

THE MAGAZINE FOR CONSUMER ELECTRONICS SERVICING PROFESSIONALS

ELECTRONICTM

Servicing & Technology

SEPTEMBER 1991/\$3.00

Cleaning without CFCs

Taming the ESD lightning

Understanding and servicing computer monitors

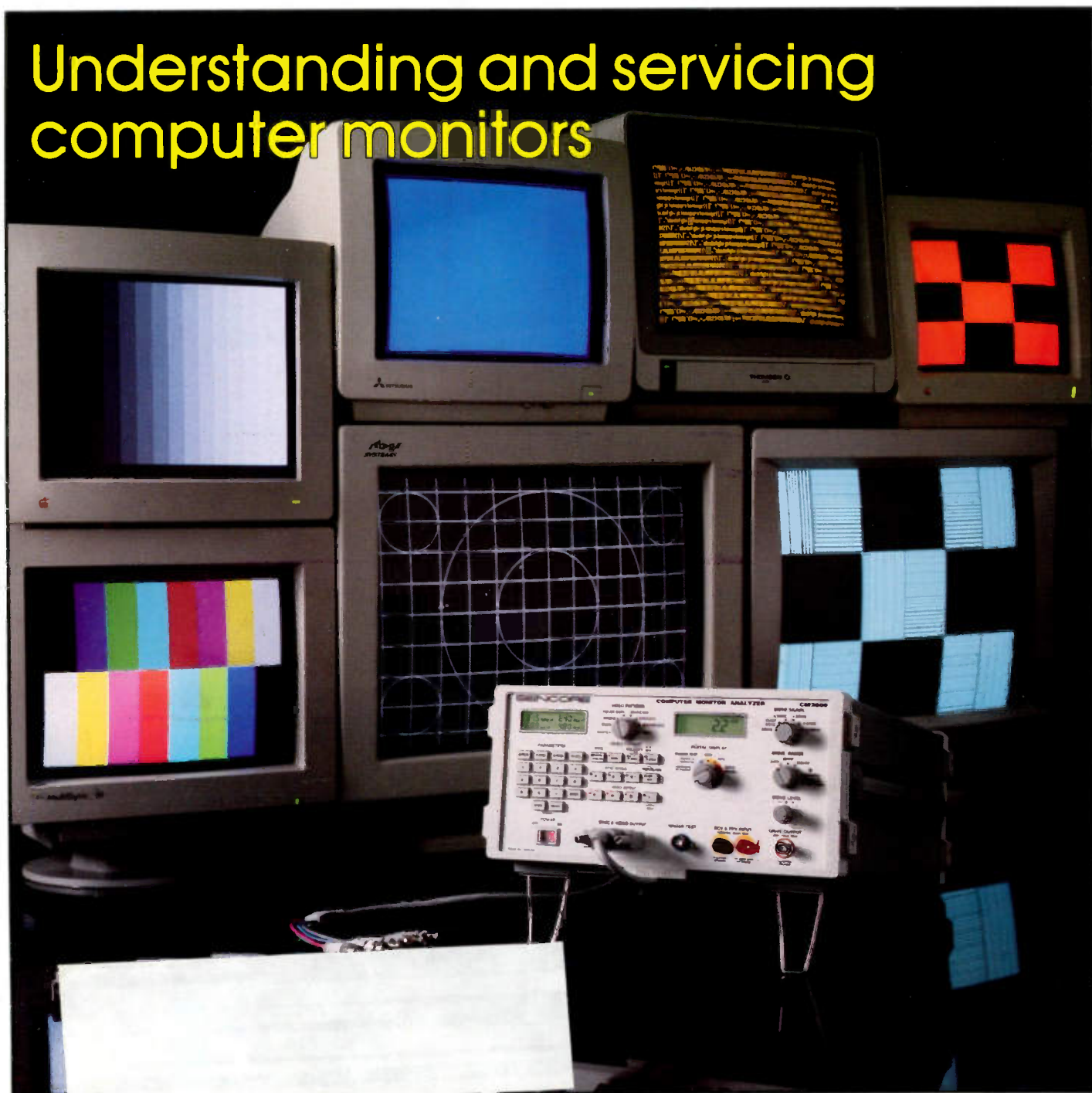

Introducing The Only Complete Solution For All Your Monitor Servicing Needs!



New!

**CM2000 Computer
Monitor Analyzer**
Patented - A Sencore Exclusive!

*The Only Analyzer
That Helps You To
Pinpoint Defects In
All Computer
Monitors!*

We've Successfully Integrated All The Features Necessary For Complete Computer Monitor Servicing Into One Easy-To-Use Instrument

Now You Can Completely Test And Troubleshoot All High Resolution And Multi-Scan Computer Monitors From The Input Connector To The CRT... Guaranteed!

Here's What The CM2000 Offers You:

- Complete High Resolution Computer Monitor Analyzing
- Fully Programmable Scan Rate And Pixel Resolution
- Innovative Performance Testing Patterns
- Special Sync-Locked Substitution Signals
- Patented "Ringer" Test To Dynamically Analyze All:
 - Yokes
 - IHVT/Flybacks
 - Switching Transformers
- Integrated 2,000 DCV And PP Meter
- Exclusive "Hook-up" Adaptors Available
- Portable Troubleshooting For All Your Field Service Needs

Call 1-800-SENCORE ext. 735,
(736-2673)
and see what we've accomplished!

SENCORE

3200 Sencore Drive, Sioux Falls, South Dakota 57107

Circle (16) on Reply Card

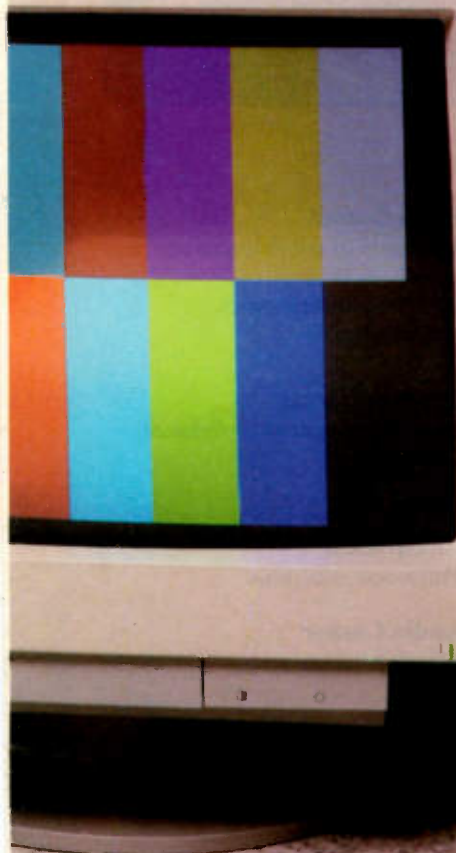

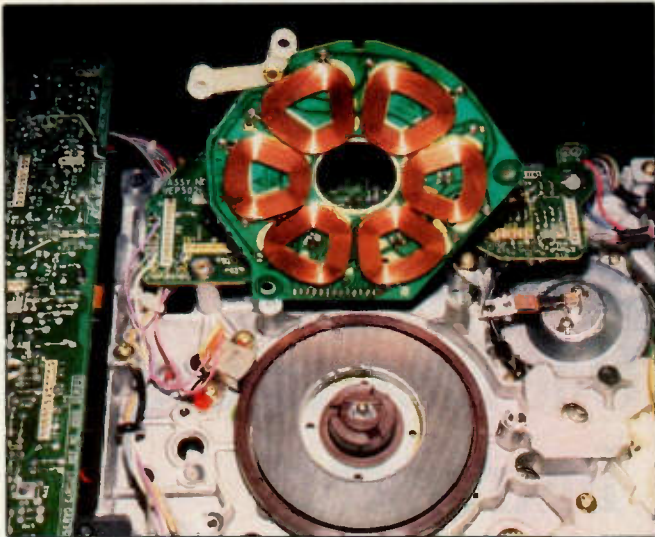

page 16



page 14

FEATURES

- | | | |
|---|---|--|
| <p>8 Understanding and servicing computer monitors
<i>By Stan Warner</i>
When you encounter a personal computer monitor that needs servicing, it might be monochrome, RGB, CGA, VGA, or multisync. This article, the first of two, explains some of the similarities and some of the differences in the circuitry of these monitors.</p> <p>11 Cleaning without CFCs
<i>By Bruce Riffel</i>
Chlorinated fluorocarbons (CFCs) are not only superior cleaning agents for electronics assemblies, they damage the ozone layer. Chemical companies are developing products that will be equally effective cleaning agents, but will not damage the ozone layer.</p> <p>14 Controlling electrostatic discharge
<i>By the ES&T staff</i>
Electrostatic discharge is destructive as well as interesting. In the electronics business, even the slightest crackle of static electricity can mean the death knell for an electrostatic sensitive device.</p> | <p>16 Hall effect sensors in VCRs and other applications
<i>By Victor Meeldijk</i>
Still relatively unknown, the Hall effect is being used for sensing in a myriad of products, including VCRs. This article provides information on these devices.</p> <p>37 Electronic servicing precautions
<i>By Homer L. Davidson</i>
Servicing some of today's products may be hazardous to your health. These suggestions will help you stay alive and in one piece while you service these products.</p> <p>46 When there is a need to hold a meter reading
<i>By Bob Gesinger</i>
When taking voltage measurements using a handheld multimeter, being able to "hold" the reading on the display after the probe is removed can often prove valuable.</p> | <p>41 Video Corner
A glossary of television terms</p> <p>42 Test Your Electronics Knowledge</p> <p>48 Business Corner
Manage your personal finances carefully</p> <p>50 What Do You Know About Electronics?
Full moon syndrome</p> <p>52 Audio Corner
What's Midi?</p> <p>54 Products</p> <p>56 Computer Corner
RS-232 communications chip tester</p> <p>58 Readers' Exchange</p> <p>60 Advertiser's Index</p> |
|---|---|--|

DEPARTMENTS

- 5** Editorial
Electronics servicing precautions
- 6** News
- 7** Literature
- 27** Profax

ON THE COVER

The number of personal computers in use has rapidly and steadily increased over the past few years. Add to that the fact that the computer user has a choice of monitors: monochrome, RGB, CGA, VGA, multisync; and you have a recipe for confusion in the servicing of these products. A logical, orderly tour through the various kinds of monitors will help sort out the confusion. (Photo courtesy Sencore).

DO IT ALL!

NTSC COMPOSITE, SUBCARRIER,
ALL CHANNELS/VHF/UHF/CATV,
INT/EXT VIDEO & AUDIO MOD
CIRCLE, DEMOD ALIGNMENT
BURST FLAG, BLACK BURST
RGB, Y/B-Y/R-Y, Y/C, REM
REMOTE CONTROL, ON-
ON SCREEN PROGRAM
15 MHz MULTIBURST,
15 MHz VIDEO SWEEP
DOT/CROSSHATCH
MOD STAIRCASE
CHECKER, SYNC
CHROMINANC
LUMINANCE,
SMPTE BARS
GENLOCK,
100 PRESE
WINDOW
RASTER
Y/C, E
BLA
SU
S



The world of technology has become much less simple than in times past. Equipment once run from a single composite feed may now be driven by S-VHS, Hi-8, or component signals, not to mention VHF, UHF, and CATV. To meet all these expanding signal source needs — and more — Leader introduces the Model 408 general-purpose video test generator.

The GENLOCKable 408 also produces multiburst and video sweep to 15 MHz, as well as many more precision test signals. And on-screen programming provides for easy signal creation for wide-ranging test situations. For routine testing, create up to 100 preset test setups. And there's much more to this uniquely feature-rich generator. There's even a PAL version available.

To get the whole long story of Leader's amazingly versatile Model 408, call toll free: 1 800 645-5104. In NY, call 516 231-6900. See what our new do-it-all can do for you!

1 800 645-5104
LEADER
FOR PROFESSIONALS WHO KNOW
THE DIFFERENCE

Leader Instruments Corporation, 380 Oser Avenue, Hauppauge, New York 11788
Regional Offices: Chicago, Dallas, Los Angeles, Atlanta. In Canada call Omnitronix Ltd., 416 828-6221.

FAX DIRECT
1-800-582-1255

EASYTECH

THE ELECTRONICS SOURCE

ORDER DIRECT
1-800-582-4044

METEX 4 1/2 DIGIT LCD DMM

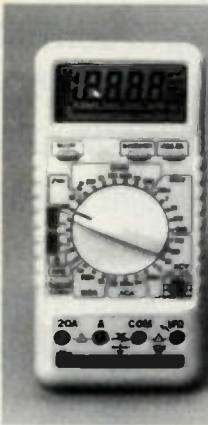

M4650CR

FUNCTION	RANGE	ACCURACY	RESOLUTION
DC VOLTAGE	200mV		10µV
	2V		100µV
	20V	±0.05% of rdg+3dpts	1mV
	200V		10mV
AC VOLTAGE	200mV		10µV
	2V		100µV
	20V	±0.5% of rdg+10dpts	1mV
	200V		10mV
DC CURRENT	200µA		100nA
	2mA	±0.3% of rdg+3dpts	10µA
	20mA	±0.5% of rdg+3dpts	1mA
	200mA	±0.8% of rdg+5dpts	10mA
AC CURRENT	200µA		100nA
	2mA	±0.8% of rdg+10dpts	10µA
	20mA	±1.0% of rdg+10dpts	1mA
	200mA	±1.2% of rdg+15dpts	10mA
RESISTANCE	200Ω	±0.2% of rdg+5dpts	0.01Ω
	2KΩ		0.1Ω
	20KΩ		1Ω
	200KΩ	±0.15% of rdg+3dpts	10Ω
CAPACITANCE	20nF	±0.5% of rdg+5dpts	100pF
	200nF	±2.0% of rdg+20dpts	0.1pF
	2µF		10pF
	20µF	±3.0% of rdg+30dpts	1nF
FREQUENCY	20KHz		1Hz
	200KHz	±2.0% of rdg+10dpts	10Hz

GENERAL CHARACTERISTICS:

Max. Display: 19999 counts with automatic polarity indication • **Max. Input Current of AC and DC:** 20A (max. of 15 minutes) • **Overrange Indication:** "OL" and "Bar graph flashing" figure on display • **Max. Common Mode Voltage:** 500V_{DC/AC} RMS • **Reading Rate Time:** Approx. 1-2 readings per sec. • **Temp. for Guaranteed Accuracy:** 23°C ±5°C • **Temperature Ranges:** Operating 0°C to 40°C, 32°F to 104°F, Storage -10°C to 50°C, 14°F to 122°F • **Power Supply:** One 9V battery (Included) • **Size:** 3.4"W x 7.4"D x 1.3"H • **Unit Weight (Excluding carrying case):** 0.8 lbs. • **Accessories:** Operating manual, 9V battery, test leads, spare fuse, and carrying case. RS-232C Cable, Floppy Disk (Optional)

Order #	Price	Description	Weight
M4650CR	109.95	4 1/2 Digit LCD Multitester	1.50 lbs.
RS232C	9.95	RS-232 Interface (Cable and Floppy Disk)	3.5 oz.

POWER STRIPS



- Economical 6 Outlet Power Strip
- Circuit Breaker Protected

Order #	Price	Description	Weight
E6102	9.95	Power Strip	1.89 lbs.

JUMPER WIRES



FEATURES

- 22 Awg wire
- Stripped 0.25"
- 14 assorted lengths

(25 pieces each length)

Order #	1-9	10+	Description	Weight
JW350	9.95	8.95	Jumper Wire Kit	8.8 oz.
JW350R	7.95	6.95	Refill Pack	2.3 oz.

MAGAZINE/CATALOG STORAGE BINDER

Ever wondered what to do with all those magazines or catalogs you have lying around? Here is the perfect solution. Holds up to 12 issues of most standard monthly magazines or up to 12 catalogs and magazines of various shapes and sizes (8.5" x 11" max.). Space provided on the rib for easy listing of material contained in each binder.

Order #	1-9	10+	Description	Weight
MB12R	4.95	4.45	Binder	1.22 lbs.

SOLDER IRON STANDS



E100L E100M

Order #	1-9	10+	Description	Weight
E100L	3.95	3.75	Economical	8.9 oz.
E100M	4.45	4.25	Multi-Purpose	1.51 lbs.

POWER SOCKET



Order #	1-9	10+	Description	Terminals
E3PS	1.09	.89	Power Socket	3

POWER CABLES



Order #	1-9	10+	Description	Cond.
AC34	1.50	1.40	4' Power Cable	3
AC36	2.15	1.95	6' Power Cable	3
AC312	3.95	3.25	12' Power Cable	3

SOLDERING STATIONS

Features - 168-3CK

• The AUTOTEMP 168-3CK soldering station offers the ultimate in controlled temperature hand soldering • The soldering tip is grounded through the power unit to ensure less than 0.4mV or 0.03mA leakage • The cartridge element wire is precision wound at the end of the stainless steel shaft to ensure max. temperature as close to the working surface of the tip as possible. This results in both rapid heating and instant recovery • AutoTemp is constructed with a lock-out feature to allow supervisors the ability to set and lock the stations at a specific temperature • Ideal for hobbyists, service technicians or production lines.



Features - XY9-60DK

• SUPERTEMP XY9-60DK solder station offers a unique electronic control circuit that maintains tip temperature to within ±3°C (6°F) of ldlng. This is accomplished by embedding the thermocouple sensing unit in the top of the heating element shaft so that the tip actually sits against it • Revolutionary electronic "Zero Voltage" thyristor switching protects voltage and current sensitive components (CMOS devices) against transient voltage spikes caused in stations using mechanical switching action • Heat-up time to working temperature approx. 60 seconds • Supertemp units exceed all soldering equipment military specifications regarding electro-static sensitive devices due to zero voltage switching and fully grounded tip.



Order #	Price	Description	Weight
168-3CK	69.95	60 Watt Soldering Station	2.38 lbs.
XY9-60DK	109.95	60 Watt Soldering Station (Digital Readout)	4.68 lbs.

TOOL KITS



E8305

The best collection of fix-it and put-it-together tools. Ideal for do-it-yourself, handyman and professional craftsman. Designed for most maintenance and repair jobs around the house, workshop, etc. Compact vinyl covered carry-along suitcase with combination lock and sturdy removable pallets. Provides safe storage and keeps all tools clean and organized. Case Size: 17.5" x 12.5" x 3.5"



E8900

Both units feature: DMM's, pliers, utility knife, screw driver sets, hex key sets, wrenches, soldering iron, solder, desoldering pump, solder stand and much more!

The most popular tools come packed in this large and complete kit. Use it for building, repairing and general maintenance of most electronic equipment. The heavy duty, molded poly case is built to hold 2 pallets, and has a bottom center partition. The case comes with 2 surface type locks, a durable handle, side buckles and strap. Case Size: 18" x 14" x 7"

Order #	Price	Description	Weight
E8305	119.95	51 Piece Professional Tool Kit	12 lbs.
E8900	199.95	92 Piece Electrician's Tool Kit	17 lbs.

EASYTECH

THE ELECTRONICS SOURCE



2917 Bayview Drive
Fremont, CA 94538



Order Direct: 1-800-582-4044

Fax Direct: 1-800-582-1255

Customer Service: 1-415-770-2345

Monday-Friday, 7am - 5pm (PST)/10am-8pm (EST)

COD-No personal checks, US funds (\$5.00 Surcharge)

USPS UPS Federal Express Airborne

Add 5% of total for shipping UPS Ground (\$3.00 min.).
Actual shipping charges based on weight.

Call or write today for your free copy of our 1991 catalog.

California residents, add appropriate sales tax.

12 month warranty on all EasyTech products.

30 day money back guarantee.

We reserve the right to substitute manufacturers.

Prices subject to change without notice.

Circle (5) on Reply Card

Electronics servicing precautions

Every occupation has its hazards. Some occupations, of course, are more hazardous than others. Every technician knows that to put his hand carelessly inside a TV while power is applied is to invite a nasty shock, and so avoids doing that.

Of course, the hazards of consumer electronics servicing can't compare with hazards of some other occupations that are inherently dangerous. For example, mining is one of those occupations that is dangerous to practitioners simply because digging deep holes in the ground, detonating explosives, and shoveling and hauling huge quantities of earth and rock are simply dangerous. Miners and their families live in constant dread of the untimely explosion, the cave in that traps or kills tens of workers. And every once in a while it happens.

In the same league of hazard is the occupation of construction on tall buildings; working the "high steel." Here you have workers working at dizzying heights, handling heavy objects, working under dangling objects. Here again, the activities and equipment associated with the job make it dangerous, and every once in a while, no matter how many precautions are taken, one of these workers will be badly injured or killed.

The one advantage that miners, construction workers and people with similar occupations have is that the hazards are in most cases quite obvious. If you fall from a great height, you will come to grievous bodily harm. The dangers from a truckload or ore, or a bundle of explosives are unmistakable. The hazards of many other occupations are far more subtle.

A classic example is the health hazard associated with the occupational use of mercury in the profession of making hats, as embodied in the "Mad Hatter" made famous in "Alice in Wonderland." At that time, hatters, people who made hats, were more likely than the population at large to show signs of mental derangement, hence the expression

"mad as a hatter." It was only within recent years that medical science determined that because hatters ingested or absorbed small amounts of the mercury that they used in making hats, their brains were damaged, and they therefore acted abnormally.

Another example of a subtle health hazard occurred in the manufacture of radium dial wrist watches. For years, women who worked on the assembly line of watch companies painting the radium onto the dials were exposed to radium. They even licked the brushes to shape them. Some years later, the incidence of cancers in these women was found to be many times the incidence in the population at large.

Today even office workers are not immune to some of the occupational hazards. Hours at a time spent typing without a rest has been one of the causes of a malady known as "Carpal Tunnel Syndrome." People who contract this problem, caused by calcification or inflammation of the hole in the wristbone through which the nerves and cartilages pass from the arm to the hand, begin to develop a numbness in their hands and fingers, limiting the kinds of work they can do.

It's always a good idea for workers in any profession to be alert to the hazards that might work in the workplace. In the article "Electronic servicing precautions" in this issue, Homer Davidson points out some of the more obvious, and some of the less obvious hazards associated with consumer electronic servicing. A wise technician will heed them.

But also important is to be alert to any condition that might constitute a hazard. For example, avoid coming into contact with substances that might be dangerous, avoid breathing smoke, dust and fumes, where possible, stay as far away from magnetic fields, X-radiation and other such hazards as possible. In short, beware of any hazards, known or suspected.

Nile Conrad Person

"Professionalize your service business" theme for 35th NASD School of Service Management

The 35th annual National Association of Service Dealers (division of NARDA) School of Service Management will be held September 21-24, 1991 at the Airport Hilton, Memphis, TN it was announced by Gerry McCann, President of NASD and President of McCann's Electronics, Metairie, LA.

"Demands for quality customer care, increased competition from manufacturers and the continuing acceleration of other demands on the service business owner make it imperative for servicers to conduct their business as professionally as possible," McCann said. "We have chosen the theme "Professionalize Your Service Business" for the 1991 school to emphasize the importance of a professional attitude on the part of service business employees and toward managing the business."

Keynoting the theme is the presentation, "Professionalizing The Service Force" by Jack L. Huffman, Director of Service Management Programs at the University of Wisconsin.

Two manufacturers service managers are also featured on the program. John Newman, Vice President, Service, Toshiba of America Corp., will talk on, "The Electronic Manufacturer And The Independent Servicer." William Hill, National Service Manager, Frigidaire Company, will give a presentation on, "The Appliance Manufacturer And The Independent Servicer."

To examine the side of the question, a panel, "Competing With Factory Service" will be moderated by Regis Oneal, Best Service Company, Pittsburgh, PA.

Other program topics will be: "Service Advertising Panel" moderated by Paul Muse, Best Appliance Parts & Service, Houston, TX; "Maintaining Your Business Legally" presented by NARDA/NASD general counsel, Robert Goldberg; "Service Business Management Workshop" presented by NASD Managing Director, David Ashton; "Outfront Planning For The Independent Servicer" presented by

NARDA Executive Director, John Shields; and the fifth annual "Better Ideas Contest" moderated by Gerry McCann and his wife, Faye.

Completing a very full three and one-half days of topics will be the presentation, "Servant - Service - Servicing" by C.G. "Connie" Bell, President of National Electronics Sales and Service Dealers Association (NESDA). This will be a talk on applying the basic techniques of management to all aspects of running a service business. Dave Borsani, Service Today - A Complete Appliance Service, Cleveland, OH will give a presentation on "Installation of Appliances - New Opportunities - Less Investment."

The president of the Service Contract Industry Council, division of NARDA, and the service contract company, Elite Group, Suzanne Schneider, will moderate a panel which will include key executives from the service contract industry, talking about how to use service contracts profitably.

The program will also include a presentation by Ann R. Mullis, Managing Director of Personnel Services for Federal Express Corporation, on "Federal Express" Formula for Employee Retention and Success" and a talk on "Managers Managing People" by trainer Bill Henry.

In addition to these workshops, presentations and panels which are part of the regular program beginning at 9:00 am Saturday, September 21 and going through noon Tuesday, September 24, two extra activities are available to SSM participants. Sharp Electronics Corporation has provided a tour of their Memphis plant manufacturing TVs, microwaves and other products on Tuesday afternoon. There's also a special extra seminar on the subject "Is A Computer System For You" to be presented Friday afternoon, September 20, the day before the SSM begins. Attendance at this afternoon seminar requires an additional \$35.00 registration fee. It will be presented by three computer companies, Advanced Retail Systems, PVS Computer Solutions and R&D Business Systems.

Registration for the full program is \$295.00 per person. A complete brochure with complete descriptions of all programs is available from NASD, 10 E. 22nd Street, Suite 310 Lombard, IL 60148, (708) 953-8950.

IBM researchers make first high-temperature superconducting magnetic gradiometer

The first-high temperature superconducting magnetic gradiometer to be operated at liquid-nitrogen temperature has been reported by researchers at the IBM T.J. Watson Research Center. The announcement follows one made by the same researchers early in 1991 concerning a related magnetic measuring device, a magnetometer, the first complete device of its kind to operate at liquid-nitrogen temperature, 320°F below zero.

These research achievements show that IBM continues to make significant strides in demonstrating the feasibility and practicality of high-temperature superconducting electronics technology.

A gradiometer is a magnetic device, which, like a magnetometer, uses the most magnetically sensitive detector known, a superconducting quantum interference device, or SQUID. So a gradiometer, like a magnetometer, can measure extremely weak magnetic fields.

However, a gradiometer has the advantage of not needing to be magnetically shielded from external fields like those from the earth and from nearby electrical equipment and electronic instrumentation. Without such shielding, which can be cumbersome, magnetometer measurements would be subject to interference.

The ability to operate these devices at liquid-nitrogen temperature and above is a significant advantage over operating their counterparts at liquid-helium temperature because liquid nitrogen is much less expensive and the devices need much less thermal insulation. In the case of the heart and brain measurements, the devices can consequently be placed much closer to the patient, thereby providing increased accuracy. ■

THE MAGAZINE FOR CONSUMER ELECTRONICS SERVICING PROFESSIONALS

ELECTRONIC

Servicing & Technology

Electronic Servicing & Technology is edited for servicing professionals who service consumer electronics equipment. This includes service technicians, field service personnel and avid servicing enthusiasts who repair and maintain audio, video, computer and other consumer electronics equipment.

EDITORIAL

Nils Conrad Persson, *Editor*
Jeffrey Uschok, *Assistant Editor*

CONSULTING EDITORS

Homer L. Davidson, *TV Servicing Consultant*
William J. Lynott, *Business Consultant*
Victor Meeldijk, *Components Consultant*
John E. Shepler, *Audio Consultant*
Sam Wilson, *Electronics Theory Consultant*

PRODUCTION

Elizabeth Ryan, *Art Director*
Barbara Terzo, *Assistant Art Director*
Susan Reale, *Artist*
Dorothy Kehrwieler, *Production Manager*
Emily Kreutz, *Production*
Pat Le Blanc, *Phototypographer*
Florence V. Martin, *Phototypographer*

BUSINESS

Richard A. Ross, *Publisher*
Dorothy Kehrwieler, *General Manager*
Frank V. Fuzia, *Controller*
Catherine Ross, *Circulation Director*
Melissa Kehrwieler, *Data Processor*
Denise Pyne, *Customer Service*

SALES OFFICE

Electronic Servicing & Technology
76 N. Broadway, Hicksville, NY 11801
516-681-2922; Fax, 516-681-2926

Jonathan Kummer, *Advertising Manager*
Emily Kreutz, *Sales Assistant*



Member, Electronic
Servicing Dealers
Association

EDITORIAL CORRESPONDENCE

P.O. Box 12487
Overland Park, KS 66212
913-492-4857

Electronic Servicing & Technology (ISSN 0278-9922) is published monthly by CQ Communications, Inc., 76 N. Broadway, Hicksville, NY 11801. Telephone (516) 681-2922. Second class postage paid at Hicksville, NY and additional offices. Subscription prices (payable in US dollars only): Domestic—one year \$24, two years \$36. Foreign countries—one year \$30, two years \$42. Entire contents copyright 1991 by CQ Communications, Inc. Electronic Servicing & Technology or CQ Communications, Inc. assumes no responsibility for unsolicited manuscripts. Allow six weeks for delivery of first issue and for change of address. Printed in the United States of America.

Postmaster: Please send change of address notice to Electronic Servicing & Technology, 76 N. Broadway, Hicksville, NY 11801.

CQ Communications, Inc. is publisher of CQ The Radio Amateur's Journal, Popular Communications, ComputerCraft, CQ Radio Amateur (Spanish CQ), CQ Amateur Radio Equipment Buyer's Guide, CQ Amateur Radio Antenna Buyer's Guide, and Electronic Servicing & Technology.

Literature

Free static elimination catalog and handbook

New from Chapman is a 32 page catalog and handbook which explains how to identify the source of static problems and specify a cost-effective solution from Chapman's line of static eliminators. Industrial systems include meters, powerful "hot" and shockless bars, and volume static eliminators. Workbench and ESD applications are covered with static-eliminating airguns and benchtop ionizers.

Circle (55) on Reply Card

Computerized cross reference

NTE Electronics, Inc. has announced the availability of "QUICK-CROSS," the industry's first IBM PC-based, high-speed, cross reference database, for its line of semiconductors and newly introduced relay line. The software, a computer-assisted cross reference guide that helps users select the proper NTE replacement device for over a quarter million industry device numbers, will enable the user to locate any of over 4,750 cross-referenced device numbers.

Circle (56) on Reply Card

Autoranging DMMs fact sheet

Series 3000 autoranging DMMs are described in a two-page full-color fact sheet from American Reliance Inc. Top-of-the-line is a programmable autoranging drop-proof DMM with bar graph display - the Model 3200. According to the manufacturer, it is the world's first 4,000 count programmable auto-ranging DMM with bar graph display.

Four DMMs are included in the 3000 Series with accuracy from 0.5% + 2 to 0.25% + 2; and accuracy of 1% + 3 to 0.5% + 3.

Circle (57) on Reply Card

Soldering/desoldering station brochure

Pace Inc. has produced a full color brochure highlighting the features of its new MBT 201, a low cost soldering/desoldering station which can be easily upgraded to a complete SMT/Thru-Hole installation and removal system.

The standard system features the company's patented high-perfor-

mance SNAP-VAC desoldering which provides safe, effective thru-hole component removal - even on heavy multilayer boards, and their new IR-70 High Capacity SMT/Thru-Hole iron for enhanced thermal performance in a variety of applications.

Circle (58) on Reply Card

Catalog update - new and used test equipment

RAG Electronics announces the availability of a free catalog of new and used electronic test equipment.

The update features used equipment with big savings on oscilloscopes, spectrum analyzers, DMM's, power supplies, signal sources, environmental chambers, and more, from such manufacturers as Hewlett-Packard, Tektronix, and Fluke. Factory new test equipment is also included, featuring a full line of Tektronix Oscilloscopes, Fluke DMM's plus others.

Circle (59) on Reply Card

New TV accessories product line

Philips ECG has introduced a new line of TV accessories with performance improvement, system expansion and installation convenience in mind. The new line of ECG TV accessories consist of 30 devices including UHF/VHF/FM antenna amplifiers, TV/VCR indoor amplifiers, splitters, signal separators/combiners, A/B switches, matching transformers, attenuators, and coaxial cable installation accessories.

Circle (60) on Reply Card

Complete UPS Line

Tripp Lite announces its newly expanded line of UPS systems, featuring on-line and stand-by battery backups from 180 to 4000W. These units are capable of powering PCs, LAN workstations, file servers, minis, telecom equipment and more. The complete family is profiled in Tripp Lite's new eight-page UPS Systems brochure. The brochure showcases Tripp Lite's worldwide power protection solutions with application and installation notes plus complete technical specifications.

Circle (61) on Reply Card

Servicing computer monitors

Part I: Theory of operation of the various types of monitors

By Stan Warner

There's a revolution occurring in the computer monitor display world. Monitors once confined to displaying input and output in mundane word processing, spreadsheet and number crunching chores are giving way to exciting new applications.

Brilliant colors and crystal clear graphics are enabling us to do tasks never before thought possible. In industry, products are designed and prototyped in intricate detail on a computer monitor display long before being manufactured. Surgeons create computer-animated 3-D images of their patients, before they pick up a scalpel. Desktop publishing systems, which combine text and graphics, are bringing printshop quality to financial reports, company newsletters and sales presentations.

One of the consequences of this revolution is that a computer servicing technician will encounter many different types of monitors over a period of time, and may have to perform service on any one of them. This two part article will bring some assistance to the beleaguered technician. This segment will describe the theory of operation of the popular types of monitors. Part II, which will appear in a future issue, will describe some of the actual failure modes and suggest servicing procedures to correct the problems.

The definition of "resolution"

The resolution or picture clarity of computer monitors has been improving steadily since the early 1980's.

Warner is the application engineer in charge of new product marketing for Sencore.

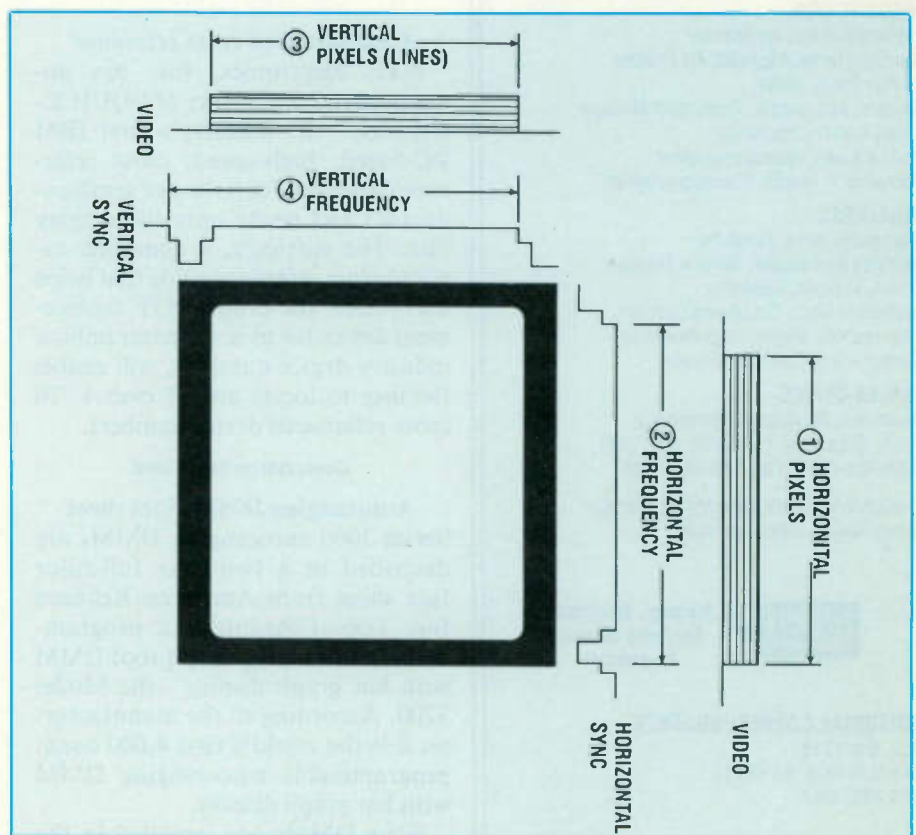

Figure 1. A computer monitor's performance capabilities can be defined by four parameters: horizontal pixels, horizontal frequency, vertical pixels and vertical frequency.

Where the early monitors could only display eight colors and fuzzy text and graphics, the mainstream computer monitors today are capable of producing a very sharp, crystal clear picture in a multitude of colors.

Four input signal parameters determine a computer monitor's performance capabilities: horizontal frequency, horizontal pixels, vertical pixels, and vertical frequency (Figure

1). Following is a definition of each of these terms:

- horizontal frequency - the number of times per second the electron beam travels horizontally across the screen and back (horizontal scan).
- horizontal pixels - (note: a pixel is the smallest picture element or "dot" that can be lit on the display) is the number of dots that can be displayed horizontally across the screen.

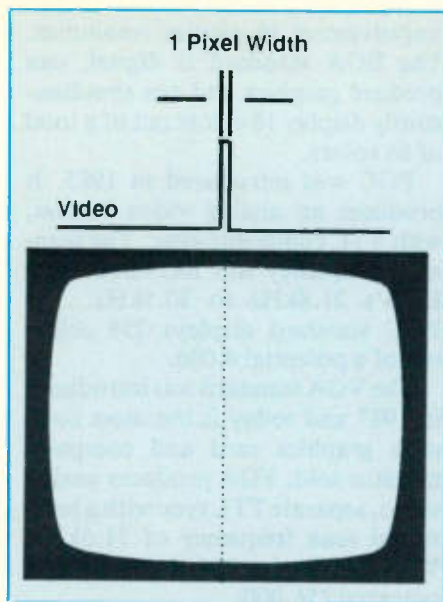

Figure 2. A one pixel line is best suited for testing a monitor's maximum bandwidth.

- vertical pixels - the number of dots that can be displayed vertically on the CRT. The number of vertical pixels is similar to the number of lines in television terminology.
- vertical frequency - the number of times per second the electron beam travels from the top of the screen to the bottom and back (vertical scan).

Picture resolution is the number of transitions that a monitor is capable of making between a pixel being "on" (light) and a pixel being "off" (dark) on the display. The bandwidth of a monitor is the fastest transition between a pixel being "on" and "off" that the monitor circuits are capable of passing and displaying. The higher the bandwidth, the more resolution and clarity appears in the picture. The vast improvements in computer monitor picture resolution have been made by increasing the horizontal scanning frequency and

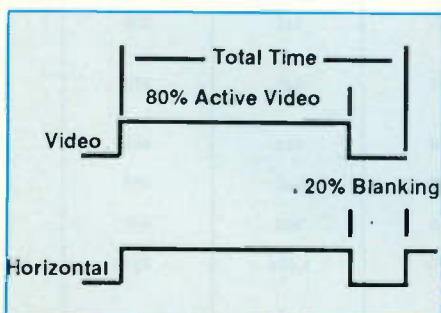

Figure 3. One scan line is made up of active video and blanking.

increasing the number of pixels displayed in one scan time. In other words, more pixels are displayed in less time.

Bandwidth and resolution

A computer monitor's bandwidth is best checked with a pattern that produces lines that are a single pixel wide (Figure 2). If the monitor is able to display a crisp, distinct line, it has the bandwidth needed to "turn on" a single pixel at a time.

The area that is of concern in a bandwidth test, is the area across the display that is seen by the user. This area is called active video. Active video uses about eighty percent of the total horizontal scan time (Figure 3). The rest of the time is spent in blanking; the electron beam is shut off and is moving back across the display.

The concept of picture resolution and bandwidth can be best understood through an example. Figure 4 compares the bandwidth of the mainstream monitor in the early eighties to today's most popular computer monitor format.

This example shows that the increased scanning frequency and the increased number of displayed pixels increases the computer monitor's required bandwidth from 12.6 MHz to 28.3 MHz. If you've used both low resolution and high resolution computer monitor types, you'll agree that the improvement in picture clarity is phenomenal. As a point of reference, the very best bandwidth that can be achieved from a television is 4.2MHz.

Analog monitors vs digital monitors

There are two main computer monitor types: analog and digital. A digi-

tal monitor receives TTL level signals and creates its colors through combinations of "ones" and "zeros" (Figure 5). Monochrome digital computer monitors display one or two shades of green, amber or black and white. Color digital computer monitors have up to four input lines: red, green, blue and intensity. They can display eight, 16 or 64 colors.

Analog computer monitors receive a signal that is typically 0.7Vpp in amplitude. They can display an infinite number of colors and shades of gray because the input is not restricted to just a "one" or "zero" but any voltage level between zero and 0.7V (Figure 6). Analog color computer monitors have three inputs: red, green and blue. Analog monochrome computer monitors have a single input. These monitors can create infinite shades of gray.

Monitor synchronization schemes

Computer monitors have one of three sync input schemes: separate horizontal and vertical sync, separate composite sync or composite sync on video (almost always green video). The "separate sync" and "separate composite sync" computer monitors receive sync at TTL levels. The "composite sync on video" computer monitors are always analog so the sync is a part of the 0.7Vpp video signal. These monitors have a sync and video separator as well as a vertical and horizontal sync separator.

Most computer monitors require a progressive scan sync signal. A few of the newer computer monitors on the market receive an interlaced signal.

Low Resolution Computer Monitor

Horizontal Scan = 15.7kHz
 Horizontal Pixels = 640
 Total Scan Time = $1/15.7\text{kHz} = 63.7\mu\text{Sec}$
 Active Video Time = $(80) \times (63.7\mu\text{Sec}) = 51.0\mu\text{Sec}$
 Note: 640 pixels will be displayed in 51.0 μSec .
 Display time per pixel = $51.0\mu\text{Sec}/640\text{ pixels} = 79.6\mu\text{Sec}$
 Bandwidth (frequency response) required to turn on a single pixel = $1/79.6\mu\text{Sec} = 12.6\text{MHz}$.

High Resolution Computer Monitor

Horizontal Scan = 31.5kHz
 Horizontal Pixels = 720
 Total Scan Time = $1/31.5\text{kHz} = 31.7\mu\text{Sec}$
 Active Video Time = $(80) \times (31.7\mu\text{Sec}) = 25.4\mu\text{Sec}$
 Note: 720 pixels will be displayed in 25.4 μSec .
 Display time per pixel = $25.4\mu\text{Sec}/720\text{ pixels} = 35.3\mu\text{Sec}$
 Bandwidth (frequency response) required to turn on a single pixel = $1/35.3\mu\text{Sec} = 28.4\text{MHz}$.

Figure 4. This comparison illustrates the relationship of bandwidth and number of pixels in determining the resolution of a monitor.

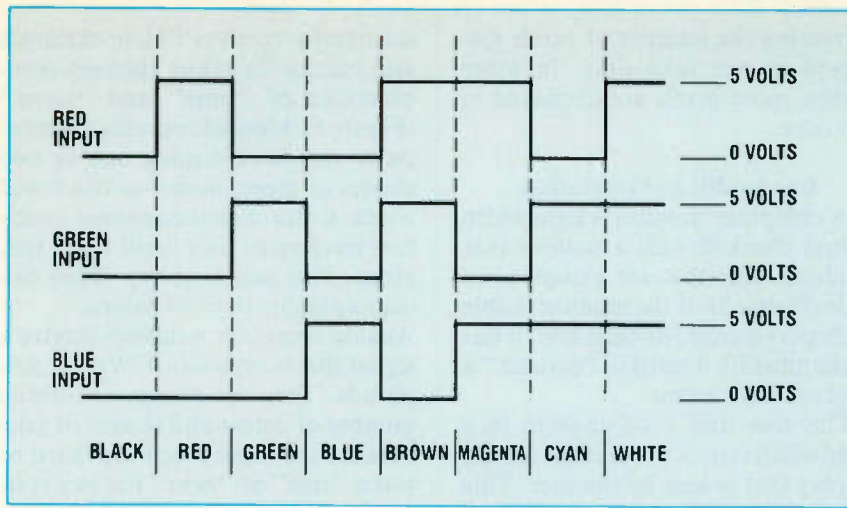

Figure 5. The signal input to digital monitors is either a logic low or logic high.

Computer graphics

Computer monitors receive their signals from a video graphics adapter card or circuitry located inside the computer. The adapter card generates the video and sync signals needed by the monitor. There are several different video graphics standards, such as color graphics adapter (CGA), enhanced graphics adapter (EGA), and video graphics adapter (VGA).

Each standard produces different sync frequencies and pixel counts, and each video adapter card requires a compatible type monitor. Multi-scan monitors work with any type of video graphics adapter card because

they can sync to a wide range of frequencies.

Figure 7 shows a list of the common graphics standards. CGA and MDA were introduced in 1981. Both are digital formats. The CGA standard produces 16 colors and has graphics capabilities. The MDA standard produces only two shades of a single color and has no graphics capabilities. The Hercules standard, introduced in 1982, was the market's answer to IBM's MDA standard. Hercules produces a monochrome signal with graphics capabilities.

EGA was introduced in 1984. Because of the increased scanning frequency (CGA's 15.7kHz to EGA's 21.8kHz) it offered a considerable

improvement in picture resolution. The EGA standard is digital, can produce graphics and can simultaneously display 16 colors out of a total of 64 colors.

PGC was introduced in 1985. It produces an analog video format, with TTL composite sync. The scanning frequency was increased from EGA's 21.8kHz to 30.5kHz. The PGC standard displays 256 colors out of a potential 4,096.

The VGA standard was introduced in 1987 and today is the most common graphics card and computer monitor sold. VGA produces analog video, separate TTL sync with a horizontal scan frequency of 31.5kHz. VGA can display 256 colors out of a potential 256,000.

The Macintosh II standard produces an analog video signal with separate composite TTL sync. Other MAC standards place the composite sync signal on the green video line. The standard Macintosh video is capable of displaying 256 colors out of a potential of over 16 million.

Super VGA, 8514/A and XGA are relatively new, high-resolution graphics standards. They have scan frequencies and pixel resolutions even higher than the VGA standard. These types of graphics cards and computer monitors are not yet sold in the same mass volume as the VGA monitors. But if the trends of the past decade hold true, they will be in the mainstream in the next couple of years. ■

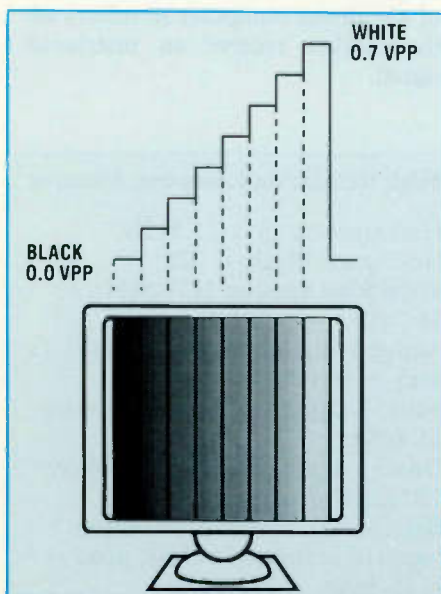

Figure 6. Analog monitors can display an infinite number of colors or gray shades.

Graphics Standards	Horizontal Frequency (kHz)	Vertical Frequency (Hz)	Horizontal Resolution (Pixels)	Vertical Resolution (Lines)
CGA (Color Graphics Adapter)	15.7	60	640	200
MDA (Monochrome Display Adapter)	18.4	50	720	350
HGC (Hercules Graphics Card)	18.4	50	720	350
EGA (Enhanced Graphics Adapter)	21.8	60	640	350
PGC (Professional Graphics Controller)	30.1	60	640	480
VGA (Video Graphics Array)	31.5	60	640	480
Apple MAC II	35.5	67	640	480
Super VGA	35.2	56	800	600
8514 A	35.2	87	1,024	768
XGA (Extended Graphics Array)	48.4	60.5	1,024	768

Figure 7. Video Graphics Standards.

Cleaning without CFCs

The sky isn't falling, it's shrinking

By Bruce Riffel

While preparing for this article, I asked a friend why service technicians, who use relatively small amounts of chlorofluorocarbons to begin with, should be concerned about the effects of CFCs on the ozone.

"That depends," he responded, "on whether they plan to have grandchildren or not."

If you are, take heed. Recent measurements from a NASA satellite indicate that the ozone layer over the United States has shrunk by as much as five percent over the past 10 years. The Environmental Protection Agency says that estimate is 50 percent larger than any previous figure and it suggests the shrinkage could be as high as eight percent.

Simply put, the protective layer between the sun's harmful ultraviolet rays and the earth is disappearing. The culprit? Chlorine. One of several sources of upper atmospheric chlorine is chlorofluorocarbons, used in the manufacture and servicing of a variety of electronics components.

In an effort to reduce the world's output of chlorofluorocarbons, some 67 nations have signed the 1990 Montreal protocol, which seeks to ban CFCs and other chlorine-containing compounds by the year 2000. The United States' Clean Air Act and various pieces of legislation in several states, such as Vermont and California, all are committing the U.S. to an even faster track of removing CFCs from the environment by taxing the compound out of economic viability.

With uses ranging from air conditioning and refrigerators to propellants from foam and thermoplastics, the electronics industry is not the peering ozone, few scientists doubt the need to allow the protective layer to replenish itself, which will take at best guess more than 50 years.

Riffel is a chemical research chemist with Tech Spray, Inc., a manufacturer of chemical products.

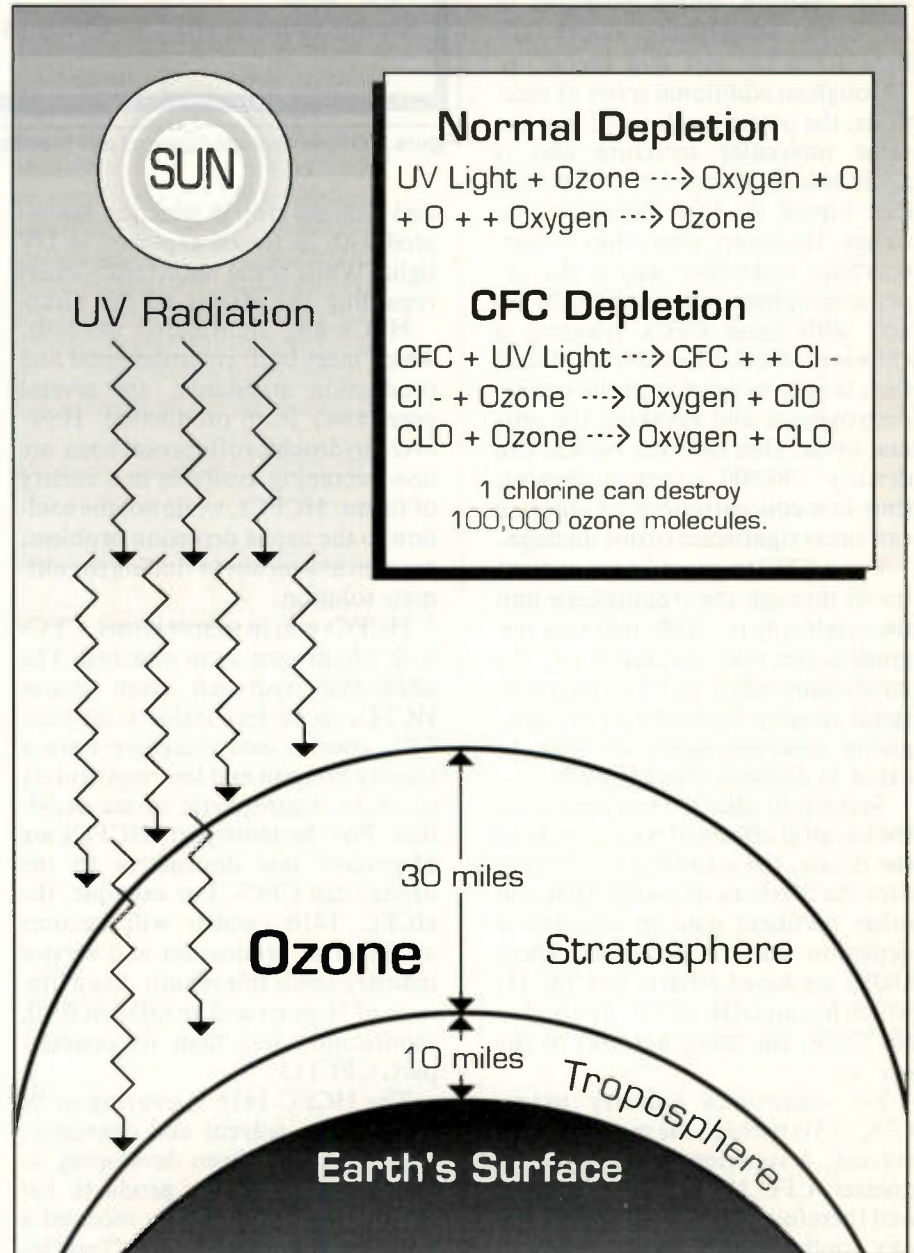

Figure 1. When CFCs reach the upper atmosphere they release chlorine radicals that cause destruction of the ozone layer.

Replenishment can only begin by eliminating the current uses of CFCs and finding alternative sources for their varied uses. Ideally, chemical

companies will someday be able to provide manufacturers and the service industry with hydrofluorocarbons or fluorinated alcohols that

meet today's standards without harming the environment either by depleting the ozone or contributing to global warming.

leading user of CFC. However, CFCs play a vital role in the manufacture and repair of electronic components. Nevertheless, when recharging an air conditioner or cleaning a printed circuit board with a CFC-based solvent, these Ozone-grabbing compounds are released into the atmosphere.

In the normal atmospheric ultraviolet reaction, ozone molecules in the upper atmosphere absorb UV light from the sun and break up. Through an additional series of reactions, the ozone is reformed into the same molecular structure and is again able to absorb ultraviolet light (See Figure 1). Thus the cycle continues. However, when chlorofluorocarbons make their way to the upper atmosphere, ultraviolet light reacts with these CFCs releasing a chlorine radical. The chlorine radical then is able to react with the ozone, destroying it and breaking the normal cycle. One chlorine radical can destroy 100,000 ozone molecules, thus low concentrations of chlorine can cause significant ozone damage.

For a CFC to cause harm, it must travel through the troposphere into the stratosphere. Although this migration can take several years, the most commonly used CFCs have lifespans ranging from 65 to 120 years, giving chlorine plenty of time to cause its damage. (See Figure 2).

Seeking to identify and categorize the harmful effects of compounds on the ozone, the scientific community uses the lifetimes of compounds and other pertinent data to calculate a depletion unit or potential. These ODFs are based relative to CFC 11, which has an ODF of 1.0. The higher the ODF, the more harmful to the ozone.

For electronics industry usage, CFC 113 is perhaps the most versatile solvent. A superior defluxer and degreaser, CFC 113 is safe on plastics and therefore can be used in virtually any application. However, it has an ozone depletion factor of 0.8. While this is 20 percent less than CFC 11, CFC 113's lifespan is still 90 to 110 years and thus can cause significant ozone damage.

Without the protective ozone the sun's UV light is allowed to reach the earth's surface. Some studies have shown dramatic increases in cancer

Compound	Ozone Depletion Factor	Lifespan
CFC-11	1.0	65 Years
CFC-12	1.0	120
CFC-113	0.8	90
CFC-114	1.0	
HCFC-22	10.05	20
HCFC-123	0.02	2
HCFC-124	0.02	
HCFC-141b	0.15	10
HCFC-142b	0.06	22
HFC-134a	0.0	
Methyl Chloroform	0.10 (1,1,1-Trichloroethane)	

Figure 2. Ozone depletion factors and lifespan of various chemical compounds.

and reduced crop production associated with increased exposure to UV light. While some uncertainty exists regarding the effects of the disap-

HFCs and fluorinated alcohols, which meet both environmental and production standards, are several years away from production. However, hydrochlorofluorocarbons are now becoming available in a variety of forms. HCFCs, while not the solution to the ozone depletion problem, are seen as a means to finding the ultimate solution.

HCFCs are, in simple terms, CFCs with a hydrogen atom attached. The additional hydrogen atom causes HCFCs to be less stable than their CFC cousins and therefore have a shorter lifespan and less opportunity to cause stratospheric ozone depletion. For the most part, HCFCs are 85-percent less destructive to the ozone than CFCs. For example, the HCFC 141b, which will become available at production and service industry levels this month, has a lifespan of 10 years and an ODF of 0.10, significantly less than its counterpart, CFC113.

The HCFC 141b is proving to be an excellent solvent and degreaser. Tech Spray has been developing its Envi-Ro-Tech Series products for several years and in July received a bulk-size shipment of 141b. Tests indicate that although 141b has a lower threshold limit value, it is not a direct replacement for CFC 113. It is slightly more aggressive toward some plastics and is more expensive to produce.

Using HCFCs will require some adaptation in service technician practices, not unlike any other new product. For example, while the manufac-

turer should provide technicians with a plastics compatibility guide, when servicing a machine or component the new solvent should be used sparingly to determine compatibility. Also, technicians will want to examine the board for soft plastics or test in an inconspicuous area before use.

Admittedly, the use of 141b-based products may seem tedious at first. But it is proving to be the most versatile substitute to CFC 113 and most closely matches the needs of service technicians. Obviously 141b-based products are more versatile for the technician's work environment than many other alternatives, such as highly flammable alcohol. Most importantly, however, is its ozone sparing characteristics.

The tenets of the Montreal Protocol allow HCFCs to be used until 2010 by which time manufacturers should have available clear and distinctive alternatives to chlorofluorocarbons that are harmless to the environment.

Meanwhile, ozone depletion is continuing. The current Montreal Protocol and the Clean Air Act were agreed upon in 1990, long before the EPA announced its most recent findings in April. Given these most recent numbers, expect a push to further limit CFC use.

Announcing the NASA study's results and implications, Eileen Clausen, EPA Director of the Office of Atmospheric and Indoor Air Programs, said, "We're going to take another squeeze at what's left."

It is likely that squeeze will affect manufacturers and service technicians alike, whether grandchildren are planned or not.

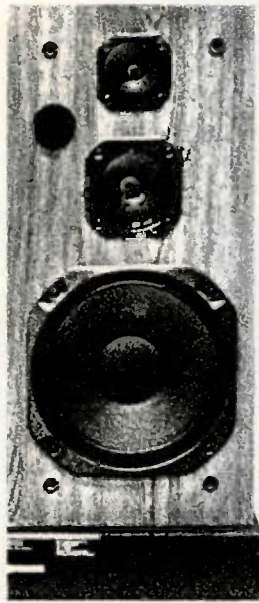

SEE IT GET IT SELL IT PROFIT

WINTER CES[®]



1992 INTERNATIONAL WINTER CONSUMER ELECTRONICS SHOW[®]
JANUARY 9-12, 1992 LAS VEGAS, NEVADA USA

Pick up sound ideas from the industry's leaders. Tune into more than 19 high-powered workshops on topics like "Multimedia: What Does The Market Say?" And experience nearly 1,300 displays of audio, video and home office products—including the latest in digital audio recorders and home theater. Attend Winter CES and set the stage for bigger profits!



**SAVE
\$30!**

RECEIVE YOUR FREE WINTER CES BADGE BY MAIL.

Just complete and mail this **before December 6** to:

Consumer Electronics Shows • c/o CompuSystems, Inc.
P.O. Box 6579 • Broadview, IL 60153-6579

126

To qualify, please complete this form and attach your business card.

*FULL NAME

*COMPANY

ADDRESS

CITY STATE ZIP CODE

COUNTRY PHONE TELEX

Last four digits of your Social Security Number (for internal use only)

**FOR EXHIBIT SALES
INFORMATION, PLEASE
CALL 202-457-8700.**

Please check only **one** badge category:

- | | | | |
|--|--|---|--------------------------------------|
| <input type="checkbox"/> 1 Retailer | <input type="checkbox"/> 5 Manufacturer's Rep. | <input type="checkbox"/> 11 Consultant: | <input type="checkbox"/> 12 Analyst: |
| <input type="checkbox"/> 2 Distributor | <input type="checkbox"/> 6 Manufacturer | <input type="checkbox"/> A Advertising | <input type="checkbox"/> A Financial |
| <input type="checkbox"/> 3 Dept./Chain Store Buyer | <input type="checkbox"/> 7 Institutional Buyer | <input type="checkbox"/> B Marketing | <input type="checkbox"/> B Market |
| <input type="checkbox"/> 4 Premium Catalog Buyer | | <input type="checkbox"/> C Public Relations | |
| | | <input type="checkbox"/> D Management | |

IF YOUR FREE BADGE DOES NOT ARRIVE IN THE MAIL, it will be waiting for you when you arrive at the show at the "Advance Registration Pick-Up Desk."

SDRRY, if you mail this after December 6, we can't honor your request for a free badge. You can register on-site for a \$30 fee. Winter CES is open to all trade members 18 or older.



The Consumer Electronics Shows are sponsored and produced by the Electronic Industries Association's Consumer Electronics Group.

Taming the lightning

Controlling electrostatic discharge

By the ES&T Staff

Information source: The 1990/91 catalog from Desco

Static electricity is a fascinating phenomenon. It's the stuff that is formed during a summer thunderstorm and provides the electrical fireworks display of lightning and crashing thunder. In the dry winter months it makes your clothing cling, and gives you a jolt when you touch something grounded after you walk across a rug.

Unfortunately, the discharge of static electricity is destructive as well as interesting. In a thunderstorm the lightning can damage structures, knock down trees, cause fires, even kill people.

In the electronics business, even the slight crackle of static electricity can mean the death knell for an electrostatic sensitive device. In fact, given the extreme sensitivity of some of today's semiconductor devices, an electrostatic discharge (ESD) that a human wouldn't even be aware of could be enough to seriously damage or destroy an IC.

The cause

Static electricity is developed whenever two materials are brought together and then separated. The atoms of one of the materials pick up an excess of electrons, and the atoms of the other material end up with a deficit of electrons. Both materials are electrostatically charged and will ultimately become discharged upon contact with some other material or a ground potential.

Any of a number of materials may

become charged as described above. A synthetic shirt or trousers, a polystyrene foam coffee cup, the plastic wrap from a package of peanut butter crackers. Any of these, and many more electrostatically chargeable materials might be the medium of destruction for that IC sitting innocently on the work bench.

Avoiding/preventing ESD damage

There are a number of ways to keep ESD sensitive circuit components from being damaged by ESD. One is to prevent the build-up of static electric charges in the first place by draining it away as it is generated. Another is to prevent the discharge of static electricity that has built up, when ESD-sensitive devices are present. Yet another is to package ESD-sensitive devices so that even if a discharge does take place, that it does not occur through the device. In a good ESD damage prevention program, all of these factors are used. Something else that a good ESD damage prevention program does is to educate the technicians and other people who work with the ESD sensitive products to be aware of the problem and to take appropriate precautions.

Electrical overstress should also be avoided

Another, related, cause of damage to sensitive components is electrical overstress (EOS). In fact, ESD is considered one of a number of causes of EOS. If a component encounters



Figure 1. This symbol is related to the standard RS-471 promulgated by the Electronic Industries Association. You will find it on certain items along with wording that describes the hazard. It also is sometimes used to designate areas where ESD sensitive components may be exposed.



Figure 2. This symbol may be found on military spec. items. It is specified for use by MIL-STD-129J dated September 25, 1984. The military standard specifies what items it must be used on, size, color and wording for products that are to comply with the standard. The symbol is also sometimes used to designate areas where ESD/EOS sensitive materials may be exposed.



Figure 3. This ESD symbol means "no sparks," and is a symbol meaning that a product or package, such as a container for ICs will not generate static electricity and is therefore safe for use in areas where ESD sensitive components may be exposed.

voltage or current higher than the values for which it is rated, it may be damaged. EOS may be caused by such things as electrical malfunctions

(short circuits or power-line surges or spikes, for example), electromagnetic fields, other types of radiation, or ESD.

Symbols

As you're working on some of the newer consumer electronics equipment, you should be aware of the symbols shown in Figures 1 through 3. You might find them on certain portions of the products themselves, the schematic diagrams, or the packaging material that the replacement components/modules come in.

Sources of ESD information

The susceptibility of so many of the components that go into today's sophisticated, feature packed con-

sumer electronics products to ESD damage is a very real and serious problem. It is only made more serious by the fact that it's such an easy problem to ignore, until it's too late. The most important and effective measure that can be employed to counteract this problem is information and education.

A number of manufacturers and organizations are interested in educating engineers technicians and managers about the problem and its avoidance. Figure 4 is a list of many of these education sources and the materials they have available. It would also be a good idea to contact manufacturers and suppliers of ESD protection equipment. They might have other useful information. ■

Available from Desco (761 Penarth Avenue, Walnut CA 91789)

7600 Training Pamphlet. An illustrated 15-page booklet entitled "What you should know about Electrostatic Discharge Control." It may be purchased from a distributor of the company's products.

"P-2009 A guide to your new air ionization system."

"P-2007 Safe grounding of ESD work stations."

"P-2000 Installation of static dissipative ESD work station kits."

"P-2205 Wrist straps, grounding, testing and maintenance."

Available, for a charge, from other sources

"ESD control in the manufacturing environment."

Reliability Analysis Center/IITRI
PO Box 4700
Rome, NY 13440-8200
315-337-0900

"AT&T electrostatic discharge control handbook, Issue 2."

This is the handbook on ESD control used by AT&T Technologies
800-432-6600

EOS/ESD association procedures and standards

These standards are currently

available from the EOS/ESD Association.

S1 - Wrist Straps

S2 - Garments

S3 - Ionization

S4 - Work surfaces, Glossary of terms, Human body modeling, Grounding 315-339-6937.

Training tapes

"That's enough static"

Media Associates
PO Box 5747
Springfield, VA 22150
800-628-3556

"ESD awareness system 1985"
American Telephone and Telegraph
475 South Street
Morristown, NJ 07960
201-631-7357

"ESD control training"
SAR Associates
1212 E. Dominick St.
Rome, NY 13440
315-339-3968

"ESD Insights"
Lockheed Missiles & Space Inc.
PO Box 3504
Sunnyvale, CA 94088
408-742-6997

"Electrostatic discharge damage prevention"
Anderson Effects, Inc.
PO Box 657
Mentone, CA 92359
714-794-3792

"ESD: the invisible threat"
Naval Sea Systems Command
Don Cross (06Q25)
Washington, DC 20362-5101
202-692-6424

"Static awareness is for you"
Tektronix, Inc.
PO Box 500,
Delivery Station 74-115
Beaverton, OR 97077
503-627-1586

"Nemesis of Electronics: ESD"
"Please don't give me any static"
"Static No Problem"
Don Frank MC18-08
Douglas Aircraft
3855 Lakewood Blvd.
Long Beach, CA 90846
213-593-2811

"Electrostatic discharge overview"
NCR Education Services
101 W. Schantz Ave.
Dayton, OH 45479
800-845-2273

"(Don't gimme) No static"
Martin Marietta Electronics Systems
PO Box 628077
Orlando, FL 32862
407-356-4769

"Mission success/failure"
"ESD limited handling"
"ESD temporary"
Martin Marietta
Attn: Skills Training Manager
PO Box 179
Denver, CO 80201
303-977-5912

Figure 4.

Hall effect sensors in VCRs and other applications

By Victor Meeldijk

In common applications, Hall effect sensors are used in VCRs to sense reel motion and speed and rotation direction of the capstan and cylinder head motors. They are also used in bounceless switches, in computer printers, in position sensors, flow rate sensors, shaft encoders, piston position sensors, in measuring equipment such as gaussmeters and wattmeters and to sense wheel rotation in automobile anti-lock braking (ABS), systems. This article discusses Hall sensors,

Meeldijk is the Reliability/Maintainability Engineering Manager for Diagnostic/Retrieval Systems, Inc. Oakland, NJ 07436

the types available, and how to repair a VCR cylinder head motor that has a Hall effect sensor IC in it.

The discovery of the Hall effect

The Hall effect was discovered in 1879 at Johns Hopkins University by the American physicist Edwin Herbert Hall. The effect is, a small electrical potential is created when a stationary magnetic field is placed perpendicular to a current-carrying semiconductor. Figure 1 shows that the voltage, current and magnetic field are all mutually at right angles to each other. The voltage caused by the electric field exactly balances the

force exerted by the magnetic field, (Figure 2).

Most Hall effect elements available hold current constant and vary voltage with magnetic field strength. The use of this effect up until recently was hindered by very low magnetically induced output voltage, high noise levels and device temperature sensitivity.

The present Hall effect sensors combine the Hall Element, a Schmitt trigger and an output amplifier on an integrated circuit (Figure 2). The addition of a supply voltage regulator allows the sensors to operate over a wide power supply input, from

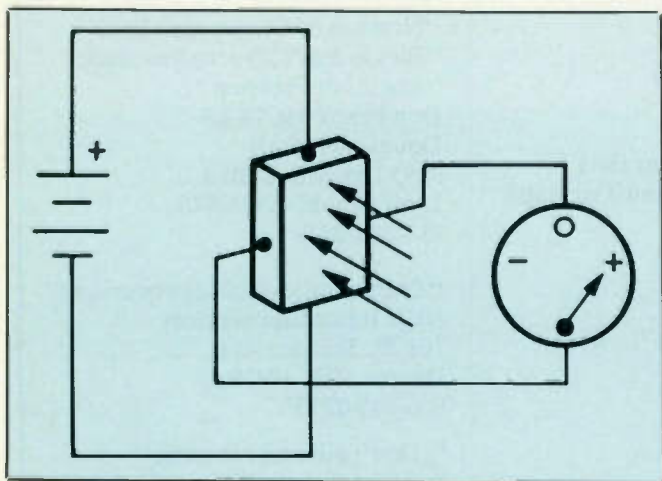

Figure 1. The output voltage of a Hall effect sensor is directly proportional to the magnetic field present at right angles to the direction of current flow through the sensor. (courtesy of Allegro Microsystems, Inc., Worcester, MA).

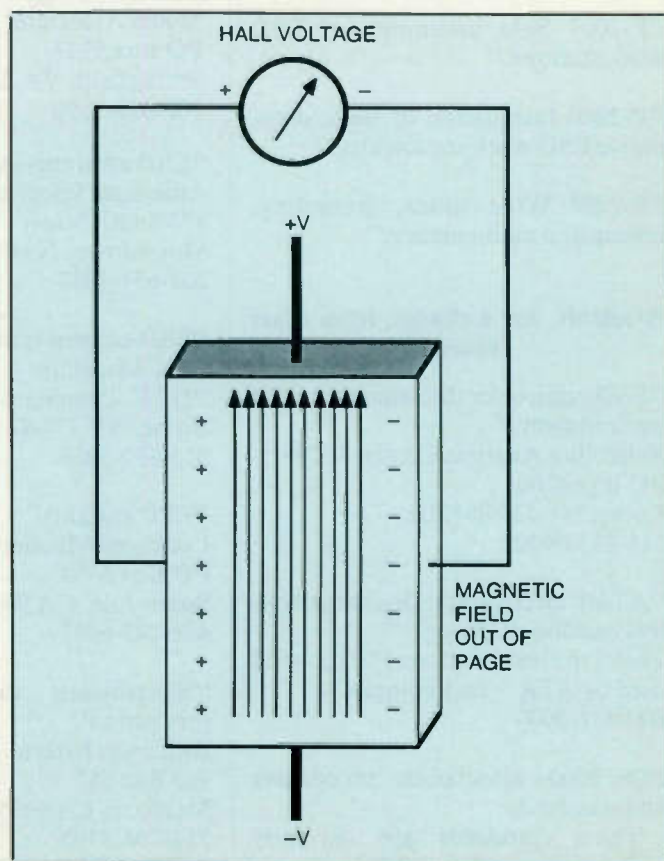

Figure 2. In a conductor exposed to an external magnetic field the electrons follow a curved path causing a buildup of charge at right angles to the current. Eventually the charge (voltage) caused by the electric field exactly balances the force exerted by the magnetic field. This is the Hall voltage. (Courtesy of Allegro Microsystems, Inc. Worcester, MA).

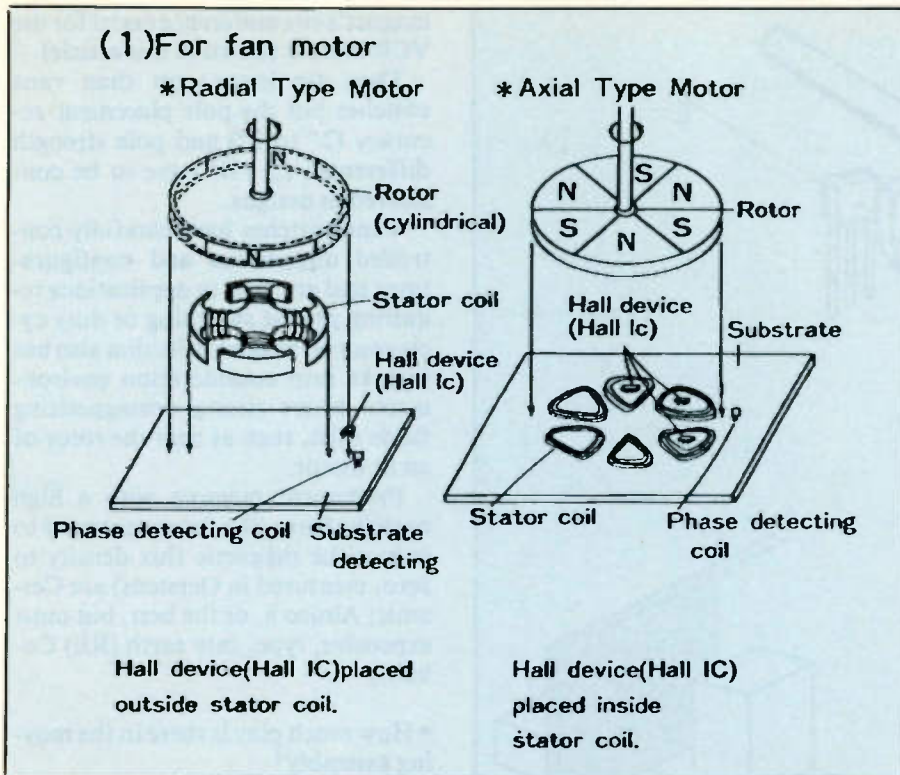

Figure 3. Typical motor applications (Courtesy Sharp Electronics Corp., Mahwah, NJ).

A single magnet passing close to the sensor will produce a pulse output. In a VCR this pulse is used to determine VCR reel rotation and speed and is used in the tape footage counter circuit. The Hall effect devices are usually located under the take-up and supply reels (although manufacturers do use optical sensors as well to monitor the tape reels, see Figure 4).

Hall effect sensor types

Hall effect sensors are available in several types, both analog and digital. A description of some of them follows:

- An analog Hall sensor has a continuous output voltage which is proportional to the magnetic field strength (increased voltage with a stronger field, lower voltage output with a weaker magnetic field). Either magnetic pole may provide the magnetic field.
- Digital types of Hall sensor Bipolar - positive gauss (South Pole) turns it "ON" and negative gauss (North Pole) turns it "OFF".
- Bipolar Latching - guaranteed to switch "ON" with positive gauss (and remain on even after the magnetic field has been removed) and turn "OFF" with negative gauss.
- Unipolar - switches "ON" with positive gauss and turns "OFF" when the magnetic field is removed (or drops below a certain strength). This is used in a Vane Switch which is activated by an iron vane which

4.5Vdc to 25Vdc and some units incorporate reverse power supply protection up to -28Vdc.

The sensors operate up to 100KHz (200KHz for silicon types), sense very low gauss (magnetic flux density) levels and have a very long operating life (units have exhibited over 35 billion operations). There are units that operate over the temperature range of -40C to +150C, with transients to 175C. This high upper temperature

range makes them suitable for use in automotive applications such as anti-lock brake systems, wheel speed sensors, ignition cam and crank timing sensors and transmission speed sensors (Figure 3).

In certain applications, a small magnetic field that changes like a sine wave, will produce a sine wave output. This is the waveform found in a motor like a VCR cylinder head motor.

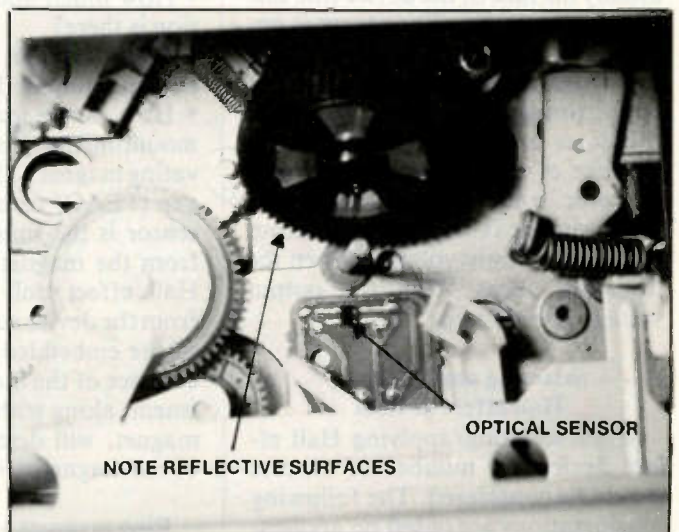
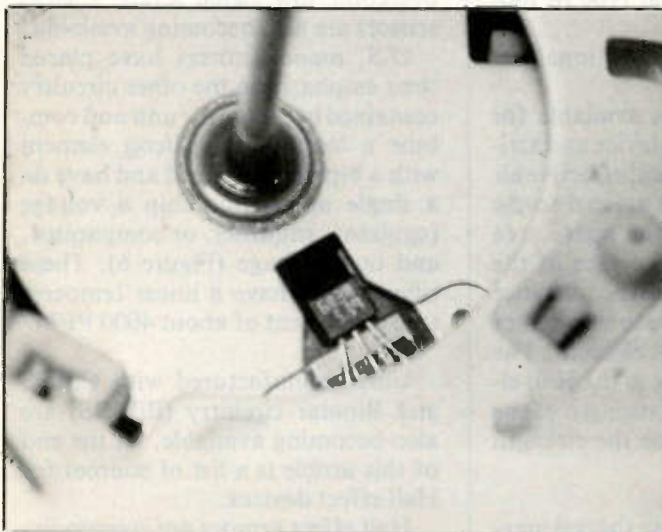

Figure 4. (A) A Hall sensor mounted under a VCR take-up reel. (B) An optical sensor in a different VCR used to monitor the take-up reel.

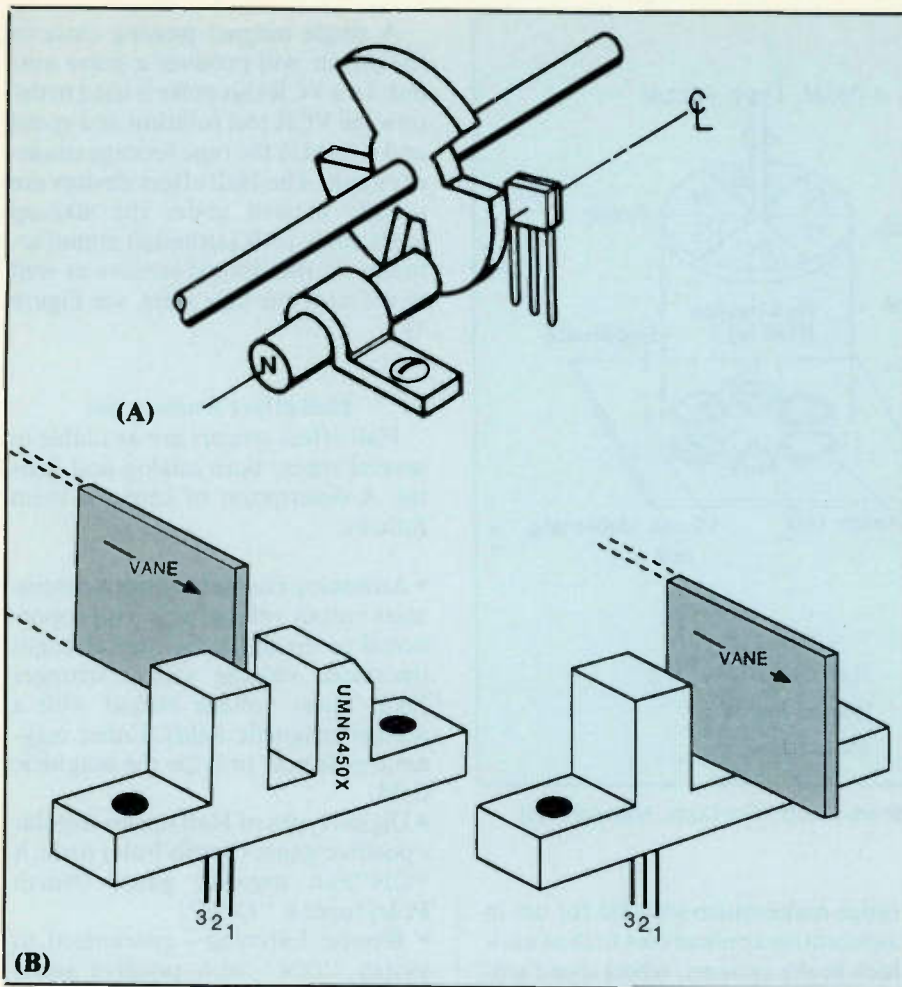

Figure 5. (A) A ferrous vane rotor and (B) the same application using a sensor with an integral magnet (Courtesy Allegro Microsystems, Inc., Worcester, MA).

passes through the air gap between a magnet and a Hall effect sensor (See Figure 5).

Hall sensor operation

The active area of a Hall sensor is usually the face of the device (the side with the lettering). The sensor is operated by a magnetic field of sufficient strength (flux density) and polarity (orientation). The magnetic flux lines must be perpendicular to the face of the package. With open collector transistor outputs, when the transistor is "OFF", the output equals the supply voltage. When the transistor turns "ON" the output voltage goes to zero.

Selecting and applying Hall effect devices

When selecting/applying Hall effect devices, a number of factors should be considered. The following considerations are based on application guidelines contained in Allegro Microsystems Databook AMS-500,

(an indispensable source of information if you are designing with Hall Effect sensors, along with data on IC package temperature and thermal resistance).

- How much and what type of motion is there?
- What angular and positional accuracy is required?
- How much space is available for mounting the sensing device and activating magnet? The total effective air gap (TEAG) from the magnet to the sensor is the sum of the active area from the magnet to the face of the Hall effect unit plus the distance from the device surface to the surface of the embedded Hall element. The distance of the magnet to the Hall element, along with the strength of the magnet, will determine the strength of the magnetic field.

Ring magnets are disc shaped magnets with the magnetic poles either radially or axially spaced around the

magnet's circumference (axial for the VCR motors shown in this article).

They are lower cost than vane switches but the pole placement accuracy (2° to 3°) and pole strength differences ($\pm 5\%$) have to be considered in designs.

Vane switches have carefully controlled dimensions and configurations and are used in applications requiring precise switching or duty cycle control. Magnet selection also has to take into consideration environments where strong demagnetizing fields exist, such as near the rotor of an ac motor.

Permanent magnets with a high coercive force (the force necessary to reduce the magnetic flux density to zero, measured in Oersteds) are Ceramic, Alnico 8, or the best, but most expensive, type, rare earth (RE) Cobalt.)

- How much play is there in the moving assembly?
- How much mechanical wear can be expected over the lifetime of the machine?
- Will the product be a mass-produced assembly, or a limited number of machines that can be individually adjusted and calibrated?
- What temperature extremes are expected?

Characteristics and costs of Hall sensors

Japanese Hall effect sensor designs differ from American designs in that they use high sensitivity Gallium Arsenide (GaAs) and Indium Antimonide (InSb) sensor elements to overcome low signal levels. CMOS sensors are also becoming available.

U.S. manufacturers have placed their emphasis on the other circuitry contained in the sensor unit and combine a low output silicon element with a bipolar front end and have on a single monolithic chip a voltage regulator, amplifier, or comparator, and output stage (Figure 6). These silicon units have a linear temperature coefficient of about 4000 PPM/ $^\circ\text{C}$.

Units manufactured with CMOS and Bipolar circuitry (BiMOS) are also becoming available. At the end of this article is a list of sources for Hall effect devices.

Hall effect sensors are commodity items (like LED's), typically costing about 50 cents each. The units, how-

ever, that contain more circuitry around the Hall Element, and are produced in low volume quantities, usually cost a few dollars.

The Japanese devices, which are generally low cost items, with very small profit margin (without an established U.S. market) may be difficult to obtain. Therefore if designing with this device, alternate sources should be investigated.

Some alternatives to Hall sensors

Other low cost sensing elements include the magnetic sensor reed relay which costs about 10 cents but needs signal conditioning circuitry to eliminate contact bounce, and low-cost plastic encapsulated optical interrupters which operate to 100KHz, and to 100C.

The optical sensors however, are unreliable in smoky or dusty environments. The optical sensor, which is available in a low cost plastic package, has supplanted the use of the Hall effect device in many VCR sensing applications.

In addition to the above types of sensors, there are magnetoresistive effect sensors that are based upon the property of a current carrying magnetic material to change resistivity in the presence of an external magnetic field.

In typical sensors, a device is made up of four permalloy strips connected to form the arms of a Wheatstone bridge and trimmed with resistors to give a zero offset at 25C. The bridge imbalance in the presence of a magnetic field is used to indicate magnetic field strength. These devices can be used in position sensing and current measurement circuits.

Hall effect IC's in VCR motors

Panasonic VCR models PV-1360, 1361, 1362, 1362-K, 1560, 1560-K, VH5261, and VH5261-K have a cylinder head motor and capstan motor that incorporate a Hall effect IC for speed control. See Figures 7 and 8 (Note: Service manuals for Panasonic, Matsushita and Quasar units are available from MSC Service Literature, PO Box 848, Arlington Heights, IL 60006, 1-800-447-4700).

In the cylinder motor, if this IC fails the motor will erratically turn in one direction, then in the other direction, because IC2603, the cylinder motor drive IC is not getting any feedback pulses. The VCR will then

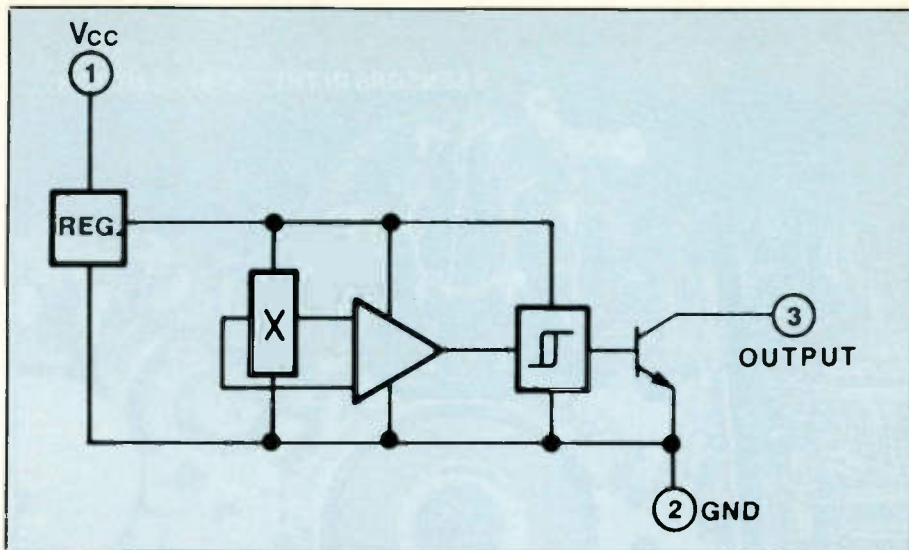

Figure 6. A Hall effect sensor may combine a voltage regulator, amplifier and output stage (Courtesy Allegro Microsystems, Inc., Worcester, MA).

automatically go into stop mode. While the failure rate of Hall sensors is very small they can be damaged during troubleshooting. The cylinder motor Hall sensor can be damaged if, while probing IC2603 (AN3812K) or the pins of P2602, the probe shorts the I/O lines of the sensor.

As noted above, a Hall effect sensor is a commodity device and costs less than \$1.00. Replacement cost of the motors is high, however. The Cylinder Head Motor (part number VEGS0099) is about \$100.00. Obviously, then, when the problem is isolated to the Hall effect sensor, it would be most cost effective if only

the sensor could be replaced. Unfortunately, Panasonic does not break out the Hall IC's in the parts list and does not consider them a replaceable item. You can, though, if you want.

Identifying and handling the Hall sensor

Examining the sensors in the VCR cylinder drives does not reveal any manufacturer logo, although there is a part number, 4KA. Panasonic technicians indicate that this may be a special part and no information is available as they do not sell their Hall sensors in this country (including series DN6800) (Note: Technical help



Figure 7. Hall effect sensor in a cylinder head motor.

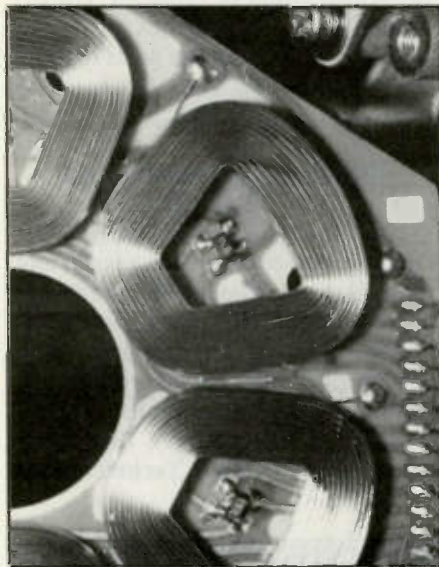
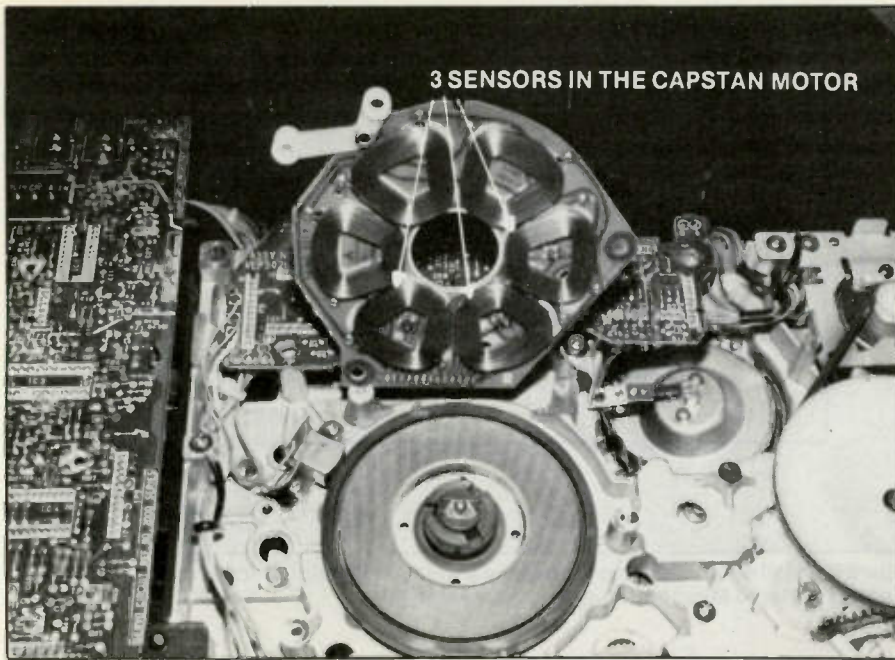

Figure 8. Hall effect sensors in a VCR capstan motor.

and device leads with the soldering iron. When the solder has been removed, carefully take hold of the sensor with needle nose pliers and twist it gently to break the glue that holds it to the circuit board in the motor.

Checking out the replacements

I tried the Micro Switch 634SS2 by putting it on a small bracket so that the sensor was located just above the cylinder head motor magnet (see Figure 12). This particular sensor is too large to mount inside the motor.

With the replacement sensor located exactly above the location of the internal sensor, the motor speed and indexing, with respect to the original location of the video heads was correct. Pin 2 of P2602 is connected to ground, pin 3 is HE +, pin 4 is VH + and pin 5 is HE -.

Proper motor operation was achieved with this sensor in place, but it would be much better to use as a replacement a sensor that would fit inside the motor.

The other sensor that was finally obtained was the Sanyo SHS264, which is physically the same (an SOT-143 package) as the original sensor (as previously noted, the Japanese sensors are very difficult to obtain). When I installed this unit, the motor was fully functional.

The orientation of this device is by lead 1 which is wider than the rest of the leads. This lead, and the one diagonally opposite it are the outputs. The power supply inputs are device leads 2 and 4, with the "+" input going to pin 2 which is on the same side of the device as the wide lead. The "+" side of the input power goes to connector pin 4 and the "-" side, or ground, goes to connector pin 2.

Sources of Hall effect sensors

Because the Hall effect is being used in a number of electronics applications, your chances of running across one that needs replacement become more likely. Following are the names of several sources of Hall effect devices, and the identification of many of the products that they offer. At the end is a list of company names, addresses and telephone numbers.

Allegro Microsystems, Inc.

Linear devices: UGN 3501 linear output silicon types; UGN and UGS-

on Panasonic VCR's is available at 708-640-5147). Therefore, all information about the function of this IC must be determined from its operation and the voltages on the schematic.

Examining the Service Manual block diagram, Figure 9, shows that this is a differential output device with a supply voltage of 4.97V. The pins of the sensor are connected to pins 2, 3, 4 and 5 of P2602. From the schematic it is determined which device leads are inputs and outputs.

The available parts, from the manufacturers listed at the end of the article, reveal a few possible substitutes. These devices are: the SHS264 from Sanyo Semiconductor, which is

physically the same part with the same output pins; the Sharp LT110, LT120, or LT130, MuRata Erie HE 101AA, and the physically larger Micro Switch 612SS4 (digital output) or the 634SS2 (analog output). See Figure 10.

Replacing the Hall sensor

To remove the defective Hall sensor it's best to use a soldering/desoldering station designed for surface mount components. A pencil soldering iron with the tip ground to a fine point can be used (Figure 11) if you do not have surface mount desoldering equipment available.

Place desoldering braid on the leads of the device and heat the braid

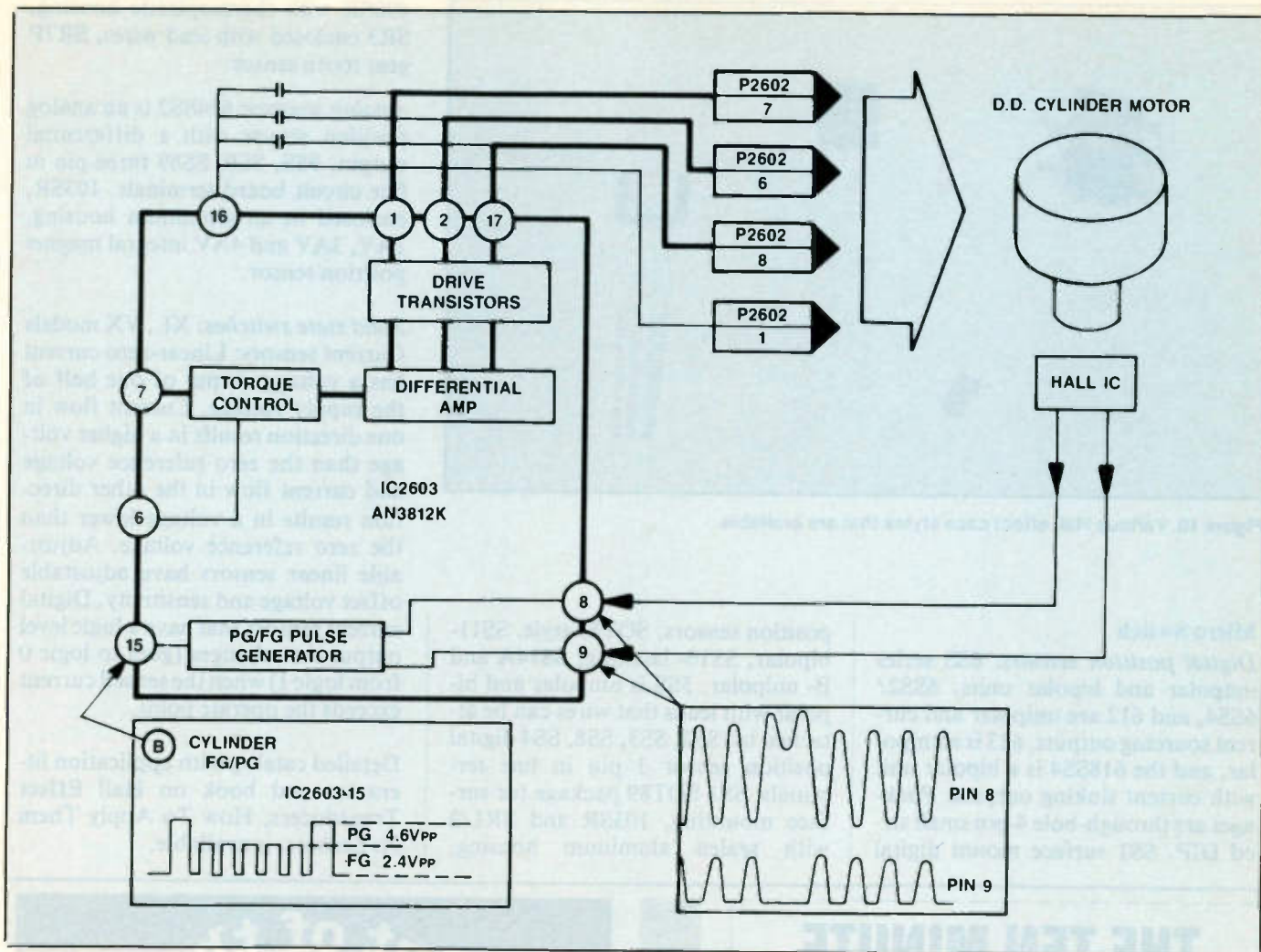

Figure 9. The service manual block diagram showing the Hall effect sensor in a cylinder head motor.

3503U single output ratiometric - south pole drives output higher than null output level while north drives output lower than null output voltage level. UGN3501U is a 3-lead in-line through-hole mounting package.

Switches: UGN and UGS3055U, multiplexed two wire sensors to communicate over a two wire power/signal bus, available in a 3 pin SIP package. UGN and UGS3059KA are ac-coupled gear-tooth sensors in a 5-pin SIP package. UGN3013, 3113; UGN and UGS3019, 3020, 3040 3119, 3120, 3130, 3140 single output unipolar type digital switches; 3030 type - single output bipolar, these devices available as 3-pin SIP and SOT-89 packages; the 3100 series devices are available in an "HH" package which is a hermetically-sealed TO-260AA package for military applications. Screening to MIL-STD-883 is also available. Selected devices for operation up to +170C are available on special order.

UGN3235K is a dual output 4 pin SIP. UGN and UGS3132 and 3133 are ultra sensitive switches available in SOT 89 (TO-243AA) surface mount package or SIP packages. The UGQ5140K is a unipolar switch designed for magnetic actuation of low-power incandescent lamps or inductive loads such as relays or solenoids. The device includes current surge protection circuitry to 900mA (rated -40C to ±85C in a 4-pin mini-SIP package). UMN6450X is a vane switch in a 3-pin plastic housing rated for operation over temperatures of -20C to +85C.

Latches: UGN3035U, UGN and UGS3075 are bipolar digital latches, UGN and UGS3077 symmetrical duty cycle latches (for brushless dc motor control); UGN and UGS 3275 comprise a dual complementary output type. UGN3175 and 3177 are latches for brushless dc motors that use multipole ring magnets. UGN-5275K is a complementary output de-

vice for electronic commutation of brushless motors capable of sinking up to 300mA, available in a 4-pin mini-SIP package. Other special gear tooth sensors also available.

Devices are silicon types.

NOTE: UGN is rated -20C to +85C, and UGS -40C to +125C. Devices generally come in T or U packages which are 3-lead SIP packages, U being lower profile than the T. LT packages which are SOT 89 surface mount, and LL which are long leaded LT packages are also available for most of the above types. Detailed catalog with application information available.

Analog Devices

AD22150, a monolithic Hall effect sensor, open collector output with signal conditioning designed for automotive applications.

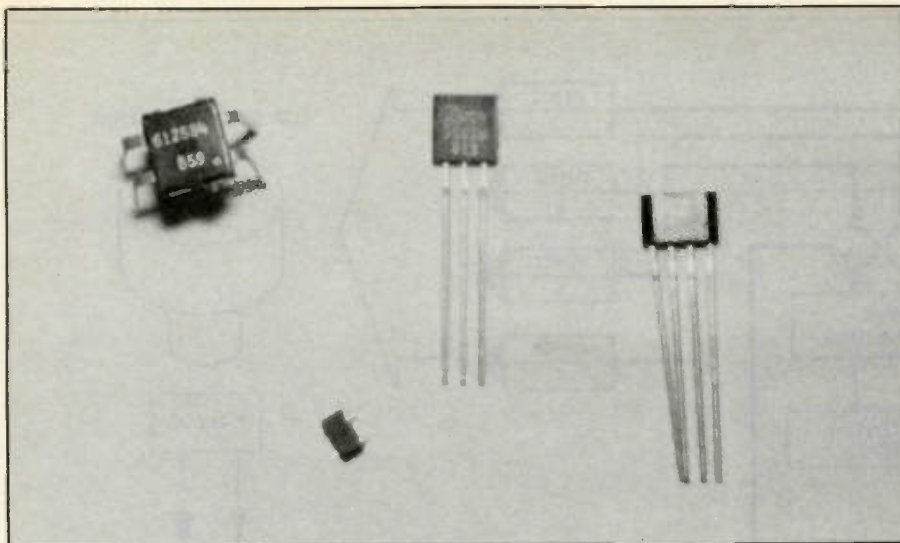

Figure 10. Various Hall effect case styles that are available.

Micro Switch

Digital position sensors: 6SS series unipolar and bipolar units. 6SS2/6SS4, and 612 are unipolar and current sourcing outputs, 613 is a unipolar, and the 618SS4 is a bipolar unit with current sinking outputs. Packages are through-hole 4-pin small sized DIP. SS1 surface mount digital

position sensors, SOT89 style. SS11-bipolar, SS16- latching, SS14A and B- unipolar. 5SS is unipolar and bipolar with leads that wires can be attached to. SS2, SS3, SS8, SS4 digital position sensor 3 pin in line terminals. SS1 SOT89 package for surface mounting, 103SR and SR1/2 with sealed aluminum housing,

400SR with thermoplastic housing, SR3 enclosed with lead wires, SR7P gear tooth sensor.

Analog sensors: 634SS2 is an analog position sensor with a differential output. 9SS, SS9, SS89 three-pin in line circuit board terminals. 103SR, enclosed in an aluminum housing. 1AV, 3AV and 4AV integral magnet position sensor.

Solid state switches: XL, VX models
Current sensors: Linear-zero current has a voltage output of one half of the supply voltage. Current flow in one direction results in a higher voltage than the zero reference voltage and current flow in the other direction results in a voltage lower than the zero reference voltage. Adjustable linear sensors have adjustable offset voltage and sensitivity. Digital current sensors that have a logic level output that changes (goes to logic 0 from logic 1) when the sensed current exceeds the operate point.

Detailed catalog with application literature and book on Hall Effect Transducers, How To Apply Them As Sensors, is available.

THE TEN MINUTE TREATMENT!

TEST / CLEAN / RESTORE
 CUSTOMER CRT's ON THE SPOT



**BELTRON
 SYSTEM™
 2000**

The Smart One

- Fully Automatic.
- Microprocessor-Controlled Test/Clean/Restore and Auto Sequences.
- Simple and Safe for use with Today's CRT Voltage Ratings.
- Portable. Fits in own Attache Case.
- AC-Powered.
- Profitable. Enhances any Service Offering.
- Simplifies CRT Replacement Scheduling.

To Order Call
800/626-6929
 FAX: 415/568-1397
 TEL: 415/568-5282



Circle (4) on Reply Card

Come Out of the Dark.

Shed some light on your managerial skills with the Certified Service Manager exam from NESDA, the association dedicated to sales and service dealers and technicians. For a **FREE** practice test and some answers to *your* questions, just send the following to NESDA:

Name _____

Address _____

City _____ State _____

Zip _____

Phone _____

National Electronics Sales &

NESDA

Service Dealers Association

2708 W. Berry St.
 Ft. Worth TX 76109
 (817) 921-9061

MuRata/Erie

GaAs surface mount HE101AA with dual outputs. Ohio Semitronics, Inc. Models HR and HS sensor probes with leads.

Optek Technology Inc.

Sensors: OH090U, OH180U, OH360U, OHN3013U, OHN and OHS 3019U, 3020U, 3030U, 3131U, 3040U, 3140U.

Latches: OHN and OHS 3075U bipolar types.

Silicon type devices. NOTE: OHN is rated -20C to +85C and the OHS is -40C to +125C.

Packages are 3-pin, through hole mount. Detailed catalog with optical sensor application information

Philips Components

Magneto-resistive sensors. Catalog details operation and application examples.

Sanyo Semiconductor Corp.

InSb linear output SHS110, SHS210, 211, 311, 411; linear high output types SHS220, 230, 320, 330, 331 and GaAs linear types SHS260, 263, 264 (low cost), 361 and high output types SHS271 and 371.

Packages are 4-pin small surface mount types or through-hole SIP and DIP styles.

Seiko Instruments U.S.A., Inc.

S-8143A and S-8145A, CMOS types,

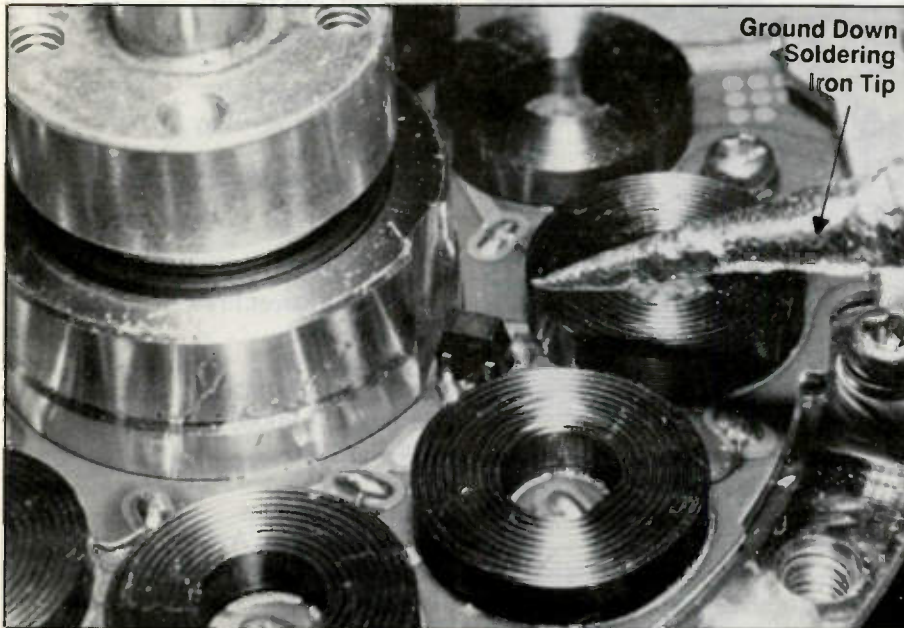

Ground Down
Soldering
Iron Tip

Figure 11. If surface mount desoldering equipment is not available, grind a pencil tip to a fine point, and then tin it with solder.

**MCM ELECTRONICS
and FLUKE®**

Join the thousands of electronic service and repair customers who have come to depend on Fluke quality. MCM Electronics is proud to offer the new Fluke 70 Series II. Fluke's impressive upgrades to the world's most popular multimeter line include:

- Improved accuracy
- Improved readability
- Automatic touch hold®
- Improved test lead set
- New single chip technology



TENMA™

In addition, MCM Electronics offers Tenma test equipment, test leads and accessories to fulfill all your test equipment needs. Call today for your free subscription to the MCM Electronics 200 plus page catalogs, **1-800-543-4330.**



MCM ELECTRONICS
650 CONGRESS PARK DR.
CENTERVILLE, OH 45459-4072
A PREMIER Company

ES-61

Circle (10) on Reply Card

Electro Tool
Tools for the Professional



platt - Case - Deluxe polypropylene. Chemical resistant. Tools by CooperTools and others. 800T case, complete with tools...\$349.99
800T case only ...\$112.00



OptiVISOR - Superior magnification. Optical Glass Prismatic lenses, (not plastic) Select any one of (6) magnifications ...\$21.50

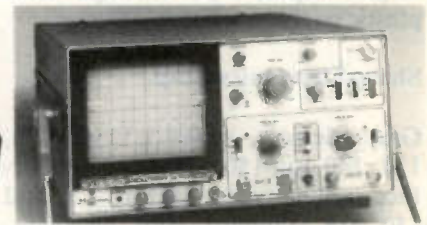

GoldStar - 20 MHz Dual Trace Oscilloscope OS-7020A-Large 6" rectangular, high sensitivity: 1mV/div, high accuracy: ±3%, stable, low-drift design, 8 divisions of displayed dynamic range and accurate, distortion-free waveform measurements ...\$375.00



Electro Tool, Inc.
9103 Gillman, Livonia, MI 48150
Customer Service: (313) 422-1221
ORDERS ONLY: 1 (800) 772-3455



Circle (26) on Reply Card

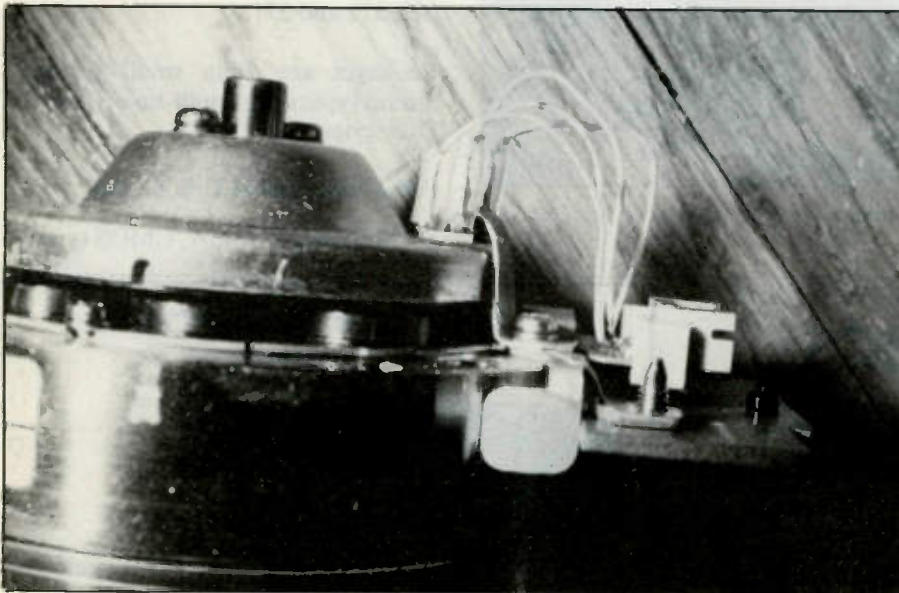
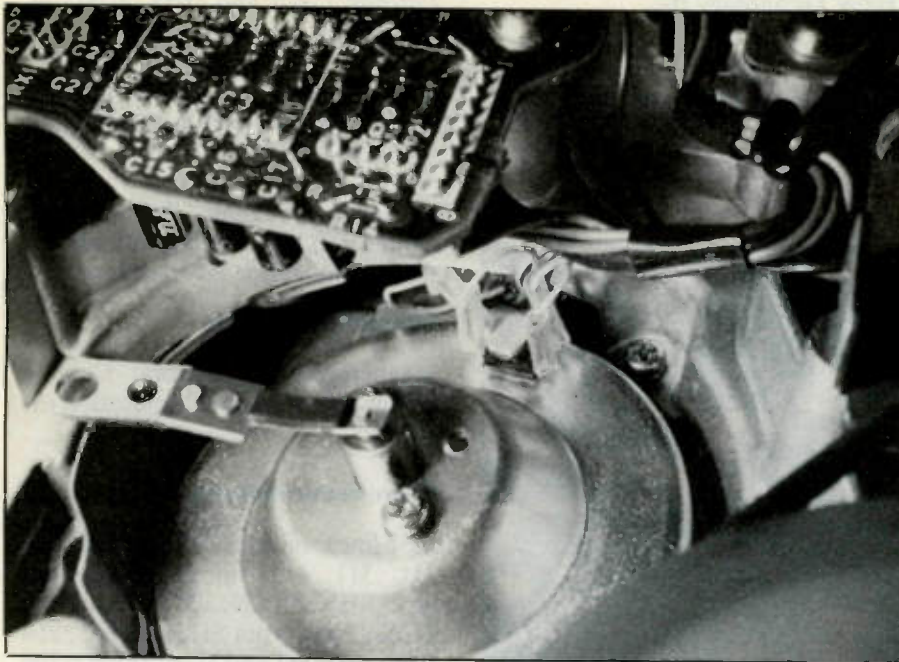

Figure 12. Mounting of the microswitch 634SS2 sensor outside the cylinder motor.

single output, 3-pin through-hole plastic package sensors.

Sharp Electronics Corp.

GaAs devices, series LT110, 120, 130, 140 and 150 series. All are surface mount types, LT110, 120 and 130 are standard chip packages, LT160 is a compact chip and the LT 140 and 150 are ultra compact chip packages. All have 4 pins.

Hall device IC's include fan motor IC's: LT201, 202 and 210, non-contact switch IC's: LT250, 251, 260 and 261. LT 250 and 260 types are standard 4-pin surface mount chip pack-

ages while the LT202 is an 8-pin surface mount device.

Siemens Components, Inc.

HKZ 101, vane switch; SAS 231 IC which produces output proportional to magnetic field, 6-pin surface mount package. TLE series of Hall effect switches for alternating or for unipolar magnetic fields in 3-lead through-hole package or micropack. TLE 4910K Hall effect IC with analog output.

Toshiba America
THS series surface mount sensors. ■

Company addresses

Allegro MicroSystems Inc.
(was Sprague Semiconductor. Now owned by Sanken Electric Co. Ltd.)
Suffolk Building
53 Regional Drive
Concord, NH 03301
603-228-5533

Analog Devices
One Technology Way
PO Box 9106
Norwood, MA 02062-9106
617-326-8703

Micro Switch (A Honeywell Div.) 11
W. Spring Street Freeport, IL 61032
815-235-6600
MuRata/Erie
2200 Lake Park Drive
Smyrna GA 30080
404-436-1300

Ohio Semitronics
1205 Chesapeake Ave.
Columbus, Ohio 04321-2287
614-486-9561

Optek Technology Inc.
1215 West Crosby Road
Carrollton, Tx 75006 214-323-2200

Phillips Components
Discrete Products Division 2001
West Blue Heron Blvd
P.O. Box 10330
Riviera Beach, Florida 33404
407-881-3200

Sanyo Semiconductor Corp
7 Pearl Court Allendale, N.J. 07401
201-825-8080

Seiko Instruments U.S.A. Inc
1130 Ringwood Court
San Jose, CA 95131-1726
408-433-3208

Sharp Electronics Corp.
Sharp Plaza
Mahwah, NJ 07430
201-529-8757

Siemens Components, Inc.
2191 Laurelwood Road
Santa Clara, CA 95954
408-980-4500

Toshiba America Electronics Co.
9775 Toledo Way
Irvine, CA 92718
714-455-2000

BASIC CIRCUIT DIAGRAM

SEPTEMBER 1991

Profax Number

Hitachi
CT2541/2542 Color TV 3080

Product safety should be considered when component replacement is made in any area of an electronics product. A star next to a component symbol number designates components in which safety is of special significance. It is recommended that only exact cataloged parts be used for replacement of these components.

Use of substitute replacement parts that do not have the same safety characteristics as recommended in factory service information may create shock, fire, excessive x-radiation or other hazards.

This schematic is for the use of qualified technicians only. This instrument contains no user-serviceable parts.

The other portions of this schematic may be found on other Profax pages.

Product safety should be considered when component replacement is made in any area of an electronics product. A star next to a component symbol number designates components in which safety is of special significance. It is recommended that only exact cataloged parts be used for replacement of these components.

Use of substitute replacement parts that do not have the same safety characteristics as recommended in factory service information may create shock, fire, excessive x-radiation or other hazards.

This schematic is for the use of qualified technicians only. This instrument contains no user-serviceable parts.

The other portions of this schematic may be found on other Profax pages.

All integrated circuits and many other semiconductors are electrostatically sensitive and require special handling techniques.

PRODUCT SAFETY NOTE: Components marked with a Δ and shaded have special characteristics important to safety. Before replacing any of these components, read carefully the **PRODUCT SAFETY NOTICE** of this Service Manual. Don't degrade the safety of the receiver through improper servicing.

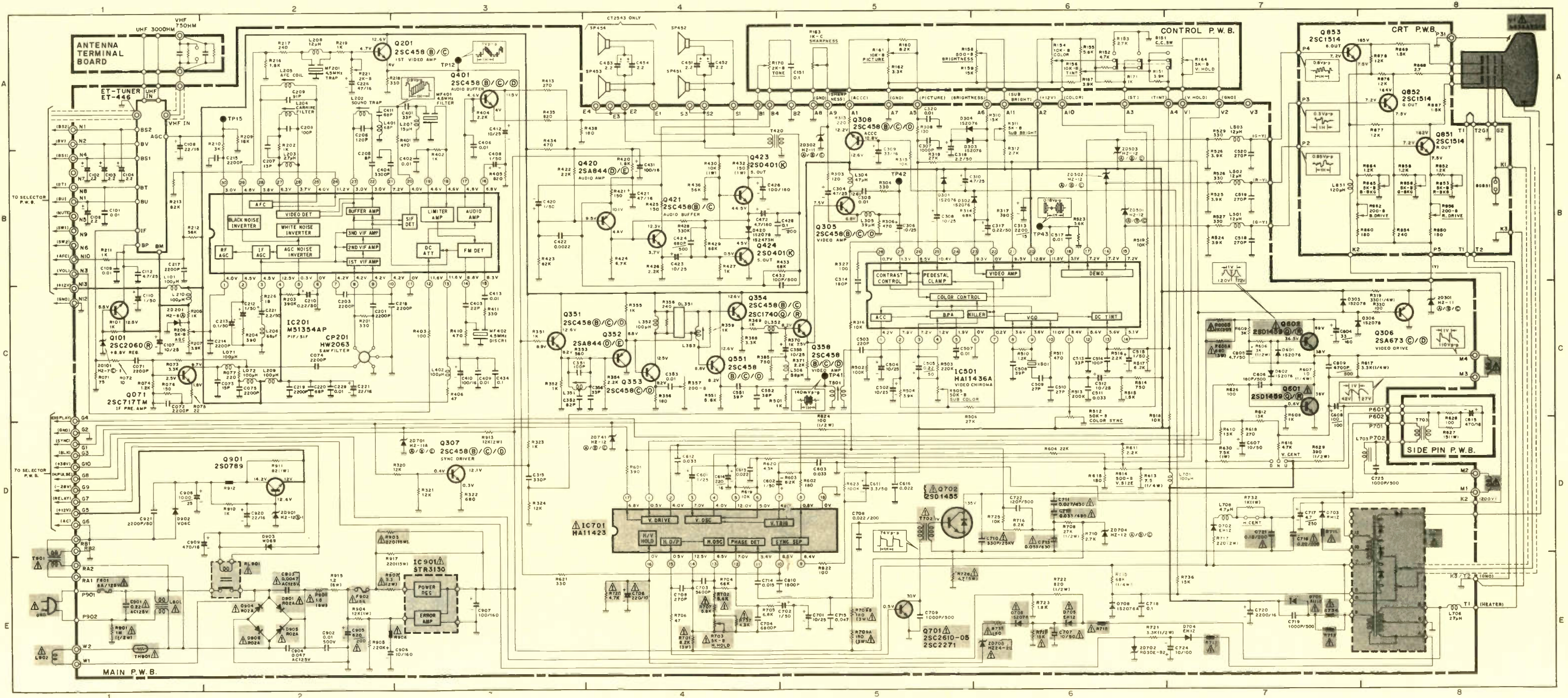

TUNER CIRCUIT DIAGRAM

Product safety should be considered when component replacement is made in any area of an electronics product. A star next to a component symbol number designates components in which safety is of special significance. It is recommended that only exact cataloged parts be used for replacement of these components.

Use of substitute replacement parts that do not have the same safety characteristics as recommended in factory service information may create shock, fire, excessive x-radiation or other hazards.

This schematic is for the use of qualified technicians only. This instrument contains no user-serviceable parts.

The other portions of this schematic may be found on other Profax pages.

All integrated circuits and many other semiconductors are electrostatically sensitive and require special handling techniques.

WIRING DIAGRAM

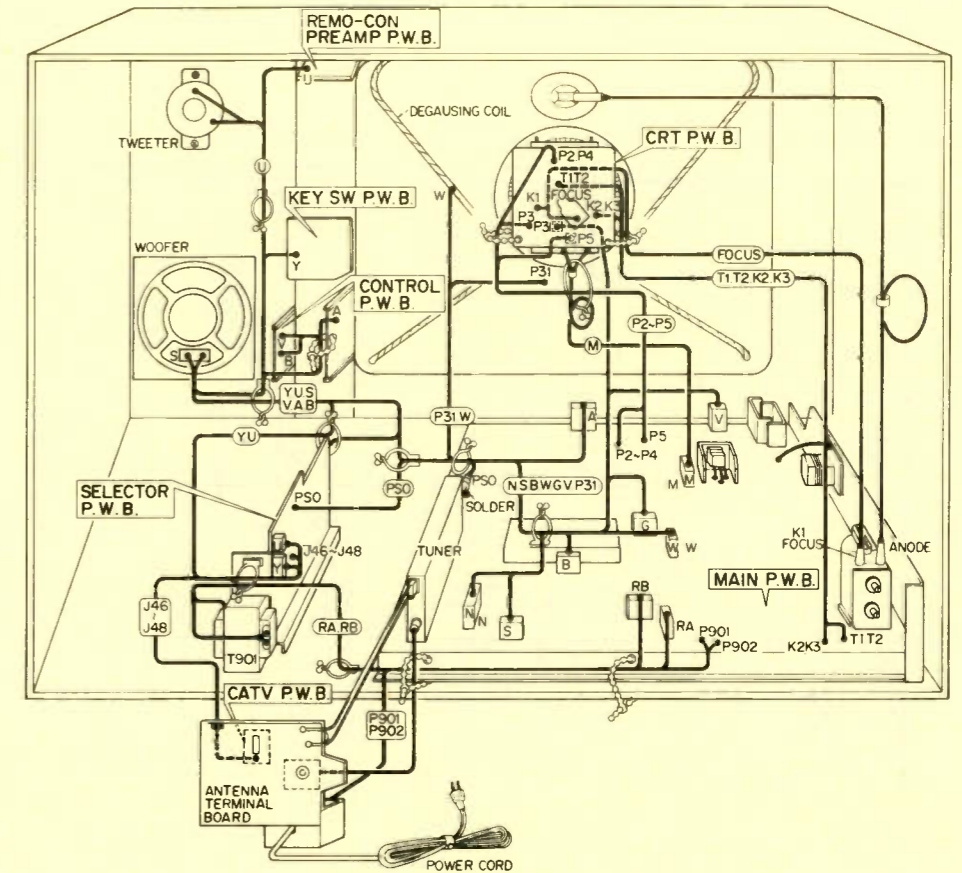

R/C TRANSMITTER P.W. BOARD

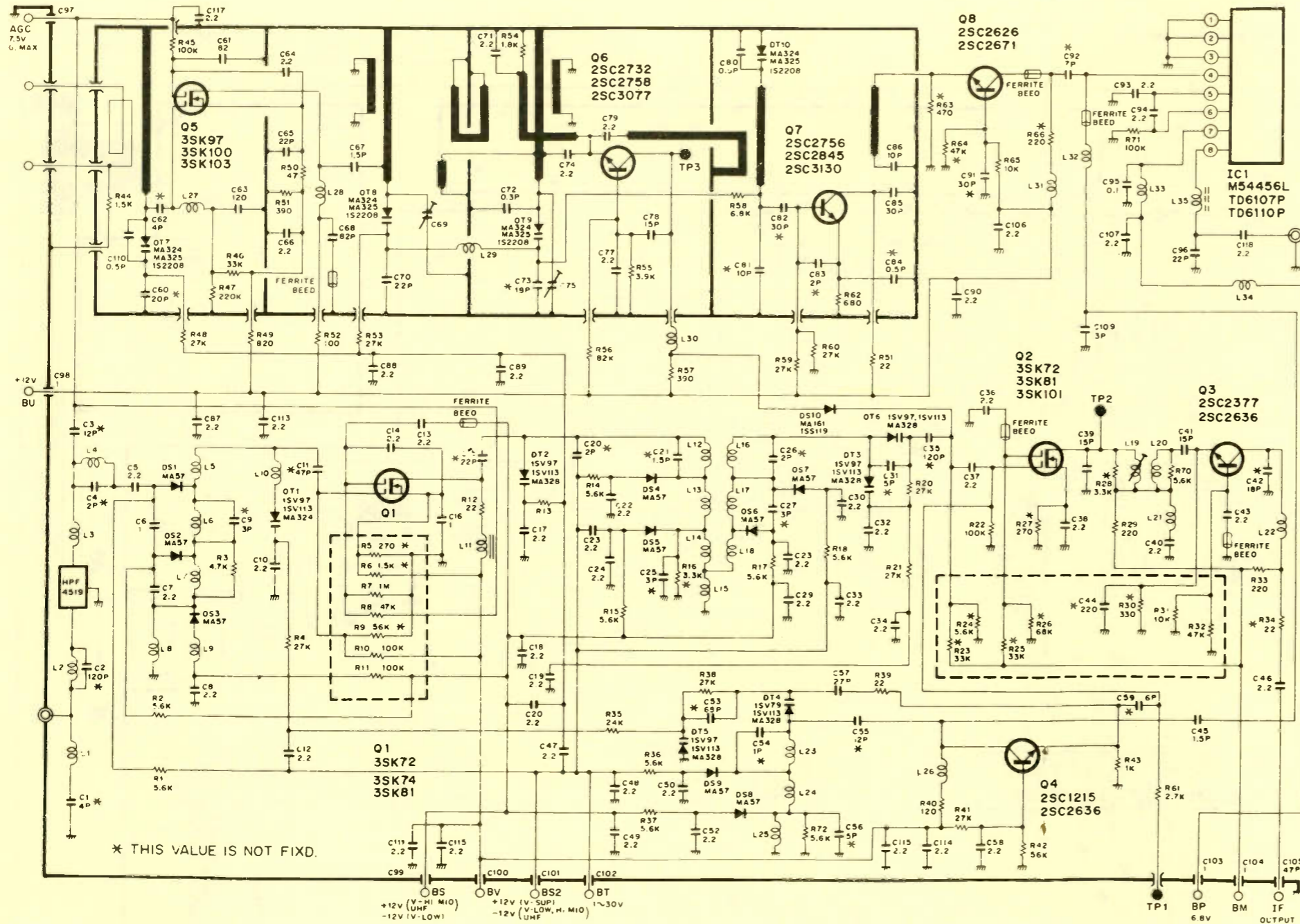
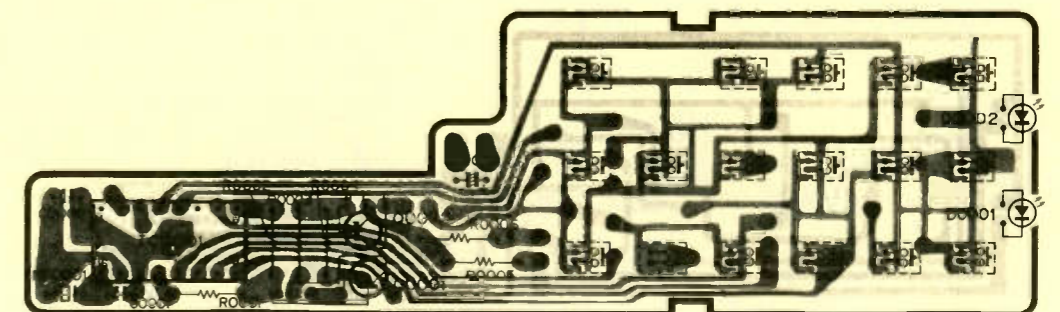

* THIS VALUE IS NOT FIXD.

PRINTED WIRING BOARD

Product safety should be considered when component replacement is made in any area of an electronics product. A star next to a component symbol number designates components in which safety is of special significance. It is recommended that only exact cataloged parts be used for replacement of these components.

Use of substitute replacement parts that do not have the same safety characteristics as recommended in factory service information may create shock, fire, excessive x-radiation or other hazards.

This schematic is for the use of qualified technicians only. This instrument contains no user-serviceable parts.

The other portions of this schematic may be found on other Profax pages.

All integrated circuits and many other semiconductors are electrostatically sensitive and require special handling techniques.

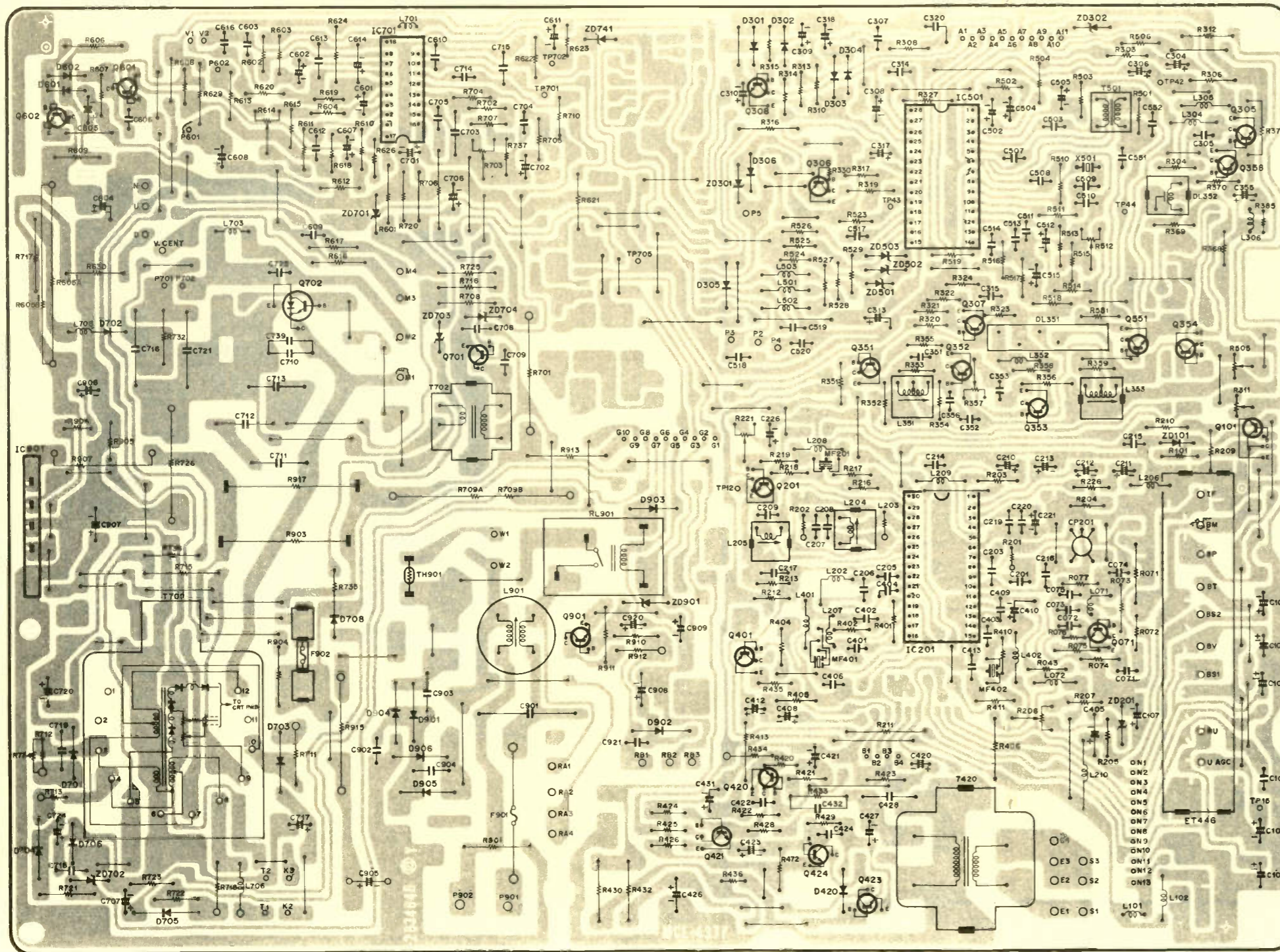

PROGRAM SELECTOR P.W. BOARD

Product safety should be considered when component replacement is made in any area of an electronics product. A star next to a component symbol number designates components in which safety is of special significance. It is recommended that only exact cataloged parts be used for replacement of these components.

Use of substitute replacement parts that do not have the same safety characteristics as recommended in factory service information may create shock, fire, excessive x-radiation or other hazards.

This schematic is for the use of qualified technicians only. This instrument contains no user-serviceable parts.

The other portions of this schematic may be found on other Profax pages.

All integrated circuits and many other semiconductors are electrostatically sensitive and require special handling techniques.

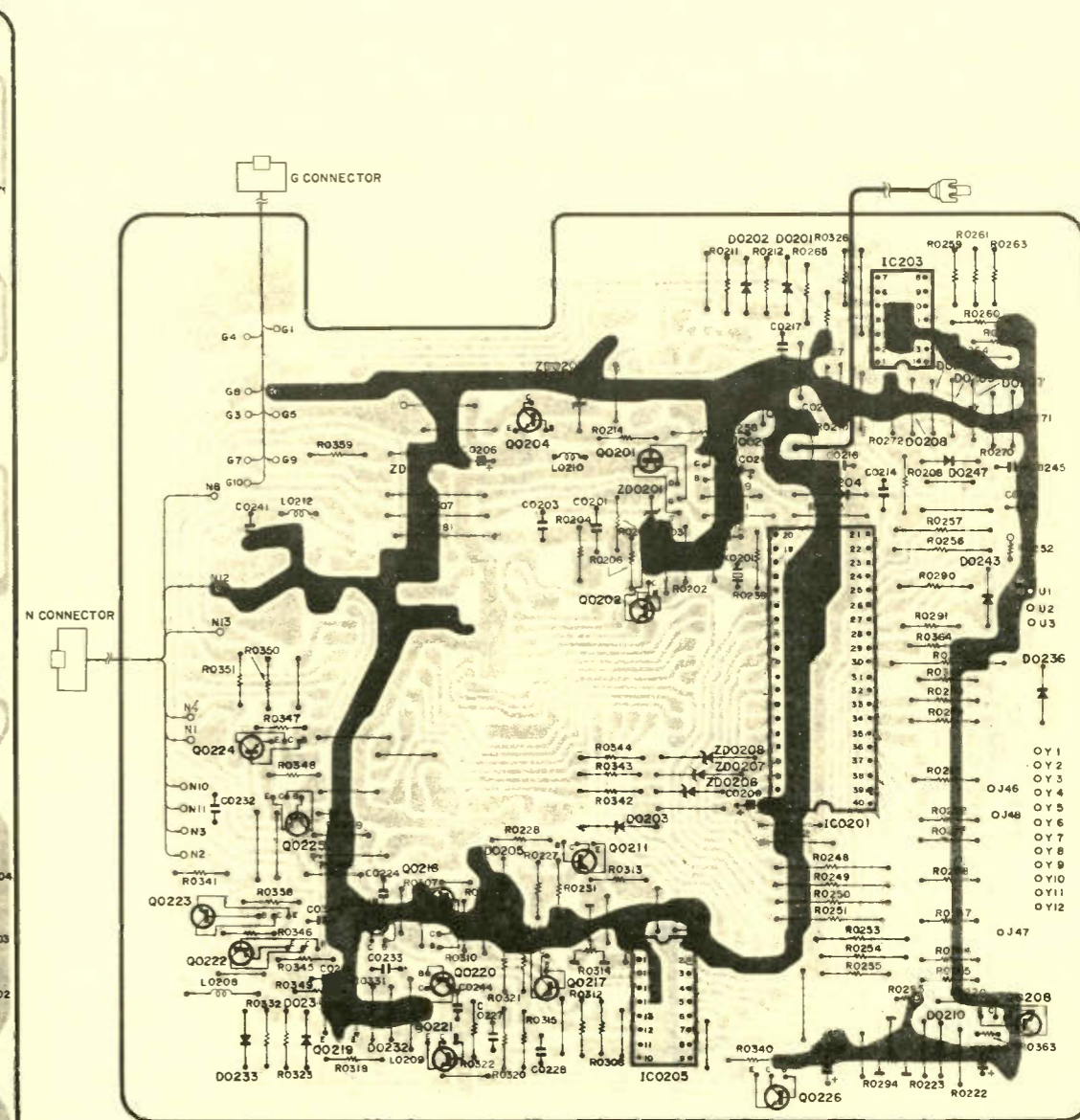

PROGRAM SELECTOR CIRCUIT DIAGRAM

Product safety should be considered when component replacement is made in any area of an electronics product. A star next to a component symbol number designates components in which safety is of special significance. It is recommended that only exact cataloged parts be used for replacement of these components.

Use of substitute replacement parts that do not have the same safety characteristics as recommended in factory service information may create shock, fire, excessive x-radiation or other hazards.

This schematic is for the use of qualified technicians only. This instrument contains no user-serviceable parts.

The other portions of this schematic may be found on other Profax pages.

All integrated circuits and many other semiconductors are electrostatically sensitive and require special handling techniques.

Product safety should be considered when component replacement is made in any area of an electronics product. A star next to a component symbol number designates components in which safety is of special significance. It is recommended that only exact cataloged parts be used for replacement of these components.

Use of substitute replacement parts that do not have the same safety characteristics as recommended in factory service information may create shock, fire, excessive x-radiation or other hazards.

This schematic is for the use of qualified technicians only. This instrument contains no user-serviceable parts.

The other portions of this schematic may be found on other Profax pages.

All integrated circuits and many other semiconductors are electrostatically sensitive and require special handling techniques.

PROGRAM SELECTOR CIRCUIT DIAGRAM

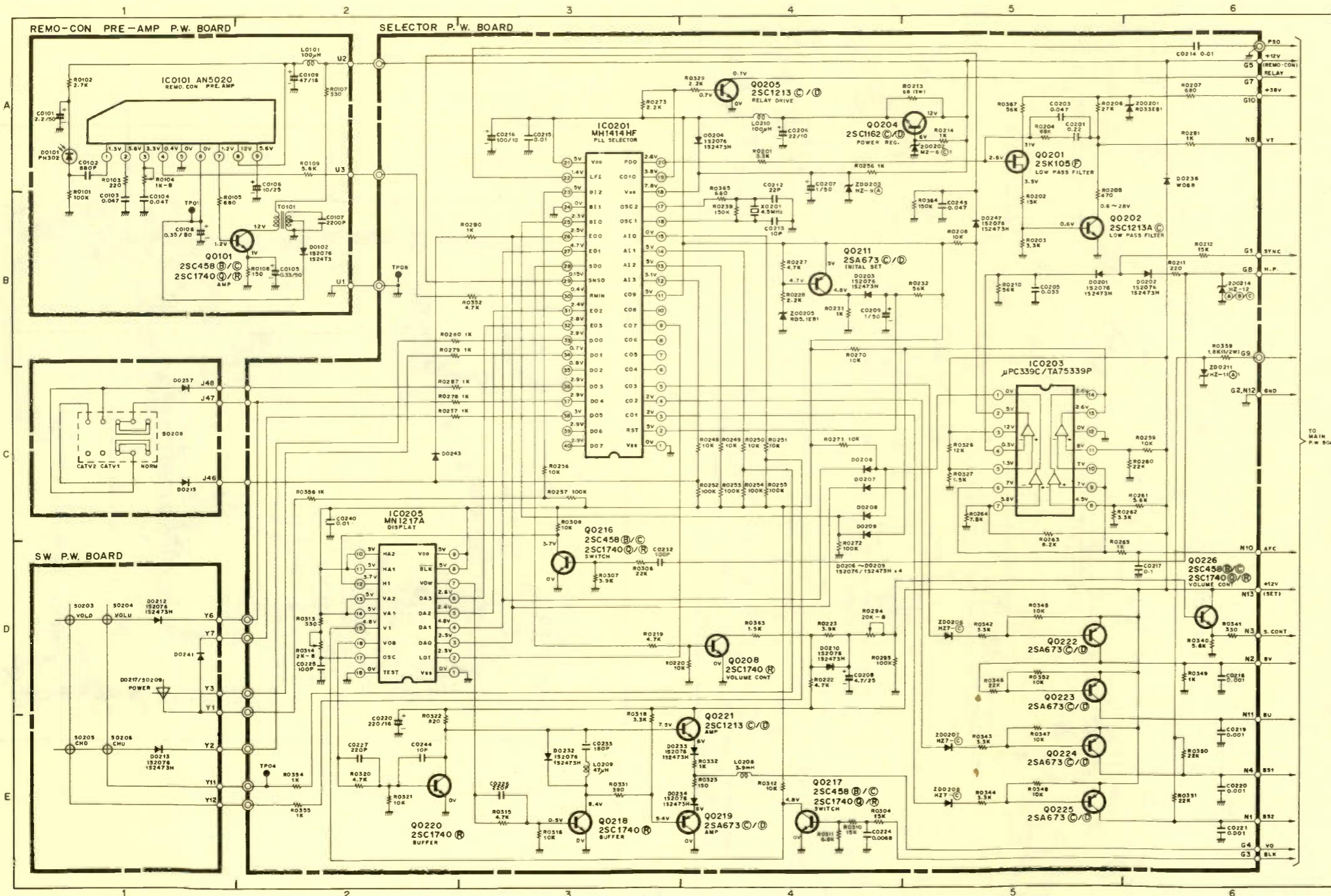

CONTROL P.W. BOARD

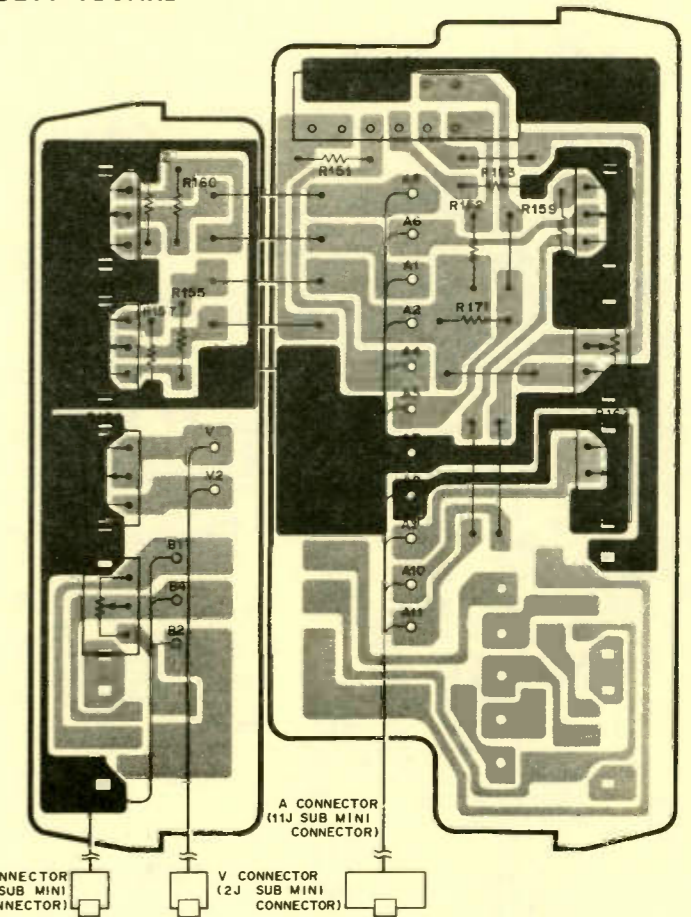

Electronic servicing precautions

By Homer L. Davidson

Every now and then, technicians need to be reminded to be careful while working on electronic entertainment products. Although the TV technician may not think his occupation can be dangerous, it can be (see Figure 1). Servicing a TV chassis, replacing the CRT, servicing the compact disc player and microwave ovens have a few dangers associated with them.

Before servicing any new consumer product, do you take the time to read the safety precautions listed in front of the service manual? You might say that's old stuff to me, but manufacturing innovations can lead to new servicing hazards that you may not be aware of. Play it safe. Following are some precautions that you should be mindful of.

The hot chassis

Today, just about every TV chassis you work upon has a hot ac chassis. The chassis may be at power line voltage, so touching it and touching earth ground at the same time could cause accidental shock. Some technicians stand on a rubber mat when they work. This provides electrical insulation, with an added benefit of foot relief.

Before beginning to service any TV chassis, plug it into an isolation transformer (see Figure 2). Make sure no grounded test instruments are connected to the chassis while it is connected to the power line unless it's connected through an isolation transformer. Failure to observe this precaution may cause damage to the test equipment and the TV chassis, as well as possible injury to the technician. Remember, some of these new TV chassis have both a hot and cold grounded chassis.

Connecting grounded ac test equipment to the TV circuits may place the

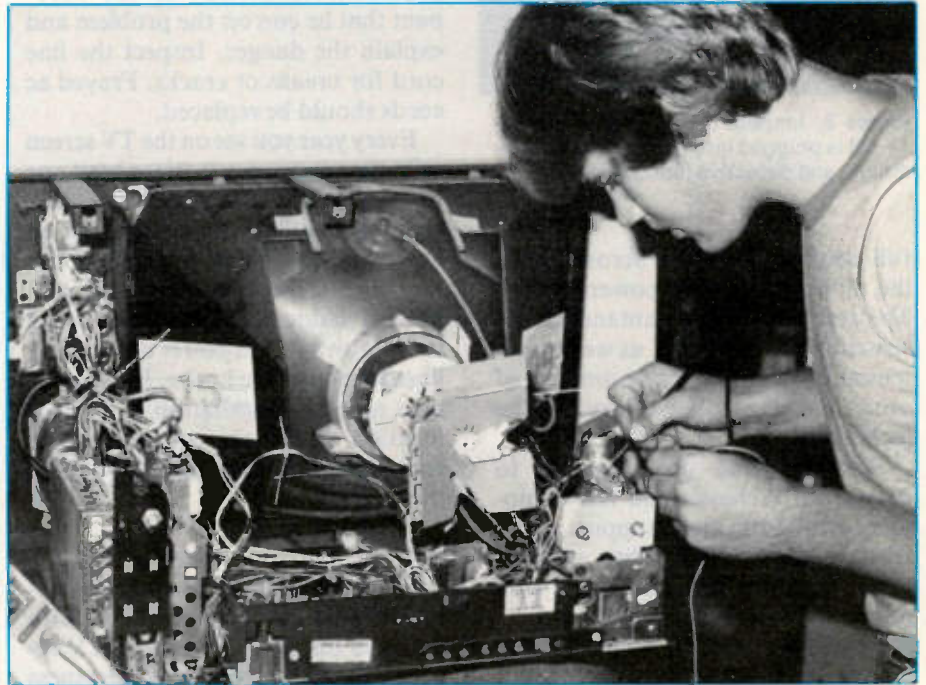

Figure 1. Be careful when taking voltage measurements around the picture tube or flyback transformer circuits.

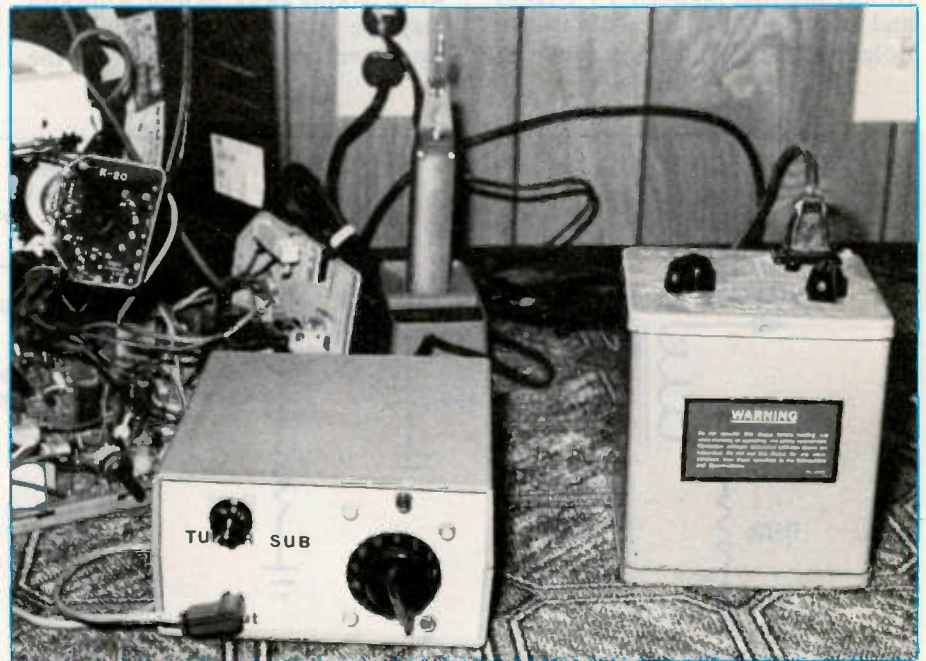

Figure 2. Always, use a variable isolation transformer when working on transformer like TV chassis. If you don't, besides damaging test equipment, you can destroy several parts in the TV set.

Davidson is a TV servicing consultant for ES&T.

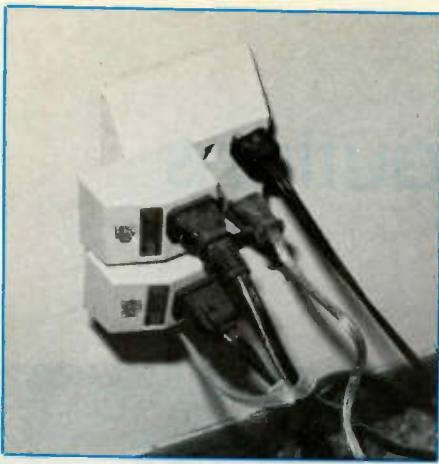

Figure 3. Inspect the outlets where the TV set is plugged into for overloaded conditions and defective line cords.

full power line voltage across one of the diodes in the TV power supply. The result will be instantaneous destruction of that diode, as well as potential for a considerable amount of other damage, plus injury to the technician.

Another good precaution is to keep the TV chassis and test equipment away from metal support posts, furnace ducts, and other exposed metal that you can touch and that may provide a good ground.

Remember, some TV chassis may have 85 to 90Vac between chassis and earth ground regardless of how the ac power plug is inserted. Service an ac TV set only with an isolation transformer inserted between TV chassis and power line. Choose a variable isolation transformer for servicing

the IHVT circuits and frequency controlled power supplies.

Power lines and power cords

When on a house call, check the power outlet receptacle for too many connecting cords (see Figure 3). Low voltage from an overloaded circuit may be the cause of poor TV operation. The overload could also be a fire hazard. If you encounter this problem, recommend to the occupant that he correct the problem and explain the danger. Inspect the line cord for breaks or cracks. Frayed ac cords should be replaced.

Every year you see on the TV screen or in the newspaper stories about one or two people who are accidentally injured or killed while repairing an antenna. Most antenna installers and servicing technicians use long aluminum ladders. Keep those metal ladders away from power lines and ac lines that enter the house. Pass up the next antenna installation if it's in a location where the antenna might some day come into contact with the power lines.

TV high voltage

Exercise extreme care when working around the picture tube. With voltages on parts of today's TV receiver exceeding 32KV, carelessness can be extremely dangerous.

It's not only the initial shock that may cause injury, but damage done when jerking away, as well. Knuckles may be smashed, expensive test equipment can be knocked off the

service bench, or tools may fly out of your hands causing injury to fellow workers.

Be careful when taking high voltage measurements at the picture tube anode terminal. Sometimes the high-voltage probe is difficult to get underneath the rubber anode socket, resulting in pulling off of the high-voltage instrument ground wire and the technician receives the full voltage. Make sure that HV meter ground wire is firmly clipped to the TV chassis. Take the HV measurements only with a high-voltage probe or HV probe connected to a VTVM.

After all TV repairs are finished, check for proper B+ or high voltage adjustment control, if the particular TV has that adjustment on it. Improper adjustment of this control may place excessive HV upon the picture tube. Excessive HV may cause an X-radiation hazard and TV breakdown. If the HV or B+ adjustment does not function, repair the defective power supply or horizontal output circuits (see Figure 4). The one minute adjustment may prevent another call back.

X-Ray radiation danger

Since higher voltages are found on the CRT in newer sets, the TV chassis may have a shut down circuit to disable the TV if the high voltage exceeds predetermined limits. In the early TV chassis, when the HV became excessive the horizontal circuits were disabled and the set went into horizontal lines. Today, many TV

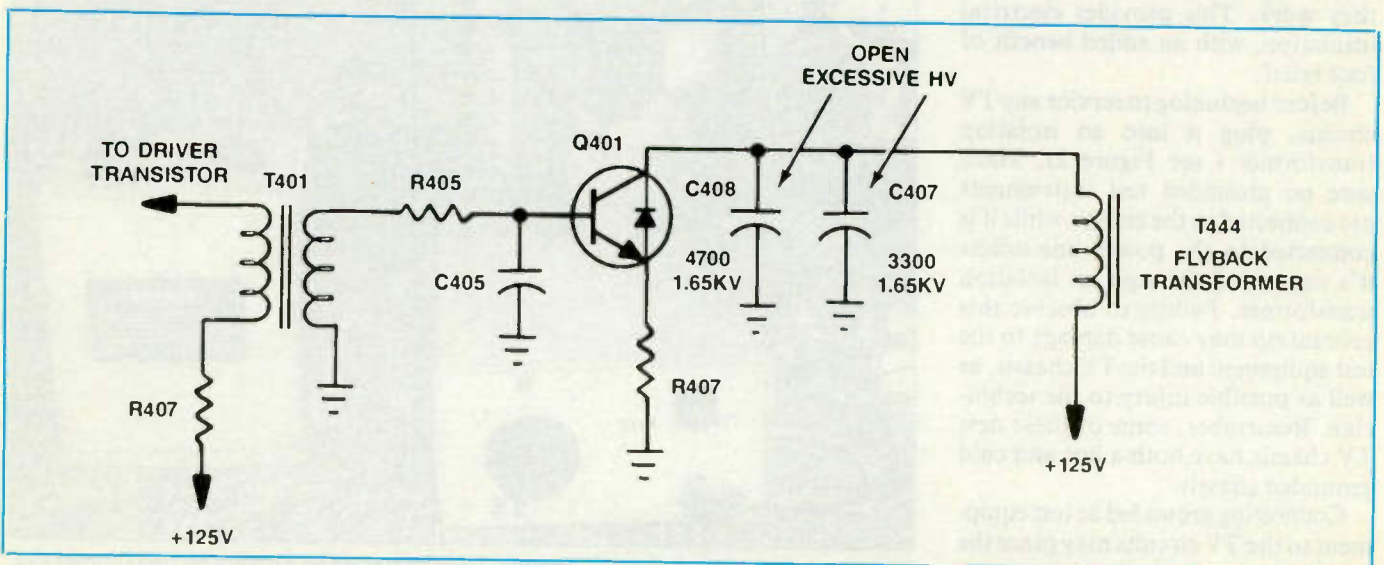

Figure 4. Excessive high voltage may result from an open bypass or tuning capacitor in the horizontal output circuits. Don't overlook excessive voltage from the low voltage power supply.

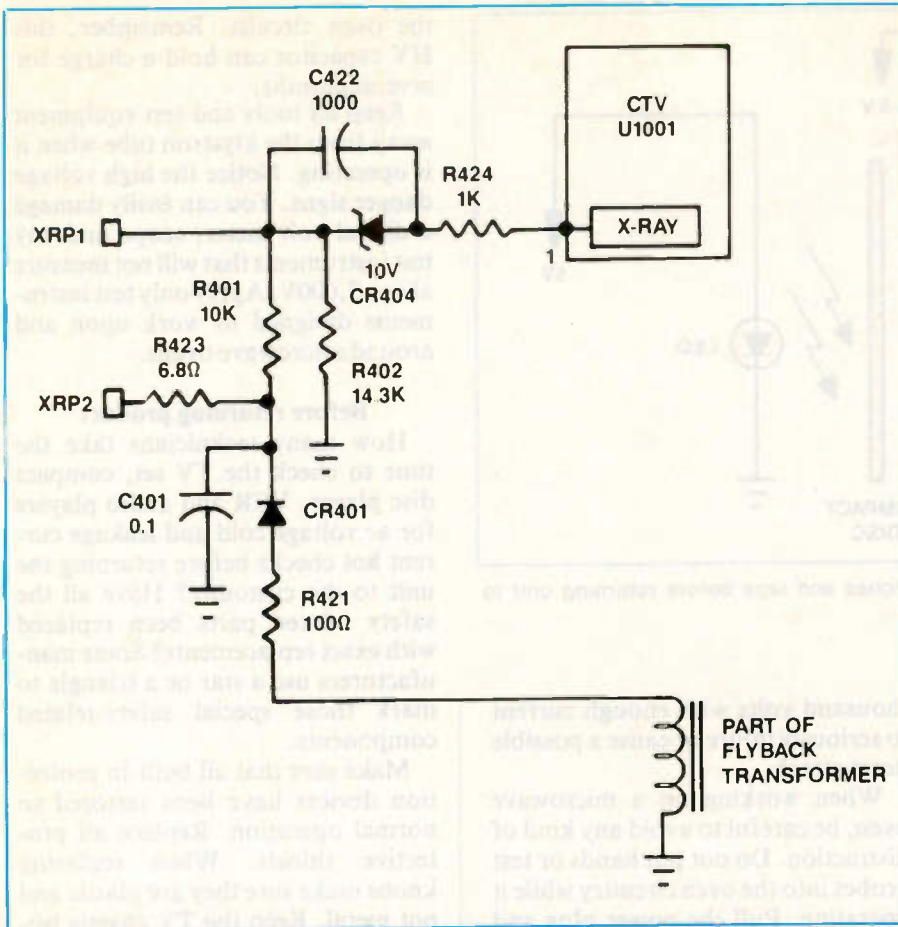

Figure 5. Make sure the X-radiation circuits are working in the TV set. Here in the RCA CTC136 chassis, XRP1 and XRP2 can be shorted to test HV shutdown circuits.

sets disable the horizontal output circuits, preventing excessive high voltage and causing HV shutdown.

In one such arrangement, the X-ray shut down circuit receives a negative pulse from the horizontal output transformer. If the high voltage goes higher, the negative pulse becomes more negative, increasing the voltage applied to zener diode CR404 (see Figure 5). This applies higher voltage to pin 1 of the CTV IC (U1001), activating the X-ray circuits, shutting down the horizontal drive pulse.

The X-radiation circuits should be tested routinely before returning the TV to the customer. In this RCA CTC136 chassis, simply short XRP1 and XRP2 and the chassis should shut down. If not, check for defective components in the protection circuits. When the HV X-ray circuits keeps shutting down the chassis, check for possible defective horizontal output or B+ defective circuits. Make sure the X-ray shut down circuits are working to protect the customer.

Replacing that picture tube

Extreme care should be exercised when removing and replacing the color picture tube. Besides being heavy, they can be dangerous if not handled properly. How many technicians have accidentally dropped the back TV cover down upon the neck of the CRT and snapped off the gun assembly? Not only is it dangerous in the home, it's embarrassing and downright costly.

Before removing the old picture tube, put on a pair of protective goggles. Do not carry the tube against your body. Do not handle the picture tube by the neck. Always, ask for extra help with these large picture tubes. Always protect the neck of the picture tube. Although some picture tubes are equipped with implosion protection, protect your eyes at all times.

CD laser beam

Your eyes can be easily damaged while servicing the innocent compact disc player. Take great care to be absolutely sure that the laser beam never enters the eyes (see Figure 6). Do not look directly at the laser beam coming from the pickup or allow it to strike against your fingers, skin or arms with power on. Keep your eyes at least a foot away from the laser di-

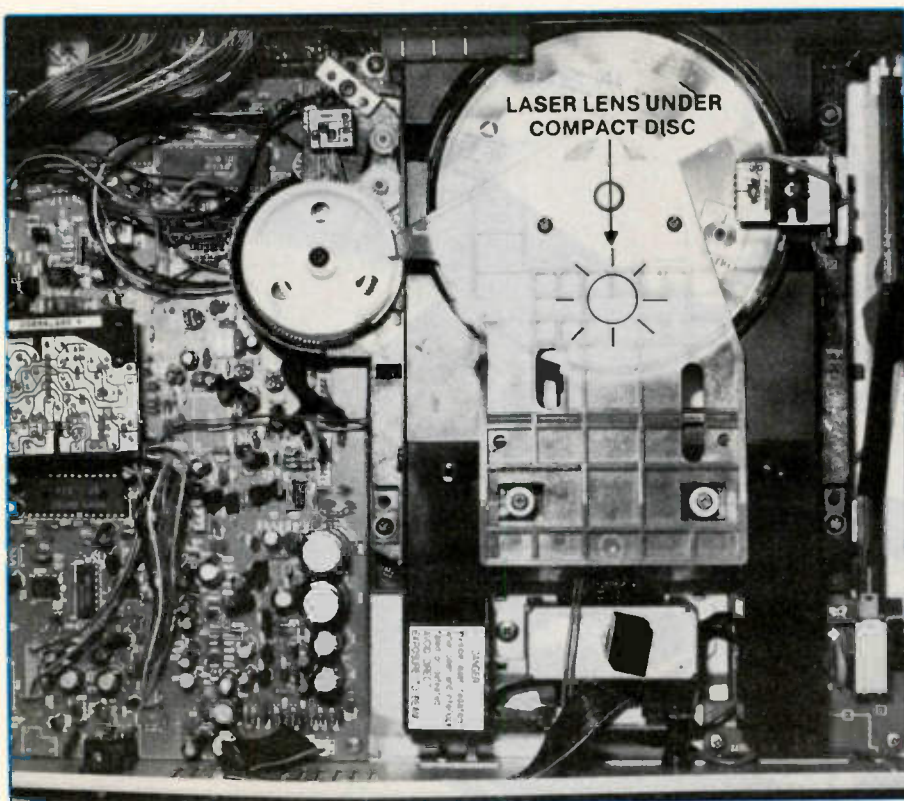

Figure 6. Keep a compact disc or cover the laser lens with tin foil when interlocks are defeated and the chassis is turned upside down for service.

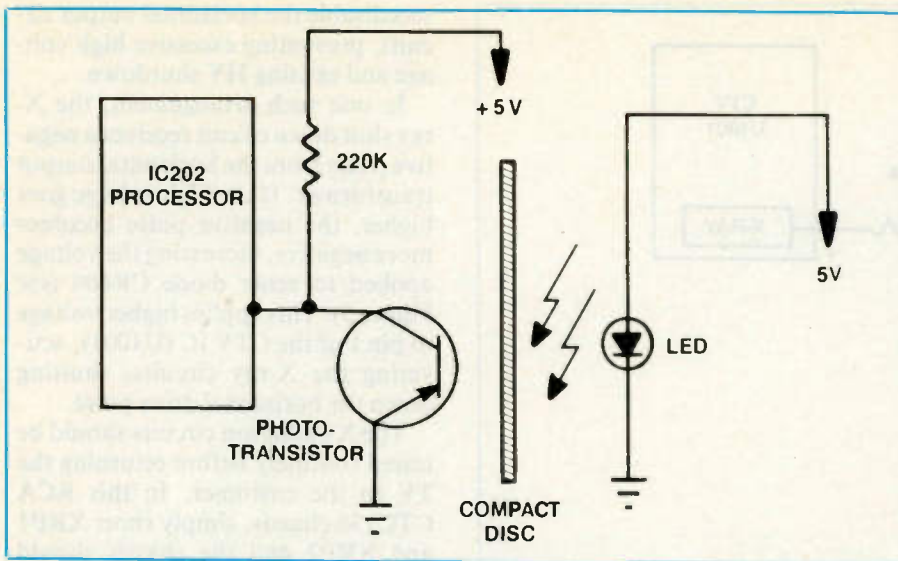

Figure 7. Remove all defeated interlocks, switches and tape before returning unit to customer.

ode. Remember, you can not actually see this laser beam.

Keep the compact disk on the turntable at all times, while servicing the CD player. If interlocks must be jumpered to service the player, make sure they are not still defeated when the unit is ready to be picked up or delivered (see Figure 7). Tape a piece of tin foil over the laser lens assembly if the unit must be turned sideways or upside down for servicing.

If the lens assembly must be cleaned, pull the ac plug. Remove the disc pressure lever assembly to get at the laser lens assembly. This unit looks directly upward to the compact disk. Dust off the lens area with an air brush used for cleaning camera lenses. When excessively dusty or dirty, carefully clean off with lens cleaning liquid with cotton swab or cleaning stick.

Replace all components and put a CD into the player before firing up the compact disk player. Remove clips and tape from around or over interlocks after repairs are made.

Microwave high voltage

After removing the back cover of the microwave oven, with the line cord disconnected, discharge the HV capacitor before attempting to do any service work (see Figure 8). Remember, each time the oven is fired up, this HV capacitor must again be discharged before you touch any components or attach test instruments for certain tests. This HV capacitor may charge up to several

thousand volts with enough current to seriously injure or cause a possible heart attack.

When working on a microwave oven, be careful to avoid any kind of distraction. Do not put hands or test probes into the oven circuitry while it operating. Pull the power plug and discharge the HV capacitor before clipping voltage or current meters to

the oven circuits. Remember, this HV capacitor can hold a charge for several months.

Keep all tools and test equipment away from the klystron tube when it is operating. Notice the high voltage danger signs. You can easily damage a digital volt meter, scope and any test instruments that will not measure above 3,000V. Apply only test instruments designed to work upon and around microwave ovens.

Before returning product

How many technicians take the time to check the TV set, compact disc player, VCR and audio players for ac voltage cold and leakage current hot checks before returning the unit to the customer? Have all the safety related parts been replaced with exact replacements? Some manufacturers use a star or a triangle to mark those special safety-related components.

Make sure that all built-in protection devices have been restored to normal operation. Replace all protective shields. When replacing knobs make sure they are plastic and not metal. Keep the TV chassis isolated away from the customer or children in the house. Replace all

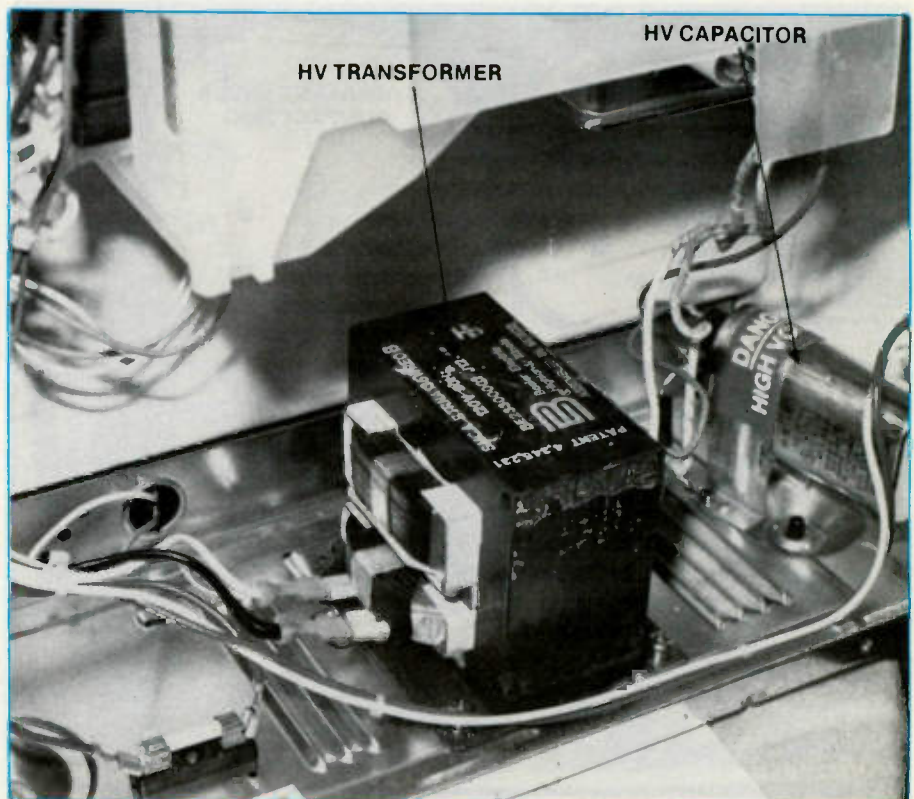

Figure 8. Discharge that HV capacitor in the microwave oven each time before touching any of the circuitry.

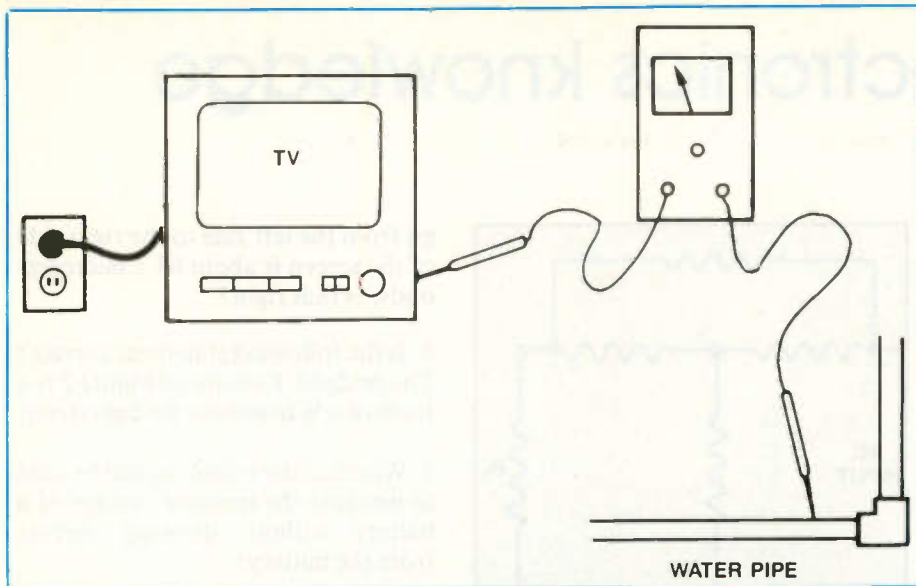

Figure 9. Check product for voltage and current leakage before returning to the customers.

back covers on the TV set, even while waiting for special parts.

For a chassis or antenna check, short the ac plug with clip wires. Rotate switch on. Connect one lead to the ac prong and the other lead to the antenna terminals or exposed metal screws at the rear cover of the ohm-

meter. If the measurement is less than $1M\Omega$, check for leakage within the TV set or commercial product.

Now check the instrument or unit for a hot current leakage test. Plug the unit into the ac power line with switch on, then turned off. Take the ac current test by touching metal

screws, front panel bezel, metal cabinet, and metal overlays with the leakage meter negative terminal grounded to a water pipe or earth ground. If the current exceeds 0.5mA, check for component leakage within the set (see Figure 9).

Notice when you connect either the TV set to the antenna terminals or replace the cable if you receive a shock or sparking occurs between the two hookups. If this happens, take a current or voltage measurement at once. Do not leave the unit in the home until adequate repairs are made.

Conclusion

Always, read the safety precautions in the front of the service manual, on a new or unknown product, before you begin servicing. Keep wide awake at all times when working around the hot chassis, high voltage and possible eye damaging equipment. Look and think before attaching test equipment. Keep fingers and hands out of dangerous places with the instrument operating. Proceed with precautionary measures, just take it easy, and maybe live a little longer. Be careful out there! ■

TRY VIDEO DISPLAY FIRST!

Why bother making a lot of telephone calls to find the CATHODE RAY TUBE or FLYBACK TRANSFORMER that you need. Your time is too valuable for that.

Make one call that has all of the answers:

800-241-5005 Ext. 22



300,000 tubes in stock

4,000 tube types

Monochrome and color

Flyback transformers

Most knowledgeable sales engineers

Custom engineering for discontinued types

Low prices

Longest warranty

Same day shipping; overnight if necessary

VIDEO DISPLAY CORPORATION
1868 Tucker Industrial Dr., Tucker, GA 30084 USA
(404) 938-2080 • (In US) 800-241-5005 • FAX 404-493-3903



Test your electronics knowledge

By J.A. Sam Wilson, CET

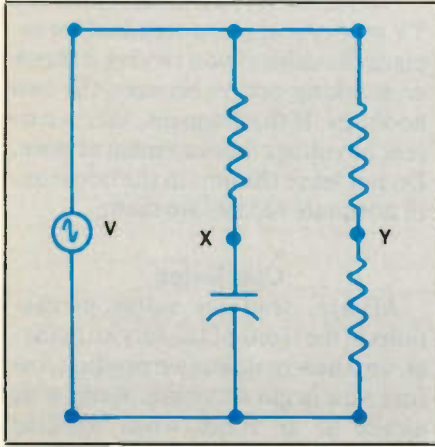

Figure 1.

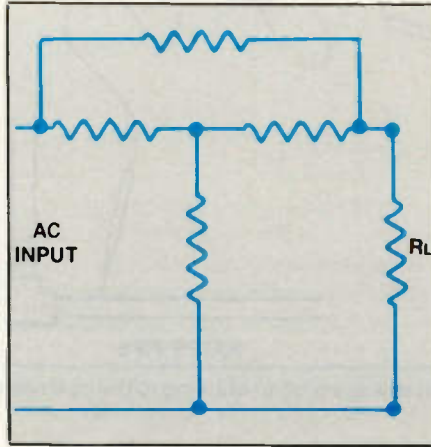

Figure 2.

1. Is the following statement correct? A comb filter is used to separate chrominance and luminance signals.

2. Which of the following statements is true regarding the circuit of Figure 1.?

- A. The voltage at point X lags behind the voltage at point Y.
- B. The voltage at point X leads the voltage at point Y.

Wilson is the electronics theory consultant for ES&T.

3. Is the following statement correct? When ac power is delivered to a TV set on two conductors, one of the conductors is earth grounded.

4. The ratio of signal-to-noise at the input of an amplifier to signal-to-noise at the output of the amplifier is called _____.

5. Assume the horizontal frequency in a TV set is 15,750 hertz. That means the time for the CRT beam to

go from the left side to the right side of the screen is about 63.5 microseconds. Is that right?

6. Is the following statement correct? The bridged-T circuit of Figure 2 is a form of a Wheatstone Bridge circuit.

7. Which of the following can be used to measure the terminal voltage of a battery without drawing current from the battery?

- A. Thermocouple meter
- B. Electrodynamic meter
- C. Voltmeter with a D'Arsonval meter movement
- D. Potentiometer

8. Is the following statement true? When a SAW filter is adjusted to twice its normal frequency it will pass only the harmonic frequencies of a sine wave input.

9. What is the name of the transparent scale fitted to the face of an oscilloscope CRT?

10. Is the following statement correct? The address bus in an 8-bit microprocessor has eight parallel conductors.

(Answers on page 53)

Looking For A Faster, Easier Way To Repair VCR's?

TENDEL Offers 4 Powerful, UNIVERSAL Tools Which Will...

- **CUT YOUR REPAIR TIME!**
 - Tentel Gauges Quickly & Easily Diagnose Mechanical Problems In VCR's
 - **ELIMINATE GUESSWORK!**
 - Tentel Gauges Are A Proven Method For Accurate Measurements To Help Restore VCR's To Factory Specifications
 - **FIND PROBLEMS BEFORE THEY HAPPEN!**
 - Often There Are Marginal Problems Accompanying Major Breakdowns, Tentel Gauges Help You Find Those Problems!
 - **STAND OUT FROM YOUR COMPETITION!**
 - Tentel Gauges Allow You To Find Problems Other Shops Can't Find
- Give Customers A Reason To Choose Your Service Center**

If You're a Whiz At Electronics, We'll Make You A Whiz With Mechanical Problems. Call Now TOLL-FREE To Find Out More About These Powerful Tools

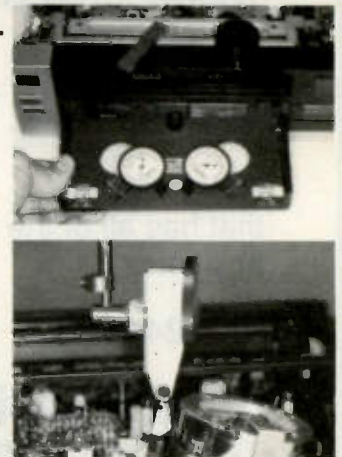

TENDEL® Corp.

4475 Golden Foothill Parkway
El Dorado Hills, CA 95630

Call For Your **FREE CATALOG**
(800) 538-6894 / (916) 939-4005

A glossary of television terms

In every technical profession there are large numbers of specific technical terms. Most of the terms are pretty well understood, but some terms remain fuzzy, and some others are defined colloquially so that they are imprecise.

For those reasons, it's helpful once in a while to review the definitions of those terms, and sometimes to introduce a few new terms that might have been introduced because of advances in the technology.

Following are definitions of some key terms that are used in conjunction with television.

AC-Coupled - A connection which removes the constant voltage (DC component) on which the signal (AC component) is riding. Usually implemented by passing the signal through a capacitor.

AM - Amplitude Modulation (AM) is the process by which the amplitude of a high frequency carrier is varied in proportion to the signal of interest. In the NTSC television system, AM is used to encode the color information and to transmit the picture.

APL - Average Picture Level. The average signal level (with respect to blanking) during active picture time, expressed as a percentage of the difference between the blanking and reference white levels.

Back Porch - The portion of the video signal which lies between the trailing edge of the horizontal sync pulse and the start of the active picture time. Burst is located on back porch.

Reprinted with permission from the book "Television Measurements: NTSC Systems," written by Margaret Craig, an Engineering Manager in the Tektronix Television Division, published by Tektronix, Beaverton, OR.

Bandwidth - The range of frequencies over which signal amplitude remains constant (within some limit) as it is passed through a system.

Baseband - Refers to the composite video signal as it exists before modulating the picture carrier. Composite video distributed throughout a studio and used for recording is a baseband.

Black Burst - Also called "color black", black burst is a composite video signal consisting of all horizontal and vertical synchronization information, burst, and usually setup. Typically used as the house reference synchronization signal in television facilities.

Blanking level - Refers to the 0 IRE level which exists before and after horizontal sync and during the vertical interval.

Breezeway - The portion of the video signal which lies between the trailing edge of the horizontal sync pulse and the start of burst. Breezeway is part of back porch.

Broad Pulses - Another name for the vertical synchronizing pulses in the center of the vertical interval. These pulses are long enough to be distinguished from all others, and are the part of the signal actually detected by vertical sync separators.

Burst - A small reference packet of the subcarrier sine wave, typically 8 or 9 cycles, which is sent on every line of video. Since the carrier is suppressed, this phase and frequency reference is required for synchronous demodulation of the color information in the receiver.

B-Y - One of the color difference signals used in the NTSC system, ob-

tained by subtracting luminance from the blue camera signal. This is the signal which drives the horizontal axis of a vectorscope.

Chrominance - Chrominance refers to the color information in a television picture. Chrominance can be further broken down into two properties of color: hue and saturation.

Chrominance Signal - The high-frequency portion of the video signal which is obtained by quadrature amplitude modulation of a 3.58 MHz subcarrier by R-Y and B-Y.

Color Difference Signals - Signals used by color television systems to convey color information in such a way that the signals go to zero when there is no color in the picture. R-Y, B-Y, I and Q are all color difference signals.

Component video - video which exists in the form of three separate signals, all of which are required in order to completely specify the color picture. For example: R, G and B or Y, R-Y, and B-Y to the luminance signal.

Composite video - A single video signal containing all of the necessary information to reproduce a color picture. Created by adding quadrature amplitude modulated R-Y and B-Y to the luminance signal.

CW - Continuous Wave. Refers to a separate subcarrier sine wave used for synchronization of chrominance information.

db (Decibel) - A decibel is a logarithmic unit used to describe signal ratios. For voltages $db = 20 \log_{10} (V1/V2)$

DC-Coupled - A connection configures so that both the signal (AC com-

ponent) and the constant voltage on which it is riding (DC component) are passed through.

DC-Restorer - A circuit used in picture monitors and waveform monitors to clamp one point of the waveform to a fixed DC level.

Demodulator - In general, this term refers to any device which recovers the original signal after it has modulated a high frequency carrier. In television, it may refer to: An instrument which takes video in its transmitted form (modulated picture carrier) and converts it to baseband. And secondly it refers to the circuits which recover R-Y and B-Y from the composite signal.

Equalizer - The pulses which occur before and after the broad pulses in the vertical interval.

Envelope Detection - A demodulation process in which the shape of the RF envelope is sensed. This is the process used by a diode detector.

Field - In interlaced scan systems, the information for one picture is divided up into two fields. Each field contains one half of the lines required to produce the entire picture. Adjacent lines in the picture are in alternate fields.

FM - Frequency modulation (FM) is the process by which the frequency of a carrier signal is varied in proportion to the signal of interest. In the NTSC television system, audio information is transmitted using FM.

Frame - A frame contains all the information required for a complete picture. For interlaced scan systems, there are two fields in a frame.

Front Porch - The portion of the video signal between the end of active picture time and the leading edge of horizontal sync.

Gamma - Since picture monitors have a non-linear relationship between the input voltage and brightness, the signal must be correspondingly pre-distorted. Gamma correction is always done at the source (Camera) in television systems: the R, G and B signals are converted to $R^{1/\gamma}$, $G^{1/\gamma}$ and $B^{1/\gamma}$. Values of about 2.2 are typically used for gamma.

Genlock - The process of locking both sync and burst of one signal to sync and burst of another, making the two signals completely synchronous.

Graticule - The scale which is used to quantify the information on a waveform monitor or vectorscope display. Graticules may either be screened onto the forceplate of the CRT itself (internal graticule), or onto a piece of glass or plastic which fits in front of the CRT (external graticule). They can also be electronically generated.

Harmonic Distortion - If a sine wave of a single frequency is put into a system, and harmonic content at multiples of that frequency appears at the output, there is harmonic distortion present in the system. Harmonic distortion is caused by non-linearities in the system.

Horizontal Blanking - Horizontal blanking is the entire time between the end of the active picture time of one line and the beginning of active picture time of the next line. It extends from the start of front porch to the end of block porch.

Horizontal Sync - Horizontal Sync is the -40 IRE pulse occurring at the beginning of each line. This pulse signals the picture monitor to go back to the left side of the screen and trace another horizontal line of picture information.

Hue - Hue is the property of color which allows us to distinguish between colors such as red, yellow, purple, etc.

Hum - Undesirable coupling of the 60Hz power sine wave into other electrical signals.

Intercarrier Sound - A method used to recover audio information in the NTSC system. Sound is separated from the video by beating the sound carrier against the video carrier, producing a 4.5 MHz IF which contains the sound information.

IRE - A unit equal to 1/140 of the peak-to-peak amplitude of the video signal, which is typically one volt. The 0 IRE point is at blanking level, with sync tip at -40 IRE and white extending to +100 IRE. IRE stands for Institute of Radio Engineers, the organization which defined the unit.

Linear Distortion - Refers to distortions which are independent of signal amplitude.

Luminance - The signal which represents brightness, or the amount of light in the picture. This is the only signal required for black and white pictures, and for color systems it is obtained as a weighted sum ($Y = 0.3R + 0.59G + 0.11B$) of the R, G and B signals.

Modulated - When referring to television test signals, this term implies that chrominance information is present. (For example, a modulated staircase has subcarrier on each step.)

Modulation - A process which allows signal information to be moved to other frequencies in order to facilitate transmission or frequency-domain multiplexing. See AM and FM for details.

Non-Linear Distortion - Refers to distortions which are amplitude-dependent.

NTSC - National Television System Committee. The organization which developed the television standard currently in use in the United States, Canada and Japan. Now generally used to refer to that standard.

PAL - Phase Alternate Line. Refers to the television system used in Europe and many other parts of the world. The phase of the chrominance signal alternates from line to line to help cancel out phase errors.

Quadrature AM - A process which allows two different signals to modulate a single carrier frequency. The two signals of interest Amplitude Modulate carrier signals which are the same frequency but did differ in phase by 90 degrees (hence the Quadrature notation). The two resultant signals can be added together, and both signals recovered at the other end, if they are also demodulated 90 degrees apart.

Quadrature Distortion - Distortion resulting from the asymmetry of sidebands used in vestigial sideband television transmission. Quadrature distortion appears when envelope detection is used, but can be eliminated by using a synchronous demodulator.

RF - Radio Frequency. In television applications, RF generally refers to the television signal after the picture carrier modulation process.

RGB - Red, Green and Blue. The three primary colors used in color television's additive color reproduction system. These are the three color signals generated by the camera and used by the picture monitor to produce a picture.

R-Y - One of the color difference signals used in the NTSC system, obtained by subtracting luminance from the red camera signal. The R-Y signal drives the vertical axis of a vectorscope.

Saturation - The property of color which relates to the amount of white light in the color. Highly saturated colors are vivid, while less saturated colors appear pastel. For example, red is highly saturated, while pink is the same hue but much less saturated.

Setup - In NTSC systems, video black is typically 7.5 IRE above the blanking level. This 7.5 IRE level is referred to as the black setup level, or simply as setup.

Subcarrier - The modulation sidebands of the color subcarrier contain the R-Y and B-Y information for NTSC, subcarrier frequency is 3.579545 MHz.

Synchronous Detection - A demodulation process in which the original signal is recovered by multiplying the modulated signal with the output of a synchronous oscillator locked to the carrier.

Termination - In order to accurately send a signal through a transmission line, there must be an impedance at the end which matches the impedance of the source and of the line itself. Amplitude errors and reflections will otherwise result. Video is a 75 Ohm system, so a 75 Ohm terminator must be put at the end of the signal path.

Unmodulated - When used to describe television test signals, this term refers to pulses and pedestals which do not have high-frequency chrominance information added to them.

Vectorscope - A specialized oscilloscope which demodulates the video signal and presents a display of R-Y versus B-Y. The angle and magnitude of the displayed vectors are respectively related to hue and saturation.

Vertical Interval - The synchronizing information which appears between

fields and signals the picture monitor to go back to the top of the screen to begin another vertical scan.

Waveform Monitor - A specialized oscilloscope for evaluating television signals.

Y - Abbreviation for luminance

Zero Carrier Reference - A 120 IRE pulse in the vertical interval which is produced by the demodulation to provide a reference for evaluating depth of modulation. ■

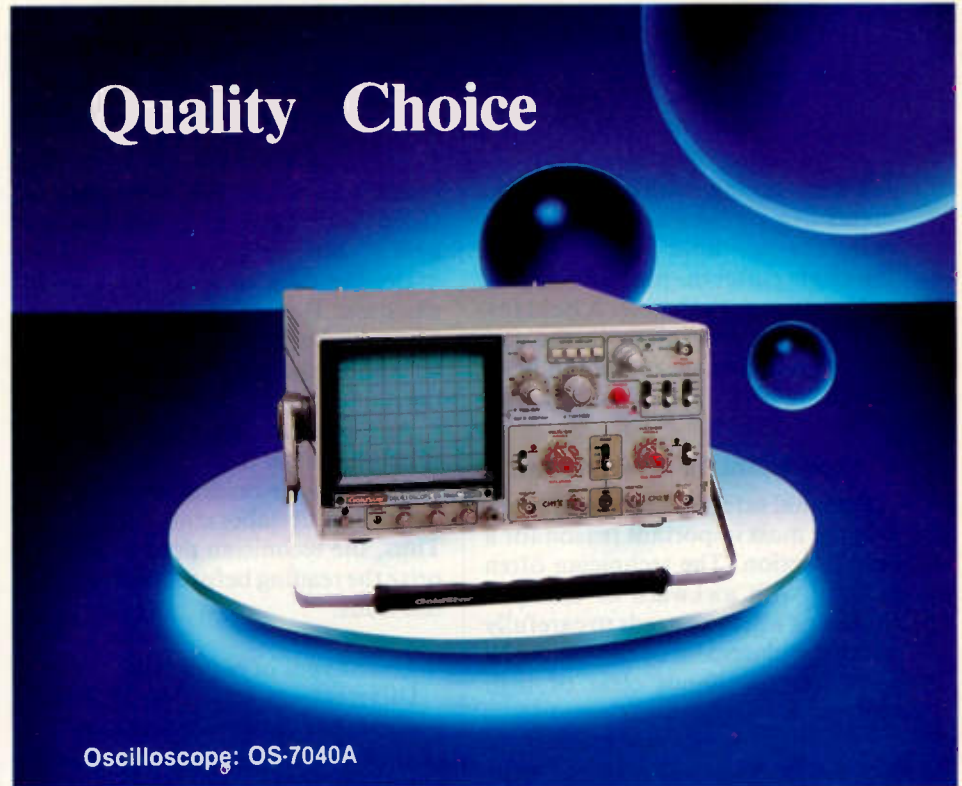

Oscilloscope: OS-7040A

OSCILLOSCOPE



•OS-7020A
20MHz, DUAL TRACE



•OS-8020R
20MHz, DUAL TRACE
CRT READOUT DISPLAY

FREQUENCY COUNTER & POWER SUPPLY



•FC-7011: 100MHz
•FC-7052: 550MHz
•FC-7102: 1GHz



•GP-103: 18V/1.0A
•GP-105: 30V/0.5A
•GP-233: 18V/1.0A, 18V/1.0A
•GP-235: 18V/1.0A, 30V/0.5A

DIGITAL MULTIMETER BENCH & HAND-HELD



•DM-7241: 4 1/2 DIGITS
MANUAL RANGING,
LED MEMBRANE
FUNCTION INDICATION



•DM-6335
3 1/2 DIGITS,
AUTO
RANGING,
MEMORY,
HOLD
FUNCTION



•DM-8135
3 1/2 DIGITS,
AUTO
RANGING,
MEMORY, HOLD,
TR, hFE CHECK
FUNCTION,
BAR GRAPHIC
DISPLAY



•DM-7333
3 1/2 DIGITS,
MANUAL
RANGING,
TR, hFE CHECK
CAPACITANCE,
FREQUENCY
FUNCTION



•DM-8433
3 1/2 DIGITS,
MANUAL
RANGING,
TR, hFE CHECK
CAPACITANCE,
TEMPERATURE
FUNCTION



•DM-8243
4 1/2 DIGITS
MANUAL
RANGING,
TR, hFE CHECK
CAPACITANCE,
FREQUENCY
FUNCTION



GoldStar Precision

13013 East 166th Street, Cerritos, Ca. 90701, U.S.A
Tel.: (213) 404-0101 Tx.: (910) 583-5719 LGILA
Fax.: (213) 926-0849

Circle (7) on Reply Card

When there is a need to hold a meter reading

By Bob Gesinger

When taking voltage measurements using a handheld multimeter, being able to "hold" the reading on the display after the probe is removed can often prove valuable. A hold feature can prevent injury to the user and prevent damage to the unit being probed.

Applications for a hold feature

Personal safety of the user is probably the most important reason for a hold function. The technician often is faced with awkward or cramped situations where he needs to carefully watch the placement of the test probe while keeping hands clear of high voltages or moving machinery.

In a high energy environment, a probe slip can cause a short in the electrical circuit resulting in serious injury to the user or damage to the meter. It can even cause the technician to accidentally fall into the work area.

The hold feature enables the technician to concentrate on placing and removing the test leads safely before turning to the meter to read the measurement.

Similarly, a probe slip can cause damage to the unit being tested. An example is a printed wire board with high density surface mounted components that use fine pitch lead spacing. A slip of the probe can cause two connections to be shorted together, damaging the board. Telephone interchange panels are another example of a type that poses difficulties for the technician.

A third application for holding the

reading is when the technician is faced with hard to reach components. Measuring voltage values under the dash of a car is a typical situation. Here the technician is laying on his back, and can't see the meter and the probed area at the same time.

As a convenience, a hold function is helpful when it is necessary to record the meter reading in a maintenance log or laboratory notebook. Thus, the technician need not memorize the reading before removing the test leads.

Types of meter hold

Different meters use different methods to hold the reading, and not all methods are appropriate in all applications. For example, an analog meter may use a pointer lock. Once the meter has the reading, the technician must turn to the meter to lock the movement pointer before removing the probes. As a result, this method of hold offers convenience only, and is not suitable for the other three applications noted above.

Some digital multimeters have a hold button on the meter, which locks the reading into the display. But as with the analog pointer lock, this is a manual function which must be performed on the meter while the test leads are still connected. For the same reasons as above, it is for convenience only.

Another type uses a hold button on the probe, itself, to lock in the reading display. Since the probe with button is already in the technician's hands, this method of hold would appear to be usable in most applications. However, there are drawbacks. The addition of the button increases the size of the probe, making

it difficult to reach into tight spaces. The technician is also limited to the use of this specific type of probe, which is not usable when using meter accessories such as high-voltage probes.

A fourth method is best described as semi-automatic. A button on the meter is pressed to engage the hold function before ever attempting to connect the test leads. When the probes are connected, the meter locks on to the reading and holds it with no further action required of the technician. Thus, in all applications, the technician can remove the test leads, and himself, from harm's way before turning his attention to the meter. However, after the measurement is noted, the technician needs to reset the hold cycle before another reading can be held.

The final, and most advanced, method is a fully-automatic hold. This feature holds consecutive stable readings without requiring the technician to manually reset the meter. The user engages hold by simply pressing a button on the meter, then connects the probes. When the reading has been captured, the meter emits an audible beep. The technician can then remove the probes, observe the reading, and probe another point without reinitializing the meter's hold feature.

Automatic hold now standard

This automatic hold was once reserved for high end models. Many of today's advanced DMMs now incorporate capacitance testing, frequency function and many other useful features.

The computer does it

A calculator-style microcomputer is used to control the digital circuitry

Gesinger is a product specialist for Service Equipment Group, John Fluke Mfg. Co., Inc.



of the meter. It is also programmed to perform the automatic touch hold algorithm. The computer looks for stable readings over a limited number of measurement cycles while ignoring readings from open test leads. For voltage and current measurements, open test leads result in low

readings; for ohms and diode-test measurements, open leads cause off-scale readings. When the computer senses a valid input, it generates the corresponding display, freezes it, and proceeds again to ignore open test leads until a new series of stable samples comes along. ■

LEARN to CLEAN/MAINTAIN/REPAIR CAMCORDERS



HUGE EXPANDING MARKET!

Work from your home - part-time or full-time! No prior experience needed - Average mechanical ability only requirement for your success! Over 15 million camcorders in use - Over 5 million expected to be sold in 1991 alone!

It is a fact that the vast majority of camcorder malfunctions (just like VCRs!) are due to simple mechanical failure... We can show you how to easily fix those breakdowns and earn an average of \$85.00/Hr. while working at home!

Get In Now - Soon camcorders will be like VCRs, i.e., one in almost every home.

For a camcorder cleaning job you can earn \$65.00 for less than 30 minutes work.

For a camcorder repair job you can earn over \$100.00.

FREE INFORMATION PACKAGE Call or write:

Toll-Free 1-800-537-0589

Viejo Publications, Inc.

5329 Fountain Ave., Dept. ESTC
Los Angeles, CA 90029

Circle (22) on Reply Card

Improve Your Form.

3-Part

A continuous feed form used for customer c.o.d. service or parts/accessory sales receipts

(N3CN). Not for warranty billing. Computer generated software to be available soon.

5-Part

Available in snapout (N5SN) or continuous feed (N5CN). Matching fields with N3SN.

except for customer estimate and receipts. For warranty billing.

7-Part

A universal snapout form (N7SN) designed for both customer service c.o.d. and manufacturer warranty billing.

Complies fully with the requirements of state and local ordinances, including California.

Discounts

Carbonless NESDA Forms are available to NESDA members at additional savings. For pricing information and samples, or information regarding other NESDA membership benefits, write to NESDA, 2708 W. Berry St., Ft. Worth, TX 76109; or call (817) 921-9061.

The NESDA Form

NESDA, 2708 W. Berry St.
Fort Worth TX 76109
Phone: (817) 921-9061

A N S W E R S



New Freeze Technology

- Antistat
- CFC-Free
- Chills Faster

New E-Series® Freeze-It® Antistat eliminates electrostatic charge. Safe for static sensitive components and environmentally engineered for enhanced productivity in electronic circuit applications.

Talk to our application engineers about the benefits of E-Series products. Call 1-800-645-5244

Chemtronics®
8125 Cobb Center Drive
Kennesaw, GA 30144
(404) 424-4888

 **Chemtronics®**

 Morgan

Circle (3) on Reply Card

Manage your personal finances carefully, too

What have you done for yourself lately?

If you're like many service dealers I know you keep more careful watch over the financial health of your business than over your own personal finances. That's not a good idea; both need and deserve your best efforts.

Here are a few thoughts on the subject: Perhaps the most important single financial instrument for self-employed persons today is popularly known as the Keogh plan. Virtually everyone who qualifies as self-employed can benefit from participation in some form of this retirement benefit. If you qualify and have not yet set up your own plan, you're working under a self-imposed handicap. If you have an accountant, slap his wrist for not having insisted that you set one up.

Take action now. Whatever you do, don't allow another year to pass without signing up. If you do, you'll be throwing money away.

An in-depth discussion of Keogh plans is not practical in this limited space, but the essentials are quite simple. Uncle Sam allows you to invest up to 20% of your net self-employed income each year in your personal retirement fund. You are allowed to choose from any popular investment vehicles for this money including CDs, stocks or bonds, government securities, money market accounts, even (heaven forbid) passbook savings accounts. Not only are your annual deposits into your retirement fund tax deferred, the interest or dividends they earn are also allowed to compound free of tax. The benefits of this feature over an extended time are truly astonishing.

In return for this concession, you must handle your fund as a retirement program - certain financial penalties will be assessed against any withdrawals before you reach age

59%. After you reach that age, though, you may withdraw your money in any amount without penalty. At that time, you must pay income taxes on the amounts withdrawn. Presumably, you will withdraw your money after retirement when you will likely be in a lower tax bracket; thus, your savings are compounded even further.

How much is this all worth? Assuming a 28% tax bracket, and an annual deposit of \$6,000, 28% of the deposit (\$1,680 in this case) is an immediate saving. You would have paid that amount as income taxes in the current year. Instead, the government allows you to deposit those dollars in YOUR retirement fund. And this can happen every year, with the amount varying in accordance with your earnings, your tax bracket, and how well you can spare money for your future. From there, the magic of compound interest will perform its miracles.

If you happen to be an employee (even in your own corporation) the Individual Retirement Account (IRA) is for you. Same general principles, but the limit on annual deposits is \$2,000. If you are an employee and also have self-employed income, you may be eligible for (gulp) both plans. Recent legislation has imposed new limitations on the amounts of tax deferred deposits that may be put into an IRA by certain employees, so it's important to check with your accountant or tax advisor on this type of plan.

Caution: Keogh and IRA are *not* places to park idle funds that you may need to withdraw for college tuition or the down payment on your new home. Despite some recent relaxation of the rules on this type of withdrawal, you should feel reasonably sure that you can wait until retirement to draw on this money.

Your accountant or financial institution can supply you with detailed information on either plan, but get there soon. By now it is probably

clear to you that Social Security is destined to fall woefully short on *security*. Only you can provide properly for your comfort and security in your retirement years.

But what about now? Building future security while enjoying maximum purchasing power from the dollars you spend today is the most sensible financial goal of all, but to do it, you must put the basics of sound financial management to work for you. With interest rates at their lowest point in some years, and still falling, it's important that you make the small effort necessary to learn the options open to you for the investment of any other cash that you may have available.

Certificates of deposit, a relatively new form of investment, run from six months to as long as seven years. They make it possible for individuals to enjoy interest rates on savings that are only marginally lower than those paid for the largest corporate deposits. But please don't keep any money in a passbook savings account. Checking accounts that pay about the same rate of interest, and money market accounts that allow immediate access to your money, have made passbook accounts obsolete for the knowledgeable investor.

If you are concerned about your family's security after your death, you should be aware of current federal legislation involving estate taxes. For all practical purposes, all but the largest estates involving a surviving spouse will now escape federal estate taxes. This has implications involving such matters as joint ownership and the wording of wills.

Today, personal financial management is every bit as important as the management of business finances. And anyone who can steer his company ship through tricky fiscal waters can easily learn to do the same for his personal assets. When it comes to protecting the financial health of yourself and your family, you must learn to be your own doctor.

Lynott is president of W.J. Lynott Associates, a management consulting firm specializing in profitable service management and customer satisfaction.

Presenting an affordable Light Box System.

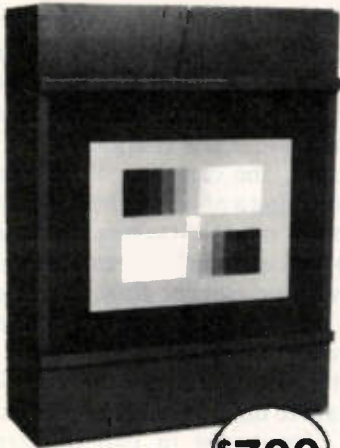

Model TR100 CB
Camera Light Box
with (2) transparencies

- (2) 3200° Kelvin Lamps (meets mfr. spec.)
- 1-year conditional guarantee
- Transparencies mounted in acrylic with optical scratch-resistant surface
- 11-step gray scale transparency
- 7-Bar color transparency
- All orders are shipped within 72 hours, U.P.S.

\$799

The method most
manufacturers recommend

NUTRONIX (313) 726-1278



P.O. Box 77103 • Sterling Hts., MI 48077



Circle (11) on Reply Card

Infrared Remote Tester

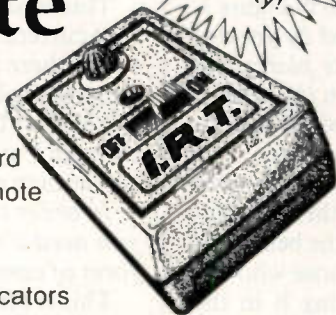

- Checks All Keyboard Operations on Remote
- High Sensitivity for Checking Range
- LED and Tone Indicators
- Uses Standard 9 Volt Battery (Not Included)
- Designed and Made in the USA

Added Bonus!

Service Tips on Repairing Remotes

- Special Introductory Price, only \$54.95
With soft carrying case, \$62.95. (Add \$5.00 shipping, WI residents add 5.5% sales tax, No C.O.D.s please)



To Order Dial

1-800-388-2356

Hours 10:00 a.m. to 5:00 p.m. C.S.T. M-F
(Please allow 3-4 weeks for delivery)

I.R.T., a product of SIRIUS TECHNOLOGY, a division of Tainter Lake Electronics, R.R.2, Box 196A, Colfax, WI, 54730 Ph. (715) 962-3592

Circle (25) on Reply Card

DUST-OFF PLUS® GOES TO EXTREMES

In the real world, dust and lint often end up in places where no ordinary duster can reach. Far from ordinary, Dust-Off Plus, with the patented 360° Vector Valve®, is the first and only product designed to safely blast dust out of tough-to-reach places so office equipment stays up and running!



Our revolutionary Vector Valve swings up, down and in full circles to deliver moisture-free blasts targeted

exactly at your most difficult dust problems. Perfect for keyboards, disk drives, copiers,



fax machines, audio/video equipment, Dust-Off Plus lets you easily reach places no duster has ever gone before!

Dust-Off Plus is the type of innovation you expect from America's #1 name in pressurized dusters. Go to work on dust with a supply today.

FALCON

Now Dust Has No Place To Settle

Falcon Safety Products, Inc.
Branchburg, NJ 08876
(908) 707-4900 • FAX (908) 707-8855

Circle (6) on Reply Card

The full moon syndrome

By J.A. Sam Wilson, CET

Recently I wrote an article called "Electronics with Butter and Jelly." It appeared in this magazine. I mentioned a few of the misconceptions that are floating around about basic theory. I have been asked by a number of people to expand on that material.

The ideas in that article are based upon the basic models used in teaching electronics. Those models are very important in getting students started in electronics, but, they should not be considered to be written in stone. In my opinion, there is a time in the career of a technician when those models should be modified and expanded. More accurate information as we know it should be substituted when possible.

Every time I have done this in the past I got a tub full of strange mail. I am sure that much of it is written in the light of a full moon. The problem is that I am stepping on some ideas that people have believed to be absolutely true for a long time. They get married to their models, and the idea of a divorce is out of the question.

Models have limits

In most cases when electronics concepts are explained by the use of models the model is not 100% wrong. For example, I know the limitations of the electron current concept, but, whenever I am checking out a circuit I still trace electron current paths. Here is an explanation of the statements given in this article. In each case I will repeat the incorrect statement first.

For a parallel-tuned circuit, the equation for the parallel resonant frequency is the same as for a series-tuned circuit.

I discussed this recently in this magazine and sent the derivation of the parallel resonant frequency equation to anyone who asked for it. If you like your theory laced with a

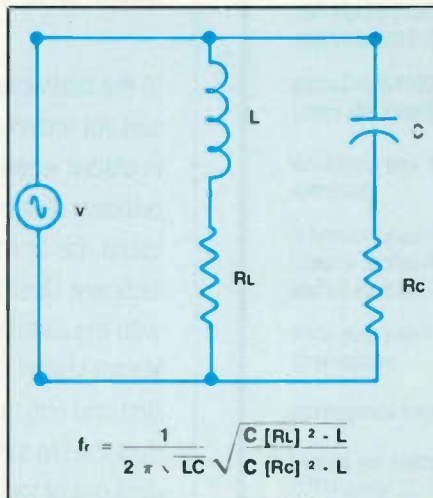

Figure 1.

large helping of math, send two postage stamps and I'll send you one. Better still, review the material in a previous issue.

The series and parallel equations are the same IF , and only IF , the resistances in the parallel branches can be considered to be zero ohms. The complete equation is given in Figure 1.

A capacitor is charged by forcing electrons into one of its plates and drawing them away from the other.

Ben Franklin designed an experiment that corrects this notion.

I have described this experiment many times in this and other publications. I'll do it again for the benefit of newer subscribers and those who did not get around to reading it in the past.

Figure 2 shows two pails made of a conducting metal separated by a pail made with an insulating material. The three pails form a capacitor. A high voltage - say a half million volts - is used to charge that capacitor. Then the pails are carefully taken apart.

The metal pails are assembled as shown in the illustration. Since unlike charges are attracted, if there were more electrons in one pail in the other the charge would be neutralized in this step!

In the final step the three pails are reassembled. An arc is drawn between the metal pails showing that the capacitor is still charged.

Clearly, the capacitor is charged by producing a physical change in the dielectric - not by changing the direction of electrons in the metal plates.

Electronic current flow is actually a flow of tiny particles called electrons.

In the first place, it is not entirely accurate to describe electrons as particles. They exist in two different states: *Particle* and *Energy*. There is a famous principle in science called the "Heisenberg Uncertainty Principle." It says you can't tell if an electron is a particle or energy at any particular instant of time.

In addition to the fact that the description of electron flow as a flow of *particles* is not accurate, there is another problem. Electron current is usually described as a flow of free electrons. They are electrons that are easily separated from their atoms in a metal.

This concept does not explain electron current flow in a P-type material where there are not enough free electrons to explain the current.

Physics books call the current through P-type material "hole flow" rather than electron flow.

In order to have a flow of current you need a voltage source and some form of conductor.

This is actually two statements.

First, I will address the idea that you need some form of conductor in order to have a current flow. Current flows easily through a vacuum and a vacuum is an insulator - not a conductor. Even though vacuum tubes have all but disappeared, we still have the cathode ray tube to demonstrate that idea.

Second, an electronic current is more accurately described as a flow of *charge carriers* (electrons and holes).

At room temperature there is a current flow in a resistor that is not

Wilson is the electronics theory consultant for ES&T.

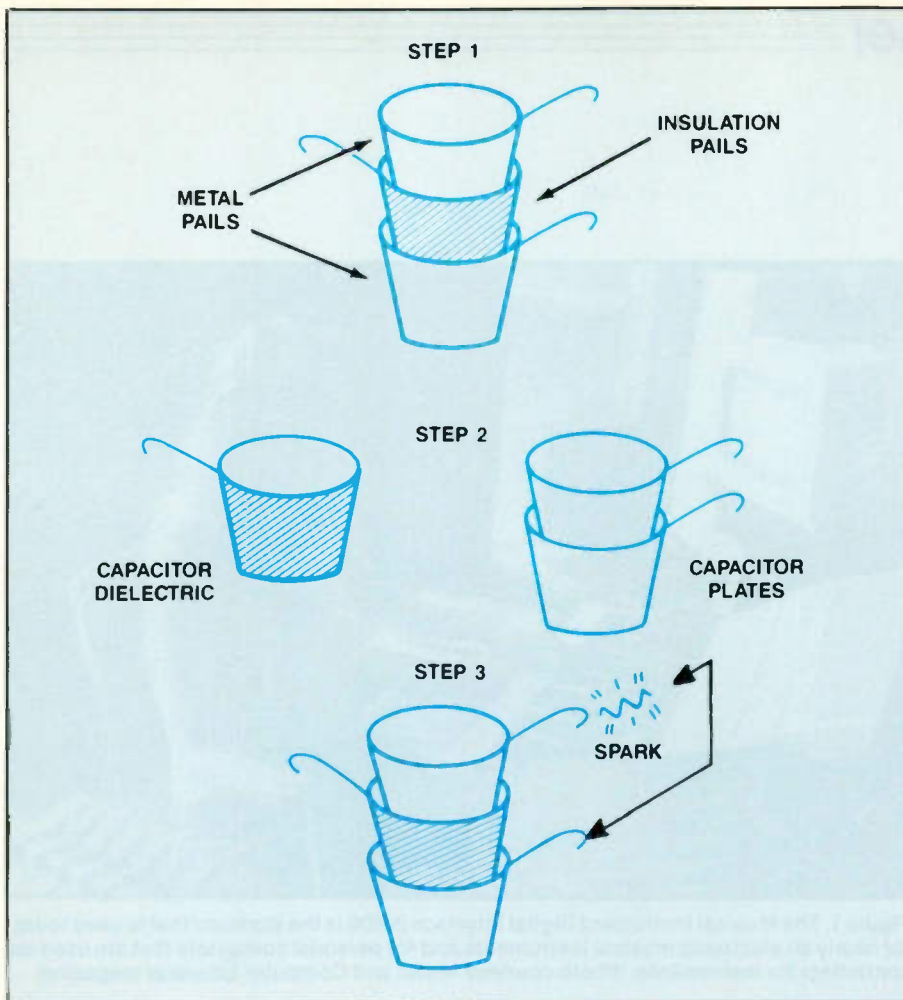

Figure 2.

connected to anything. It is called an *intrinsic current*. It is very small random current in the resistor. It produces a voltage across the resistor at all temperatures above absolute zero (zero degrees Kelvin). The voltage consists of random peaks, and, it is called a *noise voltage*.

The noise voltages are very important when you are considering noise in high-frequency equipment. For example, if you connect a resistor across the antenna terminals of a radio or television receiver you will inject the noise voltage into the first r-f amplifier.

Another name for the noise (voltages) generated by random currents in resistors is thermal agitation noise. It increases as the temperature increases. It is this noise that causes the hissing sound in a speaker when you turn the volume up and detune the receiver.

You may not hear an increase in loudness of the hissing noise when you connect a resistor across the an-

tenna terminals. That depends upon the amount of noise already present and the AGC, noise limiter, and, other circuits in the receiver.

There are other examples of current without an accompanying voltage.

Voltage is the force or pressure that pushes electrons through a conductor.

This idea comes from the fact that like charges repel and unlike charges attract. So, the negative terminal of a battery pushes the electrons away and the positive terminal attracts them. It is an easy step from there to the idea that the voltage across the battery terminals is a force or pressure that moves the electrons.

Voltage is not a force or pressure. Voltage is a unit of work. I wish I had room at this point to go into that further. It explains a lot of things about circuit behavior. Later.

Electronic current can flow in a material if it has a surplus of free electrons. Materials without free electrons are insulators.

This subject has already been discussed.

A speaker converts electric energy to sound energy; and, a microphone converts sound energy to electric energy.

With the possible exception of theoretical atomic devices, there is no device that can convert energy directly from one form to another. The idea comes from a *model* of a transducer, such as a speaker or microphone which says a transducer is a device that converts energy from one form to another. Carried to the component world, that statement translates to "a speaker converts electric energy to sound energy" and "a microphone converts sound energy to electric energy."

These statements are not true, but, they are useful as models.

The technically correct definition of a transducer is a device that permits the energy of one system to control the energy of another system.

If you happen to invent a device that does convert energy directly from one form to another, don't tell anyone! Just get in touch with your new partner . . . Sam Wilson, CET ■

LEARN TO CLEAN/MAINTAIN/REPAIR FAX MACHINES

HUGE NEW UNTAPPED MARKET!

**EARN
\$65/HRI**

Over 8 million Fax machines in homes/offices - predictions are for over 25 million by 1992!

- Work from your home/van
- Home study program gets you started servicing fax machines in 2 weeks!
- No special tools/equipment needed
- Earn additional profits selling fax supplies!
- Fax machines are not cheap - therefore, you can get good \$\$ for the repair
- Average Fax machine requires professional service every 18 months.
- Home study training program includes full instructions on EVERY ASPECT of Fax maintenance/repair. FULL COVERAGE of how to set up your home-based service business

FREE DETAILS
CALL 1-800-537-0589
Or Write to: Viejo Publications, Inc.
5329 Fountain Ave. Dept. EFX
Los Angeles, CA 90029

What's Midi?

By John Shepler

In servicing electronic music keyboards or some personal computers, you may have come across a connector labeled "MIDI" and wondered how it is used. This column will be a brief introduction to the Musical Instrument Digital Interface, generally abbreviated MIDI and pronounced like "city."

MIDI came about in the early 80's as the electronic music business was beginning to take off. Up to that time, musical synthesizers were large expensive devices used only by movie and TV studios and a few musicians. The connections between instrument modules were made with patch cords. The interface characteristics were different for each manufacturer. What was desired was a common standard, like RS232, so that a synthesizer from one company could talk to a sound module or sampler from another.

MIDI is the standard that is used today for nearly all electronic musical instruments and for personal computers that are used as controllers for instruments. The MIDI connector is also a standard. It is a 5 pin DIN connector. You'll see these female connectors labeled MIDI IN, MIDI OUT, and MIDI THRU. A MIDI cable consists of two 5 pin male DIN connectors and a shielded twisted pair cable up to 50 feet long.

The MIDI signal is a serial data bus that runs at 31.25 Kbaud. The data is asynchronous with a start bit, 8 data bits, and a stop bit. This is similar to the serial buses on computers. MIDI however, is a one way bus. For bi-directional communication you need two ports and two cables. The circuit is a 5mA current loop rather than a voltage level. Logical 0 is current ON at 5mA. Logical 1 is current OFF. You can buy test probes that plug in the MIDI OUT jack and indicate an active port by flashing an LED.

Because MIDI is a single data path, only 3 of the 5 DIN pins are used. Pin 2 is always the cable shield and also ground on MIDI OUT and



Figure 1. The Musical Instrument Digital Interface (MIDI) is the standard that is used today for nearly all electronic musical instruments and for personal computers that are used as controllers for instruments. (Photo courtesy Music and Computer Educator magazine)

MIDI THRU. Pins 4 and 5 are the serial data. Pins 1 and 3 are not connected.

The data on the MIDI bus consists of 8 bit words that are either status words or data words. These are called "MIDI messages." The status word tells what type of command is being issued and which of 16 receivers should use the status and following data words. The MIDI bus is similar to a LAN in this respect. There is one transmitter and 1 to 16 receivers all connected to the same bus. The channel number tells which receiver the data is intended for. Some status words broadcast data for use by all channels.

How is MIDI actually used? A musician shops the music stores for a synthesizer, drum box, sound modules, sampler, and sequencer. These instruments are then connected using MIDI cables from MIDI OUT to MIDI IN. MIDI THRU simply repeats the data on MIDI IN so that several instruments can be daisy-chained together on the same bus.

The sequencer is generally the controlling instrument. This works something like the roll on a player

piano. It generates a sequence of note commands for the other instruments to play. Remember that the MIDI bus does not transmit digitized audio. It consists of commands and data for musical instruments to generate the audio. This is why such a slow data rate (31.25 Kbaud) is acceptable for MIDI.

Computer sequence programs use PC software to edit the music sequence and can actually display and print sheet music for the composition. The sequencer is the master or transmitter. The other instruments that actually make the music are the receivers or slaves. A sound device is a device that has no keyboard. It is a slave device that generates audio based on MIDI messages. Sound modules emulate pianos, guitars, horns, or other instruments.

With the price of digital electronics dropping every year, it is likely that you will get involved in servicing MIDI equipment at some time. Look for books on MIDI in the music section of book stores. A very good technical description of MIDI is contained in *The MIDI Manual* by David Miles Huber, published by Sams. ■

Shepler is an electronics engineering manager and broadcast consultant. He has more than twenty years experience in all phases of electronics.

Test your electronics knowledge

Answers to the quiz (from page 42)

1. Correct. The comb filter delays one line, then adds and subtracts the delayed signal from the composite signal.

2. B. In a capacitive circuit the voltage lags the current.

3. Correct. You cannot always rely on a TV chassis being safe because it has a polarized plug. That type of plug is supposed to put the chassis at ground potential. However, if a home handyman has been busy, the AC lines can be reversed. Always check the polarity of AC lines in the home.

4. Noise factor. This is the definition of the term noise factor.

5. Not right. It takes about 53.5 mi-

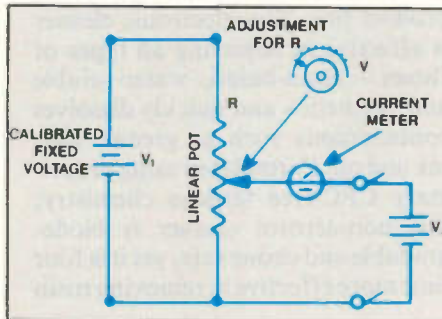

Figure A.

croseconds to trace one line on the CRT.

6. Correct. Redraw the circuit connecting the common points. Then, redraw the circuit again as a Wheatstone bridge.

7. D - Figure A shows a simplified

version of a potentiometer. In this circuit V_1 is a fixed voltage that has been calibrated so that the markings on the linear variable resistor correspond to precise voltage values. Voltage V_2 is to be measured. When the dial (V) is adjusted so that no current flows, the voltage reading of V is the same value as V_2 .

8. Not true - for two reasons. There are no harmonic frequencies of a pure sine wave. Also, SAW (Surface Acoustic Wave) filters are not adjustable.

9. Graticule - It serves as a reference for measuring voltage, current, time etc.

10. Not true. The address bus of an 8-bit microprocessor carries 16 bits.

333 New ECG® Capacitors, Accessories In Catalog.



Miniature general-purpose aluminum electrolytic radial and axial lead caps; AC motor start and AC motor run versions, plus accessories. Catalog: 740 cross references for 9 brands, applications guide. Ask for a copy at 900 Philips ECG distributor locations or call 1-800-526-9354.



Philips ECG



PHILIPS

Circle (13) on Reply Card

New ECG® Semis Master Guide Marks Silver Anniversary.



From the pioneer and leader in universal replacement semis, 300 new products, 21,000 more crosses. Easy cross-referencing of 4,000 ECG devices to 262,000 industrial and entertainment part numbers. At 900 Philips ECG distributor locations or call 1-800-526-9354.



Philips ECG



PHILIPS

Circle (14) on Reply Card

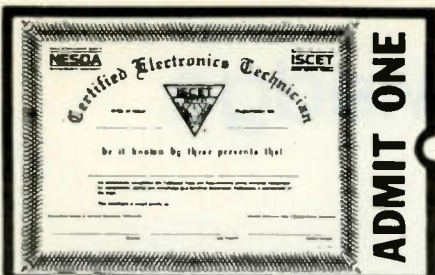

Your Ticket To SUCCESS

Over 28,000 technicians have gained admittance worldwide as certified professionals. Let your ticket start opening doors for you.

ISCET offers Journeyman certification in Consumer Electronics, Industrial, Medical, Communications, Radar, Computer and Video. For more information, contact the International Society of Certified Electronics Technicians, 2708 West Berry Street, Fort Worth, TX 76109; (817) 921-9101.

Name _____

Address _____

City _____

State _____ Zip _____

Send material about ISCET and becoming certified.

Send one "Study Guide for the Associate Level CET Test." Enclosed is \$10 (inc. postage).

SAVE TIME

For fast, accurate service, please remove the peel off label used to address your magazine, and attach it to the Reader Service Card, the Address Change Card or to any correspondence you send us regarding your subscription.

Products

CFC-free cleaner

Chemtronics has added a new all natural cleaner/degreaser, E-Series Chem-Solv, to its expanding E-Series product line. This electronic cleaner is effective in removing all types of fluxes - rosin-based, water-soluble and synthetic - and quickly dissolves contaminants such as grease, dirt, ink and oil. Formulated using proprietary CFC-free terpene chemistry, this non-aerosol cleaner is biodegradable and ozone safe, yet it is four time more effective in removing rosin



than conventional TMS-based flux removers. The solvent evaporates without leaving any residue, eliminating the need for a secondary rinse. This multi-purpose cleaner works on every phase of electronic and electrical equipment maintenance, including PWB's, connectors, motors, controls and relays.

Circle (62) on Reply Card

DMM catalog

BelMerit Corp introduces a new product catalog that details the manufacturer's line of digital and analog multimeters, function generators, frequency counters, ac/dc power supplies, accessories and product specifications are covered.

Smart CRT restoration system

The new automatic Beltron System 2000 CRT Restorer from Conway Manufacturing is designed to facilitate computer CRT maintenance and

repair service. The microprocessor controlled unit greatly simplifies the testing, cleaning and restoration of problem CRT's on-site, typically within 10 minutes to minimize customer downtime, according to the manufacturer. Automatic routines with user prompts are specifically engineered for both monochrome and color CRT's in the computer LAN preventive maintenance and repair environment. The product features a high-visibility vacuum fluorescent alpha-numeric display and a regulated 0-20Vdc filament circuit isolation transformer.

Circle (63) on Reply Card

Ozone safe chemicals

Four Star Chemicals introduces a line of Freon-free chemicals for the electronics service center that will not damage the ozone layer. The line includes Contact Cleaner and Contact Cleaner with lube that will clean grease and grime from metal and metallic surfaces without attacking paint, plastics or insulation; SS-500 Safety Solvent cleaner and degreaser; Freezer, a spray for detecting thermal intermittents and related problems; Flux-Gone; Anti Stat, Pro Duster and more.

Circle (64) on Reply Card

Duster line is ozone-safer

Falcon Safety Products now has safer Dust-Off XL their most popular duster up to date. The 360° Vector Valve allows the can to remain upright while the nozzle moves up and down 180° and sweeps in full 360° circles. According to the the manufacturer they have the entire line environmentally safer. These safer duster formulas meet the latest

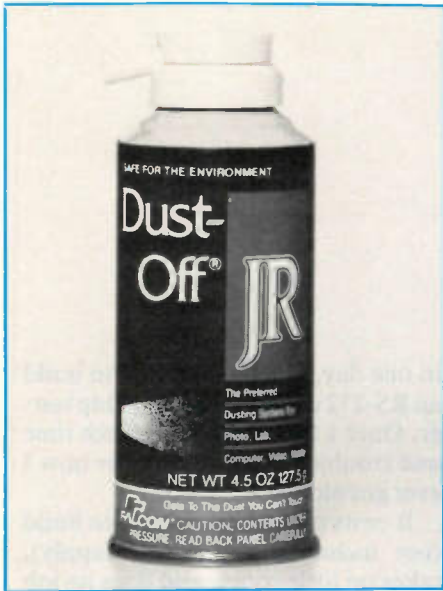

EPA and Montreal Protocol ozone protection standards. Dust-OFF is a portable dusting system used to clean and maintain sensitive equipment. They remove dust, lint and dirt without leaving any residue, adding moisture, or endangering the ozone.

Circle (65) on Reply Card

Illuminated magnifier

HMC has a new 8MC series lamp which utilizes a 22-watt circline fluorescent tube to cast an even glow on your task for optimum brightness and accuracy. It reduces eyestrain and fatigue by combining the two key factors in aiding vision - light and magnification. The contemporary "floating arm" lets you position the light source with the touch of a finger, and keeps it in place so your hands remain free to perform other tasks. The 5-inch crown optical glass



lenses are available in 3-diopter (+ 75% magnification) and 5-diopter (+125). Another option is an 11-diopter (+ 275) lens system with a 3-inch viewing area.

Circle (66) on Reply Card

Huntron Instruments now has the Huntron Shortrack Model 90, which finds board defects caused by shorts.

The unit working with a Tracker 1000, 2000, or 5100DS, locates and follows current flow to pinpoint the location of a low impedance fault. The Tracker can detect the fault on a certain node of a PCB but the Shor-track can find the exact location. Through the use of an inductive probe, this device gives an approximate indication of the relative amount of current that is flowing in any trace.

Circle (67) on Reply Card

For A Little You Get A Lot

STACK PROBES

OUTSTANDING TEST RESULTS

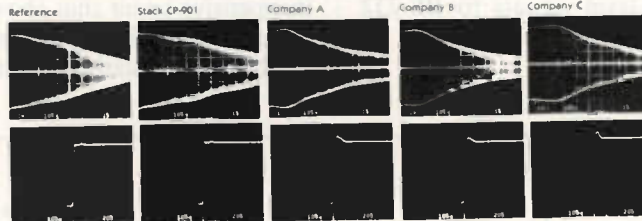

There is a significant difference in frequency response and rise-time/overshoot between a Stack probe and competing probes. A Stack probe gives you more of what you need to know.



- Floating attenuation screw allows calibration without distortion
- No dB loss at high end of bandwidth
- Glass filled tip for heat resistance
- High accuracy ($\pm 3\%$ at $\times 10$)
- Compatible with most Tektronix and other oscilloscopes

For a little more, you get a lot
THE RIGHT ANSWERS
 and that will save you time, energy and money.
 Stack probes a quality product.

STACK
 COAXIAL CONNECTORS & RF COMPONENTS

FAX (503) 643-6129 PHONE (503) 643-4899
 CUI Stack, Inc., 9640 S.W. Sunshine Ct. 700#, Beaverton, OR 97005 USA

Circle (2) on Reply Card

RS-232 communications chip tester

By Matt J. McCullar

It seems you can't open the lid of any type of computer without seeing the MC1488 and MC1489 chips running the communications ports. You find them on Apple IIc motherboards, Apple Super Serial cards, various types of Tandy motherboards, and RS232 cards for PC-compatible computers. The fact that Radio Shack sells these chips shows how popular they are. Their job is to adapt TTL-level signals to RS-232

levels and back again. Unfortunately, these chips don't seem to live long. And finding a bad chip can take a while without proper equipment, especially in the field.

Why should a technician be bothered with dragging an oscilloscope out of the van, hooking up cables, loading software, and examining test points, when he or she can just drop a suspect chip into a small, lightweight, inexpensive tester that shows immediately if the chip is good or bad?

This is the situation I found myself

in one day, and so I decided to build an RS-232 communications chip tester. Once I found out how much time and trouble it saves, I wonder how I ever got along without it.

It costs only about \$20.00 to build (not including the power supply), takes up little room, and does its job quickly and easily. The entire project can be built in one or two evenings.

Is a chip bad? Put an MC1488 into the upper socket and an MC1489 into the lower socket. Turn on the power. Do all four LEDs flash? If so, both

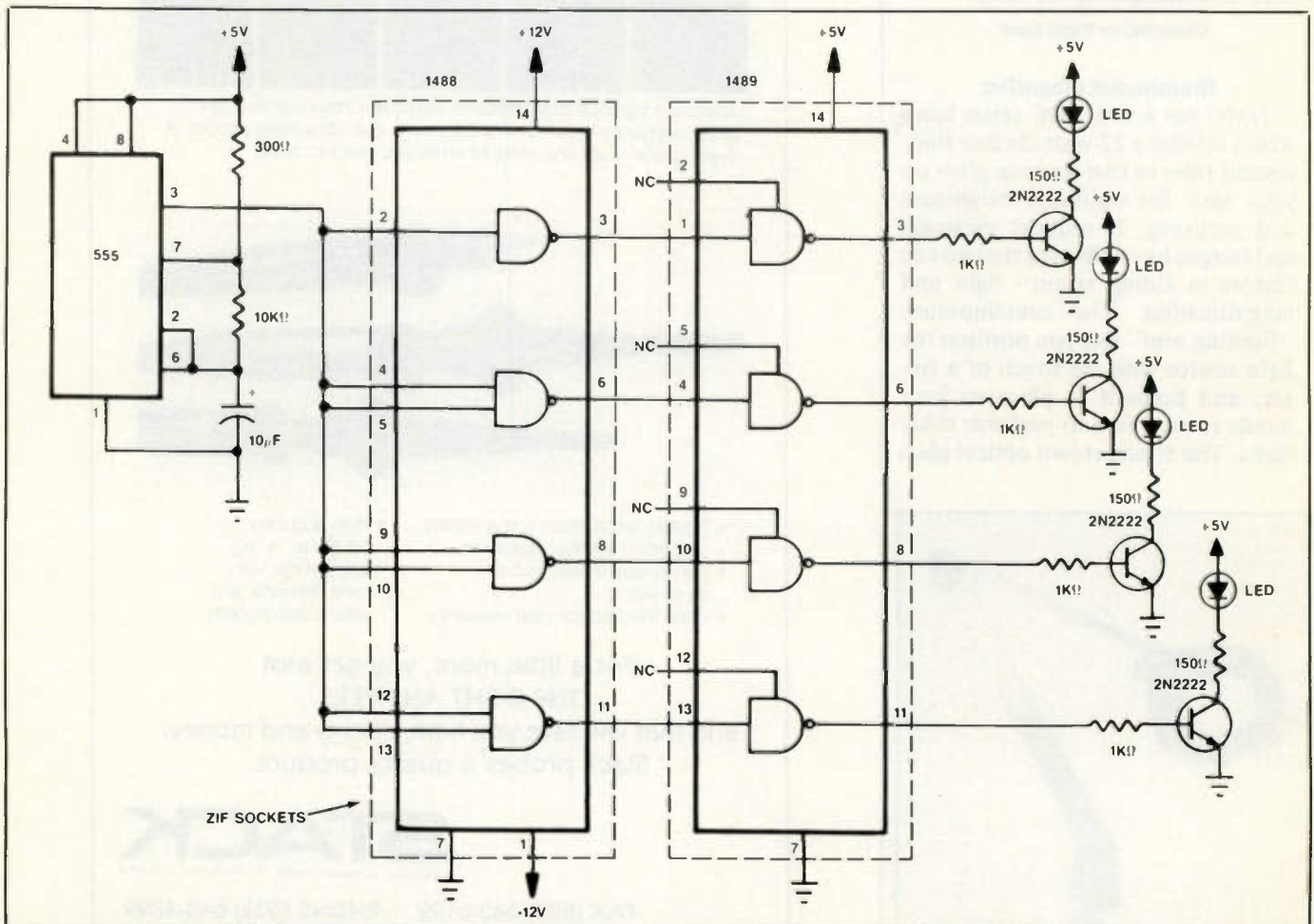

Figure 1. This schematic shows how the RS-232 communications chip tester is wired.

Device	Quantity
Integrated Circuits	
555	1
MC1488	1
MC1489	1
Transistors	
2N2222	4
Resistors	
150Ω	4
300Ω	1
1KΩ	4
10KΩ	1
Capacitors	
10μF, 10V or greater	1
Miscellaneous	
LEDs (Your choice of color)	4
14-Pin ZIF Sockets	1
Power Supply	
(+5, +12 AND -12V)	
Breadboard, Cabinet Mounting Hardware, Etc.	

Figure 2. To build the RS-232 communications chip tester you will need these components and supplies.

chips are good. If any LED stays lit, or stays dark, one of the chips is bad.

Circuit description

The schematic diagram for this tester is shown in Figure 1. The 555 operates as a square-wave oscillator running at about 4KHz. This TTL-level signal drives all four gates of the MC1488. Inside this chip, the signals are converted to RS-232, with voltage levels swinging from +12V to -12V and back. These RS232 signals are then converted back to TTL within the MC1489. The final TTL signals are then sent to the LEDs to show at a glance if all the signals went from start to finish correctly. All four LEDs flashing indicate two good chips; it is a good idea to keep a set of known-good RS-232 chips handy for comparison purposes.

Packaging

Because I didn't care how this project looked, as long as it worked, I didn't bother spending a lot of money on its cosmetics. Consequently, mine looks pretty ugly—but it works and works cheaply. I mounted mine inside a small Radio Shack Blue Box, because it was cheap and easy to work with.

You can see a power supply schematic isn't included; that's because small, lightweight switching-type power supplies are plentiful these days and can be bought for peanuts. If you want to build your own, however, there are plenty of schematics available. I wouldn't waste my time on it.

I happened to have a spare Apple Computer power supply handy, so I mounted this project on top of it. Be sure the power supply you use can deliver its voltages with little or no load present on its terminals. It must deliver +5V, +12V and -12V. This project pulls very little current, so any supply you use should prove satisfactory.

Be sure to leave pins 2, 5, 9, and 12 of the MC1489 unconnected. These pins act as controllers for the gates inside the chip, and connecting anything to them will decrease the quality of signal going through them.

To make life easier, I used zero-insertion-force (ZIF) sockets to hold the chips. They allow quick and easy installation of the integrated chips. Some come with locking levers. Be careful not to bend the legs of these sockets, because they are not flexible and will break off easily. Mount them in your cabinet so you can install suspect chips without obstructions.

During use, be sure to install the chips in their sockets *before* turning on the power. And label which socket is which, so someone doesn't accidentally put the two chips in the wrong sockets.

If you find this project useful, you might want to make two of them: one for the service center and one for the tool kit. That way you'll have one wherever you are. ■

Parts Express
International Inc.

FREE CATALOG

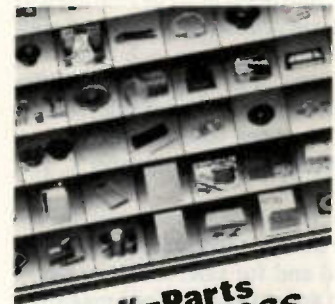

Parts Express
International Inc.
90-'91 CATALOG

CALL TOLL FREE 1-800-338-0531

CALL TOLL FREE
1-800-338-0531

Free catalog is sent via bulk mail. For express delivery, please send \$2.50 to cover 1st class postage costs. Foreign customers send \$5.00 to cover postage.

340 East First St. Dayton, Ohio 45402

Circle (12) on Reply Card

LEARN VCR
CLEANING/MAINTENANCE/REPAIR
EARN UP TO \$1000 A WEEK, WORKING
PART TIME FROM YOUR OWN HOME!



Secrets Revealed!

NO Special Tools or Equipment Needed.

EARN UP TO \$60 AN HOUR AND MORE!

THE MONEYMAKING OPPORTUNITY OF THE 1990's

If you are able to work with common small hand tools, and are familiar with basic electronics (i.e. able to use voltmeter, understand DC electronics)...

If you possess average mechanical ability, and have a VCR on which to practice and learn...then we can teach YOU VCR maintenance and repair!

FACT: up to 90% of ALL VCR malfunctions are due to simple MECHANICAL or ELECTRO-MECHANICAL breakdowns!

FACT: over 77 million VCRs in use today nationwide! Average VCR needs service or repair every 12 to 18 months!

Viejo's 400 PAGE TRAINING MANUAL (over 500 photos and illustrations) and AWARD-WINNING VIDEO TRAINING TAPE reveals the SECRETS of VCR maintenance and repair - "real-world" information that is NOT available elsewhere!

Also includes all the info you'll need regarding the BUSINESS-SIDE of running a successful service operation!

FREE INFORMATION

CALL TOLL-FREE 1-800-537-0589
Or write to Viejo Publications, Inc.
5329 Fountain Ave.
Dept. EST
Los Angeles, CA 90029

Circle (21) on Reply Card

Reader's Exchange has been reinstated as a free service.

The following restrictions apply to Reader's Exchange:

- Only individual readers may Reader's Exchange, and items must be restricted to those that are ordinarily associated with consumer electronics as a business or hobby. If you're in business to sell the item(s) you want to offer for sale, the appropriate place for your message is in a paid advertisement, not Reader's Exchange.

- Readers Exchange items must be restricted to no more than three items each for wanted and for sale, and may be no more than approximately four magazine column lines in length (about 20 words).

Send your Reader's Exchange submissions to:

Reader's Exchange
Electronic Servicing & Technology
76 N. Broadway
Hicksville, NY 11801

FOR SALE

Private estate sale. 50 recently used pieces. Sencore, Hewlett-Packard, Dynascan etc. Oscilloscopes, UHF signal generators, waveform analyzer, CB etc. Send SASE for list/parts to *Electronics PO Box 252 Glen Ridge, NV, 07028 (201)-783-9733*.

Retiring, send for test equipment list, enclose SASE, also tubes no list send needs, 29 South St. Lebanon, PA 17042.

Sencore SC61 waveform analyzer, new still in unopened original shipping box, will ship 1800.00. *John Neel PO Box 327 Howland, ME 04448, 207-732-3496*.

Sencore SG165 Analyzer - \$895.00. B&K 415 sweep aligner - \$95.00, both like new with all cables and manuals, and original cartons. B&K 177 VTM -\$69.00 - original carton. Will sell separately. *Koleske TV Sales and Service, 1124 N. Mason St. Appleton, WI 54914 (414) 734-5340*.

Sencore electronic test equipment for sale. VA62, VC63, PR57, LC102, SCR250, and CH256. Call 407-778-8543 after 4:30 pm. Ask for Billy.

VC-63 VCR-Tester \$295.00, VC-61 60Mhz waveform analyzer \$2000.00, VA62 \$2000, everything new, *Phillip Gene Murphy 891 Lennox Rd., Clarksville, TN 37042 (615) 645-2282*.

Knight R/C tester \$20 and shipping. Simpson VTVM 312 \$40 and shipping. B&K 466 CRT Tester \$45.00, EICO Model 324 Signal Generator \$15.00, Tubes and Zenith and RCA modules for sale. *M.E. Andrews Jr. P.O. Box 91, Exeter RI 02822*.

Curtis Mathes MSP-151 accurator arm \$100.00 KSR-330 Satellite receiver stereo \$250.00, KSL-830 LNA \$50.00. A66ABU30X CRT (New in box) \$125.00 or best offer on these items. *A-Z Audio Video Specialists, 3638 E. Indian School Rd., Phoenix, AZ 85018 (602) 954-6788*.

Retiring. Make you best offer on tubes, transistors, components, books, schematics, electronic courses, radios, test equipment. Send a SASE for each list. *J. Horsley 67 Theodore Street, Buffalo, NY 14211*.

B&K Model 1249 NTSC Generator, color bars, convergence, 30 Mhz for VCR servo problems. Brand new! \$190.00 includes shipping. *Dean Oliver 1228 County Rd. 200 N Pesotum, IL 61863 (217) 867-2648*.

Sams VCR Photofacts 92 to 224 \$450.00. Shop test equipment send SASE for list. *Charlie's TV 2603 W. Dorothea Visalia, CA 93277 209-732-1240*.

252 Tekfax from Sept 1953 to 1978 in excellent condition. \$25. Classic Sherwood tubes AM-FM tuner 1st in excellent condition \$40.00 Will ship anywhere. *J.A. Herb 411 Tule, Montovrsville, PA 17754. (717) 368-8717*.

1 pinpoint low ohms shorts with a simple circuit. Schematic \$1.00 plus LSASE. *Service Dept P.O. Box 26 Wauchula, FL 33873*.

B&K 1050 telephone analyzer with all cables for sale. Almost new, asking \$1000.00 OBO. *Florida Electronics Servicers, INC, (305) 431-9448*.

1 Sencore "Z" meter model LC53, 1 Sencore Super Cricket Model TF30 complete with all adapter units. In perfect condition. *Clark Chamberlain 528 Lakehoma Place, Mustang, OK 73064*.

Test Jig-Ex. Cond With telematic adaptors-make offer. *Bill Maida 274 Sabal Palm Pl. Longwood, FL 32779 (407) 869-6138*.

Prolog mod M980 PROM Programmer, accessories and manuals. \$200.00 plu shipping. B&K model -2005 RF Signal generator. Test leads and manual. Used less than 1 hour total \$125.00 plus shipping. *Brad M. Doody Rt. 2 Box 199 Chester, VT 05143 (802) 875-3779*.

Sony KCA-60BRS 3/4 U-matic. Tapes box of 10 \$100.00. *Joe P.O. Box 1151 Homstead, FLA 33030*.

Sencore VA62, NT64, VC63, and SC61 all manuals and cables \$4500 OBO. *Frank Wolf (207) 729-0566*.

B&K 1077B analyst and 415 sweep/marker generator. Both with cables and manuals \$100 each. *Leo Bienenstock, 200 Banff Springs Way, San Jose, CA 95139, (408) 227-5264*.

Microfiche machine 9X12 datamate 80, \$75.00. B&K 1246 Pattern generator, \$75.00. Madules for TVs. Send SASE to: *Sal Criabari 1312 Well Drive, Camp Hill, PA 17011*.

WANTED

Need copy of schematic for Marantz model fifteen power amp. *Richard Sereda Canada College A-V Redwood City, CA 94061*.

Need schematic for Fanin Cabrini SC61, "beeper guy" model 34-1, Monopril board for 10tid. *Dr. Paul Somona 201 East St, Dover, CO 78654*.

Operating and service manual for HP 1600A logic analyzer. *James Frey Red Cross Store/V.P. 1962 Redwood Ave, Defiance, OH 43512*

Sams Photofacts -2369 and up. Must be complete. *Weldon Robertson 144 Beidler St. Muskegon, MI 49441 (616) 722-4883*.

Heathkit analog circuit design course. Willing to pay a reasonable price for the purchase of or a usage fee so I can zerox. *Ron Grega, 107 Ridgeview Dr., Dunmore PA 18512. (717) 347-6842 after 4:30 pm. weekdays*.

Sylvania IC-15-37700-1 or ECG-792, hand remote control for Fisher VCR FVH-4000. *Ed Herbert, 410 N. Third St., Minersville PA 17954*.

Sencore LC75 or LC102 LCR Analyzer. Happy to pay reasonable price and shipping to Papua New Guinea. *Dick Goodwin, Christian Radio Missionary Fellowship, PO Box 345, Mt Hagen, Papua New Guinea (675) 521505 Fax (675) 522014*.

Misc TV, test equipment, Heathkit EE3201, EE3401, courses and ET 3200 ET 3400 trainers. 4-5" SONY B&W Micro TV and 1-3" SONY B&W. Send LASE for list. Will swap for AF trains. *Allan Eisenhour 9 Rachel Carson Lane Centerville, MASS 02632*.

A schematic for MTC color TV, model number MTV-138 (Distributed by JC Penny). *M.A. Morales 2265 Davidson Avenue Bronx, NY, 212-367-4852*.

Electronic Adventure Series Written By John Blaine Published by Grosset and Dunlap Bob Carroll, 19828 N. Isaacson (309) 274-8239.

Source/price list for HD1404BP, MC14081BCP, TC4069UBP, 3900N JRC 7016. *CM "Chuck" Kelly 3336 Chatham, Wkgn ILL 60086-2123, 708-688-2369*.

Xerox copy of Instruction manual for RCA WR508A mini chro bar generator. *RCA WR525A Marker/signalyst with manual*.

1930's E.H. Scott custom-built radios, usually chrome plated. Also seeking Crosely 37-tube WLW console, model 3716, circa 1938. (517) 349-2249.

Source for a complete service manual and parts for a color TV. Multitech Model No. MC-0570B. *A.Edward Ruppel 1207 Adams Street*.

Classified advertising is available by the word or per column inch.

By-the-word: \$1.65 per word, per insertion, pre-paid. Minimum charge is \$35 per insertion. Initials and abbreviations count as full words. Indicate free category heading (For Sale, Business Opportunities, Miscellaneous, Wanted). Blind ads (replies sent to ES&T for forwarding) are \$40 additional. No agency discounts are allowed for classified advertising by the word. Contact Emily Kreutz at 516-681-2922 to place your classified ad (by-the-word). Or send you order, materials and payment to Emily Kreutz, Electronic Servicing & Technology, 76 North Broadway, Hicksville, NY 11801.
Per Column Inch (Classified Display): \$235 per column inch, per insertion, with frequency discounts available. 1" minimum, billed at 1/4" increments after that 10" maximum per ad. Blind ads are \$40 additional. Reader Service Number \$25 additional to cover processing and handling costs. (Free to 4-inch or larger ads.) For more information regarding classified display advertising please contact Jonathan C. Kummer at 516-681-2922. Optional color (determined by magazine) \$150 additional per insertion.

FOR SALE

REPAIR MANAGEMENT SOFTWARE: for IBM PC's. Repair tracking, inventory, reports, billing, maillist, more. Demo disk \$15. CAHILL ELECTRONICS, PO Box 568, Kingston, NH 03848. 6-91-3t

PHOTOFACTS: Folders under #1400, \$5.00. Above #1400, \$7.00, sent same day first class postpaid. Allen Loeb, 414 Chestnut Lane, East Meadow, NY 11554. 516-481-4380. 7-91-3t

COMPUTER AIDED TV/VCR REPAIR SOLUTIONS: 5 1/4" IBM Compatible disks. 1,000 VCR, Printout \$55, Disks \$51. 3,500 TV, Printout \$95, Disks \$91 (Harddrive). Time saver. Add to or quick scan by model, chassis or stage. Electronic Solutions, 407 W. Ave. "N", San Angelo, TX 76903. 8-91-6t

TELEVISION-MONITOR TROUBLESHOOTING: 350 Symptoms/Cures, nothing old listed, \$20.00. Older Symptom/Cures, 1978 back, \$10.00. 35 Steps to Easier TV Repairs, \$20.00. Buy all three \$42.00. Refund if not satisfied. Jones Enterprises, Box 702, Niceville, FL 32588. 8-91-2t

TV CASE HISTORIES UPDATED! Volume 2.0 contains 1,150+ histories. Satisfaction assured, \$28. Supplement to Volume 1.0 with 450+ histories, \$10. Mike's Repair Service, P.O. Box 217, Aberdeen Proving Ground, MD 21005. 8-91-3t

SCORE:VA62, VA63, NT64, EX231. Includes all cables in original boxes. Excellent Condition. \$2495.00 or best offer. Elmer's TV, 88 McLain Road, Indiana, PA 15701. 412-463-1314. Also send S.A.S.E. for list. 9-91-1t

TROUBLESHOOTING TV dogs - Over 500 symptoms and cures newly updated listing - free bonus - VCR cures. Send \$10.95 to Century Electronics, 600 Starkey Road, 607, Largo, FL 34641. 9-91-2t

5000: ACTUAL CURRENT "TECHNICIAN" TECH-TIP REPORTS: Symptoms, Cures & Part Numbers. 1987 Through 1991. TV-VCR-CD-LD-CAMERA-CAMCORDER - PROJECTION - STEREO - AMPLIFIERS - SATELLITE-MICROWAVE-CASSETTES-PHONO-ETC. We service All Consumer Electronics and Factory Authorized for 36 Major Manufacturers. If it came through our doors, It's on it's way to "YOURS"! SEND \$20.00 FOR DEMO DISK OR \$25.00 PRINTED FORM. \$125.00 per 1000 database disk price or \$500.00 for 5000. Printed form add \$25.00 Per 1000 Tips. AMEX-MIC-VISA & CHECKS, 2-Wks Delivery 305-474-2677 Factory Service 8614 SR-84, Ft. Lauderdale, FL 33324. 8-91-12t

REDUCED 85% Diehl Mark III scanner \$79. Diehl Mark V scanner \$199. New. Restored remote control keypads with our conductive coating \$8.99 ppd. WEEC, 2805 University Avenue, Madison, WI 53705. 608-238-4629. 608-233-9741. 9-91-1t

SCORE:VA62, \$2,700. B & K seep function generator model 3020, \$350. B & K NTSC model 1249, \$350. B & K video tester 490, \$500. Sams photofacts 838 to 2480, 2698 to 2788, school library editions 1-38, \$15. Bowman Electronics, PO Box 1149, Bowman ND 58623, 701-523-3570. 8-91-1t

BUSINESS OPPORTUNITIES

SOUTHERN CALIFORNIA San Diego VCR-Cameras-Stereo-Repair Shop. Low overhead. Busy Area \$18,000. 619-748-5049. 9-91-2t

LET THE GOVERNMENT FINANCE: your small business Grants/Loans to \$500,000. Free recorded message: 707-448-0330. (OD6). 6-91-2t

SOUTHERN CALIFORNIA TV-VCR-Satellite Service and Rental Store. Fully equipped established over 40 years. Owner retiring, must sell. Price and terms negotiable. 818-895-1400 ask for Robert. 9-91-2t

MISCELLANEOUS

CAMCORDER REPAIR: Don't turn away good profits let our experienced technicians provide your shop with complete camcorder repair service. Also, VCR, "Tough Dogs." Call 1-800-846-4648. Edington VCR/TV, 204 North Kimble Drive, Bloomington, IN 47404. 8-91-2t

Readers' Exchange

FOR SALE

Sencore SG165 AM/FM stereo analyzer. 209-739-8645 Bruce Nolan.

Heath electronics course for dc electronics ac, semiconductors, and electronic circuits. Plus the work book. All parts, never been experiments and all parts. Never been used also brand new trainer with meter all for \$200.00. *daniel Seidler 3721 W 80 Street, Chicago, ILL 60652, 312-284-8221.*

B&K CRT restorer model 470 \$200.00. HP 100 MHz dual trace storage oscilloscope \$750, and Biomation Logic analyzer model K105D \$800. *Please call 314-74-1254 after 5pm.*

Sencore VA48 \$650, Big Mack CRT tester \$125.00; B&K 415 Sweep Gen \$75, 467 CRT tester \$175, 520B transistor tester \$150, 1210 Color Bar Gen \$100, plus much more: *Bob Jull, Box 467, 1105 Pine Street, Cottonwood, ID 83522 (208) 962-3345.*

Sencore SC61, LC101, SCR 250 CR70. Like new. 503-889-9416.

Hickock model 380 frequency counter with manual and case. \$100.00 plus shipping, Hickock model 517 dual trace scope with manual and probes \$280.00 plus shipping. *AAA TV 4 Common St. Wrentham, MA 02093, 508-384-3113.*

Tektronix 549 and 1A1, \$300. Tektronix 545 and CA, \$200. Manuals for above items included. *John Kirkpatrick 3809 Ruggles St. Durham, NC 27704 919-477-7515.*

VA48 video analyzer purchased from Sencore 1985. Excellent condition \$450.00. Glen Wall, Rt 7 Box 97, Mt. Vernon, IL 62864 618-244-3881.

Digital capacitor tester \$49.00 new multi-tester-check up to 6Megohms, \$10.00 new stereo car radio power booster \$15.00 New. *Joe Oracki 3502 Northern Parkway Balto, MD 21206 1-301-254-0284.*

Avcom PSA-35 Spectrum analyzer with carrying case. \$1000.00 frequency 10MHz to 4.2GHz. Battery operated. *Jud Williams, PO Box 947, Roswell, GA 30077, 404-475-3192.*

Sencore SG80 AM/FM stereo analyzer. Sencore PA81 Audio power analyzer, service manuals name brand audio. 319-583-2153 after 7pm CST.

Transformers and chokes (6 pages), test equip (1), books/manuals (8). Send LASAE with stamp for each 5-pages lists. (215) 646-3641. *Call Chuck Vaccaro, 708 Booth Lane, Ambler, PA 19002.*

brand new (red, blue, green) CRT's for Sony projection screen. Part #'s SD186 or 8-738-352-05 or 8-738-351-05, 8-738-353-05. Still in the boxes, call 218-751-2620 ext TV Service.

B&K 1250 NTSC generator; B&K 1045 telephone product tester; B&K 1035 Wow and flutter; B&K 1211 color pattern generator; B&K 530 Lab Semi-conductor tester. Price and complete listing: Ed Wilkie 602-547-0227.

TUBES • TUBES • TUBES
World's Largest Range
 Over 2,000 Types, Domestic & Foreign
UP TO 85% OFF Ask for price list
International Components Corporation
 Toll Free 800-645-9154 • N.Y. State 516-293-1500
 105 Maxess Road, Melville, New York 11747

Circle (8) on Reply Card

Tech's Guide To Pricing
NEW
"Sperry Tech's Pricing Guide"
 Updated new 6th edition...a framework for setting rates that apply to Hi-Tech products...a formula that guarantees SUCCESS!
 Call Toll Free for details
 1-800-228-4338

Circle (18) on Reply Card

AC/DC VOLTAGE
 AC/DC CURRENT
 DIODE TEST
 LOGIC TEST
 LED TEST GOOD/BAD
 5 FREQ RANGES
 5 CAPACITANCE RANGES
 LOW BATTERY Warning
 CONTINUITY TEST/BUZZER
 TRANSISTOR CHECKER
20 MHz FREQ COUNTER

PRO 400
\$69.95 Stock No. 990092
2 YEAR WARRANTY PARTS LABOR

KELVIN Electronics
 7 Fairchild Ave., Plainville, NY 11803
 (516) 349-7620 1(800) 645-9212
 VISA FAX (516) 349-7830
 MC

Circle (9) on Reply Card

TEST EQUIPMENT
 Oscilloscopes • Multimeters
 Function Generators • Frequency Counters
 Power Supplies • Video Head Testers • Etc.

Since 1972 **CALL OR WRITE FOR OUR FREE CATALOG**

BRUNELLE INSTRUMENTS INC.
 P.O. Box 1223 • Newport Vermont 05855
 Tel: 1-800-567-3506 Fax: 1-819-569-1408

Circle (1) on Reply Card

THE SOURCE . . . for quality Electronic Parts & Accessories.
"We'll get your parts to you as fast as you need them!"
 Call today and ask about our **PREMIUM DELIVERY** and for your **FREE** copy of our catalog . . .
1-800-558-9572
 or for 24 hour ordering call FAX 414-473-4727
"First in Quality, Service and Delivery"

PREMIUM PARTS+
 ELECTRONICS COMPANY
 P.O. Box 28 • Whitewater, Wisconsin 53190

Circle (15) on Reply Card

Advertisers' Index

Company	Page Number	Reader Service Number	Advertiser Hotline
Brunelle Instruments	60	1	800/567-3506
CUI Stack, Inc.	55	2	503/643-4899
Chemtronics	47	3	800/645-5244
Consumer Electronics Show	13		202/457-8700
Conway Manufacturing	22	4	415/568-5282
EasyTech	4	5	800/582-4044
Electro Tool, Inc.	23	26	800/772-3455
Falcon Safty Products	49	6	908/707-4900
Goldstar Precision	45	7	213/404-0101
Iscet	54		817/921-9101
International Components Corporation	60	8	800/645-9154
Kelvin Electronics	60	9	516/349-7620
Leader Electronics	3	54	800/645-5104
MCM Electronics	23	10	800/543-4330
NTE, Inc.	BC	75	800/631-1250
NESDA	22,47		817/921-9061
Nutronix	49	11	313/939-4710
Parts Express	57	12	513/222-0173
Philips ECG	53	13,14	800/225-8326
Premium Parts+	60	15	800/558-9572
Sencore	IFC,1	16	800/SEN-CORE
Sirius Technologies	49	25	715/962-3592
Sperry Tech	60	18	800/228-4338
Tektronix, Inc.	IBC	27	800/TEK-WIDE
Tentel	42	19	800/538-6894
Video Display Corporation	41	20	800/241-5005
Viejo Publications	47,51,57	21,22,23	800/537-0589

We'd like to see your company listed here too. Contact Jonathan C. Kummer to work out an advertising program tailored to suit your needs.

SAVE TIME

For fast, accurate service, please remove the peel off label used to address your magazine, and attach it to the Reader Service Card, the Address Change Card or to any correspondence you send us regarding your subscription.

SALES OFFICE

THE MAGAZINE FOR CONSUMER ELECTRONICS SERVICING PROFESSIONALS
ELECTRONIC
 Servicing & Technology

76 North Broadway
 Hicksville, NY 11801
 (516) 681-2922
 FAX: (516)681-2926

Jonathan Kummer
 Advertising Manager

Emily Kreutz
 Sales Assistant

Low-cost maintenance tools.



Tek TSG 100 Series Test Signal Generators are proof you don't have to pay a lot to get a valuable tool for video service. Each one offers the performance you'd expect from much higher priced generators. Plus the signals and features you need to meet equipment maintenance requirements. All in a compact, lightweight package.

The TSG 130 is a low-cost, multifomat solution for testing and servicing Betacam®,

MIL, S-VHS, Hi-8 and NTSC video equipment. The TSG 120 supports S-VHS, Hi-8 and NTSC formats. And the TSG 100 is a popular choice for NTSC-only applications.



Get the full story and a product demonstration from your Tek representative. We think you'll agree: low-cost, hard-working TSG 100 Series Test Signal Generators are some of the most productive maintenance tools you'll ever get your hands on!

Tektronix
COMMITTED TO EXCELLENCE

NTE KEEPS YOU UP AND RUNNING.

NTE specializes in "replacitivity," the science of getting things up and running again—fast! After all, downtime is costly, so no one can wait weeks on end for an OEM part to come in. With NTE, no one has to! One call gives you access to 3,550 top of the line universal replacement semiconductors that are cross-referenced to more than 240,000 original devices! Included in the NTE line are: bipolar transistors, integrated circuits, rectifiers, diodes, thyristors, optoelectronic devices, varistors, resistors, capacitors, and much, much more. All are backed by NTE's exclusive two-year warranty.

For your copy of the NTE Technical Guide contact your local NTE distributor, or simply fill in the coupon below and send it to us today with a check or money order for \$3.25 each.



NTE ELECTRONICS, INC.

A WORLDWIDE REPUTATION FOR QUALITY, SERVICE AND VALUE

Please rush me _____ copies of the EST1991
NTE Technical Guide and Cross Reference
manual at \$3.25 each. I have enclosed
my check or money order for a
total of \$ _____

Name _____

Company _____

Address _____

City _____

State _____ Zip _____

Mail to: NTE, 44-T Farrand St., Bloomfield, NJ 07003



For the name of your nearest NTE distributor, call NTE: Toll Free: 1-800-631-1250 (incl. Canada)
Tel: (201) 748-5089 • FAX: (201) 748-6224

Circle (75) on Reply Card

