

THE MAGAZINE FOR CONSUMER ELECTRONICS SERVICING PROFESSIONALS

# ELECTRONIC<sup>T.M.</sup>

Servicing & Technology

MAY 1991/\$3.00

Servicing camcorder motor circuits

Rethinking the technician's toolkit

## Printed circuit board repair

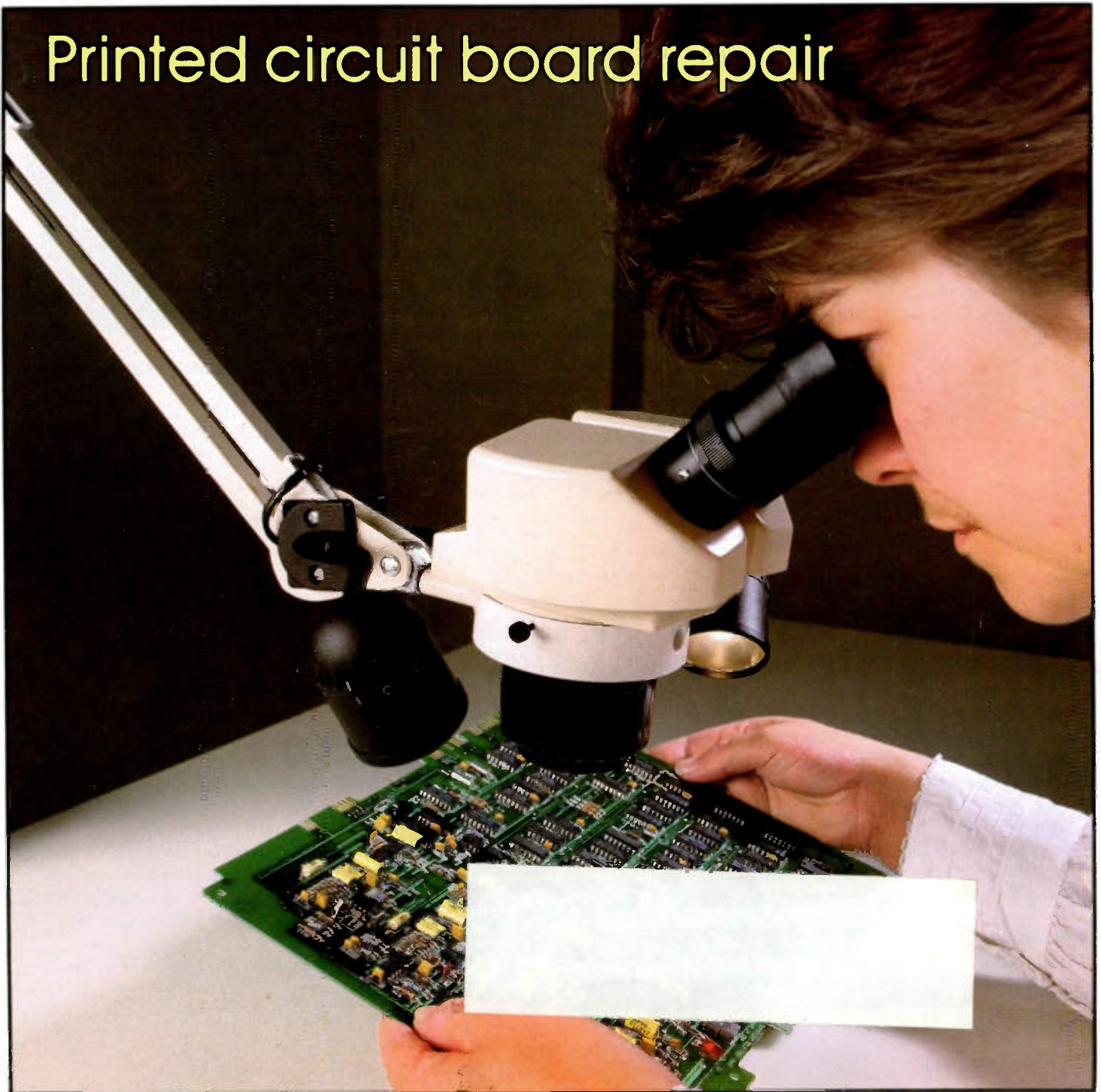

Introducing a new companion to your  
VA62A Universal Video Analyzing System!

# Isolate All Playback Or Record Problems In All VCRs . . . Now And In The Future, Or Your Money Back!

*New!*



VA62A Universal Video Analyzer

VC93 All Format VCR Analyzer  
Patent Pending

**Now you'll have everything to completely analyze all VCR  
video, audio, and servo problems.**

**Automatic Servo Analyzing:** (patent pending)

Automatically determine if the VCR has a capstan servo, cylinder servo, luminance/chrominance circuit defect in virtually the time it takes to connect to the video and audio line outputs.\*

**Exclusive Video Head Substitution:**

Never again install another video head without being 100% positive it will fix the problem. Exclusive video head substitution signals isolate head problems from all other circuit problems.

**Exclusive Hi-Fi Stereo And Audio Signals:**

Finally there is an answer for troubleshooting VCR Hi-Fi audio circuits. Isolate defects from the spinning heads to the line outputs.

**Isolate Defects Throughout The Entire VCR:**

Exclusive phase- and chroma-locked drive signals isolate problems in any stage from the heads to the output. Every signal you need is there, including: FM luminance, chroma, video, and head switching (SW30) signals.

**Includes Extra Features To Complete Your Servicing Needs:**

You get: an Internal NTSC video pattern, standard video and audio line output, a servo sub bias supply to 10 VDC, an autoranged DC and PPV meter, plus it supports all common VCR formats.

*\*Using the optional Servo Performance Test Leads and Servo Performance Test Tape.*

**Call 1-800-SENCORE ext. 544 for more information!  
(736-2673)**

Circle (84) on Reply Card

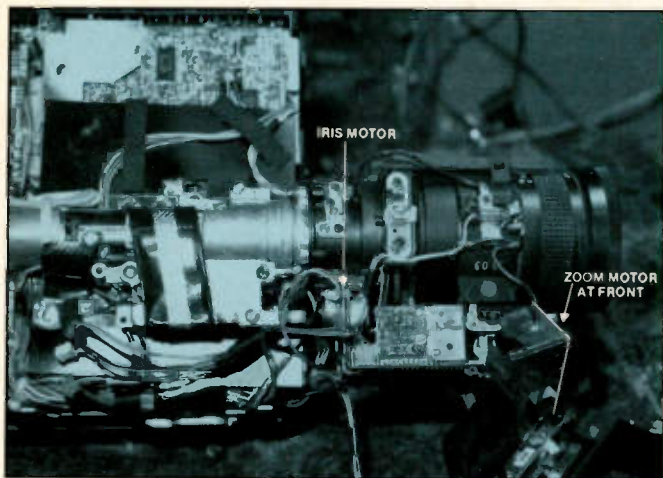

page 8



page 14

## FEATURES

### 8 Servicing camcorder motor circuits

By Homer L. Davidson

A camcorder may have as many as five motors. In this article Davidson tells you how to check the function of each of the motors in a defective camcorder to determine where the problem lies.

### 14 Rethinking the technician's toolkit

By Conrad Persson

Factors like projection TV and fax machines make servicing in the home more important than ever before.

### 16 Printed circuit board repair

By Thomas G. Vlazny

Printed circuit boards are occasionally damaged by such things as a lightning strike, some kind of shock to the product, like being dropped, or sometimes a careless technician.

### 22 Thermal clues in troubleshooting

By Victor Meeldijk

In most cases, a malfunction in an electronic product will result

in some kind of thermal clue as to the nature of the problem. Meeldijk gives some examples of thermal clues in this article and suggests ways to use your sense of touch, or even a thermometer to locate and correct problems.

### 38 Exploring the 80286 and 80386-based microcomputers: Combining theory and practical service techniques

By John A. Ross

If you plan to service IBM compatible personal computers, once you've learned about the 8088 processor, you'll want to learn about the 80286 and the 80386. This series of articles provides both background and troubleshooting information on personal computers based on both of these devices.

### 44 A game of logic from A to Z

By Lambert C. Huneault, CET  
Sharpen up your logic gate skills with this logic game.

### 27 Profax

### 37 Audio Corner

The importance of tape head azimuth

### 48 What Do You Know About Electronics?

Talking to microprocessors and computers

### 51 Video Corner

Tape trouble sensors

### 52 Test Your Electronics Knowledge

Doing a little something extra

### 53 Books/Photofact

### 54 Products

### 57 Technology

### 58 Computer Corner

### 59 Readers' Exchange

### 60 Advertiser's Index

## DEPARTMENTS

2 Editorial

4 News

6 Literature

21 Business Corner

Turn customer complaints into profits

## ON THE COVER

Repairing a printed circuit board requires that you clean the board thoroughly and inspect it carefully to determine the nature of the problem before you proceed to the repair stage. Such a repair may allow you to bring a product that would have otherwise been abandoned back to life, or make a product repair that would have otherwise been prohibitively expensive. (Photo courtesy Contact East).

# Where are you? Where are you going?

In last month's editorial we talked about all of the aspects of running a service business, and all of the skills and abilities it entails: everything from the technical skills to diagnose and repair one of today's ultra sophisticated TVs or camcorders, to writing an ad for your business and deciding where is the best place to advertise, to hiring and firing.

We suggested that to just sit back and think about the complexity of what you're doing is a good mental exercise. Here's another good exercise. Think about how long you've been in business. What kinds of products are you servicing now? Are you entirely satisfied with the amount and kinds of business you're doing?

If you have any feeling at all that there's something else you could or should be doing, read on.

The soul searching that I'm about to suggest is not entirely my idea. In the course of carrying out a project recently, I had occasion to talk at length to a large, successful consumer electronics sales and service organization in the western part of the U.S. They have a number of locations, service a broad range of products, have a formal management system in place, and employ in the range of 100 people in the service end of the business alone.

In spite of their success, the company is constantly re-evaluating its position in the marketplace. On a continuing basis, they ask all members of the company to think about who the customer is, how the customer should be treated, how to improve service to the customer. In addition, they regularly take a close look at the business to determine if they're doing everything they can to keep the business growing. A wise

man once said "when you stop getting better, you stop being good".

Something that would benefit any service business would be to regularly re-evaluate their position in light of the changing technological and business climate. For example, many businesses got started when the typical electronics service center was a "Radio and TV shop". Many businesses have kept that designation. No doubt many still limit their work to those products.

And there are no doubt many shops that are admirably successful servicing just those products. On the other hand, many businesses have gone out of business because they have continued to service just those products. Many shops have thrived, however, because they have recognized the limitations of servicing a limited range of products that have in many cases become more expensive to service than to replace, and have branched out into other areas. Again, such diversification may not be for everyone, but if you decide not to do so, that decision should be based on a thorough evaluation of the position of the business.

Here are some of the facts, questions and considerations that you should be thinking about:

1. A few years ago, many shops began servicing radios and TVs because that represented the entire range of consumer electronics products. That has changed. Nowadays, consumers own a far broader range of consumer electronics products. In addition to radios and TVs there are VCRs, camcorders, compact disc players, microwave ovens, personal computers, fax machines, cordless telephones. Are you sure you shouldn't be servicing some of those?

2. Many household appliances are now controlled by microprocessor and related electronics. Would it make sense to at least look into whether or not to service those?

3. In what other ways has the business changed and what have you done to keep up?

4. What changes are coming down the pike, and what can you do now to prepare for them? Off the top of my head, here are two: high definition TV and the consumer electronics bus (CEBUS) that will allow consumer electronics products, appliances and home support equipment like furnaces, air conditioners, etc. to talk to each other. Both of these, and no doubt many more products of advancing technology will present service facilities with a wealth of both problems and opportunity.

To get back to that immensely successful business I mentioned at the outset of this editorial, in spite of their great success in consumer electronics servicing, they're actively looking into servicing of home appliances, and in fact are working on an analysis of what would be involved in launching such a venture and what the return would be.

Whether your business is diminishing, staying about the same or growing, it's always a good idea once a year or at some other regular intervals to take a look at where you are, take a look back to see how you got there, and look ahead to see where you're going. Such an exercise might help you determine if you like your eventual destination, and if not, to make course corrections before it's too late.

*Nile Conrad Pearson*

# SELECT 5 BOOKS for only \$4.95

(values to \$102.75)

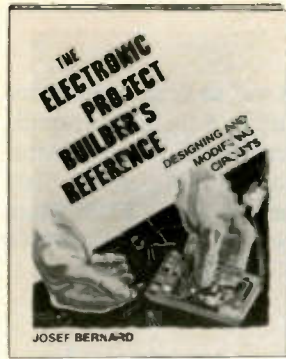
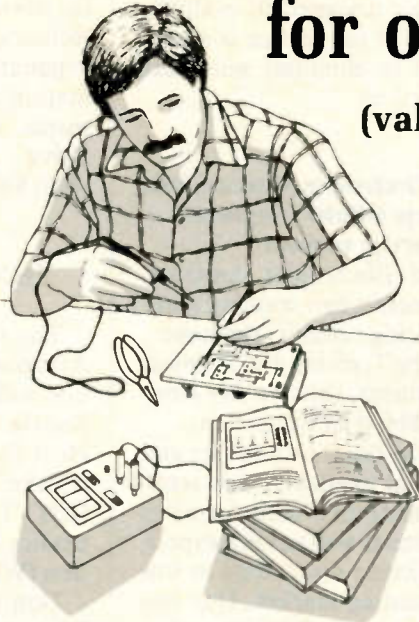

3260 \$22.95



9290 \$36.00

Counts as 2



3321P \$16.95



2826P \$16.95



3279 \$36.95

Counts as 2



3031P \$17.95



2980P \$19.95



3267P \$96.95



3342 \$25.95

Counts as 2



3374P \$16.95



2707P \$17.95



2800P \$16.95



2613P \$17.95

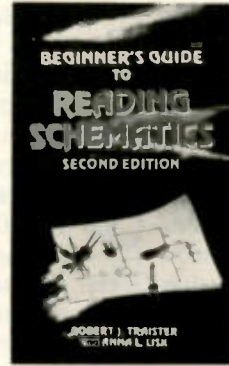

3632 \$18.95



3329 \$29.95

Counts as 2



2867P \$18.95



2987P \$16.95



2925P \$9.95

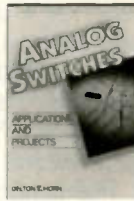

3445 \$21.95



2995 \$25.95

Counts as 2

Your most complete source for electronics books for over 25 years.

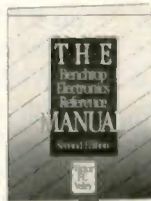

3414 \$39.95

Counts as 2



3107P \$18.95



2865P \$14.95



3138 \$60.00

Counts as 3

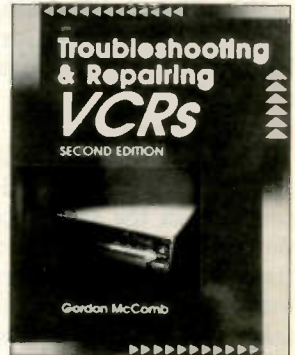

3777 \$32.95

Counts as 2

**Membership Benefits • Big Savings.** In addition to this introductory offer, you keep saving substantially with members' prices of up to 50% off the publishers' prices. • **Bonus Books.** Starting immediately, you will be eligible for our Bonus Book Plan, with savings of up to 80% off publishers' prices. • **Club News Bulletins.** 15 times per year you will receive the Book Club News, describing all the current selections—main, alternates, extras—plus bonus offers and special sales, with scores of titles to choose from. • **Automatic Order.** If you want the Main Selection, do nothing and it will be sent to you automatically. If you prefer another selection, or no book at all, simply indicate your choice on the reply form provided. You will have at least 10 days to decide. As a member, you agree to purchase at least 3 books within the next 12 months and may resign at any time thereafter. • **Ironclad No-Risk Guarantee.** If not satisfied with your books, return them within 10 days without obligation! • **Exceptional Quality.** All books are quality publishers' editions especially selected by our Editorial Board.



10076 \$39.95

Counts as 2



3274 \$22.95



3270 \$32.95

Counts as 2



2926 \$25.95

Counts as 2



3343 \$29.95

Counts as 2

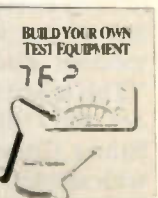

3475 \$27.95

Counts as 2

## ELECTRONICS BOOK CLUB

Blue Ridge Summit, PA 17294-0810

Please accept my membership in the Electronics Book Club and send the 5 volumes listed below, billing me \$4.95. If not satisfied, I may return the books within ten days without obligation and have my membership cancelled. I agree to purchase at least 3 books at regular Club prices during the next 12 months and may resign any time thereafter. A shipping/handling charge and sales tax will be added to all orders.

Name \_\_\_\_\_

Address \_\_\_\_\_

City \_\_\_\_\_

State \_\_\_\_\_ Zip \_\_\_\_\_ Phone \_\_\_\_\_

Valid for new members only. Foreign applicants will receive special ordering instructions. Canada must remit in U.S. currency. This order subject to acceptance by the Electronics Book Club. ESTM591

All books are hardcover unless number is followed by a "P" for paperback.

(Publishers' Prices Shown)  
©1991 ELECTRONICS BOOK CLUB

### **Servicer relations meeting at NARDA/NASD convention**

The Service Contract Industry Council (SCIC) sponsored an opportunity for servicers to meet one on one with any SCIC member to discuss whatever problems they might be encountering with any (SCIC) members. This was arranged because the service industry has been reporting difficulties in getting paid for services performed by third party administrators.

The meeting was held on Sunday during the NARDA Convention. There was strong support and willingness to address any and all issues by the SCIC members. The meeting was attended by Delta Warranty, Elite Group, Inc., Federal Warranty Service Corp., Independent Dealer Services, National Electronics Warranty, Philips Marketing Services Inc., Phoenix Service Corp., Service Plan., Transamerica Commercial Financial and Universal Protection Plan.

The SCIC was established to initiate, develop and establish ethical practices in the service contract industry in the relationship of administrators, providers, dealers, distributors and servicers of contracts and to take any and all steps which may be properly be considered to be advisable or necessary to eliminate unethical practices.

This meeting was an initial step toward opening up the communication between the service industry and the service contract industry. Another step was to invite Cornelius C. (Connie) Bell, president of the National Electronics Sales and Service Dealers Association (NESDA), to the SCIC General Membership Meeting on Sunday, March 10, 1991, to present his views on the service contract industry and how the service industry and SCIC can work together.

"We encourage any servicer who was unable to attend but who wishes to review related business issues with any of our members to contact the member directly," said Schneider. "This is just the beginning," Schneider said, "the SCIC standards and Ethics Committee is also working with servicer, retailer and consumer groups to adopt a formalized dispute resolution procedure for SCIC. All

these steps are designed to evaluate the standards of the service contract industry and to eliminate unethical business practices."

### **Mitsubishi Electronics America, Inc. introduces cellular telephone service seminar**

Mitsubishi Electronics America, Inc., announces a new training seminar for servicing cellular telephones. Created by the Training and Publications Department, this two day seminar is available to all technicians.

Utilizing the latest technology and test equipment available, this seminar will educate new technicians in cellular service as well as keep experienced technicians up to date in this rapidly expanding market. Day one begins with a comprehensive review and description of: communication basics, RF systems, cellular telephone systems, subscriber activation, programming and operation, and ends with an overview of installation.

Attendees will be working with a popular model transportable phone, and interacting with widely used cell site simulators. Day two includes: troubleshooting procedures, disassembly, diagnostics, adjustments and repairs. The participants will be presented with a variety of typical problems normally faced by service technicians. Using the materials and equipment provided, they will have a unique opportunity to experience hands-on testing and troubleshooting under the guidance of a knowledgeable instructor. In addition to the comprehensive documentation provided, educational video tapes produced by the Technical Services Division will be used to demonstrate and reinforce the finer points of cellular phone service and technology. The session will end with a discussion of future technology. An exam will be given and a certificate awarded to those passing the test.

Along with the knowledge and experience gained during this comprehensive seminar, the participants will leave with a technical manual and a video tape for future reference. Utilizing the latest technology and test equipment available, this seminar will educate new technicians in cellu-

lar service as well as keep experienced technicians up to date in this rapidly expanding market. For more information call or write Mitsubishi Electronic America, Inc., 5757 Plaza Drive, Cypress, California 90680 (800) 888-6773 Touch 4.

### **Technician convention set for satellite area**

The 1991 Electronics Technicians Association (ETA) Annual Convention will take place June 7 & 8 in the Seattle, WA suburb of Kirkland. Host for this 12th National meeting is Lake Washington VocTech School (LWVT) and the Washington Electronics Service Technician Association (WESTA).

Don Howell, CET, Chairman of ETA, and an electronics technology instructor at LWVT, is the general convention chairman. Howell says that there is a great amount of enthusiasm for the gathering because no ETA convention has taken place in the northwest to date.

While a full schedule of spouse and children's events, business meetings of ETA and committee work will take place, the primary effort of the convention is directed towards dual-session seminars which will occur each day. Technicians will find seminars on hardware and troubleshooting topics as well as self improvements and small shop management.

Efforts are underway to evolve two new classifications of technician certification. Expected to be unveiled at this convention, and a week later at the Satellite Dealers Coalition (SDC) Show in St. Louis, will be prototype exams for satellite installers. SDC & ETA are working jointly on the project.

In the same area of certification is an effort to develop a set of standards for field service personnel. While all other categories of ETA-I certification examinations contain strictly technical testing material, the Field Service Certification will also contain customer relations, efficiency and behavior items.

For complete details, a seminar schedule and display opportunities contact ETA at: 602 N. Jackson St., Greencastle IN 46136 or call 800-359-6706.

### **Report explores high definition television technology and related systems**

Due to major technological advances in recent years, television technology is about to undergo a revolution. A report released by the Office of Technology Assessment (OTA), "The Big Picture: HDTV and High Resolution Systems," examines the scope of this development and how the United States might benefit.

The report evaluates the potential influence high definition television (HDTV) and related high resolution systems (HRS) may have in the consumer entertainment industry, and how they may affect communications, national security, research and education. The report also focuses on how HDTV and HRS are causing the U.S. to re-examine current national policies dealing with manufacturing, educational and training standardization, communications, military command, structural economic problems and the relationship between government and business. Finally the report discusses the importance HDTV holds for the U.S. in rebuilding its leadership role in global and domestic technology markets.

This 108-page report, "The Big Picture: HDTV and High Resolution Systems," stock number 052-003-01193-0 is available for \$5.00. To order send payment to Dept. 36-IP, Superintendent of Documents, Washington, DC 20402-9325; or to order with VISA or MasterCard phone (202) 783-3238.

### **EIA sponsors vocational industrial clubs of America's (VICA) national skill Olympics**

Vocational students from across the United States will compete against each other this June in the Vocational Industrial Clubs of America's National Skill Olympics, sponsored by the Electronic Industries Association's Consumer Electronics Group (EIA/CEG).

Students will draw on their many, varied vocational skills in the three-part olympics, being held Thursday, June 27, 1991, in Louisville, Kentucky.

The first part of the competition places contestants at individual test stations to complete an assigned problem within 25 minutes. The second part consists of two specific vocational activities, and the third part consists of a written examination on safety and theory questions relating to the consumer electronics industry.

Entrants compete in secondary and post-secondary categories for a variety of prizes donated by members of EIA/CEG and such companies as Snap-On-Tool, National Education Centers, the International Society of Certified Electronic Technicians, the Howard Sams and McGraw Hill publishing companies, Electronic Servicing and Technology and Radio Electronics magazines. Prizes include over \$14,000 in tools donated by the Snap-On-Tool Company, and two \$10,000 scholarships donated by National Education Centers.

According to Don Hatton, staff vice president of EIA/CEG's product services department, "The national winners are eligible to compete in the International Skill Olympics, which are held every two years. The next one will be held in Taiwan in 1993."

Hatton says the chance to compete in the International version of the Skill Olympics is especially important. "Technology is global in nature," he says. "Products also have a global orientation, as do technicians. In order to grow in their abilities, technicians should think globally, rather than keep their skills confined within domestic borders.

### **EIA 1991 Source code and date code booklet now available**

The Electronics Industries Association's Engineering Department has recently published its 1991 source code and date code booklet. This booklet, published annually, contains an alphabetical and numerical listing of code numbers which are stamped or marked on electronic products to identify production sources or the vendor assuming product responsibility. These numeric symbols are assigned and registered by the Electronic Industries Association's Engineering Department. The

EIA code also provides for the adding of numerals to the source code symbol to identify the year and week of production.

EIA Engineering Department Staff Vice President John Kinn said in announcing the availability of the Publication, "The source code and date code service is available to all manufacturers of electronic equipment and components for a annual registration fee of \$30.00."

Copies of the 1991 EIA Source Code and Date Code Booklet are available from the EIA Engineering Department, 2001 Pennsylvania Ave N.W., Washington, D.C. 20006 at a cost of \$5 each.

### **EIA releases two new training videotapes for electronic technicians**

Electronic technicians can increase their skills in two important areas, thanks to two new training videotapes being released this month by the Electronic Industries Association's Consumer Electronics Group (EIA/CEG).

"Professional Equalizer and Amplifier Installation" is the fourth in the popular Car Audio series and focuses on the installation of car audio products.

Troubleshooting Microprocessors" is the tenth in a series of training tapes geared toward troubleshooting the wide variety of consumer electronics products.

"Our training videotapes are designed to help technicians upgrade their techniques so they can effectively service today's sophisticated consumer electronic products," says Don Hatton, staff vice president of EIA/CEG's Product Services Department. "In order to operate at peak efficiency, technicians must keep educating themselves about the latest technologies being introduced in the industry. Our training tapes are designed to do just that."

Hatton notes that plans are underway to revise a pair of tapes about soldering that are currently in distribution "in order to incorporate more information on surface mount and leadless components." He says that the new soldering tapes will be available by the third quarter of 1991.

**Electronic Servicing & Technology** is edited for servicing professionals who service consumer electronics equipment. This includes service technicians, field service personnel and avid servicing enthusiasts who repair and maintain audio, video, computer and other consumer electronics equipment.

**EDITORIAL**

Nils Conrad Persson, *Editor*  
Jeffrey Uschok, *Assistant Editor*

**CONSULTING EDITORS**

Carl Babcoke, *Consumer Servicing Consultant*  
Homer L. Davidson, *TV Servicing Consultant*  
Christopher H. Fenton, *Circuit Fabrication Consultant*  
William J. Lynott, *Business Consultant*  
Victor Meeldijk, *Components Consultant*  
Kirk G. Vlstain, *Audio Consultant*  
Sam Wilson, *Electronics Theory Consultant*

**PRODUCTION**

Elizabeth Ryan, *Art Director*  
Barbara Terzo, *Artist*  
Dorothy Kehrwieler, *Production Manager*  
Emily Kreutz, *Production*  
Pat Le Blanc, *Phototypographer*  
Florence V. Martin, *Phototypographer*

**BUSINESS**

Richard A. Ross, *Publisher*  
Dorothy Kehrwieler, *General Manager*  
Frank V. Fuzia, *Controller*  
Catherine Ross, *Circulation Director*  
Melissa Kehrwieler, *Data Processor*  
Denise Pyne, *Customer Service*

**SALES OFFICE**

Electronic Servicing & Technology  
76 N. Broadway, Hicksville, NY 11801  
516-681-2922; Fax, 516-681-2926

Jonathan Kummer, *Advertising Manager*  
Emily Kreutz, *Sales Assistant*



Member, Electronic  
Servicing Dealers  
Association

**EDITORIAL CORRESPONDENCE**

P.O. Box 12487 Overland Park, KS 66212  
913-492-4857

Electronic Servicing & Technology (ISSN 0278-9922) is published monthly by CQ Communications, Inc., 76 N. Broadway, Hicksville, NY 11801. Telephone (516) 681-2922. Second class postage paid at Hicksville, NY and additional offices. Subscription prices (payable in US dollars only): Domestic—one year \$24, two years \$36. Foreign countries—one year \$30, two years \$42.

U.S. Government Agencies: Subscriptions to Electronic Servicing & Technology are available to agencies of the United States government, including military services, only on a cash with order basis. Requests for quotations, bids, contracts, etc. will be refused and will not be returned or processed.

Entire contents copyright 1991 by CQ Communications, Inc. Electronic Servicing & Technology or CQ Communications, Inc. assumes no responsibility for unsolicited manuscripts. Allow six weeks for delivery of first issue and for change of address. Printed in the United States of America.

Postmaster: Please send change of address notice to Electronic Servicing & Technology, 76 N. Broadway, Hicksville, NY 11801.

CQ Communications, Inc. is publisher of CQ The Radio Amateur's Journal, Popular Communications, Modern Electronics, CQ Radio Amateur (Spanish CQ), CQ Amateur Radio Equipment Buyer's Guide, CQ Amateur Radio Antenna Buyer's Guide, and Electronic Servicing & Technology.

**Relay application guide**

An updated and expanded version of the popular Bosch Relay Application Guide has just been published.

Now in its 4th edition, the Guide's 28 pages are filled with useful diagrams, schematics, and applications (all listed in alphabetical order), which provide important, time-saving information for installers of the Bosch-Mini Giant Relay or Socket. The David Levy Corporation (DLC) has annually compiled the Bosch Guide since 1988. "These applications have been submitted by 25 top-notch manufacturers, installers and technicians in the autosound and mobile electronics industry," said David Levy, President of DLC. "These are insider tips and short cuts that can really save lots of time and headaches when it comes to things like alarm, autosound, cellular, and special lighting applications in vehicles where SPDT or SPST relays are needed."

Circle (31) on Reply Card

**Catalog highlights solder system tester**

Electrical and electronic test equipment, including this solder system tester which also enables testing for ESD protection, is presented in Tegam's new, fully-illustrated catalog. Also included is information on Tegam's capabilities for developing custom temperature sensing devices and systems. Digital thermometers, calibrators, multi-probe switchboxes, fail-safe personal voltmeters, and a wide range of other instruments and equipment are also presented.

The 20-page catalog, with products described from the user's point of view, features large photos of each product.

Circle (32) on Reply Card

**Product catalog**

Tektronix' 1991 catalog with more than 3,000 products, is now available. The 388-page, hardbound catalog lists the company's line of products in three broad areas—electronic test and measurement instruments, professional broadcast equipment and computer peripherals. This year's catalog features more than 70 hardware and software products released since Tek's last catalog was published.

In test and measurement, about a dozen new oscilloscopes have been added to a full line of analog and digital instruments. New products include digital signal analyzers, communication signal analyzers, high-end digital sampling scopes, mid-range scopes and a new hand-held battery-operated scope. New plug-in card modular accessories are included in this year's book. Other instruments include generators, and Centurion which is a 100 MHz plug-in module for logic analyzers.

Circle (33) on Reply Card

**Bulletin describes new analog multimeters**

A 2-page, 4-color product bulletin is available from Simpson Electric Company, which describes the company's recently introduced 260-8XI and 260-8XPI analog multimeters. The meters offer increased durability and scale visibility, plus a highly visible yellow ABS plastic case for harsh environments.

The text of the new literature is primarily devoted to describing product features, like direct trend indication, easy nulling and peaking, and quick positive "yes/no" checks for voltage and current. The text also covers an audible continuity mode which is available for rapid troubleshooting. The product bulletin also includes complete product specifications and a list of accessories which include an optional "Grab-N-Go" padded carrying case.

Circle (34) on Reply Card

**Ceramic filter catalog/application manual**

Murata Erie is now offering a 28-page design manual and catalog for their line of ceramic filters for communications, home entertainment and automotive applications. Included are single and multiple element filters covering many standard frequencies—455 KHz, 3.58 MHz, 4.5 MHz and 10.7 MHz and more—to meet almost any application requirement. Ceramic discriminators and signal detectors are also included as are filters for surface mounting. Electrical, mechanical and response characteristics are covered in detail. Application information includes theory of operation and circuit design considerations.

Circle (35) on Reply Card



### New catalog introduces SMT and microprocessor test accessories

Pomona Electronics has introduced a new, 140-page 1991 catalog of electronic test accessories. Highlights include a new 32-pin PLCC (0.05 pin spacing) clip for popular new EEPROM devices and 100 and 132 pin QFP SMT test clips for Motorola 68020/68030 and Intel 80386SX microprocessors. Additional accessories to make testing SMT devices easier and more reliable provide a complete solution for this growing area.

The catalog also features new IC clip kits, coax/BNC universal adapter kits, digital multimeter test lead kits, cable and patch accessories and jumper kits.

Ten major product categories are presented with an easy-to-use index and includes the company's most popular selection of jumpers and cables, boxes, plugs and jacks, connectors, adapters, single-point test clips and static control devices.

Circle (36) on Reply Card

### Industrial indoor air quality brochures

Nederman Inc. has introduced two new brochures that describe their full line of products engineered to remove smoke, dust, fume and vehicle exhaust from the workplace. The 10-Z and 30-Z brochures outline the concept of Source Capture and how it applies to industrial indoor air quality. Each piece contains information about the products and the options and accessories available. The 10-Z provides information on the vehicle exhaust extraction products while the 30-Z contains information on fume, dust and smoke extraction and filtration.

Circle (37) on Reply Card

### Catalog of electronic test equipment

An 8-page, fully-illustrated catalog describing Simpson Electric's Mercer line of high-quality, low-cost test equipment is now available. Instruments featured in the catalog include hand-held and pocket digital multimeters, multifunction frequen-

cy counters, 2MHz sweep/function generators, logic probes, and hand-held volt-ohm-milliammeters. Special digital testers and the Mercer Digi-Clamp are also described. The catalog also provides users with lists of specifications and accessories, as well as ordering information.

Circle (38) on Reply Card

### New 1991 catalog

Sixty five ways to save time and money designing and testing today's electronics is a new 36-page catalog from Global Specialities, featuring high performance affordably priced electronic testing and prototyping equipment.

The catalog is packed with products: digital multimeters, test instruments, power supplies, frequency counters, logic test, breadboards, and PC prototyping cards.

New products featured include a ten instrument in one handheld multimeter, three logic analysis test kits, and a digitally synthesized function generator.

Circle (39) on Reply Card

# Ready, Willing and Able.

## 324 PanaVise Electronic Work Center ▶

This economical package makes work areas more efficient and manageable. Parts, tools, solder, soldering iron holder and PC board are exactly where you want them! Features famous PanaVise "tilt, turn and rotate" control. Solder spool holder self-centers the feed, and the soldering iron holder keeps the iron at an easy-to-reach angle. Rugged, sturdy and tough, it also accepts all regular PanaVise interchangeable heads.

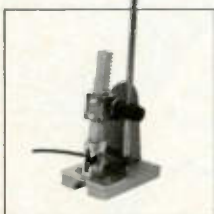

### ▲ 560 Crimp Press

This is the ultimate solution to problems associated with hand crimpers. The PanaVise Crimp Press offers effortless operation, may help prevent Carpal-Tunnel Syndrome, applies even pressure on all surfaces, and is competitively priced with hand crimpers. Accepts PanaVise, Shattuck and Paladin die sets.



### ◀ 301 Standard PanaVise

Here's the world's best small vise and the perfect introduction to PanaVise quality and convenience. One control knob locks work firmly into position! Also accepts all regular PanaVise interchangeable heads.



**PANAVISE**®

1485 Southern Way  
Sparks, Nevada 89431  
Tel: (702) 353-2900  
Fax: (702) 353-2929

Circle (11) on Reply Card

# Servicing camcorder motor circuits

By Homer L. Davidson

A deluxe VHS camcorder may employ as many as five different motors, while an inexpensive unit uses only two or three motors. These motors provide three separate groups of functions: 1. Tape loading and unloading 2. Tape and head drum operation 3. Control of camera optics.

The function of the loading motor is to eject, load and unload the video cassette (Figure 1). The capstan motor provides tape movement in play, record, fast-forward, and search modes. The drum or cylinder motor rotates the drumhead assembly.

The iris motor mechanically opens and closes the iris assembly, the portion of the lens assembly that controls the amount of light admitted. The automatic focus motor controls the camera focus and the zoom motor moves the lens assembly for close or far distance pictures. Both the zoom and focus motors are located upon the camera lens assembly. The small JVC GR-C9U camcorder has only a drum, capstan and loading motor.

## Motor problems and symptoms

Before beginning disassembly of a defective camcorder, check all of its functions. Notice if the symptom reported by the owner is tied to more than one operation. For example, a defective capstan motor or circuit may be the cause of any of a number of problems: improper play or record operations, improper tape speed, inoperative fast-forward and search modes.

Improper motor operation may be caused by problems in the motor itself, or problems in the circuits and components that control the motor, or belts and gears driven by the mo-

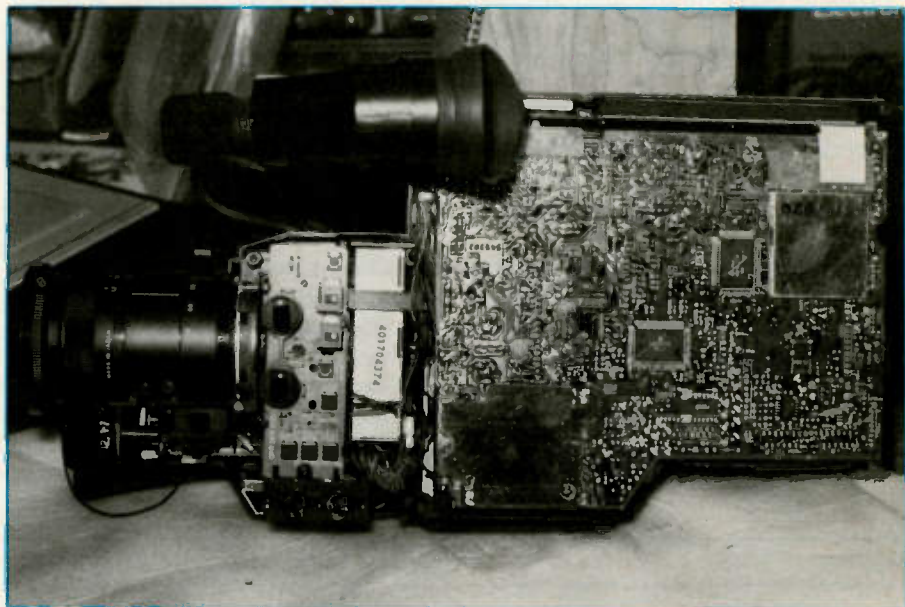

Figure 1. The large VHS camcorder may have 5 or 6 motors and motor circuits. Both outside covers must be removed to test the various motors.



Figure 2. The loading motor is found off to one side in the VHS RCA CPR300 camcorder.

Davidson is a TV servicing consultant for ES&T

tor. Motor malfunctions may be the result of improper control signals, transistor or IC control circuits or improper applied voltage. The defective motor may be mechanically noisy or produce noise in the picture and sound circuits. If the control circuits are intermittent, the motor will operate intermittently.

A motor that fails to operate may have an open winding, or the problem could be a bad socket or lead connections, or the problem could be that there is no input voltage. Incorrect motor speed may result from worn or dry bearings. First, check the motor drive belts for slippage caused by worn or stretched belts. Binding within the gear assembly or bent drive assemblies, may be the cause of slow camcorder operation, or total lack of operation. Inspect the belt and drive mechanisms to see if that's the cause of the problem before removing the suspected motor.

#### Loading motor problems

In lower priced camcorders, the cassette is loaded and unloaded manually, while in other models the eject button is pressed and the loading door opens so the cassette can be loaded or removed (Figure 2). Some camcorders are loaded by pushing in the loaded cassette door assembly and others operate electronically.

Suspect a defective loading motor or control circuits when the loading motor will not eject, load or unload cassettes. Often the loading motor is controlled by a signal from the system control IC to the motor drive transistor or IC. Some of the early loading motors were controlled by power type transistors, while the latest models are all IC control components (Figure 3). In this camcorder, the motor voltage is supplied by IC902.

When the camcorder is in the STOP position, no voltage is present at either pins 2 or 4 of IC902, feeding to the loading motor. With signal at pin 22 of IC901, loading voltage appears at pin 2 of IC902, supplying voltage to the motor. When in the unloading mode, a signal at pin 23 of IC901 causes IC902 to apply voltage at pin 4, reversing the polarity of voltage at the loading motor.

#### The capstan motor

The capstan motor provides tape movement in play, record, rewind,

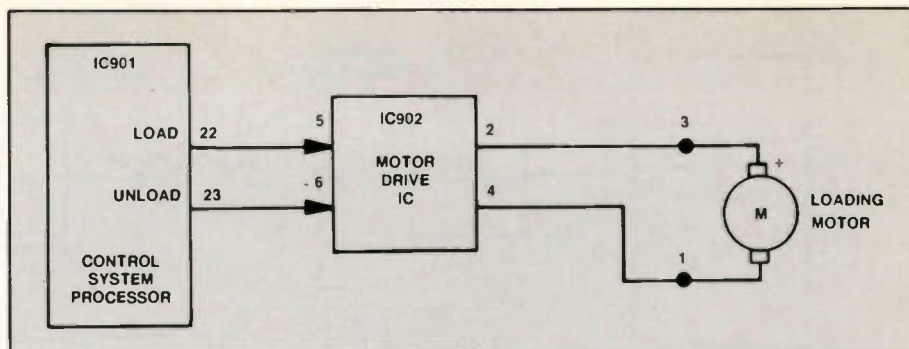

Figure 3. The typical loading motor is controlled by a system control and motor driven IC or transistor circuit. Transistor driving circuits may be found in the early camcorders.

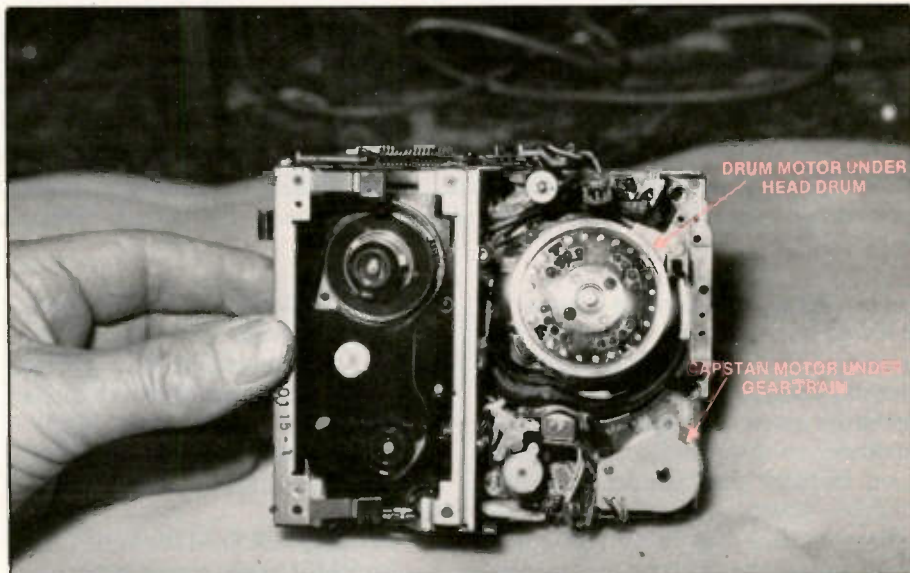

Figure 4. The capstan motor may drive a gear or belt system to provide play, record, fast-forward and search modes.

fast forward and search modes. The capstan motor may be referred to as the mode motor in some camcorder circuits. This motor may drive the mechanical assemblies via gears or belts (Figure 4). Always check the rubber drive belts and pulleys when the symptom is slower speed or slippage. Complete failure to operate may indicate a broken or loose drive belt.

The system or servo IC may control the capstan motor through a capstan motor drive IC. Sometimes the capstan and cylinder motors are fed from the same signal source. The system processor (IC901) controls the direction of rotation of the capstan motor in the forward and reverse modes (CAPSTAN FWD and CAPSTAN REV).

The CAPSTAN FWD signal is fed from pin 36 of IC901 to pin 5 of the capstan motor driver IC, IC604 (Figure 5). IC604 applies 2V to the cap-

stan motor at pin 2 in forward motion. When the capstan signal is in reverse mode, IC604 applies 2V to pin 10. Forward motion includes play, record and search, while in reverse, the motor provides search and rewind.

When in fast-forward mode, pins 36, 35, 34, 33, and 32 provide a combination of signals that cause approximately +4.6V to be applied to pin 2 of the capstan motor. In rewind mode, pins 37, 35, 34, 33 and 32 provide a combination of signals that cause +4.6V to be applied to pin 10 of the capstan motor. When the reel idler is rotating without a load, the voltage is approximately 2.4V at the capstan motor terminals. No voltage or signal is found on any of the IC pins in STOP mode.

#### Drum and cylinder motors

The drum or cylinder motor rotates the cylinder or drum at a high

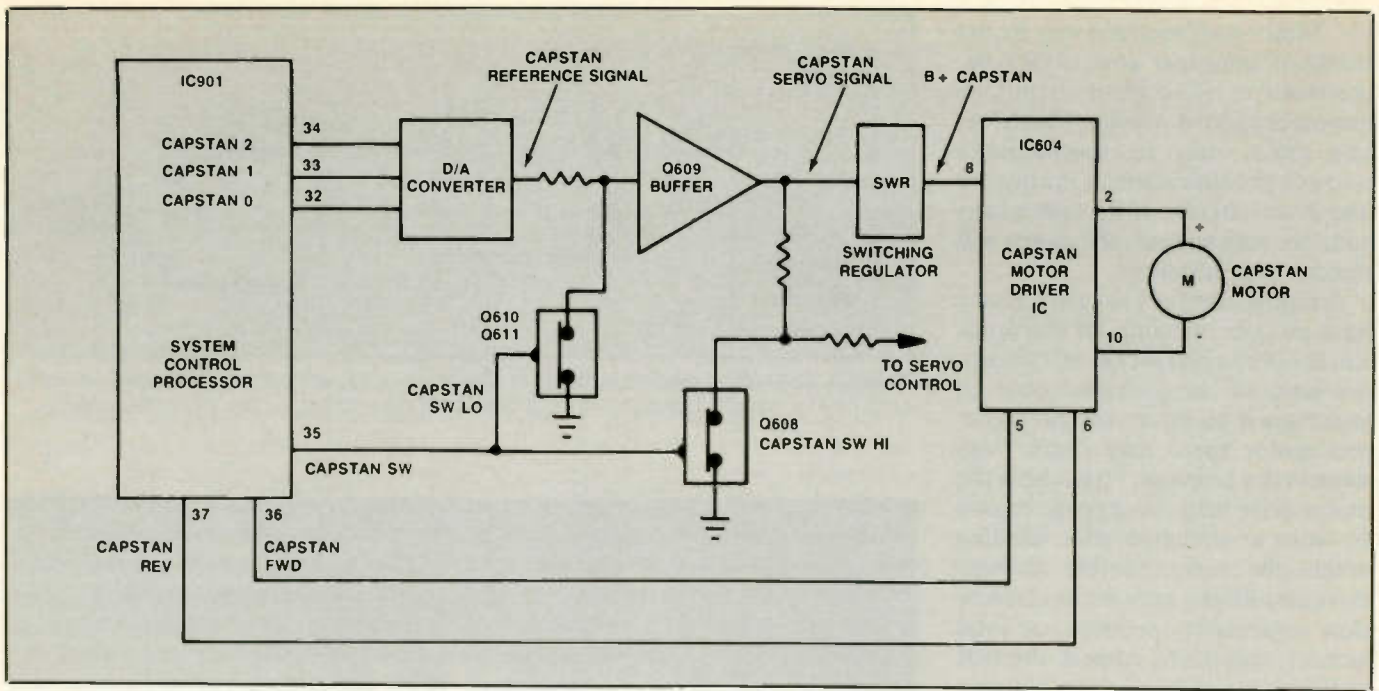

Figure 5. The capstan motor system control and driver ICs found in the Realistic 150 camcorder.

rate of speed. The drum or cylinder is located at the top of the motor assembly. The cylinder and drum assembly consists of an upper and lower drum assembly. Operation of the cylinder or drum motor is complex and includes the cylinder or drum motor speed control, recording phase control and motor. In some camcorders the cylinder motor may be referred to as the mode-cylinder motor.

The cylinder and capstan motors are controlled by servo circuits. In the RCA CPR100 camcorder, the phase and speed of the cylinder mo-

tor is controlled by IC601. The control signals from pins 61 and 64 (IC601) are added in the buffer IC552 and the output of this circuit is applied to the motor driver IC551. Pins 10, 11, and 12 of IC551 apply directly to the cylinder drive coils (Figure 6).

The Sony CCD-M8E/M8U and Zenith VM6150 drum motor circuits are complex with many different components. The Sony drum motor is a sensorless three-phase unidirectional brushless current motor. The Zenith drum servo motor circuits consists of the recording speed con-

rol, recording phase control, and drum control. The cylinder or drum drive voltage is applied to the buffer IC which controls the current flowing through the three-phase cylinder or drum motor drive coils.

#### Checking auto focus motor circuits

The basic auto focus circuit consists of an infrared sensor, processor IC, motor drive IC and motor. The focus motor is located upon the lens assembly and usually the infrared assembly underneath the lens assembly. The infrared emitting signal can be detected with an infrared indica-

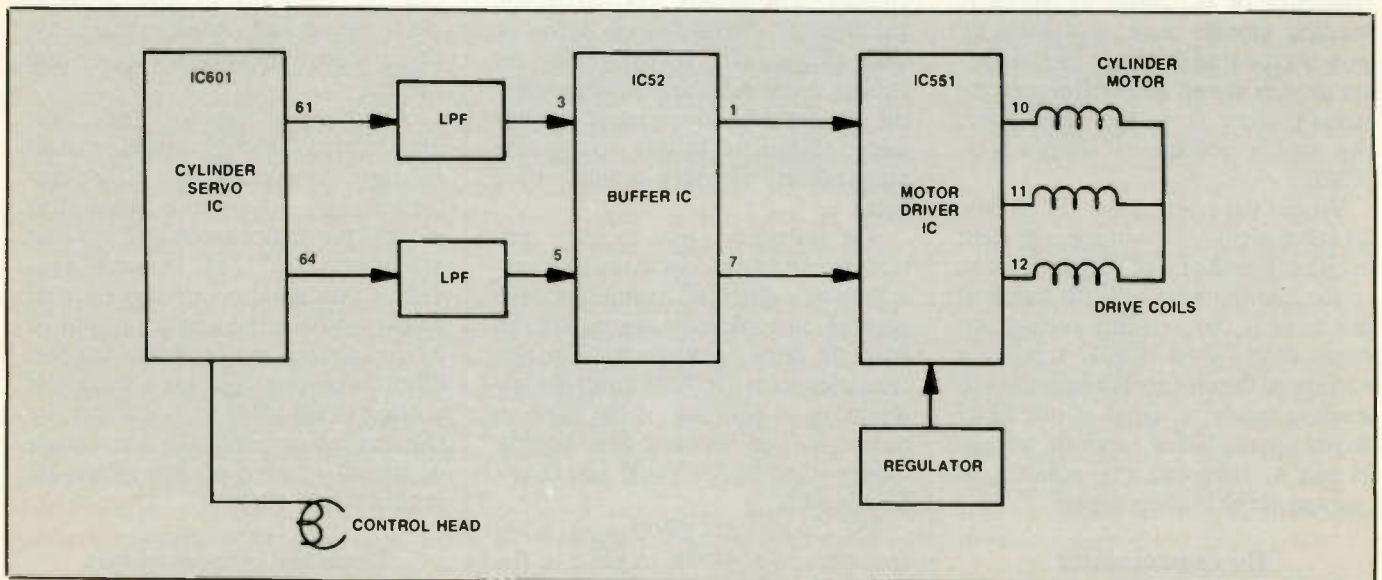

Figure 6. A typical block diagram of the RCA CPR100 cylinder speed/phase control motor circuits.

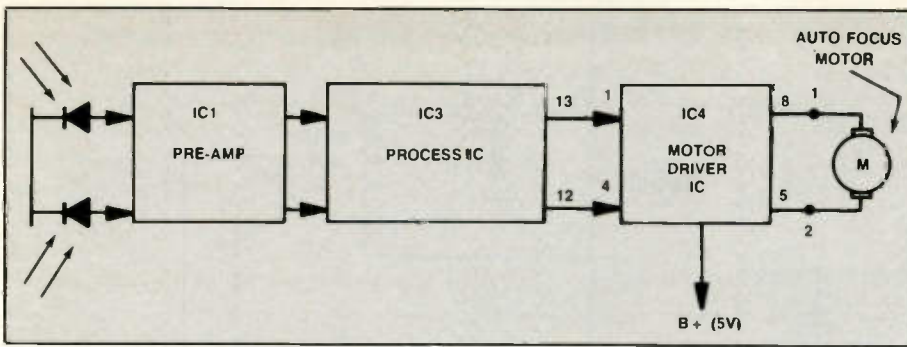

Figure 7. The basic block diagram of the auto focus (AF) motor circuit. The auto focus motor is located at the lens assembly.

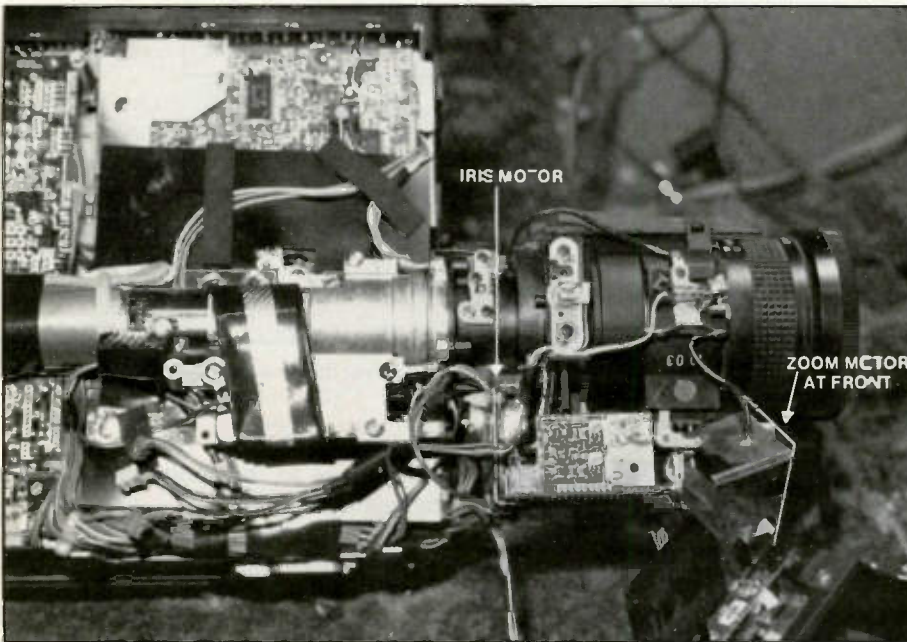

Figure 8. The location of the zoom and iris motors in a Quasar VM10 camcorder.

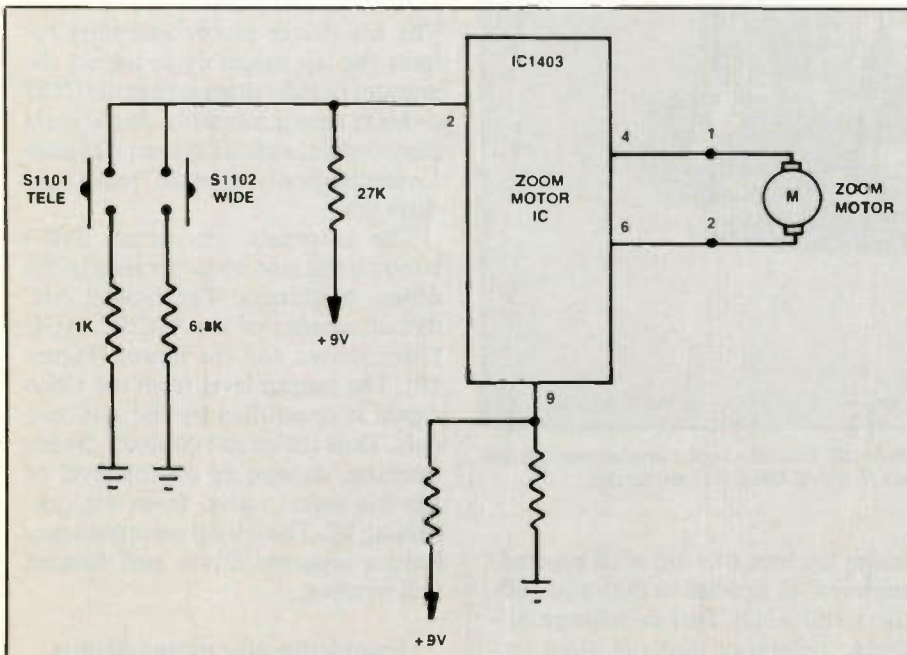

Figure 9. The TELE and WIDE zoom motor simply operates by switching a different size resistor in the zoom motor driver IC circuit.

tor like ones that check the TV infrared remote transmitter.

When switched to Auto Focus position, B+ voltage is applied to the auto focus control circuits. The auto focus circuit generates an infrared output signal that hits the subject and bounces back to the two photodiodes. The reflected signal is rectified by the diodes and produces electrical current in proportion to the amount of infrared light received by each diode (Figure 7).

IC1 amplifies the two signals. The signals are synchronized and detected by a clock signal in IC3. These signals are compared to the reference signal. Now, the focus correction signal is applied to the motor drive circuits (IC4). The correction voltage is applied to the focus motor. You may find transistors instead of IC components in some auto focus motor drive circuits.

Check the auto focus mode by scanning different areas with the camcorder. Bring your hand up close to the lens assembly. If the focus circuits are performing, the lens assembly will rotate back and forth. Check the infrared signal with the infrared tester by placing it close against the emitting diodes below the lens assembly. Remove the covers and check the auto focus circuits if the lens assembly does not move.

### The zoom motor circuits

The focus and zoom motors are located on the lens board assembly. The zoom motor brings the image up close from far away. The power zoom (PZ) motor is operated independently with a TELE or WIDE switch operation (Figure 8). Often, the zoom switch is located near the hand that holds and operates the camcorder. The dc zoom motor may operate from transistors, in the early models, or IC components in the later camcorders, and may operate directly from the system control IC. The zoom motor may have an IC driver, ahead of the motor assembly, like all other motors in the camcorder. Notice the voltage applied to most zoom motors is very low (0 to 6.5V).

When the input level is 1V, it may take 8 to 10 seconds for the zoom lens to go all the way out or in. Within the Realistic 150 model, the zoom direction is determined from the voltage level applied to pin 2 of IC 1403 (Figure 9). Actually, the amount of volt-

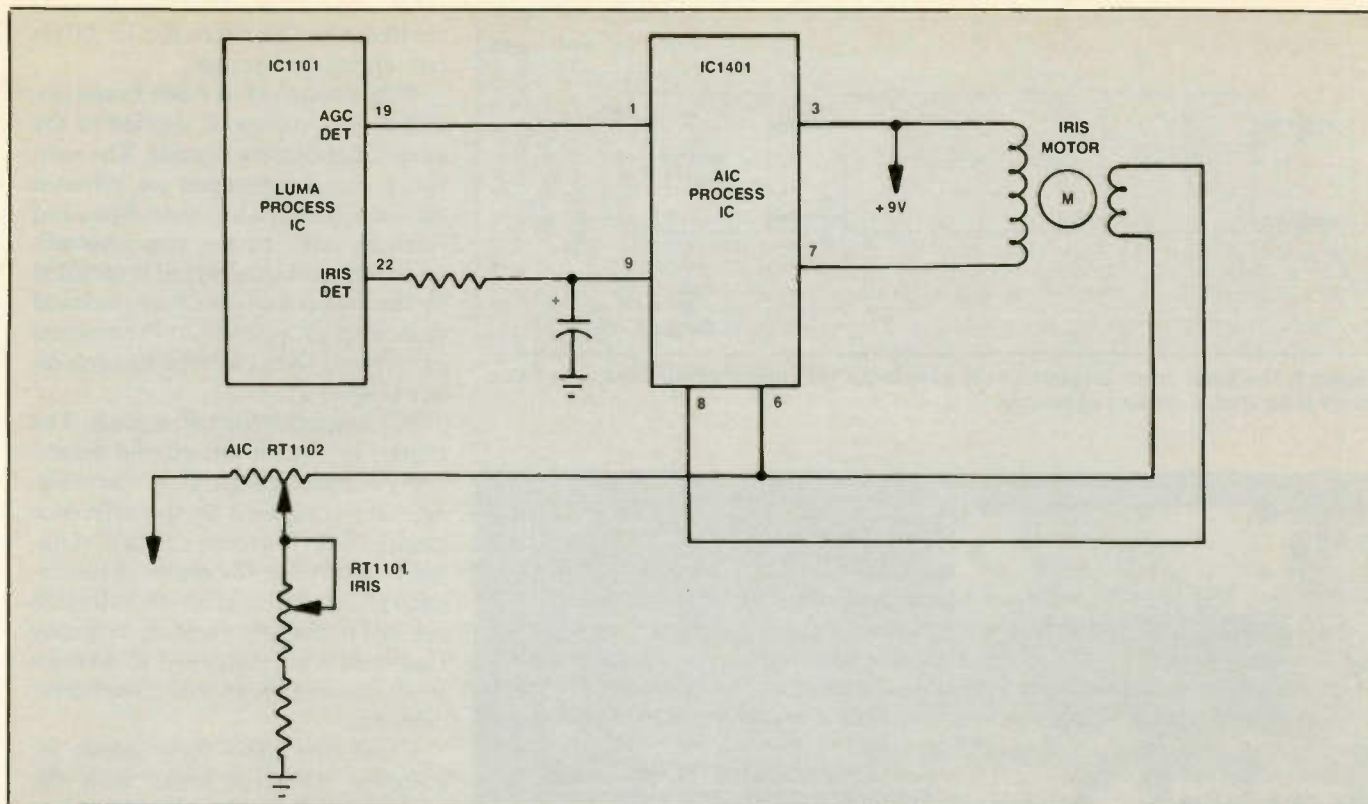

Figure 10. A block diagram of the iris motor circuits. The iris motor may consist of a damper and driver motor winding.

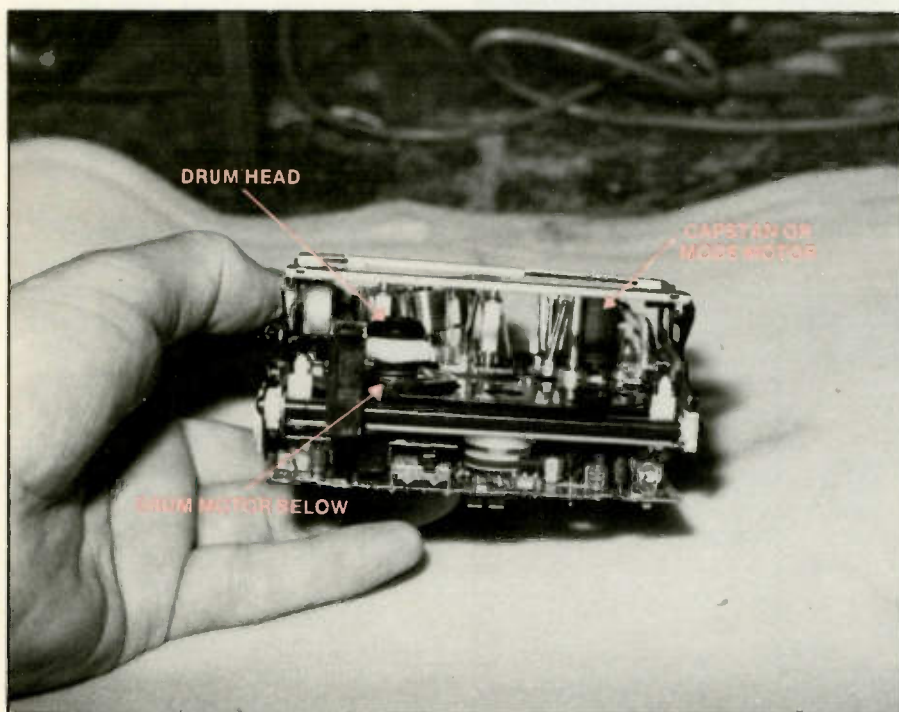

Figure 11. The motors found in the camcorder are small. The drum and capstan motors are sandwiched between the sub and bottom chassis in a JVC GR-C9U camcorder.

age applied to IC1403 determines the position of the zoom motor.

With the TELE switch, the lens assembly is zoomed all the way in with an input (0.3V) voltage. When S1102 (wide) is pressed, the motor will

zoom the lens way out with approximately 6.4V applied to the input voltage terminal (2). Just switching a different resistance into the input terminal 2, applies a different voltage to pin 2, which in turn applies a differ-

ent voltage to the zoom motor terminals 1 and 2.

#### The iris motor assembly

The iris driver, zoom, and AF motors are located on the lens assembly. Usually, the iris driver is located at the rear next to the camcorder body, the zoom motor in the middle and the auto focus (AF) motor out in front. The iris driver motor assembly rotates the iris assembly to adjust the amount of light that reaches the CCD or MOS sensor assembly. In the early camcorders, a meter system was used to mechanically operate brake and drive coils.

The automatic iris circuit (AIC) controls the lens iris according to the object brightness. The typical AIC circuit consists of the AIC IC, AGC killer, driver and iris motor (Figure 10). The output level from the video signal is controlled by the AIC circuit. Thus the circuit controls the iris opening, depending on the level of the iris detect signal from the processing IC. The iris driver motor may have a separate driver and damper coil winding.

#### Troubleshooting motor circuits

When a camcorder motor malfunctions, the first step in diagnosis

is to measure the dc voltage at the motor terminals to determine if the motor is defective or if the problem is in the control circuits. If voltage is present, suspect a defective motor. Check the motor winding for continuity. The motor resistance may be only a few ohms. When voltage is not present, check the motor drive IC circuits. Locate the driver IC and check the voltage applied to the motor circuit. If voltage is present, suspect poor wiring or a defective motor socket. Check each pin of the driver IC and compare the voltage with those listed on the schematic. Especially, check the supply voltage terminal. Low voltage at the IC supply voltage terminal in conjunction with absence of output motor voltage may indicate a leaky IC. The supply voltage may be supplied from a regulator transistor.

Scope the input signal waveforms from the servo, processing and mechanism IC. Usually both the capstan and cylinder motors are affected when the problem is a defective servo circuit.

Voltage is not present at the motor

terminals until the operation button is pressed. Don't overlook the possibility that the problem might be caused by a dirty or open operation switch. Especially check the loading and zoom motor switches in the low-priced camcorders when the camcorder does not eject, load or unload. Inspect the zoom motor gear drive assembly when the lens assembly is stuck at either end.

Do not overlook broken, stretched or worn drive belts or a worn idler wheel when the problem is slow speed or no operation. Check for bent, broken or damaged components when the motor voltage is present without any movement. Poor board connections, component connections, socket connections and broken pc wiring may prevent the camcorder motor from functioning.

The capstan and loading motor may set off to the side of the main chassis for easy replacement. The drum and cylinder motor is rather difficult to remove, as it may be mounted between two different chassis (Figure 11). The zoom, iris and focus motors may be easily removed

with only one or two mounting screws. Some motor cables or wiring plug into the circuits, while others are soldered directly to the pc wiring.

### Conclusion

There are many different capstan, cylinder and drum motor servo driver systems. Some are quite simple, while others are rather complex. Most dc motors are driven by a transistor or IC component, except the drum and cylinder motor circuits.

The dc camcorder motors can reverse direction by switching the voltage polarity applied at the motor terminals. Remember, the voltage found upon the motor terminals may be quite low, from a fraction of a volt up to 6.5V. Always, have the camcorder schematic handy before servicing the master processing, control and servo IC circuits. Critical troubleshooting charts are found in many camcorder service manuals.

The material for this article was adapted from the book *Troubleshooting and repairing camcorders*, by Homer L. Davidson. TAB Books Inc. #3337. ■

## Improve Your Form.

### 3-Part

A continuous feed form used for customer c.o.d. service or parts/accessory sales receipts

(N3CN). Not for warranty billing. Computer generated software to be available soon.

### 5-Part

Available in snapout (N5SN) or continuous feed (N5CN). Matching fields with N3SN.

except for customer estimate and receipts. For warranty billing.

### 7-Part

A universal snapout form (N7SN) designed for both customer service c.o.d. and manufacturer warranty billing. Complies fully with the requirements of state and local ordinances, including California.

### Discounts

Carbonless NESDA Forms are available to NESDA members at additional savings. For pricing information and samples, or information regarding other NESDA membership benefits, write to NESDA, 2708 W. Berry St., Ft. Worth, TX 76109; or call (817) 921-9061.

## The NESDA Form

NESDA, 2708 W. Berry St.  
Fort Worth TX 76109  
Phone: (817) 921-9061



## 12 Vaco Hex Key styles in all sizes to meet your exact needs

- T-Handles • Folding Sets • L-Keys
- Ball Ends • Kits

# KLEIN

VACO hex keys made from top grade alloy steel...precise fit with square cut ends for optimum torque...heat treated for toughness...corrosion resistant. See your distributor.



The choice of professionals... since 1857

7200 McCormick Blvd.  
P.O. Box 599033  
Chicago, IL 60659-9033

Circle (5) on Reply Card

# Rethinking the technician's toolkit

By Conrad Persson

There was a time in the not so distant past when planning the technician's toolkit was a more or less haphazard affair. The technician might take a look at the items he had on the bench and make a selection of tools based on what he saw there: a couple of different sizes of straight screwdriver and Phillips head screwdrivers, a socket set or nutdriver set, a soldering iron, a DMM, a pair of pliers. Oh, and maybe a pair of long-nose pliers, maybe some dikes, a few other tools, then off to the customer's house to work. And if you didn't have what you needed, you might carry the TV back to the shop, pulling the chassis from the console if that was necessary.

Things have changed dramatically in the last few years. So much so that taking some time to really think out what should go in the toolkit of a technician who will be doing servicing at the customer's site could reap large dividends.

As an example of how things have changed is the projection TV. They're big and bulky, and they're not designed to have the chassis pulled to bring back to the shop. If a projection TV has to be brought into the shop, it will probably take two people and a pretty good sized truck to do it. Many service centers now just contract a moving company for this effort. That means a charge to the customer of \$100 or more just for the transportation.

Then there are personal computers in the home. Even though these products are not very big or heavy and can be easily transported, if the customer has a computer, it's entirely possible that he has come to depend on it, and wants it up and running in the office, not on a truck or in the shop. Besides, because most IBM compatible computers at least are modular in nature, they can often be repaired on site if the technician has the proper replacements on hand.

Another example of a product that



New realities in on-site consumer electronics servicing require a new approach to buying/building a field technician's toolkit.

is probably best serviced on site is a facsimile machine. Again, if a customer has one, he has probably become dependent on it and wants it in the home office, and working. In addition, fax machine problems are frequently caused by problems that have nothing to do with the fax machine that seems to be causing the problem. The problem may be in the fax machine with which the customer's fax machine is trying to communicate. The problem may be with the telephone line, either at the site or somewhere in between the customer's fax machine and the fax machine at the distant end. In such cases, if you bring that product into the shop for work, the diagnosis will be "no trouble found" and when you return the fax machine to the customer it still won't work.

## Planning a toolkit

In view of these and other recent changes in consumer electronics products and the needs of consumers, the most important tool for stocking an efficient toolkit is planning. Just as you carefully plan your workspace and decide what products your shop will service, you must put time and

thought into stocking a complete, but still portable, toolkit. Ask the technicians who actually do the on-site servicing for their opinion on tool selection. You do not have to include every tool they suggest, but their input will contribute to a more efficient toolkit.

Evaluate the work your shop does, what types of repairs you will make on-site, and what repairs you will only make in the shop. Here is a checklist to help you build an efficient toolkit.

- Determine what type of products you will service on-site.
- Many components in today's consumer electronics products are subject to Electrostatic Discharge (ESD) damage. Be certain that your toolkit is equipped with a grounding wrist-strap and antistatic mat. Also include antistatic bags to carry printed circuit boards you may replace.
- If you will service personal computers, a selection of diagnostic disks will help you pinpoint problems. Make sure that the disks are adequately protected from physical and magnetic damage.
- Do not forget the accessories. An angled mirror like the ones used by

Persson is editor of ES&T.



dentists may enable you to see into the dark recesses of a product. A hand magnifier may let you see details you cannot otherwise see, thus let you complete a repair that would not have been possible. A flexible shaft or angled shaft may allow you to remove and replace screws that you might otherwise not be able to touch without extensive disassembly.

- Inevitably, you will drop a fastener or other important part. According to Murphy's Law, it will land in the most inaccessible spot. To recover the missing part, you should have the two types of part retrievers: the magnetic and the spring loaded grabber. Both can turn desperate scrambling into routine servicing, but be careful to keep the magnetized retriever away from the diagnostic disks.

- There is never enough light. Carrying a flashlight and an ac-powered lamp in your toolkit will enable you to place enough light wherever you need it. In further deference to Mr. Murphy, you might want to carry spare lightbulbs and batteries.

- Another important ingredient in a well-stocked toolkit is a selection of cleaning supplies and lubricants, including paper towels and rags. Dust and dirt love to collect in the warm electrified atmosphere of consumer electronics products. Electromechanical components, such as magnetic heads in VCRs and disk drives, may become clogged with oxides and require cleaning.

- Other supplies to consider are a vacuum cleaner, a can of air under pressure, soft brushes, isopropyl alcohol, Freon, foam, or chamois swabs and screen wipes.

- You should carry basic test and measurement equipment, such as a DMM, an oscilloscope and the appropriate gauges.

- Two-way communication, either via a two-way radio system or a cellular telephone, or both, might more than pay for itself. In many cases, if a field technician is faced with a problem he just can't quite solve, consultation with a more experienced technician back at the service center might turn a "I'll have to take it into the shop" situation into a "you're back in business" situation. Another way you might use two-way communication between the field technician and home base is to express parts from the shop or a distributor to the work site to avoid interrupting a re-

pair or taking a set into the shop.

- The type of carrying case you select is also important. You can choose between an attache case, a soft-sided pouch or a formed aluminum case. Before purchasing a kit, you may want to ask your distributor's advice. Which one is best for you depends on the type of products you will be servicing, how many tools and test instruments you will carry, and how much abuse your kit will have to withstand. If you will equip several technicians, you may want to purchase each type of case, then determine which one lasts the longest and which one the technicians prefer.

#### Some other considerations

Planning a toolkit for on-site servicing of today's consumer electronics products should also take into account some of the recent develop-

ments in the kinds of tools and accessories available.

For example, there was a time when to take an oscilloscope to the site would have been quite a challenge. An oscilloscope that would have been useful for servicing a TV would have been too heavy, bulky, susceptible to vibration and shock damage, and much too expensive to take out of the safety of the shop.

Today, the innovations in oscilloscope technology have made inexpensive wideband scopes available in packages small enough to fit the toolkit, with price tags that make them inexpensive enough that they can be considered a toolkit item.

Another innovation that makes today's toolkit far more valuable than a toolkit of a few years ago is the modern DMM. In addition to checking voltage, current and resistance, many of today's DMMs can check diode function, capacitance, and frequency.

### Your tool kit?



### Our tool kit!

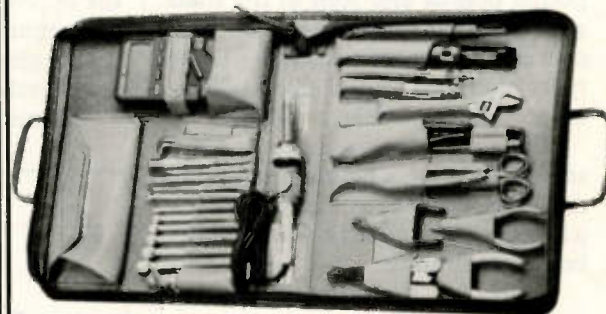

**When thinking about  
tool kits - think JENSEN!**



**JENSEN TOOLS INC.**

7815 South 46th St., Phoenix, AZ 85044-5399  
Phone: (602) 968-6231 FAX: (800) 366-9662  
Call or write for your free catalog, today!

Circle (3) on Reply Card

# Printed circuit board repair, step by step

By Thomas G. Vlazny

**D**amaged printed circuit (PC) boards can be repaired. If you choose to learn how to do it, you can improve your soldering skills. You can create an image for yourself as a craftsman. You can profit from this skill and you can save some money in the process. Of course, there are times when board replacement is the only answer. Here are some suggestions for inspection and evaluation of PC boards and some techniques on repair.

Many of the PC boards used in consumer products today are either single-sided or double-sided. These are the two circuit board styles most technicians have the tools to repair. The sandwich and multilayer boards are best replaced rather than repaired. Another type of board, usually seen only in military electronics are potted PC boards; those encapsulated in a thick coating of an epoxy compound. The thick coating associated with potted boards and seen in the solid state rectifiers makes the repair process impossible, or nearly so. These types of boards should also be designated in the replacement category.

There are some special tools every shop should have before attempting any PC board repairs. See Table 1 for a list of both standard and special PC board repair tools.

Figure 1A shows a single-sided board. Figure 1B shows the double-sided board. We have also marked the component and trace sides of the single-sided board for identification during this discussion.

## Single-sided boards

Because single-sided boards are more common, let's start with them.

Vlazny is an instructor at Bus Tran Institute in Milwaukee. He has over twenty years of experience in the electronics industry and is owner of Educational Commitments. He is also an active member of NESDA, IS CET, WESA and ASCD.

Table 1

Low-wattage soldering iron	PCB holding fixture
Solder-sucker	Solder flux
Desoldering braid	Thin rosin-core solder
Magnifying lamp	Needle-nose pliers
Small ball-peen hammer	Diagonal cutters
Heat sinks	End nippers
Toothpicks	Hookup wire (20 to 22 AWG)
Tweezers	Wirewrap (insulated wire)
Standard office staples	Emery cloth
Isopropyl alcohol	Cotton or foam swabs
Hand drill/bits	Epoxy glue
Fiberglass repair kit	Soldering aids
Plasticoat spray or lacquer	Plastic strips or tongue depressors

Table 1. Before attempting any extensive printed circuit board repair, you should have these tools and supplies on hand.

Note from the drawing that there are circuit traces only on one side. The parts location, parts orientation, part numbers, and even the value of the components may be imprinted on the opposite side. All the inspection and repair techniques suggested for the single-sided PC board will take place on the trace side except as noted.

Any number of faults may be pres-

ent on a damaged circuit board which will have to be weighed in making the decision to repair or replace. An obvious fault such as massive destruction would easily put the board in the replace category. If it comes in in pieces, replace it. In many cases, surprisingly, lightning damage or fire damage may be repaired. The actual damage may be far less than what the

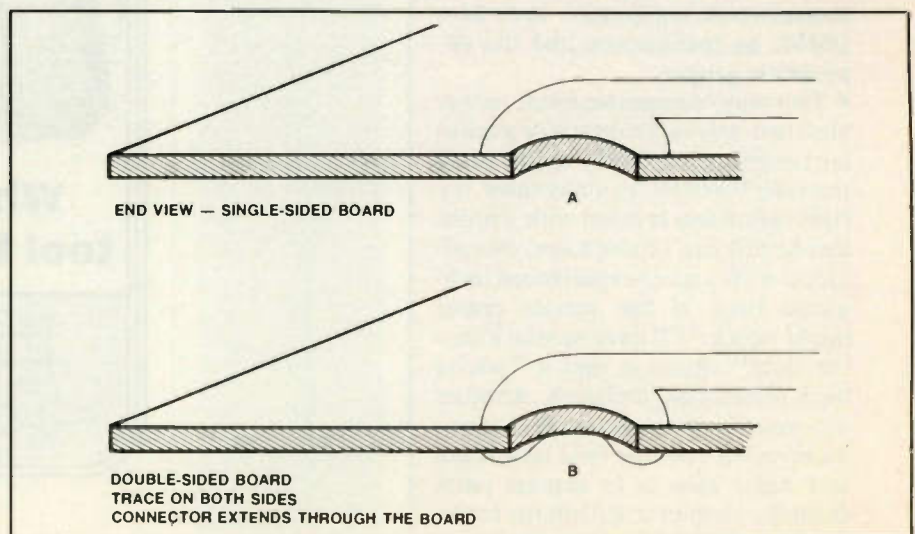

Figure 1

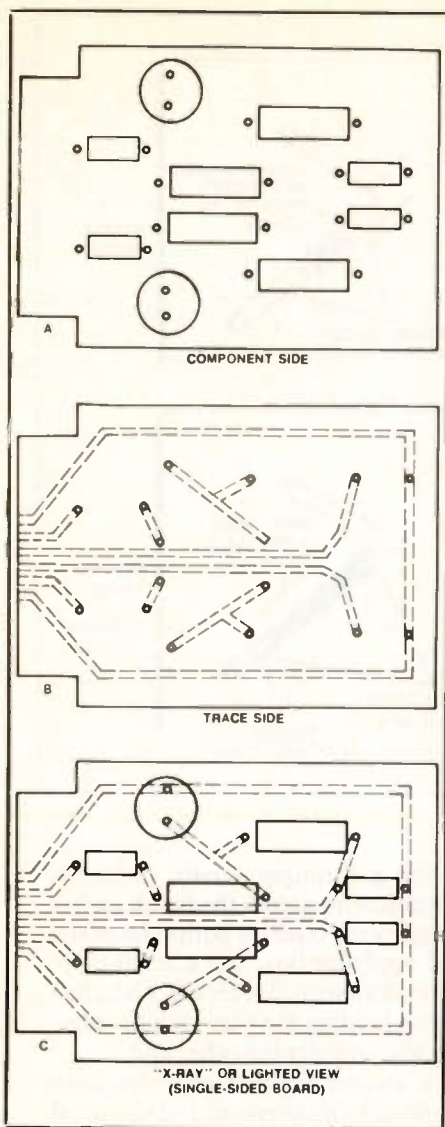

Figure 2

first impressions suggest. Judge your ability to repair this type of damage on the amount and location of damaged traces, number of lost connection pads and the overall component damage.

In addition, note the style of component mounting: conventional or surface mount. You should know up front that the repair of surface-mount devices requires a very steady hand and strong soldering skills.

Dirt, dust, carbon black and even the insides of electrolytic capacitors may inhibit your view of the damage. You must be able to see the damage to repair it. If you are serious about PC board repair then consider the following suggestions carefully.

### Preparing the board for repair

An important first step is to clean the board with soap and water. Use a soft brush to remove dirt, but do this

gently or you may cause some damage. Don't scrub the board; you only want to remove loose debris.

Rinse with clear water; preferably distilled. If you have dry compressed air in your shop, you may use that to blow dry the PC board. This will remove most of the water. If you don't have compressed air, then remove excess water by placing a folded cloth on the workbench and *gently* tapping the edge of the board on the cloth.

Dry the PC board by placing it in an oven (not a microwave) on a low setting. This baking may take as long as 12 hours. Be sure to allow for this.

After the board has baked and been allowed to cool, wipe it with denatured alcohol using a soft cloth and cotton or foam swabs. This eliminates chemical deposits and accelerates the evaporation of any water remaining under the components.

Once the board is clean and dry, inspect it using a gooseneck lamp, or your shop lights as a backlight (See Figure 2). View the board from the *component* side and follow the traces

to ensure that there are no breaks. Flex the board slightly to aid in determining if there are any damaged traces. This inspection also ensures the physical (structural) integrity of the PC board.

For a closer inspection (See Figure 3), mount the PC board in a holder, trace side up. Be sure there is adequate light. Use a magnifying glass to assist you. Check for any of the following problems:

- poor solder joints
- burned or broken components
- frayed wire leads
- lifted contact pads
- lifted traces
- broken jumper wires
- cracked IC leads
- cracked traces (which may not have shown up in step 2).

Mark any of these with a colored pencil. Be sure not to use a standard lead pencil because the mark it makes is a conductive graphite line.

In addition to the above, look

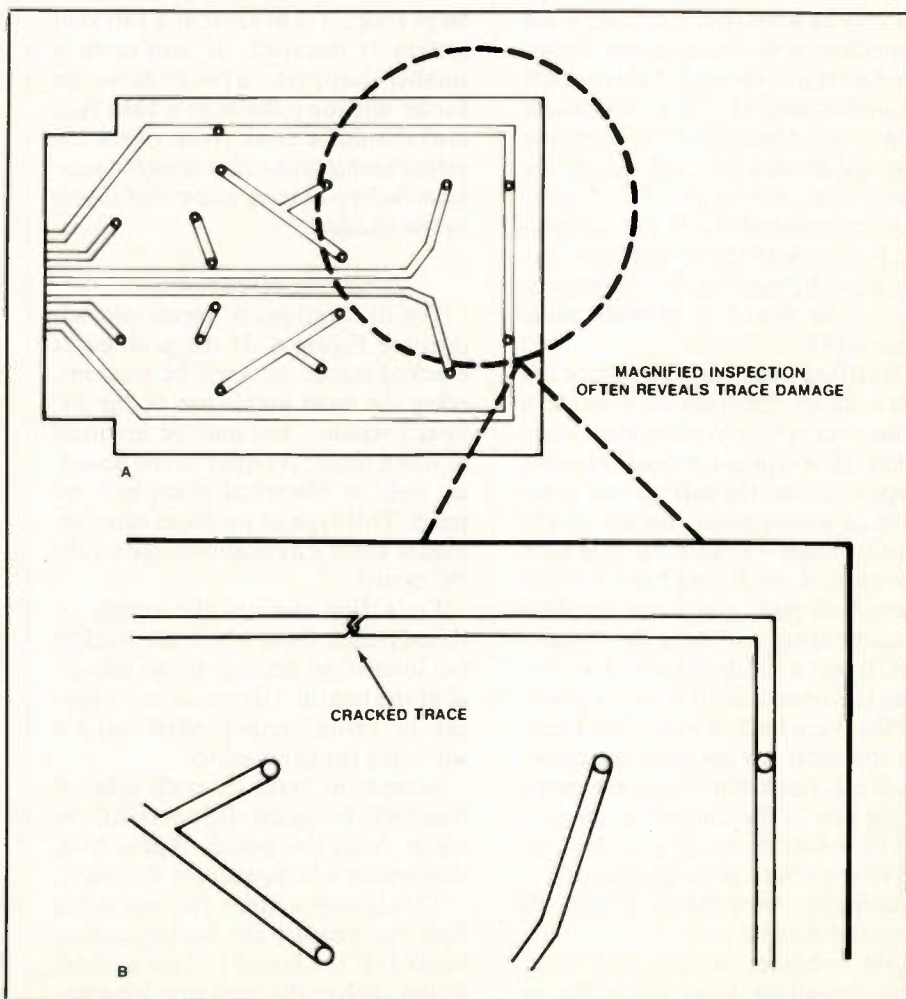

Figure 3

closely at the coating over the circuit board itself. Bubbling or discoloration may indicate hidden damage. If need be, remove the coating carefully to assist you in evaluating the PC board.

### Repairs when all circuit traces are intact

If the problem is burned or broken components, broken jumper wires or cracked IC leads, the method of repair is obvious: replace these components and jumpers. If the problem is poor solder joints, again the solution is simple: resolder using a small amount of flux in addition to flux core solder.

When the problem is a frayed wire lead, start by desoldering the wire connection, being sure to use a solder sucker or desoldering braid to remove all the solder from the connector pad. Leads may be tack soldered, or connected through-the-board. In either case, cut back the insulation  $\frac{1}{8}$  to  $\frac{1}{4}$  inch and tin the wire. Resolder the lead using care not to move the connection until the solder solidifies.

It may be advisable, especially if the connection is subject to some strain, to use a drop of epoxy to help support the connection. If it is a tack solder connection, place the epoxy over the wire as it crosses the trace side of the board. Use care so you don't cover another connection. If the connection is a through-the-board style, the epoxy can be used on the component side of the board to provide some strain relief.

For lifted traces, lightly scrape the board under the trace to provide a surface for epoxy to adhere to. Use a toothpick to spread a small amount of epoxy across the surface and press down to assure good contact. If the trace includes a mounting hole with contact pad, or if you have a lifted connection pad, you must desolder the component and clean the connection. Insert a toothpick into the hole from the trace side to assist in pressing the trace back down. This keeps the hole clear for use after the epoxy has dried. Be careful not to get epoxy on the side of the connector that you will be soldering to. If you do, you will have to burn through it when resoldering the components. The fumes produced may be toxic.

One reminder on this and other fumes resulting from soldering or other chemicals: be sure you work in

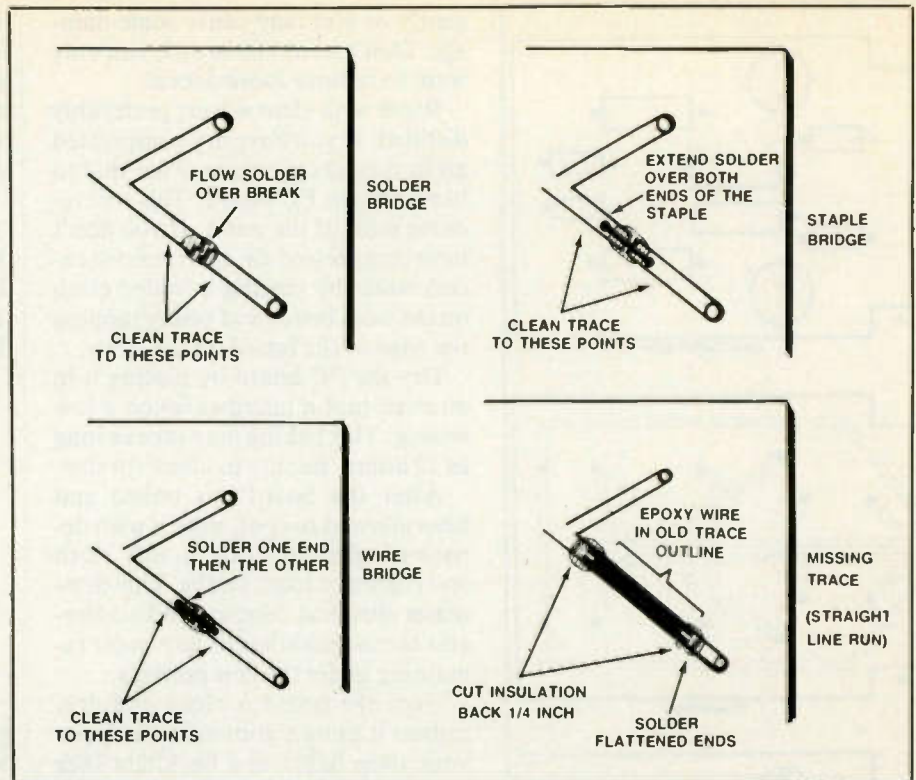

Figure 4

a well ventilated space. If you are in a large shop, it is likely that a full vent system is installed. If you're in a smaller shop, even a fan to move the fumes outside (similar to a bath vent fan) should be used. *Note: check environmental protection laws for your state before venting untreated fumes to the outside.*

### Repairing cracked traces

For illustrations of repair procedures see Figure 4. If the problem is cracked traces, you will be encountering the most ambitious of the PC board repairs, and may be involved in some physical repair to the board, as well as electrical/electronic repairs. This type of problem often includes some physical damage to the PC board.

Let's first discuss the repair of flexed traces: those which are cracked but involve no damage to the material of the board. The repair technique can be easily accomplished using a soldering iron and solder.

Scrape the trace on both sides of the crack, being careful not to lift the traces from the board. Apply flux, then solder a bridge across the crack.

This is only a quick fix, and often does not provide the lasting quality needed. If the board is rigid a solder bridge such as this may provide a serviceable repair.

For a stronger repair, solder a piece of wire across the break. After scraping the trace on both sides of the and applying flux, use a small piece of hookup wire. Solder one end, then firmly holding the wire with a soldering aid, connect the other end.

A second method provides both physical reinforcement and electrical continuity. Scrape the trace on both sides of the crack to remove any oxidation or other contaminants and then drill a small hole through the trace and through the circuit board on each side of the break. (Remember we are discussing a single-sided board although this method will work for double-sided boards if done with care.) Be careful not to drill into any components. Space the holes the length of a standard staple. Insert the staple and solder over it. Because the ends of the staple extend through the PC board, they will provide some support to the trace and allow for some flexing of the PC board. Epoxy placed in the drill holes will further reinforce this repair.

### Circuit kits

Another thing to keep in mind for the repair of simple pad loss or for cracked traces, is the availability of circuit design kits. These kits come complete, in most cases, with conductive trace ribbon. This ribbon

may have the adhesive on the strip already. Circular and rectangle pads of tinned copper with adhesive backing is also available.

Kits which have rivets to support through-hole board repair, such as the double-sided boards, are available. The entire repair would be usable and electrically sound but these kits do not often include strengthening provisions.

Almost all circuit boards have some type of coating to protect the traces, often untinned copper, from oxidation. Because you have to scrape off this protection to repair broken traces, after you complete the repair you should replace this coating. Sprays and bottled lacquers are available from hobby shops and electronics supply houses to complete these circuit repairs.

### Replacing long circuit runs

Longer gaps in circuit traces would require a different repair method. With the sizes of trace used in many of the consumer products today, re-wiring boards should only be accomplished when there is no alternative.

As a rule of thumb, if there are more than 3 full traces missing, replace the board. Of course this is only a suggestion; the technician on the job must make the decision.

If the traces to be replaced are straight line traces, those having no connection pads along their length, the following method might be used.

Scrape the trace at each end of the missing portion. Refer to the schematic or to an x-ray drawing of the board as needed.

The gauge of the wire to be used depends on the size of the existing trace. Carefully squeeze or pound one end of the selected wire flat to provide a larger soldering surface. Solder the flattened end of the wire to one of the exposed trace ends. Epoxy the wire into the same routing channel as the original trace if possible.

Cut, flatten, then solder the other end and you have effectively replaced the trace connection.

The use of drill holes in this method depends on the technician. The replacement of large trace lengths does not often demand strength.

### Sectional replacement

If there are component connections along the trace path, then a sectional

replacement technique may be used.

Start at one end, scrape, flatten and solder the wire. (The drill method may be used if desired. On single sided boards it would be recommended.)

Run the length of wire needed to reach the first connection point.

Form a loop at the end of the run. This will take the place of the pad lost when the trace was destroyed. This loop can also be flattened to provide a heat sink type connection such as many semiconductor components require in order to dissipate the heat they generate.

Additional lengths of the trace path can be formed by repeating the technique described above.

It is best if using the section method, that each trace run overlap the last. It is also best to wait until the entire length has been completed before putting epoxy on it.

Trace repair on an undamaged board requires minimum time. This time is well spent if you now have produced a serviceable circuit board. Use your time well; don't hurry the repair.

### Repairing damage to the PC board structure

This last area for discussion covers some of the more unusual types of repair. For example, there's the case where the board shows evidence of physical damage and there is trace damage and possible component damage. The customer says it's a very special piece of equipment. The manufacturer doesn't make or stock the board or the manufacturer isn't even in business any more. What do you do?

You can tell the customer it's still a great piece of furniture. Or you can etch a board of your own using one of the many products on the market. Or you may repair the existing board.

Here are some techniques for physical as well as electrical/electronics repair. You will be spending more time on these repairs but you can become a true craftsman. The feeling you receive from a restoration is a very good feeling indeed. The accomplishment can increase your customer base through word of mouth, which as we all know is the most powerful form of advertisement.

Of course the initial inspection is vital to the success of this endeavor. Use the first steps listed to assist you. Don't take on too much. Don't

get in over your head. Know your limitations.

### Partial cracking

If the board is not completely separated, you have a good chance of completing this repair. For a single-sided board, repair the physical damage, then repair the traces. For the physical repair, you'll need epoxy glue and a fiberglass PC board repair kit. Follow this procedure:

1. Make a drawing of the component placement and trace wiring if support documentation is not available.
2. Carefully remove all components in the area of the repair. The area you need for the fiberglass repair strips will depend on the extent of the damage. Overlap to good board space should be 1½ to 2 inches, minimum.
3. Force some epoxy glue into the cracks in the board and gently straighten the board. Clamp the board if necessary and allow the epoxy to cure.
4. Working from the component side of the board, use emery paper or sandpaper to roughen the surface around the crack.
5. Following the directions on the fiberglass kit, apply strips to the board in an overlapping manner. A minimum of two strips should be used. Remember this process adds thickness to the board, so if space is critical, be careful.
6. Allow the strips to dry thoroughly, then drill holes to accommodate the component mounting. If trace repair is called for, do it now.
7. After all circuit board repairs are complete, remount the components, replacing those needing replacement and test the circuit. Following these steps should leave you with a serviceable circuit board.

### Full board separation

When the board has actually broken apart, it should be replaced. If the customer insists, and is willing to pay for it, or for the reasons mentioned above repair is necessary, the same seven steps could be used on a completely separated PC board. There would, however, be an addition made to Step 5: the use of thin strips of plastic, or tongue depressors may be added to support board strength.

### Cracking across ICs or connectors

This type of repair can be divided into two categories: those requiring no replacement of the component,

and those which require component replacement. Regardless of the category, the method is the same.

For this type of repair, many of the methods above will work. In addition, where practical, once the PC board has been repaired, reinstall all ICs using sockets, even if the originals were soldered in. This will provide additional reinforcement in the vicinity of the repair. Inspection here is required on two levels. The *light* and *close* inspections described earlier are done twice. The first time through, the inspection centers on the board and component faults. You would perform the second inspection after the IC or connector has been removed, this time focusing on the damage revealed by component removal.

If an IC was originally installed in a socket, take care to observe the

standard electrostatic discharge damage precautions with the IC so you may use it again. Inspect the socket very carefully. Small cracks in the base of the socket may affect the electrical integrity of the connection more than the physical. If any of the ICs you remove were soldered into the circuit, replace these with new components when rebuilding the board. It's almost impossible to desolder and resolder ICs without damaging them. Connectors, if soldered into the circuit require the same care as the ICs. Whether the connector is male or female, it is very important that you use some strengthening method when repairing the board. These connectors will be subject to more stress and strain than other components. Making your repairs as strong as possible ensures the performance reliability of the PC board.

This also means reduced chances of an expensive callback repair.

### Repairing double-sided boards

Double-sided circuit boards can be repaired in the same manner as single-sided boards *if* the following precautions are taken.

1. Often the traces on one side of the board may cause shadows on the opposite side. The light inspection may show little and may not produce the results desired.
2. Close inspection is performed on both sides of the board. Particular care must be paid to lifted connector pads. These pads often go through the board to complete a circuit pathway.
3. Repair techniques requiring drilling must be checked for location. It is not wise to drill through a good trace. Use one of the alternative methods.
4. Partial cracking often affects *both* sides of the board. Change the techniques as follows:
  - a. Repair the traces on one side before starting the physical repair.
  - b. Use the plastic coating or lacquer, making sure that the coating is dry before starting physical repairs.
5. Don't attempt the repair if the board is cracked completely through.
6. Take extra care with the IC and connector repairs because they often extend through the board.

With these steps, double-sided boards can be as easy to repair as single-sided boards.

The use of the suggestions here can provide you with profit, but you must be willing to make the effort. The satisfaction of completing a job of this magnitude can be rewarding in many ways.

In today's high exchange repair field, board repair is a valuable skill. You can cultivate that skill. The overall decision to repair or replace the board will rest with the technician if operating as an independent. The decision rests with company or corporate policy if the technician is working for someone else.

Think of circuit board repair as a possible slow-time activity. This method may also be used by managers to train technicians.

This isn't just a make work activity. The output is a valuable product. In addition, the training provided will mean faster repairs as the skill of the technician is honed. ■

**WATCH FOR**

**BUSINESS CORNER**

This exclusive monthly column will show you how to run your service operation more efficiently and profitably. You'll learn about

- building customer satisfaction
- writing service contracts
- marketing your services

**ES&T**

## Pacenter™

CLASSROOM TRAINING

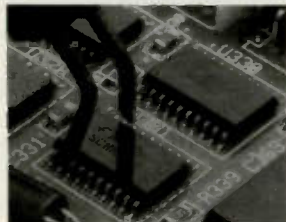

For over 30 years PACE has provided the most comprehensive "hands-on"

training to industry and governments worldwide in SMT and Thru-Hole electronic assembly, rework and repair using

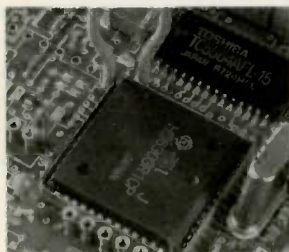

the latest techniques, equipment, video and training aids.

Call us today at 301 490-9860 for more information and class schedules



9893 Brewers Court  
Laurel, MD 20723-1990  
FAX: 301 498-3252

Circle (10) on Reply Card

# Turn complaints into profits

By William J. Lynott

Trying to satisfy complaining customers is a damned nuisance - one of the most expensive and least satisfying aspects of the service business. Right?

Wrong.

In recent years, the most perceptive business executives have come to recognize customer complaints for what they really are: a marvelous tool for building a business to ever-increasing levels of growth and profitability.

Of course, a lot of people in our industry remain unmoved by what sounds to them like a such a Pollyannaish theory. Most complaining customers, they will tell you, are intransigent - some downright nasty. Ignoring them entirely, or trying to, is the way that some service dealers still prefer to deal with that problem.

But there's a far more profitable way. For many years we had little more than subjective opinions to support the idea that liberal treatment of dissatisfied customers - even unreasonable customers - can bring about direct improvements to the bottom line. But all that changed a few years ago when a Washington-based research organization, Technical Assistance Research Programs (TARP), published the results of their scientific study of this subject. Their researchers followed up on thousands of customer complaint letters received by one of America's largest corporations.

The results of their investigation provided the first hard evidence to show that unhappy customers are prime candidates for conversion into valuable company assets.

Direct interviews with customers who had lodged complaints against the company revealed interesting if

not suprising behavior.

Customers who complained and were not happy with the response they received told as many as 20 friends and associates about their dissatisfaction.

As if that weren't punishment enough, 30% said they stopped doing business with the company entirely as a result of their experience. Another 45% said they would buy less from the company in the future.

Stated in familiar terms, those statistics are telling us that customers with unresolved complaints become harmful influences on our company's fiscal health. Unhappy customers tend to aggressively spread the negative news of their experience far and wide.

But now for the good news. The same study also revealed clear evidence that customers with complaints - even very serious complaints - tend to *INCREASE* their loyalties to the company, provided their complaints are satisfactorily resolved.

The study showed that customers whose complaints were brought to a satisfactory conclusion told four or five people about it; and 10% of those customers actually *INCREASED* the amount of business they did with the company before the incident that triggered the complaint.

Another way to describe all of this, of course, is simply word-of-mouth advertising - long since established as the most powerful form of advertising in existence. Most successful business persons have come to recognize that the opinions of a firm's customers are far more potent than the best of media advertising. And, of course, their opinions can work against a company every bit as effectively as they can work in favor of a company.

When you add all this together, it becomes clear that treating unhappy customers with courtesy and sincere interest in resolving their complaints is sound business judgement. When

these efforts are successful, in most cases, you will not only have saved an existing customer, you will have created a walking evangelist - one who will spread your gospel with far more zeal than those expensive Yellow Pages.

Of course, as with all worthwhile efforts, this program is easier said than done. But that's precisely what makes it worthwhile. If it were easy, everyone would be doing it.

For openers, it's important to recognize that a liberal attitude toward customer complaints requires some financial investment. Often, satisfying a customer complaint will require doing a repair job over again at no charge, or honoring a warranty that has just expired. For some service dealers I've met, granting concessions of that sort would be considered about as desirable as having a root canal.

Service dealers who feel that way are victims of one of the most persistent characteristics of human nature: the tendency to regard a complaining customer as an adversary - an opponent to be defeated.

That's not true, of course; and even the toughest of customers have been known to turn into pussycats when they come across someone sincerely interested in resolving what to them is invariably a justified complaint.

Taking advantage of the full potential of word-of-mouth advertising sometimes means giving in to customers who are clearly in the wrong. And to be sure, this can be difficult for even the most enlightened of us, especially in those cases where unexplainable chemistry causes sparks to fly between two people.

But for the service dealer who is successful in teaching himself and his employees the dollar-and-cents value of making that extra effort to resolve *EVERY* customer complaint, the bottom line rewards will prove well worth the effort. ■

Lynott is president of William J. Lynott Associates, a management and consulting firm specializing in profitable service management and customer satisfaction research.

# Using thermal clues in troubleshooting

By Victor Meeldijk

*In troubleshooting electronic equipment, especially when you may have little data to work with (no service manual or schematics) the temperature of various components may help you to localize the problem.*

The temperature of components can tell you a lot about their condition, or the condition of other devices in the circuit. Sometimes the problem is obvious, such as the burned IC shown in Figure 1. In many cases, thermal clues can lead help you pinpoint the actual cause of the problem, as illustrated by the following examples.

## A VCR repair

A Samsung model VR2410 VCR, after loading a tape was totally unresponsive to all front panel controls, even the on/off switch was not functioning and the unit could not be turned off. I tried disconnecting then reconnecting the power cord but the symptom remained and the VCR would not reset.

Because the problem happened right after a tape was inserted and loaded into the machine (this model is a front loader), I checked the tape sensors to see if they had failed causing the VCR to be in a mode where the system microprocessor was not responsive to inputs from the front panel. All the sensors checked ok. Next I checked the power supply to see if all voltages were within tolerance. They were. Next I checked all microswitches to see if they were in their proper modes (open or closed).

During this examination I removed the bottom cover and happened to touch the tape loading motor. It was

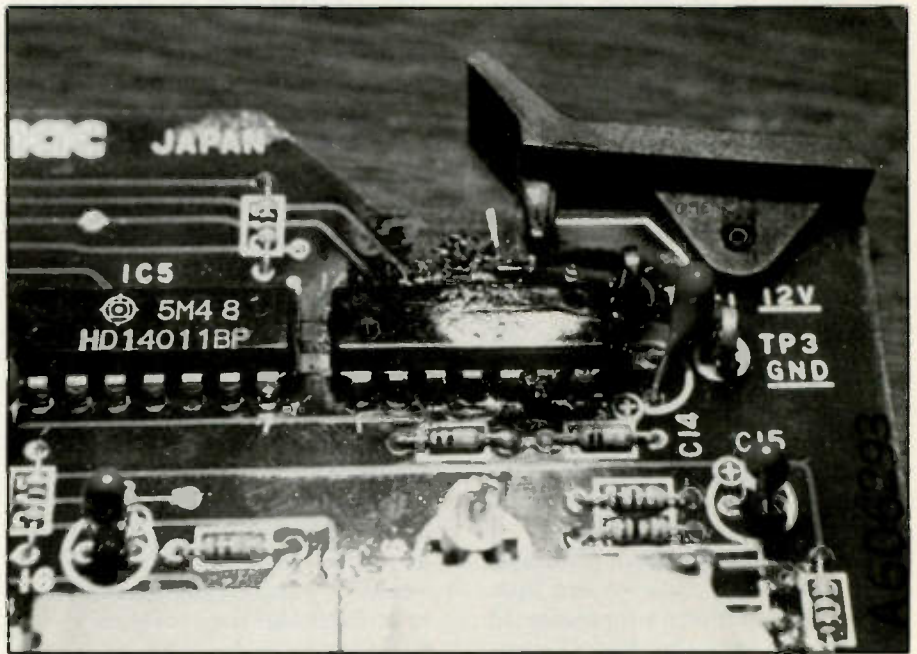

Figure 1. Not all failures are as obvious as this burned IC.

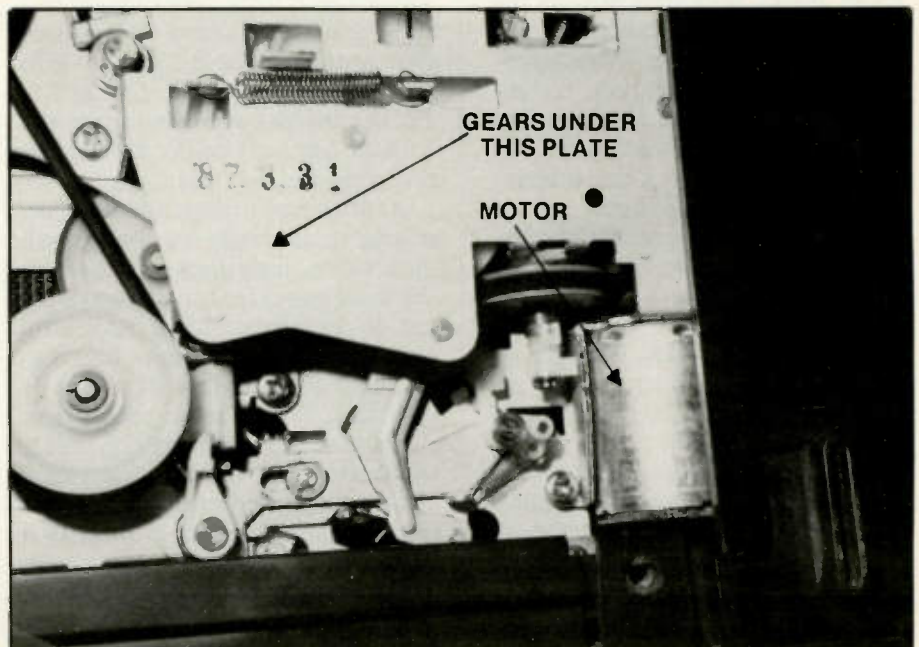

Figure 2. A hot VCR tape loading motor led me to find that the problem was jammed loading gears.

Meeldijk is a Reliability/Maintainability Engineering Manager with Diagnostic/Retrieval Systems, Inc. of Oakland, NJ.



### Package and Pin Assignment

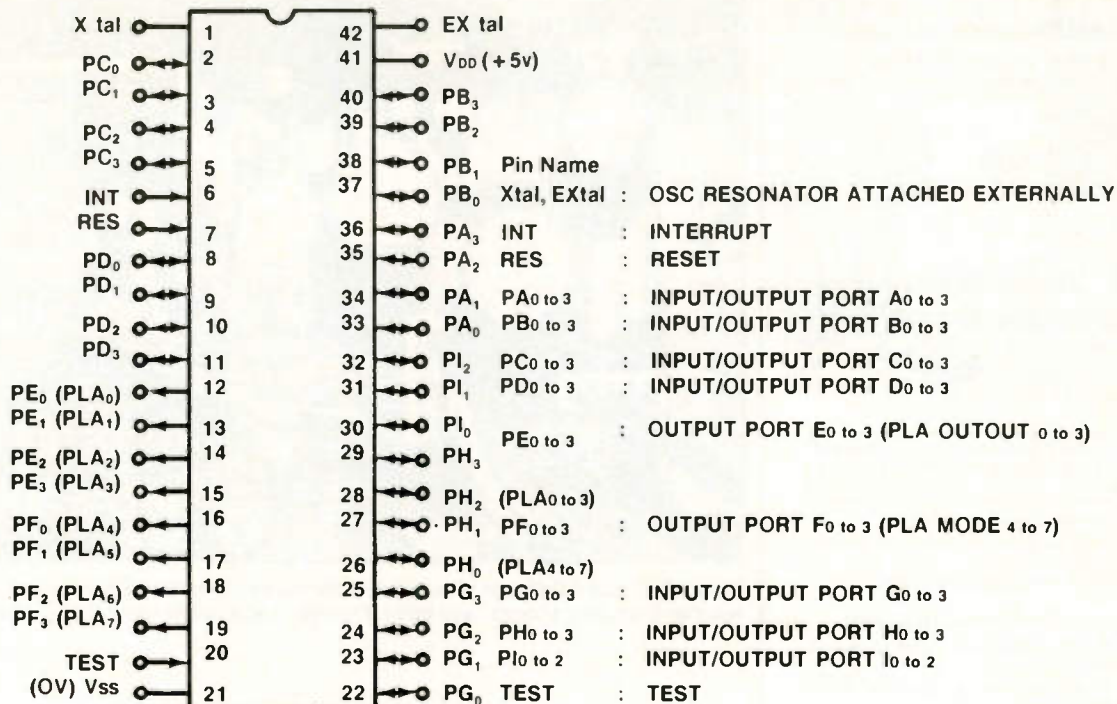

Figure 3. The pinouts of the microprocessor used in the Sanyo TAS 1000 telephone answering machine.

hot. Further checking revealed that it also wouldn't turn. Removing the belt allowed the motor to turn freely. This symptom, in conjunction with the other symptoms, suggested that during the tape insertion mode the gears had jammed and the system control was waiting for a signal from a microswitch to indicate that tape loading had been completed (Figure 2). From the initial system examination it looked as if the tape was properly loaded around the video cylinder. I loosened the gear cover plate screws and moved the gears to unjam the tape loading mechanism. The unit worked fine after that.

### The failed telephone answering machine

A Sanyo TAS 1000 telephone answering machine seemed totally dead, and would not respond to any play or record controls. I tested the ac adaptor and determined that it was operational. Next, in checking the voltage at the input connector I found a crack in the trace on the printed wiring board. I repaired this crack with a short jumper wire, but there was no change in the symptom. The presence of voltage in the motor circuits of the recorder, and front

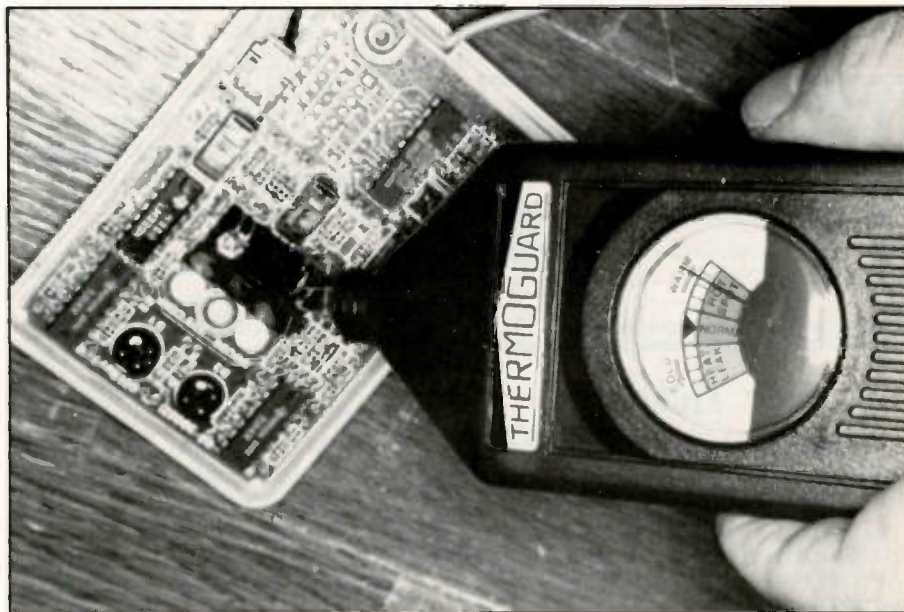

Figure 4. The operation of the infrared LED was verified by the use of a temperature meter.

panel control signals going to the microprocessor (Sanyo LM6405A) made it appear as if the microprocessor had failed.

Because a service manual was not available (although it could be ordered from a Sanyo/Fisher parts distributor) I contacted Sanyo Semiconductor to see if a specification sheet

on the microprocessor was available (in New Jersey the number is 201-784-0303). This device is a programmed 4 bit microcomputer that has to be ordered by the part number in the service manual. Sanyo sent a specification sheet for the generic device.

According to the pinout diagram (Figure 3) 5V should appear at pin

## LEARN TO CLEAN/MAINTAIN/REPAIR FAX MACHINES

HUGE NEW UNTAPPED MARKET!



Over 8 million Fax machines in homes/offices - predictions are for over 25 million by 1992!

- Work from your home/van
- Home study program gets you started servicing fax machines in 2 weeks!
- No special tools/equipment needed
- Earn additional profits selling fax supplies!
- Fax machines are not cheap - therefore, you can get good \$\$ for the repair
- Average Fax machine requires professional service every 18 months.
- Home study training program includes full instructions on EVERY ASPECT of Fax maintenance/repair. FULL COVERAGE of how to set up your home-based service business

### FREE DETAILS

CALL 1-800-537-0589

Or Write to: Viejo Publications, Inc.

5329 Fountain Ave. Dept. FX400

Los Angeles, CA 90029

Circle (20) on Reply Card



## Your Ticket To SUCCESS

Over 28,000 technicians have gained admittance worldwide as certified professionals. Let your ticket start opening doors for you.

ISCET offers Journeyman certification in Consumer Electronics, Industrial, Medical, Communications, Radar, Computer and Video. For more information, contact the International Society of Certified Electronics Technicians, 2708 West Berry Street, Fort Worth, TX 76109; (817) 921-9101.

Name \_\_\_\_\_

Address \_\_\_\_\_

City \_\_\_\_\_

State \_\_\_\_\_ Zip \_\_\_\_\_

Send material about ISCET and becoming certified.

Send one "Study Guide for the Associate Level CET Test." Enclosed is \$10 (inc. postage).

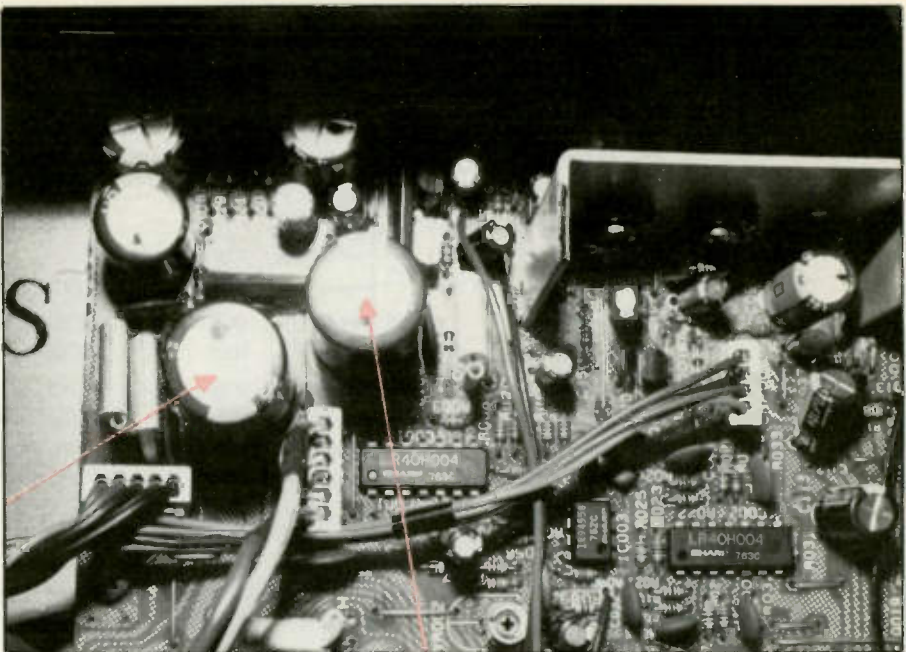

Figure 5. These CD player filter capacitors were suspected to be leaky because they were warmer than they should have been. Further checks confirmed that they were leaky.

41. I checked the microprocessor input and found that there was no voltage at this pin. As I traced back through the circuit I found Q1 to be very hot. Further checks revealed that this transistor, a 2SD545, was shorted, resulting in the loss of the supply voltage to the microprocessor. After I replaced this transistor the telephone answering machine was operational.

### An optical computer mouse

The owner of a personal computer told me that the mouse, a Mouse Systems Corporation model M2 optical mouse, was not controlling the cursor in the up and down direction. I suspected that one of the light emitting diodes had failed. When I applied power to the unit using an external 5V power supply, one of the LEDs glowed red but the other one was dark. This however is no indication of whether this is the problem as this other LED is an infrared device which does not emit visible light.

When I tested the LED with a temperature meter, I found that it was warm, indicating that it was working (Figure 4). When I moved the mouse in either the up/down or side-to-side motions checking for output signals, I noted signals in all cases. Connecting the mouse to a computer also verified that it worked. Further questioning of the owner revealed that it was now being used in a differ-

ent computer and the computer port it was connected to may not have been set up properly. In this case, checking of all indications, including checking the output from the LED with a thermometer made it possible to draw a conclusion about the condition of the device.

### An intermittent CD player

A Sharp CD player, model DX-620, would not play the first half of any CD. It continuously searched for the track to lock onto. It would however lock onto and play the last half of any CD. Examining the Eye pattern did not prove helpful and the player was not mechanically misaligned.

In checking the power supply section, I noted that two of the filter capacitors (C103, C104) were warm and one (C096) was hot (Figure 5). This is a clear indication that the capacitors were leaky. I measured the output voltage of the power supply and found that it was out of specification. The +5V output was +4.23V and the -5V output was -4.27V. The capacitors, and subsequently the voltage regulator, were replaced.

From these examples you can see that thermal clues can tell you not only when a component is defective, but whether it is working. Looking for these thermal clues early in the troubleshooting process can decrease the time it takes to do repairs. ■

## CHASSIS SCHEMATIC

Product safety should be considered when component replacement is made in any area of an electronics product. A star next to a component symbol number designates components in which safety is of special significance. It is recommended that only exact cataloged parts be used for replacement of these components.

Use of substitute replacement parts that do not have the same safety characteristics as recommended in factory service information may create shock, fire, excessive x-radiation or other hazards.

This schematic is for the use of qualified technicians only. This instrument contains no user-serviceable parts.

## CHASSIS SCHEMATIC

Product safety should be considered when component replacement is made in any area of an electronics product. A star next to a component symbol number designates components in which safety is of special significance. It is recommended that only exact cataloged parts be used for replacement of these components.

Use of substitute replacement parts that do not have the same safety characteristics as recommended in factory service information may create shock, fire, excessive x-radiation or other hazards.

This schematic is for the use of qualified technicians only. This instrument contains no user-serviceable parts.

The other portions of this schematic may be found on other Profax pages.

All integrated circuits and many other semiconductors are electrostatically sensitive and require special handling techniques.

MAY 1991

Profax  
Number

RCA/GE  
KCS 203 Color TV

3076

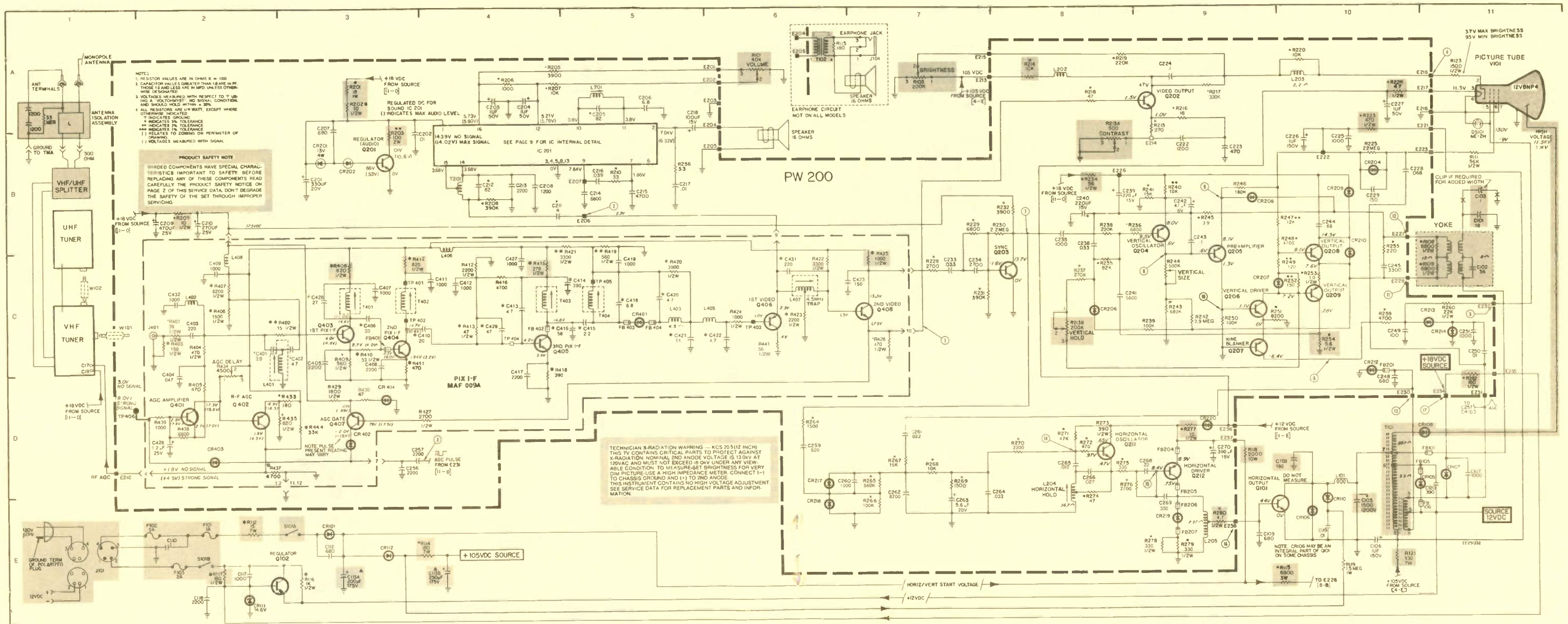

RCA/GE  
KCS 203  
COLOR TV

MAY 1991

Product safety should be considered when component replacement is made in any area of an electronics product. A star next to a component symbol number designates components in which safety is of special significance. It is recommended that only exact cataloged parts be used for replacement of these components.

Use of substitute replacement parts that do not have the same safety characteristics as recommended in factory service information may create shock, fire, excessive x-radiation or other hazards.

This schematic is for the use of qualified technicians only. This instrument contains no user-serviceable parts.

The other portions of this schematic may be found on other Profax pages.

All integrated circuits and many other semiconductors are electrostatically sensitive and require special handling techniques.

PW 200 CIRCUIT BOARD ASSEMBLY

ADD 200 PREFIX TO COMPONENT NUMBERS

PW200 COMPONENT LOCATION GUIDE

C1	2-C	R6	1-C
C2	2-C	R7	1-C
C3	1-C	R8	1-C
C4	1-C	R9	1-A
C5	1-C	R10	2-C
C6	1-C	R13A	3-D
C7	1-B	R13B	3-D
C8	1-C	R14	1-D
C9	2-A	R15	2-D
C10	2-A	R16	2-D
C11	1-C	R17	1-D
C12	1-C	R18	2-D
C13	1-C	R19	1-D
C14	1-B	R20	1-D
C15	2-C	R23	4-C
C16	2-B	R24	4-A
C17	2-C	R25	3-B
C18	1-D	R28	2-C
C22	2-D	R29	2-C
C23	2-D	R30	2-B
C24	1-D	R31	4-B
C25	3-B	R32	2-B
C26	4-C	R34	2-A
C27	4-A	R35	3-D
C29	3-B	R36	3-C
C33	2-C	R37	3-D
C34	2-C	R38	2-C
C35	2-C	R39	3-C
C38	3-C	R40	3-B
C39	3-B	R41	3-D
C40	2-C	R42	3-D
C41	3-D	R43	3-D
C42	3-C	R44	2-D
C43	3-C	R45	3-C
C44	2-A	R46	3-C
C45	3-B	R47	3-C
C48	3-A	R48	3-B
C49	3-B	R49	4-C
C50	2-A	R50	3-C
C56	2-D	R51	3-B
C57	2-C	R52	3-C
C59	3-A	R53	3-D
C60	3-B	R54	4-D
C61	3-A	R55	3-C
C62	3-A	R59	3-B
C63	4-B	R60	3-B
C64	4-B	R61	1-A
C65	4-D	R62	1-A
C66	4-C	R64	3-A
C68	4-C	R65	3-A
C69	4-B	R66	3-B
C70	4-A	R67	3-A
		R68	4-B
CR1	1-B	R69	4-B
CR2	2-B	R70	4-C
CR4	3-B	R71	4-C
CR6	3-C	R72	4-C
CR7	4-C	R73	4-C
CR8	3-C	R74	4-D
CR9	3-A	R75	4-C
CR10	3-B	R76	4-B
CR12	3-A	R77	4-B
CR13	3-A	R78	4-A
CR14	2-A	R79	4-A
CR17	3-A	R80	4-A
CR18	3-B		
CR19	4-A	T1	1-C
CR20	4-A		
FB1	3-A		
FB4	4-B	E1	1-C
FB5	4-B	E2	1-C
FB6	4-A	E3	2-A
FB7	4-A	E4	1-D
		E5	1-D
IC201	2-C	E6	2-D
		E7	1-B
L1	1-B	E13	1-D
L2	1-D	E14	2-D
L3	2-D	E15	1-D
L4	4-D	E16	2-D
L5	4-B	E17	3-A
		E18	3-A
Q1	2-B	E21	4-C
Q2	2-D	E22	4-C
Q3	2-B	E23	3-B
Q4	3-C	E26	2-A
Q5	3-C	E27	3-C
Q6	3-C	E28	4-B
Q7	3-B	E30	3-A
Q8	3-B	E31	2-A
Q9	4-D	E32	3-A
Q11	4-C	E33	1-A
Q12	4-B	E34	1-A
		E35	1-A
R1	1-A	E36	4-A
R2	1-B	E37	4-B
R3	1-B	E38	4-A
R5	1-C	E40	1-B

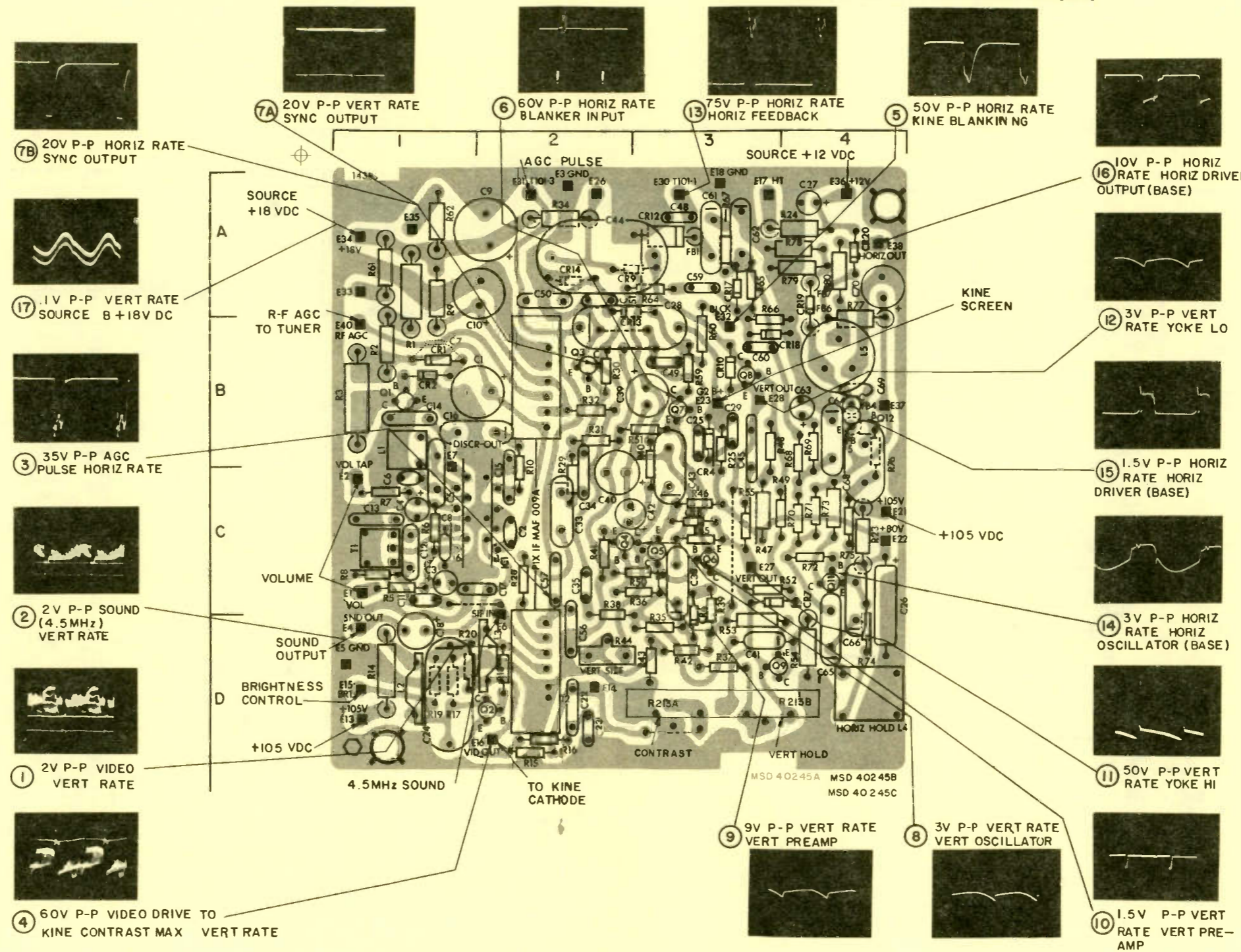

**KRK 235 TUNER R-F ALIGNMENT**

Product safety should be considered when component replacement is made in any area of an electronics product. A star next to a component symbol number designates components in which safety is of special significance. It is recommended that only exact cataloged parts be used for replacement of these components.

Use of substitute replacement parts that do not have the same safety characteristics as recommended in factory service information may create shock, fire, excessive x-radiation or other hazards.

**Oscillator Injection Current Adjustment**

Rotate tuner and sweep generator from Channel 83 (887 MHz) thru Channel 14 (473 MHz), while observing crystal injection current level on UHF alignment fixture milliammeter. The oscillator injection current should measure between 0.7 and 5.0 MA, and is adjustable by orienting the injection loop (L6), in the oscillator compartment, toward the oscillator line to increase injection or away from the oscillator line to decrease injection. If satisfactory injection is not attainable, replace CR 1.

NOTE: The injection limits are best attained with R-F alignment and oscillator frequency approximately correct.

**Oscillator Adjustment**

Do not adjust oscillator segments unless necessary. If oscillator alignment is necessary, use the following procedure.

Adjust segment 1 on oscillator capacitor (C2) to make channel 83 R-F picture and sound markers (885.25 and 889.75 MHz) coincide with I-F picture and sound markers (45.75 and 41.25 MHz). Rotate tuner and sweep generator to channels 78, 73, 68, 63, 58, 53, 48, 43, 38, 33, 28, 23, 18, and 14; adjust segments no. 2 through 15 to set oscillator on respective channels (UHF picture and sound carriers shown in R-F Frequency Chart).

**Antenna And R-F Adjustments**

Rotate tuner and sweep through channels 83, 78, 73, 68, 63, 58, 53, 48, 43, 38, 33, 28, 23, 18, and 14. Adjust R-F and Antenna seg-

This schematic is for the use of qualified technicians only. This instrument contains no user-serviceable parts.

The other portions of this schematic may be found on other Profax pages.

All integrated circuits and many other semiconductors are electrostatically sensitive and require special handling techniques.

ments of tuning capacitors C1 and C11 to obtain maximum output on scope between picture and sound markers. Optimum curves for channels 14 and 83 are shown.

**Performance Test**

Replace outer cover. Remove tuner from test hook-up and connect it through specified cable (W104 UHF/VHF link) to the UHF-I-F input of a VHF tuner (KRK 253 or equivalent) and a TV receiver monitor. Observe off the air picture. Heat tuner for several minutes with hot air at approximately 65°C. Check oscillator for excessive drift (drift should not degrade black and white picture).

Rotate channel selector several times in each direction, returning to the same channel each time. There should be no noticeable fine tuning creep or poor resetability upon returning to the selected channel.

Compare the picture as received on a weak but usable channel for signal to noise ratio with the same channel as viewed on a standard operating receiver.

Tap the tuner gently using a wood tapper and observe the picture for intermittents and flashing.

NOTE: All checks specified above should be performed on several channels.

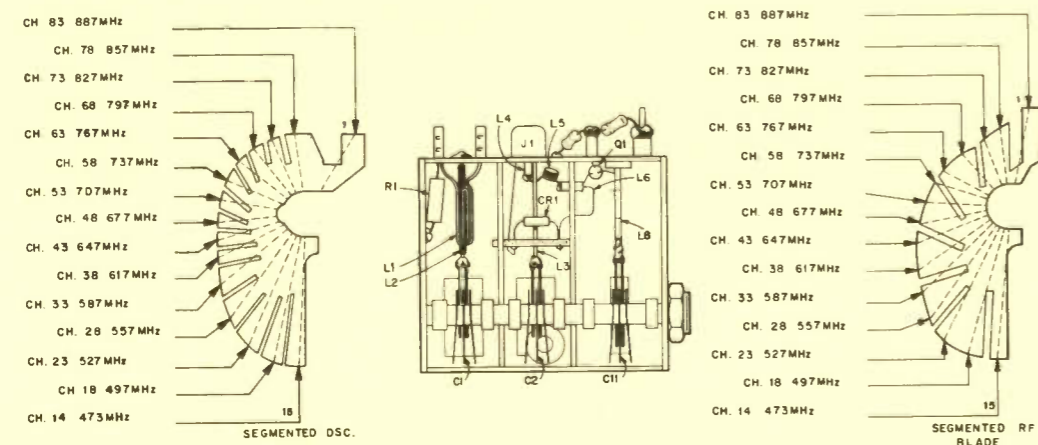
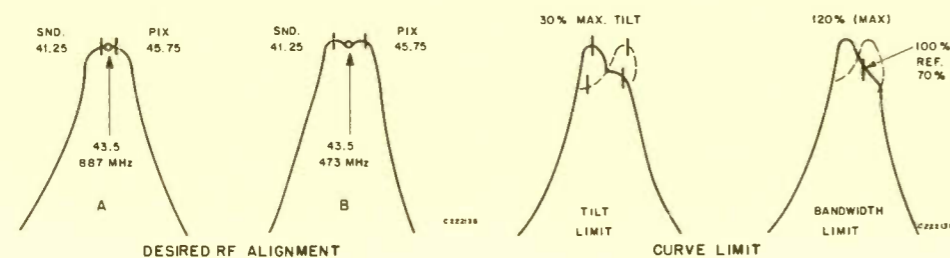
**Oscillator Blades**
**UHF Tuner—Side View**
**Antenna and R-F Blades**
**Figure 15A. UHF Tuning Capacitors**

**Figure 15B. UHF Alignment Curves**

KCS 203(L) Series (AC/DC)

 Reprinted by permission of the RCA/GE Corporation of America  
 Copyright 1991, CQ Communications, 76 N. Broadway, Hicksville, NY 11801

**ALIGNMENT PROCEDURES**

Product safety should be considered when component replacement is made in any area of an electronics product. A star next to a component symbol number designates components in which safety is of special significance. It is recommended that only exact cataloged parts be used for replacement of these components.

Use of substitute replacement parts that do not have the same safety characteristics as recommended in factory service information may create shock, fire, excessive x-radiation or other hazards.

This schematic is for the use of qualified technicians only. This instrument contains no user-serviceable parts.

The other portions of this schematic may be found on other Profax pages.

All integrated circuits and many other semiconductors are electrostatically sensitive and require special handling techniques.

**Picture I-F Alignment**
**CHASSIS PREPARATION:**

Disconnect AC power from receiver.  
 Disconnect R234 from E226 on PW 200 (Figure 20) to remove power from vertical oscillator.  
 Connect EXTERNAL B+ 18V regulated power supply to E226 on PW 200 (Figure 20).  
 Bias — apply 6.5V AGC bias to I-F at TP 406 on I-F module MAF 009A (Figure 16).

**Picture I-F Alignment**

Unplug I-F cable from J401 on I-F module MAF 009A (Figure 16).  
 Sweep — connect I-F sweep cable to TP 402 (MAF module) through pad shown in Figure 16.  
 Scope — connect to TP 403 (MAF module), adjust for 2V P-P display.

**STEP ① ADJUST 3RD I-F TRANSFORMERS**

Adjust T403 and T404 on MAF module for a flat-topped response curve within limits shown in "A" of Figure 16.

**STEP ② ADJUST TRAP FREQUENCY**

Sweep — move to J401 through a direct 75 ohm cable. Adjust L401 on MAF module for minimum at 47.25MHz.

**STEP ③ ADJUST OVERALL I-F RESPONSE**

Adjust T401 and T402 for maximum response at 44.25MHz. Refer to curve "B" of Figure 16 for marker placement and response curve limits.

NOTE: T401 may be adjusted to remove tilt from top of response curve (not more than 1/4 turn).

Remove test equipment, and restore set to normal operation. Check picture and sound "off the air" signal. If necessary, adjust R-F AGC control R434 on module MAF 009A; tune in strong (snow free) local channel, adjust R434 until snow appears then back off adjustment until snow just disappears. Check all channels; adjust control for optimum performance on all available channels.

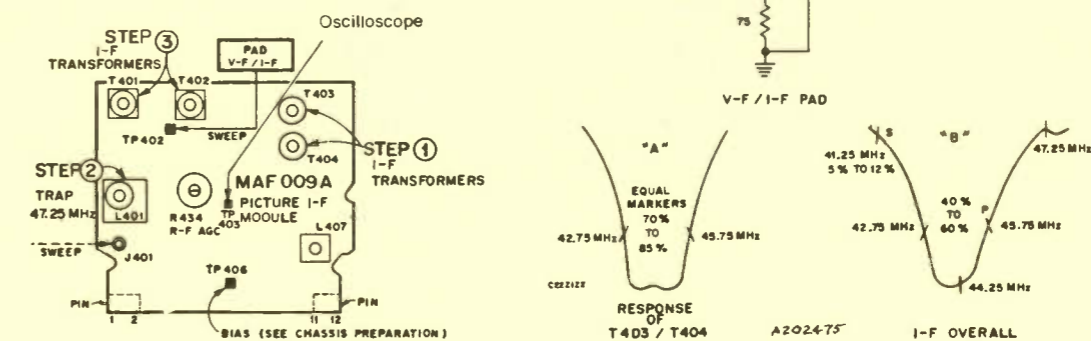
**Figure 16. Picture I-F Adjustments and Response Curves**
**4.5 MHz Trap & Sound I-F Alignment (Figure 17)**
**CHASSIS PREPARATION:**

Restore all connections and prepare chassis for "off the air" operation.  
 Connect AC through isolation transformer.  
 Connect 4.5MHz Resonant Demodulator Probe Figure 17 to MAF module, pin 10.  
 Meter — to output of probe.  
 Tune set to local station and adjust fine tuning through best picture to herringbone (4.5MHz) pattern.  
 Adjust meter range so that pointer is near mid-scale.

**STEP ① 4.5MHz TRAP ADJUSTMENT**

Adjust L407 on Picture I-F module MAF 009A for minimum meter reading.

**STEP ② SOUND I-F ALIGNMENT**

Remove test equipment.  
 Tune set to strong local channel.  
 Adjust T201 on PW 200 (Figure 20) for maximum sound.  
 Disconnect antenna and remove cable to reduce signal level until hiss is heard in sound.  
 Adjust L201 on PW 200 (Figure 20) for maximum undistorted sound.

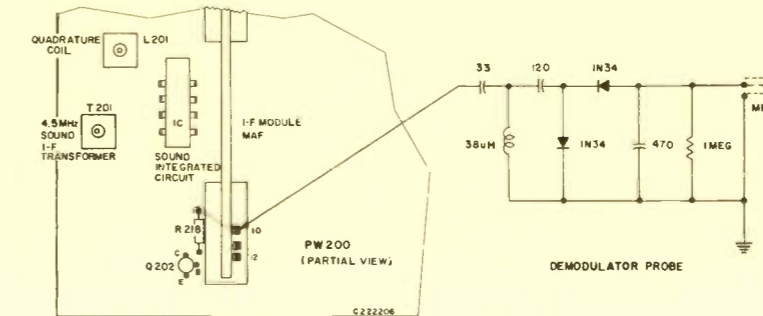
**Figure 17. Sound I-F Adjustments**

 Reprinted by permission of the RCA/GE Corporation of America  
 Copyright 1991, CQ Communications, 76 N. Broadway, Hicksville, NY 11801

KCS 203(L) Series (AC/DC)

**PICTURE I-F MODULE**

Product safety should be considered when component replacement is made in any area of an electronics product. A star next to a component symbol number designates components in which safety is of special significance. It is recommended that only exact cataloged parts be used for replacement of these components.

Use of substitute replacement parts that do not have the same safety characteristics as recommended in factory service information may create shock, fire, excessive x-radiation or other hazards.

This schematic is for the use of qualified technicians only. This instrument contains no user-serviceable parts.

The other portions of this schematic may be found on other Profax pages.

All integrated circuits and many other semiconductors are electrostatically sensitive and require special handling techniques.

ADD 400 PREFIX TO COMPONENT NUMBERS

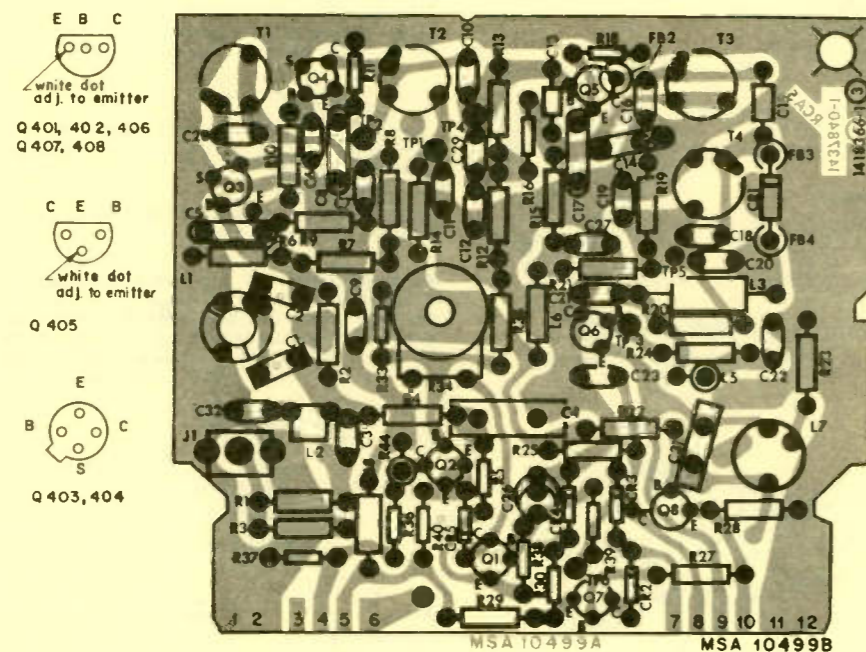

Figure 18. MAF 009A — Picture I-F Module Circuit Board

**INTEGRATED CIRCUIT**

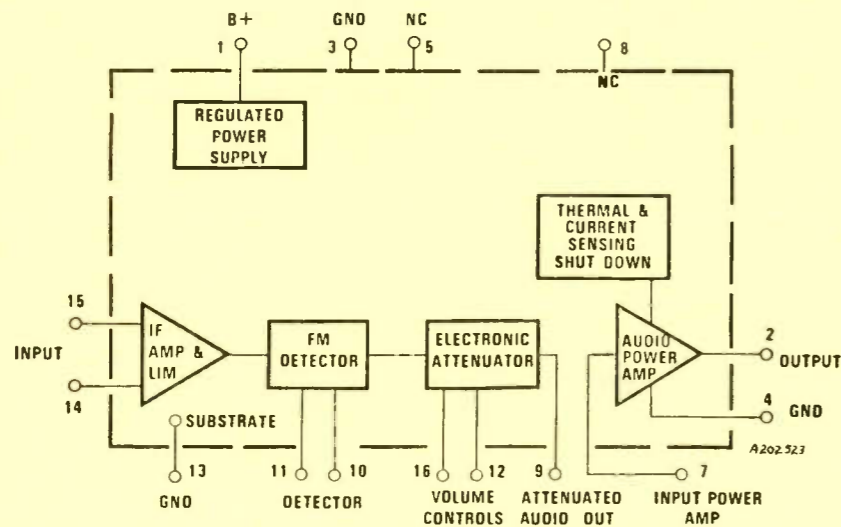

Figure 19. Sound Circuit — IC 201

**UHF TUNER KRK 235-SCHEMATIC AND R-F ALIGNMENT**

Product safety should be considered when component replacement is made in any area of an electronics product. A star next to a component symbol number designates components in which safety is of special significance. It is recommended that only exact cataloged parts be used for replacement of these components.

Use of substitute replacement parts that do not have the same safety characteristics as recommended in factory service information may create shock, fire, excessive x-radiation or other hazards.

This schematic is for the use of qualified technicians only. This instrument contains no user-serviceable parts.

The other portions of this schematic may be found on other Profax pages.

All integrated circuits and many other semiconductors are electrostatically sensitive and require special handling techniques.

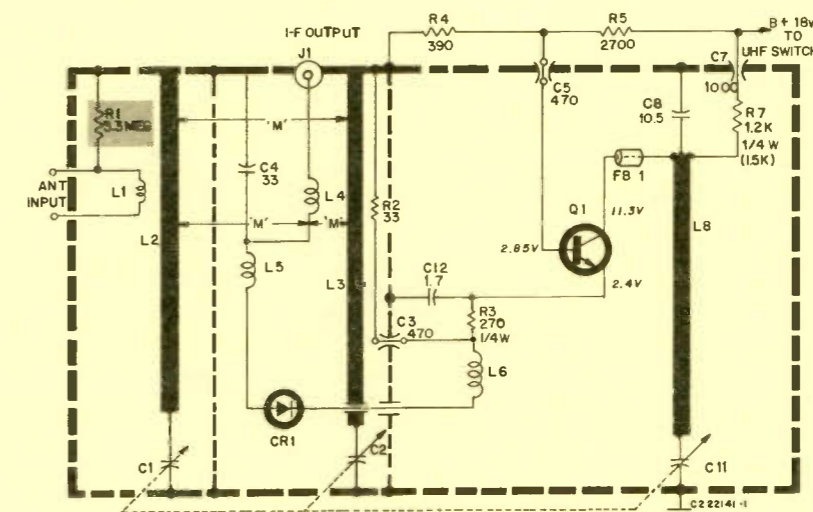

Figure 13. UHF Tuner — KRK 235KP,ZP

STAR or SHADING (\*) See PRODUCT SAFETY NOTICE on page 2 of this Service Data.

**UHF Tuner KRK 235 R-F Alignment**

Sweep — adjust sweep and tuner to channel 83. Set fine tuning control to center of its range. Apply enough sweep signal to obtain response curve on scope.

NOTE: Remove outer cover from tuner. The inner oscillator compartment shield should remain in place.

(continued on page 12)

**Test Equipment Required:**

- UHF Sweep Generator**..... Wavetex Model 1504 UHF sweep generator system including the all channel marker and programming unit with channel readout.
- Marker Generator**..... Crystal calibrated
- Oscilloscope**..... Scope with sensitivity of 10 mV full scale
- Power Supply**..... 18 volt regulated
- Power Supply**..... variable from 0 to +10.5 volts
- Meter**..... DC Milliammeter, 0 to 5 ma, 20 ohms resistance
- ..... 50 to 300 ohm (Figure 10F)
- Monitor**..... RCA XL-100 Type TV receiver for monitoring performance.

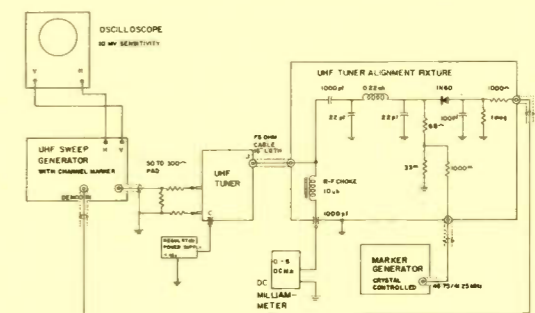

Figure 14. UHF Test Equipment Hookup

**Initial Connections For UHF Alignment (Figure 14)**

Power Supply — connect +18V to C7. The DC current should be approximately 1.1 mA. (DC Milliammeter crystal current is between 0.7 ma and 5.0 ma on all channels).

# The importance of head azimuth

By John Shepler

Compact discs, cassettes, and reel tape can sound equally good on the average consumer stereo system. The most important factor in clear, crisp audio reproduction is accurate alignment.

Digital audio, either CD or DAT tape, has the advantage over analog recording that digital either sounds good or doesn't work at all. Analog tape equipment has the nasty habit of drifting out of alignment so that the degradation of the audio happens a little at a time. In a few months or a few years, the customer knows the cassette deck doesn't sound as good as the CD player he or she just bought, but doesn't realize this is an alignment problem and not an inherent weakness of magnetic tape.

A crucial alignment for any tape equipment involves head azimuth. Azimuth is a term from navigation and astronomy that means angle or horizon arc. For head tapes, the azimuth is the angle that the head can lean from side to side. An out of azimuth head is shown in Figure 1.

Why is the azimuth so important?

Shepler is an electronics engineering manager and broadcast consultant. He has more than 20 years experience in all phases of electronics.

The higher the frequency, the more critical the azimuth alignment becomes. At 15 or 20 kHz, turning the alignment screw a quarter turn can mean a change of several dB of response. It is a very touchy adjustment.

Moreover, head azimuth affects stereo phasing even more than high frequency response. You can see from Figure 1 that as the head tilts, the top and bottom poles shift so that the music on the bottom track gets to the pole piece sooner than the music on the top track. This time difference results in a high frequency phase shift. Phase shift is most important in systems where the left and right channels are combined to create a mono channel or surround-sound center channel. Any phase shift will result in a cancellation of high frequencies, resulting in "muddy" mono audio.

Most tape players have an azimuth adjustment screw on the head bracket. This includes portable cassette players. You will often see a hole in the case near the tape head for the azimuth adjustment screw.

If azimuth weren't so touchy, all tape equipment would be built with

the heads held firmly perpendicular to the tape path by rigid mounts. However, mechanical alignment isn't accurate enough to ensure proper high frequency response.

To properly adjust head azimuth you need a reference tape. This is a test tape that has been made on equipment perfectly aligned to NAB or other industry standards. This is what the mastering and duplicating equipment is aligned to. The service manual will have you set a reference level at 1,000 Hz or so. Then the test tone will change to 15,000 Hz or higher and you will adjust the head azimuth for the highest possible reading. For stereo reproducers, you further tweak the azimuth for an oscilloscope pattern indicating the phase is properly aligned. This pattern is an angled straight line, rather than a circle or oval.

Recorders must also be aligned. In many cassette recorders, the record and playback is done with the same head so that only one adjustment is needed. For three-headed machines, the play head is first aligned with the reference tape, then high frequency tones are recorded while the record head is adjusted for a high frequency peak output and correct phasing.

How often does azimuth need adjustment? That depends on how often the machine is used, whether it gets any jolts that can knock the head out of alignment, and how good the head bracket mechanism is. Professional recorders are checked at least once a week and many recording studios set the azimuth before every session. A home machine that is infrequently used might go several years without becoming misaligned. Any tape equipment brought in with complaints of dull or muddy sound is a candidate for realignment.

One quick tip: You can sometimes get by without an alignment tape on some of the cheaper players. Pick a prerecorded tape with a lot of treble instruments, such as cymbals, and adjust the azimuth for the sharpest sound. Most other tapes will then also sound good. ■

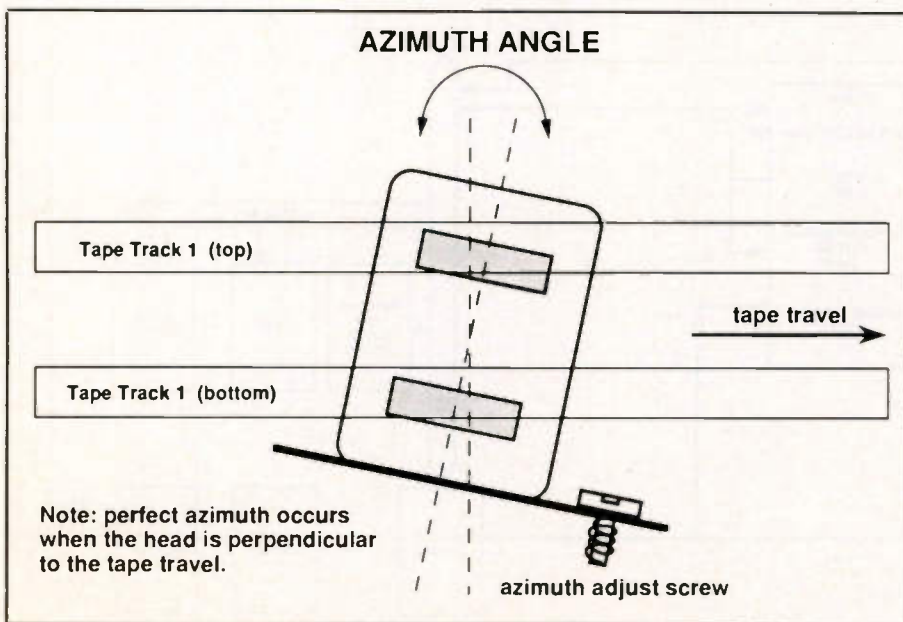

Figure 1. Azimuth adjustment.

# Exploring the 80286 and 80386-based microcomputers:

## Combining theory and practical service techniques

### Part One: Troubleshooting the 80286 Microprocessor

By John A. Ross

In a past series of articles entitled "Servicing Zenith Microcomputers" the discussions dealt exclusively with microcomputers that featured the 8088 microprocessor. Not surpris-

Ross is a technical writer and a microcomputer consultant for Ft. Hayes State University, Hays KS.

ingly, technological advances have directed the consumers' preferences to faster, more powerful computers.

Operating speeds have increased from the 4.77 through 8MHz operating speeds of the 8088-based microcomputer to 33MHz for the fastest 80386-based microcomputers. Ran-

dom-access memory (RAM) addressing capacities have grown from the 640 Kbyte ceiling of the 8088-based microcomputer to sixteen Mbytes for the 80286-based microcomputers and fifty-four Mbytes for the 80386-based microprocessor.

Those improvements result from

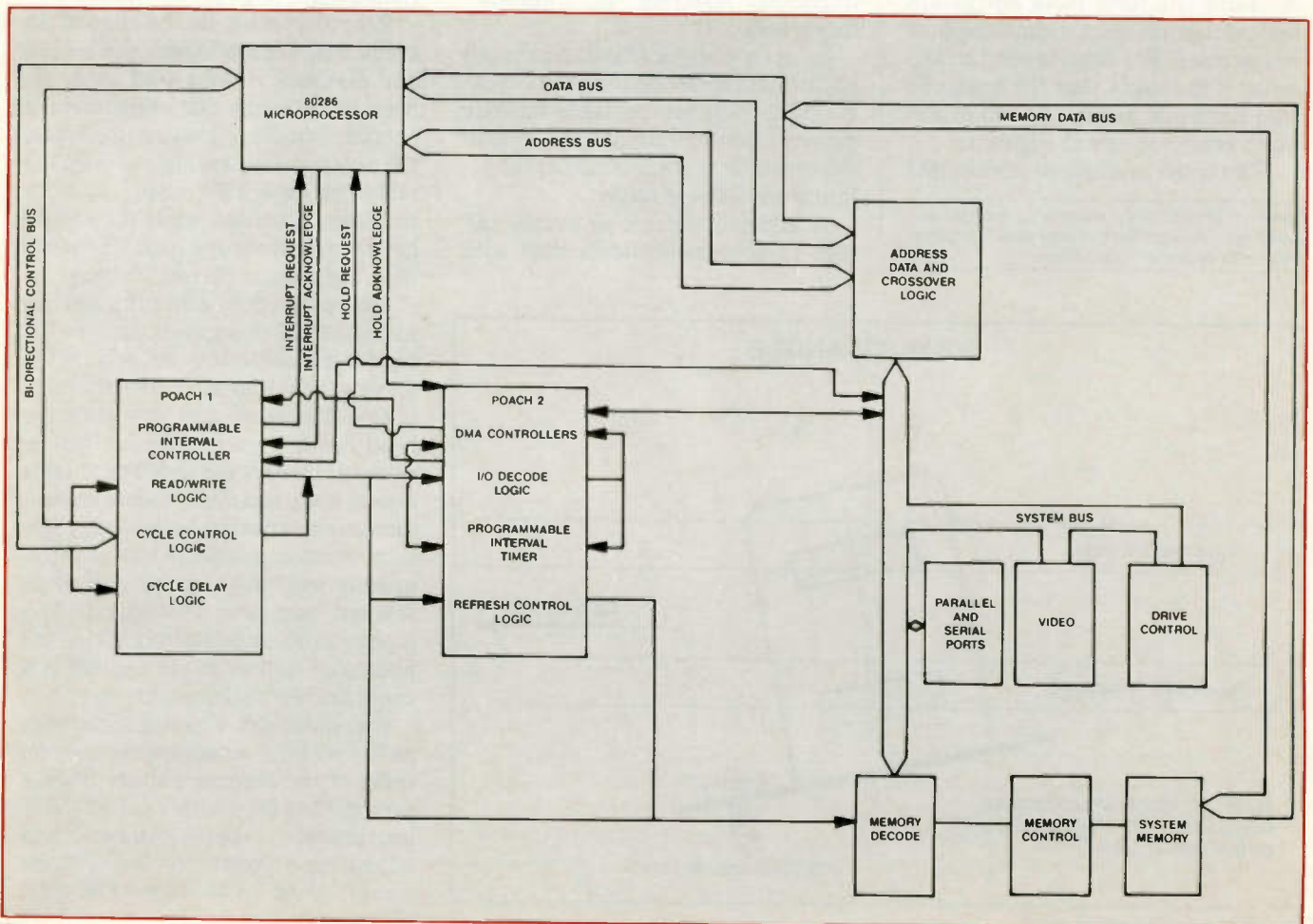

Figure 1.



an industry move from the once-standard eight and sixteen-bit internal microprocessor to the now-standard thirty-two bit internal architecture.

Even though the thirty-two bit architecture has become the new standard for IBM compatible microcomputers, technicians must remain aware of the sixteen-bit architecture. While the second portion of this article will concentrate on building capabilities to service 80386-based microcomputers, we will take a serious look at troubleshooting the 80286-based microprocessor in this section. Preparing to service the 80286-based microcomputers calls for equipment such as the DMM, a frequency counter with a range of at least 50MHz, a logic probe, a 100MHz oscilloscope and a logic analyzer.

### Microprocessor control

Microprocessor control of microcomputer operations comes through the proper sequencing of the control, address, data and status signals. As we know, central processing unit circuitry consists of mostly control and timing circuits.

Figure 1 shows the 80286 microprocessor plus the address decoding logic, bus control logic and timing circuits. As with the 8088-based microcomputers seen in the earlier series of articles, the monitor ROM contains the basic instruction operating set, or BIOS, program that allows the proper initialization and functioning of the CPU.

Two integrated circuits, called POACH, or *PC On A Chip* sets, contain the logic functions needed by the microprocessor. Of those functions, the POACH 1 integrated circuit contains the clock generation, interface, bus control, interrupt control and real-time clock operations.

POACH 2 includes the programmable interval timer, clock generation, memory mapping, refresh generation and DMA controlling functions. Figure 2A depicts the functions of the POACH chip set. Additionally, Figure 2B shows the individual integrated circuits with pin-out descriptions and also gives definitions for most of the signals.

To gain a close-up of the 80286 microprocessor signal action, let's move to Figure 3. This figure displays a block diagram of the microprocessor along with pin-out designations and signal descriptions.

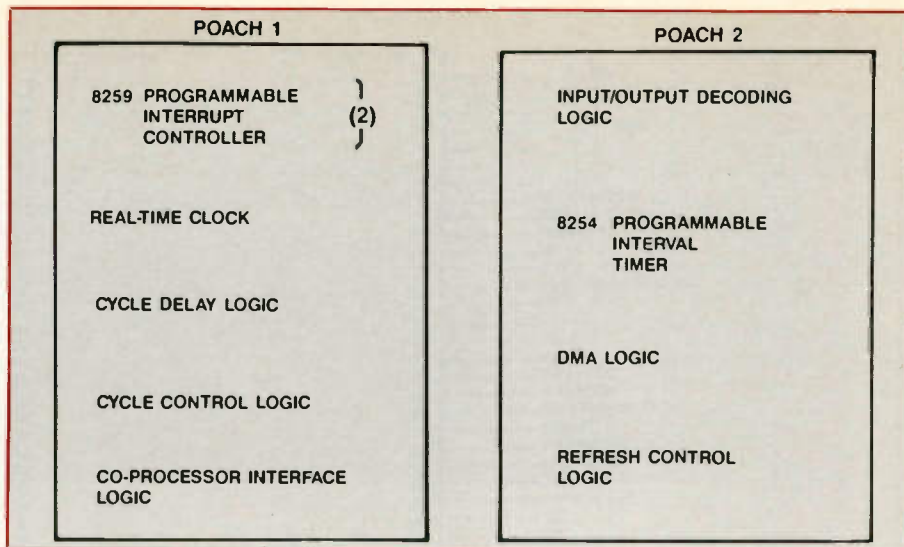

Figure 2A.

Quickly considering Figure 3, a parallel bus interface attaches the 80286 central processing unit to the external system memory, the system input/output, and any other additional devices. Several different busses, such as the twenty-four bit address bus, a sixteen bit data bus along with control and status lines, make up the parallel bus. Those control and status lines govern the transfer of information across the entire bus with the memory input/output, one and zero status signals. Each status signal operates only during the first half of the bus cycle.

### Troubleshooting considerations

Several specific signals become important in troubleshooting a microcomputer with CPU problems. Initially, look for activity at pins 4, 5, 63, 66 and 67 at the microprocessor. These pins carry the status one, status zero, the READY and the memory input/output signals respectively. Without the proper decoding of the status signals, the microprocessor cannot identify the status of current bus action.

Again, considering the microprocessor signal action, also check pins 64 and 65 for the proper bus hold and bus hold acknowledge signal action.

Even if you find the correct signals at the microprocessor, also check for the proper signal action at the POACH 1 IC. Pins 18, 19, 20, 21, 56, 64 and 65 of the POACH 1 chip carry the status zero, status one, memory input/output, READY, interrupt acknowledge, hold acknowledge and refresh ready signals respectively. If these signals "stick" at a digital high state, the microprocessor becomes

isolated from the bus. Consequently, no bus cycles can occur. For the sake of convenience, Figure 4 defines these signals and shows their proper status.

Sixteen data lines labeled as data 0 through data 15 connect the central processing unit to the circuitry that produces the secondary data bus. Most of that circuitry takes the form of crossover buffers and latches. Connections from the secondary bus link the central processing unit to other areas of the CPU circuitry, which also includes the math co-processor. Of the sixteen data lines, the data 0 through data 7 lines carry even addressed word transfers, while the data 15 through data 8 lines carry odd addressed word transfers. From the secondary data bus, data bits SD 0 through SD 7 connect to control circuitry seen in the POACH circuitry.

### Data transfer

Byte transfers from the data bus to the input/output bus take two different forms. Noticeably, as the even byte transfers happen in one cycle, the odd byte transfers occur in two cycles. This two-cycle operation becomes necessary because of the A0 and BHE signal action. Address line zero, or A0, is an input signal to the POACH 1 chip from the microprocessor. As an output from pin one of the microprocessor, the byte high enable, or BHE, signal indicates the transfer of data on data lines D8 through D15. Either inactive or low A0 and BHE signal operations indicate an even word transfer.

When the A0 and BHE signals go to an active state, a transfer of odd bytes takes place. Even and odd bytes

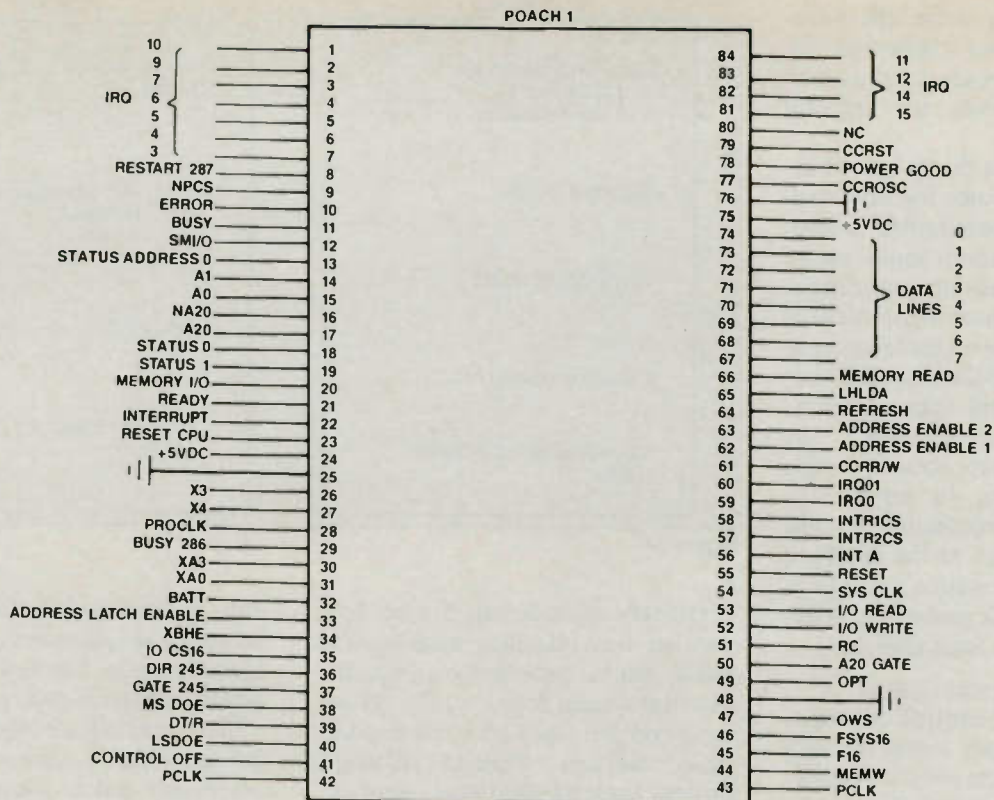

**Definitions of POACH circuit signals**

**POACH ADDRESS and Clock Signals**

**A20 Gate** - Address 20 Gate - sets condition for CPU Address 20 which allows the A20 to swing low or high

**ALE** - Address Latch Enable - controls address latching

**NA20** - CPU Address 20 - Input signal from pin 20 of microprocessor to POACH 1

**SAO** - System Address Line 0 - Controlled line when DMA controller has use of the bus

**XAO-18** - External Address Line - These lines handle I/O port addressing

**CS287** - Chip Select 287 - Chip select signal for coprocessor

**ERROR** - Indicates a coprocessor error

**NPCS** - Numeric Processor Chip Select - Chip select signal for coprocessor

**BUSY** - Numeric Processor is executing a command

**OSC** - Oscillator - Output signal from POACH 2 carries the fully shaped clock signal

**PCLK** - Peripheral Clock - Output clock signal

**PROCLK** - Processor Clock - Clock signal for CPU

**SYSCLK** - System Clock - Synchronizes other devices in the computer

**X1-4** - Oscillator - Oscillator inputs to POACH 1 and 2

**POACH Circuit Bus Control Signals**

**ACK** - Acknowledge - Allows data to flow into and out of system

**CNTLOFF** - POACH 1 - Enables low-order data bus latching

**DIR245** - Direction 245 - Controls the high to low byte transfer for eight bit peripherals

**DT/R** - Data Transmit/Receive - Controls direction of data transfer between local and external bus lines

**GATE 245** - Enables high to low byte transfer for eight bit peripherals

**LSDOE** - Least Significant Data Output Enable - enables data transfer between local and external bus lines for the most significant data bytes

**MSDOE** - Most Significant Data Output Enable - enables data transfer between local and external bus lines for the most significant data bytes

**RDXDB** - Read External Data Bus - Controls direction of data flow on system and external bus lines

**REFRESH** - Initiates memory refresh cycle

**XBHE** - External Bus Enable - Input signal to generate MSDEN

**XDO-7** - External Data Bus - Lines that carry bi-directional 8-bit signals to and from I/O ports

**POACH 1 CPU SIGNALS**

**CPU HLDA** - CPU Hold Acknowledge - Input signal from the microprocessor showing that the microprocessor has given control of the bus to an external device, usually the DMA controller

**LHLDA** - Latched Hold Acknowledge

**XF16** - Fetch 16 - Indicates a word memory access and inhibits command delays for I/O memory access operations

**FSYS16** - Fetch System 16 - Latched Fetch 16

Figure 2B.

POACH 2

8	1	84	9	
7	2	83	10	
6	3	82	11	
5	4	81	12	
4	5	80	13	
3	6	79	14	
2	7	78	15	
1	8	77	16	
0	9	76	17	
	10	75	18	
VSS1	11	74	19	
VCC1	12	73	20	
0	13	72	21	
1	14	71	22	
2	15	70	23	
3	16	69	X2	
4	17	68	X1	
5	18	67	OSC	
6	19	66	SPEAKER	
7	20	65	NMI	
NC	21	64	CPU HRO	
HLDA	22	63	8042CS	
REFRESH READY	23	62	T/C	0
ADDRESS ENABLE	24	61		1
ADDRESS ENABLE	25	60		2
CCRR/W	26	59		3
CS 287	27	58		4
IRO0	28	57		5
INTRKS	29	56		6
INTR2CS	30	55		7
INTERRUPT ACKNOWLEDGE	31	54		
RESET	32	53	VSS2	
SYSTEM CLOCK	33	52	VCC2	7
I/O READ	34	51		6
I/O WRITE	35	50		5
P2	36	49		4
ACKNOWLEDGE	37	48		3
DMA ADDRESS ENABLE	38	47		2
RDX DB	39	46		1
DPCK	40	45		0
MASTER	41	44	MEMORY WRITE	
REFRESH	42	43	MEMORY READ	
I/O CHANNEL READY			I/O CHANNEL CHECK	

**SM/I/O** - System Memory or Input/Output - indicates either a memory cycle or I/O port cycle

**POACH 1 Interrupt Controller Signals**

**INTA** - Interrupt acknowledge - the interrupt controller uses this signal from POACH 1 to POACH 2 to acknowledge that it has received an interrupt

**INTR** - Interrupt request - Output signal from POACH to the CPU used when a valid interrupt is received

**INTR1CS** - Interrupt Controller 1 Chip Select - POACH 2 sends this signal to POACH 1 to select the master interrupt

**INTR2CS** - Interrupt Controller 2 Chip Select - POACH 2 sends this signal to POACH to select the slave interrupt controller

**IRQ** - Interrupt Request - Various kinds of interrupt requests

**8042CS** - 8042 Chip Select - POACH 2 output chip select signal for keyboard processing

**OPT** - Keyboard Output Buffer Full - Input signal to POACH 1 from system

control processor carries keyboard interrupt request

**POACH 2 DMA Controller Signals**

**AEN** - Address Enable - controlling signals for the address bus

**DACKO-7** - Direct Memory Access Acknowledge - Output of POACH 2 acknowledges DMA requests

**DMAAEN** - Direct Memory Access Address Enable-high during DMA access of system memory

**DRQO-7** - Direct Memory Access Request - requests from various peripherals to use direct memory access transfers

**Master** - input to POACH 2 from externally connected devices requesting DMA control

**T/C** - Terminal Count - Output signal from POACH 2 shows that the active DMA channel has reached its terminal count limit

**XMEMR and XMEMW** - Output signals from POACH 2 that indicate external read and write operations

**LEARN VCR**  
CLEANING/MAINTENANCE/REPAIR  
EARN UP TO \$1000 A WEEK, WORKING  
PART TIME FROM YOUR OWN HOME!



Secrets Revealed!

NO Special Tools or Equipment Needed.

EARN UP TO \$60 AN HOUR AND MORE!

THE MONEYMAKING OPPORTUNITY OF THE 1990's

IF you are able to work with common small hand tools, and are familiar with basic electronics (i.e. able to use voltmeter, understand DC electronics)...

IF you possess average mechanical ability, and have a VCR on which to practice and learn...then we can teach YOU VCR maintenance and repair!

FACT: up to 90% of ALL VCR malfunctions are due to simple MECHANICAL or ELECTRO-MECHANICAL breakdowns!

FACT: over 77 million VCRs in use today nationwide! Average VCR needs service or repair every 12 to 18 months!

Viejo's 400 PAGE TRAINING MANUAL (over 500 photos and illustrations) and AWARD-WINNING VIDEO TRAINING TAPE reveals the SECRETS of VCR maintenance and repair - "real-world" information that is NOT available elsewhere!

Also includes all the info you'll need regarding the BUSINESS-SIDE of running a successful service operation!

FREE INFORMATION

CALL TOLL-FREE 1-800-537-0589

Or write to Viejo Publications, Inc.

5329 Fountain Ave.

Dept. EST

Los Angeles, CA 90029

Circle (19) on Reply Card

**Troubleshooting Guide**  
with Vision



Don't let VCR problems bring your Service Department to a standstill. With Mitsubishi's *VCR Troubleshooting Guide*, you'll find numerous techniques which can be applied to a wide range of popular VHS VCR brands. By using Mitsubishi's unique On-screen Index system, the information you need is quickly accessed, turning you down time to up time fast.

**MITSUBISHI**  
ELECTRONICS AMERICA INC.

Only \$49.95

Order Part Number TT-103

Includes One WORKBOOK

1 (800) 553-7278

MASTER CARD/VISA

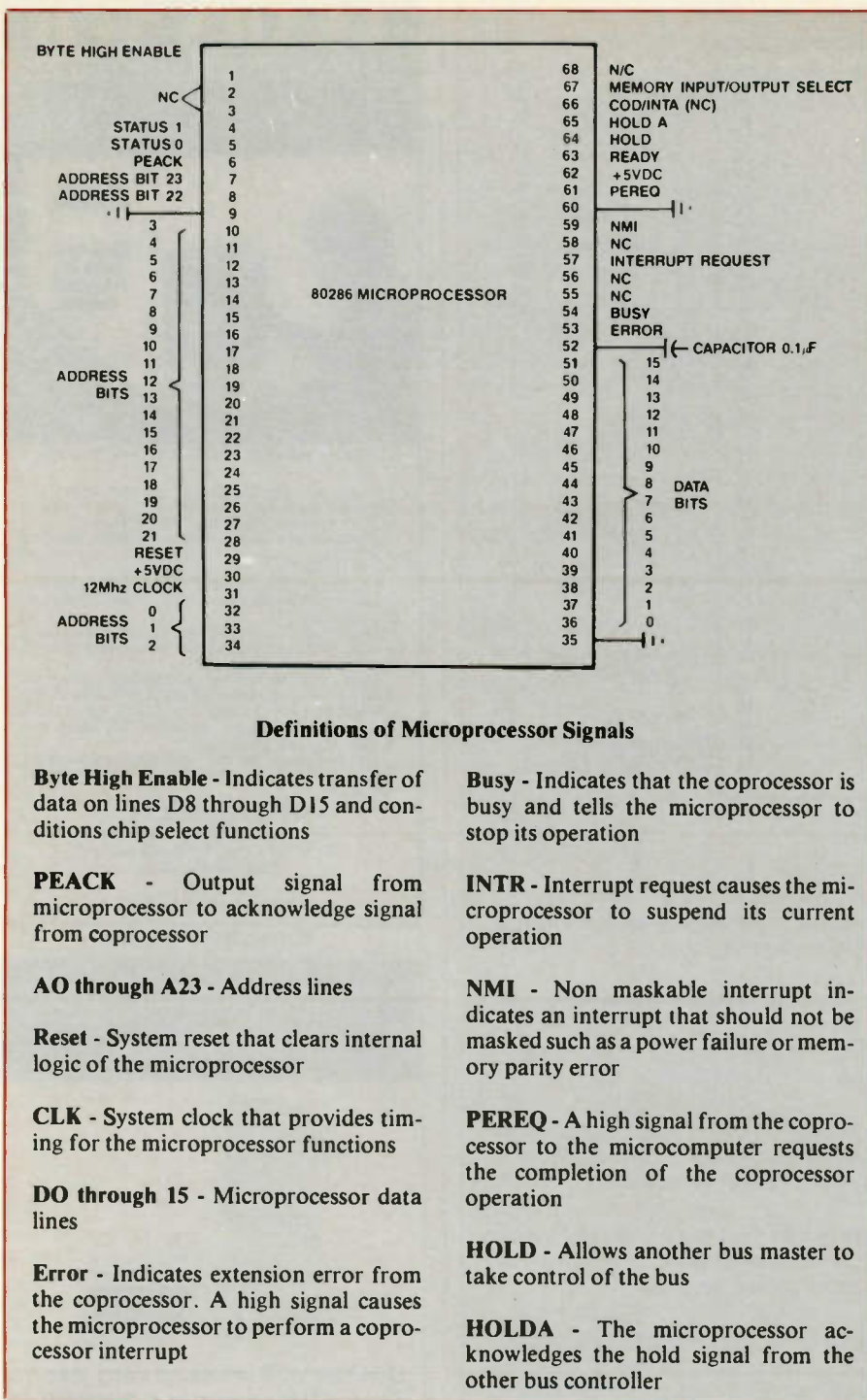

### Definitions of Microprocessor Signals

**Byte High Enable** - Indicates transfer of data on lines D8 through D15 and conditions chip select functions

**PEACK** - Output signal from microprocessor to acknowledge signal from coprocessor

**AO through A23** - Address lines

**Reset** - System reset that clears internal logic of the microprocessor

**CLK** - System clock that provides timing for the microprocessor functions

**DO through 15** - Microprocessor data lines

**Error** - Indicates extension error from the coprocessor. A high signal causes the microprocessor to perform a coprocessor interrupt

**Busy** - Indicates that the coprocessor is busy and tells the microprocessor to stop its operation

**INTR** - Interrupt request causes the microprocessor to suspend its current operation

**NMI** - Non maskable interrupt indicates an interrupt that should not be masked such as a power failure or memory parity error

**PEREQ** - A high signal from the coprocessor to the microcomputer requests the completion of the coprocessor operation

**HOLD** - Allows another bus master to take control of the bus

**HOLDA** - The microprocessor acknowledges the hold signal from the other bus controller

### Definitions of Status Signals

**Status Zero** - Lines that allow the microprocessor to distinguish read operations from write operations

**Status One - Ready** - When high, the microprocessor cycles extend

**Memory Input/Output** - Status line that allows microprocessor to distinguish between memory and I/O operations

**Interrupt Acknowledge** - Signal from interrupt controller acknowledges that an interrupt has been received

Figure 4.

coprocessor calls for the study of both Figure 1 and Figure 2. Obviously, the 80286 controls the bus action through the use of internal logic and control signals. However, the action of the POACH 1 and POACH 2 circuitry also affects bus action.

Going back to Figure 1, DMA control with its HOLD and HOLDA signals, comes from the second POACH integrated circuit. With the HOLD signal, the DMA controller requests control of the bus from the microprocessor. Actual control of the bus by the DMA controller happens when the microprocessor receives the HOLDA signal. Figure 5 displays the waveforms seen during the direct memory access operation.

### Diagnosing problems

If you encounter possible microprocessor problems, checking for the proper signal action at the POACH chips will aid the diagnosis. Pins 65 of POACH 1, and 21 of POACH 2 carry the HLDA or Hold Acknowledge signal, while pin 64 of the POACH 2 chip shows the CPUHRQ signal and pin 65 carries the HLDA signal. If the signal at any one of these points becomes "stuck," the memory refresh function will not occur. At times, the malfunction of a floppy disk drive will lead you to look for a "no memory refresh" condition.

Other signals become derived from the POACH 1 IC action. By sending the pin 21/READY signal to a digital high state, the POACH 1 informs the microprocessor when it should complete the bus cycle. Another signal, the input/output channel ready, or IOCHRDY, signal adds wait states to the microprocessor action. Since

or words access the 64K addresses of the input/output bus. Input/output peripherals attach to either the upper or lower set of lines found on the data bus. Odd I/O addresses access peripherals connected to the upper data lines. Even byte and word input/output addresses enter peripherals attached through the lower data lines.

All the output memory and input/output port address memory information flows through the address bus. Generally, you may monitor ad-

dress bus action by watching the states of the A0 and BHE signals. When a data transfer takes place on data bits 0 through 7, the A0 signal goes to a digital low state. When the BHE signal goes to a digital high state, the address bus goes to an off state and a data transfer occurs on the upper data lines. During the input/output transfers, the address lines A16 through A23 go to a digital low state.

Considering the action of the mi-

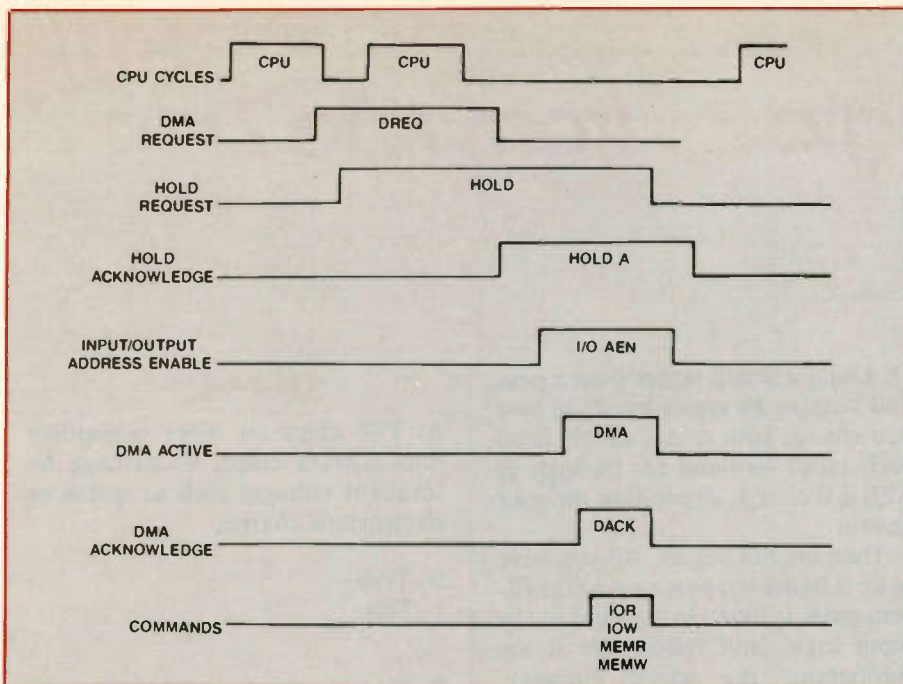

Figure 5.

some memory and peripheral devices cannot transfer data at the maximum rate requested by the microprocessor, the wait states accommodate the transfer of data to those devices.

If the microcomputer includes an

optional coprocessor, three signals from the POACH 1 circuitry match the microprocessor with the coprocessor. One signal, the processor extension request or PEREQ signal, shows that the coprocessor has re-

quested data from the microprocessor or the system memory. A second signal, the processor extension acknowledge or PEACK signal, shows that the data transfer has started. An input signal to the POACH 1 circuit, labeled as the Busy 286, or BSY286 signal, shows that the coprocessor continues to execute an instruction. With that signal, the coprocessor also indicates that it cannot accept another instruction.

Keeping those troubleshooting ideas in mind, we'll move to the 80386 microprocessor in the next part of this article. Although the 80386 microprocessor traces its lineage back to the beginnings of the '86 family of microprocessors, technicians will easily recognize many differences. Because of those differences, we will initially compare the 80286 and the 80386. Since the 80386 utilizes the thirty-two bit architecture, instead of the once-common sixteen-bit architecture, we'll also spend some time defining "thirty-two bit architecture." After those brief comparisons and definition, we'll outline the functions of the 80386 microprocessor along with servicing procedures. ■

**Come Out of the Dark.**

If you're groping for a better method of running your business, let NESDA light your way with Service Control System II, a business management software system designed to help you run a more efficient business (NESDA members also receive a 20% discount). For more information about NESDA and Service Control System II, just send the following information:

Name \_\_\_\_\_  
 Address \_\_\_\_\_  
 City \_\_\_\_\_ State \_\_\_\_\_  
 Zip \_\_\_\_\_  
 Phone \_\_\_\_\_

National Electronics Sales &  
**NESDA**  
 Service Dealers Association

2708 W. Berry St.  
 Ft. Worth TX 76109  
 (817) 921-9061

**Presenting an affordable Light Box System.**

Model TR100 CB Camera Light Box with (2) transparencies

- (2) 3200° Kelvin Lamps (meets mfr. spec.)
- 1-year conditional guarantee
- Transparencies mounted in acrylic with optical scratch-resistant surface
- 11-step gray scale transparency
- 7-Bar color transparency
- All orders are shipped within 72 hours, U.P.S.

**\$799**

The method most manufacturers recommend

**NUTRONIX (313) 726-1278**

P.O. Box 77103 • Sterling Hts., MI 48077

Circle (9) on Reply Card

# A game of logic . . . from A To Z

By Lambert C. Huneault, CET

If "all work and no play" hits close to home, how about taking a little time out from your busy service work and spending a few minutes playing a little game! This adventure which takes you through a maze of logic gates should be fun if you're already familiar with digital electronics, and informative if you're a bit green or perhaps a little rusty on the subject.

The game is quite simple: you begin by answering the ten questions (A through J) which follow; your answers determine whether logic 0 (LOW) or logic 1 (HIGH) gets applied to the corresponding input terminals in the circuit diagram (Figure

Huneault now retired, was an electronics instructor and head of the REE Department at St. Clair College of Applied Arts and Technology in Ontario, Canada.

1). Using a pencil rather than a pen, and keeping an eraser handy in case you change your mind, simply label each input terminal (A through J) with a 0 or a 1, depending on your answer.

Then the fun begins. All you have to do is figure out how each of the fifteen gates is likely to respond to the input logic, and follow the action throughout the whole circuitry. Write down the resulting logic level (0 or 1) at each of the nodes (points K through W). Finally, write down—in the blank spaces provided on the diagram—the logic state (0, 1, or high-impedance) at each of the three output terminals (X, Y and Z).

So why not go ahead and play the game right now. We'll reveal the answers shortly, but no peeking until *after* you finish the exercise!

## Ten questions

A. TTL chips are more susceptible than CMOS chips, to damage by transient voltages such as spikes or electrostatic charge;

0 - True  
1 - False

B. Binary number 10100100 is equivalent to decimal number 164;

0 - True  
1 - False

C. Decimal number 422 is equivalent to hex number 01A7;

0 - True  
1 - False

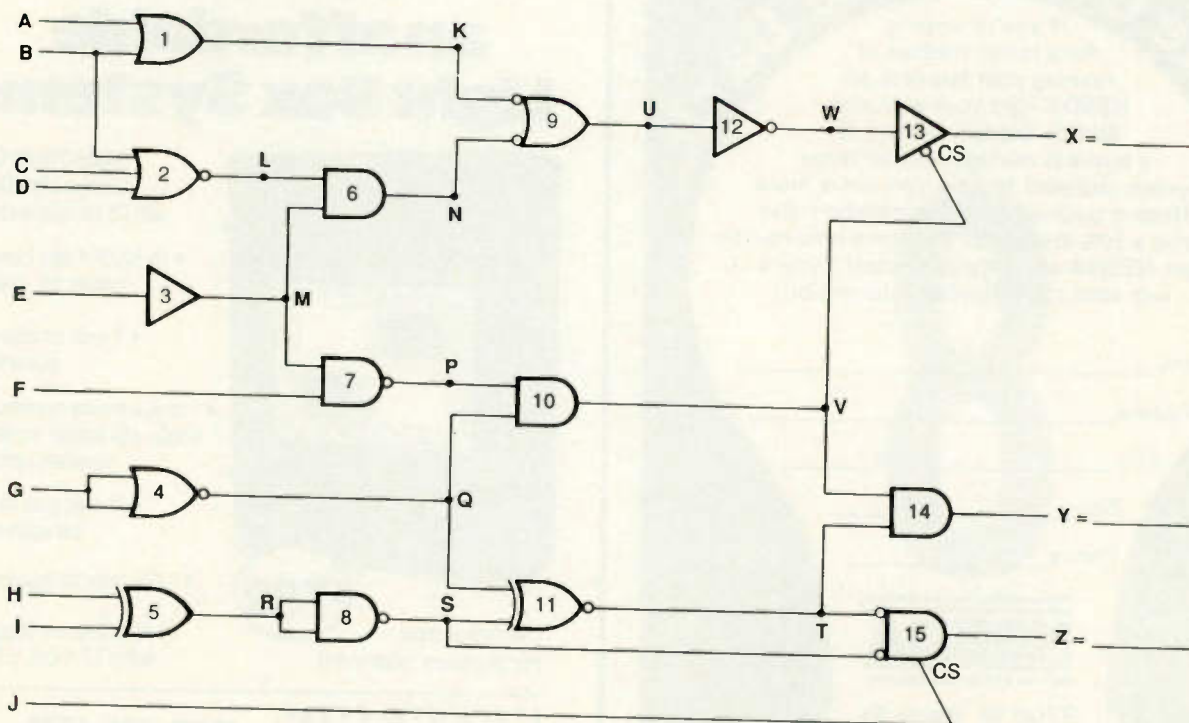
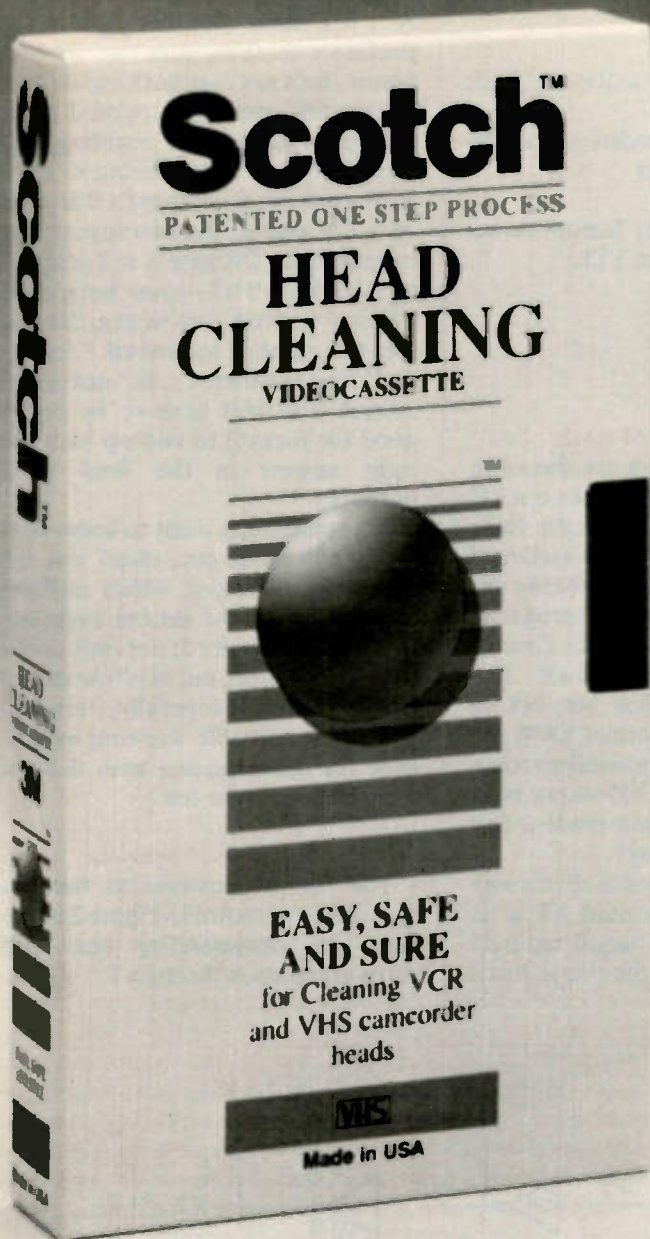

Figure 1.



**When you come up with a superior product, people talk:**

“This is the first head cleaning system I feel confident I can recommend.”

*George Bluzer, CET/CSM, Largo, FL*

“We sell it and recommend it.”

*Don Erwin, CSM, San Diego, CA*

“A quality product and safe to use.”

*Bill Warren, CET/CSM, Knoxville, TN*

“Great product... it's safe and effective.”

*George Weiss, CSM, Chicago, IL*

NESDA experts agree that the best solution to cleaning video recorder heads is the simplest. Unique to its category, the Scotch™ Head Cleaning Videocassette is the only recorded magnetic tape-based head cleaning cassette.

“It's effective, it's safe and it's economical.”

*As featured in the Advance Technology Nov./Dec. '87 supplement*

Call 1-800-443-6975 to order the Scotch Head Cleaning Videocassette model SCO-3198-4.

You may obtain information by writing: 3M Consumer Video and Audio Products Division, 3M Center Building 233-5N-01, St. Paul, MN 55144-1000.

**Scotch™ Head Cleaning Videocassettes. Easy. Safe. Sure.**

D. In digital logic, the expression "A + B" means:

- 0 - A AND B
- 1 - A OR B

E. BCD number 0110 0011 is equivalent to:

- 0 - decimal number 63
- 1 - hexadecimal number 63

F. In TTL logic circuits featuring positive logic, a voltage of +3.6V is normally seen as a:

- 0 - logic LOW
- 1 - logic - HIGH

G. A JK flip-flop has a logic LOW at its J input and a logic HIGH at its K input. Regardless of the previous output state, after one clock pulse its Q output will be:

- 0 - LOW
- 1 - HIGH

H. EPROM stands for:

- 0 - Erasable Programmable Read Only Memory
- 1 - Electrically Programmable Read Only Memory

I. Which of the following statements is true?:

- 0 - Multiplexers are sequential logic circuits
- 1 - Encoders and decoders are combinational logic circuits

J. MOS ICs generally feature slower switching speeds than TTL;

- 0 - False
- 1 - True

### The moment of truth

The correct answers are shown in Figure 2. How did you make out? If you came up with the right logic states at X, Y and Z, you're a winner! Congratulations! You probably answered the ten questions properly, and correctly figured out the flow of logic throughout the circuit. But don't be too smug just yet; before you give yourself a score of 100%, be aware that it is quite possible to come up with the correct XYZ output even though you might have made a few mistakes along the way!

The test was designed in such a way that you don't really need 100% to pass. Thanks to the "good nature" of some of the gates, the circuit has a

certain amount of built-in "generosity"; it's better than having a tough professor marking your test! For example, let's say that both inputs of a certain OR gate are supposed to be HIGH (logic 1), thus resulting in a HIGH output. But because of a wrong answer you placed a 0 instead of a 1 at one of the two inputs; the output of the OR gate is still going to be HIGH, isn't it?—even though one of your answers was wrong. So you see, the game is somewhat "forgiving" here and there . . . but not everywhere! You still have to be pretty good (or lucky!) to end up with the right answers at the final XYZ outputs.

If you honestly want to know how you *really* made out, check out the following discussion which explains the reasons for the various logic levels shown in Figure 2; not only at the output terminals, but at *all the circuit nodes* as well. Hopefully, this will provide a valuable learning experience for those readers who did not fare too well in the test.

### Gate by gate analysis

The correct answers to the ten questions are shown in Figure 2 in the form of corresponding ones and zeros at inputs A through J.

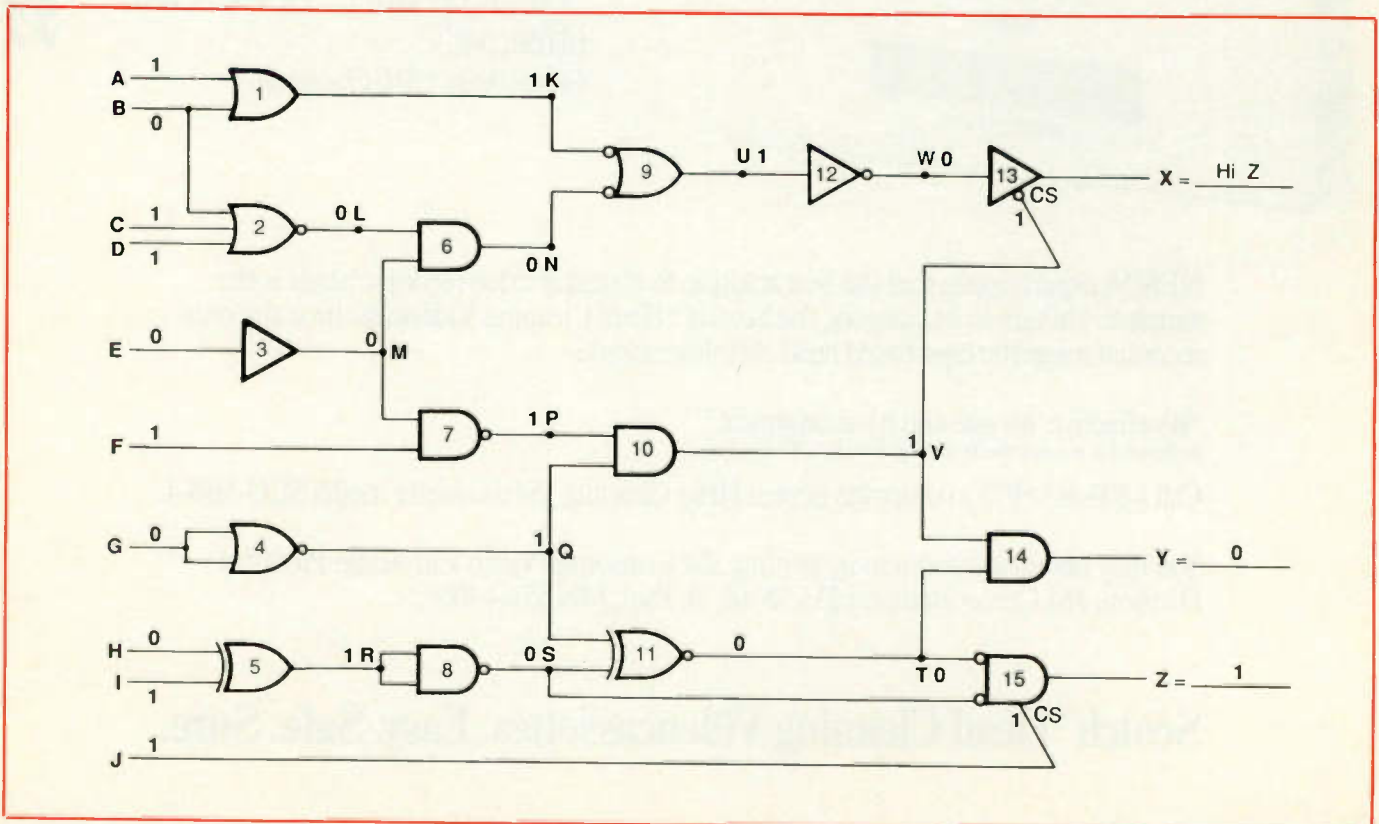

Figure 2.



Gate 1 is an OR gate; with 1 and 0 as inputs, output  $K = 1$ .

Gate 2 is a three-input NOR gate with 0, 1 and 1 as inputs. As long as at least one of the inputs is HIGH, a NOR gate outputs a LOW; therefore  $L = 0$ .

Gate 3 is a non-inverting buffer; with 0 at its input, its output  $M = 0$ .

Gate 4 is a NOR gate with its input terminals tied together; it thus becomes an inverter. Therefore, with 0 at its input its output  $Q = 1$ .

Gate 5 is an EXCLUSIVE OR gate (XOR). This type of gate outputs a HIGH when its inputs are *different*, and a LOW when its inputs are *similar*. Thus, with a 0 and a 1 as inputs, its output  $R = 1$ .

Gate 6 is an AND gate. With both L and M inputs LOW, it follows that output  $N = 0$ .

Gate 7 is a NAND gate whose inputs M and F are LOW and HIGH, respectively. Therefore its output  $P = 1$ .

Gate 8 is a NAND gate functioning as an inverter because its inputs are tied together. Therefore its HIGH input ( $R = 1$ ) is inverted into a LOW output, i.e.  $S = 0$ .

Gate 9 is a NAND gate featuring the commonly encountered OR symbology with inverting bubbles at the inputs. With  $K = 1$  and  $N = 0$  as inputs, the NAND gate has an output  $U = 1$ .

Gate 10 is an AND gate. With P and Q inputs HIGH, output  $V = 1$ .

Gate 11 is an EXCLUSIVE NOR gate. If it were an XOR gate, its dissimilar inputs ( $Q=1$  and  $S=0$ ) would result in a HIGH at its output. But it's an XNOR gate, so its output is the opposite, i.e.  $T = 0$ .

Gate 12 is an inverting buffer. Logic 1 at its input (U) is therefore inverted, i.e.  $W = 0$ .

Gate 13 is a *tri-state* buffer, with an *active-low* CHIP SELECT terminal (CS), as indicated by the bubble symbol. This type of buffer would be activated, i.e. its input logic would pass right through to the output terminal, if the CS terminal were at a LOW logic level. However, since gate 10 outputs a 1 (logic HIGH) at node V, buffer 13 becomes *disabled*. Therefore output terminal X becomes effectively disconnected, i.e. it switches to the HIGH-IMPEDANCE state, thus assuming neither the 0 nor the 1 logic level.

Gate 14 is an AND gate with 1 and

0 inputs (V and T); therefore its output  $Y = 0$ .

Finally, gate 15 is a tri-state NOR gate featuring AND symbology with inverting input bubbles, and an *active-high* chip select terminal (no bubble at pin CS). Since line J is HIGH, the chip is *enabled*. With two LOW inputs (T and S), the NOR gate outputs a HIGH, i.e.  $Z = 1$ .

**Would you like to see more of these puzzles?**

So there you have it, logic from A to Z. If you enjoyed the puzzle or learned from it and would like to see more in future issues of ES&T, kindly let the Editor know; we might cook up another game or two, perhaps featuring some more sophisticated chips.



### The technician as perpetual student

Your editorial in the November issue, "The Technician as Perpetual Student," went to the heart of the issue of technical training and the constant upgrading of technicians.

The International Society of Certified Electronics Technicians (ISCET) administers the Certified Electronics Technician examinations. In just the past five years, the basic exam (Associate) and each of the options has undergone major changes in content based on the changes in technology. Any technician who passes the exam may join ISCET. This opens the door to vast amounts of new technology delivered to his door each year. ISCET's on-going commitment to keeping its members up with technology goes hand-in-hand with the concerns expressed in your editorial. As we watch the mail from our members arrive at the ISCET headquarters, it is gratifying to see an appetite for new technology among our members. It is sometimes frightening,

however, to see the elementary level of a few of those requests.

Your November issue of *Electronic Servicing and Technology* was one of the best ever. Keep up the good work in doing your part to help technicians who "are willing to expend whatever effort is required to keep abreast of those advances."

**Barbara G. Rubin**  
Director of Member Services ISCET

Have a question, a comment, a gripe, a suggestion? Found a better way of servicing an electronics product discussed in an article? Or maybe you would like to see an article about a subject you haven't seen covered yet. We want to hear your ideas.

**Feedback**  
Electronic Servicing & Technology  
P.O. Box 12487  
Overland Park, KS 66212

## Talking to microprocessors and computers

By Sam Wilson

An important step in becoming proficient in any technology is to master the vocabulary. Unfortunately, there are some serious pitfalls to this step. Since there is no absolute authority for definitions, different authors may use a term in slightly different ways.

Add to that problem the fact that popular use of a term can lead you away from its true meaning. Unfortunately, schools do usually include technical jargon in their courses. The overall result is that there can be misunderstandings when a technical article is written.

In my experience writing for *ES&T* I have run across this problem a number of times. In a few cases I have had a wrong idea from the way the term was used in some practical application. Fortunately, our readers are quick to jump in with corrections and criticisms. Usually, (but not always) the letters I get are very professional. That is one of the good things about writing for *ES&T*, we have high-class readers.

You may be surprised to find that some of the terms used in this article have a broader meaning than you learned or that you are used to. Keep an open mind as we sail through a few expressions used in computer talk.

Here is the question being addressed in this article: How does an idea get from a human into a microprocessor or computer? The human is a programmer, a very clever person who knows how to tell the microprocessor or computer what to do.

The microprocessor may be an internal part in a computer that is used to process instructions and data, or it may be in a non-computer application that has a more limited function.

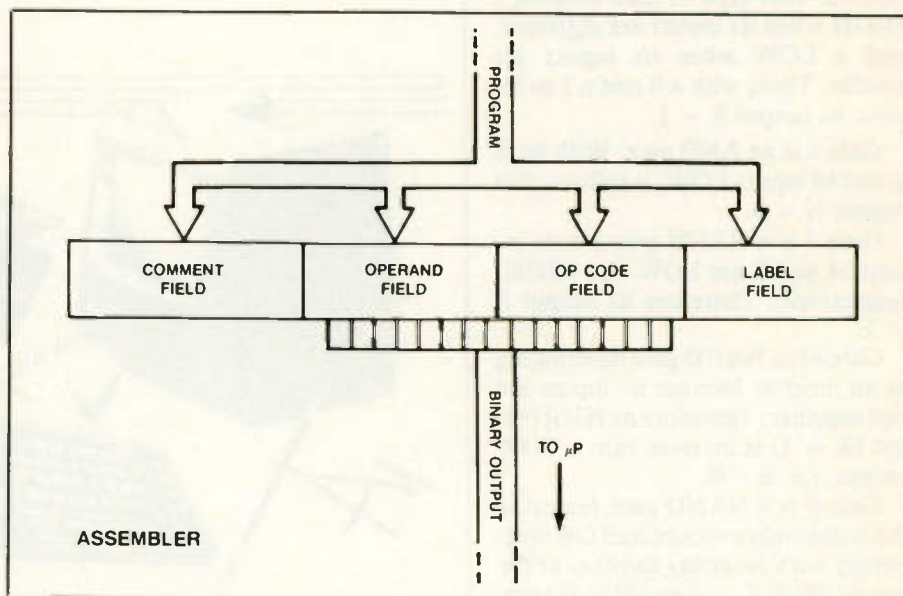

Figure 1.

In that case it is a *dedicated microprocessor*. For example, a dedicated microprocessor is used in the tuner of many television receivers.

### Mnemonics

First, let me discuss the meaning of the term *machine language*. It refers to a combination of 1's and 0's that can be utilized by a microprocessor or computer. In other words, machine language is made up of binary digits. That is the only language a microprocessor can understand!

The unabridged dictionary definition of the word *mnemonic* is: Assisting or intended to assist the memory. Read that again and see if you can find anything in there about computers or computer language, or, any reference to any particular way of making the mnemonic.

Here is an important exercise in the use of mnemonics. You will need a pencil and paper if you want to participate. Copy the following machine

language codes onto a sheet of paper. (Note: these are imaginary codes given for the purpose of this demonstration! I just don't want some enthusiast to poke them into his or her machine and kill all the plants in the house.)

Do not mark this page. Use your memory to transfer the numbers.

```
1 1 0 1 1 0 1 1 1 0 1 0 0 0 1 1
1 0 1 1 0 1 0 1 1 0 1 1 1 1 0 0
0 1 0 0 1 0 0 1 1 1 0 1 0 1 1 1
0 1 0 1 1 0 1 0 1 1 1 0 0 1 0 1
```

That's not an easy thing to do. What you need is some kind of *mnemonic* to help you remember the codes until you get them copied.

Now, copy the following hexadecimal codes:

A	6	C	4
B	2	F	1
5	4	1	5
E	E	4	6

It is a lot easier to copy those hexadecimal numbers that represent ma-

## ASSEMBLY LANGUAGE SOURCE PROGRAM

Memory Address	Instruction Mnemonic	Comments
0100	LDA \$43 FF	Get Data (First Word)
0103	ADD \$5900	Add The 2nd Data Word
0106	STA \$4700	Store The Sum In Memory

Note: The codes are meaningless. They are only given for examples.

Figure 2.

chine language. They are *hexadecimal mnemonics* that aid in memorizing the machine language codes so they can be copied easily!

From the above exercise you can see that it would be easier to program a microprocessor in hexadecimal (hex) numbers compared to the job of programming in machine language.

However, a microprocessor cannot use hexadecimal codes directly because it only works with binary numbers. Therefore, some automatic method of converting from the hex to the binary codes is necessary. That method will be discussed a few paragraphs down the line.

There are many examples and types of mnemonics. In the language of computers the word mnemonic is usually used to refer to letter symbols—called *symbolic codes*. They make it easier to write instructions and data. Again, those symbolic codes must be converted into machine language so the microprocessor or computer can operate.

Here are a few examples of *symbolic mnemonics* -

**ABA** - Add the contents of Accumulator A to the contents of Accumulator B.

**LDX** - Load the index register

**CLR** - Clear

Symbolic mnemonic codes are easier to remember than hexadecimal codes because they are closer to the English language. They are very useful because they enable the programmer to instruct the computer without having to use hexadecimal numbers or worse yet, long strings of binary codes.

### Assembler

The next word I want to discuss is *assembler*. Usually, this is a software

program that has been placed in memory. In a computer an assembler converts symbolic and hexadecimal codes into machine language.

If I am writing about the typical computer assembler I will describe the software program that converts codes directly into machine language.

I have a microprocessor evaluation board that allows me to use the 6802 microprocessor for a wide variety of experiments. It has a numbered keypad that I use to enter hexadecimal codes. A program in a read-only memory [ROM] converts those hex numbers into their binary equivalents and delivers them to the microprocessor.

In this case I am doing one of the jobs usually done by the assembler. I get the symbolic mnemonic codes from a table supplied by the manufacturer. The hexadecimal equivalents [also supplied by the manufacturer] are entered by me via the keyboard and the program in ROM converts them to machine language.

### Fields

Now let me review the term *field* as it is used in computer talk. An instruction sent by a programmer to an assembler is usually divided into several sections that are called fields. A typical arrangement of the fields delivered to one type of assembler is illustrated in Figure 1. For a given application there may be more fields.

Figure 2 shows how an instruction may look for that arrangement of fields. This instruction is taken from a manufacturer's literature. I have changed the actual codes to make them meaningless.

Note that the symbolic code in Figure 2 tells the computer what to do. The location of where to do it is in another field and that location is written as a hexadecimal number. (In the

**THROW AWAY YOUR DMM!  
TOSS OUT THE SEMI CHECKER!  
TRASH YOUR SIGNAL CHECKER!**



Prices range from \$239 to \$399 depending on version and options.

"The SEMIANLYZER, with the signal tracing option is the most complete test equipment on the bench."  
- R. Hohl, General Motors Corp., MI

"The SEMIANLYZER is the best buy; it does more than the (\$1,000) HUNTRON TRACKER."  
- D. Yielding, Sentinel Computers, WI

"The SEMIANLYZER speeds up service on TV and VCR...the most used test instrument on my bench."  
- M. Zeigmann, AJ's TV-SAT-VCR Service, IA

- CHECKS AND IDENTIFIES SEMICONDUCTORS IN CIRCUIT.
- MEASURES LEAKAGE, VOLTAGE BREAKDOWN AND NOISE LEVEL OF CAPACITORS, SEMICONDUCTORS, LEDS, ETC.
- BEEPS TONES FOR VARIOUS COMPONENT CONDITIONS.
- SIGNAL TRACER FOR AUDIO, DIGITAL, VIDEO WITH BUILT IN DMM FOR MONITORING DC ON AC SIGNALS.

See the complete line of unusual test equipment from Electronic Design Specialists like the TELETESTER and the BUS LINE TRACER in our

FREE CATALOG!

SOUTHGATE DISTRIBUTORS

275 Rock Island Road, North Lauderdale, FL 33068



(305) 720-4497



Circle (15) on Reply Card

Parts Express

International Inc.

FREE CATALOG



CALL TOLL FREE 1-800-338-0531

CALL TOLL FREE

1-800-338-0531

Free catalog is sent via bulk mail. For express delivery, please send \$2.50 to cover 1<sup>st</sup> class postage costs. Foreign customers send \$5.00 to cover postage.

340 East First St. Dayton, Ohio 45402

Circle (12) on Reply Card

# Organize and Protect Your Copies of **ELECTRONIC**

Servicing & Technology

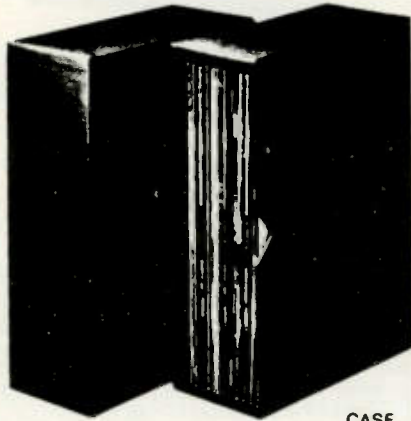

CASE

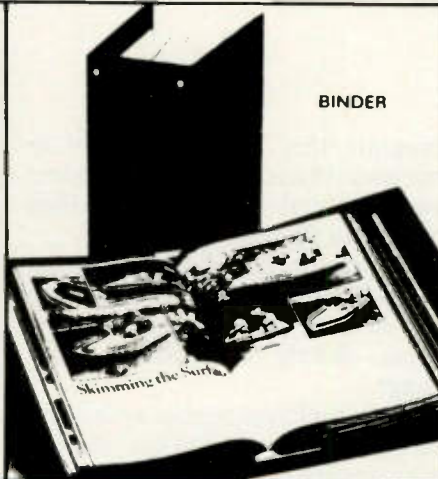

BINDER

Now there's an easy way to organize and keep copies of your favorite magazine readily available for future reference.

Designed exclusively for PC by Jesse Jones Industries, these custom-made titled cases and binders provide the luxury look that makes them attractive additions to your bookshelf, desk or any location in your home or office.

Whether you choose cases or binders, you'll have a storage system that's durable and well organized to help protect your valuable copies from damage.

- Cases and binders designed to hold a year's issues (may vary with issue sizes).
- Constructed of heavy reinforced board, covered with durable leather-like material.
- Title hot-stamped in gold.
- Free personalization foil for indexing year.
- Cases V-notched for easy access.
- Binders have special spring mechanism to hold individual rods which easily snap in. This allows magazines to be fully opened for easy readability.

Electronic Servicing & Technology  
Jesse Jones Industries, Dept. P-Com  
499 East Erie Avenue, Philadelphia, PA 19141

Please send \_\_\_\_\_ cases; \_\_\_\_\_ binders  
for Popular Communications Magazine.

- Enclosed is \$ \_\_\_\_\_
- Charge my: (Minimum \$15)
- American Express    Visa
- MasterCard    Diners Club

Card # \_\_\_\_\_ Exp. Date \_\_\_\_\_

Signature \_\_\_\_\_

Charge Orders: Call TOLL FREE 7 days, 24 hours 1-800-972-5858

Print Name \_\_\_\_\_

Address \_\_\_\_\_

No P.O. Box Numbers Please

City/State/Zip \_\_\_\_\_

PA residents add 6% sales tax

Quantity	Cases	Binders
One	\$ 7.95	\$ 9.95
Three	\$21.95	\$27.95
Six	\$39.95	\$52.95

Add \$1 per case/binder postage and handling. Outside USA \$2.50 per case/binder. (U.S. funds only.)

**SATISFACTION GUARANTEED**

next issue the idea of data will be added to the microprocessor or computer input.)

The complete mnemonic, as shown in Figure 2, is delivered to the assembler where it is converted to machine language. The machine language goes to the microprocessor in a computer, or, directly to a microprocessor in some applications, then the instructions are carried out.

## Compilers

Assembly language is certainly easier than using hexadecimal codes, and hexadecimal codes are easier to use than machine language. However, there is a step up from assembly language that makes the job of programming easier yet. A *compiler* can be used to convert a higher language into a lower form. Examples of these higher languages are BASIC, FORTRAN, COBOL, and C.

Also, the compiler takes care of a lot of little nuisance jobs like deciding where to put information in memory. However, there is a trade-off that must be considered. The higher the level of the language the more complicated the system must be in order to use it.

My evaluation board is very simple but I cannot use BASIC or any other high-level language to program it. I have a computer that has a compiler. It can understand a BASIC program but it is very much more complicated than the microprocessor board.

There is another tradeoff that is often mentioned when comparing systems. With my evaluation board I can load a program in memory with machine language. Then, I tell the microprocessor to run that program. It is about as fast as a program can be executed. If I enter a program in a computer using FORTRAN it has to go through a number of steps before it gets to the microprocessor.

Assuming the same clock speed in the two systems, and the same job being done, it could take the FORTRAN program as much as a few microseconds longer to get to the microprocessor.

However, if I'm in that much of a hurry I can just start sooner. So far, what we have accomplished is to define a few terms. In the next issue I will put those terms to use as we follow a program from the programmer's head, through a computer, and into a microprocessor.

# Tape trouble sensors

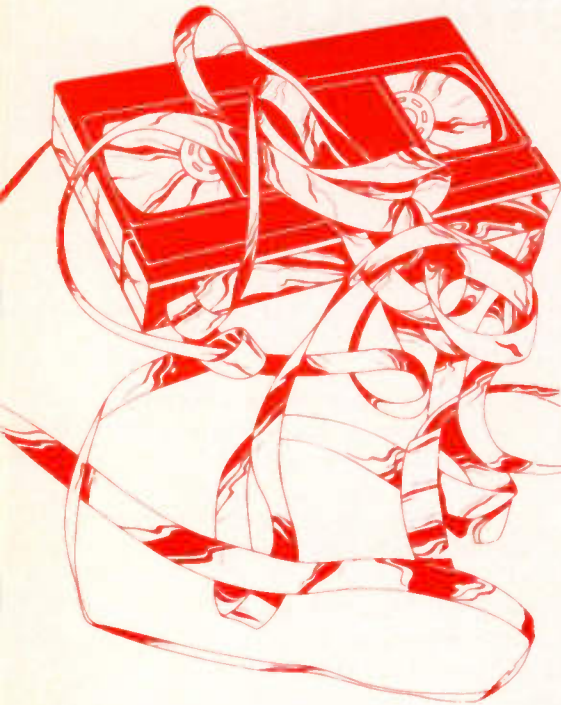

By the ES&T Staff.

*This description of tape trouble sensors is based on the technical information manual for the Hitachi VT-F440A, F445A Series of VCRs.*

The system microprocessor is responsible for monitoring a number of tape and trouble sensors located in the mechanism to protect the tape and mechanism against malfunctions. There are six sensors: the safety tab switch, the takeup reel sensor, the supply reel sensor, tape end sensors, the cylinder lock sensor, capstan lock sensor and power lock sensor.

Each of these sensors has the purpose of sensing conditions that could cause damage to the tape or the VCR mechanism. If such a condition is sensed the microprocessor will shut down the system before any damage is caused. Any time the VCR fails to operate, one of these sensors might be the cause.

### The safety tab switch

This switch detects whether or not the erasure prevention tab of the cassette is present. When the tab is removed, the safety tab switch provides a signal to the system control microprocessor that inhibits the record function: when you press Re-

cord and Play at the same time, the VCR plays the tape. In some VCRs, if a tape with the safety tab that has been removed is inserted and you try to set the VCR up to record later, nothing happens when you press the Timer switch. In some other VCRs, when you press the Timer switch, the cassette ejects.

### The Reel sensor

The reel sensors detect the speed of the takeup and supply reel disks. In one scheme, a 16-pole magnetized plate is located under the takeup and supply reels. The sensors generate 8 pulses per revolution. The system control microprocessor receives the pulses at the designated pins. When the microprocessor doesn't receive any reel sensor pulses for a predetermined amount of time in play, fast forward, rewind or search, the VCR is placed into the Stop mode.

In some VCRs, the signal from the supply reel sensor and the take up reel sensor are used to calculate the tape remaining time.

### End sensors

The end sensors detect whether or not the end of the tape has been reached. One end sensor is located at the supply side of the cassette and one is located at the takeup side of the cassette. The system microprocessor receives both end sensor outputs. When the portion of the tape with magnetic material on it is in the tape path, the infrared light to both the takeup and the supply end sensors is blocked. When the light is blocked, both end sensors are turned off and the appropriate signal is sent to the system control microprocessor.

When the transparent leader at the beginning of the tape is in the tape path, the supply end sensor is energized, which sends an appropriate signal to the system control microprocessor. This tells the microprocessor that the tape is fully wound on the supply reel and it turns the VCR off.

When the transparent leader at the end of the tape is in the tape path, the takeup end sensor is energized by the infrared light from the LED, and sends a signal to the system control microprocessor that the tape is fully wound on the takeup reel. This sends a signal to the system microprocessor which causes it to first stop the play mechanism, and then to rewind the tape.

If both end sensors are illuminated by the LED at the same time, this tells the system control microprocessor that there is no cassette in the VCR which inhibits all mechanical functions.

### Cylinder lock motor

The cylinder lock motor detects whether or not the cylinder motor is rotating correctly during play or record. This sensor, which is part of the system control microprocessor, receives the 30Hz signal from the head cylinder and monitors the frequency. If the frequency drops below a predetermined value, it informs the system control microprocessor that the cylinder motor is defective, unloads the mechanism to protect the tape and turns off the power.

### Capstan lock sensor

The capstan lock sensor detects whether or not slack tape is rewound during tape unloading. The capstan motor lock sensor is part of the system control microprocessor and receives the capstan FG pulse and monitors its frequency. If the frequency is less than a specified value, this informs the system control microprocessor that the capstan motor is not rewinding the slack, stops unloading, and turns off the power.

### Power lock sensor

This sensor detects if power came up correctly or if there is some kind of abnormal load on the power supply. If it detects a problem, it will turn off the power.

# Test your electronics knowledge

By Sam Wilson

1. Which of the following tolerances is not readily available in large quantities of new carbon-composition resistors?

- A. 5%
- B. 10%
- C. 20%
- D. [None of these choices is correct.]

2. A set of rules having a fixed number of steps, and used for solving a problem, is called a/an \_\_\_\_\_.

3. Instead of using a standard off-the-shelf microprocessor, you can

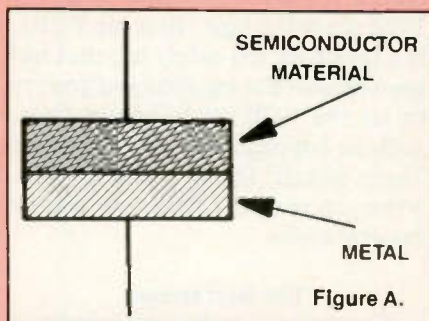

make one out of individual integrated circuits. This is called

- A. bit slicing
- B. bead ledging
- C. microphone
- D. assembling

4. The ratio of width to height for a television picture is called the \_\_\_\_\_.

5. Which type of device lets you select the intrinsic standoff ratio by using a resistive voltage divider?

6. Figure A shows the construction for one kind of diode called a

- A. step-recovery diode
- B. cermet diode
- C. hot carrier diode
- D. diac

7. When the junction of two dissimilar metals is heated a voltage is generated across the junction. This is an example of the

- A. Hall effect
- B. Seebeck effect
- C. Thompson effect
- D. Peltier effect

8. If you want to locate the BFO in a communications receiver you should expect it to be connected to the

- A. if section
- B. tuner
- C. audio voltage amplifier
- D. audio power amplifier

9. Is the following a true statement? "The carrier of a single-sideband, suppressed-carrier signal can be re-inserted in a modern communications receiver by using the BFO."

- A. It is a true statement
- B. It is not a true statement

10. Differential amplifiers - like the ones used at the input of an operational amplifier - should NOT respond to identical signals delivered to both terminals at the same time. A measure of how well this is accomplished is called the \_\_\_\_\_.

Wilson is the electronics theory consultant for ES&T.

## Tick. Tick. Tick.

That familiar adage, time is money, means just that at CIE. CIE makes it possible for students who can study at an accelerated pace to realize significant savings off the cost of an Associate Degree in Electronics. CIE places a restriction only on the maximum time you are allowed to successfully complete your studies in our A.A.S. program (8 six-month terms). If you



complete the entire program in two terms, three terms...or seven terms you'll only be charged for those terms... no additional charges for books, lab equipment, or lesson programs.

At CIE, the world leader in electronics home-study, you'll learn from the best and you'll learn at your own pace in your own home at a very affordable price (even more affordable at an accelerated pace). No income interruptions, no conflicting class schedules, no traffic, no hassles, just the academic curriculum to prepare you for a richly rewarding career in electronics.

Yes! Send me CIE's Free School Catalog. AES47

Name \_\_\_\_\_

Address \_\_\_\_\_

City \_\_\_\_\_ State \_\_\_\_\_ Zip \_\_\_\_\_

Phone (\_\_\_\_\_) \_\_\_\_\_

Check box for G.I. Bulletin on Educational Benefits:

Veteran  Active Duty

Mail to:



**CLEVELAND  
INSTITUTE OF  
ELECTRONICS**  
1776 East 17th Street  
Cleveland, Ohio 44114  
(216) 781-9400

ES&T periodically publishes reviews on books that are particularly applicable to our readers. We do not have any information other than that supplied below each review. Contact the publishing company for further ordering or pricing details.

**Modern Spectrum Analyzer Theory and Applications, by Morris Engelson, 255 pages, JMS Books, \$62.00.**

The spectrum analyzer has a well deserved reputation as one of the most difficult to use and understand instruments. For years users have turned for help to Modern Spectrum Analyzer Theory and Applications. Now this reference volume has been reissued by JMS along with a brand new companion to bring the user up to date on the latest techniques and procedures. The book is a thorough treatment on theory and basic application of the spectrum analyzer. A companion Modern Spectrum Analyzer Measurements, 218 pages provides information on the latest measurement practice.

Both volumes are immediately available prepaid at \$62 (US) per book including shipping and handling costs. The price for both books ordered as a pair is \$110, prepaid. US users can order books via a company purchase order to be billed at a billing charge of \$5 for the first book and \$3 for each additional book. Books can be ordered for air shipment outside the US by prepayment in US dollars of \$10 for the first book and \$7 for each additional book.

JMS, P.O. Box 25170, Portland, OR 97225. Fax (503) 292-0449, or call (503) 292-7035.

**Surface-Mount Devices Troubleshooting and Repair, by David L. Heiserman Prentice Hall Books, 192 pages.**

Designed specifically for technicians who are already skilled in basic electronic principles and devices, this manual differentiates between surface-mount (SM) technology and conventional feed-through technology. Heiserman devotes a substantial portion of this work to the major

types of SM devices, helping readers understand how to identify components and their terminals. Nearly every chapter contains soldering and desoldering techniques, and a discussion of the latest in specialized soldering tools is featured. The book discusses getting acquainted with SM technology, SM packages SM mounting media and methods, SM troubleshooting techniques, replacing SM devices. It also goes into discrete SM semiconductors, and working with SM integrated circuits.

Prentice Hall Books, Englewood Cliffs, NJ 07632

**Lenk's Audio Handbook: Operation and Troubleshooting, by John D. Lenk; McGraw-Hill Books; 304 pages; illustrated; 6" x 9"; \$39.95.**

In this book John D. Lenk presents practical advice and information on everything from the basics of the subject through experimentation and simplified design to testing and the troubleshooting procedures involved. With step-by-step and circuit directions for audio technicians, field-service engineers, and serious audiophiles, this reference provides

sufficient information for the user to design and build audio circuits from scratch. No previous design experience is required to apply the design data and techniques given. Detailed coverage is given to such products as CD players, AM/FM tuners, turntables, graphic equalizers, tape cassettes, surround sound systems, laser-optic devices, and the audio components of camcorders, stereo-TVs, and VCRs.

For each product, Lenk offers essential material in easy-to-understand, nontechnical language. He gives a complete description of each device (including the specifications); reports on the operating procedures, controls, and indicators; explains troubleshooting and adjustment procedures (based on manufacturer recommendations); and provides circuit diagrams that indicate the key information needed: input/output, adjustment and test points, signal paths, and power connections. Readers may order this book from McGraw-Hill by calling 1-800-2-MCGRAW.

McGraw-Hill Publishing Company, 11 West 19th Street, New York, NY 10011; (212) 337-5945 or 337-5951.

## Photofact

### FISHER

2806-1.....PC-9327  
2808-1..PC-9120 (CH. G2E-91200)

### PANASONIC

2803-1...CTM-2782S, CTM-2783S  
(CH. AEDP192/GL7S-1)

### SANYO

2803-2.AVM274 (CH. A5V-27400)

### SEARS

2809-1.....564.48893950

### SHARP

2804-1.....25RC119, 25RC169,  
25RC179  
2806-2.....27RC480(BK),  
27RC480 (W)

### SONY

28005-2.....KV-27EXR10,  
KV-27EXR15 (CH. SCC-D50B-A,  
SCC-D50C-A)  
2807-1.....KV-20EXR10  
(CH. SCC-D50A-A)

### ZENITH

2804-2....SF2705H2, SF2705H52,  
SF2709TR2, SF2709TR52,  
SF5735H2, SF5735H52,  
SF5755H2, SF5755H52  
2805-2.....SF27W2, SF5227W2,  
SF5227Y2, SF5237W2  
2807-2....SF2721H2, SF2721H52,  
SF2725R2, SF2725R2, SF2725TR2,  
SF2725&R52, SF2727H2,  
SF2727H52, SF3181H

## Component/HDTV waveform monitor

*Leader Instruments* introduces a new component/waveform monitor, model 5100. Designed to provide convenient, precise video system instruments for 525/60 and 625/50



component, NTSC and PAL composite and HDTV (1125/60) signals, the unit features four-channel output (three to RGB from Y, R-Y, B-Y for 525/60 systems). The model 5100 provides full raster line select for 525/60 625/60 and 1125/60 signals. Cursor operation aids in level measurements and in presetting measured parameters to specified values.

Circle (54) on Reply Card

## Repairable oscilloscope probe with X1-X10 attenuation

*Test Probes* has introduced a 250MHz repairable oscilloscope probe with X1 and X10 switchable attenuation factors in one probe. Modular construction of the probe makes



replacement of a failed tip, ground lead, probe head, cable or BNC box easy. The features include compensation for high and low frequency to optimize pulse response and 10-60pF compensation range allows use with any scope with a 1 MΩ input resistance, a 1.4 nanosecond risetime and a 250MHz bandwidth for the 10MHz bandwidth for the X10 mode.

Circle (55) on Reply Card

## Oscilloscope on pc plug-in card

*Odem* has announced the latest addition to their line of high performance, PC based test instruments,

the ScopeBoard model 40. The instrument implements the functions of a dual-trace, 40MS/s storage oscilloscope on a 3/4 length plug-in card for IBM XT/AT/386s and compatibles. The board features dual, 8 bit flash converters sampling at up to 40Ms/s.

Circle (55) on Reply Card

## Video port expander

*Network Technologies* has developed the VOPEX-2AVMM-L video port expander, which now enables users to access a single IBM compatible PC/XT/AT from two different keyboards with monitors and mice

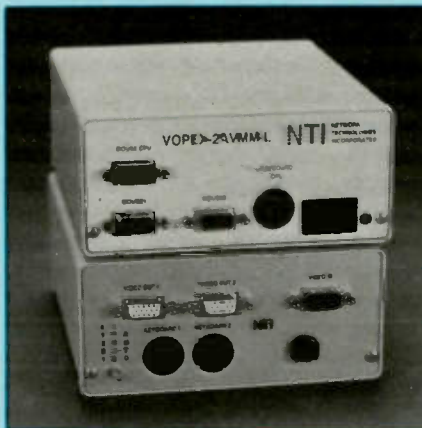

up to 500 feet away from the computer. The unit allows the same image to appear on both VGA monitors with instantaneous and automatic access from either keyboard and mouse location. This enables two users to share the same computer. It also provides access for one user from different locations.

Circle (57) on Reply Card

## Pen-type digital multimeter

*Beckman Industrial* has added the DM73 to its line of digital multimeters. The DM73 is a hand held, pen-type meter that features a 3-1/2 digit display with 0.5% accuracy (DC 2V



range) and auto-ranging. It fits easily into a shirt pocket. The DM73's compact size, lightweight design and slide switch (to change functions) make the unit suited for troubleshooting or installing electronics in tight places. The DM73 has full auto-ranging capability on 12 measurement ranges. DC voltages up to 500V, ac voltages to 250V, and resistance up to 2MΩ are measured using an accurate dual-slope integrating analog-to-digital conversion technique.

Circle (58) on Reply Card

## Soldering iron with 3/8" diameter tip

*M.M. Newman* announces a new, extra heavy-duty 60 watt soldering iron featuring a large tip that heats up to 104°F in 45 seconds and recovers quickly for big industrial and



electrical jobs. It features a 3/8" diameter chisel tip that provides the thermal inertia required for soldering larger components. Lighter and easier to handle than conventional 50 watt irons, the soldering iron is 5" long and has a 6ft. cord.

Circle (59) on Reply Card

## Surge suppressors

*Sutton Designs* has introduced the new ZX-5000 (PSC) positive shutdown circuit surge suppressor series, consisting of 16 new surge suppressor models.

The new suppressors are equipped with Sutton Designs failsafe "Positive Shutdown Circuit" which monitors the suppressor circuit for component failures and automatically stops all current flow to plugged-in equip-





ment if a suppressor component fails. They offer 600 to 840 joule protection and exceed both the IEEE category A and category B specifications. The units have a dynamic response time of less than 5 picoseconds and provide EMI/RFI noise filtration of up to -60 db in the 5 kHz to 100 MHz frequency range.

Circle (46) on Reply Card

#### Sweep generator

New from *Production Devices* is a 125B sweep generator which provides low distortion sine waves at fixed, variable or swept audio frequencies. The standard sine wave



output may be converted to a square or triangle wave by changing one internal wire. Instructions are included to re-adjust or change the fixed frequencies. It has five fixed frequencies at 20Hz, 1KHz, 3KHz, 10KHz, 20KHz.

Circle (49) on Reply Card

**Monoscope/TV pattern generator**  
*Leader Instruments Corp.* has unveiled a new Monoscope/TV pattern generator for checking high resolution television sets at the Wescon '90 electronics show today. Designed for testing the increasingly popular higher resolution, large screen television sets, the Model 435B generates monoscope patterns with a resolution of 1,000 lines, color bars, crosshatch, pulse and bar and character patterns. The high level performance of the Model 435B makes it an ideal test sig-



nal source for obtaining high quality video on both television sets and VCRs.

Circle (50) on Reply Card

#### Dual soldering station

*Pace Inc.* has introduced its new ST-50 dual soldering station. The ST-50 features PACE's new IR-70 High capacity iron which provides consistent, rapid production soldering at safe, lower tip temperatures. The ST-50 can be



upgraded to suit virtually any SMT, thru-hole or mixed technology application. The optional ThermoTweez handpiece provides rapid, one-handed removal of PLCC's and other components without damage to the board or adjacent components. The "V-TP" package adds safe, one-handed reflow and removal of flatpacks and PQFP's featuring PACE's new ThermoPik handpiece.

Circle (51) on Reply Card

#### 2 MHz sweep/function generator

*B&K Precision* announces their new model 3022 sweep/function generator with five digit frequency counter which provides a full range



of lab and service capabilities. These include sine, triangle, square wave ramp, and TTL and CMOS pulse signal outputs. All have variable duty cycle. Operating modes include sweep, AM, FM and voltage controlled generator. The 3022 covers from 0.02 Hz to 2 MHz in seven ranges. Special features include internal or external sweep capability, with continuously adjustable sweep width to a maximum 1,000:1 ratio.

Circle (52) on Reply Card

#### Source directory on disk

*IC Master* has introduced the Alternate Source Directory section of the 1990 IC Master catalog on disk for IBM XT, AT and 100% compatible personal computers with hard drives. The version 3.1 contains all the listings that appear in the Alternate Source Directory section in volume One of the printed version of the 1990 IC Master. ICMASD has been completely updated to be the most comprehensive and reliable guide available to all integrated circuits known to have a realistic replacement or alternative. The new version contains over 155,000 listings covering both current and discontinued parts.

Circle (53) on Reply Card

#### Computer assisted instructional language

*Texasoft* has released version 2.00 of its popular computer assisted instructional language named PC-CAI. This language is designed to allow instructors to create computer

driven tutorials, tests or demonstrations. It includes a menu-driven authoring program called CREATE, which allows the creation of PC-CAI programs without having to write computer language code. PC-CAI version 2.00 offers new enhancements such as support for PCX type graphics, an easier menuing command, more graphics drawing commands, and enhanced grading capabilities.

Circle (40) on Reply Card

### Ultra-Slim shears

Cooper Tools introduces Ultra-slim, flush cut shears with special grips for protection against electrostatic discharge (ESD). This feature helps to avoid damage to sensitive electronic components. The five-inch shears have an improved handle design that provides shear cutting action with less effort while reducing user fatigue.

Circle (41) on Reply Card

### Wipers for field service operations

Tech spray announces TechClean Wiper (1075), a field service product for the electronics industry. Non-woven and non-abrasive, these are



lint free, static free, non-allergenic, and highly absorbent, and resistant to mildew, rot and solvents.

Circle (42) on Reply Card

### Mini-kit for PC support

The JTK-50 PC mini-kit new from Jensen Tools is designed for the maintenance and care of personal computers of all types. The all-fixed handle tools in this kit were selected to facilitate ordinary tasks like the removal and installation of PC boards and memory chips, system upgrading, attaching of peripherals, and RS-232 connector repair. Included are pliers, screwdrivers and nutdriv-

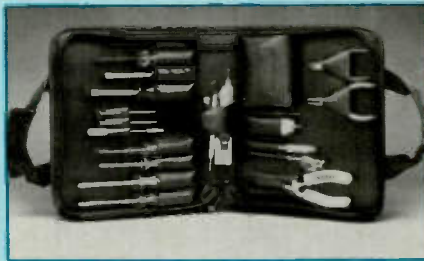

ers, a wire crimper/stripper, 4" compudriver, RS-232 insertion/extraction tool, DIP inserter, DIP extractor, inspection mirror, penlight, and adjustable 4" wrench. These tools are held securely in a compact (11.5" x 10" x 2.5") Cordura-Plus zipper case. The case features two roomy outside pockets and is available alone.

Circle (43) on Reply Card

### Line conditioner

The Tripp Lite LC-1200 line conditioner provides excellent voltage regulation and power line conditioning for operating computers, cash regis-

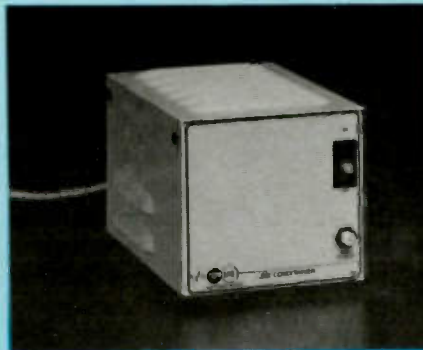

ters, audio equipment and other sensitive electronic equipment. It provides up to 1200 watts of power for four ISOBAR spike protected AC output receptacles. Two isolated filter banks provide maximum equipment protection. The LC-1200 are voltage regulators that correct damaging brownout (low voltage) conditions, while also guarding against voltage surges. Voltage regulation complies with ANSI C84.1 specifications. Complete spike, line noise and RFI/EMI filtering is built-in, so external surge suppression is unnecessary.

Circle (44) on Reply Card

### Digital megohmmeter

Amprobe Instruments introduces the model AMB-4D battery operated digital megohmmeter. This newest



edition offers the ability to automatically perform dielectric absorption ratios. This ratio is the most common method used to test insulation in a plant or on equipment to prevent possible equipment damage or fatal shock. Other features include a response time of less than 5 seconds, low battery indication manual or automatic operation and audible and visual indication in the auto mode.

Circle (45) on Reply Card

### Triple power supply

Global Specialties announces the new 1310, an economical, bench style triple power supply. The 1310 has three independent outputs, a +5VDC 1 amp and two variable 1.3-20VDC 250mA each. It features series and

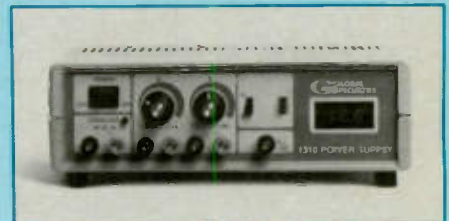

parallel operation and digital current and voltage metering. Display accuracy  $\pm 0.5\%$ ,  $\pm 1$  digit with a 3 digit,  $3\frac{1}{2}$  inch LED display.

Circle (46) on Reply Card

### Variable power supply

Emco Electronics is pleased to announce the introduction of its new 30V 5A variable power supply (the PSV-5). This unit features dual panel meters, coarse and fine voltage adjustment, and a hi-lo current switch with min-max control. The PSV-5 is overload and short circuit protected.

Circle (47) on Reply Card

# World's fastest high-capacity memory chip

IBM scientists have announced they have built the world's fastest high-capacity memory chip. The experimental chip can send or receive eight billion bits of information per second, the fastest "data rate" of any chip yet reported. The development promises to maximize the speed of future high-performance workstations, supercomputers and mainframe computers.

The IBM researchers made their

announcement at the International Solid-State Circuits Conference. The record breaking chip is a Static Random Access Memory (SRAM) chip that holds 512K (524,288) bits of information.

The chip, which the scientists code-named "lightning" because of its speed, can "read" individual bits of information - a measure known as "cycle time" - in just 2 billionths of a second. The lightning chip holds the

world speed records for both cycle and access time for memory chips with more than 64K (65, 536) bits of information storage.

In an actual computer, SRAM chips make data immediately available for processing. The high speed of the new SRAM is the result of innovative circuit design and to a patented "pipelining" process, which allows the chip to overlap read and write operations rather than perform them one-by-one. The application of pipelining allows the new lightning SRAM to process information twice as fast as would otherwise be possible.

The new lightning SRAM uses complementary metal oxide semiconductor (CMOS) technology, the most widely used method of chip fabrication. The new chip brings great speed improvement to CMOS technology, already attractive because of its low power requirements and low cost. Typical circuit elements average 0.8 microns (32 millionths of an inch) in size.

In the past, silicon SRAM chips in large computers have often been made using "bipolar" technology, which has been faster than CMOS technology but is more expensive, uses much more power, and is limited in capacity. The new lightning chip is the fastest SRAM of any technology, for chips of greater than 64K bits memory capacity.

The research team also found a way to make their CMOS memory chips communicate with high-speed bipolar logic chips, which operate with a different voltage. These developments effectively moved the lower-power and less expensive CMOS technology into the mainframe arena.

Indeed, IBM's new System/390 line of mainframe computers, introduced last year, contains CMOS SRAM chips that are the predecessors to the experimental lightning chip and were developed by the same research team, working with designers at the company's Burlington, VT, facility. ■

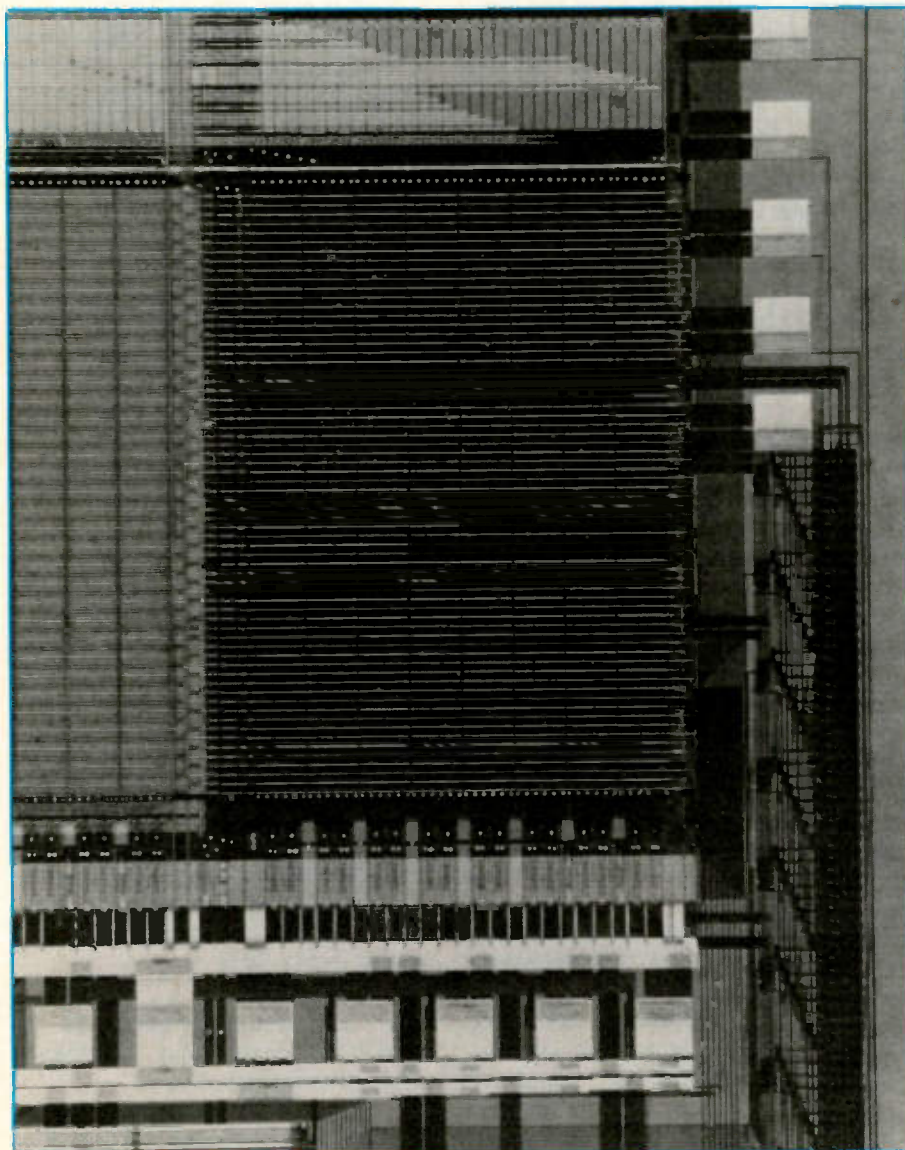

Figure 1. IBM's high-capacity memory chip.

# A little extra

By Glenn R. Patsch

When you service a personal computer consider doing a little something extra for your customers.

## Cleanup

Clean the keyboard and monitor screen for the PC. You might be surprised how much a customer appreciates this. Clean monitor screens are easier to read and reduce eyestrain which causes headaches. Clean keyboards are more pleasant to use. Dirt gets between the keys and inside the keyboard causing problems.

## Static

When you clean the monitor screen using a regular cleaner, static

often results. The static causes additional airborne dust to be drawn to the screen. Staticide wipes and sprays work very well. This controls static on the screen for one to two weeks depending on conditions where the screen is located.

## Dust covers

Recommend that dust covers for keyboards and monitors be used to keep dust away when the equipment is not in use. I prefer the fabric dust covers made by Inland. These are anti-static, neutral gray color and are made from 50/50 cotton/polyester material. They look great and work well. In addition to custom fitted sizes for specific equipment they make universal sizes in small, medium and large for keyboards and monitors. I use the universal sizes since

they fit virtually everything and eliminate having to keep a large inventory.

## Surge suppressors

Surge suppressor power strips protect the PC and peripherals and make it more convenient for the customer. The power strip uses a single switch to turn everything on and off. This prevents a printer or monitor from being left on all weekend. I strongly recommend every PC have a power strip with surge suppression.

## A little extra

A little extra care will reward you with happy customers, repeat business and good word of mouth advertising. It is much easier to keep existing customers than find new ones. Next time you have your car serviced wouldn't you be pleased if they washed it too! ■

Patsch is a consultant specializing in the selection, evaluation, and installation of IBM personal computer and compatible hardware and software.



**SAVE  
TIME**

*For fast, accurate service, please remove the peel off label used to address your magazine, and attach it to the Reader Service Card, the Address Change Card or to any correspondence you send us regarding your subscription.*

## Test your electronics knowledge

### Answers to the quiz

1. C - 20% resistors are not being manufactured by most companies. However, there are still a lot of them around.
2. an algorithm - Algorithms are also used for making computer programming steps.
3. A - An advantage of bit slicing is high speed. However, they are more difficult to use because they do not have built-in programs. Some manufacturers supply integrated circuits that combine some of the "slices" in a bit slice. In my microprocessor book (published by Tab) I show how a microprocessor can be put together as a bit slice.
4. aspect ratio - For TV and many computer monitors the aspect ratio is 4/3.
5. A programmable unijunction transistor [PUT] - It is used for the same purposes as a UJT, but, the intrinsic standoff ratio of a UJT is set by the manufacturer.
6. C - There is no internal junction voltage in a hot-carrier diode, so, it is not necessary to supply a given amount of forward bias before it starts to conduct. That makes it ideal for use as a diode detector.
7. B - This is the principle of operation for a thermocouple.
8. A - It generates a signal frequency that can be used for carrier re-insertion. The BFO frequency is tunable in today's receivers.
9. A - The frequency generated by the BFO is tunable, and, it is highly stable in today's receivers.
10. CMRR - [Common - Mode Rejection Ratio] - It is usually expressed in dB. ■

Classified advertising is available by the word or per column inch. By-the-word: \$1.85 per word, per insertion. Initials and abbreviations count as full words. Blind ads (replies sent to ES&T for forwarding) are \$40 additional. Minimum charge: \$35 per insertion.

Per Column Inch (Classified Display): \$235 per column inch, per insertion, with frequency discounts available. 1" minimum, billed at 1/4" increments after that 10" maximum per ad. Blind ads are \$40 addition. Reader Service Number \$25 additional to cover processing and handling costs. (Free to 4-inch or larger ads.)

Optional color (determined by magazine) \$150 additional per insertion. No agency discounts are allowed for classified advertising.

Contact Emily Kreutz, 516-881-2922, for information on frequency and pre-payment discounts, or to place your classified ad. Or send your order and materials to Emily Kreutz, Electronic Servicing & Technology, 78 North Broadway, Hicksville, NY 11801.

## FOR SALE

**REDUCED 85%**, Diehl Mark 111 scanner \$79. Diehl Mark V scanner \$199. New. Restore remote control keypads with our conductive coating \$8.99 ppd. WEEC, 2805 University Ave., Madison, WI 53705. 608-238-4629. 608-233-9741. 6-90-1fn

**TV TOUGH DOGS:** 300 symptoms and cures. Send \$10.95 to DAVIS TV, 11772 Old Fashion Way, Garden Grove, CA 92640. 10-87-1fn

**VHS-VCR REPAIR SOLUTIONS SETS I,II,III,IV,V,VI.** Each contains 150 symptoms and cures, updated cross reference chart, free assistance, \$11.95 each all six \$59.95. Eagle Electronics, 52053 Locks Lane, Granger, IN 46530. 12-89-1fn

**COMPUTER AIDED TV/VCR REPAIR:** 3,500 solutions, 37 manufacturers. Printout or IBM compatible. Hard drive, 5 1/4 disk. Time saver. Quick scan by model, chassis, and stage. Send \$90 to Electronics Solutions 407 W. Ave "N", San Angelo, TX, 76903. 1-91-8t

**PHOTOFACTS:** Folders under #1400, \$5.00. Above #1400, \$7.00, sent same day first class postpaid. Allen Loeb, 414 Chestnut Lane, East Meadow, NY 11554. 516-481-4380 4-91-3t

**SENCORE TEST EQUIPMENT FOR SALE:** SC-61 \$2,000, VA-62 \$2,000, CR-70 \$700, LC-75 \$500, PF-57 \$300, TF-46 \$300, OR BEST OFFERS. CALL BILL AT 907-246-3403/3390 OR FAX: 907-246-1115. 5-91-1t

**LARGEST SELECTION OF ORIGINAL TV & VCR IC'S AND TRANSISTORS: WRITE FOR CATALOG. PRELCO, PO BOX 894, UNION, NJ 07083, 908-851-8600. 5-91-1t**

**FOR SALE:** Regulator rebuild kit for Sylvania, Magnavox and Philco. For chassis series 19C8, 20C8, 25C8, 26C8. Having problems with regulator problems in those chassis this kit is for you. Make it an easy repair. Only \$2,700. Sibley TV, 531 Wentworth Avenue, Calumet City, IL 60409. 708-891-5550. 5-91-1t

**ATTENTION VCR SERVICE CENTERS:** 1000 VCR symptoms/cures from experience and manufacturers publications. Computer printout \$90. Guaranteed satisfaction. VCR Tuneup Center, 43 James Avenue, Redwood City, CA 94063 or call 1-800-777-7883. Mastercard and Visa accepted. 4-91-1f

**TELEVISION AND MONITOR TROUBLESHOOTING:** 350 symptoms and cures, nothing old listed, \$13.00 refundable. Jones Enterprises, P.O. Box 702, Niceville, FL 32578 2-91-1fn

**SAMS SALES:** 0-1800 \$1.00 each plus mailing. Call 516-286-4185. 4-91-2t

**REPAIR MANAGEMENT SOFTWARE:** for IBM PC's Repair Tracking, Inventory, Reports, Billing, Maillist, More. Demo Disk \$10. CAHILL ELECTRONICS, PO Box 568, Kingston, NH 03848. 603-642-4292. 4-91-3t

**TURNKEY: Electronic Service/Repair Business Located in Grants Pass, Oregon, You Can Own The Most Recommended Shop In Souther Oregon For VCR, TV, Camcorder, Etc., Repair. Contact Leral Darden At 503-474-4357 5-91-1t**

## BUSINESS OPPORTUNITIES

**VCR REPAIR:** Learn the mechanics of VCR which account for 80% of all VCR malfunctions. Video and four part manual. Send \$89.95 to ETL Video, PO Box 1711, Ft. Valley, GA 31030 or call 912-825-1736 for VISA and Mastercard. 4-91-2t

**SATELLITE TV SALES & SERVICE VCR/TV SERVICE:** Fully equipped shop includes 3 employees, 1990 truck, great test equipment, extensive technical library. In beautiful Northern California. Owner will stay for transition period. \$100,000. 1540 Gamay Place, Ukiah, CA 95482. (707) 462-8082 1-91-2t

**LARGE AUDIO/VIDEO SERVICE BUSINESS:** In sunny S.W. city. Established 20 yrs. Well equipped. Price and terms negotiable. (602) 298-8827, Eves. 8-89-1fn

**SUCCESSFUL, SMALL, ELECTRONIC AND APPLIANCE SERVICE BUSINESS:** Southern Montana, good cash flow, low overhead, many warranties and large service area. Terms, \$30,000. 406-446-2702 eves. 5-91-1t

**ARIZONA, ESTABLISHED TV/VCR REPAIR BUSINESS:** Good reputation, 2 locations, service van. Sencore equipment, negotiable terms, evenings. 602-293-8058. 4-91-1t

**I MAKE \$75.00 AN HOUR DOING SIMPLE VCR REPAIRS:** that anyone can do. Free information tells all. Jim's Video Service, 6428 O'Donnell St., Baltimore, MD 21224. 301-633-6049.

**SOUTHERN CALIFORNIA TV/VCR SALES & SERVICE** Same location for forty years. Fully equipped shop and truck. Good lease. \$25,000. Bob, C-21 818-895-1400 5-91-1t

## MISCELLANEOUS

**LOTTERY NUMBERS:** With a built in 100% guarantee! Hit the lottery on purpose! Catalog of 80 IBM/Comp. programs \$5. Sigma Box 24759 Dept: 02 Baltimore, MD 21220. 11-90-12t

## WANTED

**OLD ANTIQUE RADIOS AND TV'S:** Pre 1950. Any condition will repair some. Old tubes wanted. Thrifty TV, 16 E. Marie Hicksville, NY 11801, 516-822-4501. 12-91-1fn

**ELECTRICAL ENGINEER: (MRI/CT Engineer) - Jobsite:** Latham, NY: Utilizing knowledge of electrical engineering, image processing, digital & analog circuits, radio frequencies, magnetic fields, X/R systems & cryogenic equipment, evaluate type of repair or service required on Elscint MRI & CT diagnostic imaging equipment. On-site repair & after sales service of (CT) & (MRI) imaging equipment including repair of subunits, electronic boards & units like Digital computers, CDC drives & magtape, Matrix Images, DEL HV & Leybold cryocooling systems. Perform testing & alignment to insure proper function of equipment. Maintain CT-MRI spare parts. 40 hrs/wk; \$46,000/yr. Bachelors in Electrical Engineering + 4 years exp in the job is reqd. Apply by resume in duplicate to: NYS Dept of Labor, 100 Borad Street, Glen Falls, NY 12801. Attn: C. Hartman/J. Kelley. Refer to JO -NY0000465, DOT 003.061.010 5-91-1t

# Readers' Exchange

Reader's Exchange has been reinstated as a free service.

The following restrictions apply to Reader's Exchange:

- Only individual readers may use Reader's Exchange, and items must be restricted to those that are ordinarily associated with consumer electronics as a business or hobby. If you're in business to sell the item(s) you want to offer for sale, the appropriate place for your message is in a paid advertisement, not Reader's Exchange.
- Readers Exchange items must be restricted to no more than three items each for wanted and for sale, and may be no more than approximately four magazine column lines in length (about 20 words).

Send your Reader's Exchange submissions to:

**Reader's Exchange  
Electronic Servicing & Technology  
76 N. Broadway  
Hicksville, NY 11801**

## FOR SALE

Sound technology 1000A, 1000, 1700B \$1500. Tektronix 453 \$500, \$600. Call Jeff M-F, 8-6 at 203-529-3700

Sams photofacts sets #500 to #721. \$1.00 each or all 118 sets for \$85.00 plus shipping. John Brouzakis 247 Valley Circle Charleroi, PA 15022, 412-483-3072.

TV Servicing equipment. Just like new in mint condition. Sams photofacts 100-2543 complete new and used parts. Factory info, books etc \$7985.00 Call anytime. David Lehmann 1-417-924-3350.

NTSC generator B&K 1249 like new in box \$400 FM stereo generator leader LSG 231 \$250. Bob Cahill PO Box 568 Kingston, NH 03848.

Test jigs and adapters 2 - 10J106 Telematics, 1 - Zenith 800-880 and 1 - Sylvania CK-3000 plus many adapters. Call Jim at Sibley TV (708) 891-5550.

## WANTED

Sencore LC 102 Auto Z tester. Sencore TF46 transistor tester. William Buck RDI Box 1159, Bangor, PA 18013

Sam's photofact #2551 thru #2618. Jennings Hanson 735 Clematis Rd. Venice FL., 34293. 813-497-0108.

Power board VEPS-06110A1 for Panasonic VCR model PV-1530. Joseph Lag 941 Rice Rd. Elma, NY 14059, 716-652-9164.

Radio Retailing and Radio Today magazines from 1930's and 40's. Doug Heimstead 1349 Hillcrest Dr. Fridley, MN 55432. (612) 571-1387.

Owner's manual for (a) Banana PC model SLM 001A Serial No. 216928 with model K-260 Logitech color display serial no. 6700761 N, 110/220V, 50/60 Hz 59W, also printer model MS1000, 220V a.c. 50 Hz, 120W serial No. 40000063. Antonio Gigum Nasipit, Augusan Del Norte, 8602, Philippines.

## FASTER VCR REPAIR!

**TENTEL** Gauges are  
**UNIVERSAL**

and work on all brands and models of VHS recorders. Stop guessing about **TORQUES, TAPE TENSIONS, TAPE GUIDE HEIGHTS, ELEVATOR LATCHING, VIDEO HEAD WEAR & MORE.**

DO IT RIGHT THE FIRST TIME!

Call For A **FREE CATALOG**  
**(800) 538-6894 or (916) 939-4005**

Circle (17) on Reply Card

## TUBES • TUBES • TUBES

World's Largest Range

Over 2,000 Types, Domestic & Foreign

**UP TO 85% OFF** Ask for price list

International Components Corporation  
Toll Free 800-645-9154 • N.Y. State 516-293-1500  
105 Maxess Road, Melville, New York 11747

Circle (2) on Reply Card

Tech's Guide To Pricing

**NEW**

**"Sperry Tech's Pricing Guide"**

Updated new 6th edition... a framework for setting rates that apply to Hi-Tech products... a formula that guarantees SUCCESS!

Call Toll Free for details  
1-800-228-4338

Circle (16) on Reply Card

AC/DC VOLTAGE **PRO 400**

AC/DC CURRENT  
DIODE TEST  
LOGIC TEST  
LED TEST GOOD/BAD  
5 FREQ RANGES  
5 CAPACITANCE RANGES  
LOW BATTERY Warning  
CONTINUITY TEST/SUZZER  
TRANSISTOR CHECKER  
**20 MHZ FREQ COUNTER** VISA M/C

Stock No. 990092 **\$69.95**

**30 DAY MONEY BACK GUARANTEE!**

**KELVIN Electronics**

7 Fairchild Ave., Plainville, NY 11803  
(516) 349-7620 1(800) 645-9212  
FAX (516) 349-7830



Circle (21) on Reply Card

**WE'RE THE ONE**

... for all your quality Electronic Parts and Accessories.

*We'll get your parts to you as fast as you need them!"*

Call Toll Free today for your **FREE** copy of our catalog ...

**1-800-558-9572**  
In Wisconsin 1-800-242-9553  
or for 24 hour ordering call FAX 414-473-4727

*"First In Quality And Service"*

**PRIME ELECTRONICS CO.**

P.O. Box 28 • Whitewater, Wisconsin 53190

Circle (13) on Reply Card

## Advertisers' Index

Company	Page Number	Reader Service Number	Advertiser Hotline
Cleveland Institute of Electronics	52		216/781-9400
Consolidated Electronics, Inc.	60	22	800/543-3568
Electronics Book Club	3		
ISCET	24		817/921-9101
International Components Corporation	60	2	800/645-9154
Jensen Tools	15	3	602/968-6241
Kelvin Electronics	60	21	516/349-7620
Klein Tools	13	5	
Mitsubishi Electronics	IBC,41		
NESDA	13,43		817/921-9061
NTE Electronics	BC	75	800/631-1250
Nutronix	43	9	313/939-4710
Pace, Inc.	20	10	301/490-9860
Panavise Products	7	11	702/353-2900
Parts Express	49	12	513/222-0173
Prime Electronics	60	13	800/558-9572
Sencore, Inc.	IFC	84	800/SEN-CORE
Southgate Electronics	49	15	305/720-4497
Sperry Tech, Inc.	60	16	800/228-4338
Tentel	60	17	800/538-6894
3m	45	23	800/443-6975
Viejo Publications	24,41	19,20	800/537-0589

We'd like to see your company listed here too. Contact Jonathan C. Kummer, at 516-681-2922 or FAX 516-681-2926 to work out an advertising program tailored to suit your needs.

**CONSOLIDATED ELECTRONICS**

VOLUME I - TEST EQUIPMENT

CONSOLIDATED INDUSTRIAL ELECTRONICS 16TH EDITION

**CONSOLIDATED ELECTRONICS**

Get two of the most valuable electronic catalogs ever! These 2 catalogs contain over 16,000 hard to find electronic parts & equipment. VOL. I - features 112 pages of high quality test equipment. VOL. II - features 144 pages of electronic parts, tools & cross references. Send \$5 check or money order, or call today & use your VISA or MasterCard.

**1-800-543-3568**

**CONSOLIDATED ELECTRONICS**

VOLUME II - PARTS & ACCESSORIES

CONSOLIDATED INDUSTRIAL ELECTRONICS 16TH EDITION

CONSOLIDATED ELECTRONICS, INCORPORATED 705 WATERVLIET AVENUE DAYTON, OHIO 45420 2599  
FAX: 1-513-252-4066 / TEL: 1-513-252-5662 / TELEX: 288-229 / COMPU SERVE: 76057, 3347 / EASYLINK: 62850013

Circle (22) on Reply Card

# What You Need . . . When You Need It!

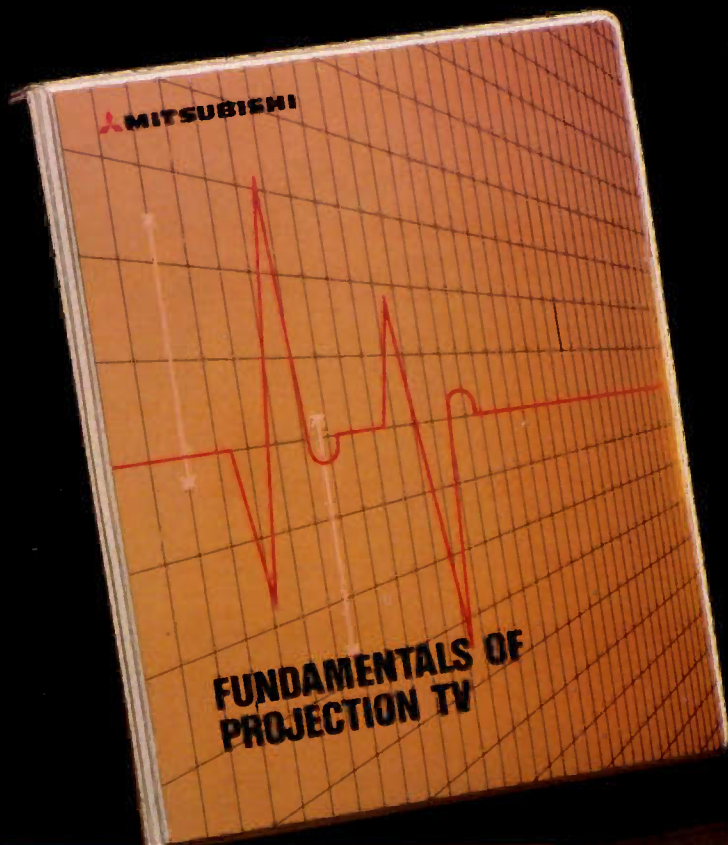

Ever been stuck in the middle of a repair, trying to remember that *one* lost detail or concept that would solve the problem for you?

A Technical Training Video from Mitsubishi could be just what you need!

Our "Fundamentals of Projection Television" contains:

- basics of light projection
- optics
- electronic and optical focusing
- light tube replacement

- as well as a *unique* method of convergence that saves time and effort.

Video training from Mitsubishi . . .  
What you need . . . When you need it!

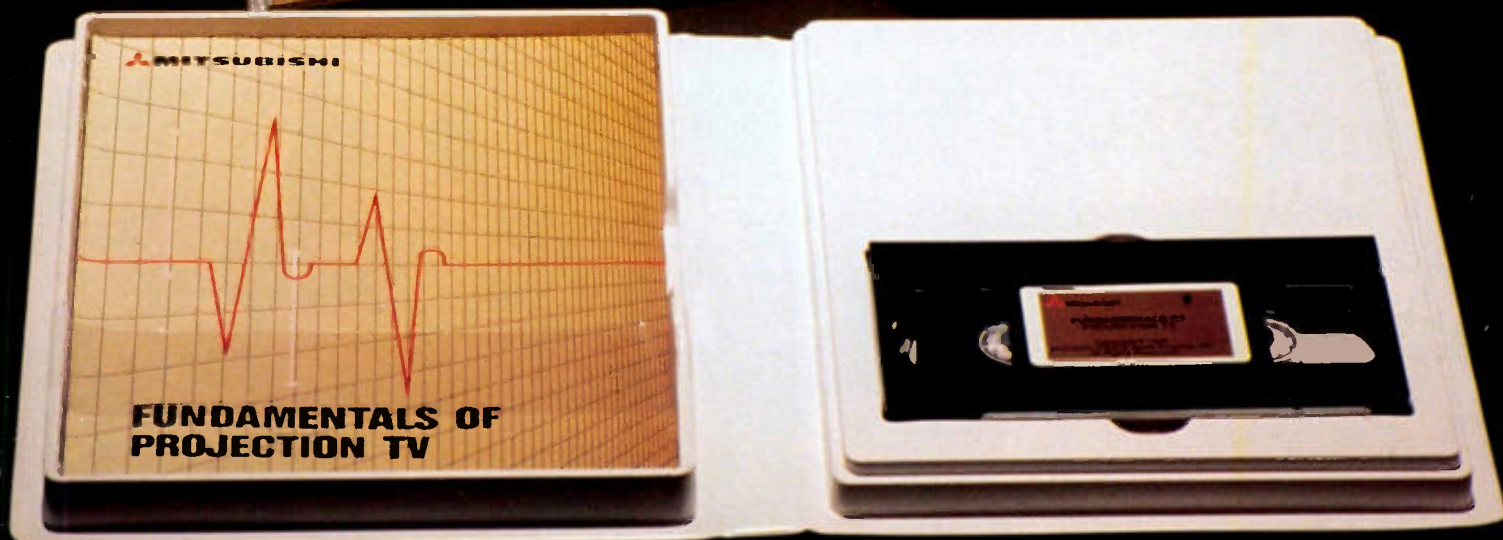

 **MITSUBISHI ELECTRONICS AMERICA, INC.**

**ONLY \$49.95 • ORDER PART # TT-111 (INCLUDES ONE WORKBOOK)**  
ADDITIONAL WORKBOOKS AVAILABLE FOR \$4.95 EACH BY ORDERING PART # TWB-111  
COD ORDERS ACCEPTED (800) 553-7278 • FAX (800) 825-6655

VISA / MASTERCARD ACCEPTED

# NTE KEEPS YOU UP AND RUNNING.

NTE specializes in "replacitivity," the science of getting things up and running again—fast! After all, downtime is costly, so no one can wait weeks on end for an OEM part to come in. With NTE, no one has to! One call gives you access to 3,550 top of the line universal replacement semiconductors that are cross-referenced to more than 240,000 original devices! Included in the NTE line are: bipolar transistors, integrated circuits, rectifiers, diodes, thyristors, optoelectronic devices, varistors, resistors, capacitors, and much, much more. All are backed by NTE's exclusive two-year warranty.

For your copy of the NTE Technical Guide contact your local NTE distributor, or simply fill in the coupon below and send it to us today with a check or money order for \$3.25 each.

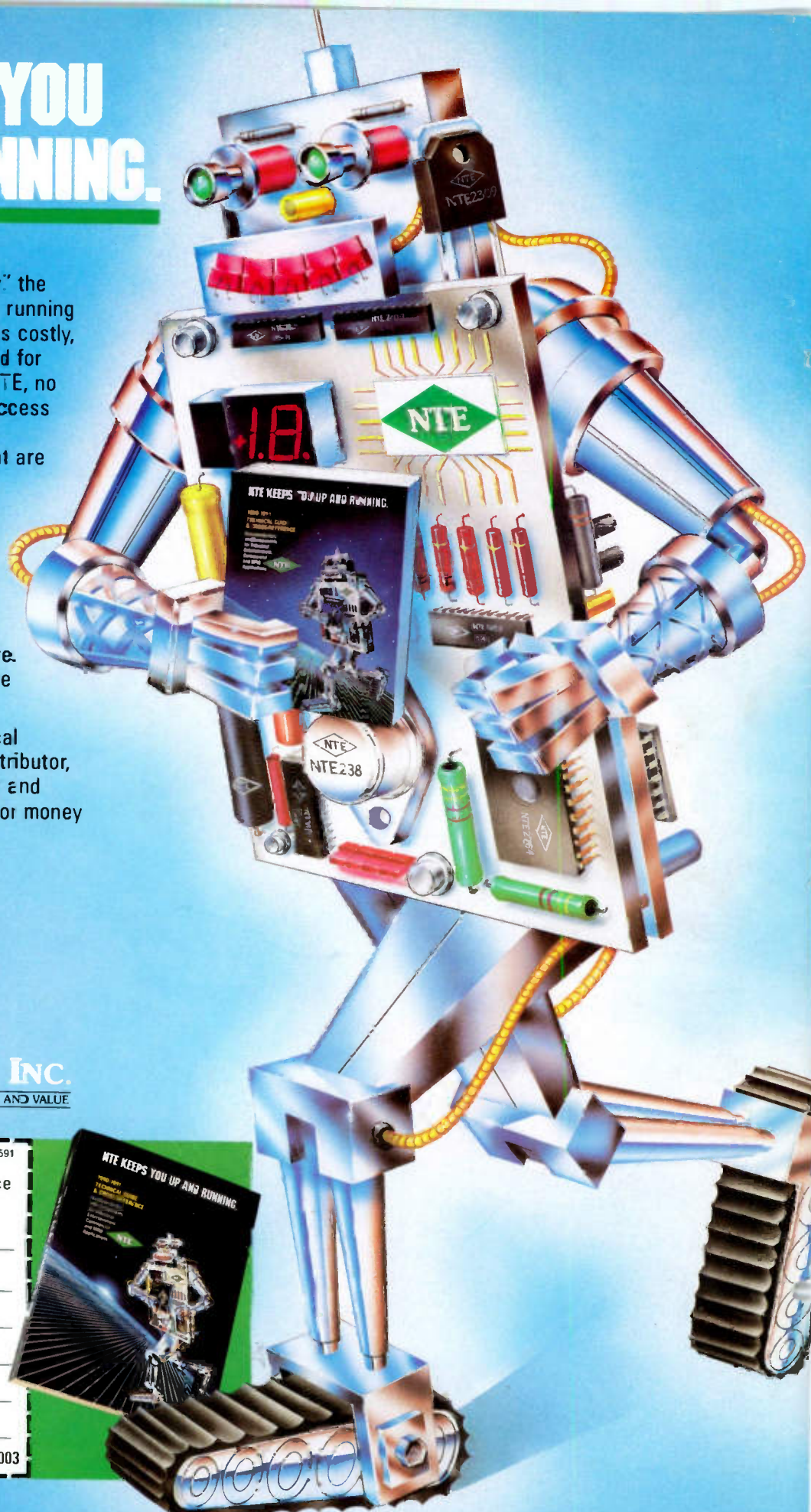

## NTE ELECTRONICS, INC.

A WORLDWIDE REPUTATION FOR QUALITY, SERVICE AND VALUE

Please rush me \_\_\_\_\_ copies of the EST591  
NTE Technical Guide and Cross Reference  
manual at \$3.25 each. I have enclosed  
my check or money order for a  
total of \$ \_\_\_\_\_  
Name \_\_\_\_\_  
Company \_\_\_\_\_  
Address \_\_\_\_\_  
City \_\_\_\_\_  
State \_\_\_\_\_ Zip \_\_\_\_\_  
Mail to: NTE, 44 T Farrand St., Bloomfield, NJ 07003



For the name of your nearest NTE distributor, call NTE: Toll Free: 1-800-631-1250 (incl. Canada)  
Tel: (201) 748-5089 • FAX: (201) 748-6224

Circle (75) on Reply Card