

ELECTRONIC^{T.M.}

Servicing & Technology

June 1990/\$3.00

Understanding and servicing VCR servo systems

Video corner: Diagnosing VCR vertical sync problems



... equipment
update: Diagnostic
tools continue
to get smarter,
easier to use

Introducing The Audio Analyzing Team For The 1990s!

New

Patented



SG80 AM Stereo-FM Stereo Analyzer™ — "The AM And FM Receiver Problem Solver"

- Complete AM Stereo-FM Stereo Analyzer—Exceeds Manufacturer Requirements.
- Patented FM Analyzing Signals Isolate Any FM Receiver Defect.
- Exclusive Integrated AM Stereo C-QUAM Analyzer.
- Digitally Accurate Performance Tests Meet EIA/IHF Requirements.
- Exclusive, Tuneable FM-IF Sweep And Markers—Aligns All IF Stages.

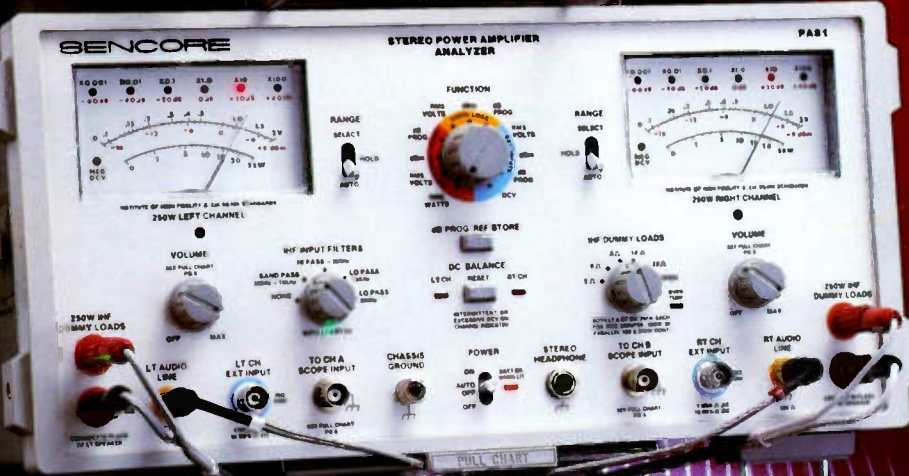

PA81 Stereo Power Amplifier Analyzer™ — "The Missing Link In Audio Analyzing"

- Twin Autoranged Frequency Compensated Wattmeters.
- Built-In EIA/IHF Filters And Loads.
- Signal Tracer With RMS And/Or dB.
- Automatic DC Balance Monitor For Intermittent Troubleshooting And Circuit Protection.
- Separation Tests To An Unprecedented 126 dB.

Approved by Motorola
Licensed under patent no. 4,218,586
C-QUAM is a registered trademark of Motorola, Inc.

*Independent Lab Report Available—Call

IEEE 488

RS232

SENCORE

3200 Sencore Drive, Sioux Falls, South Dakota 57107

Call 1-800-SENCORE (736-2673)
For A FREE Full Line Catalog
U.S. And Canada

Circle (1) on Reply Card

Ask About
A 10 Day
Video Preview

tech
tape™

Get the drop on performance with the New Survivor™ DMM



HIGH ENERGY FUSED

Your performance depends on the reliability of the instruments you use, so you need the New Survivor™ DMM. This high-performance 3½ digit meter is guaranteed to stay on the job without fail for 5 years*—or B&K-PRECISION will repair or replace it free.

The Survivor is built to quality standards you would expect only from more costly instruments. Its ruggedized case is drop resistant to five feet and tightly sealed against water and contaminants. Over-load and reverse polarity protection plus high-energy fusing defend its circuitry from electrical mishaps.

Today, many meters look alike, but few perform alike. Demand the Survivor DMM. For detailed specifications or immediate delivery, contact your local distributor.

- Measures AC/DC voltage and current to 20 amps
- 0.5% basic DC accuracy
- Audible continuity check
- Auto power off saves batteries
- Large 0.8" LCD
- 5 foot drop resistant
- Water resistant
- 5 year warranty

Model 2860 Survivor
\$99⁰⁰



BK PRECISION

MAXTEC INTERNATIONAL CORP.

Domestic and International Sales
6470 W. Cortland St., Chicago, IL 60635
312-889-1448 • FAX: 312-794-9740

Canadian Sales, Atlas Electronics, Ontario

*5 year warranty covers full instrument performance. Non-transferable. Does not cover abuse.

™ B&K-PRECISION Division, Maxtec International Corp.

EQUIPMENT UPDATE

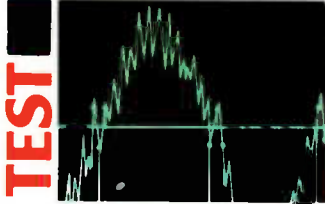

Page 10

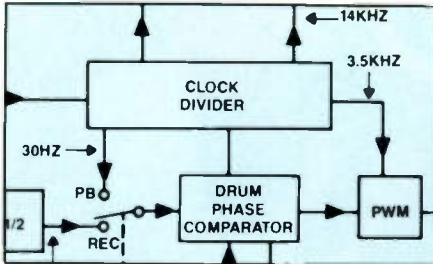

Page 38

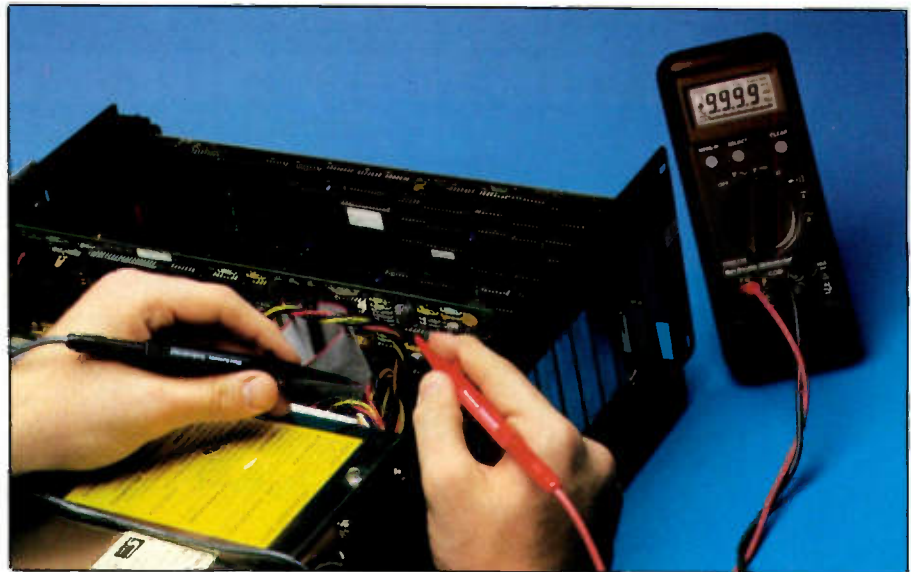

Page 14

FEATURES

10 Test equipment update

By Conrad Persson

The arsenal of testing devices available to electronic servicers continues to grow, both in numbers and sophistication. The microcomputers that power today's oscilloscopes do most of the graticule division counting, scale conversion and value calculation that the operator had to do just a few years ago. DMMs have been given autoranging, bar graph displays and a lot of other additional goodies. Test accessories like IC test clips allow the technician to get the probe on the right test point without modifying the circuit board or shorting out any connections. And diagnostic software programs allow a computer to diagnose many of its own ailments. All of this helps make a profession that's becoming progressively more difficult to pursue just a little easier.

12 Accessing ICs for testing

By Bill Hansen

14 The evolution of DMM design

By Jim Bordyn

18 When is an oscilloscope not an oscilloscope

By the ES&T staff

20 How to choose a low-cost counter

By Mark Mullins

24 Keeping PC hard disk drives up and running

By Steve Gibson

38 Drum and capstan servo systems

By Ron Smith

When the servo systems in a VCR aren't working properly, the symptoms may be noise bars in the picture, loss of sync, audio problems, or a combination of these. Understanding how the servos work, and what the symptoms are trying to tell you, can help you get that sick VCR back into operation.

27 Profax

45 Photofacts

46 What Do You Know About Electronics?

Is this circuit series or parallel?

49 Video Corner

VCR vertical sync

52 Audio Corner

Stereo phasing problems—part two

54 Business Corner

The importance of good housekeeping

56 Products

57 Test Your Electronics Knowledge

59 Readers' Exchange

60 Advertisers' Index

DEPARTMENTS

4 Editorial

Solving those servicing puzzles.

6 News

7 Literature

ON THE COVER

As electronics products become more complex, the printed circuit boards become more crowded, circuit traces become thinner, and the leads on the ICs multiply, and get smaller and closer together. The right test clip will make it easy for you to probe all the leads of that tiny IC. (Photo courtesy of ITT Pomona, Pomona, CA.)



LEADER STACKS UP A SELECTION FIT FOR A KING

If you've been stalking the city in search of an oscilloscope to suit your needs, you know that the market can seem like a jungle. But with Leader as your guide, you'll be rescued by a product line approaching gargantuan proportions. With more than 20 scopes to choose from, we'll help you eliminate those savaris from one small manufacturer to the next.

Leader's large selection also ensures you'll find a scope with the latest technology—at an appropriate price—for the size of the task confronting you. Look to Leader for analog or digital scopes; for CRT readouts and cursors; for up to 8 trace capability; for a range of bandwidths; and for battery-operated or benchtop scopes and portables weighing as little as 2.1 lbs.

If you want to be king of the hill, let Leader's extensive line of oscilloscopes help you make the climb. For help in selecting the right scope or for our full-line catalog in the Empire State call 516 231-6900. Or call toll free: 1-800-645-5104.

1 800 645-5104

LEADER

FOR PROFESSIONALS WHO KNOW THE DIFFERENCE

Leader Instruments Corporation,
380 Oser Avenue, Hauppauge, New York 11788
Regional Offices: Chicago, Dallas, Los Angeles, Boston, Atlanta.
In Canada call Omnitrax Ltd., 416 828-6221.

Circle (15) on Reply Card

For Demonstration Circle (16) on Reply Card

Solving those servicing puzzles

Have you ever done one of those word puzzles? You know the kind I mean; "There are four men: Mr. Brown, Mr. Green, Mr. Smith and Mr. Jones. One of the men is a lawyer; one is a banker . . ." and so forth. The puzzle proceeds to tell you various things about each of the characters in terms of the other characters, so that a little at a time you can discover something about each of them. The question you have to answer, which constitutes the core of the puzzle is usually something like, "Which man is the grocer?"

One of the clues might be, "Mr. Brown hired the lawyer to represent him in court." That clue tells you that Mr. Brown is not the lawyer. One at a time the clues mount up, some stated directly and some implied so that you have to be thinking sharply, until after a while you have enough clues to answer the question.

The only problem with this kind of puzzle is that you are presented with each fact in a way that makes it difficult to understand its significance in relation to the rest of the facts. Hey! If it was easy it wouldn't be a puzzle, and it wouldn't be any fun to work it.

Servicing of electronics products can be a lot like those puzzles. You're presented with a fact, or several facts at the outset. For example, the thing won't work at all, or the thing works, but the sound is wrong, or there's no picture, or the picture is snowy. Then based on those clues you have to begin probing for more clues that slowly form a pattern that in turn point toward a solution.

Several years ago one of my children, then still in grade school, brought home a book full of puzzles like the one I mentioned above. The only difference was this book included some grids and suggested a meth-

od of solving the puzzle. You'd put the name of each character in one of the boxes horizontally along the top of the grid. You'd put the name of each profession, or whatever attribute you had been given about the character, vertically along the left side of the grid. Then in the box where the column with the person's name met the row with the person's profession, which you found out through working through the puzzle, you put an X, or check mark.

After just a little while, most, or sometimes all, of the boxes were full, and it was obvious that Mr. Smith had to be the grocer, which was what you had to find out.

My first reaction to this book was that it really wasn't much fun because solving the puzzles was too easy. The puzzles really mustn't be that hard. After all, the book was for grade-school children. Then I tried a different approach to the problems. I tried doing them in my head, as I had done every time I was faced with that kind of problem in the past. The problems actually became more fun, because using this haphazard method of solution they became far more mysterious and difficult. After all, puzzles aren't supposed to be easy, and puzzles like these are enhanced by a certain air of mystery. But I didn't solve a single one when I tried doing it this way. It became clear that the reason I was able to solve the puzzles in this book so easily was not because I was suddenly smarter than before, or that these puzzles were easier than others I had worked on, but I had been given a systematic method of solving the puzzles, and with that as a tool the rest was easy.

Of course troubleshooting a piece of electronics equipment isn't like solving a puzzle like this one. For one

thing, you aren't given all the clues in a neat little package with all the clues in place just waiting for you to solve the puzzle. When you're troubleshooting, you have to write part of the puzzle yourself. You have to go out and probe here and there to come up with the clues. On the other hand, there are similarities between one of these puzzles and testing an electronic product. When you are faced with a "tough dog" as often as not it resembles one of these word puzzles because in both cases you have a lot of information floating around in your mind, whose relationship to the rest of the information is not clear.

One way to pin some of this down is to write things down, perhaps in grid form. As an example, you could draw a grid with a list of symptoms along the top and a list of the major subassemblies in the product you're working on down the left hand side. Then each time you take a reading or observe some other symptom, make a note of the observation (and I mean write it down!) and also think about what subassembly might be involved and make an X in the box where the symptom and circuit come together. If you're lucky, after a while a pattern may emerge and you'll be close to a solution.

If you're a typical servicing technician, you enjoy your work because some of its aspects are fun. You enjoy being presented with a puzzling problem in a product, assembling the clues and coming up with that "eureka!" feeling when you've solved it. A method like the one described here might help that feeling come a little sooner.

Nile Conrad Perum

FLUKE



PHILIPS



High Resolution Digital Meter:
4000 count digital readout; 20,000 count mode (Fluke 87) for 4 1/2 digit resolution

Backlit display: Makes it easy to read the DMM in dark, cramped quarters. Automatically shuts off after 68 seconds to save the battery.

Recorder: records minimums and maximums, plus true arithmetic average; audible Min Max Alert; selectable response times—1 second and 100 ms (all models) plus 1 ms Peak Min Max (Fluke 87)

Holster with Flex Stand™: Protects meter and provides test lead storage. Flexible leg allows meter to be hung from peg, bent around a pipe, or used almost anywhere.

Analog Meter: High-speed analog display updates 40 times/second—as fast as the eye can follow; X10 Zoom bargraph mode (Fluke 83 and 85) makes high resolution offset measurements a snap.

Frequency counter: Accurate down to 0.5 Hz; also measures duty cycle

Capacitance meter: Autoranging, with manual ranging at the touch of a button

FLUKE 83	FLUKE 85	FLUKE 87
Volts, ohms, amps, diode test, audible continuity, frequency and duty cycle, capacitance, TouchHold® relative, protective holster with Flex-Stand™	Volts, ohms, amps, diode test, audible continuity, frequency and duty cycle, capacitance, TouchHold® relative, protective holster with Flex-Stand™	Volts, ohms, amps, diode test, audible continuity, frequency and duty cycle, capacitance, TouchHold® relative, protective holster with Flex-Stand™
\$195*	\$229*	\$289*
0.3% basic dc accuracy	0.1% basic dc accuracy	0.1% basic dc accuracy
5 kHz acV	20 kHz acV	20 kHz acV
Analog bargraph and zoom	Analog bargraph and zoom	High resolution analog pointer
Three year warranty	Three year warranty	True-rms ac
		1 ms PEAK MIN MAX
		4 1/2 digit mode
		Backlit display
		Three year warranty

*Suggested U.S. list price

Multi-Meter

Meet the meter that brings an entire test bench to your job. The versatile Fluke 80 Series do-just-about-everything "Multi" Meter.

It offers everything you'd expect from an advanced handheld DMM, plus a lot you'd find only in dedicated instruments. Plus Fluke-exclusive features you can't buy anywhere else. All built with the most advanced surface mount design and single-chip ASIC technology for a thinner, tougher, more reliable package.

There's a fully annunciated display for clear operation. Duty cycle function. High-speed analog indicator. A protective holster with innovative Flex-Stand™ for easy, adaptable operation. Audible Input Alert™ to reduce the risk of damage to the meter, the user, and the unit being tested. Plus the strongest warranty in the business.

All good reasons to move up to the truly-multi Fluke 80 Series today. You'll find 80 Series DMMs at your Fluke distributor. For immediate, off-the-shelf delivery. Call

1-800-44-FLUKE, ext. 33 for the name of your nearest distributor.

John Fluke Mfg. Co., Inc. P.O. Box 9090 M/S 250C, Everett, WA 98206 U.S. (206) 347-5400 CANADA: 416-890-7600 OTHER COUNTRIES: (206) 356-5500

© Copyright 1989 John Fluke Mfg. Co., Inc. All rights reserved. Prices and specifications subject to change without notice. Ad no. 0102-F80

FROM THE WORLD LEADER IN DIGITAL MULTIMETERS. Circle (9) on Reply Card

FLUKE

Home appliances and automation federation proposed

In the opening session of the NARDA/NASD Convention and Expo '90, on March 11, Thomas P. Friel, Vice President of the Electronic Industries Association Consumer Elec-

tronics Group invited members of the two associations, plus other associations serving the appliance, electronics, construction, security and utility industries to join with the EIA in forming a new industry consortium. Friel extended his organization's

offer to act as a clearing house for the proposed Home Appliances and Automation Federation.

"By trading memberships, we can create an unprecedented federation to serve a broader base and more diverse interests than ever before," Friel said, and outlined the following:

- * The various facets of the industry can join efforts on Capitol Hill to ensure fair and equitable legislation and regulatory activities for the industry;
- * Interested parties could share pertinent statistics and exchange engineering expertise;
- * Federation members could work toward achieving synergy for the members of various associations; and
- * Collectively, federation members could participate in promotional and/or lobbying activities that could be cost prohibitive for any single association.

Friel said that such joint efforts are necessary in order for the industry to continue its strength and successes into the 21st century.

Five companies added to CEG

Five new member companies have recently joined the Electronic Industries Association's Consumer Electronics Group: Aura Dynamics, Inc.; Diablo Research Corp.; M&S Audio; Proton Corp.; Virginia Technologies Associates, Ltd.

Three of the companies, Aura, M&S and Proton have joined CEG's Audio Division. Diablo, a company specializing in the design and development of "intelligent" consumer electronics products capable of communicating with one another by way of existing power lines, twisted pair (telephone) wiring, coaxial cable, infrared and RF media, has joined CEG's Home Automation Division.

The fifth company, Virginia Technologies, has become a member of CEG's newest division: the Assistive Devices Division. The company is active in the research and development of technologies designed to enable people with physical and cognitive disabilities to function effectively both at home and in an office environment. ■

Quality Choice

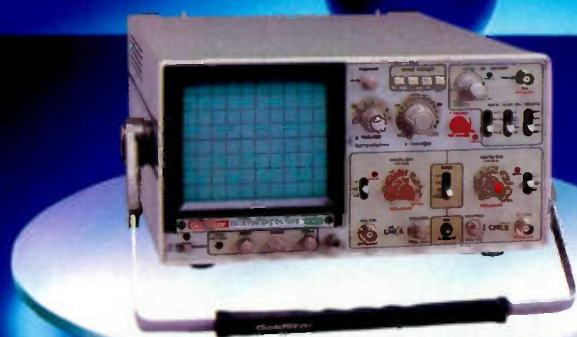

Oscilloscope: OS-7040A

OSCILLOSCOPE



•OS-7020A
20MHz, DUAL TRACE



•OS-8020R
20MHz, DUAL TRACE
CRT READOUT DISPLAY

FREQUENCY COUNTER & POWER SUPPLY



•FC-7011: 100MHz
•FC-7052: 550MHz
•FC-7102: 1GHz



•GP-103: 18V/1.0A
•GP-105: 30V/0.5A
•GP-233: 18V/1.0A, 18V/1.0A
•GP-235: 18V/1.0A, 30V/0.5A

DIGITAL MULTIMETER BENCH & HAND-HELD



•DM-7241: 4 1/2 DIGITS
MANUAL RANGING,
LED MEMBRANE
FUNCTION INDICATION



•DM-6335
3 1/2 DIGITS,
AUTO
RANGING,
MEMORY,
HOLD
FUNCTION



•DM-8135
3 1/2 DIGITS,
AUTO
RANGING,
MEMORY, HOLD,
TR, hFE CHECK
FUNCTION,
BAR GRAPHIC
DISPLAY



•DM-7333
3 1/2 DIGITS,
MANUAL
RANGING,
TR, hFE CHECK
CAPACITANCE,
FREQUENCY
FUNCTION



•DM-8433
3 1/2 DIGITS,
MANUAL
RANGING,
TR, hFE CHECK
CAPACITANCE,
TEMPERATURE
FUNCTION



•DM-8243
4 1/2 DIGITS
MANUAL
RANGING,
TR, hFE CHECK
CAPACITANCE,
FREQUENCY
FUNCTION



GoldStar Precision

13013 East 166th Street, Cerritos, Ca. 90701, U.S.A
Tel.: (213) 404-0101 Tlx.: (910) 583-5719 LGILA
Fax.: (213) 926-0849

Circle (10) on Reply Card

ELECTRONIC

Servicing & Technology

Electronic Servicing & Technology is edited for servicing professionals who service consumer electronics equipment. This includes service technicians, field service personnel and avid servicing enthusiasts who repair and maintain audio, video, computer and other consumer electronics equipment.

EDITORIAL

Nils Conrad Persson, *Editor*
 Jeffrey Uschok, *Assistant Editor*

CONSULTING EDITORS

Carl Babcoke, *Consumer Servicing Consultant*
 Homer L. Davidson, *TV Servicing Consultant*
 Christopher H. Fenton, *Circuit Fabrication Consultant*
 William J. Lynott, *Business Consultant*
 Victor Meeldijk, *Components Consultant*
 Kirk G. Vistain, *Audio Consultant*
 Sam Wilson, *Electronics Theory Consultant*

PRODUCTION

Elizabeth Ryan, *Art Director*
 Barbara Terzo, *Artist*
 Dorothy Kehrwieler, *Production Manager*
 Emily Kreutz, *Production*
 Pat Le Blanc, *Phototypographer*
 Florence V. Martin, *Phototypographer*

BUSINESS

Richard A. Ross, *Publisher*
 Dorothy Kehrwieler, *General Manager*
 Frank V. Fuzia, *Controller*
 Catherine Ross, *Circulation Director*
 Melissa Kehrwieler, *Data Processor*
 Kathleen Bell, *Customer Service*

SALES OFFICE

Electronic Servicing & Technology
 76 N. Broadway, Hicksville, NY 11801
 516-681-2922; Fax, 516-681-2926

Jonathan Kummer, *Advertising Manager*
 Emily Kreutz, *Sales Assistant*

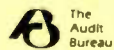

Member, Audit Bureau
 of Circulation



Member, Electronic
 Servicing Dealers
 Association

EDITORIAL CORRESPONDENCE

P.O. Box 12487
 Overland Park, KS 66212
 913-492-4857

Electronic Servicing & Technology (ISSN 0278-9922) is published monthly by CQ Communications, Inc., 76 N. Broadway, Hicksville, NY 11801. Second class postage paid at Hicksville, NY and additional offices. Subscription prices (payable in US dollars only): Domestic—one year \$24, two years \$36. Foreign countries—one year \$30, two years \$42. Entire contents copyright 1990 by CQ Communications, Inc. Electronic Servicing & Technology or CQ Communications, Inc. assumes no responsibility for unsolicited manuscripts. Allow six weeks for delivery of first issue and for change of address. Printed in the United States of America.

Postmaster: Please send change of address notice to Electronic Servicing & Technology, 76 N. Broadway, Hicksville, NY 11801.

CQ Communications, Inc. is publisher of CQ The Radio Amateur's Journal, Popular Communications, Modern Electronics, CQ Radio Amateur (Spanish CQ), CQ Amateur Radio Equipment Buyer's Guide, CQ Amateur Radio Antenna Buyer's Guide, and Electronic Servicing & Technology.

Literature

Electronic components catalog

The MCM Electronics catalog contains over 15,000 high-demand parts and components; more than 500 of them being offered to customers for the first time in this edition. Among the categories of products offered are: semiconductors, television parts, computer equipment, power centers and regulators, telephone parts and accessories, connectors, tools, batteries, speakers, VCR parts, audio parts and accessories and more.

Circle (125) on Reply Card

Presaturated cleaning products

Texwipe's new Presaturated Products Brochure describes its presaturated products, including 17 different premoistened pads and foam swabs featuring 5 products for cleaning CRT screens and keyboards. These pads and swabs are self contained products, with applicator and solvent in one packet. Included is information on the company's newest product, a fax cleaning sheet, as well as products for cleaning tape heads, office equipment, pc boards and optical surfaces, as well as antistatic products and ink removing products.

Circle (126) on Reply Card

Electronic instrument catalog

The Spring/Summer 1990 Catalog from Genstar REI Sales Company lists thousands of like-new instruments immediately for sale. These are instruments that have been previously rented through the parent company Genstar Rental Electronics, Inc. and include analyzers, desktop computers, printers, recorders, oscilloscopes, generators and more, from major manufacturers.

Circle (127) on Reply Card

DSO application guides

Three new applications guides now available from John Fluke Mfg. Co., Inc., offer answers to questions commonly raised by those considering the purchase of a digital storage oscilloscope (DSO). "Understanding DSO Bandwidth and Sampling," "DSO Truth in Digitizing," and "DSO Analysis Power," are part of

the "Straight Talk" series from Fluke. The series explains how DSOs, through increased signal acquisition power, extensive analysis capabilities, automation, and ease of use, are rapidly replacing analog scopes in many applications.

Circle (128) on Reply Card

Tool catalog

A catalog from Jensen Tools Inc. features tools, tool kits and test equipment specifically for use in workstation and network servicing. The 10" by 9" format of this full-color 32-page product guide accommodates complete technical specifications and informative display of each item. The catalog features service kits for computer, workstation and LAN maintenance. Other products include strippers, crimpers, connectors, and other LAN accessories, plus cable tools, datacom test equipment, diagnostic software, disk storage, disk drive and circuit board repair products, shipping containers, static control and more.

Circle (129) on Reply Card

Ozone-safe dust remover

Chemtronics introduces the E-Series Ultrajet gas duster, containing a second-generation EPA-exempt fluorocarbon. The product offers high purity, low toxicity, inertness and non flammability. The product delivers powerful jet blasts for cleaning critical electronic systems and has variable pressure of up to 120 psi for maximum cleaning efficiency. Ultra-filtered to less than 0.2 microns, the product is non abrasive.

Circle (130) on Reply Card

Test equipment updates

RAG Electronics is offering monthly updates of available used test equipment. These monthly updates highlight the company's newest arrivals, best values and one-of-a-kind clearance items. Test equipment from manufacturers including Hewlett-Packard, Tektronix and Fluke, covering a wide variety of oscilloscopes, spectrum analyzers, DMMs, power supplies, signal sources and more are featured.

Circle (131) on Reply Card

A majority of
almanacs are
in a way that im
cognizance of
malaise of the po
of the orga

(Why most technical guides give

It's no surprise that the easiest guides to use also happen to speak the same language as you. English. That's why all our troubleshooting guides are simply written and to the point. Whether they're for VCRs, CD players, fax machines, projection

or direct view televisions. And thanks to our on-screen video indexing, the answers you need are easier to find.

But for all the invaluable help our manuals and videos can offer, they're surprisingly inexpensive, ranging from \$40 to \$100.

maintenance
composed
pedes aggregate
ten leading to
sterior chambers
ns of vision.

you a dull ache behind the eyeballs.)

For example, there's our step-by-step fax training video (part number TT-107) which sells for \$89.95.

If you'd like to place an order, or for a free brochure, call 1-800-553-7278. If, on the other hand, you would consider it to

be a desirous maneuver if you were to initiate a request for additional enlightenment, call one of the other guys.

 **MITSUBISHI**
TECHNICALLY, ANYTHING IS POSSIBLE™
Circle (19) on Reply Card

Test equipment update

By The ES&T Staff

A number of factors drive the constant improvement in test instruments:

1. Necessity: As the electronics products that require testing, diagnosis and repair increase in sophistication and complexity, the equipment used to test those products must increase in sophistication in proportion.

2. Ability: As the technology that goes into electronics products in-

creases in sophistication, so the technology that is available for use in test equipment increases in sophistication.

3. Competition: When one of the leading manufacturers of test equipment makes a step forward in technology, or a breakthrough in price, or both, the other leaders feel compelled not only to improve their own products to that same level, but to make an improvement that takes the

state of the art yet a step further.

4. Pride: The engineers and technicians who design test equipment are driven by factors other than money. They constantly strive to do better than other engineers involved in the design and development of the same kind of product.

Given this level of impetus to excel, it should come as no surprise that with some degree of regularity test



equipment provides ever increasing sophistication, greater accuracy, more functions and smaller size, frequently at the same or even lower price.

DMMs

Digital multimeters are a good example of this kind of advance. Early DMMs featured 3 1/2 digits of precision in a bench size package. They could measure the basic parameters: volts, ohms, and milliamps. Over the years DMMs have become smaller and lighter, and more features have been added. In addition to the basic parameters, many of today's DMMs can check semiconductor junctions, give true rms readings, and some even provide things like frequency measurement. On many DMMs bar graphs have been added to the display to give trend information.

Yet with all these features added, today's DMMs are still quite inexpensive, and in many cases less expensive than the early, far less sophisticated instruments.

Oscilloscopes

Oscilloscopes are another example of advances in test equipment technology. Early oscilloscopes provided little more than a picture of a waveform that gave some useful, but limited information about the signal that was being observed. Gradually the technology has improved and features have been added, until today the oscilloscope is truly a waveform measurement and analysis tool.

As an example of the strides that have been made in oscilloscope technology, scopes with 100MHz bandwidth are now available at prices that won't empty your wallet; and even

multitrace scopes are affordable. Digital storage oscilloscopes make it possible to measure, store and compare waveforms now or later, on the spot or back at the shop. And with computerized analysis of waveforms, it's no longer even necessary to count scope face graticule divisions and perform mathematical calculations to determine signal magnitudes and frequencies: it's all displayed numerically on the face of the oscilloscope.

Counters

For extremely accurate frequency measurements, or for measuring frequencies that are too high to be displayed on an oscilloscope, a frequency counter is the testing device of choice. It's not a product that's on the bench or in the toolbox of most electronics servicing technicians, but it's a test instrument that every technician should have at least a passing familiarity with. As with just about every other kind of test instrument, counters have undergone advancements in the 1980s. The microprocessor has shown up here as it has in every other imaginable electronic product, and enabled engineers to improve product operation and add features while keeping prices at the same level.

Computer diagnostics

One of the beauties of a personal computer is that it can serve as a test instrument, even to the extent of being used to diagnose itself. Of course, using a computer to test itself won't work if the unit is totally dead, but in many cases, diagnostic and tune-up programs can be used to determine the nature of a computer's problems,

and in some cases, can actually be used to make a sick computer well. For example, there are utility programs that will write data into RAM (random-access memory) and then read the data out again. If the data read is different from the data written, the computer will be able to tell the operator that there is a problem and precisely where.

Other programs can take data that's in files that are broken into little bits all over the disk as a result of frequent writing and erasing ("fragmented" files) and reassemble them into contiguous files. The disk operates much faster after this is done.

Still other diagnostic and tune up software utilities can diagnose and/or cure ailing computers in other ways, and more such programs are being made available every day.

Test accessories

As the number of different kinds of consumer electronics products, and their sophistication and complexity continue to grow, more different kinds of test accessories become necessary: tiny test hooks that can be used to probe individual IC leads, circuit board extenders, test clips that can be clipped over a complete IC in order to extend the leads out to where you can get a test probe onto it. Many other kinds of testing accessories exist that can help make the job of diagnosing and repairing problems in modern electronics products a lot easier.

The following articles in this special report provide some detail on these kinds of advanced diagnostic and repair technology. ■

Accessing ICs for testing even hard-to-reach SMDs

By Bill Hansen













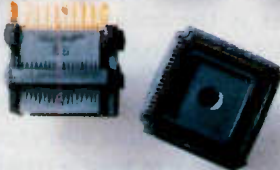

Package	No. of Pins	Material Function	Clips for Board Mounted IC's				ADAPTERS FOR SOCK	
					No. of Pins	Material Function	Pin Breakout	
DIP Dual In-Line Package (.100 Pin Spacing, Thru Hole) 	8 14 16 20 24 40	Gold plated beryllium-copper, nickel-silver, or oxide penetrating contacts			40 48 64	Insert between socket and IC, typically used for de-bugging a working system		
SOIC Small Outline IC (.050 Pin Spacing, Surface Mnt) 	8 14 16 20 24 28	Similar to above, for surface mounted DIP equivalents						
PLCC Plastic Leaded Chip Carrier (.050 Pin Spacing, Surface Mnt) 	20 28 44 52 68 84	Simultaneously contacts all four sides of IC			20 28 44 52 68 84	Insert between socket and IC, typically used for de-bugging a working system		
PGA Pin Grid Array (.100 Pin Spacing, Grid Thru Hole) 					68 (10X10) 68 (11X11) 120 (13X13) 128 (13X13) 132 (14X14)	Insert between socket and IC, typically used for de-bugging a working system		
LCC Leadless Chip Carrier (.050 Pin Spacing) 					44 68 84	Insert between socket and IC, typically used for de-bugging a working system		
PQFP Plastic Quad Flat Pack (.025 to .0315 Pin Spacing) 	EIAJ 100 (20X30) 120 (30X30) 160 (40X40)	Newest clips for surface mounted, fine pitch ICs			JEDEC 100* 100* 132* 132*	Insert between socket and IC, typically used for de-bugging a working system		

Figure 1. IC test clips and adapters, such as this, can make it easier to get your test probes connected to the points you need to test, and reduce the chance of your shorting two pins together with disastrous results.

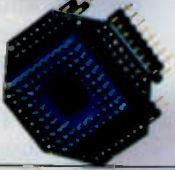
SOCKET MOUNTED IC'S		
Socket Interface		
No. of Pins	Material Function	
20 23 44 52 68 84	Replaces ICs on PC board, typically used for IC emulation	
JEDEC 100 ⁷ 100 ⁸ 132 ⁷ 132 ⁸	Replaces ICs on PC board, typically used for IC emulation	

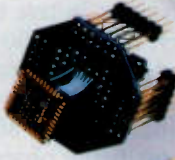
If you're trying to access ICs mounted on PCBs for testing purposes, chances are you're having problems. A recent survey of engineers and technicians involved in testing proved that. The most common complaints were not enough room, test clips were hard to put on and didn't stay on. The reason why is obvious—all involved the use of alligator clips.

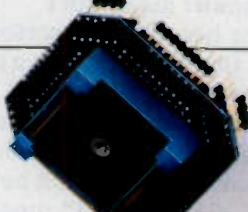
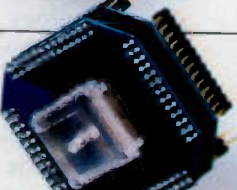
Well, you don't have to try and make-do with alligator clips or a soldering iron and fine wire. Whether you're troubleshooting the most common IC types, such as DIPS (dual in-line packages), PLCCs (plastic leaded chip carriers) or SOICs (small outline integrated circuits), or wanting to test the newest plastic quad flat pack (PQFP), there is a clip or adapter that will let you access the leads quickly and dependably.

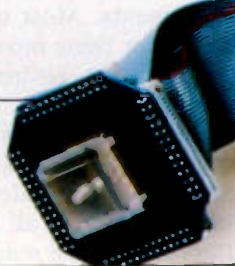
The chart in Figure 1 lists a number of IC packages and shows some of the clips and adapters available to match. The easiest solution to all of the IC testing access problems mentioned earlier is to inventory a broad range of clips, for each package type you might be testing.

Different clips for accessing different ICs

The clothes-pin type clips are fairly well known. Spring loaded, you squeeze the two halves open, position them over the ICs with the contacts aligned to the leads, and clamp them in place. Clips for newer four-sided devices fit over the ICs in a slightly different manner. You align them using a pin locator, then slide them

down over the ICs, where they wedge into place.

For a number of socket mounted packages, pin breakouts can be used. With these, an adapter is fitted into the IC's socket, between the board and the IC to be tested. Also, socket interfaces allow your emulator to directly access the PCB for development or testing. Each of these allows you to perform hands-free testing.

High testing cost means efficiency is valuable

With the cost of testing already high and increasing—in industry a fully burdened technician's hourly rate means that it can cost hundreds of dollars to test a board—it's surprising to discover that so much testing appears to be done in makeshift fashion. Testers are attempting to latch on to pins on 0.023-inch centers with single contact clips. Many still reach for a soldering iron and the finest wire they can find.

With the high cost of testing, even the most expensive clip cost seems low in comparison to the utility they offer and the savings in making a test set-up from scratch. They provide good contact, they hold the contact and allow you to complete an accurate test, hands free. They're easy to use, and go on and off quickly. They are available to fit most of the standard IC packages. So put away your wire and solder, and your alligator clips, when you're testing ICs. Doing it right is not only better, it's cheaper.

After all, the whole idea of accessing an IC for testing is to make a good contact and make sure the contact is held for the length of the test. Speed

(Continued on page 58)

Hansen is Engineering Supervisor for ITT Pomona

The evolution of DMM design

By Jim Bordyn

Digital multimeters, or DMMs, have become so widely accepted as everyday test instruments that many early innovations in DMM design are

Bordyn is Vice President, Marketing for the Instrumentation Products Division of Beckman

taken for granted. However, the era of quiet innovation isn't over for DMMs, and some products that are just being introduced point to some important design trends in these essential tools.

Described here are some of the more significant DMM product in-

novations of the last decade, as well as some improvements that are just now coming on the market.

Continuity

Here's an example of a product innovation that today is pretty much a standard DMM feature. It might be difficult to remember that a built-in continuity indicator was not available on DMMs until 1979. Previously, you had to check for opens and shorts in resistance mode and wait for the digital display to "settle down."

Display technology

Meter display technology has moved from the old d'Arsonval analog displays, to digital LEDs, and eventually to LCDs. LCDs require less current and promote longer battery life. Unfortunately, however, early liquid crystal displays tended to perform very slowly in freezing temperatures and turned black if left on a car dashboard on a summer day. Recent improvements in LCD technology include better response over wider ambient temperature ranges.

Improved durability

Ruggedized, or heavy duty, DMM models have been designed specifically to withstand harsh industrial environments. Most of the added expense for these models is in the impact-resistant, environmentally sealed casing.

Although DMMs for heavy duty applications are likely to remain a special product category, the physical durability of all DMM models is improving. The main reason is that new, inexpensive thermoplastic materials are becoming available. Cases

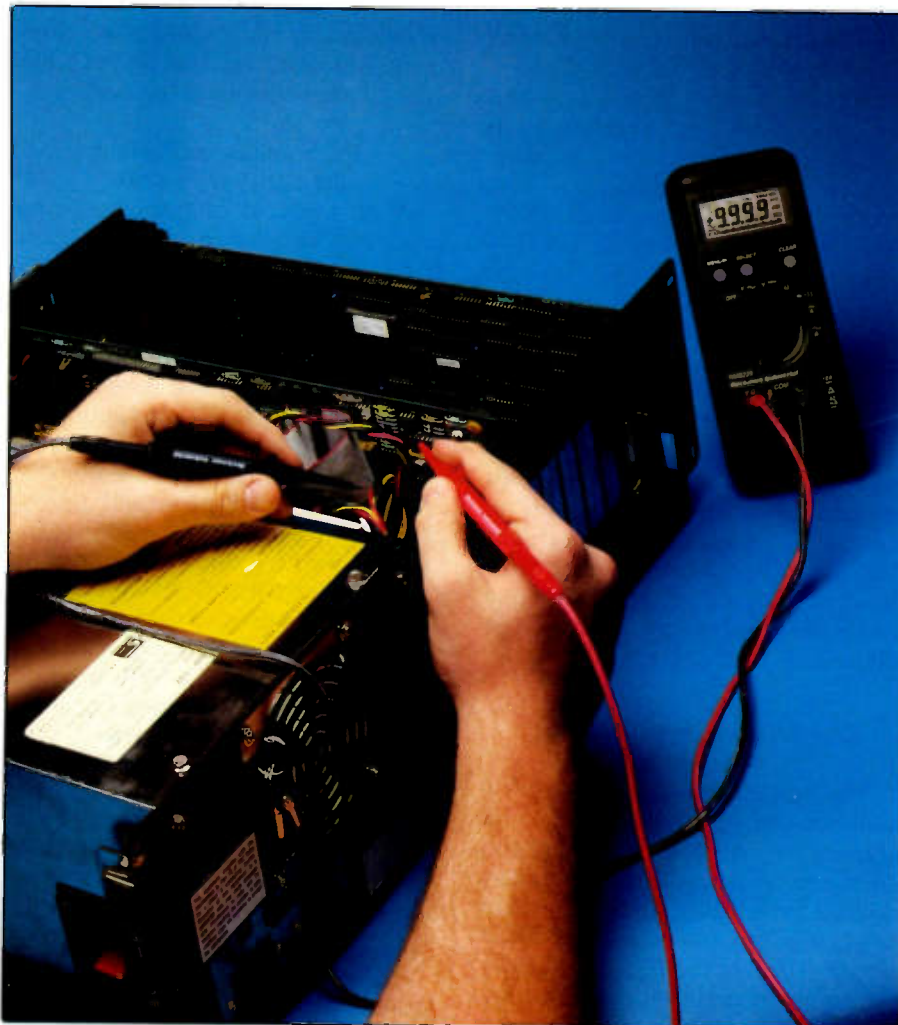

Modern DMMs provide the technician with an impressive array of features, including continuity, bar-graph display, diode check and more.

molded from these plastics offer better resistance to solvents, physical shock, and thermal stress.

Input protection

Increasingly, the preferred device for high-voltage input protection is the metal oxide varistor (MOV). A MOV reaches breakdown at a specific voltage, changing its characteristic from a resistor to a conductor, and shunting the overload to ground. The MOVs currently found in the protection circuits of some professional and heavy duty DMMs can handle overloads of several thousand volts.

The traditional way to protect current ranges is with fuses. Fuses are becoming smaller with higher voltage ratings available. It probably will be typical of future DMMs that all current ranges will be fused.

Another improvement is that some DMMs now offer "self-resetting fuses." These are not really fuses at all, but special positive temperature coefficient (PTC) resistors. In series with the input, the PTC resistor reacts to a current overload by heating up, which in turn causes its resistance to increase rapidly. The higher resistance reduces the inrush of current, thus protecting the current shunt in the meter. When the overload is removed, the PTC resistor cools, and the meter quickly recovers.

Bar graph

Some newer DMM models include a bar graph in the display that supplements the numeric reading. This simulates d'Arsonval pointer (analog) movement for making quick visual checks.

With new display controller chips in DMMs, bar graph gradations have

become finer, permitting more accurate representation. One new DMM model offers a 41 segment analog bar graph, which is a 33 percent improvement in visual resolution over previous models, on which bar graphs typically have just 31 segments. This increased resolution is particularly useful for observing slowly varying signals. It also facilitates peaking and nulling adjustments.

Auto-ranging and audible bar graph

Auto-ranging DMMs based on earlier digital technology use an analog-to-digital (A/D) converter for range selection. To find the correct range and to display a reading quickly, the A/D conversion process is made considerably faster than in a meter that does not perform auto-ranging. Fast A/D circuits tend to be noisy, however, so that several readings must be taken and averaged to assure accuracy. This is done in software, and then the reading is displayed.

Some new DMMs implement auto-ranging and A/D conversion differently in order to achieve faster response time. Two parallel circuits are used—one to select the range and another to take the reading. In the first circuit, a voltage-to-frequency converter selects the range. It is not accurate enough to make the actual measurement, but it is very fast and is sufficiently accurate to select the appropriate range. A related benefit is that this signal can be amplified and connected to a speaker so that the user can actually hear the reading as a tone. This tone is proportional in frequency to the magnitude of the reading. It is, in effect, an audible bar graph. Since this audible readout operates off the very fast voltage-to-fre-

quency converter, the tone reacts quickly to any change in the parameter being measured. This response is fast enough to detect transient or intermittent signals that would go undetected by DMMs with slower A/D conversion circuits.

Once the range is determined, a low-noise A/D circuit makes the actual measurement, measuring the parameter only once (rather taking the average of a series of readings) and displaying the result on the LCD.

True RMS measurement capability

The typical DMM uses an "average-responding" conversion approach to measuring AC voltage and current. The circuit used for average-responding works fine for pure, undistorted sine waves, but can be very inaccurate for those nonsinusoidal, or clipped, sine waves, which are encountered increasingly around switch-mode power supplies, motor controllers, and copiers. The average-responding DMM usually rectifies and filters the AC signal, and thus creates a DC, or average, level that is proportional to the root-mean square (RMS) value of the signal. The DMM circuitry uses a fixed multiplier of 1.11 times the average value to obtain the RMS value to be displayed. However, the scaling factor of 1.11 is only accurate for the measurement of pure sine wave signals.

On the other hand, DMMs with true RMS measurement capability can accurately measure the RMS value of AC signals, virtually regardless of their waveform or distortion.

Automatic shut-off

Although auto-off has been advertised widely in the test instrument

marketplace in the past, the claim rarely meant that the device would shut itself down completely. On some DMMs with this feature, the device just switches to a low-drain condition. The new DMMs, however, will turn themselves off—completely—after an hour of unattended operation.

Microprocessor enhancements

Microprocessors are finding increasing use in the latest auto-ranging DMM designs. They provide both memory and math capabilities, which make some very useful measurements possible.

Minimum/maximum recording capability.

Min/max capability allows you to leave the meter unattended for long periods of time during which the me-

ter can measure and store the highest and lowest values sensed.

Recent innovations allow auto-ranging DMMs to also perform auto-ranging when in min/max recording mode. So, you need not be concerned with the meter's setup prior to initiating the recording mode.

Automatic recording hold. A number of new DMMs offer a very useful capability for making a measurement when you are not able to observe the display at that moment. With this capability, the meter automatically detects and holds any steady readings. You can remove the test leads from the circuit and then observe the display when it is convenient or safe to do so.

Relative mode

This function enables the DMM to

subtract offset voltages, resistance values, or current values automatically. When relative mode is engaged, the meter takes the initial measurement reading, stores the value in memory, and then shows zero in the display. Upon any subsequent measurements, the meter displays the difference between the initial and the present measured values. For example, relative mode can be used to zero-out test lead resistance in order to improve the accuracy of a low-resistance measurement.

Resolution/price tradeoffs

DMM buyers now enjoy a wider selection of display resolutions, at different price levels. Until recently, most DMM offerings include display counts of 3½ digits (0000 to 1999 counts) or 3¾ digits (0000 to 3999 counts). Higher priced models offer 4½ digits (00000 to 19999 counts). A recent development is that full 4-digit DMMs now are available at relatively modest cost. These meters provide readings of 0000 to 9999 counts.

The resolution of a DMM refers to the smallest numeric value that can be read on the display. Factors that determine resolution are the number of digits displayed and the number of ranges available for each function.

One benefit of DMMs with a greater number of display counts is the ability to resolve smaller differences in commonly encountered measured values. For instance, a 3999-count DMM can display an AC voltage of 230.2, whereas a DMM with 1999 counts can only display 230 for the same measurement. In other words, you won't be able to see voltage changes in tenths on any voltage over 199.9.

The newer 4 or 4½ digit DMMs offer even more resolution. You can, for example, measure 480VAC signals with 0.1V resolution. This cannot be done with either the 3½ or 3¾ digit DMMs.

Amid all these technical considerations, let's not forget the basic good news that all of the product improvements and enhancements described here are becoming available on professional-grade DMMs at relatively modest prices. This may be a pleasant surprise for the individual user, but it can be major deciding factor for the service manager who needs to buy a hand-held DMM for every technician on the staff. ■

Take Five This Summer...

... Five training manuals that is. Our Summer Video Training Special features all five of Matsushita's Video Products Training Manuals, covering Panasonic and Quasar VHS Movie and tabletop VCRs from 1986 through 1989. Included in this package is the VP-06, our latest video products training manual, covering digital circuitry, the GII mechanism and the dual camera system for the 1989 models.

I'll take five... but pay for just four! Send me MSC's Summer Video Training Special at the special price of \$87.95, shipping and handling included. My check or money order is enclosed.
(NJ residents please add \$4.80 sales tax)

I wish to order only the VP-06. My check or money order for \$23.95 will cover its price, including shipping and handling.
(NJ residents please add \$1.20 sales tax)

Please send me a free copy of your latest catalog, featuring technical training publications, videotapes and video-based training programs.

Order Now!

Sale ends July 31, 1990

Please allow 4-8 weeks for delivery. Sorry, but we cannot accept C.O.D.s, purchase orders, credit cards, account charges or orders from outside the USA.



Ship To:
(PLEASE PRINT)

Name _____

Company _____

Address _____

City _____ State _____ Zip _____

Amount Enclosed: \$ _____

Mail Coupon To:
Matsushita Services Company
Technical Administrative Department
50 Meadowland Parkway 2B-6 Secaucus, NJ 07094

Matsushita Services Company

Panasonic

Technics

Quasar

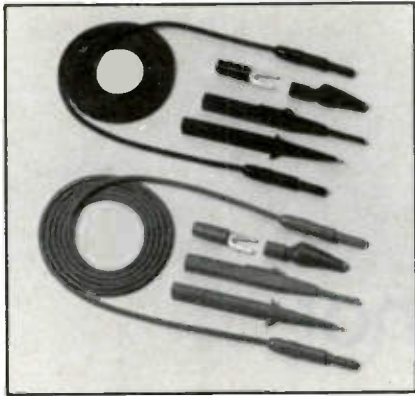

DELUXE TEST LEAD KIT

Users call TPI test leads **The Absolute Best**. The TLS2000 features the highest quality cable in the industry — with spring-loaded safety-sleeved plugs. U.L. listed (file E79581). Kit: \$29. Leads & probes only: \$19. Satisfaction guaranteed. **TEST PROBES INC.** Call toll-free for catalog: 1-800-368-5719.

Circle (36) on Reply Card

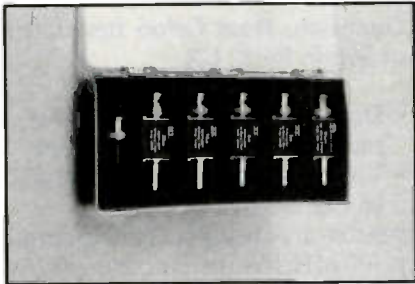

BNC ATTENUATOR KIT

Contains 4 attenuators — 3dB, 6dB, 10dB, 20dB; 1 feedthrough and 1 termination. Thick-film circuitry for low reactances. Rugged design resists shock and lasts longer. Rectangular shape stays put on the bench. Impedance: 50Ω Frequency: 1GHz. Maximum Power: 1kW peak, 1W avg. VSWR 1.2:1. Attenuator Accuracy: ±0.2dB. Terminations Resistance Tolerance: ±1%. \$150. **TEST PROBES INC.** Call toll-free for catalog: 1-800-368-5719.

Circle (37) on Reply Card

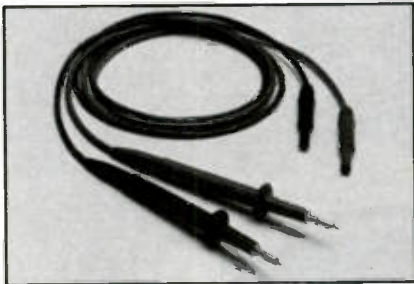

ECONOMICAL SILICON RUBBER TEST LEADS

Best value in moderately priced leads. High quality, soft, silicon rubber cable. Banana plug on measuring tip accepts push-on accessories. Plugs have spring-loaded safety sleeves. Model TL1000 \$14. Satisfaction guaranteed. **TEST PROBES INC.** Call toll-free for catalog: 1-800-368-5719.

Circle (38) on Reply Card



COAX ADAPTER KIT

- Create any adapter in seconds
- Make all combinations of BNC, TNC, SMA, N, UHF, Mini-UHF, F and RCA

The TPI 3000A kit contains male and female connectors of all 8 types, and 6 universal interfaces. Simply screw any combination of 24 connectors to one of the interfaces to create the desired adapter. \$150.

TEST PROBES INC. 9178 Brown Deer, San Diego, California 92121. Call toll-free for catalog: 1-800-368-5719.

Circle (35) on Reply Card



No Better Probe Ever at This Price!



Shown here
Model SP150
Switchable 1x-10x **\$49**

Risetime less than 1.5 nsec.

- **Universal** - works with all oscilloscopes
- **Removable Ground Lead**
- **Excludes External Interference** - even on scope's most sensitive range
- **Rugged** - withstands harsh environments including high temperature and humidity
- **Advanced Strain Relief** - cables last longer
- **Available in 10x, 1x and switchable 1x-10x**
- **10 day return policy** - performance and satisfaction guaranteed

TEST PROBES, INC. 

9178 Brown Deer Road
San Diego, CA 92121
Toll Free 1-800-368-5719

Call for free catalog and Distributor in your area

Circle (39) on Reply Card

When is an oscilloscope not an oscilloscope? When it's a computer

By The ES&T Staff

As mentioned in the introduction, oscilloscopes have come a long way in the past decade or so; advancing from waveform viewers to waveform analyzers. Microprocessors have allowed test equipment engineers to add such features as waveform parameter calculation and display, waveform storage, multiple traces, and more. Actually, taking a look at

some of the products coming to the market, you might get the idea that oscilloscopes are becoming more like computers, and, conversely, computers are more and more being used as oscilloscopes.

A scope that thinks it's a computer

Here's a description of the features of a new test instrument, called the

OmniLab, from Orion Instruments of Menlo Park, CA:

- Dual-channel 100MHz, 204 Mega-sample/sec digital oscilloscope
- Time-aligned logic analyzer (up to 96 channels)
- Arbitrary analog function generator
- 500 MHz frequency counter
- 20 MB hard disk

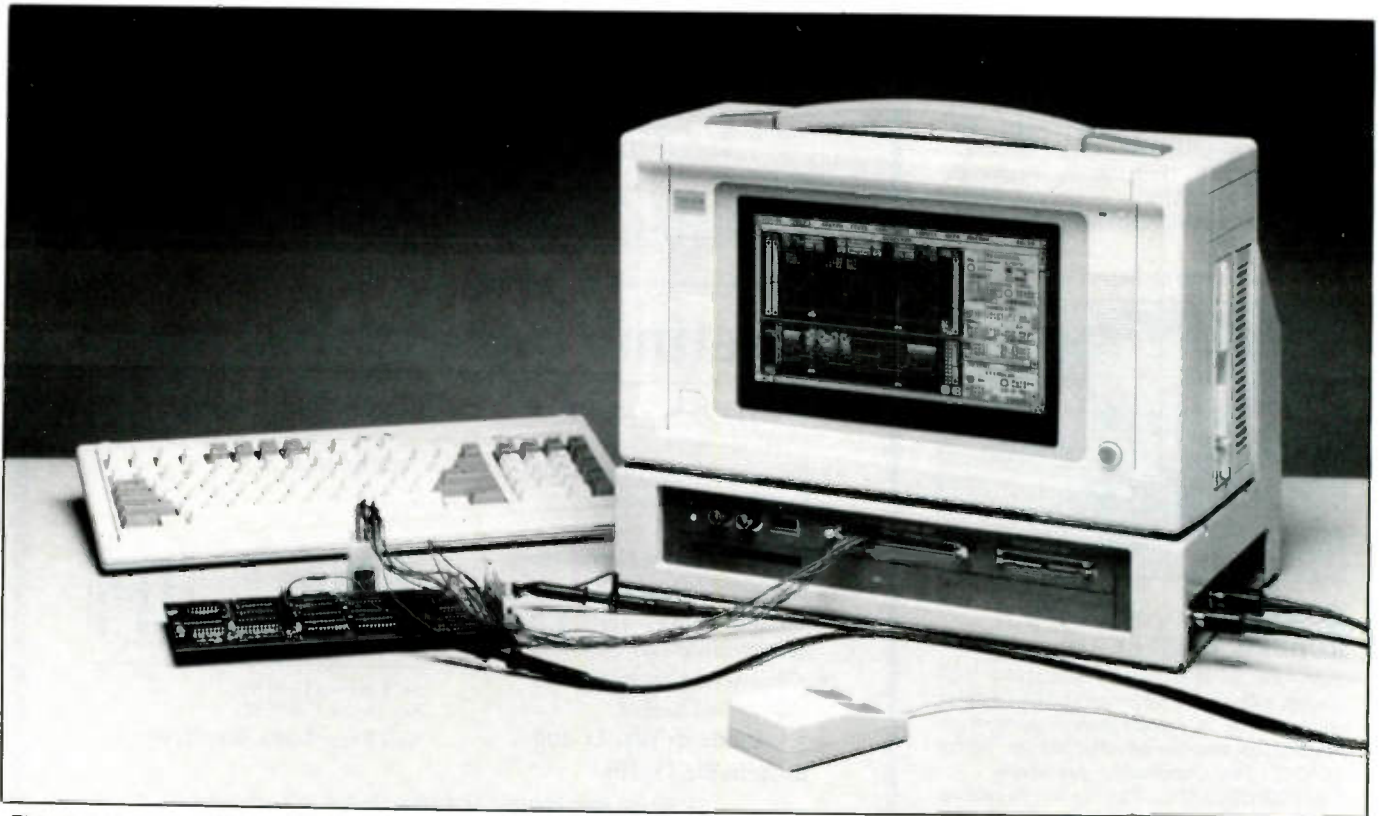

Figure 1. Increasingly sophisticated, microcomputer-based test instruments such as this oscilloscope, are displaying many of the attributes of computers, including data storage on disk, the ability to control other instruments and be controlled by other instruments, and to store detailed test procedures.

It's no fluke.

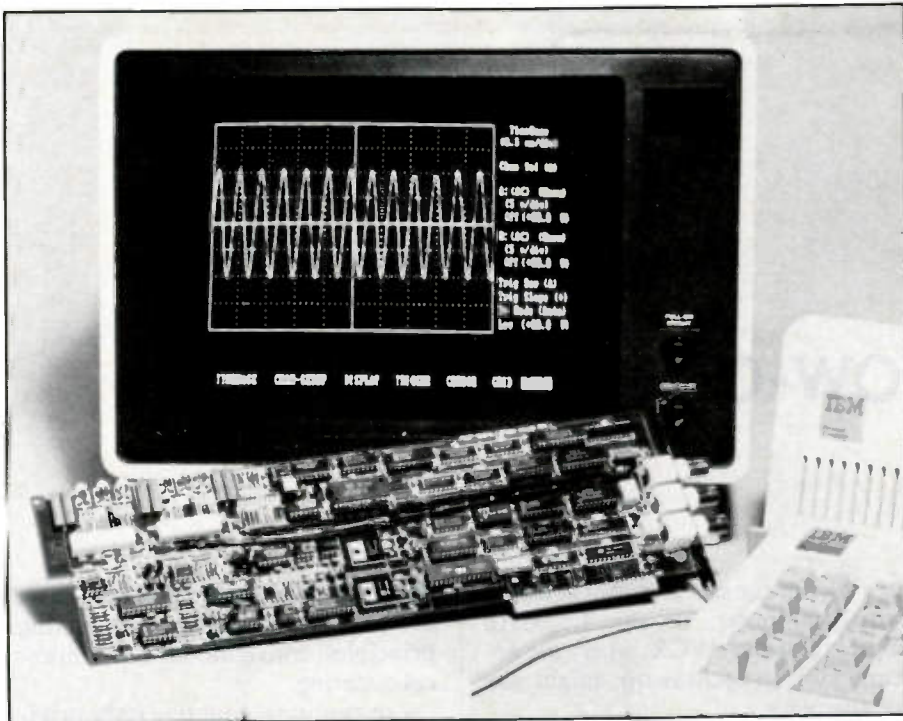

Figure 2. Add-in boards such as this oscilloscope board are being used to turn personal computers into powerful test equipment.

- 1.2 MB MS-DOS compatible floppy disk
- Printer port

At around \$14,000 per copy it's pretty much outside the comfort range for most, if not all servicing facilities, but the way performance has been going up while prices have been coming down, one day, in the not too distant future, this kind of product might be on every servicing bench.

A user can configure the unit for a specific test set-up using a mouse to adjust the settings until the test works correctly, then save the set-ups on disk. When the set-up information is recalled from disk later, the control settings, triggers, and other settings are displayed as they were originally configured. Test sequences can include prompts to guide a technician through a logical troubleshooting procedure by indicating where to connect scope probes and DIP clips.

And vice-versa

Pop this board into your PC or compatible and it can turn into an oscilloscope at the touch of a few keys on the keyboard. According to the manufacturer, Metrabyte of Taunton, MA, the PCIP-SCOPE is a 20 MHz digital sampling oscilloscope that provides all the features of a comparable bench top or rack mount instrument.

This unit provides dual-channel operation, 8-bit vertical resolution and full input protection. Software for the scope/computer comes in the form of a device driver that is loaded during system configuration each time the computer is rebooted or turned on. The user then accesses the oscilloscope by opening the device after which software commands are PRINTed to the oscilloscope circuit board and INPUTted from the board.

This device uses the computer screen for all instrument displays. Activated by a user defined hot key sequence, the display will pop up on the computer screen. The computer keyboard is used to control all instrument functions including Channel Select, Input Range, Sweep Time, Sampling, Trigger Source, Trigger Level and Function.

What's next?

Oscilloscopes along with their relatives, waveform analyzers and logic analyzers, have become truly sophisticated instruments capable of revealing a great deal about the circuits that they are being used to check, with less and less knowledge demanded of the operator. Perhaps future generations of these products will be just the test devices needed by future technicians to diagnose and repair increasingly complex consumer-electronics products. ■



Made in the U.S.A.

Building the best DMM for the money is no accident. The new RMS225 was carefully designed to give you what you wanted at a price you could afford. Visit your local distributor today and you'll agree the choice is obvious.

Fluke Model 77	Beckman Industrial RMS225
3-1/2 Digits	4 Digits
3,200 Counts	10,000 Counts
0.3% Accuracy	0.25% Accuracy
Touch Hold®	Probe Hold™
31 Segment Analog Bar Graph	41 Segment Analog Bar Graph
2,000 Hour Battery Life	500 Hour Battery Life
10A Range (Fused)	10A Range (Unfused)
Protective Holster	Protective Holster
3 Yr. Warranty	3 Yr. Warranty
—	True RMS
—	Auto Min Max™
—	Relative Mode
—	Self-Resetting Fuse (40mA Input)
\$159*	\$149

* Touch Hold is a registered trademark of the John Fluke Mfg. Co., Inc. ©1990 Fluke and Philips Catalog

Beckman Industrial™
An Affiliate of Emerson Electric Co.

Instrumentation Products Division
3883 Ruffin Road, San Diego, CA 92123-1898
(619) 495-3200 • FAX (619) 268-0172 • TLX 249031
Outside California 1-800-854-2708 Within California 1-800-227-9781
© 1990 Beckman Industrial Corporation. Specifications subject to change without notice. Fluke is a registered trademark of John Fluke Mfg. Co. Inc.

Circle (4) on Reply Card

Selecting a low-cost counter

By Mark Mullins

Frequency counters are used widely for accurate frequency measurements, for example, in telecommunications and navigation systems, and in general electronic and electro-mechanical equipment. Frequency counters are mainly used in service and maintenance, and in small-scale production testing.

One of the things that a consumer electronics servicing technician might test with a frequency counter is the frequency of the local oscillator

in a TV, or the clock crystal in a personal computer, or the 3.58MHz master clock in a VCR, where the accuracy of an oscilloscope might not be adequate.

These products have matured during the 1980s. Modern frequency counters are microprocessor-based, and offer a significantly increased performance/price ratio compared with traditional counters designed during the 1970s.

Resolution determines accuracy

Together with the timebase stability, the resolution determines the ac-

curacy of the measurement. There are basically two different counting principles: conventional and reciprocal counting.

Conventional counting is the original frequency counting principle; still used by most low-cost counters. Here the input cycles are gated to a counting register during a fixed gate time; normally 1s, but changeable in decade steps. This method has an inherent +1 input count error, which gives a resolution of 1 Hz for a 1s measuring time, regardless of the input frequency. As a result, the relative resolution is very poor for low input frequencies, and is good only for very high input frequencies (see Figure 1).

The use of microprocessors in counters made reciprocal counting possible. Instead of counting input cycles during a preset time, clock pulses from the internal timebase are accumulated during an integral number of input cycles. The measurement is always synchronized with the input period, and hence there is a +1 clock pulse error, but since the timebase oscillator normally operates at 10 MHz, the relative resolution is 1 pulse in 10 million pulses over a 1s measuring time, or 10^{-7} , for any input frequency (see Figure 2).

The displayed resolution is, of course, always limited by the available number of display digits. So a counter should have sufficient display digits to prevent the display itself from limiting the achievable resolution. Normally, 8 or 9 digits are sufficient.

Time base stability sets accuracy limits

The stability of the internal timebase sets the accuracy limits of the

Mullins is a Product Marketing Manager with Fluke

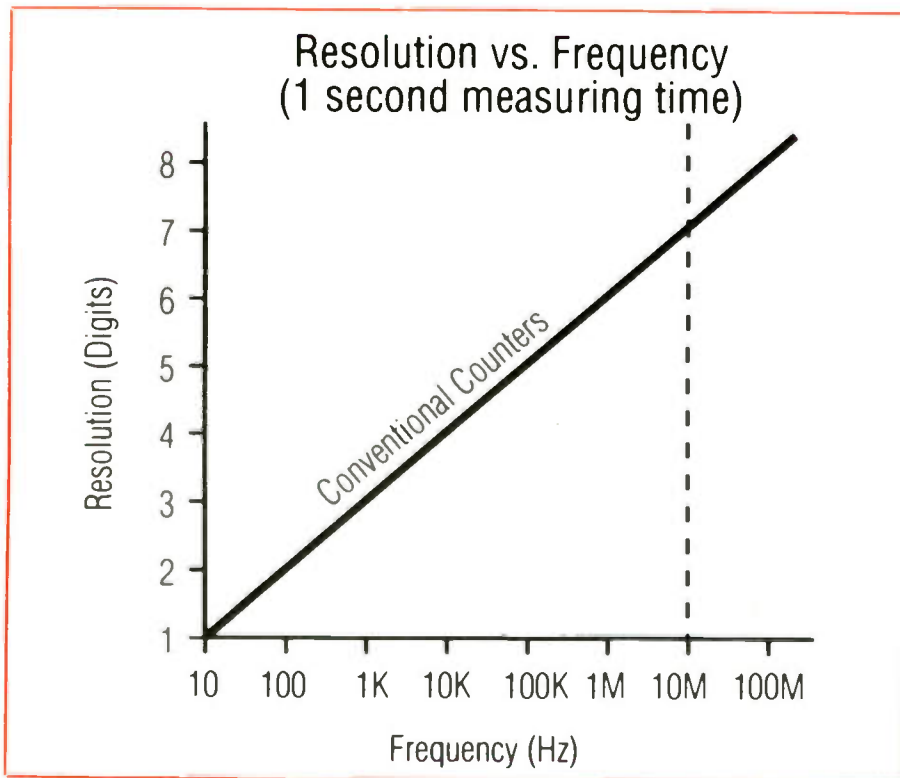

Figure 1. The relative resolution of a counter using conventional counting is very poor for low input frequencies, and is good only for very high input frequencies.

measurement. In counters, only quartz crystal oscillators are used. However, there are different categories of quartz crystal oscillators, with different levels of stability and, of course, with correspondingly different price tags. The major factors affecting oscillator stability are aging and temperature stability.

Aging is a property of crystals, and cannot automatically be compensated for in the oscillator circuits. Aging can be expressed as frequency drift against time, and determines the time between oscillator recalibrations for any desired level of accuracy. Good crystals, not surprisingly, have lower drift figures than lower quality ones. The monthly aging typically ranges from 10^{-6} to 10^{-8} , and the annual aging rate is typically 5 to 10 times higher.

Temperature stability is also a property of a crystal, but unlike aging, it can automatically be compensated for. The oscillators can be divided into four categories, depending on their frequency versus temperature characteristics. The different categories of timebase oscillators are: UCXO (or standard timebase), TCXO, MTCXO and OCXO.

UCXO, UnCompensated X-tal Oscillator, which contains a standard quartz crystal, intended to operate at room temperature. Typical stability of a UCXO is 10^{-5} over the specified temperature range, e.g. 0 to 50°C. With a UCXO, you can count on 5 relevant display digits. TCXO, Temperature Compensated X-tal Oscillator, contains a compensating network, which measures the temperature and applies a correcting voltage to the tuning circuit of the oscillator. The residual frequency stability after compensation is typically 10^{-6} over

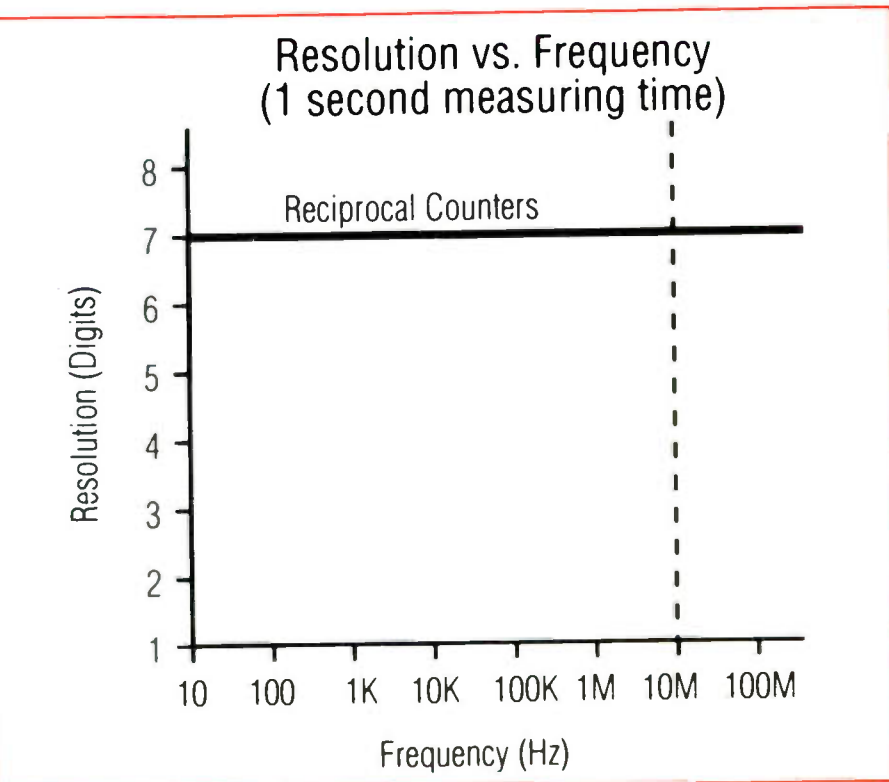

Figure 2. Reciprocal counting, made possible with microprocessors, results in excellent relative resolution at all frequencies.

the specified temperature range, e.g. 0 to 50°C, or ten times better than for the UCXO. You can count on 6 relevant display digits with a TCXO.

MTCXO, Mathematically Temperature Compensated X-tal Oscillator, consists of UCXO, a temperature measuring circuit and a ROM memory in which the crystal's temperature dependency curve is stored. In use, the operating temperature of the crystal is measured, the corresponding compensating factor is looked up in the ROM, and the microprocessor compensates the measuring result before it is displayed (see Figure 3).

This "software compensation" method yields an even better stability than the "hardware compensation" of a TCXO; typically 10^{-7} over the specified temperature range, or 100 times better than the UCXO. You can count on 7 relevant display digits with an MTCXO.

OCXO means Oven Controlled X-tal Oscillator. In these timebase oscillators, the complete oscillator circuitry is kept in an enclosure (oven), whose temperature is controlled; normally to 70°C + about 0.1°C, or sometimes to 0.01°C.

The OCXO is quite expensive, but also provides the best stability, typi-

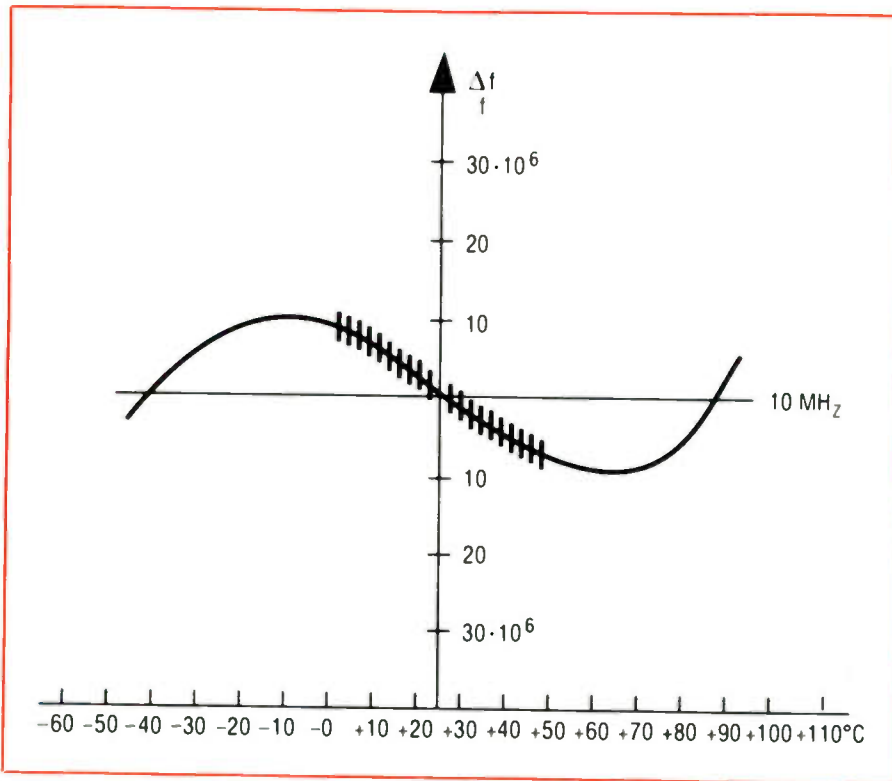

Figure 3. In a mathematically temperature compensated crystal oscillator (MTCXO), the temperature dependency curve of the crystal is stored in a read only memory. The hardware senses the temperature of the crystal, looks up the corresponding compensation information and applies it.

cally ranging from 10^{-7} for the low-end OCXOs up to 10^{-9} for the high-end oscillators. You can thus count on 7 to 9 relevant display digits.

Input trigger circuitry

No frequency counter is better than its front-end circuitry. Any

counter will trigger on noisy, distorted, or low-level signals; signals with very high or very low duty factor, AM-modulated signals etc. A high-quality counter also has a high input overload protection. Generally speaking, the design of the input front-end circuitry represents the

most significant difference between high-quality and low-quality counters.

To be able to measure on low-level signals, for example on telecommunications equipment, the counter must have a sufficiently high sensitivity; at least $\leq 30 \text{ mV}_{\text{RMS}}$. A flat frequency response is important when measuring on signals that contain harmonics, subharmonics or significant noise components. The frequency response curve must under no circumstance show any discontinuities, with "sensitivity peaks" at some frequencies. However, even a "flat", highly sensitive input will be sensitive to noise, spikes and spurious signals. When measuring on high-level signals, superimposed noise or interference can cause false triggering if the input sensitivity is too high. For audio frequency measurements, a low-pass filter can be used to reject HF noise.

However, to increase the noise immunity for all input signal frequencies, it is of the utmost importance that the input signal can be attenuated over a wide range, in not less than 10 dB steps (see Figure 4). Attenuators in the form of an AGC (Automatic Gain Control) cannot be used for measurements on AM-modulated signals. A passive input attenuator is therefore the preferred solution.

All frequency counters have AC-coupled inputs. These inputs can cause problems when making measurements on asymmetrical signals.

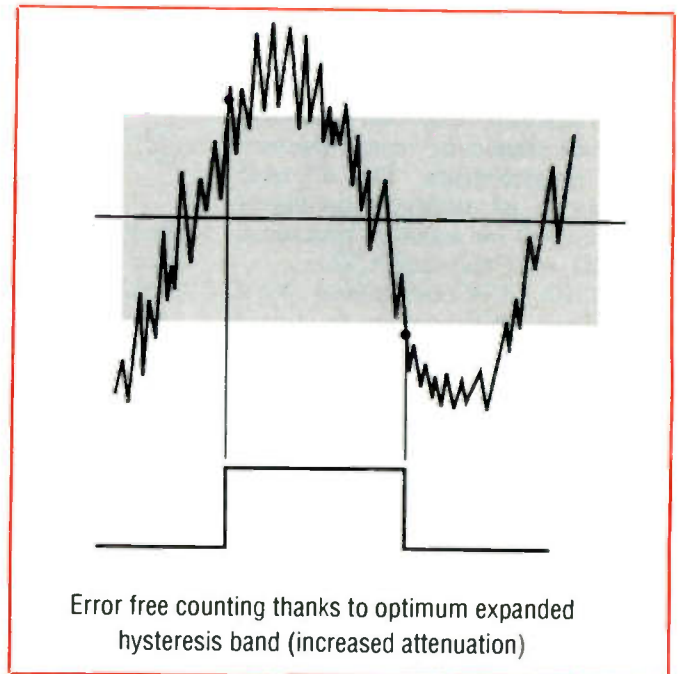
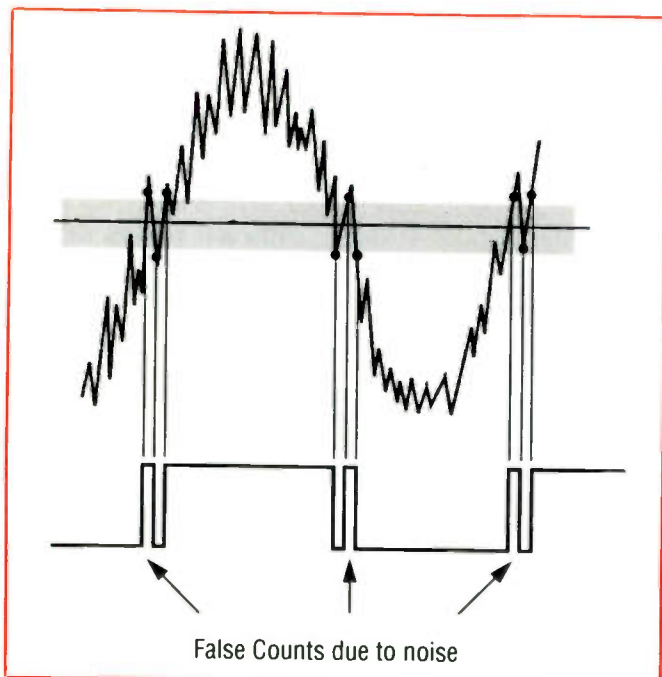

Figure 4: A variable input attenuator allows the influence of noise to be suppressed.

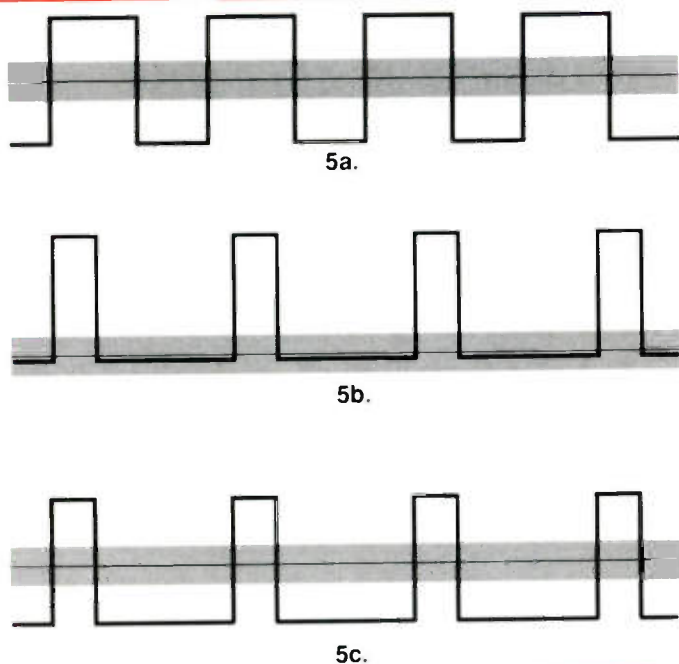

Figure 5: A trigger level offset is necessary for correct triggering on any input waveform.

With symmetrical pulses, the trigger window of the counter is neatly positioned right in the middle of the signal (see Figure 5A). When the pulses are narrower (lower duty factor), the average DC component of the signal is closer to the baseline (Figure 5B). Because of the input's AC coupling, the trigger window follows the V_{DC} level of the input signal. In the example shown in Figure 5B, the input will not trigger, since the signal has been shifted and will no longer cross the trigger window.

Most low-cost counters can't measure the frequency of signals which are too asymmetrical. There is, however, a way to solve this problem: a Trigger Level Offset. By offsetting the trigger level with a voltage equal to approximately 50% of the trigger window, the trigger window is moved back into the signal, and the input will trigger (Figure 5C).

This trigger level offset facility can be implemented automatically, i.e. the counter will automatically detect if the duty factor of the input signal is close to 0.5, very high or very low, and will set the corresponding offset. In other counters, the offset must be set manually, which means that the operator must know the characteristics of the input waveform.

Another measure of input circuitry quality is the degree of input protection against incidental overloads. A

minimum requirement is that the input must be able to withstand the ac-line voltage without damage.

Good RF screening essential

The counter must not itself generate RF radiation that could be picked-up by the measuring object. Good RF screening also protects the counter from the influence of external RF sources. Good screening of RF interference (RFI) requires that the counter have a metal cabinet that provides a closed box. Under all circumstances, counters must comply with the internationally accepted FCC part 15J regulations (US) and VDE 0871B regulations (Germany).

Ruggedness and durability for field service

A counter used for field service will need to have rugged construction, so that it can withstand abuse, and it must have a wide operating temperature range.

The electrical design is also very important for long trouble-free operation. Modern, highly integrated designs give a longer MTBF (Mean Time Between Failure) than older designs. In modern microprocessor-based counters, the counting circuitry is sometimes contained in only two components: a one-chip microcomputer and a one-chip LSI counter.

Unnecessarily complex operation or a cluttered and unclear front-panel layout could lead to operator mistakes. The modern microprocessor-based counters are, in general, more user friendly than older "hard-wired" designs. The microprocessor can automate settings (like trigger level offset), make validity checks on connected external reference signals, automatically set the correct measuring range, calculate correct display resolution, give warnings and error messages, etc.

Performance upgrading to meet changing demands

No single counter model can fulfill all possible user requirements at the same time. However, the best solution is when the basic counter model can be extended later, for example by adding a UHF input, a high-stability timebase oscillator, a battery power pack, a GPIB interface etc., whenever the need arises. Ideally, it should be easy for the user to upgrade the counter in the field by simple addition of the desired options to the basic instrument. ■

LEARN VCR

CLEANING/MAINTENANCE/REPAIR

EARN UP TO \$1000 A WEEK, WORKING PART TIME FROM YOUR OWN HOME!



Secrets Revealed!

NO Special Tools or Equipment Needed.

EARN UP TO \$50 AN HOUR AND MORE!

THE MONEYMAKING OPPORTUNITY OF THE 1990's

IF you are able to work with common small hand tools, and are familiar with basic electronics (i.e. able to use voltmeter, understand DC electronics)...

IF you possess average mechanical ability, and have a VCR on which to practice and learn...then we can teach YOU VCR maintenance and repair!

FACT: up to 90% of ALL VCR malfunctions are due to simple MECHANICAL or ELECTRO-MECHANICAL breakdowns!

FACT: over 77 million VCRs in use today nationwide! Average VCR needs service or repair every 12 to 18 months!

Viejo's 400 PAGE TRAINING MANUAL (over 500 photos and illustrations) and AWARD-WINNING VIDEO TRAINING TAPE reveals the SECRETS of VCR maintenance and repair - "real-world" information that is NOT available elsewhere!

Also includes all the info you'll need regarding the BUSINESS-SIDE of running a successful service operation!

FREE INFORMATION

CALL TOLL-FREE 1-800-537-0589
Or write to Viejo Publications, Inc.
3540 Wilshire Bl., STE 310
Los Angeles, CA 90010, Dept. EST

Circle (28) on Reply Card

Keeping PC hard disk drives up and running

Hard disks age and develop frustrating errors. Preventative maintenance products are available, which will correct potential problems before they happen.

By Steve Gibson

Today, most personal computers contain hard disks that often end up being a source of frustration both for the users and for those who support and service the PCs. Users expect

Gibson is President of Gibson Research Corp., Laguna Hills, CA.

that the data stored on the disk will always be available for use. Even though they are warned over and over again that the hard disk should be backed up after every day's use, most users don't really think that their hard disks will ever go bad. But hard disks can and do fail. They either

fail due to an electromechanical problem, or because the drive will simply not read data that has earlier been written to the disk. The inability to read data is by far the more common problem.

Products exist on the market that can prevent "inability to read data" problems from ever occurring. These products perform functions such as testing the disk's surface looking for defects in order to mark the bad sectors as off-limits for new data; re-writing the low-level format so as to realign the heads and the tracks on the disk; and tuning up the disk drive in a variety of other ways. Some of these products can even recover data after it is seemingly lost.

What can go wrong on the drive?

All hard disk drives have one or more surfaces coated with magnetic material. Each surface is subdivided into a number of tracks. Each track is divided into smaller pieces called sectors. Sectors begin with special sector-addressing information, followed by 4096 data bits organized into 512 bytes. Drives that use MFM encoding store 17 such sectors per track, while drives that use RLL encoding squeeze 26 sectors into the same space. When a drive is looking for a sector, the heads are first positioned over the appropriate track and then the track is continuously read until the proper sector-addressing in-

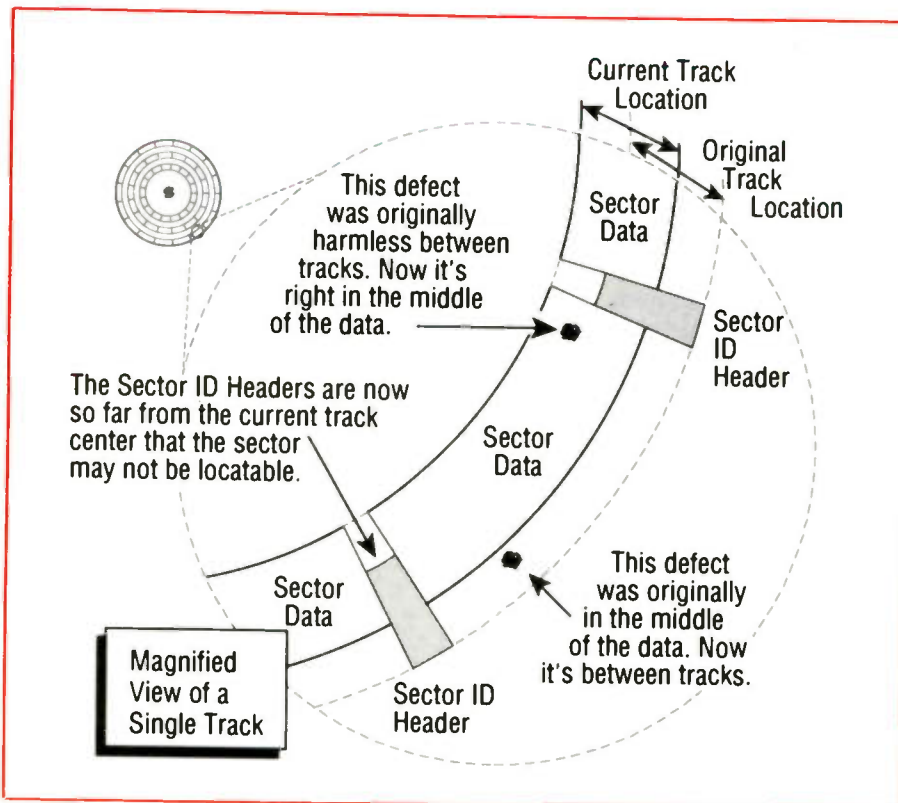

Over a period of time, the data on the hard disk may become out of position relative to the original low-level formatting, resulting in "sector not found" errors. Software that is now available can keep hard disks "tuned up", and prevent this problem.

(Continued on page 37)

HITACHI CT4580K, VP7X2 CHASSIS PROJECTION COLOR TV DEFLECTION SCHEMATIC

Product safety should be considered when component replacement is made in any area of an electronics product. A star next to a component symbol number designates components in which safety is of special significance. It is recommended that only exact cataloged parts be used for replacement of these components.

Use of substitute replacement parts that do not have the same safety characteristics as recommended in factory service information may create shock, fire, excessive x-radiation or other hazards.

This schematic is for the use of qualified technicians only. This instrument contains no user-serviceable parts.

The other portions of this schematic may be found on other Profax pages.

All integrated circuits and many other semiconductors are electrostatically sensitive and require special handling techniques.

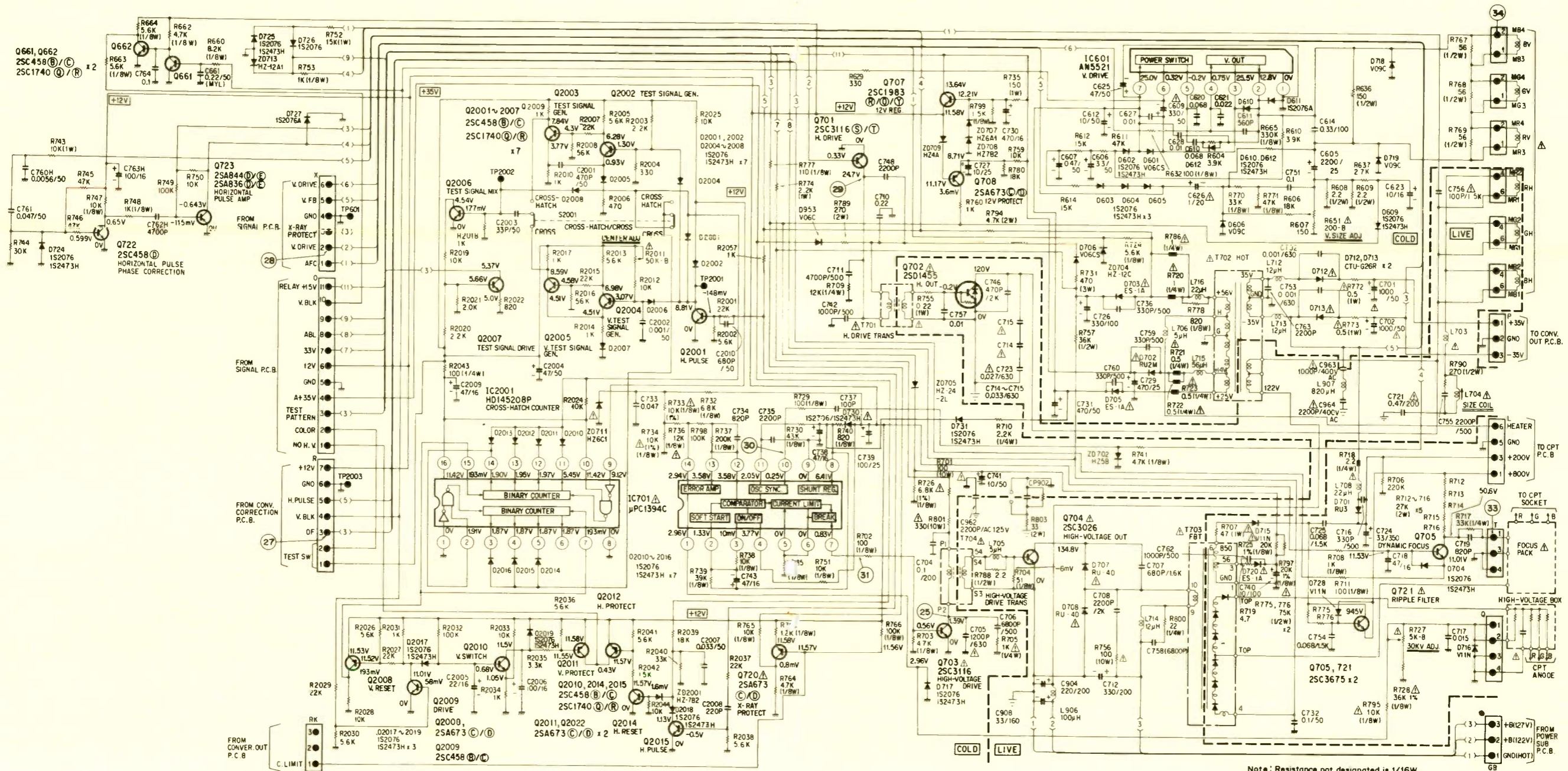

HITACHI CT4580K, VP7X2 CHASSIS PROJECTION COLOR TV CONVERGENCE ADJUSTMENT

HITACHI CT4580K, VP7X2 CHASSIS PROJECTION COLOR TV CONVERGENCE ADJUSTMENT

Product safety should be considered when component replacement is made in any area of an electronics product. A star next to a component symbol number designates components in which safety is of special significance. It is recommended that only exact cataloged parts be used for replacement of these components.

Use of substitute replacement parts that do not have the same safety characteristics as recommended in factory service information may create shock, fire, excessive x-radiation or other hazards.

This schematic is for the use of qualified technicians only. This instrument contains no user-serviceable parts.

The other portions of this schematic may be found on other Profax pages.

All integrated circuits and many other semiconductors are electrostatically sensitive and require special handling techniques.

Product safety should be considered when component replacement is made in any area of an electronics product. A star next to a component symbol number designates components in which safety is of special significance. It is recommended that only exact cataloged parts be used for replacement of these components.

Use of substitute replacement parts that do not have the same safety characteristics as recommended in factory service information may create shock, fire, excessive x-radiation or other hazards.

This schematic is for the use of qualified technicians only. This instrument contains no user-serviceable parts.

The other portions of this schematic may be found on other Profax pages.

All integrated circuits and many other semiconductors are electrostatically sensitive and require special handling techniques.

CONVERGENCE CORRECTION AND CONVERGENCE OUT CIRCUIT DIAGRAM

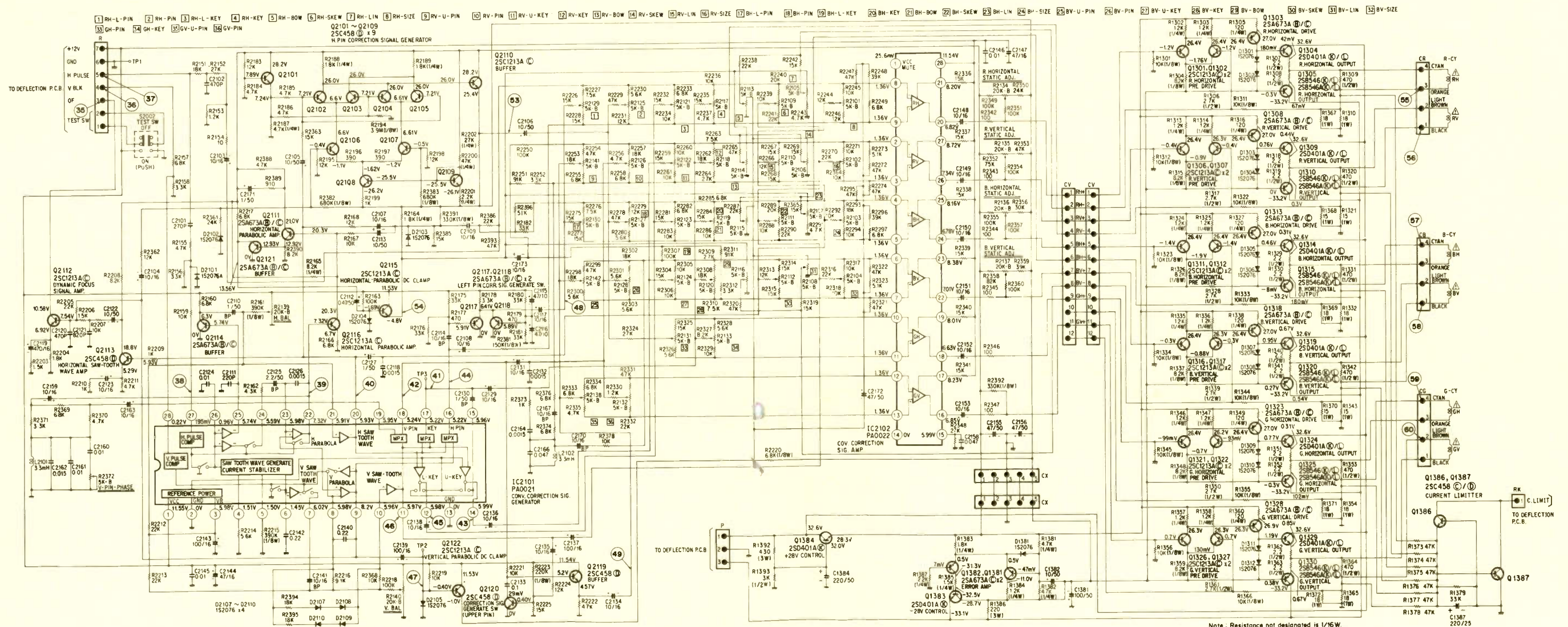

HITACHI CT4580K, VP7X2 CHASSIS PROJECTION COLOR TV
SIGNAL CIRCUIT 1/2

Product safety should be considered when component replacement is made in any area of an electronics product. A star next to a component symbol number designates components in which safety is of special significance. It is recommended that only exact cataloged parts be used for replacement of these components.

Use of substitute replacement parts that do not have the same safety characteristics as recommended in factory service information may create shock, fire, excessive x-radiation or other hazards.

This schematic is for the use of qualified technicians only. This instrument contains no user-serviceable parts.

The other portions of this schematic may be found on other Profax pages.

All integrated circuits and many other semiconductors are electrostatically sensitive and require special handling techniques.

HITACHI CT4580K, VP7X2 CHASSIS PROJECTION COLOR TV
SIGNAL CIRCUIT 1/2

Product safety should be considered when component replacement is made in any area of an electronics product. A star next to a component symbol number designates components in which safety is of special significance. It is recommended that only exact cataloged parts be used for replacement of these components.

Use of substitute replacement parts that do not have the same safety characteristics as recommended in factory service information may create shock, fire, excessive x-radiation or other hazards.

This schematic is for the use of qualified technicians only. This instrument contains no user-serviceable parts.

The other portions of this schematic may be found on other Profax pages.

All integrated circuits and many other semiconductors are electrostatically sensitive and require special handling techniques.

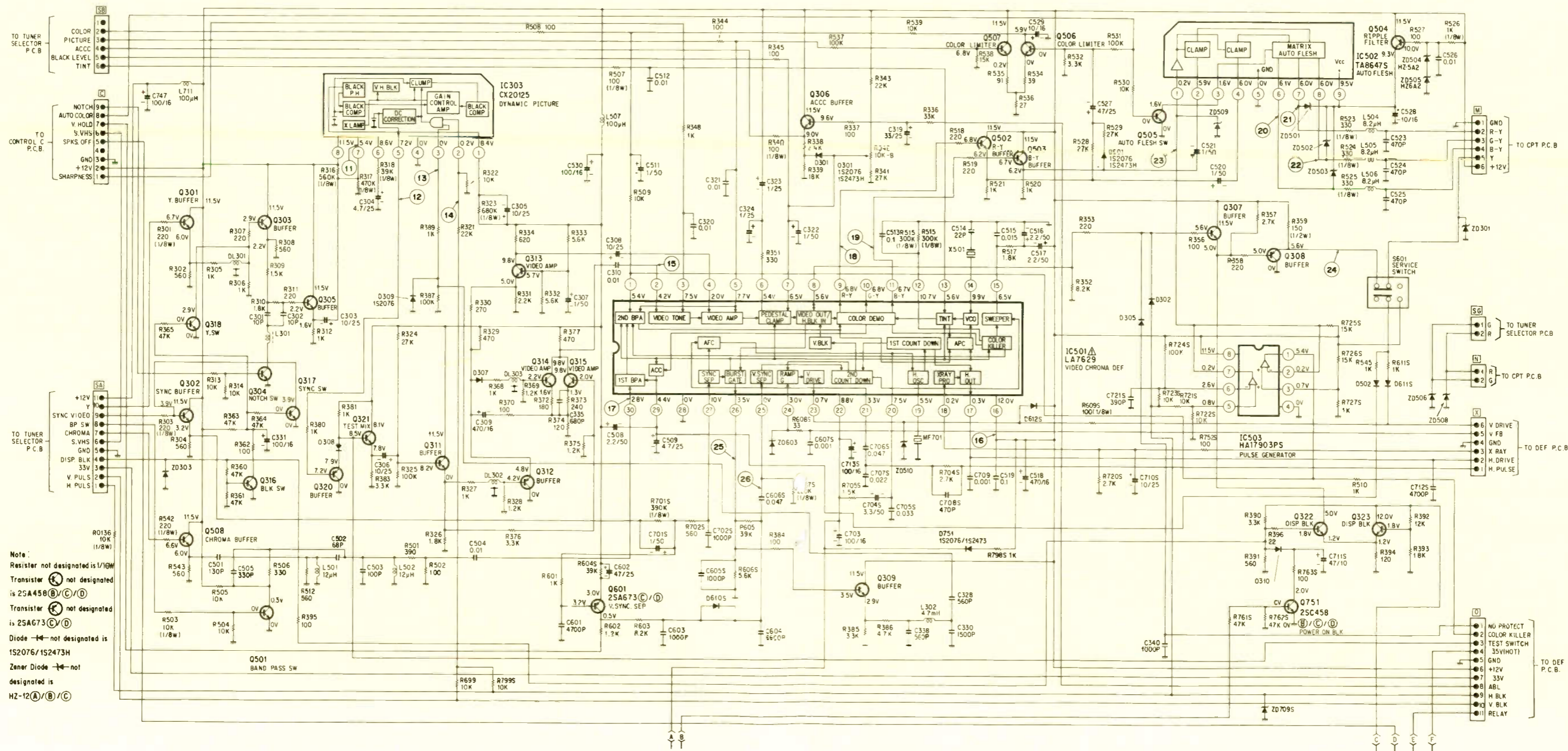

June 1990

Profax Number

Hitachi
CT4580K, VP7X2 chassis projection color TV 3065

Product safety should be considered when component replacement is made in any area of an electronics product. A star next to a component symbol number designates components in which safety is of special significance. It is recommended that only exact cataloged parts be used for replacement of these components.

Use of substitute replacement parts that do not have the same safety characteristics as recommended in factory service information may create shock, fire, excessive x-radiation or other hazards.

This schematic is for the use of qualified technicians only. This instrument contains no user-serviceable parts.

The other portions of this schematic may be found on other Profax pages.

Product safety should be considered when component replacement is made in any area of an electronics product. A star next to a component symbol number designates components in which safety is of special significance. It is recommended that only exact cataloged parts be used for replacement of these components.

Use of substitute replacement parts that do not have the same safety characteristics as recommended in factory service information may create shock, fire, excessive x-radiation or other hazards.

This schematic is for the use of qualified technicians only. This instrument contains no user-serviceable parts.

The other portions of this schematic may be found on other Profax pages.

All integrated circuits and many other semiconductors are electrostatically sensitive and require special handling techniques.

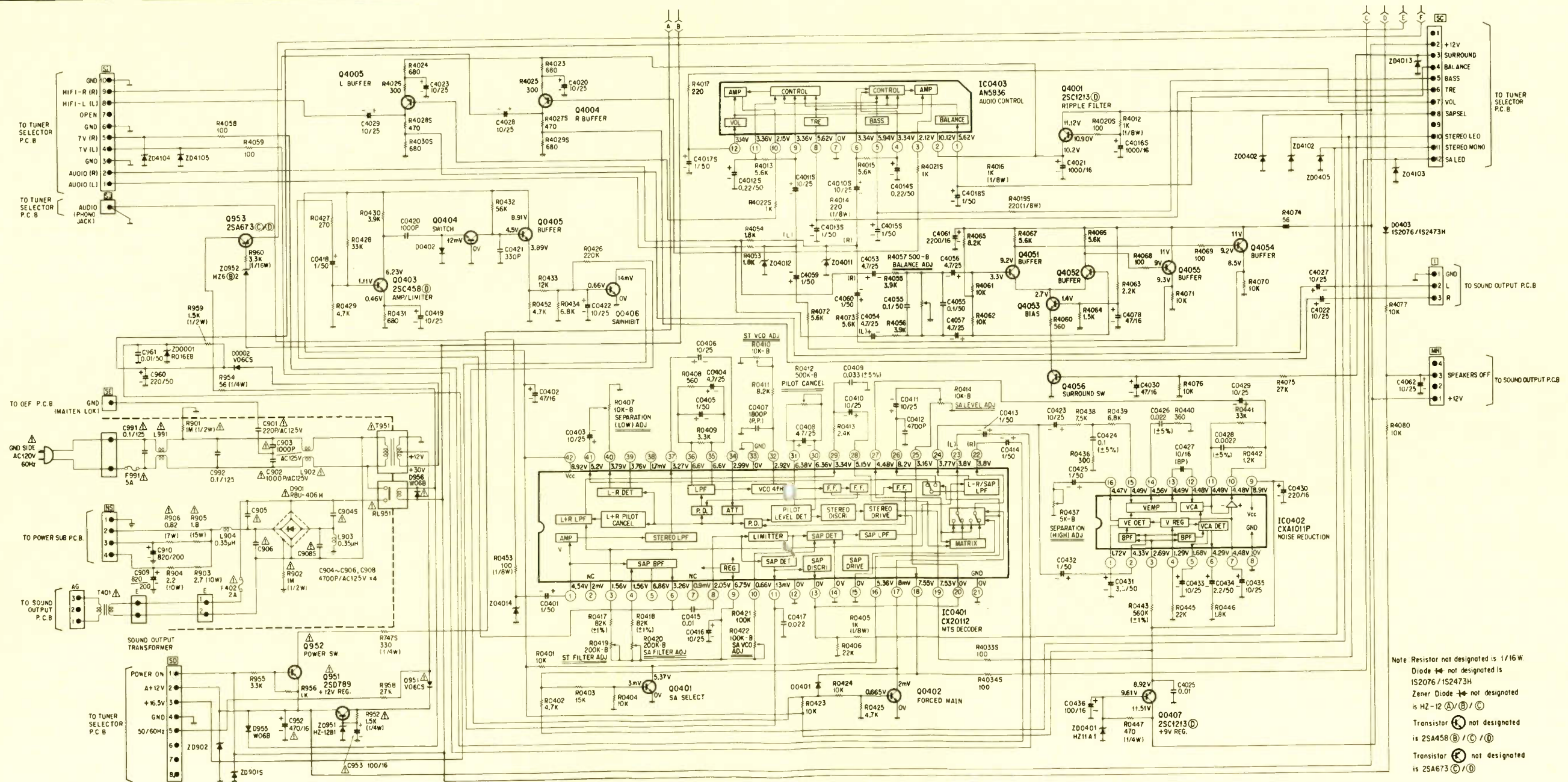

Keeping PC hard disk drives up and running

(from page 24)

formation is located. Finally, the data is read from the sector location.

This sector-addressing information is originally written to the disk's surface during a process known as low-level formatting. In other words, the low-level format actually defines the location of the tracks and sectors on the surface. Low-level formatting differs from the normal format command that exists in DOS. The format command when used on a hard disk does several things, the most important of which is to erase the File Allocation Table (FAT), which records where each file is located on the disk. Without data in the FAT, the computer cannot locate any files on the disk drive. Once the FAT is erased and reinitialized, the computer is free to rewrite new data over sectors that already have old data in them, thus eliminating any chance of recovering the old data from the drive. If a drive has been formatted in error, but new data has not been rewritten into the old sectors, there are utilities on the market that can rewrite the original FAT, thereby recovering the lost files.

One of the major problems that lead to hard disk failures is the aging of the low-level format. Remember, if the sector location information cannot be accurately read by the drive's head, data cannot be located on the drive. Think about it, every time a sector's data is changed, the entire sector is rewritten, thus strengthening the magnetic image of the data in that sector. But, the sector-addressing information put down during the low-level formatting is never rewritten. It sits there, slowly fading away, until the disk controller is finally unable to locate the sector at all. That's when DOS sends those undesirable "sector not found" messages. It is clearly much more desirable to occasionally renew the magnetic strength of the sector-addressing information.

Another leading contributor to the

"sector not found" problem is alignment drift due to long-term change in the relative position of the head and the track. If the track is not where the head positioner thinks it should be, it can't be read. Since the head positioner is a mechanical device, any wear in the mechanics of the head positioner results in misalignment of the head and the track. The gradual drifting of the relative position of the head to the track doesn't hurt the readability of the sector's data, since newly written data is positioned exactly underneath the current location of the read/write head. However, the gradual drifting of the drive's alignment drastically affects the drive's ability to find the sector in question, since the low-level format, which is always required to identify the sector, is never rewritten, and thus gradually becomes misaligned.

With time, the drive's heads can drift far enough from their original alignment that even newly written data cannot be found, because the sector cannot be found. If the low-level format of the drive is periodically rewritten, this problem will never arise.

The floating defect problem

When a drive is first manufactured, the disk surfaces are scanned and defective areas are noted. When the drive receives its initial low-level format, these defects are normally entered into the formatter, so that the sectors containing the defective spots can be flagged as bad and be completely skipped over by the DOS filing system. If the head/track alignment drifts, defects that were once located in the middle of tracks, may now "float" harmlessly between the new track locations, which frees once bad sectors for fresh data storage, and new defects that were previously unseen between tracks now migrate directly into the new track locations causing sectors that were good to be-

come unreliable. Thus, even if the tracks are rewritten to align them with where the head positioner is, it is also necessary to rigorously test the track locations for defects and update the DOS filing system with this information.

In addition to the above problems, hard disk drives can also experience a variety of other problems, some of which result in catastrophic format damage. It is clear from this discussion that the best form of preventative maintenance for hard disk drives is the occasional rewriting of the low-level formatting of the drive (at least once every 3 months is suggested).

Rewrite the low-level format non-destructively

Two approaches exist for rewriting the low-level format of the drive: destructive rewrite and non-destructive rewrite. Most available low-level formatting software instructs the user to completely back-up the information on the drive. This is necessary since the process of low-level formatting with these products erases all data on the existing tracks. The data must be restored after the low-level format is rewritten.

However, products do exist that can non-destructively rewrite the low-level format. That is, they take the data off a track and temporarily hold it in the computer's memory. Then the sector-addressing information is rewritten to eliminate the head/track misalignment, and the data is written back onto the newly located track. All of this is done without destroying any existing data or requiring its backup or restoration. Such products not only do a non-destructive low-level format, but also check the new tracks for defects to eliminate the floating defect problem. They may also tune up the drive by allowing the user to adjust the sector interleave factor for maximum drive throughput. ■

Drum and capstan servo systems

In VCR servicing, one of the more common problem areas has been the servo circuitry.

Videocassette recorders are immensely complex systems. Within a VCR, the drum in which the record and play heads are mounted spins at a high rate of speed. The capstan pulls the tape past the head drum. In order for a VCR to produce a stable picture, the speed of this drum must be precisely controlled. In addition, the tape speed as determined by the capstan motor speed, the precise position of the capstan motor, and the position of a point on the circumference of the drum must be precisely controlled so that during playback the tape head comes in contact with the tape in precisely the same place where the head contacted the tape during the recording process.

The servo systems are the systems within the VCR that provide this control. The drum servo system controls the speed and the position (normally

called phase by VCR manufacturers) of the head drum, and the capstan servo controls the speed of the capstan motor and therefore the tape speed, and the absolute position of the capstan motor at any moment. A VCR servo system provides the input that sets the speed of each motor, which in turn adjusts the relative phase of the motors, and also has components that sense phase and position and adjust the magnitude of the input to the motor to adjust that position and speed.

A rough nonelectronic analogy to a servo system is the driver of a car cruising down the highway. The driver keeps his foot on the accelerator to maintain the correct speed. He looks at the speedometer and sees that he's going five mph below the speed limit so he presses a little harder on the accelerator. After a short time he looks at the speedometer and sees that he's let the car's speed get up to three miles above the speed limit, so he eases the pressure on the accelerator

to slow down. The engine of the car is the controlled device, analogous to the head drum motor. The speedometer is the feedback signal, and the pressure on the accelerator is the input, analogous to the voltage that controls the head drum motor speed.

VCR servo systems are, in reality, a type of PLL (Phase Lock Loop) configuration. The controlled device in a conventional PLL circuit is a VCO (Voltage Controlled Oscillator), such as the local oscillator in a television tuner. A servo mechanism is a PLL in which a mechanical action is controlled. The drum and capstan servo systems in VCR control both the speed and phase (position) of the drum and capstan motors.

Basic speed control

In a VCR, the basic motor speed is initially determined by the voltage developed by a servo control IC as determined by the adjustment of a servo speed potentiometer. Correct speed is maintained by monitoring a reference signal output from the motor. This reference signal is proportional to the speed of the motor. Both the drum and capstan motors have an internal frequency generator (FG). The frequency of the FG signal is determined by the motor speed, increasing as the motor speed increases, and decreasing if the motor begins to slow. If the speed of the motor is incorrect, the FG frequency detected by the servo circuitry, will be incorrect, and an error correction voltage will be directed to the motor drive circuit to correct motor speed.

Basic phase control

Phase Control (Position Control) must be maintained in both the drum and capstan servos in both playback and record. In playback, phase con-

Adapted from an article in "The Expander," written by Ron Smith, head technical writer, Mitsubishi Sales America, Inc.

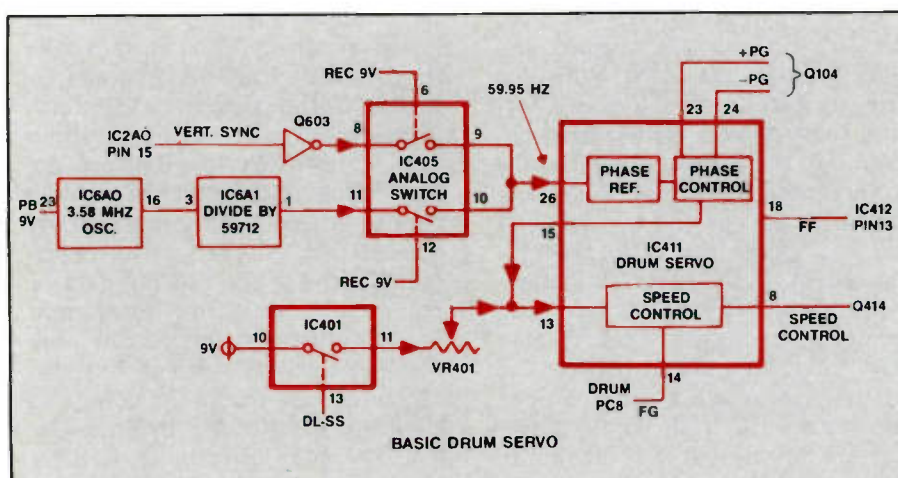

Figure 1. The drum servo controls the speed and phase (position) of the video head drum motor.

trol of the drum motor is necessary to insure accurate alignment of the video heads with the video tracks recorded on the tape. In record, phase control is necessary to insure that vertical sync is recorded at the same point in each video track. If phase control is not maintained in the capstan motor proper tracking is impossible, resulting in noise in the reproduced picture.

Video drum phase control

The basic drum servo diagram shown in Figure 1 was derived from the HS-230UR, but is similar to other Mitsubishi VCRs. The reference signal for the drum servo phase control is a 59.95Hz signal, applied to the drum servo IC411 at pin 26. In playback the reference signal is derived from a stable 3.58MHz oscillator in IC6A0. The output of the 3.58MHz oscillator is divided by 59,712 in IC6A1, resulting in a 59.95Hz output at pin 1, IC6A1. The 59.95Hz signal is directed to pin 26 of IC411 via the analog switch in IC405. In record, the reference signal is the incoming vertical sync from the program source, applied to pin 26, IC411 via Q603 and the analog switch in IC405.

In both playback and record the 59.95Hz reference signal is compared to a pulse generator (PG and -PG signal), which is representative of the position of the video heads. The flywheel on the bottom of the video drum shaft contains two magnets of opposite polarity mounted 180 degrees apart. A PG pick-up head is mounted near the flywheel, so that when the flywheel rotates the fields of the permanent magnets cut across that of PG pick-up head. Since the magnets are of opposite polarity, one positive pulse and one negative pulse are generated by the PG pick-up head

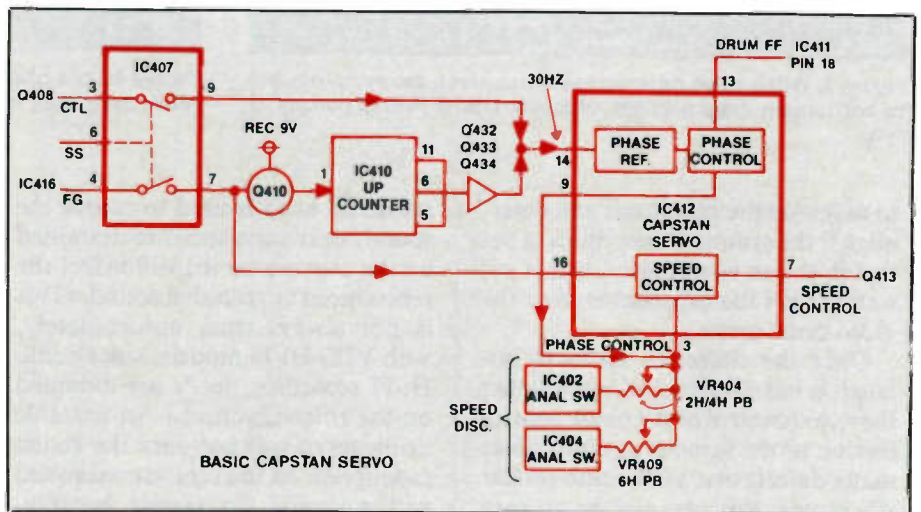

Figure 2. The capstan servo controls the speed and phase of the capstan motor, and consequently the speed and position of the videotape.

for each revolution of the drum flywheel. Consequently, the PG pulses also represent the relative speed of the drum motor. A phase difference between the reference signal and the PG signals will result in the generation of a phase correction voltage at pin 15, IC411, which is directed to the drum speed control circuit at pin 13, IC411, resulting in the required adjustment to the motor speed to assure an in-phase condition. A drum flip-flop (FF) signal is developed by IC411, available at pin 18, and will be used later as a reference signal for capstan phase control. Since the PG (position) pulses were used to form the drum FF signal, the phase of the FF signal also coincides with the position of the video heads; as such, the drum FF signals are utilized as video head switching signals.

Capstan phase control

Phase control of the capstan motor is achieved by comparing the 30Hz drum FF signal, applied to pin

13, IC412, to the 30Hz reference signal at pin 14, as illustrated in Figure 2. In record, the 30Hz reference is derived by dividing the capstan FG signal to produce a 30Hz reference signal. In playback, CTL (control track) pulses previously recorded on the tape serve as the 30Hz reference.

A difference in phase between the 80Hz reference signal and the drum FF signal results in the development of a capstan phase correction voltage output at pin 9 of IC412. The correction voltage is applied to the capstan speed control circuit at pin 3, slightly jogging the capstan motor to achieve an in-phase condition.

Troubleshooting servo systems

In VCR servicing, one of the more common problem areas has been the servo circuitry. The advent of digital servos used in the latest model VCRs has greatly reduced the number of servo problems. Many VCRs using analog servos are still in use, however, so the technician must be able

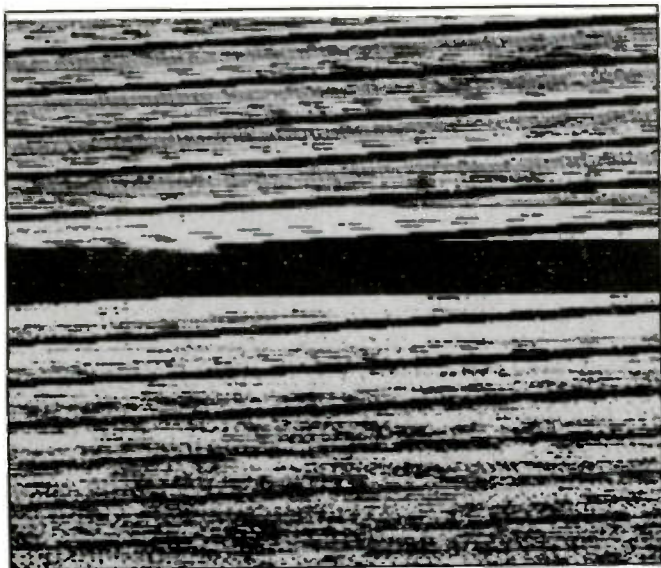

Figure 3. When video drum speed is incorrect, the symptom will be horizontally diagonal lines, characteristic of loss of horizontal sync.

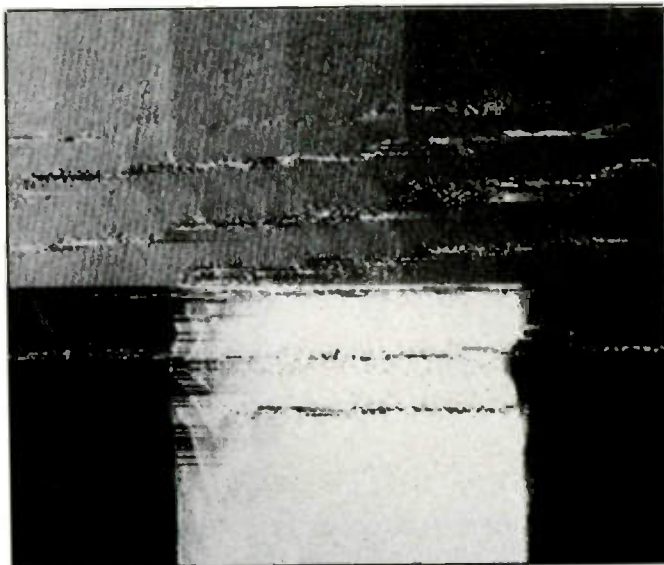

Figure 4. Loss of drum phase control usually results in a single noise bar in the picture.

to diagnose the symptoms and determine if the symptoms are due to a defect in the servo circuitry, and if so, whether it's the capstan servo or the video drum servo.

Once the defective servo is isolated, it must be determined whether the speed control or the phase control section of the servo is at fault. Since many defects in a VCR cause similar symptoms, this may not be an easy task. The following descriptions and illustrations should aid the technician in diagnosing servo problems.

Incorrect motor speed or a loss of phase control in either the capstan servo or the drum servo can produce similar symptoms in the reproduced picture in **PLAYBACK**. A substantial error in drum motor speed will usually cause a loss of horizontal and vertical synchronization, while smaller errors in the speed of either motor can cause noise in the playback picture.

A loss of phase control results in smaller speed errors, producing the associated noise or noise bars in the picture. Similar symptoms can be caused by other sections of the VCR, such as dirty or defective video heads, incorrect interchangeability adjustments, incorrect head switching, etc. Usually, when a phase control problem exists in a servo system, good tracking (a noise free picture) can be obtained momentarily but will not hold. If noise is due to other circuitry, it is usually there all the time.

When a servo problem is encountered, one key indicator that can be used to determine which servo system is at fault is the sound. Since a separ-

ate audio head is used to record the sound, only tape speed (determined by the capstan servo) will affect the reproduced or recorded sound. (This is not always true, unfortunately, with VHS Hi-Fi models, since audio Hi-Fi recording heads are mounted on the rotating drum.) An unstable drum servo will not vary the actual tape speed, so the reproduced sound will be normal. Conversely, instabilities in the capstan servo will affect tape speed, which is audible in the sound, a slow tape speed producing wow, and a fast tape speed producing high pitched sound.

Noise in playback

When the video drum is rotating at the correct speed (1800 RPM), the sync pulses picked up from the tape are at the normal NTSC frequencies, 15,734 Hertz for horizontal and approximately 60 Hertz vertical.

Drum speed errors

If the drum speed is incorrect, the horizontal and vertical sync picked up from the tape will not appear at the normal NTSC frequencies. The frequencies increase if the drum is fast and decrease if the drum is slow. Because of the incorrect sync pulse rate, the predominant symptom resulting from incorrect drum speed is horizontally diagonal lines as illustrated in Figure 3.

Drum phase errors

Should the drum phase control be lost, the video heads may not contact the tape at the correct point in time,

or may be activated when the head is not in contact with the tape. This usually causes a single noise bar in the picture, as shown in Figure 4. Usually if drum phase control is lost, the noise in the picture is not constant, but comes and goes.

Capstan speed errors

The capstan servo determines tape speed and phase. If the capstan speed control servo is defective, the tape runs at an incorrect speed and the effect is audible in the sound. An incorrect tape speed will cause a series of noise bars in the picture as shown in Figure 5. The number of noise bars varies with how far the tape speed has changed.

Capstan phase errors

If capstan phase control is lost, the video heads may traverse opposing azimuth video tracks producing a noise bar in the picture area, as illustrated in Figure 6. Usually the noise will come and go as the phase varies, and slight variation in the sound may be audible. If the customer Tracking Control has to be constantly readjusted to move noise from the picture, it is usually caused by a defect in the capstan phase servo.

Servo basic troubleshooting procedure

When it is determined which servo system is at fault the following servo basic troubleshooting procedure, in conjunction with the appropriate VCR training manual and service manual, should help the technician in

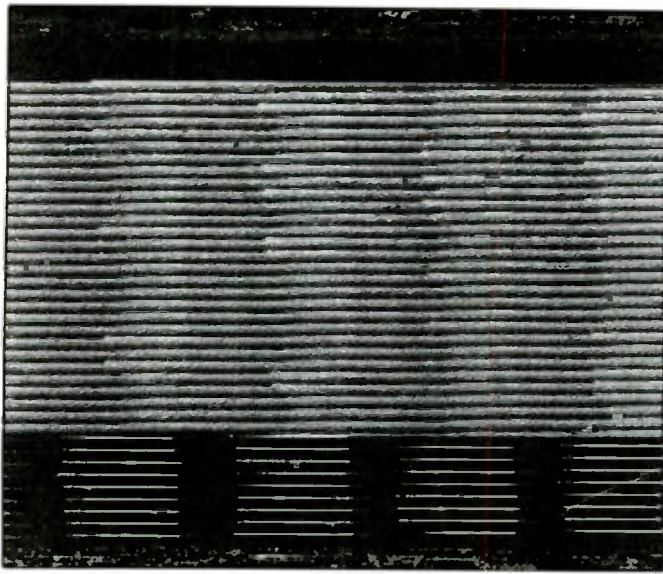

Figure 5. Incorrect tape speed, the consequence of incorrect capstan speed control, will result in a symptom consisting of a number of noise bars in the picture.

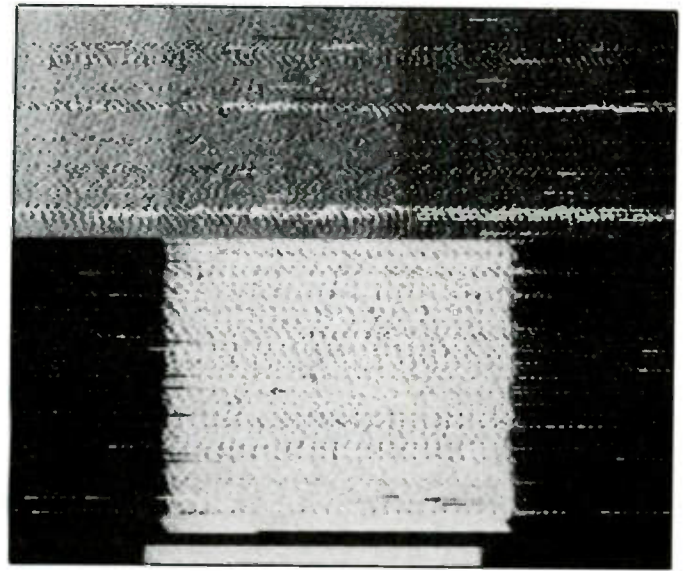

Figure 6. Loss of capstan phase control will be a noise bar in the picture that comes and goes as the phase varies.

solving servo problems. Although the nomenclature in the following procedure is derived from the HS-320UR, the basic principles can be applied to servo circuitry in other VCRs.

Symptom: Playback picture is out of sync (speed).

Noise bars in the picture (phase).

I. Capstan or drum?

A. Sound normal—Troubleshoot the video drum servo

B. Sound abnormal—Troubleshoot the capstan drum servo

II. Servo speed adjustment

Perform the servo speed adjustment as in the service manual.

A. Motor speed does NOT change. Proceed to Step III.

B. Motor speed varies but will not hold. Proceed to Step IV.

III. Determine effect of servo potentiometer

Measure the dcV at the servo speed control input, while varying the servo potentiometer.

Drum Pin 13 IC411 **Capstan** Pin 3 IC412

A. Speed control input voltage does NOT vary.

1. Check the operation of the servo potentiometer.

Drum VR401 **Capstan** VR404 (2H/4H)

		PIN 8 MODE	PIN 5 SV-REC	PIN 16 VSCO	PIN 17 VSC1	PIN 18 C-REV	PIN 20 REC 9V
RECORD	2H	L	H	L	H	L	H
	4H	M					
	6H	H					
PLAYBACK		..	L	H	L	L	L
FORWARD SEARCH		..	L	H	H	L	L
REVERSE SEARCH		..	L	H	H	H	L
FAST FORWARDING		..		H	H	L	H
REWIND		..	L	H	H	H	H

MODE SELECTOR TRUTH TABLE

Table 1. Although digital servo circuits seldom cause problems, this truth table may make diagnosis of problems easier when they do occur.

2. Check the analog switch for proper operation.

Drum IC401 **Capstan** IC402 and IC404

B. Speed control input DOES vary. Check for dcV variation at the speed control output of the servo IC as the servo potentiometer is turned.

1. Varies—troubleshoot the motor drive circuit.

2. No variation—servo IC is probably defective

Drum IC411 **Capstan** IC412

IV. Servo input signals

A. Check for all input signals to

the servo IC. Troubleshoot the signal path of any missing signals.

Drum IC411 **Capstan** IC412
 FG—pin 14 FG—pin 16
 59.95Hz—pin 26 CTL—pin 14
 PG—pin 23 Drum FF—pin 13
 —PG—pin 24

B. If all signals are present—proceed to Step V.

V. Servo IC or motor drive circuit?

Connect the dc input of an oscilloscope to the speed control output of the servo IC.

Drum Pin 8 **Capstan** Pin 7

A. Voltage varies—servo is trying

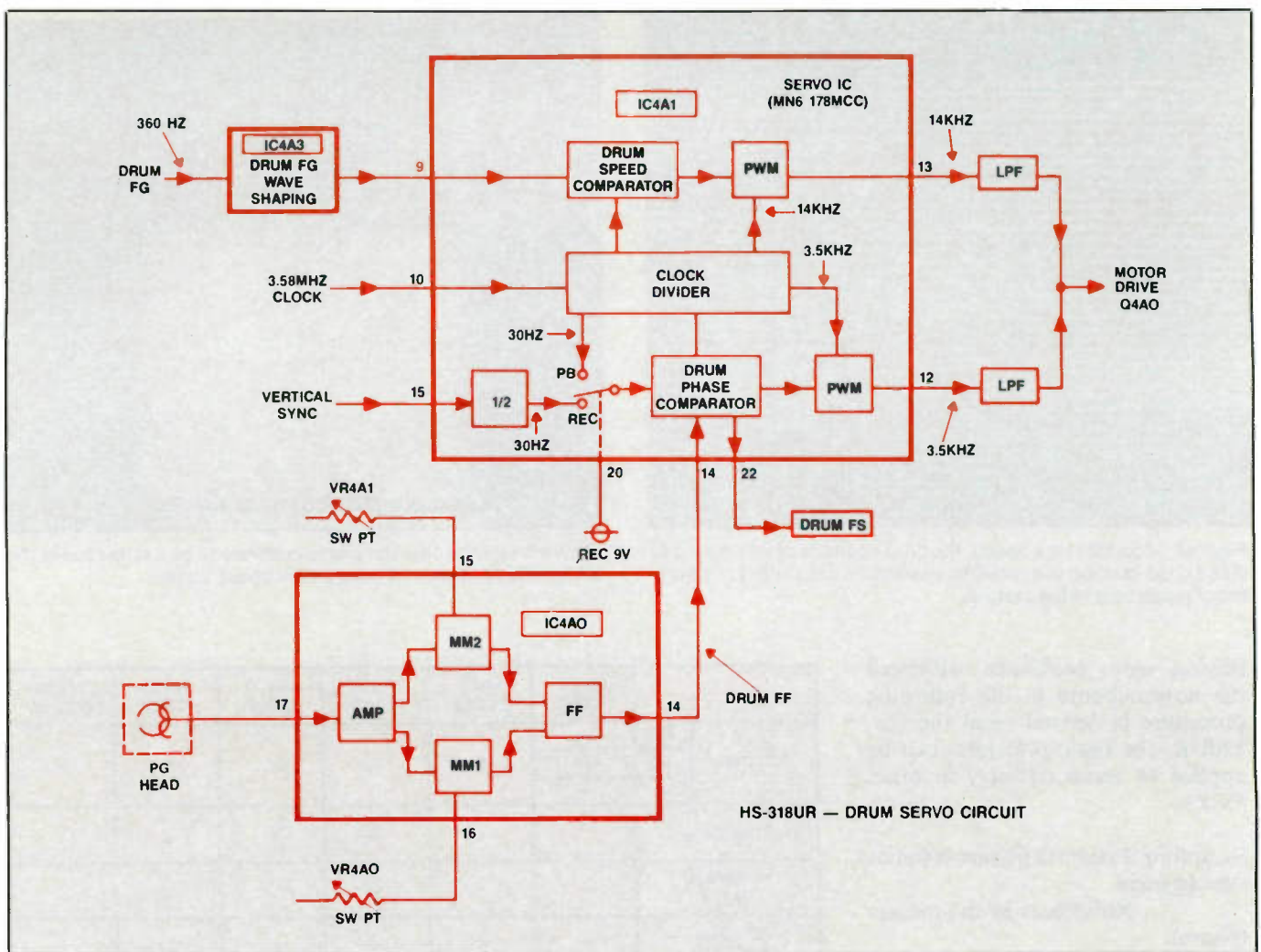

Figure 7. In this VCR both the drum servo circuitry and the capstan servo circuitry are contained in a single large-scale integrated circuit (LSI). Only the drum servo portion is shown here to avoid confusion.

to correct motor speed. Troubleshoot motor drive circuit/motor.

B. Voltage is constant—servo IC is probably defective.

Digital servo circuits

The following analysis uses the HS-318UR for illustrative purposes. The analysis also applies to other Mitsubishi VCR models.

The HS-318UR utilizes a digital servo system with a new servo IC. This large-scale integration (LSI) device, identified as MN6178MCC, was designed specifically for the NTSC television format. Both capstan and drum servos are internal to the same LSI, however, for simplification each servo system will be described individually.

Drum servo

A simplified diagram of the drum servo is illustrated in Figure 7, showing only those sections of the LSI directly related to the drum servo. Tim-

ing for all the servo LSI operations is derived from an external 3.58MHz clock oscillator, directed to the LSI (IC4A1) at pin 10. An internal clock divider generates the timing signals required by the internal digital comparators and pulse width modulators.

As in all servos used in VCRs, the servos in the HS-318UR are divided into 2 major sections, speed control and phase control. The drum speed servo sets and maintains the drum rotational speed at 1800 RPM.

During record, the drum phase servo insures that the video heads come into contact with the tape just prior to vertical sync, and assures the recording of vertical sync at the beginning of each video track, as required by the VHS format. In playback, the drum phase servo maintains a constant head-to-tape phase relationship. Any error between the video head paths and the video tracks on the tape is corrected by the capstan servo.

The frequency of the drum FG signal generated by the Hall elements in the drum motor assembly represents the drum motor speed, and is directed to the drum speed servo at pin 9 of IC4A1. The internal drum speed servo generates a variable duty cycle 14KHz PWM (pulse-width modulated) signal at pin 13. The duty cycle of the PWM signal is determined by the speed of the motor.

The 14KHz PWM signal is filtered by a discrete component low pass filter (LPF) and the resultant dc voltage is directed to Q4A0 in the drum motor drive circuit. If the motor is slow, the 14KHz PWM signal has a less positive duty cycle which, when filtered, results in a lower dc level and, via the drum motor drive circuit, increases the motor speed. Conversely, if the motor is fast, the 14KHz duty cycle is more positive, resulting in a higher filtered dc voltage, reducing the motor drive.

The drum phase servo compares

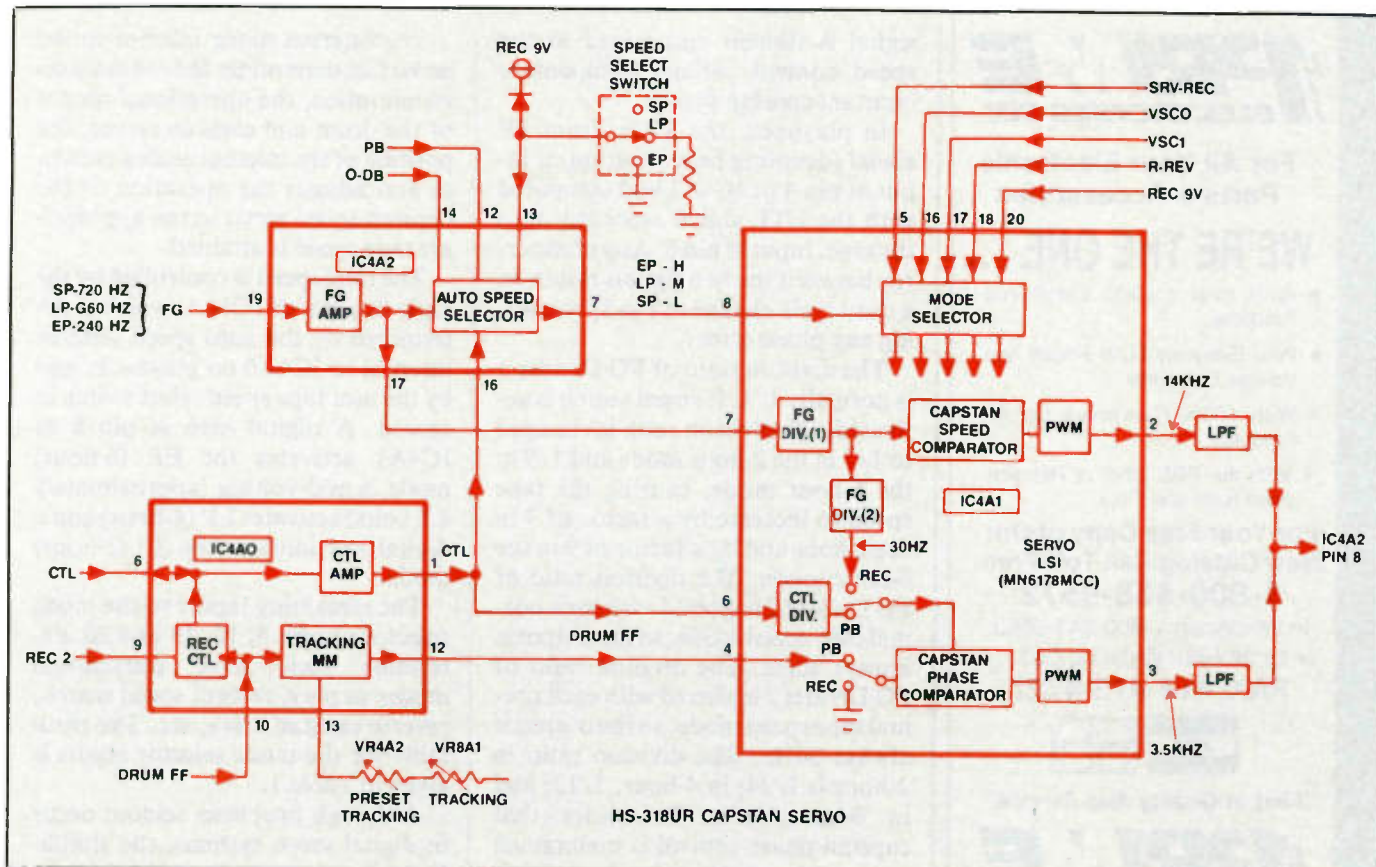

Figure 8. The capstan circuitry of this VCR shares a single LSI IC with the drum servo circuitry.

the drum FF (representing the relative head position) against a stable reference. In record, the stable reference is incoming vertical sync, directed to pin 15 of IC4A1, and in playback the reference is a 30Hz signal derived by repeatedly dividing the 3.58MHz clock signal. The drum phase servo generates a variable duty cycle 3.5KHz PWM signal at pin 12, which is filtered by a LPF and added

to the speed control voltage to correct any error in the drum phase.

Capstan servo

The capstan servo, illustrated in Figure 8, operates basically the same as the drum servo, with the exception of the signals directed to the circuitry. The capstan FG signal is directed, via IC4A2, to the capstan speed servo input at pin 7 of IC4A1. The capstan speed servo generates a 14KHz PWM

signal at pin 2, which is filtered and directed to the capstan motor drive circuitry at pin 8 of IC4A2.

In record, the capstan phase servo maintains a constant capstan phase by monitoring the capstan FG signal divided down to 30Hz. Any change in the phase of the divided 30Hz signal results in a duty cycle change in the 3.5KHz PWM signal output from pin 3 of the LSI. The 3.5KHz PWM

If You're In VCR Repair . . .

Like any profession, "The Difference Between an Expert and an Amateur Are His Tools & His Training".

When your "LUCK", "HOPE" & "FEEL" VCR repair tactics start to run out, remember that TENDEL has the right tools for professional diagnosis mechanical VCR problems.

- TENDELOMETER* Tape Tension Gauge
- Dial Torque Gauge
- Spindle Height / 6-Function Reference Plane Gauge
- Head Protrusion / Eccentricity Gauge

You can't afford to guess when your customers and your future depends on professional service, done right the first time. Let TENDEL increase your efficiency!



NOW AVAILABLE - Video Training Tape "VCR Mechanical Problem Diagnosis" - \$24.95 Includes Shipping In Cont. U.S.

TENDEL® 4475 Golden Foothill Parkway
El Dorado Hills, CA 95630

Call For A FREE CATALOG
(800) 538-6894 / (916) 939-4005

Circle (27) on Reply Card

PRIME ELECTRONICS CO.

For All Your Electronic Parts & Accessories

WE'RE THE ONE . . .

- With over 10,000 Electronic Products
- With Everyday LOW Prices and Volume Discounts
- With 100% Guarantee On All Products
- With the PRB LINE of Replacement Belts and Tires

For Your Free Copy of Our New Catalog Call Toll-Free
1-800-558-9572

In Wisconsin 1-800-242-9553
or for 24 Hour Ordering Call . . .

FAX: 414-473-4727



"First in Quality And Service"

PRIME ELECTRONICS CO.

P. O. Box 28
Whitewater, Wisconsin 53190

Circle (24) on Reply Card

signal is filtered and added to the speed control voltage to maintain constant capstan phase.

In playback, the 30Hz drum FF signal (denoting head position) is input at pin 4 of IC4A1 and compared with the CTL signal recorded onto the tape, input at pin 6. Any phase error between the two signals results in a duty cycle change at pin 3, correcting any phase error.

The division ratio of FG Divider 1 is normally 1/1. If speed search is activated, the division ratio is changed to 1/7 in the 2-hour mode and 1/9 in the 6-hour mode, causing the tape speed to increase by a factor of 7 in the 2-hour and by a factor of 9 in the 6-hour mode. The division ratio of FG Divider 2 is altered with each normal tape speed mode, so the output is always 30Hz. The division ratio of FG Divider 2 is altered with each normal tape speed mode, so the output is always 30Hz. The division ratio in 2-hour is 1/24; in 4-hour, 1/12; and in 6-hour, 1/8. To insure that capstan phase control is maintained in a speed search mode, the division ratio of the CTL divider corresponds to that of FG Divider 1 . . . 1/7 in 2-hour and 1/9 in 6-hour.

The internal mode selector in the servo LSI determines the required division ratios, the operational modes of the drum and capstan servos, the position of the internal analog switches and adjusts the operation of the capstan speed servo so the appropriate tape speed is attained.

The tape speed is controlled by the logic at pin 8 of IC4A1, which is determined by the auto speed selector internal to IC4A0 on playback, and by the user tape speed select switch in record. A digital high at pin 8 of IC4A1 activates the EP (6-hour) mode, a mid-voltage (approximately 2.5 volts) activates LP (4-hour) and a digital low initiates the SP (2-hour) mode.

The remaining inputs to the mode selector at pins 5, 16, 18 and 20, determine such servo operational modes as play, record, speed search, reverse capstan drive, etc. The truth table for the mode selector inputs is given in Table 1.

Although problems seldom occur in digital servo systems, the simplified diagrams and mode selector truth table presented in this article should be of assistance in localizing a defect should one arise. ■

THE BELTRON SYSTEM.™



A NEW GENERATION OF VIDEO SCREEN RESTORERS.

- Manual and Automatic Models. Based on original Beltron patents.
- Simple and safe to use with today's new CRT ratings—color or black/white.
- Built-in isolation transformer and regulated 0–20VDC filament circuit.
- Portable. Goes with you to simplify on-site testing and restoration.

FULL YEAR WARRANTY!
ORDER TODAY.
Call 415/568-5282



8393 CAPWELL DRIVE
OAKLAND, CA 94621

BELTRON SYSTEM™ is a trademark of Conway Manufacturing, Inc.
Circle (7) on Reply Card

Improve Your Form.

3-Part

A continuous feed form used for customer c.o.d. service or parts/accessory sales receipts

(N3CN). Not for warranty billing. Computer generated software to be available soon.

5-Part

Available in snapout (N5SN) or continuous feed (N5CN). Matching fields with N3SN.

except for customer estimate and receipts. For warranty billing.

7-Part

A universal snapout form (N7SN) designed for both customer service c.o.d. and manufacturer warranty billing.

Complies fully with the requirements of state and local ordinances, including California.

Discounts

Carbonless NESDA Forms are available to NESDA members at additional savings. For pricing information and samples, or information regarding other NESDA membership benefits, write to NESDA, 2708 W. Berry St., Ft. Worth, TX 76109; or call (817) 921-9061.

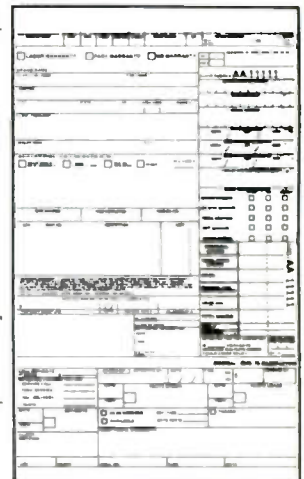

The NESDA Form

NESDA, 2708 W. Berry St.
Fort Worth TX 76109
Phone: (817) 921-9061

JVC
2729-1 C-2019/29/39

Panasonic
2730-1 CTK-2061S
(CH. AMEDP165/GL7H)
2732-1 CTK-1350R/1R/2R
(CH. ALDP153)

Philco
2732-2 C5820BAK01,
C5823BPN01, C5824BPE01,
R5051BWA01, R5075BWA02,
R5860BAK01, R5861BAK01,
R5862BPE01, R5863BHP01,
R5865BPE01, R5880BPE01,
R5882BPE01, R5883BPE01,
R5960BAK01, R5962BPE01,

Philco continued
R6862BPC01, R6862BPE01,
(CH. 25B107/8/9, 26B105/6/7)

Quasar
2726-1 SL2534DK, SL2536DD,
SL2538DP, SL2539DP,
(CH. AEDC160/GL7S2)
2727-1 SP2730DE
(CH. AMEDC148/GL7S)
2728-1 TP1920DW
(CH. ADC179/GL7H2)
2729-2 SP2030DW
(CH. AEDC177/GL7H2)
2731-1 TP2520DW
(CH. ADC144/GL7S)

RCA
2731-2 F26100AKF01,
F26101NGF01, F26103EGF01,

RCA continued
F26105MKF01, F26150BHF01,
F26155AKF01, G26330TNC01,
G26331TNC01, G26335TKC01,
G26339HPC01, G26341TNC01,
G26343TNC01, G26345TKC01,
X26025EBF01, X26027WNF01
(CH. CTC149B/E/Q)

Sears
2726-2. 564.42355950, 564.42455950

Sony
2727-2 KV27TS23/24/25/26
(CH. SCC-B55K-A/P-A/Q-A/U-A)

Sylvania
2728-2 RKZ119BK01/02

OFF AIR INTERFERENCE

Getting It? - Causing It?

101 Fast Solutions

Call our on-line experts to find *your* solution *today!* (or to request our FREE tutorial catalogs)

Filters For:

- Off Air Interference
- Mobile Radio/Paging
- Cable/Video Systems
- Broadband LAN
- TVRO Interference
- Microwave Systems
- MMDS/ITFS Systems
- TV/FM Broadcast Stations

"We Make Filters In A Hurry For Customers In Trouble!"

Microwave Filter Company, Inc.

6743 Kinne Street • East Syracuse, NY 13057

Toll Free(US/Canada): 1-800-448-1666 • Collect(NY/AK/HI): 315-437-3953
FAX: 315-463-1467 • Telex: 249-613



Ask For Catalog C/87



Ask For Catalog C/87



Ask For Fastrap Bulletin #8

3 Surge Suppressors Are Philips ECG's Newest: TV, Phone, Data Line.



EMF-TV3 protects TV signal and AC power in TVs, VCRs, cable converters, video/audio receivers.
EMF-325 protects phone and AC line in telecom equipment. **EMF-232C** is for computers and RS-232-port peripherals—a must for modems.
All at 900 Philips ECG distributor locations or call 1-800-526-9354.



Philips ECG



PHILIPS

What do you know about electronics?

Series vs parallel, and measuring rms voltage

By Sam Wilson, CET

Whether a circuit is series or parallel can sometimes be tricky to determine. A question, published in this department in the February 1990 issue, generated a great deal of controversy. Here's that question, the answer, and an explanation of why the answer given is the correct answer.

5. Refer to the crystal radio in Figure X. The radio is tuned by the combination of L and C. In this circuit, L and C are in

- A. series
- B. parallel

Answer: B

This letter was only one of many questioning that answer:

"I must take issue with Sam Wilson's column 'Test Your Electronics Knowledge.' I refer specifically to Mr. Wilson's answer to question 5. My view is that L and C are in parallel. I can illustrate this by the series-resonant, parallel-connected trap and the parallel-connected, series resonant trap. Perhaps the question was not stated properly."

Sincerely,
Gene Vinson

Sam Wilson Answers:

Thanks for taking the time to write. Your illustrations have been redrawn because it is difficult to print pencil sketches. The connections are exactly the same as on your drawings. However, for my discussion of the circuit in Figure 3, I have changed the position of point A [your symbol for the antenna terminal] to a position I have called X. My reason is that I am discussing antenna voltage. Point X is the location of that source of voltage.

Your illustrations of parallel and

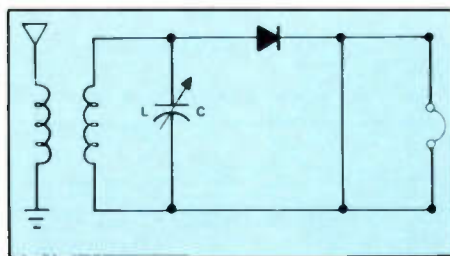

Figure X

series traps do not demonstrate that L and C of the receiver tuned circuit are in parallel. Refer to Figure 1. In order to determine if a circuit is series- or parallel-connected, start with the location of the generated voltage, then trace the generator current. In Figure 1, the generated voltage is between the antenna and ground. A popular way of showing that is given in Figure 2.

The series trap is a series circuit because the antenna voltage is directly across it. Also, the generator ac cur-

rent must flow through the inductor and through the capacitor. The transformer primary in that illustration is in parallel with the trap. That follows because the generator current can flow through the trap or through the transformer winding.

Your parallel-connected trap of Figure 3 has been redrawn in Figure 4. The generator current has a choice of flowing through the inductor or capacitor, so those components are in parallel. The transformer primary winding is in series with the trap because current flows through the trap connection AND the transformer winding.

Components are not in series just because they are drawn with one above the other. Likewise, they are not in parallel just because they are drawn side by side. Remember that the generator current [and, indirectly, the generator voltage] are used to

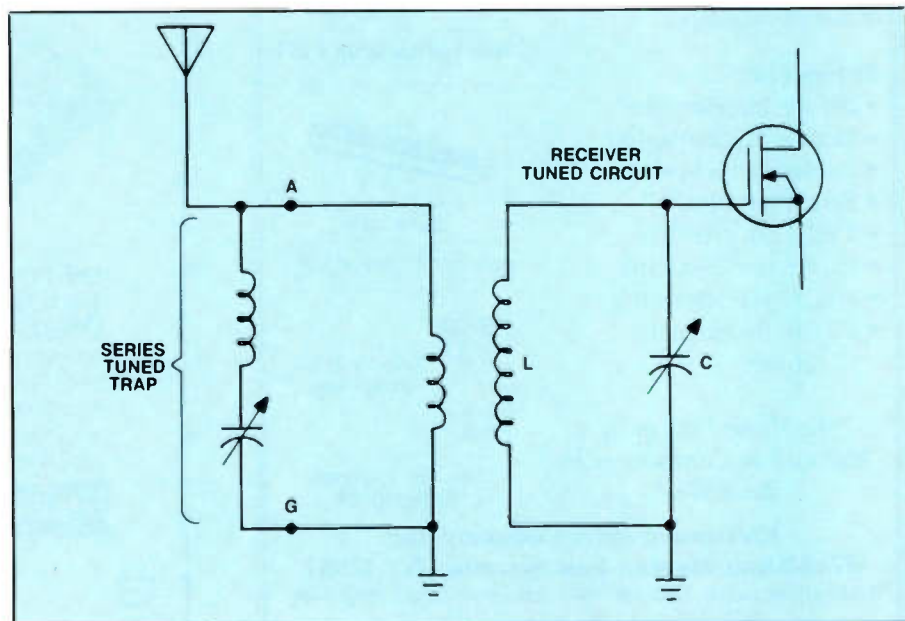

Figure 1

Wilson is the electronics theory consultant for ES&T.

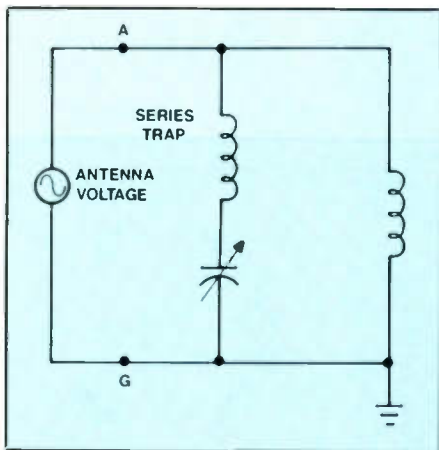

Figure 2

determine if components are in series or parallel. Always locate the generator first before deciding if components are connected in series or parallel.

Now look at the receiver LC tuned circuit in Figure 5. The secondary voltage is generated in the windings. As shown in the illustration, the generated voltage is considered to be in series with the transformer secondary. The MOSFET gate is an open circuit so no current is flowing in that branch. The generated current must flow through the inductor and capacitor. There is no choice of L or C as in the parallel trap.

In the question, a crystal radio was shown at the output of the tuned circuit. The answer is still the same. The crystal circuit is in parallel with the capacitor. An argument could be made about a series-parallel combination. However, that was not one of the choices because the question addresses the configuration of series and parallel tuned circuits.

Even without the above discussion, it should be obvious that this is a series LC circuit. Its purpose is to select one frequency [and sidebands] and reject all other frequencies. That is the characteristic of series-tuned circuits.

The voltage across the series combination is minimum at resonance. However, the voltage across the capacitor is determined by the equation:

$$V_c = (I)(X_c)$$

Since the current in the circuit is maximum at resonance, it follows that the voltage across the capacitor is also maximum. The result is that the maximum signal is delivered to the RF amplifier, or crystal circuit, when the circuit is resonant with the station frequency. A parallel tuned circuit

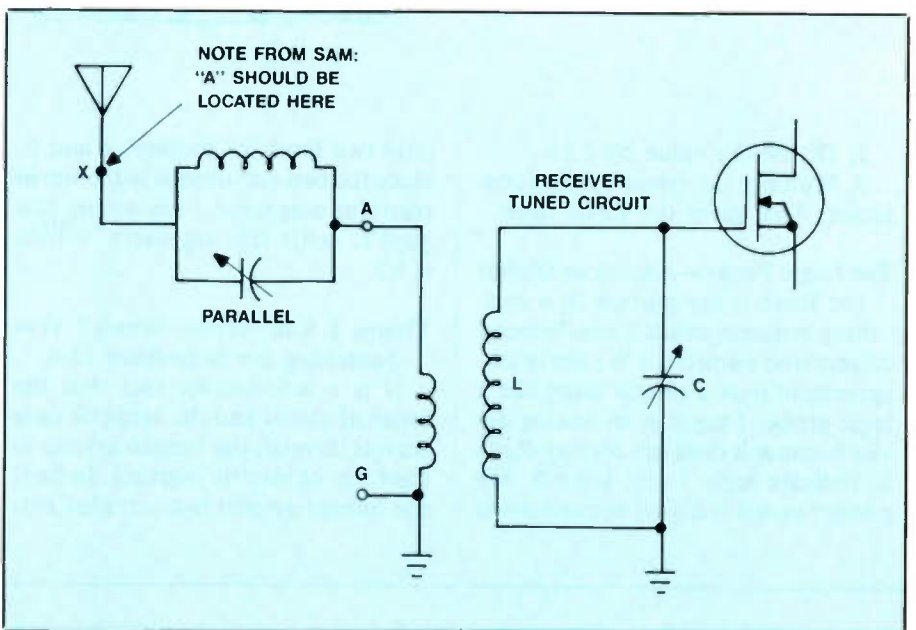

Figure 3

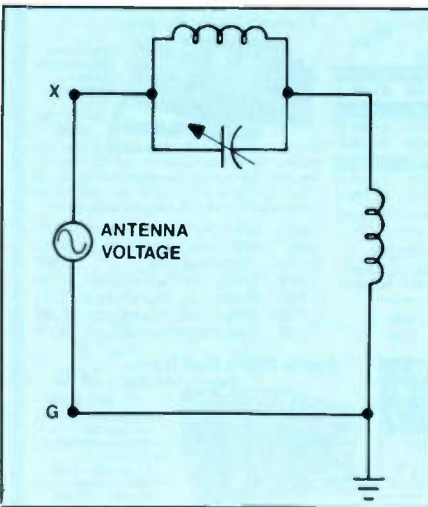

Figure 4

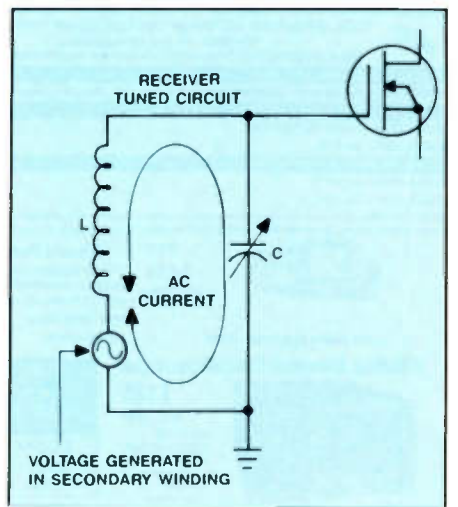

Figure 5

rejects the resonant frequency and passes all other frequencies.

Your letter brings to mind an important problem in teaching electronics. Unless the instructor makes a move to prevent it, a student will try to identify circuits only by the way they are drawn. A good example of this is shown in Figure 6. Both circuits are bridge rectifiers, but students will not recognize that unless they learn to trace—not just memorize—circuits.

Measuring rms voltage and current

I have a very classy engineering book with a genuine imitation leather cover. It gives the equation for form factor:

$$\text{form factor} = \frac{\text{RMS value}}{\text{average value}}$$

Then it goes on to say that the form factor has no practical value because it does not really give any information about the waveform. That is like saying that hamburgers are not really food because they don't contain any ham. So what?

My point is that form factor has some uses even though it is true that it does not tell you about waveform. There are books that claim that it is a measure of how closely a waveform approaches a sine wave. That just is not true. However, there are ways of using form factor. In the previous issue, it was shown that the RMS value of a nonsinusoidal wave can be measured with a VOM if you know the form factor.

Here are the steps that were given:

1. Measure the voltage as if it was a sine wave.

2. Divide the value by 1.11.
3. Multiply the result by the form factor. That gives the RMS value.

The Logic Probe—Analog or Digital

Joe Risse is my partner in a consulting business called Risse/Wilson. (Guess who named it.) We are in disagreement over a simple thing like a logic probe. I say it is an analog device because it does not display digits to indicate logic 1 and logic 0. My partner says it is digital because it has

only two levels of display: 1 and 0. Since the best technicians in the world read this magazine, I am asking you guys to settle this argument. Which is it?

Things I Ran Across When I Was Searching for Something Else

It is a well-known fact that the sense of touch and the sense of pain travels through the human system in the form of electric currents. In fact, the human system is a complex net-

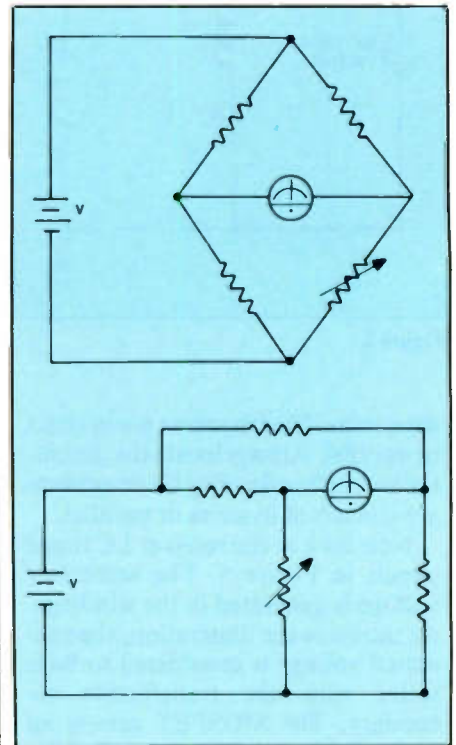

Figure 6

work of currents and voltages. What is not so well known is the fact that trees and plants also have electric systems that correspond—roughly—to the human system.

One difference is that the human connectors have synapses that connect shorter conductors. In plants there has not been any evidence of the synapses. Instead, the electric signals pass along longer conductors. The amount of electricity (voltage and/or current) varies from one type of plant to another. The same is true for trees. Experiments show that the electricity increases when a leaf of the plant is touched.

No practical use of this information has come forth so far. I would like to suggest that a large plant be placed near a door. An electronic transducer could be used to sense when leaves have been disturbed as an interloper brushes past—and touches—the plant. The sensed electric signals would then set off an alarm.

Remember, if you make millions with this idea, you wouldn't miss a few hundred thousand for my favorite charity.

Usually when I bring some dynamic technology to the attention of readers, I get letters from non-believers. ■

ELENCO & HITACHI PRODUCTS AT DISCOUNT PRICES

NEW! RSOs (Real-Time & Storage Oscilloscopes) From HITACHI **NEW!**
The RSO - Its the new solution
View, Acquire, Test, Transfer and Document Your Waveform Data

4-Channel, 100MS/s Model	Introductory Price
100MS/s (25MS/s on 4 channels simultaneously), 100MHz, 4kw x 1ch, 2kw x 2ch, 1kw x 4ch VC-6145	\$ 4,695.00

Compact, Full Feature Models

40MS/s, 100MHz, 4kw x 1ch, 2kw x 2ch	VC-6045	\$ 3,049.00
20MS/s, 50MHz, 2kw x 1ch	VC-6025	\$ 2,295.00

Low Cost/High Value Models

20MS/s, 50MHz, 2kw x 2ch	VC-6024	\$ 2,049.00
20MS/s, 20MHz, 2kw x 2ch	VC-6023	\$ 1,749.00

RSOs from Hitachi feature such functions as roll mode, averaging, save memory, smoothing, interpolation, preriggering, cursor measurements, plotter interface, and RS-232C interface. With the comfort of analog and the power of digital.

Compact Series Scopes

Delayed Sweep
Lightweight (13lbs)
2W Save
3 Yr Warranty
Model V-1065 Shown

This series provides many new functions such as CRT Readout, Cursor measurements (V-1085/1065/665), Frequency Ctr (V-1085), Sweeptime Autoring and Trigger Lock using a 6 inch CRT. You don't feel the compactness in terms of performance and operation.

Hitachi Portable Scopes

V-212 DC to 50MHz, 2-Channel, DC offset function, Alternate magnifier function \$435
V-525 CRT Readout, Cursor Meas \$1,025
V-523 Delayed Sweep \$995
V-522 Basic Model \$895

V-422 40MHz Dual Trace \$795

V-660 60MHz Dual Trace	\$1,195
V-665 60MHz Dual Trace w/Cursor	\$1,345
V-1060 100MHz Dual Trace	\$1,425
V-1065 100MHz Dual Trace w/Cursor	\$1,695
V-1085 100MHz Quad Trace w/Cursor	\$2,045
V-1100A 100MHz Quad Trace w/Cursor	\$2,295
V-1150 150MHz Quad Trace w/Cursor	\$2,775

20MHz Elenco Oscilloscope

MO-1251 \$375

- Dual Trace
- Component Tester
- 6" CRT
- X-Y Operation
- TV Sync
- 2 p-i Probes

FREE DMM with purchase of ANY SCOPE

SCOPE PROBES

P-1 65MHz, 1x, 10x \$19.95
P-2 100MHz, 1x, 10x \$23.95

Elenco 35MHz Dual Trace

Good to 50MHz \$495

MO-1252

- High luminance 6" CRT
- 1mV Sensitivity
- 6KV Acceleration Voltage
- 10ms Rise Time
- X-Y Operation + Z Axis
- Delayed Triggering Sweep
- Includes 2 p-i Probes

All scopes include probes, schematics, operators manual, and 3 year (2 yrs for Elenco scopes) world wide warranty on parts & labor. Many accessories available for all Hitachi scopes. Call or write for complete specifications on these and many other fine oscilloscopes.

WE NOW CARRY COMPLETE LINE OF FLUKE MULTIMETERS

Models: 21F, 83, 23F, 85, 25F, 87, 27F, 8050A, 73, 8060A, 75, 8062A, 77F + More

CALL FOR SPECIAL PRICING

True RMS 4 1/2 Digit Multimeter

M-7000 \$135

- 0.5% DC Accuracy
- 1% Resistance
- with Freq. Counter and deluxe case

10 Function Multimeter

CM-365 \$65

AC + DC Voltage & Amps
Resistance to 2000MΩ
Diode, Logic, A Trax test
Capacitance to 200F

Digital Capacitance Meter

CM-1550 \$58.95

- 3 Ranges
- 1pF-20,000pF
- 5% basic acy
- Zero control with case

Digital LCR Meter

LC-1801 \$125

Measures:
Coils 1uH-200H
Caps. 1pF-200uF
Res. 0.1-20M

Function Generator

Ilox \$960.00
\$28.95

Provides sine, triangle, square wave from 1Hz to 1MHz. AM or FM capability

Triple Power Supply XP-620

Assembled \$65
Kit \$45

2 to 15V at 1A, -2 to -15V at 1A (w/ or w/o 1A) and 5V at 3A

Contains all the desired features for doing experiments. Features short circuit protection, all supplies.

Wide Band Signal Generators

SG-9000 \$129

RF Freq 100K-450MHz
AM Modulation of 1KHz
Variable RF output

SG-9500 w Digital Display and 150MHz built-in Counter \$249

AC Current Meter

ST-1010 \$69.95

1000 Amps
Data & Peak hold
8 Functions
Deluxe Case

Decode Box

#9610 or #9620 \$18.95

#9610 Resistor Bias
47 ohm to 1M & 100K pot
#9620 Capacitor Bias
47pF to 10MFD

Quad Power Supply XP-580

\$59.95

2-20V at 2A
12V at 1A
5V at 3A
-5V at 5A

Fully regulated and short circuit protected
XP-575 without meters \$39.95

LEARN TO BUILD AND PROGRAM COMPUTERS WITH THIS KIT

INCLUDES: All Parts, Assembly and Lesson Manual

Model MM-8000 \$129.00

Digital Triple Power Supply

XP-765 \$249

0-20V at 1A
0-20V at 1A
5V at 5A

Fully regulated. Short circuit protected with 2 limit control. 3 separate supplies
XP-660 with Analog Meters \$175

GF-8016 Function Generator with Freq. Counter

\$249

Sine, Square, Triangle Pulse, Ramp, 2 to 2MHz
Freq. Counter: 1 - 10MHz

GF-8015 without Freq. Meter \$179

Starting from scratch you build a complete system. Our Micro Master trainer teaches you to write using RAMs, ROMs and an 8085 microprocessor, which uses similar machine language as IBM PC. You will write the initial instructions to tell the 8085 processor to get started and store these instructions in permanent memory in a 2816 EPROM. Teaches you all about input and output ports, computer timers. Build your own keyboard and learn how to scan keyboard and display. No previous computer knowledge required. Simple easy to understand instruction teaches you to write in machine language.

ROBOTICS KIT FOR ABOVE (MM-8010) \$71.95

WE WILL NOT BE UNDERSOLD!
UPS Shipping: 48 States 5%
(\$10. Max) IL Res., 7% Tax

C & S SALES INC.
1245 Rosewood, Deerfield, IL 60015
(800) 292-7711 (708) 541-0710

15 Day Money Back Guarantee
2 Year Warranty Prices subject to change
WRITE FOR FREE CATALOG

Circle (5) on Reply Card

VCR vertical sync

By Stephen J. Miller

Digital technology can often throw us a curve. Last month we looked at a deceptive headswitching circuit. This month we will explore another area where digital technology can trick us, the vertical sync signal.

In the record mode, the vertical sync signal is used both to produce the record control pulse, CTL, and as a reference signal to the drum phase control servo. In earlier machines, loss of the vertical sync signal would mean no record CTL signal and no drum phase reference signal. However, in recent designs, the vertical sync signal does not directly produce these signals. Rather, the vertical sync signal is used to reset a down-counter inside the servo IC.

CTL without vertical sync

Figure 1 shows a typical circuit. The 3.58MHz master clock is divided by 119,320 to produce a 30Hz signal. Vertical sync is divided by 2 and used to reset this down-counter. Resetting the counter in this fashion insures

Miller is a senior bench technician for a Lancaster, PA, repair company

that no phase error exists between the down-counted 30Hz and vertical sync.

This is very similar to the headswitching circuitry described last month. As with last month's circuitry, loss of vertical sync will not cause the loss of the 30Hz reference signal. Instead, it will cause a phase error to exist between vertical sync and this 30Hz reference signal.

If you're skeptical, try this little test. Take a late model Matsushita machine and, without attaching an antenna, enter the SP record mode. Next zero the counter and, after ten counts, switch the speed to LP. After ten more counts switch to the SLP speed. Finally, after an additional ten counts, rewind and playback the tape. You will find that the VCR plays back each section of tape at the same speed it was recorded in. A CTL signal is needed to perform playback speed selection, so a CTL track must have been recorded. Yet, with no antenna connected, vertical sync was not present. Therefore, in the absence of vertical sync, the machine produced its own 30Hz refer-

ence signal. Machines of many other manufacturers will produce the same results.

Record mode problems

Loss of vertical sync to the servo section affects the record mode. The usual symptom is a line in the playback picture of tapes recorded on the defective machine. This thin noise line can appear anywhere on the screen, but will remain stationary throughout a particular recording session. Playing the tape on a good machine will display the same line. Often the line is mistaken for a scratch or crease in the video tape itself. However, when recording over that tape on a good machine, the line will disappear. This line is actually the headswitching points appearing on the screen.

Figure 2 helps explain why the headswitching points appear on the TV screen. Section A shows a normal recording, while section B shows an abnormal recording. Because of the overscan, the TV viewer sees only about 90% of the vertical field or the shaded areas in Figure 2. Since there is no switching point within the shaded area of section A, no switching point will be visible to the viewer. Because of the phase error in Section B, a switching point is present in the shaded area and it will be visible to the viewer.

This type of phase problem has been a common failure in the Toshiba M-5100 series machines. The usual complaint is that pre-recorded tapes play fine, but the picture produced by self-recorded tapes has a thin blue horizontal line. In these machines, the most likely cause is servo IC, IC501 (TD6360P). To troubleshoot, enter the record mode, and using the video output signal as a reference, scope the vertical sync input, pin 25 of IC501. Positive-going sync pulses at 0.75 volts peak-to-peak should be present at pin 25. Make

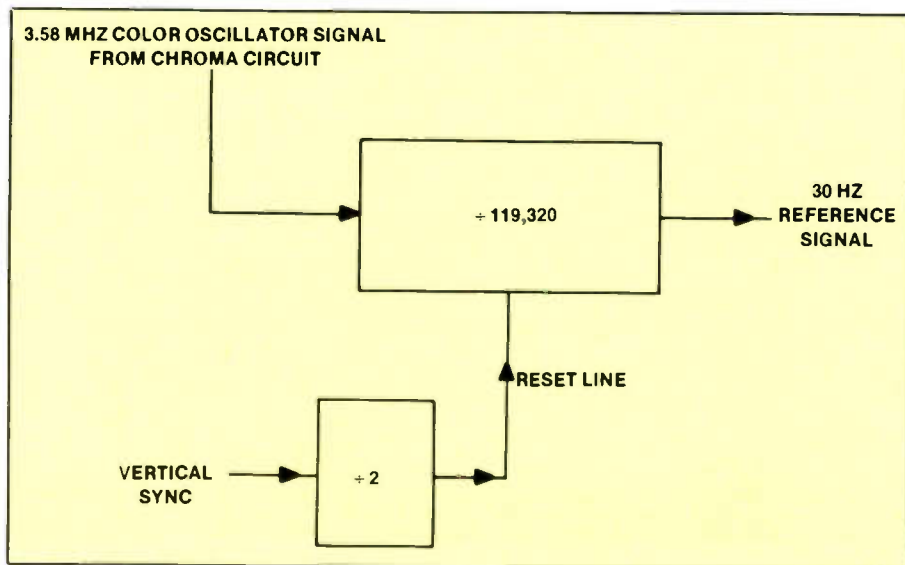

Figure 1

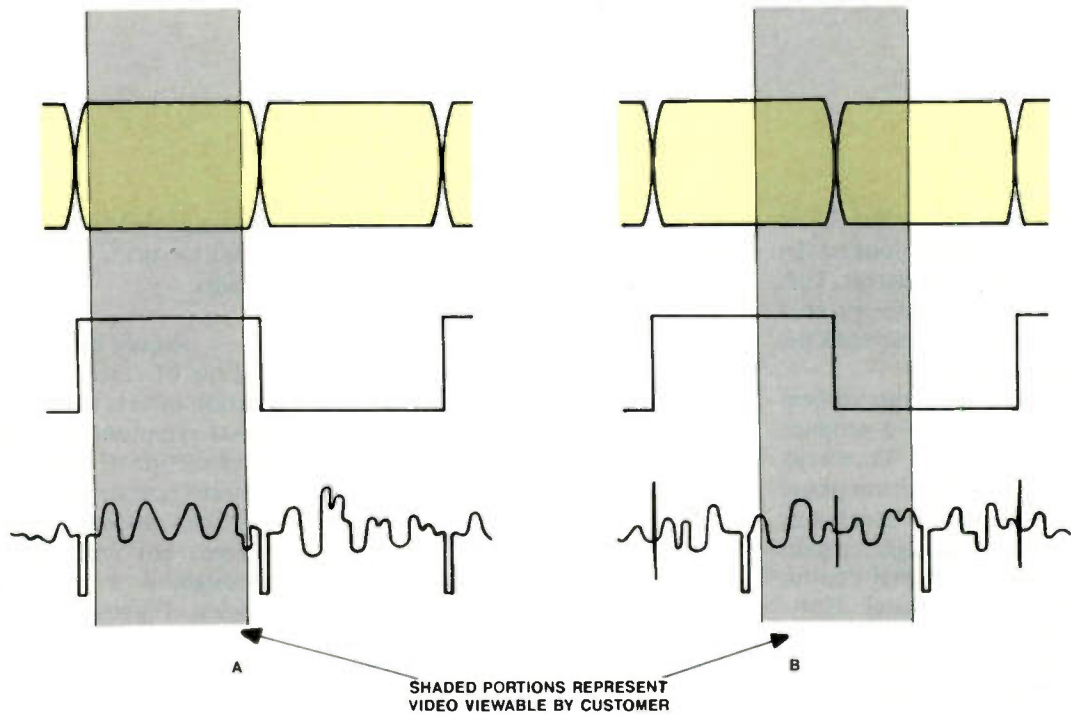

Figure 2

sure this signal is present and is in phase with the video signal. The headswitching signal at pin 29 should lead the video signal very slightly (approximately 0.4 ms in the SP mode). If this headswitching signal is out of phase with the video signal, yet the vertical sync input is present, then IC501 is defective and must be replaced. To insure continued reliability in these Toshiba machines, always check that the ground screw to the reel motor is both present and tight.

Sync separator is problem

In an Emerson VCR755, this type of phase error became a useful troubleshooting aid. The complaint was no color and bad recording. Often, color problems are time-consuming to track down as there are a great number of defects which can kill color. On the test bench, playback was in black and white. However, when playing back a recording made on this Emerson, I was pleased to see a black and white picture and a head-switching line near the center of the screen. This symptom allowed me to isolate the problem to one small area, the sync separator, without lifting a

test probe. One of the numerous signals necessary to produce color is horizontal sync, while vertical sync is necessary during recording to prevent the headswitching line from ap-

pearing on the screen. Thus, a sync separator fault would explain all the symptoms. Going to the sync separator of IC4001, pin 17, I found no signal. After making the standard volt-

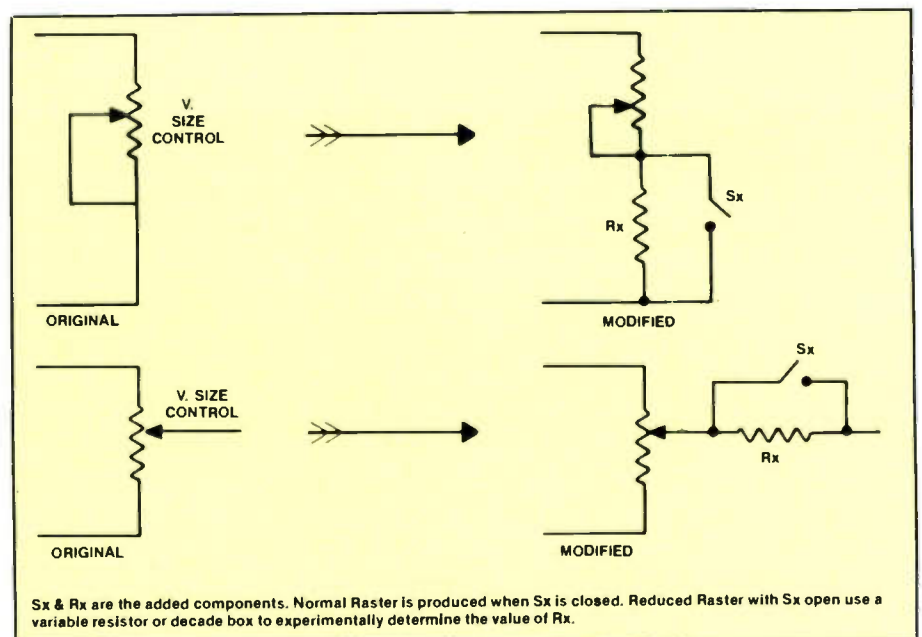

Figure 3

age checks, IC4001 was proved defective. A new chip cured all the symptoms.

Reducing height aids diagnosis

Failures involving the headswitching points can be difficult to troubleshoot because they closely resemble other faults. One thing that speeds up troubleshooting is to be able to view the area of the TV screen where the headswitching points should be. Special video monitors are available with this feature. Reducing the vertical height of your test bench TV is a less expensive method. With a moderately underscanned raster, the headswitching points of a normal machine will be visible at the bottom of the screen. I chose to install a resistor and switch combination in series with the TV's vertical height control. This modification allows me to select either normal or reduced raster (see Figure 3). Make sure to mount the switch on an insulated surface of the TV's cabinet and perform the standard AC leakage checks on the external portions of the switch before placing the set back into service.

The reduced height position is used when symptoms of incorrect headswitching points are encountered. Vertical roll or an unexplained line in the picture are two examples. If, with the switch in the reduced height position, the headswitching points are not observed at their usual position at the bottom of the screen, then a defect in the headswitching circuit should be suspected. This is a quick check, as the VCR doesn't even have to be disassembled.

A test for headswitching problems

To prove whether an unexplained line on the screen is the headswitching points, perform the following test. First make a recording at the SLP speed. Next playback the tape and, while watching the unexplained line, enter the pause mode. If the line expands to a horizontal bar or if the playback picture breaks into two disconnected parts, then the line is definitely the headswitching points. Figure 4 gives some examples. Section A is the playback picture before enter-

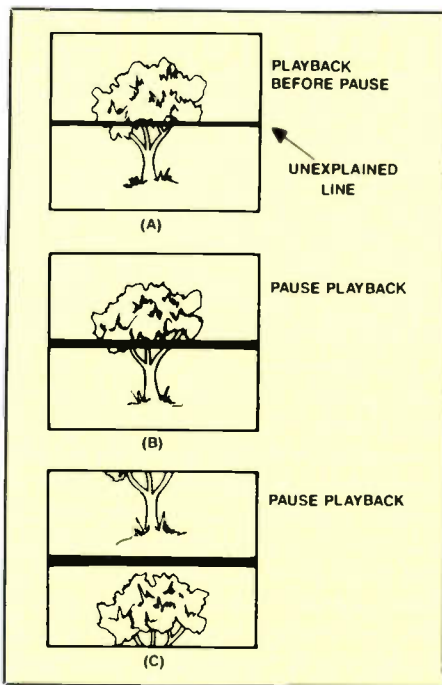

Figure 4

ing pause, while sections B and C are examples of the picture while in pause.

To understand why pause has this effect, recall that when in pause, the FM envelope often has one or more nulls or dropouts. Should a dropout occur in the vertical sync interval, the pause picture will lose vertical sync and may either shake or roll. To prevent this, the headswitching signal is used to generate a false vertical sync signal. During pause, the false vertical sync signal is mixed with the video output signal. False vertical sync is a wider pulse than normal vertical sync and therefore overrides normal vertical sync. This feature helps keep the pause picture stable, regardless of the location of any nulls in the FM envelope. Should the headswitching signal and the video signal be out of phase, then each field of pause video will contain two vertical sync pulses. One of these pulses will be visible in the screen. Depending on which pulse the TV's vertical circuits choose to lock onto, the TV display will resemble either B or C of Figure 4. Again, this is an extremely quick test to perform on any VCR as no disassembly is required. ■

THE

B.I.R.D.^{T.M.}

Battery powered InfraRed Detector

Until now, the only way to test infrared emitting devices was with a phosphor chip.....Until the B.I.R.D. The world's first handheld, Battery powered, InfraRed Detector. This instrument is so unique, it's patented! The B.I.R.D. instantly recognizes infrared light from television, VCR, and stereo remote controls, VCR tape stop circuits,

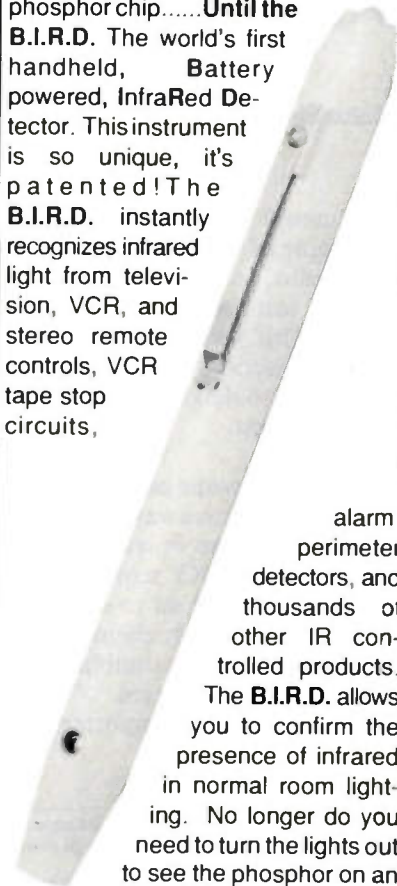

alarm perimeter detectors, and thousands of other IR controlled products. The B.I.R.D. allows you to confirm the presence of infrared in normal room lighting. No longer do you need to turn the lights out to see the phosphor on an infrared detector card. Slim one hand operation makes it easy to reach IR emitters on crowded VCR tape mechanisms. The B.I.R.D. will soon become one of the most important time saving instruments in your tool box. You will be able to test your customers' handheld remotes in seconds...even in the customer's own home!

**CALL TOLL FREE
FOR COMPLETE DETAILS**

1-800-338-0531

**Parts
Express**
International Inc.

340 E. First St.
Dayton, Ohio 45402
Phone: 513-222-0173
FAX: 513-222-4644

Circle (21) on Reply Card

Stereo phasing problems—part two

By John Shepler

Last month Audio corner talked about some of the characteristics of stereo audio, and some of the problems that can occur in stereo audio systems. This second and final installment describes how to use your oscilloscope to diagnose and correct stereo problems.

Telltale scope patterns

The most effective way to see phasing problems in an operating stereo system is with an XY scope pattern. Most scopes can be set to do this. It doesn't matter which channel feeds which input since the combined pattern is all that's important.

Figure 1. shows the important pat-

terns. Pattern A is a pure monophonic signal. The X and Y axes of the scope are being driven in the same polarity at the same time so the pattern is a straight line at a 45 degree angle. If the line is straight, but not 45 degrees exactly, the balance of the channels is not exact.

Pattern B shows an out of phase mono signal. It is the exact reverse of the in-phase signal as you would expect. For tape sources, these lines may not be exactly straight. Tape jitter causes a fuzzy line.

Pattern C shows a normal full separation stereo signal. Expect to see a fuzzy ball on the scope. If the ball is constrained and tends to be more like pattern A, then you have stereo with poor separation. It is possible that one channel may be leaking into the other or the source material may be poor.

Pattern D shows a mono signal that is nearly 90 degrees out of phase. This indicates a phase problem in the system. Perhaps a capacitor has gone bad in a filter circuit. Another possibility is when long lines, such as phone lines, are used to carry a stereo signal. Both circuits should be the same length or the phase of the channels won't line up exactly.

Troubleshooting a system

A scope set on the XY pattern and an oscillator are about all you need to find most major stereo problems. A noise generator or mono program source can be used instead of an oscillator.

Connect the scope to the output of the system, and feed the oscillator into both left and right inputs at various points in the system. You should see pattern A even when you vary the

Shepler is an electronics engineering manager and broadcast consultant. He has more than 20 years of experience in all phases of electronics.

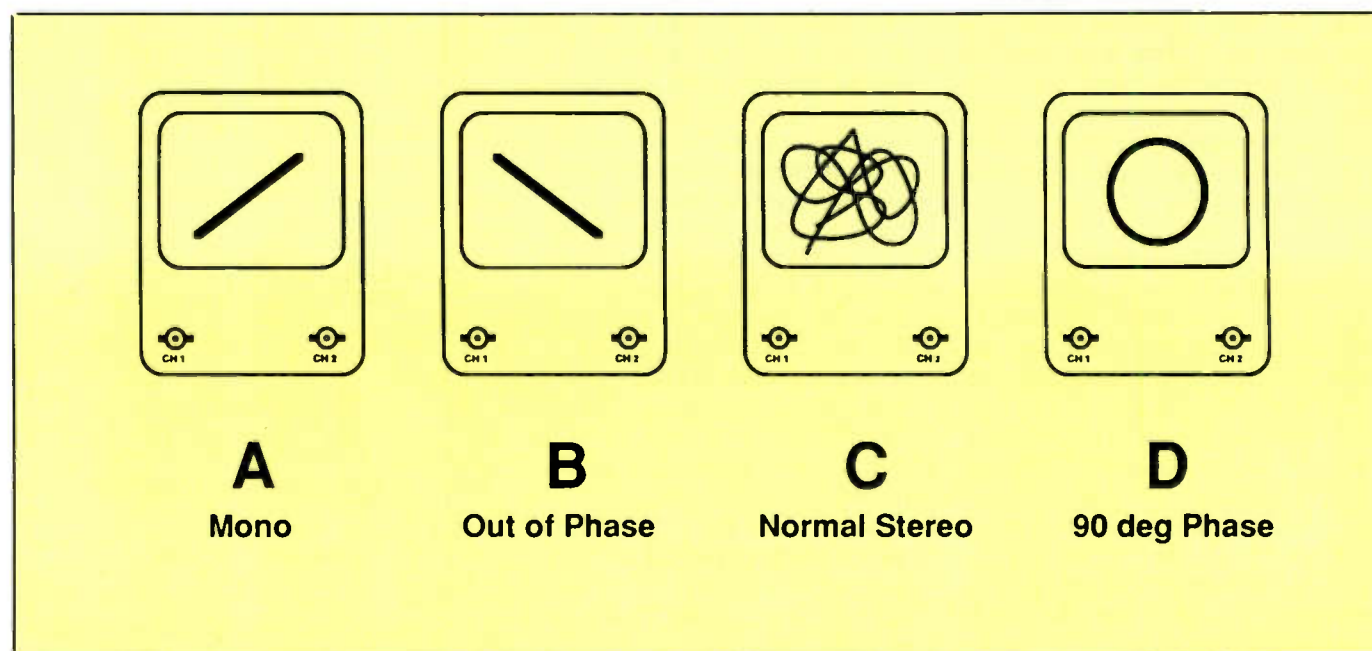

Figure 1.

frequency of the oscillator. Note that if you are going to connect the scope across speaker leads, it's possible to short out an amplifier if the hot lead gets connected to the scope chassis. Use transformer isolation or a balanced circuit input to the scope to prevent this.

If you find a phase reversal or degraded phasing, you can move the scope to the outputs of various pieces of gear, such as receivers, pre-amps, equalizers, and so on until the culprit is found. The scope can be used in the same manner inside the boxes when troubleshooting faulty circuits.

There is some unique audio circuitry in the field today, such as time delays, that may not look right on a scope depending on how they are adjusted. Equalizers, too, must have the same adjustment on both channels or they will appear out of phase. Dealing with this equipment requires some judgment as to whether it is working or not. Phasing problems are probably due to improper adjustment or wiring reversals.

Be especially careful around balanced audio systems. An unbalanced circuit usually won't work if the leads are reversed. A balanced circuit works just fine electrically. Any meters will read correctly and sound will come out of the speakers with no quality loss. However, the phase can just as easily be correct or reversed. This is especially true with microphones. Most are balanced with XLR connectors. It's too easy to reverse pins when connecting extension cables, so be aware of this weak point in the system.

Another common culprit is speaker leads. The reason one speaker wire is silver and the other copper colored is to help prevent phasing errors. When zip cord or some other wire is

substituted, it is easy to reverse the signal and common leads.

Preventing phasing problems

The easiest way to prevent phasing problems is to use a color coding scheme for hookup. Even with this, though, mistakes are made at the factory and some equipment will show up new with one channel reversed. A quick bench check with your scope before installing any new equipment will prevent later troubleshooting headaches. You should also run quick phase checks whenever you in-

stall a new audio system. Even a mono system can have multiple microphones with reversed phases. This causes sound problems that are hard to isolate since they seem to come and go.

Become familiar with the scope patterns associated with stereo sound. You will develop a valuable troubleshooting tool and will be able to solve problems that baffle others. This will translate into fewer callbacks on your own installations and additional income fixing errors in other systems. ■

Heathkit®

A leader in quality electronics for the technically sophisticated customer.

When you need kit or assembled electronic products for work, home or hobby, you can be sure Heathkit products are designed to perform reliably and effectively...year after year.

See what we have to offer. To get your **FREE Heathkit Catalog**, fill out and mail the coupon below or call toll-free today!

1-800-44-HEATH
(1-800-444-3284)

YES! Please send me a **FREE** copy of the Heathkit Catalog.

Send To: Heath Company, Dept. 030-904
Benton Harbor, Michigan 49022

Name _____
Address _____ Apt. _____
City _____
State _____ Zip _____

CL-801



Powerful Kit Laptop and Desktop Computers



Precision Test Instruments

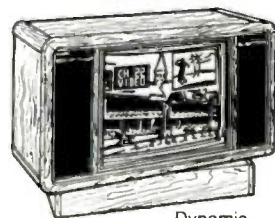

Dynamic Home Entertainment Products

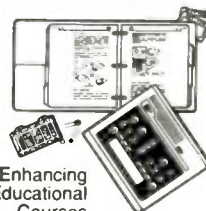

Skill-Enhancing Educational Courses and Trainers

Circle (11) on Reply Card

The importance of good housekeeping

By William J. Lynott

As a small electronics service dealer, you have several distinct advantages over the corporate bureaucracies that form some of your competition. For one, it is far easier for you to stay in tune with your customers—to be more responsive to their needs. Still, there are some important lessons to be learned from the big boys. Housekeeping for example.

If there is a universal trait in large corporations catering to the retail trade, it is in their meticulous attention to housekeeping. Retail professionals learned long ago that a sparkling clean environment is a positive influence on sales. Conversely, poor housekeeping makes a negative impression on customers—has a detrimental effect on sales.

In addition to its obvious effect on customers, I believe that housekeeping has a strong impact on both the productivity and the morale of those who are employed in the business.

Of course, few people would be inclined to argue with such simple logic; the problem is the difficulty of defining the standards that separate good housekeeping from poor housekeeping.

Working conditions

I remember visiting a friend some years ago who operates a sales and service business in New York state. I was dismayed at the working conditions I found in his operation.

Lynott is president of W.J. Lynott, Associates, a management consulting firm specializing in profitable service management and customer satisfaction research.

Discretion dictated that I keep my observations to myself, but it was difficult to hold back. In showing me the shop area, my friend commented as to how shops are “always too small.” But one look around revealed junk of every description stacked in total disarray around the room. Some of the old cartons, boxes and assorted trash had been around long enough to develop a heavy coating of dust.

In a quick estimate while still in the shop, I calculated that the productive area of that shop could have been doubled through no bigger an investment than one day’s determined housecleaning and reorganization.

My friend’s office was a tangled jumble of papers and work orders. While proudly pointing out what he considered to be the accuracy and completeness of this business records, he was struggling to put his hands on the ones he wanted to show me.

Instill the urge to buy

The sales floor, while more than adequate in size, was without pattern and lacked that squeaky-clean look that experts know helps to instill that urge to buy—a look that is virtually universal in the large retail chains.

Back in the shop, there was no attempt whatever to separate incoming goods from repaired goods, and both from goods awaiting parts or estimate approvals. All of this was evident from a visit in the shop of no more than five minutes or so. There was no question in my mind that a thorough look would have revealed a dozen specific ways in which efficien-

cy—and therefore profitability—could be improved.

To be sure, that business is located in what might be described as a “blue collar” area. No doubt the majority of his customers are of moderate means. However, it is a serious mistake for any business person to assume that standards of cleanliness, quality of service, and the other things that a customer looks for are any less acute for the person of modest means than for his more affluent counterparts.

To get back to my original point, the small service dealer has a special set of advantages that his larger competitors would dearly love to share: personal relationships with customers, the ability to react quickly to changes in the marketplace, and a strong identification with the community.

Some service dealers instinctively know how to exploit these advantages; some do not. Even those who do, however, often fail to grasp the importance of taking a page out of Big Brother’s book by muscling in on some of the ideas he has developed.

Cost-effective business technique

The concept of good housekeeping as a cost-effective business technique has been raised almost to the point of science by the large retail chains. A simple technique such as clean floors, they have learned, can actually help create an atmosphere conducive to a spending mood.

If you haven’t noticed, take a look at the floors the next time you visit one of the chain department stores.

If they are tiled, chances are you will find them spotlessly clean and buffed to a high gloss. If the floors are carpeted, the vacuum cleaner will have recently been put to use.

Up to now, you may not have noticed this basic item on the full house-keeping agenda. You can be sure, though, that you have been impressed on a subconscious level.

These lessons have been put to use in the service centers of national chains as well. Most, as you may have noticed, are neatly laid out, with special attention given to those areas visible to the customer. Shops are functional, with careful attention to work flow and neatness. Some chain service centers have been de-

signed so that repair shops, including the benches and the technicians are in full view of the customer.

The physical appearance of a service operation is at least as important as that of a retail store when it comes to establishing customer confidence and trust. Yet many servicers fail to take advantage of this easy technique for overall improvement of business operations.

How does your business rate in the housekeeping department? Be honest now. Try to see it through the eyes of a customer seeing your business for the first time. Is it possible that just a little extra attention could make your place a nicer place to do business?

CONSOLIDATED ELECTRONICS

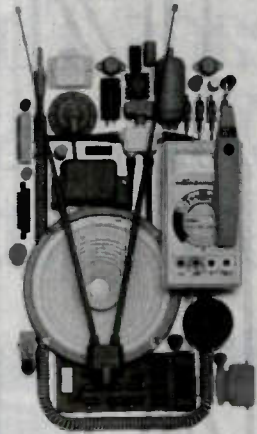

CONSUMER & INDUSTRIAL ELECTRONICS CATALOG • 17TH EDITION

THE ULTIMATE ELECTRONICS CATALOG.

Order your 260 page catalogue packed with over 10,000 money saving electronic parts and equipment. Send \$3.00 check or money order, or call 1-800-543-3568 today and use your Mastercard or Visa.
Consolidated Electronics, Incorporated
705 Watervliet Ave., Dayton, Ohio 45420-2599

NAME _____
ADDRESS _____
CITY _____
STATE _____ ZIP _____

Circle (6) on Reply Card

Come Out of the Dark.

Highlight
your opportunity
to enrich your skills
at the 1990 National Professional
Electronics Convention, August 5-11,
Las Vegas, NV. Programs will include:

- Technical training and certification.
- Management seminars and trade show.
- Registration **INCLUDES FREE 2-DAY CD SCHOOL.**

For a registration form and information,
rush the following to NESDA:

Name _____
Address _____
City _____ State _____
Zip _____
Phone _____

National Electronics Sales &
NESDA
Service Dealers Association

2708 W. Berry St.
Ft. Worth TX 76109
(817) 921-9061

TEST EQUIPMENT TO MEET YOUR NEEDS IN THE 90's.

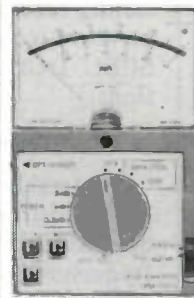

LASER POWER METER

MCM Electronics introduces a new low cost Laser Power Meter #72-670 for use in the service of compact disc players, video disc players, VCR's, remote controls and other electronic equipment that contain an infrared or laser source. This versatile Laser Power Meter has three ranges (.3mW, 1mW, 3mW) and two user selectable wave length settings (633nm, 750nm-820nm) to accurately measure power within a $\pm 5\%$ tolerance.

For a complete line of Tenma Test Equipment, see MCM's latest catalog #23.

When you order from MCM Electronics you'll experience fast order turnaround, convenient payment terms, courteous sales representatives and much more.

For more details about MCM's test
equipment offerings and a FREE
catalog subscription, call today.

1-800-543-4330



MCM ELECTRONICS
650 CONGRESS PARK DR.
CENTERVILLE, OH 45459-4072
A PREMIER Company

SOURCE NO. ES-53

Circle (17) on Reply Card

DMM Test Leads That Will Last. At Last.



On the bench or out in the field you're left to your own devices. That's why Pomona has developed 12 different DMM Test Lead Kits. You can reliably attach different probes or clips to the same lead because Pomona's "Pop Jack" coupler holds tight, just like a chinese finger puzzle until you "unlock" it. Silicone insulated wire feels great, won't be burned by the bump of a soldering iron, and stays flexible in cold temperatures.

Choice Quality, Choice Selection.

These, and a host of other features like field repairability, low-cost slide-on tips, extendable and replaceable probe tips, and a rugged pouch or case to fit in pocket or toolbox, make them the best choice. Someone's finally making test leads that will last. See your nearest Authorized Pomona Distributor or contact

POMONA ELECTRONICS
1500 E. Ninth St.,
P.O. Box 2767
Pomona, CA 91769
(714) 623-3463
FAX (714) 629-3317

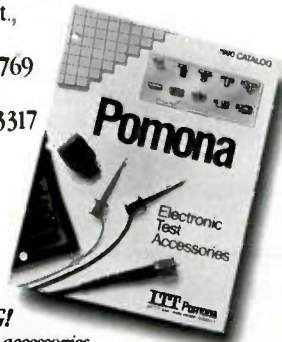

FREE
1990 CATALOG!
Thousands of test accessories
and solutions in 138 pages.
Call or write for your FREE
copy today!

ITT Pomona
AN ITT EMC WORLDWIDE COMPANY
Discover our strengths.

Circle (12) on Reply Card

Products

Desoldering station

Controlled desoldering is enhanced with the new *Weller DS500E* "user-friendly" desoldering station. The table top unit features interchangeable "keys" that deliver precise temperature control to the iron tip to within 10°F. Switching transients that may damage voltage sensitive components are eliminated with zero

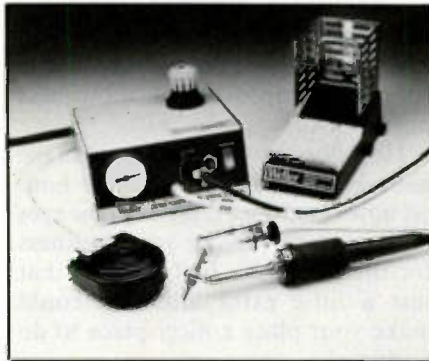

voltage circuits. A foot-activated switch controls vacuum from an exterior air system, while a cabinet-mounted gauge shows vacuum level. The easy-to-maintain station is equipped with an easy-to-clean collecting tube and optimal triplet temperature control that meets Mil-SPEC DOD-STD-2000-1 specifications.

Circle (31) on Reply Card

Portable frequency counter

CG Instruments Corp. offers the Soar Model FC-863 battery powered frequency counter with a measurement range from 10Hz to 1.3GHz for



communications, telecommunications, maintenance and production line applications. The compact, portable 6-digit LED readout unit has two input channels and uses a prescaler measuring method to enable

high accuracy measurements up to 15MHz (Ch A) and 1.3GHz (Ch B). Sensitivity is 15mV between 30 and 800 Mhz, and 25mV for the other frequency ranges. Through standard BNC connectors, the input is 1MΩ for channel A and 50j for channel B.

Circle (32) on Reply Card

Heavy duty DMM

A hand-held DMM, designed to survive the rigors of field service or general industrial applications has been introduced by *B&K Precision*.



The Model 2860, called the Survivor, which comes with a five-year limited performance warranty, is a 26-range, drop-, water- and overload resistant digital multimeter. The unit, featuring oversized 0.8-inch digits and a safety yellow case, is designed to withstand a five-foot drop and is sealed to keep out rain, grease, dirt and other contaminants. The meter features high-energy fusing and overload protection. Accuracy is within 0.5% dc, within 1.25% ac from 40Hz to 500Hz. Additional features are dc and ac measurements to 20A, resistance measurement to 20MΩ, audible continuity check, and diode junction test.

Circle (33) on Reply Card

Test your electronic knowledge

By Sam Wilson, CET

In each of the following questions, you are asked to test your recognition of basic equations used in electronics. You are also asked to identify the resulting unit of measurement when the units in the equation are given.

Only a super technician can get three or more correct.

Samples:

When V is in volts and I is in milliamperes, $V \times I$ will give the (a) _____ in (b) _____.

Answer: (a) power; (b) milliwatts

When V is in kilovolts and I is in milliamperes, $V \times I$ will give the (a) _____ in (b) _____.

Answer: (a) power; (b) watts

1. When C is in microfarads and R is in ohms, RC will give the (a) _____ in (b) _____.

2. When L is in Henries and C is in microfarads, $1/2\pi\sqrt{LC}$ will give the (a) _____ in (b) _____.

3. When f is in Hertz, $1/f$ will give the (a) _____ in (b) _____.

4. When V is in volts and I is in amperes, $V \times I \times \sin \theta$ gives the (a) _____ in (b) _____.

5. When f and bandwidth (BW) are both in Hertz, F/BW will give the _____. It has no units of measurement.

6. When the angular velocity is in radians per second and L is in Henries, angular velocity \times L will give the inductive _____ (a) _____ in (b) _____.

7. When C is in farads and V is in volts, $C \times V$ will give the (a) _____ in (b) _____.

8. When θ is in degrees, $\cos \theta$ will give the _____. It has no units of measurement.

9. If you know R in ohms, then $1/R$ will give the (a) _____ in (b) _____.

10. The reciprocal of X_C or X_L is called (a) _____, and the reciprocal of Z is called (b) _____.

Answers are on page 58.

Wilson is the electronics theory consultant for ES&T

Presenting an affordable Light Box System.

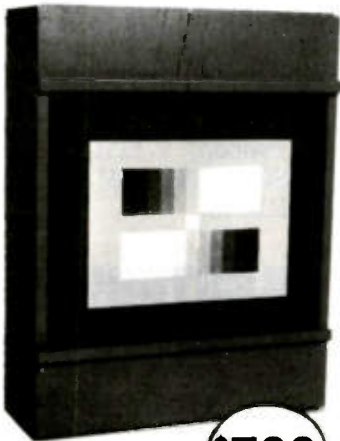

\$799

The method most manufacturers recommend

Model TR100 CB Camera Light Box with (2) transparencies

- (2) 3200° Kelvin Lamps (meets mfr. spec.)
- 1-year conditional guarantee
- Transparencies mounted in acrylic with optical scratch-resistant surface
- 11-step gray scale transparency
- 7-Bar color transparency
- All orders are shipped within 72 hours, U.P.S.

NUTRONIX (313) 726-1278

P.O. Box 77103 • Sterling Hts., MI 48077



Circle (20) on Reply Card

Replacement Work On VCRs Is Easy With ECG® Parts, Catalog.

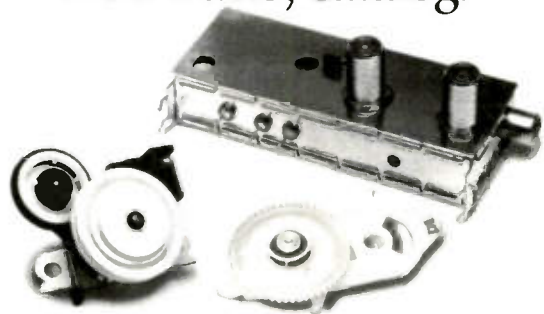

New from Philips ECG: VCR modulators for many popular brands, more opto sensing devices, additional idler wheels/assemblies and belt kits. Pinch rollers, idler components, and scores of belts complete the selection. At 900 Philips ECG distributor locations or call 1-800-526-9354.

The Smart Choice

Philips ECG



PHILIPS

Circle (23) on Reply Card

LEARN TO CLEAN/MAINTAIN/REPAIR FAX MACHINES

HUGE NEW UNTAPPED MARKET!



Over 8 million Fax machines in homes/offices - predictions are for over 25 million by 1992!

- Work from your home/van
- Home study program gets you started servicing fax machines in 2 weeks!
- No special tools/equipment needed
- Earn additional profits selling fax supplies!
- Fax machines are not cheap - therefore, you can get good \$\$ for the repair
- Average Fax machine requires professional service every 18 months
- Home study training program includes full instructions on EVERY ASPECT of Fax maintenance/repair. FULL COVERAGE of how to set up your home-based service business

FREE DETAILS

CALL 1-800-537-0589

Or write to: Viejo Publications, Inc.
3540 Wilshire BL. #310
Dept EST. Los Angeles, CA 90010
Circle (29) on Reply Card

ATTENTION TECHNICIANS

- ★ JOB OPENINGS
- ★ MONTHLY TECHNICAL TRAINING PROGRAM
- ★ BUSINESS MANAGEMENT TRAINING
- ★ SDC SATELLITE NEWS
- ★ CERTIFICATION
- ★ TECHNICAL SEMINARS

All of this in a nonprofit international association for technicians

FIND OUT MORE:



604 N. Jackson St.
Greencastle, IN 46135
1-800-359-6706

Accessing ICs

(from page 13)

and ease of use then become important. Quality clips and adapters outperform alligator clips and hand-soldered wire, measured by any of these criteria. It is possible in some cases to access IC leads with fine tweezers and probes, provided you're able to hold them in place. However, doing this for several leads is time consuming and can be unreliable.

A good contact can be assured with a "wipe" connection. The "snap ring" design that slips over all four sides of an IC "wipes" as it is pushed down into position, wedging for a tight fit. These are designed to provide a 40-50 gram normal force against the contact, assuring a tight joint. When using a clothes-pin type clip, it's a good practice to "wiggle" it a little, providing the "wiping" action for a good contact.

Clip design counts, too

There is no doubt that gold plating makes the best contact. Most quality clips and adapters use gold-plated beryllium copper contacts or pins. Lower quality pins, perhaps nickel-silver, cost less and provide an adequate contact for many applications. Some clips now offer a roughened stainless steel coating on the contacts to penetrate oxide coatings on DIP ICs exposed to contaminated environments.

Test clips require some space for installation. If you're in a position to influence the design of the board as well as test it, get the manufacturer to leave some real estate around those vital chips you're likely to want to reach. Also, they should keep in mind when they're mounting the board that there is some height to test clips. Many test clip manufacturers provide this "footprint" information in their catalogs.

Keeping an inventory of test clips on hand, to match each of the package types you're testing, can save you time and money. They allow you to perform hands-free testing. They also can help you be more accurate. And doing a better testing job, quicker, at less cost, is what it's all about.

Answers to the quiz

Questions are on page 57.

1. (a) time constant
(b) microseconds
2. (a) resonant frequency
(b) kilohertz
3. (a) period
(b) seconds
4. (a) reactive volt amperes
(b) VARS
5. Q
6. (a) reactance
(b) ohms
7. (a) charge
(b) coulombs
8. power factor
9. (a) conductance
(b) siemens
10. (a) susceptance
(b) admittance

MOVING?

If you're planning a move in the near future, don't risk missing an issue of *Electronic Servicing & Technology*. Please give us 6-8 weeks notice if you're planning on changing your address. Just write in your new address below and mail this coupon, WITH YOUR SUBSCRIPTION MAILING LABEL, to:

ELECTRONIC
Servicing & Technology

Subscriber Services
76 N. Broadway
Hicksville, NY 11801

Name _____

Address _____

City _____

State _____ Zip _____

Back by popular demand — FREE Readers' Exchange

Readers' Exchange has been reinstated as a free service, effective with the February issue.

The following restrictions apply to Readers' Exchange:

- Only individual readers may use Readers' Exchange, and items must be restricted to those that are ordinarily associated with consumer electronics as a business or hobby. If you're in business to sell the item(s) you want to offer for sale, the appropriate place for your message is in a paid advertisement, not Readers' Exchange.

- Readers' Exchange items must be restricted to no more than three items each for wanted and for sale, and may be no more than approximately four magazine column lines in length (about 20 words).

Send your Readers' Exchange submissions to:

Readers' Exchange
Electronic Servicing & Technology
76 N. Broadway
Hicksville, NY 11801

WANTED

Sams MHF (Modular High Fidelity) series books, the higher numbers preferred. *Bob Kramer, 919 Grove St., Aurora, IL 60505.*

Service manual for Emerson color TV, Model EC-131A. *Michell Electronics, 803 Sanders Rd., Port Orange, FL 32127.*

Sams Photofact folders, numbers 2299 through 2347, and number 2453 and higher. *H. Sievers, 2715 Rogge Ln., Austin, TX 78723; 512-928-4925.*

Heath 10A-4200 Time voltage module, either kit or assembled. *Sidney R. Creacey, 1358 Turquoise Ave., Mentone, CA 92359.*

Sams Photofact folders. Have some to sell or trade. Send a list of what you have to sell or trade and prices. *Johnnie Goggatt, R#2, Marshall, IL 62441; 217-826-5122.*

Schematic/service manual for Fieldmaster TR-16M and Lafayette HE-20D CB radios. Happily pay any charges. *Duff Campbell, Box 4371, Panorama City, CA 91412.*

\$\$\$\$ paid for very old scanning disk TVs by Jenkins, Baird, Western, others. Finder's fee available. *Mr. Hauff, Box 16351, Minneapolis, MN 55416.*

Sencore SC61, and/or any accessories. Also need Sams Photofact folders, numbers approximately 1500 through 2355. Also back issues of ES&T, years 1983/84/85/86/87, or any combination thereof. *Paul Carlson, 11201/2 W. Bristol St., Elkhart, IN 46514; 219-264-2147.*

Urgently require schematic and service info for 19" Hitachi color TV, Model CT-958, Serial No. T81001980, manufactured Sept. 1978. *Horace Pollack, 19923 Buhrstone Drive, Gaithersburg, MD 20879.*

VCR service manuals, new or used. Manufacturers' or Sams. Any quantity, all numbers. *Nancy Hauver, 34 Burlington Ave., Rochester, NY 14619.*

FOR SALE

Sencore VA62, VC63, EX231, original carton. Have 2, need only 1. Used very little. \$2500. *405-623-8655. Ask for Verlen or George.*

B&K Precision 1248 Digital IC color bar generator, \$110. Sencore CR 161 Auto-tracker picture tube tester & rejuvenator, \$150. Sencore TC 162 Mighty Mite VII tube tester, \$110 plus shipping. *Harry Young, 34 Appleton Dr., Brick, NJ 08723; 212-255-3193.*

B&K 415 sweep marker generator, cables and instruction book; \$225 or best offer. Shipping extra. *Fred Sarg, 3306 First Road, Vero Beach, FL 407-778-0784.*

RCA dealer's stock of XL-100 and Color Trak modules, 1969-76; RCA service literature, RCA 10J103 color jig - all for \$300, or will sell separately. *Heston, 1130 Dover St. NE, Cedar Rapids, IA 52402.*

Factory service data. Magnavox, 22 yrs., \$500; Zenith, 10 yrs., \$250; RCA, 11 yrs., \$250; extra data free. *George Crouch, 4018 Lillian Dr., Concord, CA 94521; 414-682-8841.*

Beckman scope, model no. 9502, cursors and CRT readout, original carton, \$800 plus shipping. B&K tube checker, model no. 667, all manuals, \$50. ES&T magazines, back issues to 1981, \$100 plus shipping. *L. Hypnar, 6408 E. Elis, Mesa, AZ 85205.*

Sencore TF46 "Super Cricket" transistor/FET tester, \$95 plus shipping. RCA WV-500B solid state volt-ohmmyst, \$55 plus shipping. Both in excellent condition, and with manuals. *R.F.M. Service, 585 Marlu Drive, Pocatello, ID 83201. 208-233-9249.*

Classified

Classified advertising is available by-the-word or per column inch. **By-the-word:** \$1.65 per word, per insertion. Initials and abbreviations count as full words. Blind ads (replies sent to ES&T for forwarding) are \$40 additional. Minimum charge: \$35 per insertion.

Per Column Inch (Classified Display): \$235 per column inch, per insertion, with frequency discounts available. 1" minimum, billed at 1/4" increments after that. 10" maximum per ad. Blind ads are \$40 additional. Reader Service Number \$25 additional to cover processing and handling costs. (Free to 4-inch or larger ads.)

Optional color (determined by magazine) \$150 additional per insertion. No agency discounts are allowed for classified advertising.

Contact Jeff Uschok, 516-681-2922, for information on frequency and pre-payment discounts, or to place your classified ad. Or send your order and materials to Jeff Uschok, Electronic Servicing & Technology, 76 North Broadway, Hicksville, NY 11801.

HELP WANTED

EXPERIENCED AUDIO OR TV TECHNICIANS. Possibly even service manager position. Medium sized and growing shop in beautiful Eugene, Oregon 503-343-7683. 6-90-2t

FOR SALE

PHOTOFACTS: Folders under #1400, \$4.00. Above #1400, \$6.00 Sent same day first-class postpaid. Loeb, 414 Chestnut Lane, East Meadow, NY 11554. 4-90-3t

1990 CRT REFERENCE MANUAL, lists heaters, cathodes, G1's & G2's, basings & pinouts for all color, projection, oscilloscope and camera pickup CRT's. 1949-1990. Dandy Manufacturing Co., 2323 Gibson Street, Muskogee, Oklahoma 74403 (918) 682-4286. 5-90-2t

REDUCED 85%, Diehl Mark III scanner \$89. Diehl Mark V scanner \$219. New. Restore remote control keypads with our conductive coding \$8.99 ppd. WEEC, 2805 University Ave., Madison, WI 53705. 608-238-4629. 608-233-9741. 6-90-1fn

TV TOUGH DOGS: 300 symptoms and cures. Send \$9.95 to DAVIS TV, 11772 Old Fashion Way, Garden Grove, CA 92640. 10-87-1fn

TV TROUBLESHOOTING: Over 300 problems/solutions. Nothing old listed. \$12.00, add \$1.50 shipping. Refund if not satisfied. Jones Enterprises, Box 702, Niceville, FL 32578. 12-89-1fn

VHS-VCR Repair Solutions Sets I, II, III, IV, V. Each contains 150 symptoms and cures, cross reference chart, free assistance, \$11.95 each all five \$49.95. Eagle Electronics, 52053 Locks Lane, Granger, IN 46530. 12-89-1fn

BUSINESS OPPORTUNITIES

LARGE AUDIO/VIDEO SERVICE BUSINESS. In sunny S.W. city. Established 20 yrs. Well equipped. Price & terms negotiable. (602) 298-8827. eves. 8-89-1fn

AUDIO VIDEO SALES AND SERVICE BUSINESS in eastern Colorado, well established, well equipped, ideal for family. (303) 246-3766 evenings. 5-90-2t

CENTRAL FLORIDA TV/VCR/Microwave Shop Fully equipped, established 1973, owner retiring. A-1 Business Brokers 904-629-8888. 6-90-1t

OWNER RETIRING. Turn key television and stereo repair. Oldest of its kind in the area. Contract terms available. \$99,000. Contact Ed LaRocque of Roth & Wehrly Realtors, Fort Wayne, Indiana 219-482-1300. 6-90-1t

GET IN NOW ON THE \$12 BILLION A YEAR COMPUTER SERVICE INDUSTRY

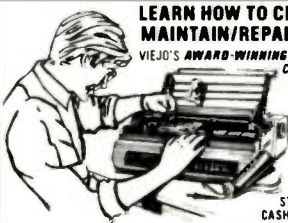

LEARN HOW TO CLEAN/ MAINTAIN/REPAIR PRINTERS...

VIEJO'S AWARD-WINNING TRAINING VIDEO AND COMPANION TRAINING MANUAL (OVER 300 ACTION-PACKED PAGES) REVEALS SECRETS OF PRINTER REPAIR... WITH YOUR AVERAGE MECHANICAL ABILITY WE CAN SHOW YOU HOW TO REPAIR UP TO 95% OF ALL PRINTERS - START EARNING EXTRA CASH IN DAYS!

• SERIOUS LACK OF TRAINED TECHNICIANS
OVER 37 MILLION PC'S IN USE... APPROXIMATELY 85% HAVE A PRINTER ATTACHED... **VAST MAJORITY OF PRINTER BREAKDOWNS ARE DUE TO SIMPLE MECHANICAL OR ELECTRO-MECHANICAL FAILURE.**

FREE INFO CALL 1-800-537-0589 OR WRITE TO: **VIEJO PUBLICATIONS**
3540 WILSHIRE BL. #310
DEPT. EST 2, L.A. CA 90010

Circle (30) on Reply Card

TV TECHNICIANS

TEST/CLEAN/RESTORE with a **UNIVERSAL CRT ADAPTER** that fits all CRT testers and quickly hooks-up to all CRT's on the market (now or in the future). Guarantees profit & total CRT servicing. Used by TV Repair, US Govt., Airlines, Computer Serv., Dept. of Defense. Patented Adaptor-Sockets-CRT Reference/Setup book—Only \$59.95 plus \$2.50 postage & handling. Our 6th year. Over 15,000 sold. Chargecards/Checks/COD. Money Back Guarantee.

FREE CALL 1-800-331-9658
DANDY MFG. CO./RANDALL ELECTRONICS
(918) 682-4286, 2323 Gibson St., Muskogee, OK 74403

Circle (8) on Reply Card



"Sperry Tech's Pricing Guide"

Updated now 6th edition... a framework for setting rates that apply to Hi-Tech products... a formula that guarantees **SUCCESS!**

Call Toll Free for details
1-800-228-4338

Circle (26) on Reply Card

TUBES • TUBES • TUBES

World's Largest Range

Over 2,000 Types, Domestic & Foreign

UP TO 85% OFF Ask for price list

International Components Corporation
Toll Free 800-645-9154 • N.Y. State 516-293-1500
105 Maxess Road, Melville, New York 11747

Circle (13) on Reply Card

INCREASE SERVICE PROFITS

—With Precise Labor Charges—

The DTS125 Digital Timekeeping System is a unique stand-alone device that tracks labor hours and charges. Large memory stores 125 accounts by your tag #s. User-friendly design includes keypad and graphics display. Sturdy bench-top enclosure. Trial period. Cost is \$289.00 + \$3.50 S&H.

Johnson Electronic Technologies
5 Kane Industrial Dr. • Hudson, MA 01749
(508) 562-1157

Circle (14) on Reply Card

Advertisers' Index

Company	Page Number	Reader Service Number	Advertiser Hotline
Amprobe Instruments	IBC 2	2	307/382-5663
B & K Precision	1	3	312/889-1448
Beckman Industrial Corp.	19	4	619/495-3200
C & S Electronics	48	5	800/292-7711
Consolidated Electronics, Inc.	55	6	800/543-3568
Conway Manufacturing, Co.	44	7	415/568-5282
Dandy Mfg. Co.	60	8	800/331-9658
ETA	58		800/359-6706
Fluke Manufacturing	5	9	800/227-3800
Goldstar Precision	6	10	213/404-0101
Heath Company	53	11	800/44-HEATH
ITT Pomona Electronics	56	12	714/623-3463
International Components Corporation	60	13	800/645-9154
Johnson Electronics	60	14	508/562-1157
Leader Instruments Corp.	3	15,16	800/645-5104
MCM Electronics	55	17	800/543-4330
Matsushita Services Co.	16		201/348-7589
Microwave Filter Co.	45	18	800/448-1666
Mitsubishi	8,9	19	800/553-7278
NESDA	44,55		817/921-9061
Nutronix Inc.	57	20	313/939-4710
Parts Express Int'l Inc.	51	21	513/222-0173
Philips ECG	45,57	22,23	800/526-9354
Prime Electronics	44	24	800/558-9572
Sencore, Inc.	IFC	1	800/SEN-CORE
Sperry Tech, Inc.	60	26	800/228-4338
Tentel	43	27	800/538-6894
Test Probes, Inc.	17	35,36,37	800/368-5719
		38,39	
Viejo Publications	23,58,60	28,29,30	800/537-0589
Zenith	BAC		

SAVE TIME

For fast, accurate service, please remove the peel off label used to address your magazine, and attach it to the Reader Service Card, the Address Change Card or to any correspondence you send us regarding your subscription.

SALES OFFICE

THE MAGAZINE FOR CONSUMER ELECTRONICS SERVICING PROFESSIONALS
ELECTRONIC
Servicing & Technology

76 North Broadway
Hicksville, NY 11801
(516) 681-2922
FAX: (516)681-2926

Jonathan Kummer
Advertising Manager
Emily Kreutz
Sales Assistant

GO AHEAD... Make A Mistake

Fused to 600 Volts AC/DC to help protect instrument as well as user from mis-application

MODEL AM-12 ▶

- 20 Industrial Ranges
 - .1 Ω Resolution
 - Pocket Size
- Price: \$44.85

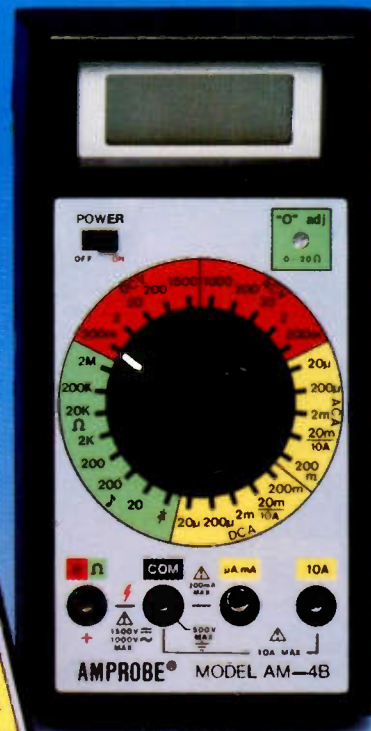
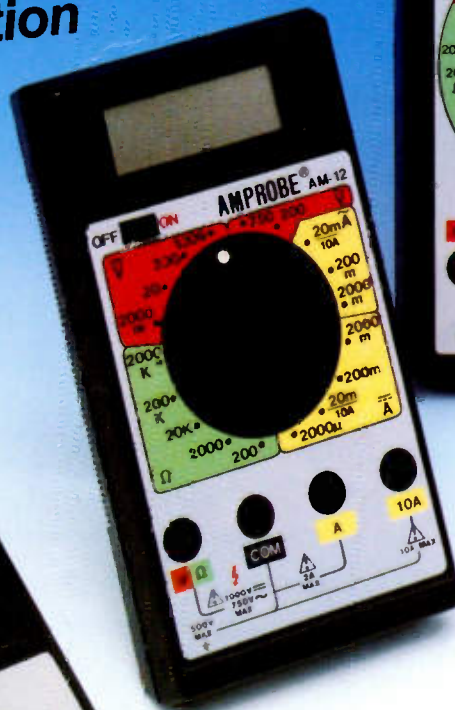

MODEL AM-4B ▲

- .01 Ω Resolution
 - Sensitive 20 μ A/20 Ω Ranges
 - Audible Continuity
- Price: \$104.85



◀ MODEL AM-14

- Direct Temperature Reading
 - 200mV & 20M Ω Ranges
 - Convenient Intermediate Range
 - Audible Continuity
- Price: \$64.85

ALL MODELS INCLUDE

- Over Range Indication
- Low Battery Indication
- Auto Zeroes
- Reversed Polarity Indication
- Standard Banana Jacks
- PTC Protection to 500V AC/DC on all Ohms Ranges
- Fuse Protection to 600V AC/DC on all mA/ μ A Ranges

AMPROBE INSTRUMENT®

DIVISION OF CORE INDUSTRIES INC., LYNBROOK, NEW YORK 11563

630 MERRICK ROAD, P.O. BOX 329
Area Code 516-593-5600 • ITT TLX 4971416
FAX 516-593-5682

Circle (2) on Reply Card



THE PROFESSIONAL CHOICE!

Zenith chemicals are designed to meet the ever increasing demand of your service department.

Backed by a name you can trust, Zenith chemicals can keep you operating at peak performance... and they're the choice of today's leading professionals.

Call your Zenith distributor today and put Zenith chemicals to work for you!

ZENITH CHEMICALS

THE QUALITY GOES IN BEFORE THE NAME GOES ON®