

THE MAGAZINE FOR CONSUMER ELECTRONICS SERVICING PROFESSIONALS

ELECTRONic™

Servicing & Technology

MARCH 1990/\$3

Product directory • Services directory • Mailing Addresses

Replacement parts/components directory

ELECTRONICS SERVICING

BUYERS'

guide

A48089-----KWEDA2320 APR90 ESQ
R10407881061985133 GG 1

RAY KOWECK

11232 DALE
WARREN

MI

48093

Cut Your Video Troubleshooting Time By 54%* With The VA62A Universal NTSC Video Analyzing System

**New
And Improved!**



VA62A Universal Video Analyzer
Patented

- Identify tuner problems with All-Channel, VHF, UHF, and Cable RF Generators.
- Pinpoint IF Problems with modulated troubleshooting signal and exclusive programmable IF/RF generators.
- Isolate any video problems with patented video and standard color-bar patterns.
- Find defective stages, without disconnecting parts, using exclusive phase-locked drive signals.
- Test yokes and flybacks, plus measure signal levels with autoranged digital meter.

* Based on a nationwide survey of users who reported an average time savings of 54% compared to their previous test equipment.

Call 1-800-SENCORE
(736-2673)

In Canada 1-800-851-8866

Update For New Technology With Exclusive Phase-Locked Accessories

VC63 VCR Test Accessory

Solve the VCR servicing challenge with substitute VCR signals, phase-locked to your VA62A.



NT64 NTSC Pattern Generator

Meet all Warranty Requirements by adding the NTSC full-field and split-field patterns to your VA62A Universal Video Analyzer.

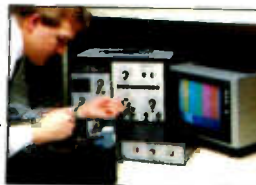

ST65 Video Analyzer Stereo TV Adder

Easily test and troubleshoot today's new MTS Stereo TVs & VCRs.



RG67 NTSC Video Monitor Adaptor

Expand into analog and digital video monitor service with phase-locked R, G, B and I signals.



SENCORE

LIVE ACTION

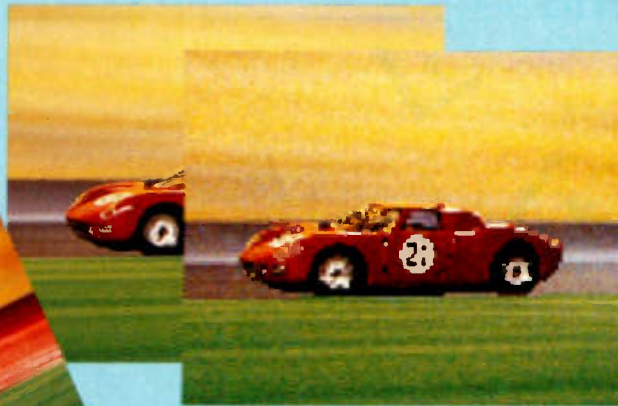

STOP ACTION, INSTANT REPLAY

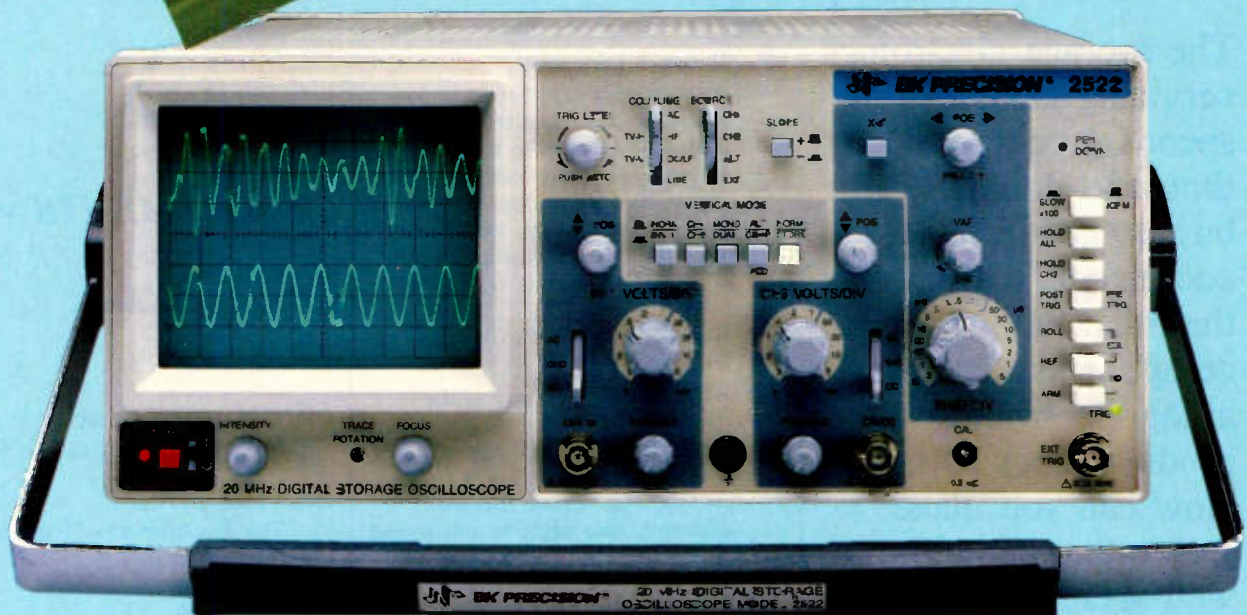

Catch all the action with the new B&K-PRECISION 2522 Digital/Analog oscilloscope.

The new B&K-PRECISION Model 2522 is a full-feature analog scope for live action and a DSO for stop action.

- Full analog and digital operation.
- 20MHz analog operation.
- 10 MS/second sampling rate on 1 or 2 channels.
- Equivalent time sampling to 20MHz.
- 2k memory per channel.
- Pre-trigger capture.

A touch of a button switches the 2522 from analog to digital operation. It's an easy-to-operate scope with the performance you need, at a price you'll like.

Don't let the action pass you by. The 2522 will put you on the fast track for performance and results. For immediate delivery or complete specifications, contact your local B&K-PRECISION distributor.

\$1495



BK PRECISION

MAXTEC INTERNATIONAL CORP.

Domestic and International Sales
6470 W. Cortland St., Chicago, IL 60635
312-889-1448 • FAX: 312-794-9740

Canadian Sales, Atlas Electronics, Ontario

Circle (3) on Reply Card

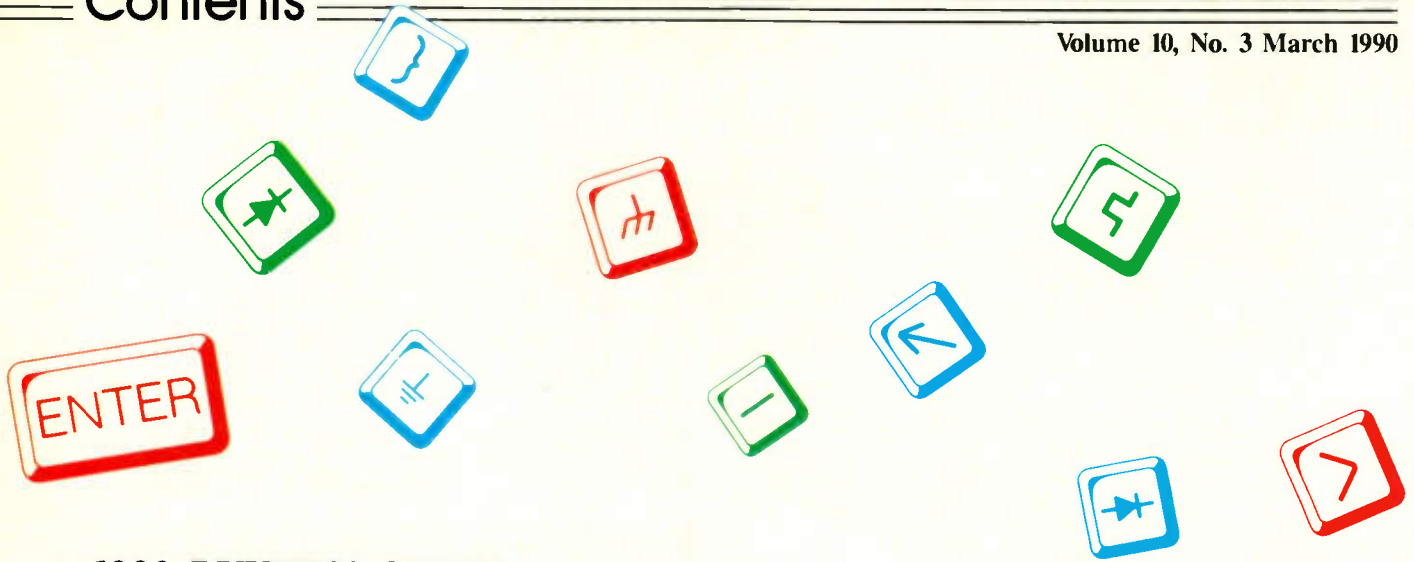

1990 BUYERS' GUIDE

The average electronics servicing facility spends a couple of thousand dollars a year buying new test equipment, and more than that buying the components that bring ailing electronics products back to life. How can you make sure every penny is well-spent? By doing your homework — contact several companies, compare costs, compare features and service. This fourth annual Buyers' Guide is designed to help you locate the services you'll need in the next year faster and easier, with just one source of reference.

THE MAGAZINE FOR CONSUMER ELECTRONICS SERVICING PROFESSIONALS
ELECTRONIC
Servicing & Technology

- 9 Product Directory**
As new technology becomes more complicated, so does the test equipment required to keep new technologies up and running. If you simply have to have the newest gizmo on the market, we'll bring the marketplace to you in this part of the Buyers' Guide.
- 37 Replacement Parts/Components Directory**
What's the toughest part of the servicer's job? Fixing the product? That's the easy part. The tough part is finding the right parts to fix the product. This section lists the companies that might be able to end your search.
- 44 Software/Services Directory**
Maybe you don't actually need to buy anything. You just want to rent some equipment or get your test equipment recalibrated. Step right up to the services section. Here's where you'll find companies to do specialty rework or repair, consulting and calibration.
- 44 Association/Educational Sources Directory**
Trying to keep on top of new technology? Or maybe you just want to share some experiences with others who know the trials and tribulations of electronics servicing. This section puts you in contact with people who can help you find your way around the servicing industry.
- 45 Company Mailing Addresses**
Now turn to the addresses section of the Buyers' Guide. The products or services you need are now just a phone call away.

DEPARTMENTS

- 6 Editorial**
Home Automation
- 27 Profax**
- 54 Computer Corner**
"Where Do I Plug in This Cable?"
- 56 Video Corner**
The Amplifier as a Troubleshooting Aid — Part II
- 57 Feedback**
- 58 Audio Corner**
Solving RFI Complaints — Part II
- 60 Advertisers' Index**

ON THE COVER

Some terms have a crossover in other fields that is especially apt — for example, a computer "menu" of functions. The Buyers' Guide isn't yet offered as a computer menu that lets you press key number 1 to order a diode or capacitor. (in the future — who knows?) However, the 1990 Buyers' Guide "product menu" can certainly offer some specials you might want to order in 1990. (Graphic design by Barbara Miles)

LEADER

CARVER DENON harman/kardon  HITACHI

NEC ONKYO  PIONEER®  SANSUI

SHARP® SONY®  TEAC® YAMAHA®

These leaders specify Leader.

When servicing electronics, depend on Leader for your test equipment needs.

Leader meets the standards of so many, because we set such high standards in design.

Equip your bench with our standard test equipment as required by manufacturers. Leader continually consults manufacturers and their service facilities to determine what products and features you'll need. The unique features on Leader equipment help you work smarter and increase efficiency.

You'll find hard-to-beat capabilities and value throughout the Leader line.

See all there is to Leader's leadership, and benefit from our more than 34 years of experience. Phone now to discuss your equipment requirements, for a copy of our catalog, and for the name of your nearest "Select" Leader Distributor. All Leader equipment is backed by a TWO-YEAR WARRANTY, and factory service on both coasts.

Call toll-free
1 800 645-5104
In NY State
516 231-6900

Leader Instruments Corporation
380 Oser Avenue, Hauppauge, New York 11788
Regional Offices:
Chicago, Dallas, Los Angeles, Boston, Atlanta
In Canada call Omnitronix Ltd. 416 828-6621

LEADER
FOR PROFESSIONALS WHO KNOW
THE DIFFERENCE

1. LCG-400S NTSC Pattern Generator
2. LVS-5850B NTSC Vectorscope
3. LDC-823S 250-MHz Frequency Counter
4. LMS-238 TV Stereo Generator
5. 3216 AM-FM Stereo Generator
6. LHM-80B High Voltage Meter

7. LSW-333 TV Sweep Generator
8. LAG-126S Audio Generator
9. LMV-185A AC Millivoltmeter
10. LFM-39A Wow & Flutter Meter

11. LDM-171 Distortion Meter
12. LTC-906 Transistor Checker
13. LDM-853A Digital Multimeter
14. LPS-152 DC Power Supply
15. LPM-8000 Laser Power Meter
16. LBO-2060 CRT Readout Oscilloscope

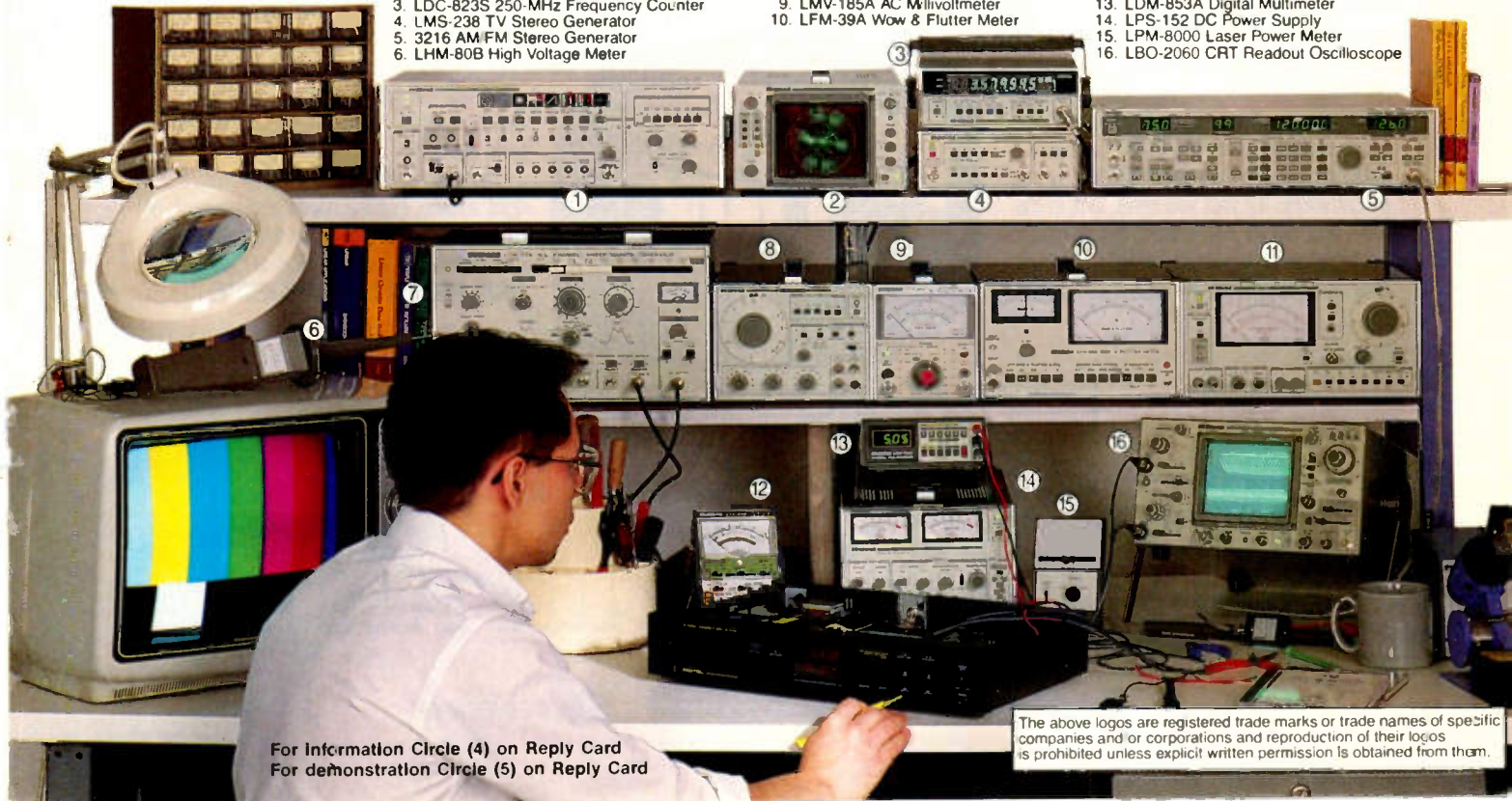

For information Circle (4) on Reply Card
For demonstration Circle (5) on Reply Card

The above logos are registered trade marks or trade names of specific companies and or corporations and reproduction of their logos is prohibited unless explicit written permission is obtained from them.

DELIVERY IS THE MOST IMPORTANT FUNCTION OF A PARTS DISTRIBUTOR. BUT IT'S NOT ENOUGH.



MATSUSHITA AUTHORIZED PARTS-LINK™ DISTRIBUTORS. BECAUSE IT PAYS TO BE SURE.

Some distributors are quick to promise fast delivery of replacement electronic parts. But they may not always be the right parts. That's never a problem when you put your trust in a Matsushita Authorized PARTS-LINK™ Distributor — your best source for Panasonic, Technics and Quasar original replacement parts. For basic stocking, each distributor maintains over 1,000 of the most demanded part numbers for off-the-shelf delivery. Even if the part you need isn't so common, your Matsushita distributor is tied into our exclusive PARTS-LINK™ network, tracking over 385,000 part numbers, so that we can locate the part you need, lock in the order, and deliver it — if overnight delivery is requested to your doorstep within 24 hours. They can even cross-reference these original

replacement parts to other Matsushita built products so that you can retain the high quality and reliability of Matsushita's design.

THE DIFFERENCE BETWEEN A PROMISE KEPT, AND A PROMISE BROKEN.

Your Matsushita Authorized PARTS-LINK™ Distributor isn't authorized by accident; each has met (and continues to meet) stringent requirements to ensure fast, courteous and responsive service backed by Matsushita's replacement parts warranty.

The right part at the right time from the right source. For the name and location of your Matsushita Authorized PARTS-LINK™ Distributor — see our listings at right. **YOUR SOURCE OF CONFIDENCE.**



MATSUSHITA SERVICES COMPANY

50 Meadowland Parkway, Secaucus, NJ 07094

Panasonic Technics Quasar

MATSUSHITA

AUTHORIZED REPLACEMENT PARTS DISTRIBUTORS

Panasonic® • Technics™ • Quasar®

ARIZONA
ARIZONA WHOLESALE SUPPLY CO. (C/M) • 2020 E. University Dr., Phoenix 85062 • 602-258-7901
ELECTRONIC PARTS CO. (C/V/M) • 4021 N. 31st Ave., Phoenix 85017 • 602-277-7281

CALIFORNIA
ANDREWS ELECTRONICS (C/V/M) • 25158 Avenue Stanford, Valencia 91355 • 805-257-7700
AUDIO VIDEO PARTS, INC. (C/V/M/A) • 1071 South La Brea Ave., Los Angeles 90019 • 213-933-8141
CASS ELECTRONICS (C/V/M/A) • 801 Seventh Ave., Oakland 94606 • 415-839-2277
CHUCK HURLEY ELECTRONICS (C/M/A) • 2557 Albatross Way, Sacramento 95815 • 916-927-5891
E AND K PARTS, INC. (C/V/M/A) • 2115 Westwood Blvd., Los Angeles 90025 • 213-475-6848
HURLEY ELECTRONICS (C/M) • 10712 Inglewood Ave., Inglewood 90304 • 800-356-8734
HURLEY ELECTRONICS (C/M) • 730 W. Spruce, San Bernardino 92410 • 714-885-0721
HURLEY ELECTRONICS (C/V/M) • 318 16th St., San Diego 92101 • 619-235-6245
HURLEY ELECTRONICS (C/M) • 2101 N. Fairview, Santa Ana 92706 • 714-971-2992
PACIFIC COAST PARTS (C/V/M/A) • 15024 Staff Court, Gardena 90248 • 213-515-0207
WHOLESALE VACUUM (V) • 5811 Rose Ave., Long Beach 90813 • 213-428-6411

COLORADO
DENVER WALKER WINTRONICS (C/M) • 1001 W. Arizona Ave., Denver 80223 • 303-744-9505

CONNECTICUT
SIGNAL ELECTRONICS SUPPLY, INC. (C/M/A) • 589 New Park Ave., West Hartford 06110 • 203-233-8551

FLORIDA
HERMAN ELECTRONICS (C/V/M/A) • 1365 N.W. 23rd St., Miami 33142 • 305-634-6591
LAYCO, INC. (C/V/M) • 501 South Main St., Crestview 32536 • 904-682-0321
VANCE BALDWIN (C/A/M) • 2207 S. Andrews Ave., Fort Lauderdale 33316 • 305-523-3461
VANCE BALDWIN (C/M/A) • 1801 NE 2nd Ave., Miami 33132 • 305-379-4794
VANCE BALDWIN (C/V/M/A) • 1007 N. Himes Ave., Tampa 33607 • 813-870-2606
VANCE BALDWIN (C/V/M) • 500 Clematis St., West Palm Beach 33401 • 407-832-5671

GEORGIA
BUCKEY VACUUM CLEANER (V) • 2870 Plant Atkinson Rd., Smyrna 30080 • 404-351-7300
WHOLESALE INDUSTRIAL (C/M/A) • 5925 Peachtree Corners East, Norcross 30071 • 404-447-8436

HAWAII
PANASONIC HAWAII, INC. (C/V/M) • 99859 Iwalaia St., PO Box 774, AIEA, HI 96701 • 808-488-1996

ILLINOIS
B-B & W, INC. (C/V/M) • 2137 S. Euclid Ave., Berwyn 60402 • 312-242-1533
HESCO, INC. (V) • 6633 North Milwaukee Ave., Niles 60648 • 312-647-6700
JOSEPH ELECTRONICS, INC. (C/M/A) • 8830 N. Milwaukee Ave., Niles 60648 • 312-297-4200
UNION ELECTRONIC DIST. (C/V/M/A) • 16012 S. Cottage Grove, South Holland 60473 • 312-333-4100

INDIANA
ELECTRONIC SERVICE PARTS (C/V/M) • 2901 E. Washington St., Indianapolis 46201 • 317-269-1527

IOWA
JONES DISTRIBUTING CO. (C/V/M/A) • 2650 Bndgeport Dr., Sioux City 51111 • 712-277-8600

KANSAS
G & A DISTRIBUTORS, INC. (C/V/M/A) • 635 N. Hydraulic St., Wichita 67201 • 316-262-3707

KENTUCKY
MAJOR DISTRIBUTING COMPANY (C/M) • 449 S. 16th St., Paducah 42003 • 502-443-5345
SERVICE ELECTRONICS SUPPLY (C/V) • 1046A New Circle Rd., NE, Lexington 40505 • 606-254-5786

MARYLAND
FAIRWAY ELECTRONICS (C/V/M) • 3040 Waterview Drive, Baltimore 21230 • 301-576-8555
FAIRWAY ELECTRONICS (C/V/M/A) • 4210 Howard Ave., Kensington 20795 • 301-564-1440
TRITRONICS, INC. (C/V/M/A) • 1306 Continental Dr., Abingdon 21009-2334 • 301-676-7300

MASSACHUSETTS
MIL ELECTRONICS (C/V/M/A) • 27-33 Jones Rd., Waltham 02154 • 617-891-6730
SIGNAL ELECTRONICS SUPPLY, INC. (C) • 484 Worthington St., Springfield 01105 • 413-739-3893
TEE VEE SUPPLY CO. (C/V/M/A) • 407 R Mystic Avenue, P.O. Box 649, Medford, MA 02155 • 617-395-9440

MICHIGAN
G.M. POPKEY CO. (C/V/M/A) • 4477 East Paris Ave. S.E., Grand Rapids 49512 • 616-698-2390
REMCOR ELECTRONICS (C/M/A) • 10670 Nine Mile Rd., Oak Park 48237 • 313-541-5666

MINNESOTA
NESS ELECTRONICS, INC. (C/V/M/A) • 441 Stinson Blvd. NE, Minneapolis 55413 • 612-623-9505
MID AMERICA VACUUM CLEANER SUPPLY CO. (V) • 666 University Ave., St. Paul 55104 • 612-222-0763

MISSISSIPPI
TRI-STATE ELECTRONICS (C/V/M) • 605 W. Fortification St., Jackson 39203 • 601-355-3431

MISSOURI
CITITRONIX, INC. (C/V/M/A) • 1641 Dielman Rd., St. Louis 63132 • 314-427-3420
MANHATTAN ELECTRONICS, INC. (C/V/M) • 1101 E. 76th Terrace, Kansas City 64131 • 816-361-9440
TACONY CORP. (V) • 1760 Gilsinn Lane, Fenton 63036 • 314-349-3000

NEW HAMPSHIRE
TEE-VEE SUPPLY CO. (C/V/M/A) • 58 Elm St., Nashua 03060 • 603-889-4171

NEW JERSEY
NIDISCO ELECTRONICS (C/V/M/A) • 181 Route 46 W. Lodi 07644 • 201-773-1771

NEW YORK
DALE ELECTRONICS (C/V/M/A) • 7 E. 20th St., New York City 10003 • 212-475-1124
GREEN TELE-RADIO DIST. (C/M/A) • 84-00 73rd Avenue, Glendale 11385 • 718-821-1114
GMB SALES (C/V/M/A) • 140 Terminal Rd., Setauket 11733 • 516-689-3400
MILL ELECTRONIC SUPPLY (C/V/M/A) • 2026 McDonald Ave., Brooklyn 11223 • 718-336-4575
PAGO APPLIANCE PARTS (C/M/A) • 700 Broadway, Buffalo 14212 • 716-856-8133
PANSON ELECTRONICS (C/V/M/A) • 268 Norman Avenue, Greenpoint 11222 • 718-383-3400
RADIO EQUIPMENT CORP. (C/A) • 196 Vulcan St., Buffalo 14207 • 716-874-2690
STAR FOR PARTS (V) • 250 Rabro Drive East, Hauppauge 11788-0255 • 800-525-6046
UNITED TELETRONIC PARTS (C/M) • 3860 10th Ave., New York 10034 • 212-569-2330

NORTH DAKOTA
WESTECH DISTRIBUTING (C/V) • 1345 Main Ave., Fargo 58103 • 701-237-4885

OHIO
FOX INTERNATIONAL, INC. (C/V/M/A) • 23600 Aurora Rd., Bedford Heights 44146 • 216-439-8500

OREGON
DIVERSIFIED PARTS (C/V/M/A) • 2104 S.E. 9th Ave., Portland 97214 • 503-236-6140
THE MOORE CO. (C/V/M) • 333 SE 2nd, Portland 97214 • 503-234-5000

PENNSYLVANIA
AMERICAN VAC DISTRIBUTORS (V) • 3130 E. Thompson St., Philadelphia 19134 • 215-423-4522
CRS ELECTRONICS (C/M) • 818 Brownsville Rd., Pittsburgh 15210 • 412-431-7700
LINWOOD WHOLESALE, INC. (C/M) • 1139 Sumner Ave., Whitehall 18052 • 215-820-0357
S.E.I. ELECTRONICS INC. (C/V/M/A) • 2520 N. Broad St., Philadelphia 19132 • 215-223-9400

RHODE ISLAND
JABBOUR ELECTRONICS (C/V/M/A) • 1744 Cranston St., Cranston 02920 • 401-944-2570

SOUTH CAROLINA
WHOLESALE INDUSTRIAL (C/V/M) • 515 E. Bay St., Charleston 29403 • 803-722-2634

TENNESSEE
CURREY S, INC. (C) • 923 8th Ave., S. Nashville 37203 • 615-242-4223
MILLS MORRIS CO. (C/V/M/A) • 677 Phelan Ave., Memphis 38101 • 901-774-9810
SHIELDS ELECTRONICS SUPPLY, INC. (C/V/M/A) • 4722 Middlebrook Pike, Knoxville 37921 • 615-588-2421

TEXAS
ELECTRONIC COMPONENT (C/V/M/A) • 2401 Bissonnet, Houston 77005 • 713-528-1543
FOX INTERNATIONAL (C/V/M) • 752 So. Sherman, Richardson 75081 • 214-231-1826
M-TRONICS (C/V/M/A) • 3201 West Ave., San Antonio 78213 • 512-340-4069
PORTER BURGESS CO. (C/V/M) • 1233 Levee St., Dallas 75207 • 214-741-5161
SHERMAN ELECTRONICS (C/V/M) • 702 San Pedro Ave., San Antonio 78212 • 512-224-1001
SHERMAN ELECTRONICS (C/V/M) • 1701 Morgan Ave., Corpus Christi 78404 • 512-888-9454
SOUTHWEST MANUFACTURERS, INC. (V) • 3243 S. Jones St., Fort Worth, TX 76110-4397 • 817-926-8281
VCP INTERNATIONAL INC. (V) • 2285 Merritt Dr., Garland 75040 • 214-271-7474

VIRGINIA
AVEC ELECTRONICS CORP. (C/M) • 711 Granby St., Norfolk 23510 • 804-627-3502
AVEC ELECTRONICS CORP. (C/M) • 2002 Staples Mill Rd., Richmond 23230 • 804-359-6071
FAIRWAY ELECTRONICS, INC. (C/V/M) • 2304 Chamberlayne Ave., Richmond 23222 • 804-321-7255

WISCONSIN
DEALER OFFICE EQUIPMENT INC. (A) • 19300 W. Janacek Court, Waukesha 53186 • 414-784-7850
DYKRO, INC. (C/V/M) • N90 W14401 Commerce Dr., Menomonee Falls 53051 • 414-255-1900
G.M. POPKEY COMPANY (C/V/M/A) • 2035 Larsen Rd., Green Bay 54307-2237 • 414-497-0400

CODING:
(C) . . . Consumer Electronic Parts
(V) . . . Vacuum Parts
(M) . . . Major Appliance Parts
(A) . . . Accessories

(as of 2/1/90)

Matsushita Services Company, 50 Meadowland Parkway, Secaucus, NJ 07094

Home automation

Home automation is the latest buzzword in the consumer electronics business. It's "the integration of home appliances through centralized and/or distributed intelligence," according to a spokesman for the Electronic Industries Association Consumer Electronics Group (EIA/CEG).

As an example of what home automation might one day mean to consumers, it may eventually be possible to call your home and turn on your VCR to record a TV program. Or you might be able to program your clothes washer and dishwasher to operate during the nighttime hours when electricity is less expensive. Not only that, but your dishwasher might be able to communicate with the hot water heater to make sure the water is hot enough before it turns on.

When you're first confronted with this extension of technology, it seems as if maybe it's overkill. Who needs to have their appliances talking to one another? On the other hand, if you consider the changes in home electrical and electronics technology that have taken place in just the past century, the advances represent a degree of change that not even the most prescient observer could have predicted.

A scant 100 years ago, electric power was introduced, and then only for two applications: lighting and traction engines. Electricity was a marvel, but no one could conceive of homes full of the electrical servants we enjoy today. Lighting at that time was produced by oil, gas or candles. Keeping food cool was accomplished by using ice that nature created during the winter months. Heating was managed manually, with wood or coal as the fuel, in fireplaces, stoves or primitive central heating units. Everything was mechanical and manually powered: clocks, drills, saws. There were no vacuum cleaners, radios, TVs, VCRs, video games, personal computers.

Considering the almost incomprehensible growth and development of electrical and electronic products in what amounts to just a few years, the development of a technology that allows them to communicate with each other seems a small step, one that's almost inevitable

and makes you wonder why it wasn't developed sooner.

The nature of home automation might take one of several forms. One possibility is a central unit from which you could program all of the appliances. An alternative is a distributed system with intelligence at each appliance. An engineering standard for one approach to home automation, called CEBus (*consumer electronics bus*), was announced at this year's winter Consumer Electronics Show.

There are a number of ways in which such a system would benefit consumers and help to justify the added cost of such a system:

- Energy cost savings would accrue by affording finer control of home heating and allowing the homeowner to keep the hot water heater at lower temperatures.
- Security could be enhanced by allowing the homeowner to monitor the front door through the TV or program the lights to go on and off when no one is in the house.
- Convenience could be enhanced through a battery-operated clock that could automatically reset all of the digital clocks in the home, including those in appliances.

Here is a technology that consumer electronics servicing companies might want to keep track of. The opportunities of servicing the technology seem great. Consumer electronics products that break down provide a lot of opportunity for servicing technicians. Consumer products with some degree of intelligence that are interlinked through some kind of network present a degree of complexity that may provide a great deal of opportunity for service organizations that want to install, service and even counsel consumers in the use of these systems.

This opportunity is not without pitfalls. Soon many consumer electronics complaints may be caused simply by a failure to communicate. When that happens, the problems servicers face will be compounded: Is the problem in appliance A, appliance B, the software, or is it the communications path? When this type of problem occurs, it may take some uncommon diagnostic procedures to get to the root of the problem.

This magazine will be providing increased coverage of home automation as developments are announced.

Nils Conrad Persson

THE MAGAZINE FOR CONSUMER ELECTRONICS SERVICING PROFESSIONALS

ELECTRONIC

Servicing & Technology

Electronic Servicing & Technology is edited for servicing professionals who service consumer electronics equipment. This includes service technicians, field service personnel and avid servicing enthusiasts who repair and maintain audio, video, computer and other consumer electronics equipment.

EDITORIAL

Nils Conrad Persson, *Editor*
Tom Cook, *Senior Managing Editor*
Alisa Carter, *Associate Editor*
Jennifer Hinkle, *Editorial Assistant*

CONSULTING EDITORS

Carl Babcock, *Consumer Servicing Consultant*
Homer L. Davidson, *TV Servicing Consultant*
Christopher H. Fenton, *Circuit Fabrication Consultant*
William J. Lynott, *Business Consultant*
Victor Meeldijk, *Components Consultant*
Kirk G. Vistain, *Audio Consultant*
Sam Wilson, *Electronics Theory Consultant*

ART

Barbara Miles, *Graphic Designer*

BUSINESS

Cameron Bishop, *Group Vice President*
Greg Garrison, *Marketing Director*
Kevin Callahan, *Creative Director*
Evelyn Hornaday, *Promotions Manager*
Darren Sextro, *Promotions Coordinator*
Dee Unger, *Advertising Business Manager*
Melissa Langstaff, *Advertising Coordinator*

ADVERTISING

Carol Summers, 212-702-3402
Len Keeler, 714-694-0774

ADMINISTRATION

R. J. Hancock, *President*
Chuck Rash, *Corporate Circulation Director*
Sandra Stewart, *Circulation Director*
Steve Singleton, *Circulation Manager*
Customer Service, 913-541-6628



Member, Audit Bureau of Circulation



Member, American Business Press



Member, Electronic Servicing Dealers Association

CORRESPONDENCE

Editorial and advertising: P.O. Box 12901, Overland Park, KS 66212 (a suburb of Kansas City, MO); 913-888-4664. Circulation: P.O. Box 12960, Overland Park, KS 66212. Home office fax: 913-541-6697. Home office telex: 42-4156 INTERTEC OLPK

SUBSCRIPTION PRICES: one year, \$24; two years, \$36 in the USA and its possessions. Foreign countries: one year, \$30; two years, \$42. Single copy price: \$3; back copies, \$5. Adjustment necessitated by subscription termination to single copy rate. Allow 6 to 8 weeks for new subscriptions.

PHOTOCOPY RIGHTS: Permission to photocopy for internal or personal use is granted by Intertec Publishing Corp. for libraries and others registered with Copyright Clearance Center (CCC), provided the base fee of \$2 per copy of article is paid directly to CCC, 21 Congress St., Salem, MA 01970. Special requests should be addressed to Eric Jacobson, publisher. ISSN 0278-9922 \$2.00 + 0.00

Electronic Servicing & Technology (ISSN 0278-9922) is published monthly for \$24 per year by Intertec Publishing Corp., 9221 Quivira Road, Overland Park, KS 66215. Second-class postage paid at Shawnee Mission, KS and additional mailing offices. POSTMASTER: Send address changes to ELECTRONIC SERVICING & TECHNOLOGY, P.O. Box 12960, Overland Park, KS 66212.

©1990 by Intertec Publishing. All rights reserved.



TROUBLESHOOTERS!

PRECISION HAND-HELD INSTRUMENTS



B & K Precision Test Bench™

- 41 range voltmeter • Ammeter
- Ohmmeter • Frequency counter
- Capacitance meter • Logic probe
- Transistor & diode tester • Extra large LCD display

Model
388-HD
Reg. \$129.95

\$119⁹⁵



SCOPE Digital Multimter

- 11 function, 38 ranges including Logic Level Detector, Audible and Visual Continuity, Capacitance & Conductance measurements

Model
DVM-638
Reg. \$87.50

\$79⁹⁵



SCOPE 3 1/2 Digit LCD Mini Meter

- 0.5% accuracy • AC/DC Voltage
- DC current • Resistance • Diode test • 300 hrs. battery life
- Overload protection: DC-500V, AC-350V, ohms - 250V DC/AC

Model
DVM-630
Reg. \$50.00

\$32⁵⁰



SCOPE Hand-Held 3 1/2 Digit LCR Meter

- Measure capacitance, resistance and inductance • Overload protection • Includes test leads, test clips, 9V battery and spare fuse

Model
LCR-680

\$129⁹⁵



SCOPE Pocket Size Audio Signal Generator

- Sine/square wave patterns • 20Hz to 150 KHz • Battery operated
- Frequency accuracy ±3% (or less)
- Output 1.2V rms max. (no load)
- Low battery indicator • Test leads & 9V battery included

Model
RC-555
Reg. \$69.95

\$64⁹⁵

DUAL TRACE OSCILLOSCOPES



A.W. SPERRY 20 MHz OSCILLOSCOPE

- Built-in component checker
- Z-axis input • Low power consumption • TV Video sync filter
- High-sensitivity XY mode
- Front panel trace rotator
- Includes 2 test probes

Model
620C

\$369⁹⁵

HITACHI 35 MHz OSCILLOSCOPE

- 19 calibrated sweeps • 6" CRT with internal graticule, scale illumination & photographic bezel
- Auto focus • XY operation • TV sync separation
- Includes 2 probes (10:1 and 1:1)

Model
V-355
Reg. \$899.95

\$598⁰⁰



TRAINERS AND TOOLS

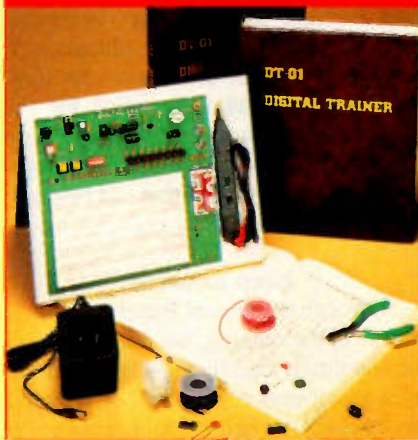

SCOPE DIGITAL TRAINER

- Learn logic circuits and equipment design • Connects to oscilloscopes, signal generators and more
- Logic probe included • Solderless breadboard and crib sheets help you build almost any circuit
- Runs off 4 "AA" batteries or AC adapter (included)

Model
DT-01

Reg. \$149.95

\$110⁰⁰

ATTACHE-STYLE TOOL CASE

- 53 individual tools • 31 interchangeable screwdriver/nutdriver blades and handles
- 2 specialty screwdriver/nutdriver sets and kits
- Removeable 3-panel, hinged pallet and tray
- Partitioned bottom compartment
- 19 1/2" x 13 1/2" x 6 3/4"

Model
TCM-100/ST

\$499⁹⁵



ASK FOR YOUR FREE CATALOG

Fordham TOLL FREE 800-645-9518

(In NY State 800-832-1446)

260 Motor Parkway
Hauppauge, New York 11788



Money orders, checks accepted
C.O.D.'s require 25% deposit.

Service & Shipping Charge Schedule
Continental U.S.A.

FOR ORDERS	ADD
\$25-50	\$4.50
\$51-100	\$5.50
\$101-200	\$7.00
\$201-300	\$8.00
\$301-400	\$9.00
\$401-500	\$10.00
\$501-750	\$12.50
\$751-1000	\$15.00
\$1,001-1,250	\$17.50
\$1,251-1,500	\$20.00
\$1,501-2000	\$25.00
\$2,001 and Up	\$30.00

Not too many years ago, determining which replacement component you needed to repair a consumer electronics product (almost invariably a TV) was not much of a problem. If it was a tube you needed, you pulled out a new tube and replaced the faulty one. And almost certainly you had the right tube. It didn't matter who made the tube; the identification number was the same and the characteristics were the same. With the handful of manufacturers, it was no problem keeping track of addresses and phone numbers. You practically knew them by heart.

Today the unit being repaired might be a TV, VCR, camcorder or CD player, made by one of 20 different manufacturers under one of a hundred national and private brands. If you need a transistor or an integrated circuit, you might have to cross-reference among

somewhere in that stack of paperwork. Or maybe you would like to attend an electronics servicing seminar, but you have no idea who offers one. If you figure the EIA is your source, you still have to figure out where to find that eternally misplaced address.

That's why we put together this Buyers' Guide — all the information you need is pulled together in one place. No need to hang on to stacks of papers. Here's your one-source alternative.

If you want a multimeter, turn to the Product Directory and look up multimeters. Every company that responded to our questionnaire will be listed there, and every company's address will be listed in the Address Directory.

We've broken down this information into five categories:

- Product Directory page 9.
- Replacement Parts/

you this company distributes, not manufactures, that product.

You will notice that certain company names are in blue. Those companies have advertised in this issue. If you want to see the actual piece of equipment or read a detailed description, turn to the page number listed to the far right. The ad alone might give you enough information to help you decide.

Once you know who you want to contact for more information, turn to the Company Address Directory. The address, telephone number and fax number for each company are listed there. (Of course, if the company you are interested in has advertised in this issue, you can just pull out your Reader Service card on page 36 and circle the reply number listed under the advertisement.)

The Replacement Parts/Components Directory works the same way. Just look up the type of component you need, then turn to the Company Address Directory to make your contact. The Company Address Directory lists information on approximately 450 companies and associations that offer products or services for the electronics servicer.

Checking out services

Consult the Services Directory if you need to contact a consultant, get a disk drive or head refurbished, plug into an on-line service, find a company to repair or rework a PC board, rent or lease equipment, calibrate your older test equipment, or repair a tuner.

Keeping up with the Joneses

The Association/Educational Sources Directory helps you find books, schools and training seminars for continuing your electronics servicing education. It also points you toward sources for service literature and schematics for the products you service. Finally, it lists those companies that produce management software systems that can help you run your business.

Keep in touch

Although the annual Buyers' Guide is a year in the making, we realize it can't be absolutely complete — new companies are always popping up or moving, and technology keeps adding new products to track. If you know a company the other readers should be aware of, or if you would like us to extend our coverage to new product areas, drop us a line. Of course, if you find a mistake, please contact us immediately. We'll publish a correction in the next Feedback department. ■

BUYERS' Guide



several component manufacturers or suppliers before you can identify one that you either have on hand or can get without too much trouble. Just keeping track of the names and addresses of suppliers can be a major task.

Here's help. This fourth annual **ES&T Buyers' Guide** contains information on hundreds of manufacturers and distributors who make or sell thousands of products. The guide will tell you who makes what, and it will give you addresses and phone numbers to contact. Don't forget to save this issue. We get long-distance calls every day from readers who need an address; one look in the Buyers' Guide is usually all it takes to help them.

Using the Buyers' Guide

If you need to buy a new multimeter this year, you would probably know the names of some of the big multimeter manufacturers, and you might have some of those companies' addresses

Components Directory . . . page 37.

- Software/Services Directory page 44.
- Association/Educational Sources Directory page 44.
- Company Address Directory page 45.

Finding a product or part

We have subdivided the product directory according to certain types of products:

- Test equipment.
- Test equipment accessories.
- Circuit damage protective equipment and supplies.
- Supplies/accessories equipment.
- Audio and video accessories.
- Tools.

For example, if you are looking for a VCR test jig kit, turn to the test equipment accessories section of the Product Directory. The companies listed there all say they offer test jig kits. If the company name is followed by a *D, that tells

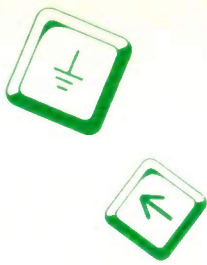

Product directory



See Adv. Page

See Adv. Page

See Adv. Page

See Adv. Page

Test equipment

AC LEAKAGE TESTERS

Accutest Instruments*D
 AEMC Corp.
 Amprobe Instrument
 CG Instruments Inc.
Consolidated Electronics, Inc.*D 56
 Electronic Parts Supply*D
Fordham Radio Supply Co.*D 7
 GC Electronics Div. of GC Thorsen Co.
 GMB/dba Fox International*D
 The Instrument Mart, Inc.*D
 Kelvin Electronics*D
 Kikusui International Corp.
 Kyoritsu Electrical Instruments Works, Ltd.
 MCM Electronics*D
 Omega Engineering Inc.
 Omnitron Electronics*D
 Philips Consumer Electronics Service Co.*D
 RAG Electronics Inc.*D
Sencore Electronics IFC
 Simpson Electric Co.
 Specialized Products Co.*D
 TIF Instruments, Inc.
 Transcat*D

AUTOMATED TEST EQUIPMENT

Advanced Measurement Technologies
 Allied Electronics, A Div. of Hall-Mark Electronics*D
 Amprobe Instrument
 Analogic Corp.
 Anasco Corp.*D
 Anritsu Meter Co. of America
 BMI-Basic Measuring Instruments
 Brian Instruments, Inc.
 BTC Test & Measurement*D
 Colorado Data Systems
 CSTS Inc.
 Elgar Corp.
 EM Corp.
 Fiskars Electronics Corp. AC Power Div.
 John Fluke Mfg. Co. Inc.
 GenRad, Inc.
 Genstar Rental Electronics Inc.*D
 GlobeTech International, Inc.
 W.L. Gore & Associates, Inc.
 Heath Co.
 Hilevel Technology, Inc.
 Hy-Tronix Instruments, Inc.
 IET Labs, Inc.
 The Instrument Mart, Inc.*D
 Intelco Corp.
 Joseph Electronics*D
 KeyTek Instrument Corp.
 Kikusui International Corp.
Leader Instruments Corp. 3
 Markenrich Corp.
 Moody Tools, Inc.
 Omnitron Electronics*D
 Racal-Dana Instruments Inc.
 RNJ Electronics Inc.*D
 Schlumberger Instruments
Sencore Electronics IFC
 Soltec Corp.
 Spanta, Inc.
 A.W. Sperry Instruments, Inc.
 Tektronix, Inc.
 Temco Instruments Inc.
 3M/Photodyne Inc.
 TIF Instruments, Inc.
 Triplett Corp.
 Verite
 Wandel & Goltermann, Inc.

Wavetek Corp.

BREAKOUT BOXES

American Reliance Inc.
 Anasco Corp.*D
 A R Div. of Telenex Corp.
 Arrow Electronics Inc. Catalog Sales Div.*D
 Atrix, Inc.*D
 B&B Electronics Mfg., Co.
Beckman Industrial Corp. An Affiliate of Emerson Electric Co. 39,41
 Black Box Corp.*D
Consolidated Electronics, Inc.*D 56
 Contact East, Inc.*D
 Convex Corp.
 Datacom Technologies, Inc.
 Datatran Corp.
 Electro Standards Lab, Inc. Data Communications Products Div.
 Electronic Parts Supply*D
Fordham Radio Supply Co.*D 7
 GC Electronics Div. of GC Thorsen Co.
 Hall-ComSec, Inc.
 HMC-Hub Material Co.*D
 International Data Sciences
 IQ Technologies, Inc.
 JDR Micro*D
 W.S. Jenks & Son*D
 Jensen Tools Inc.*D
 Joseph Electronics*D
 Kelvin Electronics*D
 Kobetron Inc.
 L-Com Inc.
 Marconi Instruments
 MCM Electronics*D
 MetraByte Corp.
 Milo Associates, Inc.*D
 M-Test Equipment
 P.K. Neuses Inc.*D
 Nu-Data Inc.
 Omnitron Electronics*D
 ORA Electronics
Parts Express International Inc.*D 51
 Patton Electronics Co.
 RAG Electronics Inc.*D
 RNJ Electronics Inc.*D
 Scooter Products Ohm Electrics, Inc.*D
 Specialized Products Co.*D
Techni-Tool Inc.*D 19
 Tektronix Communications Network Analyzers Div.
 Transcat*D
 Tucker Electronics Co.*D
 Wandel & Goltermann, Inc.

CELLULAR TELEPHONE TEST EQUIPMENT

Allied Electronics, A Div. of Hall-Mark Electronics*D
Consolidated Electronics, Inc.*D 56
 Direct Conversion Technique, Inc.
 The Instrument Mart, Inc.*D
 Marconi Instruments
 Omnitron Electronics*D
 Rapid Systems
 RNJ Electronics Inc.*D
 Sony Service Co.

CONTINUITY TESTERS

Accutest Instruments*D
 AEMC Corp.
 Atrix, Inc.*D
Beckman Industrial Corp. An Affiliate of Emerson Electric Co. 39,41

B&K-Precision Maxtec International Corp. 1
 The Boardworks
 Brunelle Instruments Inc.
Consolidated Electronics, Inc.*D 56
 Contact East, Inc.*D
 CSTS Inc.
 Desco Industries
 EDS, Inc.
 Electronic Design Specialists
 Electronic Parts Supply*D
 Electronics Warehouse Corp.*D
 EMCO Electronics
Fordham Radio Supply Co.*D 7
 GC Electronics Div. of GC Thorsen Co.
 GenRad, Inc.
 HMC-Hub Material Co.*D
 Itera/Belmoor*D
 JDR Micro*D
 W.S. Jenks & Son*D
 Jensen Tools Inc.*D
 Joseph Electronics*D
 Kelvin Electronics*D
 Klein Tools, Inc.
 Kyoritsu Electrical Instruments Works, Ltd.
 L-Com Inc.
 Lii' Bitty Tester, Inc.
 MCM Electronics*D
 Microtest, Inc.
 Milo Associates, Inc.*D
 Miltex Supply Corp.*D
 Nu-Data Inc.
 Omega Engineering Inc.
 Omnitron Electronics*D
 Patton Electronics Co.
 RNJ Electronics Inc.*D
 Salen Enterprises*D
 Scooter Products Ohm Electrics, Inc.*D
 Simpson Electric Co.
 Specialized Products Co.*D
 Speco Div.
 A.W. Sperry Instruments, Inc.
Techni-Tool Inc.*D 19
 TIF Instruments, Inc.
 Tool Kit Specialists, Inc.*D
 Tool-Tronics, Inc.*D
 Universal Enterprises
Vaco Products 21
 Yokogawa Corp. of America

CRT TESTERS/RESTORERS

Accutest Instruments*D
 Bursma Electronic Distributing*D
Consolidated Electronics, Inc.*D 56
 Dandy Mfg. Co.
 Electronic Parts Supply*D
 Electronics Warehouse Corp.*D
Fordham Radio Supply Co.*D 7
 GMB/dba Fox International*D
 HMC-Hub Material Co.*D
 The Instrument Mart, Inc.*D
 Itera/Belmoor*D
 W.S. Jenks & Son*D
 Joseph Electronics*D
 Kelvin Electronics*D
 MCM Electronics*D
 Omnitron Electronics*D
 Philips Consumer Electronics Service Co.*D
 RAG Electronics Inc.*D
 RNJ Electronics Inc.*D
Sencore Electronics IFC
 Sony Service Co.
Techni-Tool Inc.*D 19

CURVE TRACERS

Accutest Instruments*D

Allied Electronics, A Div. of Hall-Mark Electronics*D
 Brunelle Instruments Inc.
 Bursma Electronic Distributing*D
Consolidated Electronics, Inc.*D 56
 Electronic Parts Supply*D
 Electronics Warehouse Corp.*D
 IET Labs, Inc.
 The Instrument Mart, Inc.*D
 Joseph Electronics*D
 Kelvin Electronics*D
Leader Instruments Corp. 3
 Lectronic Research Labs*D
 Omnitron Electronics*D
 Performance Technologies
 RAG Electronics Inc.*D
 RNJ Electronics Inc.*D
 Tektronix, Inc.
 Tucker Electronics Co.*D

DATA COMMUNICATION ANALYZERS/MONITORS/TESTERS

Accutest Instruments*D
 Advanced Measurement Technologies
 A R Div. of Telenex Corp.
 Arium Corp.
 Atrix, Inc.*D
 B&B Electronics Mfg., Co.
 Black Box Corp.*D
 Colorado Data Systems
 Contact East, Inc.*D
 Convex Corp.
 Datacom Technologies, Inc.
 Datatran Corp.
 Digitech Industries Inc.
 Direct Conversion Technique, Inc.
 Electro Standards Lab, Inc. Data Communications Products Div.
 Frederick Engineering, Inc.
 Genstar Rental Electronics Inc.*D
 HMC-Hub Material Co.*D
 International Data Sciences
 IQ Technologies, Inc.
 JDR Micro*D
 W.S. Jenks & Son*D
 Jensen Tools Inc.*D
 Joseph Electronics*D
 Kobetron Inc.
 MCM Electronics*D
 MetraByte Corp.
 Micromax Corp.
 Microtest, Inc.
 M-Test Equipment
 Nu-Data Inc.
 Omnitron Electronics*D
 Patton Electronics Co.
 RAG Electronics Inc.*D
 Solomat Instrumentation
 Soltec Corp.
 Sony Service Co.
 Specialized Products Co.*D
Techni-Tool Inc.*D 19
 Tekelec
 Tektronix Communications Network Analyzers Div.
 Tektronix, Inc.
 Telecommunications Techniques Corp.
 3M/Photodyne Inc.
 Wandel & Goltermann, Inc.

DISC DRIVE ANALYZERS/TESTERS

Analogic Corp.
 Applied Memory Technology
 Arium Corp.
 AVA Instrumentation, Inc.
 Brian Instruments, Inc.
 Computer Doctors
 Contact East, Inc.*D
 Data Tech Reliance, Inc.

Product directory

See Adv. Page	See Adv. Page	See Adv. Page	See Adv. Page
HMC-Hub Material Co.*D JDR Micro*D W.S. Jenks & Son*D Jensen Tools Inc.*D Kenwood U.S.A. Corp. IBC Kobetron Inc. Omnitron Electronics*D Philips Consumer Electronics Service Co.*D Pioneer Research RAG Electronics Inc.*D Sony Service Co. Specialized Products Co.*D Windsor Technologies, Inc.	Philips Consumer Electronics Service Co.*D Racal-Dana Instruments Inc. RAG Electronics Inc.*D Ramsey Electronics Inc. Rapid Systems RNJ Electronics Inc.*D Salen Enterprises*D Scooter Products Ohm Electrics, Inc.*D Sencore Electronics IFC Sibex Inc. Simpson Electric Co. Spanta, Inc. Specialized Products Co.*D A.W. Sperry Instruments, Inc. Techni-Tool Inc.*D 19 Tool Kit Specialists, Inc.*D Transcat*D Triplett Corp. Tucker Electronics Co.*D VIZ Test Equipment Div. of Kappa Networks Inc.	GAUGES: HEAD PROTRUSION/SPRING TENSION/STYLUS FORCE/OTHER Accutest Instruments*D Electronics Warehouse Corp.*D HMC-Hub Material Co.*D Hunter Associates Jonard Industries Corp. Moody Tools, Inc. P.K. Neuses Inc.*D Omnitron Electronics*D Philips Consumer Electronics Service Co.*D Techni-Tool Inc.*D 19 Tentel Corp. TIF Instruments, Inc.	HSC Electronic Supply*D The Instrument Mart, Inc.*D JDR Micro*D W.S. Jenks & Son*D Jensen Tools Inc.*D Joseph Electronics*D Kelvin Electronics*D Kikusui International Corp. Leader Instruments Corp. 3 Lectronic Research Labs*D Marconi Instruments MarKenrich Corp. MCM Electronics*D Milo Associates, Inc.*D NCM Electronics Omnitron Electronics*D Orion Instruments, Inc. Power-Science Industries RAG Electronics Inc.*D Ramsey Electronics Inc. RNJ Electronics Inc.*D Rochester Instruments Systems Scooter Products Ohm Electrics, Inc.*D Sencore Electronics IFC Sibex Inc. Specialized Products Co.*D Techni-Tool Inc.*D 19 Teledata Systems 3M/Photodyne Inc. Tucker Electronics Co.*D VIZ Test Equipment Div. of Kappa Networks Inc. Wandel & Goltermann, Inc. Wavetek Corp.
DISTORTION ANALYZERS Accutest Instruments*D Anasco Corp.*D ARS Electronics*D BTC Test & Measurement*D Consolidated Electronics, Inc.*D 56 Digitech Industries Inc. Electronic Parts Supply*D Electronics Warehouse Corp.*D Genstar Rental Electronics Inc.*D Hameg, Inc. The Instrument Mart, Inc.*D Joseph Electronics*D Leader Instruments Corp. 3 Omnitron Electronics*D Philips Consumer Electronics Service Co.*D RAG Electronics Inc.*D 3M/Photodyne Inc.	FUNCTION GENERATORS Accutest Instruments*D Allied Electronics, A Div. of Hall-Mark Electronics*D American Reliance Inc. Analog Corp. Anasco Corp.*D Arrow Electronics Inc. Catalog Sales Div.*D Ballantine Labs, Inc. Beckman Industrial Corp. An Affiliate of Emerson Electric Co. 39,41 B&K-Precision Maxtec International Corp. 1 Brunelle Instruments Inc. Bursma Electronic Distributing*D Colorado Data Systems Consolidated Electronics, Inc.*D 56 Contact East, Inc.*D C&S Sales*D Davie Tech Inc. Electronic Parts Supply*D Electronics Warehouse Corp.*D Elenco Electronics, Inc. EMCO Electronics John Fluke Mfg. Co. Inc. Fordham Radio Supply Co.*D 7 Gage Applied Sciences Inc. Genstar Rental Electronics Inc.*D Global Specialties A Div. of Interplex GoldStar Precision Co. Ltd. 23 Hameg, Inc. Heath Co. HMC-Hub Material Co.*D HSC Electronic Supply*D The Instrument Mart, Inc.*D JDR Micro*D W.S. Jenks & Son*D Jensen Tools Inc.*D Joseph Electronics*D Kelvin Electronics*D Kenwood U.S.A. Corp. IBC Kikusui International Corp. Leader Instruments Corp. 3 Lectronic Research Labs*D MCM Electronics*D Mercer Electronics MetraByte Corp. Milo Associates, Inc.*D Omnitron Electronics*D Philips Consumer Electronics Service Co.*D RAG Electronics Inc.*D Rapid Systems RNJ Electronics Inc.*D Salen Enterprises*D Scooter Products Ohm Electrics, Inc.*D Sibex Inc. Simpson Electric Co. Spanta, Inc. Specialized Products Co.*D Techni-Tool Inc.*D 19 Teledata Systems Transcat*D Tucker Electronics Co.*D Wavetek Corp.	GENERATORS, AUDIO Accutest Instruments*D Allied Electronics, A Div. of Hall-Mark Electronics*D Anasco Corp.*D Ballantine Labs, Inc. B&K-Precision Maxtec International Corp. 1 Brunelle Instruments Inc. Bursma Electronic Distributing*D Consolidated Electronics, Inc.*D 56 C&S Sales*D Electronic Parts Supply*D Electronics Warehouse Corp.*D Elenco Electronics, Inc. EMCO Electronics GMB/dba Fox International*D Hameg, Inc. HSC Electronic Supply*D The Instrument Mart, Inc.*D W.S. Jenks & Son*D Jensen Tools Inc.*D Joseph Electronics*D Kelvin Electronics*D Kenwood U.S.A. Corp. IBC Kikusui International Corp. Leader Instruments Corp. 3 Marconi Instruments MCM Electronics*D Milo Associates, Inc.*D Omnitron Electronics*D RAG Electronics Inc.*D RNJ Electronics Inc.*D Salen Enterprises*D Scooter Products Ohm Electrics, Inc.*D Sencore Electronics IFC Specialized Products Co.*D Techni-Tool Inc.*D 19 Teledata Systems VIZ Test Equipment Div. of Kappa Networks Inc. Wavetek Corp.	GENERATORS, VIDEO Accutest Instruments*D B&K-Precision Maxtec International Corp. 1 BTC Test & Measurement*D Bursma Electronic Distributing*D Consolidated Electronics, Inc.*D 56 C&S Sales*D Electronic Parts Supply*D Electronics Warehouse Corp.*D GMB/dba Fox International*D The Instrument Mart, Inc.*D W.S. Jenks & Son*D Joseph Electronics*D Kelvin Electronics*D Leader Instruments Corp. 3 MCM Electronics*D NCM Electronics Network Technologies, Inc. Omnitron Electronics*D RAG Electronics Inc.*D RNJ Electronics Inc.*D Sencore Electronics IFC Simpson Electric Co.
FREQUENCY COUNTERS Acculex Corp. A MetraByte Co. Accutest Instruments*D Allied Electronics, A Div. of Hall-Mark Electronics*D Anasco Corp.*D Arrow Electronics Inc. Catalog Sales Div.*D Atrix, Inc.*D Ballantine Labs, Inc. Beckman Industrial Corp. An Affiliate of Emerson Electric Co. 39,41 B&K-Precision Maxtec International Corp. 1 Brunelle Instruments Inc. Bursma Electronic Distributing*D CG Instruments Inc. Colorado Data Systems Consolidated Electronics, Inc.*D 56 Contact East, Inc.*D Createc Signal Computer*D C&S Sales*D Davie Tech Inc. Electronic Parts Supply*D Electronics Warehouse Corp.*D Elenco Electronics, Inc. EMCO Electronics Extech Instruments Corp. John Fluke Mfg. Co. Inc. Fordham Radio Supply Co.*D 7 Genstar Rental Electronics Inc.*D Global Specialties A Div. of Interplex GoldStar Precision Co. Ltd. 23 Hameg, Inc. Heath Co. HMC-Hub Material Co.*D HSC Electronic Supply*D IET Labs, Inc. The Instrument Mart, Inc.*D JDR Micro*D W.S. Jenks & Son*D Jensen Tools Inc.*D Joseph Electronics*D Kelvin Electronics*D Kenwood U.S.A. Corp. IBC Kikusui International Corp. Leader Instruments Corp. 3 Lectronic Research Labs*D Marconi Instruments MCM Electronics*D Mercer Electronics MetraByte Corp. Milo Associates, Inc.*D Omnitron Electronics*D Orion Instruments, Inc.	GENERATORS, SIGNAL Accutest Instruments*D Allied Electronics, A Div. of Hall-Mark Electronics*D American Reliance Inc. Analog Corp. Anasco Corp.*D B&K-Precision Maxtec International Corp. 1 Bursma Electronic Distributing*D Colorado Data Systems Consolidated Electronics, Inc.*D 56 Delta Electronics, Inc. Digitech Industries Inc. Electronic Parts Supply*D Electronics Warehouse Corp.*D Elenco Electronics, Inc. EMCO Electronics John Fluke Mfg. Co. Inc. Fordham Radio Supply Co.*D 7 Gage Applied Sciences Inc. GenRad, Inc. Genstar Rental Electronics Inc.*D Global Specialties A Div. of Interplex GMB/dba Fox International*D GoldStar Precision Co. Ltd. 23 Hameg, Inc. HMC-Hub Material Co.*D	HV PROBES Accutest Instruments*D Anasco Corp.*D Beckman Industrial Corp. An Affiliate of Emerson Electric Co. 39,41 Bursma Electronic Distributing*D Consolidated Electronics, Inc.*D 56 Electronic Parts Supply*D Electronics Warehouse Corp.*D EMCO Electronics GMB/dba Fox International*D Hameg, Inc. HSC Electronic Supply*D The Instrument Mart, Inc.*D W.S. Jenks & Son*D Jensen Tools Inc.*D Joseph Electronics*D Kelvin Electronics*D KeyTek Instrument Corp. Kyoritsu Electrical Instruments Works, Ltd. Leader Instruments Corp. 3 MCM Electronics*D Milo Associates, Inc.*D Omnitron Electronics*D RAG Electronics Inc.*D RNJ Electronics Inc.*D Scooter Products Ohm Electrics, Inc.*D	

How to build a high-paying career, even a business of your own, in computer programming.



RICK BRUSH,
NRI PROGRAMMER/ANALYST

Start with training that gives you hands-on programming experience—at home and at your own pace. Training that begins with BASIC, then continues with Pascal, C, and COBOL—today's hottest computer languages. Training that even includes a powerful IBM-compatible computer, modem, and programming software you keep.

Start with real-world training. The kind of training only NRI provides.

Now with NRI's new at-home training in Computer Programming, you can be one of today's highly paid, creative team of computer wizards who give computers the power to carry out an astonishing range of business, professional, and personal applications. Now, with NRI, you can be a computer programmer, ready to build a high-paying career—even a business of your own—making computers do anything you want them to do.

The only programming course that includes a powerful computer system and software you keep.

Unlike any other school, NRI gives you hands-on programming experience with a powerful IBM compatible West Coast computer system, including 2400

baud internal modem, 640K RAM, disk drive, monitor, and invaluable programming software—BASIC, Pascal, C, and COBOL—all yours to keep.

You get the experience and the know-how, the computer and the software to get to the heart of every programming problem, design imaginative solutions, then use your choice of four key computer languages to build original, working programs.

No matter what your background, NRI gives you everything you need to succeed in programming, today's top-growth computer career field.

You need no previous experience to build a successful programming career with NRI training. Indeed, your NRI lessons start by walking you step by step through the fundamentals, giving you an expert understanding of the programming design techniques used every day by successful micro and mainframe programmers. And then the fun really begins.

C, and COBOL. Then, rounding out your training, you use your modem to "talk" to your instructor, meet other NRI students, even download programs through NRI's exclusive programmers network, PRONET.

Your career in computer programming begins with your FREE catalog from NRI.

For all the details about NRI's at-home training in Computer Programming, send the coupon today. Soon you'll receive NRI's fascinating, information-packed, full-color catalog.

Open it up and you'll find vivid descriptions of every aspect of your NRI training. You'll see the computer system included in your course up close in a special, poster-sized foldout section. And, best of all, you'll find out how your NRI training will make it easy for you to build that high-paying career—even a business of your own—in computer programming.



You master today's hottest computer languages, gaining the skills you need to build programs for a wide variety of real-world applications.

With your personal NRI instructor on call and ready to help, you use your computer and software to actually design, code, run, debug, and document programs in BASIC, Pascal,

Send for your NRI catalog today. It's yours, free.

If the coupon is missing, write to us at the NRI School of Computer Programming, McGraw-Hill Continuing Education Center, 4401 Connecticut Avenue, NW, Washington, DC 20008.

IBM is a Registered Trademark of the IBM Corporation



Only NRI gives you an IBM-compatible computer with modem, 640K RAM, disk drive, monitor, and software—BASIC, Pascal, C, and COBOL—all yours to keep!

NRI School of Computer Programming

McGraw-Hill Continuing Education Center
4401 Connecticut Avenue, NW
Washington, DC 20008



YES! Please rush me my FREE catalog describing NRI's at-home training in Computer Programming.

NAME _____ (please print) _____ AGE _____

ADDRESS _____

CITY/STATE/ZIP _____ 5482-030
Accredited Member National Home Study Council

At Thomson Consumer Electronics, we've written four best sellers covering replacement semiconductors and parts.

VCR Key Items Cross-Reference.

READ this to locate the RCA & GE replacement part numbers for over 90% of the parts most frequently used in over 900 VCR models. Ideal for one-stop shopping. Less hassle, too, since the reference is set up by the manufacturer and the model number.

SK Series Solid State Replacement Guide.

READ this to find data on over 3,000 items which replace over 217,000 solid state devices through cross-reference; also included, many replacements for discontinued items and those devices not readily available.

Remote Control Catalog.

READ this for all RCA & GE TV, VCR and audio models using remote

controls; catalog includes photo reference and multiple cross-reference.

Manufacturer's Identification Microfiche.

READ this to locate the RCA & GE stock number when your only source is the original manufacturer's number; eliminates the need to refer to service data for stock numbers.

Spending hours locating replacement semiconductors?

READ



Here's \$5 to cover postage and handling for all four books.

Name _____

Title _____

Firm _____

Address (No PO box) _____

City _____ State _____ Zip _____

Phone _____ Best time to call _____am _____pm

Thomson Consumer Electronics, Inc.

Distributor and Special Products

2000 Clements Bridge Road, Deptford, NJ 08096-2088

1F7827
1F8489
SKG202F

1F5790
5C8486

See Adv. Page	See Adv. Page	See Adv. Page	See Adv. Page
Electronic Parts Supply* Electronics Warehouse Corp.* Extech Instruments Corp. GenRad, Inc. Genstar Rental Electronics Inc.* GMB/dba Fox International* HMC-Hub Material Co.* HSC Electronic Supply* The Instrument Mart, Inc.* W.S. Jenks & Son* OmniTron Electronics* Pacer Industries, Inc. Philips Consumer Electronics Service Co.* RAG Electronics Inc.* RNJ Electronics Inc.* Simpson Electric Co. Speco Div. Techni-Tool Inc.* 19 Transcat* Yokogawa Corp. of America	Start International* Tegam, Inc. TEP, Inc. TIF Instruments, Inc. Tool Kit Specialists, Inc.* Tool-Tronics, Inc.* Transcat* Triplett Corp. Tucker Electronics Co.* Universal Enterprises VIZ Test Equipment Div. of Kappa Networks Inc. Wavetek Corp. WestCon Div. of Sycon Corp. Yokogawa Corp. of America	Fordham Radio Supply Co.* 7 GC Electronics Div. of GC Thorsen Co. Genstar Rental Electronics Inc.* GoldStar Precision Co. Ltd. 23 Hameg, Inc. Heath Co. Hitachi Denshi America, Ltd. HMC-Hub Material Co.* HSC Electronic Supply* IET Labs, Inc. The Instrument Mart, Inc.* Itera/Belmoor* JDR Micro* W.S. Jenks & Son* Jensen Tools Inc.* Joseph Electronics* Kelvin Electronics* Kenwood U.S.A. Corp. IBC Kyoritsu Electrical Instruments Works, Ltd. Leader Instruments Corp. 3 Lelectronic Research Labs* MCM Electronics* Mercer Electronics MetaByte Corp. Milo Associates, Inc.* Mouser Electronics* P.K. Neuses Inc.* Omega Engineering Inc. OmniTron Electronics* Philips Consumer Electronics Service Co.* Phillips ECG PrimeLine A Div. of Soltec Corp. Racal-Dana Instruments Inc. RAG Electronics Inc.* RNJ Electronics Inc.* Salen Enterprises* Schlumberger Instruments Scooter Products Ohm Electrics, Inc.* Sencore Electronics IFC Soltec Corp. Specialized Products Co.* Speco Div. Solder Absorbing Technology, Inc. Specialized Products Co.* Speco Div. A.W. Sperry Instruments, Inc. Start International* Techni-Tool Inc.* 19 Tegam, Inc. Tektronix, Inc. TIF Instruments, Inc. Tool Kit Specialists, Inc.* Tool-Tronics, Inc.* Transcat* Triplett Corp. Tucker Electronics Co.* Universal Enterprises VIZ Test Equipment Div. of Kappa Networks Inc. Yokogawa Corp. of America	Global Specialties A Div. of Interplex GMB/dba Fox International* GoldStar Precision Co. Ltd. 23 Gould Inc. Test & Measurement Group Hameg, Inc. Heath Co. Hitachi Denshi America, Ltd. Hi-Techniques Inc. HMC-Hub Material Co.* HSC Electronic Supply* The Instrument Mart, Inc.* JDR Micro* W.S. Jenks & Son* Jensen Tools Inc.* Joseph Electronics* Kelvin Electronics* Kenwood U.S.A. Corp. IBC Kikusui International Corp. Leader Instruments Corp. 3 Lelectronic Research Labs* M.A.T. Electronics* 60 MCM Electronics* MetaByte Corp. Milo Associates, Inc.* Mouser Electronics* Nicolet Test Instruments OmniTron Electronics* Orion Instruments, Inc. Philips Consumer Electronics Service Co.* PrimeLine A Div. of Soltec Corp. RAG Electronics Inc.* Rapid Systems RNJ Electronics Inc.* Salen Enterprises* Scooter Products Ohm Electrics, Inc.* Sencore Electronics IFC Soltec Corp. Specialized Products Co.* Speco Div. A.W. Sperry Instruments, Inc. Techni-Tool Inc.* 19 Tektronix, Inc. Tool Kit Specialists, Inc.* Transcat* Tucker Electronics Co.*
METERS, VOLTMETERS, AC	METERS, WOW AND FLUTTER		
ABB Metrawatt Inc. Accutest Instruments* AEMC Corp. Allied Electronics, A Div. of Hall-Mark Electronics* Amprobe Instrument Analogic Corp. Anasco Corp.* Atrix, Inc.* Ballantine Labs, Inc. Beckman Industrial Corp. An Affiliate of Emerson Electric Co. 39,41 Biddle Instruments B&K-Precision Maxtec International Corp. 1 Bursma Electronic Distributing* CG Instruments Inc. Classic Components Supply Inc.* Com-Kyl Inc.* Consolidated Electronics, Inc.* 56 Contact East, Inc.* Cooper Associates* Electro-Tech Systems, Inc. Electronic Parts Supply* Electronics Warehouse Corp.* EMCO Electronics Esterline Angus Instrument Corp. Extech Instruments Corp. John Fluke Mfg. Co. Inc. Fordham Radio Supply Co.* 7 GMB/dba Fox International* GoldStar Precision Co. Ltd. 23 Hameg, Inc. HMC-Hub Material Co.* HSC Electronic Supply* IET Labs, Inc. The Instrument Mart, Inc.* Itera/Belmoor* JDR Micro* W.S. Jenks & Son* Jensen Tools Inc.* Joseph Electronics* Kelvin Electronics* Kenwood U.S.A. Corp. IBC Kikusui International Corp. Kyoritsu Electrical Instruments Works, Ltd. Leader Instruments Corp. 3 Lelectronic Research Labs* M.A.T. Electronics* 60 MCM Electronics* MetaByte Corp. Milo Associates, Inc.* Mouser Electronics* Nu-Data Inc. Omega Engineering Inc. OmniTron Electronics* Pacer Industries, Inc. Philips Consumer Electronics Service Co.* RAG Electronics Inc.* RNJ Electronics Inc.* Scooter Products Ohm Electrics, Inc.* Sencore Electronics IFC Simpson Electric Co. Specialized Products Co.* Speco Div. A.W. Sperry Instruments, Inc.	ABB Metrawatt Inc. Accutest Instruments* Consolidated Electronics, Inc.* 56 Electronic Parts Supply* Electronics Warehouse Corp.* The Instrument Mart, Inc.* W.S. Jenks & Son* Joseph Electronics* Kenwood U.S.A. Corp. IBC Kikusui International Corp. Leader Instruments Corp. 3 OmniTron Electronics* Philips Consumer Electronics Service Co.* RAG Electronics Inc.* RNJ Electronics Inc.* Tucker Electronics Co.*		
MICROWAVE LEAKAGE TESTERS	MULTIMETERS: ANALOG/DIGITAL		
Accutest Instruments* Consolidated Electronics, Inc.* 56 Displaytek Corp. Electronic Parts Supply* GMB/dba Fox International* The Instrument Mart, Inc.* W.S. Jenks & Son* Lelectronic Research Labs* OmniTron Electronics* RNJ Electronics Inc.* Simpson Electric Co. A.W. Sperry Instruments, Inc. Universal Enterprises	ABB Metrawatt Inc. Accutest Instruments* AEMC Corp. Allied Electronics, A Div. of Hall-Mark Electronics* American Reliance Inc. Amprobe Instrument Analogic Corp. Anasco Corp.* Arrow Electronics Inc. Catalog Sales Div.* Atrix, Inc.* Ballantine Labs, Inc. Beckman Industrial Corp. An Affiliate of Emerson Electric Co. 39,41 Biddle Instruments B&K-Precision Maxtec International Corp. 1 Brunelle Instruments Inc. Bursma Electronic Distributing* CG Instruments Inc. Classic Components Supply Inc.* Colorado Data Systems Consolidated Electronics, Inc.* 56 Contact East, Inc.* Cooper Associates* C&S Sales* Electronic Parts Supply* Electronics Warehouse Corp.* Elenco Electronics, Inc. EMCO Electronics Esterline Angus Instrument Corp. Extech Instruments Corp. John Fluke Mfg. Co. Inc.		
	OSCILLOSCOPES		
	ABB Metrawatt Inc. Accutest Instruments* Allied Electronics, A Div. of Hall-Mark Electronics* American Reliance Inc. Analogic Corp. Anasco Corp.* Arrow Electronics Inc. Catalog Sales Div.* Ballantine Labs, Inc. Beckman Industrial Corp. An Affiliate of Emerson Electric Co. 39,41 B&K-Precision Maxtec International Corp. 1 Brunelle Instruments Inc. Bursma Electronic Distributing* Consolidated Electronics, Inc.* 56 Contact East, Inc.* Createc Signal Computer* C&S Sales* Davie Tech Inc. Electronic Parts Supply* Electronics Warehouse Corp.* Elenco Electronics, Inc. EMCO Electronics John Fluke Mfg. Co. Inc. Fordham Radio Supply Co.* 7 Gage Applied Sciences Inc. Genstar Rental Electronics Inc.*		PERSONAL COMPUTER REPAIR/TEST EQUIPMENT Accutest Instruments* Allied Electronics, A Div. of Hall-Mark Electronics* American Reliance Inc. Aristo Computers* Arium Corp. Atrix, Inc.* B&B Electronics Mfg., Co. Black Box Corp.* Chicago Case Co. 57 Computer Doctors Contact East, Inc.* C&S Sales* Datatran Corp. Electro Standards Lab, Inc. Data Communications Products Div. Electronics Warehouse Corp.* GenRad, Inc. HMC-Hub Material Co.* HSC Electronic Supply* The Instrument Mart, Inc.* IQ Technologies, Inc. JDR Micro* W.S. Jenks & Son* Jensen Tools Inc.* Joseph Electronics* MCM Electronics* MetaByte Corp. Milo Associates, Inc.* M-Test Equipment Network Technologies, Inc. Nu-Data Inc. OmniTron Electronics* Schlumberger Instruments Specialized Products Co.* Speco Div. Sprague Magnetics, Inc.* Techni-Tool Inc.* 19 Tool-Tronics, Inc.* Vu-Data Corp. Windsor Technologies, Inc.

NTE KEEPS YOU UP AND RUNNING.

NTE specializes in "replacitivity," the science of getting things up and running again—fast! After all, downtime is costly, so no one can wait weeks on end for an OEM part to come in. With NTE, no one has to! One call gives you access to 3,550 top of the line universal replacement semiconductors that are cross-referenced to more than 238,000 original devices! Included in the NTE line are: bipolar transistors, integrated circuits, rectifiers, diodes, thyristors, optoelectronic devices, varistors, resistors, capacitors, and much, much more. All are backed by NTE's exclusive two-year warranty.

For your copy of the NTE Technical Guide contact your local NTE distributor, or simply fill in the coupon below and send it to us today with a check or money order for \$3.25 each.



NTE ELECTRONICS, INC.

A WORLDWIDE REPUTATION FOR QUALITY, SERVICE AND VALUE

Please rush me _____ copies of the NTE Technical Guide and Cross Reference manual at \$3.25 each. I have enclosed my check or money order for a total of \$ _____

Name _____

Company _____

Address _____

City _____

State _____ Zip _____

Mail to: NTE, 44 Farrand St., Bloomfield, NJ 07003



FOR THE NAME OF YOUR NEAREST NTE DISTRIBUTOR, CALL NTE TOLL FREE: OUTSIDE NJ 1-800-631-1250 • INSIDE NJ 1-800-624-2624

Circle (8) on Reply Card

Product directory

See Adv. Page

See Adv. Page

See Adv. Page

See Adv. Page

RECEPTACLE CIRCUIT TESTERS

AESI/Stedl Watt
Atrix, Inc.*D
Consolidated Electronics, Inc.*D 56
Contact East, Inc.*D
Electronics Warehouse Corp.*D
HMC-Hub Material Co.*D
Ideal Industries
W.S. Jenks & Son*D
Jensen Tools Inc.*D
Joseph Electronics*D
Kobetron Inc.
Kyoritsu Electrical Instruments Works, Ltd.
MCM Electronics*D
Milo Associates, Inc.*D
Omega Engineering Inc.
Omnitron Electronics*D
Techni-Tool Inc.*D 19
3M/Electronic Products Div.
Transcat*D
Vaco Products 21
Verite

SEMICONDUCTOR TESTERS

Accutest Instruments*D
Allied Electronics, A Div. of Hall-Mark Electronics*D
Anasco Corp.*D
Arrow Electronics Inc. Catalog Sales Div.*D
Beckman Industrial Corp. An Affiliate of Emerson Electric Co. 39,41
Bursma Electronic Distributing*D
Computer Doctors
Consolidated Electronics, Inc.*D 56
EDS, Inc.
Electronic Design Specialists
Electronic Parts Supply*D
Electronics Warehouse Corp.*D
GenRad, Inc.
GlobeTech International, Inc.
Hameg, Inc.
Hilevel Technology, Inc.
HMC-Hub Material Co.*D
Hy-Tronix Instruments, Inc.
IET Labs, Inc.
The Instrument Mart, Inc.*D
JDR Micro*D
W.S. Jenks & Son*D
Jensen Tools Inc.*D
Joseph Electronics*D
Kelvin Electronics*D
Kobetron Inc.
Leader Instruments Corp. 3
Lil' Bitty Tester, Inc.
MCM Electronics*D
Milo Associates, Inc.*D
Omnitron Electronics*D
Philips Consumer Electronics Service Co.*D
RAG Electronics Inc.*D
RNJ Electronics Inc.*D
Scooter Products Ohm Electrics, Inc.*D
Sencore Electronics IFC
Speco Div.
Tektronix, Inc.
3M/Electronic Products Div.
Transcat*D

SPECTRUM ANALYZERS

Accutest Instruments*D
Analogic Corp.
Anasco Corp.*D
Delta Electronics, Inc.
Electronic Parts Supply*D
GenRad, Inc.
Genstar Rental Electronics Inc.*D
W.L. Gore & Associates, Inc.
Hameg, Inc.
Heath Co.
HSC Electronic Supply*D
The Instrument Mart, Inc.*D
W.S. Jenks & Son*D
Lectronic Research Labs*D
Marconi Instruments
Omnitron Electronics*D

Penntek Instruments
Philips Consumer Electronics Service Co.*D
RAG Electronics Inc.*D
Ramsey Electronics Inc.
Rapid Systems
Schlumberger Instruments
Techni-Tool Inc.*D 19
Tektronix, Inc.
Tucker Electronics Co.*D
Wandel & Goltermann, Inc.

TELEPHONE ANALYZERS/TESTERS

Accutest Instruments*D
Advanced Measurement Technologies
Allied Electronics, A Div. of Hall-Mark Electronics*D
American Reliance Inc.
Anasco Corp.*D
Arium Corp.
B&K-Precision Maxtec International Corp. 1
Bursma Electronic Distributing*D
Consolidated Electronics, Inc.*D 56
Contact East, Inc.*D
Datacom Technologies, Inc.
Digitech Industries Inc.
EDS, Inc.
Electronic Design Specialists
Electronic Parts Supply*D
Electronics Warehouse Corp.*D
HMC-Hub Material Co.*D
The Instrument Mart, Inc.*D
International Data Sciences
JDR Micro*D
W.S. Jenks & Son*D
Jensen Tools Inc.*D
Joseph Electronics*D
Kelvin Electronics*D
MCM Electronics*D
P.K. Neuses Inc.*D
Nu-Data Inc.
Omnitron Electronics*D
Philips Consumer Electronics Service Co.*D
RAG Electronics Inc.*D
RNJ Electronics Inc.*D
Simpson Electric Co.
Specialized Products Co.*D
Techni-Tool Inc.*D 19
Tektronix Communications Network Analyzers Div.
Telecommunications Techniques Corp.
3M/Electronic Products Div.
3M/Electrical Products Div.
Triplet Corp.

TEMPERATURE SENSORS

Acculex Corp. A MetraByte Co.
Accutest Instruments*D
Allied Electronics, A Div. of Hall-Mark Electronics*D
American Reliance Inc.
Amprobe Instrument
Anritsu Meter Co. of America
B&K-Precision Maxtec International Corp. 1
BMI-Basic Measuring Instruments
Brunelle Instruments Inc.
Bursma Electronic Distributing*D
CG Instruments Inc.
Consolidated Electronics, Inc.*D 56
Cooper Associates*D
Electronic Parts Supply*D
Electronics Warehouse Corp.*D
Extech Instruments Corp.
HMC-Hub Material Co.*D
HSC Electronic Supply*D
The Instrument Mart, Inc.*D
JDR Micro*D
W.S. Jenks & Son*D
Jensen Tools Inc.*D
Joseph Electronics*D
Kelvin Electronics*D
Kyoritsu Electrical Instruments Works, Ltd.
MetraByte Corp.
Omega Engineering Inc.
Omnitron Electronics*D
Pacer Industries, Inc.

Philips Consumer Electronics Service Co.*D
RAG Electronics Inc.*D
Rapid Systems
RNJ Electronics Inc.*D
Simpson Electric Co.
Soldier Absorbing Technology, Inc.
Solomat Instrumentation
A.W. Sperry Instruments, Inc.
Tegam, Inc.
TIF Instruments, Inc.
Tool Kit Specialists, Inc.*D
Tool-Tronics, Inc.*D
Transcat*D
Wavetek Corp.
WestCon Div. of Sycon Corp.

TRANSISTOR TESTERS

Accutest Instruments*D
Allied Electronics, A Div. of Hall-Mark Electronics*D
Anasco Corp.*D
Beckman Industrial Corp. An Affiliate of Emerson Electric Co. 39,41
B&K-Precision Maxtec International Corp. 1
Bursma Electronic Distributing*D
Consolidated Electronics, Inc.*D 56
Cooper Associates*D
C&S Sales*D
EDS, Inc.
Electronic Design Specialists
Electronic Parts Supply*D
Electronics Warehouse Corp.*D
Elenco Electronics, Inc.
Hameg, Inc.
HMC-Hub Material Co.*D
HSC Electronic Supply*D
Hy-Tronix Instruments, Inc.
IET Labs, Inc.
The Instrument Mart, Inc.*D
JDR Micro*D
W.S. Jenks & Son*D
Jensen Tools Inc.*D
Kelvin Electronics*D
Kobetron Inc.
Kyoritsu Electrical Instruments Works, Ltd.
Leader Instruments Corp. 3
Lil' Bitty Tester, Inc.
MCM Electronics*D
Milo Associates, Inc.*D
Mouser Electronics*D
Omnitron Electronics*D
Philips Consumer Electronics Service Co.*D
RAG Electronics Inc.*D
RNJ Electronics Inc.*D
Scooter Products Ohm Electrics, Inc.*D
Sencore Electronics IFC
Speco Div.

VECTORSCOPIES

Accutest Instruments*D
BTC Test & Measurement*D
C&S Sales*D
Electronic Parts Supply*D
Electronics Warehouse Corp.*D
Hameg, Inc.
Hitachi Denshi America, Ltd.
The Instrument Mart, Inc.*D
W.S. Jenks & Son*D
Joseph Electronics*D
Kelvin Electronics*D
Kenwood U.S.A. Corp. IBC
Leader Instruments Corp. 3
Lectronic Research Labs*D
Omnitron Electronics*D
Philips Consumer Electronics Service Co.*D
RAG Electronics Inc.*D
RNJ Electronics Inc.*D
Tektronix, Inc.
Video Midwest & AVC Divisions of Vaughn Communications*D

WAVEFORM MONITORS

Accutest Instruments*D
Analogic Corp.

BMI-Basic Measuring Instruments
BTC Test & Measurement*D
C&S Sales*D
Electronic Parts Supply*D
Electronics Warehouse Corp.*D
Fordham Radio Supply Co.*D 7
Gage Applied Sciences Inc.
Genstar Rental Electronics Inc.*D
Gould Inc. Test & Measurement Group
Hitachi Denshi America, Ltd.
Hi-Techniques Inc.
HSC Electronic Supply*D
The Instrument Mart, Inc.*D
W.S. Jenks & Son*D
Joseph Electronics*D
Kelvin Electronics*D
Kenwood U.S.A. Corp. IBC
Leader Instruments Corp. 3
Lectronic Research Labs*D
Omnitron Electronics*D
Philips Consumer Electronics Service Co.*D
RAG Electronics Inc.*D
Rapid Systems
RNJ Electronics Inc.*D
Tektronix, Inc.
3M/Photodyne Inc.
Tucker Electronics Co.*D
Video Midwest & AVC Divisions of Vaughn Communications*D
Yokogawa Corp. of America

OTHER TEST EQUIPMENT

Accutest Instruments*D
Advanced Measurement Technologies
AEMC Corp.
Allied Electronics, A Div. of Hall-Mark Electronics*D
American Reliance Inc.
Amprobe Instrument
Analogic Corp.
Anasco Corp.*D
A R Div. of Telenex Corp.
Ballantine Labs, Inc.
Beckman Industrial Corp. An Affiliate of Emerson Electric Co. 39,41
Biddle Instruments
B&K-Precision Maxtec International Corp. 1
Black Box Corp.*D
Brunelle Instruments Inc.
BTC Test & Measurement*D
Colorado Data Systems
Computer Doctors
Computer Service Technology, Inc.
Consolidated Electronics, Inc.*D 56
Contact East, Inc.*D
Datacom Technologies, Inc.
Datel, Inc.
Delta Electronics, Inc.
Direct Conversion Technique, Inc.
EDS, Inc.
Electron Processing
Electronic Design Specialists
Electronics Warehouse Corp.*D
EM Corp.
Extech Instruments Corp.
Genstar Rental Electronics Inc.*D
Global Specialties A Div. of Interplex
GoldStar Precision Co. Ltd. 23
Hameg, Inc.
Heath Co.
Hilevel Technology, Inc.
HMC-Hub Material Co.*D
HSC Electronic Supply*D
Ideal Industries
IET Labs, Inc.
In-Circuit Test, Inc.
The Instrument Mart, Inc.*D
Intelco Corp.
JDR Micro*D
W.S. Jenks & Son*D
Jensen Tools Inc.*D
Jonard Industries Corp.
Joseph Electronics*D
Kelvin Electronics*D
Kenwood U.S.A. Corp. IBC
KeyTek Instrument Corp.
Klein Tools, Inc.
Kobetron Inc.

Product directory

See Adv. Page

Kyoritsu Electrical Instruments Works, Ltd.
 Kyros Corp.
Leader Instruments Corp.3
 Electronic Research Labs*^D
 Marconi Instruments
 MCM Electronics*^D
 Milo Associates, Inc.*^D
 Moody Tools, Inc.
 Mouser Electronics*^D
 M-Test Equipment
 Nu-Data Inc.
Nutronix Inc. 19
 Omnitron Electronics*^D
 Orion Instruments, Inc.
 Pacer Industries, Inc.
 Pacific Power Source
 Performance Technologies
 Philips Consumer Electronics Service Co.*^D
 Power-Science Industries
 PrimeLine A Div. of Soltec Corp.
 Racal-Dana Instruments Inc.
 RAG Electronics Inc.*^D
 Ramsey Electronics Inc.
 Rapid Systems
 RNJ Electronics Inc.*^D
 Royal Soldering Systems, Inc.
 Salen Enterprises*^D
 Schlumberger Instruments
Sencore ElectronicsIFC
 Simpson Electric Co.
 Soltec Corp.
 Spanta, Inc.
 Specialized Products Co.*^D
 Speco Div.
 A.W. Sperry Instruments, Inc.
 Static Control Services, Inc.
 Static Prevention Inc.
Techni-Tool Inc.*^D19
 Tegam, Inc.
 Tekelec
 Tektronix Communications Network Analyzers Div.
 Telecommunications Techniques Corp.
 Temco Instruments Inc.
 Temptronic Corp.
 Tentel Corp.
 3M/Electronic Products Div.
 3M/Electrical Products Div.
 3M/Photodyne Inc.
 Transcat*^D
 Triplett Corp.
 Tucker Electronics Co.*^D
 Universal Enterprises
Vaco Products 21
 Vector Electronics
 Verite
 VIZ Test Equipment Div. of Kappa Networks Inc.
 Wandel & Goltermann, Inc.
 Wavetek Corp.
 Yokogawa Corp. of America

Test equipment accessories

AUDIO DUMMY LOADS

Electronic Parts Supply*^D
 Electronics Warehouse Corp.*^D
 Joseph Electronics*^D
Leader Instruments Corp. 3
 MCM Electronics*^D
 Omnitron Electronics*^D
Parts Express International Inc.*^D 51
 RAG Electronics Inc.*^D
Sencore ElectronicsIFC

DECADE BOXES: CAPACITANCE/INDUCTANCE/RESISTANCE

Accutest Instruments*^D
 AEMC Corp.
 Anasco Corp.*^D
 Arrow Electronics Inc. Catalog Sales Div.*^D
 Brunelle Instruments Inc.

Company mailing addresses begin on page 45

Slippery Stuff FOR THE TECHNICAL AGE.

The electronics industry is racing into the 21st century with sophisticated technology that demands far more than conventional lubricants can deliver. Now there's a product which cleans and protects as it lubricates. TFL-50[®] is so exceptional, it's almost unfair to call it just a lubricant.

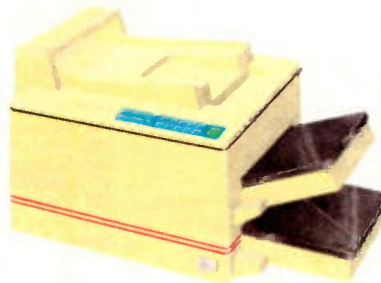

TFL-50 Wet is a homogenized, hydrophobic lubricant. It displaces moisture, thus protecting electronic equipment. It cleans and lubricates rheostats and other moving parts that may "gum up" and become intermittent. And because TFL-50 is non-staining, office machine paper will not be affected.

TFL-50 Dry is non-penetrating – it never transfers! It serves as a non-stick surface which repels airborne contaminants, making it an excellent protective thin film coating for circuit boards. TFL-50 Dry disperses static electricity, the enemy of modern electronics. Spray it directly on terminal glass to eliminate static charge and clean and repel dust.

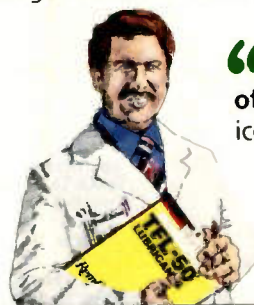
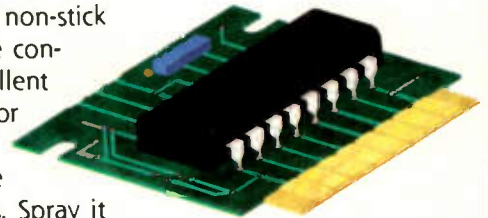

“TFL-50 has the highest concentration of Teflon[®] available. It's as slippery as ice on ice. And unlike petroleum-based lubes, TFL-50 is clean, non-staining, and anti-corrosive. Frankly, it is unfair to call it just a lubricant.”

TFL-50 LUBRICANTS

RemChem™

A Division of RemGrit Corporation, a member of The InterTech Group. RemGrit[®] and TFL-50[®] are registered trademarks of the RemGrit Corporation. Teflon[®] is a registered trademark of E.I. du Pont de Nemours & Co., Inc., Wilmington, DE 19898.

939 Barnum Avenue • Bridgeport, Connecticut 06608
 Tel: 203-336-2525 • Telex: 240327 • FAX: 203-576-6769



Call the TFL-50[®] distributor nearest you for more information.

American Service System
 MA 1-800-422-3697

Vogel Sales
 CA 415-285-2606
 Brandon Supply
 CA 213-921-0407

Noland Company
 VA 804-275-0031
 StrongRidge/Canada
 CAN 416-458-9888

For technical information call Jordan Jacks at 302-995-7537

Circle (9) on Reply Card

March 1990 *Electronic Servicing & Technology* 17

See Adv. Page

See Adv. Page

Omnitron Electronics*
 Ostby-Barton Test Probes
 Pacer Industries, Inc.
**Parts Express International
 Inc.*D** 51
 Philips Consumer Electronics Service
 Co.*D
 Probe Master Inc.
 Racal-Dana Instruments Inc.
 RAG Electronics Inc.*D
 RNJ Electronics Inc.*D
Sencore Electronics IFC
 Simpson Electric Co.
 The Superior Electric Co.
Techni-Tool Inc.*D 19
 TeleMatic Div. of UXL Corp.
 Tentel Corp.
 TEP, Inc.
 Test Probes, Inc.
**Thomson Consumer
 Electronics, Inc. Distributor
 & Special Products***D**** 13
 3M/Electronic Products Div.
 3M/Electrical Products Div.
 3M/Photodyne Inc.
 TIF Instruments, Inc.
 Tool Kit Specialists, Inc.*D
 Triplett Corp.
 Tripp-Lite
 Wandel & Goltermann, Inc.

Power-Science Industries
 RAG Electronics Inc.*D
 Rochester Instruments Systems
 Safe Power Systems Div. of Acme
 Electric Corp.
 Sola
 Specialized Products Co.*D
 The Superior Electric Co.
 Sutton Designs, Inc. Computer Power
 Div.
Techni-Tool Inc.*D 19
 Transcat***D**
 Tycor International Inc.
 VIZ Test Equipment Div. of Kappa
 Networks Inc.

STANDBY POWER SYSTEMS

AESI/Stedi Watt
 Allied Electronics, A Div. of Hall-Mark
 Electronics***D**
 Arrow Electronics Inc. Catalog Sales
 Div.***D**
 Bursma Electronic Distributing***D**
 Computer Power, Inc.
**Consolidated Electronics,
 Inc.*D** 56
 Contact East, Inc.***D**
 Controlled Power Co.
 Cooper Associates***D**
 Deltron, Inc.
 Dynatech Computer Power, Inc.
 Electronic Specialists, Inc.
 Electronics Warehouse Corp.***D**
 Elgar Corp.
 General Power Corp.
 HMC-Hub Material Co.***D**
 HSC Electronic Supply***D**
 ICS, Inc. Electro-Pac Div.
 JDR Micro***D**
 W.S. Jenks & Son***D**
 Joseph Electronics***D**
 Kalgio Electronics Co. Inc.
 MCM Electronics***D**
 Milo Associates, Inc.***D**
 Omnitron Electronics***D**
 Pacific Power Source
 Para Systems
 Performance Technologies
 Perma Power Electronics, Inc.
 RAG Electronics Inc.***D**
 Safe Power Systems Div. of Acme
 Electric Corp.
 Scooter Products Ohm Electrics,
 Inc.***D**
 SL Waber, Inc.
 Sola
 Sutton Designs, Inc. Computer Power
 Div.
 Thordarson/Melssner
 Transcat***D**
 Tripp-Lite
 Tycor International Inc.

SURGE/SPIKE PROTECTORS

AESI/Stedi Watt
 Allied Electronics, A Div. of Hall-Mark
 Electronics***D**
 Amprobe Instrument
 Arrow Electronics Inc. Catalog Sales
 Div.***D**
 Atrix, Inc.***D**
 Black Box Corp.***D**
 BMI-Basic Measuring Instruments
 Bursma Electronic Distributing***D**
 Computer Power, Inc.
**Consolidated Electronics,
 Inc.*D** 56
 Contact East, Inc.***D**
 Controlled Power Co.
 Cooper Associates***D**
 Datatran Corp.
 Dynatech Computer Power, Inc.
 Electro Standards Lab, Inc. Data
 Communications Products Div.
 Electronic Parts Supply***D**
 Electronic Specialists, Inc.
 Electronics Warehouse Corp.***D**
 Elgar Corp.
 EM Corp.
Fordham Radio Supply Co.*D 7
 GC Electronics Div. of GC Thorsen Co.
 GMB/dba Fox International***D**
 HMC-Hub Material Co.***D**

*Circuit damage
 protective
 equipment/supplies*

**Power conditioning
 equipment**

GROUNDING SYSTEMS

AESI/Stedi Watt
 Atrix, Inc.***D**
**Consolidated Electronics,
 Inc.*D** 56
 Dynatech Computer Power, Inc.
 HMC-Hub Material Co.***D**
 W.S. Jenks & Son***D**
 Jensen Tools Inc.***D**
 Joseph Electronics***D**
 Milo Associates, Inc.***D**
 Nu-Concept Systems, Inc.
 Omnitron Electronics***D**
 Plastic Systems, Inc.
 Power Distribution Inc.
 Specialized Products Co.***D**
 Tech Spray, Inc.
 Tool-Tronics, Inc.***D**
 Trio-Tech Static Systems
 Tycor International Inc.

POWER LINE MONITORS

Accutest Instruments***D**
 AESI/Stedi Watt
 Allied Electronics, A Div. of Hall-Mark
 Electronics***D**
 Anasco Corp.***D**
 Atrix, Inc.***D**
 BMI-Basic Measuring Instruments
 Brunelle Instruments Inc.
 Computer Doctors
**Consolidated Electronics,
 Inc.*D** 56
 Contact East, Inc.***D**
 Cooper Associates***D**
 Electronics Warehouse Corp.***D**
 Gage Applied Sciences Inc.
 HMC-Hub Material Co.***D**
 JDR Micro***D**
 W.S. Jenks & Son***D**
 Jensen Tools Inc.***D**
 Joseph Electronics***D**
 Mendon Electronics Corp.
 Milo Associates, Inc.***D**
 Nu-Data Inc.
 Omnitron Electronics***D**
 Power Distribution Inc.

**Presenting
 an affordable
 Light Box System.**

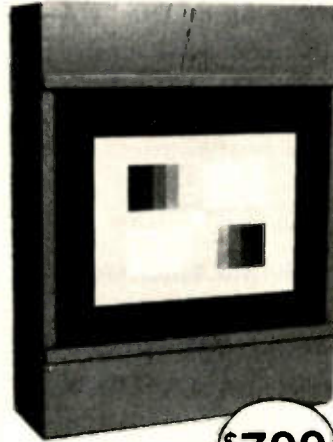

\$799

The method most
 manufacturers recommend

Model TR100 CB
 Camera Light Box
 with (2) transparencies

- (2) 3200° Kelvin Lamps
 (meets mfr. spec.)
- 1-year conditional
 guarantee
- Transparencies mounted in
 acrylic with optical scratch-
 resistant surface
- 11-step gray scale
 transparency
- 7-Bar color transparency
- All orders are shipped
 within 72 hours, U.P.S.

OMNITRON (313) 726-1278

P.O. Box 77103 • Sterling Hts., MI 48077

**TOOLS & TOOL KITS,
 TEST EQUIPMENT
 FOR EVERY NEED
 IN THE INDUSTRY**



The NEW 1990
TECHNI-TOOL catalog includes the
 biggest and best selection of tools, tool kits and test equipment
 you'll find anywhere. The catalog has more than 18,000 items
 from over 650 manufacturers. You can find anything you need,
 from electro-mechanical and assembly devices to electronic,
 telecommunication and field service tool kits. We also carry a
 full-line of items for aerospace production, computer mainte-
 nance and the fast growing surface
 mount technology. **TECHNI-TOOL**
 offers a complete line of ESD, static
 control and clean room items.

For more info. call (215) 825-4990,
 FAX (215) 828-5623, or write:

TECHNI-TOOL inc.

5 Apollo Road, P.O. Box 368,
 Plymouth Meeting, PA 19462 USA.



Circle (11) on Reply Card

See Adv. Page

See Adv. Page

See Adv. Page

See Adv. Page

HSC Electronic Supply*
 Itera/Belmoor*
 JDR Micro*
 W.S. Jenks & Son*
 Joseph Electronics*
 Kalglo Electronics Co. Inc.
 Kobatron Inc.
 L-Com Inc.
M.A.T. Electronics* 60
 MCG Electronics, Inc.
 MCM Electronics*
 Mllo Associates, Inc.*
 Mouser Electronics*
 Nu-Data Inc.
 Omega Engineering Inc.
 Omnitron Electronics*
 Omnium Corp.
 ORA Electronics
 Panamax
 Para Systems
 PerfectData Corp.
 Perma Power Electronics, Inc.
 Philips ECG
 Plastic Systems, Inc.
 Power Distribution Inc.
 Power-Science Industries
 RAG Electronics Inc.*
 RNJ Electronics Inc.*
 Safe Power Systems Div. of Acme
 Electric Corp.
 Scooter Products Ohm Electrics,
 Inc.*
 SL Waber, Inc.
 Sola
 Specialized Products Co.*
 The Superior Electric Co.
 Support Systems International Cables
 & Accessories Div.
 Sutton Designs, Inc. Computer Power
 Div.
Techni-Tool Inc.* 19
**Thomson Consumer
 Electronics, Inc. Distributor
 & Special Products* 13**
 Thordarson/Meissner
 Transcat*
 Tripp-Lite
 Tritronics Inc.*
 Tycor International Inc.
 Verite
 Winders & Geist
**Zenith Sales Co. A Div. of
 Zenith Electronics Corp. BC**

UNINTERRUPTIBLE POWER SUPPLIES

AESI/Stedi Watt
 Allied Electronics, A Div. of Hall-Mark
 Electronics*
 American Power Conversion Corp.
 Anasco Corp.*
 Arrow Electronics Inc. Catalog Sales
 Div.*
 Best Power Technology
 Black Box Corp.*
 Bursma Electronic Distributing*
 Clary Corp.
 Classic Components Supply Inc.*
 Computer Power, Inc.
**Consolidated Electronics,
 Inc.* 56**
 Controlled Power Co.
 Cooper Associates*
 Deltron, Inc.
 Electronics Warehouse Corp.*
 Elgar Corp.
 Fiskars Electronics Corp. AC Power
 Div.
 General Power Corp.
 HMC-Hub Material Co.*
 HSC Electronic Supply*
 ICS, Inc. Electro-Pac Div.
 JDR Micro*
 W.S. Jenks & Son*
 Joseph Electronics*
 Kalglo Electronics Co. Inc.
 L-Com Inc.
 Lowell Corp.*
 MCM Electronics*
 Milo Associates, Inc.*
 Omnitron Electronics*
 Pacific Power Source
 Panamax
 Para Systems

Performance Technologies
 Perma Power Electronics, Inc.
 Philtek Power Corp.
 Power-Science Industries
 RAG Electronics Inc.*
 Safe Power Systems Div. of Acme
 Electric Corp.
 Scooter Products Ohm Electrics,
 Inc.*
 SL Waber, Inc.
 Sola
 Specialized Products Co.*
 The Superior Electric Co.
 Sutton Designs, Inc. Computer Power
 Div.
Techni-Tool Inc.* 19
 Thordarson/Meissner
 Transcat*
 Tripp-Lite
 Tycor International Inc.
 Viteq Corp.

VOLTAGE REGULATORS

Accutech Instruments*
 AESI/Stedi Watt
 Allied Electronics, A Div. of Hall-Mark
 Electronics*
 Arrow Electronics Inc. Catalog Sales
 Div.*
 BMI-Basic Measuring Instruments
 Classic Components Supply Inc.*
 Computer Power, Inc.
**Consolidated Electronics,
 Inc.* 56**
 Contact East, Inc.*
 Controlled Power Co.
 Cooper Associates*
 Electronic Parts Supply*
 Electronic Specialists, Inc.
 Electronics Warehouse Corp.*
 HMC-Hub Material Co.*
 Itera/Belmoor*
 JDR Micro*
 W.S. Jenks & Son*
 Jensen Tools Inc.*
 Joseph Electronics*
 Kalglo Electronics Co. Inc.
 Lectronic Research Labs*
 MCM Electronics*
 Milo Associates, Inc.*
 Omnitron Electronics*
 Pacific Power Source
 Performance Technologies
 Perma Power Electronics, Inc.
 Power Distribution Inc.
 Power-Science Industries
 RAG Electronics Inc.*
 Salen Enterprises*
 Scooter Products Ohm Electrics,
 Inc.*
 Shape Magnetronics, Inc.
 Sola
 The Superior Electric Co.
 Transcat*
 Tripp-Lite
 Tycor International Inc.
 Verite

Electrostatic discharge protection

ANTISTATIC CHEMICALS

Accutech Co.
 Allied Electronics, A Div. of Hall-Mark
 Electronics*
 Anasco Corp.*
 Astec Co. Div. of Static Solutions Inc.
 Atrix, Inc.*
 Bursma Electronic Distributing*
 Chapman Corp.
 Charleswater Products, Inc.
 Chemtronics Inc.
 Clean Room Products Inc.
 Com-Kyl Inc.*
**Consolidated Electronics,
 Inc.* 56**
 Contact East, Inc.*
 Cooper Associates*
 Davle Tech Inc.
 Dow Chemical USA
 Echelon Industries*
 Electronics Warehouse Corp.*
 GC Electronics Div. of GC Thorsen Co.
 GMB/dba Fox International*
 HMC-Hub Material Co.*
 H&S Industries*
 Itera/Belmoor*
 JDR Micro*
 W.S. Jenks & Son*
 Joseph Electronics*
 Klein Tools, Inc.
 Master Bond
M.A.T. Electronics* 60
 MCM Electronics*
 Micro Care Corp.
 Miller-Stephenson Chemical Co.
 Milo Associates, Inc.*
 Miltex Supply Corp.*
 P.K. Neuses Inc.*
 Omnitron Electronics*
 ORA Electronics
**Parts Express International
 Inc.* 51**
 Patlon Industries, Inc.
 PerfectData Corp.
 Philips Consumer Electronics Service
 Co.*
 Plastic Systems, Inc.
 Rawn Co., Inc.
ReaGrit Corp. 17
 Richmond Technology
 RNJ Electronics Inc.*
 Rogers Anti-Static Chemicals
 Semtronics Corp.
 The Simco Co., Inc.
 Start International*
 Static Prevention Inc.
 Statikil, Inc.
 Tech Spray, Inc.
Techni-Tool Inc.* 19
 The Twexico Co.
 Gregory Thomas, Inc.
**Thomson Consumer
 Electronics, Inc. Distributor
 & Special Products* 13**
 3M/Electrical Specialties
 Tool Kit Specialists, Inc.*
 Tool-Tronics, Inc.*
 The Triangle Tool Group, Inc.
 Trio-Tech Static Systems
 Wescorp
**Zenith Sales Co. A Div. of
 Zenith Electronics Corp. BC**

Westward Electronics, Inc.

Westward Electronics, Inc.

ANTISTATIC MATS/BENCHTOPS/WRISTSTRAPS/OTHERS

Accutech Co.
 Advance Unit of Zero Corp.
 Airmold/W.R. Grace Co.
 Allied Electronics, A Div. of Hall-Mark
 Electronics*
 Astec Co. Div. of Static Solutions Inc.
 Atrix, Inc.*
 The Boardworks
 Bursma Electronic Distributing*
 Charleswater Products, Inc.
 Clauss Cutlery Co.
 Clean Room Products Inc.
 Colonial Glove & Garment Inc.
 Com-Kyl Inc.*
 Contact East, Inc.*
 Cooper Associates*
 Davle Tech Inc.
 Desco Industries
 Electronics Warehouse Corp.*
 C.H. Ellis Co., Inc.
 GC Electronics Div. of GC Thorsen Co.
 Hand Tool Industries, Inc.
 HMC-Hub Material Co.*
 H&S Industries*
 Ideal Industries
 Isles Industries
 JTT Pomona Electronics
 JDR Micro*
 W.S. Jenks & Son*
 Jensen Tools Inc.*
 Joseph Electronics*
 MCM Electronics*
 Melmat Inc.
 Milo Associates, Inc.*
 Miltex Supply Corp.*
 Mouser Electronics*
 P.K. Neuses Inc.*
 NRD Inc. Static Control Products
 Nu-Concept Systems, Inc.
 Oak Technical Inc.
 Omnitron Electronics*
 Omnium Corp.
 Partfolio, Inc.
**Parts Express International
 Inc.* 51**
 Patlon Industries, Inc.
 Philips Consumer Electronics Service
 Co.*
 Plastic Systems, Inc.
 Plato Products, Inc.
Prime Electronics Co.* 54
 The Rex Co.
 Richmond Technology
 RNJ Electronics Inc.*
 Scooter Products Ohm Electrics,
 Inc.*
 Seco Industries
 Semtronics Corp.
 Sentinel Foam Products
 The Simco Co., Inc.
 Solder Absorbing Technology, Inc.
 Sony Service Co. National Parts Div.*
 Specialized Products Co.*
 Start International*
 Static Inc. A Sealed Air Co.
 Static Prevention Inc.
 Tech Spray, Inc.
Techni-Tool Inc.* 19
 Gregory Thomas, Inc.
**Thomson Consumer
 Electronics, Inc. Distributor
 & Special Products* 13**
 3M/Electrical Specialties
 Tool Kit Specialists, Inc.*
 Tool-Tronics, Inc.*
 Trace Racks
 The Triangle Tool Group, Inc.
 Trio-Tech Static Systems
 Ungar, Div. Eldon Industries, Inc.
 Verite
 Wescorp
 Workplace Systems

ESD FLEXIBLE PACKAGING

Accutech Co.
 Advance Unit of Zero Corp.
 Airmold/W.R. Grace Co.
 Armand Mfg. Inc.

Product directory

See Adv. Page

See Adv. Page

Astec Co. Div. of Static Solutions Inc.
 Atrix, Inc.*D
 Charleswater Products, Inc.
 Colonial Glove & Garment Inc.
 Com-Kyl Inc.*D
 Contact East, Inc.*D
 C.H. Ellis Co., Inc.
 Highland Products, Inc.
 HMC-Hub Material Co.*D
 H&S Industries*
 W.S. Jenks & Son*
 Joseph Electronics*
 MCM Electronics*
 Mllo Associates, Inc.*
 Miltex Supply Corp.*
 NRD Inc. Static Control Products
 Omnitron Electronics*
 Partfolio, Inc.
 Patton Industries, Inc.
 Philips Consumer Electronics Service
 Co.*D
 Plastic Systems, Inc.
 Quality Packaging Supply Corp.*
 Republic Packaging Corp.
 Richmond Technology
 Seco Industries
 Semtronics Corp.
 Sentinel Foam Products
 The Simco Co., Inc.
 Start International*
 Static Inc. A Sealed Air Co.
 Static Prevention Inc.
 Tech Spray, Inc.
 Gregory Thomas, Inc.
 3M/Electrical Specialties
 Tool Kit Specialists, Inc.*
 Wescorp

Atrix, Inc.*D
 Battery Specialties*
 Batt-Tronic
 Bursma Electronic Distributing*
 Classic Components Supply Inc.*
 Com-Kyl Inc.*
**Consolidated Electronics,
 Inc.*D** 56
 Contact East, Inc.*
 Davle Tech Inc.
 Electronic Parts Supply*
 Electronics Warehouse Corp.*
 GMB/dba Fox International*
 HMC-Hub Material Co.*
 HSC Electronic Supply*
 Itera/Belmoor*
 JDR Micro*
 W.S. Jenks & Son*
 Joseph Electronics*
 Kelvin Electronics*
Matsushita Services Co. 4 5
 MCM Electronics*
 Miltex Supply Corp.*
 Mouser Electronics*
 Omnitron Electronics*
**Parts Express International
 Inc.*D** 51
Prime Electronics Co.*D 54
 RNJ Electronics Inc.*
 Sanyo Energy Corp.
 Scooter Products Ohm Electric,
 Inc.*
 Sony Service Co. National Parts Div.*
 Specialized Products Co.*
 Speco Div.
 A.W. Sperry Instruments, Inc.
 Tool Kit Specialists, Inc.*
 Tripp-Lite
 Tritronics Inc.*
 Video Midwest & AVC Divisions of
 Vaughn Communications*
 Wescorp

STATIC DETECTION METERS

Accutech Co.
 Advance Unit of Zero Corp.
 Astec Co. Div. of Static Solutions Inc.
 Atrix, Inc.*
 Chapman Corp.
 Charleswater Products, Inc.
 Clean Room Products Inc.
 Com-Kyl Inc.*
 Contact East, Inc.*
 Davle Tech Inc.
 Electro-Tech Systems, Inc.
 HMC-Hub Material Co.*
 H&S Industries*
 W.S. Jenks & Son*
 Jensen Tools Inc.*
 Joseph Electronics*
 Miltex Supply Corp.*
 Monroe Electronics, Inc.
 NRD Inc. Static Control Products
 Omnitron Electronics*
 Philips Consumer Electronics Service
 Co.*
 Plastic Systems, Inc.
 Semtronics Corp.
 The Simco Co., Inc.
 Specialized Products Co.*
 Start International*
 Static Control Services, Inc.
 Static Inc. A Sealed Air Co.
 Static Prevention Inc.
 Statikil, Inc.
 Tech Spray, Inc.
Techni-Tool Inc.*D 19
 Gregory Thomas, Inc.
 3M/Electrical Specialties
 Tool Kit Specialists, Inc.*
 Wescorp

BENCHES/CABINETS

Advance Unit of Zero Corp.
 Allied Electronics, A Div. of Hall-Mark
 Electronics*
 A R Div. of Telenex Corp.
 Arrow Electronics Inc. Catalog Sales
 Div.*
 Clean Room Products Inc.
 Com-Kyl Inc.*
**Consolidated Electronics,
 Inc.*D** 56
 Contact East, Inc.*
 Electronic Parts Supply*
 Hand Tool Industries, Inc.
 HMC-Hub Material Co.*
 Isles Industries
 W.S. Jenks & Son*
 Joseph Electronics*
 Klein Tools, Inc.
 MCM Electronics*
 Mouser Electronics*
 Omnitron Electronics*
 Scooter Products Ohm Electric,
 Inc.*
 Specialized Products Co.*
Techni-Tool Inc.*D 19
 Tool Kit Specialists, Inc.*
 Video Midwest & AVC Divisions of
 Vaughn Communications*
 Workplace Systems
 Zero Corp., East Div.

CHEMICALS

All Electronics Corp.*
 Allied Electronics, A Div. of Hall-Mark
 Electronics*
 Atrix, Inc.*
 The Boardworks
 Bursma Electronic Distributing*
 Caig Labs, Inc.
 Channel Master Div. of Avnet, Inc.
 Chemtronics Inc.
 Com-Kyl Inc.*
**Consolidated Electronics,
 Inc.*D** 56
 Contact East, Inc.*
 Cooper Associates*
 CRC Industries, Inc.
 Dow Chemical USA
 Echelon Industries*
 Electronic Parts Supply*
 Wescorp

Supplies/accessories equipment

BATTERIES

All Electronics Corp.*
 Allied Electronics, A Div. of Hall-Mark
 Electronics*
 Ambico
 American Design Components*
 Arrow Electronics Inc. Catalog Sales
 Div.*
 Wescorp



76 Vaco Vacombo® convenient, compact handles and blades fill most of your tool needs

Individual blades and handles...and
 multi-tool pouch kits:

• Screwdrivers • Nut drivers • Hex keys

Quickly exchange and combine
 handles, extensions, and blades in
 the field. Tight, precision fit. Durable
 vinyl pouches. Tools built for a
 lifetime. See your VACO distributor.

Send for
 FREE CATALOG



7200 McCormick Blvd.
 Chicago, IL 60645

Come Out of the Dark.

Highlight your professionalism with customer relations materials which show your professional affiliation and special services. Public relations materials are just one of many "enlightening" benefits offered to members of NESDA. For more information about NESDA, plus samples of parts return bags and pamphlets, just send the following information:

Name _____
 Address _____
 City _____ State _____
 Zip _____
 Phone _____

National Electronics Sales &
NESDA
 Service Dealers Association

2708 W. Berry St.
 Ft. Worth TX 76109
 (817) 921-9061

*One of a series.

See Adv. Page	See Adv. Page	See Adv. Page	See Adv. Page
Electronics Warehouse Corp.*D Falcon Safety Products, Inc. Fordham Radio Supply Co.*D 7 GC Electronics Div. of GC Thorsen Co. GMB/dba Fox International* HMC-Hub Material Co.*D HSC Electronic Supply* Itera/Belmoor* JDR Micro* W.S. Jenks & Son* Jonard Industries Corp. Joseph Electronics* Klein Tools, Inc. M.A.T. Electronics*D 60 MCM Electronics* Micro Care Corp. Micro-Circuits Co., Inc. Miller-Stephenson Chemical Co. Milo Associates, Inc.* Miltex Supply Corp.* Mouser Electronics* Multicore Solders OmniTron Electronics* Parts Express International Inc.*D 51 PerfectData Corp. Philips Consumer Electronics Service Co.* Philips ECG Planned Products Prime Electronics Co.*D 54 Quietrol Co. Rawn Co., Inc. RemGrit Corp. 17 RNJ Electronics Inc.* Rogers Anti-Static Chemicals Scooter Products Ohm Electrics, Inc.* Sony Service Co. National Parts Div.* Specialized Products Co.* Statikil, Inc. Tech Spray, Inc. Techni-Tool Inc.*D 19 Tool Kit Specialists, Inc.* Tool-Tronics, Inc.* The Triangle Tool Group, Inc. Tritrronics Inc.* Zenith Sales Co. A Div. of Zenith Electronics Corp. BC	Statikil, Inc. TDS Tech Spray, Inc. Techni-Tool Inc.*D 19 The Texwipe Co. Tool-Tronics, Inc.* Video Midwest & AVC Divisions of Vaughn Communications* Viziflex Seels, Inc. Keyboard Cover Div. LAMPS All Electronics Corp.* Allied Electronics, A Div. of Hall-Mark Electronics* ARS Electronics* Atrix, Inc.* Bursma Electronic Distributing* Classic Components Supply Inc.* Com-Kyl Inc.* Consolidated Electronics, Inc.*D 56 Contact East, Inc.* Cooper Associates* Electronic Parts Supply* Electronics Warehouse Corp.* Fordham Radio Supply Co.*D 7 GC Electronics Div. of GC Thorsen Co. GMB/dba Fox International* Grobet USA HMC-Hub Material Co.* Jensen Tools Inc.* Joseph Electronics* Kelvin Electronics* M.A.T. Electronics*D 60 MCM Electronics* Milo Associates, Inc.* Miltex Supply Corp.* OmniTron Electronics* ORA Electronics Parts Express International Inc.*D 51 Philips Consumer Electronics Service Co.* Prime Electronics Co.*D 54 RNJ Electronics Inc.* Scooter Products Ohm Electrics, Inc.* SHOGYO International Corp. Specialized Products Co.* Start International* Techni-Tool Inc.*D 19 Tool-Tronics, Inc.* Video Midwest & AVC Divisions of Vaughn Communications*	Tool-Tronics, Inc.* SHELVES/RACKS/BINS Allied Electronics, A Div. of Hall-Mark Electronics* Arrow Electronics Inc. Catalog Sales Div.* Clean Room Products Inc. Com-Kyl Inc.* Contact East, Inc.* Davle Tech Inc. Fordham Radio Supply Co.*D 7 HMC-Hub Material Co.* W.S. Jenks & Son* Joseph Electronics* MCM Electronics* Melmat Inc. Miltex Supply Corp.* OmniTron Electronics* Plastic Systems, Inc. Scooter Products Ohm Electrics, Inc.* Specialized Products Co.* Start International* Techni-Tool Inc.*D 19 3M/Photodyne Inc. Tool Kit Specialists, Inc.* Trace Racks Video Midwest & AVC Divisions of Vaughn Communications* Workplace Systems SOLDER/DESOLDERING BRAID/FLUX All Electronics Corp.* Allied Electronics, A Div. of Hall-Mark Electronics* Arrow Electronics Inc. Catalog Sales Div.* Atrix, Inc.* The Boardworks Bursma Electronic Distributing* Chemtronics Inc. Com-Kyl Inc.* Consolidated Electronics, Inc.*D 56 Contact East, Inc.* C&S Sales* Davle Tech Inc. Electronic Parts Supply* Electronics Warehouse Corp.* Elenco Electronics, Inc. GC Electronics Div. of GC Thorsen Co. GMB/dba Fox International* Grobet USA HMC-Hub Material Co.* HSC Electronic Supply* Itera/Belmoor* JDR Micro* W.S. Jenks & Son* Jensen Tools Inc.* Jonard Industries Corp. Joseph Electronics* Kelvin Electronics* M.A.T. Electronics*D 60 MCM Electronics* Milo Associates, Inc.* Miltex Supply Corp.* Mouser Electronics* Multicore Solders Omega Engineering Inc. OmniTron Electronics* Parts Express International Inc.*D 51 Philips Consumer Electronics Service Co.* Philips ECG Planned Products Plato Products, Inc. Prime Electronics Co.*D 54 Rawn Co., Inc. RNJ Electronics Inc.* Scooter Products Ohm Electrics, Inc.* Solder Absorbing Technology, Inc. Solder Removal Co. Sony Service Co. National Parts Div.* Specialized Products Co.* Start International* Tech Spray, Inc. Techni-Tool Inc.*D 19	Thomson Consumer Electronics, Inc. Distributor & Special Products*D 13 3M/Electrical Products Div. Tool Kit Specialists, Inc.* Tool-Tronics, Inc.* Tritrronics Inc.* Ungar, Div. Eldon Industries, Inc. TUBING Allied Electronics, A Div. of Hall-Mark Electronics* Arrow Electronics Inc. Catalog Sales Div.* Bursma Electronic Distributing* Classic Components Supply Inc.* Consolidated Electronics, Inc.*D 56 Contact East, Inc.* Electronic Parts Supply* Electronics Warehouse Corp.* GMB/dba Fox International* HSC Electronic Supply* W.S. Jenks & Son* Joseph Electronics* Kelvin Electronics* MCM Electronics* Milo Associates, Inc.* Mouser Electronics* M.M. Newman Corp. OmniTron Electronics* Scooter Products Ohm Electrics, Inc.* Tool-Tronics, Inc.* WIRE AND CABLE Advance Unit of Zero Corp. All Electronics Corp.* Allied Electronics, A Div. of Hall-Mark Electronics* Arrow Electronics Inc. Catalog Sales Div.* Bursma Electronic Distributing* Channel Master Div. of Avnet, Inc. Classic Components Supply Inc.* Consolidated Electronics, Inc.*D 56 Contact East, Inc.* Cooper Associates* Electro Standards Lab, Inc. Data Communications Products Div. Electronic Parts Supply* Electronics Warehouse Corp.* GC Electronics Div. of GC Thorsen Co. GMB/dba Fox International* W.L. Gore & Associates, Inc. HSC Electronic Supply* Itera/Belmoor* ITT Pomona Electronics JDR Micro* Jensen Tools Inc.* Joseph Electronics* Kelvin Electronics* M.A.T. Electronics*D 60 MCM Electronics* Milo Associates, Inc.* Mouser Electronics* Omega Engineering Inc. OmniTron Electronics* ORA Electronics Parts Express International Inc.*D 51 Philips Consumer Electronics Service Co.* Prime Electronics Co.*D 54 RNJ Electronics Inc.* Scooter Products Ohm Electrics, Inc.* SHOGYO International Corp. Support Systems International Cables & Accessories Div. Tappan Wire & Cable Thomson Consumer Electronics, Inc. Distributor & Special Products*D 13 3M/Electrical Products Div. Tritrronics Inc.* Video Midwest & AVC Divisions of Vaughn Communications* Winegard Co. Zenith Sales Co. A Div. of Zenith Electronics Corp. BC

See Adv. Page

See Adv. Page

See Adv. Page

See Adv. Page

Audio/video accessories

A/B SWITCHES

- All Electronics Corp.*D
- Allied Electronics, A Div. of Hall-Mark Electronics*D
- Ambico
- Atrix, Inc.*D
- Bursma Electronic Distributing*D
- Channel Master Div. of Avnet, Inc. **Consolidated Electronics, Inc.*D** 56
- Cooper Associates*D
- Electro Standards Lab, Inc. Data Communications Products Div.
- Electronic Parts Supply*D
- Electronics Warehouse Corp.*D
- GC Electronics Div. of GC Thorsen Co.
- GMB/dba Fox International*D
- HSC Electronic Supply*D
- International Components Corp.
- Itera/Belmoor*D
- JDR Micro*D
- Joseph Electronics*D
- Kelvin Electronics*D
- L-Com Inc.
- M.A.T. Electronics*D** 60
- MCM Electronics*D
- Milo Associates, Inc.*D
- Omega Engineering Inc.
- OmniTron Electronics*D
- ORA Electronics
- Parts Express International Inc.*D** 51
- Patton Electronics Co.
- Philips Consumer Electronics Service Co.*D
- Prime Electronics Co.*D** 54
- RNJ Electronics Inc.*D
- SHOGYO International Corp.
- Sony Service Co. National Parts Div.*D
- Support Systems International Cables & Accessories Div.
- Tritronics Inc.*D
- Video Midwest & AVC Divisions of Vaughn Communications*D
- Winegard Co.
- Zenith Sales Co. A Div. of Zenith Electronics Corp.** BC

COUPLERS/SPLITTERS

- All Electronics Corp.*D
- Allied Electronics, A Div. of Hall-Mark Electronics*D
- Bursma Electronic Distributing*D
- Channel Master Div. of Avnet, Inc. **Consolidated Electronics, Inc.*D** 56
- Cooper Associates*D
- Electro Standards Lab, Inc. Data Communications Products Div.
- Electron Processing
- Electronic Parts Supply*D
- Electronics Warehouse Corp.*D
- GC Electronics Div. of GC Thorsen Co.
- GMB/dba Fox International*D
- HSC Electronic Supply*D
- International Components Corp.
- Itera/Belmoor*D
- JDR Micro*D
- Joseph Electronics*D
- Kelvin Electronics*D
- M.A.T. Electronics*D** 60
- MCM Electronics*D
- Milo Associates, Inc.*D
- Mouser Electronics*D
- Multiplex Technology, Inc.
- Omega Engineering Inc.
- OmniTron Electronics*D
- ORA Electronics
- Parts Express International Inc.*D** 51
- Philips Consumer Electronics Service Co.*D
- Prime Electronics Co.*D** 54
- RNJ Electronics Inc.*D
- Scoter Products Ohm Electrics, Inc.*D
- Sony Service Co. National Parts Div.*D

Company mailing addresses begin on page 45

- Spectrum 2000, Inc.
- 3M/Photodyne Inc.
- Tritronics Inc.*D
- Video Midwest & AVC Divisions of Vaughn Communications*D
- Winegard Co.
- Zenith Sales Co. A Div. of Zenith Electronics Corp.** BC

FILTERS

- Allied Electronics, A Div. of Hall-Mark Electronics*D
- Bursma Electronic Distributing*D
- Channel Master Div. of Avnet, Inc.

- Classic Components Supply Inc.*D
- Clean Room Products Inc.
- Consolidated Electronics, Inc.*D** 56
- Cooper Associates*D
- Datel, Inc.
- Electronic Parts Supply*D
- Electronic Specialists, Inc.
- Electronics Warehouse Corp.*D
- GMB/dba Fox International*D
- HSC Electronic Supply*D
- International Components Corp.
- Itera/Belmoor*D
- Joseph Electronics*D
- MCM Electronics*D
- Microwave Filter Co., Inc.

- Milo Associates, Inc.*D
- Mouser Electronics*D
- Multiplex Technology, Inc.
- OmniTron Electronics*D
- Parts Express International Inc.*D** 51
- PerfectData Corp.
- Philips Consumer Electronics Service Co.*D
- RNJ Electronics Inc.*D
- Sony Service Co. National Parts Div.*D
- Speco Div.
- Tripp-Lite
- Video Midwest & AVC Divisions of Vaughn Communications*D
- Winegard Co.



OSCILLOSCOPE



•OS-7020A
20MHz, DUAL TRACE

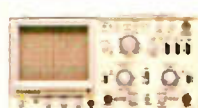

•OS-8020R
20MHz, DUAL TRACE
CRT READOUT DISPLAY

FREQUENCY COUNTER & POWER SUPPLY



•FC-7011: 100MHz
•FC-7052: 550MHz
•FC-7102: 1GHz



•GP-103: 18V/1.0A
•GP-105: 30V/0.5A
•GP-233: 18V/1.0A, 18V/1.0A
•GP-235: 18V/1.0A, 30V/0.5A

DIGITAL MULTIMETER BENCH & HAND-HELD



•DM-7241: 4 1/2 DIGITS
MANUAL RANGING,
LED MEMBRANE
FUNCTION INDICATION



•DM-6335
3 1/2 DIGITS,
AUTO
RANGING,
MEMORY,
HOLD
FUNCTION



•DM-8135
3 1/2 DIGITS,
AUTO
RANGING,
MEMORY, HOLD,
TR, hFE CHECK
FUNCTION,
BAR GRAPHIC
DISPLAY



•DM-7333
3 1/2 DIGITS,
MANUAL
RANGING,
TR, hFE CHECK
CAPACITANCE,
FREQUENCY
FUNCTION



•DM-8433
4 1/2 DIGITS,
MANUAL
RANGING,
TR, hFE CHECK
CAPACITANCE,
TEMPERATURE
FUNCTION



•DM-8243
4 1/2 DIGITS
MANUAL
RANGING,
TR, hFE CHECK
CAPACITANCE,
FREQUENCY
FUNCTION



GoldStar Precision

13013 East 166th Street, Cerritos, Ca. 90701, U.S.A
Tel.: (213) 404-0101 Tlx.: (910) 583-5719 LGILA
Fax.: (213) 926-0849

Circle (13) on Reply Card

	See Adv. Page	See Adv. Page	See Adv. Page	See Adv. Page
RF SWITCHERS				
Allied Electronics, A Div. of Hall-Mark Electronics* ^D				
Ambico				
Bursma Electronic Distributing* ^D				
Channel Master Div. of Avnet, Inc.				
Consolidated Electronics, Inc.*^D	56			
Cooper Associates* ^D				
Delta Electronics, Inc.				
Electronic Parts Supply* ^D				
Electronics Warehouse Corp.* ^D				
GMB/dba Fox International* ^D				
International Components Corp.				
Itera/Belmoor* ^D				
Joseph Electronics* ^D				
M.A.T. Electronics*^D	60			
MCM Electronics* ^D				
Omnitron Electronics* ^D				
Parts Express International Inc.*^D	51			
Philips Consumer Electronics Service Co.* ^D				
Prime Electronics Co.*^D	54			
RNJ Electronics Inc.* ^D				
Sony Service Co. National Parts Div.* ^D				
Video Midwest & AVC Divisions of Vaughn Communications* ^D				
Wavetek Corp.				
SIGNAL MIXERS				
Allied Electronics, A Div. of Hall-Mark Electronics* ^D				
Ambico				
Audio-Technica U.S., Inc.				
Bursma Electronic Distributing* ^D				
Channel Master Div. of Avnet, Inc.				
Consolidated Electronics, Inc.*^D	56			
Cooper Associates* ^D				
Electronic Parts Supply* ^D				
Electronics Warehouse Corp.* ^D				
GMB/dba Fox International* ^D				
Itera/Belmoor* ^D				
Joseph Electronics* ^D				
Multiplex Technology, Inc.				
Omnitron Electronics* ^D				
Parts Express International Inc.*^D	51			
Philips Consumer Electronics Service Co.* ^D				
RNJ Electronics Inc.* ^D				
Sony Service Co. National Parts Div.* ^D				
3M/Photodyne Inc.				
Video Midwest & AVC Divisions of Vaughn Communications* ^D				
Tools				
<hr/>				
HEAT GUNS				
All Electronics Corp.* ^D				
Allied Electronics, A Div. of Hall-Mark Electronics* ^D				
Arrow Electronics Inc. Catalog Sales Div.* ^D				
Brunelle Instruments Inc.				
Classic Components Supply Inc.* ^D				
Com-Kyl Inc.* ^D				
Consolidated Electronics, Inc.*^D	56			
Contact East, Inc.* ^D				
Davle Tech Inc.				
Dremel				
Electronics Warehouse Corp.* ^D				
GC Electronics Div. of GC Thorsen Co.				
Hand Tool Industries, Inc.				
HMC-Hub Material Co.* ^D				
HSC Electronic Supply* ^D				
Ideal Industries				
W.S. Jenks & Son* ^D				
Jensen Tools Inc.* ^D				
Joseph Electronics* ^D				
Kelvin Electronics* ^D				
MCM Electronics* ^D				
Miltex Supply Corp.* ^D				
M.M. Newman Corp.				
Omnitron Electronics* ^D				
Paladin Corp.				
Philips Consumer Electronics Service Co.* ^D				
RNJ Electronics Inc.* ^D				
Scotter Products Ohm Electrics, Inc.* ^D				
Sony Service Co. National Parts Div.* ^D				
Specialized Products Co.* ^D				
Techni-Tool Inc.*^D	19			
Tool Kit Specialists, Inc.* ^D				
Tool-Tronics, Inc.* ^D				
Ungar, Div. Eldon Industries, Inc.				
Brian R. White Co., Inc.* ^D				
JIGS/FIXTURES/VISES				
Allied Electronics, A Div. of Hall-Mark Electronics* ^D				
Com-Kyl Inc.* ^D				
Consolidated Electronics, Inc.*^D	56			
Contact East, Inc.* ^D				
Data Tech Reliance, Inc.				
Electronics Warehouse Corp.* ^D				
Grobet USA				
Hand Tool Industries, Inc.				
HMC-Hub Material Co.* ^D				
HSC Electronic Supply* ^D				
HSC Service Co. Div. of Hitachi Sales Corp. of America				
JDR Micro* ^D				
W.S. Jenks & Son* ^D				
Joseph Electronics* ^D				
Milo Associates, Inc.* ^D				
Mitsubishi Electric Sales America, Inc.				
Omnitron Electronics* ^D				
PanaVise Products, Inc.	37			
Philips Consumer Electronics Service Co.* ^D				
Sony Service Co. National Parts Div.* ^D				
Start International* ^D				
Techni-Tool Inc.*^D	19			
Tentel Corp.				
Tool-Tronics, Inc.* ^D				
SOLDERING/DESOLDERING EQUIPMENT				
All Electronics Corp.* ^D				
Allied Electronics, A Div. of Hall-Mark Electronics* ^D				
American Design Components* ^D				
A.P.E. Corp.				
Arrow Electronics Inc. Catalog Sales Div.* ^D				
Atrix, Inc.* ^D				
The Boardworks				
Bursma Electronic Distributing* ^D				
Caig Labs, Inc.				
Com-Kyl Inc.* ^D				
Consolidated Electronics, Inc.*^D	56			
Contact East, Inc.* ^D				
Cooper Associates* ^D				
CooperTools				
C&S Sales* ^D				
Davle Tech Inc.				
Digi-Key Corp.* ^D				
Dremel				
Electron Processing				
Electronic Parts Supply* ^D				
Electronics Warehouse Corp.* ^D				
Elenco Electronics, Inc.				
Elvo Div. of Zumbach Electronics Corp.				
Eraser Co., Inc. Wybar Div.				
Fordham Radio Supply Co.*^D	7			
GC Electronics Div. of GC Thorsen Co.				
GMB/dba Fox International* ^D				
The Granite Corp.				
Grobet USA				
Hand Tool Industries, Inc.				
Hexacon Electric Co.				
HMC-Hub Material Co.* ^D				
HSC Electronic Supply* ^D				
HSC Service Co. Div. of Hitachi Sales Corp. of America				
Ideal Industries				
Itera/Belmoor* ^D				
JDR Micro* ^D				
W.S. Jenks & Son* ^D				
Jensen Tools Inc.* ^D				
Jonard Industries Corp.				
Joseph Electronics* ^D				
Kelvin Electronics* ^D				
MCM Electronics* ^D				
Melmat Inc.				
Milo Associates, Inc.* ^D				
Mouser Electronics* ^D				
P.K. Neuses Inc.* ^D				
Omega Engineering Inc.				
Omnitron Electronics* ^D				
Partfolio, Inc.				
Parts Express International Inc.*^D	51			
Philips Consumer Electronics Service Co.* ^D				
Prime Electronics Co.*^D	54			
R & K Supply Co.				
RNJ Electronics Inc.* ^D				
Scotter Products Ohm Electrics, Inc.* ^D				
Sony Service Co. National Parts Div.* ^D				
Specialized Products Co.* ^D				
Techni-Tool Inc.*^D				
Thomson Consumer Electronics, Inc. Distributor & Special Products*^D				
3M/Electrical Products Div.				
3M/Photodyne Inc.				
Tool Kit Specialists, Inc.*^D				
Tool-Tronics, Inc.*^D				
Vaco Products				
Brian R. White Co., Inc.*^D				
Techni-Tool Inc.*^D				
Thomson Consumer Electronics, Inc. Distributor & Special Products*^D				
Tool Kit Specialists, Inc.*^D				
Tool-Tronics, Inc.*^D				
Triplett Corp.				
Vaco Products				
Zero Corp., East Div.				
TOOL KITS				
Allied Electronics, A Div. of Hall-Mark Electronics* ^D				
Arrow Electronics Inc. Catalog Sales Div.* ^D				
Atrix, Inc.* ^D				
Brunelle Instruments Inc.				
Bursma Electronic Distributing* ^D				
Clauss Cutlery Co.				
Com-Kyl Inc.* ^D				
Consolidated Electronics, Inc.*^D	56			
Contact East, Inc.* ^D				
CooperTools				
C&S Sales* ^D				
Davle Tech Inc.				
Dremel				
Electronic Parts Supply* ^D				
Electronics Warehouse Corp.* ^D				
Elenco Electronics, Inc.				
Fordham Radio Supply Co.*^D	7			
GC Electronics Div. of GC Thorsen Co.				
GMB/dba Fox International* ^D				
Grobet USA				
Hand Tool Industries, Inc.				
HMC-Hub Material Co.* ^D				
HSC Electronic Supply* ^D				
Ideal Industries				
Itera/Belmoor* ^D				
JDR Micro* ^D				
W.S. Jenks & Son* ^D				
Jensen Tools Inc.* ^D				
Jonard Industries Corp.				
Joseph Electronics* ^D				
Kelvin Electronics* ^D				
Klein Tools, Inc.				
M.A.T. Electronics*^D	60			
MCM Electronics* ^D				
Milo Associates, Inc.* ^D				
Miltex Supply Corp.* ^D				
Moody Tools, Inc.				
Mouser Electronics* ^D				
P.K. Neuses Inc.* ^D				
Nu-Data Inc.				
Omega Engineering Inc.				
Omnitron Electronics* ^D				
Omnium Corp.				
Paladin Corp.				
Parts Express International Inc.*^D	51			
Philips Consumer Electronics Service Co.* ^D				
R & K Supply Co.				
RNJ Electronics Inc.* ^D				
Rostra Tool Co.				
Scotter Products Ohm Electrics, Inc.* ^D				
Sony Service Co. National Parts Div.* ^D				
Specialized Products Co.* ^D				
Techni-Tool Inc.*^D	19			
Thomson Consumer Electronics, Inc. Distributor & Special Products*^D				
3M/Electrical Products Div.				
3M/Photodyne Inc.				
Tool Kit Specialists, Inc.*^D				
Tool-Tronics, Inc.*^D				
Vaco Products				
Brian R. White Co., Inc.*^D				
TOOLS, MISCELLANEOUS				
All Electronics Corp.* ^D				
Allied Electronics, A Div. of Hall-Mark Electronics* ^D				
Arrow Electronics Inc. Catalog Sales Div.* ^D				
Assembly Systems Group				
Atrix, Inc.* ^D				
Aven International				
Black Box Corp.* ^D				
The Boardworks				
Bondhus				
Brunelle Instruments Inc.				

Continued on page 37.

3062

PROFAX ES&T
Manufacturers
Schematics

MARCH 1990

RCA/GE
CTC148/149-S2
chassis
color
TV

SYSTEM CONTROL SCHEMATIC (STEREO) (USED CTC148A,P,Q/CTC149A,B,E,Q CHASSIS)

Product safety should be considered when component replacement is made in any area of a receiver. Components marked with a ★ and shaded areas of the schematic diagram designate sites where safety is of special significance. It is recommended that only exact cataloged parts be used for replacement of these components.

Use of substitute replacement parts that do not have the same safety characteristics as recommended in factory service information may create shock, fire, excessive x-radiation or other hazards.

This schematic is for the use of qualified technicians only. This instrument contains no user-serviceable parts.

The other portions of this schematic may be found on other Profax pages.

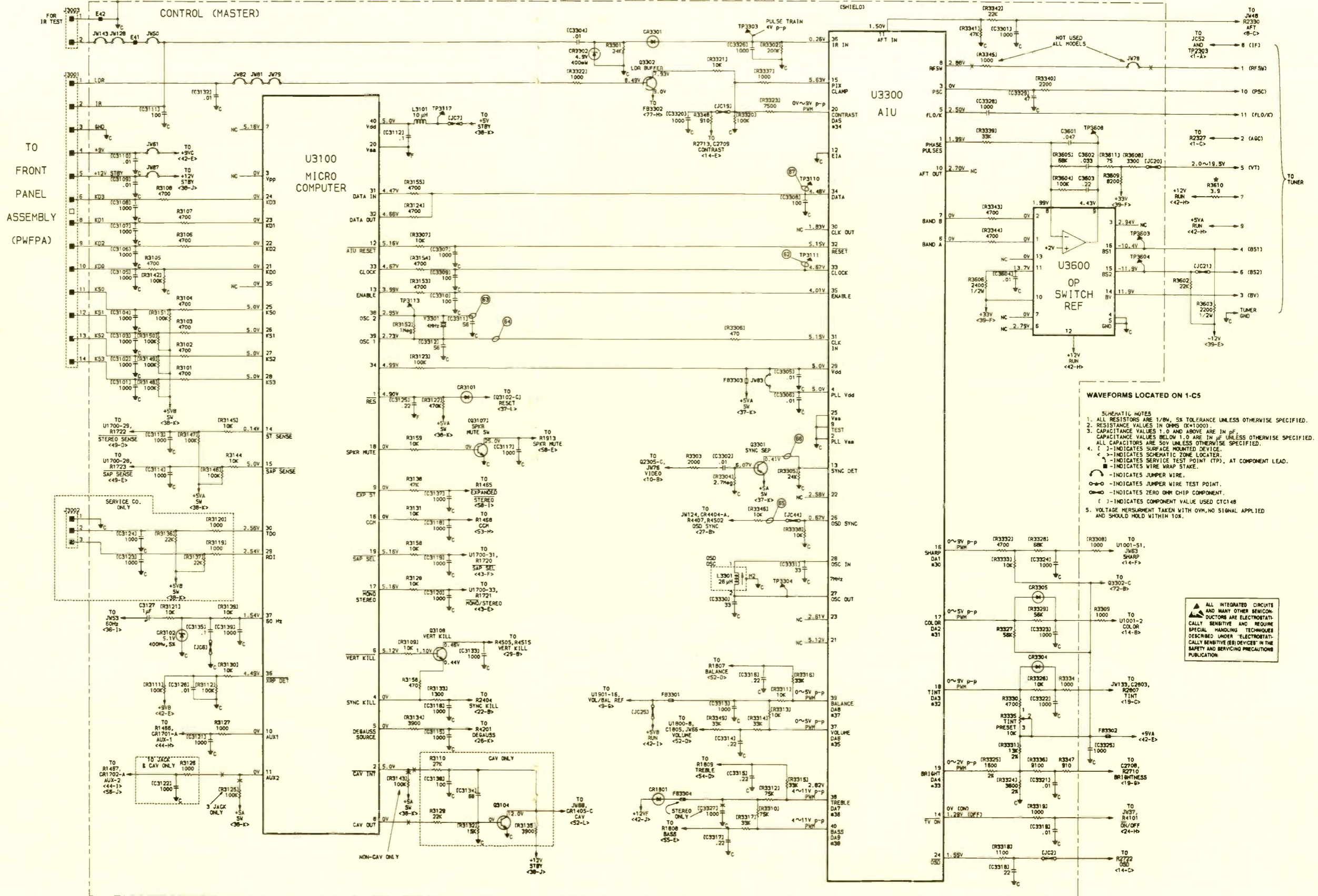

- WAVEFORMS LOCATED ON 1-C5**
- ALL RESISTORS ARE 1/8W, 5% TOLERANCE UNLESS OTHERWISE SPECIFIED.
 - RESISTANCE VALUES IN OHMS (Ω) UNLESS OTHERWISE SPECIFIED.
 - CAPACITANCE VALUES 1.0 AND ABOVE ARE IN μF UNLESS OTHERWISE SPECIFIED. CAPACITANCE VALUES BELOW 1.0 ARE IN pF UNLESS OTHERWISE SPECIFIED.
 - () - INDICATES SURFACE MOUNTED DEVICE.
 - () - INDICATES SERVICE TEST POINT (TP), AT COMPONENT LEAD.
 - () - INDICATES WIRE WRAP STAKE.
 - () - INDICATES JUMPER WIRE.
 - () - INDICATES JUMPER WIRE TEST POINT.
 - () - INDICATES ZERO OHM CHIP COMPONENT.
 - () - INDICATES COMPONENT VALUE USED CTC148.
 - VOLTAGE MEASUREMENT TAKEN WITH OHM, NO SIGNAL APPLIED AND SHOULD HOLD WITHIN 10%.

ALL INTEGRATED CIRCUITS AND MANY OTHER BICOINDUCTORS ARE ELECTROSTATICALLY SENSITIVE AND REQUIRE SPECIAL HANDLING TECHNIQUES DESCRIBED UNDER "ELECTROSTATICALLY SENSITIVE (ES) DEVICES" IN THE SAFETY AND SERVICING PRECAUTIONS PUBLICATION.

**SIGNAL CIRCUIT SCHEMATIC (NON-COMB)
(USED CTC148A,P/CTC149A CHASSIS)**

Product safety should be considered when component replacement is made in any area of an electronics product. A star (★) next to a component symbol number designates components in which safety is of special significance. It is recommended that only exact cataloged parts be used for replacement of these components.

Use of substitute replacement parts that do not have the same safety characteristics as recommended in factory service information may create shock, fire, excessive x-radiation or other hazards.

This schematic is for the use of qualified technicians only. This instrument contains no user-serviceable parts.

The other portions of this schematic may be found on other Profax pages.

All integrated circuits and many other semiconductors are electrostatically sensitive and require special handling techniques.

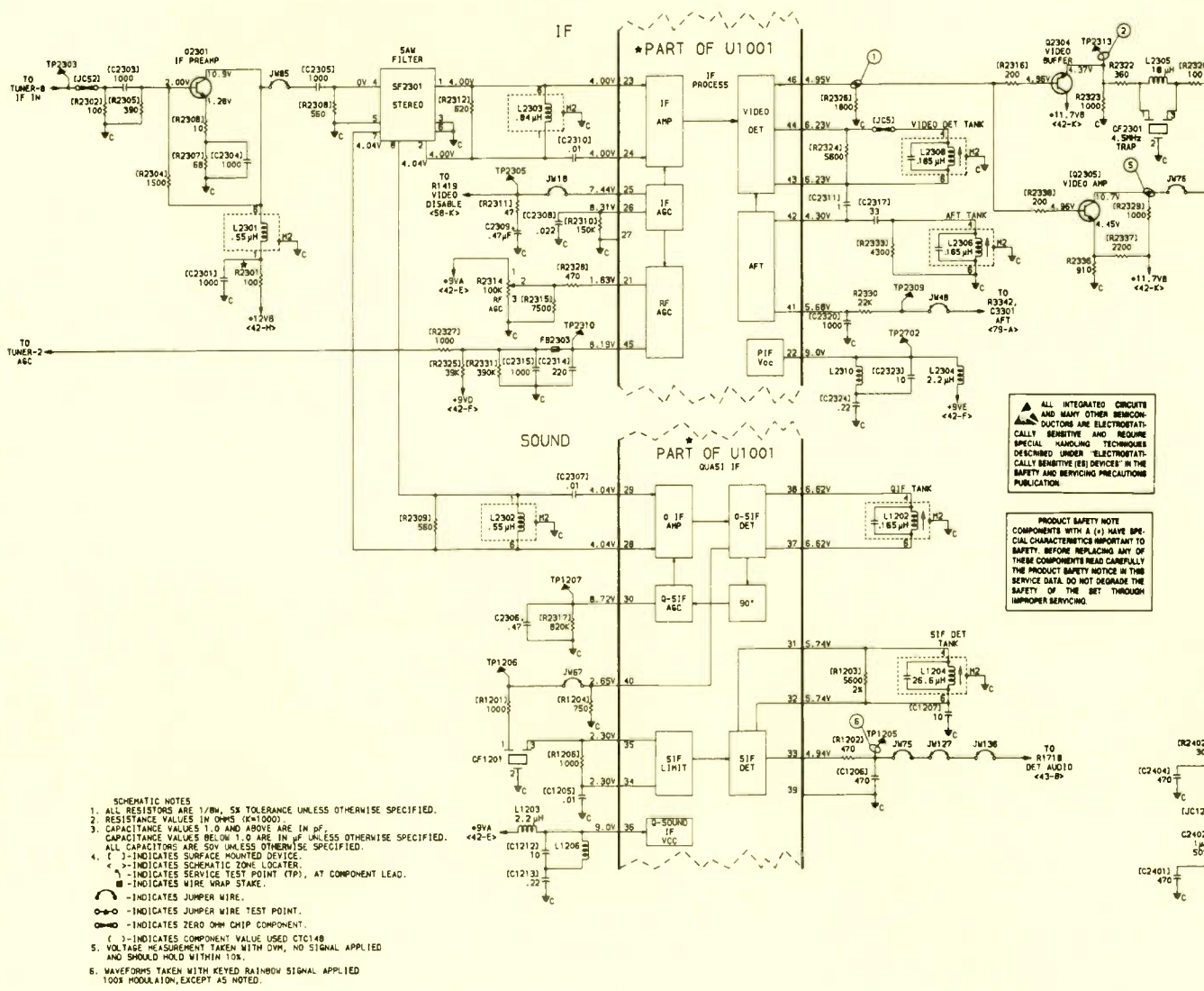

**SIGNAL CIRCUIT SCHEMATIC (NON-COMB)
(USED CTC148A,P/CTC149A CHASSIS)**

Product safety should be considered when component replacement is made in any area of an electronics product. A star (★) next to a component symbol number designates components in which safety is of special significance. It is recommended that only exact cataloged parts be used for replacement of these components.

Use of substitute replacement parts that do not have the same safety characteristics as recommended in factory service information may create shock, fire, excessive x-radiation or other hazards.

This schematic is for the use of qualified technicians only. This instrument contains no user-serviceable parts.

The other portions of this schematic may be found on other Profax pages.

All integrated circuits and many other semiconductors are electrostatically sensitive and require special handling techniques.

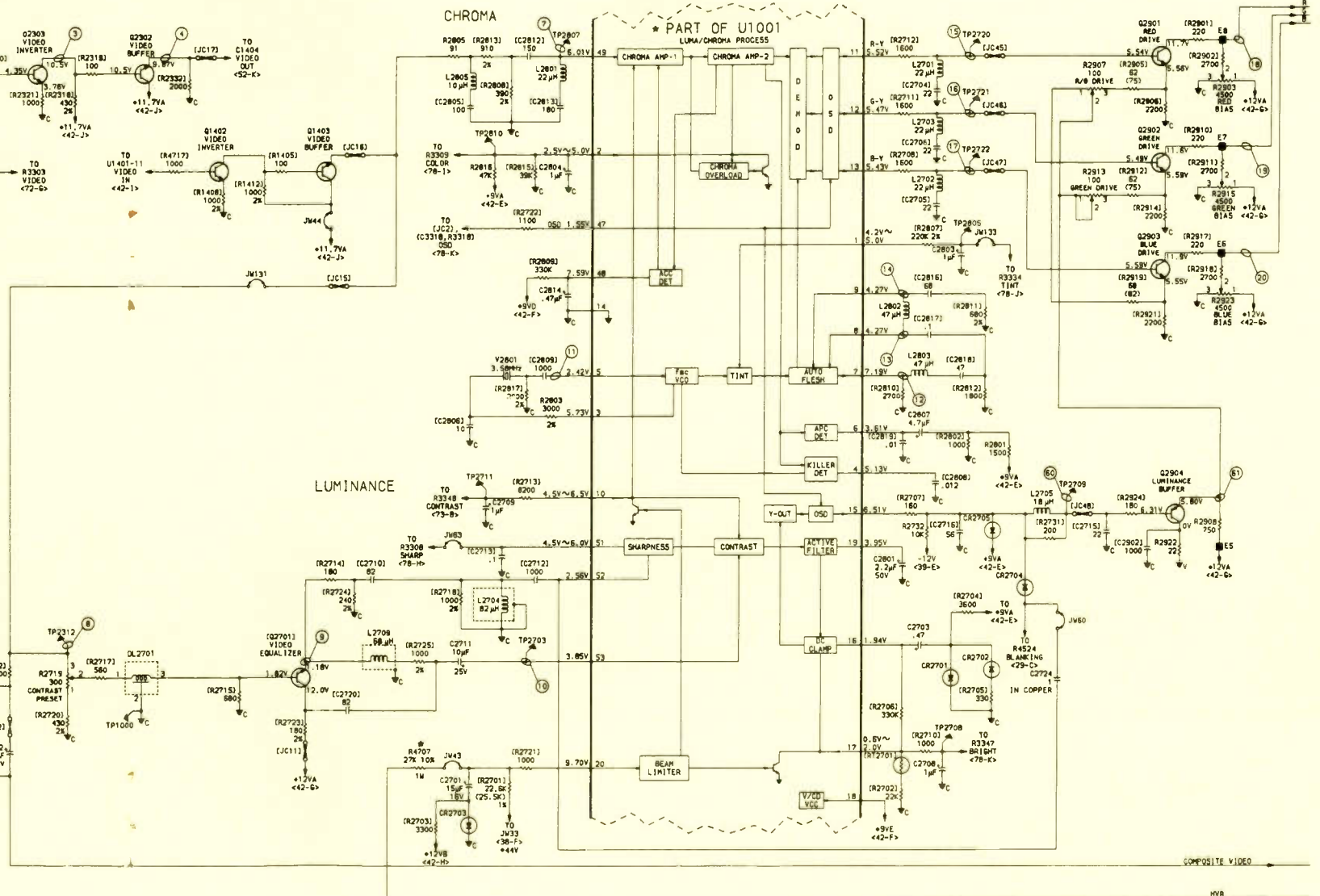

See Adv. Page	See Adv. Page	See Adv. Page	See Adv. Page
Bursma Electronic Distributing* Cementex Products, Inc. Channel Master Div. of Avnet, Inc. Com-Kyl Inc.* Consolidated Electronics, Inc.*D 56	The Granite Corp. Grobet USA Hand Tool Industries, Inc. HMC-Hub Material Co.* HSC Electronic Supply* Ideal Industries International Components Corp. Itera/Belmoor* JDR Micro* W.S. Jenks & Son* Jensen Tools Inc.* Jonard Industries Corp. Joseph Electronics* Kelvin Electronics* Klein Tools, Inc. M.A.T. Electronics*D 60	Miltex Supply Corp.* Moody Tools, Inc. Mouser Electronics* P.K. Neuses Inc.* Nu-Concept Systems, Inc. Nu-Data Inc. O.K. Industries Inc. Omega Engineering Inc. Omnitron Electronics* ORA Electronics Paladin Corp. Parts Express International Inc.*D 51	R & K Supply Co. RNJ Electronics Inc.* Rostra Tool Co. Scooter Products Ohm Electrics, Inc.* Sony Service Co. National Parts Div.* Specialized Products Co.* Techni-Tool Inc.*D 19
Contact East, Inc.* Cooper Associates* CooperTools Davie Tech Inc. Dremel Electro Standards Lab, Inc. Data Communications Products Div. Electronic Parts Supply* Electronics Warehouse Corp.* Elvo Div. of Zumbach Electronics Corp. Eraser Co., Inc. Wybar Div. GC Electronics Div. of GC Thorsen Co. GMB/dba Fox International* Thomson Consumer Electronics, Inc. Distributor & Special Products*D 13	Jonard Industries Corp. Joseph Electronics* Kelvin Electronics* Klein Tools, Inc. M.A.T. Electronics*D 60	Philips Consumer Electronics Service Co.* Plato Products, Inc. Portasol, Inc. Prime Electronics Co.*D 54	Thomson Consumer Electronics, Inc. Distributor & Special Products*D 13
	MCM Electronics* Micro-Circuits Co., Inc. Milo Associates, Inc.*	Regal Equipment Co.	3M/Electrical Products Div. 3M/Photodyne Inc. Tool Kit Specialists, Inc.* Tool Tron Industries Tool-Tronics, Inc.* The Triangle Tool Group, Inc. Vaco Products 21

Replacement parts/components directory

ANTENNAS/ROTORS/ SATELLITE SYSTEMS

The Antenna Specialists Co. Member
of the Allen Group
Bursma Electronic Distributing*
Channel Master Div. of Avnet, Inc.

Cooper Associates*
Electronics Warehouse Corp.*
Fordham Radio Supply Co.*D 7

GMB/dba Fox International*
Joseph Electronics*
MCM Electronics*
Omnitron Electronics*
ORA Electronics
**Parts Express International
Inc.*D** 51

JC Penney National Parts Center*
Philips Consumer Electronics Service
Co.*
RNJ Electronics Inc.*
Sony Service Co. National Parts Div.*
Speco Div.
Tritronics Inc.*
Winegard Co.
**Zenith Sales Co. A Div. of
Zenith Electronics Corp.** BC

Company mailing addresses begin on page 45

...THE REST OF US NEED A PANAVISE.

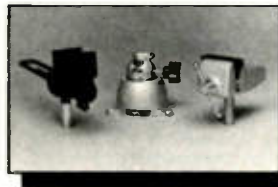

STARTER KIT—The perfect introduction to PanaVise! Two heads (Standard and Wide Opening) interchange with our "tilt, turn and rotate" Standard Base. Versatile quality for all your electronics projects. Ask for Model #302.

CIRCUIT BOARD HOLDER—Tilt, turn and rotate circuit boards to the exact position you want, then lock them into place with a single control knob! Moves work in vertical, horizontal or circular planes (perfect for front/back examination). Spring-loaded arm holds boards up to 12" wide. Ask for Model #372.

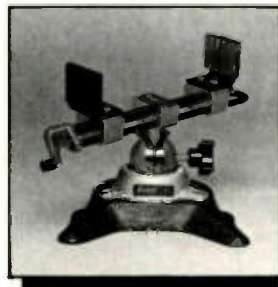
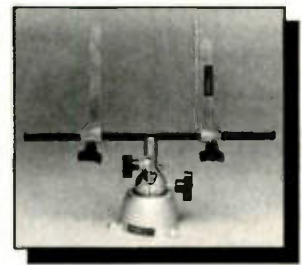

PORTABLE PANAVISE WITH EXTRA-WIDE OPENING HEAD—The weighted base mount (5 lbs.) means you can move this PanaVise with ease! The Self-Centering Extra-Wide Opening Head (opens a full 9") and full "tilt, turn and rotate" capabilities make this a truly portable, versatile addition to any workbench. Ask for Model #334.

See your local electronics
supplier or contact:

PANAVISE[®]
Phone: (213) 595-7621 Fax: (213) 595-9539

PanaVise Products, Inc.
2850 E. 29th Street
Long Beach, CA 90806

Circle (14) on Reply Card

See Adv. Page	See Adv. Page	See Adv. Page	See Adv. Page
E.F. Johnson Co. Joseph Electronics*D Keystone Electronics Corp. M.A.T. Electronics*D 60 MCM Electronics*D Milo Associates, Inc.*D Mouser Electronics*D Omnitron Electronics*D Parts Express International Inc.*D 51 JC Penney National Parts Center*D Philips Consumer Electronics Service Co.*D Schurter, Inc. Scooter Products Ohm Electrics, Inc.*D SHOGYO International Corp. Sony Service Co. National Parts Div.*D 3M/Electronic Products Div. Zenith Sales Co. A Div. of Zenith Electronics Corp. BC	Mouser Electronics*D Parts Express International Inc.*D 51 JC Penney National Parts Center*D Philips Consumer Electronics Service Co.*D Scooter Products Ohm Electrics, Inc.*D Sony Service Co. Sony Service Co. National Parts Div.*D Video Midwest & AVC Divisions of Vaughn Communications*D Zenith Sales Co. A Div. of Zenith Electronics Corp. BC	Joseph Electronics*D Kelvin Electronics*D M.A.T. Electronics*D 60 Matsushita Services Co. 4-5 MCM Electronics*D Milo Associates, Inc.*D Mitsubishi Electric Sales America, Inc. Mouser Electronics*D NTE Electronics, Inc. 15 Omnitron Electronics*D ORA Electronics Parts Express International Inc.*D 51 JC Penney National Parts Center*D Philips Consumer Electronics Service Co.*D Prime Electronics Co.*D 54 RNJ Electronics Inc.*D Schurter, Inc. Scooter Products Ohm Electrics, Inc.*D SHOGYO International Corp. Sony Service Co. Sony Service Co. National Parts Div.*D Sprague Magnetics, Inc.*D Tritronics Inc.*D Video Midwest & AVC Divisions of Vaughn Communications*D Zenith Sales Co. A Div. of Zenith Electronics Corp. BC	Mitsubishi Electric Sales America, Inc. Omnitron Electronics*D JC Penney National Parts Center*D Philips Consumer Electronics Service Co.*D Sony Service Co. National Parts Div.*D Tritronics Inc.*D Zenith Sales Co. A Div. of Zenith Electronics Corp. BC
INDUCTORS All Electronics Corp.*D Allied Electronics, A Div. of Hall-Mark Electronics*D Arrow Electronics Inc. Catalog Sales Div.*D Consolidated Electronics, Inc.*D 56 Digi-Key Corp.*D Electronics Warehouse Corp.*D GMB/dba Fox International*D HSC Electronic Supply*D HSC Service Co. Div. of Hitachi Sales Corp. of America JDR Micro*D Joseph Electronics*D MCM Electronics*D Milo Associates, Inc.*D	LAMPs/LEDs/INDICATORS All Electronics Corp.*D Allied Electronics, A Div. of Hall-Mark Electronics*D American Design Components*D Arrow Electronics Inc. Catalog Sales Div.*D ARS Electronics*D Bursma Electronic Distributing*D Classic Components Supply Inc.*D Consolidated Electronics, Inc.*D 56 Cooper Associates*D Digi-Key Corp.*D Electronic Parts Supply*D Electronics Warehouse Corp.*D Fordham Radio Supply Co.*D 7 GC Electronics Div. of GC Thorsen Co. GMB/dba Fox International*D HSC Electronic Supply*D HSC Service Co. Div. of Hitachi Sales Corp. of America Industrial Devices, Inc. Itera/Belmoor*D JDR Micro*D	MAGNETRONS ARS Electronics*D Consolidated Electronics, Inc.*D 56 GMB/dba Fox International*D Herman Electronics HSC Service Co. Div. of Hitachi Sales Corp. of America Joseph Electronics*D Matsushita Services Co. 4-5 MCM Electronics*D	MODULES Allied Electronics, A Div. of Hall-Mark Electronics*D Bursma Electronic Distributing*D Electronic Parts Supply*D Electronics Warehouse Corp.*D GMB/dba Fox International*D HSC Service Co. Div. of Hitachi Sales Corp. of America Joseph Electronics*D MCM Electronics*D Module Exchange JC Penney National Parts Center*D Philips Consumer Electronics Service Co.*D Prime Electronics Co.*D 54 PTS Electronics Corp. 53,55 Schurter, Inc. Sony Service Co. Sony Service Co. National Parts Div.*D Thomson Consumer Electronics, Inc. Distributor & Special Products*D 13 Tritronics Inc.*D Zenith Sales Co. A Div. of Zenith Electronics Corp. BC
MOTORS All Electronics Corp.*D Allied Electronics, A Div. of Hall-Mark Electronics*D			

Company mailing addresses begin on page 45

LEARN VCR

CLEANING/MAINTENANCE/REPAIR

EARN UP TO \$1000 A WEEK, WORKING PART TIME FROM YOUR OWN HOME!



Secrets Revealed!

NO Special Tools or Equipment Needed.

EARN UP TO \$60 AN HOUR AND MORE!

THE MONEYMAKING OPPORTUNITY OF THE 1990's

IF you are able to work with common small hand tools, and are familiar with basic electronics (i.e. able to use voltmeter, understand DC electronics)...

IF you possess average mechanical ability, and have a VCR on which to practice and learn...then we can teach YOU VCR maintenance and repair!

FACT: up to 90% of ALL VCR malfunctions are due to simple MECHANICAL or ELECTRO-MECHANICAL breakdowns!

FACT: over 77 million VCRs in use today nationwide! Average VCR needs service or repair every 12 to 18 months!

Viejo's 400 PAGE TRAINING MANUAL (over 500 photos and illustrations) and AWARD-WINNING VIDEO TRAINING TAPE reveals the SECRETS of VCR maintenance and repair - "real-world" information that is NOT available elsewhere!

Also Includes all the info you'll need regarding the BUSINESS-SIDE of running a successful service operation!

FREE INFORMATION

CALL TOLL-FREE 1-800-537-0589
Or write to Viejo Publications, Inc.
3540 Wilshire Bl., STE 310
Los Angeles, CA 90010, Dept. EST

Circle (30) on Reply Card

Extend Your Frequency Counter Range To 1.3GHz Without Extending Your Budget.

FC130A Frequency Counter

- .01Hz to 1.3GHz Frequency Range
- 8-Digit LED Display

- Measures Frequency, Period and Rate per Minute (RPM)
- 10mV Sensitivity (Typical)



\$595

Beckman Industrial™

An Affiliate of Emerson Electric Co

For more information and the location of your nearest authorized Beckman Industrial dealer call 1-800-854-2708 (in California 1-800-227-9781). Instrumentation Products Division, 3883 Ruffin Road, San Diego, CA 92123-1898

© 1989 Beckman Industrial Corporation Specifications are subject to change without notice.

JN161-11 0390

Circle (27) on Reply Card

Replacement parts/components directory

See Adv. Page	See Adv. Page	See Adv. Page	See Adv. Page
American Design Components* Consolidated Electronics, Inc.*D 56	Zenith Sales Co. A Div. of Zenith Electronics Corp. BC	American Design Components* Arrow Electronics Inc. Catalog Sales Div.*D	Thomson Consumer Electronics, Inc. Distributor & Special Products* D 13
Data Tech Reliance, Inc. Electronic Parts Supply* Electronics Warehouse Corp.* GMB/dba Fox International* HSC Electronic Supply* HSC Service Co. Div. of Hitachi Sales Corp. of America Itera/Belmoor* Joseph Electronics* M.A.T. Electronics* D 60	POTENTIOMETERS All Electronics Corp.* Allied Electronics, A Div. of Hall-Mark Electronics* Arrow Electronics Inc. Catalog Sales Div.* Classic Components Supply Inc.* Consolidated Electronics, Inc.*D 56	ARS Electronics* Classic Components Supply Inc.* Consolidated Electronics, Inc.*D 56	Tritronics Inc.* Video Midwest & AVC Divisions of Vaughn Communications* Zenith Sales Co. A Div. of Zenith Electronics Corp. BC
Matsushita Services Co. 4-5	Cooper Associates* Digi-Key Corp.* Electronic Parts Supply* Electronics Warehouse Corp.* Fordham Radio Supply Co.* D 7	Cooper Associates* Data Tech Reliance, Inc. Digi-Key Corp.* Electronic Parts Supply* Electronics Warehouse Corp.* Fordham Radio Supply Co.* D 7	SEMICONDUCTORS, DIODES All Electronics Corp.* Allied Electronics, A Div. of Hall-Mark Electronics* American Design Components* Arrow Electronics Inc. Catalog Sales Div.* ARS Electronics* Bursma Electronic Distributing* Classic Components Supply Inc.* Consolidated Electronics, Inc.*D 56
MCM Electronics* Milo Associates, Inc.* Mitsubishi Electric Sales America, Inc. Omniatron Electronics* Parts Express International Inc.*D 51	GC Electronics Div. of GC Thorsen Co. GMB/dba Fox International* HSC Electronic Supply* Itera/Belmoor* JDR Micro* Joseph Electronics* Kelvin Electronics* Matsushita Services Co. 4-5	Herman Electronics HSC Electronic Supply* HSC Service Co. Div. of Hitachi Sales Corp. of America ICS, Inc. Electro-Pac Div. Interconnect Devices, Inc. Itera/Belmoor* JDR Micro* Joseph Electronics* Kelvin Electronics* Matsushita Services Co. 4-5	Cooper Associates* Data Tech Reliance, Inc. Digi-Key Corp.* Electronic Parts Supply* Electronics Warehouse Corp.* GMB/dba Fox International* Herman Electronics HSC Electronic Supply* HSC Service Co. Div. of Hitachi Sales Corp. of America International Components Corp. Itera/Belmoor* JDR Micro* Joseph Electronics* Kelvin Electronics* M.A.T. Electronics* D 60
Prime Electronics Co.* D 54	MCM Electronics* Milo Associates, Inc.* Mouser Electronics* Omniatron Electronics* JC Penney National Parts Center* Philips Consumer Electronics Service Co.* PTS Electronics Corp. 53,55	Mouser Electronics* Omniatron Electronics* ORA Electronics Parts Express International Inc.*D 51	Matsushita Services Co. 4-5
RNJ Electronics Inc.* Sony Service Co. Sony Service Co. National Parts Div.* Sprague Magnetics, Inc.* The Superior Electric Co. Tritronics Inc.* Universal Enterprises Video Midwest & AVC Divisions of Vaughn Communications* Zenith Sales Co. A Div. of Zenith Electronics Corp. BC	Video Midwest & AVC Divisions of Vaughn Communications* Schurter, Inc. Scooter Products Ohm Electrics, Inc.* Sony Service Co. Sony Service Co. National Parts Div.* Video Midwest & AVC Divisions of Vaughn Communications* RECTIFIERS All Electronics Corp.* Allied Electronics, A Div. of Hall-Mark Electronics* Arrow Electronics Inc. Catalog Sales Div.* Bursma Electronic Distributing* Classic Components Supply Inc.* Consolidated Electronics, Inc.*D 56	Philips ECG PTS Electronics Corp. 53,55	MCM Electronics* Milo Associates, Inc.* Mitsubishi Electric Sales America, Inc. Mouser Electronics* NTE Electronics, Inc. 15
PHONO CARTRIDGES/STYLI Audio-Technica U.S., Inc. Bursma Electronic Distributing* Consolidated Electronics, Inc.*D 56	Sony Service Co. Sony Service Co. National Parts Div.* Video Midwest & AVC Divisions of Vaughn Communications* RESISTORS All Electronics Corp.* Allied Electronics, A Div. of Hall-Mark Electronics* Bursma Electronic Distributing* Classic Components Supply Inc.* Consolidated Electronics, Inc.*D 56	Philips ECG Power Technology Components Microsemi Co. Prime Electronics Co.*D 54	Omniatron Electronics* ORA Electronics Parts Express International Inc.*D 51
Cooper Associates* Electronic Parts Supply* Electronics Warehouse Corp.* Fordham Radio Supply Co.* D 7	GMB/dba Fox International* HSC Electronic Supply* HSC Service Co. Div. of Hitachi Sales Corp. of America Itera/Belmoor* Joseph Electronics* M.A.T. Electronics* D 60	RNJ Electronics Inc.* Scooter Products Ohm Electrics, Inc.* Sony Service Co. Sony Service Co. National Parts Div.* Tritronics Inc.* Universal Enterprises Video Midwest & AVC Divisions of Vaughn Communications* Zenith Sales Co. A Div. of Zenith Electronics Corp. BC	PTC Electronics Corp. 53,55
Matsushita Services Co. 4-5	Cooper Associates* Digi-Key Corp.* Electronic Parts Supply* Electronics Warehouse Corp.* Fordham Radio Supply Co.* D 7	Video Midwest & AVC Divisions of Vaughn Communications* Zenith Sales Co. A Div. of Zenith Electronics Corp. BC	PTC Electronics Corp. 53,55
MCM Electronics* Mitsubishi Electric Sales America, Inc. Omniatron Electronics* Parts Express International Inc.*D 51	GC Electronics Div. of GC Thorsen Co. GMB/dba Fox International* HSC Electronic Supply* HSC Service Co. Div. of Hitachi Sales Corp. of America International Components Corp. Itera/Belmoor* JDR Micro* Joseph Electronics* Kelvin Electronics* M.A.T. Electronics* D 60	Video Midwest & AVC Divisions of Vaughn Communications* Zenith Sales Co. A Div. of Zenith Electronics Corp. BC	Resistor 56
Prime Electronics Co.* D 54	MCM Electronics* Milo Associates, Inc.* Mitsubishi Electric Sales America, Inc. Mouser Electronics* NTE Electronics, Inc. 15	Video Midwest & AVC Divisions of Vaughn Communications* Zenith Sales Co. A Div. of Zenith Electronics Corp. BC	PTC Electronics Corp. 53,55
RNJ Electronics Inc.* Sony Service Co. Sony Service Co. National Parts Div.* Thomson Consumer Electronics, Inc. Distributor & Special Products* D 13	Omniatron Electronics* JC Penney National Parts Center* Philips Consumer Electronics Service Co.* PTS Electronics Corp. 53,55	Video Midwest & AVC Divisions of Vaughn Communications* Zenith Sales Co. A Div. of Zenith Electronics Corp. BC	PTC Electronics Corp. 53,55
Tritronics Inc.* Video Midwest & AVC Divisions of Vaughn Communications* PICTURE TUBES/CRTS American Design Components* Bursma Electronic Distributing* Clinton Electronics Corp. Electronic Parts Supply* GMB/dba Fox International* Herman Electronics HSC Service Co. Div. of Hitachi Sales Corp. of America Joseph Electronics* Matsushita Services Co. 4-5	Omniatron Electronics* Parts Express International Inc.* D 51	Video Midwest & AVC Divisions of Vaughn Communications* Zenith Sales Co. A Div. of Zenith Electronics Corp. BC	PTC Electronics Corp. 53,55
Mitsubishi Electric Sales America, Inc. JC Penney National Parts Center* Philips Consumer Electronics Service Co.* Sony Service Co. Sony Service Co. National Parts Div.* Thomson Consumer Electronics, Inc. Distributor & Special Products* D 13	Video Midwest & AVC Divisions of Vaughn Communications* Zenith Sales Co. A Div. of Zenith Electronics Corp. BC	Video Midwest & AVC Divisions of Vaughn Communications* Zenith Sales Co. A Div. of Zenith Electronics Corp. BC	PTC Electronics Corp. 53,55
Tritronics Inc.* TSC/Centec Video Midwest & AVC Divisions of Vaughn Communications* RELAYS All Electronics Corp.* Allied Electronics, A Div. of Hall-Mark Electronics* Arrow Electronics Inc. Catalog Sales Div.* Classic Components Supply Inc.* Consolidated Electronics, Inc.*D 56	Video Midwest & AVC Divisions of Vaughn Communications* Zenith Sales Co. A Div. of Zenith Electronics Corp. BC	Video Midwest & AVC Divisions of Vaughn Communications* Zenith Sales Co. A Div. of Zenith Electronics Corp. BC	PTC Electronics Corp. 53,55
Cooper Associates* Data Tech Reliance, Inc. Digi-Key Corp.* Electronic Parts Supply* Electronics Warehouse Corp.* GMB/dba Fox International* Herman Electronics HSC Electronic Supply* HSC Service Co. Div. of Hitachi Sales Corp. of America IC Master Hearst Business Communications	Video Midwest & AVC Divisions of Vaughn Communications* Zenith Sales Co. A Div. of Zenith Electronics Corp. BC	Video Midwest & AVC Divisions of Vaughn Communications* Zenith Sales Co. A Div. of Zenith Electronics Corp. BC	PTC Electronics Corp. 53,55
Cooper Associates* Data Tech Reliance, Inc. Digi-Key Corp.* Electronic Parts Supply* Electronics Warehouse Corp.* GMB/dba Fox International* Herman Electronics HSC Electronic Supply* HSC Service Co. Div. of Hitachi Sales Corp. of America International Components Corp. Itera/Belmoor* JDR Micro* Joseph Electronics* Kelvin Electronics* M.A.T. Electronics* D 60	Video Midwest & AVC Divisions of Vaughn Communications* Zenith Sales Co. A Div. of Zenith Electronics Corp. BC	Video Midwest & AVC Divisions of Vaughn Communications* Zenith Sales Co. A Div. of Zenith Electronics Corp. BC	PTC Electronics Corp. 53,55
Matsushita Services Co. 4-5	Video Midwest & AVC Divisions of Vaughn Communications* Zenith Sales Co. A Div. of Zenith Electronics Corp. BC	Video Midwest & AVC Divisions of Vaughn Communications* Zenith Sales Co. A Div. of Zenith Electronics Corp. BC	PTC Electronics Corp. 53,55
MCM Electronics* Milo Associates, Inc.* Mitsubishi Electric Sales America, Inc. Mouser Electronics* NTE Electronics, Inc. 15	Video Midwest & AVC Divisions of Vaughn Communications* Zenith Sales Co. A Div. of Zenith Electronics Corp. BC	Video Midwest & AVC Divisions of Vaughn Communications* Zenith Sales Co. A Div. of Zenith Electronics Corp. BC	PTC Electronics Corp. 53,55
Omniatron Electronics* JC Penney National Parts Center* Philips Consumer Electronics Service Co.* PTS Electronics Corp. 53,55	Video Midwest & AVC Divisions of Vaughn Communications* Zenith Sales Co. A Div. of Zenith Electronics Corp. BC	Video Midwest & AVC Divisions of Vaughn Communications* Zenith Sales Co. A Div. of Zenith Electronics Corp. BC	PTC Electronics Corp. 53,55
Scooter Products Ohm Electrics, Inc.* Sony Service Co. Sony Service Co. National Parts Div.* Tritronics Inc.* Video Midwest & AVC Divisions of Vaughn Communications* Zenith Sales Co. A Div. of Zenith Electronics Corp. BC	Video Midwest & AVC Divisions of Vaughn Communications* Zenith Sales Co. A Div. of Zenith Electronics Corp. BC	Video Midwest & AVC Divisions of Vaughn Communications* Zenith Sales Co. A Div. of Zenith Electronics Corp. BC	PTC Electronics Corp. 53,55
Video Midwest & AVC Divisions of Vaughn Communications* Zenith Sales Co. A Div. of Zenith Electronics Corp. BC	Video Midwest & AVC Divisions of Vaughn Communications* Zenith Sales Co. A Div. of Zenith Electronics Corp. BC	Video Midwest & AVC Divisions of Vaughn Communications* Zenith Sales Co. A Div. of Zenith Electronics Corp. BC	PTC Electronics Corp. 53,55

See Adv. Page	See Adv. Page	See Adv. Page	See Adv. Page
Itera/Belmoor*D	Allied Electronics, A Div. of Hall-Mark Electronics*D	Thomson Consumer Electronics, Inc. Distributor & Special Products*D 13	Mitsubishi Electric Sales America, Inc. Mouser Electronics*D
JDR Micro*D	Arrow Electronics Inc. Catalog Sales Div.*D	Tritronics Inc.*D	NTE Electronics, Inc. 15
Joseph Electronics*D	ARS Electronics*D	Video Midwest & AVC Divisions of Vaughn Communications*D	Omniatron Electronics*D
Kelvin Electronics*D	Bursma Electronic Distributing*D	Zenith Sales Co. A Div. of Zenith Electronics Corp. BC	ORA Electronics
M.A.T. Electronics*D 60	Classic Components Supply Inc.*D	SEMICONDUCTORS, TRANSISTORS	Parts Express International Inc.*D 51
Matsushita Services Co. 4-5	Consolidated Electronics, Inc.*D 56	All Electronics Corp.*D	JC Penney National Parts Center*D
MCM Electronics*D	Cooper Associates*D	Allied Electronics, A Div. of Hall-Mark Electronics*D	Philips Consumer Electronics Service Co.*D
Milo Associates, Inc.*D	Data Tech Reliance, Inc.	American Design Components*D	Philips ECG
Mitsubishi Electric Sales America, Inc.	Digi-Key Corp.*D	Arrow Electronics Inc. Catalog Sales Div.*D	Power Technology Components Microsemi Co.
Module Exchange	Electronic Parts Supply*D	ARS Electronics*D	Prime Electronics Co.*D 54
Mouser Electronics*D	Electronics Warehouse Corp.*D	Bursma Electronic Distributing*D	PTS Electronics Corp. 53,55
NCM Electronics	GMB/dba Fox International*D	Classic Components Supply Inc.*D	RNJ Electronics Inc.*D
NTE Electronics, Inc. 15	HSC Electronic Supply*D	Consolidated Electronics, Inc.*D 56	Scooter Products Ohm Electrics, Inc.*D
Omniatron Electronics*D	HSC Service Co. Div. of Hitachi Sales Corp. of America	Cooper Associates*D	Sony Service Co.
ORA Electronics	Itera/Belmoor*D	Data Tech Reliance, Inc.	Sony Service Co. National Parts Div.*D
Parts Express International Inc.*D 51	JDR Micro*D	Digi-Key Corp.*D	Thomson Consumer Electronics, Inc. Distributor & Special Products*D 13
JC Penney National Parts Center*D	Joseph Electronics*D	Electronic Parts Supply*D	Tritronics Inc.*D
Philips Consumer Electronics Service Co.*D	Kelvin Electronics*D	Electronics Warehouse Corp.*D	Video Midwest & AVC Divisions of Vaughn Communications*D
Philips ECG	M.A.T. Electronics*D 60	GMB/dba Fox International*D	Zenith Sales Co. A Div. of Zenith Electronics Corp. BC
Prime Electronics Co.*D 54	Matsushita Services Co. 4-5	Herman Electronics	SOCKETS
PTS Electronics Corp. 53,55	MCM Electronics*D	HSC Electronic Supply*D	All Electronics Corp.*D
RNJ Electronics Inc.*D	Milo Associates, Inc.*D	HSC Service Co. Div. of Hitachi Sales Corp. of America	Allied Electronics, A Div. of Hall-Mark Electronics*D
Scooter Products Ohm Electrics, Inc.*D	Mitsubishi Electric Sales America, Inc.	International Components Corp.	AMP Inc.
Sony Service Co.	Mouser Electronics*D	Itera/Belmoor*D	Arrow Electronics Inc. Catalog Sales Div.*D
Sony Service Co. National Parts Div.*D	NTE Electronics, Inc. 15	JDR Micro*D	ARS Electronics*D
Thomson Consumer Electronics, Inc. Distributor & Special Products*D 13	Omniatron Electronics*D	Joseph Electronics*D	Classic Components Supply Inc.*D
Tritronics Inc.*D	Parts Express International Inc.*D 51	Kelvin Electronics*D	Cooper Associates*D
Video Midwest & AVC Divisions of Vaughn Communications*D	JC Penney National Parts Center*D	M.A.T. Electronics*D 60	Davile Tech Inc.
Zenith Sales Co. A Div. of Zenith Electronics Corp. BC	Philips Consumer Electronics Service Co.*D	Matsushita Services Co. 4-5	Electronic Parts Supply*D
SEMICONDUCTORS, SCRs/TRIACS	Philips ECG	MCM Electronics*D	
All Electronics Corp.*D	RNJ Electronics Inc.*D	Milo Associates, Inc.*D	
	Scooter Products Ohm Electrics, Inc.*D		
	Sony Service Co.		
	Sony Service Co. National Parts Div.*D		

Company mailing addresses begin on page 45

ES&T Buyers' Guide 1991

Help us make the 1991 ES&T Buyers' Guide more complete. If your company or organization is not listed in the 1990 Buyers' Guide, contact us by October 1 to receive information about the 1991 Buyers' Guide. Send your name and address to:

Directory Manager
ES&T Buyers' Guide
P.O. Box 12901
Overland Park, KS 66212

More Features Give This 100MHz Counter Universal Appeal At \$339.

UC10A Universal Counter

- 5Hz to 100MHz Frequency Range
- 8-Digit LED Display

- Measures Frequency, Period, Frequency Ratio, Time Interval and Unit Count
- 4 Selectable Gate Times

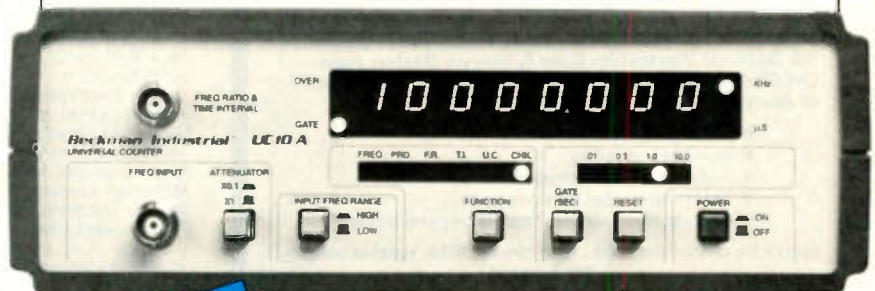

\$339

Beckman Industrial™
An Affiliate of Emerson Electric Co.

For more information and the location of your nearest authorized Beckman Industrial dealer call 1-800-854-2708 (in California 1-800-227-9781). Instrumentation Products Division, 3883 Ruffin Road, San Diego, CA 92123-1898

© 1989 Beckman Industrial Corporation.

Specifications are subject to change without notice.

Circle (28) on Reply Card

Replacement parts/components directory

See Adv. Page	See Adv. Page	See Adv. Page	See Adv. Page
Electronics Warehouse Corp.*D	Audio-Technica U.S., Inc.	Arrow Electronics Inc. Catalog Sales	Universal Enterprises
Emulation Technology Inc.	Bursma Electronic Distributing*D	Div.*D	Video Midwest & AVC Divisions of
Everett/Charles Contact Products	Consolidated Electronics,	Bursma Electronic Distributing*D	Vaughn Communications*D
Fordham Radio Supply Co.*D 7	Inc.*D 56	Classic Components Supply Inc.*D	Zenith Sales Co. A Div. of
GC Electronics Div. of GC Thorsen Co.	Cooper Associates*D	Consolidated Electronics,	Zenith Electronics Corp. BC
GMB/dba Fox International*D	Electronic Parts Supply*D	Inc.*D 56	
HSC Electronic Supply*D	Electronics Warehouse Corp.*D	Cooper Associates*D	
HSC Service Co. Div. of Hitachi Sales	Fordham Radio Supply Co.*D 7	Digi-Key Corp.*D	
Corp. of America	GMB/dba Fox International*D	Electronic Parts Supply*D	
Interconnect Devices, Inc.	HSC Service Co. Div. of Hitachi Sales	Electronics Warehouse Corp.*D	
Itera/Belmoor*D	Corp. of America	Fordham Radio Supply Co.*D 7	
JDR Micro*D	International Components Corp.	GC Electronics Div. of GC Thorsen Co.	
E.F. Johnson Co.	Itera/Belmoor*D	GMB/dba Fox International*D	
Joseph Electronics*D	Joseph Electronics*D	HSC Electronic Supply*D	
Kelvin Electronics*D	M.A.T. Electronics*D 60	HSC Service Co. Div. of Hitachi Sales	
Keystone Electronics Corp.	Matsushita Services Co. 4-5	Corp. of America	
M.A.T. Electronics*D 60	MCM Electronics*D	Itera/Belmoor*D	
Matsushita Services Co. 4-5	Milo Associates, Inc.*D	JDR Micro*D	
Milo Associates, Inc.*D	Mitsubishi Electric Sales America, Inc.	Joseph Electronics*D	
Mouser Electronics*D	Mouser Electronics*D	Kelvin Electronics*D	
Omniatron Electronics*D	Parts Express International	Matsushita Services Co. 4-5	
JC Penney National Parts Center*D	Inc.*D 51	MCM Electronics*D	
Philips Consumer Electronics Service	JC Penney National Parts Center*D	Milo Associates, Inc.*D	
Co.*D	Philips Consumer Electronics Service	Mitsubishi Electric Sales America, Inc.	
PTS Electronics Corp. 53,55	Co.*D	Mouser Electronics*D	
Schurter, Inc.	Prime Electronics Co.*D 54	NKK Switches	
Scouter Products Ohm Electrics,	RNJ Electronics Inc.*D	Omniatron Electronics*D	
Inc.*D	SHOGYO International Corp.	ORA Electronics	
SL Waber, Inc.	Sony Service Co.	Parts Express International	
Sony Service Co.	Sony Service Co. National Parts Div.*D	Inc.*D 51	
Sony Service Co. National Parts Div.*D	Speco Div.	JC Penney National Parts Center*D	
3M/Electronic Products Div.	Tritronics Inc.*D	Philips Consumer Electronics Service	
Vaco Products 21	Video Midwest & AVC Divisions of	Co.*D	
Video Midwest & AVC Divisions of	Vaughn Communications*D	Prime Electronics Co.*D 54	
Vaughn Communications*D	Zenith Sales Co. A Div. of	RNJ Electronics Inc.*D	
Zenith Sales Co. A Div. of	Zenith Electronics Corp. BC	Schurter, Inc.	
Zenith Electronics Corp. BC		Scouter Products Ohm Electrics,	

SPEAKERS

All Electronics Corp.*D
 Allied Electronics, A Div. of Hall-Mark
 Electronics*D
 ARS Electronics*D

SWITCHES

All Electronics Corp.*D
 Allied Electronics, A Div. of Hall-Mark
 Electronics*D
 American Design Components*D
 AMP Inc.



Plug in!

To the NESDA system.

YOUR BUSINESS is in the world's fastest changing industry. If you're not careful, you could find your business in the dark.

But, you don't have to stay there.

Through a system of local, state, and regional groups, the National Electronics Sales & Service Dealers Assn. (NESDA) keeps members up-to-date with the fast pace of advancing technology while offering:

- ◆ Managerial and technical training.
- ◆ Business contacts.
- ◆ Technical and management certification.
- ◆ Information on new products.
- ◆ Legislative activities that affect the industry.

Oon't be left in the dark. Let the NESDA system work FOR YOU!

For more information and an application, write to:
NESDA, 2708 W. Berry St., Ft. Worth, TX 76109; Ph (817) 921-9061

Name _____

Bus. Name _____

Address _____

State _____ Zip _____ Phone _____

Member of State Local Assn. _____

Arrow Electronics Inc. Catalog Sales	Universal Enterprises
Div.*D	Video Midwest & AVC Divisions of
Bursma Electronic Distributing*D	Vaughn Communications*D
Classic Components Supply Inc.*D	Zenith Sales Co. A Div. of
Consolidated Electronics,	Zenith Electronics Corp. BC
Inc.*D 56	
Cooper Associates*D	VACUUM TUBES
Digi-Key Corp.*D	Allied Electronics, A Div. of Hall-Mark
Electronic Parts Supply*D	Electronics*D
Electronics Warehouse Corp.*D	ARS Electronics*D
Fordham Radio Supply Co.*D 7	Bursma Electronic Distributing*D
GC Electronics Div. of GC Thorsen Co.	Consolidated Electronics,
GMB/dba Fox International*D	Inc.*D 56
HSC Electronic Supply*D	Electronics Warehouse Corp.*D
HSC Service Co. Div. of Hitachi Sales	Fordham Radio Supply Co.*D 7
Corp. of America	GMB/dba Fox International*D
Itera/Belmoor*D	Herman Electronics
JDR Micro*D	HSC Electronic Supply*D
Joseph Electronics*D	International Components Corp.
Kelvin Electronics*D	Joseph Electronics*D
Matsushita Services Co. 4-5	Kelvin Electronics*D
MCM Electronics*D	MCM Electronics*D
Milo Associates, Inc.*D	Milo Associates, Inc.*D
Mitsubishi Electric Sales America, Inc.	Omniatron Electronics*D
Mouser Electronics*D	JC Penney National Parts Center*D
Parts Express International	Philips Consumer Electronics Service
Inc.*D 51	Co.*D
JC Penney National Parts Center*D	Scouter Products Ohm Electrics,
Philips Consumer Electronics Service	Inc.*D
Co.*D	Sony Service Co. National Parts Div.*D
Prime Electronics Co.*D 54	Thomson Consumer
RNJ Electronics Inc.*D	Electronics, Inc. Distributor
SHOGYO International Corp.	& Special Products*D 13
Sony Service Co.	Tritronics Inc.*D
Sony Service Co. National Parts Div.*D	Video Midwest & AVC Divisions of
Speco Div.	Vaughn Communications*D
Tritronics Inc.*D	Zenith Sales Co. A Div. of
Video Midwest & AVC Divisions of	Zenith Electronics Corp. BC
Vaughn Communications*D	
Zenith Sales Co. A Div. of	VIDEO HEADS
Zenith Electronics Corp. BC	Consolidated Electronics,
	Inc.*D 56
	Electronic Parts Supply*D
	Electronics Warehouse Corp.*D
	Fordham Radio Supply Co.*D 7
	GMB/dba Fox International*D
	Herman Electronics
	HSC Service Co. Div. of Hitachi Sales
	Corp. of America
	Joseph Electronics*D
	M.A.T. Electronics*D 60
	Matsushita Services Co. 4-5
	MCM Electronics*D
	Mitsubishi Electric Sales America, Inc.
	Nippon Shokuhin Sangyo
	Omniatron Electronics*D
	JC Penney National Parts Center*D
	Philips Consumer Electronics Service
	Co.*D
	Prime Electronics Co.*D 54
	RNJ Electronics Inc.*D
	Sony Service Co.
	Sony Service Co. National Parts Div.*D
	Sprague Magnetics, Inc.*D
	Thomson Consumer
	Electronics, Inc. Distributor
	& Special Products*D 13
	Tritronics Inc.*D
	Video Midwest & AVC Divisions of
	Vaughn Communications*D
	Zenith Sales Co. A Div. of
	Zenith Electronics Corp. BC
	YOKES
	Consolidated Electronics,
	Inc.*D 56
	Electronic Parts Supply*D
	Electronics Warehouse Corp.*D
	Fordham Radio Supply Co.*D 7
	GMB/dba Fox International*D
	HSC Service Co. Div. of Hitachi Sales
	Corp. of America
	Joseph Electronics*D
	Matsushita Services Co. 4-5
	Mitsubishi Electric Sales America, Inc.
	JC Penney National Parts Center*D
	Philips Consumer Electronics Service
	Co.*D
	Sony Service Co.
	Sony Service Co. National Parts Div.*D
	Thomson Consumer
	Electronics, Inc. Distributor
	& Special Products*D 13
	Tritronics Inc.*D
	Video Midwest & AVC Divisions of
	Vaughn Communications*D
	Zenith Sales Co. A Div. of
	Zenith Electronics Corp. BC

SHOW CASE.

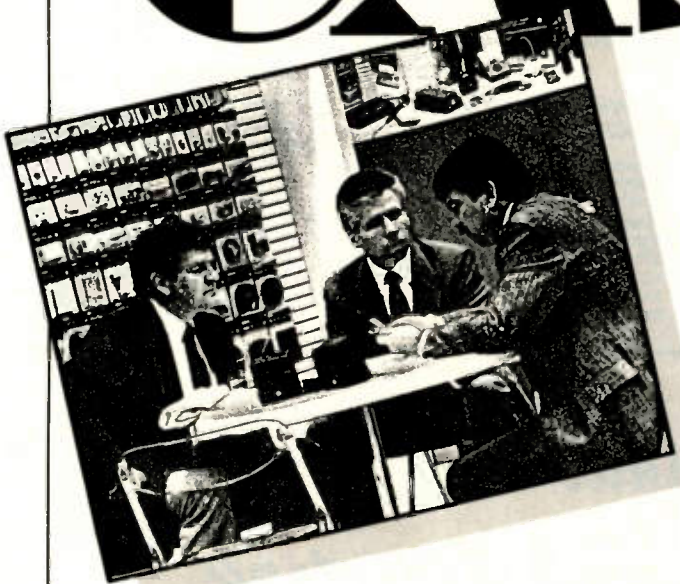

More than 56,000 of your closest competitors will be at the next CES.® The reason: it's the industry's new-product Show Case. Don't let profit opportunities get away because you can't. Attend  Summer CES.

Summer CES: Be there! Your competitors will be.

1990 International Summer Consumer Electronics Show®

Saturday, June 2 through
Tuesday, June 5, 1990
Chicago, Illinois USA

**Pre-register
and Save \$25!**

The Consumer Electronics Shows are sponsored and produced by the Electronic Industries Association Consumer Electronics Group.



Register me for  Summer CES right away!

To obtain your badge by mail, we must receive this form no later than May 4, 1990. Be sure to attach your business card. If we receive this form after May 4 but before May 18, you may pick up your badge on-site at the "Advance Registration Pick-Up Desk" in the Main Registration Area of McCormick East and McCormick North. Two forms of ID will be required. Forms received after May 18 will not be processed. Please register on-site after paying the \$25 fee (U.S.).

To register more than one qualified individual, duplicate this form and attach business cards.

Please mail this form to the following address: Consumer Electronics Shows, % CompuSystems, Inc., P.O. Box 6579, Broadview, Illinois 60153-6579.

You will receive your badge within 6 weeks. Complete Show information, including a housing form, will be sent separately. Please do not preregister, if you have already done so.

Please check **only one** badge category:

- 1 Retailer
- 2 Distributor
- 3 Dept./Chain Store Buyer
- 4 Prem./Catalog Buyer
- 5 Manufacturer's Rep
- 6 Manufacturer
- 7 Institutional Buyer
- 11 Adv./Mktg./PR/Consultant
- 12 Financial/Market Analyst

*Name

*Company

Street

City

State

Zip

Phone

Last four digits of your Social Security Number
(for internal use only)

*Only 21 characters including space will appear on your badge.

For the trade only. No one under 18 years of age will be admitted. Over-the-counter sales are not permitted.

Badges are not transferable. Misuse is grounds for confiscation. Badge replacement fee—\$25.00. For exhibit sales information please call (202) 457-8700.

Software/services directory



See Adv. Page

See Adv. Page

See Adv. Page

See Adv. Page

COMPUTER DIAGNOSTIC SOFTWARE

B&B Electronics Mfg., Co.
Designer Technology
Digitech Industries Inc.
Gibson Research Corp.
JDR Micro*D
Jensen Tools Inc.*D
Sony Service Co.
Specialized Products Co.*D
Windsor Technologies, Inc.

Sprague Magnetics, Inc.*D
TSC/Centec

ONLINE SERVICES

JDR Micro*D
McGraw-Hill Publishing Co.
Schweber Electronics Electronic
Catalog Div.*D

PC BOARD REPAIR/REWORK

A.P.E. Corp.
Circuit Repair Corp.
Data Tech Reliance, Inc.
JDR Micro*D
W.S. Jenks & Son*D
Joseph Electronics*D
La Guardia Enterprises
Module Exchange
Nu-Concept Systems, Inc.
Pace, Inc.
JC Penney National Parts Center*D
PTS Electronics Corp. 53,55
RepairPro
The Rex Co.
Sprague Magnetics, Inc.*D
TSC/Centec
Vortec Corp.
**Zenith Sales Co. A Div. of
Zenith Electronics Corp. BC**

CONSULTANTS

Advanced Measurement Technologies
CSTS Inc.
Data Tech Reliance, Inc.
JDR Micro*D
Learning Tree International
W.J. Lynott, Associates
Micromax Corp.
TeleMatic Div. of UXL Corp.
Video Midwest & AVC Divisions of
Vaughn Communications*D

DISC DRIVE/HEAD REFURBISHMENT

Data Tech Reliance, Inc.
Northern Magnetics, Inc.
RepairPro

RENTAL/LEASING EQUIPMENT

Brian Instruments, Inc.
Electro-Metrics
Electro Rent Corp.
Genstar Rental Electronics Inc.*D
GlobeTech International, Inc.
Lectionic Research Labs*D
RAG Electronics Inc.*D
Tucker Electronics Co.*D
United States Instrument Rentals
Video Midwest & AVC Divisions of
Vaughn Communications*D

SERVICE BULLETIN SOFTWARE

Designer Technology
Electronics Warehouse Corp.*D

SERVICE MANAGEMENT SOFTWARE

America West C&E, Inc. 56
Database Dimensions
Frederick Engineering, Inc.
Magic Solutions, Inc.
Management Technix Inc.
Micro Design, Inc.
NESDA 21, 42
Nu-Data Inc.
Sperry Tech Inc.

TEST EQUIPMENT REPAIR/CALIBRATION

Brian Instruments, Inc.
Brunelle Instruments Inc.
BTC Test & Measurement*D
CSTS Inc.
Electro Rent Corp.
Electronics Warehouse Corp.*D
EM Corp.
John Fluke Mfg. Co. Inc.
W.S. Jenks & Son*D
Lectionic Research Labs*D
PTS Electronics Corp. 53,55
RAG Electronics Inc.*D
Tegam, Inc.
Tekserv*D
Triplett Corp.
Tucker Electronics Co.*D
United States Instrument Rentals
Vortec Corp.

TUNER/MODULE REPAIR

Bursma Electronic Distributing*D
Electrodyn, Inc.
Electronic Parts Supply*D
Electronics Warehouse Corp.*D
Module Exchange
JC Penney National Parts Center*D
PTS Electronics Corp. 53,55
Sera Service Independent Electronic
Rebuilder
Sprague Magnetics, Inc.*D
**Zenith Sales Co. A Div. of
Zenith Electronics Corp. BC**

Association/educational



sources directory



BOOKS/MANUALS

Allied Electronics, A Div. of Hall-Mark
Electronics*D
American Business & Venture
Publishing
Banner Technical Books
Black Box Corp.*D
Bursma Electronic Distributing*D
Channel Master Div. of Avnet, Inc.
**Consolidated Electronics,
Inc.*D 56**
Contact East, Inc.*D
D.A.T.A. Business Publishing
Electronic Industries Associates
Consumer Electronics Group
Electronic Parts Supply*D
Electronic Technology Today*D
Electronics Warehouse Corp.*D
ETA-Electronics Technicians
Association
GMB/dba Fox International*D
Heath Co.
HSC Electronic Supply*D
IC Master Hearst Business
Communications
IS CET 54
JDR Micro*D
W.S. Jenks & Son*D
Joseph Electronics*D
Kelvin Electronics*D
Learning Tree International
W.J. Lynott, Associates
Matsushita Services Co. 4-5
McGraw-Hill Publishing Co.
MCM Electronics*D

Mllo Associates, Inc.*D
Mitsubishi Electric Sales America, Inc.
NASD, A Div. of NARDA
NESDA 21, 42
Omega Engineering Inc.
Pace, Inc.
**Parts Express International
Inc.*D 51**
JC Penney National Parts Center*D
Phillips Consumer Electronics Service
Co.*D
Prentice-Hall
Rapid Systems
RNJ Electronics Inc.*D
Howard W. Sams & Co.
Scooter Products Ohm Electrics,
Inc.*D
Sencore Electronics IFC
Sony Service Co.
Specialized Products Co.*D
Sperry Tech Inc.
TAB Books Inc.
**Thomson Consumer
Electronics, Inc. Distributor
& Special Products*D 13**
United Techbook Co.
Viejo Publications 39

EDUCATIONAL/TRAINING SEMINARS/VIDEOS

A R Div. of Telenex Corp.
Bergwall Productions, Inc.
**B&K-Precision Maxtec
International Corp. 1**
BMI-Basic Measuring Instruments

Electronic Industries Associates
Consumer Electronics Group
ETA-Electronics Technicians
Association
John Fluke Mfg. Co. Inc.
Industrial Training, Inc.
IS CET 54
W.S. Jenks & Son*D
Joseph Electronics*D
Learning Tree International
Matsushita Services Co. 4-5
McGraw-Hill Publishing Co.
Mitsubishi Electric Sales America, Inc.
NASD, A Div. of NARDA
National Advancement Corp.
NESDA 21, 42
Omega Engineering Inc.
Pace, Inc.
Phillips Consumer Electronics Service
Co.*D
Rapid Systems
Sencore Electronics IFC
Sharp Electronics, Corp.
Sony Service Co.
Ucando VCR Educational Products
Windsor Technologies, Inc.

SCHOOLS: CORRESPONDENCE/RESIDENT

Cleveland Institute of Electronics
Cook's Institute of Electronics
Engineering
Electronic Industries Associates
Consumer Electronics Group

Joseph Electronics*D
NASD, A Div. of NARDA
NRI School of Electronics 11
Phillips Consumer Electronics Service
Co.*D

SERVICE LITERATURE/SCHEMATICS

Bursma Electronic Distributing*D
**Consolidated Electronics,
Inc.*D 56**
Craig Consumer Electronics
Electronic Parts Supply*D
Electronics Warehouse Corp.*D
HSC Service Co. Div. of Hitachi Sales
Corp. of America
Joseph Electronics*D
Allen J. Loeb*D
Matsushita Services Co. 4-5
Mitsubishi Electric Sales America, Inc.
**Parts Express International
Inc.*D 51**
JC Penney National Parts Center*D
Phillips Consumer Electronics Service
Co.*D
RNJ Electronics Inc.*D
Howard W. Sams & Co.
Schweber Electronics Electronic
Catalog Div.*D
Sony Service Co.
**Thomson Consumer
Electronics, Inc. Distributor
& Special Products*D 13**



Company mailing addresses



ABB Metrawatt Inc.
2150 W. Sixth Ave., Unit J
Broomfield, CO 80020
303-469-5231
800-821-6327
Fax 303-469-4256

Acculex Corp.
A MetraByte Co.
440 Myles Standish Blvd.
Taunton, MA 02780
508-880-3660
Fax 508-880-0179

Acculube II Inc.
22025 70th Ave. S.
Kent, WA 98032
206-395-0882

Accutech Co.
P.O. Box 70016
Pasadena, CA 9117-7016
818-286-7485

Accutest Instruments*D
P.O. Box 130
Clarksburg, NJ 08510
609-259-0460
800-524-0747
Fax 609-259-0227

Advance Unit of Zero Corp.
6900 Beck Ave.
North Hollywood, CA 91605
818-841-1519
Fax 818-841-8892

Advanced Measurement Technologies
2741 Plaza Del Amo, Suite 201
Torrance, CA 90503
213-320-7757
Fax 213-320-0199

AEMC Corp.
99 Chauncy St.
Boston, MA 02111
617-451-0227
800-343-1391
Fax 617-423-2952

AESI/Stedi Watt
2005 Lincoln Way E.
Chambersburg, PA 17201
717-263-5681
800-345-1280
Fax 717-263-1040

Airmold/W.R. Grace Co.
P.O. Box 610
Roanoke Rapids, NC 27870
919-536-2171
800-344-5716
Fax 919-536-2201

All Electronics Corp.*D
P.O. Box 567
Van Nuys, CA 91408
818-904-0524
800-826-5432
Fax 818-781-2653

Allied Electronics, A Div. of Hall-Mark Electronics*D
401 E. Eighth
Fort Worth, TX 76102
817-336-5401
800-433-5700
Fax 817-336-9168

Ambico
P.O. Box 427
Norwood, NJ 07648-0427
201-767-4100
Fax 201-767-4109

America West C&E, Inc.
311 Washburn Drive
Rock Springs, WY 82901
307-382-5663
Fax 307-382-7323

American Business & Venture Publishing
131-79 232nd St.
Laurelton, NY 11413
718-712-0365

American Design Components*D
815 Fairview Ave.
Fairview, NJ 07022
201-941-5000
800-776-3800
Fax 201-939-8918

American Power Conversion Corp.
350 Columbia St.
Peace Dale, RI 02883
401-789-5735
800-443-4519
Fax 401-789-3710

American Reliance Inc.
9241 E. Valley Blvd.
Rosemead, CA 91770
818-287-8400
800-654-9838
Fax 818-287-8855

AMP Inc.
P.O. Box 3608
Harrisburg, PA 17105-3608
717-564-0100
800-522-6752

Amprobe Instrument
630 Merrick Road
Lynbrook, NY 11563
516-593-5600
Fax 516-593-5682

Analogic Corp.
8 Centennial Drive
Peabody, MA 01960
508-977-3000
800-343-8333
Fax 508-532-6097

Anasco Corp.*D
42-A Cherry Hill Drive
Danvers, MA 01923
508-777-8888
800-826-2726

Anritsu Meter Co. of America
795 Franklin Ave.
Franklin Lakes, NJ 07417
201-848-0033
Fax 201-848-1845

The Antenna Specialists Co.
Member of the Allen Group
30500 Bruce Industrial Parkway
Cleveland, OH 44139
216-349-8400
Fax 216-349-8407

A.P.E. Corp.
142 Peconic Ave.
Medford, NY 11763
516-654-1197

Applied Memory Technology
2822 Walnut Ave., Unit E
Tustin, CA 92680
714-838-1860
Fax 714-730-6928

A R Div. of Telenex Corp.
7401 Boston Blvd.
Springfield, VA 22153
703-644-9190
800-368-3261
Fax 703-644-9011

Aristo Computers*D
6700 S.W. 105th Ave., Suite 307
Beaverton, OR 97005
503-626-6333
800-3-ARISTO
Fax 503-626-6492

Arium Corp.
1931 Wright Circle
Anaheim, CA 92806-6052
714-978-9531
Fax 714-978-3341

Armand Mfg. Inc.
5020 Rivergrade Road
Baldwin Park, CA 91706
818-960-4081

Arrow Electronics Inc.
Catalog Sales Div.*D
1860 Smithtown Ave.
Ronkonkoma, NY 11779
516-467-1000
800-932-7769
Fax 516-585-0878

ARS Electronics*D
7110 Decells Place
Van Nuys, CA 91406
818-997-6200
800-422-4250
Fax 818-997-6158

Assembly Systems Group
19520 Nottingham Road
Cleveland, OH 44110
216-486-2100

Astec Co.
Div. of Static Solutions Inc.
P.O. Box 9
Hawthorne, NJ 07507
201-595-7001

Atrix, Inc.*D
14301 Ewing Ave. S.
Burnsville, MN 55337
612-894-6154
800-222-6154
Fax 612-894-6256

Audio-Technica U.S., Inc.
1221 Commerce Drive
Stow, OH 44224
216-686-2600
Fax 216-688-3752

AVA Instrumentation, Inc.
8010 Highway 9
Ben Lomond, CA 95005
408-336-2281
Fax 408-336-5049

Aven International
777 E. Eisenhower Parkway
Suite LL01
Ann Arbor, MI 48108
800-624-8170
Fax 313-994-9446



Ballantine Labs, Inc.
P.O. Box 97
Boonton, NJ 07005
201-335-0900

Banner Technical Books
1203 Grant Ave.
Rockford, IL 61103
815-962-4725

Battery Specialties*D
1940 Freeman Ave.
Long Beach, CA 90804
213-437-1809
800-854-5759

Batt-Tronic
P.O. Box 10
Orangeburg, NY 10962
914-359-8858
Fax 914-359-3436

B&B Electronics Mfg., Co.
P.O. Box 1040
Ottawa, IL 61350
815-434-0846
Fax 815-434-7094

Beckman Industrial Corp.
An Affiliate of Emerson Electric Co.
3883 Ruffin Road
San Diego, CA 92123-1898
619-495-3200
800-227-9781
Fax 619-268-0172

Becktron
P.O. Box 528
Riverton, WY 82501
307-856-0771
800-592-4141

Bergwall Productions, Inc.
P.O. Box 238
Garden City, NY 11530-0238
516-222-1111
800-645-3565
Fax 516-222-9383

Best Power Technology
P.O. Box 280
Necedah, WI 54646
608-565-7200
800-356-5794
Fax 608-565-2929

Biddle Instruments
510 Township Line Road
Blue Bell, PA 19422
215-646-9200
Fax 215-643-2670

BitWise Designs, Inc
701 River St.
Troy, NY 12180
518-274-0755
800-367-5906
Fax 518-274-0764

B&K-Precision
Maxtec International Corp.
6470 W. Cortland St.
Chicago, IL 60635
312-889-1448
Fax 312-694-9740

Black Box Corp.*D
P.O. Box 12800
Pittsburgh, PA 15241
412-746-5500

BMI-Basic Measuring Instruments
335 Lakeside Drive
Foster City, CA 94404
415-570-5355
800-876-5355
Fax 415-574-2176

Company mailing addresses

The Boardworks
P.O. Box 1678
Covina, CA 91722
818-967-3681

Bondhus
P.O. Box 660
Monticello, MN 55362
612-295-2162
800-328-8310
Fax 612-295-4440

Brian Instruments, Inc.
626 S. State College Blvd.
Fullerton, CA 92631
714-992-5540
Fax 714-992-5553

Brunelle Instruments Inc.
73 Sixth Range S.
St. Elie D'Orford, Que.
Canada J0B 2S0
819-563-9096
800-567-3506
Fax 819-569-1408

BTC Test & Measurement* D
7500 Six Forks Road
Raleigh, NC 27615
919-676-8378
800-882-6872
Fax 919-676-8384

Bursma Electronic Distributing* D
1030 Scribner N.W.
Grand Rapids, MI 49504
616-459-4325
800-777-2604
Fax 616-459-1294



Caig Labs, Inc.
P.O. Box J
Escondido, CA 92025
619-743-7143
Fax 619-743-2460

Celebrity Research & Development Group
21540 Blythe St.
Canoga Park, CA 91304
818-716-7755

Cementex Products, Inc.
P.O. Box 1402
Burlington, NJ 08016
609-387-1040
800-654-1292
Fax 609-386-8885

CG Instruments Inc.
434 Windsor Park Drive
Dayton, OH 45459
513-434-6952

Channel Master
Div. of Avnet, Inc.
P.O. Box 1416
Smithfield, NC 27577
919-934-9711
Fax 919-934-0380

Chapman Corp.
125 Presumpscot St.
Portland, ME 04104
207-773-4726
Fax 207-775-1369

Charleswater Products, Inc.
93 Border St.
West Newton, MA 02165
617-964-8370
Fax 617-964-0172

Chemtronics Inc.
681 Old Willets Path
Hauppauge, NY 11788
516-582-3322
800-645-5244

Chicago Case Co.
4446 S. Ashland Ave.
Chicago, IL 60609
312-927-1600
Fax 312-927-2820

Circuit Repair Corp.
108 Turnpike
Rowley, MA 01969

Clary Corp.
320 W. Clary Ave.
San Gabriel, CA 91776-1306
818-287-6111
Fax 818-286-7216

Classic Components Supply Inc.* D
3336 Commercial Ave.
Northbrook, IL 60062-1975
708-272-9650
Fax 708-272-9264

Clauss Cutlery Co.
223 N. Prospect
Fremont, OH 43420
419-332-7344
800-225-2877
Fax 419-332-8077

Clean Room Products Inc.
1800 Ocean Ave.
Ronkonkoma, NY 11779
516-588-7000
Fax 516-588-7863

Cleveland Institute of Electronics
1776 East 17th St.
Cleveland, OH 44114
216-781-9400
800-CIE-OHIO
Fax 216-781-0331

Clinton Electronics Corp.
6701 Clinton Road
Rockford, IL 61111
815-633-1444
Fax 815-633-8712

Colonial Glove & Garment Inc.
1800 Ocean Ave.
Ronkonkoma, NY 11779
516-588-6900
Fax 516-588-7863

Colorado Data Systems
3301 W. Hampden Ave., Unit C
Englewood, CO 80110
303-762-1640
800-237-2831
Fax 303-781-0253

Com-Kyl Inc.* D
1366 Borregas Ave.
Sunnyvale, CA 94089
408-734-9660
800-538-1578
Fax 408-744-1650

Computer Doctors
9204-B Baltimore Blvd.
College Park, MD 20740
301-474-3095
800-RAM-STAR
Fax 301-474-0805

Computer Power, Inc.
124 W. High St.
High Bridge, NJ 08829
201-638-8000
800-526-5088
Fax 201-638-4931

Computer Service Technology, Inc.
2546 Merrell Road
Dallas, TX 75229
214-241-2662
Fax 214-241-2661

Consolidated Electronics, Inc.* D
705 Watervliet Ave.
Dayton, OH 45420-2599
513-252-5662
800-543-3568
Fax 513-252-4066

Contact East, Inc.* D
335 Willow St. S.
North Andover, MA 01845
508-682-2000
800-225-5370
Fax 508-688-7829

Controlled Power Co.
1955 Stephenson Highway
Troy, MI 48083
313-528-3700
800-521-4792
Fax 313-528-0411

Convex Corp.
21400 Ridgetop Circle
Sterling, VA 22170
703-450-0311
800-642-0602
Fax 703-450-2789

Cook's Institute of Electronics Engineering
4251 Cypress Drive
Jackson, MS 39212
601-371-1351

Cooper Associates* D
112 Oakwood Road
McMurray, PA 15317
Fax 412-941-3410

Cooper Tools
P.O. Box 30100
Raleigh, NC 27622
919-362-7501
Fax 800-423-6175

Craig Consumer Electronics
14450 Industry Circle
La Mirada, CA 90638
714-670-7644

CRC Industries, Inc.
885 Louis Drive
Warminster, PA 18974
215-674-4300
Fax 215-674-2207

Createc Signal Computer* D
3337 Kifer Road
Santa Clara, CA 95051
408-738-3744
800-222-2688
Fax 408-749-8172

Creative Electronics
1417 N. Selfridge
Clawson, MI 48017
313-435-8916

C&S Sales* D
1245 Rosewood
Deerfield, IL 60015
708-541-0710
800-292-7711
Fax 708-520-0085

CSTS Inc.
4015 E. Leaverton Court
Anaheim, CA 92807
714-632-1300
Fax 714-632-1937



Daetron
935 The Queensway
Postal Station U, Box 641
Toronto, Ont., Canada M8Z 5Y9
416-676-1600

Dandy Mfg. Co.
2323 Gibson St.
Muskogee, OK 74403
918-682-4286
800-331-9658

D.A.T.A. Business Publishing
8977 Activity Road
San Diego, CA 92126
619-578-7600
800-447-4666
Fax 619-530-0637

Data Tech Reliance, Inc.
33901 Ninth Ave. S.
Federal Way, WA 98003
206-952-2440
800-423-DISK

Database Dimensions
3002 Oak Sprawl
San Antonio, TX 78231-1732
512-492-1388

Datacom Technologies, Inc.
11001 31st Place W.
Everett, WA 98204
206-355-0590
Fax 206-353-9292

Datatron Corp.
355 Yuma St.
Denver, CO 80223
303-778-0870

Datel, Inc.
11 Cabot Blvd.
Mansfield, MA 02048
508-339-3000

Davie Tech Inc.
2-05 Banta Place
Fair Lawn, NJ 07410
201-796-1720

Delta Electronics, Inc.
5730 General Washington Drive
Alexandria, VA 22312
703-354-3350

Deltron, Inc.
Wissahickon Ave.
North Wales, PA 19454
215-699-9261
800-523-2332
Fax 215-699-2310

Desco Industries
761 Penarth Ave.
Walnut, CA 91789
714-598-2753
Fax 714-595-7028

Designer Technology
4009 Pacific Coast Highway
Torrance, CA 90505
213-379-9506
800-289-3001
Fax 213-379-9608

Deutsch Industrial Products Div.
37149 Industrial Ave.
Hemet, CA 92343
714-929-1200
Fax 714-652-9784

Digi-Key Corp.* D
701 Brooks Ave. S.
Thief River Falls, MN 56701
218-681-6674
800-344-4539
Fax 218-681-3380

Digitech Industries Inc.
P.O. Box 547
Ridgefield, CT 06877
203-438-3731

Direct Conversion Technique, Inc.
906 University Place
Evanston, IL 60201
708-491-7888
800-523-5883
Fax 708-491-7955

Displaytek Corp.
P.O. Box 737
Addison, TX 75001
214-239-9193
Fax 214-239-9199

Company mailing addresses

Diversified Case
34 Main St.
Whitesboro, NY 13492
315-736-3028
Fax 315-736-2049

Dow Chemical USA
2020 Willard H. Dow Center
Midland, MI 48674
800-441-4369 Chemicals,
800-447-4367 Plastics

Dremel
4915 21st St.
Racine, WI 53406
414-554-1390

Dynatech Computer Power, Inc.
5800 Butler Lane
Scotts Valley, CA 95066
408-438-5760
800-638-9098



Echelon Industries*^D
20681 E. Truss Court
Walnut, CA 91789
714-594-1891

Edroy Products
245 N. Midland Ave.
Nyack, NY 10960
914-358-6600
800-233-8803

EDS, Inc.
951 S.W. 82nd Ave.
North Lauderdale, FL 33068
305-726-2427

Electro-dyn, Inc.
938 S. Morton St.
Bloomington, IN 47403
812-334-1023

Electro-Metrics
100 Church St.
Amsterdam, NY 12010
518-843-2600

Electro Rent Corp.
6060 Sepulveda Blvd.
Van Nuys, CA 91411-2501
818-843-1221
800-232-2173

Electro Standards Lab, Inc.
Data Communications Products
Div.
36 Western Industrial Drive
Cranston, RI 02921
401-943-1164
Fax 401-946-5790

Electro-Tech Systems, Inc.
115 E. Glenside Ave.
Glenside, PA 19038
215-887-2196
Fax 215-887-0131

Electron Processing
P.O. Box 68
Cedar, MI 49621
616-228-7020

Electronic Design Specialists
951 S.W. 82nd Ave.
North Lauderdale, FL 33068
305-726-2427

Electronic Industries Associates
Consumer Electronics Group
2001 Pennsylvania Ave. N.W.
Washington, DC 20006
202-457-4919
Fax 202-835-8939

Electronic Parts Supply*^D
4071 Emeryville St.
Emeryville, CA 94608
415-420-1040
800-227-0104
Fax 415-465-6850

Electronic Specialists, Inc.
P.O. Box 389
Natick, MA 01760
508-655-1532
800-225-4876
Fax 508-653-0268

Electronics Warehouse Corp.*^D
1910 Coney Island Ave.
Brooklyn, NY 11230
718-375-2700
800-221-0424
Fax 718-375-2796

Elenco Electronics, Inc.
150 W. Carpenter Ave.
Wheeling, IL 60090
708-541-3800

Elgar Corp.
9250 Brown Deer Road
San Diego, CA 92121
619-450-0085
800-73-ELGAR
Fax 619-458-0267

C.H. Ellis Co., Inc.
P.O. Box 1005
Indianapolis, IN 46206
317-636-3351
Fax 317-635-5140

Elvo Div. of Zumbach Electronics Corp.
140 Kisco Ave.
Mount Kisco, NY 10549-1407
914-241-1008

EM Corp.
6433 Havelock Ave.
Lincoln, NE 68507
402-467-3541
Fax 402-467-3545

EMCO Electronics
31 Sheer Plaza
Plainview, NY 11803
516-845-7080
Fax 516-845-7082

Emulation Technology Inc.
2344 Walsh Ave.
Santa Clara, CA 95051
408-982-0660
Fax 408-982-0664

Eraser Co., Inc.
Wybar Div.
P.O. Box 4961
Syracuse, NY 13221
315-454-3237
Fax 315-454-3090

Esterline Angus Instrument Corp.
P.O. Box 24000
Indianapolis, IN 46224
317-244-7611
Fax 317-247-4749

ETA-Electronics Technicians
Association
604 N. Jackson St.
Greencastle, IN 46135
317-653-3849
800-359-6706
Fax 317-653-3849

Everett/Charles Contact Products
700 E. Harrison Ave.
Pomona, CA 91767
714-625-5551
800-537-1783 (CA)
Fax 714-624-9746

Extech Instruments Corp.
150 Bear Hill Road
Waltham, MA 02154
617-890-7440
Fax 617-890-7864

E-Z Hook Div., Tektest, Inc.
P.O. Box 450
Arcadia, CA 91006
818-446-6175



Factron Test Fixture Group
One Fairchild Square
Clifton Park, NY 12065
518-877-7042
Fax 518-877-7052

Falcon Safety Products, Inc.
P.O. Box 1299
Somerville, NJ 08876-1299
201-707-4900
Fax 201-707-8855

Fiskars Electronics Corp.
AC Power Div.
1142 Mark Ave.
Carpinteria, CA 93013
805-684-8311

John Fluke Mfg. Co. Inc.
P.O. Box 9090
Everett, WA 98206
206-347-6100
800-426-0361
Fax 206-356-5116

Fordham Radio Supply Co.*^D
260 Motor Parkway
Hauppauge, NY 11788
516-435-8080
800-645-9518

Frederick Engineering, Inc.
10200 Old Columbia Road
Columbia, MD 21046
301-290-9000
Fax 301-381-7180



Gage Applied Sciences Inc.
2695 Paulus St.
Montreal, Que., Canada H4S 1E9
514-337-6893
Fax 514-337-8411

GC Electronics
Div. of GC Thorsen Co.
1801 Morgan St.
Rockford, IL 61102
815-968-9661

Gemini Inc.
103 Mensing Way
Cannon Falls, MN 55009
507-263-3957
800-533-3631
Fax 507-263-5987

General Power Corp.
1045 S. East St.
Anaheim, CA 92805-8508
714-956-9321
800-854-3469
Fax 714-491-8644

GenRad, Inc.
300 Baker Ave.
Concord, MA 01742
508-369-4400
800-828-8890
Fax 508-369-6974

Genstar Rental Electronics Inc.*^D
6307 DeSoto Ave., Suite J
Woodland Hills, CA 91367
818-887-4000
800-227-8409
Fax 818-715-9249

Gibson Research Corp.
22991 La Cadena
Laguna Hills, CA 92653
714-830-2200
Fax 714-830-0300

Global Specialties
A Div. of Interplex
P.O. Box 1405
New Haven, CT 06505
203-624-3103
800-572-1028
Fax 203-468-0060

GlobeTech International, Inc.
1705 S. Research Loop
Tucson, AZ 85710
602-298-6900
800-654-7314
Fax 602-298-1913

GMB/dba Fox International*^D
140 Terminal Road
Setauket, NY 11733
516-689-5400
800-874-1765
Fax 800-635-0596

GoldStar Precision Co. Ltd.
13013 East 166th St.
Cerritos, CA 90701
213-404-0101
Fax 213-926-0849

W.L. Gore & Associates, Inc.
1901 Barksdale Road
Newark, DE 19711
302-368-3700
Fax 302-738-5993

Gould Inc.
Test & Measurement Group
3631 Perkins Ave.
Cleveland, OH 44114
216-361-3315

The Granite Corp.
24200 Burbank Blvd.
Woodland Hills, CA 91367
818-887-5533
Fax 818-883-5188

Grobet USA
750 Washington Ave.
Carlstadt, NJ 07072
201-939-6700
800-847-4188
Fax 201-939-5067



Hall-ComSec, Inc.
2029 Manchester Drive
Fort Collins, CO 80526
303-482-9905

Hameg, Inc.
88-90 Harbor Road
Port Washington, NY 11050
516-883-3837
800-247-1241
Fax 516-883-3894

Hand Tool Industries, Inc.
1933 Lake St.
Kent, OH 44240
216-678-8787
Fax 216-678-9011

Heath Co.
Benton Harbor, MI 49022
800-44-HEATH

Company mailing addresses

Herman Electronics
1365 N.W. 23rd St.
Miami, FL 33142
305-634-6591
800-327-8378
Fax 305-634-6247

Hexacon Electric Co.
161 W. Clay Ave.
Roselle Park, NJ 07204
201-245-6200
Fax 201-245-6176

Highland Products, Inc.
P.O. Box 794
Dover, NJ 07801
201-366-0156
Fax 201-366-6665

Hilevel Technology, Inc.
31 Technology Drive
Irvine, CA 92718
714-727-2100
800-HI-LEVEL

Hitachi Denshi America, Ltd.
150 Crossways Park Drive
Woodbury, NY 11797
516-921-7200
Fax 516-921-0993

Hi-Techniques Inc.
152 Owen Road
Madison, WI 53716
608-221-7500
800-248-1633
Fax 608-221-7509

HMC-Hub Material Co.*D
33 Springdale Ave.
Canton, MA 02021
617-821-1870
800-482-4440
Fax 617-821-4133

H&S Industries*D
402 W. Arrow Highway, Suite 14
San Dimas, CA 91773
714-599-6090
Fax 714-592-9960

HSC Electronic Supply*D
3500 Ryder St.
Santa Clara, CA 95051
408-732-1573
800-442-5833
Fax 408-732-6428

HSC Service Co.
Div. of Hitachi Sales Corp. of
America
401 W. Artesia Blvd.
Compton, CA 90220
800-447-2882

Hunter Associates
P.O. Box 6795
Bridgewater, NJ 08807
201-526-8440
800-524-0692
Fax 201-526-8348

Hy-Tronix Instruments, Inc.
P.O. Box 827
Newton, KS 67114
316-283-5730
800-835-1005



IC Master
Hearst Business Communications
645 Stewart Ave.
Garden City, NY 11530
516-227-1330
Fax 516-227-1901

ICS, Inc.
Electro-Pac Div.
520 Interstate Road
Addison, IL 60101
312-543-6200

Ideal Industries
Becker Place
Sycamore, IL 60178
815-985-5181

IET Labs, Inc.
534 Main St.
Westbury, NY 11590
516-334-5959
Fax 516-334-5988

In-Circuit Test, Inc.
One Fairchild Square
Clifton Park, NY 12065
518-877-7042
Fax 518-877-7052

Industrial Devices, Inc.
260 Railroad Ave.
Hackensack, NJ 07601
201-489-8989
Fax 201-489-6911

Industrial Training, Inc.
5376 52nd St. S.E.
Grand Rapids, MI 49512
616-698-8688
800-253-4623
Fax 616-698-0325

The Instrument Mart, Inc.*D
295 Community Drive
Great Neck, NY 11021
516-487-7430
Fax 516-487-7796

Intelco Corp.
8 Craig Road
Acton, MA 01720
508-264-4485
Fax 508-264-9677

Interconnect Devices, Inc.
5101 Richland Ave.
Kansas City, KS 66106
913-342-5544
Fax 913-342-7043

International Components Corp.
105 Maxess Road
Melville, NY 11747
516-293-1500
800-645-9154

International Data Sciences
7 Wellington Road
Lincoln, RI 02865
401-333-6200
800-IDS-DATA
Fax 401-333-3584

IQ Technologies, Inc.
11811 N.E. First St., Suite 201
Bellevue, WA 98005
206-451-0232
800-227-2817
Fax 206-453-3273

ISCET
2708 W. Berry
Fort Worth, TX 76109
817-921-9101
Fax 817-921-3741

Isles Industries
895 Beacon St.
Brea, CA 92621
714-990-8997

Itera/Belmoor*D
1365 39th St.
Brooklyn, NY 11218
718-633-2800
800-221-5802
Fax 718-633-4375

ITT Pomona Electronics
1500 E. Ninth St.
Pomona, CA 91766
714-623-3463
Fax 714-629-3317



JDR Micro*D
2233 Branham Lane
San Jose, CA 95124
408-559-1200
800-538-5000
Fax 408-559-0250

W.S. Jenks & Son*D
1933 Montana Ave. N.E.
Washington, DC 20002
202-529-6020
Fax 202-832-3411

W.S. Jenks & Son*D
6632 Electronic Drive
Springfield, VA 22151
703-750-5406

Jensen Tools Inc.*D
7815 South 46th St.
Phoenix, AZ 85044
602-968-6241
Fax 602-438-1690

E.F. Johnson Co.
11095 Viking Drive, Suite 220
Eden Prairie, MN 55344
612-942-1000
800-533-8991

Jonard Industries Corp.
134 Marbledale Road
Tuckahoe, NY 10707
914-793-0700
Fax 914-793-4527

Joseph Electronics*D
8830 N. Milwaukee
Niles, IL 60648
708-297-4200
800-323-5925
Fax 708-297-6923



Kalglo Electronics Co. Inc.
6584 Ruch Road
Bethlehem, PA 18017-9359
215-837-0700
800-524-0400
Fax 215-837-7978

Kelvin Electronics*D
7 Fairchild Ave.
Plainview, NY 11803
516-349-7620
800-645-9212

Kenwood U.S.A. Corp.
2201 E. Dominguez St.
Long Beach, CA 90810
213-639-4200

Keystone Electronics Corp.
31-07 20th Road
Astorla, NY 11105-2017
718-956-8900
800-221-5510
Fax 718-956-9040

KeyTek Instrument Corp.
260 Fordham Road
Wilmington, MA 01887
508-658-0880
Fax 508-657-4803

Kikusui International Corp.
19601 Marliner Ave.
Torrance, CA 90503-1671
213-371-4662
800-545-8784
Fax 213-542-4943

Klein Tools, Inc.
7200 McCormick Blvd.
Chicago, IL 60645
708-677-9500

KnickerBocker Case Div.
K-L Industries
1801 N. Central Park Ave.
Chicago, IL 60647
312-489-4600
800-621-0084

Kobetron Inc.
2271 Arbor Blvd.
Dayton, OH 45439
513-299-0990

Kyoritsu Electrical Instruments Works, Ltd.
865 Broadway Ave., Suite 104A
Holbrook, NY 11741
516-563-0109
Fax 516-563-0801

Kyros Corp.
P.O. Box 406
Madison, WI 53701
608-238-3587



La Guardia Enterprises
5882 Rich Hill Way
Yorba Linda, CA 92686
714-579-1276

L-Com Inc.
1755 Osgood St.
North Andover, MA 01845
508-682-6936
800-343-1455
Fax 508-689-9484

Leader Instruments Corp.
380 Oser Ave.
Hauppauge, NY 11788
516-231-6900
800-645-5104
Fax 516-231-5295

Leads Metal Products, Inc. (ENDECO)
5127 East 65th St.
Indianapolis, IN 46220-4865
317-251-1231
Fax 317-251-1232

Learning Tree International
P.O. Box 45974
Los Angeles, CA 90045-0974
213-417-8888
800-421-8166
Fax 213-410-2952

Leetric Research Labs*D
1423 Ferry Ave.
Camden, NJ 08104-1396
609-541-4200
800-358-8378
Fax 609-541-7852

Lil' Bitty Tester, Inc.
3154 Main St.
Chula Vista, CA 92011
619-425-1472

Allen J. Loeb*D
414 Chestnut Lane
East Meadow, NY 11554
516-481-4380

Lowell Corp.*D
P.O. Box 15053
Worcester, MA 01615-0053
508-756-5103
800-456-9355
Fax 508-755-0075

W.J. Lynott, Associates
614 N. Easton Road, Suite 200
Glenside, PA 19038
215-886-3646



Magic Solutions, Inc.
610 Vermeulen Place
Franklin Lakes, NJ 07417
201-891-6383

Management Technix Inc.
P.O. Box 668
Whitmore Lake, MI 48189-0668
313-449-4409

Marconi Instruments
3 Pearl Court
Allendale, NJ 07401
201-934-9050
800-233-2955

MarKenrich Corp.
1812 Flower Ave.
Duarte, CA 91010-2931
818-359-9190

Master Bond
154 Hobart St.
Hackensack, NJ 07601
201-343-8983
Fax 201-343-2132

M.A.T. Electronics*D
975 Jaymor
Southampton, PA 18966
215-364-7667
800-628-1118

Matrix Enterprises Inc.
7015 Carroll Road
San Diego, CA 92121
619-450-9475

Matsushita Services Co.
50 Meadowland Parkway
Secaucus, NJ 07094
201-348-7000
800-447-4700

McGraw-Hill Publishing Co.
1221 Ave. of the Americas
New York, NY 10020
212-512-2609

MCG Electronics, Inc.
12 Burt Drive
Deer Park, NY 11729
516-586-5125
800-851-1508
Fax 516-586-5120

MCM Electronics*D
650 Congress Park Drive
Dayton, OH 45459
513-434-0031
800-543-4330
Fax 513-434-6959

Melmat Inc.
1400 West 240th St.
Harbor City, CA 90710
213-325-1625
800-635-6289
Fax 213-325-0603

Mendon Electronics Corp.
3800 Monroe Ave.
Pittsford, NY 14534
716-248-8480
800-227-6937
Fax 716-248-3021

Mercer Electronics
859 Dundee Ave.
Elgin, IL 60120
708-697-2265
Fax 708-697-2272

MetraByte Corp.
440 Myles Standish Blvd.
Taunton, MA 02780
508-880-3000
Fax 508-880-0179

Micro Care Corp.
34 Ronzo Road
Bristol, CT 06010
203-585-7912
800-638-0125
Fax 203-585-7378

Micro-Circuits Co., Inc.
Route 1, Box 518
New Buffalo, MI 49117
616-469-2727

Micro Design, Inc.
Benjamin Fox Pavillion, Suite 509
Jenkintown, PA 19046
215-884-1112

Micromax Corp.
P.O. Box 438
Berlin, NJ 08009
609-965-4973

Microtest, Inc.
2920 E. Northern, Suite 105
Phoenix, AZ 85028
602-971-6464

Microwave Filter Co., Inc.
6743 Kinne St.
East Syracuse, NY 13057
315-437-3953
800-448-1666
Fax 315-463-1467

Miller-Stephenson Chemical Co.
George Washington Highway
Danbury, CT 06810
203-743-4447
800-992-2424
Fax 203-791-8702

Milo Associates, Inc.*D
4169 Millersville Road
Indianapolis, IN 46205
317-546-6456
Fax 317-547-1729

Miltex Supply Corp.*D
502 W. Wrightwood
Elmhurst, IL 60126
312-941-7100
800-325-8700

Mitsubishi Electric Sales America, Inc.
P.O. Box 6007
Cypress, CA 90630-0007
714-220-2500
800-553-7278
Fax 800-825-6655

Module Exchange
706 Space Way
Duncanville, TX 75137
214-298-1212
800-632-6637
Fax 214-780-5726

Monroe Electronics, Inc.
100 Housel Ave.
Lyndonville, NY 14098
716-765-2254
Fax 716-765-9330

Moody Tools, Inc.
P.O. Box 230
East Greenwich, RI 02818
401-885-0911
800-223-9036
Fax 401-461-5670

Mouser Electronics*D
2401 Highway 287 N.
Mansfield, TX 76063
817-483-4422
800-346-6873
Fax 817-483-0931

M-Test Equipment
P.O. Box 460008
San Francisco, CA 94146-0008
415-861-2382
800-334-4293
Fax 415-864-1076

Multicore Solders
Cantiague Rock Road
Westbury, NY 11590
516-334-7997

Multiflex Seals, Inc.
Viziflex Keyboard Seals Div.
16 E. Lafayette St.
Hackensack, NJ 07601
201-487-8080

Multiplex Technology, Inc.
251 Imperial Highway
Fullerton, CA 92635
714-680-5848
800-423-0584
Fax 714-680-0645



NASD, A Div. of NARDA
10 East 22nd St., Suite 310
Lombard, IL 60148
708-953-8950
Fax 708-953-8957

National Advancement Corp.
2730-J S. Harbor
Santa Ana, CA 92704
714-754-7110

NCM Electronics
1500 Wyatt Drive, Suite 9
Santa Clara, CA 95054
408-496-0290
Fax 408-496-0388

NESDA
2708 W. Berry
Fort Worth, TX 76109
817-921-9061
Fax 817-921-3741

Network Technologies, Inc.
19145 Elizabeth St.
Aurora, OH 44202
216-543-1646
800-RGB-TECH
Fax 216-543-5423

P.K. Neuses Inc.*D
1401 Rohlwing Road
Rolling Meadows, IL 60008
312-253-6555

M.M. Newman Corp.
P.O. Box 615
Marblehead, MA 01945
617-631-7100
Fax 617-631-8887

Nicolet Test Instruments
5225 Verona Road
Madison, WI 53711
608-273-5008
Fax 608-273-5061

Nippon Shokuhin Sangyo
1499 Bayshore Highway, Suite 220
Burlingame, CA 94010
415-697-1558
800-772-6772

NKK Switches
14415 N. Scottsdale Road
Scottsdale, AZ 85260
602-991-0942

Northern Magnetics, Inc.
P.O. Box 16409
Minneapolis, MN 55416
612-333-3071

NRD Inc.
Static Control Products
2937 Alt Blvd.
Grand Island, NY 14072
716-773-7634
Fax 716-773-7744

NRI School of Electronics
4401 Connecticut Ave. N.W.
Washington, DC 20008
202-244-1600
Fax 202-244-2047

NTE Electronics, Inc.
44 Farrand St.
Bloomfield, NJ 07003
201-748-5089
800-631-1250
Fax 201-748-6224

Nu-Concept Systems, Inc.
P.O. Box 587
Colmar, PA 18915
215-822-8400
800-762-4278
Fax 215-822-1427

Nu-Data Inc.
32 Fairview Ave.
Little Silver, NJ 07739-1515
201-842-5757
Fax 201-842-1161

Nutronix Inc.
P.O. Box 77103
Sterling Heights, MI 48077
313-726-1278
Fax 313-726-9150



Oak Technical Inc.
219 S. Sycamore St.
Ravenna, OH 44266-1203
216-296-3416
Fax 216-296-6117

O.K. Industries Inc.
4 Executive Plaza
Yonkers, NY 10701
914-969-6800
800-523-0667
Fax 914-969-6650

Omega Engineering Inc.
P.O. Box 4047
Stamford, CT 06907
203-359-1660
800-826-6342
Fax 203-359-7700

Omnitron Electronics*D
280 N. Midland Ave.
Saddle Brook, NJ 07662
201-703-9800
Fax 201-703-9804

Omnium Corp.
P.O. Box 186
Stillwater, MN 55082
612-430-2060
800-328-0223
Fax 612-430-2094

ORA Electronics
9410 Owensmouth Ave.
Chatsworth, CA 91311
818-772-2700
800-431-8124
Fax 818-718-8124

Company mailing addresses

Orion Instruments, Inc.
180 Independence Drive
Menlo Park, CA 94025
415-327-8800
800-729-7700
Fax 415-327-9881

Ostby-Barton Test Probes
487 Jefferson Blvd.
Warwick, RI 02886
401-739-7310
800-654-7180
Fax 401-732-4937



Pace, Inc.
9893 Brewers Court
Laurel, MD 20707
301-490-9860
Fax 301-498-3252

Pacer Industries, Inc.
1450 First Ave.
Chippewa Falls, WI 54729
715-723-1141
800-283-1141
Fax 715-723-7890

Pacific Power Source
15122 Bolsa Chica St.
Huntington Beach, CA 92649
714-898-2691
800-854-2433
Fax 714-891-1928

Paladin Corp.
3543 Old Conejo Road
Suite 101-102
Newbury Park, CA 91320
805-499-0318
800-272-8665
Fax 805-499-4006

Panamax
150 Mitchell Blvd.
San Rafael, CA 94903
800-472-5555
Fax 415-472-5540

PanaVise Products, Inc.
2850 East 29th St.
Long Beach, CA 90806
213-595-7621

Para Systems
1455 LeMay Drive
Carrollton, TX 75007
800-238-7272
Fax 214-446-2011

Partfolio, Inc.
1281 Anderson Drive, Suite A
San Rafael, CA 94901
415-459-1015

Parts Express International Inc.*D
340 E. First St.
Dayton, OH 45402
513-222-0173
800-338-0531
Fax 513-222-4644

Patlon Industries, Inc.
P.O. Box 562107
Miami, FL 33256
305-255-7744

Patton Electronics Co.
7958 Cessna Ave.
Gaithersburg, MD 20879
301-975-1000

JC Penney
National Parts Center*D
6840 Barton Road
Morrow, GA 30260
404-961-8400
800-527-7115

Penntek Instruments
14 Peace Drive
Lewistown, PA 17044
717-248-2507

PerfectData Corp.
1825 Surveyor Ave.
Simi Valley, CA 93063
805-581-4000

Performance Technologies
P.O. Box 947
Roswell, GA 30077
404-475-3192

Perma Power Electronics, Inc.
5601 W. Howard Ave.
Chicago, IL 60648
312-763-0763
800-323-4255
Fax 312-763-8330

Philips Consumer Electronics
Service Co.*D
P.O. Box 555
Jefferson City, TN 37760
615-475-3801
800-851-8885
Fax 615-636-5865

Philips ECG
Baldwin Green Common, Suite 109
Woburn, MA 01801
617-932-9070
800-233-8767
Fax 617-323-4691

Phitek Power Corp.
2200 Queen St., Unit 11
Bellingham, WA 98226-4753
206-647-1553
800-727-4877
Fax 206-647-1564

Pioneer Research
1745 Berkeley St.
Santa Monica, CA 90404
213-829-6751
800-233-1745
Fax 213-453-3929

Planned Products
303 Potrero St., Suite 53
Santa Cruz, CA 95060
408-459-8088
Fax 408-459-0426

Plastic Capacitors Inc.
2623 N. Pulaski Road
Chicago, IL 60639
312-489-2229
Fax 312-489-0496

Plastic Systems, Inc.
261 Cedar Hill St.
Marlboro, MA 01752
508-485-7390
Fax 508-480-0257

Plato Products, Inc.
P.O. Box 1298
Glendora, CA 91740
818-967-3821
800-423-4510
Fax 714-592-7062

Portasol, Inc.
7422 Carmel Executive Park
Charlotte, NC 28226
704-543-6239
Fax 704-543-6839

Power Distribution Inc.
2800 Sprouse Drive
Richmond, VA 23231
800-225-4838

Power-Science Industries
7667 Vickers St.
San Diego, CA 92111
619-292-4322

Power Technology Components
Microsemi Co.
23201 S. Normandie Ave.
Torrance, CA 90501
213-534-3737
Fax 213-530-5609

Prentice-Hall
Route 9W
Englewood Cliffs, NJ 07632
201-592-3090

Prime Electronics Co.*D
P.O. Box 28
Whitewater, WI 53190
800-558-9553 (WI)
800-558-9572
Fax 414-473-4727

PrimeLine
A Div. of Soltec Corp.
12977 Arroyo St.
San Fernando, CA 91340
818-365-0101
800-525-5554

Probe Master Inc.
4898 Ronson Court
San Diego, CA 92111
619-560-9676
800-854-1519

PTS Electronics Corp.
P.O. Box 272
Bloomington, IN 47402
812-824-9331
800-333-PTS1



Quality Packaging Supply Corp.*D
24 Seneca Ave.
Rochester, NY 14621
716-544-2500
Fax 716-544-2586

Quietrole Co.
P.O. Box 389
Spartanburg, SC 29304
803-576-4627



Racal-Dana Instruments Inc.
4 Goodyear St.
Irvine, CA 92718
714-859-8999
800-RAC-DANA
Fax 714-859-2505

RAG Electronics Inc.*D
21418 Parthenia St.
Canoga Park, CA 91304
818-998-6500
Fax 818-407-5559

Ramsey Electronics Inc.
793 Canning Parkway
Victor, NY 14564
716-924-4560
Fax 716-924-4555

Rapid Systems
433 North 34th St.
Seattle, WA 98103
206-547-8311
Fax 206-548-0322

Rawn Co., Inc.
P.O. Box 9
Spooner, WI 54801
715-635-8711
800-826-6791
Fax 715-635-2200

Regal Equipment Co.
P.O. Box 4910
Rumford, RI 02916
401-722-2740
800-346-4072

RemGrit Corp.
939 Barnum Ave.
Bridgeport, CT 06608
203-336-2525
Fax 203-576-6769

RepairPro
11210 Steeplecrest Drive
Suite 300
Houston, TX 77065
713-890-2257
800-BOARD-FX

Republic Packaging Corp.
9160 S. Green
Chicago, IL 60620
312-233-6530

The Rex Co.
744 Salem St.
Glendale, CA 91203
818-241-1100

Richmond Technology
P.O. Box 1129
Redlands, CA 92373
714-794-2111

R & K Supply Co.
1854 Hinckley Hills Road
Hinckley, OH 44233
216-278-7018
800-362-6780
Fax 216-278-2434

RNJ Electronics Inc.*D
P.O. Box 528
Lindenhurst, NY 11757
516-226-2700
800-645-5833
Fax 516-957-9142

Rochester Instruments Systems
255 N. Union
Rochester, NY 14605
716-263-7700
Fax 716-262-4777

Rogers Anti-Static Chemicals
105 W. Madison, Room 1708
Chicago, IL 60602
312-276-0665

Rostra Tool Co.
30 E. Industrial Road
Branford, CT 06405
203-488-TOOL
Fax 203-488-6497

Royal Soldering Systems, Inc.
744 Salem St.
Glendale, CA 91203
213-245-1077
Fax 818-956-5862



Safe Power Systems
Div. of Acme Electric Corp.
528 West 21st St., Suite 6
Tempe, AZ 85282
602-894-6864
800-325-5848
Fax 602-920-0470

Salen Enterprises*D
P.O. Box 915
Morton Grove, IL 60053
312-465-1424

Howard W. Sams & Co.
4300 West 62nd St.
Indianapolis, IN 46268
317-298-5457
800-428-SAMS

Company mailing addresses

Sanyo Energy Corp.
1201 Sanyo Ave.
San Diego, CA 92073
619-661-6620
Fax 619-661-6743

Schlumberger Instruments
20 North Ave.
Burlington, MA 01803
617-229-4825
800-225-5675
Fax 617-229-4825

Schurter, Inc.
1016 Clegg Court
Petaluma, CA 94954
707-778-6311
Fax 707-778-6401

Schweber Electronics
Electronic Catalog Div.*D
50 Washington St.
Norwalk, CT 06854
203-838-5100
800-843-3656

Scouter Products
Ohm Electrics, Inc.*D
746 Vermont St.
Palatine, IL 60067
312-359-6040
800-323-2727

Seco Industries
2245 East 38th St.
Los Angeles, CA 90058
213-589-6131
Fax 213-589-7915

Semtronics Corp.
P.O. Box 2248
Peachtree City, GA 30269
404-487-6681
800-247-4863
Fax 404-487-1128

Sencore Electronics
3200 Sencore Drive
Sioux Falls, SD 57107
605-339-0100
800-SEN-CORE
Fax 605-335-6379

Sentinel Foam Products
130 North St.
Hyannis, MA 02601
508-775-5220
800-323-5005
Fax 508-771-1554

Sera Service
Independent Electronic Rebuilder
2343 N.W. 20th St.
Miami, FL 33142
305-642-4000
800-759-6767

Shape Magnetronics, Inc.
901 DuPage Ave.
Lombard, IL 60148
708-620-8394
Fax 708-620-0784

Sharp Electronics, Corp.
Sharp Plaza, Box M
Mahwah, NJ 07430
201-529-9246
Fax 201-529-9271

SHOGYO International Corp.
287 Northern Blvd.
Great Neck, NY 11021-4799
516-466-0911
Fax 516-466-0922

Sibex Inc.
1040 Harbor Lake Drive
Safety Harbor, FL 34698
813-726-4343

The Simco Co., Inc.
2257 N. Penn Road
Hatfield, PA 19440
215-822-2171

Simpson Electric Co.
853 Dundee Ave.
Elgin, IL 60120
708-697-2260
Fax 708-697-2272

SL Waber, Inc.
520 Fellowship Road
Mount Laurel, NJ 08054
609-866-8888
800-634-1485
Fax 609-866-1945

Sola
1717 Busse Road
Elk Grove Village, IL 60007
708-439-2800
Fax 800-626-6269

Solder Absorbing Technology, Inc.
144 Oakland St.
Springfield, MA 01108
413-788-6191
800-628-8862
Fax 413-733-0490

Solder Removal Co.
1077 E. Edna Place
Covina, CA 91722
818-967-3681
800-767-9425
Fax 818-331-9701

Solomat Instrumentation
652 Glenbrook Road
Stamford, CT 06906
203-348-9700
800-932-4500

Soltec Corp.
12977 Arroyo St.
San Fernando, CA 91340-1597
818-365-0800
800-423-2344
Fax 818-365-7839

Sony Service Co.
Sony Drive
Park Ridge, NJ 07656
201-930-1000

Sony Service Co.
National Parts Div.*D
8281 N.W. 107th Terrace
Kansas City, MO 64153
816-891-7550
Fax 800-821-5662

Sorensen Co.
5555 N. Elston Ave.
Chicago, IL 60630
312-775-0843
800-525-2024
Fax 312-775-7432

Spanta, Inc.
P.O. Box 193
Franklin Lakes, NJ 07417
201-848-0033
Fax 201-848-1845

Specialized Products Co.*D
2117 W. Walnut Hill Lane
Irving, TX 75038
214-550-1923
800-527-5018

Speco Div.
P.O. Box 624
Lindenhurst, NY 11757-0624
516-957-8700
800-645-5516
Fax 516-957-9142

Spectrum 2000, Inc.
4854 Sterling Drive
Boulder, CO 80301
303-444-2828
Fax 303-444-2929

THE

B.I.R.D. T.M.

Battery powered InfraRed Detector

Until now, the only way to test infrared emitting devices was with a phosphor chip.....**Until the B.I.R.D.** The world's first handheld, **Battery** powered, **InfraRed De-** tector. This instrument is so unique, it's patented! The **B.I.R.D.** instantly recognizes infrared light from television, VCR, and stereo remote controls, VCR tape stop circuits,

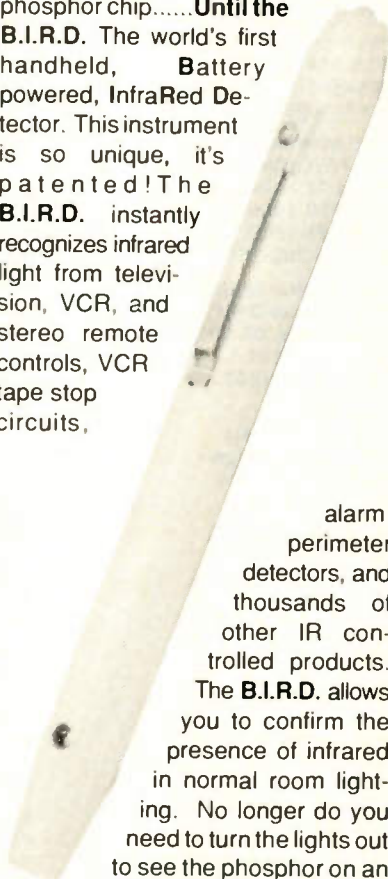

alarm perimeter detectors, and thousands of other IR controlled products. The **B.I.R.D.** allows you to confirm the presence of infrared in normal room lighting. No longer do you need to turn the lights out to see the phosphor on an infrared detector card. Slim one hand operation makes it easy to reach IR emitters on crowded VCR tape mechanisms. The **B.I.R.D.** will soon become one of the most important time saving instruments in your tool box. You will be able to test your customers' handheld remotes in seconds...even in the customer's own home!

**CALL TOLL FREE
FOR COMPLETE DETAILS**

1-800-338-0531

**Parts
Express**
International Inc.

340 E. First St.
Dayton, Ohio 45402
Phone: 513-222-0173
FAX: 513-222-4644

Circle (15) on Reply Card

Company mailing addresses

A.W. Sperry Instruments, Inc.
245 Marcus Blvd.
Hauppauge, NY 11788
516-231-7050
800-645-5398
Fax 516-434-3128

Sperry Tech Inc.
P.O. Box 5234
Lincoln, NE 68506
800-228-4338

Sprague Magnetics, Inc.*D
15720 Stagg St.
Van Nuys, CA 91406
818-994-6602
800-553-8712
Fax 818-994-2153

Start International*O
15775 N. Hillcrest, Suite 508
Dallas, TX 75248
214-960-1986
800-527-1809
Fax 214-702-9551

Static Control Services, Inc.
870 Research Drive, Suite 9
Palm Springs, CA 92262
619-325-3211
Fax 619-322-2073

Static Inc.
A Sealed Air Co.
Old Sherman Turnpike
Danbury, CT 06810
203-791-3600

Static Prevention Inc.
211 Gemini
Brea, CA 92622
714-680-6478

Statikil, Inc.
P.O. Box 4370
Akron, OH 44321
216-666-3701

The Superior Electric Co.
383 Middle St.
Bristol, CT 06010
203-582-9561
Fax 203-584-1483

Support Systems International
Cables & Accessories Div.
150 S. Second St.
Richmond, CA 94804
415-234-9090
Fax 415-233-8888

Sutton Designs, Inc.
Computer Power Div.
215 N. Cayuga
Ithaca, NY 14850
607-277-4301
800-326-8119
Fax 607-277-6983



TAB Books Inc.
Blue Ridge Summit, PA
17294-0850
717-794-2191
800-233-1128
Fax 717-794-2080

Tappan Wire & Cable
256 Oak Tree Road
Tappan, NY 10983
914-359-9300
800-247-9099

TDS
Route 1, Box 80
Sterling, NE 68443
402-866-2103

Tech Spray, Inc.
88 N. Hughes
Amarillo, TX 79105
806-372-8523
800-858-4043
Fax 806-372-8750

Techni-Tool Inc.*D
5 Apollo Road
Plymouth Meeting, PA 19462
215-825-4990
Fax 215-828-5623

Tegam, Inc.
7230 N. Ridge Road
Madison, OH 44057
216-428-7505
Fax 216-428-1068

Tekelec
26580 W. Agoura Road
Calabasas, CA 91302
800-835-3539
Fax 818-880-6993

Tekserv*O
127 Riverneck Road
Chelmsford, MA 01824
508-459-9480
Fax 508-453-6336

Tektronix Communications
Network Analyzers Div.
625 S.E. Salmon
Redmond, OR 97756
503-923-4415
800-833-9200

Tektronix, Inc.
P.O. Box 500
Beaverton, OR 97077
503-627-2711
800-835-9433

Telecommunications Techniques
Corp.
20410 Observation Drive
Germantown, MD 20876
301-353-1550
800-638-2049
Fax 301-353-0734

Teledata Systems
68 Reservoir Road
New Milford, CT 06776
203-355-8285
Fax 203-354-8787

TeleMatic Div. of UXL Corp.
108-02 Otis Ave.
Corona, NY 11368
718-271-5200

Temco Instruments Inc.
P.O. Box 847
Lewisburg, WV 24901
304-647-5102
800-442-5525

Temptronic Corp.
55 Chapel St.
Newton, MA 02158
617-969-2501

Tentel Corp.
4475 Golden Foothill Parkway
El Dorado Hills, CA 95630
916-939-4005
800-538-6894
Fax 916-939-4114

TEP, Inc.
P.O. Box 104
Winona, OH 44493
216-222-1415

Test Probes, Inc.
9178 Brown Deer Road
San Diego, CA 92121
619-535-9292
800-368-5719
Fax 619-535-1260

The Texwipe Co.
P.O. Box 575
Saddle River, NJ 07458
201-327-9100
800-284-5577
Fax 201-327-5945

Gregory Thomas, Inc.
P.O. Box 1305
Aurora, IL 60507
708-859-3007
800-782-8422
Fax 708-896-9770

Thomson Consumer Electronics, Inc.
Distributor & Special Products*O
2000 Clements Bridge Road
Deptford, NJ 08096-2088
609-853-2244
Fax 609-853-2231

Thordarson/Meissner
628 Belmont
Mount Carmel, IL 62863
618-262-5121
800-851-3583

3M/Electronic Products Div.
3M Austin Center, Box 2963
Austin, TX 78769-2963
512-984-1800
800-225-5373 Sales
800-328-7732 Technical

3M/Electrical Products Div.
3M Austin Center, Box 2963
Austin, TX 78769-2963
512-984-5651

3M/Electrical Specialties
P.O. Box 2963
Austin, TX 78769-2963
512-984-3113
800-328-1368

3M/Photodyne Inc.
3760 Calle Tecate
Camarillo, CA 93010
805-388-8378
Fax 805-499-9311

TIF Instruments, Inc.
9101 N.W. Seventh Ave.
Miami, FL 33150
305-757-8811
800-327-5060
Fax 305-757-1028

Tool Kit Specialists, Inc.*D
1366 Borregas Ave.
Sunnyvale, CA 94089
408-745-6020
800-748-6413
Fax 408-744-1650

Tool Tron Industries
RFD 4, Suite 4967
Boerne, TX 78006
512-755-2295
Fax 512-249-9112

Tool-Tronics, Inc.*D
20 Fairfield Place
West Caldwell, NJ 07006
201-808-4637
Fax 201-227-7029

Trace Racks
P.O. Box 970
El Segundo, CA 90245
213-772-3309
800-358-1400

Transcat*O
P.O. Box D-1
Rochester, NY 14606
716-458-4801
800-828-1470

The Triangle Tool Group, Inc.
Cameron Road
Orangeburg, SC 29115
803-534-7010
Fax 803-536-6632

Trio-Tech Static Systems
7313 Ethel Ave.
North Hollywood, CA 91605
818-764-3800
800-423-2817

Triplet Corp.
1 Triplett Drive
Bluffton, OH 45817
419-358-5015
800-TRI-PLET

Tripp-Lite
500 N. Orleans St.
Chicago, IL 60610
312-329-1777
Fax 312-644-6505

Tritronics Inc.*D
1306 Continental Drive
Abingdon, MD 21009
301-676-7300
800-638-3328 Parts

TSC/Centec
303 N. Curry Pike
Bloomington, IN 47401
812-334-0411
800-333-4872

Tucker Electronics Co.*D
P.O. Box 551419
Dallas, TX 75355-1419
214-348-8800
800-527-4642
Fax 214-348-0367

Tycor International Inc.
6107 Sixth St. S.E.
Calgary, Alta, Canada T2H 1L9
403-259-3200
Fax 403-253-0663



Ucando VCR Educational Products
P.O. Box 386
Greenville, OH 45331
513-548-6113

Ungar, Div. Eldon Industries, Inc.
5620 Knott Ave.
Buena Park, CA 90621
714-994-2510
Fax 714-523-7790

United States Instrument Rentals
2988 Campus Drive
San Mateo, CA 94403
415-572-6600
800-USIE-123

United Techbook Co.
P.O. Box 1658
Longmont, CO 80502
303-651-3184

Universal Enterprises
5500 S.W. Arctic Drive
Beaverton, OR 97005
503-644-8723
800-547-5740
Fax 503-643-6322



Vaco Products
7200 McCormick Blvd.
Chicago, IL 60645
708-677-9500

Vector Electronics
12360 Gladstone Ave.
Sylmar, CA 91342
818-365-9661
800-423-5659
Fax 818-365-5718

Company mailing addresses

Verite
P.O. Box 697
Harbor City, CA 90710
213-320-5552
Fax 213-320-0199

Video Midwest & AVC Divisions of Vaughn Communications*D
7951 Computer Ave. S
Minneapolis, MN 55435
612-832-3232

Viejo Publications
3540 Wilshire Blvd., Suite 310
Los Angeles, CA 90010
213-962-8416
800-537-0589
Fax 213-962-0628

Viteq Corp.
10000 Aerospace Road
Lanham, MD 20706
301-731-0400
800-678-4877
Fax 301-731-5995

VIZ Test Equipment
Div. of Kappa Networks Inc.
175 Commerce Drive
Fort Washington, PA 19034
215-643-6950
800-523-3696
Fax 215-643-5237

Viziflex Seels, Inc.
Keyboard Cover Div.
16 E. Lafayette St.
Hackensack, NJ 07601
201-487-8080

Vortec Corp.
10125 Carver Road
Cincinnati, OH 45242
513-891-7474
800-441-7475
Fax 513-891-4092

Vu-Data Corp.
9180 Brown Deer Road
San Diego, CA 92121
619-452-7670
Fax 619-452-2543



Wandel & Goltermann, Inc.
1030 Swabia Court
Research Triangle Park, NC 27709
919-941-5730

Wavetek Corp.
9145 Balboa Ave.
San Diego, CA 92123
619-450-9971

Wescorp
144 S. Whisman Road
Mountain View, CA 94041
415-969-7717
800-537-7828

Product directory begins on page 9

WestCon Div. of Sycon Corp.
959 Cheney Ave.
Marion, OH 43302
614-382-5771
Fax 614-383-6254

Westward Electronics, Inc.
2851 S. Parker Road, Suite 715
Aurora, CO 80014
303-337-3740

Brian R. White Co., Inc.*D
313 Henry Station Road
Ukiah, CA 95482
707-462-9795
Fax 707-462-4800

Winders & Geist
P.O. Box 83088
Lincoln, NE 68501
402-474-3400
800-432-3219
Fax 402-474-4369

Windsor Technologies, Inc.
130 Alto St.
San Rafael, CA 94901
415-456-2200
Fax 415-456-2244

Winegard Co.
P.O. Box 1007
Burlington, IA 52601
319-754-0600

Workplace Systems
562 Mammoth Road
Londonderry, NH 03053
603-622-3727
800-258-9700
Fax 603-622-0174



Yokogawa Corp. of America
2 Dart Road
Newnan, GA 30265
404-253-7000
Fax 404-251-2088



Zenith Sales Co.
A Div. of Zenith Electronics Corp.
11000 Seymour Ave.
Franklin Park, IL 60131
312-671-7550

Zero Corp., East Div.
288 Main St.
Monson, MA 01057
413-267-5561
Fax 413-267-5569



New mother- boards and chassis.

PTS has hundreds of motherboards/chassis available for immediate exchange. Plus, PTS has factory-trained technicians for quality, complete motherboard, chassis, electronic tuners and tuner clusters remanufacturing service. Exact replacement motherboards/chassis from PTS meet or exceed industry standards. These are just a few of the hundreds of motherboards/chassis available from PTS!

Magnavox

APW002
A100026
EMH103

Zenith

9-470
9-516
9-770
9-592

RCA

CTC145
CTC149
CTC136

GE

EP93X535
EP93X488
EP93X631

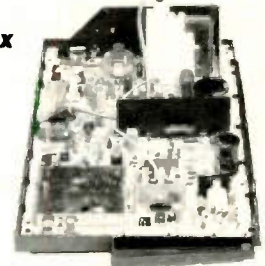

Depend on PTS for savings, speed and quality!
Order direct and save!

1-800-333-PTS-1

To order - or for the servicenter or distributor nearest you - call today!



FREE PRODUCT GUIDE!

Call today for your FREE copy of the PTS Catalog and Parts Reference Guide! Comprehensive listing of the world's largest inventory of TV modules, motherboards, tuners, thousands of exact replacement parts. Plus new sections on VCR parts and service, new products, rebuilding services, and more!

PTS

PTS Corporate Headquarters
P.O. Box 272, Bloomington, IN 47402

Circle (16) on Reply Card

PRIME ELECTRONICS CO.

For All Your Electronic
Parts & Accessories

WE'RE THE ONE . . .

- With over 10,000 Electronic Products
- With Everyday LOW Prices and Volume Discounts
- With 100% Guarantee On All Products
- With the PRB LINE of Replacement Belts and Tires

For Your Free Copy of Our
New Catalog Call Toll-Free
1-800-558-9572

In Wisconsin 1-800-242-9553
or for 24 Hour Ordering Call . . .
FAX: 414-473-4727



"First in Quality And Service"

PRIME ELECTRONICS CO.

P. O. Box 28
Whitewater, Wisconsin 53190

Circle (18) on Reply Card

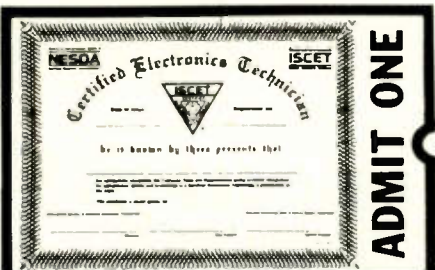

Your Ticket To SUCCESS

Over 25,000 technicians have gained admittance worldwide as certified professionals. Let your ticket start opening doors for you.

ISCTET offers Journeyman certification in Consumer Electronics, Industrial, Medical, Communications, MATV, Radar, Computer, and Video. For more information, contact the International Society of Certified Electronics Technicians, 2708 West Berry St., Fort Worth, TX 76109 • (817) 921-9101

Name _____
Address _____
City _____
State _____ Zip _____

Send material about ISCTET and becoming certified.

Send one "Study Guide for the Associate Level CET Test." Enclosed is \$10 (includes postage).

Computer Corner

"Where do I plug in this cable?"

By Glenn R. Patsch

The back of a personal computer (PC) can be a confusing maze of cables and connectors. Although cable connections are a basic part of PC servicing, not immediately knowing which cable goes where can slow you down, whether you're reconnecting a repaired PC, adding peripherals or just cleaning up someone else's connection mess.

Figure 1 shows a typical PC back panel for the IBM PC, PC/XT and PC/AT. Most of the connections are pretty straightforward. On the left side of the panel is the ac power cord (1). Some PCs also have a 120V ac power connector (2) for the IBM monochrome monitor. This power connector allows the monochrome monitor to be turned on and off with the power switch on the PC. To the right of the power cord is the 5-pin DIN connector (3) for the keyboard. On older PCs, a second 5-pin DIN connector (4) was used to connect to a cassette tape deck.

On the right side of the panel are the expansion card slots. The older PCs had five slots; the newer PC/XTs and PC/ATs have eight slots. Each of the slots can hold an expansion card that may have a connector. Serial and parallel port expansion cards have connectors. Hard disk controller cards and

Patsch is a consultant specializing in the selection, evaluation and installation of IBM PC and compatible hardware and software.

memory expansion cards usually don't.

The main bulk of the PC's connectors can be found in the expansion card slots. Connecting cables to the PC — or figuring out problems with improperly connected cables — isn't difficult if you understand which connector should be used for which peripheral. Here's a run-down on the connectors you'll use with each peripheral.

Floppy drives

A 37-pin female D connector is used to connect to one or two external floppy drives. This is the largest connector you will usually find, but it is rarely used. Many non-IBM floppy disk controller cards do not include the connector and cannot operate external floppy drives. The IBM PS/2 uses this connector to attach to an external 5.25-inch floppy drive.

Printers

A 25-pin female D connector is a parallel port. The parallel port is normally connected to a printer, or it may be connected to a scanner that uses the parallel port. The 25-pin connector can be used alone or with a 9-pin D connector.

A female 9-pin D connector is connected to a video monitor. A male 9-pin D connector is a serial port. The IBM and Hercules monochrome video adapter cards combine the 9-pin female D

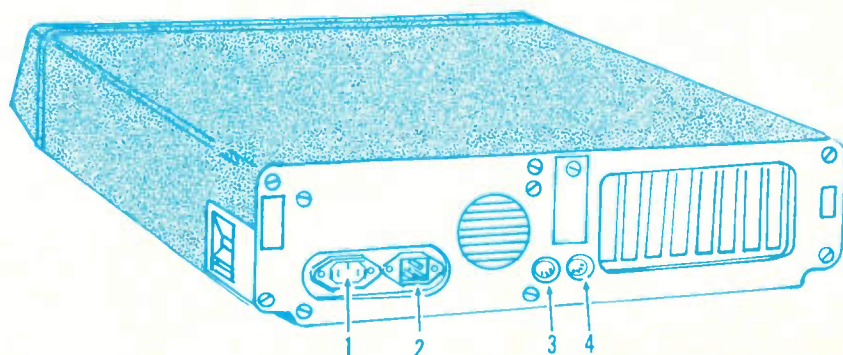

Figure 1. A typical PC back panel for the IBM PC, PC/XT and PC/AT. The numbers show connections for (1) the ac line cord, (2) an ac power connector for a monochrome monitor, (3) the keyboard, (4) a cassette tape deck and, to the right, expansion card slots.

connector for the video monitor with a 25-pin female parallel printer D connector in one slot.

A 25-pin or 9-pin male D connector also is a serial port. The 9-pin male D connector was used more with the PC/AT to allow both a 25-pin female parallel port and a serial port connector to fit in one expansion slot. A 9-pin-to-25-pin adapter or cable is used to connect to the 9-pin serial connector. This combination can also be found on several multifunction cards, such as the AST I/O mini card.

Modems

A modular telephone connector is a modem card. The expansion card usually has a 1,200- or 2,400-baud modem. Many modem cards have two modular telephone connectors, allowing you to connect one to the incoming telephone line jack and the other to a telephone.

Monitors

Video monitors will use two types of connectors: A 9-pin female D connector or a 15-pin female D connector.

With the 9-pin female D connector, the monitor used could be one of three types:

- **Monochrome:** If it is paired with a 25-pin female D connector parallel port, it is usually for a monochrome monitor.
- **Color graphics (CGA):** If there is one RCA-type phono jack right above the 9-pin D connector, it is usually the IBM CGA card. The RCA-type phono jack provides a 1.5V composite video signal.
- **Enhanced graphics (EGA):** The EGA monitor also uses a 9-pin female connector. If there are two RCA phono jacks above the 9-pin female D connector, it is usually an EGA card. The two RCA-type phono jacks are the EGA feature jacks and are not usually connected to anything. On the IBM EGA card, four DIP configuration switches are visible through a small square hole at the top of the card.

All of these video connectors use standard TTL levels to drive the monitors. Be sure to connect the video mon-

itor to the correct adapter card. If you still cannot tell which video monitor to use, open up the PC and look at the video adapter card. It usually has the manufacturer's name and monitor type printed on the edge of the adapter card. Most PCs have only one video monitor, and figuring out which type of video adapter is in use is not a problem.

The 15-pin female D connector (pins in three rows of five) is used for the VGA video monitor. This is the video connector that is standard on the PS/2. The VGA uses an analog direct drive 75 Ω , 0.7V video signal.

As a guideline, the older PCs and PC/XTs most often use the monochrome and CGA monitors. The PC/AT uses the monochrome, CGA and EGA monitors. The VGA monitors are usually found on the newer 386 PCs and the IBM PS/2s. Most of the older monochrome monitors are being replaced by EGA and VGA monitors.

Other connectors

If the pins of a 15-pin female D connector are arranged in two rows, it is a game control adapter and is used to connect to one or two joysticks. The game control adapters are not common.

A coax connector is found on local area network (LAN) cards and expansion cards that connect to a mainframe, allowing the PC to act as a 3270-type terminal.

You may find more than one parallel and serial connectors. There is no simple way to find which connector is for the first parallel printer and which is for the second parallel printer and so on. You could open up the PC and check how the DIP switches on each card are configured to determine which connector is for which port. An easier method is to connect the printer to one of the parallel connectors and try it. If it does not work, you can switch the cables to the other connector or use DOS commands to direct output to LPT1 (first parallel), LPT2 (second parallel), COM1 (first serial), COM2 (second serial) and so on. ■

Free new product guide.



Order your
FREE PTS
Catalog and Parts
Reference Guide today!

You'll have the industry's most complete in stock inventory of TV and VCR Exact Replacement Parts available overnight. All makes. All models. Plus new VCR Parts and VCR camcorder service, new disc drive and computer service, plus all makes of tuners, tuner clusters, modules, new motherboards/chassis and much more! Call toll free today and order your FREE PTS Catalog and Parts Reference Guide!

Now PTS ships Federal Express for as little as \$2.00 over UPS ground rates. And every in stock order received before 2:00 pm. is shipped the same day. That's PTS Express Service!

To order — or for the servicenter or distributor nearest you — call today!

1-800-333-PTS-1

DTS

PTS Corporate Headquarters
P.O. Box 272, Bloomington, IN 47402

Circle (17) on Reply Card

C\$ERVICE^(R)

The software package written specifically for service/repair companies.

- Job Ticket Tracking
- Recurring Rental Billings
- Maintenance Contract Analysis
- Maintenance History Tracking
- Service Van Inventory Control
- Technician Productivity Analysis
- Accounting
 - General Ledger
 - Accounts Receivable
 - Inventory
 - Accounts Payable
 - Payroll

Save time and money by coordinating your operations with our service software. IBM compatible. Demonstration program available for evaluation.

America West C&E, Inc.
311 Washburn Drive
Rock Springs, WY 82901
800-542-WEST
FAX:307-382-7323

Circle (19) on Reply Card

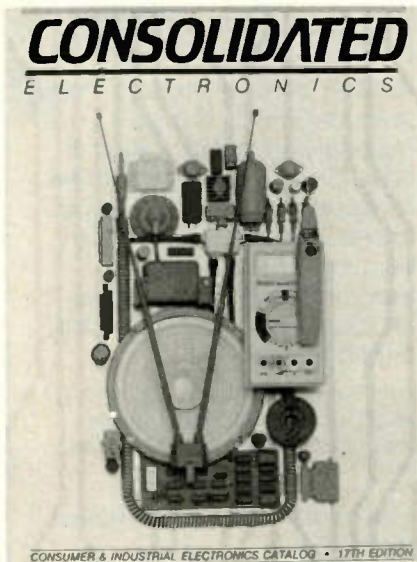

THE ULTIMATE ELECTRONICS CATALOG.

Order your 260 page catalogue packed with over 10,000 money saving electronic parts and equipment. Send \$3.00 check or money order, or call 1-800-543-3568 today and use your Mastercard or Visa.

Consolidated Electronics, Incorporated
705 Watervliet Ave., Dayton, Ohio 45420-2599

NAME _____
ADDRESS _____
CITY _____
STATE _____ ZIP _____

Circle (20) on Reply Card

Video Corner

The amplifier as a troubleshooting aid – Part II

By Stephen J. Miller

Last month, we looked at a useful little amplifier, the Radio Shack mini-amp (catalog number 277-1008C). This month, we will continue to investigate uses for this versatile amplifier. The myriad of uses for this amp will surprise you.

I have successfully used this amp to test PG and FG pick-up sensors in VCR motor circuits. Often these sensors have low-level output signals that are difficult to check without a scope pre-amplifier. Because these sensors are usually an integral part of the motor, the entire motor must be replaced when the sensor is bad. Therefore, to test the sensor by substitution, you would have to order an entire motor assembly, which is usually quite expensive. By using the mini-amp as a pre-amp, I have been able to test these low-level sensors with my scope.

Testing audio circuits

The audio circuits in the new VCR models are becoming very complicated. Units today have built-in stereo decoders, multiple inputs and outputs, and both linear and hi-fi audio capabilities. With so many audio signal paths, problems can be difficult to track down. However, by using the mini-amp as a signal tracer, you can sample the audio at various points and quickly track down

the problem. Just be sure to include a dc blocking capacitor in the input lead of the mini-amp.

To prevent the loading down of sensitive circuits, I use the divide-by-3 probe shown in Figure 1. This probe reduces the loading effect of the mini-amp by increasing its input impedance from 5k Ω to 15k Ω . Because of the amp's high gain, the divide-by-3 probe can be used in most instances. I only use the direct probe for very low-level signals.

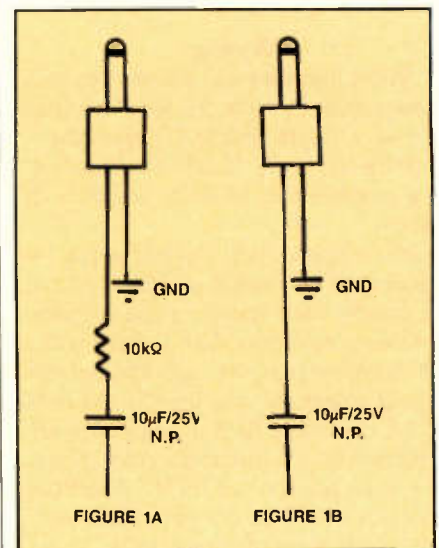

Figure 1. To prevent the loading down of sensitive circuits, use the divide-by-3 probe shown in Figure 1A. Because of the amp's high gain, the divide-by-3 probe can be used in most instances. Only use the direct probe (Figure 1B) for very low-level signals.

Miller is a senior bench technician for a Lancaster, PA, repair company.

Feedback

Avoiding bouncing checks

Mr. Lynott's article "Business Corner" in the December 1989 issue failed to mention the easiest way to solve the problem of collecting bounced checks: having a cash-only policy!

If a shop is going to call Mr. and Mrs. X and let them know their repaired set is ready, then surely the customer will have ample time to get his check cashed at the bank before coming to pick up the unit. What could be simpler?

Does this approach work? A fellow technician friend who runs a full-time repair shop uses this approach. He has a sign, placed conspicuously where the customer will see it, that says his shop is cash only. He reminds the customer of this fact when he gives him a receipt and when he calls to advise the customer that his set is ready. The only exceptions are persons known personally to him.

Usually the best solution to a problem is to avoid the problem in the first place. In the past 16 months, my friend has had more than 1,500 units dropped off for repair (he is basically a 1-man shop) with this policy, and it hasn't caused any problems.

Another costly way to prevent the problem is to use a check-verification plan in which the company offering the plan backs up any checks if the repair company calls in each check as it is received. Again, this avoids the problem in the first place, but it obviously cuts into the shop's profits.

In my own case, I operate only on a part-time basis and by word of mouth, so virtually all of my customers are known to me. Accepting checks has not proved to be a problem — no bounced checks in 14 years of operation.

M.B. Danish
Aberdeen Proving Ground, MD

I read with interest William Lynott's Business Corner in the December 1989 issue, and I would like to pass along a procedure I have been using for years: When the customer tenders a check, instead of asking for a driver's license, I ask for a Visa or MasterCard. I write down not only the account number, but also the expiration date. If the check is not honored for any reason, I write up a charge slip and deposit it.

Kenneth E. Hull, CET
Aurora, IL

Both probes are shown in Figure 1.

A common audio complaint is an audio warble or garbled playback audio. These symptoms can be caused by either audio amp problems or mechanical problems in the tape-transport mechanism. To determine whether the problem is mechanical or electrical, I connect the direct probe across the audio head. If the problem can be heard in the mini-amp's speaker, then a mechanical problem exists. By using this technique, you will not waste valuable time troubleshooting the wrong area.

The most common mechanical problem that causes audio warble is oxide buildup on the video head cylinder. Often these lumps of oxide will not affect the video, but will cause momentary tape stretching and audio distortion. Therefore, when a mechanical problem is indicated, give the VCR a good inspection and thorough cleaning.

Another common cause of audio distortion is a defective takeup clutch. A VCR with a bad clutch will usually produce audio in which the actors sound as if they're under water. Problems in the back-tension system can affect the audio as well. Finally, because of the slow tape speed, some warble in the linear track audio is normal in the EP speed. Although the warble can be minimized, it cannot be eliminated in the slow speed.

Next month, we'll finish this series with the amplifier as an IR device tester.

One case for all your needs . . .
files and paper, tools and parts
. . . samples and briefcase

THE 2X1

CASE SERIES FITS ALL YOUR NEEDS



With and without parts boxes, this is the fast-selling, great utility, **CORDURA® CARRYING CASE SERIES**. Innovative, new, designed especially for professional executives and technicians. So many features: soft handle for easy carrying, double-lockable zippers and pockets inside and outside; sturdy; attractive; with unique options.

Two models to purchase; one includes compartmented parts box for components, fuses, parts, etc.

Get the facts on **THE 2X1 CASE SERIES** from your manufacturers' sales representative or, communicate with us for informative, colorful, sales literature.



Chicago Case Co.

4446 S. Ashland Avenue, Chicago, IL 60609
(312) 927-1600 FAX: (312) 927-2820

Circle (21) on Reply Card

Solving RFI complaints – Part II

By John Shepler

When a customer's radio, which glitches and distorts at home, works just fine in the shop, one of the first things to suspect is radio frequency interference (RFI).

Last month's column detailed the easiest and least expensive solution — shielding and grounding the equipment — as well as the brute-force method — filtering and bypassing. However, external methods might not be enough; internal filtering may be necessary.

Internal filtering

Sometimes an external bypass cap or commercial filter isn't enough. This is especially true when the signal is getting through a non-metallic case, such as phono equipment or a guitar amplifier

Shepler is an electronics engineering manager and broadcast consultant. He has more than 20 years of experience in all phases of electronics.

or telephone. In these instances, the fix has to be applied directly to the circuit board.

The first line of defense is at the amplifier input. In microphone, musical instrument, phono or tape pre-amps, a small ceramic bypass cap from the input connector to chassis will keep the RF from reaching the first amplifier stage. Figure 1 shows a complete input filtering. The bypass cap will usually be in the range of 10pF to 470pF. The value of the cap varies with the frequency you are trying to filter and also the impedance of the input. For audio, you can find the maximum value by increasing the capacitor until the response of the amplifier is affected at frequencies above the audio band.

The following formula is also handy for picking an appropriate capacitor:

$$f=1/(6.28 \times R \times C)$$

R is the input impedance in megohms, C is the bypass capacitor in picofarads, and f is the frequency in MHz where the high-frequency response is down by 3dB.

Input filtering is most effective at FM, 2-way and TV frequencies. You want to use very small (5pF or 10pF) capacitors on pre-amp inputs because tape heads and magnetic phono cartridges are sensitive to capacitive loading. Be sure to carefully measure the response of any amp or pre-amp after you add filtering.

Figure 1 also shows a couple of other handy techniques. A ferrite bead slipped over a wire lead will inductively block higher frequencies. You can also coil the wire from the input to the first stage to create an inductor that will block very high frequencies but not affect audio.

Next month, we'll finish this series with a look at desensitizing the amp.

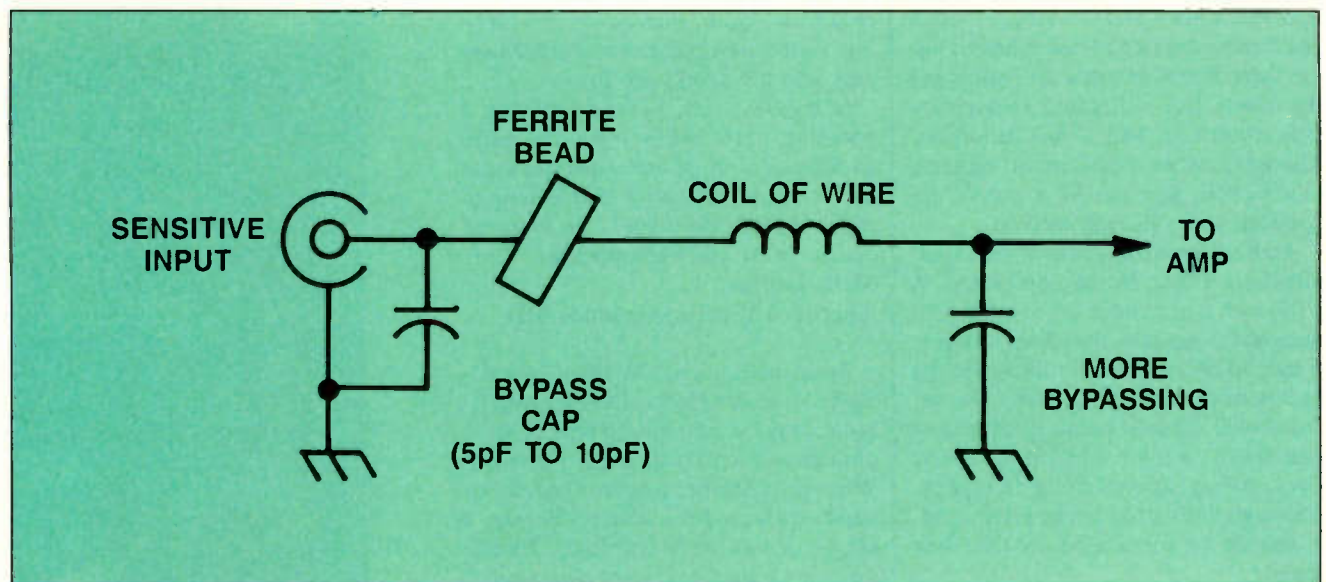

Figure 1. In microphone, musical instrument, phono or tape pre-amps, a 10pF to 470pF ceramic bypass cap from the input connector to chassis will keep the RF from reaching the first amplifier stage. A ferrite bead slipped over a wire lead will inductively block higher frequencies. You can also coil the wire from the input to the first stage to create an inductor that will block very high frequencies but not affect audio.

Classified

Effective with
March, 1990 Issue

Classified advertising is available by-the-word or per column inch. **By-the-word:** \$1.65 per word, per insertion. Initials and abbreviations count as full words. Blind ads (replies sent to ES&T for forwarding) are \$40 additional. Minimum charge: \$35 per insertion.

Per Column Inch (Classified Display): \$235 per column inch, per insertion, with frequency discounts available. 1" minimum, billed at 1/4" increments after that. 10" maximum per ad. Blind ads are \$40 additional. Reader Service Number \$25 additional to cover processing and handling costs. (Free to 4-inch or larger ads.) Optional color (determined by magazine) \$150 additional per insertion. No agency discounts are allowed for classified advertising.

Contact Renée Hambleton, 913-888-4664, for information on frequency and prepayment discounts, or to place your classified ad. Or send your order and materials to Renée Hambleton, Electronic Servicing & Technology, P. O. Box 12901, Overland Park, KS 66212.

HELP WANTED

HELP WANTED: Senior Technicians for large consumer electronics repair facility. CAMERA TECHNICIANS, VCR TECHNICIANS, AUDIO TECHNICIANS. Two locations—Wheeling and Lombard, Illinois. Call (708) 537-6666. 3-90-11

RURAL FEMALE OWNED WARRENTY SERVICE CENTER (14 manufacturers) plus TVRO needs unpretentious tech. Room, board, & commission, (502) 378-6201 8-10 PM (CST). Box 1062, Russell Springs, KY 42624-2062. 3-90-11

BUSINESS OPPORTUNITIES

LARGE AUDIO/VIDEO SERVICE BUSINESS. In sunny SW city. Established 20 yrs. Well-equipped. Price & terms negotiable. (602) 298-8827. evs. 8-89-1fn

LARGE VIDEO/AUDIO COMPUTER SERVICE business in Florida: established 20 years. Price negotiable. Send inquiries to P.O. Box 630203, Miami, FL 33163. 3-90-11

EQUIPMENT WANTED

TUBES WANTED—We buy receiving and transmitting tubes. Send your list for bid. New tubes in original boxes only. Also need radio I.F. XFMRs. Antique Electronic Supply, 688 West First St., Tempe, AZ 85281. Phone 602/894-9503, Fax 602-894-0124. 3-90-31

FOR SALE

TV TROUBLESHOOTING: Over 300 problems/solutions. Nothing old listed. \$12.00, add \$1.50 shipping. Refund if not satisfied. Jones Enterprises, Box 702, Niceville, FL 32578. 12-89-TFN

VHS-VCR Repair Solutions Sets I, II, III, IV, V. Each contains 150 symptoms and cures, cross reference chart, free assistance. \$11.95 each all five \$49.95. Eagle Electronics, 52053 Locks Lane, Granger, IN 46530 12-89-TFN

TV TOUGH DOGS: 300 symptoms and cures. Send \$9.95 to DAVIS TV, 11772 Old Fashion Way, Garden Grove, CA 92640. 10-87-1fn

REDUCED 75%, Dlehl Mark V scanner \$219, Dlehl Mark III scanner \$89. New. 2805 University Ave., Madison, Wis. 53705, 608-238-4629, 608-233-9741. 3-89-1fn

BUYING & SELLING QUALITY TEST EQUIPMENT by HP, Tektronix, Fluke, etc. Tektronix 335 portable (10.5 lb) 35 MHz oscilloscopes \$750. Vu-Data PS935 portable 35 MHz oscilloscopes \$350. Tektronix 465 oscilloscopes (100 MHz) \$1,050. Fluke 8020A handheld multimeters \$75. Much more! Calibrated & guaranteed 6 mos. Call Cal-Scope, (408) 730-4573 or FAX (408) 730-9537. 3-90-31

JUKEBOX SERVICE MANUALS. Free price list. Catalog and sample copy of Always Jukin' \$5. Charles Maler, Dept. EST, 3016 Derry Terrace, Phila., PA 19154. 3-90-11

VCR TECHNICIAN SECRETS—clean VCR's, stop VCR's from eating tapes. Send \$5.00 to: White's TV, P.O. Box 201-A, Hampton, TN 37658. 3-90-11

PHOTOFACTS 1000-2700, \$3.25 each. Sencore LC75 plus accessory \$600.00. MP2 Industries IA-446 Harrison Str., Sumas, WA 98295, 604-850-3119. 3-90-11

TV/VCR REPAIR SOLUTIONS. Printout or IBM compatible with hard drive. 3,400 solutions (26 manufacturers). Time saver. Quick scan by make, model, chassis or stage, \$90. Post paid to Electronic Solutions, 407 W. AVE "N", SAN ANGELO, TX 76903. 3-90-11

TV/VCR REPAIR SHOP near sunny, warm Palm Springs, CA. \$56K gross. One man shop. No inventory, \$6K. 619-345-6041. 3-90-11

USED VIDEO SERVICING EQUIPMENT—Sencore models TF46, DUM37, SC61, VA62 and accessories at great low price and financing is available. Call 708-864-9352. 3-90-11

ELECTRONICS-APPLIANCE SERVICE BUSINESS, located in beautiful central Oregon. Easy access to fishing, hunting, skiing. Gross 150K, well equipped shop & service trucks. Health forces sale, inventory & equipment, 75K. (503) 536-1703. 3-90-11

450 MHz SPECTRUM ANALYZER

Adapted from Nov 85 QST article by Al Helfrick, K2BLA. Features: Three Digit LED Center Frequency Digital Readout. 12 Position Calibrated SCAN WIDTH, 1 KHz to 50 MHz, Switchable Bandwidth; Wide = 300 KHz, Narrow = 10 KHz. Use your Low Frequency Scope for the Display Portion. Switchable 10 KHz video filter. Variable IF Attenuator, LOG output calibrated in 10 db steps. For complete kit, order #450-KIT \$459.95 plus \$4.50 s/h. Calif Residents add 6% sales tax. Foreign orders add 15% for shipping.

A&A ENGINEERING

2521, W. LaPalma, #K,
Anaheim, CA 92801
(714) 952-2114

GET IN NOW ON THE \$12 BILLION A YEAR COMPUTER SERVICE INDUSTRY

LEARN HOW TO CLEAN/ MAINTAIN/REPAIR PRINTERS...
VIEJO'S AWARD-WINNING TRAINING VIDEO AND COMPANION TRAINING MANUAL (OVER 300 ACTION-PACKED PAGES) REVEALS SECRETS OF PRINTER REPAIR WITH YOUR AVERAGE MECHANICAL ABILITY WE CAN SHOW YOU HOW TO REPAIR UP TO 95% OF ALL PRINTERS - START EARNING EXTRA CASH IN DAYS!

• HUGE UNTAPPED MARKET!
• SERIOUS LACK OF TRAINED TECHNICIANS

OVER 37 MILLION PCs IN USE APPROXIMATELY 85% HAVE A PRINTER ATTACHED. **MAJORITY** OF PRINTER BREAKDOWNS ARE DUE TO SIMPLE MECHANICAL OR ELECTRO-MECHANICAL FAILURE

FREE INFO
CALL 1-800-537-0589

OR WRITE TO: VIEJO PUBLICATIONS
3540 WILSHIRE BL. #310
DEPT EST 2, L.A. CA 90010

Circle (23) on Reply Card

Tech's Guide To Pricing

"Sperry Tech's Pricing Guide"
Updated new 6th edition...a framework for setting rates that apply to Hi-Tech products...a formula that guarantees SUCCESS!
Call Toll Free for details
1-800-228-4338

Circle (22) on Reply Card

FIX VCR's

Over 75% of all VCR breadowns are due to mechanical problems.

Do you have the tools to find these problems? TENTE! Does!

Call Toll Free

(800) 538-6894
In Calif -(916) 939-4005

Training Videotape - \$24.95

TENTE! 4475 Golden Foothill Parkway
El Dorado Hills, CA 95630

Circle (25) on Reply Card

TUBES • TUBES • TUBES

World's Largest Range

Over 2,000 Types, Domestic & Foreign

UP TO 85% OFF Ask for price list

International Components Corporation

Toll Free 800-645-9154 - N.Y. State 516-293-1500
105 Maxess Road, Melville, New York 11747

Circle (24) on Reply Card

VCR and Tape Transport - Cleaning System -

Removes imbedded materials from cylinders, capstans, heads, etc. In seconds. Works like nothing you've seen! For Complete Kit, send \$29.95 + \$3.00 postage and handling to:

TDS Rt. 2, Box 80, Sterling, NE 68443.

Want more information on advertised products?
Use the Rapid Facts Card.

VCR PARTS

SANYO RF Modulator #4-1164-031600	\$17.95 Ea.
FISHER RF Modulator 191002-143-9-4300	17.95 Ea.
MITSUBISHI RF Modulator #PU57855-01	19.95 Ea.
TOSHIBA RF Modulator #MSU-911	19.95 Ea.
RCA Loading Belt 157061 or 157062	10/For 8.50
FISHER Loading Belt 143-2-7504-01000	10/For 8.50
GOLDSTAR Samsung Photo Interrupter	1.99 Ea.
RCA Idler 164113	3.25 Ea.
FISHER Idler 143-0-4204-00400	3.99 Ea.
SHARP Idler NIDL0005	2.99 Ea.
SHARP Idler NIDL0006	2.99 Ea.

POPULAR SEMICONDUCTORS

2SD1341P	Original Sanyo	10 For \$19.90
2SD869	Original Toshiba	10 For 19.90
BU208A	Original Toshiba	10 For 19.90
2SD1398	Original Sanyo	10 For 19.90
STR3115	Original Sanken	3.95 Ea.
STR3125	Original Sanken	3.95 Ea.
STR30120	Original Sanken	3.95 Ea.
STK4273	Original Sanken (10 min.)	9.95 Ea.
STK0080	Original Sanken	16.95 Ea.
375 Replacement	(10 min.)	99¢ Ea.

POPULAR CAPACITORS

100MFD/50 Volts	Radial	20 For \$10.00
4.7MFD/250 Volts	Radial	10 For 5.50
10MFD/350 Volts	Radial	10 For 7.50
1000MFD/200 Volts	Snap-In	5 For 12.50
680MFD/200 Volts	Snap-In	5 For 12.50
100MFD/200 Volts	Radial	10 For 12.50
47MFD/50 Volts	Radial	10 For 4.50
10MFD/25 Volts	Non Polarized	10 For 5.00
800MFD/200 Volts	Snap-In	5 For 12.50
80MFD/450 Volts	Axial	10 For 19.90

POPULAR ITEMS

Sharp Flyback	F0009G	\$24.95 Ea.
Sharp Flyback	F0003G	24.95 Ea.
Sharp Flyback	F0014G	24.95 Ea.
Sharp Flyback	F0015G	19.95 Ea.
Sharp Flyback	F0016G	24.95 Ea.
Sanyo Flyback	FO260	14.95 Ea.
Sanyo Flyback	FO192	14.95 Ea.
Tripler	523A/526A	9.95 Ea.
Samsung	FCC1415AL	19.95 Ea.
Samsung	FCC2015AL	19.95 Ea.
Samsung	523/526A	9.95 Ea.

ASK FOR OUR FREE CATALOG!

MAT ELECTRONICS



975 Jaymor Rd.
Southampton, PA 18966

CALL TOLL FREE:

1-800-628-1118

Circle (26) on Reply Card

Advertisers' Index

Company	Pages Number	Reader Service Number	Advertiser Hotline
America West C&E, Inc.	56	19	307/382-5663
B&K Precision Dynascan Corp.	1	3	312/889-1448
Beckman Industrial Corp	39,41	27,28	619/495-3200
Chicago Case Co.	57	21	312/927-1600
Consolidated Electronics, Inc.	56	20	800/543-3568
Consumer Electronics Show	43		202/457-8700
Fordham Radio Supply Co.	7	7	800/645-9518
Goldstar Precision	23	13	213/404-0101
International Components Corporation	58	24	800/645-9154
ISCET	54		817/921-9101
Kenwood Test & Measuring Instruments	IBC	2	213/639-4200
Leader Instruments Corp.	3	4,5	800/645-5104
M.A.T. Electronics	60	26	800/628-1118
Matsushita Services Co.	4-5	6	201/348-7589
NESDA	21,42		817/921-9061
NRI Schools-Electronics Division	11		
NTE Electronics, Inc.	15	8	800/631-1250
Nutronix Inc.	19	10	313/939-4710
Panavise Products, Inc.	37	14	213/595-7621
Parts Express Int'l Inc.	51	15	513/222-0173
Prime Electronics	54	18	800/558-9572
PTS Corp.	53,55	16,17	800/333-PTSI
Remgrit Corporation	17	9	203/336-2525
Sencore, Inc.	IFC	1	800/SEN-CORE
Sperry Tech, Inc.	58	22	800/228-4338
Techni-Tool	19	11	215/825-4990
Tentel	58	25	800/538-6894
Thomson Consumer Electronics	13	29	
Vaco Products	21	12	
Viejo Publications	39,58	23, 30	800/537-0589
Zenith		BC	

ADVERTISING SALES OFFICE

THE MAGAZINE FOR CONSUMER ELECTRONICS SERVICING PROFESSIONALS
ELECTRONIC
Servicing & Technology

HOME OFFICE

Stephanie Hanaway, Associate Publisher
Melissa Langstaff, Advertising Coordinator
Renée Hambleton, Classifieds
9221 Quivira Rd.
Overland Park, KS 66215
Telephone: (913) 888-4664
Fax: (913) 541-6697

EASTERN U.S.

Carol Summers
866 Third Ave.
29th Floor
New York, N.Y. 10022
Telephone: (212) 702-3402
Fax: (212) 702-7802

WESTERN U.S.

Len Keeler
27475 Ynez Road, #374
Temecula, CA. 92390
Telephone: (714) 694-0774
Fax: (714) 694-0781

Kenwood Test Equipment. From the company you've been listening to for years.



Kenwood's expansive line of oscilloscopes economically combines performance and simplicity.

You're probably already in tune to the fact that Kenwood makes superior audio components. However, you might not have heard our whole story.

Test and measuring equipment is another vital member of the Kenwood family that stands at the forefront of electronics.

You see, we've insisted on precision testing for over 40 years now. It's been a critical step in producing entertainment and communications systems the experts

consistently applaud.

So it follows that Kenwood test and measuring instruments deliver the kind of flawless performance engineers demand. Designed to supply the ultimate combination of practicality, precision and price value.

With oscilloscopes ranging from 5 to 150MHz, Kenwood's line satisfies a wide spectrum of needs. All Kenwood scopes



Observing complex video signals is made easy with Kenwood vectorscopes and waveform monitors.

make taking accurate readings quick and simple.

For regulated DC power supplies, engineers and technicians who demand stability choose Kenwood. From func-

tion generators to multimeters, digital signal generators and a full roster of video, dig-



A wide range of regulated DC power supplies offers unsurpassed stability for automated and benchtop applications.

ital audio and compact disc test equipment, the Kenwood logo stands for reliability.

There's no substitute for experience. So when it's test equipment you need, look to the company with a truly sound understanding of electronics. Kenwood.

Contact us at 2201 E. Dominguez St., P.O. Box 22745, Long Beach, CA 90801-5745.

Or call 213/639-4200.
And hear the whole story.

Circle (2) on Reply Card

KENWOOD



PLAY IT SMART!



**INSIST ON
GENUINE ZENITH
FACTORY-FRESH
REPLACEMENT PARTS
NOW AVAILABLE AT
AUTHORIZED
EXCHANGE COUNTERS
THROUGHOUT THE U.S.**

Two of the most important reasons for exchanging Zenith replacement parts through your participating distributor's Exchange Program:

- 1) Your replacement part will most likely contain the latest Zenith engineering updates,
- 2) You will be assured of receiving a factory-fresh replacement part remanufactured and serviced for reliability by Zenith people

as knowledgeable and dedicated as those who made the original.

Don't risk exchanging sophisticated Zenith modules, tuners, channel selectors and sub-assemblies anywhere else.

Write today and we'll help you locate an authorized distributor Exchange Counter near you!

ZENITH
The quality goes in before the name goes on.®