

The how-to magazine of electronics...

ELECTRONICTM

Servicing & Technology

JULY 1986/\$2.25

Servicing Sharp high and low voltage circuits

Voltage breakdown in transistors • More about gammas

**I only have
two
hands**

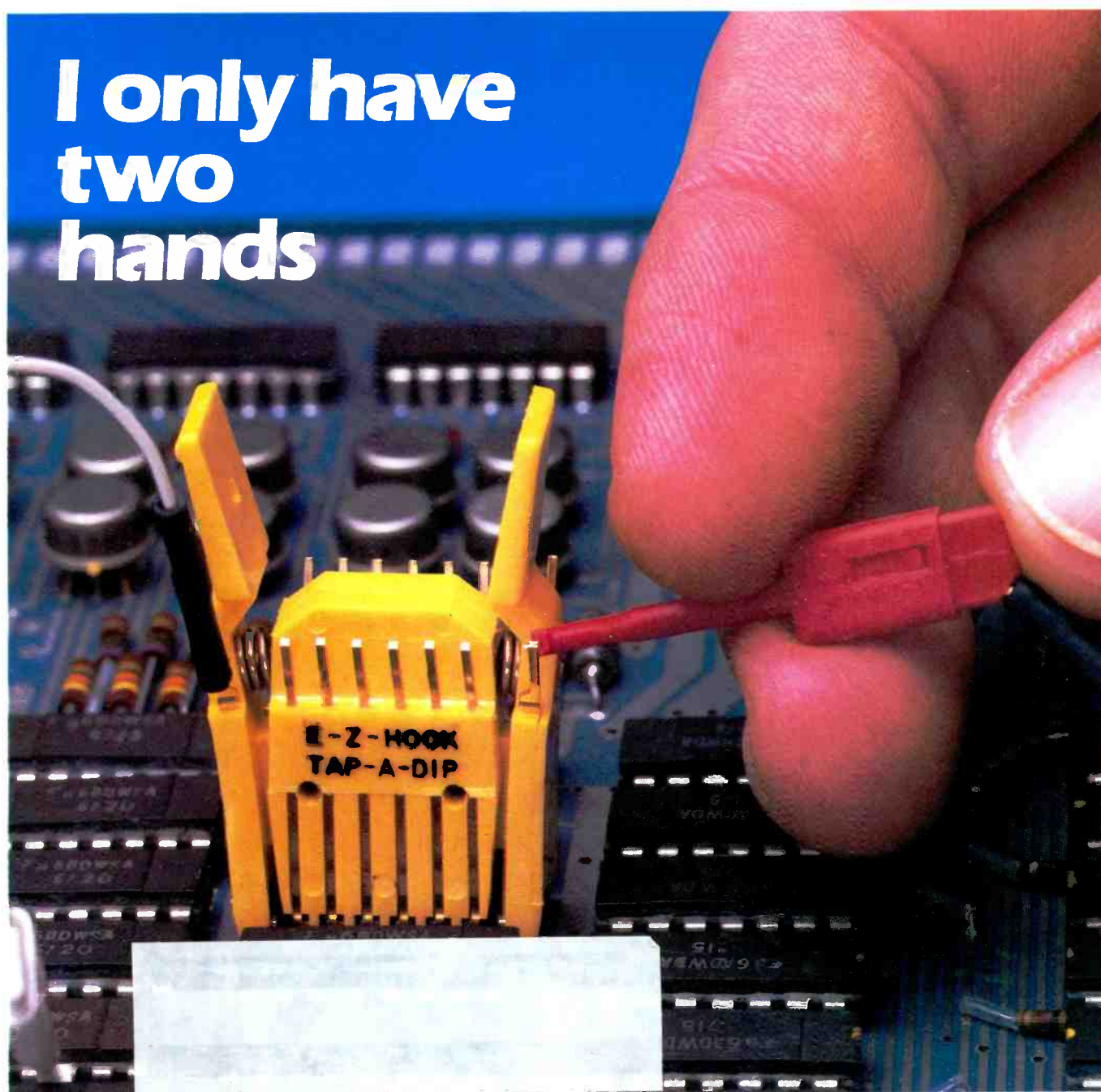



Components and Adaptors

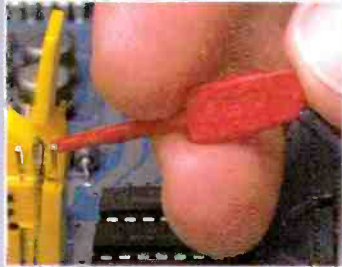

P-5 Plug-On Pico Hook

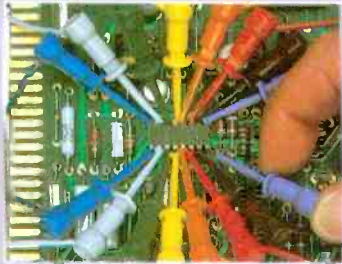

Micro-Hook



Coax Cable/Patch Cord Assemblies

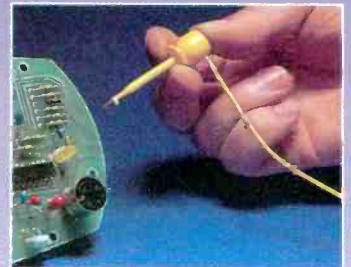
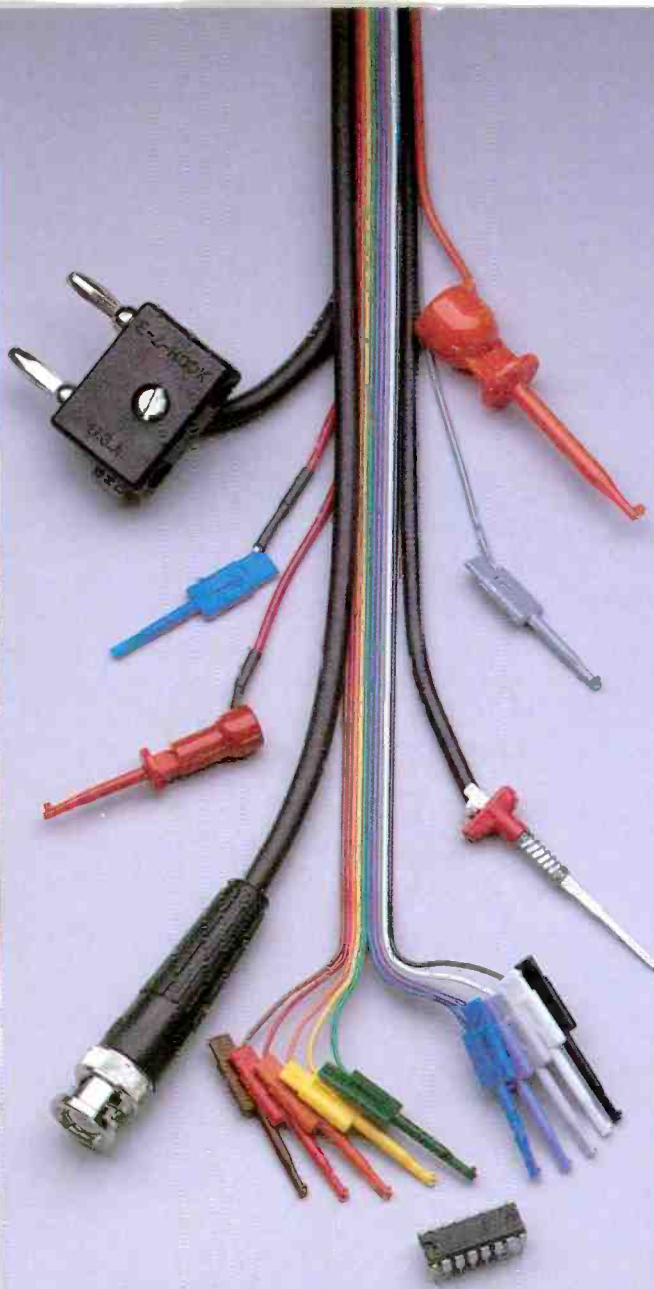

Mini-Hook Test Leads

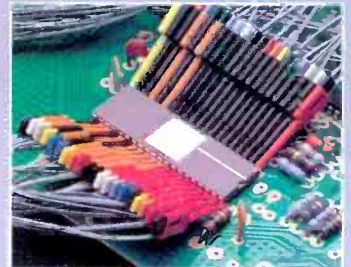

Pico-Hook, Narrow/IC

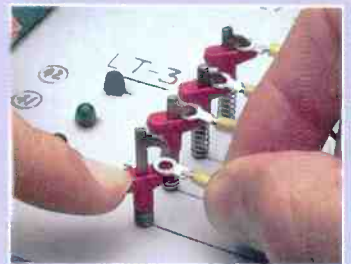

Vail-Clip, Harnessing

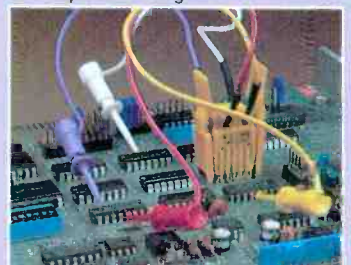

Tap-A-Dip 14 & 16 Pin Test Connectors

SIGNAL ACCURACY.

12,000 Reasons Why Industry Relies on E-Z HOOK.

Choose from over 12,000 standard test accessory products for an immediate solution to your application. They're engineered to assure a reliable contact or connection for any testing, hook-up or assembly task. And E-Z HOOK can ship what you need in 48 hours or less.

For a quick, economical answer to your testing needs, ask for our 112-page catalog of Electronic Test Accessories. It's free. And reliable.

E-Z-HOOK®

E-Z HOOK, A Division of Tektest, Inc., 225 North Second Ave., Arcadia, CA 91006
P.O. Box 450, (818) 446-6175. TWX 910-582-1614.

Circle (1) on Reply Card

WE MAKE SPECIALS
SEND US YOUR REQUIREMENTS!

Stay Tuned-In To What's Happening In Electronics

... With Membership In The Electronics Book Service!



Whether you're an engineer or electronics technician, the operator of a radio-TV repair shop, or a part time enthusiast—membership in the ELECTRONICS BOOK SERVICE is ideal for you. And here's why . . .

Approximately every four weeks you'll receive news describing recently published books on such topics as: electronic troubleshooting . . . transistor circuit analysis . . . radio and TV servicing . . . logic circuits . . . frequency modulation receivers . . . electronic switching systems . . . and oscilloscopes—to name a few.

Each book is carefully selected and offered to you at discounts up to 30%, and sometimes more!

Join now and receive your copy of John Lenk's COMPLETE GUIDE TO MODERN VCR TROUBLESHOOTING AND REPAIR . . . a \$29.95 Value . . . for only \$2.95 (plus postage, handling and applicable tax).

And as a special bonus, we'll send you DIGITAL ELECTRONICS: A WORKBENCH GUIDE TO CIRCUITS, EXPERIMENTS AND APPLICATIONS—a \$12.95 Value—FREE!

You save \$39.95 already.

Look these books over for 15 days—without obligation. If you decide John Lenk's book is not right for you, send it back and we'll cancel your membership. DIGITAL ELECTRONICS is still yours to keep—free.

Or you can keep both books as an introduction to Electronics Book Service membership. Your only obligation as a member is to purchase three more books within a year.

Mail Attached Postage-Paid Card

If card is missing, mail to: ELECTRONICS BOOK SERVICE, Member Enrollment Center, P.O. Box 442, West Nyack, New York 10995

14

Servicing Sharp high and low voltage circuits

By Homer L. Davidson

Because this series of TV receivers seems predisposed to HV/LV circuit problems, the author discusses typical failures and complex circuit operations to forearm **ES&T** readers.

22

Test your electronic knowledge

By Sam Wilson

What's that potato doing in an electronics quiz?

24

I only have two hands

By Conrad Persson

Jigs, tools and fixtures can be helping "hands" if two aren't enough when simultaneously holding AND repairing an electronics device.

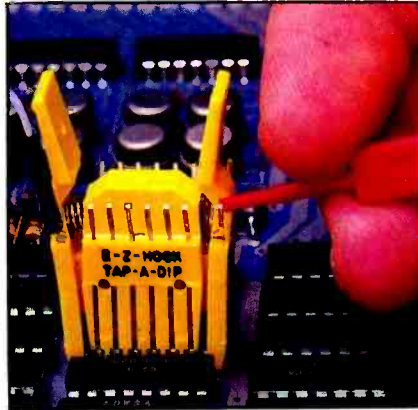

page 24

Some tasks that a technician performs are made easier through the use of the appropriate tool, jig or fixture. (Photo courtesy of E-Z Hook.)

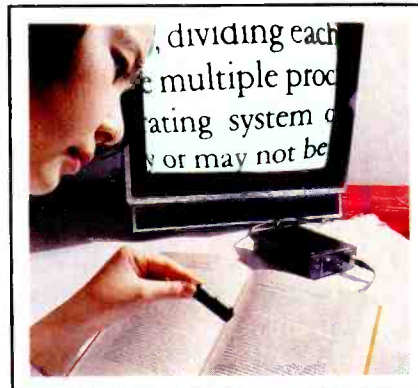

page 12

This video camera head is small enough to hold in the palm of your hand, or to be incorporated in the tip of a robot's arm. (Photo courtesy of Toshiba Corporation.)

40

Voltage breakdown in transistors

By Alvin G. Syndor

According to the author, transistors are the single most important and reliable element in modern electronic signal processing equipment. Why, then, do they become defective? What is avalanche breakdown?

52

What do you know about electronics?—Old business: transistor gamma

By Sam Wilson

More about gamma identification and related replies from readers, something about elastomers, about symbols other than MIL or IEEE, about cleaning away battery corrosion, and a warning: Technicians who mishandle solder are inviting a dreaded affliction.

Departments:

- 4 Editorial
- 8 News
- 10 Feedback
- 12 Technology
- 50 Troubleshooting Tips
- 55 Literature
- 59 Photofact
- 60 Symcure
- 61 Books
- 62 Reader's Exchange
- 64 Audio Corner

AWS TEST INSTRUMENTS



DML-4020 DATA LOGGING DMM

This microprocessor controlled portable instrument contains two autoranging digital multimeters, four comparators, one timer and a 2 inch dotmatrix printer. Both DMM's may be used individually or simultaneously to measure and record all functions. The dot matrix printer provides numerical or graphic printouts displaying sampled values at pre-selected automatic or manual time intervals. The recordings end with a calculation of lowest/highest values, number of sample intervals and calculated average. Comparator output signals are available for actuating external equipment. \$1,000.00.



DM-6592 ELECTRO-PROBE™ DMM

One of the smallest, most convenient hand-held DMM's you'll ever own. It's both autoranging and manual and is the perfect instrument for taking readings easily and accurately in hard to reach areas. Other features include instant audible continuity buzzer; one-hand operation; electronic overload protection on all ranges; data-hold button. Ranges: 0-200m/2/20/200/500Vdc; 0-2/20/200/500Vac; 0-200/2K/20K/200K/2000K/20MΩ. \$55.00.



DM-7010 4½ DIGIT ROTARY SWITCH DMM

High accuracy readings in the laboratory or in the field. Features include 4½ digit 19999 max. display; built-in frequency counter to 200KHz and conductance function; 0.05% basic dc volts accuracy; overload protection on all ranges; special electronic protection to 250Vac/dc on resistance ranges; UL1244 type test leads; diode and continuity tests. Ranges: 0-200m/2/20/200/1000Vdc; 0-200m/2/20/200/750Vac; 0-200μ/2m/20m/200m/2/10Aac/dc; 0-200/2K/20K/200K/2M/20MΩ; 0-200nS conductance; 0-20K/200KHz frequency. \$170.00.



DM-1 POCKET-PRO™ DMM

Big features are packed in this pocket-calculator sized DMM. You'll find autoranging; electronic overload protection on all ranges; auto-polarity; audible and visual continuity indication; built-in test leads; "booklet-type" carrying case is designed to fit easily in shirt pocket. Ranges: 0-2000m/20/200/400Vac/dc; 0-200/2000/20K/200K/2000KΩ; 0-200Ω continuity. \$29.95.



BL-4 CLASSMATE DIGITAL BREADBOARD LAB

Nicknamed "The Instructor's Best Friend", this completely self-contained classroom lab combines a breadboard, DC power supply (fixed and variable), signal generator (sine, triangle and square wave outputs), digital voltmeter, 8-bit LED display, BCD to 7 segment decoder and display, flip-flop gate and logic switches in one compact unit. The BL-4 is only 11" x 13" leaving more work station area free for other instructional materials and requires only one electrical outlet. \$349.95.



MONITOR 4000 EXPANDABLE RECORDING SYSTEM

The new recording system that can be expanded on as needed. Start with the XR-4000 basic 3 speed recorder, add any of five volt/amp or temperature modules, then select any of five transducers for easy current or temperature measurements. The XR-4000 can be panel mounted, used on a bench top or as a portable in its functionally designed carrying case. Basic XR-4000 3 speed recorder \$229.95. Complete kits start at \$399.95 and include XR-4000, module, transducer, carrying case, chart paper, tilt stand.

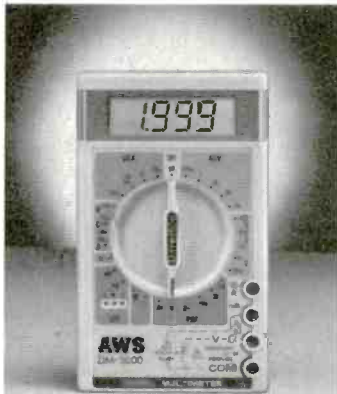

DM-3000 3½ DIGIT ROTARY SWITCH DMM

Just one of three DMM's in our Economy Series that combines quality with economy. Features include built-in HFE, battery and diode testing; conductance function; 300 hour battery life; 10Adc range; electronic overload protection on all resistance ranges; pocket-sized. (Also available models DM-1000 & 2000). Ranges: 0-200m/2/20/200/1000Vdc; 0-200m/2/20/200/750Vac; 0-200μ/2m/20m/200m/10Aac/dc; 0-200/2K/20K/200K/2M/20MΩ; 1.5V battery test; 0-1000 Hfe test; 2KΩ diode test. DM-1000: \$39.95 / DM-2000: \$54.95 / DM-3000: \$69.95.

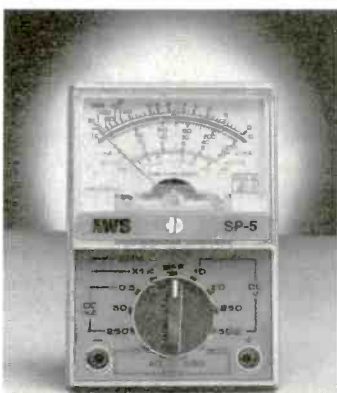

SP-5 POCKET-SIZE MULTIMETER

An unbelievable \$9.95 buys you this small yet surprisingly rugged multimeter. Perfect for the professional, homeowner and hobbyist. Its big features include safety recessed test lead connections; high impact ABS plastic case; mirrored scale plate; diode protected meter movement; uses only one 1.5V AA battery. Ranges: 0-10/50/250/500Vac/dc; 0-0.5/50/250mAdc; 0-1MΩ (5KΩ mid-scale); -20 to +56db. \$9.95.

A.W. SPERRY INSTRUMENTS INC.

For more information see your local distributor or contact A.W. Sperry Instruments Inc.
245 Marcus Blvd., Hauppauge, N.Y. 11788 • 800-645-5398 Toll-Free (N.Y. and Alaska call collect 516-231-7050).

Circle (3) on Reply Card

Tools move the world

*"Give me where to stand, and I will move the earth." Archimedes
(Talking about the lever)*

Have you ever thought about how many times a day you use a tool? This morning before you even left for work you probably ate some buttered toast, or perhaps a bowl of cereal. The butter knife and the spoon are tools. Did you brush and comb your hair? You used two more tools. Every time you cut a piece of paper or punch some holes in it, you're using a tool.

If you think about it a bit, we humans spend a lot of time using tools. In fact, many of the concepts we use are inextricably bound up with tools. Take the word "cut." You can tear things with you bare hands, or break something. But if you want a nice smooth regular edge, you'll cut the material. And cutting implies use of a tool.

And consider meal preparation. Knives and stirrers, tools for lifting and flipping. The rolling pin is a tool, and so is the biscuit cutter, the cookie cutter, the ice cream scoop.

Outside the house you mow, rake, dig, scrape, paint and many more tasks, rare to find one that doesn't require a tool.

And then if you're into woodworking or metalworking, or other similar activities, you'll have a shop full of cutting tools, measuring tools, fastening tools, holding jigs and fixtures.

Just look around. All of the physical manifestations of our

civilization are evidences of humanity's conception, manufacture and use of tools. The beautiful old cathedrals of Europe were erected using tools. Modern skyscrapers owe their existence to tools. Roads, comfortable homes full of furniture and appliances, heated by fuels, and lighted and powered by electricity are built using advanced tools.

And all of the electronic marvels in those homes: the television, the stereo, the VCR, the telephone, the computers and its peripherals are there through the intelligent use of tools.

It's through the intelligent use of his tools that the consumer electronics servicing technician makes a contribution to that same civilization. Skillful diagnosis of a problem and application of screwdriver, side cutters, soldering iron to bring a failed TV set back into working order brings the owner back into contact with the events of the world. Repair of someone's stereo puts that person back into contact with the brilliance of the classical composers.

When Archimedes made his comment about moving the earth he was talking about the lever. But tools in general have moved the earth—No, made the earth what it is today.

Nile Conrad Pearson



In less time than it took you to read just the first ten words of this sentence - - -

You could have diagnosed any problem, in any brand, solid state TV set down to circuit level, with 100% accuracy.

By simply plugging the set's AC cord into a self programming Mark VII computer, pushing one test button, and noticing which one of sixty lights are lit.

The light that is lit tells you which circuit or stage is not functional.

In nine out of ten instances, you can do so without even removing the back of the TV set! (Talk about fast estimates)

— INTERMITTENTS —
NO PROBLEM WHATEVER !

Leave the TV set's AC cord plugged into your Mark VII, leave the computer turned on, and go home for the weekend!

As soon as the set shuts down, or otherwise fails, the Mark VII will "Zero In" on **why** it failed, lite and latch the proper indicator light, automatically turn itself and the TV set off, then, sit there idle (with one light lit) awaiting your return.

All this by just plugging in the AC cord.
No other connections are required.

(In certain cases of low end, LV regulator shut down, you may have to bridge the LV regulator with an LV rect. other than this occasional inconvenience, no other connections are required. An adapter plug is provided for such instances.)

With a Mark VII you could accurately diagnose 400 TV sets down to circuit level in one 8 hour day. Unfortunately, you won't be able to replace the defective parts that quickly!

DIEHL

Call (806) 359-0329 for more info
 6661 Canyon Dr. • Amarillo, TX 79110

News

NPEC '86 management seminars

Three different management seminars will offer business management information at the 1986 National Professional Electronics Convention. The convention is being held Aug. 4-9, at the Tropicana Hotel in Las Vegas.

An early bird basic management seminar on Monday, Aug. 4, led by Gerry McCann CSM (Louisiana), will feature basic marketing and merchandising.

Featured at the Tuesday management seminar is Dr. Alan Carsrud, manager of the University Research Associates at the University of Texas. This all-day seminar will cover topics in small business development, strategic planning and capitalizing on human resources.

At the Saturday afternoon seminar, Roger Jones CSM (Florida) will discuss his "Five-Year Gold Mine," talking about pricing practices and how to make a profit on warranty service.

The 1986 NPEC also will include technical seminars, a conference for electronics instructors, the annual trade show, golf and tennis

tournaments and six evening cocktail and dinner parties.

The tax-deductible registration for NPEC '86 is \$140 per person and \$110 for each additional person from the same family or business. Registration after June 15 or at the convention door is \$150 single and \$120 for additional people. The daily registration fee is \$40.

For more information and registration forms, contact NPEC '86, 2708 West Berry St., Fort Worth, TX 76109; 817-921-9061.

Resident VCR training schools

For those of you who may have missed the end-of-June VCR training sessions set up by the Electronic Industries Association/Consumer Electronics Group in Tampa, FL, and Denver, here is good news: there are later sessions scheduled for these cities and, additionally, in Chicago.

These schools will teach a 5-day hands-on curriculum, using their instructors. The classes are for technicians currently working in the consumer electronic service industry and will be free of charge. The EIA/CEG also will supply training and handout material.

The training session will cover the basic electrical functions of playback, recording and servo control. Mechanical operation also will be included. Both VHS and Beta

formats will be covered.

Enrollment requirements: Technicians must be currently employed in a consumer electronics servicing capacity. Applications for enrollment must be submitted on company letterhead and signed by owner or superior. The application must specify the workshop location and date desired. All applications must be submitted to Don Hatton, Electronic Industries Association, Product Services, 2001 Eye Street NW, Washington, DC 20006.

Locations and Dates:

Illinois Technical College
506 S. Wabash Ave.
Chicago, IL 60605

Aug. 25-29 (Monday through Friday)

Room and board available at \$107 for the week.

United Electronics Institute
4202 Spruce St.

Tampa, FL 33607

Sept. 29-Oct. 3 (Monday through Friday)

Lodging available at local Holiday Inn or Howard Johnson's.

Denver Institute of Technology
7350 N. Broadway

Denver, CO 80221

August 25-29 (Monday through Friday)

Lodging available at local motels.

ES&T

ELECTRONIC

Servicing & Technology

Editorial, advertising and circulation correspondence should be addressed to: P.O. Box 12901, Overland Park, KS 66212-9981 (a suburb of Kansas City, MO); (913) 888-4664.

EDITORIAL

Nils Conrad Persson, *Editor*
Carl Babcoke, *Consumer Servicing Consultant*
Dan Torchia, *Group Managing Editor*
Marjorie Riggan, *Associate Editor*
Joy Culver, *Editorial Assistant*
Darryll Fortune, *Editorial Assistant*
Sondra D. Williams, *Editorial Assistant*

CONSULTING EDITORS

Homer L. Davidson
Christopher H. Fenton
Bud Izen
Victor Meeldijk
Kirk G. Vistain
Sam Wilson

ART

Kevin Callahan, *Art Director*
Tim Lynch, *Graphic Designer*

BUSINESS

Cameron Bishop, *Group Vice President*
Eric Jacobson, *Publisher*
Greg Garrison, *Sales Manager*
Stephanie Fagan, *Promotions Manager*
Kelly Hawthorne, *Marketing Assistant*
Dee Unger, *Advertising Supervisor*
Karen Royall, *Advertising Coordinator*

ADMINISTRATION

R. J. Hancock, *President*
John C. Arnst, *Circulation Director*
Jo Ann DeSmet, *Circulation Manager*
Dee Manies, *Reader Correspondent*



Member, Audit Bureau
of Circulation



Member, American
Business Press



Member, Electronic
Servicing Dealers
Association

ELECTRONIC SERVICING & TECHNOLOGY is the "how-to" magazine of electronics. It is edited for electronic professionals and enthusiasts who are interested in buying, building, installing and repairing consumer electronic equipment. This includes audio and video equipment, microcomputers and electronic games.

SUBSCRIPTION PRICES: one year \$18, two years \$30, three years \$38 in the USA and its possessions. Foreign countries: one year \$22, two years \$34, three years \$44. Single copy price \$2.25; back copies \$3.00. Adjustment necessitated by subscription termination to single copy rate. Allow 6 to 8 weeks delivery for change of address. Allow 6 to 8 weeks for new subscriptions.

PHOTOCOPY RIGHTS: Permission to photocopy for internal or personal use is granted by Intertec Publishing Corp. for libraries and others registered with Copyright Clearance Center (CCC), provided the base fee of \$2 per copy of article is paid directly to CCC, 21 Congress St., Salem, MA 01970. Special requests should be addressed to Eric Jacobson, publisher. ISSN 0278-9922 \$2.00 + 0.00

INTERTEC
PUBLISHING CORPORATION

©1986 All rights reserved.

— NOTICE —

If your company is confronted with troubleshooting or otherwise repairing a certain type, or piece of equipment on a frequent basis - - -

i.e. TV sets, VCR's, Electronic Cameras, Copy Machines, Amplifiers, Industrial Controls, Answering Machines, Radios, Robotics, Bio Medical, Military, Avionics, etc., etc., etc., - - -

The odds are staggering that we could custom program one of our Mark VII computers to accurately isolate any failure in any such device (down to circuit level) in less than two seconds!

INTERMITTENTS POSE NO PROBLEM

(See our display ad on page 7)

DIEHL

6661 Canyon Drive • Amarillo, TX 79110

Feedback

LCD vs. CRT

I would like to comment on your editorial in the January 1986 issue of the *Electronic Servicing and Technology* magazine.

I agree with you regarding vacuum tubes, heavy consumption of power, etc., however, to pick on the picture tubes as being an anachronism is unfounded; the LCD technology that you speak of may be many years away.

I feel that you wrote this editorial with technology in mind only and not the servicing portion of which I am involved. Your last paragraph states that with the coming of the LCD to replace the picture tube all good will happen. You say "There goes the high voltage," but that's not good for us in servicing, where 80% of problems are in the high voltage. You say, "The possibility of getting bit by 30,000-odd volts will be gone." How often are qualified technicians getting "bit"? You say "No more high-vacuum devices just waiting for you to be careless with a screwdriver or pair of pliers."

Come on Mr. Persson! How many technicians are inside a television with screwdrivers and pliers. You make us out to be either reckless or auto mechanics.

You say "no more flyback transformers or retrace lines when things aren't working properly." We need flyback transformer and retrace lines to remain in service.

I have been in TV service for 25 years and realize that changes and refinements are always being introduced but please give us (those who are in TV-Video service) some respect.

I enjoy your magazine and have been a subscriber for many years and will continue to subscribe to the magazine. However, I do hope that you will give due consideration to my letter.

Gus Robino
Gus Robino's TV Service
Malvern, PA

Thank you for your thoughtful comments about the January editorial.

If that editorial suggested to you or other readers that I lack respect for consumer electronics servicing technicians, or that profession, I apologize. I have the deepest respect for servicing technicians and the profession. Through my attendance at meetings and conventions of such groups as NESDA, NATESA and ETA, I have come to know and count as friends many of you.

You may be correct that LCD technology for TV pictures may be years away. In fact LCD technology may never be generally used in TV. I was speculating; one of the vices editors are generally allowed. But even if nothing comes along for many years to replace the CRT, I feel that compared to the rest of the advanced components and circuits in a modern TV set, the picture tube is a clunky, power-wasting anachronism. That's merely my opinion, not a statement of fact. I might be wrong.

And I did not mean to imply that technicians are reckless or careless. I meant to imply that a picture tube presents hazards of both high voltage and high vacuum, and one misstep by even the most careful technician can lead to damage to the television and/or injury to the technician.

And now to the most difficult question. You state that "We need flyback transformers and retrace lines to remain in service." I know that increasing reliability of TV sets and other consumer electronics products has not been good for many servicing technicians. The fact that advancing technology has exacted a toll on a profession that I care deeply about saddens me. But improvements in performance and reliability of consumer electronics products are inherently good, and enhance the quality of life. I have to be happy about that.

I don't know of anyone who isn't happy that his tires now can last 40,000 or more miles, oil changes come at longer intervals, spark plugs last 20,000 miles. Product improvements like this mean that autos, televisions, and every other kind of product are in use more by the owner and in the shop less. Great!

But recent developments have led to the purchase of huge numbers of other electronics products like VCRs, video cameras, compact disc

players, computers, disk drives and printers, many of which have moving parts that wear out, break down or go out of adjustment, and are therefore less reliable and will help keep astute servicing technicians busy for years to come.

Conrad Persson

Homer Davidson fan

Thank you for the article on "Shutdown..." by Homer Davidson (December '85 issue). Kindly say if Homer has written any book on TV troubleshooting.

I very much enjoy reading his articles and have learned a lot from them.

Enever Naggar
152 Bliss Road
Longmeadow, MA

A number of his books have been published by Tab Books, Inc., Blue Springs Summit, PA. Among these are several concerning TV repair.

Letter to Sam Wilson

The forward current transfer ratio for a transistor in a common collector configuration or h_{fc} or I_c/I_b can hardly be considered an unusual transistor parameter! ("What do you know about electronics—Capacitors and triggers," *ES&T*, March 1986.)

Certainly, the use of gamma to denote h_{fc} was unusual but I thought that the equations were self explanatory and left no doubt in the mind that gamma, in this particular instance, was being used to denote h_{fc} . To prove it, simply substitute I_c/I_b for beta and I_c/I_e for alpha in the equations and solve for gamma!

The relationships you listed (stated in h-parameter terms) can be found in any good transistor circuits text, not only for the forward current transfer ratio but also h_i , h_o and h_r in terms of the various configurations.

I enjoy your articles and I commend you for the professionalism within them. I am forced to put on the thinking cap sometimes and reach for my reference books (to keep you honest). The knowledge I have gained as a result makes the price of the magazine cheap indeed.

Roy F. Graves C-29382
Soledad, CA

WARRANTY WORK

When you compare time spent to pay received, you might find it difficult to survive on some of the warranty allowances in today's market.

If so, this ad will serve as a reminder - - -

In less time than it takes you to print the customer's name on a warranty tag, a Mark VII computer will diagnose the failure down to circuit level. In most cases it will do so - - - without even removing the back!

If your local factory field service representative says it can't be done, remind him that **Diehl** will pay any engineer / technician a year's wages who can troubleshoot just three of his most familiar TV sets, before a Mark VII can troubleshoot thirty!! Hopefully, this challenge will either cause him to take his foot out of his mouth, - - - or finish putting it in!

— INTERMITTENTS POSE NO PROBLEMS —

(See our display ad on page 7)

DIEHL

Call (806) 359-0329 for more info.

6661 Canyon Drive • Amarillo, TX 79110

New power switch for HVICs

Engineers from the General Electric Research and Development Center have released a progress report on its work with a new type of power switch that has the potential to be *built into* high-voltage integrated circuits (HVICs) to increase their power-handling capability.

By incorporating the new type of switch in HVIC microchips, it will be possible to boost the microchip's current rating by a factor of 10—to an ampere or more. This would enable system designers to decrease the chip count, and thus enhance reliability, by reducing or eliminating the need for discrete power switches.

Known as the lateral insulated gate transistor (IGT), the new type of switch has much in common with its cousin, the vertical IGT, a revolutionary device GE pioneered in the early 1980s. Like the vertical IGT, the new experimental device merges power MOSFET and bipolar transistor technologies to achieve the best features of each: high current density with low drive-current requirements.

A fundamental difference between the vertical IGT and the new lateral configuration now under development is in the placement of the contacts. In the vertical IGT, the anode contact is at the bottom of the device. In the

lateral IGT, the anode is on the top surface (along with the cathode and gate).

This configuration makes the lateral IGT compatible with standard monolithic integrated circuit fabrication processes, including those employed to fabricate HVICs. In addition, the relocation of the anode contact from the substrate to the surface permits more than one of the devices to be used on a single chip, particularly when all devices use a common cathode potential.

Beyond their compatibility with standard IC processes, lateral IGTs have potential performance advantages over existing devices

Smallest color video camera

Electronic components have gotten so small that it's now possible to manufacture a TV camera that you can hold in the palm of your hand. By separating the camera head (lens and charge-coupled-device image sensor) from the rest of the camera's electronics, engineers have developed a video camera device that's roughly the size of a human thumb.

According to the manufacturer, Toshiba Corporation, this camera, when used in combination with a TV monitor screen, can monitor superb color images that surpass the quality obtained when using conventional half-inch video camcorders, and the pictures can be recorded using a video cassette recorder.

"Our main objective in developing this system was to create a very compact and even more useful video camera system for industrial applications," explains Takehiko Kotoh, general manager of Toshiba's audio-video products engineering laboratory. "Sepa-

rating the camera head and the control unit will create a variety of new applications for video cameras in such fields as TV broadcasting, manufacturing robotics and medicine."

Broadcasters can use this system as a candid camera. The small camera head can be incorporated into the tip of a robot's arm without enlarging the arm's size. Such positioning will not hinder the robot's free movement during delicate or hazardous work, while allowing the camera to focus on whatever the "arm" can reach.

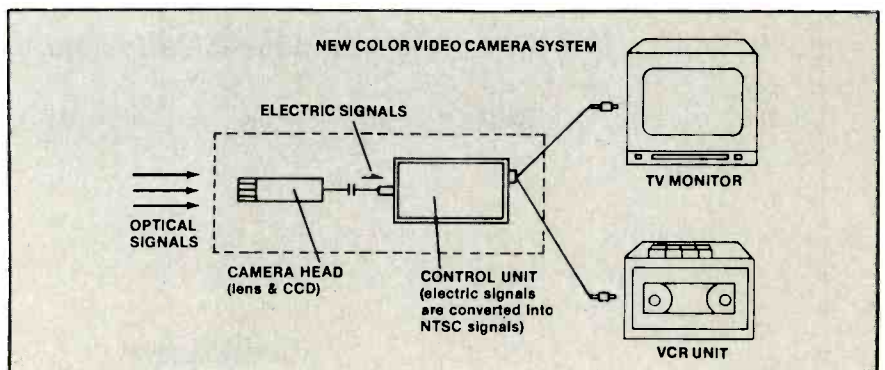

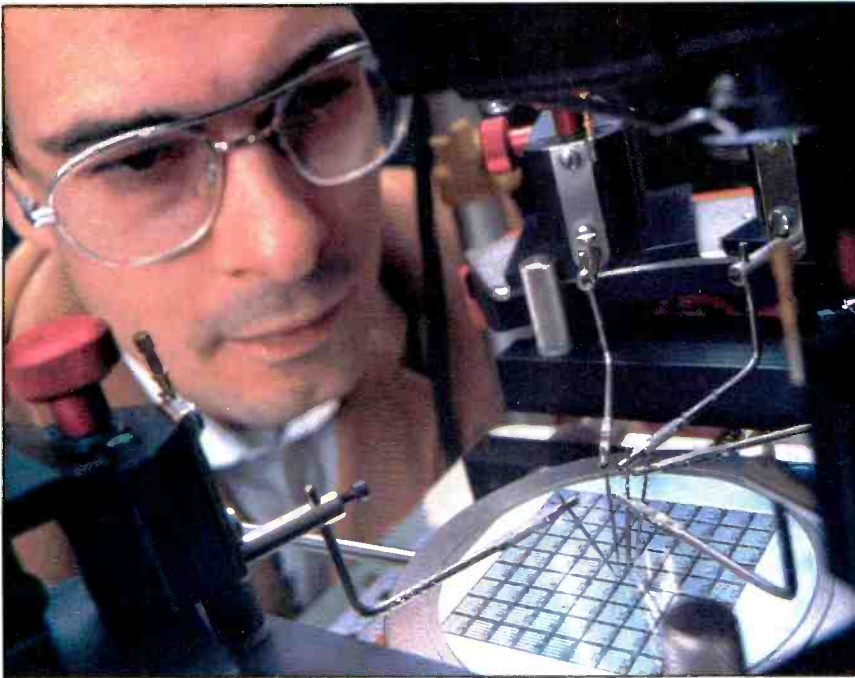

Photo courtesy General Electric Research, Development Center)

Preparing to test a wafer containing dozens of lateral IGTs is Dr. Eric J. Wildi, a member of GE's R&D Center development team.

of their type. In particular, they are amenable to design *tricks* that suppress latching of the parasitic thyristor contained in all IGT

structures. Latching of this parasitic device can cause loss of gate control.

In a technical paper presented at

the 31st International Electron Devices Meeting, Dr. Andrew L. Robinson of the GE Research and Development Center in Schenectady, NY, reported on three techniques he and his colleagues have developed to increase latching current in lateral IGTs. Employing these techniques, they have fabricated experimental devices that latch at 510A per square centimeter—more than twice the previously reported high-water mark—as well as devices that current-limit at 475A per square centimeter without latching.

The paper, co-authored by Drs. Deva N. Pattanayak, Michael S. Adler, B. Jayant Baliga, and Eric J. Wildi, also describes enhancement based on 2-dimensional computer modeling that could increase the lateral IGTs' present current-handling capability by about 30%.

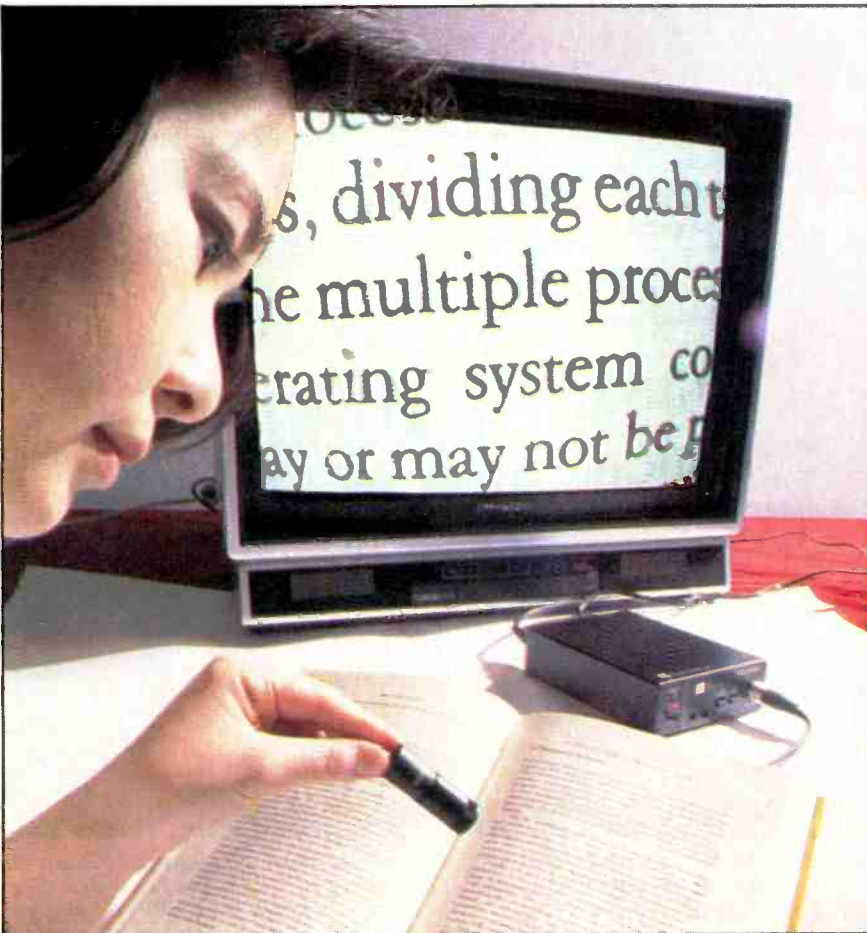

Photo courtesy Toshiba Corporation

System configuration

Inside the camera head, optical signals coming in through the wide-angle lens are turned into electric signals by the CCD image sensor with 200,000 picture dots. These signals are sent down two meters of cable to a control unit where they are processed into standard NTSC TV signals that can be fed to a monitor screen or a video cassette recorder. Aperture and focus can be adjusted manually at the head.

Toshiba's engineers achieved the tiny thumb-sized head by developing LSI packaging technology to incorporate the CCD image sensor into less than one-fourth the area currently required for mounting this type of chip. To get the desired color image reproduction, Toshiba developed an innovative color filter put on top of the CCD sensor. The new filter, using yellow, cyan and green elements instead of red, green and blue helps create natural-tone pictures of unmatched, consistent clarity.



Sharp High and Low Voltage Circuits

By Homer L. Davidson

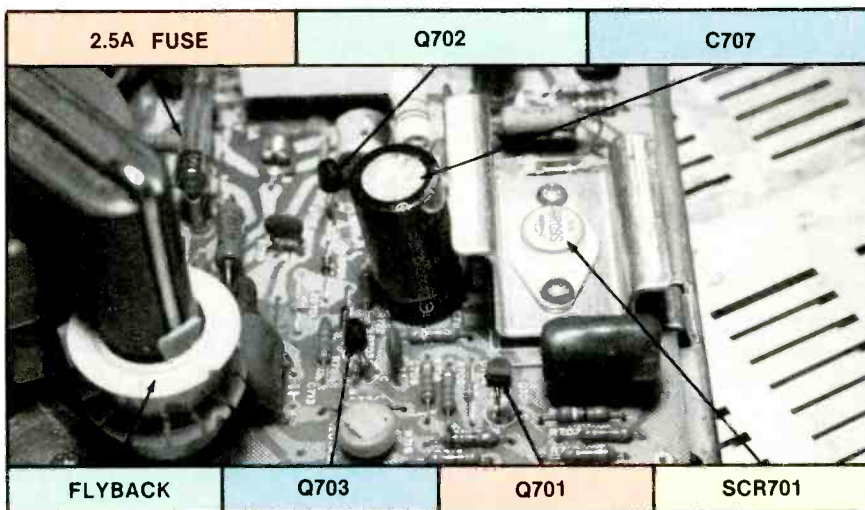

Major components of the SCR low-voltage regulator are identified by arrows in this photograph that shows the regulator corner of the Sharp 19A61 circuit board.

Television manufacturers often use successful circuits (with only minor changes) for several consecutive model years. For example, the low-voltage and high-voltage systems in Sharp's 19A61, 19A63, 19A65 and 19A69 models (Photofact 1678-2) are very similar to those in the newer C and D series.

Essentially the same SCR-regulation circuit (with several modifications) is used throughout the Sharp color TV line. Later models combine the three timing and driving transistors of Figure 1 into one integrated circuit (Figure 2). Basically the same type of regulation is used in current models with the G4 chassis.

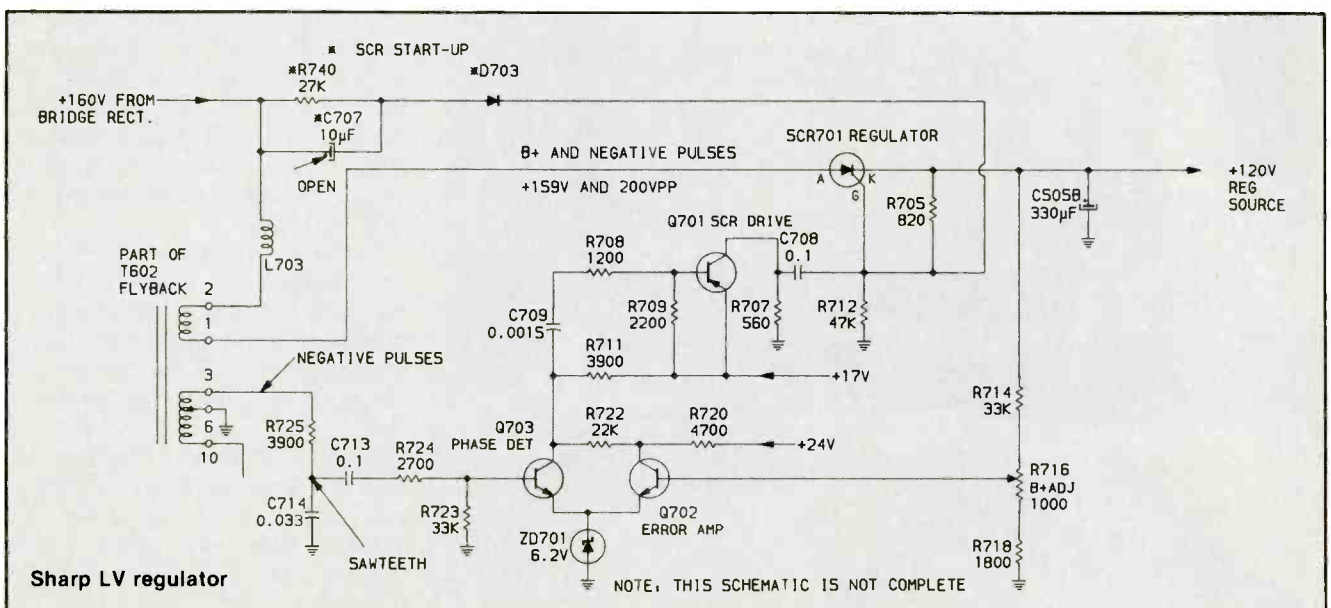
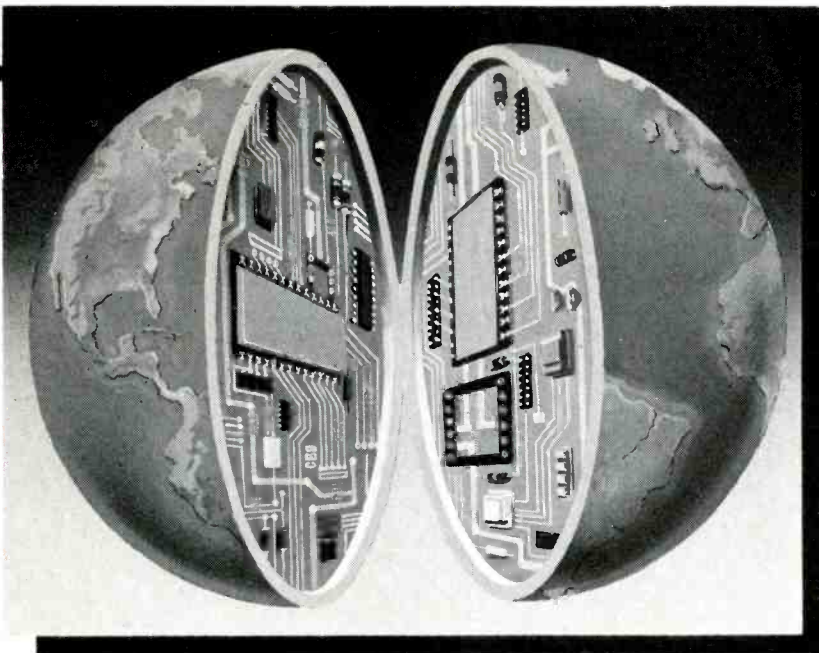

Figure 1. The complete SCR-regulated +120V-source system in simplified form is shown here. A few components that are not very important to the operation have been deleted, making the circuit operation easier to follow. When you have read these pages you might want to mark them because Figure 1 is referred to many times. The schematic shows: (1) the SCR701-regulator and its circuitry; (2) a start-up circuit for the SCR; and (3) a 3-transistor circuit that determines when the SCR should be gated-on.



CIE MAKES THE WORLD OF ELECTRONICS YOURS.

Today's world is the world of electronics. But to be a part of it, you need the right kind of training, the kind you get from CIE, the kind that can take you to a fast growing career in business, medicine, science, government, aerospace, communications, and more.

Specialized training.

You learn best from a specialist, and that's CIE. We're the leader in teaching electronics through independent study, we teach only electronics and we've been doing it for over 50 years. You can put that experience to work for you just like more than 25,000 CIE students are currently doing all around the world.

Practical training.

You learn best with practical training, so CIE's Auto-Programmed® lessons are designed to take you step-by-step, principle-by-principle. You also get valuable hands-on experience at every stage with sophisticated electronics tools CIE-designed for teaching. Our

4K RAM Microprocessor Training Laboratory, for example, trains you to work with a broad range of computers in a way that working with a single, stock computer simply can't.

Personalized training.

You learn best with flexible training, so we let you choose from a broad range of courses. You start with what you know, a little or a lot, and you go wherever you want, as far as you want. With CIE, you

can even earn your Associate in Applied Science Degree in Electronics Engineering Technology. Of course, you set your own pace, and, if you ever have questions or problems, our instructors are only a toll-free phone call away.

The first step is yours.

To find out more, mail in the coupon below. Or, if you prefer, call toll-free 1-800-321-2155 (in Ohio, 1-800-523-9109). We'll send you a copy of CIE's school catalog and a complete package of enrollment information. For your convenience, we'll try to have a representative contact you to answer your questions.

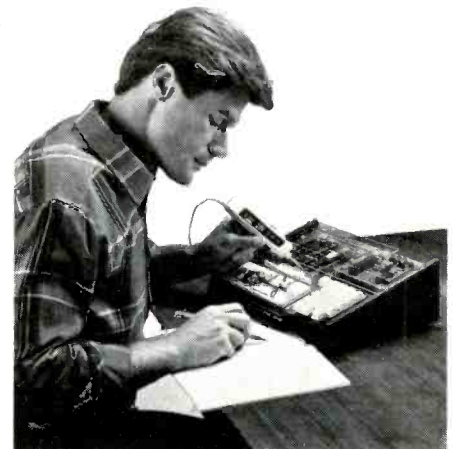

ES-09

CIE Cleveland Institute of Electronics

1776 East 17th St., Cleveland, Ohio 44114

YES! I want to get started. Send me my CIE school catalog including details about the Associate Degree Program. I am most interested in:

- | | |
|--|---|
| <input type="checkbox"/> computer repair | <input type="checkbox"/> television/high fidelity service |
| <input type="checkbox"/> telecommunications | <input type="checkbox"/> medical electronics |
| <input type="checkbox"/> robotics/automation | <input type="checkbox"/> broadcast engineering |
| <input type="checkbox"/> other _____ | |

Print Name _____

Address _____ Apt. _____

City _____ State _____ Zip _____

Age _____ Area Code/Phone No. _____

Check box for G.I. Bulletin on Educational Benefits

- Veteran Active Duty

MAIL TODAY!

OR CALL TOLL FREE 1-800-321-2155 (In Ohio, 1-800-523-9109)

Circle (5) on Reply Card

Circuits necessary for low-voltage regulation

The following circuits are required in the Sharp television for proper operation of the regulated low-voltage supply:

- a bridge-rectifier power supply with filter capacitor;
- the SCR701-regulator SCR and its circuitry;
- a 3-transistor circuit that determines when the SCR should be gated-on;
- a start-up circuit for the SCR;
- the horizontal-deflection system.

When switched on without the start-up circuit, a Sharp 19A61 will have no sound, no raster, no horizontal or vertical deflection and no voltage from the +120V supply. Yes, a start-up circuit *must* operate each power-up time. *But this start-up* is not applied directly to the horizontal-deflection system, as is customary, but instead *is applied to the SCR regulator*.

Before operations of the phase detection and pulse-driving circuits (with three transistors that control the SCR conduction times) are described in detail, it is necessary to explain other vital circuits and how they are connected together.

Low-voltage power

A circuit breaker at the 120Vac input and a 2.5A F701 fuse at the B+ output of the low-voltage bridge rectifier protects the Sharp 19A61. Positive dc voltage from the bridge rectifier is applied to the SCR regulator and also through R612 and R613 in parallel to the +12.64V supply, which is regulated by 12V zener-diode ZD601. This +12.64V supply is applied to the horizontal and vertical oscillators at all times. B+ for the horizontal-driver transistor and the horizontal-output transistor is supplied by the +120V regulated source. Therefore, a special start-up circuit is not needed for the *horizontal* system. Other low dc-voltage sources are produced by rectification and filtering of signals from the T602 flyback transformer. None of these components or circuit connections are shown in Figure 1. The schematic was kept very simple (several components of lesser importance have been omitted) so the +120V SCR-

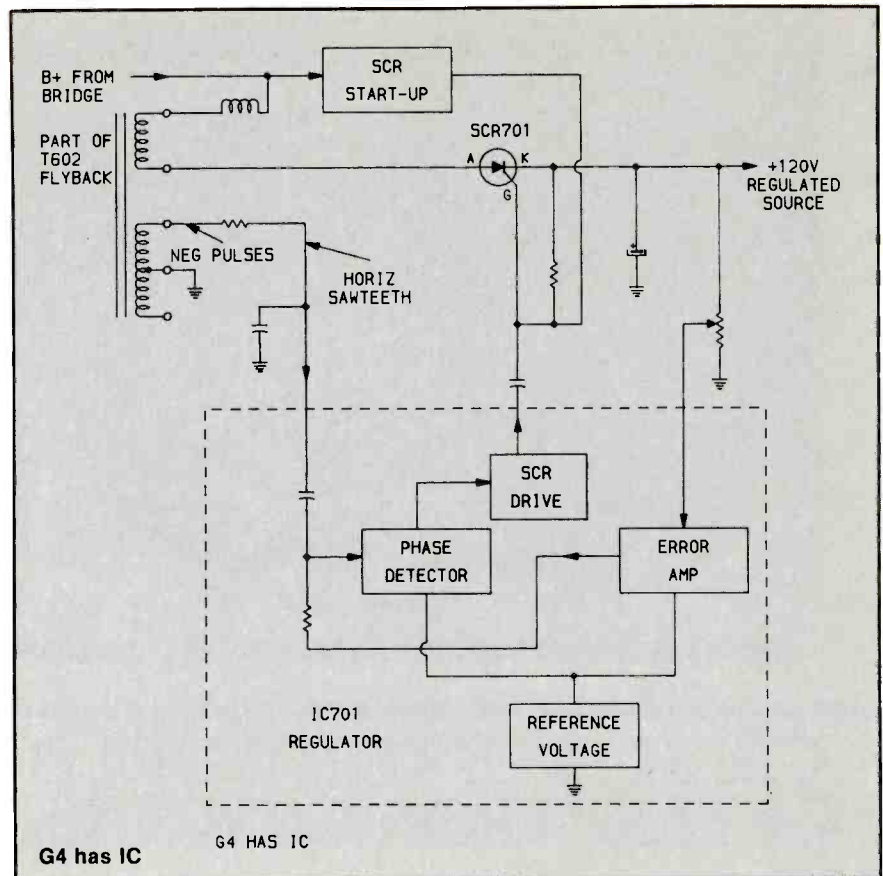

Figure 2. This circuit is the same as the one in Figure 1, except the three transistors have been placed into an integrated circuit, IC701. Some of the trouble-shooting dc-voltage tests are not possible, and the entire IC must be replaced when only the equivalent of one transistor is defective. These IC versions of the SCR turn-on circuit are used in the G4 Sharp model.

regulator operation should be more easily understood. Refer to Photofact 1678-2 if the bridge rectifier and other omitted parts of the schematic are to be tested.

SCR-regulator basics

Operation of this (or any similar) SCR-regulator circuit is based on the operation of the SCR as a series switch to break up the dc voltage into variable-duty-cycle dc pulses that are integrated by a large-value peak-reading capacitor (C705B in the Sharp circuit). For example, dc pulses with widths of 25% of one cycle produce a filtered dc voltage measuring 25% of the source dc voltage. A 50% duty cycle (symmetrical dc square waves) yield 50% of the input dc voltage. Likewise, a 100% duty cycle produces 100% at the output (a shorted SCR?)

Conduction of the series-connected SCR is started by one signal and terminated by another signal.

In the Sharp 19A61 circuit, the dc voltage at C705B (the +120V

source) is determined principally by the time (each cycle) between gating the SCR into conduction and stopping the SCR current with the next negative anode pulse. Longer conduction times increase the regulated voltage, while shorter times decrease the voltage. That is the basis for this regulation. To provide automatic regulation, circuits must vary this conduction time as needed to maintain exactly +120V.

Because the turn-off time is not variable, the phase comparison and driver circuits must adjust the time during each horizontal cycle when SCR701 conduction is initiated. That function is assigned to Q701, Q702 and Q703. Of course, this circuit must be synchronized to the receiver's horizontal sweep. R716 can be adjusted to bring the +120V source voltage into tolerance.

Another operation of the regulator that seldom is mentioned is the rectification by the SCR701 anode of all positive portions of the negative-going pulses,

the ones coming from the flyback to the SCR anode. Because the pulses are negative-going, the positive-dc voltage from their rectification alone would not be very high, but the +159V (that is present also at the SCR anode) moves the waveform's zero line 'way down on the waveform, allowing rectification of a much greater amplitude. Therefore, both on/off switching of the dc voltage at the anode and rectification of the pulse waveforms contribute to the +120V regulated voltage. On time of the on/off dcV switching is variable according to load on the +120V regulated source, although the voltage produced from waveform rectification does not vary much with load changes (only line-voltage variations significantly affect the rectification contribution).

Proof that waveform dcV and on/off dcV both add to produce the desired +120V can be obtained by analysis of the SCR701 waveform in Photofact 1678-2. And detailed proof was included in two previous **Electronic Servicing & Technology** issues. In the August 1985 issue, an explanation of phase-detector sawtooth operation for NAP E30 is given in paragraph 2 on page 11, while page 14 shows scope waveforms of sawteeth made from pulses. These waveforms illustrate how a different dc voltage can be obtained from each point on the dc sawtooth slope.

Page 10 of the May 1985 issue is a detailed explanation of SCR regulation for the 19C4 Sylvania. Simple mathematics from actual measurements shows that *chopper* action could not possibly account for so much regulated voltage. Page 12 shows simplified schematics of an SCR regulator and how rectification of the SCR pulse waveform increases the regulated voltage. Page 16 is a teaching visual about dc-pulse integration illustrated with real scope waveforms. Pages 18 and 19 show more important facts about SCR regulation, with scope waveforms and a Sylvania schematic. Page 60 has more unretouched waveforms and explanations.

SCR-regulator circuits of this type often are called *choppers*. Although the term is catchy and has value for its brevity, the name

does not apply exactly because of several important differences. For example, the SCR anode-current waveform does not have fast rise and fall times and sharp corners, as might be expected from a dcV chopper. Instead the anode current is nearly a sawtooth with rounded corners (the current cannot change rapidly through L703 and the pins 1-to-2 flyback winding combined inductances. Remember the signal operates at 15,734Hz). And of course, a plain chopper would not have the 15,734Hz negative-going pulse waveform at the SCR anode. As explained before, this also adds to the dcV output.

SCR start-up

No elaborate start-up circuit for the *horizontal-sweep* system is required in this model Sharp, because the horizontal oscillator, driver and output transistors obtain voltage from the +120V regulated supply. However, that poses a problem because an ungated SCR701 (Figure 1) is an open circuit that conducts no current when power first is applied. The SCR can have a high positive-dc anode voltage, but there will be no anode/cathode current until a minimum (or higher) positive voltage (relative to the cathode) is applied to the gate). Then the anode/cathode path becomes a near short that continues until the anode voltage and current drop below a certain minimum relative to the cathode. (A positive pulse will gate conduction on just as well as a steady dc voltage can.) During SCR conduction, removal of the positive gate voltage does not stop the conduction; the gate loses control during conduction.

The solution of a non-conductive SCR701 at power-on is a *start-up circuit* that applies one positive voltage/current pulse to SCR701's gate when ac power first is switched on for the receiver. Therefore, SCR701 is latched in the conducting mode. When the SCR701 cathode (and the +120V source) approaches +120V, the horizontal-sweep circuit begins to operate, including delivery of a strong negative pulse at the SCR701 anode to turn off the SCR701 cathode current before the +120V source becomes excessive. At the same time, the

three transistors of the regulator become operational and gate SCR701 into conduction at the precise time during each horizontal cycle that will maintain the +120V regulated supply.

These are the only three components in the SCR start-up circuit: C707; R740; and D703. Before ac power is applied to the receiver, C707 has discharged through R740 and is in its discharged state with no voltage and no current. In fact, until current is forced into C707 during start-up, the capacitor is nearly a short circuit (for a brief time). When the dc voltage rises rapidly in C705A as power is switched on, C707 passes a heavy current (detouring around current-limiting R740) through forward-biased diode D703 and on to the SCR701 base where it triggers the SCR into full conduction. With +159V at the anode, the SCR passes a large current, quickly raising the dc voltage in filter C705B and the +120V source. When this voltage becomes high enough, the horizontal-deflection system starts, producing the first negative pulse at the SCR701 anode to stop the anode/cathode conduction, and simultaneously the regulating circuit begins to operate and bring the SCR cathode voltage to about +120V (a control is supplied for critical adjustments and accurate +120V).

When the receiver is turned off, R740 bleeds C707 to the uncharged state, thus making the next SCR start-up possible (it would not be possible if a charge remained in C707 for any reason). Why is D703 included? It is necessary to prevent attenuation of the positive pulse from Q701 that is applied to the SCR701 gate. The Q701 pulses are high impedance; so without the reverse polarity of D703 to block them, the Q701 pulses would be bypassed to ground through C707 and C705A filter capacitor. Check D703 for a short if the set appears to achieve start-up then stops.

Error, phase and drive operations

Q702 monitors the +120V source voltage continuously through R714, R718 and potentiometer R716 (included to allow

precise adjustments for exactly +120V from the regulated source). Emitter voltages for Q702 and Q703 are stabilized by zener diode ZD701. Therefore, any variation of the Q702 base dc voltage is amplified and inverted, appearing at the Q702 collector that is connected by R722 to the Q703 base. *That is the end of the error-correcting function as a dc voltage.*

Next, horizontal-frequency sawteeth are necessary. They are produced by negative pulses from flyback pin 3 that are integrated into sawteeth by series resistor R725 and integrating capacitor C714. These sawteeth are capacitor-coupled to the Q703 base along with the amplified dc error voltage from the Q704 collector. When the amplified-error voltage and the instantaneous dc voltage from the sawtooth reach a certain combined voltage, Q703 suddenly is biased into saturation, producing a negative pulse at the T703 collector. The negative pulse passes through C709 to the PNP Q701 base where it provides forward bias. Q701 emitter draws heavy current from the +17V supply, with the collector current flowing through R707 to ground, and producing a positive voltage pulse across the resistor. This pulse is coupled through C708 to the SCR701 gate, triggering the SCR into conduction. Later, a negative horizontal pulse at the SCR701 anode stops the SCR conduction. That is the end of one horizontal cycle.

Details about sawtooth triggering

Some interesting circuit operations of the three regulator transistors of Figure 1 were omitted previously to avoid confusing the basic descriptions.

Assume a source of 15,734Hz sawteeth and something like a scope to view them. However, no service scope can do what we specify, so instead imagine an observation point with the individual sawteeth passing slowly one by one (or stopped with one) and expanded wide enough to permit a close and accurate visual examination of one tooth at a time. When capacitor-coupled (to remove all dc voltages), each 8VPP

sawtooth will have 0V near the vertical center of the ramp, +4Vdc at the positive peak and -4Vdc at the negative peak. (These figures are from the Sharp circuit.) Well, at least those voltages would be measured if we could stop one cycle and measure it. The 8V range can be shifted up or down by adding dc voltage through an isolation resistor. If +4V is added, the positive peak measures +8V, the center +4V and the negative peak zero. Or if +8 is added, the figures change to +12, +8 and +4V. (These can be proved by a dc dual-trace scope.) On slow scan, each ramp starts at the low positive bottom, rises through higher voltage points and arrives at the highest voltage at the positive peak. During retrace, the beam rapidly falls to the lowest voltage at the negative peak, ready for the next cycle.

...horizontal sawteeth are a vital part of the - 20V low-voltage regulation in the Sharp (and in many other models having similar circuits).

The total dc base voltage necessary to trigger Q703 into saturation conduction always is the same (the emitter is zener stabilized) regardless of the base voltage sources. In other words, the error-correcting dcV from R722 added to the instantaneous dc voltage from the position on the sawtooth must yield the identical dc voltage during all levels of +120V regulation.

Therefore, when the +120V source voltage has decreased, the error-correction voltage at Q703's base becomes more positive (through Q702). Only a low positive voltage is needed from the sawtooth, so the sampling can travel upward just a short distance before the proper medium voltage is reached and Q703 is triggered. The gating-on occurs earlier in the horizontal cycle, SCR701 conducts for a longer period of time, and the +120V source voltage is increased to the desired value.

Also, when the +120V source becomes too high, Q703's base becomes less positive. Therefore, the sawtooth must travel longer (and upward) to a higher voltage before the total voltage is high enough to trigger Q703. The

gating-on occurs later in the horizontal cycle, SCR701 conducts for a shorter period of time and the +120V source is reduced to the correct value.

As you can perceive now, the horizontal sawteeth are a vital part of the +120V low-voltage regulation in the Sharp (and in many other models having similar circuits).

Testing low-voltage and regulator circuits

Troubleshooting low-voltage and SCR regulator circuits in Sharp 19A61 (and similar model) receivers is different than testing other circuits, horizontal sweep, for example. There is no signal passing through the entire SCR-control circuits (those with three small transistors). Signal tracing is not very productive in a non-working television (although the progression from horizontal pulses, to horizontal sawteeth, to horizontal pulses of varying phase is interesting to scope in a normal receiver). The horizontal sweep and the receiver functions cannot operate when the SCR regulator is dead. At the other extreme, the SCR regulator cannot develop regulated voltage without proper operation of the horizontal-sweep system.

An excellent practical approach is to perform a few simple, but important, measurements first. These usually can point you in the right direction. Remember, the sequence of these tests may be rearranged. Begin by trying the following tests and measurements:

- Measure the dc voltage at the anode (case) of the SCR701 and output transistor Q602's collector (case). A higher voltage (perhaps +160V) at the SCR anode and around zero at the Q602 collector usually indicates a defect in the SCR701 regulator circuit.
- A zero voltage reading at both points indicates an open circuit breaker, open 2.5A T701 fuse, defective diode or diodes in the bridge circuit, an open R739 surge resistor, an open in L703 or an open in the pins-1-to-2 winding of T602 flyback. Anyway, those components and others connected to them are the suspects. Test them.
- If the horizontal-output-transistor collector's voltage is low (perhaps +60V to +90V), look for

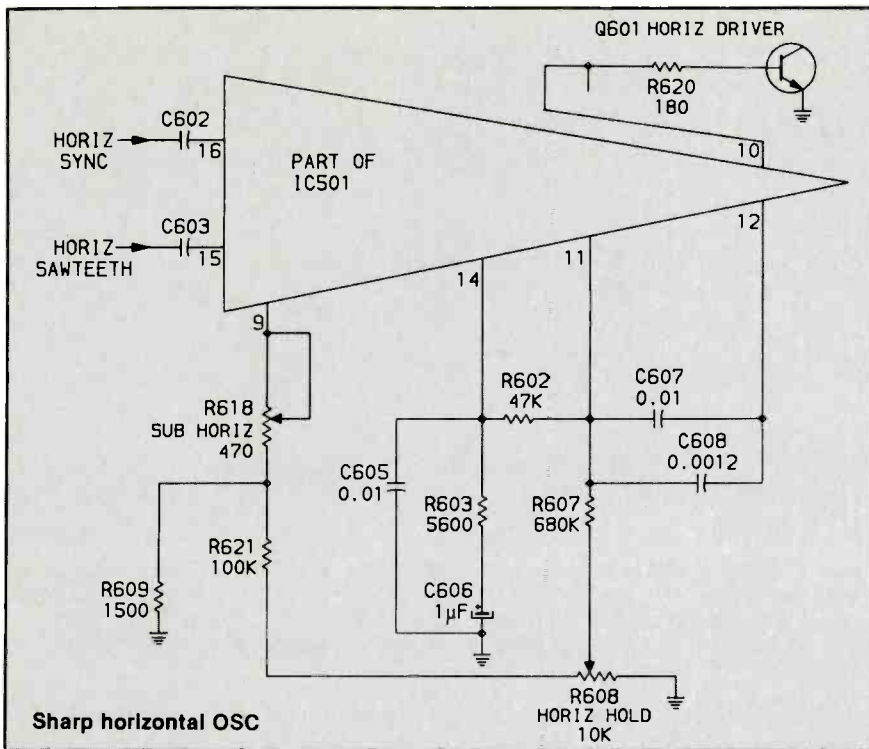
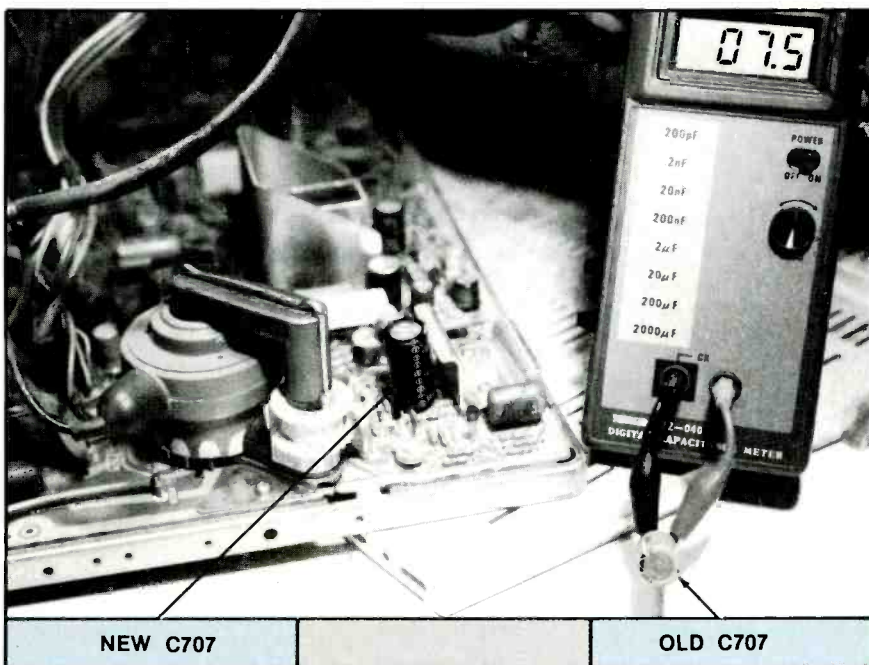

Figure 3. Part of IC501 is used for horizontal-phase detection, horizontal oscillation and horizontal locking. Additionally, a drive signal for Q601 comes from pin 10. Pin 11 connects to the horizontal-frequency (hold) control, while pin 9 has the sub-horizontal frequency control.

Suitable replacements

Q701	2SA562Y	SK3114	FCG290	GE-269 or GE-82
Q702	2SC372	SK3122	ECG123A ECG85	GF-61
Q703	2SC372	SK3122	ECG123A	GE-61
SCR701	S6089	SK3042	ECG6230	

Table 1. The Sharp number is listed with the transistor and SCR numbers, and suitable replacements (where available) are listed to the right.



Arrows point out the newly installed C707 capacitor and the original one as it is tested for capacity.

a defective component in the horizontal-output/flyback area, perhaps a bad M601 tripler HV rectifier.

- As thoroughly as your equipment allows, test these components in-circuit: SCR701; Q602 output; C705A filter, C705B filter and C707 start-up capacitor.
- If none of the major components mentioned before tested defective, and there is a suspicion of problems in the 3-transistor regulator-control circuit, use an accurate digital multimeter to check all resistors in these circuits. Also, use the DMM's diode test (if it is the voltage-drop-across-a-junction type) to check all diodes and transistors in-circuit. Some diodes are zeners that regulate specific voltage for these stages. Test zeners at least for forward voltage drop and reverse leakage.
- Measure the base, emitter and collector voltages of Q701, Q702 and Q703 and compare them against the schematic.
- Most low-voltage and regulator defects will be found by these simple methods. In the few cases where the cause is not located, the tests should give you ideas about further tests or measurements.

Case history: erratic start-up

One Sharp model 19A61 set sometimes would start up when first switched on, but at other times, the start-up would not be achieved and the receiver remained dead. Voltage readings were made one time after it refused to operate. The SCR701 anode (case) measured +169V, and the collector (case) of the Q602 horizontal-output transistor measured around 0V. This was preliminary proof that the SCR regulator was not operating, but the low-voltage supply with its bridge was normal.

SCR701 and the three associated transistors were tested for opens or leakages. Those in-circuit tests showed nothing defective. Then the dc voltages of the SCR and the three transistors were tested with power applied and the results compared with those in PF 1678-2. The decision was that the SCR had not had start-up applied. Because it is possible for a transistor to be intermittent in active service or the SCR701 to have a breakdown under load, we checked the replacement manuals for suitable

substitutes, which are listed in Table 1.

Next all electrolytic capacitors were tested for capacitance using a portable digital readout meter. C711 (the bypass for the +24V source and not shown in Figure 1) measured only 29.5 μ F although it was rated at 47 μ F. Unfortunately, replacement of C711 did not solve the erratic start-up problem.

Capacitor C707 was tested in-circuit twice and a different reading was obtained each time. When disconnected and tested out of circuit, C707 had a capacity of only 7.5 μ F, although Figure 1 calls for 10 μ F. Replacement of C707 with a new 10 μ F 200V capacitor normalized the start-up.

Horizontal oscillator

The older 19A61 Sharp receivers have conventional horizontal circuits beginning with IC501 (Figure 3) that perform many functions including vertical oscillation, vertical drive, horizontal phase detection and horizontal oscillator operation. The horizontal-oscillator frequency is determined by R608 hold-control adjustment, R607, C607, C608 the sub-horizontal-hold control and also by the automatic dc control voltage (coming from pin 14 through R602) that maintains phase lock.

When you check for horizontal drifting, first adjust the R618 sub-horizontal control and the R608 horizontal control for best horizontal locking with stability. If that does not allow satisfactory performance, accurately test the dc voltages at IC501 pins 9, 11, 12 and 14 during good stability operation and again when the drifting is very noticeable. Compare the two sets of figures. (Sometimes sprayed coolant must be applied to IC501 to start the drifting.) If the pin voltages change radically when the stability changes, the problem might be with the external components connected to pins 9, 11, 12 or 14. Check those components.

If the change between stability and instability occurs without significant change of the IC501 dc voltages, perhaps IC501 should be replaced. IC501 (or HA11113) can be replaced with a universal ECG1190. Incidentally, IC501 cannot be installed backwards, because there are more pins on one side than on the other.

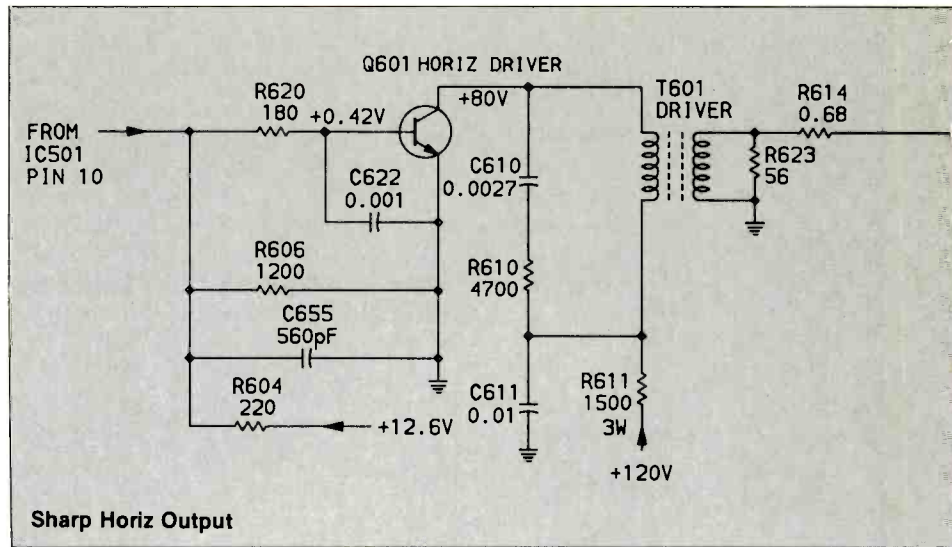

Figure 4. Although the horizontal driver and output stages are conventional, some areas and components are more likely than others to become problems. These include: driver transformer T601; the base resistors and B/E junction of Q602; shorts in Q602; an open C620; arcing in M601 tripler; and opens in R617 and D602 of the +914V boost circuit.

Horizontal driver and output

Conventional again is the word to describe the horizontal driver and output stages (Figure 4). A driver transistor is coupled to the output-transistor base by a step-down-ratio transformer. C613 (0.012 μ F from Q602 collector to ground) is the largest capacitor that tunes the pulses produced during horiz-retrace time. If C613 opens, the high voltage will become excessive and trip the safety circuit. T602's high-voltage secondary winding supplies M601 tripler, which in turn supplies high voltage and adjustable focus voltage. The Q602 collector supplies a +914V B-boost supply for the screen (G2) control. Heaters of the picture tube are supplied by horizontal from T602 flyback pins 8 and 9.

Troubleshooting the horizontal

When the low-voltage/regulator system has been found to be normal but the Sharp receiver has no high voltage or sound, suspect a defective horizontal oscillator, horizontal driver or horizontal-output stage. Although the regulator circuit is not defective, loss of the horizontal pulses to the regulator reduces the usual +120V regulated source to around +78V or lower. Disconnect the tripler's input lead and notice any effect on the abnormal regulated source. If the regulated source rises significantly, the tripler might be defective. With the input

lead removed, the receiver should have sound and +120V regulated source, if the tripler is the cause. We have found few defective Sharp flybacks, perhaps because the high-voltage winding is required to handle only about a third of the usual amplitude. The tripler does as the word implies; it multiplies the dc voltage by three.

If the collector (case) of Q602 horizontal-output transistor measures lower than about +70V, test the driver and Q602 output transistors for leakage. In addition, check the D601 damper diode for leakage. (Figure 4.)

Attempt to scope the horizontal signal from IC501 pin 10 to the Q601 horizontal driver base, the Q601 collector, the Q602 base and finally the Q602 collector. These scope waveforms should reveal where the horizontal signal stops.

Alternatively, inject a low-impedance horizontal drive signal at the Q602 horizontal-output transistor base. If the horizontal output, the flyback and the power supplies operated from the flyback are not defective, a raster and some sound should be obtained, indicating horizontal-system operation. Proper base drive also can produce +120V from the regulated supply source. These results point to problems in IC501 or the horizontal driver. If injection of a Q602 base-drive signal does not produce a raster, sound or proper regulation, the problem is with the Q602 horizontal-output

High-voltage arcs

Most high-voltage arcs occur at the anode connector on the picture tube or around the tripler unit. Arcing between tripler cases and chassis ground occurs often. If you can smell corona from an arc, but cannot see it, darken the tripler area of the chassis and look again for a visible arc. Of course, some triplers arc internally or to a metal chassis bracket where the arc cannot be seen. To locate those, switch *off* the power and feel the case of the M601 tripler. If there are warm areas, replace the tripler.

If the sound of arcing appears to come from the picture-tube anode, switch *off* the power, discharge the anode with a test lead direct to the CRT ground. Then look carefully around the CRT anode button, and around the rubber (plastic?) anode cover for any marks showing where arcs have left their trails. Clean away all marks left by the arcs on the picture-tube glass. If the anode cover is cracked, the cover and the HV wire must be replaced.

Measure the high voltage. If it is above 27.5kV when the brightness is turned down, suspect an open retrace-tuning capacitor (C613, C620 and C619). Check the capacitance of those capacitors and replace any having reduced capacitance.

Reduced brightness but normal high voltage

This symptom calls for measurement and analysis of grid, cathode and screen-grid voltages at the picture-tube socket. When one Sharp was tested, the common screen voltage measured nearly zero. Subsequent analysis proved 10Ω fusible resistor R617 (Figure 4) was open and diode D602 was shorted. (These failures are typical.)

Replacement of R617 and diode D602 restored normal brightness and control.

Comments

Circuits almost identical to these described for the Sharp often can be found in Wards or other private-name television. Servicing knowledge acquired for the Sharp 19A61, therefore, can be of use with other brands.

ES&T

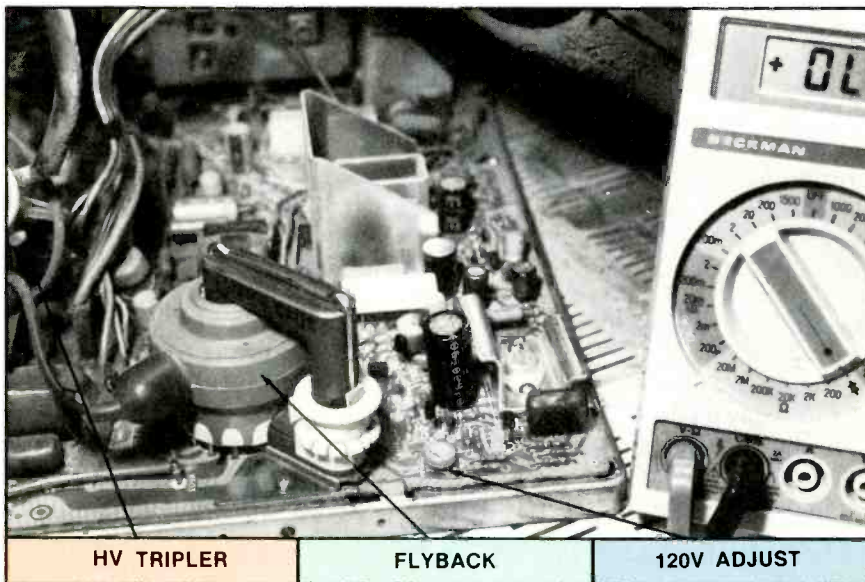
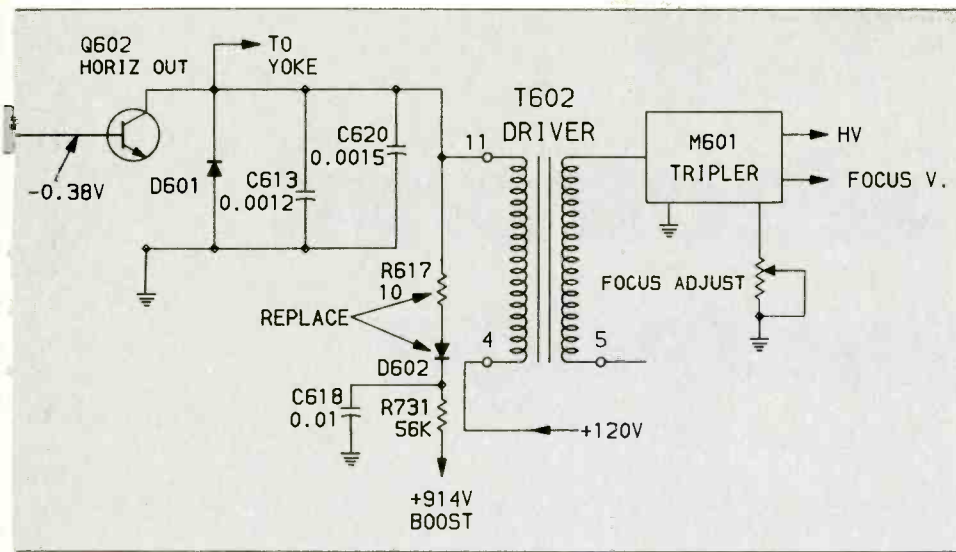

Arrows point to R716 (for adjusting the regulated +120V), the T602 flyback and the M602 tripler.

transistor or the flyback circuits. Before removing Q602 for out-of-circuit tests, disconnect R617 (the fusible resistor for the +914V boost circuit in Figure 4). If disconnection of the +914V supply brings normal horizontal sweep, the diode D602 and R617 resistor probably will require replacement. Incidentally, Q602 can be replaced with a GE-38 or SK3710 universal transistor.

No raster, but sound is normal

B+ for the sound circuits is obtained from supplies rectified and filtered from flyback power. Therefore, normal sound usually is proof the horizontal-sweep system is operating. Measure the high voltage at the picture-tube's anode button, expecting between +25kV and +26kV. If the high voltage is

not between those voltages, be certain the brightness is turned down and recheck the +120V supply voltage, adjusting R716 if necessary. Remeasure the high voltage.

Low high voltage can be caused by a defective tripler (inspect it for leakage paths, hot spots or arcs). Also, low high voltage can be caused by excessive picture-tube current produced by incorrect grid-to-cathode bias or very low cathode voltage at the picture-tube socket. With ac power *off*, remove the CRT socket/board and measure the high voltage again. If it was low before and normally high now, this is proof that incorrect voltages at the CRT socket are causing the reduced high voltage. De-voltage tests with a digital meter should be performed next on the CRT socket.

Test your electronic knowledge

By Sam Wilson

1. Figure 1 shows wires attached to terminals in preparation for soldering. Which of the following is correct?

- A.) The strong mechanical connection in A is preferred.
- B.) The connection in B is preferred.

2. Solder that is designated 60/40 has

- A.) 60% tin and 40% lead.
- B.) 60% lead and 40% tin.

3. Solder for surface mount components has tin and lead. It also has about 3%_____.

- A.) partition noise.
- B.) atmospheric noise.
- C.) thermal agitation noise.

5. Which of the symbols in Figure

2 represents a VDR (Voltage-Dependent Resistor)?

- A.) Both
- B.) Neither
- C.) Only the one marked A
- D.) Only the one marked B

6. You are going to connect a shielded wire between two low-frequency electronic units. In order for the shield to be effective, you should ground it at

- A.) one end.
- B.) both ends.

7. The power company delivers electricity to your house. They charge you for the amount of

- A.) voltage you use.
- B.) current you use.
- C.) energy you use.
- D.) power you use.

8. Which of the following can be used to neutralize the acid of a lead-acid storage battery?

- A.) A 50/50 mix of flour and salt
- B.) Baking soda
- C.) Coca-Cola

9. You have a dc voltage source but you do not know which lead is positive and which is negative. To determine the polarity, stick the two leads into

- A.) distilled water.
- B.) a potato.

10. Is the following statement correct? Sound waves travel slightly slower under the surface of the ocean compared to their speed in air.

ANSWERS to the Quiz

1. B. *Never* make a mechanical connection like the one in A! NASA prohibits it in its systems, and for good reason. If it becomes necessary to unsolder and disconnect the wire, the one in A will very likely destroy the terminal. Use the connection of B.

2. A. With a 60/40 ratio of tin to lead, the solder goes rapidly (but not immediately) from the solid state to the liquid state.

A ratio of 63/37 is called *eutectic*. It goes directly from the solid state to the liquid state at a temperature of 361°F. All other combinations of tin and lead go through a plastic state between solid and liquid; and, they require a higher temperature to get the solder into the liquid state.

3. Silver. Some technicians use 63/47, but it is better to use the solder designed specifically for surface-mount work.

Answers are continued on page 39.

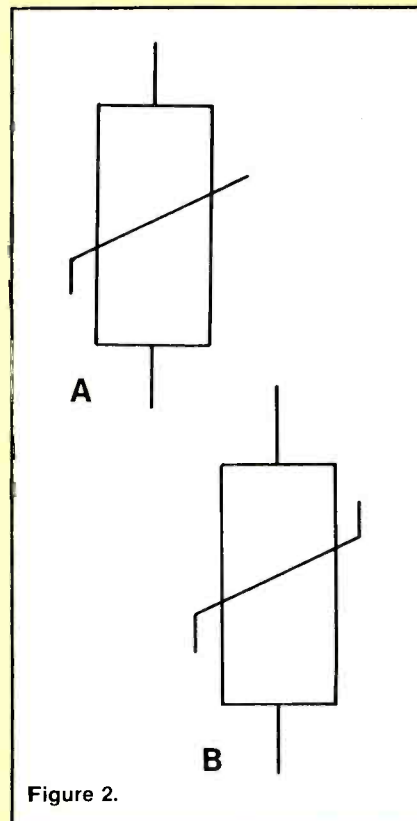
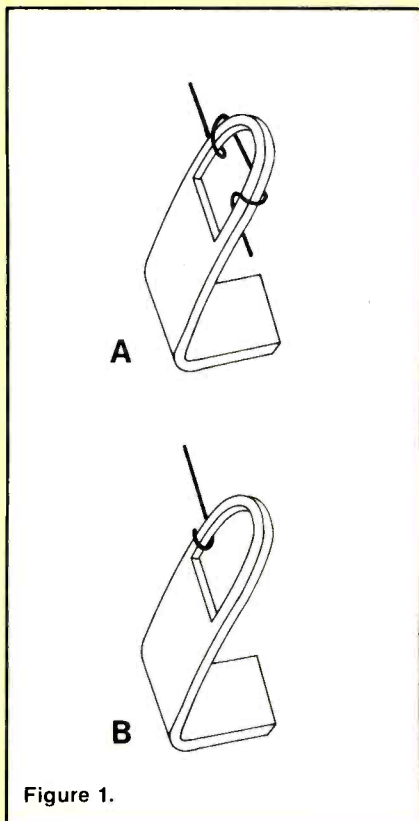

VCR REPAIR MADE EASY

Sams is Your Source for Reliable, State-of-the-Art Service Data for Major VCR Brands

The Sams standard notation format, your tool for 40 years for television and computer repairs, is now being applied to VCR servicing.

Technicians! VCR schematics, troubleshooting data, and parts listings keep you from having to adapt to different schematic styles and layouts each time you service equipment from a different manufacturer.

Become familiar with all the brand-name equipment, delete the guesswork in troubleshooting, and build customer loyalty fast from quality service in this rapidly growing market for VCR repair.

You can depend on the reliability of Sams VCR Technical Service Data. The service data is created in our own labs by Sams engineers. Every board, component location, every grid and waveform is checked and re-checked.

Repair Made Easy . . .

- Color coding of test point locations/voltage measurements and GridTrace™ are exclusive methods of reading schematics and locating components with "road map" coordinates. Circuit boards are depicted in a component-side view.
- Easy-Read Waveforms - Clear reproductions show you exactly what your test waveform should look like.
- Replacement Parts Cross References - Give you choices for equivalent components without costly and time consuming trial and error.
- VCR manuals are approximately 80 pages, 8½ x 11, and loose-leaf bound for easy use. Each manual covers one VCR model.

Sams VCR Technical Service Data is available for \$21.95 each from local electronics distributors, book stores, or from Sams. Ask for details on the "Bonus-Buy Plan" for volume discounts and for Standing Order information.

Faster Repairs. More Business. More Profit!

Technicians! Win Over \$5,000 in Test Equipment!

Just Complete the Order Form Attached and Mail to Sams or Call 317-298-5566 in Indiana, or 800-428-SAMS and Ask for Operator 880

GRAND PRIZE

Sencore

Universal NTSC Video Analyzer

Model VA62

Other Prizes

- B & K Precision-NTSC Signal Generator-Model 1251
- Simpson-Digital Multimeter-Model 464 D-3
- Fluke-Digital Multimeter-Model 8060A
- Tegam, Inc.-Digital Multimeter-Model 130A
- Triplet-Digital Multimeter-Model 3360

Test equipment is supplied to Sams by each manufacturer.

SAMS™

Howard W. Sams & Co.
A Division of Macmillan, Inc.
4300 West 62nd Street
Indianapolis, IN 46268

Find out more about Sams VCR Technical Service Data and Win!

Mail to Sams

Name _____

Company _____

Your Title _____

Address _____

City _____

State _____ Zip _____

Phone _____

List the VCR brands you would like Sams to cover and be eligible to win valuable test equipment by November 1.

Brand Model Brand Model

Mail to: **Howard W. Sams & Co.**
4300 West 62nd Street Department DM
Indianapolis, IN 46268

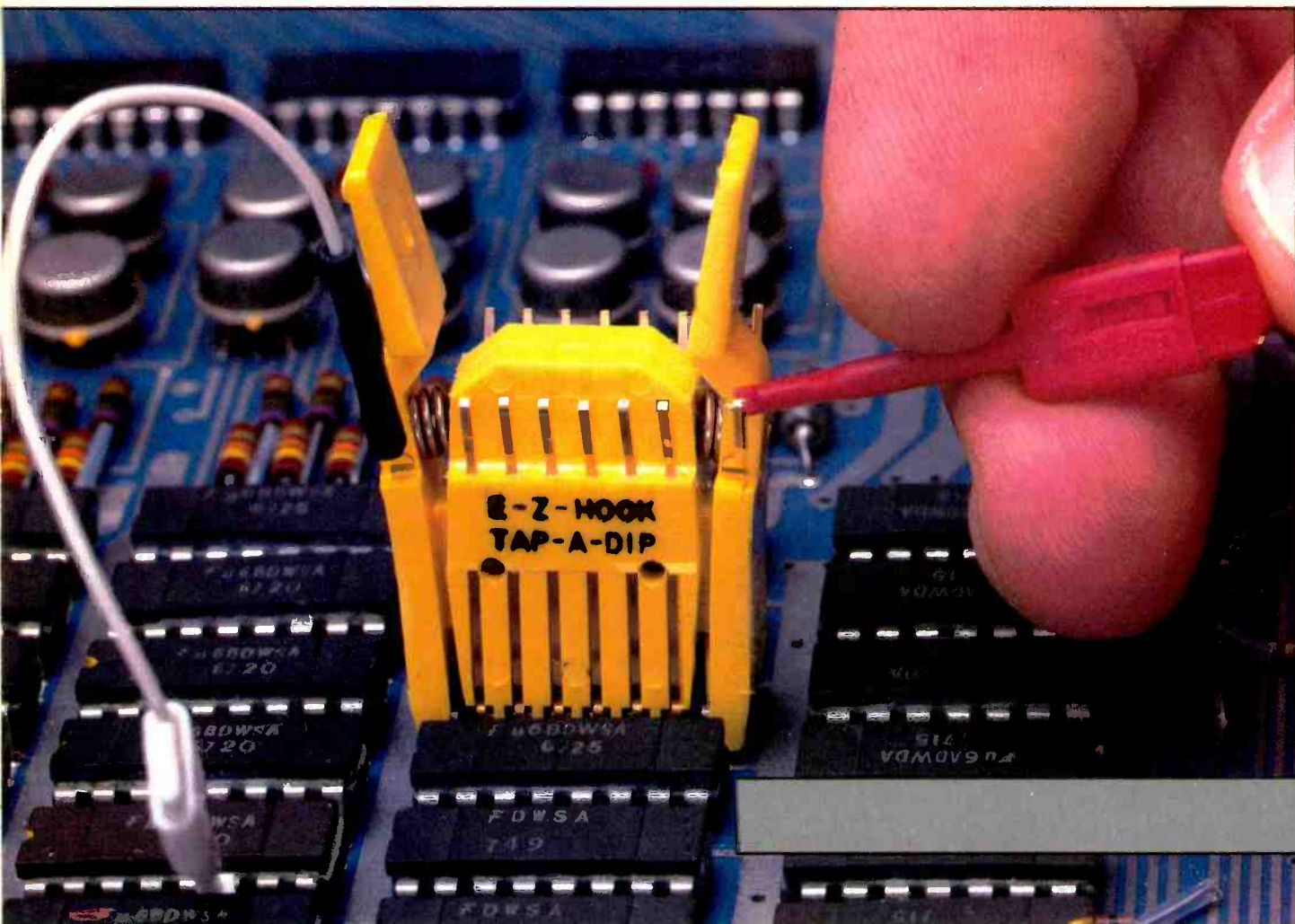

(Photo courtesy E-Z Hook.)

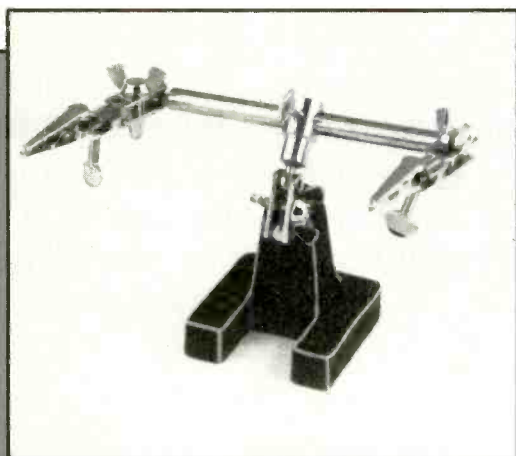

A holder as simple as this one, consisting of a couple of alligator clips mounted to a weighted or clamp base, can hold a printed circuit board while you work on it. (Photo courtesy OK Industries.)

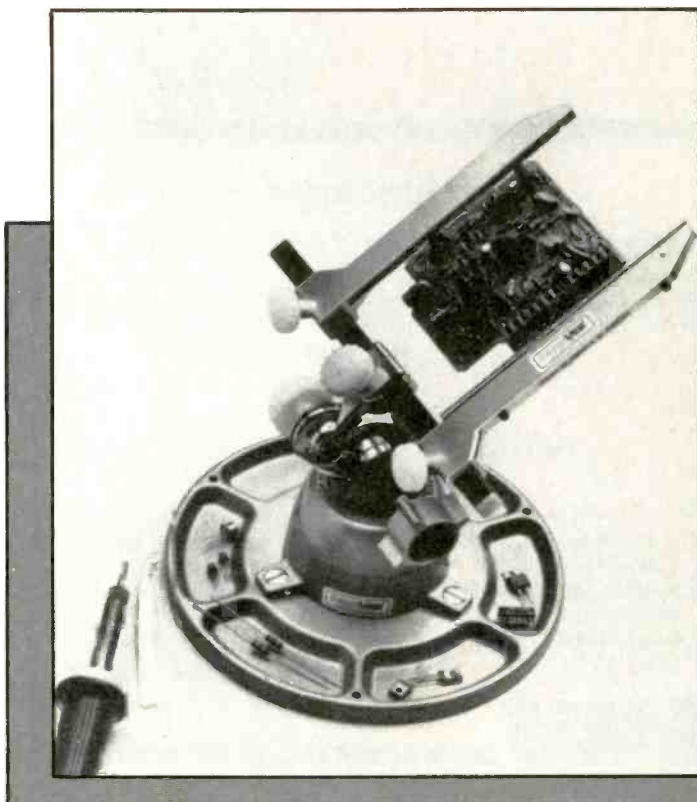

A vise such as this holds a PC board securely. (Photo courtesy Panavise.)

I only have two hands

Tools, jigs and fixtures

The right jig or fixture can make any servicing job much easier.

By Conrad Persson

As any electronic servicing technician will confirm, servicing televisions and other electronic products couldn't be simpler. Take soldering and desoldering, for example. When you need to solder a replacement component, you simply hold the PC board at the proper angle for soldering with one hand. With your other hand, you hold the

component to be soldered in place. With your other hand, you hold the tip of the soldering iron to the joint. With your other hand, you apply the solder to the heated joint and make the connection.

What's that you say? Come to think of it, that is rather a lot of hands. Unless, of course, you're one of the musicians at the bar in

Los Isley Spaceport in the movie "Star Wars."

But sometimes it does take more than two hands to repair an electronic device. So what do you do? One possibility is to clinch the leads of the replacement device over so it stays on the board when you turn it over and then prop the board against something, like a book or a box. If I count right, that reduces the necessary complement of hands to a manageable two.

Unfortunately, although an approach such as the one suggested above works, it too has problems. For one thing, clincing the leads over might make the replacement device more difficult to remove from the board if it ever needs to be replaced again. Besides, when you prop a board against an object, there's the possibility that it will slip at the most inopportune moment, resulting in solder bridges, or damage to the board or you.

With a PC board holder, you can insert replacement components, place the cover over the replacements and turn the board over for soldering with no danger of having the unsoldered components fall out. (Photo courtesy OK Industries.)

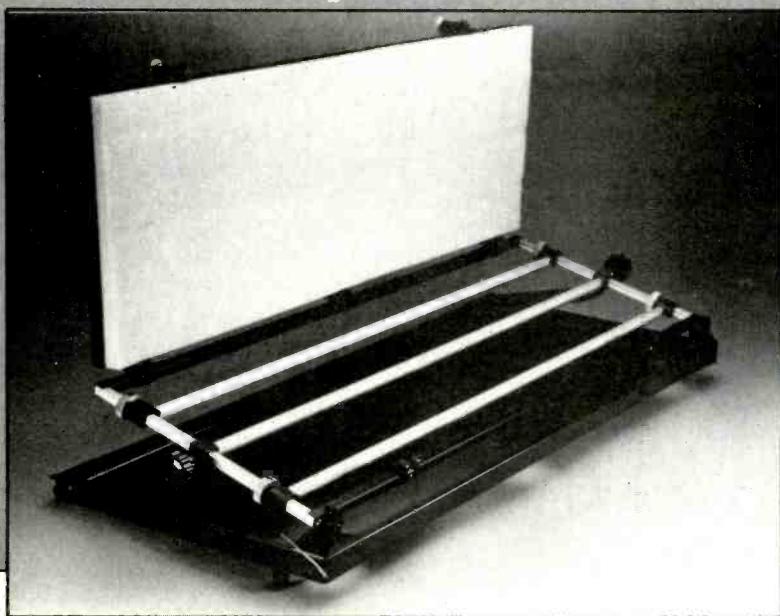

Sources of tools and jigs

Automated Product Equipment

142 Peconic Ave.
Medford, NY 11763
516-654-1197

Boardworks, The

1077 E. Edna Place
Covina, CA 91724
818-967-3681

Contact East

335 Willow St. South
North Andover, MA 01845
800-225-5370

Cooper Group

3535 Glenwood Ave.
Raleigh, NC 27622
919-781-7200

Davle Tech Inc.

2-05 Banta Place
Fair Lawn, NJ 07410
201-796-1729

Desco Industries Inc.

761 Penarth Ave.
Walnut, CA 91789
714-598-2753

Dremel

4915 21st St.
Racine, WI 53406
414-554-1390

E.C.I.

90 Knickerbocker Ave.
Bohemia, NY 11716
800-772-6767

Easco Hand Tools

3575 Hempland Road
Lancaster, PA 17604
717-285-4581

Edsyn Inc.

15958 Arminta St.
Van Nuys, CA 91406
213-989-2324

Electronic Tool

101 Castleton St.
Pleasantville, NY 10570
800-431-1106

Gripmate Enterprises

P.O. Box 6179
Arlington, VA 2206-0168
703-998-2355

W.S. Jenks & Son

2024 W. Virginia Ave. NE
Washington, DC 20002
800-638-6405

Jensen Tools Inc.

7815 S. 46th St.
Phoenix, AZ 85044
602-968-6241

Klein Tools

7200 McCormick Blvd.
Chicago, IL 60645
312-677-9500

Mascot Precision Tool

750 Washington Ave.
Carlstadt, NJ 07072
201-939-0596

Master Appliance Corporation

2420 18th Street
Racine, WI 53403
414-633-7791

Minitool Inc.

1334/F Dell Ave.
Campbell, CA 95008
408-373-1585

Moody Tools Inc.

42-60 Crompton Ave
East Greenwich, RI 02818
401-885-0911

P.K. Neuses

P.O. Box 100
Arlington Heights, IL 60006
312-253-6555

M.M. Newman Corporation

7 Hawkes St.
Marblehead, MA 01945
617-631-7100

NU Concept Computer

Route 309 and Advance Lane
Colmar, PA 18195
215-822-8400

OK Industries Inc.

3455 Conner St.
Bronx, NY 10475
212-994-6600

Oryx

4 Columbus Ave.
Mount Kisco, NY 10549
914-241-0237

Pace Incorporated

9893 Brewers Court
Laurel, MD 20707
301-490-9860

Paladin Corporation

3543 Old Conejo Road
Newbury Park, CA 91320
805-499-0318

Panavise

2850 E. 29th St.
Long Beach, CA 90806
213-595-7621

Plato Products Inc.
P.O. Box 1298
Glendora, CA 91740
818-967-3821

Products International
8929 Brookville Road
Silver Spring, MD 20910
800-638-2020

Techni-Tool
5 Apollo Road
Plymouth Meeting, PA 19462
215-825-4990

Tecra Tool Industries
3209 W. Hampden Ave.
Englewood, CO 80110
303-762-1862

Telematic
108-02 Otis Ave.
Corona, NY 11368
718-271-5200

The Eraser Company
P.O. Box 4961
Syracuse, NY 13221
315-454-3237

Ungar
100 W. Manville
Compton, CA 90220
213-774-5950

Vaco Products Co.
1510 Skokie Blvd.
Northbrook, IL 60062
312-564-3300

WAHL Clipper Corporation
2902 N. Locust St.
Sterling, IL 61081
815-625-6525

A better solution to the problem of not enough hands is to get some more hands. We humans are limited to two *natural* hands, but many manufacturers offer products such as vises, holders and grabbers that can be used to hold a device firmly in a convenient position while it is being worked on.

Another problem faced by servicing technicians is finding a place in some of today's crowded electronics products to grab onto with a test probe. Sometimes the problem is that the leads you're interested in are too small, too close together, or snuggled down well beyond a crowd of other components. Sometimes the problem is all three.

Here again, manufacturers have recognized the problem, and have come up with a host of solutions: test clips extend the leads out to where you can get at them with a test probe, test adapters let you insert test points in line with cable connectors, and similar test adapters allow you to switch individual lines in or out of the circuit to enable you to isolate portions of a circuit for testing.

Jigs and fixtures for soldering and desoldering

It's a rare electronics problem these days that doesn't involve desoldering a component and soldering its replacement into the

circuit. With modern equipment, components have become so small and their leads are so close together and circuit traces so tiny and closely spaced, soldering and desoldering have to be performed with all the skill of a brain surgeon.

It doesn't make sense, therefore, to have the PC board sliding across the workbench while you're trying to work on it. The solution is to get another pair of hands. The other pair of hands may be simple or elaborate, depending on the nature of the circuits you're working on, your operating budget and your personal preference.

For example, one of the simplest devices for holding a small printed circuit board is a jig that consists of either a weighted base or a bench clamp and a pair of alligator clips mounted so you can adjust them into almost any position. With this device you merely clip the PC board into the alligator clips, adjust the board to a convenient angle and solder away.

For larger, heavier boards, you might want something more elaborate. Depending on your particular needs, there are board holders designed only to hold the board steady while you do your soldering. More elaborate holders allow you to pivot the board easily to almost any angle. Some holders even are available that come with covers that hold the replacement

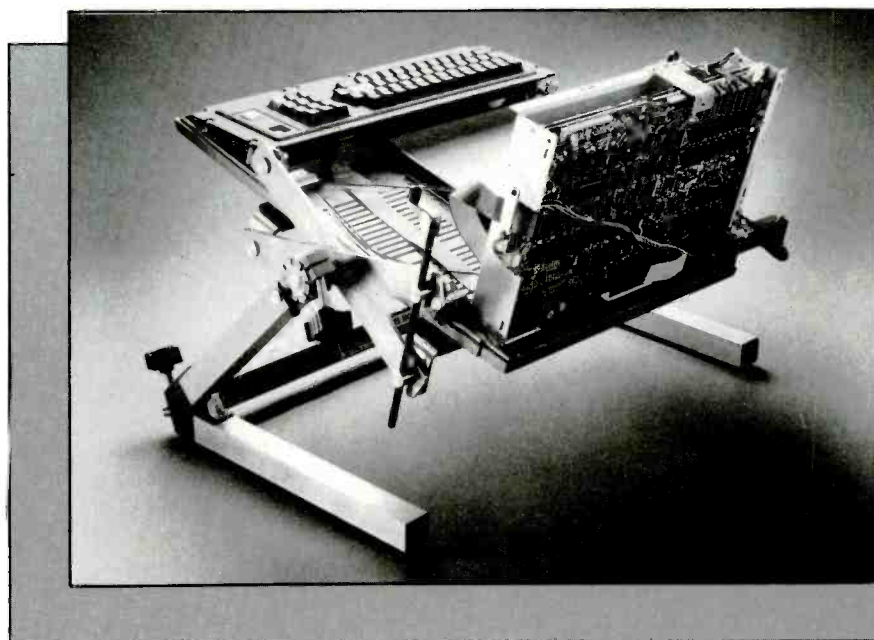

With a fixture of this type, you can clamp an entire product such as a VCR into the device and move it to any position without worrying whether it will tip or fall. (Photo courtesy Panavise.)

components in place while you solder them into the circuit. Yet other holders not only hold the board in place, but even have a solder station built right in so the soldering iron and cleaning sponge are there for your convenience when you're ready to solder.

Holding bigger items

Sometimes when you're working on a piece of equipment, a VCR, for example, it's nice to be able to hold the unit steady in any of a number of positions while you probe its insides to determine what's wrong. Without some kind of holding fixture, you might wind up dropping the unit or hurting yourself while you hold it. There are holding fixtures for this purpose, as well, that will allow you to work on a unit without having to

worry about it slipping or falling. A fixture such as this can save untold hours of frustration and even prevent damage to the equipment being repaired.

Testing adapters

Holding a PC board, or a complete piece of equipment firmly while working on it is only one of the problems faced. Consider, for example, testing a printed circuit board stuffed with standard dual-in-line integrated circuits, or, even worse, surface-mounted components. Just try poking a standard meter or scope probe in amongst the closely crowded pins of ICs on a densely packed board. If you don't cause a component-wrecking, short circuit between a couple of pins, you'll be lucky.

Fortunately, test equipment

manufacturers also have come up with any number of aids to testing in *difficult* areas. One of the simplest of these is the spring-loaded hook probe that lets you grab one pin out of a group of closely spaced pins without slipping. If very careful, and lucky, you might be able to leave power *on* and move this type of hook from pin to pin in order to trace a fault. Conventional wisdom, though, suggests that when pins are tightly packed enough to warrant using one of these hooks, you should disconnect power before moving the hook to a new test point if you want to avoid the possibility of causing damage.

Another aid in testing printed circuit boards is the test clip. This is a neat device that operates much like a spring clothespin. Each side of the clip has a number of conductors with the same spacing as the leads on a dual-in-line integrated-circuit package. To use the clip, you simply squeeze it and place it over the IC to be tested. Each conductor on the clip connects to a pin on the IC. Then, when you need to probe the IC to test a function, you just touch the respective pin on the clip, which is up away from the board and more widely separated from the other clip leads than are the leads of the IC.

Another handy testing aid is the cable interface. Have you ever tried to take test measurements at the point where a flat cable connects to a device? In most cases, manufacturers have made no provision for getting a meter or scope onto a connector while it's plugged in. Test adapter manufacturers have come up with a way to make tests at this point. It consists of a male end that plugs into the unit, and a female end into which you plug the cable connector. From each wire extends a test pin that you can probe easily to see how the signal looks like at that point.

A variation of this kind of cable test adapter features not only the cable interface and set of test points, but has two test pins with a switch between them for each conductor of the flat cable. Then if it becomes necessary to isolate a single conductor, or several conductors and probes both on the device side and on the cable side of the open switch, you easily can accomplish this.

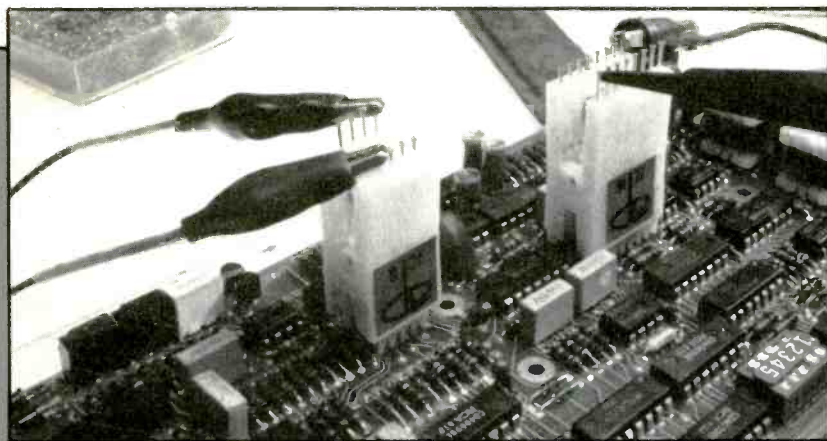

A test clip such as this lets you get the pins you need to probe up away from the crowded PC board surface, and separates them so you can get at them. (Photo courtesy A P Products.)

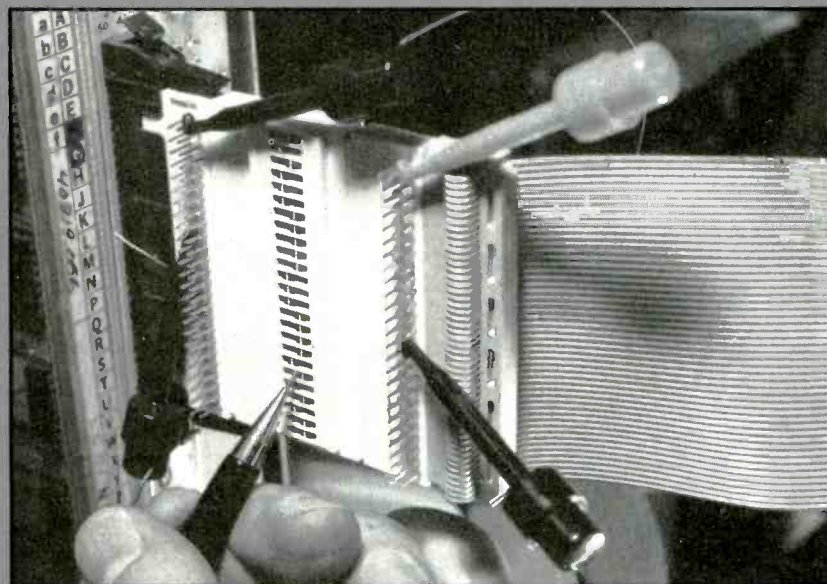

In addition to holding the piece being worked on, this handy unit features a soldering iron holder and a cleaning sponge. (Photo courtesy OK Industries.)

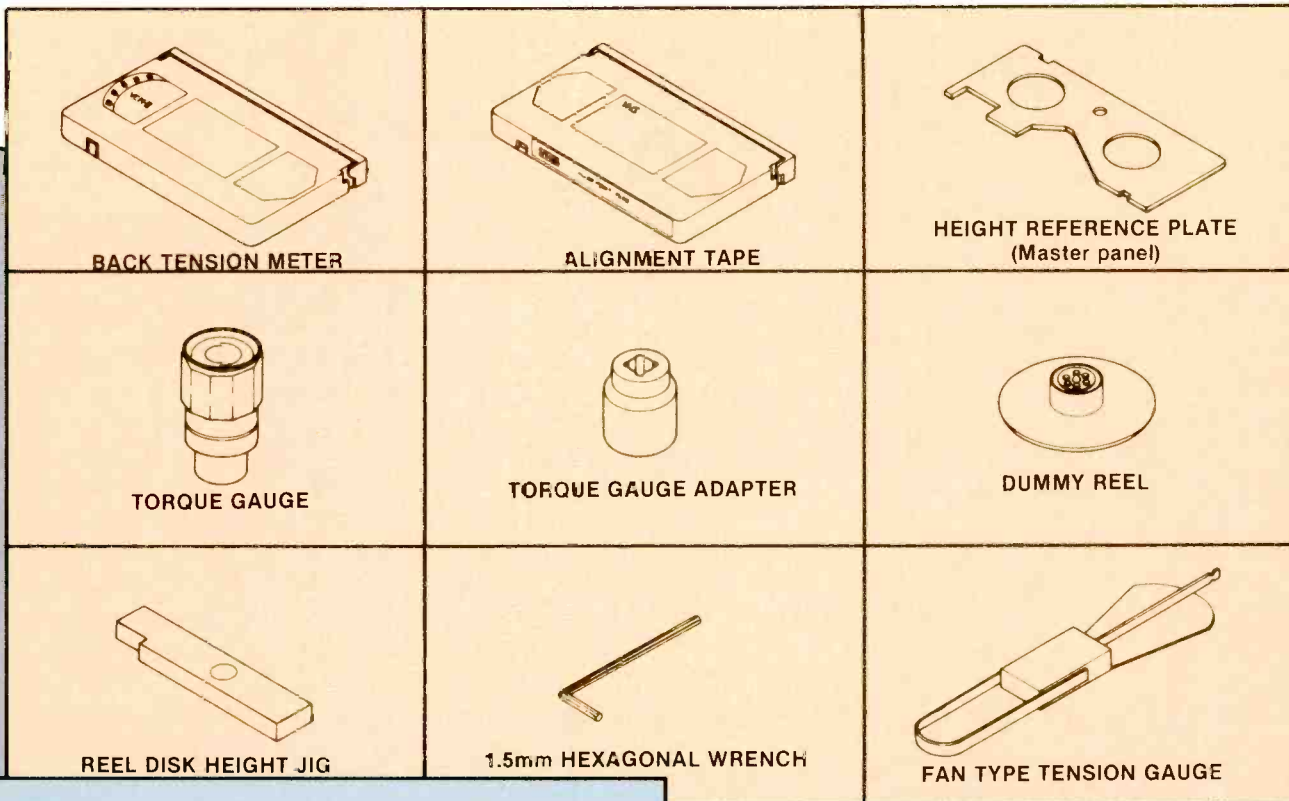

Figure 1. Servicing a consumer electronics product as sophisticated as a VCR requires special tools, jigs and fixtures such as those shown here.

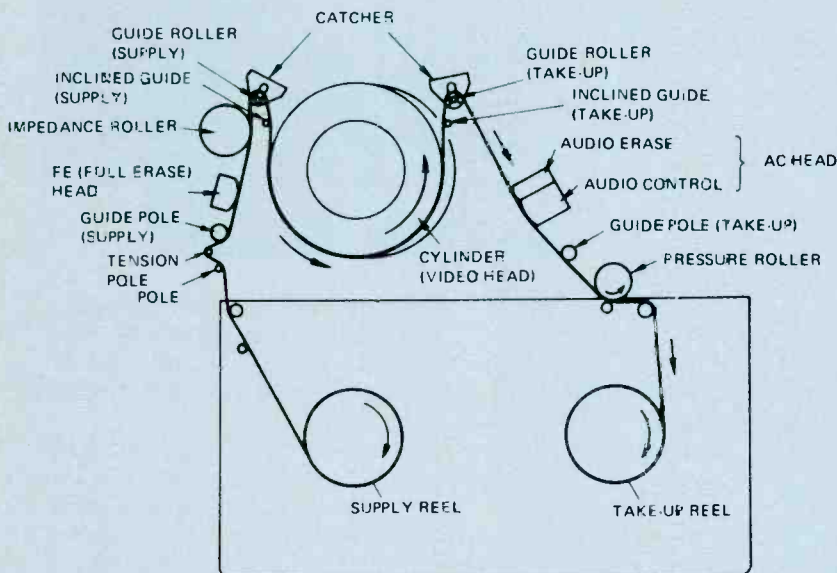
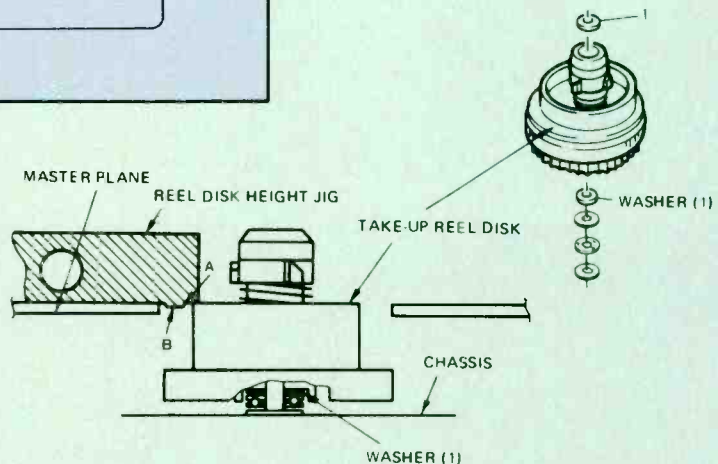

Figure 2. The tape transport system of a VCR, a marvel of modern mechanical design, must be in near-perfect adjustment in order to operate properly. Many of these adjustments require the servicing technician to have specialized tools, jigs or fixtures.

Figure 3. Reel disk height adjustment on this VHS VCR requires the use of a master plane and a reel disk height adjusting jig. If the reel disk doesn't enter between Side A and Side B of the jig, as shown, the height is adjusted by adding washers between the reel disk and its base.



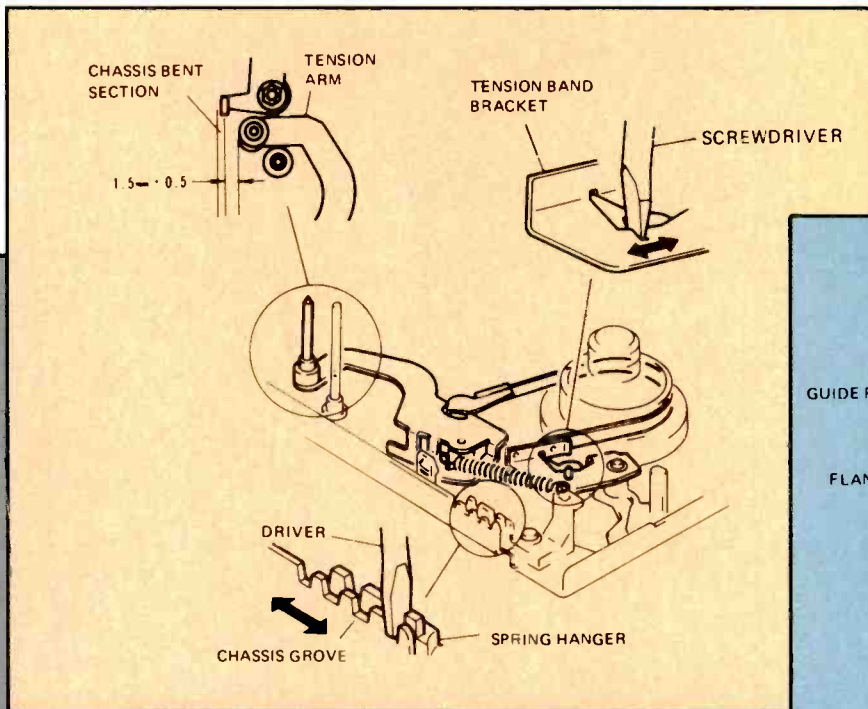

Figure 4. A back tension meter is required to adjust the tension pole. The adjustment is made by mounting the back tension meter where the cassette normally goes, turning on the VCR to PLAY, and adjusting the tension hanger to manufacturer's specs.

Figure 5. Rough adjustment of the guide pole height requires use of the master plane and reel height adjusting jig. For fine adjustment, a blank tape serves as the jig.

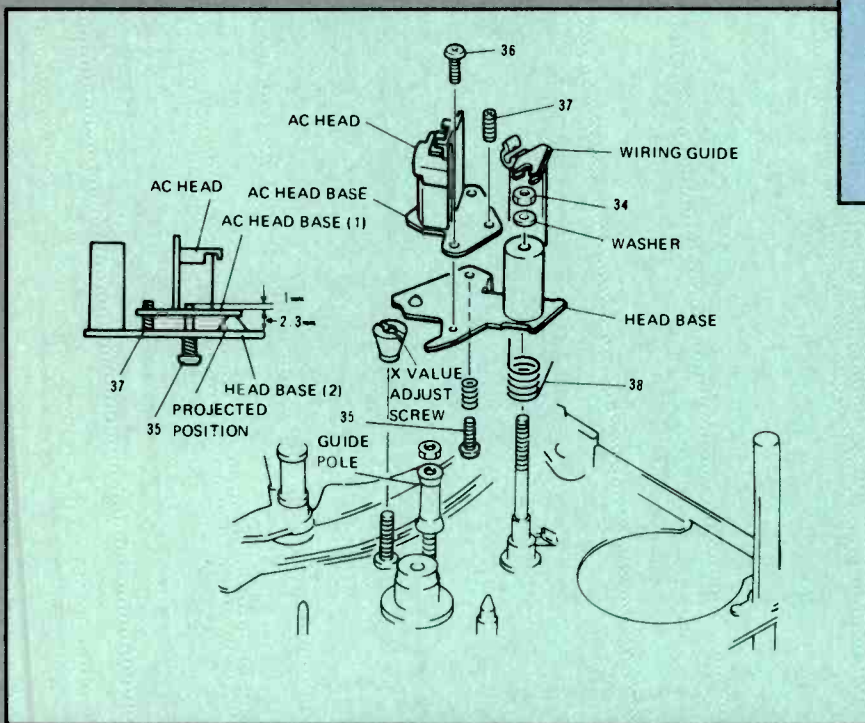
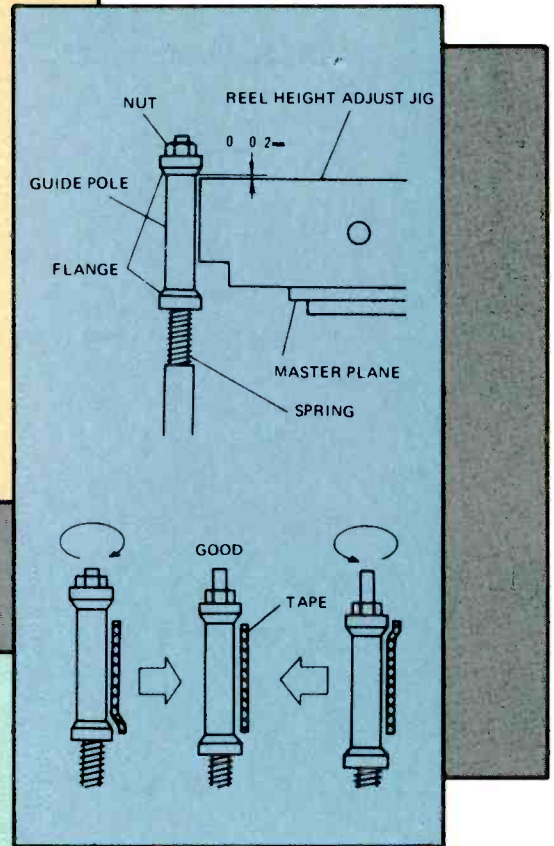

Figure 6. Adjustment of the AC head requires the same jigs as for adjustment of the guide pole: a master plane, reel height adjusting jig and a blank tape.

Illustrations of VCR jigs and fixtures are provided by General Electric Company.

Some special jigs and fixtures

Servicing electromechanical products like VCRs and record players presents its own special set of problems.

VCRs, especially, because they have parts whirling around inside pretty rapidly that must be kept in precise alignment, require a number of jigs and fixtures. There are tension gauges, height jigs, alignment tapes and more. The accompanying diagrams illustrate some of the jigs and gauges required to adjust a GE VCR and describe how they are used.

The right tool (jig, fixture) for the job.

The simplest of tasks is next to impossible without the right tool, jig or fixture. Try to unscrew a screw without that simplest of tools, a screwdriver. It pays handsome dividends in the long run always to have the needed tools and fixtures on hand, keep them in proper condition, and use them wherever they are called for.

ES&T

WARNING: BEFORE SERVICING THIS CHASSIS, BE AWARE OF X-RAY RADIATION, SAFETY PRECAUTIONS.

- NOTE:
1. Resistance is shown in ohms. K = 1,000, M = 1,000,000.
 2. Unless otherwise listed, all inductor values less than 1 are expressed μ H and the values less than 1 in pF.
 3. Unless otherwise listed, all inductor values more than 1 are expressed μ H and the values less than 1 in H.
 4. Voltages are measured with DVM from point indicated to chassis ground, using color-bar signal/all controls normal.
 5. Waveforms are measured with synchroscope from point indicated to chassis ground, using color-bar signal/controls at normal.

Profax schematics are for the use of qualified technicians only.

Product safety should be considered when component replacement is made in any area of a receiver. The shaded areas of the schematic diagram designate the components in which safety is of special significance. It is recommended that only exact cataloged parts be used for replacement of these components.

Use of substitute replacement parts that do not have the same safety characteristics as recommended in factory service information may create shock, fire, excessive x-radiation or other hazards.

This schematic is for the use of qualified technicians only. This instrument contains no user-serviceable parts.

The other portions of this schematic may be found on other Profax pages.

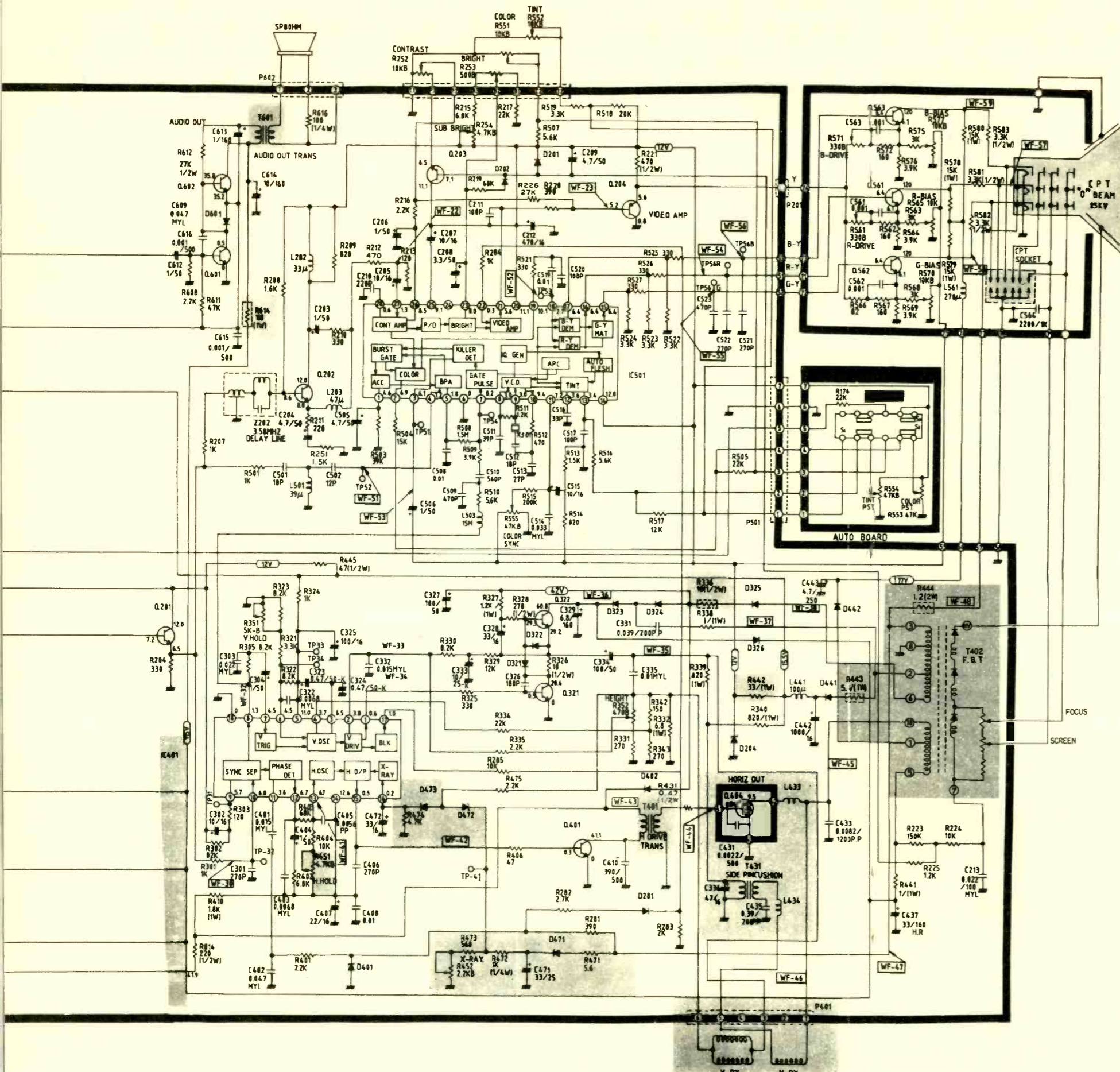

GE PM-C chassis Color TV



HORIZ. OUTPUT XSISTOR AND DAMPER DIODE ARE INCLUDED IN THE SAME UNIT. REPLACE ONLY WITH ORIGINAL EQUIPMENT GE CATALOG REPLACEMENT PART NUMBER EP15X218.

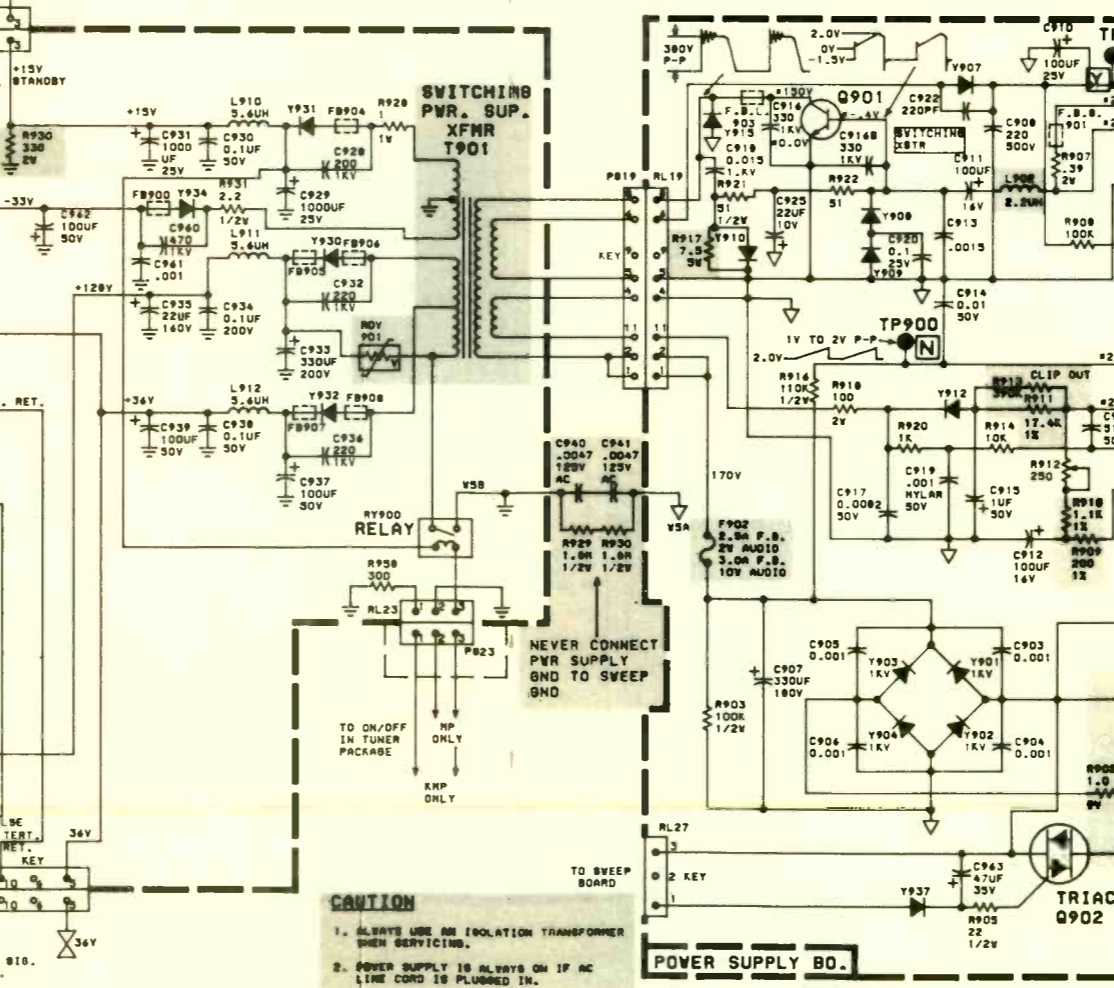
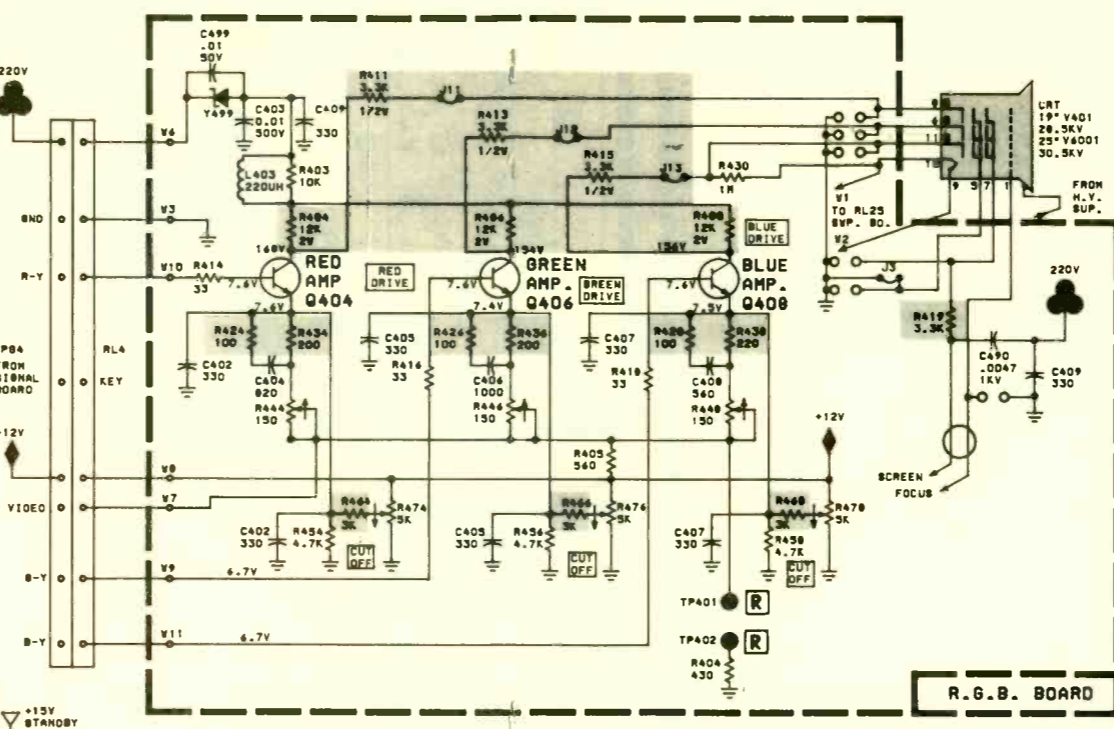
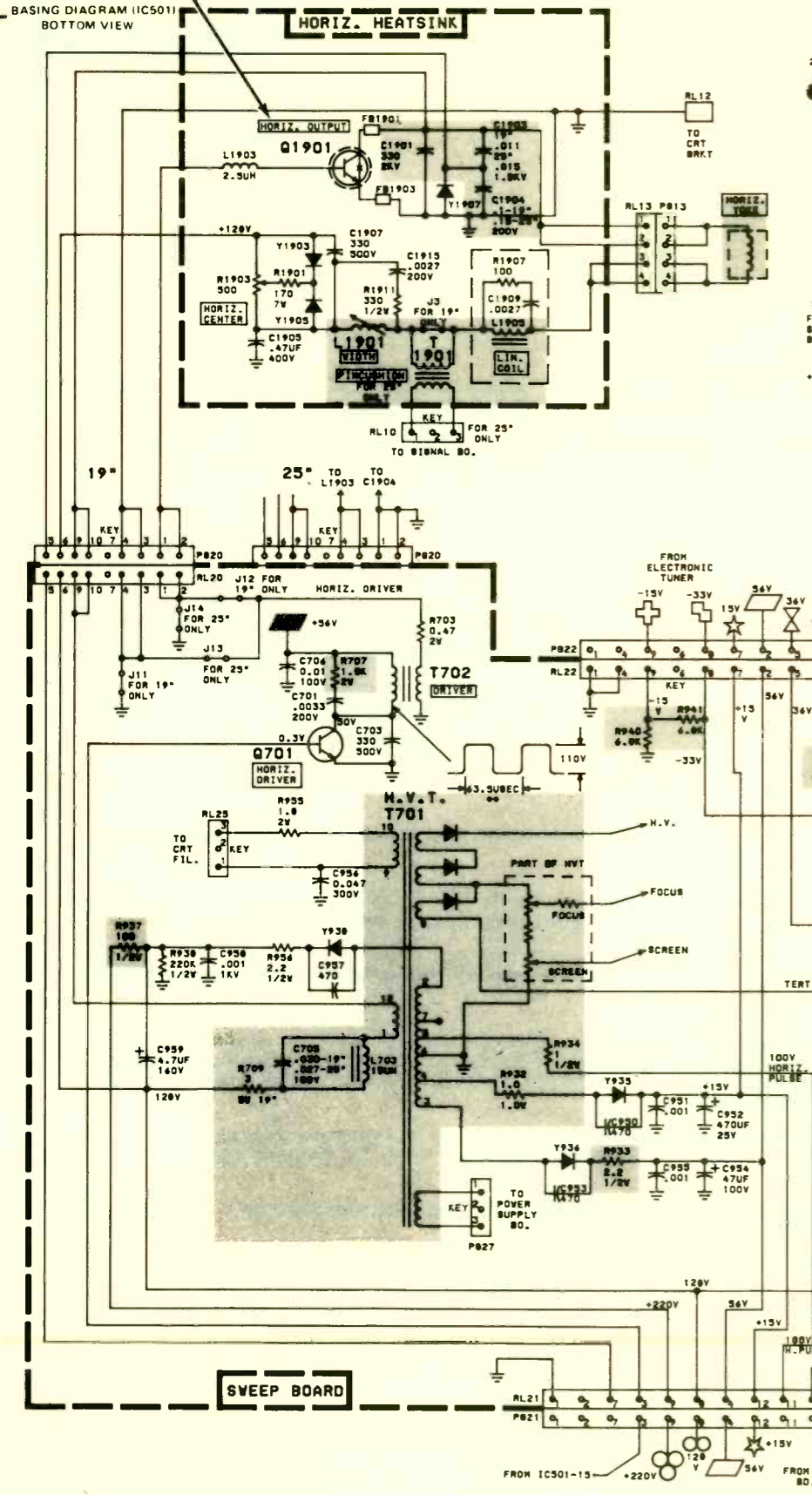

Product safety should be considered when component replacement is made in any area of a receiver. The shaded areas of the schematic diagram designate the components in which safety is of special significance. It is recommended that only exact cataloged parts be used for replacement of these components.

Use of substitute replacement parts that do not have the same safety characteristics as recommended in factory service information may create shock, fire, excessive x-radiation or other hazards.

This schematic is for the use of qualified technicians only. This instrument contains no user-serviceable parts.

The other portions of this schematic may be found on other Profax pages.

CAUTION:

THE PM CHASSIS IS A "HOT" AND "COLD" CHASSIS THAT USES A TWO-GROUND SYSTEM. THE POWER SUPPLY MODULE IS ELEVATED 70VAC ABOVE EARTH GROUND AND IS ALWAYS "HOT" WHEN THE AC CORD IS PLUGGED IN. THE REST OF THE CHASSIS IS "COLD" AND IS ISOLATED FROM THE POWER SUPPLY MODULE BY SWITCHING TRANSFORMER (T901). NEVER CONNECT THE POWER SUPPLY MODULE GROUND TO ANY OTHER GROUND IN THE RECEIVER AND ALWAYS USE AN ISOLATION TRANSFORMER WHEN SERVICING.

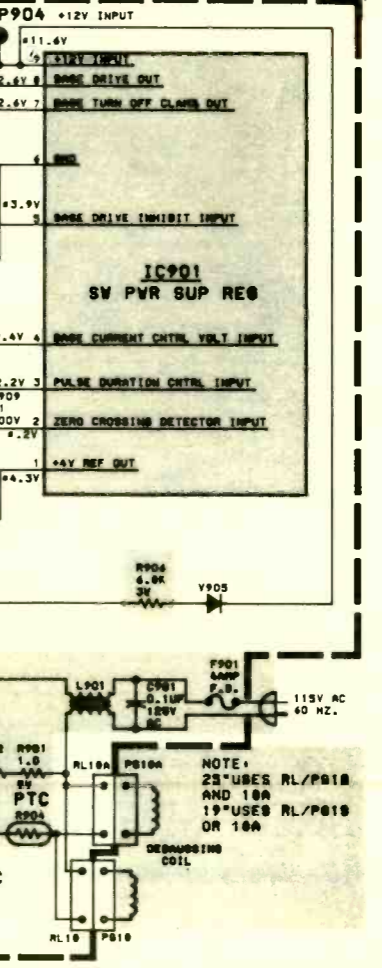

73E262153-REV 0
SCHEMATIC PM 19 AND 25
SERVICE #C01
UNLESS OTHERWISE NOTED.

K = 1,000
M = 1,000,000
CAPACITORS MORE THAN 1 - 10UF - 1PF
CAPACITORS LESS THAN 1 - UF
INDUCTORS MORE THAN 1 - UH
RESISTORS ARE 1/4 WATT

VOLTAGE MEASUREMENTS MADE WITH A VTVM WITH RESPECT TO CHASSIS EXCEPT ON PWR SUPPLY BD.
* INDICATES VOLTAGES ON PWR SUPPLY BD MEASURED WITH RESPECT TO TAB OF IC901. RECEIVER SET FOR NORMAL OPERATION WITH STRONG SIGNAL.
MEASUREMENTS MAY VARY +/-10% AT 120V AC LINE VOLTAGE.
SIGNAL WAVEFORMS TAKEN WITH KEYED RAINBOW GENERATOR SIGNAL.

** INDICATES WAVEFORMS TAKEN AT 1/2 HORIZONTAL SWEEP RATE.
*** INDICATES WAVEFORMS TAKEN AT 1/2 VERTICAL SWEEP RATE.
RL - RECEPTACLE
PB - PLUS
N.S. - NO SIGNAL

CAUTION

1. ALWAYS USE AN ISOLATION TRANSFORMER WHEN SERVICING.
2. POWER SUPPLY IS ALWAYS ON IF AC LINE CORD IS PLUGGED IN.

NF CHASSIS VOLTAGE AND CURRENT WAVEFORMS

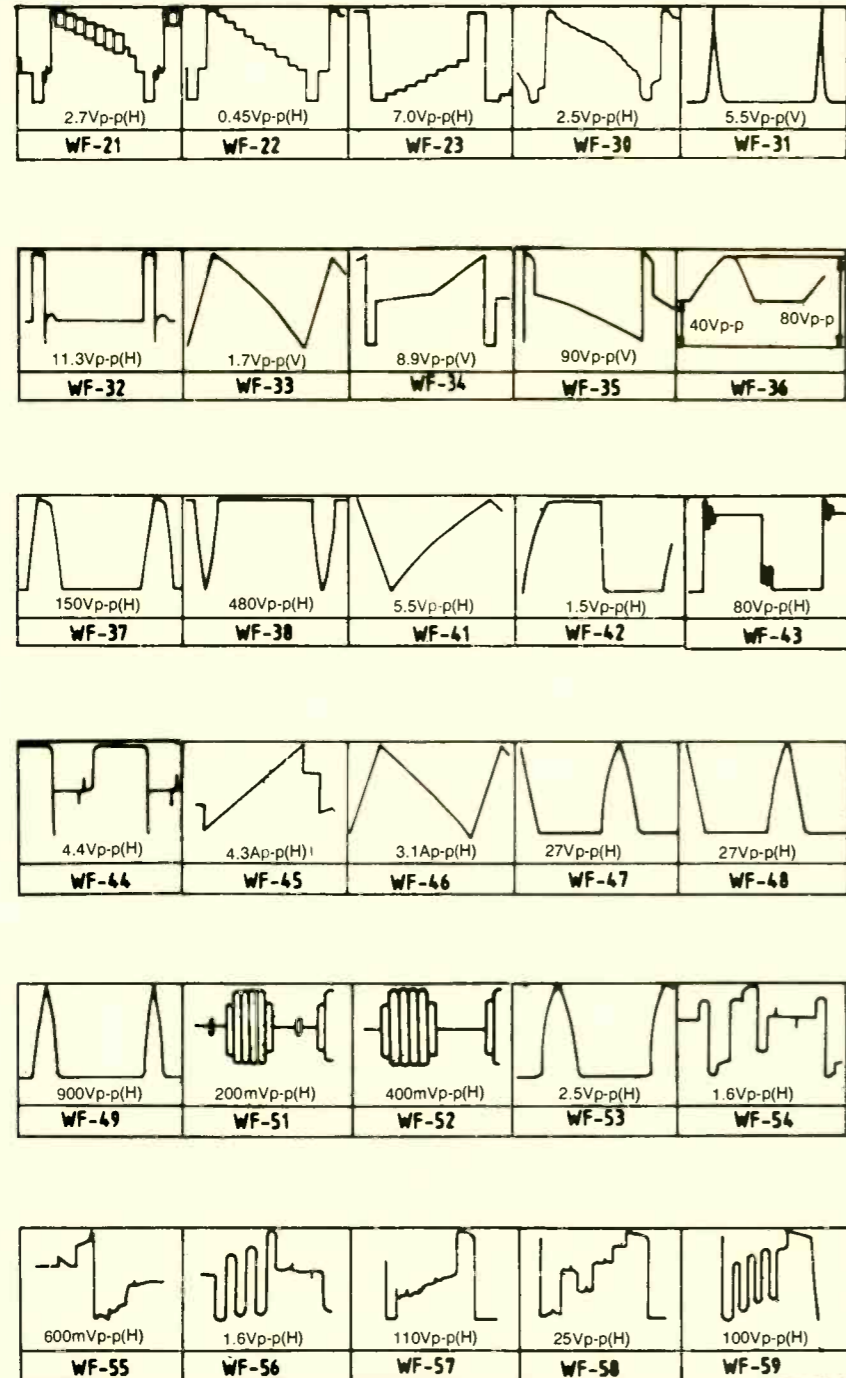

These represent the waveforms on the oscilloscope screen when the oscilloscope probes were connected to the test points on the signal circuit board corresponding to the numbers on the schematic diagram.

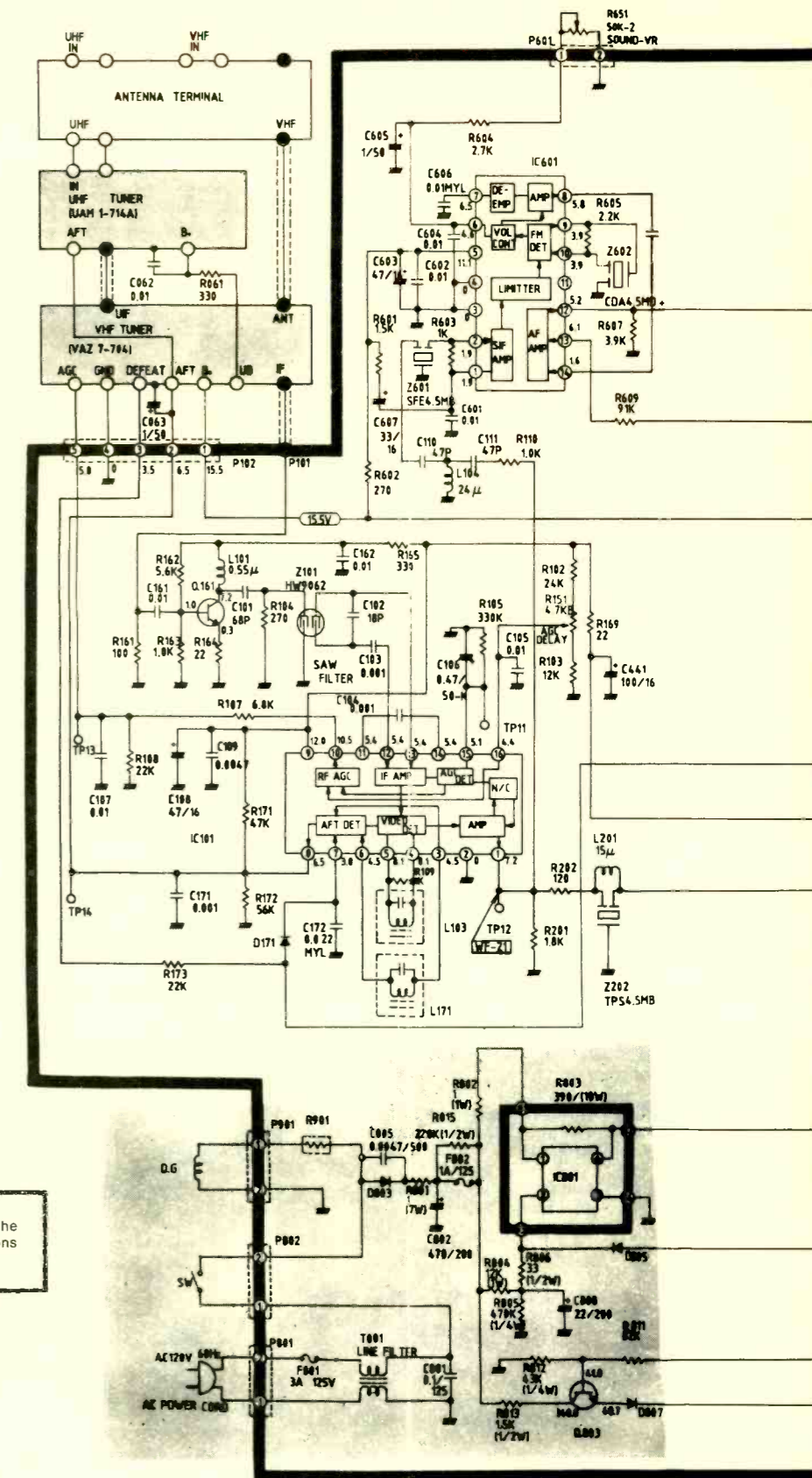
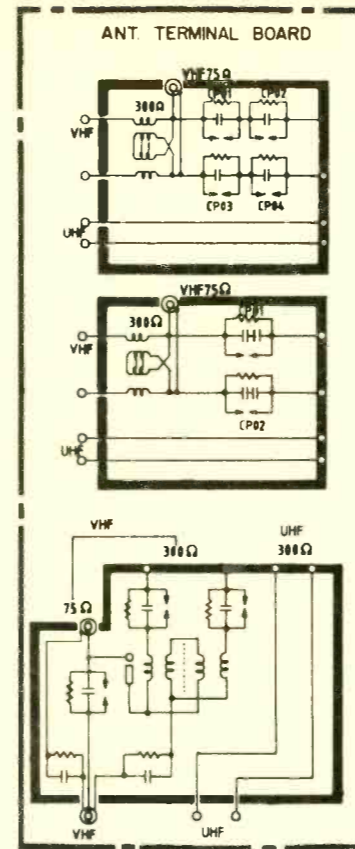

Product safety should be considered when component replacement is made in any area of a receiver. The shaded areas of the schematic diagram designate the components in which safety is of special significance. It is recommended that only exact cataloged parts be used for replacement of these components.

Use of substitute replacement parts that do not have the same safety characteristics as recommended in factory service information may create shock, fire, excessive x-radiation or other hazards.

This schematic is for the use of qualified technicians only. This instrument contains no user-serviceable parts.

The other portions of this schematic may be found on other Profax pages.

NOTICE: Because this is a basic circuit diagram, the value of components and some partial connections are subject to be changed for improvement.

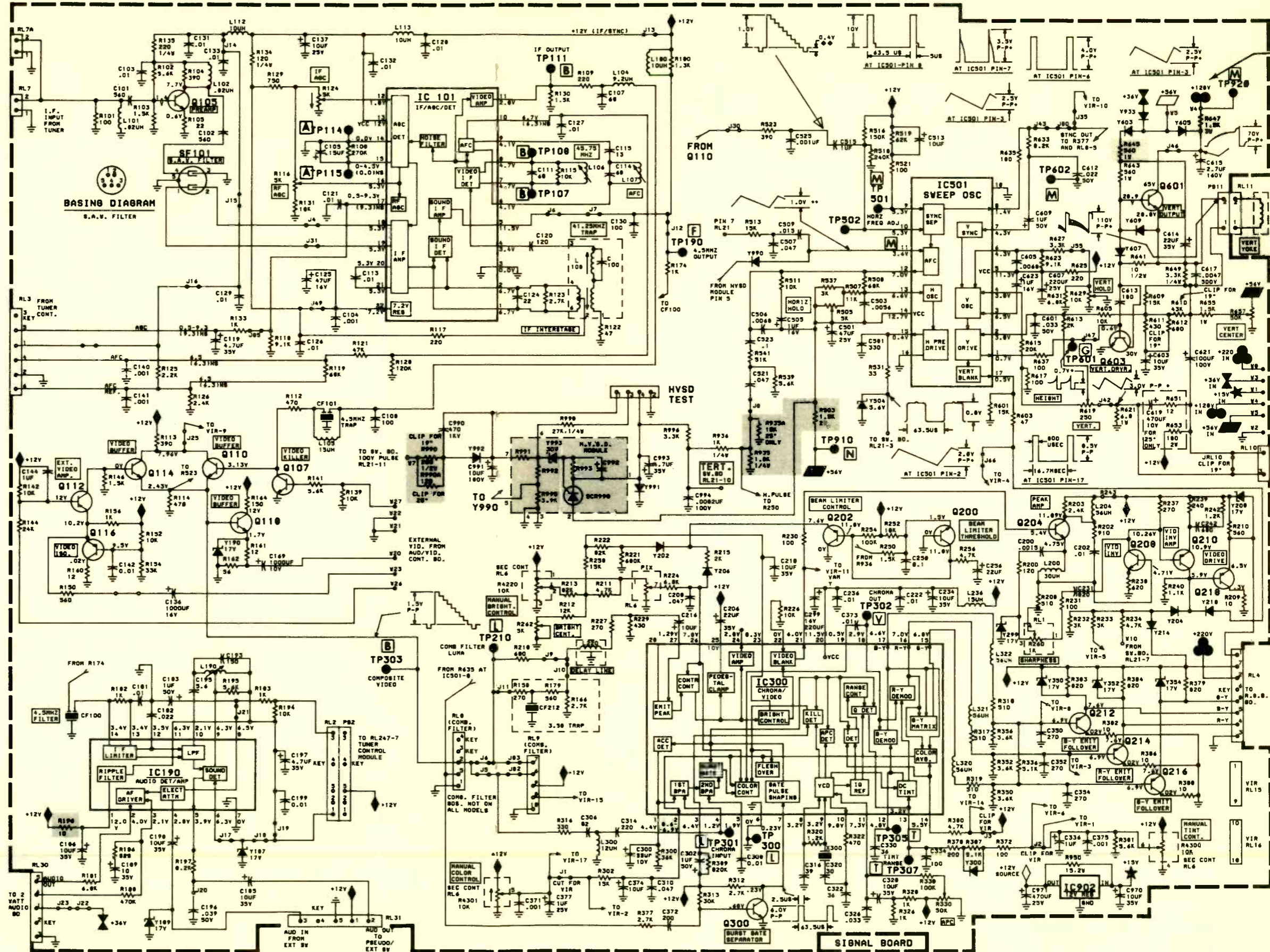

Product safety should be considered when component replacement is made in any area of a receiver. The shaded areas of the schematic designate the components in which safety is of special significance. It is recommended that only exact cataloged parts be used for replacement of these components.

Use of substitute replacement parts that do not have the same safety characteristics as recommended in factory service information may create shock, fire, excessive x-radiation or other hazards.

This schematic is for the use of qualified technicians only. This instrument contains no user-serviceable parts.

The other portions of this schematic may be found on other Profax pages.



JULY 1986 Schematic	
GE NF chassis, Color TV	2087
GE PM-C chassis, Color TV	2088

Continued from page 22.

ANSWERS to the Quiz

4. C. This type of noise is due to random charge carriers that exist in a conductor or semiconductor at room temperature. If you turn up the sound on a TV receiver that is not tuned to a station, you will hear a hissing noise. That is mostly due to thermal agitation noise in the receiver front end.

5. A. The symbol marked B is used in CET tests and in books and magazines.

The symbol marked A is used in the General Electric publication titled: "Electronic Data Library... Transient Voltage Suppression." Because they make the component, it seems reasonable that they can decide upon the symbol.

VDRs are used to eliminate transient voltages due to noise and switching.

6. A. Different units in a low-frequency electronic system can have slightly different common potentials. If you ground the shield at both ends, and the ground voltages are not the same, current will flow through the shield. That current can be ac and/or dc. The shield current can produce magnetic fields that interfere with signal flow in the center conductor.

For high frequencies the shield should be grounded at both ends.

7. C. They do *not* charge for power.

Energy is obtained by multiplying the power by the time.

$$\text{Power} \times \text{time} = \text{energy}$$

$$\text{Kilowatts} \times \text{hours} = \\ \text{kilowatt-hours}$$

8. B. You should keep a mixture of baking soda and water handy if you are working around lead-acid batteries. It is useful for cleaning terminals and neutralizing acid spills.

9. B. If you stick the two leads into a potato a blue color will surround the positive terminal.

10. NOT CORRECT! The speed of sound is higher under the surface of the ocean.

Exclusive, triple patented dynamic cap and coil analyzing . . . guaranteed to pinpoint your problem every time or your money back



with the all new LC75 "Z METER 2" Capacitor Inductor Analyzer Patented \$995

The "Z METER" is the only LC tester that enables you to test all capacitors and coils dynamically — plus, it's now faster, more accurate, and checks Equivalent Series Resistance (ESR) plus small wire high resistance coils.

- Eliminate expensive part substitution and time-consuming shotgunning with patented tests that give you results you can trust every time. Test capacitor value, leakage, dielectric absorption, and ESR dynamically; with up to 600 volts applied for guaranteed 100% reliable results — It's exclusive — it's triple patented.
- Save time and money with the only 100% reliable, in- or out-of-circuit inductor tester available. Dynamically test inductors for value, shorts, and opens, automatically under "dynamic" circuit conditions.
- Reduce costly parts inventory with patented tests you can trust. No more need to stock a large inventory of caps, coils, flybacks, and IHVTs. The "Z METER" eliminates time-consuming and expensive parts substituting with 100% reliable LC analyzing.
- Turn chaos into cash by quickly locating transmission line distance to opens and shorts to within feet, in any transmission line.
- Test troublesome SCRs & TRIACs easily and automatically without investing in an expensive second tester. The patented "Z METER 2" even tests SCRs, TRIACs, and High-Voltage Diodes dynamically with up to 600 volts applied by adding the new SCR250 SCR and TRIAC Test Accessory for only \$148 or FREE OF CHARGE on Kick Off promotion.

To try the world's only Dynamic LC Tester for yourself, CALL TODAY, WATS FREE, 1-800-843-3338, for a FREE 15 day Self Demo.



SENCORE

3200 Sencore Drive
Sioux Falls, SD 57107
605-339-0100 In SD Only
innovatively designed with your time in mind

**CALL TODAY
WATS FREE
1-800-843-3338**

Circle (7) on Reply Card

July 1986 *Electronic Servicing & Technology* 39

Voltage breakdown in transistors

By Alvin G. Sydnor

The effective selection and use of replacement bipolar junction transistors requires more than just a casual look at specifications. From our basic studies of transistors, we have learned that the transistor's ability to control current carriers and associated voltages makes the transistor the single most important and reliable element in modern electronic signal processing equipment.

Life expectancy is one very important consideration in the application of transistors in any electronic device. A transistor will withstand a variety of situations that an electron tube cannot; as an example, a transistor when immersed in water will operate for a period of time with little noticeable effect on its operating frequency. It will also withstand centrifugal

force, gravity and impacts that would completely shatter an electron tube.

We are sold on the transistors reliability and long life. Why then do we have to replace defective transistors? What happens? Why do they open? Why do they short?

Basic courses in transistors cover the structure of segments such as matter, donors, acceptors, holes and PN junctions. In general, much emphasis is placed on current and voltage in terms of source or supply.

A very large percentage (in excess of 95%) of *all* transistor failures is directly or indirectly attributable to exceeding the allowable breakdown voltage or heat dissipation of a transistor.

There are several breakdown voltages in a transistor that the

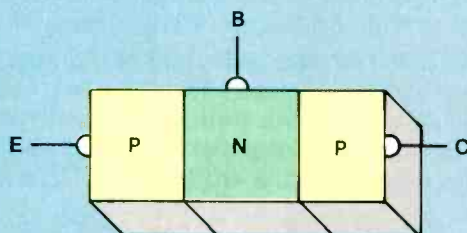

Figure 1A.

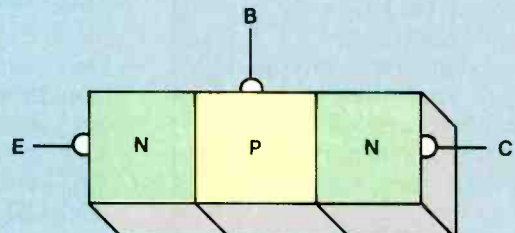
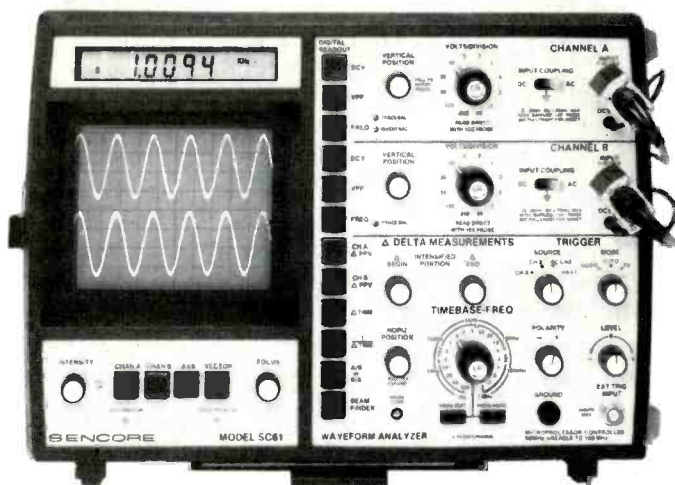

Figure 1B.

Figure 1. Bipolar junction transistors are fabricated of alternating layers of semiconductor material that has been doped to be either N or P material.

Analyze defective waveforms
faster, more accurately, and
more confidently — every time . . .
or your money back



with the SC61 Waveform Analyzer
Patented \$2,995

If you value your precious time, you will really want to check out what the exclusively patented SC61 Waveform Analyzer can do for you. 10 times faster, 10 times more accurate, with zero chance of error.

- End frustrating fiddling with confusing controls. Exclusive ultra solid ECL balanced noise cancelling sync amplifiers, simplified controls, and bright blue dual trace CRT helps you measure signals to 100 MHz easier than ever.
- Accurately and confidently measure waveforms from a tiny 5 mV all the way to a whopping 3,000 V without hesitation with patented 3,000 VPP input protection — eliminates expensive "front end" repairs and costly equipment downtime.
- Make only one circuit connection and push one button for each circuit parameter test: You can instantly read out DC volts, peak-to-peak volts and frequency 100% automatically with digital speed and accuracy. It's a real troubleshooting confidence builder.
- Confidently analyze complex waveforms fast and easily. Exclusive Delta measurements let you intensify any waveform portion. Analyze glitches, interference signals, rise or fall times or voltage equivalents between levels; direct in frequency or microseconds.
- Speed your digital logic circuit testing. Analyzing troublesome divide and multiply stages is quicker and error free — no time-consuming graticule counting or calculations. Simply connect one test lead to any test point, push a button, for test of your choice, for ERROR FREE results.

To see what the SC61 can do for your troubleshooting personal productivity and analyzing confidence, CALL TODAY, WATS FREE, 1-800-843-3338, for a FREE 15 day Self Demo.



SENCORE

3200 Sencore Drive
Sioux Falls, SD 57107
605-339-0100 In SD Only
innovatively designed with your time in mind

**CALL TODAY
WATS FREE
1-800-843-3338**

technician must be familiar with when choosing a replacement or designing a circuit.

Bipolar transistor construction

Most transistors are composed of alternating layers of sandwiched P- and N-type materials. The PNP transistor is shown in Figure 1 A and the NPN is shown in Figure 1 B. The interface where the N and P materials come together is known as a junction.

All bipolar transistors have two junctions: the collector-to-base junction and the base-to-emitter junction. Each of these two junctions has the same properties or characteristics as a semiconductor diode.

Symbolically, the transistor may be viewed as containing a collector-base diode and a base-emitter diode as shown in Figure 2. This concept is useful in this discussion, but should not be used to explain actual transistor operation.

Breakdown voltages

The transistor can be characterized by the breakdown voltage associated with the collector-to-base diode and the breakdown voltage associated with the base-emitter diode. These two breakdown voltages associated with the diodes are commonly referred to as:

V_{cb} Max, the breakdown voltage between collector and base, and

V_{be} Max, the breakdown voltage between base and emitter.

In addition to these two common types of voltage breakdown, there is a third type that is not well known or as well understood. This

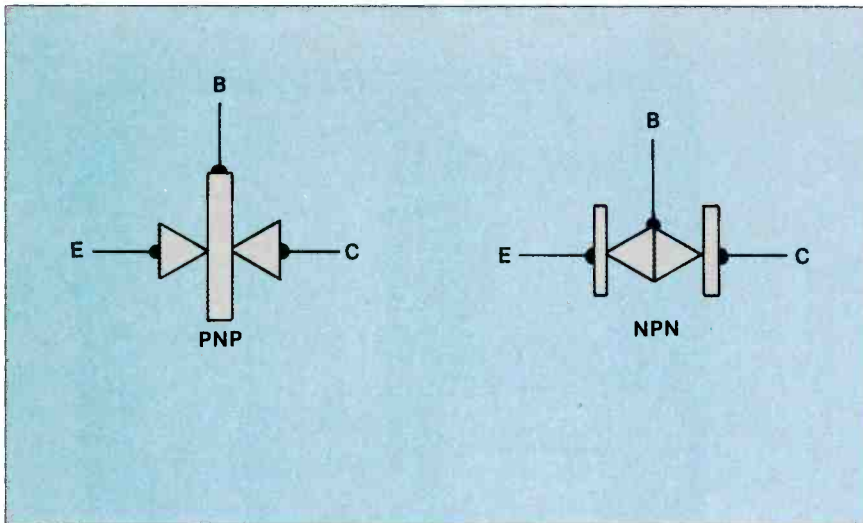

Figure 2. For some purposes, it is convenient to view transistors as being made up of a base-emitter diode and a base-collector diode. It is important not to use this model when considering transistor operation.

generally is referred to as V_{ce} maximum, and results in a breakdown directly between collector and emitter under conditions of operation when physical resistance is inserted in the circuit between the base and emitter terminals of the transistor.

The breakdown voltage between collector and emitter is a function of the resistance inserted between the base and emitter. Figure 3 shows a family of characteristic curves of collector current vs. collector voltage with a base-to-emitter external resistance.

Most all transistor manufacturers give breakdown voltage in

terms of V_{cb} and only a few will give the breakdown voltage from emitter to collector. Before a standard method of specifying V_{ce} maximum can be determined, all transistor manufacturers must be in agreement on standard values of external resistors to be inserted between base and emitter terminals.

There are three V_{ce} ratings in common use:

$$V_{ce} I_b = 0 (R_{be} = \text{infinity})$$

$$V_{ce} \text{ Max. } (R_{be} = 40\Omega)$$

$$V_{ce} \text{ Max. } (R_{be} = 0)$$

Also shown in Figure 3 are two distinct voltage breakdown points represented by the conditions where V_{ce} is measured with $I_b = 0$ and V_{cb} with respect to $R_{be} = 0$. Because the collector characteristic curves for voltages between these two breakdown voltages exhibit negative resistance characteristics, it is apparent that if the voltage on the transistor exceeds the maximum breakdown voltage on a surge, the transistor will remain broken down even after the surge voltage has disappeared. For this reason, caution must be exercised when using a transistor with a voltage supply greater than that limited by the V_{ce} rating.

Types of voltage breakdown

There are at least five types of voltage breakdown areas that must be considered. Even though each type is not strictly indepen-

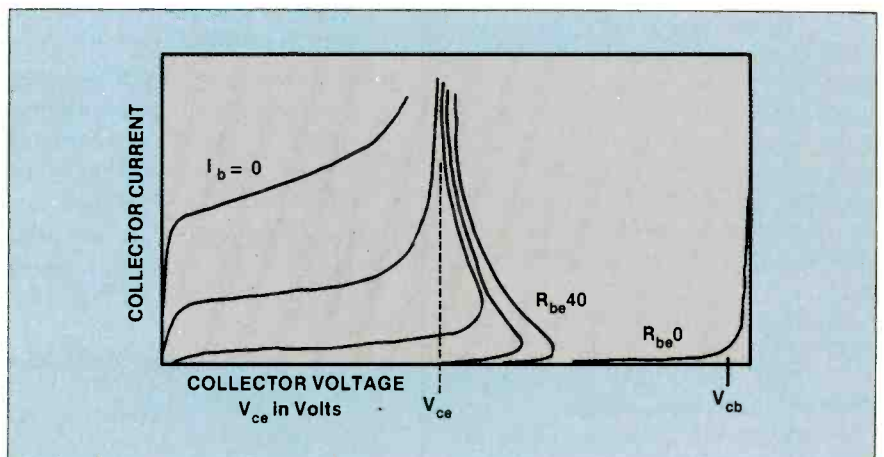

Figure 3. The collector-emitter breakdown voltage depends on the value of resistance inserted between the base and the emitter.

dent, they can be treated separately, keeping in mind that each is related to the others.

• *Avalanche breakdown*—Avalanche breakdown is a voltage breakdown occurring in the collector-base junction, similar to the Townsend effect in gas tubes. This effect is due to the high dielectric field strength that occurs across the collector-base junction as the collector voltage is increased.

The high field accelerates the free charge carriers so they collide with other atoms, knocking loose additional free charge carriers that in turn are accelerated and have further collisions.

This multiplication process occurs at an increasing rate as the collector voltage increases until at some voltage V_a (avalanche voltage) the current suddenly tries to go to infinity. The carrier multiplication factor that indicates the rate of extra charge-carrier generation may be given the symbol m and a plot of m vs. collector voltage would show a variation of m from unity to infinity with a very sharp break at V_a , the avalanche breakdown point.

This type of breakdown characterizes the maximum V_{cb} rating of most germanium PNP transistors. The ratio of an increment in collector voltage (ΔV_{cb}) to an increment in saturation current ($\Delta I_{c(s)}$) is a measure of the collector voltage stability of a transistor.

• *Alpha multiplication*—This type of breakdown is very closely related to the avalanche effect described above. Alpha multiplication is produced by the same physical phenomenon that produces avalanche, but is different as regards circuit configuration.

Because the current flowing in the collector is $I_c \approx \alpha I_e$ and because the factor m accounts for the multiplication of charge carriers so it can be considered as a multiplying factor of alpha, then the collector current can actually be given as $I_c \approx m\alpha I_e$, that says the collector current is approximately equal (\approx) to the multiplying factor times the emitter current.

Now test and restore every CRT on the market . . . without ever buying another adaptor socket or coming up embarrassingly short in front of your customer . . . or your money back



**with the new improved CR70 "BEAM BUILDER"
Universal CRT Tester and Restorer
Patented \$995**

Have you ever?

- **Thrown away a good TV CRT, data display CRT, or scope CRT** that could have been used for another two or three years because you had no way to test or restore it?
- **Lost valuable customers** because you advised them that they needed a new CRT when another technician came along and restored the CRT for them?
- **Lost the profitable extra \$35 or more** that you could have gotten for restoring a CRT while on the job and locked in the profitable CRT sale later?
- **Avoided handling profitable trade-ins or rentals** because you were afraid you'd have to replace the picture tube when you could have restored it?
- **Had a real need to test a CRT on the job, but didn't have the right adaptor socket or setup information** in your setup book?

If any of these things have happened to you, CALL TODAY, WATS FREE, 1-800-843-3338, for a FREE 15 day Self Demo.



SENCORE

3200 Sencore Drive
Sioux Falls, SD 57107
605-339-0100 In SD Only
innovatively designed with your time in mind

**CALL TODAY
WATS FREE
1-800-843-3338**

Circle (9) on Reply Card

In the common emitter configuration, beta is normally given as:

$$\beta \approx \alpha / (1 - \alpha)$$

Taking into account the alpha multiplication factor, m the common emitter equation will become:

$$\beta = m\alpha / (1 - m\alpha)$$

or

$$I_c \approx m\alpha I_b / (1 - m\alpha)$$

When the product $m\alpha$ becomes equal to unity, the denominator of the above expression becomes zero and the beta becomes infinite. This is known as alpha multiplication breakdown, and because the beta becomes infinite, the collector cur-

rent becomes infinite for collector voltages given by the condition where $m = 1/\alpha$.

This voltage is always much lower than the avalanche breakdown voltage and generally accounts for the collector-emitter breakdown voltage with base current equal to zero.

- *Punch-through* - The punch-through breakdown voltage is a voltage breakdown occurring between collector-base junction with increasing collector voltage.

As the collector voltage is increased, the space charge region (collector junction width) gradually increases until it penetrates completely through the base region, touching the emitter. At this point the emitter and collector are effectively shorted together.

This type of breakdown occurs in

some PNP junction transistors but generally the alpha multiplication breakdown occurs at a lower voltage than punch-through. Because this breakdown occurs between collector and emitter, this type of breakdown is more serious in the common emitter or common collector configurations.

- *Thermal runaway* - Thermal runaway involves the avalanche effect, and in addition it is dependent upon the circuit stability factor, the ambient temperature and the transistor power dissipation. The thermal runaway problem is a regenerative process where an increase in temperature causes an increase in the leakage current I_{co} that results in an increased collector current which in turn causes an increased power dissipation that raises the junction temperature,

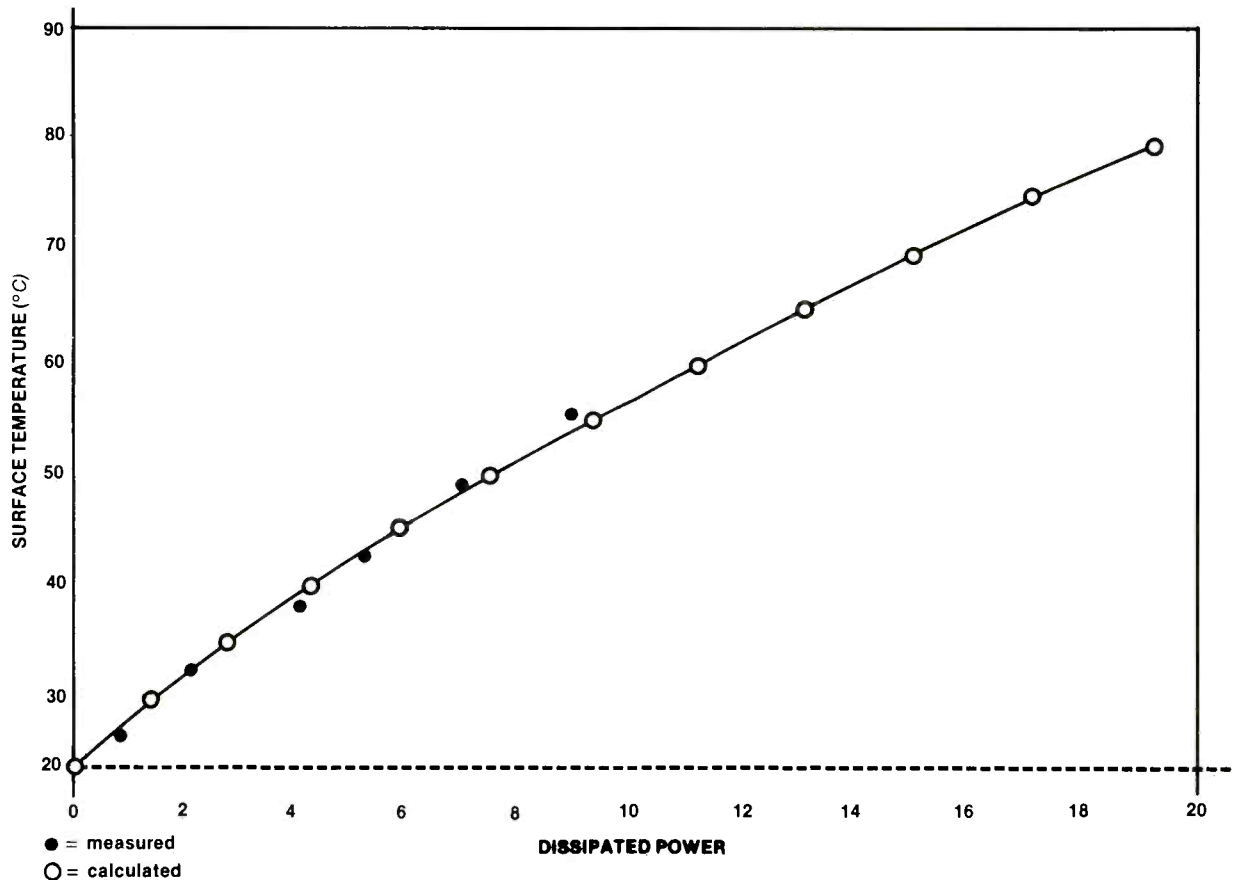

Figure 4. This is a plot of calculated equilibrium temperature vs. dissipated power for a 52-square inch brass plate heat sink at an ambient temperature of 24°C. Also shown for comparison are experimentally obtained values.

Walk "tough dog" troubles out of any TV & VCR in half the time . . . or your money back



with the exclusive, patented,
VA62 Universal Video Analyzer . . . \$3,295

Would you like to?

- **Reduce analyzing time:** Isolate any problem to one stage in any TV or VCR in minutes, without breaking a circuit connection, using the tried and proven signal substitution method of troubleshooting?
- **Cut costly callbacks and increase customer referrals** by completely performance testing TVs & VCRs before they leave your shop? Own the only analyzer that equips you to check all standard and cable channels with digital accuracy? Check complete, RF, IF, video and chroma response of any chassis in minutes without taking the back off the receiver or removing chassis plus set traps dynamically right on CRT too? Simplify alignment with exclusive multiburst pattern.
- **Reduce costly inventory from stocking yokes, flybacks, and other coils and transformers, for substitution only,** with the patented Ringing Test. Run dynamic proof positive test on any yoke, flyback, and integrated high voltage transformer . . . in-, or out-of-circuit?
- **Protect your future** by servicing VCRs for your customers before they go to your competition? Walk out "tough dog" troubles in any VCR chrominance or luminance circuit — stage by stage — to isolate problems in minutes? Have a proof positive test of the video record/play heads before you replace the entire mechanism?
- **Increase your business** by meeting all TV and VCR manufacturers' requirements for profitable warranty service work with this one universally recommended analyzer.

To prove it to yourself, CALL TODAY, WATS FREE, 1-800-843-3338, for a FREE Self Demo . . . or learn how the VA62 works first by calling for your free simplified operation and application instruction guide, worth \$10.00.



SENCORE

3200 Sencore Drive
Sioux Falls, SD 57107
605-339-0100 In SD Only
innovatively designed with your time in mind

**CALL TODAY
WATS FREE
1-800-843-3338**

causing a further increase in leakage current.

If the leakage current is high enough, which can be caused by a high temperature or high voltage, and if the current is not adequately stabilized to counteract increases in collector current because of increases in leakage currents, the process can regenerate to such a degree that the temperature of the transistor and the power dissipation rapidly increase, destroying the transistor.

This type of effect is most prominent in power transistors where the junction is normally operated at high temperatures and where high leakage currents are present because of the large junction areas.

Thermal runaway can be reduced and controlled through the choice of circuits with a low stability factor, utilization of transistors with low leakage currents, and by maintaining the circuit at low ambient temperatures.

Heat generated in a power transistor primarily at the collector junction must be removed at a sufficient rate to keep the junction temperature within a specified upper limit. This is accomplished primarily by conduction from the junction through the transistor material to a metal mounting-base that is designed to provide good thermal contact to an external heat dissipator or heat sink.

Because heat transfer always must be associated with a temperature difference, a difference in temperature will exist between the collector junction and the transistor mounting surface. It follows, therefore, that an increase in dissipated power at the collector junction will result in a corresponding increase in temperature. This difference can be expressed as:

$$P_A = \theta \Delta T$$

P_A = transistor average dissipation in watts

θ = a constant (considering thermal conductivity, length and area)

T = collector junction mount-

Circle (10) on Reply Card

ing surface temperature in degrees C

The constant Θ can be thought of as the thermal conductance from collector junction to the transistor mounting surface. Its reciprocal is therefore thermal resistance \underline{O} .

$$\underline{O} = \frac{\Delta T}{P_A}$$

The thermal resistance of a given power transistor can in most cases be obtained from the manufacturer's specifications and, in some cases, thermal conductance is provided by the specification sheet, usually in the form of derating factors. This is generally true, however, only in the case of small signal transistors.

• *Still air convection and radiation*—In general, heat sink determinations are difficult. The most satisfactory approach to a specific

heat sink problem is an experimental one such as the intelligent approximation of simple heat sink calculations that may be made from the following basic, but sufficient, information. Only heat transfer from a flat heat conductive surface through the process of still air convection and radiation will be considered.

Shown in Figure 4 is a plot of calculated equilibrium temperature vs. dissipated power for a 52-square inch brass plate and an ambient temperature of 24°C. Also included in this figure, for the purpose of comparison, are results of experimental observations.

A specific set of solutions that can be used as an aid in establishing preliminary heat sink requirements is shown in Figure 5. Remember, complex calculations result only in approximations.

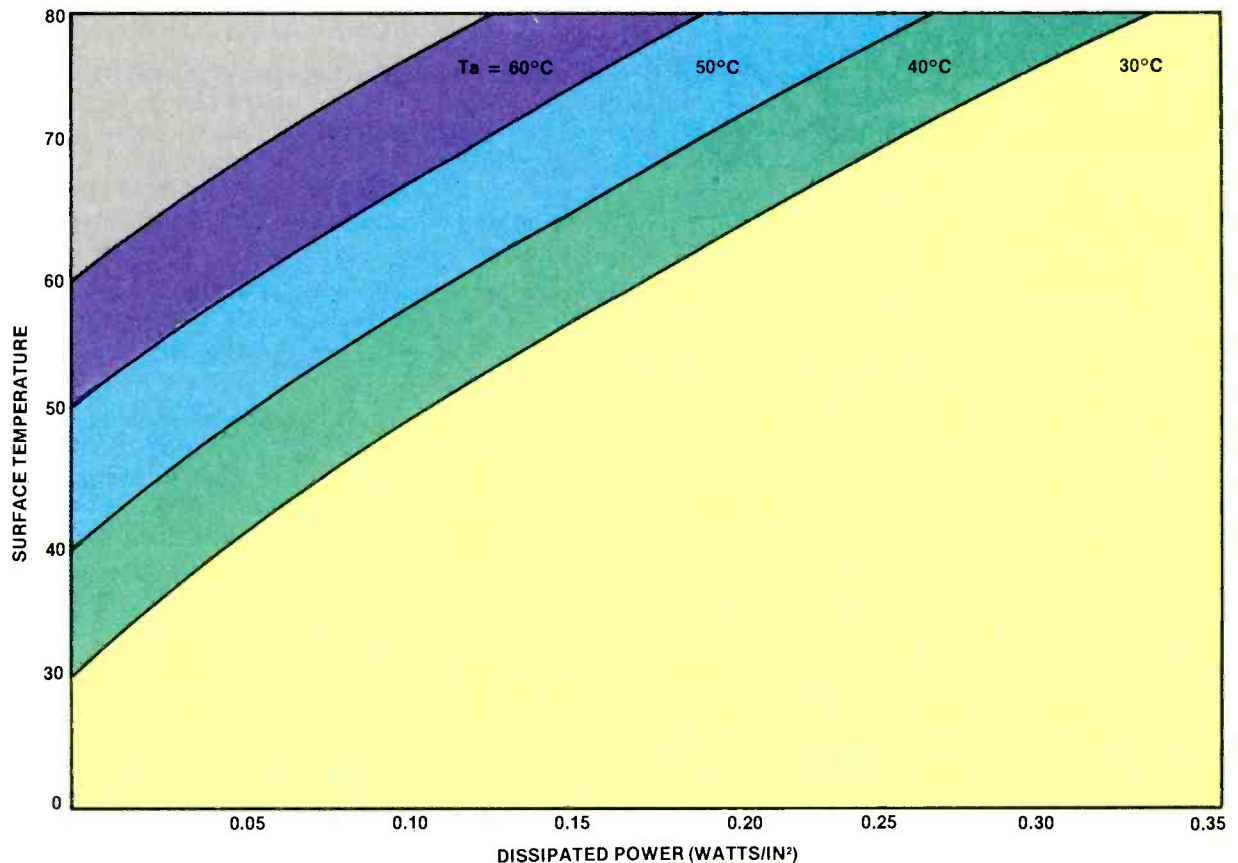

Figure 5. Surface temperature at a given value of dissipated power will vary in proportion to ambient temperature.

It often is convenient to include the effect of the heat sink in your considerations involving transistor thermal properties. In practice, this is accomplished by determining an approximate *thermal resistance* of the heat sink and adding this to the transistor thermal resistance.

• *Miscellaneous breakdown*—A discussion of voltage breakdown also should include the breakdown from base to emitter that occurs as a result of the base-emitter junction. This type of breakdown is very important in switching applications, or for any large signal application where a large voltage swing may be expected at the emitter, particularly true when the emitter is back-biased.

In multivibrator circuits, for example, the entire output swing may appear across the emitter in

some parts of the cycle. Because the factors relating to breakdown in the emitter-base junction are similar to those occurring in the collector-base junction, the same principles apply.

In the case of a symmetrical transistor, the voltage breakdown between base and emitter may be the same as that occurring from collector to base. However, in asymmetrical transistors such as silicon types, the voltage breakdown from base to emitter may be considerably lower because of the low resistivity material in the emitter region; breakdown between base and emitter generally results in destruction of the base-emitter junction.

Effects of voltage breakdown on transistors

The results of the breakdowns

A discussion of voltage breakdown should include the breakdown from base to emitter that occurs as a result of the base-emitter junction.

EVERYBODY'S A WINNER!



Sponsored by the National Electronics Sales & Service Dealers Association & the International Society of Certified Electronics Technicians

LAS VEGAS . TROPICANA . AUG. 4-9

Send for more information and an application to
NPEC, 2708 W. Berry St., Ft. Worth, TX 76109; Ph (817) 921-9061

Name _____
Address _____
City _____ State _____ Zip _____

MAKE ANY TELEVISION OUTPUT STEREO SOUND!!

Increase your profit margins by selling and installing this unique device.



Model SS-2001: The TELEVONIC™ implant unit, installed directly into any Television, creates synthesized stereo output from any channel. When connected with a stereo amplifier or receiver, it will provide a sound system found only in expensive stereo Televisions, at a fraction of the cost.

Works on any TV • Easy to install • 100% Solid State • Microchip technology • Superior Sound quality • 1 year warranty.

**REQUIRES QUALIFIED TECHNICAL INSTALLATION.
DISTRIBUTOR INQUIRIES WELCOMED.**

For Information Contact: Mr. Ernest C. Hassell • Director of Marketing
• Spectrum 2000, Inc. • 4854 Sterling Drive • Boulder, CO 80301
• 1-800-922-6333

TELEVONIC is a trademark of Spectrum 2000, Inc.
Manufactured in the U.S.A. by Spectrum 2000, Inc.

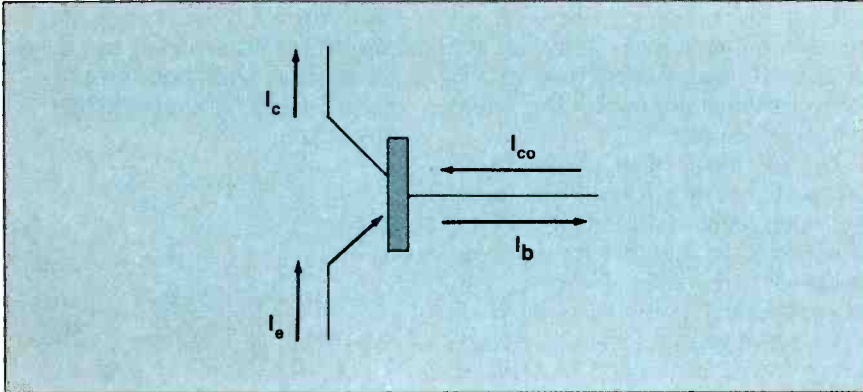

Figure 6. Leakage current depends on how the transistor is connected (see text).

discussed thus far manifest themselves in various ways on the transistor. Avalanche breakdowns usually result in destruction of the collector-base junction because of excessive currents, which, in turn, results in an open between collector and base.

Breakdowns due to alpha multiplication and thermal runaway most often result in destruction of the transistor because of excessive heat dissipation that shows up electrically as a short between collector and emitter (with the collector diode open).

This condition, which is most common in transistors that have been ruined, is not easily detected, and, therefore, is the reason we mentioned it as an *electrical short*. In most cases an ohmmeter check may indicate a good transistor.

Caution must be exercised when placing such a defective transistor in a standard transistor tester, because the short from the collector to emitter may result in damage to the meter, or the tester may indicate an alpha of unity that could give erroneous indication of the transistor's condition.

There are some transistor testers that will adequately identify this type of breakdown as well as detecting other defects.

Punch-through breakdown generally does not damage the transistor and is a self-healing type of breakdown: After the voltage is removed, the transistor again is in satisfactory operating condition.

Voltage supplies for transistors

Most transistors should be operated with supply voltages considerably less than V_{cb} , which the manufacturer generally gives in his data sheets. As a general rule, a voltage of less than 20V should be used for most common junction transistors. Voltage supplies of 30V or less are adequate for all but the highest voltage transistors.

The technician should select a transistor for common emitter and common collector circuit applications on the basis of a V_{ce} rating rather than the V_{cb} rating commonly given. It also is important that there is not a unique relationship between the V_{cb} rating and the V_{ce} maximum rating.

Any discussion of transistor failures would not be complete unless leakage current is discussed. Using the diode symbol as illustrated earlier, it is possible to define various leakage currents that exist in the transistor from this same diode viewpoint.

Because the diode leakage currents are so closely related to the breakdown voltages of the transistor, we may define three similar currents that are in common use, and they are designated in the following manner:

1. I_{co} is the current that flows in a transistor when the emitter is open-circuited and collector is reverse biased. This also can be expressed as I_{cbo} .

2. I_{eo} is the current that flows when the collector is open-circuited and the emitter is reverse biased. This can be expressed as I_{ebo} .

3. I_{ceo} is the collector current that flows from collector through the emitter when the base is open-circuited and normal reverse bias is applied to the collector.

The collector leakage current referred to as I_{co} is in reality the reverse leakage current of the collector-base diode. It has two components: a surface-leakage component that arises from surface contamination and which is directly proportional to the applied voltage; and a thermal component

that arises as a result of diode action, varies exponentially with temperature and is relatively independent of applied voltage. Just remember that the thermal component doubles in magnitude every 10°C, or exhibits a tenfold increase every 33°C.

The leakage current I_{co} is very similar leakage current that is characteristic of the emitter-base diode. It is similar in all respects to the reverse leakage current in the collector and has two components, one resulting from surface contamination, and the other due to the inherent characteristics of diode action.

The two leakage currents I_{co} and I_{eo} are of comparable magnitude although the I_{eo} is only important in switching circuits where the emitter may be reversed biased. In normal small-signal applications, the emitter is forward biased and the emitter leakage current does not need to be considered.

The leakage current I_{co} referred to earlier is not simply explained as the previous two currents. If the transistor is considered with the base open, the collector diode can be considered as reverse biased while the emitter diode is forward biased.

The leakage current I_{co} that would normally flow from the collector to the base or vice versa is not able to flow in the base lead because the base is open circuited.

Because the base current that would normally flow is I_{co} , an expression can be developed for the emitter current that flows to give a corresponding operating point. By referring to Figure 6, please note that various current directions are indicated as representing the situation that exists.

The leakage current I_{co} would like to flow from base to collector for the PNP transistor as shown in Figure 6 but because the base is open-circuited, the I_{co} cannot flow from the base. Assume an imaginary current designated as I_b that flows in a direction opposite to that of I_{co} in the base. The two currents cancel in the base lead,

which satisfies the condition of an open base.

The leakage current that flows in the collector when the base is open is very much larger than that which flows when there is a low resistance circuit path between

base and emitter. It is this large value of collector leakage current that causes thermal runaway in transistors which are operated with the base open, or with large values of resistance inserted between the base and emitter.

ES&T

CALL TOLL FREE

Include work address and phone number for Free Catalog.

800-824-2873

SCOPES

IWATSU



- All 14 models in stock
- 2-3 year warranties
- 20-250 MHz

MODEL	PRICE
5702	\$ 535
5705	\$ 899
5710	\$1245
5711	\$1695
7506	\$ 749

HITACHI V-222

Portable Dual Trace Scope

SALE \$535

LIST \$715⁰⁰



- DC-20 MHz
- 3-Way Power Supply
- Lightweight
- High Sensitivity and Fast Sweep Timer

HITACHI Hitachi Denshi America, Ltd.

- All 20 models in stock
- 2-3 year warranties
- 20-100 MHz

MODEL	PRICE
1050	\$1299
509	\$1199
VC 6041	\$4400
422	\$ 690
1100	\$1900
650	\$ 930
V209	\$ 725
1070	\$1595
1100A	\$2490
V222	\$ 550

DIGITAL MULTIMETERS

BECKMAN

Beckman Industrial

- All 300, HD, and Circuitmate series
- All accessories in stock

MODEL	PRICE
HD100	\$169
HD110	\$189
HD130	\$239
HD140	\$259
300	\$120
310	\$145
320	\$179
330	\$219
350	\$229
360	\$289
4410	\$239

FLUKE FLUKE

- Autorange
- Touchhold function
- 0.3% accuracy
- Heavy duty Analog display

MODEL	PRICE	MODEL	PRICE
73	\$ 79	75	\$ 99
21	\$ 99	23	\$145
25	\$229	27	\$259
8010A	\$279	8012A	\$359
8020B	\$199	8022B	\$154
8024B	\$249	8050A	\$389

FLUKE 77

SALE

\$114

LIST \$139⁰⁰

Analog/Digital Multimeter



POWER SOURCES

POWER DESIGNS

- Low and high voltage power sources
- 1-5 year warranties

MODEL	PRICE
2020B	\$750
2K20	\$695
4050	\$660
6150	\$725
TW5005W	\$595
TW6050A	\$880
TW347	\$695
TP340	\$750
TP343A	\$795

USED TEST EQUIPMENT, TOO!—OVER 3,000 MODELS AVAILABLE AT HUGE DISCOUNTS WITH WARRANTIES!

■ Quantity Discounts Available ■ Dealers Welcome ■ Freight and Tax Extra ■ Immediate Availability of Equipment

United States Instrument Rentals, Inc.

A U.S. Leasing Company
2988 Campus Drive
San Mateo, CA 94403

Circle (12) on Reply Card

July 1986 *Electronic Servicing & Technology* 49

Troubleshooting Tips

Insufficient brightness control Panasonic TR-504 1P B&W TV (Photofact 2042-3)

Operated on the test bench, the receiver's contrast and brightness controls had little effect, the picture appeared slightly out of focus and the left side of the raster had a dark band. Scope waveforms at three pins of the flyback appeared to be normal. Dc voltage at C441 and the diode D46 cathode was only +183V instead of the rated +400V. At first, I thought the flyback was defective, because D46 and R441 (the series resistor) checked *good* in the circuit.

Fortunately, I decided to check D46 out of circuit using my scope and the circuit that displays a right angle for good diodes. This test showed D46 had excessive leakage. *Installation of a new D46 diode brought normal operating conditions.*

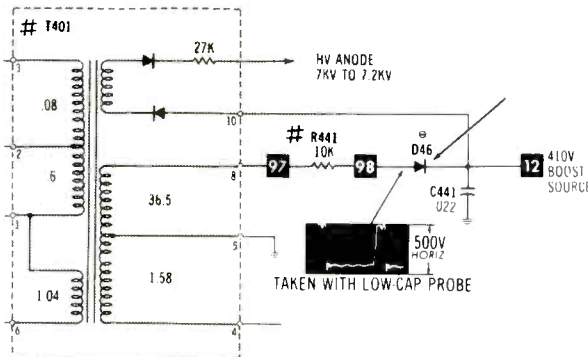

This is one example where it was wise to check everything else before replacing an expensive flyback. Also, it showed the limitations of testing some components in-circuit. For accurate readings, remove the component and test it again.

M.J. Zemaitis
Chesapeake, VA

Detuned push-button tuning Sylvania E51-04 (Photofact 2084-1)

All channels were normal except channel 2 that was mistuned into the sound bars. Many of the tuner-control circuits were checked, and I even replaced the VHF tuner, but nothing was found wrong and the tuning remained bad on channel 2.

Finally, I began testing the supply voltages. Most of them were within tolerance, but the +5V regulated supply measured +8.2V. Of course, this is not usable.

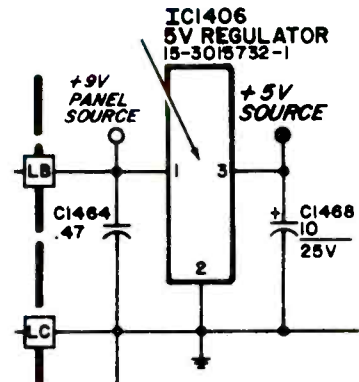

There were no adjustments on the IC-type regulator; therefore, the IC1406 was judged to be defective. I replaced it with the Sylvania part number 15-3015732-1 IC, the regulated output became +5V and the tuner operated correctly on channel 2 (and all other channels).

I started checking the incorrect elements because I reasoned that a power-supply out-of-tolerance voltage would be certain to affect all channels alike. That was not true here. In the future, I will check all supply voltages first for any tuner problem that has the same symptoms as this Sylvania.

William A. Grimm
Uniontown, PA

Dark picture RCA KCS204C B&W TV (Photofact 2120-2)

The customer's complaint was a very dark picture

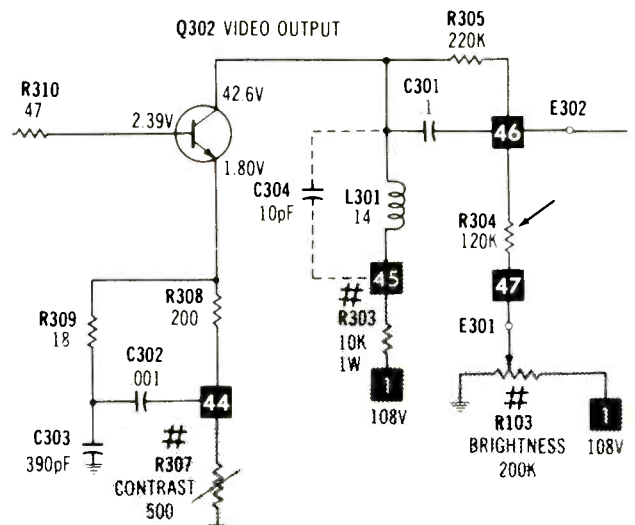



with no control of brightness. On the service bench, I checked the brightness and contrast controls, finding that only the contrast control varied the brightness. The brightness control had no effect at all.

These symptoms pointed to a defect in the brightness control circuit so I centered my attention there. Measurement of the dc voltages around Q302 video-output transistor showed the collector voltage was too high. Normal dc voltage should be about +43V, but about +68V was the reading. I checked the voltage-divider resistors around the collector and found R304 was open.

After I replaced the open R304 with a new 120kΩ resistor, *operation of the brightness control returned to normal*, giving good brightness at maximum.

David Luckner
Corning, NY



Symcures Wanted

Electronic Servicing and Technology

needs a broader variety of television Symcures. Especially needed are reports of Quasar, General Electric, Sylvania (or Philco), Sony Sears and Magnavox.

Symcures are, by definition, solutions to problems that have been encountered during the repair of *more than one* television set of the same make and model, and that may reasonably be expected to be a source of *recurrent* failure.

Please give the brand, model number, Photofact number, a brief description of the symptoms, a rough hand-drawn schematic of the area containing the defect, and a short description of the cure (including whether the defective component was open, leaky, shorted or intermittent).

ES&T editors will adapt the material to the Symcure format and have Photofact-style schematics prepared.

Send seven Symcures each time. Only six will be published, but the extra gives the editor a spare for one already printed in the past (or otherwise not suitable to the format). \$30 will be paid for each page of six actually published (remember to include full name and address).

Send to: Symcure Department
Electronic Servicing and Technology
P.O. Box 12901
Overland Park, Kansas 66212



70 Series Digital Multimeters



3½ digit multimeters combine a 3200 count LCD display with an analog bar graph for quick visual checks of continuity, peaking, nulling and trends. The unparalleled operating ease, instant autoranging and 2,000+ hour battery life make this a lot of meter for the price. 3 year warranty.

FLUKE 73
• 0.7% basic DC accuracy
• Autoranging only
Reg. \$79.00
SALE \$76.50

FLUKE 75
• 0.5% basic DC accuracy
• Autoranging
• w/range hold • 10 amp + autoranged mA ranges • Continuity & diode • Test beeper
Reg. \$99.00
SALE \$89.00

FLUKE 77
• 0.3% basic DC accuracy
• Autoranging
• w/range hold • 10 amp + autoranged mA ranges • Continuity & diode • Test beeper • Touch-Hold
Reg. \$139.00
SALE \$125.00

Send now for your **FREE** catalog of electronic tools & test equipment

w.s. **JENKS & Son**



1933 Montana Ave. NE
Washington DC 20002
(202) 529-6020

Call TOLL-FREE
1-800-638-6405

Circle (13) on Reply Card



Hi-Power TEC-VAC For Hi-Tech Cleaning

- For Dust—Toner—Debris
- Powerful—700 watt Thermal Auto-Reset Motor
- Toner Safe — Antistatic Hose & Tips
- Paper/Cloth Double Filtration System (5 micron filter) No Pass Through
- Inexpensive Disposable Bags
- Self-contained Unit in Rugged Case with Shoulder Strap
- Available in 115V, 60 Hz. and 220V, 50 Hz models



5 Apollo Road, P.O. Box 368
Plymouth Meeting, PA 19462 U.S.A.
Phone (215) 825-4990 Telex 83-4763
Fax No. 215-828-5623

Circle (14) on Reply Card

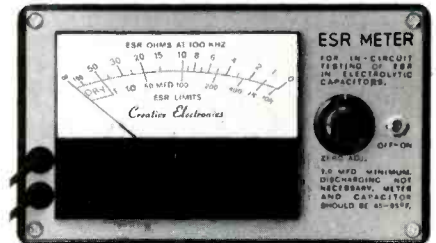

ESR METER

**CHECKS ELECTROLYTICS
IN-CIRCUIT
WITH 99% RELIABILITY**

A great time-saver that's been tested by 3 magazines and thousands of satisfied customers since 1978.

Ideal for preventive maintenance: measures electrolyte dryness & shows up intermittent opens.

60-day Satisfaction Guarantee

Send check or M.O. or call
(313) 435-8916 for COD

Or write for free brochure to:

Creative Electronics

ESR Brochure
1417 N. Selfridge
Clawson, Mich. 48017

\$130.00
postpaid
USA & CAN

Circle (15) on Reply Card

What do you know about electronics?

By Sam Wilson

Old business, transistor gamma

In a previous issue, I mentioned the transistor parameter called *gamma*. I want to thank all of the readers who took the time to write on the subject.

I answer every letter personally. It wouldn't be possible to print every letter sent by readers; I wish I could. I want you to know that your letters are very important to me and to *ES&T*.

All of the readers correctly identified gamma as being a common-collector parameter defined by the equation:

$$\gamma = Y_{CE}/Y_{CC}$$

Gamma can be obtained from beta using the following equation:

$$\gamma = \beta + 1$$

In every case the reader's letter correctly identified gamma, but none of them gave a strong support for its use in any application.

Here is one reponse to a reader's letter:

So far, I have received a number of replies, and all of them explain what gamma is. No reply so far has shown that gamma is used extensively in any practical application.

As a parameter, gamma would normally be used in the design of follower circuits. However, follower circuits are often designed by the so-called brute force method, and therefore, the parameter is not needed or used.

I suspect that some overenthusiastic author(s) came up with the idea of gamma simply because the transistor is a 3-terminal device. As such, it has three possible configurations: common emitter, common base and common collector. Two of the parameters relating to these configurations (common base and common emit-

ter) are well known as beta and alpha.

In order to make the picture complete, the third (gamma) is included in some textbooks. Although it is included in some books, it is not used extensively in practice.

I object strongly to this! It leaves readers with the impression that they have learned something valuable. In reality, it is only useful for filling the pages in the book. I could be wrong, but none of the mail has proved me wrong so far.

I'm still getting letters on the subject. If anything comes in about the extensive use of gamma, I'll let you know.

Get the lead out and keep it out

Recently, I was searching through some old magazine articles to get information on soldering. In one of the articles, there was a photograph that startled me and at the same time, worried me. It shows a technician tinning a piece of wire. In one hand, he was holding a soldering iron and in the other hand he was holding the wire being tinned. The solder for the job is being held in his mouth.

That's not the only time I've seen this trick being performed. One time in a continuing education class, I saw an experienced technician do the same thing.

It occurred to me that maybe some of our readers, especially the younger ones, may have developed this habit.

Lead is poison! Do not, under any circumstances, put lead in your mouth!

Lead is a very insidious type of poison. It gets into your system and there is no way for your

TYPICAL CONFIGURATIONS

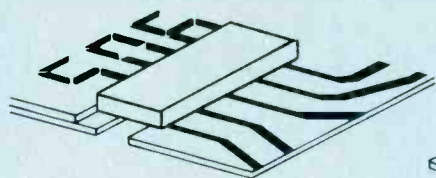

COPLANAR CONNECTION
typical display to board

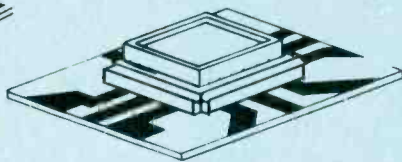

PARALLEL CONNECTION
typical hybrid to board

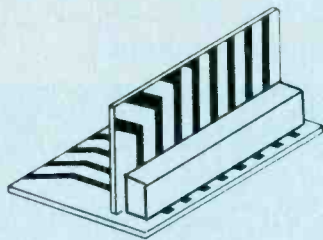

RIGHT ANGLE CONNECTION
typical mother-daughter board

Figure 1.

Redrawn from a catalog of PCK Elastomers, Inc. (a unit of the Killmorgen Corporation).

system to eliminate it. If you get enough of it in your system, you are going to have an illness from which you will never recover.

When I was in school, I took a course called Humanities. One of the subjects was the possible causes of the fall of the Roman Empire. I was surprised to learn of the possibilities: that the Romans used eating utensils and cookware made of lead. The lead could be made attractive and it was easy to work with. But the resultant health hazard was devastating.

I am not a historian, so I can't tell you how much this actually affected the destruction of the Roman Empire. But the story does emphasize the precaution against putting lead into your mouth.

You also should avoid sticking the leads of various components in your mouth because component leads often are tinned.

Even if you overlook the fact that the technician with the lead solder in his mouth was courting a debilitating illness, there is another reason why the practice is unwise. His nose and eyes were only a few inches (less than one foot) from the wire being tinned. He had no safety glasses on. It was obvious from the picture that he was going to inhale a lot of the soldering vapors.

Because this gentleman obviously is bent on total self-destruction, he doesn't need to discuss the danger to his *eyes*, I guess.

Once an idea like this gets started, it is hard to stop. If we don't discuss it now and then, it is liable to start showing up again.

Cleaning soldered terminals

On a closely related subject, technicians often employ alcohol to clean the terminals after the soldering job is finished. They use the alcohol to remove excess flux. This procedure is OK according to the NASA specifications for soldering.

However, in rare cases a technician *may* get the idea to use carbon tetrachloride for that job. This is especially true in some industries where carbon tet is readily available. Here is another very important thing to remember:

Don't use carbon tet in a closed work space!

In fact, it is a good idea to keep it out of your work area. *The fumes from carbon tet can produce serious injury to your system.*

Elastomers

Get out your six favorite books on interfacing and look up the word *elastomer*. I doubt if you will find it in any of your books, but I think it should be there.

An elastomer is a rubberlike plastic interface; for electrical or electronic applications, it can be made conductive. An example of the use of a conductive elastomer in electronics would be connecting a component to a printed circuit board without solder.

The elastomer serves two purposes: It holds the component in

Check Digital IC's in-circuit Fast!

In the field or on the bench. B&K-PRECISION gives you the answers for TTL or CMOS



Model 550 (for TTL) \$395
Model 552 (for CMOS) \$395

New B&K-PRECISION IC Comparator Testers/Logic Monitors put you on the fast track to digital troubleshooting. IC's are tested by comparison to a known good device, allowing you to test hundreds of types with one simple operation.

As logic monitors, they simultaneously indicate the logic states of up to 20 IC pins. No need to check pins singly with a logic probe.

Tests most 14 to 20 pin, 54 and 74 Series TTL (Model 550) or 4000 and 74C Series CMOS (Model 552) devices.

- Convenient one button testing
- Reverse polarity and overvoltage protection
- Uses power from equipment under test
- Memory stores short duration pulses and intermittent events
- Zero insertion force reference IC socket
- LED at each IC pin identifies where fault exists
- Includes 16 and 20 pin DIP clips
- Compact hand-held size

Available from stock at your local B&K-PRECISION distributor. For more information contact your distributor or:

B&K PRECISION
DYNASCAN CORPORATION

6460 West Cortland Street
Chicago, Illinois 60635 • 312/889-9087

International Sales, 6460 W. Cortland St., Chicago, IL 60635
Canadian Sales: Atlas Electronics, Ontario
South and Central American Sales,
Empire Exporters, Plainville, NY 11903

Circle (16) on Reply Card

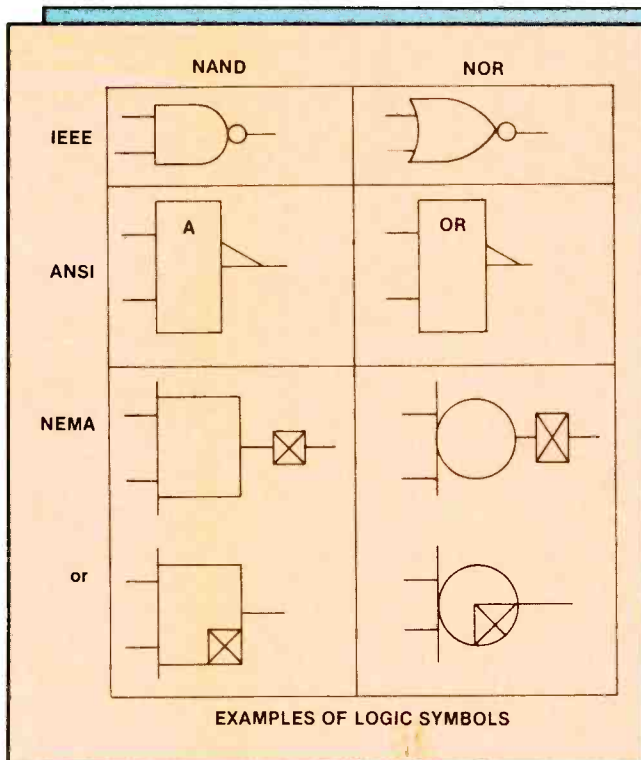
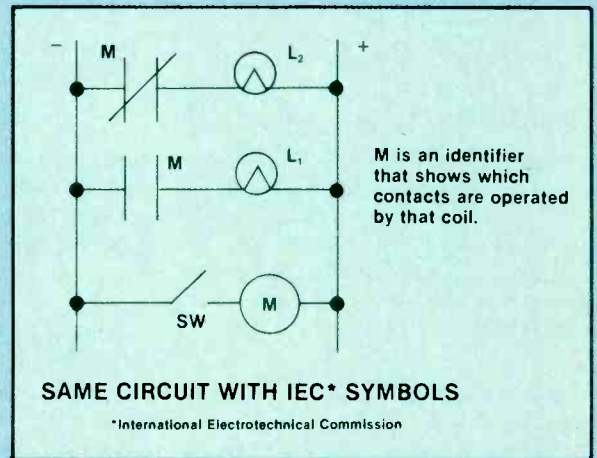
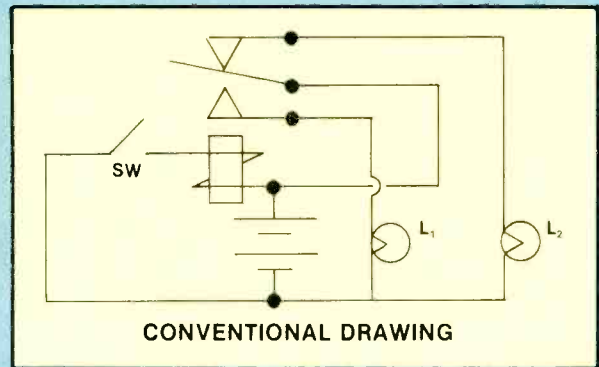

Figure 2.



place, and it completes the electrical connection between the component and the printed circuit board or other connection.

Figure 1 shows examples of how elastomers are used.

Symbols

A reader in Florida expressed some confusion over the symbols used in some articles and quizzes.

Specifically, NEMA symbols appeared in one article, and he professed that he had never seen them before. Many schools do not include symbols other than the MIL or IEEE types, and I think that is unfortunate.

I have a catalog from a major manufacturer of logic equipment that uses nothing but the ANSI symbols. Anybody who has seen industrial drawings of relay circuits probably has been exposed to the NEMA symbols.

Figure 2 shows several versions of symbols for comparison. This is not an exhaustive list, but it is a start toward showing that there are symbols beside the MIL or IEEE (conventional) symbols

which we usually see in magazines and textbooks.

New way to clean battery corrosion

Not long ago, I was writing for another publication and I mentioned that my carelessness had resulted in a serious problem. I had left the batteries in some test equipment and stored the equipment away, batteries intact.

When I tried to reactivate the equipment, the batteries had done their normal thing. They produced corrosion and leakage. I was left with a mess that was very hard to clean up.

I asked readers for advice on how to clean it and I received many excellent replies. Many of them suggested vinegar or alcohol.

Recently my mother gave me her "hurricane radio" to fix. People who live in Florida keep battery-operated radios because the electricity usually goes off during hurricanes and thunderstorms. The portable radios keep them in touch with the world.

So, my mother bought the radio

about six years ago. Because there is always more talk about hurricanes than there are hurricanes in existence, the radio never was used.

When she was getting ready for this year's anticipation of hurricanes, she turned the radio on and it wouldn't work. She handed it to me and said "fix it."

I took the back off. As I expected, it was the worst battery mess I had ever seen. I didn't have any of the things that the readers suggested. We had just moved.

I searched through the supplies and found a product called Lime Away. I applied this to the terminals with a Q-tip and, to my surprise, the corrosion and mess disappeared almost instantly. I am not trying to advertise any particular product, but I do suggest that if you're ever faced with a similar situation, get your hands on some Lime Away and the problem will be readily solved.

I returned the radio one-half day after I'd received it for repair. She already had bought a new one.

BS&T

Literature

United States Instrument Rentals announces its first guide to telecommunications test equipment. This reference guide contains complete listings for hundreds of models from 40 different manufacturers, including Telenex, Hewlett-Packard, Tektronix, Digitech, Marconi, Anritsu, Ameritec and many more. Also included in the guide are detailed product descriptions, manufacturer comparison charts and specification tables.

Circle (125) on Reply Card

Contact East is offering a one-year subscription to its tool and instrument catalog. Packed with more than 5,000 hard-to-find products for assembly line, installing, testing and repairing electronic equipment, the catalogs are buying guides for engineers, technicians and researchers.

The full-size catalogs feature color photos and detailed descriptions of precision hand tools, tool kits, test instruments, soldering supplies and static-control products, plus many new items.

Circle (126) on Reply Card

The latest, 82-page catalog from **Jensen Tools** features the most recent additions to the Jensen line of tools, tool kits and test equipment. Included are the JTK-9 PC Service Kit, the JTK-33 Executive Tool Kit in compact size for home or auto, new designs in tools chests and cases, and many unique tools available only from Jensen, all completely described and color illustrated.

Circle (127) on Reply Card

The **Rapid Systems** catalog is available, offering a full line of test and measurement peripherals for IBM, IBM compatible, Apple and Commodore personal computers. The catalog includes a section covering most commonly asked questions about personal computer based test and measurement peripherals, an applications chart, a representative and distribution

list and other new product information.

Circle (128) on Reply Card

A multicolor, 4-page technical bulletin published by **Keystone Electronics** details its new line of Safe 'N Sure test leads, accessories and universal modular kit.

Bulletin TL-86 spells out the functions and specifications of these leads that come in standard, shrouded and miniature right angle banana plug configurations. These are supplied with mating probe accessories that include screw-on test hooks, insulated alligator clips, insulated spade lugs and tip protectors.

Circle (129) on Reply Card

Electronic Specialists is offering a 40-page color catalog describing power line problems such as noise and high voltage spikes. Damaging and disruptive effects on phone equipment are described.

Typical office and commercial problems and suggested solutions are included. Hundreds of protective and interference cure products are described.

Circle (130) on Reply Card

"Tuning In To Satellite TV," a 64-page booklet published by **Satellite Orbit** magazine, gives a brief history of satellites and an explanation of the equipment a consumer needs to receive the TV signals they transmit. The guide's text is illustrated with color photos, cartoons, and charts showing the locations of the TV satellites. It includes a question-and-answer section and a glossary of terms. There is a listing of 65-plus programming services.

Circle (131) on Reply Card

To increase awareness of problems caused by electrostatic discharge, **Collins & Aikman Corporation** offers a booklet on this subject. It is estimated that ESD causes as much as \$10 billion annual loss to manufacturers and purchasers of sophisticated electronic equipment, or appliances that contain a microchip. These include computers, copiers, memory typewriters, keyboards, disk drives, VCRs, stereos and TV sets.

Circle (132) on Reply Card

Pocket logic.

Now available, a full-function pocket-size DMM with built-in logic probe.

TTL Logic Probe: 20 MHz

Hi/lo/off indications

Detects 25nS pulse widths

hFE (NPN or PNP): 1 range (1000)

DMM: Input Impedance-10 Megohms)

DCV-5 ranges (.2V to 1kV)

ACV-5 ranges (.2V to 750V)

DCA/ACA-5 ranges (200 μ A to 2A)

Ohms-8 ranges (200 ohms to 2000 Megohms)

Continuity beeper

Diode check

See one now at your local Beckman Industrial distributor.

DM20L... \$69⁹⁵*



*Suggested list price (\$US) with battery, test leads and manual.

Beckman Industrial™

Beckman Industrial Corporation
A Subsidiary of Emerson Electric Company
630 Puente Street, Brea, CA 92621
(714) 671-4800

© Copyright 1985 Beckman Industrial Corporation

Circle (17) on Reply Card

Products

One-hand operation crimper

Crimping tools, designed with a low handle force so that only one hand is needed for the crimp operation, are available from the Xcelite division of *The Cooper Group*. The handle force needed for the Xcelite crimper line is 36 pounds. The force required usually exceeds 70 pounds in tools of this type.

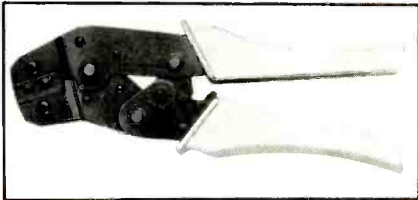

All components of the tool are made of high-quality steel, life-tested for 50,000 cycles. Built with a ratchet device that guarantees the same complete crimp every time, the tools feature a safety release mechanism so that the user, with one finger, can open the tools before the cycle is completed.

Because of the reduced size of the tools, they fit comfortably in the average male or female hand. They also fit easily into repair kits.

Two models, a mini and a maxi-crimper, are available.

Circle (75) on Reply Card

Electronic servicing software

A new full-service computer software package, Digi-TECH, is now available from *Sperry Tech*.

Digi-TECH software provides instant information for all areas of television, audio, microwave oven and VCR repair service. Software includes: warranty inquiry, work in progress, service history, diagnostic, service literature index, labor and parts pricing, automatic invoicing, financial and management reports.

The software programs are fully integrated and built around a multiscreen, mass-storage concept using bar-code technology. The bar-code technology makes it possible to keep massive amounts of information updated with maximum accuracy while reducing operator error. The Digi-TECH

package includes turn-key installation, training and user support.

Circle (76) on Reply Card

Digital multimeters

Kernco Instruments has introduced five digital multimeters.

These models are all compact, each weighing only 11 ounces. Full digital multimeter functions include dcV, acV, dcA, acA, as well as a resistance and diode check.



Overload protection for the full range is standard and the unit is battery operated. Some models will accept Type K thermocouples enabling the user to measure temperature from -50°F to 1400°F .

Circle (77) on Reply Card

High-leverage diagonal cutter

Klein's latest plier is similar to its style D228-8, but it is available in a 7-inch length. The high-leverage design provides 36% greater mechanical cutting advantage over conventional 7-inch heavy duty diagonal pliers. Supplied with standard bevel cutting

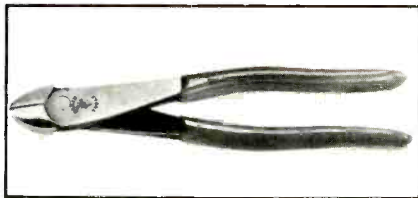

knives and comfortable red plastic dipped handles.

Circle (78) on Reply Card

Used pricing on computers

Orion Research Corporation has removed the risk of guessing by publishing a blue book giving ac-

tual market used prices. These prices are determined by national surveys providing information on which are based asking price, sale price and days to sell.

The *Orion Computer Blue Book* is in its second year of sales and follows in the 14-year tradition of four other volumes: *Audio Blue Book*, *Pro Blue Book*, *Camera Blue Book* and *Video Blue Book*.

Circle (79) on Reply Card

Cleaning, polishing brushes

The Eraser Company announces an industrial cleaning brush kit, the Eraser Kit, which can be used for a variety of cleaning and polishing applications. The kit contains five tools with brushes made from brass, stainless steel, nylon and coarse- and fine-grade FybRglass. Each tool is $3\frac{3}{4}$ -in. long with a cleaning tip diameter of $\frac{3}{16}$ -inch. The tools are suitable for a wide variety of cleaning, bur- nishing and polishing applications.

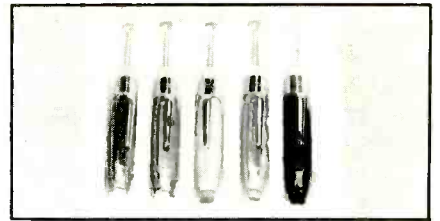

The exposed brush length on each tool is adjustable by the turn of a knob to compensate for wear. Refill brushes are available in all grades and are quickly replaced.

Circle (80) on Reply Card

1986 D.A.T.A. Books

Comparative data on over 123,000 discrete semiconductors, from 150 manufacturers worldwide, is available in three 1986 D.A.T.A. Books—*Transistor Edition 56*, *Diode Edition 53* and *Thyristor Edition 22*.

As with many other 1986 D.A.T.A. Books, the *Discrete Devices Electronics Information Series* has an improved format—to make device selection and substitution faster and easier.

The expanded table of contents now lists major component headings, specific device types by function, and the exact page number for each device type, which allows the user to locate any particular device quickly.

Circle (81) on Reply Card

Plug-in surge suppressor

Kalglo Electronics announces its new UL listed Mini-II plug-in surge suppressor.

This small unit boasts capacities often limited to more expensive devices. The compact item responds in 5ns, suppresses 13,500 pulse amps and has a capacity of 135J. Clamping starts at 150V, and its filtering circuit removes 41dB of noise at 10MHz on common mode and 49dB on normal mode. Once plugged into a wall outlet, the unused receptacle



receives the same protection as the two on the Mini-II, resulting in three protected outlets.

Circle (82) on Reply Card

Line of test equipment

Mercer Electronics, a division of Simpson Electric, has introduced a line of analog and digital test instruments. The line includes model 9401 4½-digit, full-function, hand-held DMM with 0.05% basic accuracy, and 3½-digit, hand-held DMM, model 9301, 0.25% basic accuracy.



Also offered are two pocket sized DMMs—the model 9370, 3½-digit autoranging DMM with memory mode that provides up to 99 counts of zero offset, and the model 9340, a 3½-digit DMM with

full function and range capability.

Circle (83) on Reply Card

A guide to servicing the 1541 disc drive

Howard W. Sams & Company, a division of Macmillan, has released "Commodore 1541 Troubleshooting & Repair Guide," a 228 page, 8½"x11" softbound book. Included are schematics, step-by-step troubleshooting flow charts, disassembly/reassembly instructions, calibration and alignment procedures, block diagrams, parts layouts, and both mechanical and electrical theory of operation, all presented clearly and concisely.

The theory of operation and troubleshooting flowcharts is presented at simplified and advanced levels, so that hobbyists and seasoned electronics technicians alike can use this reference.

Circle (84) on Reply Card

Compact dc supplies

Kikusui International has unveiled a pair of compact, high-resolution, multirange dc supplies for laboratory and system test ap-

Technicians,
Get Serious
About Your
Profession



Being a certified electronics technician lets people know that you are a professional in your field. It tells them that you are serious about your work and can perform up to CET standards.

Now you can order the "Study Guide for the Associate-Level CET Test" from the International Society of Certified Electronics Technicians. It includes material covering the most often missed questions on the Associate CET Exam. 8½" x 11", paperback, 60 pages.

For More Information Contact:

IS CET 2708 W. Berry, Ft. Worth, TX 76109. (817) 921 - 9101

NAME _____

ADDRESS _____

CITY _____ STATE _____

ZIP _____

_____ copies @ \$5 (+ \$1 postage.)

_____ send material about IS CET and becoming certified.

LOW COST PROBES FOR ALL SCOPES



\$43

MODEL SP1000
SWITCHABLE X1-X10
100 MHz

TPI offers equivalents to all makes of probes including modulars, at savings up to fifty percent. TPI probes compensate to all scopes. Slender, flexible cables are easier to handle yet more durable because of their unique center conductor. Performance is guaranteed.

FOR FAST RESPONSE CALL
800-368-5719

In Calif. 800-643-8382

TEST
PROBES, INC.



Your Probe Specialists
COLINE U.S. SALES & STOCKING SOURCE

P.O. Box 2113, LA JOLLA, CALIFORNIA 92038 (619) 459-4197

Circle (18) on Reply Card

plications. The ranging of voltage and current outputs provides maximum control and regulation for precision test. Model PAR 80A has an 80W output in four voltage ranges: 0-8, 16, 35 and 80 volts. The three ranges of the 160W, PAR 160 supply are 0-16, 35 and 80 volts.

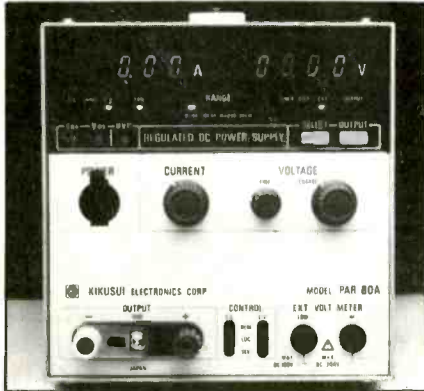

Noise and ripple levels for both the PAR 80A and the PAR 160A are less than $300\mu\text{V}$ rms (5Hz-1MHz), and the transient response (to within 0.05% + 10mV of the output voltage) is $50\mu\text{s}$.

Circle (85) on Reply Card

Conductive component carousel

A 40-bin conductive component carousel that rotates on a specially designed ball-bearing system is now available from *O.K. Industries*. Designated the CH-40C, the 40-bin carousel measures 20 inches (50cm) in diameter and stands $12\frac{3}{4}$ inches high (32cm) to save tabletop space at the electronic workbench. The bins are conductive black-carbon filled and the metal zinc-plated chassis makes it suitable for grounding to a conductive work bench.



The removable bins are designed for easy access to the smallest of components. Self-adhesive labels are supplied with the unit for easy identification of the components in each bin. There is an integrated handle for portability.

Circle (86) on Reply Card

Test powered or unpowered circuits

The Circuitracer from *Desco Industries* is a multifunction continuity tester for both powered and unpowered circuits. The model

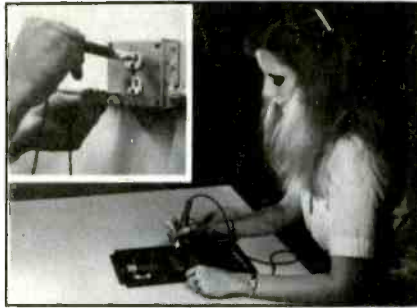

100 can test unpowered circuits using internal batteries or powered circuits up to 600V.

The model 100 has the indicator lamp at the working tip so the users can make multiple tests quickly without taking their eyes from the work.

This tester also will accept many different probe styles for testing circuit boards, wire wrap connections, or mil standard multipin connectors.

Circle (87) on Reply Card

Coaxial cable stripper

The CO-AX3 was designed and developed by *Davle Tech* for accurate removal of outer sheath from twisted pair coaxial cable and other cables of irregular configuration. A spring-loaded cutting head follows contour irregularities producing an accurate circumferential cut to controlled depth. A 90° rotation of cutting blade allows a longitudinal cut by pulling the tool along the cable axis.

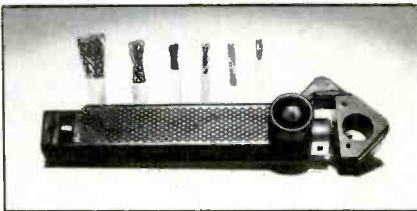

Incorporated into the tool is a retractable ripping blade that assists in splitting open the cable insulation once the longitudinal cut has been made. The tool is supplied in its own case that also contains five slip-on cable guides which control the location of the cable within the tool, and facilitate free rotation of the tool around cables with an irregular periphery.

Circle (88) on Reply Card

Triple soldering tool station

Edsyn announces availability of the model 902 soldering station.

Model 902 can handle one, two or three tools at the same time and offers two small handle 24V and one 930 CL1080 120V soldering tools. This gives the operator the choice of three different temperature settings on one soldering station. Edsyn's calibra-

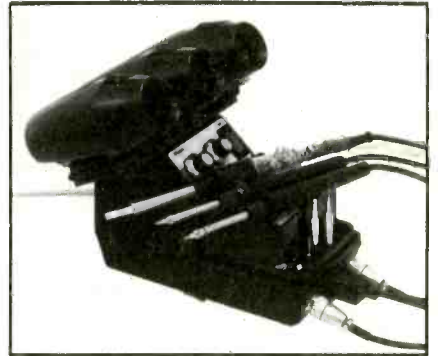

tion system makes it possible to achieve accurate temperature settings for all three tools, according to the manufacturer.

Circle (89) on Reply Card

SMD removal/replacement

Micro Electronic Systems presents an SMD removal/replacement machine called STAR (SMD terminal for assembly and rework). STAR is predominantly robotic, reducing operator skill to a minimum level.

Design considerations were no damage to either the PCB or the component being removed, no damage to adjacent components, used for limited assembly as well as rework, minimum time to complete the job (usually under 20 seconds), maximum cost effectiveness.

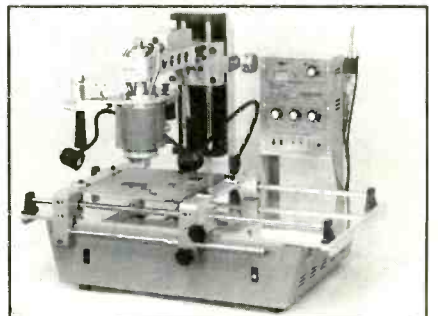

This system incorporates a feature that breaks the bond between a component and the PCB without the use of external devices or tools.

Circle (90) on Reply Card

ES&T

Photofact

These Photofact folders for TV receivers and other equipment have been released by Howard W. Sams & Co. since the last report in ES&T.

EMERSON
EC-134, EC-134S 2411-1

EMERSON
ECR-136 2414-1

EMERSON
ECR-211 2416-1

GOLD STAR
CMT-4282 2412-1

GOLD STAR
CMZ-4122 2415-1

MGA/MITSUBISHI
CS-1937, CS-1938, CS-1939 2415-2

PANASONIC
CTG-1953R 2414-2

QUASAR
Chassis APDC110, PDC110 2412-2

SEARS
564.48760550, 564.48860550 2411-2

SEARS
564.41510550, 564.42510550/551, 564.42511550 2415-3

SEARS
564.42441550, 564.42461550, 564.42480550/51,
564.42490550/51 2416-2

SONY
Chassis SCC-648A-A/B-A/C-A, SCC-552N-A 2413-1

ZENITH
SA2523NK/NK8/25CH/25CH8/27P/27P8/33PN/33PN8/
35K/35K8/37K/37K8/39P/91P/91P5/91S/91S5 2413-2

VIDEO CASSETTE RECORDER

HITACHI
VT-61A, VT-62A 2417

COMPUTERFACTS

ATARI
810 CD9

ATARI
520ST CSCS12



**Our
catalog
will make
your work easier!**

Catalog #12 from MCM has all the things you're looking for in a great electronic parts catalog.

Our wide selection will save you time! An unbeatable line-up of parts and products will make us your one and only source. You'll always find the things you need when you need them!

Save money, too! Great, low prices help you get more value for the money you spend.

Enjoy the fast, dependable service that has become our trademark. Your order will always be correct and delivered on time — that's guaranteed!

Convenient ordering — our toll-free numbers put us just a phone call away!

Call TODAY for the latest edition of the MCM catalog. Discover how this great book will make your work easier!

Catalog #12 Now Available

Call TOLL-FREE

1-800-543-4330

(In Ohio call 1-800-762-4315)
(In Alaska or Hawaii 1-800-858-1849)



MCM ELECTRONICS
A PREMIER COMPANY
858 E. Congress Park Drive
Centerville, OH 45459

Source No. ES&TII

Circle (19) on Reply Card

Chassis—General Electric AC
PHOTOFACT—1979-1

1

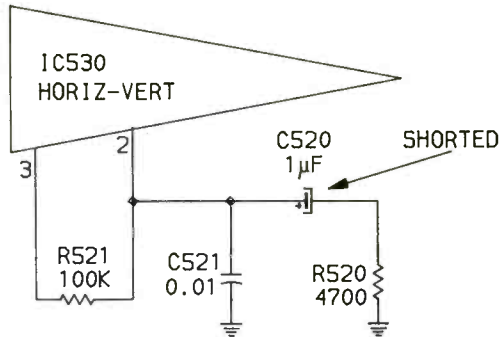

Symptom—Horizontal cannot be locked.
Cure—Check capacitor C520; replace if leaky or shorted.

Chassis—General Electric AC
PHOTOFACT—1979-1

2

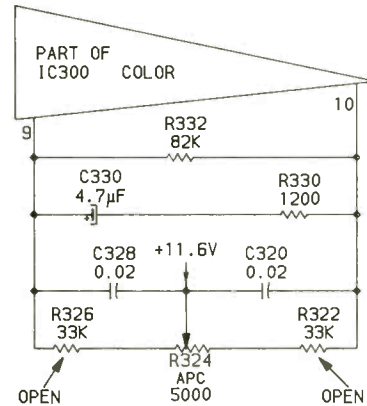

Symptom—No color
Cure—Check R326 and R322; replace either if open.

Chassis—General Electric AC
PHOTOFACT—1979-1

3

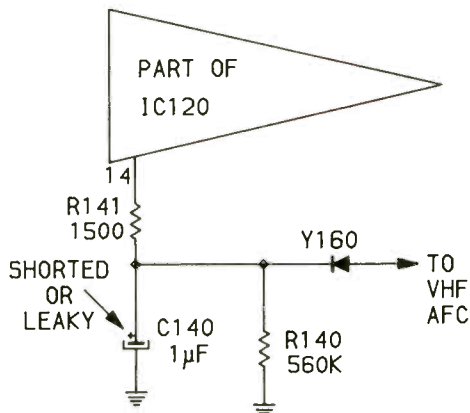

Symptom—Has raster, but no picture or sound.
Cure—Check capacitor C140; replace if leaky or shorted.

Chassis—General Electric
PHOTOFACT—1979-1

4

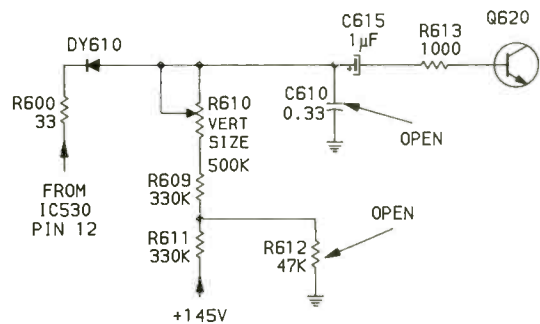

Symptom—Has no height, just one horizontal line.
Cure—Check R611 and C610; replace either if open.

Chassis—General Electric EC-D
PHOTOFACT—1976-2

5

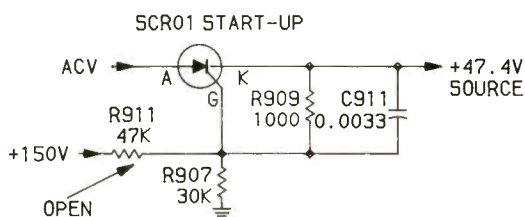

Symptom—Will not start up.
Cure—Check resistor R911; replace if open.

Chassis—General Electric EC-D
PHOTOFACT—1976-2

6

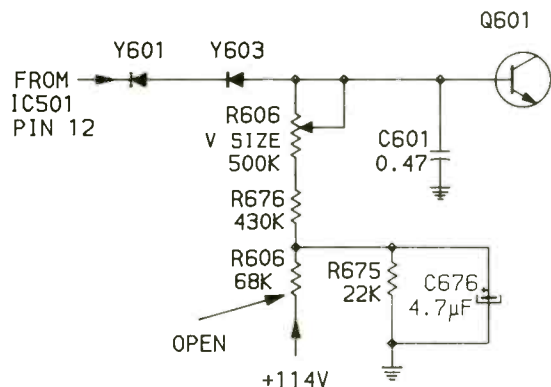

Symptom—Insufficient or no vertical height.
Cure—Check resistor R606; replace if open or greatly increased in value.

Books

Editor's note: Periodically *Electronic Servicing & Technology* features books dealing with subjects of interest to our readers. Please direct inquiries and orders to the publisher at the address given, rather than to us.

Electrical Engineering Fundamentals—2nd edition, by Vincent Del Toro; Prentice-Hall; 909 pages, \$39.95 hardbound.

This is an impressive book, especially so because it was not written to impress, but to *instruct* by imparting in clear, readable fashion what could be heavy information. Revised and updated, this edition provides a basic foundation for the study of electrical engineering that, in turn, is based on just a few experimentally established fundamental laws. Studying and understanding these

laws facilitates understanding branches of engineering where such laws provide a foundation: electronics, for example. New to this issue is a comprehensive discussion of digital systems and their importance in engineering design and practice, a chapter on the stepper motor in conjunction with digital systems and digital computers and summary review questions at the end of each chapter.

Published by Prentice-Hall, Inc., Englewood Cliffs, NJ 07632.

Microcomputer Operation, Troubleshooting and Repair, by Robert T. Paynter, Prentice-Hall; 407 pages, \$29.95 hardbound.

The author's aim—to eliminate the mystique that surrounds computer operation and causes many technicians to back off from this servicing category—has been achieved by covering introductory concepts of microcomputer operation as preparation for analyzing complete microcomputer systems. Basic digital circuits are approached from the standpoint of the purposes they serve in digital

systems. Introductions are provided to machine-level programming, CRT and keyboard circuitry.

Published by Prentice-Hall, Inc., Englewood Cliffs, NJ 07632.

Handbook of Electronics Tables and Formulas—6th edition, by the electronic engineering staff at Howard W. Sams; Howard W. Sams & Company; 265 pages, \$19.95 softbound.

In this expanded, updated edition, there are computer programs (written for Commodore 64 with conversion in Apple, Radio Shack and IBM) for calculating electrical and electronic equations and formulas. New formulas include power units, graphical reactance relations, power triangle and decibels/voltage power diagrams. New constants include standard potentiometer tapers and the Kansas City standard. Also, there are formulas and laws important to all branches of electronics, constants and government- (or industry-) established standards, symbols and codes, service-design, service and installation data.

Published by Howard W. Sams & Company, 4300 W. 62nd St., Indianapolis, IN 46268.

NESDA Computer Group

COMPUTER SALES AND SERVICE DEALERS
WORKING TOGETHER

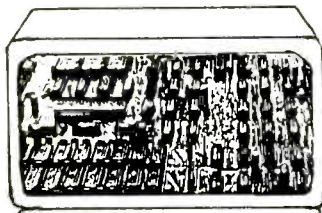

NESDA

- Service training.
- Assistance in selecting in-house equipment and software.
- Specialized software for service management.
- Factory contacts for service literature and parts.
- Involvement in a stable and productive national trade association.

FOR MORE INFORMATION SEND BUSINESS CARD TO:
NESDA COMPUTER GROUP, 2708 WEST BERRY STREET
FORT WORTH, TEXAS 76109; PHONE (817) 921-9061

Take the Guesswork Out of VCR Service

Tentel now has 3 products for quickly and easily diagnosing the mechanical performance of VCR's. **TheTentelometer®**



tape tension gauge is the world standard for tape tension measurements to prevent skewing and interchange problems. The TSH gauge series finds problems causing edge damage and binding cassettes, the two biggest causes of tape destruction. The New HPG-1 head protrusion gauge represents a breakthrough for an accurate, easy to use method of determining head life; takes the guesswork out of video head replacement. The HPG-1 for Beta, VHS, and U-matic VCR's measures head tip protrusion and drum eccentricity in both microns and ten thousandths of an inch.

These 3 products allow the entire mechanical performance of a VCR to be measured in a few minutes by only removing the top cover of the VCR.

Call or write for details—We want to help.

TENDEL (408) 379-1881
1508 Dell Avenue 800/538-6894
Campbell CA 95008 Telex 910 590 8001

Circle (20) on Reply Card

Readers' Exchange

Wanted: Jerrold AIM-719B installer's meter, or B&K 425 signal level meter. *Delman TV Inc., Audio-Video, 651 E. Park Ave., Long Beach, NY 11561; 516-432-7373.*

For Sale: Tubes—I have what you want, or will find them. Send list for quote. *Ted Youngman, 2225 Vigo St., Lake Station, IN 46405.*

Wanted: CRT D13-47 for an oscilloscope, Telequipment type No. D54. *Marcel Pellerin, 3 Belleau, Arthabaska, P. Québec, Canada. G6P 6R6.*

Wanted: B&K 467 CRT restorer and solid-state tube tester. *Alan, 1742 Avenida Sirio, Tucson, AZ 85710; 602-747-5299.*

Needed: Name of electronics store where I may buy a 60Hz timebase No. MM5369; service manual, socket chart conversion and all information about GTE Sylvania TV test jig model No. CK3000. *Andres Almanzar, 449 Torry Ave., Bronx, NY 10473.*

For Sale: Sencore SG165 stereo analyzer with manual and test probes, in good mechanical and electrical condition. Will sell for \$450 or best offer. *Roy Murchum, 2132 Eleanor, Springfield, IL 62702; 217-544-4187.*

For Sale: Tektronix 545A oscilloscope, with CA dual trace plug-in and scope mobile, \$325. *Kenneth Rafuse, Bauer Ave., Manorville, NY 11949; 516-878-6677.*

Needed: Timer crystal for Hickok model No. 660 dot bar color generator. Desperate! Hickok does not answer. *Sam Pearlman, 1403 N. Louis Ave., Tucson, AZ 85712.*

For Sale: Sams Photofact folders No. 550 to No. 2200, best offer. *Larry P. Huckeba, 6 Buchanan St., Newnan, GA 30263.*

For Sale: Sams Photofact folders No. 415 through No. 2144 in cabinets, excellent condition, many unopened, \$2,750 takes all. *Fred MacKenzie, 519 SW 6th Ave., Hallandale, FL 33009; 305-458-3824.*

For Sale: TV shop and some equipment, including Sams Photofact folders from No. 1950 through No. 1979. Further information upon request. *L.M. Hammonds, 205-623-2233 or 205-623-2566.*

Wanted: TV sound tuners (professional models); Century (battery) VTVM model VT-146 (1959) and copy of manual; amplifiers from jukeboxes. *Jim Farago, P.O. Box 65701, St. Paul, MN 55165.*

Wanted: Service manual and schematic for XAM B&W television, model 12BWBZ. *M.B. Danish, Mike's Repair Service, P.O. Box 217, Aberdeen Proving Ground, MD 21005.*

For Sale: Signal generator (U.S. Gov't), Navy, AN-USM27B, asking \$60, 25 lbs., postage paid; teletype model 33ASR, manuals available, two—take one or both, with or without stands, asking \$100 each. Many government technical manuals available: electronics, photography, gas/diesel engines...send s.a.s.e. stating requirements. *D. Test, P.O. Box 9064, Newark, NJ 07104.*

Needed: Sams Photofact folders No. 1500 to present, no missing numbers; Sams folders for VCR (all), MHF (all) and TR (all). *Rodrigo E. Pulacios, 210 Anderson Ave., Round Rock, TX 78664.*

Needed: High voltage regulator transformer model 32-10183-1, Philco television C7441 BMA, chassis 3CY90. *Smith's Radio and TV Repair, 400 Brandon Road, Richmond, VA 23224; 804-232-4654.*

Wanted: Sony color televisions (KU5000, KU5100, KU8000, KU1201, 1212) for parts, must be intact; battery pack (BP80) for Sony KU8000. **For Sale:** B&K 1471B 10MHz dual trace oscilloscope with new probes, \$275. *Rick Cobb, P.O. Box 5332, Sun City Center, FL 33570; 813-634-1940, after 6:00 EST.*

Needed: Original or Sams Photofact diagram for Toshiba color television, chassis No. C993L; IC No. 46-5002-21 for Philco color television, chassis No. 3CN20, new or used, but in good condition. Please state prices and shipping charges. *Jorge Vargas, Apartado #9583, Guayaquil, Ecuador, South America.*

For Sale: Sencore test equipment—model VA48, \$700; SG165, \$500; CA55, \$250; TF46, \$75; SC60, \$1,200; TC162, \$75; DVM38, \$200; Super Mack, \$500. All postpaid, with all accessories. *William Leer, R810 Emerald Lane, Edgar, WI 54426; 715-257-7214.*

For Sale: B&K color-bar generator, model 1245, \$100; **Wanted:** Sams Photofact 1477, reasonable. *4366 Eastport Drive, Bridgeport, MI 48722.*

Wanted: Heathkit variable isolated ac supply, model lp-5220. *Bud Amidon, Bud Amidon's Radio & TV, Owosso, MI 48868; 517-723-4319.*

For Sale: RCA WV-510 master voltohmmyst with leads and operator's manual, very good condition, and B&K model 1077 TV analyst with leads and all original equipment, excellent condition—both for \$225 plus shipping. *Roy Nelson, 50 Howell Place, Kearny, NJ 07032.*

Need: Zenith power transformer No. 95-2921 or 95-2952, new or used. Write, giving price desired. *Richard's Radio Service, Route 3, Box 230, Girard, KS 66748; 316-347-4331.*

Wanted: Heathkit ET 3400A microprocessor trainer, ETA 3400 trainer accessory, EE3401 microprocessor course with all the hardware and books—all reasonably priced. *Halkitis, 13304 Wagner Drive, Hudson, FL 33567; 813-862-9626.*

For Sale: B&K 415 sweep/marker, \$100; Heathkit vectorscope ID-4101, \$100; Heathkit yoke/flyback IT-5235, \$75. All items in excellent condition, complete with manuals and leads. Shipping not included. *Fred De Shazo, 114 W. 24th, Hutchinson, KS 67502.*

Wanted: Video tune-up software that runs on Commodore or IBM personal computers—Solas products P/N 101-C or 101-I. *S. Cohen, 1209 Robbins St., Philadelphia, PA 19124.*

For Sale: Tektronix 475 oscilloscope, 200MHz, 2-channel with delay sweep. Immaculate, new condition, three years old. Last calibration date: December 1984—meets factory specifications. Includes accessories, manuals and two P6106 probes (cost \$140 each). New, cost \$4,300, sell \$1,900. *Holiday Electronics, 1503 Grace Ave., Panama City, FL 32405; 904-769-2863, ask for Gene.*

Needed: Service and/or operator's manual for Hickok model 288AX signal generator; B&K Precision model E200C signal generator; B&K model 1077 telephone analyst; B&K model 415 sweep marker generator; Heathkit model IT-28 capacitance checker. *Mark Adams, 3661 24th Place West, Seattle, WA 98119.*

For Sale: GE EP77X44 flyback, \$35; GE EP77X55 flyback, \$50; Sencore CG22 color-bar generator, \$60. *Elmer Wieland, 237 Talbot Drive, Bedford, OH 44146; 216-232-8653.*

For Sale: B&K dual-trace oscilloscope model 1471B, 10MHz, used very little, \$400; Sencore tube checker, Continental II model MV150, \$250; Zenith color test jig, new and still in original shipping box, \$250. *Gordie's TV, 203 Main St., Hoffman, MN 56339; 612-986-2400.*

Wanted: Schematic, manual and/or service information for Hickok model 533 tube tester, Heathkit model TS-4 TV alignment generator and Sencore Lo-Boy model CG-10 standard color generator. *Kirk Ellis, Box 18 Foxfire, Selma, NC 27576.*

For Sale: Sams Photofact folders No. 822 to No. 1955, new, never used and in original shipping boxes, sell best offer; AR 19-78, CB 1-28, TR 15-64, TSM 35-113, plus 35 pieces of other test equipment, also sell best offer. I can deliver to you; send s.a.s.e. for list. **Wanted:** B&K 1077B analyst and any good short-wave radios and scanners such as Hallicrafters and Bearcat, working or not. Will buy or trade for above. *Stanley Chalker, Kodac Petina Service, 1176 Smithsonian Ave., Youngstown, OH 44505.*

For Sale: Old tubes—4, 5, 6, 7, 8 prong; American-DeForest 24-inch and 27-inch TV parts; Delco AM-FM car radios, 1963-1985; 200 new 8-track tapes; DeVry 5-inch scope; Wollensak 1500, 1515 parts. *A Svernickas, Marquette TV, 6601 S. Whipple, Chicago, IL 60629.*

For Sale: RCA marker-adder, model WR70A; Hickok Cardmatic tube checker, model 121; Service picture tube checker, model CR143; RCA color-bar generator, model WR61A; service manuals—JVC color video camera, model GC4800U; Sony VO2600 plus supplement No. 1; Sony SL8200; RCA Sams Photofact, model VBT200. All items like new and for sale for best offer. *William Krieger, Bill's TV Service, 153 West Duell St., Glendora, CA 91740.*

For Sale: B&K SA1010 signature analyzer, complete with additional documentation for easy set up. This instrument helps to find circuit faults in microcomputers, pinpoint bus faults. *Fair's TV, U.S. 13 South, RFD 2, Box 202, Pocomoke City, MD 21851; 301-957-0265, ask for Jack.*

Wanted: Panasonic picture tube No. A26JAS31X; for VCR servicing, want tape tension gauge, test tapes, alignment tools, VCR manuals and related items. *Ed Herbert, 410 N. Third St., Minersville, PA 17954.*

For Sale: Sams AR manuals No. 19 through No. 329, complete, \$1,250; Supreme manuals—Television No. 12 through No. 22, Radio No. 17 through No. 24, \$50, index included; Sams SD manuals No. 1, 2, 3, 4, 5, 8, 9, \$50. All prices plus shipping. *Patrick Nelson, 903 W. Adams St., Decatur, IN 46733; 219-728-2119.*

For Sale: Diehl Mark III analyst, \$395; Hewlett-Packard 202A low-frequency function generator, \$60; Hewlett-Packard 202C low-frequency oscillator, \$55; Tektronix 180A time mark generator, \$80; Triplett 630 PLK VOM, \$45; Heathkit IM-17 FET multimeter with 40kV HV probe, \$40; many used TV parts; hundreds of Sams, \$2 each. Send s.a.s.e. for extensive list. **Wanted:** Defective computers, monitors, other peripherals. Describe and provide price. *Frederick Jones, 407 Morningbird Court, Niceville, FL 32578.*

For Sale: Sencore SC61 60MHz waveform analyzer plus DP226 1:1 direct probe, 39G81 250MHz demodulator probe, two NP229 needle point adapters and 39G80 5kV Lo Cap probe, \$1,800 total; Sencore VA82 universal NTSC video analyzing system plus VC63 VCR test accessory, NT64 NTSC pattern generator, EX231 expander jack and AD232 banana/scope adapter, \$2,500 total. Many more items. All equipment is like new, with associated instruction manuals. Send large s.a.s.e. for complete list. *Clarence G. McKee, 9516 Zion Road, Rives Junction, MI 49277; 517-569-3139.*

Wanted: Useable Zenith yoke, part No. 51-37549-4 for chassis E-20-10. *John Pekar, 24 Flax Road, Fairfield, CT 06430; 203-259-9730.*

For Sale: B&K signature analyzer, SA1010, \$300. Comes with additional documentation and set-up notes; will troubleshoot any 8-bit computer to component level. *Jack MacGrath, P.O. Box 351, Pocomoke City, MD 21851; 301-957-0939.*

Wanted: Sam's CB servicing Photofact folder, especially No. 207, will buy others to finish my set. Please quote numbers and price. *M.E. Baker Sr., 1200 78th St., Newport News, VA 23605.*

For Sale: Tektronix 465B oscilloscopes, 100MHz, recently calibrated, includes two probes and manual, \$1,200. *Steve Stoeckel, 1001 S. Independence Blvd., Charlotte, NC 28202; 704-375-8662.*

Needed: Schematic diagram and service data for Fun-mate electronic organ, model SC-2000-A, marketed by Music Masters, Chicago. Will pay copying and mailing costs. *William Hartley, Hi-Fi Workshop, 1201 Paul Ave., Schenectady, NY 12306.*

For Sale: Sencore VA48 with manuals, mint condition (essentially new with accessories), \$650 or best offer. *Lowell Ballinger, Bayfield St., Washburn, WI 54891.*

For Sale: Diehl Mark III and Mark V. Sell or trade for TVRO, Ham, short-wave equipment or small metal lathe. *E.A. Sjolander Jr., 917 MacArthur Ave., Ashland, WI 54806; 715-682-9494.*

Wanted: Complete set of construction manuals, troubleshooting guide, etc., for Heathkit TV model GR-2000. Will photocopy and return, or purchase. *George W. Davenport, Box 204, Trenton, NC 28585; 919-448-4561.*

For Sale: Sencore SC-61 oscilloscope; VA-62 video analyzer; NT-64 pattern generator; VC-63 VCR tester; TF-46 super cricket; PR-57 isolation transformer; 183 Sams Photofact folders No. 40 to No. 2197; various parts from closed TV repair shop. All cheap. *Phone 606-498-3685.*

Wanted: B&K 467 picture tube tester/rejuvenator—good to excellent; Sams Photofact CB series, No. 201 and up. Send or phone particulars. *Cecil F. Mott, 221 Mobil Land Court, Bloomington, IL 61701; 309-838-MOTT.*

For Sale: Tektronix 545A scope with CA dual trace plug-in, \$150; IVC model 90 broadcast color camera, needs work, \$80. *A.F. Kuschner, 3340 Turtle mound Road, Melbourne, FL 32935; 305-254-1824.*

For Sale: B&K 80MHz dual trace oscilloscope, \$940; B&K 175MHz universal counter, \$325; B&K 3300 pulse generator, \$275; Heath IM-5228 VTVM, \$60; Heath 100kHz audio generator, \$110; Sencore MX11 stereo generator, \$35; Heath FET/transistor tester, \$80; Viz substitution box \$45. All these test instruments are less than one year old. *Ron Grege, 107 Ridgeview Drive, Duncmore, PA 18512; 717-347-6842.*

For Sale: Diehl Engineering Super Tech Mark IV diagnostic computer, \$375; Sencore CG25 Little Huey color-bar generator, \$100; Sencore SG165 stereo generator, \$950. All in excellent condition. *Mark Vuozzo, 17632 Jordan 38B, Irvine, CA 92715; 714-733-0372.*

For Sale: Heath digital frequency counter, model IM-2410, 101Hz to 225MHz, \$100. Like-new condition. *Dan Pancoast, 154 Bala Drive, Somers Point, NJ 08244; 609-927-6541.*

Needed: Operating manual for JVC VCR, model AH7500 U. Will buy, or copy and return. *Hector's TV Service, 3811 S. Manhattan Ave., Tampa, FL 33611; 813-831-4189.*

Needed: Schematic and/or service manual for NRI TR5000 TV receiver. Will copy and return, or buy. *R. Rabalais, Route 5, Box 84, Slidell, LA 70460; 504-649-0014.*

ES&T *inc.*

ATTENTION TECHNICIANS

- ★ JOB OPENINGS
- ★ MONTHLY TECHNICAL TRAINING PROGRAM
- ★ BUSINESS MANAGEMENT TRAINING
- ★ LOW COST INSURANCE
- ★ CERTIFICATION
- ★ TECHNICAL SEMINARS

All of this in a nonprofit international association for technicians

FIND OUT MORE:



604 N. Jackson St.
Greencastle, IN 46135

FREE! New Catalog of Hard-To-Find Precision Tools



Jensen's new catalog is jam-packed with more than 2,000 quality items. Your single source for hard-to-find precision tools used by electronic technicians, scientists, engineers, schools, instrument mechanics, laboratories and government agencies. This popular catalog also contains Jensen's world-famous line of more than 40 tool kits. Call or write for your free copy today!

JENSEN®
TOOLS INC. | 7815 S. 46th Street
Phoenix, AZ 85044
(602) 968-6241

Circle (21) on Reply Card

COMPLEX IMPEDANCE ANALYZER

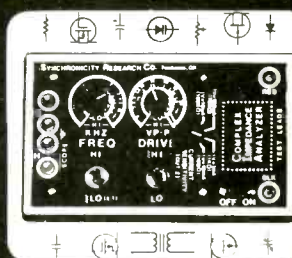

- ★ Speeds Up Field Service
- ★ Variable Freq & Drive
- ★ Tests Any Part - Quickly
- ★ Wide Z Range - CMOS Safe
- ★ Works IN or OUT of Circuit
- ★ Use With Any X-Y Scope

If you have always wanted a REAL component analyzer, but didn't want to shell out 1000's of \$, Order Your CIA Today!
\$198⁰⁰ PPD to USA address

SYNCHRONICITY RESEARCH CO.

P.O. Box 153 405-628-3695
TONKAWA, OK 74653

Circle (22) on Reply Card

Receivers

The predominance of integrated circuitry in modern equipment tends to homogenize performance. Most of the circuit is built into the IC, and manufacturers use the same or similar chips, so the differences noted among receivers usually result from adjustment of individual units rather than design advantages.

One area of note is FM audio frequency response. The demodulated stereo output of the multiplex section contains not only left and right audio, but some of the 38kHz subcarrier as well as the 19kHz pilot tone, plus harmonics and intermodulation products. Although these artifacts may be heard by no one in the family except Fido, they can cause some equipment problems if not filtered out. For example, *sub-carrier products*, as they are called, can beat with the bias signal in a tape deck and produce audible tones. If the bias oscillator frequency were 80kHz, for example, and the receiver produced a strong second harmonic of the subcarrier (38kHz x 2 = 76kHz), a 4kHz difference signal might well end up recorded, along with the desired program material. Too much 19kHz pilot leakage might overload the tweeter in a speaker system, causing failure.

To alleviate this problem, many units incorporate an RCL (resistance, capacitance, inductance) multiplex filter with a sharp cutoff, which attenuates the 19kHz pilot by 30dB or more. It's tricky to design such a filter without adversely affecting the top end of the audio signal at 15kHz, or producing phase delays at the upper end of the passband. Engineering tradeoffs result in differing performance from unit to unit. Look for as flat a response as you can find between 50Hz and 15kHz.

Unfortunately, you'll seldom see the subcarrier product rejection ratio (sometimes simply termed subcarrier suppression) specified for a receiver or tuner. That may be because it takes up too much expensive advertising space, or the manufacturer thinks no one cares. When it is quoted, the lower the better: i.e. -60dB is preferable to -50dB. If you don't plan on dubbing off the FM, you really needn't worry about it.

A receiver's usable sensitivity is often quoted, because it is usually an impressive number on the order of 1.5 μ V to 2 μ V (the smaller the number the better). The only trouble is that a signal at this level is virtually unlistenable, since it has a S/N ratio of about 30dB. A more telling figure is the 50dB quieting sensitivity because this specifies how much signal you need to get reasonably clean audio.

Cassette decks

Unlike strictly electronic devices, such as ampli-

fiers, tape machines vary widely in their frequency response capabilities. On top of that, the cassette tape used is a critical element in the system. For this discussion, we'll restrict ourselves to cassette decks, because they dominate the market. In general, cassette deck manufacturers specify an *overall* response. This is the performance you presumably can expect when recording and playing back on the same deck. There are reasons for using this method. Most folks have only one deck, which functions as recorder and player. Because recording adjustments often can make up for lackluster playback performance, the overall figure looks better on paper.

If your interest is compatibility among various decks, you need to know what the playback-only response is. But you'll look long and hard trying to find this number on a spec sheet. It wouldn't look half as good as the overall figure, and a manufacturer who honestly advertised it would be at about a half-octave disadvantage to the competition.

As if this weren't enough, it is the rare machine that actually makes frequency response spec out of the box, even if you use the recommended tape. A new deck should be adjusted for the particular tape you'll be recording with before you bring it home. One note of warning: This operation requires a competent and experienced technician who understands the tradeoffs involved. A couple of wrong adjustments and the deck will sound worse than before.

Have you ever noticed how most of the emphasis on frequency response centers on the high end? That's partly because the low end of the frequency band often has many complex perturbations because of head-related factors such as contour effect and fringing. The bass response graph of some cassette decks looks like a roller coaster track at the state fair. Careful listening is important. Most manufacturers don't show you a frequency response graph. One clue can be found in the spec sheet. If the bottom end is 40Hz or higher (\pm 3dB), the low bass is probably pretty messy.

One more caveat: Frequency response is measured with Dolby noise reduction *off*. When engaged it almost always lops a few kilohertz off the high end. Don't worry about S/N, because it generally is limited by the tape and not the deck.

We hope to make this a regular feature. Let us know what you'd like to read about, and we'll try to cover some of the more popular topics. Send your comments to me in care of *ES&T* or leave a message in my CompuServe mailbox, 72356,1355. I can't guarantee a personal answer to every letter, but all will be read.

Coming
in...

AUGUST

Servicing chroma and horizontal output circuits in RCA sets—Homer Davidson delves into the operation of these circuits, specifically in the RCA CTC 107. The article describes symptoms of problems in these circuits, discusses the nature of the problems that cause those symptoms and suggests corrective measures.

Satellite receiving antennas—Regardless of the quality and expense of satellite receiving equipment, it produces a TV picture that only is as good as its antenna. TVRO antennas and their installation, plus a vocabulary of useful terms, comprise James Kluge's latest article.

Boomerangs DO come back—Boomerang service jobs return to haunt us sometimes: These are those quirky repairs that never stay fixed. Joseph Carr suggests that overheating can be a repetitive electronics problem that often is overlooked. Read next month's "Are you being chased by an overheated boomerang?"

Audio Corner—Today's cassette decks have a "couple of LSI packages and a handful of driver transistors" compared to the 20 to 25 discrete TTL chips and numerous transistors of the 1970s models. Microcomputers make the difference. Love 'em or hate 'em, Kirk Vistain says technicians might as well "learn 'em" to take advantage of the lucrative servicing business.

Classified

Advertising rates in the Classified Section are 75 cents per word, each insertion, and must be accompanied by payment to insure publications.

Each initial or abbreviation counts a full word.

Minimum classified charge is \$15.00.

For ads on which replies are sent to us for forwarding (blind ads), there is an additional charge of \$25.00 per insertion to cover department number, processing of replies, and mailing costs.

Classified columns are not open to advertising of any products regularly produced by manufacturers unless used and no longer owned by the manufacturer or distributor.

FOR SALE

AUTOMOBILE RADIO and tape replacement parts. Delco, Chrysler, Philco-Ford, Motorola, Panasonic and many others. Large inventory. Laran Electronics, Inc., 3768 Boston Road, Bronx, NY 10469. (212) 881-9600. National (800) 223-8314, NY State (800) 446-4430. 1-85-tfn

BOOTLEGGERS BIBLE for CB Modification \$12.95, CB Radio Repair \$10.95. Linear Amplifier Planbook \$14.95, kits, etc. Catalog \$1.00 refundable—APS, POB 263 Newport, R.I. 02840 401-846-5627. 12-84-tfn

SCRAMBLED TELEVISION, encoding/decoding. New book. Theory/circuits, \$9.95 plus \$1 shipping. Work shop, Box 393ES, Dept. E, Bethpage, NY 11714. 1-85-tfn

CABLE TV CONVERTERS & EQUIPMENT. Plans and parts. Build or buy. Send S.A.S.E. C&D Electronics, P.O. Box 1402, Dept. ES&T, Hope, Arkansas 71801. 1-86-tfn

TV TROUBLE ANALYSIS TIPS. Over 300 symptoms/ remedies by circuit area; tough ones over the years. Save time and money. Send \$12.50 to CHAN TV, 8151 Grandview Rd., Chanhassen, MN 55317. 1-85-tfn

"\$500.00 Worth"—top quality radio, TV parts, only \$50.00. CX130, SG-274, PA-501, transistors, ICs, others, save!! Order from: Dependable TV, Box 1645, C'sted, St. Croix, V.I. USA 00820. 06-86-2t

SONY-TRINITRON REBUILTS are now available. Call for price & delivery, 1-716-621-5250. 7-86-tfn

MODIFICATION KIT—to improve performance of your authorized personal satellite descrambler. See all the pictures, but the modification VOIDS manufacturers warranty. Send \$25.00 for VC2000 kit. TV Shop, 127 E. Mission, Fallbrook, CA 92028, COD's 1-619-723-1302. 7-86-1t

DISCOUNT CATV CONVERTERS/DECODERS and video accessories. Solar cells for remote power and battery charging applications. Send for free information and prices—It could save you big money on your next purchase of these and other CATV items. Easy View, P.O. Box 221, Arlington Heights, Illinois 60006. (312) 952-8504. Ask for Rudy Valentine. 7-86-1t

VCR REPAIR? Do not miss this one!! **TECH TIPS**—Complete volume—all brands. Rush \$7.95 to: R. Wood, 4207 97th Ave. E, Parrish, FL 33564. 7-86-2t

VCR REPAIR SOLUTIONS for over 125 VHS Models. Over 125 symptoms and cures. The hard ones. Send \$9.95 to: Eagle Electronics, 2534 Miracle Lane, Mishawaka, IN 46545. 7-86-1t

TV TROUBLESHOOTING: Over 100 ILLUSTRATED problems-solutions of difficult repairs. Also, 12 steps to easier TV repair, \$12.00. **REMARKABLE DIAGNOSTIC TOOL:** Determine operation of high voltage circuits every time. You will not be mistaken about your conclusions, \$5.00. Jones, Box 702, Niceville, Fla. 32578. 5-86-6t

PHOTOFACT FACTS #2-995, AR-Manuals #2-327, TV—Manuals-Tape Manuals, TR—Manuals. First Class Post Paid. Hank's TV, 3743 W. 113th St., Inglewood, CA 90303. 7-86-1t

CRT REBUILDING EQUIPMENT: Oven, two sealing machines, extra pumps, glass and more. Send for complete list. \$1200 or best offer. Miller's Electronics, 106 First Street, Butler, PA 16001. 7-86-1t

PICTURE TUBE REBUILDING EQUIPMENT—All you need to rebuild any color CRT including Sony. Original cost \$4500—will take \$2900. Training available. Call KAZ: 305-275-9543. 7-86-2t

HELP WANTED

CAMERA-VIDEO Technicians needed. Top pay and benefits for well trained and experienced technicians who are expert with consumer and/or industrial cameras and VCR's. Training by manufacturers such as Sony, Hitachi, Panasonic, etc., are necessary for job experience. Come to sunny Florida and enjoy your work & leisure time. Write or call ATLANTIC ELECTRONICS INC., 1881 NE 26 St., Ft. Lauderdale, FL 33305. (305) 564-8274 10 AM to 6:30 PM. Ask for Dave or Joe. 8-85-tfn

VIDEO/AUDIO technician needed. Top pay and benefits for well trained and experienced technicians who are expert with consumer TV and audio equipment. Training by manufacturers such as: Sony, Hitachi, RCA, Panasonic, etc. are necessary for job experience. Write or call: Atlantic Electronics, Inc., 1881 NE 26th St., Ft. Lauderdale, FL 33305, 305-564-8274 (10 AM 6:30 PM). Ask for Dave or Joe. 06-86-tfn

BUSINESS OPPORTUNITIES

T.V. & ANTENNA BUSINESS. 60 miles north of L.A., Sell or Partnership, Terrific weather. Parrish, Box 6243, Ventura, California 93006. 7-86-1t

WORKING PARTNER needed to expand present business. Pay 1/2 down & balance from profits. Precision Picture Tube, Rochester, NY 14612, (716) 621-5250. 7-86-tfn

RCA AUTHORIZED SERVICENTER. \$5,000 or offer for all or parts thereof. Thacker's, 5200 Wilson Blvd., Arlington, VA 22205. 7-86-1t

Bus. Opportunity (Cont.)

3 HRS FROM SAN FRANCISCO in pine forested foothills, electronic repair business. Poor health forces sale. Bldg./shop/equipmt. & 7 rm. residence w/lg. garden, was \$165K, now \$155K. (916) 872-1962. 12/85tfn

T.V. SALES & SERVICE. Well established business located northern Virginia. Owner retiring and will help with financing. Call 703-972-7027 after 7:00 p.m. EST. 06-86-6t

PERSONALIZED 24-HOUR SERVICE ON OVER 7,000 ELECTRONIC COMPONENTS & PRODUCTS...

CALL TOLL FREE
1-800-558-9572 IN WIS 1-800-242-9553



PROJECTOR RECORDER BELT
200 Clay Street • Whitewater, WI 53190
TLX 4994411 PRBUSA

Circle (24) on Reply Card

ATTENTION ELECTRONIC TECHNICIANS



Highly Effective Home Study BSEE Degree Program for Experienced Electronic Technicians
Our New Advanced Placement Program grants Credit for previous Schooling & Professional Experience. Advance Rapidly! Our 40th Year!
FREE DESCRIPTIVE LITERATURE!
Cook's Institute of Electronics Engineering
P.O. BOX 20345, JACKSON, MS 39209

Circle (25) on Reply Card

Tech's Guide To Pricing



updated new 5th edition... a framework for setting rates that apply to Hi-Tech products... a formula that guarantees SUCCESS!
Call Toll Free for details 1-800-228-4338 8/5 CST

Circle (26) on Reply Card

DANDY-DAPTER™

PATENTED CRT ADAPTER—Don't buy another socket for your CRT Tester! This is the Only way you can win the Socket War! Guaranteed to fit your tester & allow you to test/clean/restore ANY Color, B/W, Projection, Scope or Camera CRTs. Visa/M-Card, Checks, CODs. New Low Price \$59.95 (We pay UPS) 1(800) 331-9658. DANDY ELECTRONICS, 2323 GIBSON, MUSKOGEE, OK 74403.



Circle (27) on Reply Card

ATTN. SERVICE SHOP OWNERS

Are you serious about improving your operation? We offer workable solutions from one of the most respected service management consultants. 16 years of professional experience solving the problems for major companies.

MANAGEMENT INSIGHT
R. J. SEBRING
4511 17TH AVE. W.
BRADENTON, FL 33529
(813) 792-3804

Circle (28) on Reply Card

NEW 20-PAGE CATALOG FREE

7 MILLION TUBES

Includes all current, obsolete, antique, hard-to-find receiving, transmitting, industrial, radio/TV types. **LOWEST PRICES.** Major brands in stock.
Unity Electronics Dept. E
P.O. Box 213, Elizabeth, N.J. 07206



Circle (30) on Reply Card

Advertisers' Index

	Page Number	Reader Service Number	Advertiser Hotline
B&K Precision Dynascan Corp.	53	16	312/889-9087
Beckman Industrial Corp.	55	17	714/671-4800
Cleveland Institute of Electronics	15,14A-14B	5	800/321-2155
Cooks Inst. Elec. Engrg.	66	25	601/371-1351
Cooper Group	IBC		919/362-7510
Creative Electronics	51	15	313/435-8916
Dandy Mfg. Co.	66	27	800/331-9658
Diehl Enterprises	7,9,11	4	806/359-0329
E-Z-Hook	IFC	1	818/445-6175
ETA	63		
ISCET	57		817/921-9101
Jenks W.S. & Sons	51	13	800/638-6405
Jensen Tools Inc.	63	21	602/968-6231
Management Insight	66	28	813/792-3804
MCM Electronics	59	19	800/543-4330
NESDA	47,61		817/921-9061
Precision Picture Tubes	66	29	716/621-5250
Prentice-Hall Book Clubs	3,2A-2B	2	
Projector Recorder Belt Corp.	66	24	800/558-9572
Sams, Howard W. & Co., Inc.	23	6	800/428-SAMS
Sencore, Inc.	39,41	7,8	800/843-3338
Sencore, Inc.	43,45	9,10	800/843-3338
Spectrum 2000 Inc.	47	11	800/444-2828
Sperry Aw Instruments Inc.	5	3	800/645-5398
Sperry Tech, Inc.	66	26	800/228-4338
Synchronicity Research Company	63	22	405/628-3695
Techni-Tool	51	14	215/825-5623
Tentel	61	20	800/538-6894
Test Probes, Inc.	57	18	800/368-5719
U.S. Instrument Rentals	49	12	800/824-2873
Unity Electronics	66	30	201/351-4200
Zenith	BAC		

NATIONAL REBUILT HEADQ. FOR—

SONY REBUILT PICTURE TUBES

2 YR. WARR. — FREE U.P.S.-DEL.

716-621-5250

Circle (29) on Reply Card

ELECTRONIC SERVICING & TECHNOLOGY Volume 6, No. 7. (USPS 462-050) is published monthly by Intertec Publishing Corp., 9221 Quivira Road, P.O. Box 12901, Overland Park, KS 66212. Second Class Postage paid at Shawnee Mission, KS, and additional mailing offices. POSTMASTER: Send address changes to ELECTRONIC SERVICING & TECHNOLOGY, P.O. Box 12952, Overland Park, KS 66212-9981.

ARTICLE REPRINTS

Interested in ordering custom reprints of an article from this issue? Reprints of articles about your company or products can be valuable sales and marketing tools. For information, call or write Kelly Hawthorne, Intertec Publishing Corp., P.O. Box 12901, Overland Park, Kansas 66212; (913) 888-4664.

*minimum order 1,000 copies

The technology is advanced. The temperature stays put.



EC 1000
Dial controlled with EC1201P iron.

EC 2000
Three digit LED readout with EC1201P iron.

EC3000
Dial controlled with lightweight EC1301 soldering pencil.

EC 4000
Three digit LED readout with lightweight EC1301 soldering pencil.

All EC Series stations meet Mil-spec DOD-STD-2000-1

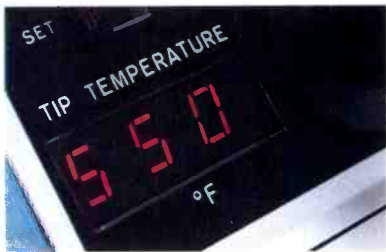

When you need controlled output soldering for sensitive components, you don't need uncontrolled temperature fluctuations at the work station. In the Weller EC Series, the tip temperature is maintained throughout the range of 350°F–850°F to within 10°F. In addition, an electronic system utilizes thyristor power control with zero voltage thyristor drive. This ensures that no high voltage spikes or magnetic fields will be present on the soldering tip.

These technologically advanced stations are capable of handling all the delicate soldering operations necessary, in even the most sophisticated applications. They offer the ultimate in soldering flexibility with a choice of controls and readouts to suit your needs precisely.



Check with your Electronics Distributor.

Weller® EC series



CooperTools

CRESCENT® LUFKIN® NICHOLSON® PLUMB® TURNER® WELLER® WIRE-WRAP® WISS® XCELITE®
The Cooper Group PO Box 728 Apex NC, 27502 USA Tel (919) 362-7510 Telex 579497

BACK AMERICA

Chances are the easiest, fastest, most rewarding way for you to get plus business is by selling Zenith Audio and Video Accessories to the same customers whose electronics you now service.



Like all Zenith products, Zenith Audio/Video Accessories are made to meet or exceed quality and performance standards that have earned Zenith a level of acceptance in the marketplace unsurpassed by any brand name in the consumer electronics industry.

And it goes without saying that the better known and the more respected a product's name the easier, faster, and the more profitably you can sell it across the counter...or while you're out of the shop on a service call.

Call your Zenith distributor's Accessory Sales Manager and learn how to turn some 6, 7 or 8 feet of floor space (or even your caddy) into a new Zenith Profit Center.

It's all there! Yours for the asking! The help and expertise of your Zenith distributor's Accessory Sales Manager and the selling power of the Zenith name on these top-performing video and audio accessories!

You bet you can make it big – and even bigger in the electronics business – by selling Zenith Audio and Video Accessories to the same customers whose electronics you now service!

Call your Zenith distributor's Accessory Sales Manager now or write direct for the name of the Zenith distributor serving your area.

Wait no longer. Call or write now!



The quality goes in before the name goes on.®