

The how-to magazine of electronics...

ELECTRONICTM

Servicing & Technology

February 1986/\$2.25

Servicing Wards HV, LV circuits • Video color camera repair, 3

Splish, splash...flood-damaged electronic equipment



**The
tin tie
that binds**

AS4847-----D 9280X0 APR86 E50
P01210810000000 01A 0X
EMIL J DE NAGEL
BOX 92A
IRON RIVER MI 54847

"I'll tell you what it takes to succeed in VTR repair service."

"It takes know-how, and the right equipment to do the job. You obviously have the know-how, or you wouldn't be reading this magazine. The equipment? The same brand that factories use to build and test sets on production lines... LEADER!"

You need professional test equipment for a professional repair job.

Leader gives you test signal sources for every conceivable video and audio application—reliable and easy-to-use instrumentation that keeps you right on track. Audio sine/square wave generators cover 10 Hz to 1 MHz with low distortion.

To see what you're getting, Leader's LBO-525L 50 MHz dual-trace oscilloscope is a natural. Put the input to a circuit on one trace, the output on the other, and actually see where distortion

occurs, how much, and when it's corrected! You'll find more features on this oscilloscope than on many others regardless of price or manufacturer's claims. Or choose from a dozen other models.

The Leader frequency counter—in a rugged metal housing—can be used to adjust chroma frequency and vertical or horizontal synch circuits. Leader's large, bright fluorescent displays are easy to read. To round out your test bench, you'll need a wow and flutter meter, mirror-backed scale ac voltmeter, and a good quality field strength meter... all from Leader.

With Leader, you've got what it takes...

...to do the job right and build a reputation as the person to see when problems develop. With Leader on your test bench, there's no limit to the jobs you can tackle, the service you offer... or the extent of your potential income.

Two-year warranty. Evaluation units.

A history of high reliability permits Leader to provide a generous two-year warranty... backed by factory service depots on the East and West Coasts. A free, trial use of Leader instruments is available to all qualified companies.

Call toll-free (800) 645-5104 to request: an evaluation unit, our full-line catalog, the name of your nearest "select" distributor and additional information about how you can succeed in VTR Service.

For VTR professionals who know the difference.

LEADER
Instruments Corporation

380 Oser Avenue
Hauppauge, N.Y. 11788 (516) 231-6900
Regional Offices:
Chicago, Dallas, Los Angeles, Boston, Atlanta.

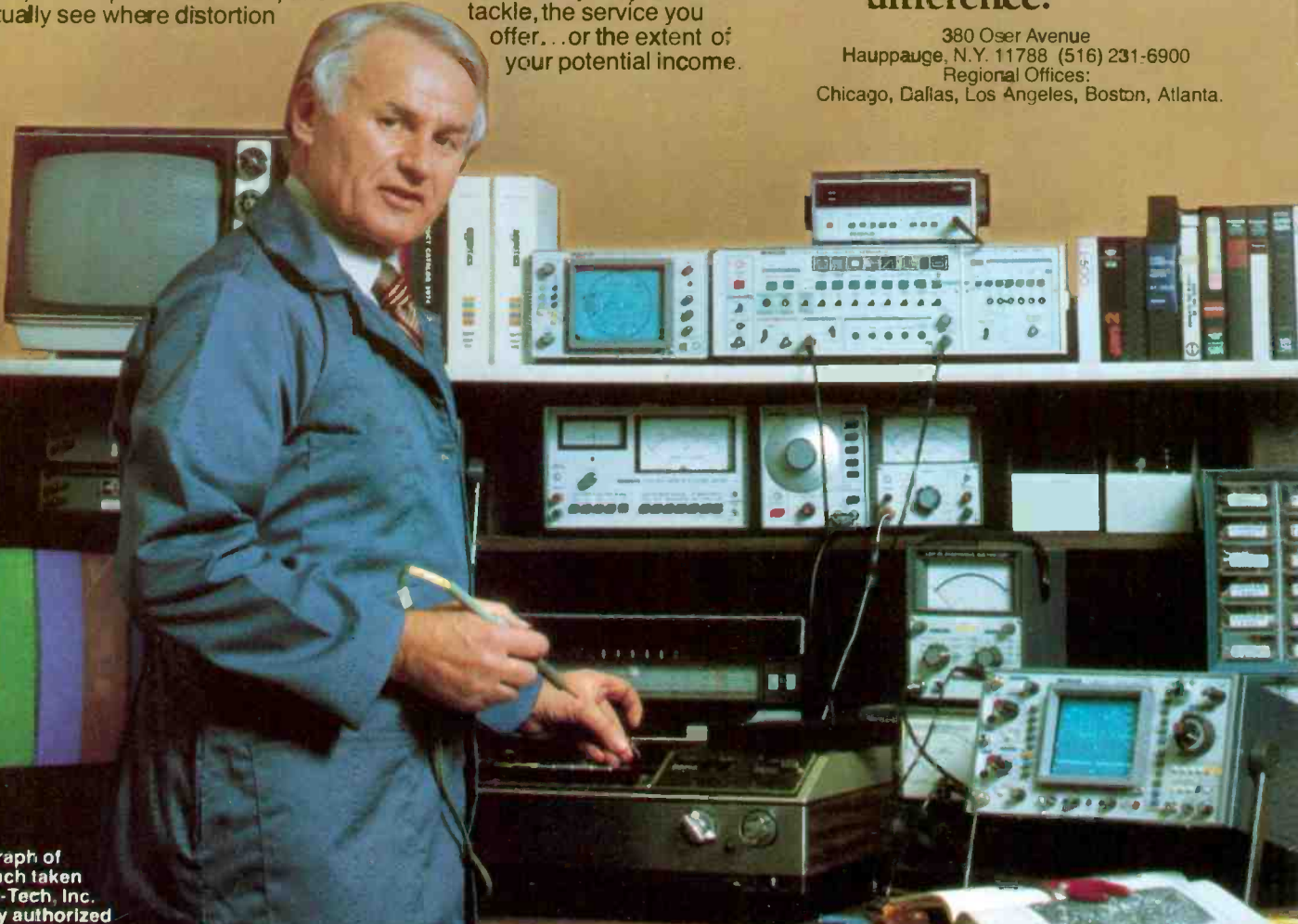

Photograph of test bench taken at Orien-Tech, Inc. a factory authorized service center.

For Information Circle (1) on Reply Card
For Demonstration Circle (21) on Reply Card

Twice As Good And Then Some...



Introducing the AWS DML-4020, 2-Channel Data Logging Digital Multimeter

We all know how versatile one 3½ digit autoranging digital multimeter can be. Picture not just one but two such pieces of microprocessor controlled test equipment in one package. Add to that the ability to use both DMM's individually or simultaneously to read and display similar or dissimilar functions.

And that's not all. Imagine how useful it would be to have a numerical or graph printout of the values you're measuring.

Want more? How about being able to program a built-in comparator with "high" and "low" limits on whatever function you're measuring, than have an array of five LED's indicate where your actual readings are in relation to the "limits" you have set.

There's still more. Automatically sample a desired function on any one of 12 different time intervals from every 5 seconds to once per hour. Then simply push a button and get a printout showing the highest and lowest values, the number of times samples were taken, and the average value of the function you've been measuring over an extended period of time (up to 30 days).

If all this sounds twice as good and then some, then you owe it to yourself to check out the new AWS DML-4020, 2 Channel Data Logging Digital Multimeter.

For more information write or call your distributor or contact A.W. Sperry Instruments Inc. 245 Marcus Blvd., Happaage, N.Y. 11788 • (800) 645-5398 Toll Free. (N.Y. and Alaska call collect (516) 231-7050).

A.W. SPERRY INSTRUMENTS INC.

Circle (3) on Reply Card

ELECTRONIC

Servicing & Technology

Volume 6, No. 2 February 1986

10

Servicing Wards HV and LV circuits

By Homer L. Davidson

Read where to direct suspicion when model GGY16229A color receiver goes completely dead: Most repairs will be required in the voltage-supply circuits.

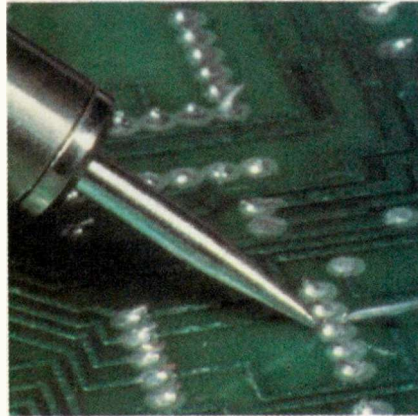

page 22

Soldering/desoldering techniques have changed because of the susceptibility to damage of today's delicate components. (Photo courtesy of Pace Inc.)

49

Splish, splash: repairing flood damaged electronic equipment

By Joseph J. Carr, CET

Is there life after water damage? Whether from flood or faucet, such damage can be reversed if electronic equipment is handled according to procedures described by the author.

22

Solder: the tin tie that binds

By Conrad Persson

Solder hasn't changed, but the size of components and wiring and the rules for soldering them to their crowded boards have changed dramatically.



page 6

Recently developed software may lead to a technician-assist computer system for diagnosing ailing circuitry. (Photo courtesy General Electric.)

52

What do you know about electronics? The padder —again

By Sam Wilson

Pursuing controversy engendered by a previous article, more about padder adjustment: on the high or low end of the band, and what is the determinant?

37

More on the telephone tester

Key information previously omitted by the author, together with detailed drawings, are presented for clarification of an ES&T November 1985 article describing telephone-tester construction.

60

Test your electronic knowledge

By Sam Wilson

This month's quiz is sound directed—think audio!

Departments:

- 4 Editorial
- 5 News
- 6 Technology
- 29 Profax
- 55 Literature
- 56 Books
- 57 Products
- 62 Reader's Exchange
- 63 Photofact

The technology is advanced. The temperature stays put.



EC 1000
Dial controlled
with EC1201P
iron.

EC 2000
Three digit LED
readout with
EC1201P iron.

EC3000
Dial controlled
with lightweight
EC1301 soldering
pencil.

EC 4000
Three digit LED
readout with light-
weight EC1301
soldering pencil.

All EC Series
stations meet
Mil-spec DOD-
STD-2000-1

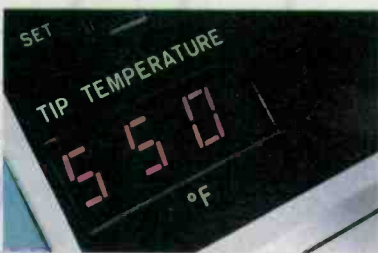

When you need controlled output soldering for sensitive components, you don't need uncontrolled temperature fluctuations at the work station. In the Weller EC Series, the tip temperature is maintained throughout the range of 350°F – 850°F to within 10°F. In addition, an electronic system utilizes thyristor power control with zero voltage thyristor drive. This

ensures that no high voltage spikes or magnetic fields will be present on the soldering tip.

These technologically advanced stations are capable of handling all the delicate soldering operations necessary, in even the most sophisticated applications. They offer the ultimate in soldering flexibility with a choice of controls and readouts to suit your needs precisely.



Check with your Electronics Distributor.

Weller® EC series

CooperTools



CRESCENT® LUFKIN® NICHOLSON® PLUMB® TURNER® WELLER® WIRE-WRAP® WISS® XCELITE®
The Cooper Group PO Box 728 Apex NC, 27502 USA Tel (919) 362-7510 Telex 579497

Circle (4) on Reply Card

BACK AMERICA

The more things change

...

The old French saying goes, "The more things change, the more they stay the same." Nowhere is change more evident than in the electronics industry. Yet if you look beyond the surface, it's also evident that in spite of massive and continuous change, many things are the same today as they were when electronics was in its infancy.

For example, as we point out in this issue in the article on soldering, today's tiny components and integrated circuits are soldered to the printed circuit board, just as the tubes and other components of yesterday's electronics products were soldered into their circuits. Today's color TV signal is still based on the NTSC standard that was established back in the days of black and white. Today's color television still delivers its picture via a CRT, just as the first commercial TV sets did many years ago. (As pointed out in an article on LCD-TV displays in January's *ES&T*, though, this may change.)

If you could sum it up, it would probably be that although the externals, the technology, the details have changed, to a degree that it makes the newer products and their functions almost unrecognizable compared to the old, the principles on which the products function have not changed.

Take video recording, for example. Today's home video recorders give users a movie theater in their own home. They provide a beautiful TV picture and stereo high fidelity sound. And all you have to do is buy or rent a cassette and pop it into your VCR to transport yourself visually and aurally into a different world. It's a far cry from the early days of wire and tape recording when you could barely get a low fidelity tape to give you recognizable words. But the principle is exactly the same: The information played back from the

tape in both cases was encoded on the tape as magnetic impulses. The difference is that the circuitry for recording and playing back the tape has been improved. Even though the tape itself is an impressive improvement over earlier tape formulations, *the principle is still the same.*

This also is true with audio. Vacuum tubes have been replaced with transistors and ICs, metal chassis have been replaced with printed wiring and the fidelity of the system has been consistently improved. Recordings have been digitized. Admittedly, that opens up an exciting new dimension. But look at what has remained unchanged. Start with the speakers: They remain based on the old principles of electromagnetism or electrostatics, just as the earliest speakers were. Today's turntables, tonearms and cartridges, although far advanced beyond the capabilities of early units, still use the same principles to generate the sound signal. And even though digital audio is based on some new developments, the disc, small and shiny though it may be, still goes "round and round" and must be *read* by some kind of *stylus*.

Look at any electronic device, consumer electronics or sophisticated test gear. A great deal has changed. In various portions of the equipment, digital has replaced analog, semiconductor has replaced vacuum tube, liquid crystal display has replaced meter movement. But a look beyond those surface changes reveals a product that's based on the same principles as were based the earliest devices. When you look at it this way to reaffirm the timeless, underlying principles of electronics instead of being dazzled by all the innovations, you will maintain the perspective that makes servicing the new products much easier.

Mike Conrad Penam

Enhanced-LCD products \$3.7 billion market by 1992

A new report from Stanford Resources, "Flat Panel Displays: The Impact of Enhanced-LCDs On The Market For High Information Content Displays," forecasts that the worldwide market for modules including these display devices will grow from \$126 million in 1986 to \$3.7 billion in 1992. This sales growth will be driven by the use of enhanced-LCDs in new products and application; not by the replacement of CRT displays in today's products.

Enhanced LCDs use a thin film semiconductor device at each element (pixel) in the display to overcome a number of current shortcomings with multiplexed LCDs. (See *January 1986, ES&T*.)

The active matrix concepts were developed more than 15 years ago that are being implemented today in small pocket-sized liquid crystal color televisions. However the displays were not manufacturable at that time because of the infancy of the high resolution fabrication techniques required. The display

industry, using techniques developed by the semiconductor industry, has advanced to the point where commercial products are now available.

There are about 30 firms actively investigating flat panel displays based on thin-film devices. This number does not include the universities nor the dozens of firms conducting preliminary research in the field.

As in many technology areas, the results obtained are proportional to the total amount of research money spent. The combined annual worldwide research and development expenditures for work on thin-film based displays is more than \$100 million. Very few technologies have been able to resist yielding products under such intense cultivation.

Car of the future will arrive talking and computerized

Television dramas of cars conversing with their drivers, tracking their location via computers, and so on, may seem farfetched, but those capabilities will move out of science fiction and into the dashboard by 1990, says a new study of the \$4.5 billion escalating U.S. market for non-entertainment automotive electronics.

"Electronics will soon become a significant factor in the cost of the automobile," predicts "Non-Enter-

tainment Automotive Electronics Market" (#1542), a new report by Frost & Sullivan. The study projects that devices ranging from fuel-mixture sensors and multipurpose CRT displays to keyless entry systems and navigational electronic compasses will contribute to a tripling of the market between 1984 and 1990.

EIA study probes attitudes of audio consumers

A detailed attitudinal survey of audio consumers was released today by the Electronic Industries Association's Consumer Electronics Group.

The 254-page study, prepared under the direction of CEG's Marketing Services Audio Committee, was distributed last month to member companies and is now available to non-members at a cost of \$750. Inquiries should be directed to EIA/Consumer Electronics Group, 2001 Eye Street, N.W., Washington, D.C. 20006 202-457-4919.

Based on the results of more than 1,600 interviews, the survey provides in-depth analysis of the purchase behavior, attitudes, listening habits and audio equipment ownership of various consumer segments. Respondents had previously been identified as recent purchasers of home, car or portable audio products. **ES&T**

ELECTRONIC

Servicing & Technology

Editorial, advertising and circulation correspondence should be addressed to: P.O. Box 12901, Overland Park, KS 66212-9981 (a suburb of Kansas City, MO); (913) 888-4664.

EDITORIAL

Nils Conrad Persson, *Editor*
Carl Babcoke, *Consumer Servicing Consultant*
Dan Torchia, *Group Managing Editor*
Marjorie Riggan, *Associate Editor*
Joy Culver, *Editorial Assistant*
Darryll Fortune, *Editorial Assistant*

BUSINESS

Cameron Bishop, *Group Vice President*
Eric Jacobson, *Publisher*
Greg Garrison, *Sales Manager*
Stephanie Fagan, *Promotions Manager*
Kelly Hawthorne, *Marketing Assistant*
Dee Unger, *Advertising Supervisor*
Karen Royall, *Advertising Coordinator*

ART

Kevin Callahan, *Art Director*
Joni Harding, *Graphic Designer*

ADMINISTRATION

R. J. Hancock, *President*
John C. Arnst, *Circulation Director*
Jo Ann DeSmet, *Circulation Manager*
Dee Manies, *Reader Correspondent*



Member, Audit Bureau
of Circulation



Member, American
Business Press

ELECTRONIC SERVICING & TECHNOLOGY (USPS 462-050) (with which is combined Electronic Technician/Dealer) is published monthly by Intertec Publishing Corp., 9221 Quivira Road, P.O. Box 12901, Overland Park, KS 66212-9981. Second Class Postage paid at Shawnee Mission, KS 66201. Send Form 3579 to P.O. Box 12952, Overland Park, KS 66212-9981.

ELECTRONIC SERVICING & TECHNOLOGY is the "how-to" magazine of electronics. It is edited for electronic professionals and enthusiasts who are interested in buying, building, installing and repairing consumer electronic equipment. This includes audio and video equipment, microcomputers and electronic games.

SUBSCRIPTION PRICES: one year \$18, two years \$30, three years \$38 in the USA and its possessions. Foreign countries: one year \$22, two years \$34, three years \$44. Single copy price \$2.25, back copies \$3.00. Adjustment necessitated by subscription termination to single copy rate. Allow 6 to 8 weeks delivery for change of address. Allow 6 to 8 weeks for new subscriptions.

PHOTOCOPY RIGHTS: Permission to photocopy for internal or personal use is granted by Intertec Publishing Corp. for libraries and others registered with Copyright Clearance Center (CCC), provided the base fee of \$2 per copy of article is paid directly to CCC, 21 Congress St., Salem, MA 01970. Special requests should be addressed to Eric Jacobson, publisher. ISSN 0278-9922 \$2.00 + 0.00

INTERTEC
PUBLISHING CORPORATION

©1986 All rights reserved.

GEN-X software developed to assist with servicing

Servicing home electronics products keeps getting harder. The products themselves have become increasingly complex, with the addition of ICs, start-up and shut-down circuits, electronic tuning, remote control, stereo-audio and more. Not only that, but in addition to TV and audio equipment, many of today's homes boast a VCR, a video camera, a microwave oven, a cordless telephone.

The repair of all of these products, with all of their sophisticated electronic circuitry, has become the responsibility of the technician who formerly repaired only televisions. The result is an almost impossible learning task.

Wouldn't it be nice if there were a computer system that could assist a technician in a step-by-step logical diagnostic process, tailored for the specific product type.

Such a system does not exist—unfortunately. But software recently developed ultimately could lead to a computer system that would be a valuable aid in diagnosing problems in consumer electronic products.



Recently, General Electric Company scientists unveiled software that dramatically reduces the time it takes to build expert systems—the special programs that enable computers to mimic the reasoning process of human authorities on a given subject. Known as GEN-X, the new software will enable experts in diagnostics, maintenance and other fields to readily input their accumulated knowledge and experience into a computer.

Developed at GE's Research and Development Center in Schenectady, NY, the software was introduced at the Ninth International Joint Conference on Artificial Intelligence at the University of California at Los Angeles.

According to Dr. Peter W. Dietz, manager of the GE R&D Center's Engineering Information Systems Branch, the new software has several unique features, including specialized graphics such as easy-to-follow decision trees and rule

At GE R&D, Dr. Bruce Pomery, left, a member of the GEN-X development team, diagnoses turbine faults for Arne Loft, consulting engineer with GE's Turbine Group, as he applies an expert system based on GEN-X software.

spreadsheets. "These graphics provide people interested in developing expert systems with a highly 'user-friendly' framework in which to organize their expert knowledge," he said. GEN-X also has a unique modular design that facilitates testing, debugging, and adding rules, and is designed to run on conventional microcomputers, Dr. Dietz added.

Development of existing first-generation expert systems has required the services of highly specialized artificial intelligence researchers known as *knowledge engineers*. These specialists have had to conduct exhaustively detailed interviews with experts in a given field in order to extract and input their knowledge and reasoning strategies. Some of today's ex-

Now electronics technicians can get into VCR Servicing quickly and easily

Learn professional VCR servicing at home or in your shop with exclusive videotaped demonstrations

Today, there are more than 10 million VCRs in use, with people standing in line to have them serviced. You can bring this profitable business into your shop with NRI professional training in VCR servicing. This top-level training supports the industry's claim that the best technicians today are those who service VCRs.

Integrated Three-Way Self-Teaching Program

In one integrated program, NRI gives you a study guide, 9 instructional units, 2 hours of video training tapes accompanied by a 32-page workbook that pulls it all together. At home or in your shop, you'll cover all the basic concepts of video recording, mechanical and electronic systems analyses, and the latest troubleshooting techniques. Your workbook and instructional units also contain an abundance of diagrams, data, and supplementary material that makes them valuable additions to your servicing library.

The "How-To" Videotape

Your NRI Action Videocassette uses every modern communications technique to make learning fast and easy. You'll enjoy expert lectures and see animation and video graphics that make every point crystal-clear. You'll follow the camera eye into the heart of the VCR as step-by-step servicing techniques are shown. Both electronic and mechanical troubleshooting are covered . . . including everything from complete replacement and adjustment of the recording heads to diagnosing micro-processor control faults.

Plus Training On All The New Video Systems

Although your course concentrates on VCRs covering Beta, VHS, and 3/4" U-Matic commercial VCRs, NRI also brings you up to speed in other key areas. You'll get training in capacitance and optical video disc players, projection TV, and video cameras. All are included to make you the complete video technician. There's even an optional final examination for NRI's VCR Professional Certificate.



Covers Beta and VHS
systems with actual
instruction on
videotape.

The Best Professional Training

This exclusive self-study course has been developed by the professionals at NRI. NRI has trained more television technicians than any other electronics school! In fact, NRI has consistently led the way in developing troubleshooting techniques for servicing virtually every piece of home entertainment equipment as it appears in the marketplace.

Satisfaction Guaranteed . . . 15-Day No-Risk Examination

Send today for the new NRI Self-Study Course in VCR Servicing for

Professionals. Examine it for 15 full days, look over the lessons, sample the videotape. If you're not fully satisfied that this is the kind of training you and your people need to get into the profitable VCR servicing business, return it for a prompt and full refund, including postage. Act now, and start adding new business to your business.

Special Introductory Offer

This complete VCR training course with two hour videotape is being offered for a limited time only, on orders received from this ad, at our low introductory price of \$179.95. Save \$20 by acting now!

NRI Training For Professionals
McGraw-Hill Continuing Education Center
3939 Wisconsin Avenue Washington, DC 20016

YES! Get me started in profitable VCR servicing. Rush me my NRI self-study course in VCR Servicing for Professionals. I understand I may return it for a full refund within 15 days if not completely satisfied.



NRI Training For Professionals
McGraw-Hill Continuing
Education Center
3939 Wisconsin Avenue
Washington, DC 20016

PLEASE SPECIFY TAPE FORMAT DESIRED VHS BETA

Name (please print) _____

Company _____

Street _____

City/State/Zip _____

Enclosed is my check money order for \$179.95 (D.C. residents add 6% tax) Make check payable to NRI

Charge to VISA MasterCard _____

Interbank Number _____

Card Number _____ Expiration Date _____

Signature _____

(required for credit card sales)

2830-028

pert systems literally have taken years to complete.

With the new software, by contrast, the process can be reduced to a matter of months, and the assistance of knowledge engineers will no longer be required for many applications. Scientists and engineers and others possessing a basic familiarity with computers will be able to input their own ex-

pertise simply by following instructions in a *fill-in-the-blanks* format provided by the software.

The heart of any expert system is its knowledge base or *body of knowledge*, which includes a variety of facts (pieces of evidence that describe the problem) and rules (conditional statements that help to define the solution to the problem). Like repair personnel, an ex-

pert system relies on flexible, humanlike thought processes ("If this and this are true, then do this...") to diagnose problems, rather than on rigid procedures.

Expert systems contain hundreds of such rules generated from the real-life expert. It is this key information that GEN-X is able to extract and encapsulate quickly and accurately.

Coming: the super- smart credit card

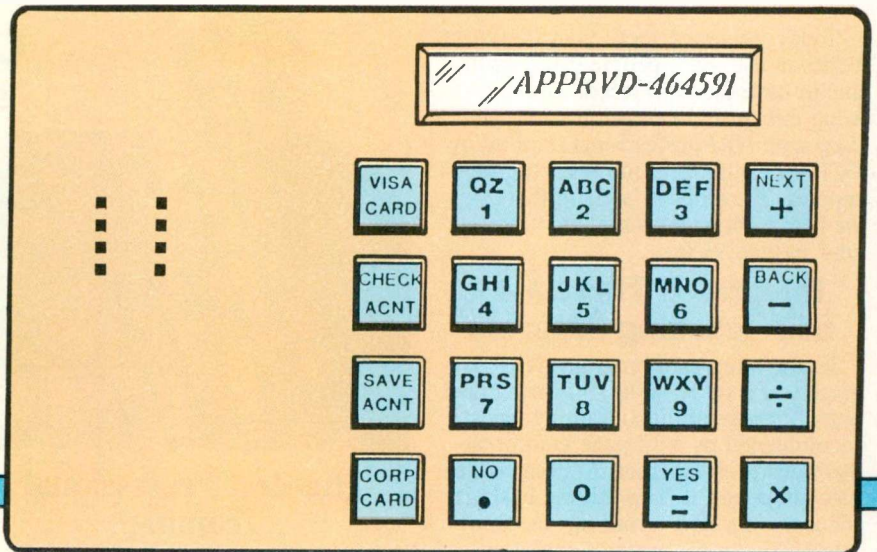

Did you ever think you'd be carrying a microcomputer in your wallet? Sounds far-fetched, but if a joint development effort by Toshiba Corporation and Visa International bears fruit, future credit cards, *super smart* cards, will be based on an intergrated circuit containing a microcomputer.

This next-generation card will have a calculator-like keyboard and a display on the back, and a built-in battery (not seen in conventional IC cards) while retaining the same size and thickness of the present credit card: 54mm long, 86mm wide and 0.76mm thick.

Cardholders will choose which account they want to use; checking, savings, credit or other account, by pressing a key on the back of the card. They will enter their personal identification numbers on the keyboard and the amount of the transaction. The card then will verify user identity, check the balance in the appropriate account, deduct the amount of the transactions and record it in the contained memory device. All these functions will be performed without the need for any computer support. When in

another country, the card will display the amount of money converted to the country's currency.

In addition, the card will show the time of the day and function as an electronic notepad for the cardholder's convenience.

These functions will make possible a reduction in the burden and cost of communications with the credit card company by banks and merchants to check the identification and credit worthiness of the user. Meanwhile, the card will give cardholders immediate control over their financial assets. Simultaneously, the credit card company will be better able to prevent counterfeit cards and the improper use of credit cards.

The new card also will be connected to Visa computers and banks by using on-line card reader/writer terminals at the stores so that the amount of money will be deducted immediately from the user's bank account. Furthermore, although it will bear no magnetic stripe, the new card can be used in conventional magnetic-stripe-reading terminals, the dominant terminals in

Microcomputer-based "smart" credit card will keep track of financial transactions as they occur. In addition, the card will show time of day and function as an electronic notepad.

today's market, because the card is equipped to simulate a magnetic stripe.

Visa International now issues 130 million credit cards; it plans to replace these gradually with the new super-smart cards after completion of various tests. Toshiba plans to discuss further details of the new card with Visa, and complete development by the summer of 1987, then start sample shipments to Visa for field-testing at particular areas.

An IC card resembles a conventional magnetic credit card, but contains a microprocessor and a memory device that allow it to store 100 times as much data as magnetic cards. Growing worldwide attention has been focused on the IC card, because it can be safely used in a variety of ways that include identification and access passes, electronic banking, and for storing personal records. **ES&T**

We've set a new pace in desoldering.

PACE introduces a breakthrough in fast, spike-safe desoldering and temperature-controlled soldering: the MicroBenchTop™ Systems.

Our MBT-200 (desoldering/soldering) and MBT-100 (desoldering) systems deliver instantaneous vacuum for non-destructive removal of any solder joint—thanks to

the PACE “instant rise” rotary carbon vane pump. And our new low-voltage, lightweight handpiece has the best “tip to grip” ratio in the industry—with finger-tip actuation for more precise control.

MicroBenchTop Systems are designed to meet UL as well as international electrical standards for even the

most sensitive and demanding desoldering applications. And their low cost makes them even more attractive. Call us today at 301-490-9860 or Telex 87446 for a free demonstration.

PACE

® PACE, Incorporated
9883 Brewers Court
Laurel, MD 20707
U.S.A.

Systems for Development, Production
and Repair of Electronic Assemblies



See us at the Nepcon West Show,
Booth no/341.

MBT-100, left. MBT-200, right.

Circle (5) on Reply Card

© 1985 PACE, Inc.

Servicing Wards HV and LV circuits

By Homer L. Davidson

Most repairs will be required in the various voltage-supply circuits. These include the line-rectified supply, the SCR regulator, the horizontal-sweep system, the start-up circuit and the shutdown system. They are given the most coverage.

A large percentage of electronic failures in the Wards model GGY16229A color receiver (Photofact 2170-2 and photograph, see below) originate in the horizontal-sweep system and the low-voltage power supplies that operate with power from the flyback. These two general areas plus the input ac power, along with its rectification and regulation, are the first areas that should be investigated when a receiver is completely dead. Then the technician must decide the priority of these tests as symptoms are noted.

Low voltage and regulator

A conventional 4-diode bridge rectifies the 120Vac line voltage and filters the output with one large capacitor C518A (Figure 1). This is the unregulated supply,

measuring +158V in normal operation, that supplies all power to the receiver. If the receiver is in shutdown mode, it is the only one having a dc voltage (slightly higher than normal).

However, the +158V supply furnishes no power directly to any circuit except the SCR513 regulator. The +112V regulator output directly powers the start-up circuit, horizontal driver and output transistors and nothing else. Power from the horizontal-output transistor to the flyback is rectified, filtered and used for many low-voltage supplies. Without voltage from the +112V regulator, nothing in the receiver operates.

Regulation by SCR513 is accomplished by varying the length of time during each horizontal cy-

cle that the SCR conducts power from the +158V supply to the +112V supply. **Electronic Servicing and Technology** has analyzed regulators having the same basic principles in several previous issues. Please refer to some of those articles if you would like a more detailed explanation. In all of these, a heavier load on the regulated supply (or a lower line voltage) reduces the regulated supply below +112V and causes the circuit to gate-on the SCR earlier in each horizontal cycle. Each cycle ends at the tip of the horizontal retrace pulse, so this allows the +158V supply to flow for a longer period of time, thus increasing the +112V supply voltage. A lighter load on the regulated supply allows the +112V supply to rise above that value and the circuit gates-on the SCR later in each horizontal cycle. Therefore, there is less time for the +158V supply to flow into C518B, and the voltage decreases to the correct +112V.

Another benefit of the circuit that is not readily apparent is the increase of the +112V supply from rectification of all positive portions of the pulse waveform that is at the SCR anode. Remember the +158V is there too, which forces more of the waveform positive. Proof? Well, 112V is about 70.9% of the 158V source voltage. If gating the +158 solely was responsible for the +112V, the SCR would be gated-on about the same 70.9% of the time. Instead, anyone with a scope and a current probe can prove the SCR current flows only for 30% of the time; slightly higher with high brightness. The same proof is obtained by interpreting correctly the SCR513 anode waveform. Just vary the brightness from dark-to-

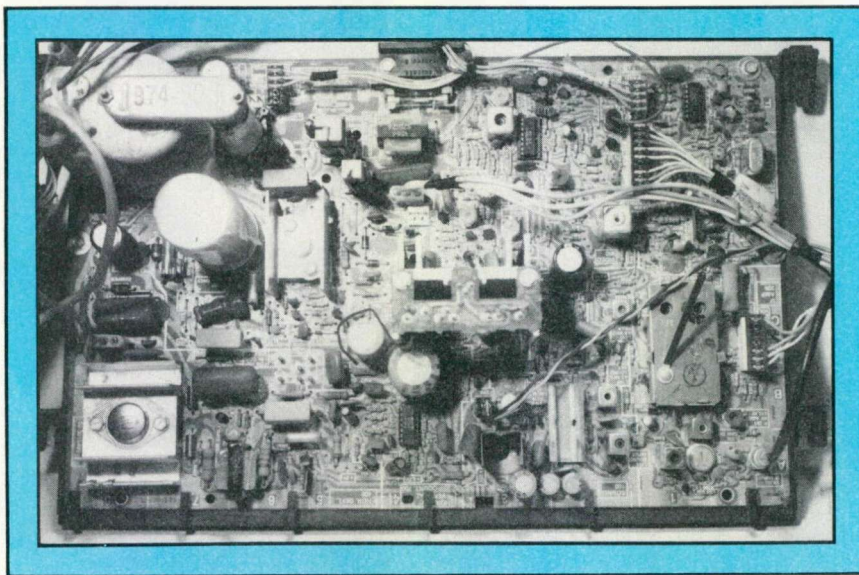

A Wards model GGY16229A (Photofact 2170-2) has most components on one large circuit board. In addition, nine transistors, several variable controls and other components are mounted on the circuit board that includes the picture-tube socket. Two tuners and other controls for the customer to adjust are on the color receiver's front panel. A large percentage of electronic failures originate in the horizontal-sweep system and low-voltage power supplies.

high brightness and notice which area of the waveform becomes wider with the need for more power. Of course, it is the area just to the left of each negative-going pulse. The rectification dc voltage is added to the +112V supply so SCR513 does not have to conduct 70% of the time.

Rectifying horizontal sweep

Almost any desired dc voltage can be obtained by rectifying horizontal from the flyback and filtering it in the usual way. For example, +220V is needed for the collector resistors of the 3-color output transistors (mounted on a small board that includes the picture-tube socket and several other components). Diode SC527 rectifies the positive pulses from flyback pin 10, and the ripple is filtered by C540 (Figure 2). The cold end of the screen control is returned to this supply, to prevent the screen voltage from being too low at reduced settings.

Loss of the +220V supply usually is caused by failure of diode SC527, so check it first. If the +220V supply is reduced to near zero, this reduces the positive voltages at the three CRT cathodes. Therefore, the cathodes and grid have nearly the same dc voltage, thus increasing the brightness. In most cases, the picture will be too bright and exhibit retrace lines.

For all brightness problems, check the CRT socket voltages against the ones shown in Photofact. Then work back from there through screen circuit, grid circuit or cathode circuits.

Other important voltages

Figure 3 shows how diode SC530 and filter capacitor C540 produce +25V that is used for a few stages and then reduced by a series resistor, a series resistor plus a zener diode, a regulator transistor, an inductance, and, finally, another zener diode to form seven additional lower voltages from the original +25V supply (check the Photofact 2170-2, page 35, power supply for details). Only two supplies taken from the +25V source are shown in Figure 3. Each supply should be tested for voltage separately. It is possible for a con-

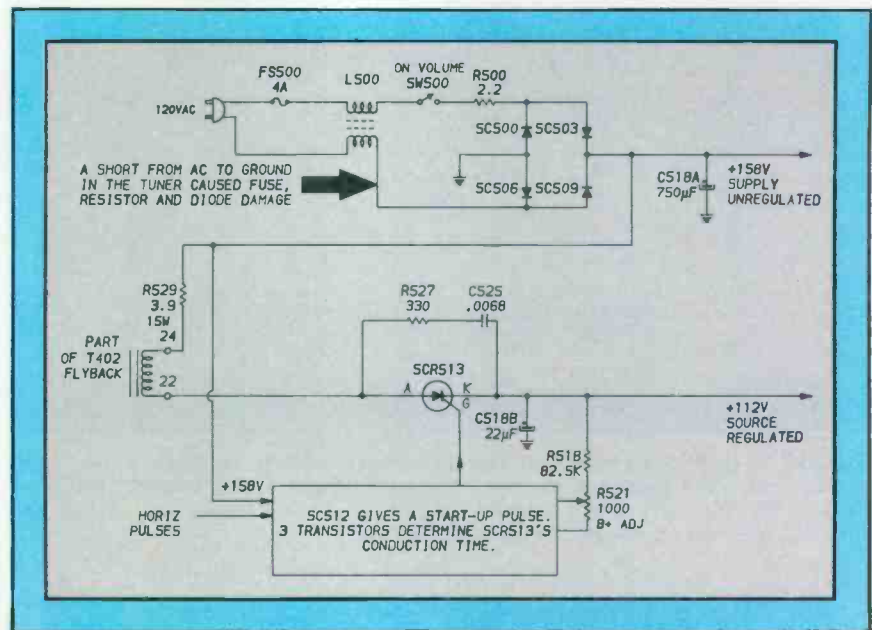

Figure 1. One side of the ac line voltage first passes through the 4A FS500 fuse, the L500 line filter and then reaches the on/off switch SW500. From SW500, the ac power passes through current-limiting resistor R500 and reaches its destination: one ac end of the bridge rectifier (with four identical diodes). The other side of the ac line goes only through the other winding of the L500 line filter and is connected to the other ac end of the bridge. The remaining two diode anodes are grounded, while the two cathodes of the bridge produce the B+ voltage that is made peak reading and filtered by capacitor C518A. Output of C518A is the unregulated +158V supply, which is sent only to the regulator SCR513 and its timing circuit. During normal operation, the +158V passes through 3.9Ω R529 and the pins-22 to 24 flyback winding to the SCR513 anode. Therefore, a mixture of +158V and negative-going horizontal-frequency pulses are present at the SCR513 anode simultaneously. Gating-on of SCR513 passes some +158V to C518B, while the pulses turn off the SCR512 condition, regulating the +112V source. But something needs to start up the +112V supply (even before the horizontal starts). Here are the steps. The first circuit to begin working is the bridge rectifier and C518A (with what will be +158V at completion). At turn-on, this C518A voltage is increasing rapidly and it passes a point where zener diode SC512 conducts dc power that is sent to the SCR513 gate. Therefore, SCR513 conducts much of the +158V into the +112V line. But simultaneously, some of this same +112V-type voltage passes through R421 (shown in the Figure 10 shut-down schematic), then is clamped to about +8V by zener SC403, passes to the Q400 base (Q400 has collector voltage from the same +112V source) so the emitter follows whatever the base does, and the emitter voltage is sent to IC700 pin 9 as B+ for the horizontal oscillator. All three horizontal stages (oscillator, driver and output) now have some B+ and the horizontal system begins to operate. Meanwhile back at the SCR513 regulator, the negative anode pulses have made the SCR non-conductive during retrace of each horizontal cycle, while the other flyback pulses that are applied to the timing circuit have given the operation a standard, so variations of the +112V source determine when during each cycle the SCR513 is gated into conduction to replenish the charge in C518B. Start-up now is over, and the operation is normal.

siderable overload to reduce one of the derived supply voltages without reducing the parent +25V source very much.

Incidentally, the +21.6V source is CircuiTrace 13 that feeds the vertical-output transistor, while the +20.4V source is CircuiTrace 11 that supplies the main voltage for the IC102 sound IC. Also, the sound volume control obtains power from +23.8V at CircuiTrace 5.

As an example of the many stages and circuits that are affected when a supply voltage fails,

the +23.8V supply is formed by either a diode or a 4.7Ω resistor that brings in the +25V power, while the +23.8V supply is filtered by C164, a 1,000µF, electrolytic that filters and gives some voltage regulation. All these stages and devices are supplied directly by this +23.8V source identified in the Photofact as CircuiTrace 5:

- sync-separator transistor;
- vertical sync amplifier transistor;
- AGC for the VHF tuner;
- first video amplifier transistor;
- second video amplifier;

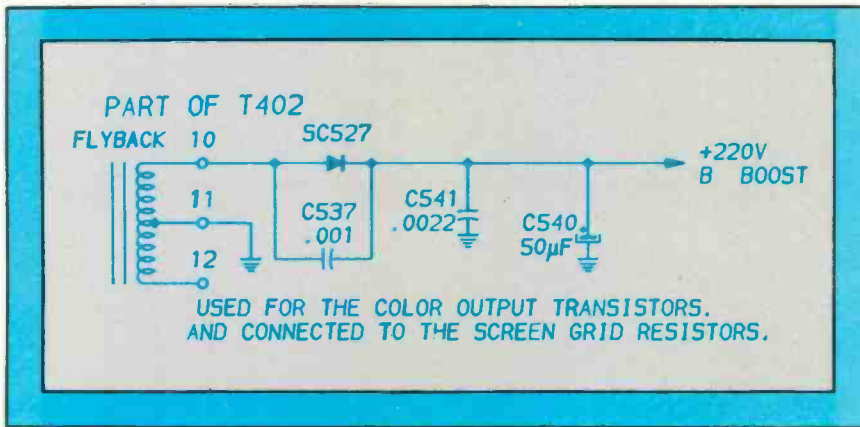

Figure 2. In this Wards television, only two power supplies are made by rectifying signals from the flyback transformer. The +220V boost supply furnishes collector voltage for the color-output transistors and the output regulators. It was one selected to be monitored by the shut-down sensors.

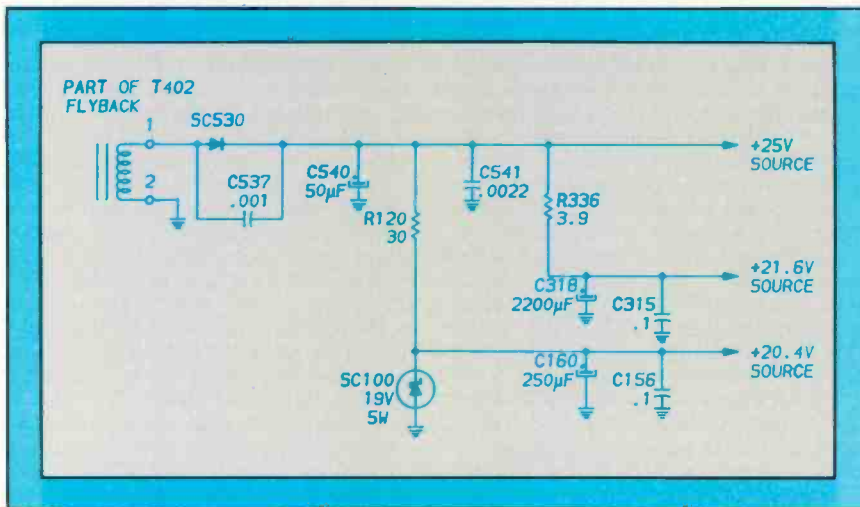
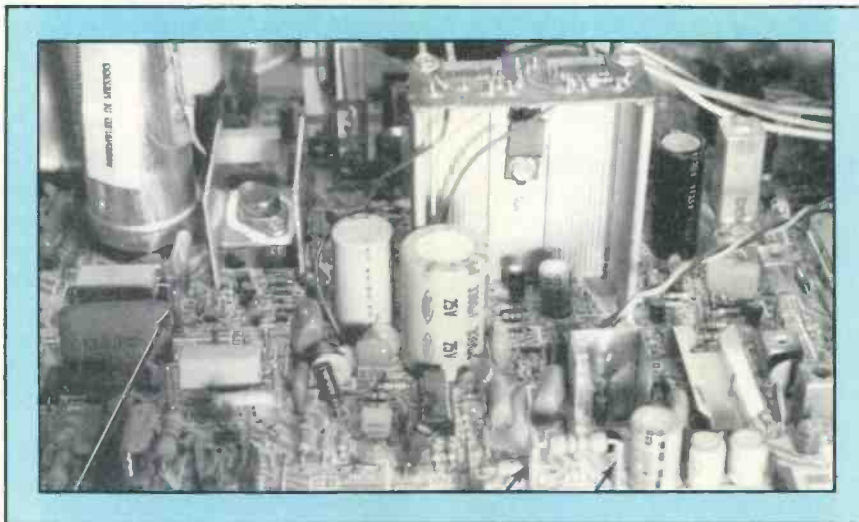

Figure 3. The only other flyback-voltage rectified supply is the +25V source. Seven other supplies are taken from the +25V source by using dropping resistors, zener diodes, transistor voltage stabilizers and many filter capacitors. If the +25V source has a defect and produces zero voltage, the other seven sources also each have zero voltage.



Arrows point to several large high-wattage resistors that are mounted high above the circuit board by rivets or pins that also serve as connections. This helps prevent charred or burned areas on the circuit board.

- IC900 video/chroma IC;
- IC602 chroma demodulator;
- Q903 video back-seat video driver;
- Q904 video driver; and
- contrast, sharpness, brightness and sound controls.

There may be others as well, but these serve to illustrate the point that failure of a key low-voltage supply such as the +25V or +23.8V can have widespread symptoms and problems.

As shown in the photograph, lower left, many smaller components of these low-voltage supplies are located near the chassis' front. C518 is the large metal capacitor at the upper left in the photograph, while the Q303 vertical output transistor is mounted on the large heat sink (just to the right of center). Notice that several large, high-wattage resistors are mounted about an inch above the board by long standoffs.

Checking LV power circuits

If the 4A FS500 was blown when the Wards television was received, and the replacement 4A fuse blew immediately at turn-on, the first step is testing all four bridge rectifiers, particularly SC500 and SC506, for shorts or serious leakages. Any of the bridge rectifiers (Figure 1) can become shorted by power-line surges or the secondary effects of lightning strikes. Surge-current-limiter resistor R500 can become open or have a changed resistance from these transients that must travel through it to reach the diodes and C518A.

Don't forget the possibility of excessive ac line voltage, either temporary or permanent. I could find nothing wrong with one such television that blew fuse and diodes at least once a week. It was on the fourth set of bridge diodes that I checked the line voltage and found it to be 136Vac! No more fuses or diodes blew after the line voltage was reduced by the power company.

If all else fails, and one diode shorts every week or two, replace all four diodes with 3A types of high reverse-voltage rating.

Unusual short circuit

Although leaky bridge diodes SCR500 and SCR506 had been

replaced, the 4A fuse continued to blow at turn-on. R500 was found to be open, and was replaced. All diodes were checked again in-circuit (Figure 1) with SCR506 testing a virtual short. But after SCR506 was removed from the circuit, it tested normal leakage. Now a dead short was measured across the terminals where SC506 had been connected by soldering. C509 (the 0.001 capacitor paralleled across the diode) had no leakage when one end was disconnected.

In other words, one side of the ac line was grounded to the receiver ground, but nothing was defective. After several minutes tracing wires on the Photofact schematic, I removed the volume-control plug from the chassis *and the short was gone*. That isolated the 120Vac short-to-ground as somewhere in the tuner assembly. Two small neon bulbs are used to indicate UHF or VHF operation. A 33kΩ resistor at each neon bulb limits the current when the 120Vac is applied to the bulb. One of the small switching dial-light components (SW506) on the rear of the VHF tuner was touching the tuner shield (ground). This shorted one side of the 120Vac line at a point shown by an arrow and a brief explanation in the Figure 1 schematic. Moving the 120V connection a safe distance from the ground and adding some tape for added protection stopped the ground. The reinstallation of C509 and diode SC506 and reinsertion of the volume-control plug restored normal operation.

Checking the regulator

Four simple dc-voltage measurements will give you more usable information than will a dozen other tests made at random or with an inappropriate instrument. Those four points are: 1.) the +158V output of the bridge rectifier; 2.) the anode of SCR513 (Figure 1); 3.) the cathode of SCR513 or other convenient source of the regulated +112V source; 4.) the Q402 (horizontal-output transistor) collector (case).

Little variation from the standard +158V should be expected. If the load is very light, the voltage might rise to almost +169V, but that is unusual. If it is significantly lower than +158V, and there is no sign of an overload, perhaps

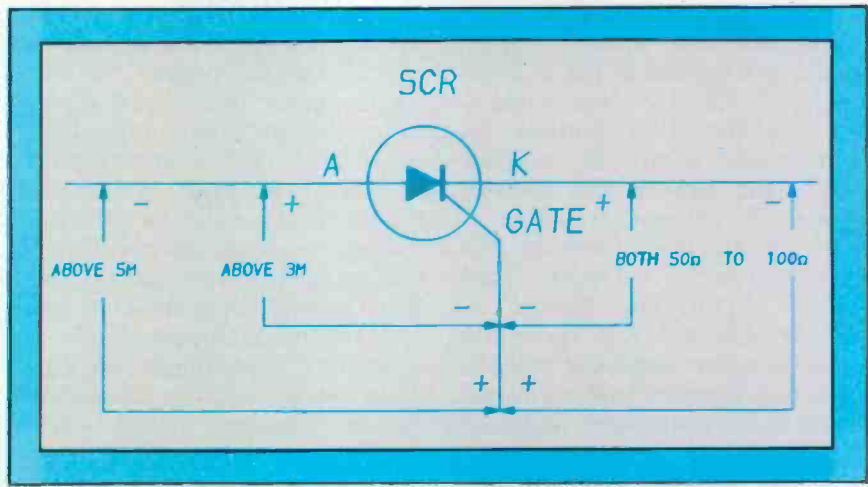

Figure 4. SCR's can be tested with fair accuracy with a *high-power* ohmmeter, as shown by the chart. The meter is placed where the typical readings are shown. The + and - refers to the polarity of the ohmmeter leads. (If you are not certain, measure the voltage and polarity by using a voltmeter.)

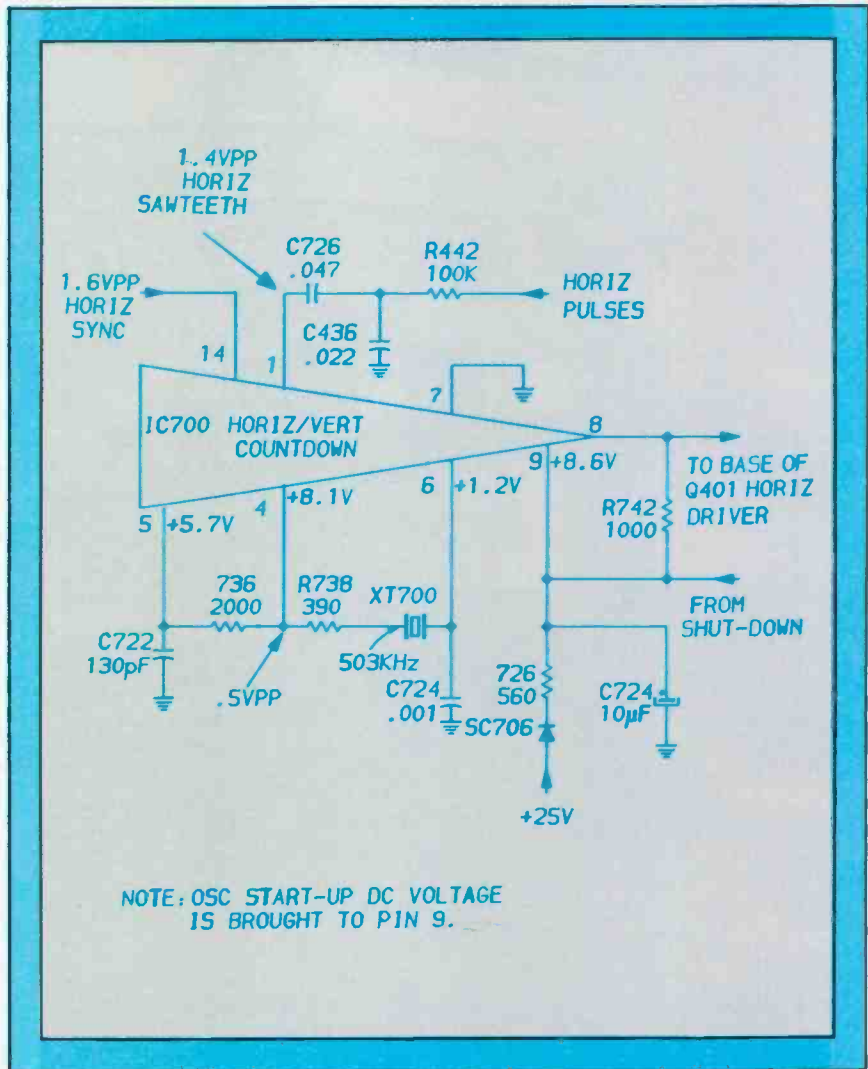

Figure 5. Important waveforms and voltages of IC700 are shown here. Horizontal locking requires two signals: horizontal sync (at pin 14); and horizontal sawteeth (at pin 1). Pins 4, 5 and 6 are used for the 503.5kHz oscillator that is divided down for horizontal and vertical sweep frequencies. Pin 9 of IC700 is the B+ input which is used with a dc voltage brought in during start-up. Normal operation supplies pin 9 through SC706 and R726. Shut-down is initiated when the pin 9 voltage is drained out rapidly. Base signal for Q401 driver comes from pin 8.

C518A is open or partially open.

Virtually the entire +158V should be expected at the SCR513 anode. If SCR513 is *not* conducting, they should be identical. An appropriate anode dc voltage proves the flyback pin 22 to 24 winding is not open. Neither is R529 (3.9 Ω) open, nor is the associated wiring. Of course, if the +158V supply has normal dc voltage while the SCR anode has none, the open component must be found and repaired before you can proceed. An open there might be the only defect. Remember, R529 is a 15W resistor that operates quite warm in normal service.

If the SCR513 cathode has a dc voltage that is just a few volts

above or below the desired +112V, perhaps the R521 B+ adjustment control needs proper rotation while reading the +112V supply. Otherwise, the drain on the supply might be too high or unusually low, or components in the 3-transistor timing circuit might be defective. Voltage readings alternated with resistance readings usually will find the bad component or transistor in the timing circuits.

There is one minor warning: Some dc voltage (up to +158V) can be measured at the +112V supply, even when SCR513 has been removed. That's because 10k Ω 2W R515 is connected between +158V and +112V source. Obviously, such a high value resis-

tor cannot operate the horizontal-sweep system. And if the +158V is normal but the +112V is near zero, the resistor will burn to a crisp. Watch out for it.

A good time to give the SCR513 a resistance check is while it is out of the chassis, as shown in Figure 4. Of course, when you want to force a transistor, diode or SCR junction to conduct (necessary here for the gate tests), be sure the ohmmeter has 1.5V or higher across the probes. In other words, use a *high-power* ohmmeter not a *low-power* one designed to keep junctions from conducting.

Horizontal oscillator and driver

Pins 4, 5 and 6 of IC700 (Figure 5) are for the horizontal oscillator that operates at 503.5kHz with internal dividers to provide horizontal and vertical drive frequencies. Of course, locking is performed at the usual 15,734.4Hz frequency by horizontal sync at pin 14 vs. a sawtooth filtered from horizontal-sweep pulses and delivered to pin 1. Proper locking is not possible without both these signals. Horizontal frequency long-duty-cycle pulses (near square waves) for the base of Q401, the horizontal-driver transistor, leave IC700 at pin 8.

Pin 9 wiring also is shown. At first, pin 7 seems to have no function except bringing B+ from the +25V supply to the internal oscillator and dividers. However, pin 9 also is used for start-up of the oscillator (remember the +25V supply is dead until after start-up), and it is essential for shutdown. Refer to Figure 7, page 18, for those two functions.

SC706 appears to do nothing because the +25V supply forward biases it, and it passes the voltage on to pin 9. But SC706 has a vital switching function. When the feeble start-up dc voltage comes in to pin 9, the +25V supply voltage is zero. Therefore, SC706 is reverse biased, which disconnects all the heavy +25V supply load. It does not decrease the small start-up voltage, so all of it goes to pin 9 and IC700.

Pin 9 of IC700, the collector of Q401 driver and the Q402 output collector all receive start-up voltage at the same time. The horizontal-sweep system begins operation with these three stages

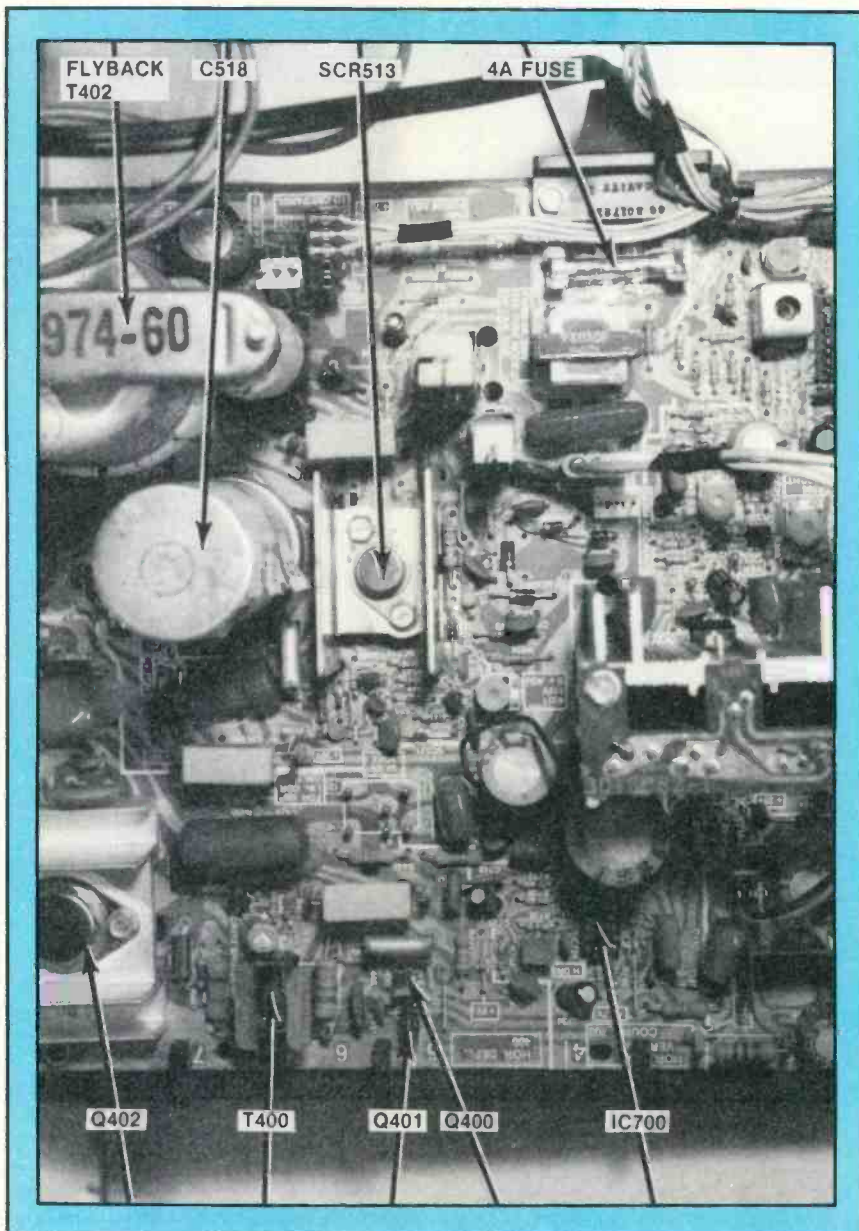

Location of IC700 is pointed out by arrow. IC700 is mounted in a socket, which simplifies the replacement. Another arrow identifies the FS500 4A line fuse.



**Punch up a new program.
Profits by remote control.**



This program appeals to a vast audience. Millions of glued-to-the-recliner remote control transmitter addicts. When their RCT conks out, they get very impatient. They want it fixed or replaced right now. Waiting weeks for a new unit from the original manufacturer doesn't please them.

You've got them coming and going.

Philips ECG has replacements for RCTs that cover most TV/VCR manufacturers from A to Z. (AOC to Zenith). For example, five models replace 18 RCA models. In fact, over 170 OEM remote control transmitters can be covered by just 71 replacement RCTs. And like all Philips ECG products, they fit and they work.

Philips ECG has an express delivery plan that makes you a hero.

You don't commit to anything but ordering from your Philips ECG distributor. If it's a replacement for a popular OEM brand he might have it in stock. If not, Philips ECG guarantees express delivery. This

means you beat an OEM repair or replacement schedule by days or weeks. In fact, in a matter of days your customer

is back on the recliner, pushing buttons and smiling contentedly. And you're a hero.

Contact your local Philips ECG distributor today for a free Cross Reference RCT catalog. Start making profit by remote control right away.



Time-Saving Money Maker! Philips Remote Control Transmitter Tester

On site or in shop, this tester quickly and positively verifies all remote control transmitting functions, including those for TV receivers, VCRs and cable converters... both infrared and ultrasonic types. It's a first from Philips ECG for the television industry. Put it to work saving time and making money for you. Battery-operated, weighs just four ounces.

If it's ECG, it fits. And it works.

Philips ECG

A North American Philips Company

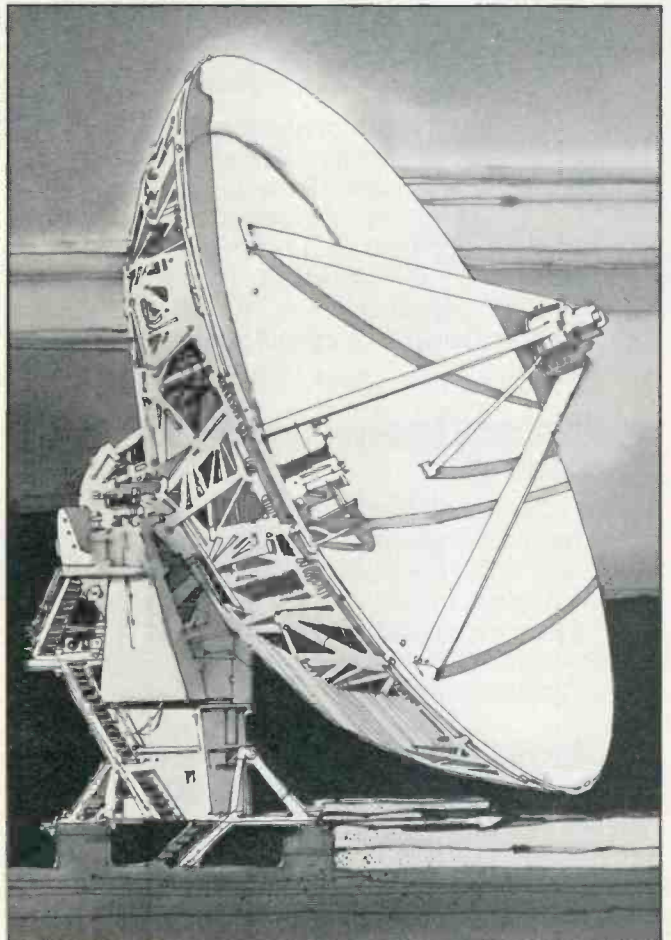
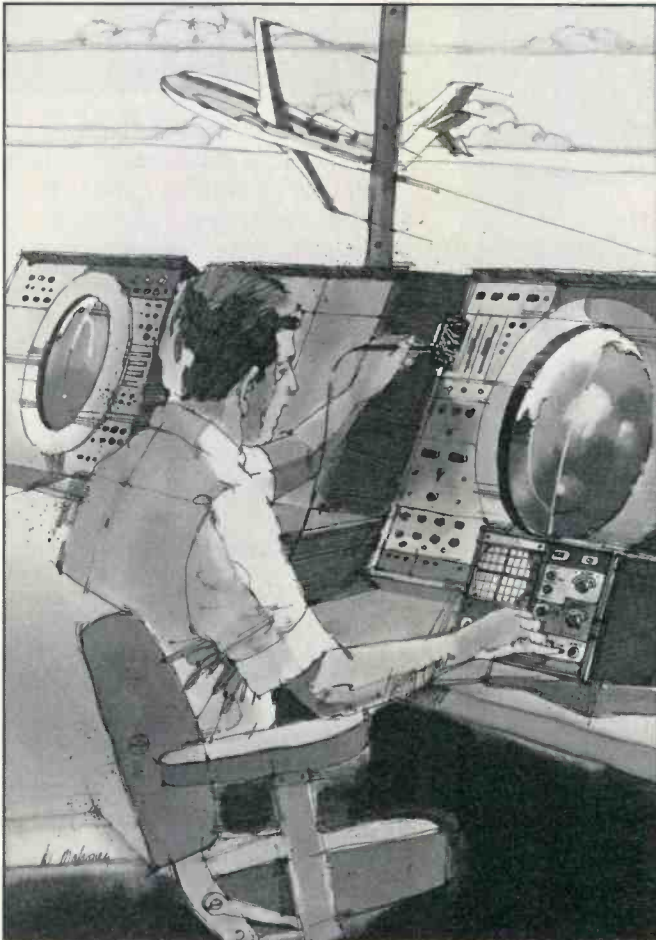
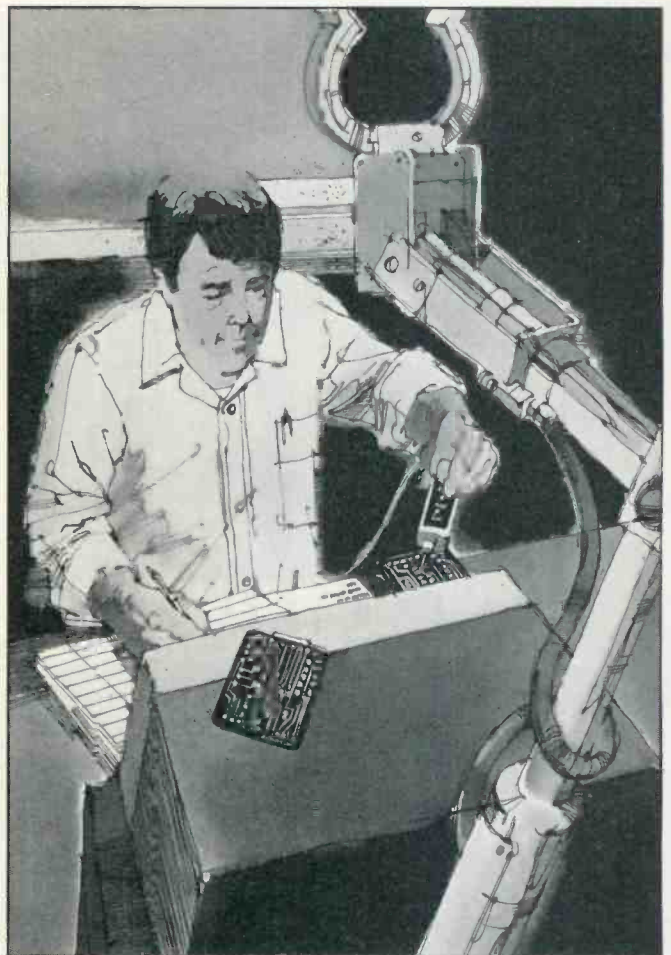
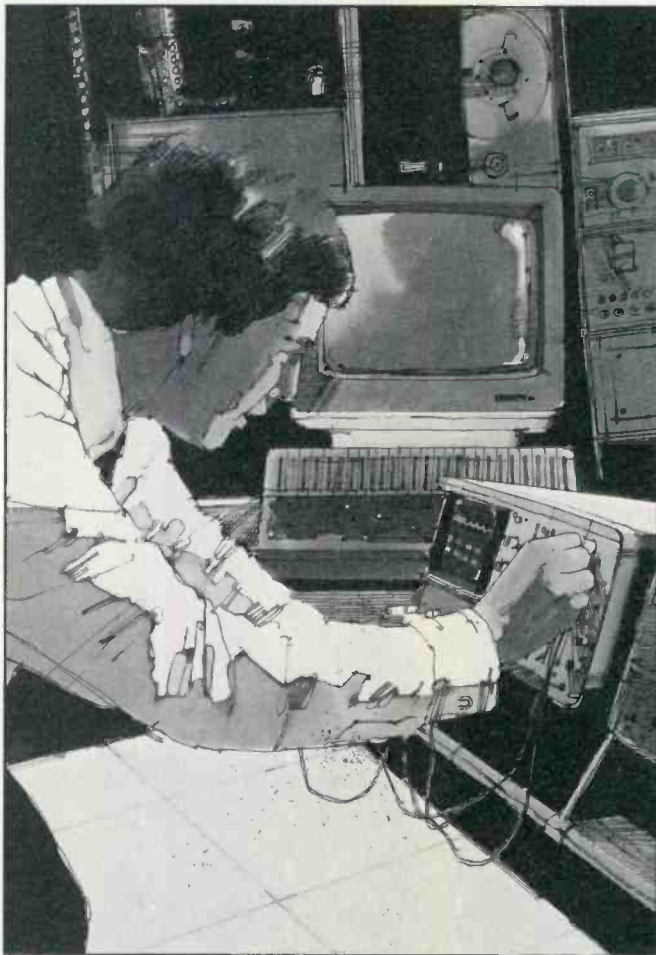

CIE MAKES THE WORLD OF ELECTRONICS YOURS.

Today's world is the world of electronics. To be part of it, you need the right kind of training, the kind you get from Cleveland Institute of Electronics, the kind that can take you to a fast growing career in business, aerospace, medicine, science, government, communications, and more.

Specialized training.

You learn best from a specialist, and that's CIE. We're the leader in teaching electronics through independent study, we teach only electronics and we've been doing it for over 50 years. You can put that experience to work for you just like more than 25,000 CIE students are currently doing all around the world.

Practical training.

You learn best with practical training, so CIE's Auto-Programmed® lessons are designed to take you step-by-step, principle-by-principle. You also get valuable hands-on experience at every stage with sophisticated electronics tools CIE-designed for teaching. Our 4K RAM Microprocessor Training Laboratory, for example, trains you to work with a broad range of computers in a way that working with a single, stock computer simply can't.

Personalized training.

You learn best with flexible training, so we let you choose from a broad range of courses. You start

with what you know, a little or a lot, and you go wherever you want, as far as you want. With CIE, you can even earn your Associate in Applied Science Degree in Electronics Engineering Technology. Of course, you set your own pace, and, if you ever have questions or problems, our instructors are only a toll-free phone call away.

The first step is yours.

To find out more, mail in the coupon below. Or, if you prefer, call toll-free 1-800-321-2155 (in Ohio, 1-800-362-2105). We'll send you a copy of CIE's school catalog and a complete package of enrollment information. For your convenience, we'll try to have a representative contact you to answer your questions.

CIE Cleveland Institute of Electronics
1776 East 17th St., Cleveland, Ohio 44114

YES! I want to get started. Send me my CIE school catalog including details about the Associate Degree program.

Print Name _____

Address _____ Apt. _____

City _____ State _____ Zip _____

Age _____ Area Code/Phone No. _____ / _____

Check box for G.I. Bulletin on Educational Benefits

Veteran Active Duty **MAIL TODAY!**

OR CALL TOLL FREE

1-800-321-2155

(In Ohio, 1-800-362-2105)

Circle (6) on Reply Card

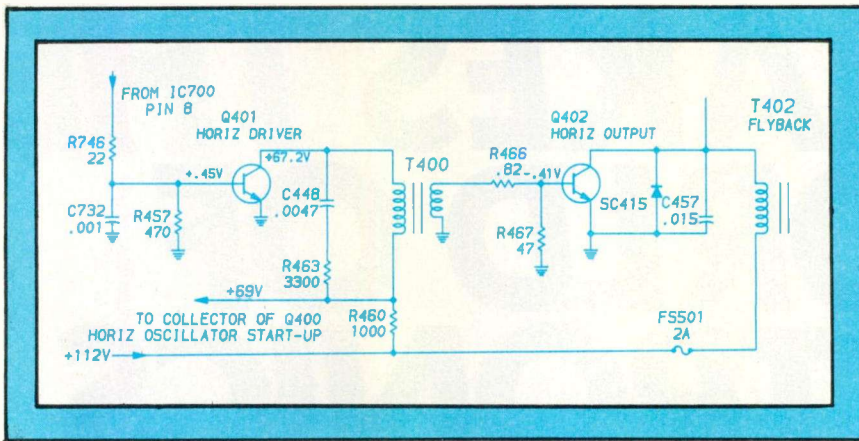

Figure 6. Although the circuit details and component values vary from one model to another, the driver and horizontal output stage of one color receiver is very similar to many others. So it is here. The FS501 2A fuse is a plug-in type that makes replacement easy. Or it can be removed to eliminate B+ from the Q402 collector during tests. If C467 (.015 μ F) becomes open, the high voltage will increase greatly, causing shutdown. An open C456 (0.001 μ F in parallel with C457) also increases the high voltage, but not very much. Every time you test a horizontal output transistor, also test the damper diode (SC415 in this case). Check it for forward voltage drop and with reverse voltage for leakage. Remember that a damper diode must pass as much current in the negative direction as the output transistor does in the positive direction. If there is no damper, or it is open, the collector/base junction of the output transistor must pass the negative current in addition to its normal positive current function. That is why a missing damper results in a delayed failure of the horizontal output transistor.

operating weakly; then the power increases rapidly until the system has full power and can supply all deflection, HV, and flyback power that is rectified to produce low-voltage supplies (photo, page 14).

Driver and output stages

Conventional is the best word to describe the driver and horizontal-output circuitry. Not all receivers have a fuse for the output transistor and its flyback winding, as this one does. Having a convenient way to disconnect the horizontal output collector from B+ saves time with some tests (schematic in Figure 6).

Voltage for the Q400 collector was taken from R460 (collector voltage-dropping resistor for the horizontal-driver transistor) as an easy way to obtain a dc voltage of less than +70V for Q400. There is no signal connection there.

Start-up and shutdown circuits

An old saying wryly states, "The

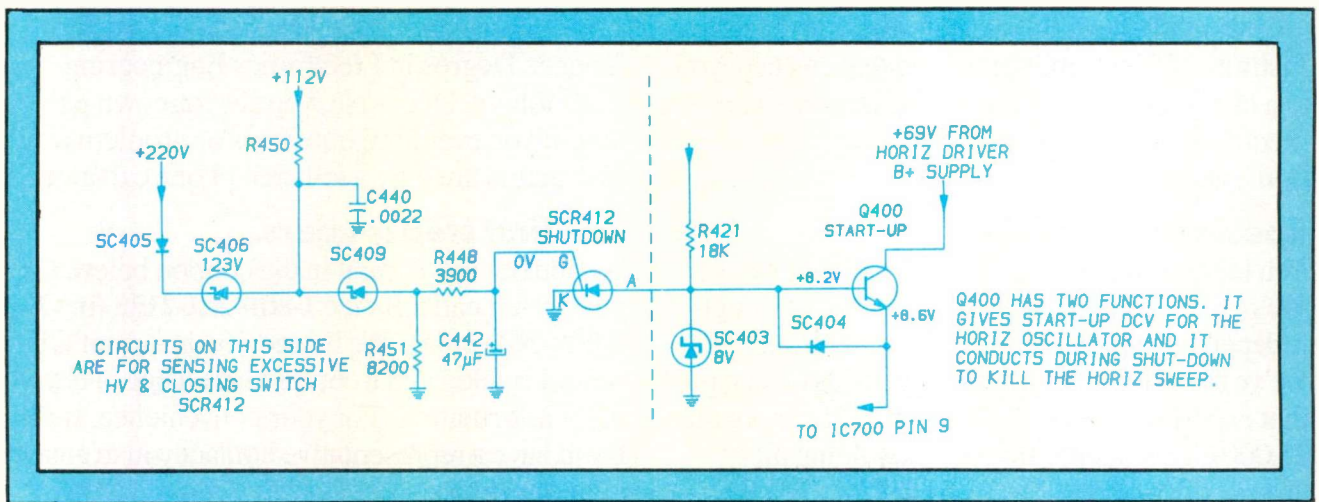
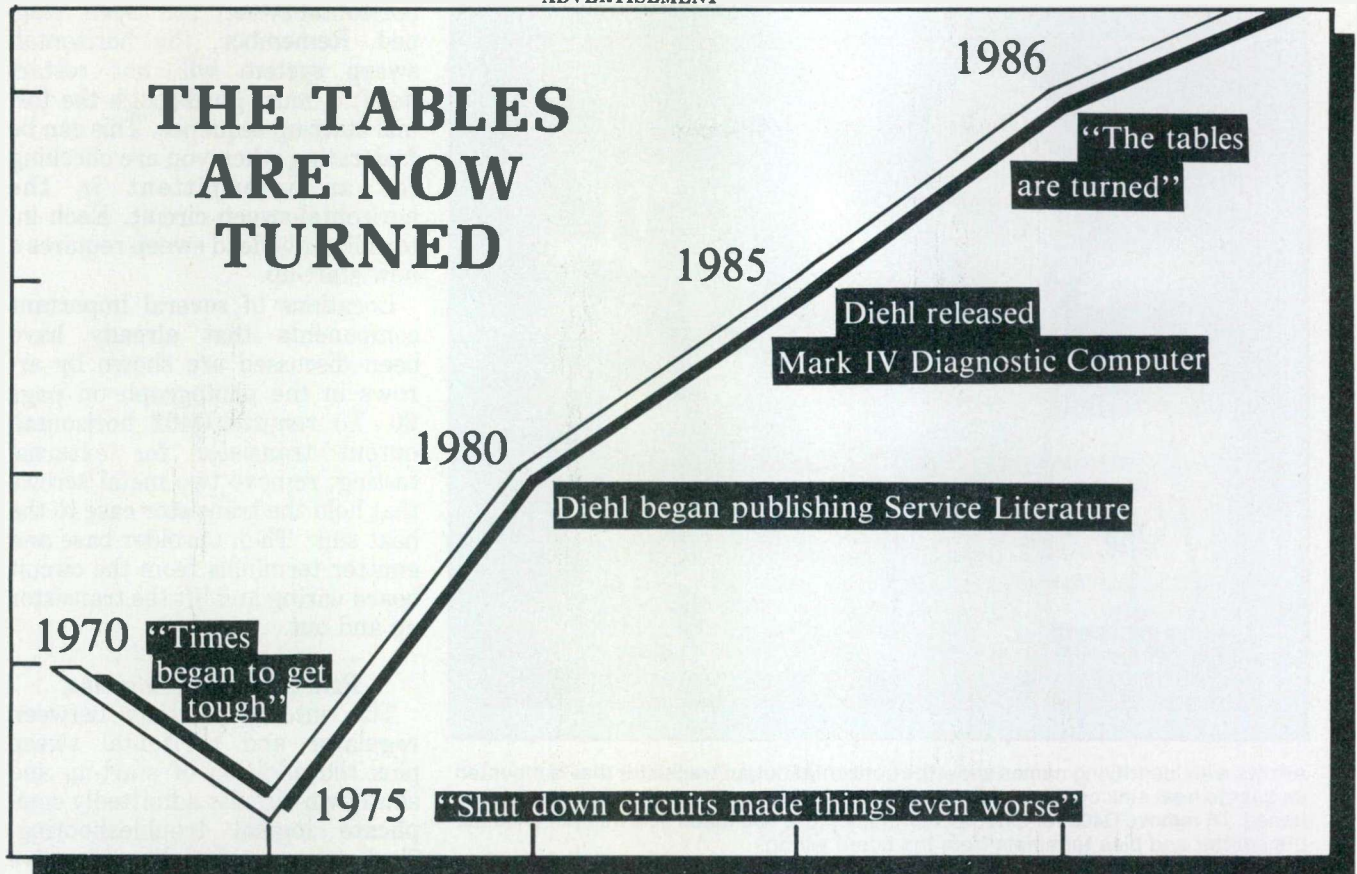

Figure 7. When the television is turned on, a start-up circuit in the regulator provides some B+ voltage to the +112V line. That voltage is received by R421, in this schematic, and is sent to the Q400 base. If the voltage is larger than +8V, the zener diode SC403 regulates the Q400 base voltage to about +8V (8.2V in the sample). The Q400 collector has voltage from the +112V line also, so Q400 acts as an emitter follower. Whatever voltage the base has is duplicated (minus 0.7V) by the emitter. If the base has +8.2V, then the emitter produces +7.5V which is sent to the IC700 pin 9. Although slightly less than the normal pin 9 voltage, it is sufficient to start the horizontal oscillator and its dividers. During this time, diode SC706 is reverse biased (there is no +25V supply) and disconnects the large +25V-supply load. The other two horizontal stages also have voltage from whatever start-up voltage is on the +112V line; therefore, the horizontal sweep begins to operate. The Q400 base is clamped to +8.2V by the zener, while the emitter is connected to IC700 pin 9 where the voltage is +8.6V. Q400 is reverse biased and inactive during this time of normal operation. SC706 becomes forward biased and operates pin 9 from the +25V supply through R726. Start-up is over. Voltage sensing of the +112V source is performed by 123V zener diode SC409. Voltage sensing of the +220V supply is accomplished by adding 123V zener diode SC406 to the previous SC409. If either supply exceeds the zener voltage rating, the zener will conduct voltage to R448 and R451. R451 is a low value to reduce the false alarms. R448 and C442 form a low-pass filter to integrate erratic voltages, while C442 is storage for the dc voltages. Because the SCR412 cathode is grounded, a positive voltage of around 1V will gate SCR412 into conduction. This conduction grounds any positive voltage that is at the anode. Notice that the anode is connected to the SC403 zener mentioned previously and to one end of R421 that brings in +112V to the zener. Also, the anode connects to Q400 base (which has no significance here) and the cathode of SC404 (which is important). Assume that an overvoltage at a sensor has gated-on SCR412, SC404's cathode is grounded through the SCR anode while SC404's anode is connected to IC700 pin 9. Therefore, the pin 9 power flows through SC404, through the SCR412 and to ground. Without B+, the oscillator and dividers stop working, and a split second later the horizontal sweep is totally dead. This is shutdown. Wait a minute or two for C518A and C442 to completely discharge, and start-up can be initiated again. If the cause of the shutdown has been repaired, the color received will operate normally.



1986

**PROMISES
TO BE
THE BEST
YEAR YET**

—FOR TECHNICIANS—

IN THE PAST:

We've all seen it happen. A piece of equipment comes in for repair (dead on arrival). In the process of trying to get it to power up, some half dozen or so components "self destruct", and the customer no longer wants it repaired. Furthermore, they don't even want it back: Nor do they want to pay for the time it took you to prepare the estimate.

A few days later, you see this same customer at the local discount chain store buying a replacement unit for less than your wholesale price.

Well, unless that chain store is

prepared to give everyone a 60% discount (off their advertised price), things are about to change - - -

Particularly, the labor costs of repairing electronic equipment that frequently develops low voltage power supply problems. Or problems in other circuits that ultimately show up as symptoms that would normally lead even a good technician to "suspect" low voltage power supply problems.

The main problem has been pure and simple. The bench time required to complete repairs on most electronic equipment has made today's service shops totally non-competitive with the replacement cost of the same piece of equipment at the local discount chain. And, non-competitive with the continually lower costs of purchasing a brand new unit.

The main culprit is, that it takes more and more time to isolate the stage or circuit that has failed, than it does to actually complete repairs once isolation has been achieved. In the meantime, today's technology offers more and more "opportunities" that cause additional components to self destruct while you are attempting to isolate the actual stage or circuit that has failed. If you're not really

careful, it's pretty easy to make a major service problem out of what started out as a very minor repair job, with regards to the number of new parts that will be required, and the amount of time that will be required to replace them.

INSTEAD OF THE ABOVE, IMAGINE THIS:

A home stereo amp or similar piece of equipment shows up at your bench for repair. Without even taking the back off, you plug it into a computer. The computer tells you (1) if any shorts exist in the unit; (2) if so, what type of a short exists. (i.e. is it a shorted LV rectifier, a shorted output transistor, a shorted driver transistor, a shorted pre-amp, etc., etc.). The computer has such an effective current limiting feature that it will virtually not permit a chain of components to self destruct. If on the other hand, the circuit under test is open, the computer lights an "open" light and tells you so. If the current consumption is normal, it also tells you that, with a "normal" light. If the current consumption is low, the bar graph on the computer lets you know.

This new concept of troubleshooting all but eliminates the possibility of spending tedious

Continued on Page 43

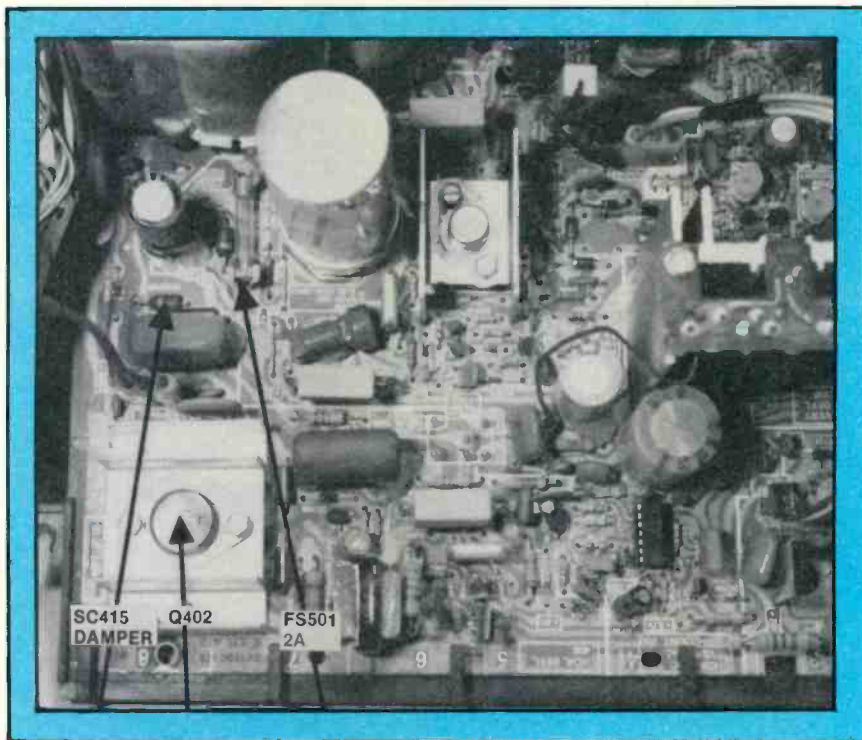

Arrows with identifying names show the horizontal-output transistor that is mounted on a large heat sink on the circuit board and other components that have been mentioned. To remove Q402 for external testing, remove two metal screws then unsolder the emitter and bias terminals from the board wiring.

headlines give, but the fine print takes away" in regard to contracts and policies. The Figure 7 explanation below the schematic has an error when it says Q400 conducts during shutdown to kill the horizontal sweep. Actually, the IC700 pin 9 B+ flows through diode SC404 and then through SCR412 to ground (when the SCR is gated-on) to accomplish shutdown. Follow the path on the schematic.

None of the safety circuits in various models actually check the dc high voltage directly. But this Wards receiver does the next best thing. The +220V supply is monitored by the shutdown circuit. And that is good because this +220V is rectified from positive-going horizontal pulses (the same waveform as the ac high-voltage before rectification). Therefore, the +220V supply should rise and fall in step with the high voltage. An excessive +112V regulated source can cause much component damage and generate dangerous X-rays if it rises too high; therefore, it also is monitored by the shutdown circuit. Excessive voltage of either or both supplies will gate-on the SCR and produce

shutdown as it eliminates all horizontal sweep and all dc power rectified from the sweep power. The symptoms are: no sound, no raster and usually no voltages except the +158V supply.

Most shutdown circuits have a latching effect to prevent the horizontal sweep from starting up again spontaneously after a few seconds. The Wards shutdown circuit (Figure 7) has two latches. One is SCR412. After any SCR is gated into anode conduction, the conduction will continue until the current drops below a certain small value before it becomes an open circuit again. After the SCR conduction has removed the B+ from pin 9 and stopped the horizontal oscillator (and with it the horizontal-sweep system), there might be some small voltage remaining in the +112V supply that through R421 continues to supply current to the SCR412 anode. Only when the current reaches the de-latching point can the circuit undergo start-up.

The other latch is that start-up cannot occur until filter capacitor C518A is discharged to almost 0V. Wait at least a minute or two before trying start-up after the

horizontal-sweep has been stopped. Remember, the horizontal-sweep system will not restart itself; it must go through the formal start-up sequence. This can be frustrating when you are checking for an intermittent in the horizontal-sweep circuit. Each intermittently dead sweep requires a new start-up.

Locations of several important components that already have been discussed are shown by arrows in the photograph on page 20. To remove Q402 horizontal-output transistor for external testing, remove two metal screws that hold the transistor case to the heat sink. Then unsolder base and emitter terminals from the circuit board wiring and lift the transistor up and out.

Practical servicing tips

The interconnections between regulator and horizontal sweep plus the addition of start-up and shutdown circuits admittedly complicate logical troubleshooting. Technicians who like to live dangerously merely can disconnect the shutdown circuit, and take a chance that nothing expensive will be damaged by the excessive high-voltage arc. Of course, the shutdown circuitry might have become defective. Perhaps we need a backup sensor for the shutdown circuit!

Disabling the shutdown circuit—

Connect the gate and cathode of SCR412 together with a firm connection (remember the gate is low impedance) and have a HV meter probe touching the picture-tube anode as the receiver power is switched on. If the sound comes on, the meter reads no higher than 29kV, and then the picture appears to be normal, the defect must be in the shutdown circuit. First measure the +220V source and the +112V regulated supply. If both supplies are correct, check for dc voltage between SC406 and SC409. There should be +112V. Then check at the output of 123V zener SC409 (at the junction of R448 and R451) for any dc voltage. There should be none. Measure the resistance of 8200Ω R451. If it is open, the circuit will be very sensitive to the slightest leakages in SC406 and SC409 and to any rapid changes in the two source

voltages. Make certain C442 is not open. Remove the gate-to-cathode short and measure the gate voltage. It should be zero. One or more of these tests should have uncovered something wrong or defective. And replacing the defective part or parts should stop the unwanted shutdown. Remove all temporary wires used during testing.

Finding excessive high voltage—

There are only a few defects that can increase the high voltage enough to be dangerous. Some technicians (without thinking very deeply) will say, "Shorted turns in the primary winding." Of course, fewer primary turns give the effect of more secondary turns. However, the shorted turns would reduce the primary inductance to virtually zero and place a huge overload on the horizontal-output transistor. The usual cause of excessive high voltage is an open retrace-tuning capacitor. There are two in the Wards chassis. The most important one is C457 (0.015 μ F as shown in Figure 6) and the other is 0.001 μ F C456. Both are connected between collector and emitter (grounded) of Q402. Smaller capacitance values narrow the HV pulses and increase the amplitude, while larger values broaden the pulses and decrease the amplitude. Replace only with factory-supplied capacitors or with replacements manufactured for use with pulse circuits. *Do not use "garden" varieties of cheap replacements.*

*Checking the horizontal output stage—*Our intent is to drive the output stage from test equipment, thus allowing the oscillator to be studied in detail. But first the output stage must be known to be in good condition. Check Q402 for shorts and leakages in-circuit. Is there a resistance reading from the Q402 case to both ends of the 2A FS501 fuse? If so the fuse and flyback winding are not open.

Inject a horizontal signal from an analyst to the base and emitter of Q402. Also, add a clip lead from ground to the Q401 driver base, just in case the oscillator comes to life. Check the +25V source to be certain the substituted drive waveform is working correctly.

If a raster or out-of-lock picture can be seen, begin testing the

horizontal oscillator circuit. Pin 9 should have about +8.6V, pin 4 should have the proper countdown oscillator waveform, and the horizontal drive waveform should be at pin 8. If any waveforms are incorrect, check the dc voltages. Remember the Q401 base is shorted for the analyst test. If any waveforms or dc voltages are very incorrect, replace IC700. Experience has shown that replacement of Q402 and IC700 solves most problems.

But what about another receiver with drive signal from the analyst that did not have high voltage? First, measure the dc voltage at 2A fuse FS501. If it is very low, the regulation is not operating without the horizontal pulses. Check the output transistor and flyback as best you can, but if the tests are not conclusive, it might be necessary to obtain voltage temporarily from the +158V supply. Power the ac through an isolation transformer and a variable-voltage transformer (these can be two items or one if it has the correct specifications). Before applying ac power, connect a test lead from the +158V supply to the input side of FS501 (near the flyback). Now apply 85Vac from the variable transformer to the television. This should supply approximately +112V to the 2A fuse and the output transistor.

Remember the Q402 base signal is supplied by an external analyst. After the power has been on for a minute or two, turn it off and feel the Q402 case. It should be cold to cool. If it is very warm, the suspect is the flyback. Check it for shorted turns or defective internal diodes (if you have the equipment). If the Q402 output is not too warm, prepare a HV meter and try the operation without the yoke, or better yet, with the red yoke wire disconnected. If the HV is increased, the yoke probably has shorted turns. Defective flybacks often will make popping or frying sounds, and with the power off, a bad one will feel very warm.

After the output alone has been made to operate smoothly with the temporary power supply, then the analyst should be removed, all temporary jumpers and test leads should be removed and the performance should be checked at 120Vac.



Power to the Product!

Low cost B&K-PRECISION DC power supplies with high cost features

NEW



Model 1630 (3 amp) \$225
Model 1610 (1 amp) \$150

Now you can have the power you need, wherever you need it, at a surprisingly low cost.

These new B&K-PRECISION power sources each give you control up to 30 volts DC with fully adjustable current limiting. Other features include:

- Excellent regulation and low-ripple characteristics
- Dual meters monitor voltage and current simultaneously
- Two current ranges
- Fine and coarse voltage controls
- Isolated output
- Protected against reverse polarity external voltages
- Two identical supplies can be connected in series or parallel
- Can be used as a constant voltage or constant current source

Compare prices, features and performance, and you'll agree that the 1610 and 1630 power supplies are revolutionary.

Available for immediate delivery at your local B&K-PRECISION distributor. For additional information or the name of your local distributor contact B&K-PRECISION.

BK PRECISION
DYNASCAN CORPORATION

6460 West Cortland Street
Chicago, Illinois 60635 • 312/889-9087
International Sales, 6460 W. Cortland St., Chicago, IL 60635
Canadian Sales: Atlas Electronics, Ontario
South and Central American Sales,
Empire Exporters, Plainville, NY 11803

Circle (19) on Reply Card

Solder:

The *tin* tie that binds

By Conrad Persson

Much has been written about the tremendous advances in electronics: transistors, ICs, printed circuit boards, microcomputers, LEDs, LCDs. It almost leaves you breathless. One thing hasn't changed: When components are physically and electrically connected into the circuit, it's usually done with a soft, low-melting metal alloy called solder.

Although solder and its use in electronics haven't changed materially over the years, the size of the components and wiring that solder connects together, in general, has been reduced dramatically. The susceptibility of these devices to damage from excessive heat, electrostatic discharge and physical stress has increased inversely. Therefore, soldering/desoldering techniques have changed.

Back in those earlier days when a component needed to be desoldered, you yanked out the 100W soldering gun and poured the heat to the joint while you pulled and poked at the wire with one of a variety of desoldering aids. If you removed the suspect component from the circuit and it proved not to be the culprit, you could solder it back in and continue by trial and error.

The rules have changed a great deal. In today's world of crowded boards and delicate components and traces, you don't remove a component unless you're dead sure it has failed. When you do remove

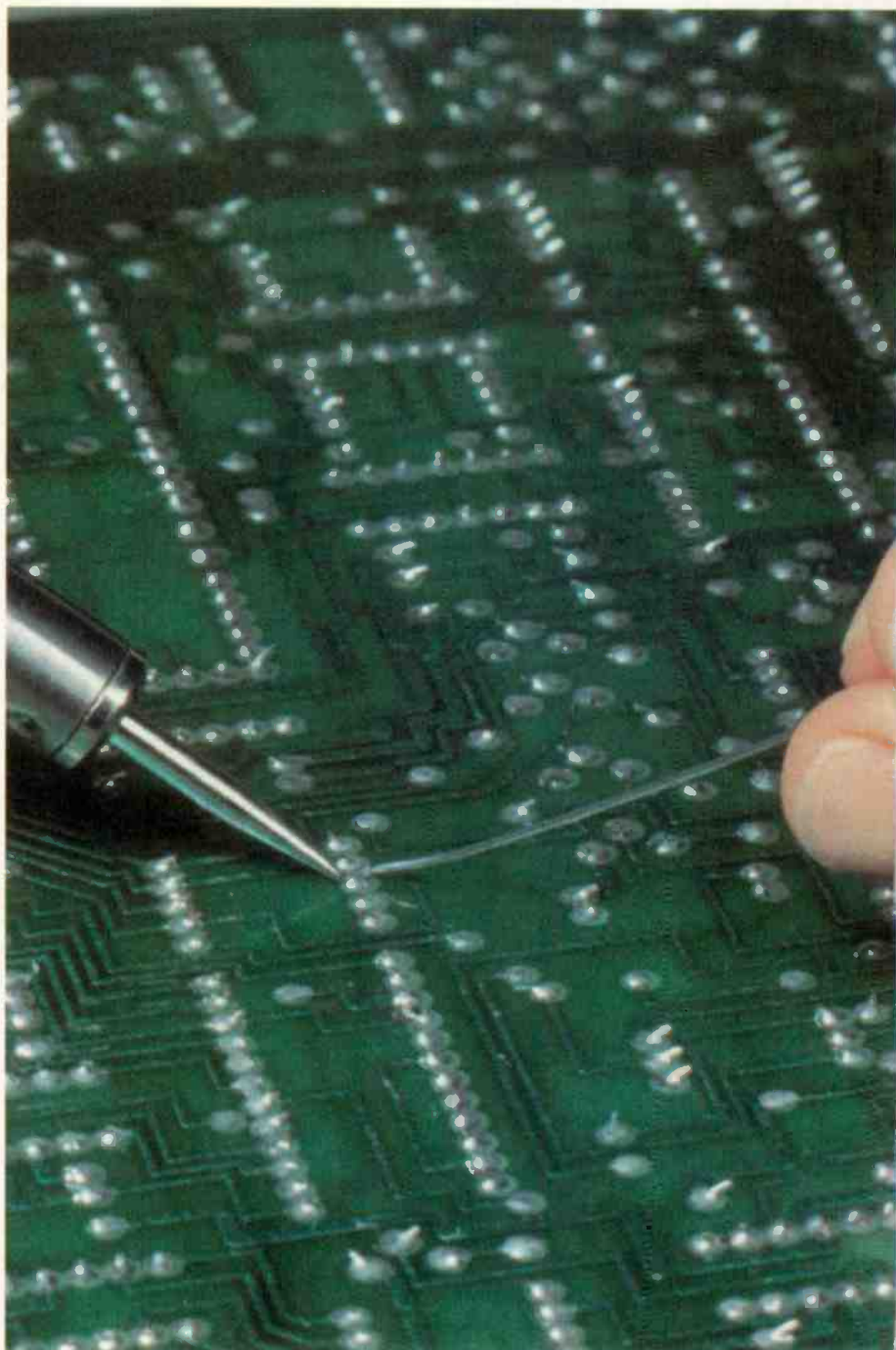

We wish to thank the Electronic Industries Association, Consumer Electronics Group and Sony Corporation of America. The information for this article was adapted largely from the instructional videotapes "High Tech Soldering" produced by EIA/CEG and "Chip Component Replacement" produced by Sony.



a component, you use a small-tip soldering iron, preferably temperature controlled, and apply only as much heat as is necessary to melt the solder enough to release the component.

The right soldering supplies

When you sit down at the service bench, open up a modern consumer electronic product and determine that one of the circuit components is at fault and will have to be desoldered from the circuit and replaced, you should have certain materials available.

Solder

Solder should be 0.015" (15 thousandths) wire solder with a rosin core. It should be made of virgin tin and desilvered lead, and be free from impurities such as zinc, aluminum, iron, copper, and cadmium. The lowest melting solder, and the one that yields the strongest bond, is made with a ratio of 63% tin and 37% lead, but 60 tin/40 lead is nearly as good and is far less expensive. Most electronic work is done with the moderately priced 60/40 solder.

Some manufacturers recommend silver solder for some work. Silver solder contains about 3% silver along with the lead and tin. Silver solder is recommended when soldering such components as ceramic capacitors that have silver-palladium fired-on conductive surfaces. If straight tin/lead solder were used to solder these components, the solder might absorb some of the silver from the component, causing a weak joint and poor adhesion. The small amount of silver in the solder reduces the migration of the silver.



There's Always One Catalog You Can Count On- **MCM** **ELECTRONICS!**

You want a company you can depend on for quality.

You want a company that's famous for fast service.

And you want a company that's known for great, low prices.

What you want is **MCM Electronics**.

Because if you want to get the best out of your business, it only makes sense to order from the best.

Nobody will serve you better.

CATALOG #11 NOW AVAILABLE

CALL TOLL FREE
1-800-543-4330

(IN OHIO, 1-800-762-4315)
(IN ALASKA AND HAWAII, 1-800-858-1849)



MCM ELECTRONICS
A DIVISION OF PREMIER INDUSTRIAL
858 E. Congress Park
Centerville, OH 45459

SOURCE NO. ES&T-8

Circle (8) on Reply Card



A repair and rework center, such as this one offered by A.P.E. provides facilities to completely repair all printed circuit board types: conventional, S-M, hybrid.

Silver solder is used in the same manner as ordinary solder and performs essentially the same except for a slightly higher melting point.

This brings up an important point: You should always have the manufacturer's literature on hand when you're servicing a piece of equipment. In the case of soldering components, if the literature calls for silver solder, use it. Otherwise 60/40 should be fine.

Flux

Ordinarily the rosin core of the solder you'll be using will be adequate to clean oxide from the joint as you solder. In some cases, you may need additional flux. It's not a bad idea to have some high-quality liquid rosin flux on hand. Rosin is a non-conductive, non-corrosive flux and so is recommended for electronic work.

Cleaners

Rosin flux is sticky and will collect dust, which will, in time, build up and cause leakage. Cleaning off any excess flux will remove a potential cause of the units failing later. Besides, a repaired board is much easier to inspect if it's been cleaned. You should have a cleaner of a type recommended by electronics manufacturers that can clean rosin, oils and general dirt.

The soldering iron

Obviously, the most important tool for soldering and desoldering is the soldering iron. If the volume of soldering you do is small, you might want to use a simple iron

along with various aids and materials. Or, if you will be doing a lot of soldering and desoldering, you might want to consider a complete PC board rework station consisting of a soldering tool, a desoldering tool, vacuum removal of solder and more. Whatever type of tool you select, it should be pencil-size unit between 10W and 50W, and should be temperature controlled in order to avoid damage to components and circuit traces. An added feature you might want to have is a reduced-current mode iron: That's one which uses a lowered current when it's idle, thereby reducing energy usage and prolonging the life of the element.

In these days of integrated circuits with the attendant danger of zapping a MOS device with static electric discharge, it's recommend-

ed that your soldering tools be grounded in order to drain off any charge as it accumulates. Soldering tools that are grounded are grounded through a resistance of 250,000Ω to 1MΩ to drain away the static charge without posing a shock hazard to the user.

Other tools

The need for some of the tools to aid soldering and desoldering is obvious. For example, you'll want to have some long-nose pliers, some cutters and maybe an array of picks and other desoldering aids. With components rapidly shrinking in size, you'll find that tweezers in a variety of sizes will be very helpful.

It also is handy to have a third hand available when you're working on PC boards. Some kind of fixture to hold the board will be a great help while you hold the soldering iron in one hand and a pair of tweezers or a coil of solder in the other.

The most important tool of all, might just be a good magnifying lamp. After all, we're dealing with ICs so small that a good sneeze will send them flying into oblivion and circuit traces so fine they're almost invisible. When you've finished your repair on a defective board, and you need to look closely to be sure you don't have any solder bridges or other technician-induced problems, you're going to



For PC board soldering and desoldering, you'll probably want to use at least a temperature-controlled soldering station, such as the EC3000 shown here, by Weller.

want plenty of light, and some magnification.

Desoldering tools and supplies

The whole idea of desoldering is to remove the component with the least possible application of heat, the least possible damage to the PC board, and the least cost. Again, the issue of cost will be determined by the volume of soldering and desoldering you do. If you never will do a very high volume of this type of work, then the lowest possible investment in capital equipment is probably the best approach. On the other hand, if you're going to be doing board after board, then the most economical method probably will be the one that lets you work the fastest regardless of the cost of the equipment.

Desoldering braid

For low volume soldering applications, desoldering braid is probably one of the few things other than a good soldering iron that you'll need. This material is nothing more than fine copper wire formed into a braided wire, impregnated with rosin flux and rolled up into a coil for easy handling. You simply place the braid or wick against the joint to be desoldered, and apply the soldering iron. The heat from the soldering iron melts the solder, and capillary action wicks the melted solder into the braid. Besides the advantage of low investment, the capillary action acts at relatively low temperature, and the presence of the braid between the iron and the PC boards helps to keep the delicate circuit traces from being damaged.

Desoldering braid is available in a variety of widths, and the size of braid used for a particular job should be selected to be just wide enough to cover the joint, or land, being worked on. And you may get braid either plated or unplated. The unplated absorbs more solder per area of wick, but the plated has a longer shelf life because the plating material doesn't oxidize as readily as copper.



A repair and rework system can provide you with just about any combination of PC board repair capabilities you can imagine, as shown here.

Suction devices

Another approach to eliminating solder from a joint is to melt the solder, and while it's still molten, suck it out. There are basically two simple, inexpensive ways to do this. The cheapest is to use a suction bulb device that has a Teflon or other heat resistant nozzle attached: Melt the solder, squeeze the bulb, apply the nozzle tip to the melted solder and release the bulb quickly. With any luck, the melted solder will be sucked through the nozzle and wind up as a tiny ball of solidified solder in the bulb.

Another manual solder-sucking device is the spring-loaded plunger. With this device, you press the plunger against the force of a spring within a cylinder. You apply the nozzle of this tool against the molten solder of the joint being worked on and press the trigger. This releases the spring, the plunger slides up into the cylinder, creating a vacuum at the nozzle tip and again, with a little luck, the

solder ends up in the cylinder.

These two devices have the advantage of being low cost. Also you can do quite a number of solder joints with them before they need to be cleaned out.

The solder/desolder station

If you're going to be doing a large volume of PC board soldering and desoldering day after day, you'll be more concerned with production than with economy of equipment. If you are in this category, you might consider a complete solder/desolder station. These can cost from a few hundred to a few thousand dollars, so they're obviously not for everyone. But one of these units, depending on your selection, can do everything from soldering and desoldering conventional components to soldering and desoldering surface-mount components, to repairing the printed circuit board.

Some of the options on one of these stations include having two,

Art courtesy of Pace, Inc.

or even more, heat producing units on the same unit so you can vacuum-desolder with one unit and solder with the other without having to change tips. You can get one with a self-contained air pump to give you both vacuum and air under pressure, or if you already have compressed air available, you can buy a unit that's designed to interface with your existing air system. You can opt for attachments that will let you strip wires thermally. You can have just about anything you could possibly need to rework a PC board in one of these units: Just bring money.

Skill: The most important tool

The EIA, in their high-tech soldering/desoldering videotape, emphasize one thing above all, and it sure makes sense: *The most important tool of all is diagnostic skill. It may seem to have nothing to do with soldering, but lack of diagnostic skills may be the greatest cause of component and board damage resulting from attempted repair.*

In the past, one of the most common test methods was to replace a suspect part, then test the unit. In times past, the approach made sense. Today, however, most consumer electronic products consist of delicate components crowded onto printed circuit boards with equally delicate circuit traces. If you attempt to remove one of these components and it turns out that there was no problem to start with, there probably will be a problem when you're finished. Under the best of conditions, a trained technician with the proper tools causes stress to both the component and the board. If you try replacing components one at a time in an attempt to find the cause of the problem, you might end up with a board that's beyond repair.

In short: *If you don't know what the problem is, don't shotgun it.*

Turning on the heat

Once you're sure you've isolated the problem to a component and you're ready to replace it, then it's time to use whatever method that your particular circumstances

have led you to choose. By now, almost everyone who handles a soldering iron has gained familiarity with replacing standard DIP ICs, so this article won't address that. The challenge these days is handling some of the newer, extremely small devices, those with leads close together such as surface-mount devices.

In researching for this article, I reviewed several videotapes, read a great deal of manufacturer's literature and found there are a number of ways to go about soldering and desoldering some of the new components. Depending upon your particular situation and skills, one or another of the methods might work best for you. Several alternatives will be presented here. You might want to experiment to determine which method you like.

Chip components

Chip components are tiny, and they're soldered on the same side of the PC board they're mounted on, but they're really not hard to handle. Starting with 2-terminal devices, resistors and capacitors, a method for removing chip components recommended by the EIA is to grasp the failed component with pliers or tweezers, melt the solder at one end of the device then quickly apply the soldering iron to the other end of the component while applying a very gentle, twisting motion. Move the soldering iron back and forth between the ends as necessary to reach a point where both ends are molten enough to lift the unit away.

This brings up a very important consideration for soldering and desoldering of surface-mount devices. In many cases, a drop of adhesive was applied between the component and the board during the manufacturing process to hold it in place while the board is mass soldered. This glue is specially formulated so that once it has cured, *if a twisting force is applied*, it will shatter and the devices can be separated easily. Usually the adhesive is heat sensitive as well, and application of heat will soften it enough to remove a component.

Not all components on a board

will be glued down. In many cases, certain ICs or other components will be soldered manually after the mass soldering of all of the other components is complete. Because these devices do not have to be held in place for a mass production operation, they do not need to be glued down.

Another approach to chip component removal was shown in a soldering/desoldering instructional tape available from Sony. Using two soldering irons, you can place one at each of the two joints, heat both simultaneously, and lift the removed component away between the irons.

Using either of these methods, you'll probably be left with some excess solder on the lands. Application of a clean soldering iron might be enough to remove all the excess. If not, use solder wick or a vacuum device along with heat from the iron to get rid of it.

Because resistors and capacitors are relatively insensitive to heat, when you're readying the replacement device, you can make the job easier by preheating it to about 150°F (you can do this by applying heat from a hair dryer for about two minutes) then loading one land with solder. Place the prewarmed chip in position and apply the soldering iron. When the first end has solidified, apply heat and solder to the other end to complete the repair.

If you find that you have removed a chip component from the board that wasn't the problem (and this really shouldn't be allowed to happen), don't solder it back onto the board. *NEVER reuse a chip component that has been removed from a PC board.* If it wasn't completely destroyed, its life probably has been significantly shortened; it likely will be a cause of failure in the future.

Chip transistors

You can handle removal of chip transistors much the same way as you would 2-terminal devices. Start with the side where there's only one terminal and melt the solder connecting it to the circuit. When the solder is melted, carefully raise the terminal away from

the board. Then, applying heat to both of the other terminals alternately, get both warm enough to melt the solder and lift the device from the board. Replacement of a chip transistor may be performed in much the same manner as replacement of a passive device, except do not preheat a semiconductor device.

Flat packs (chip ICs)

Never remove one of these unless you're dead SURE it's defective. With a flat pack, as with other components, there are several methods to remove the device. One shown by the EIA on its training tape is to use solder braid to remove as much solder as possible from each terminal, then, taking one terminal at a time, heat the terminal, and with a pick, gently lift it from the land it's soldered to. When all terminals have been lifted, remove the IC. If the device

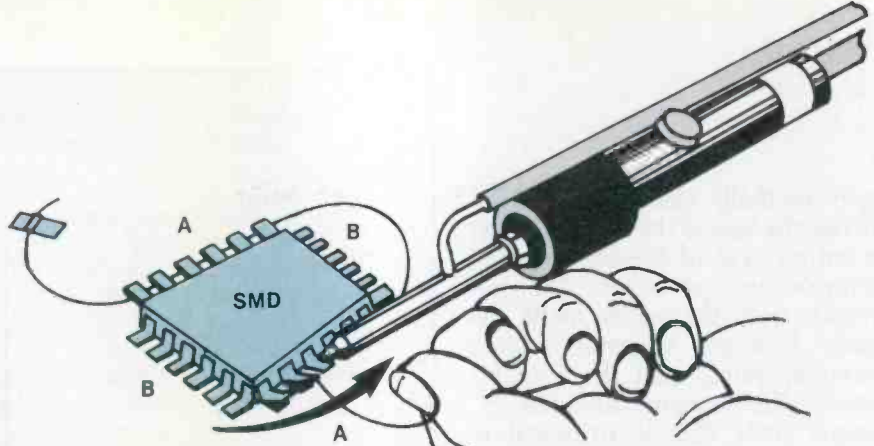

One nonconventional method of removing surface-mount devices from a PC board is to run a length of non-kinking wire between the body and the leads of the component, add heat from a hot-air station and pull the wire between leads and lands when the solder is molten. (This method and the drawing were provided by Edsyn)

was glued down, it may be necessary to twist it to break the adhesive.

Another method of removing one of these multiterminal devices is to use a special desoldering head for your iron that will heat all the terminals at the same time. Of course, you have to be careful to choose one of the correct size for

the IC you'll be removing. There are special wire forms that you place under the leads of the IC.

When you have heated all the leads, simply lift up on both the soldering iron and the wire form at the same time.

Still another method recommended by Edsyn, Inc. is to insert a length of 0.010" diameter pull

PICK YOUR WICK

Chemtronics manufactures desoldering wicks in two wire constructions: Chem-Wik for general purpose desoldering with maximum solder holding capacity and Chem-Wik Lite, faster acting for critical heat sensitive components. As electronic equipment becomes smaller, more complex, more demanding, Chemtronics family of pure copper desoldering wicks will meet your needs with a choice of performance characteristics for virtually every desoldering application.

Send for free literature today.



Chemtronics
681 Old Willets Path
Hauppauge, NY 11788
800-645-5244
In NY 516-582-3322
Telex 968567

OPTIMA ELECTRONICS

TO ORDER CALL TOLL FREE 1-800-327-0224

POPULAR CAPACITOR ASSORTMENT BAGS (PC Mount)

- mfd (1)(2,2),(3,3),(4,7),(10),(22),(33),(47), (100),(220),(330),(470) -12 pcs. @ 50V \$3.25
- mfd (.47),(1),(2,2),(3,3),(4,7),(10),(22),(33),(47) -9 pcs. @ 160V \$3.30
- mfd (1),(2,2),(3,3),(4,7),(10),(22),(33),(47) -8 pcs. @ 250V \$3.95
- mfd (1),(2,2),(3,3),(4,7),(10),(22),(33) -7 pcs. @ 350V \$3.75
- mfd (1),(2,2),(3,3),(4,7),(10) -5 pcs. @ 450V \$2.95

Call and ask for our current flyer.

HORIZONTAL OUTPUT TRANSISTORS

- \$2.50 ea. Min. 10, 1 yr. Warranty
- 1308K Sanyo
- 2SD1341P Sanyo
- AN238
- 2SD1555
- 2SD1398 Sanyo
- 2SC1172B Toshiba

MONTHLY SPECIALS

- \$ 8.95
- \$ 3.50 ea.
- 10 for \$22.50
- 100 for \$169

TRANSISTORS & I.C.'s...MIN. 10, CAN MIX

- STR380 ... \$6.40
- STR383 ... \$6.40
- STR384A ... \$6.80
- STR3125 ... \$6.40
- 2SD871 ... \$3.95
- HA13001 ... \$3.000
- MN8303 ... \$3.95
- MB3712 ... \$1.35
- MB3713 ... \$1.35
- TDA2005 ... \$3.95
- 221-103 ... \$4.95
- 221-132 ... \$2.95
- 221-140 ... \$7.95
- 221-158-01 ... \$3.95
- 221-175 ... \$7.95
- 221-178 ... \$4.95
- 221-179-01 ... \$7.95
- 221-190 ... \$7.95
- 221-193 ... \$5.95
- 185-9-01 (triac) ... \$1.50
- 85 ... 10 for \$2.00
- 89 ... 5 for \$15.00
- 123AP ... 10 for \$2.00
- 152 ... 10 for \$5.95
- 153 ... 10 for \$5.95
- 159 ... 10 for \$5.95
- 196 ... 10 for \$8.95
- 291 ... 10 for \$9.95
- 292 ... 10 for \$10.95
- 375 ... 10 for \$14.95
- STK563F ... \$6.40

GENERAL

- Mono/Stereo Head Phones Packaged With/Adaptor, Min. Six ... \$7.95 ea.
- Professional Wired/Wireless Mic ... \$26.95 ea.
- UHF/VHS 2 Way Splitters20 for \$12.00
- Matching Transformer ... 100 for \$22.95
- FO192A Color Flyback ... \$18.28 ea.
- F1123 Color Flyback ... \$15.54 ea.
- PN2222A (123AP) Min. 50005c ea.
- 2N3055 (130) Min. 2049c ea.

Quantity Prices Available

Letters of credit and all checks placed on deposit with Bank of Barnett, FL. VISA & Master Charge accepted. Min. order \$75. FOB Dania, FL. Catalog \$3, refundable upon order.

SEND CHECK OR MONEY ORDER TO:

OPTIMA ELECTRONICS

2022 Tigertail Blvd., Dania, FL 33004

Phone (305) 920-3550 TOLL FREE: 1-800-327-0224

Circle (9) on Reply Card

Circle (10) on Reply Card

wire (actually this is piano wire) under the legs of the IC, and, using a hot air type of desoldering unit, blow warm air across the terminals until the solder melts. As each terminal becomes molten enough, gently pull the wire between the terminal and the PC board land. This is sufficient to break the solder bond and make it possible to remove the device.

The company also recommends this method in cases where you're almost certain that a particular device is faulty, but the only way to be sure is to disconnect one of its terminals from the circuit. With this method, or using a pick, you can lift one or two pins to isolate those IC functions from the rest of the circuit for testing, without having to remove the IC from the board.

Connecting the replacement IC

Here's where you get to use that bottle of liquid flux we recommended that you keep on hand. After you've removed the failed device and cleaned up any excess solder, brush the lands with liquid flux. This does two things for you. First, because very little solder is needed for each connection, the flux core might not be enough to properly clean the joint. Second, the flux is sticky, and this will help hold the IC in place while you solder it.

Once you have the IC in place, and after making sure it's properly aligned with the PC board lands, solder down a couple of leads, then solder the rest.

There appear to be at least two schools of thought on soldering the leads of a flat pack. The EIA videotape showed the technician carefully applying the soldering tip to each lead and touching the solder wire to it, trying to avoid causing any solder bridges. On the other hand, the Sony tape advises you to tack down the IC, then put some solder on the tip of the soldering iron and draw it slowly across the leads.

In both cases, an important step is to inspect the final product carefully to ensure that no solder bridges have occurred. In the event that there are solder

bridges, it's no problem to get rid of them. Again, there are at least two methods. The simplest is to make sure that the soldering tip is well tinned but free of excess solder and draw it along the length of the gap between the leads from the body of the device outwards. The tip should pick up the excess solder forming the bridge. Another method is to apply solder wick and the heat of the iron at the solder bridge and absorb the excess solder with the wick. This should leave enough solder between the leads and the lands to assure a good connection.

After experience with these two methods, you already may have selected the method that is both comfortable to use, and that you are confident will ensure a good, reliable solder joint every time.

For further study

Soldering skill always has been a determining factor in successful building or repairing electronic circuits. Poor soldering technique may lead to cold solder joints or voids that in time may lead to failure. Sloppy soldering may result in short circuits that result in the production of smoke where there should be none—at great expense.

Today, soldering skill is of paramount importance to technicians. We hope that this article has given you some guidelines for proper

soldering. If you will be doing much soldering of PC boards from high-tech consumer electronic products, you would be well advised to take advantage of instructional videotapes, courses and other assistance offered by consumer electronic product manufacturers, soldering equipment manufacturers, or organizations such as the EIA.

After having seen videotaped instructions offered by EIA and Sony, I can say that if I had to go out and repair a crowded, printed circuit board, I would be a lot more comfortable with the information the tapes gave me. If I were to rate the two tapes for usefulness, I'd have to give the EIA tape a slight edge, but the Sony minicourse comes with a small PC board and some surface-mount components to practice with. And practice-soldering on a board using components that are expendable is probably a good idea before taking a chance with a \$1,000-plus VCR or video camera.

You might wish to contact the manufacturers and organizations listed above in this article and ask them what kind of information and course material they have available. Other consumer electronics manufacturers also may have soldering/desoldering information for free. Check with your favorite manufacturer to find out.

Here is a list of the manufacturers and organizations that provided information on which this article is based:

Automated Production
Equipment Corp.
142 Peconic Ave.
Medford, NY 11763

Chemtronics, Inc.
681 Old Willets Path
Hauppauge, NY 11788

Contact East
7 Cypress Drive
Burlington, MA 01803

The Cooper Group
P.O. Box 30100
Raleigh, NC 27622

Edsyn Tools
15958 Arminta St.
Van Nuys, CA 91406

GC Electronics
400 S. Wyman St.
Rockford, IL 61101

Pace, Inc.
9893 Brewers Court
Laurel, MD 20707

Wahl Clipper
Sterling, IL 61081

Sony Corporation of America
Sony Drive
Park Ridge, NJ 07656

Electronic Industries of America,
Consumer Electronics Group
2001 Eye Street, N.W.
Washington, D C 20006

Use of substitute replacement parts that do not have the same safety characteristics as recommended in factory service information may create shock, fire, excessive x-radiation or other hazards. The other portions of this schematic may be found on other Promax pages.

Product safety should be considered when component replacement is made in any area of a receiver. The shaded areas of the schematic diagram designate the components in which safety is of special significance. It is recommended that only exact cataloged parts be used for replacement of these components.

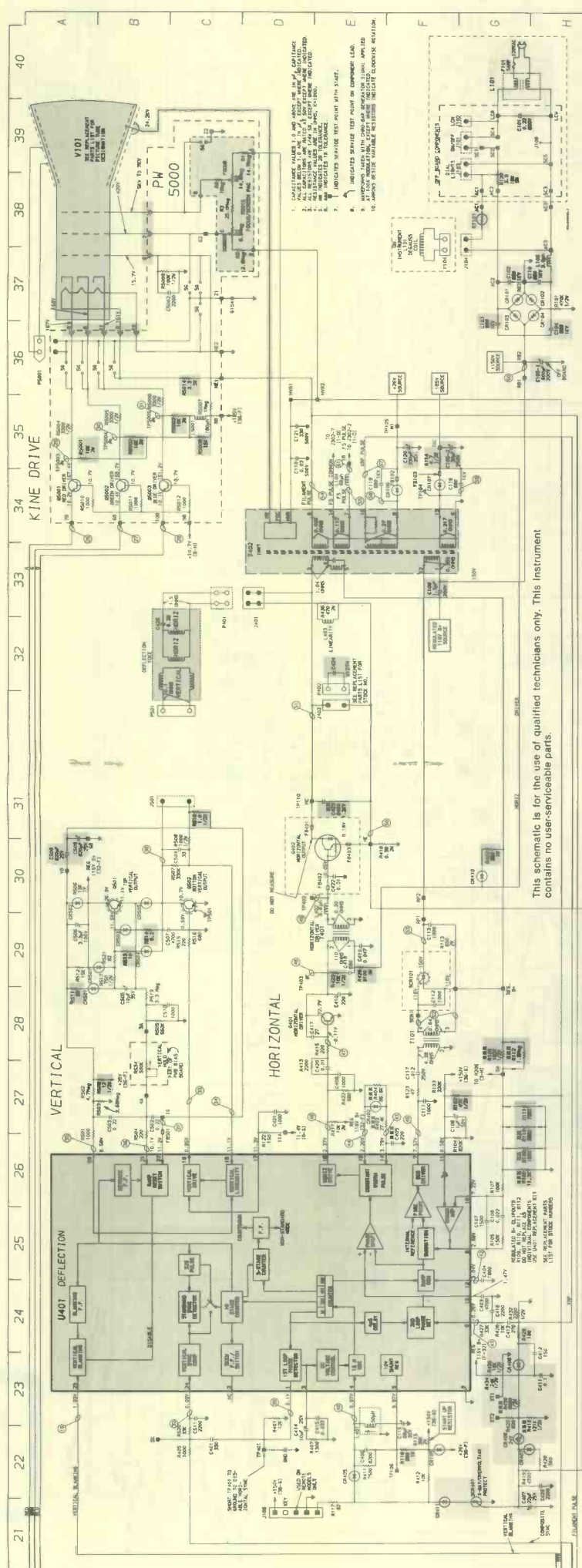

HORIZONTAL

VERTICAL

This schematic is for the use of qualified technicians only. This instrument contains no user-serviceable parts.

1. CAPACITANCE VALUES 1.0 AND ABOVE ARE IN μ F UNLESS OTHERWISE SPECIFIED.
2. ALL CAPACITORS ARE POLARIZED UNLESS OTHERWISE INDICATED.
3. RESISTANCE VALUES ARE IN OHMS UNLESS OTHERWISE INDICATED.
4. RESISTORS ARE 1/4 WATT UNLESS OTHERWISE INDICATED.
5. INDICATES TAP TERMINALS.
6. INDICATES SERVICE TEST POINT OR COMPASS LEAD.
7. INDICATES SERVICE TEST POINT WITH START.
8. INDICATES SERVICE TEST POINT ON COMPASS LEAD.
9. ALL TAP MARKINGS MUST BE COMPARED WITH ORIGINAL DRAWING.
10. SHOWN ACTIVE TERMINALS INDICATE GROUND TERMINAL.

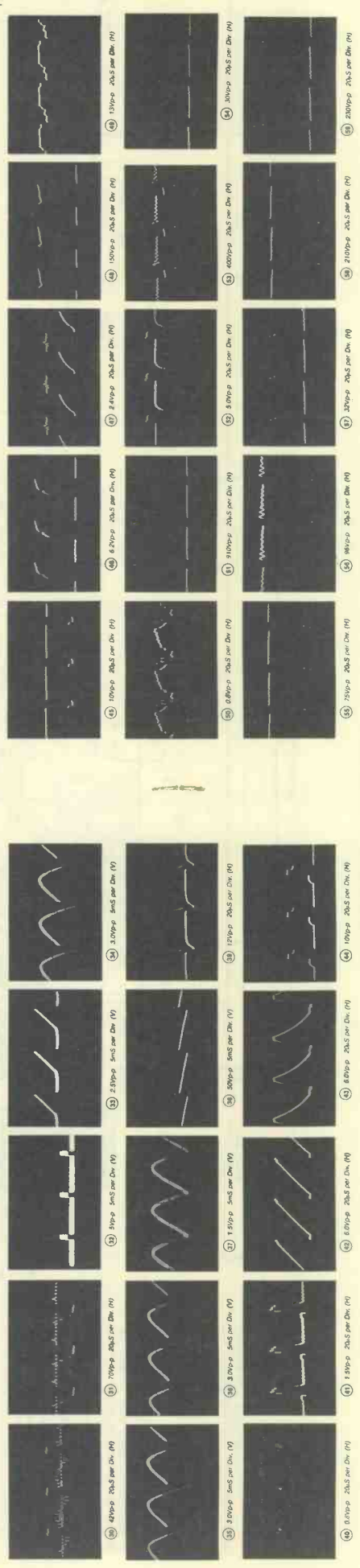

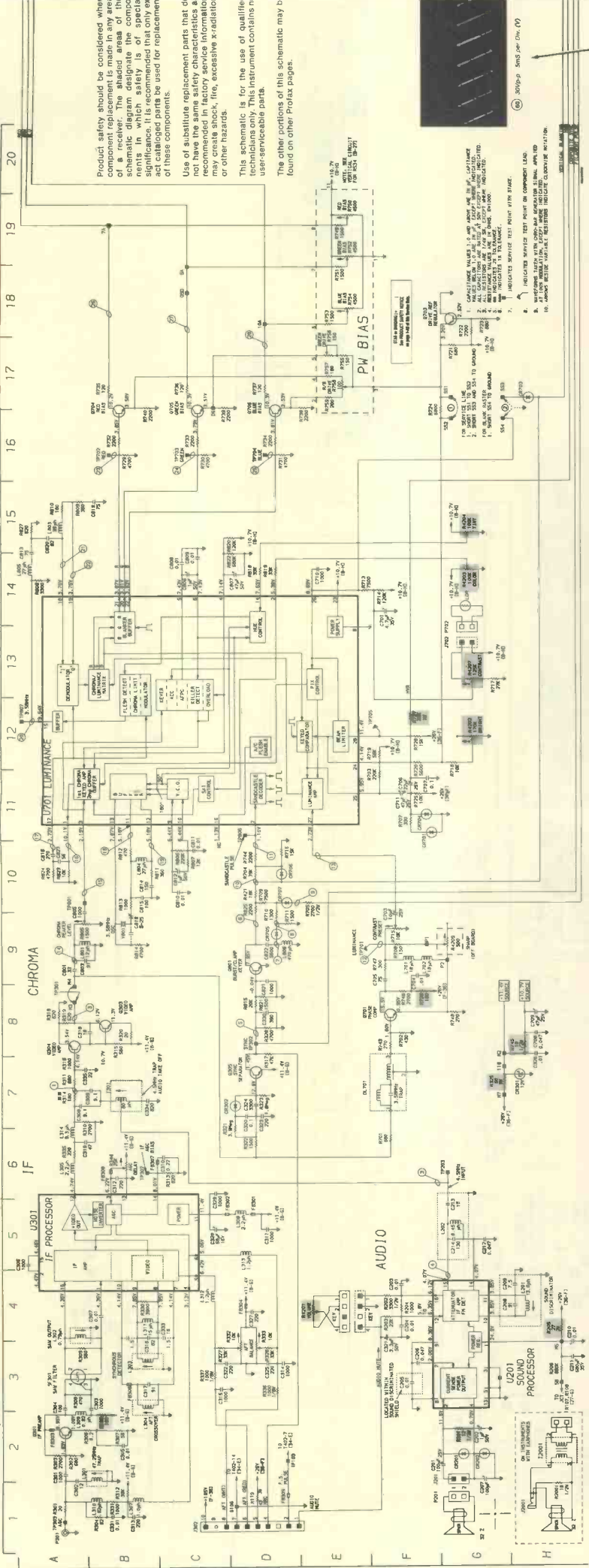

Product safety should be considered when component replacement is made in any area of a receiver. The shaded area of the schematic diagram designate the component significance. It is recommended that only original catalogued parts be used for replacement of these components.

Use of substitute replacement parts that do not have the same safety characteristics as recommended in factory service information may create shock, fire, excessive x-radiation or other hazards.

This schematic is for the use of qualified technicians only. This instrument contains no user-serviceable parts.

The other portions of this schematic may be found on other Profax pages.



1. Adjust to service test point on component lead.
 2. At low resistance, correct value is indicated.
 3. Check actual resistance indicated against the value.

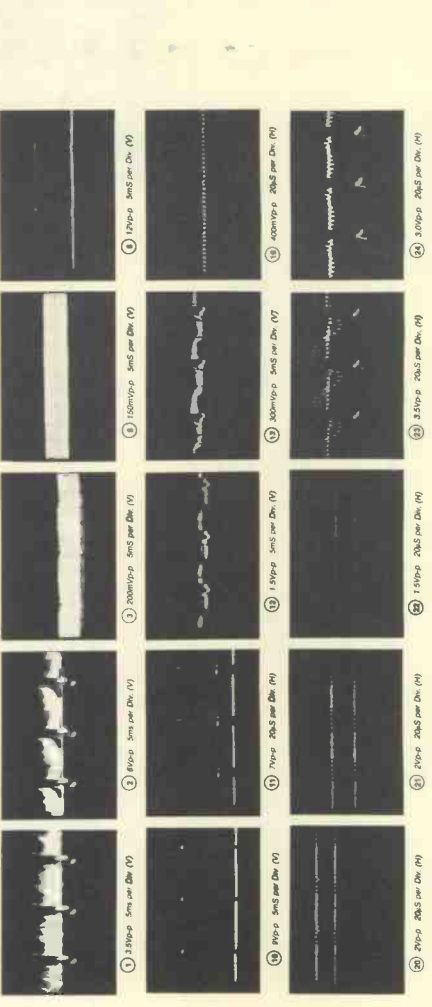
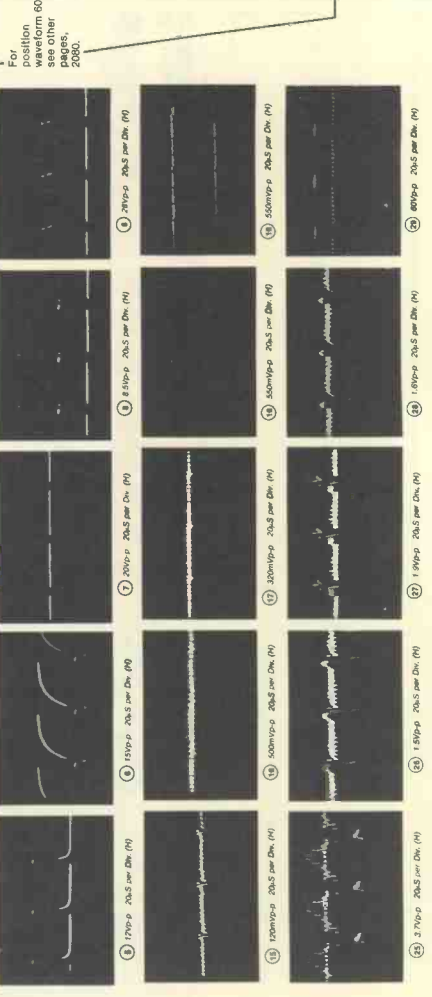

For position waveform 60, refer to other pages, 2080.

CAUTION
 This Receiver Uses a Line Operated Bridge Rectifier. A Hazardous Out Voltage Exists Between the Chassis and Earth Ground Regardless of the Plug Polarization. An Isolation Transformer Should Always Be Used To Service This Receiver.

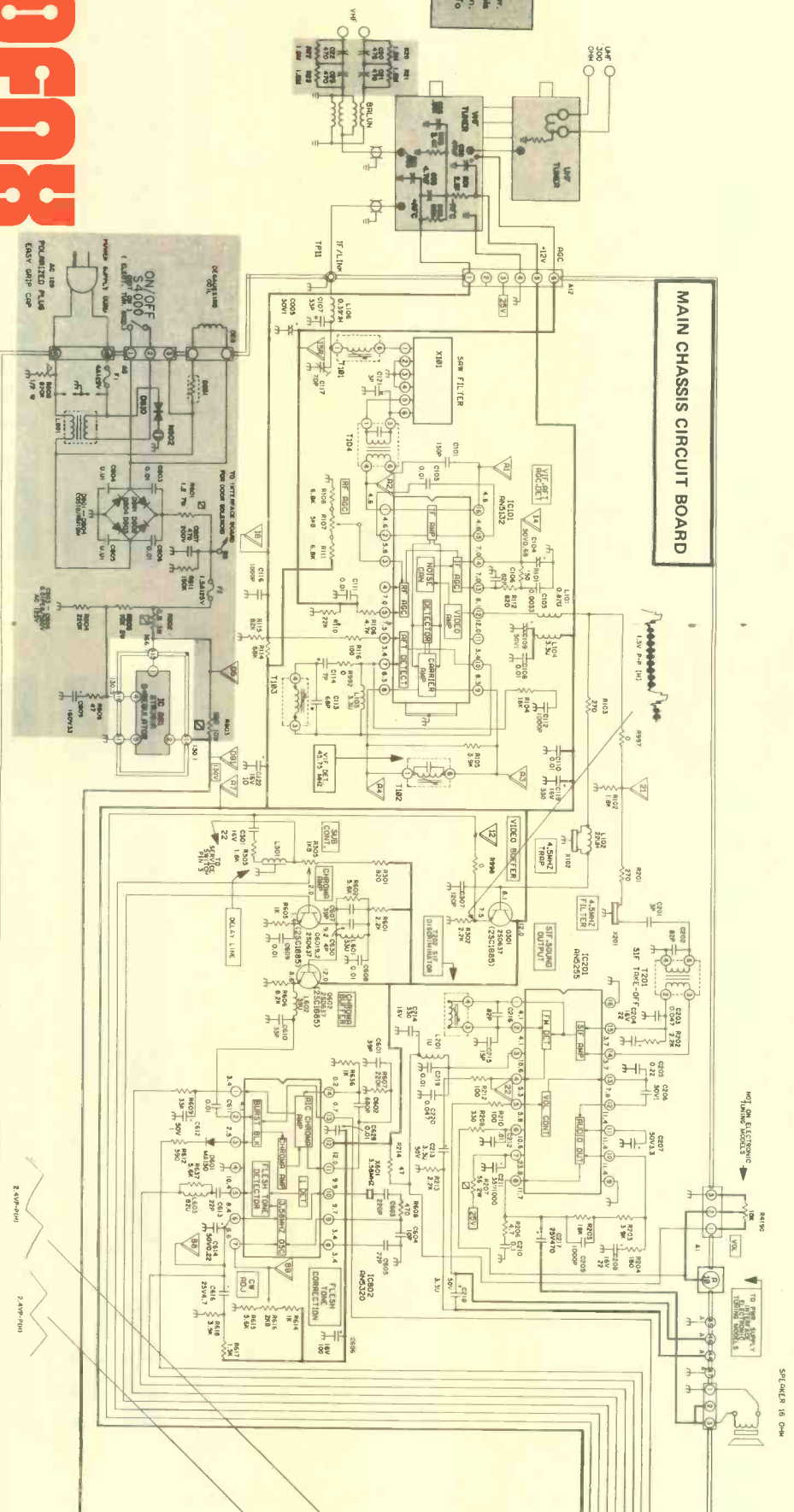

MAIN CHASSIS CIRCUIT BOARD

ESL
 Manufacturers' Schematics
PROFORM

GE 13" x 17" BC-A chassis color TV 2079
 Schematic no. 2080
 RCA CTC 117 color TV 2080

Product safety should be considered when component replacement is made in any area of a receiver. The shaded areas of the schematic diagram designate the components in which safety is of special significance. It is recommended that only exact cataloged parts be used for replacement of these components.

Use of substitute replacement parts that do not have the same safety characteristics as recommended in factory service information may create shock, fire, excessive x-radiation or other hazards.
 This schematic is for the use of qualified technicians only. This instrument contains no user-serviceable parts.
 The other portions of this schematic may be found on other Protax pages.

More on the telephone tester

Editor's note: Letters and phone calls from a number of readers pointed out that although the telephone tester featured as a construction project in the November 1985 issue of ES&T appeared to be a valuable piece of equipment, a few key pieces of information were omitted.

We have contacted the article's author, Joseph Szumowski; he provided us with the following information.

- The 7812 and 7805 are IC voltage regulators with a V_{IN} , V_{OUT} and ground lead. These are labeled on the package when you buy them, or you can check your ECG or SK substitution guide—it depends on the case style you purchase. (See Figures 1 and 2.)

- The diode in the power supply is a 1A, 600PIV rectifier diode. Any general purpose rectifier should do.

- The resistor above the LED in the schematic is 470Ω , $\frac{1}{2}W$.

- The value of the choke coil is

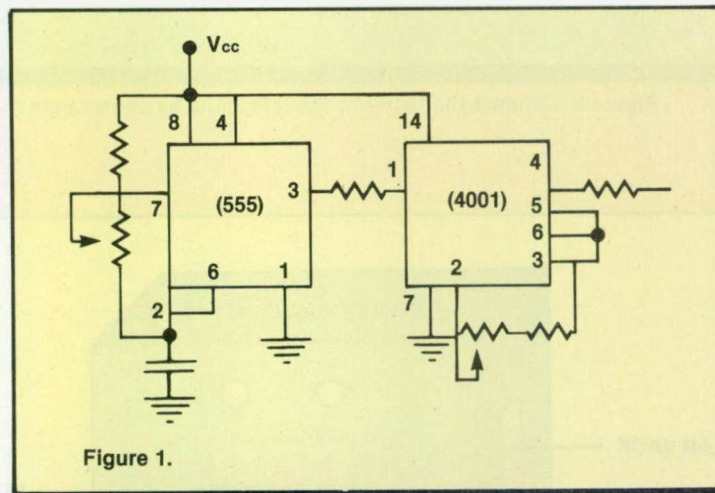

Figure 1.

Figure 1. The pin numbers for two of the ICs—the 555 and the 4001—were omitted from the schematic in the November article. This is how the pins are labeled.

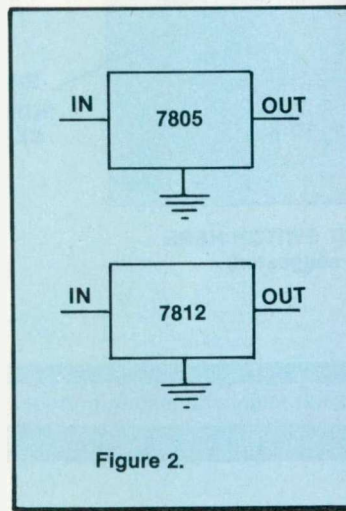

Figure 2.

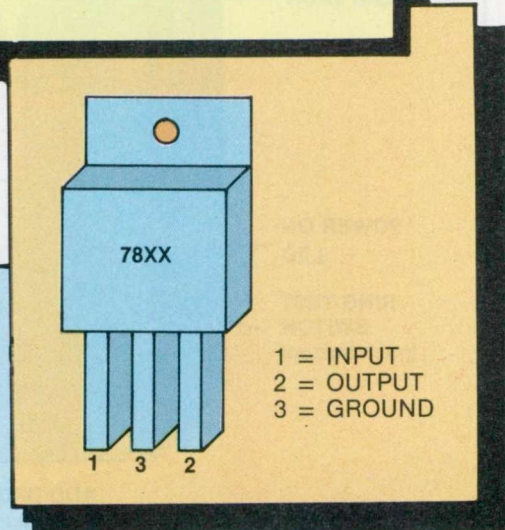

Figure 2. The functions of the pins on the 7805 and the 7812 are as shown here.

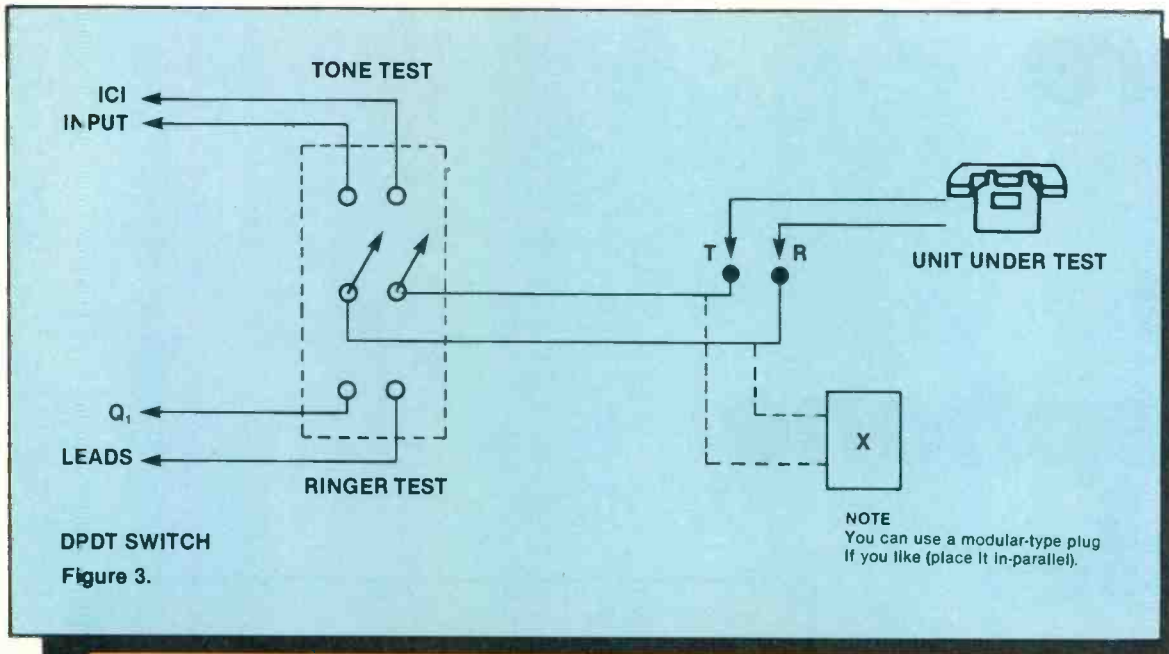

Figure 3. Connect the tester to the telephone as shown here in order to perform tests.

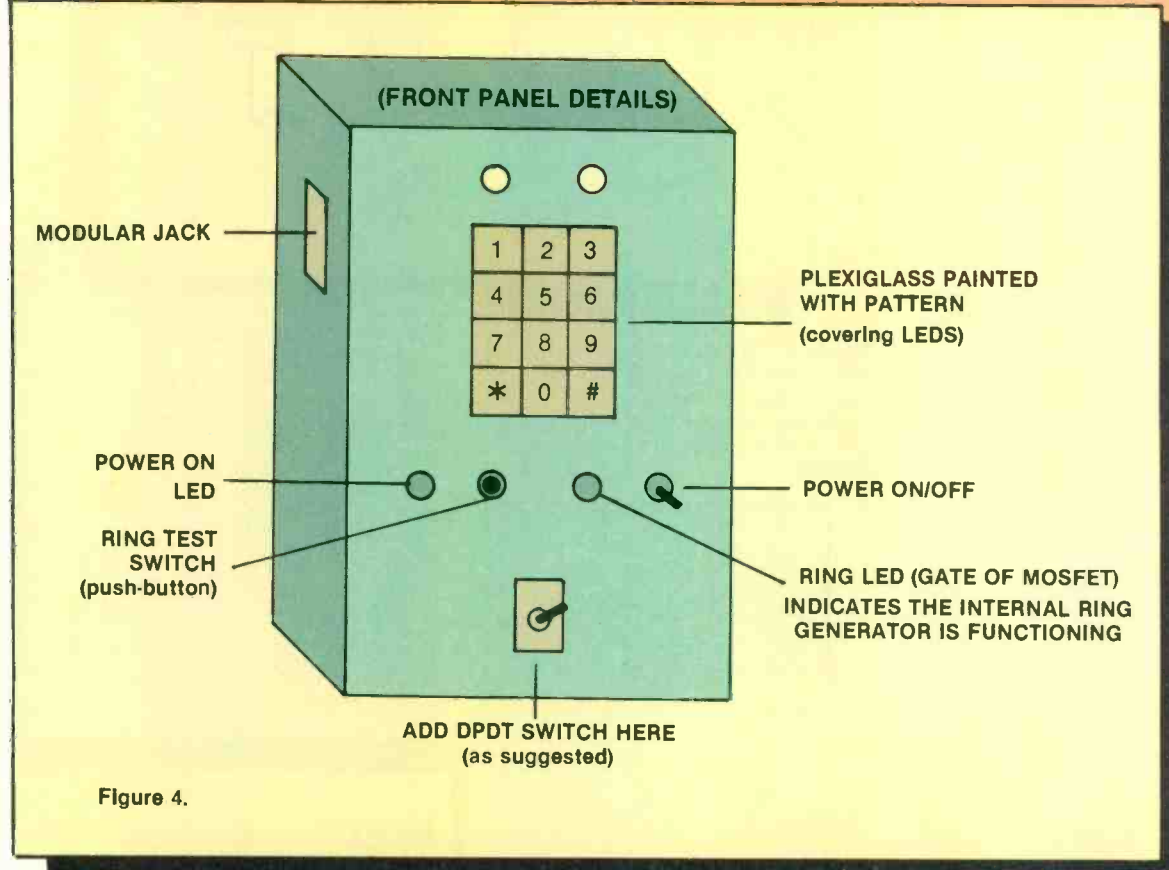

Figure 4. Here's what the completed telephone testing unit looks like.

not critical; it is simply an inductive load for the MOSFET. I used a 1H, 200mA filter choke coil.

- The resistors from IC3 to the LEDs in the display are simply current-limiting resistors to protect the LEDs. I used what I had available in my junk parts box. Using 470Ω resistors would provide sufficient brightness (over 220Ω or 330Ω would be fine) and limiting protection. The difference will be in the brightness of the LED.

- The markings *T* and *R* on the jacks designate *Tip* and *Ring*, terms commonly used by the telephone company (this is a holdover from the days of the operator who connected calls with patch plugs: The plugs have a connector at the tip, and the second connector is in the form of a ring, corresponding to today's stereo plugs). In the telephone system, these are connected to the

red and green wires, respectively. In most systems, the yellow and black wires are not used for the telephone function.

Note, though, that in some telephones it may be necessary to connect the yellow wire with the green wire to allow the ringer to operate. In my experience this is rare, and the only wires I connected were the green and red.

Testing procedure

1.) Connect the telephone under test to the T and R pins. (See Figure 3 for connections.)

2.) Place the DPDT switch in the ringer test position and press the ringer test button. *NOTE: Don't forget to set R17 (IC5) to the correct frequency (20Hz).* Another way to set it is to connect a known-good telephone and adjust R17 for proper ringing.

3.) Now place the DPDT to the

Tone Testing position. Be sure the leads are in proper polarity. If the leads are connected backwards, the telephone won't be damaged; the tone pad simply will not work. Again, use a known-good telephone and check R4 for the proper gain setting (IC amplifier). Depress a key on the tone keypad and observe D1. Remember that this setting is important: If the gain of IC1 is not set properly, the decoder (IC2) will not function.

The address of the company that makes the DTMF decoder is as follows:

Teltone Corporation
10801 120th St.
Kirkland, WA 98033
206-827-9626

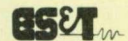

NESDA Computer Group

COMPUTER SALES AND SERVICE DEALERS
WORKING TOGETHER

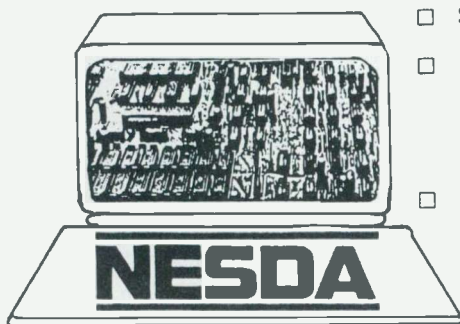

- Service training.
- Assistance in selecting in-house equipment and software.
- Specialized software for service management.

- Factory contacts for service literature and parts.
- Involvement in a stable and productive national trade association.

FOR MORE INFORMATION SEND BUSINESS CARD TO:
NESDA COMPUTER GROUP, 2708 WEST BERRY STREET
FORT WORTH, TEXAS 76109; PHONE (817) 921-9061

Durable Desoldering Tools

**Sterling™ Brand from Wahl
Clipper Corporation**

- High quality at a low price. You pay a little and get a lot.
- Anti-static or static-free desoldering tools available. End all worries about static electricity harming your components.
- Replaceable tips last twice as long as regular teflon tips (approximately 2,000 suction).
- Easy one-hand operation. Grooved handgrip and curved thumb-holder reduce fatigue during long desoldering operations.
- Self-cleaning. Plunger clears the tip of hardened solder. You'll always get a high-vacuum suction.

For more information on anti-static or static-free desoldering tools, or our full line of soldering irons, call or write.

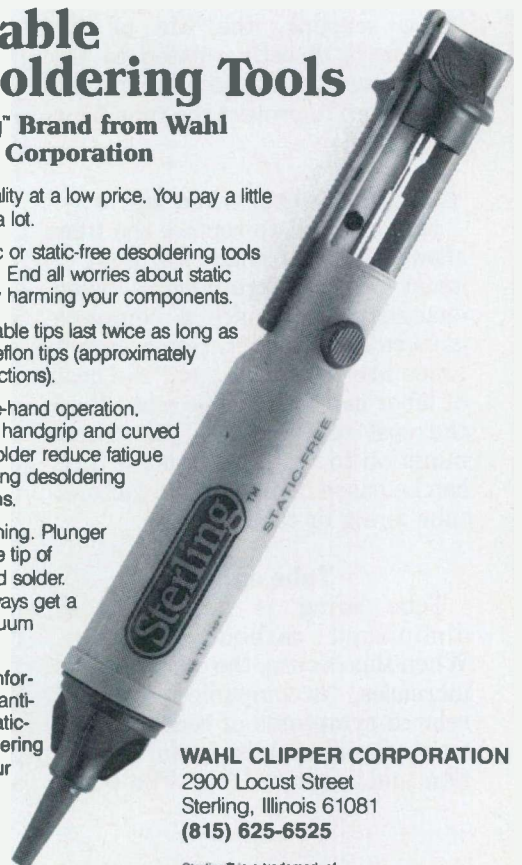

WAHL CLIPPER CORPORATION
2900 Locust Street
Sterling, Illinois 61081
(815) 625-6525

Sterling™ is a trademark of Wahl Clipper Corporation.

Circle (11) on Reply Card

Repairing the consumer color video camera

Part 3

By Neil Heller

With few exceptions, color video cameras are almost 100% solid-state. These components have proven to be reliable over many years of operation. The main component, the image pickup tube, is a thermionic device and has a photosensitive target. Excessive light can cause *image burn* on the target faceplate. In addition, the cathode can become depleted. For these reasons, the life of the camera is directly related to the operating time of the tube and the care taken to protect the tube from damage.

Changing tubes: when and why

Any attempt to replace the tube should not be made without a great deal of forethought. Tube changes will require a complete camera realignment. Replacement tubes are expensive, and the cost of labor can at times be more than the cost of the tube. The determination to replace a camera tube can be based on one of two factors: tube aging or tube damage.

Tube aging

Tube aging is the result of diminished cathode emission. When this occurs, the dark current increases, accompanied by the related symptoms of reduced contrast, signal-to-noise ratio, resolution and increased lag. The point

at which the tube is no longer usable is left up to the operator. Due to the high sensitivity specifications and lack of stripe filter, 3-tube color cameras have an advantage in operating life over single-tube cameras.

Deterioration of the target faceplate in a single-tube camera causes loss of resolution of the stripe filter. When this occurs, the camera loses its ability to produce red and blue. The only signal left yields green. This loss is not limited to the faceplate. Differences in beam scanning also can be caused by the yoke assembly.

Tube damage

Good judgement and proper handling are essential to preventing costly repairs caused by tube damage. The most common type of tube damage is usually caused by an inexperienced operator who, without thinking, points the camera at the sun or a high contrast scene. Concentrated light decreases the variable properties of the target to the point where it can no longer respond to changing light levels. Usually image burn is confined to a spot rather than affecting the complete faceplate. There are myths that certain types of tubes are not susceptible to this problem, but all types of targets are subject to image burn. The

type of target material will determine the degree of susceptibility. Image burn can occur even when the camera is not operational. Always remember to iris down and cap the camera lens when the camera is not in use.

Don't make the mistake of confusing burn with dust. Image burn shows up as white spots due to physical or chemical changes in the target material. Dust reduces the amount of light available to the target, so it shows up as a gray spot, which will vary in contrast as the lens is opened and closed. In addition, because the dust particle lays on top of the target's focal plane, it will appear slightly out of focus. If you think you have a dust problem, carefully clean the lens glass and optical faceplate with a non-abrasive tissue. If this method doesn't solve the problem, then remove the tube from the yoke assembly and clean the target faceplate. Remember, removing the tube means that the camera must be readjusted in order to return it to operating condition.

Another cause of tube damage that closely resembles burns is *tube spotting*. Never leave the camera in a position where it is resting on its lens. Because of the construction of the image pickup tube, bits of metallic dust have a tendency to adhere to the positive target

faceplate due to its positive potential. These metal particles can alter the ability of the tube to produce a proper picture. Therefore, it is advisable to avoid holding the camera in any way that may allow gravity to foster this condition. Never hold the camera lens-down. If the camera is resting on a tripod, leave it tilted up at a small angle.

Finally, avoid high temperatures. It's wise to keep video equipment in a safe place however, leaving your camera in the back seat of a car or in the trunk is a good way to damage the tube. Temperatures above 104°F or 40°C can cause chemical changes in the pickup tube, lowering the target resistance. This can cause an image to burn more readily into the faceplate.

Should image burn occur, endeavor to correct this condition by defocusing your camera on a

well-lit, white background. This method of rejuvenating the tube is often used in B&W cameras. However, because of the operation of the color camera tube, the sensitivity may be reduced to a point where it can no longer produce color, or the picture may be too noisy to be acceptable. If you want to try this method, make sure that the lens opening is not greater than $f/4$. Running your camera this way for approximately one to two hours should help to *burn out* the image.

Setting up the test equipment

This section provides an outline of detailed adjustments for single-tube color cameras. Also included is a description of the function of each of the major circuits and some service hints.

The outline is not meant to replace the manufacturer's service manual, but to serve as a general guide. Specific circuit descriptions

and alignment procedures for your individual camera can be found in the manufacturer's manual

General setup

Camera testing begins with the setup of your measuring equipment. Your adjustments can be only as accurate as your test equipment. As previously discussed, all alignment procedures should be performed under 3200°K lights, set to a level as indicated by the camera's sensitivity specification. The video output of the camera should be routed to the waveform monitor, vectorscope, and, finally, to the color output monitor. If your camera has test-monitor capability, connect this output to a B&W monitor for registration adjustments.

Remember that the last piece of test equipment in the video chain must be terminated in 75Ω. All test equipment that the video

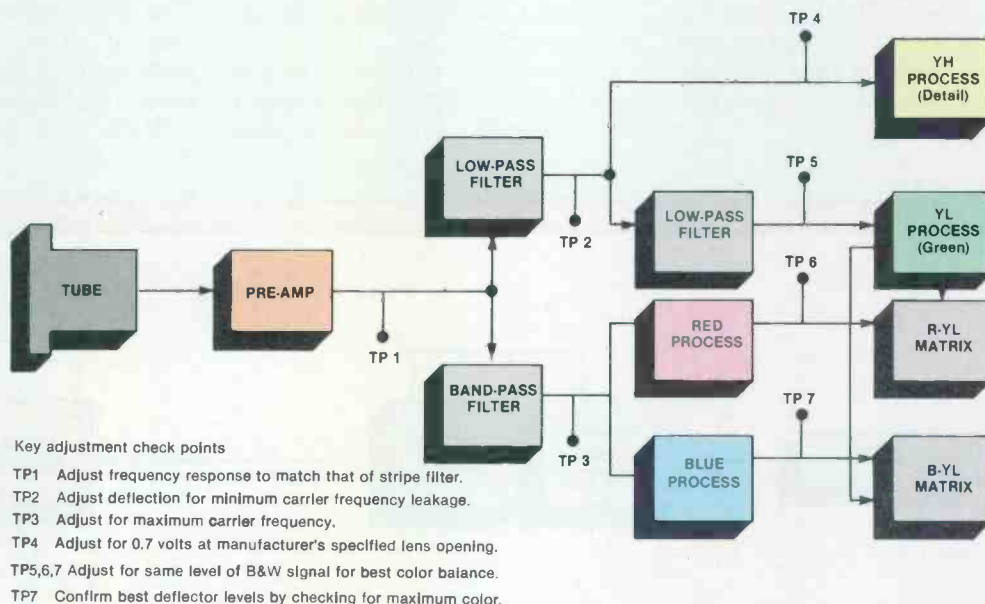

Figure 1. Block diagram of color camera shows key adjustment check points.

signal *loops through* must be unterminated. Failure to terminate video lines properly will result in the camera's output appearing greatly distorted. Unterminated lines expand the video and sync levels, causing the picture to appear excessively bright. Double terminated lines suppress the video and sync levels and cause the picture to appear excessively dark. After confirming that the video line is properly terminated, you can proceed to calibrate the test equipment.

Calibrating test equipment

Waveform monitor setup:

1. Allow the waveform monitor to warm up for at least 15 minutes before beginning setup.

2. Rotate the intensity control clockwise until the trace is at the desired brightness. Be careful not to turn the intensity control up to full brightness, because operating the CRT in this manner for long periods of time can greatly reduce its life.

3. Use the vertical position control on the trace to place the beam on the 0 IRE graticule line. Use the horizontal position to start the beam trace at the first major division mark on the 0 IRE graticule line. This is located on the left side of the waveform.

4. Now set the VOLTS FULL SCALE switch on the 1V CAL position. Use the vertical position control to center the display vertically in the -40 to 100 IRE unit area of the graticule. This calibrator waveform sets the lower (sync tip) and upper (white peak) limits on the video signal.

5. If the calibrator signal appears to lack definition, adjust the astigmatism and focus controls to obtain a well defined waveform.

Vectorscope setup:

1. With no signal input, adjust the intensity until the beam can be seen. As with the waveform monitor, be careful not to set the intensity level of the CRT too high, as damage can result. Allow the vectorscope at least 15 minutes to warm up.

2. Use the focus control to obtain the best-defined beam.

3. Use the horizontal and vertical position controls to move the beam to the crosspoint of the horizontal and vertical graticules.

4. Depress the mode select button (gain control) twice. The test circle will appear. Confirm that the circles are all concentric and the outermost circle is equal to the graticule circle.

5. Set the camera's output signal to color bars. This is where the camera acts as a test

generator. Use the signal to confirm that the individual colors fall within their appropriate 2.5° and 2.5 IRE graticule boxes. The burst signal should be found directly on the 0, 180° line. If the total color-bar signal appears to be shifted in position, use the vectorscope's phase control. Make sure you use the burst signal as a reference.

Prior to setting up the last piece of test equipment, the color video monitor, recheck the signal on the waveform monitor and vectorscope to confirm that the signal levels are properly set. If any deviation is found in the sync level of the waveform monitor and/or burst level of the vectorscope, recheck your cable termination before proceeding.

Monitor set up

Previously, we covered most of the common operational monitor checks. Many types of monitors are used, not just for viewing, but also as test fixtures. When relying on the monitor to judge the camera's color reproduction, it is extremely important that the color balance of the monitor be correct. This adjustment can be performed only if your monitor has adjustments for the three individual guns: *red, blue and green*.

Begin this procedure by ad-

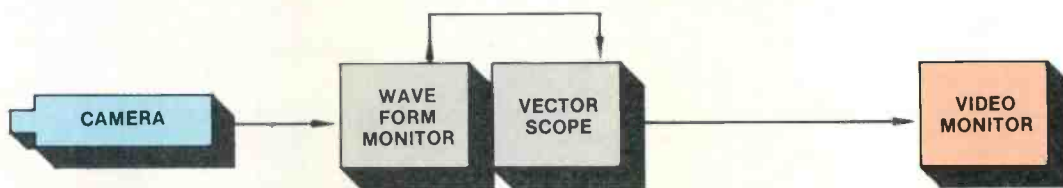

Figure 2. Color camera test setup. The last point in the video chain must be terminated in 75Ω.

Continued from Page 19

hours, chasing potential problems that ultimately never existed in the first place. We now manufacture such a device. It's called our Mark VI Diagnostic Computer.

If you work on a lot of equipment that employs any type of a transformer, (i.e. the horiz sweep transformer in a TV set), you will no doubt want to consider one of our slightly more sophisticated computers. Take TV service as an example, our Mark VII Computer provides you with two separate twelve unit bar graphs. The first bar graph gives you a read out on **resistive** load power consumption. The second bar graph gives you a read out on **inductive** load power consumption. Both graphs provide you with an open and a normal read out, both employ current limiting control.

WHAT DO THESE BAR GRAPHS TELL YOU ABOUT TV SERVICE?

First off, just a few examples:

If the red "nine" or "ten" light is lit in the **resistive** bar graph, it's time to start changing the LV rectifiers. With these lights lit, the short is positively located on the B+ side of the primary winding of the (horiz sweep) transformer. It cannot be anywhere else. If the red "six" or "seven" lights are lit, either the horiz output transistor is shorted, or something on its collector line is shorted, (i.e. damper diode, safety capacitor, pin cushion transformer, discharge capacitor for the horiz yoke circuit, etc.). A short that produces a red light in the **resistive** bar graph will not be, and cannot **possibly** be located on the secondary side of the sweep transformer, it has to be on the collector line of the horiz output.

A red "nine" light in the **inductive** bar graph and the TV set either has a shorted CRT, or a shorted HV tripler. A red "eight" light means a shorted scan derived B+ rectifier, or its associated filter capacitor, and so on. Each light, in each of the bar graphs has a very specific meaning. The best part is, thus far, you haven't so much as taken the back off the TV set so long as the horiz osc / driver, and the LV regulator is functional. If one or the other is not functional, you will naturally have to substitute it with horiz drive injection to the base of the set's horiz output transistor, or in the

ADVERTISEMENT

case of an in-op LV regulator, restore primary low voltages.

Aside from looking at the power consumption label on the equipment under test, then, setting the computer's range control to that setting, absolutely no programming is ever required to operate either of the above computers. Just turn the equipment on, turn the computer on, plug the repair job into the computer, push one **single** button and look at the bar graph(s).

If you do not do TV work, the Mark VI will do everything you will ever want done. If you work **primarily** on TV sets, plus any other equipment that comes in, you will most definitely want the Mark VII unit. (You will not need both).

You might say that the Mark VI is somewhat like a variac that permits you select the amount of **wattage** (instead of voltage) that you wish to apply to a circuit, with a built-in computer that tells you if a resistive short exists in the equipment under test, and if so, what type of a short exists, and just how severe it is.

The Mark VII does all of the above, except that it has an additional computer that tells you whether the short is resistive or inductive (on the secondary side of a transformer), and again, just how severe the short is.

The watts output range of both units is 25, 50, 75, 100, 125, 150 thru 250 watts in 25 watt increments. The greatest part is, if a short exists, you can't tear anything else up (such as additional components). In the event of a short, the computer simply lights one of the "short" lights in it's bar graph. Based on which light is lit, you now know essentially where the short is.

Once a short light comes on, the computer immediately reduces it's output to whatever level is "comfortable".

As you are about to see, the Mark VII unit is expandable (the Mark VI is not expandable).

IF YOU PREFER NOT TO WORK AT ALL:

Then you will want to purchase a Mark VII computer, and consider the following self contained "add on" computer which we have appropriately named the "Eliminator" (for obvious reasons). Since it is a plug in expansion system

for the Mark VII, you can add an "Eliminator" package to your Mark VII at a later date.

The "Eliminator" expands the features that are found in the Mark VII units. It's main frame is built around an eighty square inch gaseous display panel which provides you with a generic block diagram of the entire lv, lv regulator, horiz output, horiz sweep circuits, scan derived B+ sources, horiz oscillator and driver circuits, horiz yoke & P.C. circuits, vertical, color output, start up, shut down and B+ run circuits (to name just a few).

With the "Eliminator", all you do is set the same power consumption switch, plug the TV set into the computer, turn it on, then, press just one single button. The gaseous display will now light up the stage, circuit, or in many instances, the actual component that has failed. In instances where the TV set's horiz oscillator, driver or output is not operational, the "Eliminator" will light an instruction telling you to interface to the set's horiz output device. When this happens, remove the TV set's horiz output device (transistor or SCR), and plug in the computer's interface plug (which looks like a horiz output transistor). Then, press the test button again. A similar instruction is given for instances where the TV set's LV regulator must be analyzed. In some eighty percent of all cases, neither instructions will be given because neither will be required for the "Eliminator" to analyze the entire overall circuit.

Yes, this means that you can virtually analyze most TV sets right down to circuit level in **every** instance. And, right down to **very specific** component level in **most** cases without ever taking the back off!

In fact, the only instances that will require you to remove the back in order to do so with virtually 100% accuracy, are cases where the TV set's horiz osc / driver, or output stages are in-op. Or, in cases where the LV regulator circuit is not cooperative. Virtually no other types of circuit failures will require the removal of the TV set's back for an accurate diagnosis to circuit level!

In fact, the "Eliminator" will spot any type of a shorted condition and many types of open conditions without removing the back, **and** without you're even so much as looking at the set's CRT.

Under the above conditions, the

Continued on Page 59

ADVERTISEMENT

justing the monitor's brightness, chroma and phase controls, but, first, review the setup of these controls that begins by inputting the camera's color-bar signal.

1. Turn *off* all monitor presets and turn down the chroma control to its lowest position.

2. Adjust the brightness control until all levels of the individual color bars can be seen clearly.

3. Adjust the chroma level until color can be seen.

4. Adjust the phase control until the yellow bar appears to have the purest hue, or most yellow appearance.

Now you can take advantage of the setup control found in the more sophisticated types of monitors.

White balance adjustment

1. Set the color monitor to the monochrome mode.

2. Place the monitor in the SET-UP or TEST mode. This switch suppresses the horizontal scan to a single line.

3. Turn *off* the red and blue channel guns. Next, adjust the gain of the green channel until you

can see a complete line. Turn *off* the green gun and repeat this adjustment, using the blue and red channel gains. If all gains are set to be uniform, the combination of the red, blue and green guns will produce a white line. If the line appears to have a tint of a particular color, lower its gain. If color balance is not achieved, it will be necessary to repeat this procedure.

Remember that the perception of white will differ with each individual and the conditions of viewing. Depending upon these conditions, white can appear to be greenish, reddish, yellowish or some other slight tint. For this reason, there has to be an agreed-upon value for absolute white. As with color cameras, we can use color temperatures and measure white in terms of the Kelvin degrees. The standard for NTSC monitors is approximately 9300°K.

In addition to color balance adjustments, high grade monitors also have provisions for aligning the scan of the individual guns. This type of adjustment is similar

to registration of a camera. While viewing the color-bar signals with the monitor set to the mono mode, check to see that the transition points between the bars are clearly defined by a single line. This check is limited to horizontal resolution errors only. Some monitors contain an internal test signal generator for adjusting convergence. Ordinarily, these adjustments are unnecessary. However, it is a good idea to check the monitor's convergence so that monitor scanning errors will not frustrate you during camera setup and registration.

When monitor setup is complete, check to see that the monitor is set to the color mode, and switch your camera from the color bar to the operation mode.

The single-tube color camera

The single-tube color camera combines the separate red, green and blue tubes found in a 3-tube camera on a color stripe filter system so that the three individual colors can be reproduced by a single tube. Refer to article one of this series (ES&T, December 1985) for a review of how these filters create color. Because this camera processes signals from only a single tube, the electronics that would have been associated with the two additional tubes are dispensed with. All the major functions of signal processing can be confined to two printed circuit boards. One handles video processing, and the other, sync generating and deflection processing.

As with any type of color camera, the quality of picture reproduction depends on the operation of the type of tube, and operation of the sync and deflection circuits. The single-chip sync generator creates all the major pulses needed to produce the composite signal. The horizontal and

Pickup tube positioned in yoke assembly. If front of tube loses contact with target, picture output will be zero.

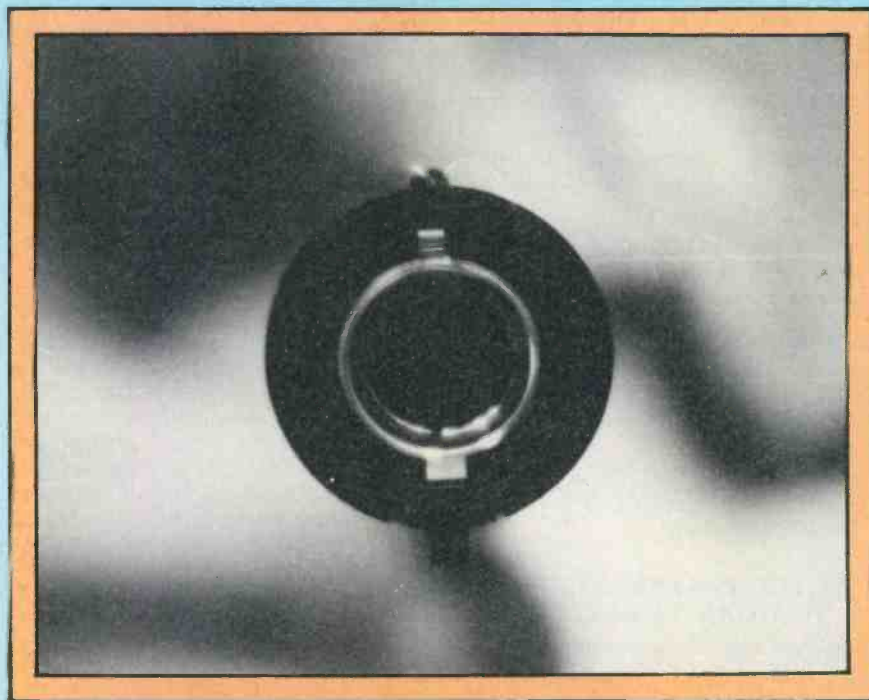

Vectorscope trace shows misadjusted stripe filter.

vertical deflection pulses are integrated into sawtooth waveforms and applied to the deflection yokes. The horizontal drive is coupled to the high voltage circuit and is used by the dc-to-dc converter to create the high voltage supply for the pickup tube. In addition, the high voltage supply also powers the beam and target. Vertical and horizontal deflection pulses are changed into parabolic and sawtooth waveforms by a series of integrators for use in the camera's shading circuits.

The sync and deflection board also contains the encoder circuits, which use the subcarrier from the sync generator for R-Y, B-Y modulation.

Video processing

The signal from the target output enters the pre-amplifier and is amplified by a series of transistors starting with an FET amplifier. The weak signal from the pickup tube must be amplified with a consideration to maintaining a high signal-to-noise ratio. From the pre-amplifier, additional signal processing will result in lowering the overall S/N, because of noise added by the video processing circuits. Usually, in order to maintain good S/N, a portion of the signal from the last transistor amplifier is fed back to the first-stage FET. This results in a better condition for signal transfer and improved frequency response.

For the 3-tube color camera, the primary consideration for frequency response centers on depth of modulation. In the single-tube camera, the frequency response of the pre-amplifier directly affects color reproduction. Remember that the beam scanning across the stripe filter will produce a carrier frequency. This frequency then will be used to create red, green, and blue. The frequency response

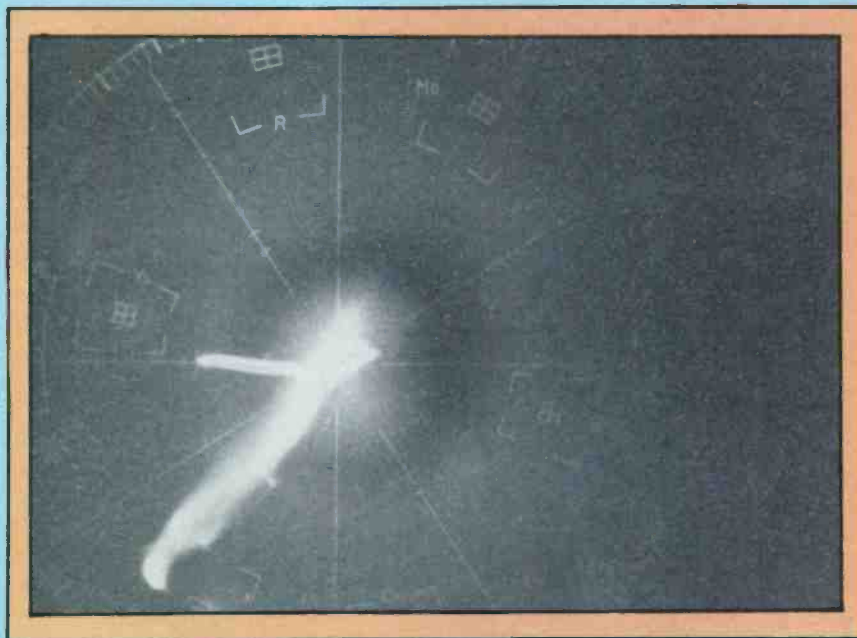

of the pre-amp must remain flat safely past the point of the carrier frequency.

After the signal enters the video processing board from the pre-amp, the signal is dc clamped and amplified. The signal then is divided by means of low-pass and bandpass filter systems. The low-pass filter blocks the color carrier and allows the luminance signal to pass. This signal, known as YH, contains all the picture details, and after passing through an additional low-pass filter, a cut-off point of 0.5MHz will be used to create the YL or green component.

The red and blue components begin by being separated from the luminance carrier by means of a bandpass filter, whose center frequency is equal to the carrier created by the horizontal scan and color stripe. Like the luminance signal, the color carrier is further separated into its red and blue components. This is accomplished by taking advantage of the 90°-phase difference between the two colors created by the different angles of the cyan and yellow filters. Finally, the red and blue carriers are added to the green

(YL) signal, to form the R-YL, B-YL signal input for the NTSC encoder.

Camera adjustments

Start by reviewing some of the concepts covered in article two (ES&T, January 1986): Procedures begin by creating the right conditions. Allow the camera to warm up for at least 20 minutes.

Adjust the 3200°K lights to the *lux* or *footcandle* level indicated by the sensitivity specification, or as otherwise indicated by the manufacturer's service manual. Remember to set the camera's filter or color-control switch to 3200°K light. Open the camera's lens to the setting indicated by the camera's sensitivity specification (usually *f4* or *f5.6*) or as otherwise indicated by the manufacturer's service manual.

Finally, make sure you have the proper test charts available. For the single-tube camera, adjustments will use the logarithmic gray scale, a white card and a chart to check color reproduction. Most manufacturers provide a test chart with the camera to test color reproduction.

You might have noticed that we haven't included a registration chart. The single-tube camera will not require any registration. In addition, geometric distortion will be determined by the setting of the beam deflection to obtain the best possible stripe filter output. You will have to live with any geometric distortion after the scan is set up. Many technicians have attempted to use the registration chart to set geometry and have been left frustrated, wondering why color reproduction is poor.

Adjustments

1. *Power Supply:* Always begin any camera adjustments by checking the power supply. Because single-tube cameras are so dependent on proper stripe recovery for good color reproduction, power supply problems can make this recovery impossible.

You will notice that the average single-tube camera will not have the variety of adjustments offered by the 3-tube camera. Industrial single-tube cameras will distinguish themselves from consumer versions by having adjustable blanking. Most consumer-model cameras have fixed output sync generators with no adjustments.

When the camera does not have

an internal color-bar generator, perform the burst phase and chroma gain adjustments in the following way:

Focus the camera on a skin tone pattern. For adjusting the camera in this way, you will be dependent on the color monitor for judging these settings. In order to use the color monitor most effectively as a test fixture, it must be preset with a color-bar generator. Remember not to leave the monitor in the preset condition. Adjust for best reproduction of skin tone or yellow.

Note: Prior to making any electronic adjustments, preset all operator controls to their center positions and recheck the electronic color balance setting for 3200°K. Preset all static shading (dark shading) and all dynamic shading (target shading) adjustment controls to their mechanical centers. This will give you a maximum range after the adjustment procedure has been completed.

2. *Electronic Focus:* Looking at the output of the bandpass filter (red and blue) adjust the electronic focus to obtain the maximum signal. Because blue is the hardest signal for the stripe-filter system to reproduce, also check for maximum blue signal output.

Next set the physical position of the tube for best back focus and deflection. Loosen the tube-holding screw located on the yoke assembly. Hold the tube socket with your fingers. Exercise caution as the socket can contain voltages as high as 1,000 or more dc. Although the amperage is low, the shock will be enough to wake you up.

3. *Tube back focus:* Zoom the lens in and rotate the lens focus ring to achieve the best picture. (Remember not to touch the electronic focus, as it was previously set for best stripe filter output). Zoom the lens out to its farthest position. If the picture looks out of focus, pull the tube backwards in the yoke for the best focus position. Be careful not to pull the tube too far back as it can lose contact with the target, causing the camera to have no signal output.

4. *Beam deflection:* Observe the signal output at the bandpass filter. Rotate the tube until the signal is as flat as possible. The reason for this is that the beam must cross the stripes to define each one clearly: yellow, clear and cyan. This means that the angle of intersection must yield maximum filter resolution. Due to the difference in each of the stripes, the response will not be completely flat, causing the output of each stripe to vary.

This is a critical adjustment for color reproduction. The beam scan across the color stripe must produce the exact carrier color frequency throughout the entire horizontal scan. Distortion at any point in the scan will cause the carrier to leak into the YH (luminance signal) and reduce the amplitude of the red and blue signals. As a result of this, it will not be possible to achieve unity of the three primaries in that part of the picture. In most cases, the base color of green will prevail, and the pic-

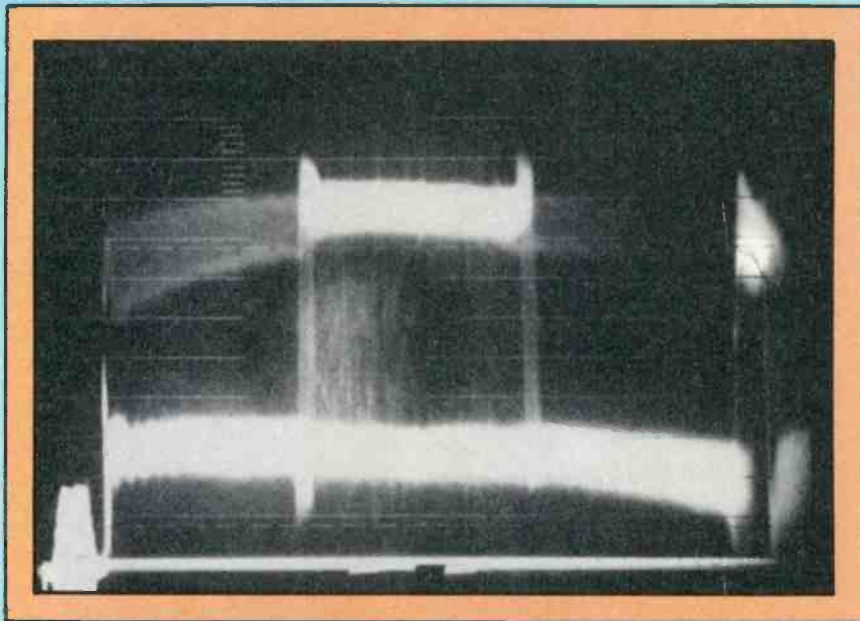

Waveform monitor display shows presence of chroma in B&W areas.

ture will take on a green or greenish-yellow hue.

To make this adjustment, you must first calculate the duration of the carrier sine wave. Do this by dividing the stripe filter into 1 as specified by the manufacturer. This results in the time period of carrier frequency.

For example, assume that the camera in question has a 3.8MHz carrier.

The period would be:

$$\frac{1}{3.8\text{MHz}} \approx 0.25\mu\text{s}.$$

You can use the delay mode of the scope to view this signal.

5. *Horizontal size:* Locate the center of the horizontal line and adjust the sine wave for a 0.25μs duration. When viewing the output of the PBF, adjust for maximum amplitude at the center of the waveform. When viewing the output of the LPF, adjust for

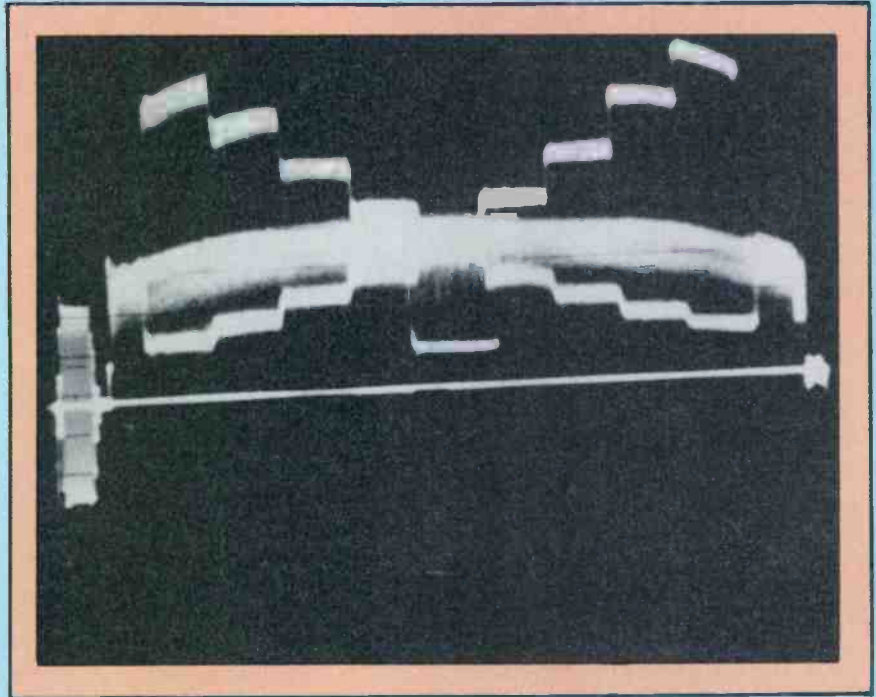

This waveform monitor display, with the camera focused on a gray scale subject, shows properly adjusted color balance.

Symcures Wanted

Electronic Servicing and Technology

needs a broader variety of television Symcures. Especially needed are reports of Quasar, General Electric, Sylvania (or Philco), Sony Sears and Magnavox.

Symcures are, by definition, solutions to problems that have been encountered during the repair of *more than one* television set of the same make and model, and that may reasonably be expected to be a source of *recurrent* failure.

Please give the brand, model number, Photofact number, a brief description of the symptoms, a rough hand-drawn schematic of the area containing the defect, and a short description of the cure (including whether the defective component was open, leaky, shorted or intermittent).

ES&T editors will adapt the material to the Symcure format and have Photofact-style schematics prepared.

Send seven Symcures each time. Only six will be published, but the extra gives the editor a spare for one already printed in the past (or otherwise not suitable to the format). \$30 will be paid for each page of six actually published (remember to include full name and address).

Send to: Symcure Department
Electronic Servicing and Technology
P.O. Box 12901
Overland Park, Kansas 66212

HIGH VOLTAGE TRIPLERS/MULTIPLIERS

REPLACEMENT FOR

ECG®/GE®/SK®

500A /GE527 & SK3304	8.75	6.95
523 /GE528 & SK3306	8.85	7.20
526A /SK3306	8.85	7.20
528 /SK3906	10.70	8.70
529 /GE529 & SK3307	9.99 3 MIN.	7.95 100 MIN.

OUTPUT TRANSISTORS

165 /SK3115 & GE38	... 2.25	1.95	1.75
238 /GE37 & SK3710	... 2.25	1.95	1.75
283 /SK3467	... 2.75	2.35	1.80
2SD1341P	... 2.25	1.95	1.75
2SC1172B	... 2.25 5 MIN.	1.95 50 MIN.	1.55 100 MIN.

AUDIO POWER

TYPE	10 min	50 min	100 min	TYPE	10 min	50 min	100 min	TYPE	10 min	50 min	100 min
152/SK3893	.30	.25	.21	196/SK3054	.49	.44	.39	291/SK3440	.49	.44	.39
153/SK3274	.30	.25	.21	197/SK3083	.59	.54	.49	292/SK3441	.49	.45	.40

RECTIFIER DIODES

125	1000V/2.5A	7¢	500	1000
156	1000V/5A	18¢	6¢	5¢
506	DAMPER/HI-VOLT—FAST RECOVERY	29¢	24¢	19¢

\$\$\$ ADDITIONAL SAVINGS \$\$\$

TYPE	10 min	50 min	100 min	TYPE	10 min	50 min	100 min
102A35	.32	.29	17149	.44	.38
123A18	.16	.14	18438	.33	.28
123AP13	.11	.09	18538	.33	.28
12838	.35	.29	19860	.54	.49
12938	.35	.29	19918	.15	.12
13059	.55	.49	23419	.16	.13
15916	.13	.11	37544	.42	.39
162	2.25	1.95	1.49	71275	.69	.60
163A	2.35	1.99	1.55				

FOR A COMPLETE LIST CALL OR WRITE—C.O.D. Orders Welcome (Min. Order \$25)

DIGITRON ELECTRONICS

110 HILLSIDE AVENUE, SPRINGFIELD, NEW JERSEY 07081
Toll Free 1-800-526-4928 In NJ 201-379-9016 Telex 138441
PRICES SUBJECT TO CHANGE WITHOUT NOTICE. OFFER GOOD WHILE SUPPLY LASTS.
ECG is a Trade Mark of Phillips ECG, Digltron Ele. not associated with Phillips ECG.

Circle (13) on Reply Card

minimum amplitude at the center of the waveform.

6. *Horizontal linearity, Lin-1, Lin-2:* Locate the start of the horizontal line and use the delay mode to observe the individual sine wave. Adjust the corresponding linearity control for a $0.25\mu\text{s}$ duration. When viewing the output of the BPF, adjust for maximum amplitude at the beginning of the horizontal line. When viewing the output of the LPF, adjust for minimum amplitude at the end of the waveform.

When doing the linearity adjustment, one control will affect the beginning of the waveform and the other control will affect the end of the active video horizontal line.

Note: In setting the horizontal scan, you established a consistent carrier frequency for each horizontal line. Even though the vertical scan is made up of horizontal lines, you still must adjust the vertical scanning so that the frequency is maintained for each field. When the horizontal and vertical scans are properly adjusted, the resulting frequency will be that of the carrier. This is the zero frequency. When the rate of vertical

scan is offset, the rate of the carrier is changed at the particular point, top, middle, or bottom of the picture. In electronics, when two identical frequencies are slightly offset, they beat. The further apart they are from each other, the more they beat. The closer they are, the less they beat. And when they are the same, no beating, or *zero beating* occurs.

Red-blue separation adjustment

After the signal from the pre-amp passes through the BPF, the red and blue color signals still must be separated. The total color signal is a combination of two horizontal lines. To separate the colors, the camera electronics must shift the signal 90° in order to match the phase shift created by the physical layout of the color stripes. Adjusting the R/B separation electronically adjusts the 90° -phase shift, thereby regulating the amount of red/blue separation.

Vectorscope display shows good black color balance and proper reproduction of yellow/flesh tone.

At this point, you have created separate red, green and blue signals, as well as a luminance component that contains the picture details. The adjustments from this point will depend on matching the pedestals and gains of the red, green and blue signals to achieve a unity of gain for proper white balance.

This adjustment is accomplished by focusing the camera on the gray scale and using the oscilloscope to match each of the primary channel outputs. If you have a vectorscope or waveform monitor, you can perform this adjustment by looking at the composite output. In the case of the waveform monitor, look for minimum subcarrier leakage. In the case of the vectorscope, compress the signal into the center, which represents an absence of color or black.

Confirm tacking adjustments by iris the lens down and looking for chroma in the waveform. White balance must be maintained with changes in incoming light.

Finishing the adjustments: your personal opinion.

As previously noted in this series, color cameras are unlike other types of video equipment in that performing adjustments by the book does not always guarantee the best results. Beauty is in the eye of the owner. Often your perception of blue, green and red can be different from that of the user. Because of this, part of the adjustment process requires that the end result please the consumer. With color cameras there can be many variables to that final goal. As a personal suggestion, and not one found in the service manual, attempt to show the user the camera picture. The little extra time it takes to answer questions, clear up misconceptions and do a little bit of final color adjustment can go a long way toward ensuring user satisfaction. Always keep in mind that the repair of a color camera is a balance between the facts of electronics and the opinion of the user.

ES&T_{inc}

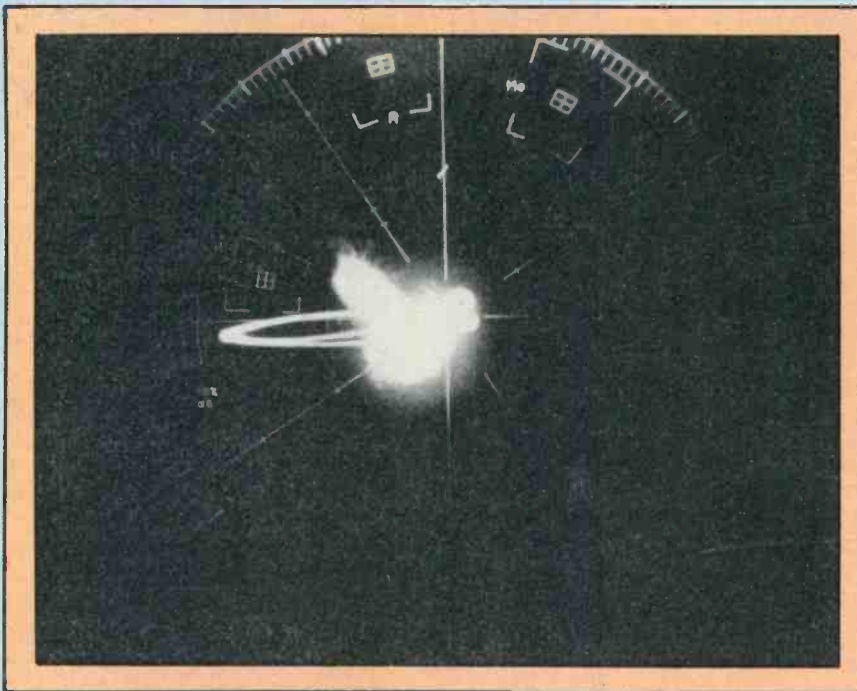

SPLISH SPLASH

Repairing Flood Damaged Electronic Equipment

By Joseph J. Carr, CET

Last fall, five days of heavy rains pelted the East Coast. In the Falls Church, VA, area, the river crested 11 feet above flood stage, but 80 miles upstream in the mountains it became a 54-foot high wall of water that overwhelmed the best efforts of hundreds of bone-tired volunteers. Despite backbreaking heroic efforts, the sandbag wall at the edge of one town gave way. Over the next 24-hours, the water rose, flooding basements and gushing into the first floor of most homes and businesses to a height of six feet. As the waters receded, the governor called out the National Guard to prevent looters, and people returned home to recover what they could. After cleaning out the water moccasins that inevitably come along with the flood waters, they found their possessions soaked and mudcaked. Among the damaged goods were electronic products, which they hoped could be salvaged. Would you know what to do?

Although most flood damage

scenarios are not as dramatic as described, it does happen. And from time to time you hear of electronic equipment that has taken a bath: boating accidents, plumbing failures ("Gee! was that plastic pipe running just above my stereo set?") and a variety of other problems can splash equipment out of service. Fortunately, there are certain things that a skilled technician can do to restore operation.

If the insurance company pays off well enough, then the flood victim could buy a new product. But if the insurance company refuses to pay ("Sorry...wind driven water damage excluded..."), or if there is no insurance, then restorative action might be indicated. Even if the insurance company does pay off, the owner often can buy the equipment back for salvage value. Someone I know received \$325 for a 2-year old 2-way radio and bought it back from the insurance company for \$20. The company sent him a check for \$305, and he kept the carcass.

Some of the steps that I recom-

mend may sound a little bizarre to you from a normal perspective. They make it possible to restore an expensive piece of equipment, however. *Some* of the steps might cause a little damage that also will have to be repaired (especially those involving baking the moisture out or using chemicals to clean the rig). If that makes you nervous, then please remember that in the case described you cannot harm the equipment anymore: **IT IS ALREADY A TOTAL LOSS!** Any restoration is pure gravy.

It should be understood that you are undertaking heroic measures that may not be successful.

The first thing to do is *refrain from turning the set on*, even for a brief test to see if it is broken. Satisfy yourself right now that even a short dunk will cause fatal damage. Still, the all-too-natural urge is to see if the equipment survived the flood: If it was immersed, then it didn't survive.

The first job is to remove the covers and give the rig a bath.

When I first started writing for ES&T, I lived in an eastern seaport town where saltwater damage to electronic equipment was common. The shop where I worked part-time (while attending engineering school) received a \$1,800 UHF-FM taxicab radiotelephone set that had been immersed the night before during a storm (it seems that the saltwater river tributary overflowed its banks just high enough to cover the radio mounted in the trunk well). The first thing the shop owner did was take the transceiver out on the back parking lot and give it a 10-minute shower with a garden hose. He had lived in that town all his life, and therefore had much experience with water damaged radio gear.

Incidentally, if the damage is caused by saltwater, then do the cleaning job immediately, if not sooner. The longer salt residue remains in the equipment, the greater will be the corrosion damage, and the lower the chance of successful restoration.

In some cases, it will be necessary to follow the shower with an immersion bath. A technician I know uses a 25-gallon tub, the kind you might use to give a large dog a bath. He mixes together in the tub two to four quarts of liquid grease-cutting detergent, a small bottle (2 to 4 fl. oz.) of fingernail polish remover (acetone) and enough tap water to fill the tub all the way to the rim. Leave the set in the bath for an hour, and then pour out the solution; rinse the tub out thoroughly and refill with plain tap water (some people prefer distilled water, which is available in bottles in most areas). This second bath removes the residue left by the chemicals in the first bath.

Note: This bath may damage some plastics. If this worries you, then use plain soapy water. It isn't quite as effective as a solvent, but it works to a degree. Keep in mind that most plastic pieces can be replaced, and the damage usually will not prevent the set from operating: It is already a total loss, so don't worry about trivial secondary damage.

The next step is drying the unit out *thoroughly*. If you live in Arizona (yes, they have floods in the desert), then simply leave the

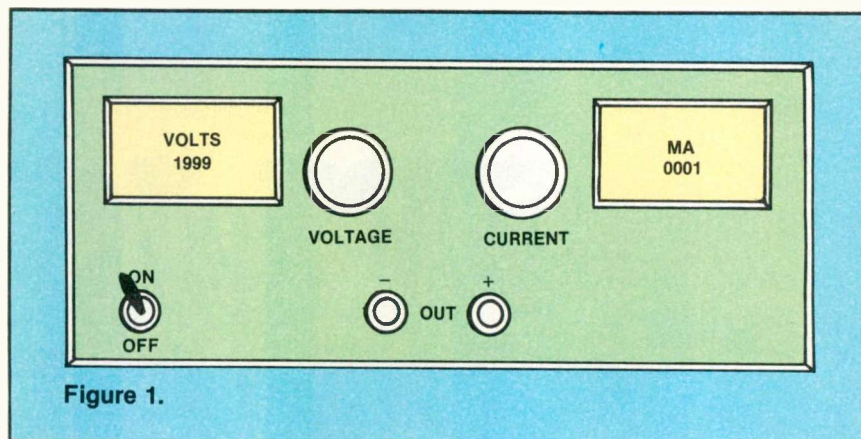

Figure 1.

rig out in the sun for about a week; everyone else will have to use some other method. The kitchen oven is a good bet, provided that it can be regulated to maintain a temperature of 125°F to 130°F. That range is low for a kitchen oven, and some might not be designed to remain that cool. But beware—higher temperatures will dry the set out faster, but they also will melt some of the plastics used in it. The drying process takes several days, perhaps as long as a week.

Another alternative is to build a cardboard (or other material) box and use several hundred watts of incandescent lamps to provide heat. Use a thermometer inside the enclosure to ensure that A.) the 130°F *melt limit* is not exceeded, and B.) the box doesn't catch fire from neglect (cardboard burns). Again, up to about a week is needed, although I have dried out a car radio that was dropped in fresh water (for a few minutes) in only one day.

Now comes the Big test. In some cases, the only way to test the equipment is to turn it *on* and look for smoke. I prefer a more conservative approach that sneaks up on it one step at a time. My first step in the test is to disconnect the dc power supply; this step can be absolutely essential to the future health of the set being repaired—especially those with high voltage (HV) power supplies.

Without connecting the set to ac power, connect a bench power supply to the circuitry that was previously connected to the rig's internal power supply. It is essential that you use a dc power supply that will provide the same voltage(s) as the original internal supply, and in addition (this is im-

portant) has a *current limiter* control (Figure 1). The output voltage is set to the dc voltage normally supplied by the rig power supply, and the current limiter control is set for a short-circuit current only a little above the normal operating current of the circuit under test.

Why go to such trouble? The reason is prevention of major secondary damage. There is almost inevitably a short circuit or other condition that draws loads of current. If such a condition exists in the equipment, then the internal power supply in normal use probably produces enough current to burn up components, printed wiring board tracks and other adjuncts. After the circuit is checked out, then you can check out the power supply and, if working, reconnect it.

The low-voltage dc power supply should be checked out separately, especially if it uses a series-pass regulator as many sets do. If the regulator circuit is not working, then several possible faults allow the rectifier output to be connected to the regulator output; this occurs when the series-pass transistor is either shorted or hard biased to full turn-on. Since the rectifier voltage always is higher than the regulator output voltage, it can damage circuits that were just pronounced healthy.

High-voltage power supplies have special problems. Small amounts of moisture that are no problem in low-voltage supplies will zap a HV supply into never-never land. The special problem is the HV transformer. If moisture has penetrated the transformer, then it may have to be replaced. It may help to provide some extra drying for the transformer, but be prepared to replace it. Figure 2

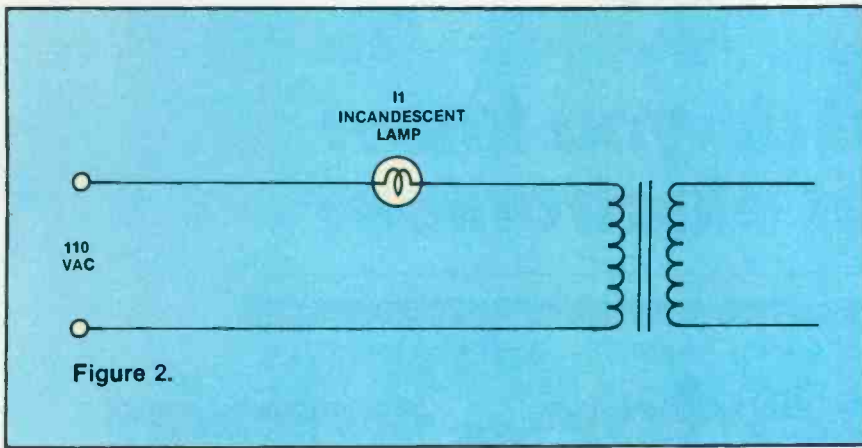

Figure 2.

shows a method for drying a power transformer. A 115Vac lamp in series with the primary of the HV transformer allows enough current to flow to cause internal heat build-up to accelerate drying, but not enough to zap the transformer if it is shorted. If the HV power supply uses a 220Vac primary circuit, then place one lamp in series with each ac hot line. (See Figure 2, above.)

Some remaining areas of concern and probable damage are

those components where moisture can get in and remain hidden. These include: trimmer capacitors, air variable capacitors, IF and RF transformers, switches and potentiometers, paper capacitors and electrolytic capacitors.

You can open trimmer capacitors up to the minimum capacity position (screw all the way out) and apply a hair dryer or incandescent lamp for 10 to 15 minutes. Whether this step is needed can be determined after the initial power-

on test shows a specific problem. Otherwise, you will mess up the alignment of the set for nothing. This step should not, therefore, be used merely as a matter of course, only in response to a specific symptom. Now you know what to do.

Similarly, air variable capacitors may have corroded contact wipers between the rotor and stator, and this will be apparent when the rig is turned on.

Paper and electrolytic capacitors can absorb water, especially if they have a fiber or cardboard end cap. If the capacitor shows signs of being soggy, then replace it; capacitors are, after all, relatively low-cost items.

If there remains a lot of scum on the printed wiring board, then spray-clean it with Freon TF or some similar material. I prefer to use a small paint brush or cheese cloth to help remove the residue.

You will find that flood-damaged sets often are salvageable. The methods described have been used by professional service technicians for a lot of years, and are proven successful.

ES&T



Plug in!

To the NESDA system.

YOUR BUSINESS is in the world's fastest changing industry. If you're not careful, you could find your business in the dark.

But, you don't have to stay there.

Through a system of local, state, and regional groups, the National Electronics Sales & Service Dealers Assn. (NESDA) keeps members up-to-date with the fast pace of advancing technology while offering:

- ◆ Managerial and technical training.
- ◆ Business contacts.
- ◆ Technical and management certification.
- ◆ Information on new products.
- ◆ Legislative activities that affect the industry.

Don't be left in the dark. Let the NESDA system work FOR YOU!

For more information and an application, write to:
NESDA, 2708 W. Berry St., Ft. Worth, TX 76109; Ph (817) 921-9061

Name _____

Bus. Name _____

Address _____

State _____ Zip _____ Phone _____

Member of State Local Assn. _____

COMPACT ECONOMICAL DESOLDERING



It's so Dependable, there's a Two-Year Warranty on the Pump. The EX-525 may be A.P.E.'s lowest-cost portable solder extractor, but it's full of features: • easily desolders components from multi-layer PC boards • pump is vibration-isolated for quiet operation. Model 550 for use with shop air • EX-1000 handpiece is non-clogging and temperature-regulated by panel controls.

You need the A.P.E. EX-525 in your shop. Call or write today for all the details. **Automated Production Equipment Corp., 142 Peconic Ave., Medford, N.Y. 11763 • 516-654-1197, TWX: 510-228-2120**

DEPEND ON A.P.E.

Circle (14) on Reply Card

What do you know about electronics?

The padder—again

By Sam Wilson

Some time ago, I wrote an article about the use of padder capacitors. What followed was a controversy about whether padders should be adjusted at the high end or low end of the band.

Both sides of the argument were presented, and it looked as though that would be the end of it. However, Antonio Moreno, CET, has sent an interesting write-up on the padder. His background is with the military, which is a viewpoint that has not been considered here. The material he sent follows.

In some early superhets, ganged capacitors were made with identical ganged sections. When both sections of the capacitor were identical, the total capacity of the oscillator tank circuit was reduced by placing an adjustable mica capacitor, called a *padder*

capacitor, in series with the oscillator tuning capacitor. In the process of alignment, the padder capacitor was adjusted for perfect tracking at the low end of the band. The process of adjusting the tuned circuits, to maintain this constant difference at both the high and low ends of the tuning bands, is known as *aligning*.

In order to align the superhet at the high-frequency end of the band, trimmers are placed in parallel with each section of the tuning capacitor.

What is perfect tracking?

Perfect tracking is the condition when the oscillator tuned circuit is resonant exactly 456kHz higher than the RF-tuned circuits for all settings of the tuning dial. The mixer and oscillator circuits of a

superheterodyne are said to *track* when these circuits maintain a constant frequency difference between them throughout the tuning range. The frequency difference is the intermediate frequency (IF).

Because the oscillator circuit generally is set to a frequency higher than that of the mixer and RF circuits, the capacitance and inductance of its tuned circuit is usually smaller. Also, for the higher oscillator frequency, the *percentage* of frequency shift for the oscillator tuning capacitor must be smaller for the same tuning range than that of the mixer and RF capacitors.

The lower capacitor shift is achieved in some receivers by using a smaller coil and a smaller tuning capacitor with specially shaped plates in the oscillator circuit. (The special shape of the plates ensures tracking throughout one frequency band.) This method cannot be used, however, in multiband receivers, because each band requires a differently shaped oscillator tuning capacitor.

In some designs, the tuning capacitors for the RF and oscillator circuits are the same size. The required frequency difference then is made up with a smaller oscillator coil. Tracking is attained with *trimmer* and *padder* capacitors. The trimmer is connected in parallel with the oscillator tuning capacitor, and the padder is connected in series with it as shown in Figure 1.

At the *high-frequency* end of the tuning range, the oscillator-tuning capacitor is set for minimum capacitance. The parallel trimmer

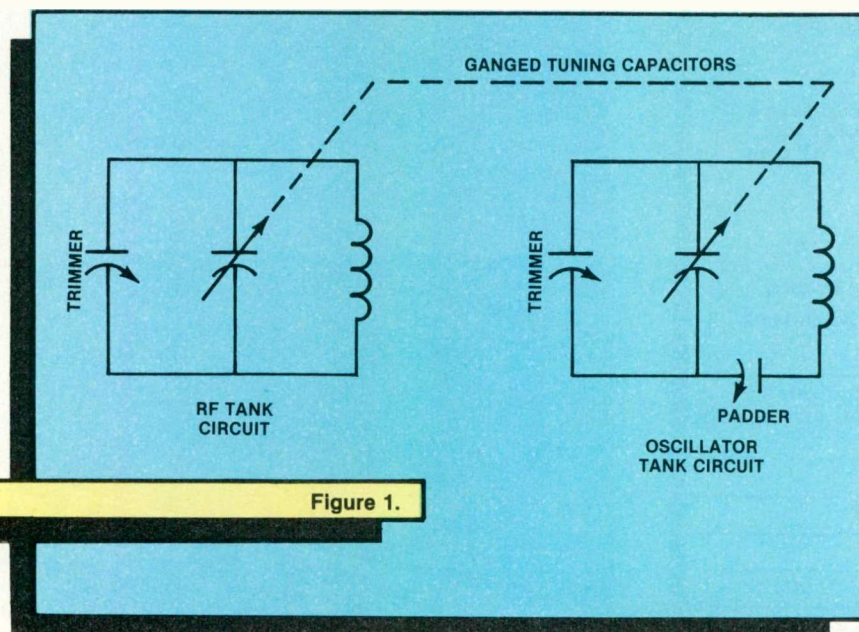

Figure 1.

has about the same order of magnitude as this minimum value and its adjustment determines the proper resonant frequency at this end of the frequency range.

At the *low-frequency* end of the tuning range, the capacitance of the oscillator-tuning capacitor is near maximum, and, therefore, the small parallel trimmer is negligible in comparison with it. Now, however, the *series padder* is comparable in magnitude to the main tuning capacitor and affects the resonant frequency.

The value of the *padder* is usually about two to four times the magnitude of the maximum oscillator-tuning capacitance.

Because the total capacitance of two series capacitors is influenced chiefly by the smaller of the two capacitors, the effect of the series padder on the total tuning capacitance at the low-frequency end is small, but suffices to set the resonant frequency within the limits required for proper tracking.

By proper adjustment of the padder and trimmer capacitors, reasonable tracking accuracy can

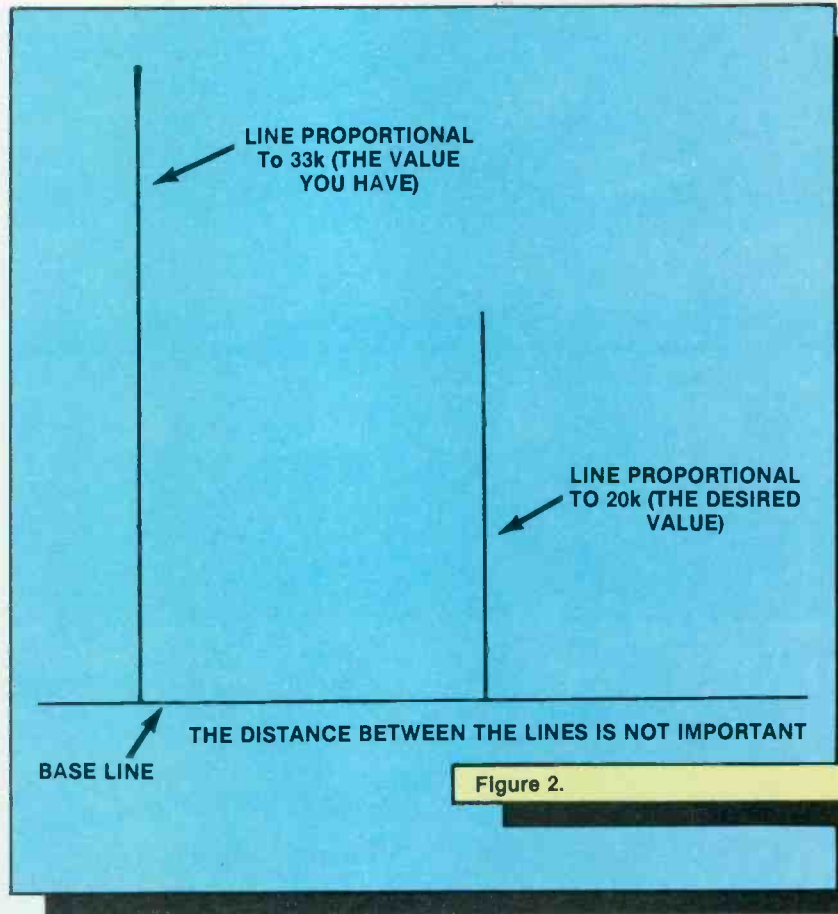

MOVING?

If you're planning a move in the near future, don't risk missing an issue of *Electronic Servicing & Technology*. Please give us 6-8 weeks notice if you're planning on changing your address. Just write in your new address below and mail this coupon, WITH YOUR SUBSCRIPTION MAILING LABEL, to:

ELECTRONIC

Servicing & Technology

P.O. Box 12901, Overland Park, KS 66212

For address change you MUST affix label from cover here. Print new address below.

Name _____
 Address _____
 City _____
 State _____ Zip _____

STEP INTO THE FUTURE....TODAY! NEPCON WEST '86, BOOTH 1744

Electronic Controlled
 Soldering and Desoldering Stations
 Covered by U.S. and Foreign Patents and Pending Applications

LONER • 951

Single, Dual, or Tri-Pod
 Soldering Stations



HOT-AIR LONER • 1036

Hot-Air Soldering &
 Desoldering Station
 • Easy SMD removal
 • No contact soldering

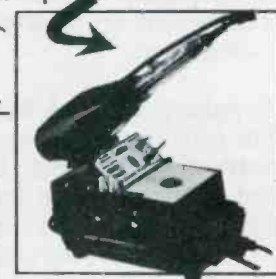

LONER • 960

ROCKET PLUG

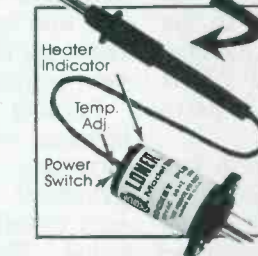

SEE THE NEW
SOLDAPULLT® 500
 Shown by appointment only

EDSYN^{ING}®

15958 Arminta St. • Van Nuys, CA 91406 • (818) 989-2324
 Cable Address: Edsynex • Telex No. 65-1469

Circle (20) on Reply Card

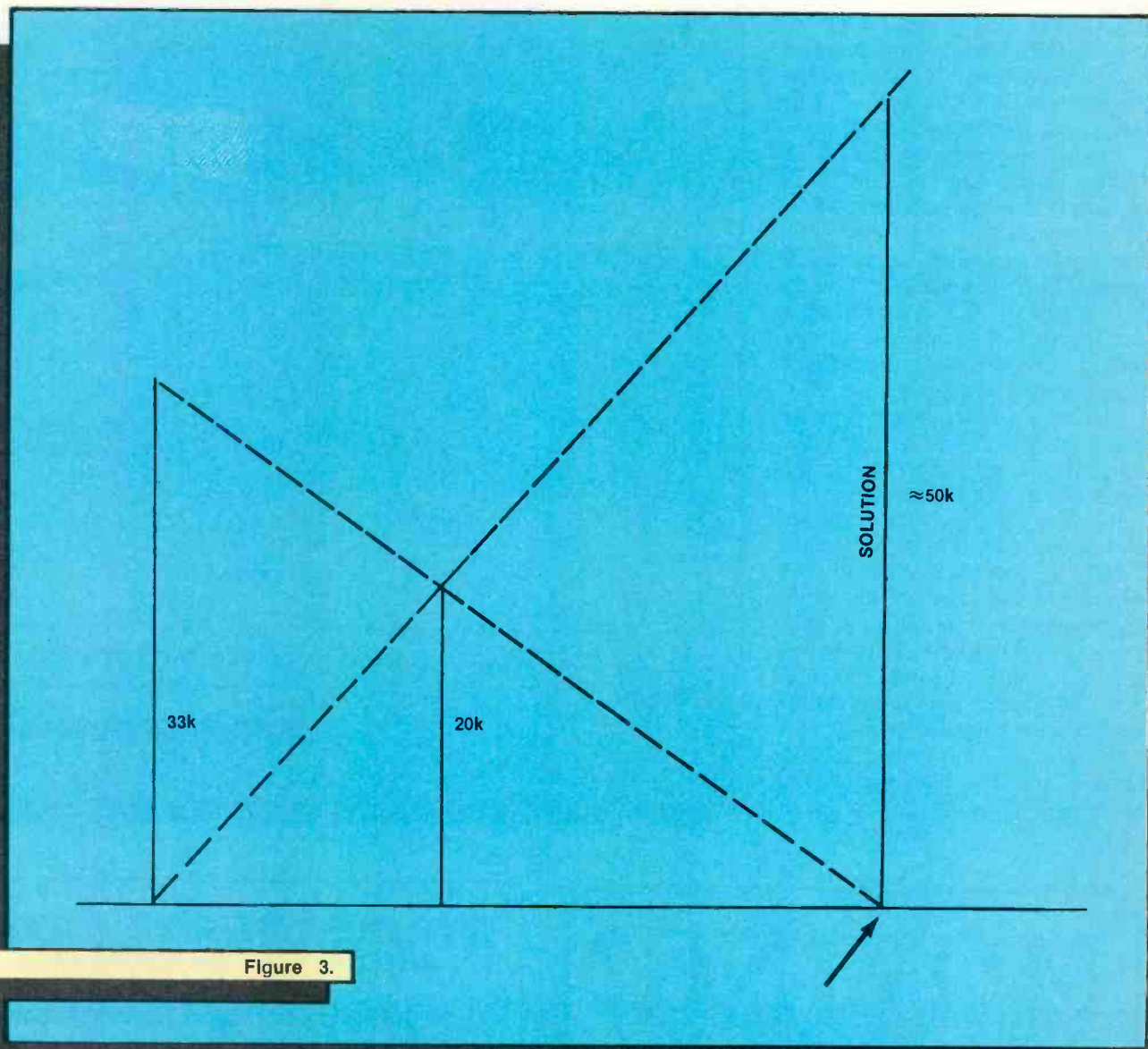

Figure 3.

be attained throughout the frequency range. If several bands are used, separate trimmer and pad-der capacitors are usually provided for each band.

Graphing the junk box parts

I'm convinced that some of the construction projects I've read about have only been built in the author's mind. Successful completion requires a mythical "Junk Box" that is stocked like a parts supply warehouse.

The articles usually have a key sentence that goes like this: "This project can be constructed in one evening using parts from your junk box. You will need a goniometer, a cosine resolver, a 10-turn logarithmic pot, a working head from an old magnetometer, and a magnesium bar with dimen-

sions of 5"x3"x17". Get the rest of the parts (resistors and capacitors) from your local supply.

Some day I want to see one of those junk boxes.

What I have seen are boxes of resistors and capacitors that have been saved for future use. The value you need is seldom there, so you end up putting two or three resistors in series so you can get your project into operation.

Parallel combinations are good because they can handle higher currents and run cooler. A graphical solution makes it very easy to select the required parallel value. The following example shows how easy it is.

You need 20k. You have a 33k resistor and a box of unlikely choices. Start by drawing a base line on the graph paper.

Make a vertical line that is proportional to the value you want (20k), and another line proportional to what you have. Figure 2 shows what you now have. You can draw the lines any convenient distance apart.

Connect and extend the ends of the lines as shown in Figure 3. Observe the point where the line with a negative slope crosses the X axis. Figure 3 shows how your drawing should look.

Draw a vertical line from the point marked on the X axis. Extend that line until it crosses the line with the positive slope. The length of your vertical line will be proportional to the value you need. The graphical solution shows that you need about 50k.

I don't know where you will find a goniometer.

ES&T

Literature

An 18-page supplement to the current ECG semiconductor master replacement guide, the thirteenth edition, has been made available by the Distributor and Special Markets Division of **Philips ECG**, a North American Philips company. The new supplement contains information updating coverage of the master guide that lists more than 3,500 ECG solid-state replacements for foreign and domestic types used in entertainment, commercial and industrial equipment including maintenance, repair and operations (MRO).

Technical information is given in the supplement for 41 new ECG semiconductor additions that expand the ECG line to almost 3,600 types. The supplement's cross-reference section lists some 4,500 entries including new replacement information and some cross-reference changes to the master guide.

Circle (125) on Reply Card

VIZ Test Equipment, a division of **VIZ Manufacturing Company**, has announced its 19-page, power supply and test equipment catalog. A guide to the manufacturer's full line of test equipment includes laboratory and industrial dc power supplies, isolated ac power sources, frequency counters, analog meters, signal generators, testers, digital meters and wattmeters.

Each product section presents photographs, descriptions and specifications, VIZ's latest literature, the VIZ warranty statement, and a list of warranty service centers and sales offices throughout the country.

Circle (126) on Reply Card

"Everything You Need To Know About Home Satellite TV" is the title of a new 16-page booklet available free to consumers from **Luxor North America**. It answers 78 of the questions most frequently asked about satellite television.

The question and answer booklet

is organized into seven sections under the headings: *Getting Started, The Channels, The Birds, Satellite TV Programming, The Dish, Satellite TV Receivers and Tuning In.*

Circle (127) on Reply Card

Rush Wire Strippers announces a 4-page brochure describing the model RW-3A hand-operated multiconductor cable stripper.

The brochure includes technical and application data for this model that is designed to remove both the outer jacket insulation and the insulation from inner conductors of multiconductor cables in one operation.

Circle (128) on Reply Card

Contact East is offering a free, one-year subscription to its latest Tool and Instrument catalog that lists more than 5,000 hard-to-find products for assembling, installing, testing, and repairing electronic equipment. Orders to this company are shipped within 24 hours.

Circle (129) on Reply Card

Products and materials for protecting microcircuits against static electricity damage in production, shipment and use has been catalogued by **Wescorp**.

The catalog includes photographs and specifications of wrist straps; protective systems, shipping, storage and handling equipment; ionization systems; detection instruments; and floor and benchtop covers.

Circle (130) on Reply Card

A coaxial cable and accessory catalog has been released by **L-COM Data Products**. Listed are 450 line items composed of ready-made coaxial cables with molded-on connectors; BNC, TNC, "N," UHF and Twinaxial.

Also included are many types of coaxial adaptors, compact coaxial transfer switches, cable testers, wall plates and many accessories, plus a series of rack panels that allows a variety of coaxial cable types to terminate and to be patched at will.

All items listed are regarded as standard types and are usually available from stock.

Circle (131) on Reply Card

ES&T

PRB . . . OFFERS THE PROFITABLE SYSTEM FOR SELLING VIDEO RECORDER BELTS



The PRB stock number describes the required belt. You just size the belt on our handy MEASURE-A-BELT gauge and you'll have all the info needed to find your belt. The PRB System is fast, easy and profitable!

For details on our profitable belt system and the complete line of PRB electronic components just call toll free . . .

National	In Wisconsin
1-800-558-9572	1-800-242-9553
Business Number	TLX
1-414-473-2151	4994411 PRB USA
In Canada call collect: 1-613-225-5003	

PRB
PROJECTOR RECORDER BELT
200 Clay Street, Whitewater, WI 53190

Circle (15) on Reply Card

HANDHELD MONITOR TESTER

For 15KHz RS170 color/mono display
MONTEST-RGB

- Battery Powered
- Color Balance
- Convergence Alignment
- 11x11 Crosshatch
- Full Raster
- Color Bars



\$249.95



30 day money back guarantee

NTI

Network Technologies Incorporated
"Innovators in Personal Instruments"

19145 Elizabeth Street, Aurora, Ohio 44202
Call 216-543-1646 and order yours today!

Circle (16) on Reply Card

ATTENTION TECHNICIANS

- ★ JOB OPENINGS
- ★ MONTHLY TECHNICAL TRAINING PROGRAM
- ★ BUSINESS MANAGEMENT TRAINING
- ★ LOW COST INSURANCE
- ★ CERTIFICATION
- ★ TECHNICAL SEMINARS

All of this in a nonprofit international association for technicians

FIND OUT MORE:



R.R. 3 Box 564
Greencastle, IN 46135



Only the Best May Display This Emblem

- Serving Ethical Servicers for 34 years
- "Watchdog" for the Independent Servicer
- NATESA SCOPE Magazine
- Business Counseling
- Profit-Making Service Invoices
- Business Manual
- Service Contract Cookbook
- Customer Grievance Arbitration
- Technician Development
- Annual Convention

NATESA
4621 N. Kedzie Ave.
Chicago, IL 60625
312-463-2499

Books

*Editor's note: Periodically **Electronic Servicing & Technology** features books dealing with subjects of interest to our readers. Please direct inquiries and orders to the publisher at the address given, rather than to us.*

Analog Printed Circuit Design & Drafting, by Darryl Lindsey; Bishop Graphics; 430 pages; \$149.95 hardbound, includes binder of drafting aids priced separately at \$99.95.

The author teaches the intricacies of analog printed circuit design and drafting by having readers create PCB design and artworks. There also is a thorough explanation of schematic diagrams, an in-depth description of components and PC board packaging, and an analysis of PCB design considerations. Self-help quizzes and tests appear, variously, at the end of each chapter.

For a free bulletin detailing information about this book, contact the customer service department of the publisher and request Bulletin No. 5008.

Bishop Graphics, P.O. Box 5007, Westlake Village, CA 91359.

Electronic Prototype Construction, by Stephen D. Kasten; Howard W. Sams & Co.; 400 pages; \$17.95 paperback.

Anyone interested in and involved with electronics will find this book easy to read and full of practical information for converting schematics and ideas into functional electronic prototype units. Four major categories of prototype construction are presented: wire-wrapping, printed circuit boards, graphic techniques and hardware packaging. Various facets of the categories are discussed, together with specific tools, equipment and techniques relevant to each. All of the construction areas necessarily overlap, but each section is definitively organized, with sometime-novel approaches aimed

at simplifying construction and minimizing the need for expensive equipment. Because one book cannot cover such a wide subject, there are numerous references to other resources.

Howard W. Sams, 4300 W. 62nd St., Indianapolis, IN 46268

Most-Often-Needed 1926 to 1950 Philco Diagrams and Servicing Information, compiled by Kristina H. Beitman; ARS Enterprises; 177 pages; 8½x11 format, \$17.

This latest in the long line of technical service manuals published by Supreme Publications since the 1930s (Supreme is now part of ARS Enterprises) covers most Philco sets that collectors and repair shops are likely to encounter—more than 250 Philco models and chassis.

ARS Enterprises, P.O. Box 997, Mercer Island, WA 98040.

Linear and Interface Circuits Applications, Volume 1, by D.E. Pippenger and E.J. Tobaben; Texas Instruments; 140 pages; \$11.95 paperback.

With the computer age as an immediate sequel to the technology of the single integrated circuit chip, a broad range of integrated circuits has been developed that can be divided into two general classes: logic and non-logic. This book is the first of a series that addresses the non-logic devices.

Volume 1 discusses operational amplifiers, comparators, video amplifiers, voltage regulators and timers. Information on display drivers and data line drivers, receivers and transceivers will be presented in Volume 2; Volume 3 will inform readers about peripheral drivers, data acquisition circuits, and special functions.

The books have been divided into basically independent sections, with each section covering a product category that begins with the basic theory of that product, followed by the key characteristics and applications of correlative devices. Circuit examples have been selected from numerous customer inquiries and related laboratory simulations.

Texas Instruments, P.O. Box 225474, Mail Station 8218, Dallas, TX 75265.

ES&T

Products

Desoldering handpumps

Now available from *A.P.E. Corporation* is a complete line of desoldering handpumps: Model DP-1 is all-metal construction, with anti-static tip; model DP-2 is anti-static and conductive with conductive tip; model DP-3 is a large capacity plastic construction desoldering device; model DP-4 is

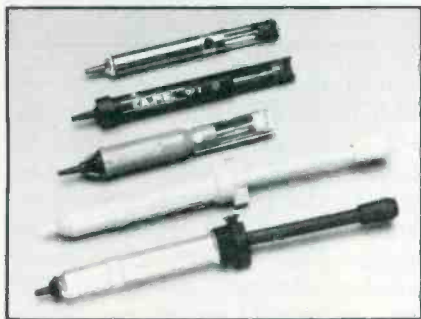

spring actuated on the return and is all plastic; model DP-5 is spring actuated, conductive and anti-static with anti-static tip.

Circle (75) on Reply Card

Desoldering braid

Philips ECG, a subsidiary of *North American Philips*, has introduced Swiftwick desoldering braid, available in 5- and 25-foot length spools. The five most popular widths range from 0.03 inches



for fine desoldering to 0.13 inches for heavy desoldering jobs. The spool labels are color coded for easy identification of five sizes.

Swiftwick is a sensitive copper braid produced through a patented

vacuumization process that yields a high-speed reaction wick. It is recommended by the company for use in all solder removing operations whether delicate, intricate or routine.

Circle (76) on Reply Card

4½ digit hand-held DMM

A.W. Sperry Instruments announces its model DM-7010 4½ digit DMM, which features nine functions on 33 ranges, with basic dc accuracy of 0.05% of reading.

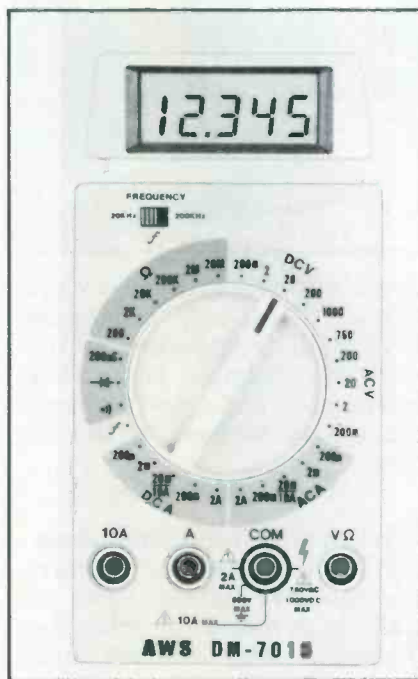

Other features include a maximum display of 19999, ac/dc current functions, resistance and conductance capability, diode and continuity tests, frequency counter up to 200kHz, overload protection on all ranges, safety designed input jacks and a built-in tilt stand.

Circle (77) on Reply Card

Wireless home video transmission

Wawasee Electronics introduces the model JB700 wireless home video transmission system that accepts all raw audio-video signal inputs from a VCR, video camera or satellite receiver and converts them to the VHF TV band channel 2 to 6 for wireless relay to other televisions in a home.

No extra channels are required; the need for A-B switches and cable installation is eliminated. Preset station is channel 6; user option available of 2 to 6 channels.

The unit is used to transmit TV

the Boardworks Pocket-Size Soldering

- Safe, no open flame.
- Only 7 inches long.
- Adjustable, with 10-60 W power.
- 3 tip sizes.
- No cords or batteries.
- Runs 60 minutes on one refill.
- Heats and cools in seconds.

Portasol™ is the first butane-powered, portable soldering iron that's safe, convenient and economical. Not much larger than a felt marker and as easy to use as a cigarette lighter, Portasol is the ideal tool for soldering and desoldering in tight spots or where no electrical outlets are available. And because it's static free, Portasol is ideal for use with CMOS and other static-sensitive components.

See the flameless, static-free Portasol soldering iron at your nearest Boardworks electronics supply dealer. For the location of the Boardworks dealer nearest you, call or write to:

The Boardworks
1077 E. Edna Place
P.O. Box 1678
Covina, CA 91722
Telephone (818) 967-3681

ACTUAL SIZE

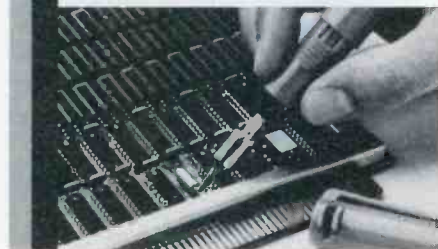

Circle (18) on Reply Card

Full-featured frequency counter.

The DM850 offers more than any digital multimeter in its price class:

4½ digits. DCV accuracy is

.05% + 3 digits

True RMS

Frequency counter to 200KHz

Data Hold display capability

DCV-5 ranges (.2V to 1kV)

ACV-5 ranges (.2V to 750V)

DCA/ACA-6 ranges (.2mA to 10A)

Ohms-6 ranges (200 Ohms to

20 Megohms)

Continuity beeper

Diode check

Built-in bail

Anti-skid pads

Prices: DM850 (True RMS) . . . \$219⁹⁵*

DM800 (Average RMS) . . . \$169⁹⁵*

See one now at your local Beckman Industrial distributor.



*Suggested list price (SUS) with battery, test leads and manual.

Beckman Industrial™

Beckman Industrial Corporation
A Subsidiary of Emerson Electric Company
630 Puente Street, Brea, CA 92621
(714) 671-4800

© Copyright 1985 Beckman Industrial Corporation

Circle (22) on Reply Card

signals to remote TV locations throughout the home without using a coaxial cable system to deliver the signals. It comes complete with plug-in cables and telescope antenna.

Circle (78) on Reply Card

Hot tweezer tool

Surface-mounted components can be removed quickly and safely says *Plato* by using Hot Grips. A wide selection of interchangeable

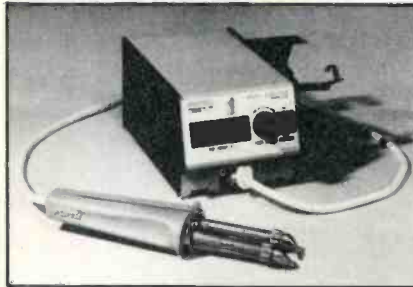

tools is available to desolder chips, SOICs, SOTs and quad-packs. Regulated temperature, ergonomically designed hand piece, rapid heat-up and spike-free operation are all features of this hot tweezer tool.

Circle (79) on Reply Card

Temperature recording labels

CelsiDot single level temperature-sensitive labels now are available on rolls with 1,200 pieces of identical dots. There are 40 different temperature ratings available between 105°F (40°C) and 550°F (260°C). The original

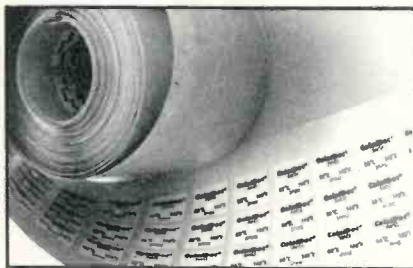

white temperature-sensitive indicating triangle will turn permanently black when exposed above its rated temperature level.

The self-adhesive labels from *SAT*, a *Spirig* company, can be applied to any clean, dry surface to monitor safe or unsafe temperatures reached during practical use within hours, days, weeks or years following application. A blackened dot will document that equipment has been exposed above its specified temperature level.

Circle (80) on Reply Card

3-Channel oscilloscopes

Iwatsu Instruments has announced two new delayed-sweep oscilloscopes that feature accuracy of ±2% for vertical and horizontal deflection with a CRT accelerating voltage of 12kV, allowing easy viewing of high-speed signals and signals of slow repetition and fast rise time.



Both the SS-5706 30MHz and SS-5705 40MHz oscilloscopes offer 3-channel inputs for simultaneous display. Each channel is equipped with an independent position control to increase measurement range. The SS5705 also incorporates alternate sweep, so that the enlarged waveform of a delayed sweep can be displayed simultaneously with the original waveform, up to six traces.

Circle (81) on Reply Card

SMD Test TWEEZERS

Two SMD Test Tweezer clips for surface-mounted devices have been designed by *ITT Pomona Electronics*. Model 5143 features two single stacking banana plugs as the terminal end. Model 5142 features a BNC male connector.

Both SMD Test Tweezer clips have a conductor in each leg enabling the user to test at the same time both sides of a surface-

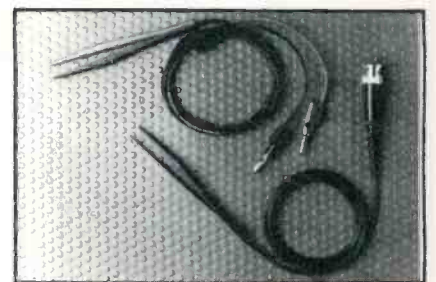

mounted device. These nylon tweezers are fitted with gold plated beryllium copper contacts; they permit testing surface-mounted devices whether the devices are loose, on a circuit board or on a reel.

Circle (82) on Reply Card

"Eliminator" will spot such things as open fuses, surge resistors, bad filter capacitors, shorted LV rectifiers, open LV regulator devices, defective LV regulator drive circuits, shorted or open horiz output devices, bad damper diodes and safety capacitors, shorted pin cushion transformers, yokes, discharge capacitors in the horiz yoke circuit, centering diodes, shorted horiz driver transistors, shorted oscillator stages, open horiz osc / driver stages, defective start up circuits, shut down circuits, and scan derived B+ circuits, (with regards to shorted rectifiers and associated filters in scan derived B+ circuits, the "Eliminator" will tell you specifically which circuit(s) are connected to the shorted scan B+ winding).

If the resistor is open that couples the secondary of the horiz driver transformer to the base of the horiz output, the "Eliminator" will tell you so.

If the scan derived B+ circuit is open that feeds the horiz osc and driver stages, the "Eliminator" will tell you so.

If the vertical output circuit is either open or shorted the "Eliminator" will tell you so. The same goes for shorted red, green, and blue, video output transistors.

If the CRT is developing a second anode short when it gets hot, the "Eliminator" will likewise tell you so.

Nothing, - - - absolutely nothing, no amount of other test equipment, no quantity of technicians, and no possible combination of the above can compete with just one "Eliminator". It can't be done!

If you so desired, you could no doubt cut your present labor rates in half, work only a fraction of your present hours, simultaneously double your production output, and at least triple your present net profit, with just one "Eliminator".

You could place an ad in the paper or on TV that states "Bring your color TV repair job in for a genuine computer diagnosis, and an accurate estimate, for a total cost of only ten dollars. With our new computer, we can repair your color TV set for about half of the normal labor rates". (We are not recommending this).

In the race between discount chain stores and their ever decreasing cost of replacement equipment, you (not them) will now be able to compete for the purchasing power of today's consumer. The best part is, Y O U can make some really big money while T H E Y try (for a change), to find some way to compete with Y O U!! Unless the TV set has a bad CRT, flyback or yoke, they won't be likely to find such a way, short of passing their new TV sets out a significant loss!

It should come as no surprise why we have chosen to name our new computer the "Eliminator"!

The "Eliminator" is a full fledged, bonified, total logic, decision making computer that carries a 100% two year parts and labor warranty (except for physically obvious abuse, and cosmetics). If you can find a way to tear it up, we will repair it free of charge. You pay only for transportation.

IMAGINE THIS:

A TV set shows up in your shop. You plug it into your computer, press one button and a red light comes on in back of the vertical output circuit in the block diagram of the computer's display panel. In just one second, without so much as removing the back of the TV set, you know where the problem is.

Generally speaking, red lights indicate shorts, yellow lights mean that an open circuit exists.

Another set shows up. You plug it in and the surge resistor in the LV supply of the block diagram is lit up yellow. You replace the surge resistor and push the test button again. This time the LV rectifier in the scan derived B+ supply for the R, B, G video outputs is lit up red. You replace the LV rectifier, push the test button, and presto! The set now has a picture on it! It's fixed and ready for the cookout bench.

After pushing the test button for the next set, a red light comes on behind the LV rectifiers. In another the HV multiplier is lit up red.

Later in the same day, the start up circuit is red for one set, another TV set comes in with a color picture but, the shut down stage in the block diagram is red.

In fact, any problems in any of the previously mentioned long list of circuit failures will be displayed in either yellow or red on the screen of your "Eliminator" when and if they

fail. In many instances, if your computer sees two or more problems at the same time, it will simultaneously display both.

It may sound like the "pipe dream" of some technician turned "mad inventor", but, we are already manufacturing them, and they do exactly what we have stated. If you would like to own either a Mark VI, Mark VII or the "Eliminator" (which is an add on, plug in computer for the Mark VII unit), you can bet your socks that we have a dealer in your area who would like to show you one in operation. If we don't have, we very soon will! Without actually seeing one in use, it's impossible to imagine everything it will do. We used to sell via direct mail, but, when we decided to release the "Eliminator" we realized the necessity of local dealers who could demonstrate it "hands on".

For this reason, we have chosen TV service shops or technically qualified parts wholesalers to sell our products.

Yes, we still manufacture our Mark III and Mark V computers for analyzing horiz / hi-voltage circuits. For those who already have a Mark III or V unit, the Mark VI or Mark VII will certainly compliment the operation of either unit. A member of our design team recently stated, "Owning a Mark III is like being released from a set of life long shackles. Getting a Mark V was like having the same shackles removed and being permitted to use hand tools for the first time. Buying an "Eliminator" is just like having the world's greatest technician come to work for you. Then, realizing that he also owned a magic wand."

If you would like a "hands on" demonstration, and are willing to drive fifty or so miles to get one, call (806) 359-0329, or write to the above address asking for same. We will be pleased to give you the name, address and phone number of your nearest sales dealer.

Your local dealer will do "hand stands" for a chance to show you our test equipment in action. But be aware that in most cases, you will have to go to his shop for a "hands on" demonstration. Please keep in mind that he is not only your sales dealer, he also has a TV repair business to run. Even so, who could better demonstrate test equipment than the people who are using it on a day to day basis! The drive to his shop will be more than worth the time.

Test your electronic knowledge

By Sam Wilson

1. To reproduce a glitch, an oscilloscope must have a vertical amplifier that has

- A.) a very high gain.
- B.) a very wide bandwidth.
- C.) no phase inversion.
- D.) dc amplification.
- E.) no feedback.

2. Anything you do to increase the gain of an amplifier will automatically decrease its

- A.) noise.
- B.) distortion.
- C.) cost.
- D.) phase shift.
- E.) bandwidth.

3. Which of the following is a method often used to increase the bandwidth of an amplifier?

- A.) Decrease its power supply voltage
- B.) Increase its gain
- C.) Use degenerative feedback
- D.) Use regenerative feedback
- E.) Introduce white noise

4. For an operational amplifier (like the one in Figure 1), the bandwidth would be increased by

- A.) increasing the resistance of R_L .
- B.) decreasing the resistance of R_L .
- C.) increasing the resistance of R_f .
- D.) Decreasing the resistance of R_f .
- E.) (None of these choices is correct.)

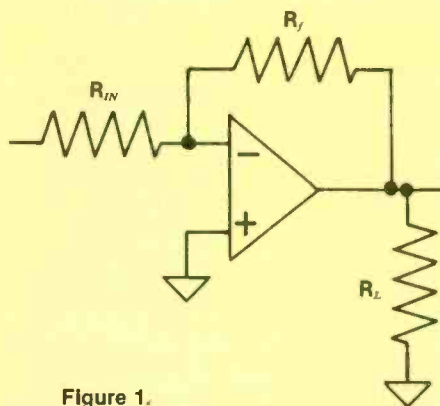
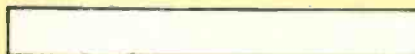

Figure 1.



5. Which of the following has the greatest frequency stability?

- A.) Wideband amplifiers
- B.) Narrowband amplifiers
- C.) Oscillators
- D.) Any amplifier with regenerative feedback
- E.) Medium bandwidth amplifiers

6. A graph showing the gain of an amplifier over the range of frequencies it is designed to cover is called

- A.) a Fourier analysis.
- B.) a stability plot.
- C.) a peaking graph.
- D.) a gain graph.
- E.) a Bode plot.

7. If a graph shows amplifier output power over a range of frequencies, the bandwidth of the amplifier is measured at the

- A.) maximum frequency point.
- B.) maximum amplitude point.
- C.) frequency range between the points where the curve drops to 70.7% of maximum.
- D.) -6dB points.
- E.) points where the output is 50% of maximum.

8. Technicians must be careful not to confuse low-frequency compensation in an amplifier circuit with

- A.) decoupling filters.
- B.) peaking compensation.
- C.) load resistors.
- D.) regenerative feedback.
- E.) noise generators.

9. Which of the following types of coupling is best for the vertical amplifier section of an oscilloscope?

- A.) Transformer
- B.) Impedance
- C.) R-C
- D.) Direct
- E.) Link

10. Which of the following is a problem with direct-coupled amplifiers?

- A.) Poor gain
- B.) Level shifting
- C.) Loss of low frequencies
- D.) Narrowband
- E.) 180° phase shift

Answers to the Quiz

1. B. A glitch is a short-duration pulse that is rich in harmonics. A wideband amplifier is needed for reproducing the harmonics and, thereby, reproducing the rapid rise of the glitch.

2. E. In the past, there have been some letters about this. However, the statement generally is true. It assumes that you have a working class-A amplifier.

3. C. Degenerative feedback, which is also called negative feedback, reduces the gain and increases the bandwidth of an

amplifier.

4. D. When R_f is decreased the gain is reduced. That, in turn, increases the bandwidth.

5. A. High-gain, narrowband amplifiers are more unstable. An oscillator is a very high-gain amplifier with a very narrow bandwidth.

6. E.

7. E. This is one definition of bandwidth.

8. A. Both circuits look the same.

However, decoupling circuits usually have a shorter time constant.

9. D. Assuming the circuit is properly designed, a direct-coupled amplifier has a very wide bandwidth.

10. B. With direct-coupled stages, each successive amplifier requires a high voltage for its operation. In bipolar circuits, an NPN amplifier is followed by a PNP type to shift the dc level. Another method used is to have an emitter follower in the output.

ES&T

**Coming
in...**

MARCH

Protecting against static electricity damage— Static electricity of a potential far lower than necessary to cause your clothes to cling or to cause a snap when you touch the faucet is enough, if discharged through a static-sensitive device, to destroy it. This article reviews the reasons why devices have become increasingly static sensitive, suggests easily followed procedures to minimize ESD damage, and discusses some of the products that are available to inhibit buildup of static electricity or drain it away as it builds up.

Servicing the Commodore 64— Starting with a review of the circuit design and theory of operation, this article takes the reader on a guided tour of the Commodore 64 personal computer, including suggested troubleshooting steps. An especially valuable feature of this article is a description of the symptoms observed after each major component was removed from the circuit.

Power protection for electronic equipment— A high-energy spike on your ac power line can disrupt the operation of sophisticated electronics equipment, or even destroy components. Other power line perturbations like sags, surges and electrical noise can impair the operation of electronics products. This article describes the nature of these power-line problems and suggests ways to combat them.

What do you know about electronics?— Capacitors and triggers. A Schmitt Trigger is a valuable circuit for two reasons: It provides abrupt transitions between its two output states and it exhibits hysteresis, which makes it stable in either state. Sam Wilson gives details about the operation of this valuable, interesting circuit, and ruminates about capacitors and transistor parameters.

Readers' Exchange

For Sale: Tubes—new 6AC7, 6B45, 6H6, 6SR7, 6X5, 35A5; L octals pretested, 6A8, 7B7 (two), 14AF7, 50X6; octals pretested, 1A7, 5W4, 6C5 (two), 6K6, 6N7, 6SA7 (two), 6SK7 (two), 6SL7, 6SW7 (two), 6SQ7 (two), 6SS7, 6X5 (two), 12A8, 2SW4 (two), 2S26; extras included, 1W 41-78 (two), 6F7. \$50 plus shipping, c.o.d. *M.E. Andrews Jr., Box 91, Exeter, RI 02822.*

Wanted: Service literature for KLH model 27 tuner amplifier. Will copy and return or pay for copy. *Jim Geier, Box 341, Ketchum, ID 83340.*

Needed: Flyback transformer for Broadmoor TV model 3513, part No. 0927076M or TCF-11. Please state price. *George Saylor, 2319 Parrish St., Philadelphia, PA 19130.*

For Sale: Sams Photofact folders 601 to 999 and assorted others. Must sell, \$1 each; digital capacitor meter with power transformer and a VTVM, \$125 or will trade for a DMM and a subtuner. *David Muratore, 27 Clarkview Road, New Windsor, NY 12550; 914-562-2805.*

For Sale: 300 new radio and TV tubes, \$150 plus shipping. All are in original cartons except a few of the older radio tubes. *T.W. Benson, 204 Riverside Ave., Tallahassee, AL 36078; 205-283-4266.*

For Sale: Various makes of multimeters, \$10 to \$75, send for lists; EICO multisignal tracer model 145, \$35; Jackson TV signal generator model TVG2, \$35. Payable in U.S. funds plus postage, or by money order. No checks. *Ed Barlow, Box 29, Tweed, Ontario, Canada K0K3J0.*

For Sale: Monsanto timer-counter model 100A, \$75; signal generator by LAB-VOLT, model 710, solid-state, \$50; color-TV parts, including picture tubes, all in perfect condition. *Gary Barzily, 84-39 120th St., Jamaica, NY 11415.*

For Sale: Sencore VA48, like new, \$650. *M. Burkhard, 21440 Iglesia Drive, Woodland Hills, CA 91364; 818-347-3748.*

Wanted: Books or manuals dealing with electrical aspects of neon sign construction and shop equipment. Will pay reasonable price. *Steve Mashburn, Route 3, Box 393-H, Muskogee, OK 74401; 918-687-1108.*

Wanted: Sams out-of-print "Transistor Circuit Design," by Oklee. *John H. Stephens, P.O. Box 168, Wickes, AR 71973.*

For Sale: 450 new receiving tubes; 700 used receiving tubes; used and new yokes and flybacks; ES&T schematics, 1970 to 1985. \$600 for all. *Jerry Finkel, 4924 NW 54th Court, Ft. Lauderdale, FL 33319.*

For Sale: Panasonic and Quasar service manuals, 1200 +, with 1985 supplements (bought out former Panasonic distributor). Included are manuals for televisions, microwaves, receivers—from foot warmers to hair dryers—plus some VCR and video camera manuals, and 15 binders valued at \$200. All, \$500 plus shipping. *Cyril Brennan, 661 Horseshoe Curve, Pike Road, AL 36064; 205-277-0189.*

For Sale: EICO model 950B bridge, \$35; DM6013 digital capacitance meter, \$45; prices plus shipping and COD All instruments in excellent condition, and with leads and manuals. *Ronald Kolasa, 4942 E. Flower Ave., Mesa, AZ 85206.*

Wanted: Conar model 400 Novice transmitter, model 500 Novice receiver and Conair model 215 digital multimeter. *William P. Jarvis, 1214 Fifth Ave., Beaver Falls, PA 15010.*

Needed: Schematics and service manual, or information, for the Panasonic open reel-to-reel helical scan videotape recorder model NV3082 and its companion video camera WV3082. *Robert C. Pease, Bob's Electronics, 340 E. Fourth Ave., Stanley, WI 54768; 715-644-2557.*

Wanted: Flyback transformer for Admiral color television, part No. 79A 187-1, chassis No. M10. Used, fair price. Sams Photofact folder 1477, reasonable price. *L.H., 4366 Eastport Drive, Bridgeport, MI 48722.*

Needed: Servicing literature for amplifier—Analog (AEA) A610 power amp. Schematics and service manuals, or any information, welcome; the company is out of business. *Norman D. Thompson, 141 Crystal Lake Road, Middletown, CT 06457; 203-284-4082.*

Needed: Supremes TV-1, TV-2 and R-1 manuals; Simpson 269 and 260, series-6 manuals. *C.T. Huth, 229 Melmore St., Tiffin, OH 44883.*

For Sale: VIZ Senior Voltohmyst model WV98C, like new, \$100 or best offer; new 8060 Fluke, 4½-digit with frequency measurements, true rms, dB-referenced, resistance measurement to 300M and other features, never been used, \$295. Prices plus COD, insurance and shipping. *Stanley Todorow, GG8468 Belle Bluff Drive, Grand Blanc, MI 48439.*

For Sale: B&K 1076 TV analyst, B&K 960 transistor radio analyst, RCA WO-535A oscilloscope. All are complete with manuals and test leads. \$350 for all, I will pay shipping. Free B&K 350 CRT checker with purchase. *David Lehmann, RR2, Box 104, Mansfield, MO 65704; 417-924-3350.*

For Sale or Trade: Regulated power supply, Heathkit model HWA 202-1, with output to 2.2A at 13.8V, ac input, can be wired for 120V or 240V, uses 3-wire grounded line cord, good condition, with manual, \$25; commercial cable system AM-FM receiver, Cablenet model 4033A, has 75 input, works great, \$7.50; H.F. transceiver, Heath HW-101, covers 80m to 10m, CW/SSB, with power supply, CW filter, SSB filter and manual, output 100W, with special Swan vernier main tuning knob, \$125. Other items too numerous to list, send s.a.s.e. *Mike Adams, Able TV and Electronics, 6333 Highway 2921, Panama City, FL 32404; 904-785-7824.*

Wanted: Magnavox AM-FM integrator, part No. 250564-1, new or used. *A.S.R. TV Service, 199-05 32nd Ave., Bayside, NY 11358; 718-352-5078.*

For Sale: NRI basic and advanced CB Communication Course, and NRI Audio Servicing Course that includes a trainer and electronic components for experiments, \$150; Simpson model 465A autoranging digital multimeter, \$200; 41 Sams CB service manuals, \$100; B&K model PR28 high voltage multiplier probe, new, \$18. All, excellent condition, with usual instruction manuals. *Clarence G. McKee, 9516 Zion Road, Rives Junction, MI 49277; 517-569-3139.*

Wanted: Sams Photofacts folders, 1400 to 2000. *Ray Brumbaugh, 118 Kaywood Drive, Statesville, NC 28677; 704-872-5742.*

Wanted: Schematics or service manuals for Radio Hallicrafters model S408, Zenith TV model 14DC15, Zenith radio ch. 5E60BT. State price. *Ram TV Service, San Vincente 4E, Mayaguez, PR 00708.*

For Sale: Sencore TF-151A transistor, FET tester, \$85; EICO 944 flyback, yoke tester, \$15. All, good condition, with manuals. *Bob Hogaboam, 7445 Chesterfield Road, Pensacola, FL 32506; 904-455-5587.*

Wanted: Complete kit of alignment tapes and mechanical jigs for servicing VHS VCRs. Also looking for NTSC generagto and a wow-and-flutter meter. Reasonably priced. *Dave's Stereo and TV Service, 111 Fourth St., Fulton, IL 61252; 815-589-4662.*

Wanted: B&K 747B tube tester in good condition. *C. Mott, Box 222, Mobil Land Court, Bloomington, IL 61701; 309-828-3515.*

Needed: General radio manual 1710-0100 for 1714 system power control, 1711 tracking sweep generator, 1713 parameter and 1712 tracking detector. *Bill Janton, Computer Technology, Flowing Wells High School, 3725 N. Flowing Wells Road, Tucson, AZ 85705.*

Wanted: Half-track or stereo playback for American Concertone model 505E reel-to-reel audio tape machine. *Don Setliff, Don Setliff Radio, Route No. 1, Box 237A, Apple Grove, WV 25502.*

For Sale: Model SG165 Sencore, like-new condition, \$795, will pay shipping; two Sony picture tubes No. 470FWB22 and 330AB22, \$80 each. *Robert F. Nestor, 3407 Arlington Ave., Riverside, CA 92506; 714-684-9893.*

Wanted: Schematics and/or operating instructions for Commercial Trades Institute model TC-20 tube checker and EICO model 625 tube tester. *M.E. Carney, RD No. 2, Box 139, Bridgeton, NJ 08302.*

Wanted: Capitol Radio Engineering Institute's Engineering Mathematics program No. 270. Reasonably priced. *D.M. Merritt, 29911 Mira Loma Drive, Apt. 2, Rancho, CA 92390.*

Wanted: For Bohsei TC-700 13" color television—doubler, part No. 2459-002-010; flyback, part No. 2859-000-0202. *Scott Winter, 572 Central Ave., Needham, MA 02192; 617-787-3510 (days), 617-449-4893 (evenings).*

For Sale: VA48, used only once. Complete with instructions and in original box. Make offer. *William J. Maida, 274 W. Sabal Palm Place, Longwood, FL 32779.*

For Sale: EICO model 944 flyback and yoke tester, unused, \$30; EICO model 495 scope voltage calibrator, \$20; Hickok model KS-15750-L1 tube tester, \$100. Send certified check. *N. Young, 214 E. Robertson St., Brandon, FL 33511.*

Wanted: New 455kHz miniature tube IF transformers—Zenith 95-1505, J.W. Miller 16-PC5, 12-C7, 14-C1, kHz455, GE M76J37-10. Also, Miller 7702-Z, etc. 14-pin IC F706APC. Manuals for Hickok tube tester model 533A, and Heath DX-20 transmitter. *WB2IQE Rock Radio, J.R. Fickeisen, 5014 Skinner Hill, Moravia, NY 13118; 315-497-1480.*

Photofact

Photofact folders for TV receivers and computers released by Howard W. Sams since ES&T's last report.

CITEK 7495A, 7498A	2380-1
CITEK 7494	2382-1
CITEK/TEKNIKA 5579/3579	2376-1
CITEK/TEKNIKA 5589/3589	2378-1
GOLD STAR CMT-2515	2382-2
KTV KCT1300	2381-1
MAGNAVOX Chassis 19C106-00AA/107-00AA/109-00AA/ 111-00AA/115-00DA/116-00AA/119-00AA/ 121-00CA	2376-2

MAGNAVOX RE4042WA01	2379-1
MITSUBISHI CS-1304	2381-2
PHILCO Chassis 13C501, 13C502	2380-2
SEARS 564.49050450/451	2382-3
SHARP 20J650	2377-1
SONY KV1976R (CH. SCC-548R-A)	2378-2
TOSHIBA Chassis TAC8336	2379-2
WARDS GNB12894A/B/C	2377-2

COMPUTERFACTS

RADIO SHACK TRS-80 Model 26-3002	CC13
STAR Model Gemini-15X	CP16

Classified

Advertising rates in the Classified Section are 75 cents per word, each insertion, and must be accompanied by payment to insure publications.

Each initial or abbreviation counts a full word.

Minimum classified charge is \$15.00.

For ads on which replies are sent to us for forwarding (blind ads), there is an additional charge of \$25.00 per insertion to cover department number, processing of replies, and mailing costs.

Classified columns are not open to advertising of any products regularly produced by manufacturers unless used and no longer owned by the manufacturer or distributor.

FOR SALE

AUTOMOBILE RADIO and tape replacement parts. Delco, Chrysler, Philco-Ford, Motorola, Panasonic and many others. Large inventory. Laran Electronics, Inc., 3768 Boston Road, Bronx, NY 10469. (212) 881-9600. National (800) 223-8314, NY State (800) 446-4430. 1-85-tfn

BOOTLEGGERS BIBLE for CB Modification \$12.95, CB Radio Repair \$10.95. Linear Amplifier Planbook \$14.95, kits, etc. Catalog \$1.00 refundable—APS, POB 263 Newport, R.I. 02840 401-846-5627. 12-84-tfn

SCRAMBLED TELEVISION, encoding/decoding. New book. Theory/circuits, \$9.95 plus \$1 shipping. Workbook, Box 393ES, Dept. E, Bethpage, NY 11714. 1-85-tfn

TV TROUBLE ANALYSIS TIPS. Over 300 symptoms/ remedies by circuit area; tough ones over the years. Save time and money. Send \$12.50 to CHAN TV, 8151 Grandview Rd., Chanhassen, MN 55317. 1-85-tfn

MAKE TELEPHONE answering machine servicing simple & professional. Without tying up your phone lines, our ring simulator will activate any machine on the market. You can hear the outgoing message, give your message, and also have the availability to check machines that have remote capability. Send your check for \$85.00 made payable to PSI, INC, to cover cost of machine shipping and handling or call (201) 845-6669. PSI, Inc. is located at: 34, Route 17 North, Paramus, New Jersey 07652. 4-84-tfn

CABLE CONVERTERS. Lowest price. Dealer inquiries accepted. Quantity Discounts. FREE CATALOG. P.G. Video Corp, 61 Gatchell St., Dept. ES&T, Buffalo, NY 14212. 5-85-tfn

REPAIR OF ZENITH circuit board 9-160-all; with dud exchange \$33.00. One year guarantee. Kiniral Electronics, 68-26 64th Place, Glendale, N.Y. 11385, (718) 366-3859. 12-8-5-3t

SANYO HORIZONTAL OUTPUT TRANSISTOR 2SD1341, \$1.99 plus other name brand transistors, IC's, RF-Power, Sanyo rechargeable batteries and LED's. For best buys plus service call 1-800-458-6053. PA call 1-800-672-7100. M/C/VISA honored. Savings, service, quality. At B&D we do it better. B&D Enterprises, Box 305, Kane, PA 16735. 1-86-2t

HEWLETT PACKARD 333A Distortion Analyzer \$495. B&K 801 cap analyst \$60.00. Both mint, prices negotiable. Konney, 2519 N. Austin, Chicago, 60639. 312-237-7845. 2-86-11

SONY-TRINITRON REBUILTS are now available. Call for price & delivery, 1-716-621-5250. 1-86-2t

CABLE TV CONVERTERS & EQUIPMENT. Plans and parts. Build or buy. FREE Information. C&D Electronics, P.O. Box 1402, Dept ES&T, Hope, Arkansas 71801. 1-86-tfn

INDIVIDUAL PHOTOFAC FOLDERS (Not sets) #1 to #1400. \$3.00 first-class postpaid. Loeb, 414 Chestnut Lane, East Meadow, NY 11554. 1-86-3t

HELP WANTED

CAMERA-VIDEO Technicians needed. Top pay and benefits for well trained and experienced technicians who are expert with consumer and/or industrial cameras and VCR's. Training by manufacturers such as Sony, Hitachi, Panasonic, etc., are necessary for job experience. Come to sunny Florida and enjoy your work & leisure time. Write or call ATLANTIC ELECTRONICS INC., 1881 NE 26 St., Ft. Lauderdale, FL 33305. (305) 564-8274 10 AM to 6:30 PM. Ask for Dave or Joe. 8-85-tfn

BUSINESS OPPORTUNITIES

3 HOURS FROM SAN FRANCISCO! Town of paradise in pine forested foothills. Electronic repair business. Building/shop/equipment/7 room residence with large garden. \$165K, (916) 872-1962. 12-85-tfn

SELF DESIGNERS, Investors, and Electro-Hobbyists we offer you our Complete Home Robot Designs. Exclusively from Cad Design Services. For your designs and listings of other current designs, send a check or money order for \$5.00 to: CAD Design Services, P.O. Box 1192, Jackson, MI 49204. 1-86-2t

TV REPAIR SHOP Well established. Located in rapidly growing Phoenix area. Nets \$60K+. Owner will carry with substantial down. VR Business Brokers, 935 E. Main St., Mesa, AZ 85203, Phone (602) 833-8923. 2-86-11

MID COAST MAIN Electronic repair shop for sale. House, shop, van, and all equipment \$84,000. Call or write Dolphin Electronics, Route 90, West Rockport, ME 04865, 207-236-9074. 12-85-2t

UNIVERSITY DEGREES—Economical home study for Bachelor's, Master's, Doctorate. Prestigious faculty counsels for independent study and life experience credits. Free Information—Richard Crews, M.D. (Harvard), President, Columbia Pacific University, 1415 Third St., Dept. 2B82, San Rafael, CA 94901; Toll Free: 800/227-0119; California: 800/552-5522; or 415/459-1650. 2-86-11

NEW!... 5th edition

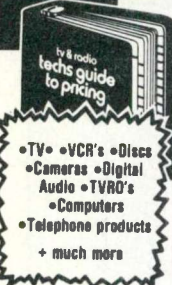

The new 5th edition of Tech's Guide to Pricing is a step by step succession of progressive pricing tiers by product category... a totally new concept, a formula that guarantees success...

FREE with order... 36 page booklet... filled with ideas, answers to questions you won't find in any other publication!



For details call **1-800-228-4338**
Mon/Fri 8/5 C.S.T.
You won't be disappointed!

Circle (23) on Reply Card

DANDY-DAPTER™

PATENTED CRT ADAPTER—Don't buy another socket for your CRT Tester! This is the Only way you can win the Socket War! Guaranteed to fit your tester & allow you to test/clean/restore ANY Color, B/W, Projection, Scope or Camera CRTs. Visa/M-Card, Checks, CODs. New Low Price \$59.95 (We pay UPS) 1(800) 331-9658. DANDY ELECTRONICS, 2323 GIBSON, MUSKOGEE, OK 74403.



Circle (24) on Reply Card

In our continuing efforts to serve you...

From time to time, Intertec Publishing Corp. makes its subscriber lists available to carefully screened companies or organizations whose products, services or information may be of interest to you. In every case, list users must submit their promotional material for approval. They may use the list only once.

No information other than name and address is ever divulged although names may be selected by segment to which the particular offer might appeal.

We are confident that the majority of our readers appreciate the controlled use of mailing lists. A few people may prefer their names not be used.

If you wish to have your name removed from any lists that we make available to others, please send your request together with your mailing address label to:

ELECTRONIC
Servicing & Technology

Direct Mail Mgr.
Intertec Publishing Corp.
P.O. Box 12901
Overland Park, KS 66212

Advertisers' Index

	Page Number	Reader Service Number	Advertiser Hotline
Automated Production Equipment Corp.....	51	14	516/654-1197
B&K Precision, Dynascan Corp.	21	19	312/889-9087
Beckman Industrial Corp.	58	22	714/671-4800
Boardworks	57	18	818/967-3681
Chemtronics, Inc.	27	9	800/645-5244
Cleveland Institute of Electronics ...	16,17	6	800/321-2155
Cleveland Institute of Electronics	16A-16B		800/321-2155
Cooper Group	3	4	919/362-7510
Dandy Mfg. Co.	64	24	800/331-9658
Diehl Engineering	19,43,59	12	806/359-0329
Digitron Electronic	47	13	800/526-4928
E-Z-Hook	IBC	2	818/445-6175
Edsyn Inc.	53	20	818/989-2324
ETA.....	56		
Leader Instrument Corp.	IFC	1,21	516/231-6900
MCM Electronics	23	8	800/543-4330
NATESA	56		
NESDA	39,51		817/921-9061
Network Technologies, Inc.....	55	16	216/543-1646
NRI Schools-Electronics Division.....	7		202/244-1600
Optima Electronics	27	10	800/327-0224
Pace, Inc.	9	5	301/490-9860
Philips ECG	15	17	800/225-8326
Projector Recorder Belt Corp.	55	15	800/558-9572
Sperry AW Instruments Inc.....	1	3	800/645-5398
Sperry Tech, Inc.	64	23	800/228-4338
Wahl Clipper Corp.	39	11	815/625-6525
Zenith	BAC		

ARTICLE REPRINTS

Interested in ordering custom reprints of an article from this issue?* Reprints of articles about your company or products can be valuable sales and marketing tools. For information, call or write Kelly Hawthorne, Intertec Publishing Corp., P.O. Box 12901, Overland Park, Kansas 66212; (913) 888-4664.

*minimum order 1,000 copies



Components and Adaptors

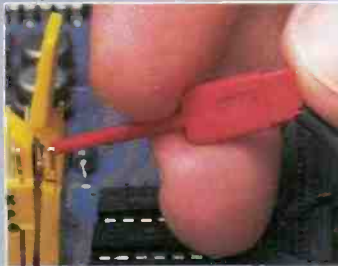

P-25 Plug-On Plcc Hook

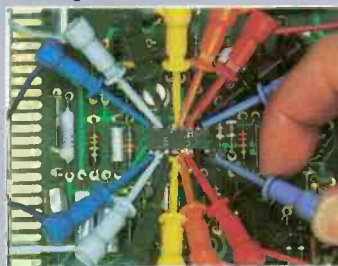

Micro-Hook

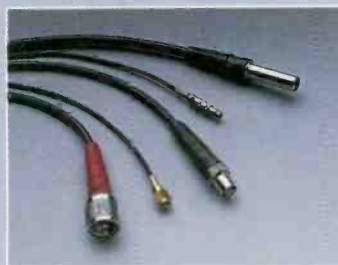

Coax Cable/Patch Cord Assemblies

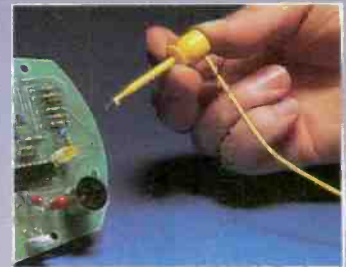
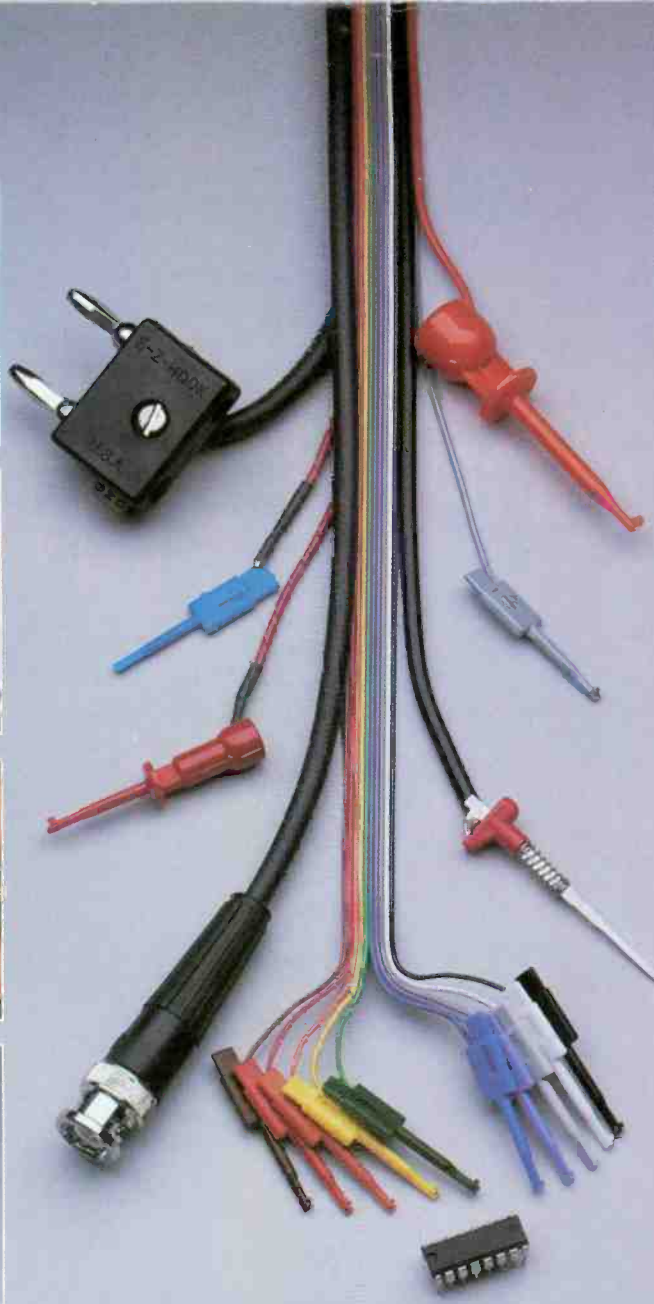

Mini-Hook Test Leads



Pico-Hook, Narrow/IC

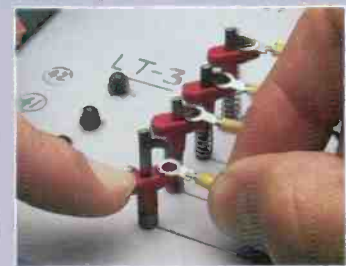

Nail-Clip, Harnessing



Tap-A-Dip 14 & 16 Pin Test Connectors

SIGNAL ACCURACY.

12,000 Reasons Why Industry Relies on E-Z HOOK.

Choose from over 12,000 standard test accessory products for an immediate solution to your application. They're engineered to assure a reliable contact or connection for any testing, hook-up or assembly task. And E-Z HOOK can ship what you need in 48 hours or less.

For a quick, economical answer to your testing needs, ask for our 112-page catalog of Electronic Test Accessories. It's free. And reliable.

E-Z-HOOK®

E-Z HOOK, A Division of Tektest, Inc., 225 North Second Ave., Arcadia, CA 91006
P.O. Box 450, (818) 446-6175. TWX 910-582-1614.

Circle (2) on Reply Card

WE MAKE SPECIALS
SEND US YOUR REQUIREMENTS!

Go for 'em! Solid margins year-around! They're yours in the video aftermarket! With this new VCR Care Kit by Zenith!

You bet there's a VCR aftermarket out there! A sizeable one. Perhaps as big as *twenty million plus* households. So that capitalizing on it with VCR accessories like this beautifully packaged Zenith VCR Care Kit can be very, very profitable.

Look and see for yourself!

Inside this kit, latest in a long line of Zenith video accessories – and available separately, too – are a great new VCR Head Cleaner. A T-120 VHS Blank Video Tape. A VCR Dust Cover. And a clear VHS Tape Storage Cover. All proudly bearing and backed by Zenith, a name renowned for superb product performance and reliability.

They are at your Zenith distributor's place now, these new Universal VCR Care Kits, ready for immediate delivery to heads-up service techs alert to the money to be made in the overall video aftermarket.

Actually, there's more in store than ever before in this expanding line of Zenith video accessories. More than just this new Universal VHS VCR Care Kit. Solid margins, for example. The kind that can turn some 6, 7 or 8 feet of your floor space into a video accessory profit center right before your eyes.

So hurry! Quit second-guessing yourself! Neither this video accessory business nor VCR aftermarket is going to wait for you. Call your Zenith distributor's Parts & Accessories Sales Manager!

Besides being an integral part of Zenith's new VCR Care Kit, this VCR Head Cleaner is also available separately as Model T-HC from your Zenith distributor.

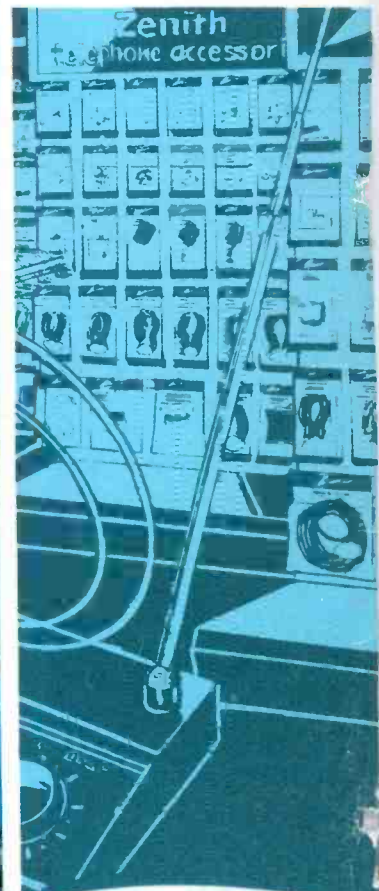

Zenith Service, Parts & Accessories
11000 Seymour Avenue, Franklin Park, Illinois 60131
A Division of Zenith Electronics Corporation