

# ELECTRONIC<sup>TM</sup>

*Servicing & Technology*

APRIL 1985/\$2.25

The video connection – part two • 10 typical Samsung TV problems

Understanding the floppy disk • Thick and thin film components

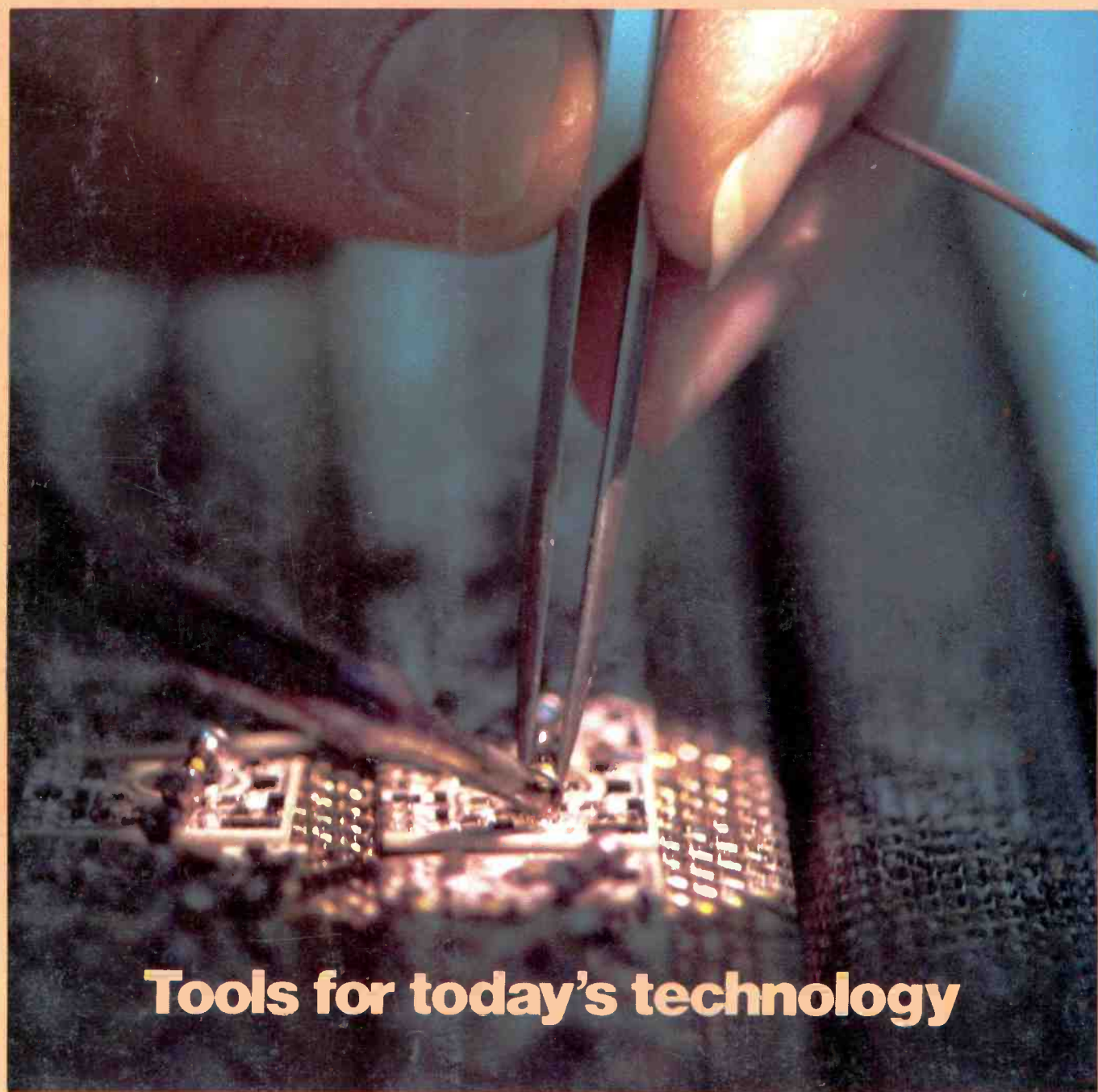

**Tools for today's technology**

# LEADER

LBO-516

## NEW 100-MHz OSCILLOSCOPE

✓ \$1395

Manufacturer's  
Suggested  
List Price

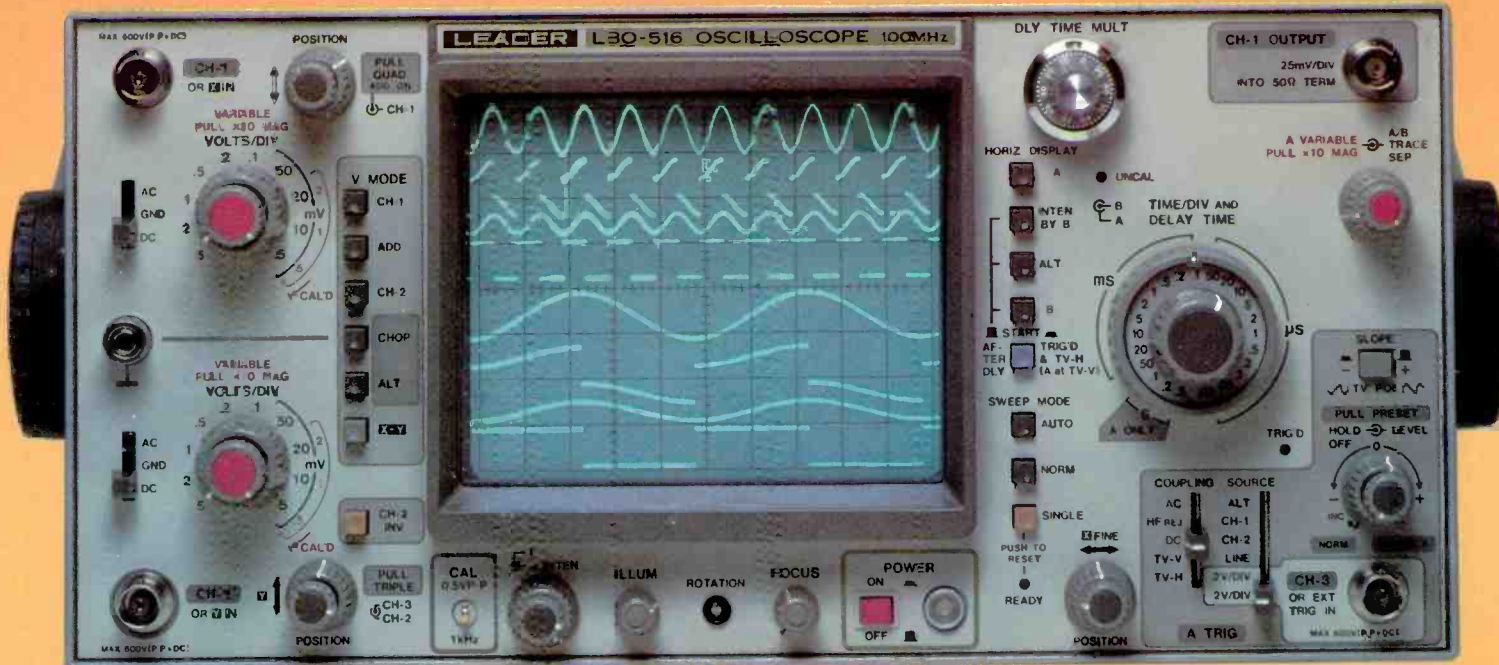

✓ 8-Trace  
Capability

✓ Alternate  
Triggering

✓ 2 Time Bases

✓ 3-Channel  
Input

✓ Clear, Bright  
Trace

✓ 0.5 mV  
Sensitivity

✓ 2-Year Warranty

✓ Coast-to-Coast  
Service

For immediate delivery or  
more information call toll-free

✓ 800-645-5104

In New York State  
516-231-6900

For professionals

who  
know  
the  
difference.

**LEADER**  
Instruments Corporation

380 Oser Ave., Hauppauge, NY 11788

For Information Circle (1) on Reply Card  
For Demonstration Circle (2) on Reply Card



# DO ■■■

Pass up this ad if you don't want to **save money**

**S**uper Savings

IMMEDIATE DELIVERY

Your Complete Electronic Parts Source!

CEI works around the clock to bring you the lowest prices all year round.

**CEI** Consolidated Electronics, Incorporated  
Your complete semiconductor source!

To Order Call:  
**1-800-543-3568**  
NATIONAL WATS  
**1-800-762-3412**  
OHIO WATS  
TELEX NO. 288-229  
IN DAYTON:(513) 252-5662

See inside for more of our everyday low prices!

OPEN EVENINGS AND SATURDAYS

THE CEI PRICE CHECK IT OUT

OPEN EVENINGS AND SATURDAYS

Now call toll free anywhere in Canada, Alaska, Hawaii, and Puerto Rico!

High quality, name brand semiconductors, plus all of the other electronic parts you'll ever need, all under one roof. Give **CEI** a call today, toll free, and discover why Consolidated Electronics truly is your complete electronic parts source!

**1-800-543-3568**

NATIONAL WATS

TELEX NO. 288-229

**1-800-762-3412**

OHIO WATS

IN DAYTON:(513) 252-5662

**THE CEI PRICE**  **Check it out!**

**CEI** Consolidated Electronics, Incorporated  
**Your Complete Electronic Parts Source!**

705 WATERVLIT AVE, DAYTON OHIO. 45420-2599

Circle (6) on Reply Card

# ELECTRONIC

*Servicing & Technology*

## 10 Tools for new technologies

Recently introduced technology includes digital electronics in everything from cars and refrigerators to televisions and VCRs, surface-mounted components and static-sensitive semiconductors, to name a few. This article describes some of the tools, techniques and test equipment developed expressly for this new equipment.

## 16 Test your electronic knowledge

*By Sam Wilson*  
Learn something new or try a review. This continuing series challenges you with questions from electronics' dim and distant past through today's most recent developments.

## 18 The video connection- Part II

*By Martin Clifford*  
As yesterday's television gives way to today's video entertainment center, the number of components increases and the number of ways to connect and misconnect them grows. In this series, Clifford guides you through the connectors and accessories, and gives some suggestions for keeping it all straight.

## 42 10 typical Samsung TV problems

*By Homer Davidson*  
Every brand of TV set experiences certain malfunctions that are more or less characteristic of that set. Knowing what some of them are can help pinpoint a problem with minimum wasted effort. Davidson provides pointers on clearing up problems with Samsung sets.

## 50 Understanding the floppy disk

Troubleshooting the mass storage device for the personal computer, the floppy disk drive, is aided by an understanding of how information is stored on the disk itself. Here's an explanation of how disks are made and how information is stored on them.

## 56 What do you know about components? – Printed circuits and zener diodes

*By Sam Wilson*  
Through thick and thin (films), Sam Wilson takes a look at printed circuit manufacturing techniques, and finishes up with a treatise on applying zener diodes.

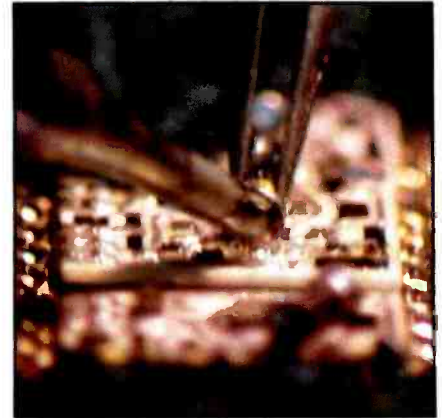

The thick-film circuit is just one of many achievements of modern electronic technology. Dealing with this advanced technology often requires equally advanced tools and test equipment. See the related story on page 10.

*(Photo courtesy DuPont Magazine)*



Page 6

## Departments:

- 4 Editorial
- 6 Technology
- 23 Photofact
- 24 New Products
- 55 News
- 59 Readers' Exchange
- 62 Literature





# The technology is advanced. The temperature stays put.



**EC 1000**  
Dial controlled with EC1201P iron.

**EC 2000**  
Three digit LED readout with EC1201P iron.

**EC3000**  
Dial controlled with lightweight EC1301 soldering pencil.

**EC 4000**  
Three digit LED readout with lightweight EC1301 soldering pencil.

All EC Series stations meet Mil-spec DOD-STD-2000-1



When you need controlled output soldering for sensitive components, you don't need uncontrolled temperature fluctuations at the work station. In the Weller EC Series, the tip temperature is maintained throughout the range of 350°F – 850°F to within 10°F. In addition, an electronic system utilizes thyristor power control with zero voltage thyristor drive. This

ensures that no high voltage spikes or magnetic fields will be present on the soldering tip.

These technologically advanced stations are capable of handling all the delicate soldering operations necessary, in even the most sophisticated applications. They offer the ultimate in soldering flexibility with a choice of controls and readouts to suit your needs precisely.

Check with your Electronics Distributor.

## Weller® EC series



**The difference between work and workmanship.**

BOKER® CRESCENT® LUFKIN® NICHOLSON® PLUMB® WELLER® WISS® XCELITE®  
The Cooper Group PO Box 728 Apex NC, 27502 USA Tel (919) 362-7510 Telex 579497

Circle (7) on Reply Card

## Computer as test equipment

Since their introduction sometime in the early seventies, personal computers have evolved from systems that were, for the most part, little more than toys or hobby equipment into real computers that can be used in the home or place of business to store and retrieve information, to process words, to solve mathematical problems or to perform a host of other tasks; not to mention playing games.

This evolution, or perhaps revolution, has been fueled by a number of advancements that occurred more or less simultaneously: The hardware became more sophisticated and easy to use, while the software also became more sophisticated and easy to use. Because of the avalanche of interest of people in computers, they began to be produced in quantity, and so the price came down. No doubt there are many other reasons that could be cited. As more and more applications of personal computers were developed, it became more and more obvious that the computer is indeed a general purpose device.

One development that has become evident recently, and that should be of great interest to just about anyone who is involved in electronics, is the use of the personal computer as test equipment.

One such example is the oscilloscope peripheral mentioned in this issue in the article "Tools and test equipment for new technology." This unit consists of hardware that picks up the signal to be analyzed and converts the analog signal into a digital signal. The software allows the computer to process the signal information and display it on the face on the computer monitor. Because one of the computer's inherent features is memory, this information about

the waveform may not only be captured and displayed, but it may be stored for analysis later.

Another computer peripheral that turns the computer into a piece of test equipment is the Video Tune-Up for the Commodore 64. In the same article, you'll also find a description of this unit, which converts the computer into a full-function video analyzer.

Everywhere you look there are products that contain microprocessors. In some cases, the microprocessor merely adds convenience features; as in a microwave oven where it allows you to thaw the food, then automatically switches into a cooking mode. In other cases, the microprocessors improve energy efficiency, or provide a degree of control not possible by the mechanical systems they're incorporated into; as in automotive engines. In still other cases, some products we take for granted today wouldn't exist at all, or at least not in the form we're familiar with, were it not for the microprocessor: the videocassette recorder and the digital compact disc player to name two. Now these new peripherals, in turn, add extra features to an already useful piece of equipment, the personal computer.

It's anybody's guess where microcomputers will show up next, or what new use will be found for the personal computer. There's no question though that the microcomputer will continue to grow in importance, and will have to be well understood by anyone who wants to remain in the forefront of electronics.

*Nils Conrad Persson*

### **ELECTRONIC** Servicing & Technology

Editorial, advertising and circulation correspondence should be addressed to: P.O. Box 12901, Overland Park, KS 66212-9981 (a suburb of Kansas City, MO); (913) 888-4664.

#### EDITORIAL

Nils Conrad Persson, *Editor*  
Carl Babcoke, *Consumer Servicing Consultant*  
Rhonda Wickham, *Managing Editor*  
Joy Culver, *Associate Editor*

#### ART

Kevin Callahan, *Art Director*  
Jonl Harding, *Graphic Designer*

#### CIRCULATION

John C. Arnst, *Director*  
Evelyn Rogers, *Manager*  
Dee Manies, *Reader Correspondent*

#### ADMINISTRATION

R. J. Hancock, *President*  
Cameron Bishop, *Publisher*  
Eric Jacobson, *Associate Publisher*

#### ADVERTISING

Greg Garrison, *National Sales Manager*  
Julie Roberts, *Production Manager*  
Stephanie Fagan, *Marketing Coordinator*  
Kelly Hawthorne, *Marketing Assistant*



Member, Audit Bureau  
of Circulation



Member, American  
Business Press

ELECTRONIC SERVICING & TECHNOLOGY (USPS 462-050) (with which is combined Electronic Technician/Dealef) is published monthly by Intertec Publishing Corp., 9221 Quivira Road, P.O. Box 12901, Overland Park, KS 66212-9981. Second Class Postage paid at Shawnee Mission, KS 66201. Send Form 3579 to P.O. Box 12952, Overland Park, KS 66212-9981.

ELECTRONIC SERVICING & TECHNOLOGY is the "how-to" magazine of electronics. It is edited for electronic professionals and enthusiasts who are interested in buying, building, installing and repairing home-entertainment electronic equipment (audio, video, microcomputers, electronic games, etc.).

SUBSCRIPTION PRICES: one year \$18, two years \$30, three years \$38 in the USA and its possessions. Foreign countries: one year \$22, two years \$34, three years \$44. Single copy price \$2.25; back copies \$3.00. Adjustment necessitated by subscription termination to single copy rate. Allow 6 to 8 weeks delivery for change of address. Allow 6 to 8 weeks for new subscriptions.

PHOTOCOPY RIGHTS: Permission to photocopy for internal or personal use is granted by Intertec Publishing Corp. for libraries and others registered with Copyright Clearance Center (CCC), provided the base fee of \$2 per copy of article is paid directly to CCC, 21 Congress St., Salem, MA 01970. Special requests should be addressed to Cameron Bishop, publisher.  
ISSN 0278-9922 \$2.00 + 0.00

**INTERTEC**  
PUBLISHING CORPORATION

©1985 All rights reserved



# Take home a world champion.

**\$85\*** gets you a technical knockout.  
**The Fluke 70 Series.**  
**Winners of the digital vs. analog battle.**

Since their debut, they've become the worldwide champions of the industry.

Never before have such tough, American-made meters offered so many professional features at such unbeatable prices.

Each comes with a 3-year warranty, 2,000+ hour battery life, and instant autoranging.

You also get the extra resolution of a 3200-count LCD display, plus a responsive analog bar graph for quick visual checks of continuity, peaking, nulling and trends.

Choose from the Fluke 73, the ultimate in simplicity. The feature-packed Fluke 75. Or the deluxe Fluke 77, with its own protective holster and unique "Touch Hold" function\*\* that captures and holds readings, then beeps to alert you.

So don't settle for just a contender. Take home a world champion.

For your nearest distributor or a free brochure, call toll-free anytime  
**1-800-227-3800, Ext. 229.** From outside the U.S., call 1-402-496-1350, Ext. 229.

**FROM THE WORLD LEADER  
IN DIGITAL MULTIMETERS.**



FLUKE 73	FLUKE 75	FLUKE 77
\$85*	\$99*	\$129*
Analog/digital display	Analog/digital display	Analog/digital display
Volts, ohms, 10A, diode test	Volts, ohms, 10A, mA, diode test	Volts, ohms, 10A, mA, diode test
Autorange	Audible continuity	Audible continuity
0.7% basic dc accuracy	Autorange/range hold	"Touch Hold" function
2000+ hour battery life	0.5% basic dc accuracy	Autorange/range hold
3-year warranty	2000+ hour battery life	0.3% basic dc accuracy
	3-year warranty	2000+ hour battery life
		3-year warranty
		Multipurpose holster

\* Suggested U.S. list price, effective July 1, 1984.  
\*\* Patent pending.



# Flat color television is on the way

A newly developed color display may soon replace standard CRTs with flat screens in TV/video equipment. The flat panel, developed by Matsushita Electric Industrial Company, has been incorporated in a prototype of a flat color television featuring a 10-inch diagonal screen and a depth of less than four inches.

The color flat panel features a square, completely flat screen which reproduces distortion-free images throughout the entire display area. These features make the screen suitable for *new media* and office automation display applications where space efficiency is crucial. New media consist of several new services, including teletext, direct broadcast satellite, high definition TV and cable/pay TV.

The color flat panel was developed using Matsushita's matrix drive and deflection system. The panel's screen consists of 3000 picture cells arranged in a matrix: 200 units horizontally and 15 vertically. Each picture cell is scanned by one electron beam which excites phosphor stripes.

The matrix drive and deflection system produces a color flat panel that has the flatness of LCD (liquid crystal displays) and EL (electroluminescent) displays, as well as the high color reproducibility, high resolution and brightness of existing color picture tubes.

Matsushita's flat color TV prototype provides a resolution of 270 TV lines, a contrast ratio of more than 50, and a brightness of more than 70-foot-Lamberts (fL).

### Matrix drive and deflection system

The matrix drive and deflection system produces 3000 controlled beams by forming a matrix of 15 filament cathodes and 200 electron-beam control electrodes which cross cathodes at right angles.



Each beam is horizontally deflected in six steps (two sets of RGB) and vertically deflected in 32 steps (including the interlace) to form images consisting of 192,000 elements on the display panel. A complete picture is formed through the line-at-a-time method.

This deflection method also reduces the number of electrode terminals required to approximately 1/7 of the number used in the conventional matrix driving method.

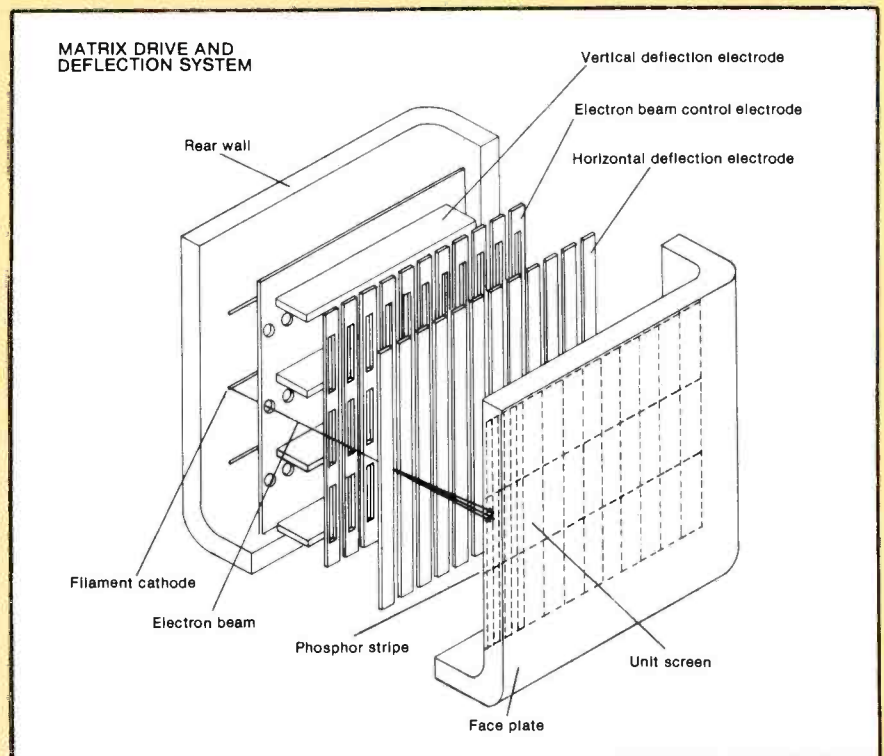

	SPECIFICATIONS	
	Color Flat Panel	Flat Color Television
Screen size:	200mm x 150mm	10-inch diagonal
Dimensions:	282(W) x 222(H) x 65(D)mm	370(W) x 355(H) x 99(D)mm
Weight:	7.5kg	14kg
Power consumption:	7W	70W
Brightness:	70fL	70fL
Resolution:	picture element pitch of 0.5mm	270 TV lines
Contrast:	More than 50	Gray scale: 64



# Sams makes it simple! ES & T makes it economical!

ES & T Book Club offers a  
20% discount on these Sams books:



**SEMICONDUCTOR GENERAL PURPOSE REPLACEMENTS** (5th Edition) includes almost 225,000 bipolar and field-effect transistors, diodes, rectifiers, ICs and more. No. 22418, List price \$9.95, Your price \$7.95.

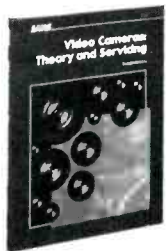

**VIDEO CAMERAS: THEORY AND SERVICING** introduces you to all aspects of video cameras from image tubes to the final interface. Includes a helpful troubleshooting section. No. 22382, List price \$14.95, Your price \$11.95.



**HOW TO MAINTAIN AND SERVICE YOUR SMALL COMPUTER** provides simple maintenance procedures you can use on all small computers to reduce problems and downtime. No. 22016, List price \$17.95, Your price \$14.35.



**MICROPROCESSOR BASED ROBOTICS** teaches you the mechanics of robotic arms and legs, tactile sensing, motion and attitude sensing, vision systems and voice command systems. No. 22050, List price \$16.95, Your price \$13.55.



**HOWARD W. SAMS CRASH COURSE IN DIGITAL TECHNOLOGY** quickly provides you with a solid foundation in digital fundamentals, state-of-the-art components, circuits and techniques. No. 21845, List price \$19.95, Your price \$15.95.



**INSTRUMENTATION TRAINING COURSE—PNEUMATIC AND ELECTRONIC INSTRUMENTS** (Vol. 1 and 2) is a two-book set that presents theory, construction, alignment, installation and operation of a variety of pneumatic and electronic instruments. No. 21581, List price \$27.95, Your price \$22.35.

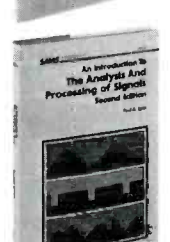

**INTRODUCTION TO THE ANALYSIS AND PROCESSING OF SIGNALS** (2nd Edition) covers periodic, aperiodic, sampled-data, random signals, signal comparisons, filters, signal recovery and more. No. 22253, List price \$19.95, Your price \$15.95.

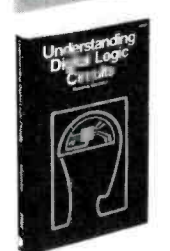

**UNDERSTANDING DIGITAL LOGIC CIRCUITS** is written for radio, TV or audio technicians interested in digital logic. It covers adders and subtractors, flip-flops, registers, encoders and decoders. No. 21867, List price \$18.95, Your price \$15.15.

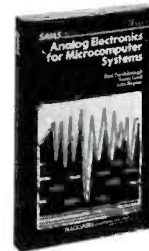

**ANALOG ELECTRONICS AND MICRO-COMPUTER SYSTEMS** covers power supply design, analog signal conditioning, data acquisition principles, data communication links, implementation of PID control and more. No. 21821, List price \$19.95, Your price \$15.95.

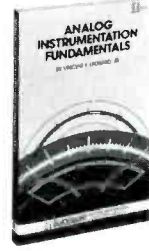

**ANALOG INSTRUMENTATION FUNDAMENTALS** provides excellent coverage of ammeters, voltmeters, ohmmeters, bridges, filters and attenuators. Includes many hands-on examples. No. 21835, List price \$19.95, Your price \$15.95.



**DESIGN OF OP-AMP CIRCUITS WITH EXPERIMENTS** illustrates the design and operation of linear amplifiers, differentiators and convertors voltage and current converters, and active filters. No. 21537, List price \$11.95, Your price \$9.55.



**ELECTRONIC PROTOTYPE CONSTRUCTION** discusses IC-based and microcomputer-related schematics and ideas for evaluation and testing. No. 21895, List price \$17.95, Your price \$14.35.

Order as many Sams books as you want!

QUANTITY	BOOK NO.	PRICE	AMOUNT	<input type="checkbox"/> PAYMENT ENCLOSED <input type="checkbox"/> CHECK <input type="checkbox"/> MONEY ORDER <input type="checkbox"/> VISA <input type="checkbox"/> MASTERCARD Interbank No. _____	
_____	_____	_____	_____	Account No. _____	Expiration Date _____
_____	_____	_____	_____	Name (print) _____	
_____	_____	_____	_____	Signature _____	
_____	_____	_____	_____	Address _____	
_____	_____	_____	_____	City _____ State _____ Zip _____	
			Amount of Order \$ _____	<b>Mail to:</b> Electronic Servicing and Technology Book Club	
			Add Shipping & Handling 2.00	P.O. Box 12901	
			Total Amount of Order \$ _____	Overland Park, KS 66212	

**ELECTRONIC**  
Servicing & Technology

Circle (9) on Reply Card

### Focusing technology of electron beam

This system's lack of a shadow mask, found in conventional color picture tubes, necessitates a fine electron beam of the same width as a phosphor stripe. Matsushita found the optimum electrode structure using the 3-dimensional simulation technology previously developed by the company.

Separation of the horizontal and vertical lens systems to provide individual control of their focusings resulted in improved resolution and color reproducibility.

### Precision processing and assembly technology

Uniform electronic character-

istics, to assure uniformity in brightness and purity in color, were provided by the development of a processing technology for precision structural components and a relevant technology for precision assembly of these components. Of special importance to uniform display was the development of a cementing process that evenly and alternately adheres 0.1mm grid electrodes with insulating plates.

### Digital technology

Signal processing and driving are performed digitally. Picture brightness is controlled by varying the pulse width that drives electron beams, thereby generating 64

steps in gray scale.

Color reproduction is performed by digitizing the picture signal and alternately driving red, green and blue signals. Resolution is markedly improved by giving time differences in sampling each.

Using a microcomputer for fine adjustment of the diameter and position of electron beams on the phosphor screen results in uniform brightness and high color reproducibility.

Through the development of these new technologies, the flat color television is said by the manufacturer to offer crisp, high-quality pictures that cannot be produced by conventional flat color displays.

## Register temperature in one minute Digital thermometer

SPECIFICATIONS	
Range	32.0—43.0 °C 90.0—110.0 °F
Accuracy	± 0.1 °C ± 0.2 °F
Display	3-digit LCD
Response Time	Oral—1 min. Armpit—2 min.
Peak Hold Device	Incorporated
Indicator	4mm-high LCD
Switching	Push-button
Battery	Silver oxide (SR-41W type)
Power Consumption	0.3mW; up to 2050 measurements
Automatic Power-Off	After 10 min.
Dimensions	120 x 12.9 x 10.5mm (4.7 x 5.0 x 4.1 inch)
Weight	9g (3 ounces)

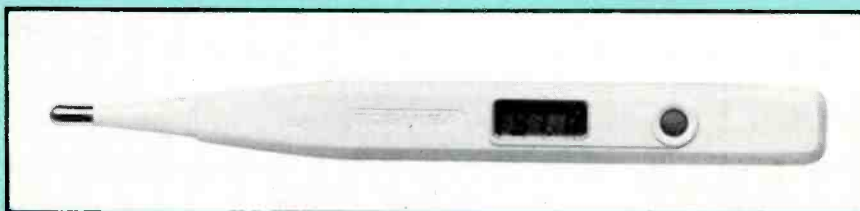

An electronic clinical thermometer that features a read-at-a-glance 3-digit LCD has been developed by Toshiba Glass Company, a subsidiary of Toshiba Corporation. This electronic unit is as precise as a glass tube mercury thermometer—accurate within 0.2°F (0.1°C)—yet takes only one minute under the tongue to register the body's temperature.

Other features of the thermometer include: a wide measurement range—90° to 100°F (32° to 43°C); a visible display that makes it possible to *see* rather than to *read* the temperature; and an on/off switch making it unnecessary to shake down mercury after each reading as in conventional thermometers.

For this device, a low power consumption CMOS LSI chip was developed. This chip calculates temperatures by measuring the small variations in electric frequency, as emitted from a heat sensor or thermistor, to match changes in temperature.

The thermometer is offered in either Fahrenheit or Celsius readings and includes a slip-on, plastic protective case. It is available in the United States for about \$14.

**OSI**



# ATTENTION TV TECHNICIANS

Diehl Engineering, the same people who conceived, designed and now manufacture **Super Tech** diagnostic computers for analyzing start up, shut down, flyback and flyback related circuits, now has something else that will make your job faster, easier and much more profitable.

## A NEW PUBLICATION

You might say that our monthly **Technician / Shopowner** newsletter is an all out training program for those who are already working in the TV service industry, as well as for those who soon plan to be doing so.

Each month we take at least one concept, circuit or function and totally dissect it. We then explain every conceivable aspect in plain and simple English. When we are finished, you not only understand the operation, you also understand how the operation, "inter-reacts" with all of the other circuits that it is related to.

Once every aspect of operation has been explained, we show you how to break the subject down into sections. Then, show you how to troubleshoot each section on an individual basis.

Because of the manner in which our publication is written, the subject knowledge that is gained in each monthly issue is so broad, that it "spills over" into your every day troubleshooting routine.

Our **Technician/Shop owner** monthly newsletter is 100% devoted to the TV technician. It contains nothing but pertinent information on TV repair. We do not sell advertising space. Those who subscribe, do so because of its technical content, which we pledge to be far superior to anything else that you can obtain.

Each monthly issue (manual) contains up to 68 pages filled with schematics, diagrams and illustrations that relate to the very circuits that you are seeing today. We do not teach this year's chassis, we realize that you are seeing sets that are five, ten or even fifteen years old.

Our newsletter is not a collection of part numbers that cause specific problems in specific chassis when they fail. Instead, we explain what each individual component in a given circuit does, what purpose it serves, and what effect it will have if and when it fails.

Our subscribers can look at any resistor, any capacitor, any diode, any transformer, etc., in any circuit, and know exactly what purpose it serves. They will know what turns the circuit on, what turns it off, why and when such action occurs, and what happens if a specific action does not occur.

Our subscribers will no longer have to be content to know that R421 causes a particular chassis to shut down if it becomes open, they will know **why** it does.

Our subscribers will no longer run around in circles hoping to stumble over a "bad" component, they will know **exactly** what they are looking for, and --- how to find it!

When it comes to troubleshooting color TV sets, we have introduced more, innovative techniques than any other firm in the world (including manufacturers).

### In case that amuses you, consider this:

Everyone else in the industry is telling you to probe here and there in this chassis, there and somewhere else in another chassis, in hopes of isolating the actual circuit that has failed. Conventionally, one specific technique that works for one chassis may do nothing but smoke components in the next.

Yet, while others have been teaching "conventional" techniques (usually a different one for each chassis), we at **Diehl Engineering**

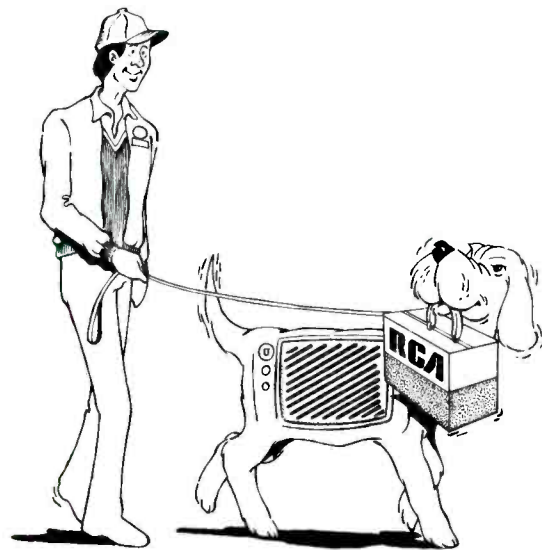

designed a computer that will isolate the defective stage in any hi-voltage circuit that employs a horiz output transistor (including Sony). With our **Super Tech** computer, you push the same four buttons no matter which set you are working on. Any brand, any age any chassis, **SuperTech** will give you an **accurate** answer. (see our ad on pg. 13)

We are not implying that those who teach "conventional" techniques are technically incompetent. Far from it, some of them are brilliant! We simply have a new and much easier way of looking at things. Ours is easier to understand and far more versatile. Because of the manner in which we present it, the retention level is also higher (according to those who are now using our literature).

Any staff that can design a computer that can analyze **any** hi-voltage circuit (except for those which use a trace and retrace SCR i.e. RCA CTC 40-81) must surely have a thorough knowledge of **all** circuits. Soon we will release similar computers for vertical and audio circuits, another for tuner, IF, AGC, video, blanking, ABL, Chroma, matrix and CRT, and still another for troubleshooting VCR!

The point is, we at **Diehl** engineering understand circuitry. We also know how to **explain** circuitry in such a way that it is easily understood.

Each month's issue is printed in the form of a manual. Each manual is pre-drilled so that it can be filed in a 3 ring binder for instant reference (the 3 ring binder is not provided).

**The First Issue** covers resistors, capacitors, diodes, inductors, transistors, IC chips and time constant circuitry. It explains how each component works, why it works, why it fails, and how each component relates to the overall circuit, all in plain and simple, down to earth, everyday English, without the use of mathematical formulas. After reading this issue, you can look at any component in any circuit and **truly** understand **what** it does, **why** it does it and what will happen if it doesn't do it; right down to each individual resistor, capacitor, and diode.

**The Second Issue** covers SCR driven hi-voltage circuits such as those used in RCA CTC 40-81, Philco, Coronado, Bradford, etc. After reading this issue, this circuit will become no more complex than simple amplifier. Over 30 illustrated schematics are used to teach this circuit in absolute detail. Such things as HV regulator functions, shut down features, etc. are thoroughly explained.

**The Third Issue** covers RCA LV regulator circuits (CTC 85 and up). It explains how each individual component operates, what it does, when it does it and, how to effectively troubleshoot the overall circuit.

Our no paid advertising policy makes our newsletter a little more expensive, but it also gives us "cover to cover" space for nothing but pertinent technical information on TV service. At \$9.95 per issue, a twelve month subscription costs only \$119.40. Very economical, considering that its technical content is equal to a "full blown" study course on TV repair. If you wish, you may try the first three issues for only \$21.00 (just seven dollars per issue, a savings of \$8.85 off the regular price).

For immediate service on C.O.D., Visa, or Master Charge orders:

**Phone (806) 359-1824 or (806) 359-0329.**

**If you are looking for help - - - we have it!**

Diehl Engineering, 6004 Estacado Lane, Amarillo, Texas 79109.

Circle ( 12 ) on Reader Service Card.

# Tools for New Technologies

In just the past few years, we have been inundated by new electronic products as well as new ICs, components and circuits to enhance the operation of existing products. Just take a look around: VCRs, audio compact disc players, pocket size televisions (in color, no less), home computers with all their peripherals and telephones with advanced features are just a few of the products that have become available recently.

The tools and test equipment designed for an earlier generation of consumer electronic products will no doubt be adequate to diagnose and repair many of the failures these products will experience. On the other hand, many of the new circuits, components and products will not yield to the tools, test equipment and techniques designed to service an earlier generation of home electronic products.

## New soldering/desoldering tools

Take a look, for example, at some of the new surface-mounted circuit components being used more and more extensively, especially in the tightly-packed innards of tiny, lightweight products like hand-held televisions, ear-phone radios and video camera/recorders. (For a detailed introduction to surface-mounted components, see the article "Are you ready for surface-mount components" in the February 1985 **ES&T**.)

When you're trying to extricate one of these tiny IC packages from a PC board, even a 25W soldering pencil looks huge. To complicate matters, once you do manage to get all the solder removed from every lead, you may find that the IC shows no inclination whatever for being separated from the circuit board.

The secret in this case, is in knowing that the manufacturer may have used a tiny drop of adhesive to hold the component in

place until the leads were soldered. If the solder has been completely removed, all you need to do is grip the IC with a pair of pliers and twist. The adhesive bond is formulated so it will shatter when this kind of force is applied.

Now the challenge becomes how to solder in a replacement IC without: 1) applying so much heat that a foil lifts; 2) applying so much heat that a junction within the package gets too much heat; or 3) causing solder bridges between leads.

Manufacturers of soldering/desoldering equipment and accessories have responded to these innovations in component and circuit construction with a selection of equipment designed to make the task of soldering/desoldering these tiny devices possible, although not necessarily easy.

For example, there's the 200W self-contained digital electronic temperature controlled IC removal/replacement station called a Heat-A-Dip station, manufactured by Micro Electronic Systems of Brookfield, CT. It accommodates

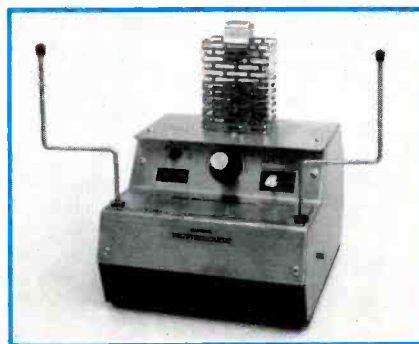

Desoldering equipment such as the Heat-A-Dip can simplify the removal of an IC from the PC board by heating all the leads at one time.

all ICs, 6 through 64 pin, on single or multilayer boards and is also capable of special applications such as rapid removal of connectors, relays, switches, etc.

The system, according to the manufacturer, is accurate to within 10 degrees Fahrenheit and

includes a Pull-A-Dip IC extraction tool, Dip-A-Dip IC insertion tool and Wipe-A-Dip dross remover.

The standard system is for 14/16 pin ICs, while the balance of the rework heads and tools are available as options.

The unit features Teflon PCB protection designed to eliminate, measling, burning, lifting of pads and land areas because everything is in the molten state when removing the old IC and replacing it with a new one, all in one operation. It also features a stainless steel top for easy removal of excess solder.

Anyone who has done any soldering knows there are times when it would be nice to have a third hand. A soldering iron from Gardner Precision Engineering, Woking, Surrey, England, does the next best thing; it allows you to control both soldering iron and solder with one hand.

The iron houses 13 feet of coiled flux-cored solder in a transparent polycarbonate handle and incorporates an operator-controlled self-feeding mechanism that supplies soldering wire to the tip. You can apply the tip and solder simultaneously with only one hand to the joint being soldered, leaving your other hand free to hold together the parts being soldered.

Simultaneous application of tip, solder and flux to the workpiece reduces the risk of cold solder joining that can result from coating the tip with solder and applying the tip to the joint in a second operation.

The combination of lightness, small size and 1-handed operation makes the tool suitable for a wide variety of applications, according to the manufacturer, particularly for soldering small, difficult-to-reach components. Applications range from production and repair work with electrical, electronic, radio and TV equipment to jewelry and model making.

To feed the joint with solder, you turn a serrated hardened steel





Self-feeding soldering iron allows the operator to feed solder with the same hand that holds the iron, freeing the other hand to hold the board.

wheel with the index finger of the hand holding the tool. The wheel engages with the soldering wire stored in the handle, draws it out and feeds it to the tip via a stainless steel tube. This tube projects out of the handle and curves upwards at its delivery end to bring the solder into direct contact with the tip.

The solder reservoir is transparent so you can see when it must be refilled. The company supplies disposable refill tubes containing 13 feet of coiled flux-cored soldering wire. To refill the reservoir—which occupies about half the space within the handle—a cap at the rear of the handle is unclipped. Next, a short section of soldering wire from the refill tube is fed into a nylon tube in the reservoir until it engages with the feed wheel. As the wheel is turned to feed the wire into the stainless steel delivery tube, the refill tube is inserted into the rear of the handle and then removed, leaving its contents coiled in the reservoir.

Because printed circuit boards have become so crowded and intricate, soldering and desoldering

in many cases require the skills of a fine craftsman. This has been recognized by the industry, and a wealth of educational material has been produced. Several TV set manufacturers have produced educational brochures or videotapes describing how to solder/desolder tiny components from fine foil traces on circuit boards.

The Electronic Industries Association Consumer Electronics Group (EIA/CEG) in Washington, DC, has prepared two videotapes on soldering/desoldering: one for supervisors and one for technicians. These are available at nominal cost from EIA.

Manufacturers of soldering/desoldering equipment also have been busy, putting together educational materials on soldering/desoldering. One such company is Pace of Laurel, MD. They have prepared a complete educational program with curricula and equipment for the implementation of repair skills for schools dealing with careers in electronics.

According to Pace, the program may be used for vocational training or to meet specific core requirements (for PCB rework and repair/advanced photocopying) that are found in most electronics curricula. This program includes: videotape programs accompanied by textbooks and instructor's guide, plus station setups to provide *hands-on* training.

There are eight individual lessons: Repair concepts; Elements of construction; Component removal; Solder extraction with continuous vacuum; Removing conformal coatings; Damage repair; Replating edge connectors; and Preventing electrical damage. Normal duration of the course is 60 hours, depending upon the skill level of the student.

### The personal computer as test equipment

As anyone who has investigated

computers is aware, one of the greatest obstacles to understanding computers is their general-purpose nature. Because a computer manipulates information in its most fundamental form, the binary digit, it is capable of performing an extremely broad range of tasks. You can use a microcomputer as an electronic filing cabinet, a word processor, a graphic arts design board, a video game machine, a musical instrument or a textbook...to name a few of its applications. All you have to do is get the required software and possibly a piece of peripheral hardware to provide an interface.

A company named Rapid Systems, in Bellevue, WA has developed software and a peripheral that, they claim, will turn your IBM, Apple or Commodore personal computer into an oscilloscope.

The peripheral provides a powerful digital oscilloscope; the personal computer provides intelligent control and analysis. The unit is a 4-channel digital oscilloscope, with a 2MHz sampling rate, 500kHz analog bandwidth and diode pro-



Soldering/desoldering has become such a critical skill that many agencies offer comprehensive courses on it, such as the one shown here.

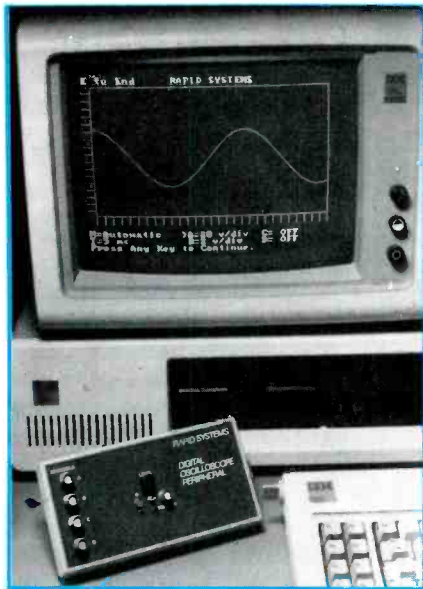

A digital oscilloscope peripheral, along with the requisite software can turn your personal computer into a digital-storage oscilloscope.

tection on all inputs. Graphics display is color enhanced, using up to 138 x 288 pixels for data display (up to four traces) and four lines of text for initial (default) values of the scope's parameters.

A fast, informative menu driven operation provides keyboard control of gain parameters for channels A, B, C and D, time base values, number of channels and trigger mode. Plus, all the post processing capabilities of the personal computer are available—to store and retrieve wave forms from disk, to analyze and process the information, and to compute and word process.

Another software package that turns a personal computer into a test instrument is the Video Tune-Up for the Commodore 64/SX-64 by Solas Products of Spring House, PA. This software, according to the manufacturer, converts the computer into a low cost full-function video analyzer.

It is useful for aligning, setting up, evaluating, testing or servicing a color or monochrome video monitor/TV receiver. The program generates all standard video test patterns (crosshatch, purity field, color bars, gray scale, etc.) and also provides a fully animated video performance test which is not available on even the most expensive video analyzers.

The package is menu driven for easy push-button operation. This feature saves time because paging through a large, bulky reference manual is not required. Video Tune-Up is part of the company's Tech Series of C.A.S. (Computer Aided Service) programs. The product is being actively marketed to computer group, home, lab, field, shop, college, broadcast, video production and technical school users of Commodore computers.

### Tools for servicing those computers

Wonderful they are, and wonderful things they do, but computers are electronic beasts with electronic and electromechanical peripherals that wear out, break down and otherwise fail and need fixing.

People who are primarily involved in television, video and

audio frequently are unfamiliar with computers and just a little reluctant to attempt to diagnose and repair one. In many cases, someone who has spent a little time studying computer circuitry will find that troubleshooting a computer is more straightforward than troubleshooting a TV set.

Test equipment manufacturers offer all manner of test devices for troubleshooting the computer system down to whatever level you'd choose. And one of the convenient features of servicing components is that, depending on the nature of the problem, frequently the computer's logic itself can help the servicer determine the nature of the problem. It's kind of like a doctor asking "Where does it hurt?"

One example of getting a computer to diagnose itself is the Test Drive diagnostic disk by Dymek Corporation of San Jose, CA. This

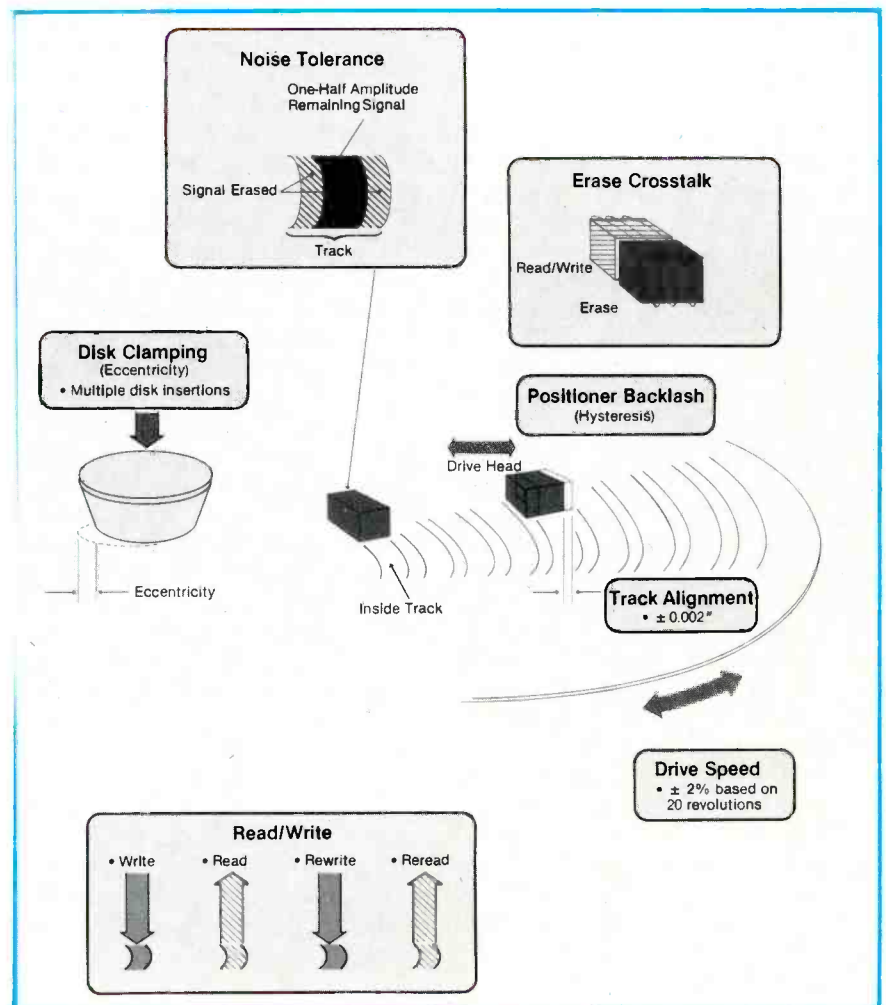

Diagnostic software can help pinpoint the cause of problems in personal computers. A disk called TestDrive checks these seven disk interchange factors.



# SUPER TECH'S \$10,000<sup>00</sup> RCA CHALLENGE

**JUST ONE SUPER TECH MARK IV  
— AGAINST —  
ANY FIFTEEN RCA FACTORY ENGINEERS**

Who understands **RCA** TV sets better than the engineering team that designed them? The answer is no one. Who has the finest, most qualified engineering staff in the TV industry? We think **RCA** does. If we thought otherwise, we would have selected someone else to challenge!

Yet the fact is, we are thoroughly convinced that just one "average" technician using a Super Tech computer can diagnose **nine** RCA color TV sets (CTC 85 thru CTC 118) down to circuit level, before any **fifteen** RCA factory design engineers can do likewise to just **three**.

**SUPER TECH WILL GIVE THE RCA ENGINEERS  
THREE TO ONE ODDS  
AND STILL WIN**

We're willing to start out with twelve **RCA** color sets. Let RCA "install" two major flyback, start up, shut down related problems of any type in each, so as to make each set as difficult to diagnose as possible, without mis-wiring the set. Let **Diehl Engineering** do likewise, so that each set will now have **four** major problems.

By drawing straws, **Diehl Engineering** will "select" nine sets and, **RCA** will inherit the other three to diagnose.

All four problems in a given set must be **accurately** diagnosed before the next set can be looked at. All sets may be "modified" to employ a "bolted in" horiz output transistor prior to the contest, which will be held at Diehl's facilities in Amarillo, Texas. **RCA** may use **any amount** of "other" test equipment that is presently available to any independent TV shop. Diehl Engineering agrees to use nothing more than a Mark IV Super Tech, an / HV probe and an **RCA** senior volt ohmist (what else)!

**If we fail to accurately diagnose all NINE of our sets  
before RCA can diagnose their THREE  
We will hand the RCA team \$10,000 in cash.**

Diehl Engineering reserves the right to publicize the results.

With **Super Tech**, all we have to do is remove the horiz output transistor, plug in Super Tech's interface plug, make one ground connection then, push four buttons. Within sixty seconds (per set), including hook up time, we will accurately diagnose all four problems down to circuit level. Sixty seconds  $\times$  nine sets = nine minutes! Lord only knows what fifteen RCA engineers can do!

**Shouldn't you be using a Super Tech Computer?  
At only \$995<sup>00</sup> can you afford NOT to be using one!**

(Also notice our ad on service literature. See our ad on page 9.)

**Nothing Can Compete With A Super Tech  
No Matter How Good It Is - - - No Matter Who Is Using It!**

Visa, Master Charge and C.O.D. orders welcome.

Phone (806) 359-1824 or (806) 359-0329

**DIEHL ENGINEERING • 6004 Estacado Lane • Amarillo, TX 79109**

Or circle ( 13 ) on Reader Service Card.

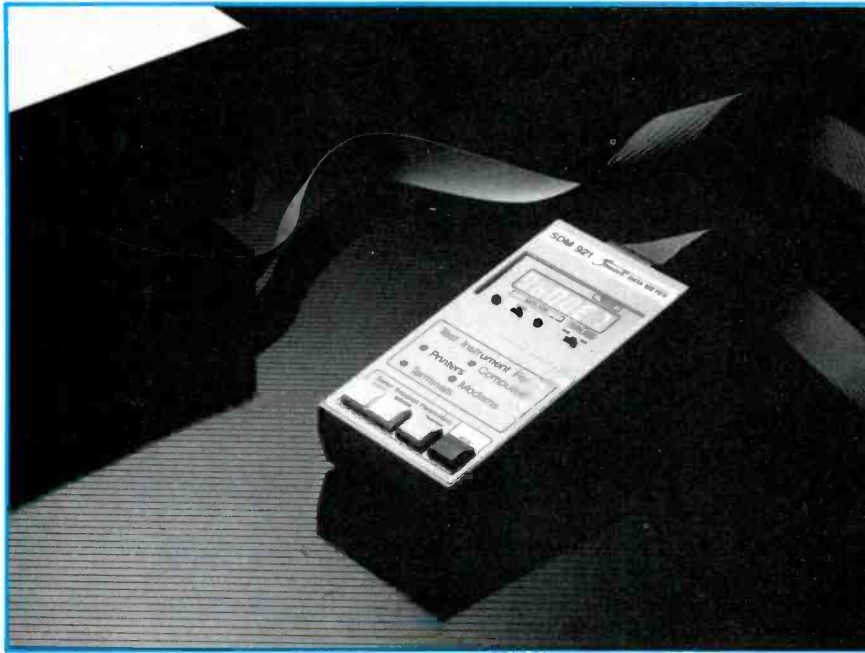

Resolving communications problems between computers can be frustrating. A test device like the Smart Data Meter can eliminate a lot of guess work.

disk, formerly called RID (for Recording Interchange Diagnostic) is available for a number of personal computer disk drives including IBM PC and XT, Apple II System Family, Radio Shack TRS-80 and Commodore 64. Other formats will be available, or may already be available. The disk performs seven tests that, if passed, ensure that a disk recorded on one disk drive will be capable of being read by another disk drive.

To operate this diagnostic tool, it is only necessary to place the disk into the drive, type a simple command into the keyboard and wait. The disk then exercises the drive automatically; and after about a minute, it prints on the monitor screen whether the disk passed the following seven tests:

- Disk speed
- Noise tolerance
- Write/read
- Track alignment
- Positioner backlash (Hysteresis)
- Erase crosstalk

When two computers are connected together in order to communicate with one another, but fail to communicate, the number of possible causes for the problem is staggering. It could be that single piece of hardware associated with either computer. It might be a software problem. Sometimes it's

an error in terminating the cable. It might possibly be that the data transfer settings are incompatible. Sorting out such a problem can be an exercise in frustration.

A device called the Smart Data Meter allows the user to find out what the problem is much faster than random guesswork, according to the manufacturer, IQ Technologies of Bellevue, WA. This hand-held, battery-powered unit reads the data transmission parameter settings of computers and peripherals.

Connected to the RS232 port of the computer, the Smart Data Meter's liquid crystal display will indicate the computer's present baud rate (300 to 38,400), word length, and parity setting. It will also determine the preset values of peripheral devices, for example, printers, plotters, modems, etc.

As circuits, components and products become smaller and lighter, some servicing devices must follow suit. The Mini-Vac is, according to the manufacturer, a lightweight, quality constructed vacuum cleaner that is designed to remove minute particles of dust and debris from hidden or hard-to-reach areas. Unlike compressed air, which disperses the pollutants, this minuscule vacuum cleaner vacuums them permanently away.

The unit is equipped with two interchangeable wands, two fine-bristle brushes, a cloth vacuum bag and it can be dc or ac powered. It is useful for cleaning delicate areas including computers, stereo and video equipment, art/crafts, hobbies, typewriters, electronics and more.

### Antistatic products

Solid-state electronics equipment has proved to be extremely reliable. Transistors and ICs, if they're operated within their design parameters, rarely fail. Unfortunately, from time to time these devices are subjected to conditions they were not designed for. One of the worst enemies of metal-oxide semiconductor (MOS) devices is static electricity. A few thousand volts of static electricity applied to a MOS device and zap—it ceases to work.

This problem is being met in a number of ways by manufacturers. There are grounding wrist straps used to continuously drain static electricity from the body as it builds up. There are antistatic laminates for bench tops, antistatic mats to place on bench tops or floors. Antistatic and conductive foams and wraps protect static sensitive devices while they are in transit or storage. You can even find conductive materials to spray on carpeting to eliminate the static buildup that stings your finger when you touch a light switch or faucet, and can even send an IC into oblivion.

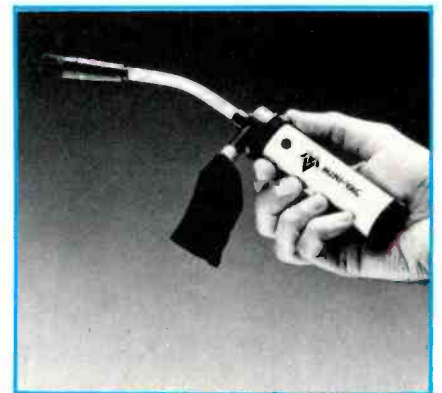

Miniaturization of circuits and devices has resulted in tiny spaces and hard-to-reach places where dust can collect. A miniature vacuum cleaner may be the solution.



Antistatic kits are available from a number of manufacturers. One kit from RCA Distributor and Special Products Division, Deptford, NJ, consists of a static-dissipative workbench mat, a wrist strap and coil cord for the worker and a grounding cable that drains static electricity to ground.



A few thousand volts of static electricity can destroy delicate MOS devices in a flash. When handling such devices, you should take precautions to ensure that static buildup is continuously drained away.

A field service kit from Charleswater Products of West Newton, MA, contains a choice of nylon and vinyl work surfaces, two different size wristbands, and cords to connect from wriststrap to work and from work surface to ground.

### Don't get left behind

Through the ages, humanity has been defined by the materials and tools used: the stone age, the bronze age, the iron age. A common observation of historians is that people who stubbornly stick with the tools and materials of a passing age, while the rest of civilization is changing, inevitably get left behind.

Anyone planning to do diagnosis and repair of the new crop of sophisticated electronics devices should at least take a look at the new tools, test equipment and materials available. It might keep them from being a stone-age technician in a space-age society.

**ES&T**

# EIGHT HIGH-TECH SOLUTIONS FROM PHILIPS ECG.



## New high-purity chemicals for your high-tech repairs.

Circuit refrigerants, flux removers, restorers and cleaners. They're going to extend the life and improve the performance of your electronic components and electronic repairs.

Today, no matter what your repair job, no matter how large or small, a world leader in electronics has your solution. High-tech chemicals from Philips ECG.

High-tech chemicals are available from your Philips ECG distributor. For the name of the distributor nearest you, call 1-800-225-8326.

## PhilipsECG

A North American Philips Company  
*Dedicated to Excellence.*

Circle (11) on Reply Card

April 1985 *Electronic Servicing & Technology* 15

# Test your electronic knowledge

By Sam Wilson

1. Refer to the circuit of Figure 1. The internal resistance of the battery is so small that it can be disregarded. If the ammeter (I) and battery (V) are interchanged, the ammeter will indicate:  
 (A) a higher current.  
 (B) the same value of current.  
 (C) a lower value of current.  
 (D) (This question cannot be answered without additional information.)

2. Which of the op amps in Figure 2 has a higher gain?  
 (A) the one in Figure 2A.  
 (B) the one in Figure 2B.  
 (C) Both amplifiers have the same gain.  
 (D) (This question cannot be answered without additional information.)

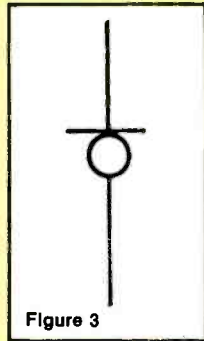
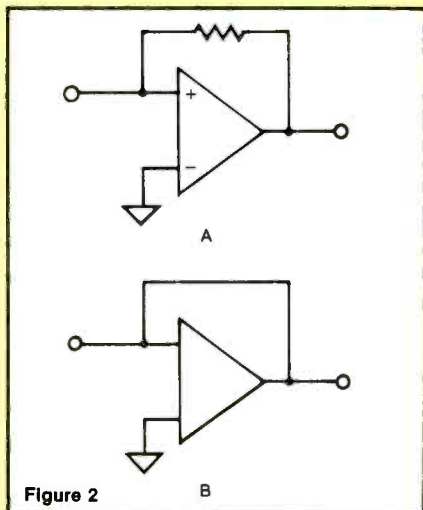
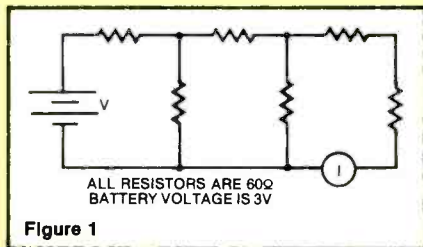

A	B	L
0	0	
0	1	
1	0	
1	1	

Figure 4

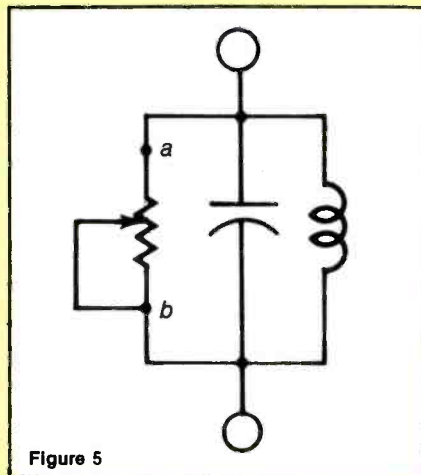

3. Using three toggled flip flops, the highest number that can be counted is:  
 (A) 3  
 (B) 7  
 (C) 8  
 (D) 9

4. Which of the following best describes the device in Figure 3?  
 (A) slope detector.  
 (B) bead ledge.  
 (C) constant resistance.  
 (D) constant current.

5. Complete the truth table in Figure 4 to indicate the following Boolean expression:

$$\overline{A + B} + AB = L$$

6. To increase the bandwidth of the circuit in Figure 5, move the arm of the variable resistor:  
 (A) toward *a*.  
 (B) toward *b*.  
 (C) to a point that is exactly half-way between points *a* and *b*.

7. The output of the inverter in Figure 6 should be:  
 (A)  $\overline{A + B}$   
 (B)  $\overline{AB}$   
 (C)  $\overline{A} \overline{B}$   
 (D) (None of the above is correct)

8. Which of the following would most likely have a snubber?  
 (A) an SCR circuit with a resistive load.  
 (B) an SCR circuit with an inductive load.  
 (C) an SCR crowbar circuit.  
 (D) an SCR bridge regulator.

9. Connect a single resistor into the circuit of Figure 7 that will make it possible to connect the two lamps in series as shown.

10. What is the resistance of the resistor that you used in your answer to question 9?

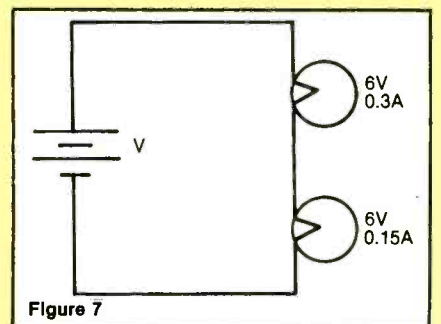
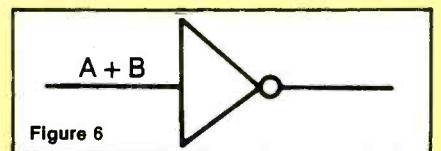

Answers on page 63



# Exclusive Offer

## for Microprocessor Based Equipment Servicing MANAGERS ...and key technical personnel

If you manage a facility which services computers, word processors, health care equipment or any other equipment which is microprocessor based, you can receive FREE a new magazine written exclusively with your management interests in mind.

Introducing...

# MMicroservice Management

With MSM, you receive in-depth, **useable** management information to help you run your business for maximum profit and efficiency. And updates on the newest equipment and technologies presented with a management perspective, to help you determine which products will work best for you and your technical staff.

Typical articles and topics covered in MSM include:

Business/Service Management  
Marketing Strategy & Techniques  
Personnel Management/Employee  
Training

Pricing Strategy  
Successful Business Case Studies  
Technology Updates for Managers

New Products  
New Literature  
Association/Industry News

MSM is the **only** international magazine which directly serves **management** in the microprocessor based equipment servicing industry. And it's absolutely FREE to all **qualified** microservicing facility managers and key technical personnel.

To receive your free subscription to Microservice Management, simply complete and return the coupon. We'll promptly mail you a subscription order form.

**YES!** Send my free subscription form for **Microservice Management**

Mail to: Jane Powell, Subscription Department  
MSM  
P.O. Box 12901, Overland Park, KS 66212

Name \_\_\_\_\_ Title \_\_\_\_\_

Company \_\_\_\_\_

Address \_\_\_\_\_

City \_\_\_\_\_ State \_\_\_\_\_ Zip \_\_\_\_\_

Equipment Serviced \_\_\_\_\_

# THE VIDEO CONNECTION

By Martin Clifford

In the first installment to this series, connectors, baluns, transmission lines, signal separators and cables were discussed in accordance with video system connections. With an understanding of those components, we can begin to examine simple hookups and also what connection considerations are necessary when making them.

The basic video connection consists of a TV receiver, an outdoor antenna and a transmission-line downlead. With this arrangement, the signal source is network television. The setup is simple, but it is subject to connection faults.

There are two points in this system where impedance matching is important: at the antenna and at the antenna terminal block of the television. Mismatching at either of these points can cause a drop in signal strength and produce multiple images on the screen.

Television antennas are available in two impedances—75 $\Omega$  and 300 $\Omega$ —regardless of the number of parasitic elements (directors and reflectors) and whether they are VHF/UHF/FM, or are solely VHF or UHF. The impedance has nothing to do with antenna gain or directivity, and it does not follow that a 300 $\Omega$  antenna is four times as good as one rated at 75 $\Omega$ .

As indicated in Figure 1, folded dipoles are 300 $\Omega$ ; open dipoles are 75 $\Omega$ , with the impedance measured at the connecting points of the transmission line.

For TV work, the transmission line, the connecting link between the antenna and the input to the TV set also can have two possi-

ble impedances: 75 $\Omega$  or 300 $\Omega$ , while the TV set can be 75 $\Omega$  for VHF and UHF, or 300 $\Omega$  for VHF and UHF, or 300 $\Omega$  for one of these and 75 $\Omega$  for the other.

Impedance matching can be handled by a resistive network, as indicated in Figure 1C, by a matching stub, or by a balun. The balun is preferable because it has a smaller insertion loss and may be easier to connect, and is readily available.

A typical arrangement consists of a folded dipole antenna, connected to a 300 $\Omega$  2-wire transmission line leading to the 300 $\Omega$  input of a TV set. This video connection has its limitations.

In electrically noisy locations, 75 $\Omega$  coaxial cable is preferable to 2-wire line. Further, the transmission line, without a band separator, usually delivers the VHF signal only. In a hookup of this kind, the TV set generally picks up UHF via a circular type of built-in antenna, often supplied with the TV set.

## The antenna connection

Two factors determine the type of connection to use at the antenna: the antenna impedance and the impedance of the transmission line downlead to the TV receiver. If there is a difference in impedance, a 75 $\Omega$  antenna and a 300 $\Omega$  transmission line or a 300 $\Omega$  antenna and a 75 $\Omega$  downlead, then a balun must be used at the antenna. This is a balun only, not a combined balun/band separator.

Even with a balun, impedances must be matched because the balun has a characteristic input im-

pedance and output impedance. The easiest arrangement, but not always the most desirable, is when impedance matching at the antenna is automatic, with the antenna impedance matching that of the downlead, without the need for a balun.

## Connecting two antennas

Most antennas today are VHF/UHF/FM types and are capable of supplying these three signals. However, some installations use three separate antennas. The disadvantage is the greater cost of the separate antennas and the need for individual downleads, but such antennas can be individually adjusted for best signal reception for each of the signal sources. Another advantage is that no band separators are required.

## The single downlead

Most antennas today are designed for VHF/UHF/FM signal pickup, therefore just a single downlead is required. Figure 2 shows a 300 $\Omega$  antenna connected to a 2-wire line that is also 300 $\Omega$ . At the receiver, a combined balun/band separator is used to do two jobs; separate the VHF and UHF signals and to match impedances at the antenna terminal block on the TV set. Although not shown in the drawing, the balun possibly could have a 300 $\Omega$  output for connection to an FM set. The antenna is a folded dipole, although not shown as such.

The same antenna can be used with coaxial cable (Figure 3) as the downlead, but because the antenna is a 300 $\Omega$  type, a matching transformer (balun) must be used at the antenna connection points. Near the antenna block on the TV set, a balun/band separator must be used.

Note that this balun is not the same as the one used earlier in Figure 2. In that drawing, the input impedance of the balun is 300 $\Omega$ ; in Figure 3, its input impedance is 75 $\Omega$ . However, the output impedances in both drawings, Figures 2 and 3, are identical.

The antenna matching transformer in Figure 3 is a balun but it is not a band separator. Its only



function is that of impedance matching between the 300Ω antenna and the 75Ω downlead coaxial cable. Thus, in Figure 3 we have two baluns: one for impedance matching only; another for both impedance matching and band separation.

### The antenna terminal block on the TV set

No standardization exists for signal input to TV sets so any combination can be used. The VHF/UHF input both can be 75Ω, or 300Ω, or one can be 75Ω and the other 300Ω. Figure 4 illustrates a TV set in which both inputs, VHF and UHF, are 300Ω. This is an arrangement in which separate antennas are used for VHF and UHF. If a 300Ω antenna is used, no baluns are needed, and because this is a system with separate transmission lines, no band separator is required.

Figure 5 shows the antenna terminal block of another TV set with the VHF having a 75Ω input and the UHF a 300Ω input. Again, because separate downloads are used, no band separation is required. The coax cable automatically matches the VHF input, and the 300Ω twin lead automatically matches the 300Ω UHF input. No balun is needed at the antennas if a 75Ω type is used for VHF and, a 300Ω type is used for UHF.

### Installing new cable

Sometimes, in an electrically noisy area, it may be necessary to substitute coaxial cable for existing 2-wire transmission line. Figure 6A shows the existing arrangement with twin lead connected to a 300Ω antenna. No

**Figure 1.** Drawings A, B and C show matched impedances; D, E and F are mismatched impedances. Impedance mismatch can occur at the antenna; at the TV receiver or both.

**Figure 2.** 300Ω line connected to 300Ω antenna. A balun/band separator is used to separate VHF from UHF and also to match the different input impedances of the TV set.

**Figure 3.** This is the same arrangement as that in Figure 2, except that a coaxial line is used as the downlead.

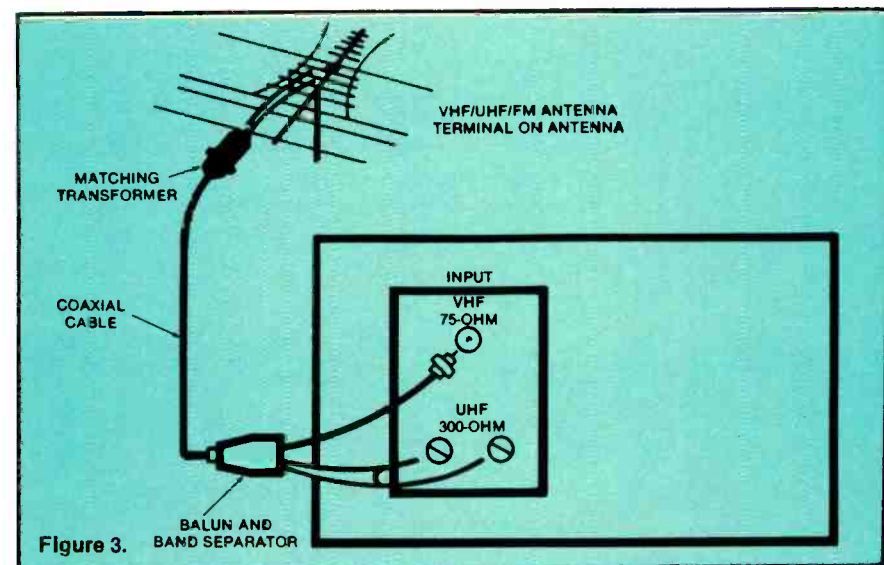
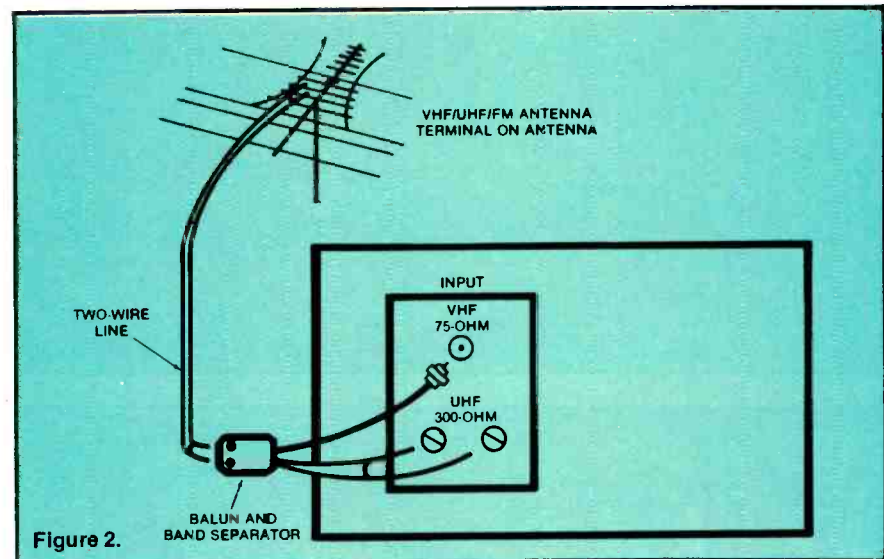
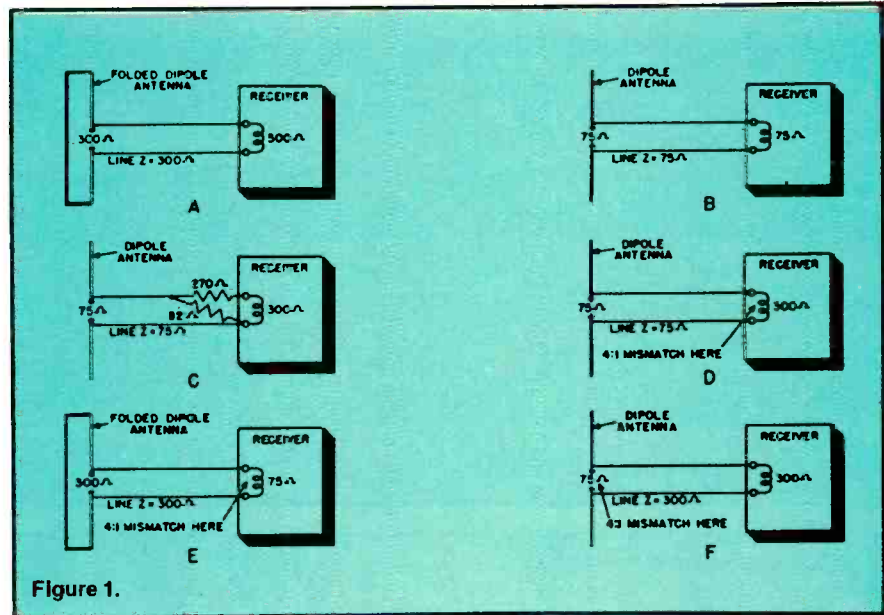

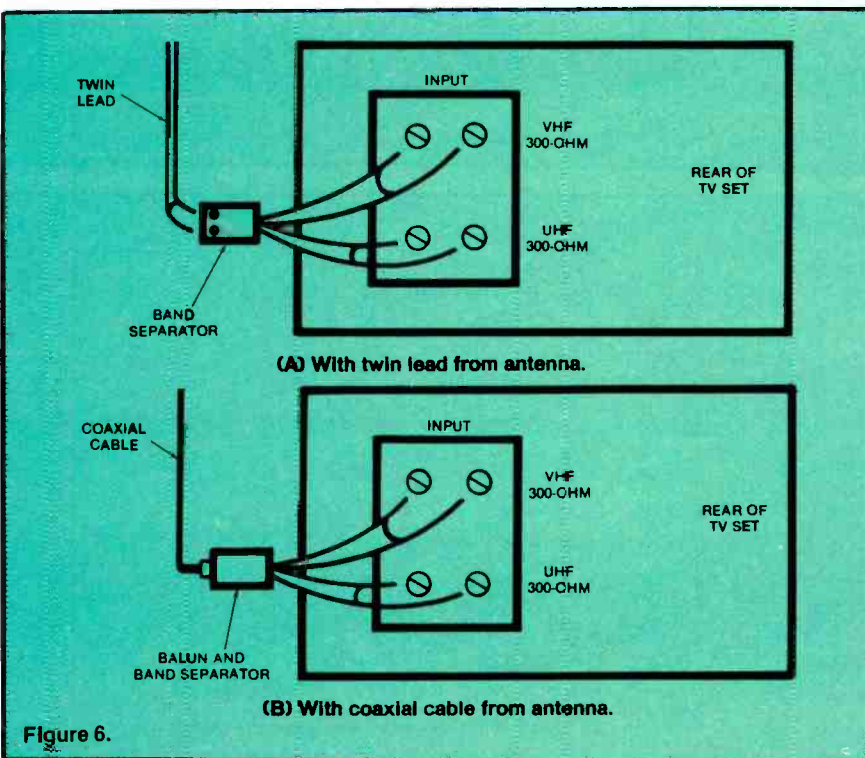
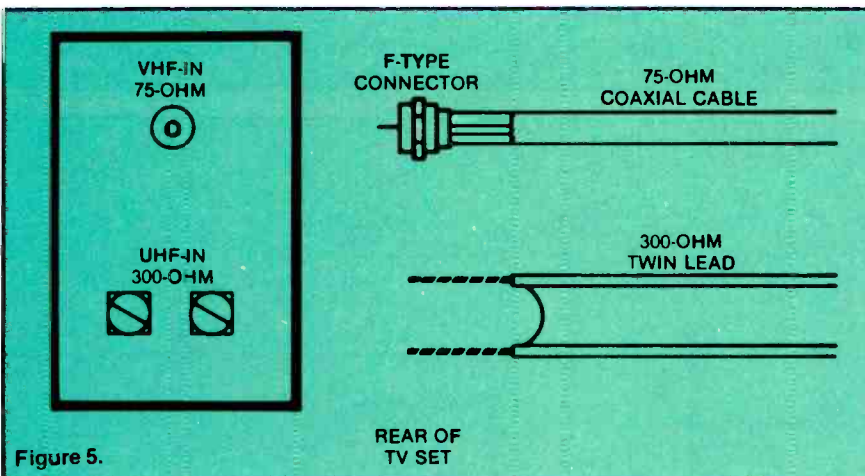
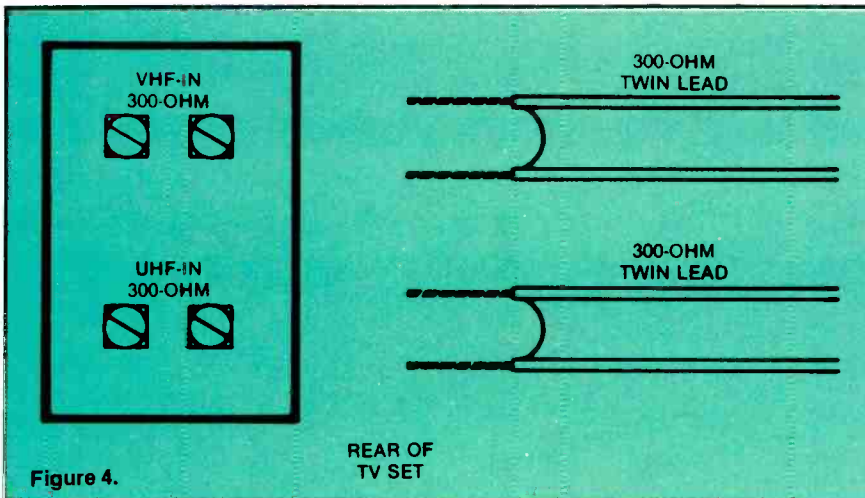

balun is needed anywhere in this installation because the two inputs, VHF and UHF, are also 300Ω. However, a band separator is needed in Figure 6A, while a combined balun/band separator is required in Figure 6B. No balun is used in Figure 6A inasmuch as the impedance of the twin lead automatically matches the input impedances at the TV set. Note in Figure 6B that a balun must be used to match the downlead to the antenna inputs.

### Driving two TV sets using 75Ω downlead

Today, homes usually have two TV sets. Both can be color or one can be color and the other black and white. The fact that sets are color or monochrome does not affect the input impedance at the antenna terminals.

One of the problems is that a consumer sometimes will buy a second TV set without considering the possible problems. Often the second set will not work as well in the home as it did in the showroom because: a) in the showroom demonstration, a videotape is used, providing a quality, high-signal-level source; b) the consumer is unaware of the need for impedance matching and band separation; or c) the consumer may not know that an RF pre-amplifier may be needed when two TV sets are used.

Figures 7A and 7B show two possible video connection arrangements with both using the same type of antenna. The antenna is a 300Ω type so, in drawing 7A, a 300Ω to 75Ω outdoor matching transformer balun (T2) is used.

Matching transformers can be indoor or outdoor types, with the outdoor type weatherproofed. The

**Figure 4.** TV receiver antenna terminal block with 300Ω inputs for VHF and UHF. (Courtesy GC Electronics.)

**Figure 5.** TV receiver antenna terminal block with 75Ω input for VHF; 300Ω input for UHF. (Courtesy GC Electronics.)

**Figure 6.** Substitution of coaxial cable for twin lead will require a balun at the antenna and a balun/band separator at the TV set.



download identified as C32 or C33 is a measured length of raw coaxial cable fitted with suitable connectors.

Raw cable is used because the length of downloads must be tailored for individual installations. Suitable coaxial connectors must be attached after lengths are determined because raw cable is not supplied with fittings.

In the home, near the TV set, is a 2-way signal splitter, S1. A signal splitter is required at this point because the signal must follow two paths to the TV receivers. Although the terms *band separator* and *signal splitter* are sometimes used interchangeably, they are different.

A band separator is exactly what the name implies, a device for separating the VHF and UHF bands, and sometimes the FM band as well. A signal splitter is a device for dividing the existing signal into equal parts. If two TV sets are to be driven, half the signal consisting of VHF- and UHF-signal energy will be for one of the TV sets; the other half, for the second set.

Signal splitters are needed when more than one TV set is to be operated from a single antenna. Splitters are 2-way, 3-way and 4-way types, depending on the number of TV sets to be operated. Signal splitters also are sometimes known as 2-set couplers, 3-set couplers, etc. Note, in Figure 7, that the splitter precedes the band separator.

The antenna inputs on the two TV sets in drawing 7A are identical, with  $75\Omega$  for VHF and  $300\Omega$  for UHF. For each of these receivers, a balun/band separator must be used with the balun having a  $75\Omega$  input and both  $75\Omega$  and  $300\Omega$  outputs.

The arrangement shown in Figure 7B is almost the same. Because the same antenna is used, a  $300\Omega$  to  $75\Omega$  matching transformer, T2, is needed at the antenna. The coaxial cable leads into a 2-way hybrid splitter, S1, to feed signals to both TV sets. In this case, the two TV sets have  $300\Omega$  input impedances for both VHF and UHF. Consequently, the

balun B1 has an input of  $75\Omega$  and a pair of outputs, each  $300\Omega$ .

Each of the drawings shows how the 2-way hybrid splitter S1 is connected to baluns B7 or B1 with a length of coaxial cable, C1, C2 or C3, usually 3-, 6- or 12-feet long, supplied with F-type plugs at both ends. The length to be used is determined by how close the 2-way hybrid splitter S1 is to baluns B1 or B7.

It is pointless to have the connecting coaxial cable any longer than necessary. C1, C2 or C3 can be a pre-prepared coaxial cable. A crimping tool and scrap lengths of coaxial cable are all that is necessary to make a connecting cable any desired length.

### The preamplifier

When two TV sets are connected to a single antenna, the signal is

The  
Professionals'  
Choice

# PTS

## Coast to coast more professionals choose PTS.



Professional service dealers have made PTS the world's largest independent electronics rebuilder.

Servicemen depend on more PTS rebuilt tuners, modules, remotes, converters, and line amps than all other rebuilt brands combined.



### PTS CORPORATION

P.O. Box 272  
Bloomington, IN 47402  
(812) 824-9331

Send for your free PTS Products Guide today!

With 15 PTS Servicenters, over 1,500 distributors, and 50,000 satisfied service dealers and technicians nationwide it's no wonder PTS is #1.

Choose PTS for service, quality and availability. PTS is The Professionals' Choice.



Circle (15) on Reply Card

April 1985 *Electronic Servicing & Technology* 21

divided fairly equally between them with a signal splitter. This is no problem if the signal is adequate for driving both TV sets, but if the signal is marginal, viewing on each of the sets may be poor. In

that case, an RF pre-amp (radio-frequency pre-amplifier) should be

**Figure 7.** Method for driving two TV sets from a single antenna using 75Ω downlead. (Courtesy GC Electronics.)

inserted in the line between the antenna and the TV receivers.

The preferable location for the pre-amplifier, a wideband, solid-state unit, is as close to the antenna connections as possible. The pre-amplifier is often mounted on the antenna mast, and generally has a built-in low-voltage power supply with operating power from an outlet in the home.

The pre-amp is not equipped with an *on-off* switch and remains permanently powered, but the drain on the ac line is quite small. The pre-amp has no operating controls, and has a fixed amount of gain, with the amount of amplification varying, depending on the model and the manufacturer.

The pre-amp precedes signal splitters and balun/band separators. Impedance matching is still essential. Some of these units are made to accommodate either 75Ω or 300Ω input and can supply an output of 300Ω or 75Ω, or both. Pre-amps also can be used in fringe areas even if just one TV set is to be connected.

While it is more convenient to connect the pre-amp at some place in the home, mounting it on the antenna is preferable because this improves the signal-to-noise ratio. The transmission line, if 300Ω twin lead, can act as an antenna, picking up electrical noise. The pre-amp, placed in the home, will amplify the noise picked up by the line, in addition to the signal.

### Making a sketch

For every installation, whether simple or complex, it is a good idea to make a simple sketch, indicating the types of baluns, signal splitters, connecting cables, antenna impedance, type of downlead used, plus some data about the pre-amp, if any. At some point, the TV set owner may want to add another TV receiver, change TV sets or may want a better picture display.

Whatever the reason, having the information on file will help determine feasibility and cost. Further, if servicing or modifications are required, having the video connection data will save considerable time by eliminating the need for tracing cables.

**ES&T**

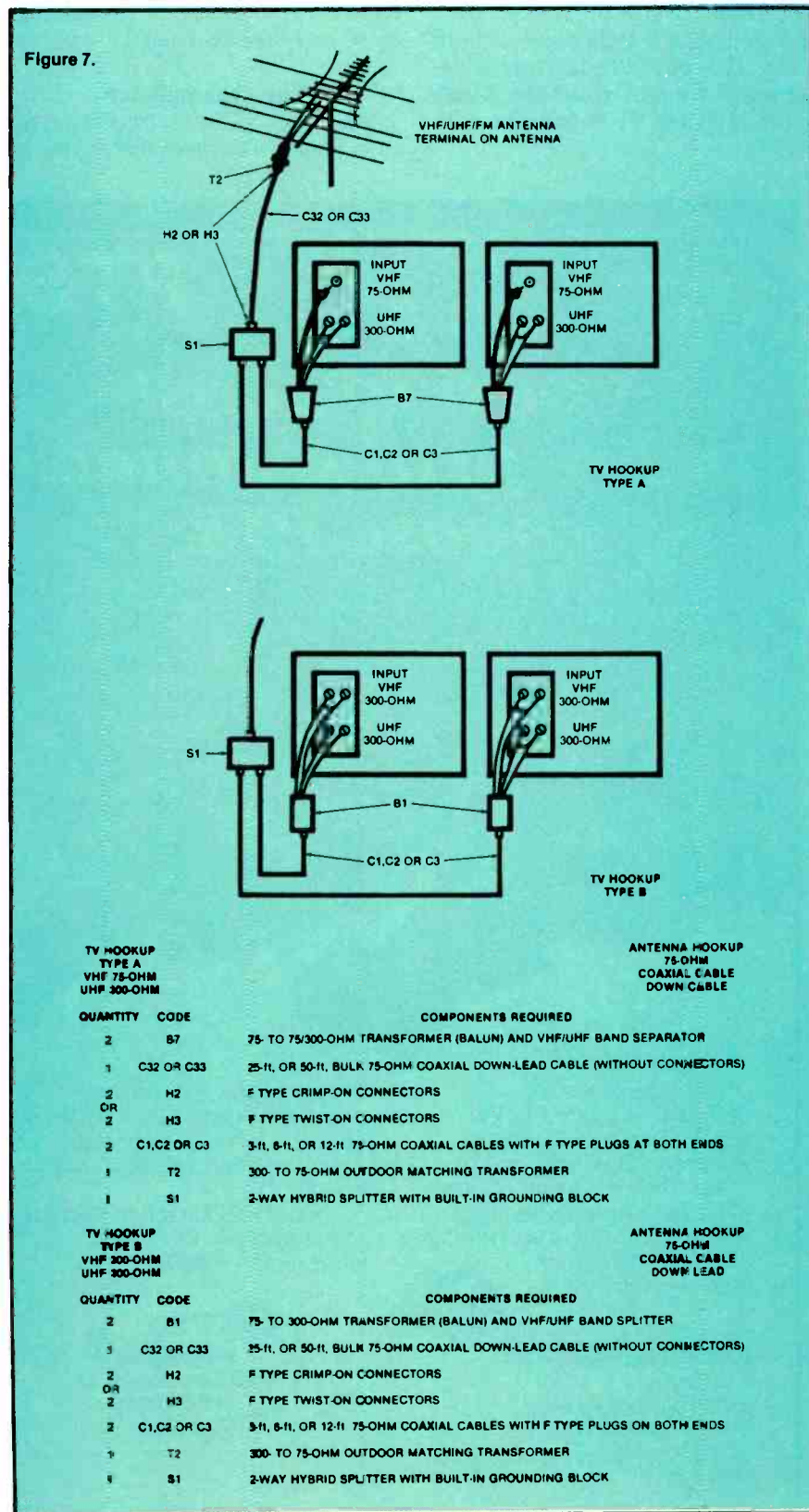



# REPLACING FIVE BELTS AT ONCE IS SMARTER THAN ONE AT A TIME.



It makes sense for your customers. And dollars for you. Sooner or later, every VCR belt needs replacing. And when one goes, the others aren't far behind. So make the most of it with RCA's VCR Belt Kits (stock numbers 199094 and 199095) for RCA, Magnavox, Panasonic, Quasar,

Sylvania, and other VCRs. You'll save customers the expense of extra repair trips and make extra profit for yourself replacing all the belts at once.

The smart money's on RCA, for a whole line of VCR replacement parts and accessories. See your RCA VCR Parts Distributor or for more information, write: RCA Distributor and Special Products Division, Deptford, N.J. 08096-2088. Attn: Sales Promotion Services.

**RCA** VCR Parts

## Photofact

These Photofact folders for TV receivers and other equipment have been released by Howard W. Sams & Co. since the last report in ES&T.

### DUMONT

DL1940W ..... 2318-1

### JC PENNEY

685-2087K,-00 ..... 2314-1  
685-2042K,-40/094K,-00 ..... 2315-1

### KMC

1333RG ..... 2318-2

### MAGNAVOX

CE3925SL01 ..... 2315-2

### MIDLAND

15-049 (24-3306-8) ..... 2313-1  
15-048 (24-3322-5) ..... 2319-1

### RCA

Chassis CTC123A ..... 2318-3

### SEARS

564.49071450/9100450 ..... 2316-1  
564.43240450/3340450/3440450/3540450 ..... 2317-1  
564.41490450 ..... 2319-2

### SHARP

13J11/15 ..... 2313-2

### SONY

Chassis SCC-486N-A,A,O-A ..... 2313-3  
Chassis SCC-486L-A,M-A ..... 2314-2

### SYLVANIA

CZD102SL01 ..... 2319-3

### WARDS

GNB17216A,B/7226A,B/7236A,B/7316A,B ..... 2316-2  
GNB12905A,B ..... 2317-2  
INTELLIVISION II  
5872 ..... 2317-3

# Products

## Field service kit

Gregory Thomas, Inc., has introduced a field service kit for technicians performing repair/maintenance functions on static-sensitive PCBs in the field. The static control kit is fully equipped for protection against electrostatic discharge (ESD) from service personnel.

The kit contains a conductive elastic wristband with 6-foot coil cord; a 24" x 24" conductive mat with pockets for storage; and a 10-foot coil ground cord for attachment of the mat to a ground reference. Optional accessories include conductive bags for PCB storage in transit and conductive shunts for shorting the contacts on PCBs.

Circle (75) on Reply Card

## Soldering station

The 925 soldering station, from Edsyn, Van Nuys, CA, is designed for production line soldering and is safe on static-sensitive components. The soldering instrument

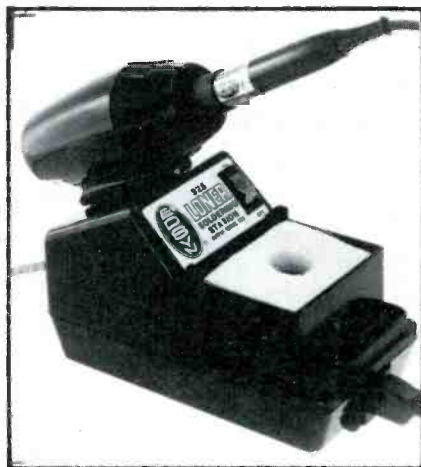

contains the proportional solid-state circuitry that regulates temperature to  $\pm 6^\circ\text{F}$  ( $3^\circ\text{C}$ ). Temperature range is  $400^\circ\text{F}$  to  $800^\circ\text{F}$  ( $205^\circ\text{C}$  to  $425^\circ\text{C}$ ). The temperature set screw is under the collar to deter unauthorized temperature adjustment.

While not in use, the soldering instrument is placed in its remov-

able, closed pod atop the power supply. Its closed design minimizes heat loss, thus conserving energy. It also extends tip life, and isolates the hot element and tip from objects that could pass through an open spring-type holder. The holder also catches solder splashes in a solder debris collector.

Circle (76) on Reply Card

## 4½-digit DMM

The model KT5005 DMM available from Theall Engineering, Oxford, PA, is a low-cost, accurate 4½-digit hand-held multimeter. The meter can resolve  $100\mu\text{V}$  on the 200mV range and provides accuracy of 0.05 percent on the dc ranges up to 200Vdc. The 1000Vdc range provides resolution of 1Vdc

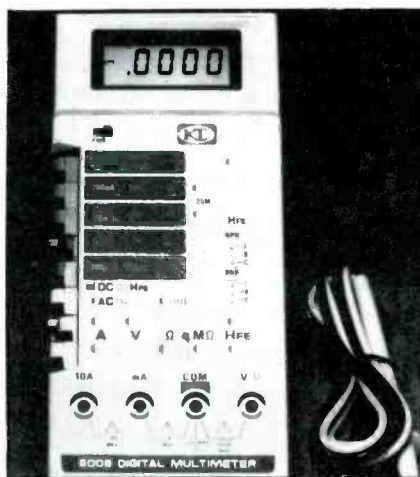

with an accuracy of 0.1 percent. There are six resistance ranges from  $200\Omega$  to  $20\text{M}\Omega$ . The meter is able to resolve  $100\text{m}\Omega$  on the  $200\Omega$  range with an accuracy of 0.2 percent.

Model KT5005 also is provided with five ac voltage ranges, six dc current ranges, six ac current ranges as well as diode test and hFE test capability. The meter features auto polarity, overload indication, 150-hour battery life with a low battery indicator and comes with a tilt stand, test leads and carrying case.

Circle (77) on Reply Card

## SAVE TIME

Attach  
your peel-off address label  
to the Reader Service Card  
when inquiring about  
products in *ES&T* issues.

## Abrasive cords to remove solder

A complete line of abrasive cords and tapes for deburring, polishing and removing solder in electronics applications is available from E.C. Mitchell Company, Middleton, MA. These abrasive cords and tapes are suitable for reaching around components or leads and through holes to remove solder from PC boards. Cords come in 0.012-inch to 0.0150-inch diameters and tapes in widths from 1/16 inch to 1/4 inch.

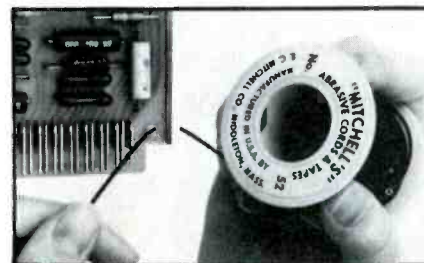

Saturated with aluminum oxide, silicone carbide or crocus for ultra-fine polishing, the abrasive cords and tapes are packaged on 25-yard adhesive tape-like spools in 18 different sizes.

Circle (78) on Reply Card



## Standby power supply

A 250W standby power supply that provides transient-free switching and 14 minutes of uninterrupted power at full load, has been introduced by Dynatech Computer Power, Scotts Valley, CA. The Powerhouse 250 is designed for consumer and industrial applications including use with a wide range of computer, video and audio products as well as scientific instruments.

In the event of a power dip or outage, the Powerhouse system transfers from commercial power to its own power in 1 to 4ms of pulse width modulated output. Typical transfer time of the Powerhouse is 2ms. The unit also will remain on for several seconds following a return to power to insure a smooth transition. The

Continued on page 41



Continued from page 24

Powerhouse can accommodate up to 300W; however the run time will be slightly less than 14 minutes.

Circle (79) on Reply Card

### Function generator

Beckman Industrial Corporation, Instrumentation Products Division, Brea, CA, has introduced a new function generator to its Circuitmate product line that offers high feature content instrumentation at low cost. The Circuitmate FG2, an ac operated instrument, is capable of producing clean, high-quality signals in the 0.2 to 2.0MHz range. Features of the FG2 include: push-button selection for output frequency and function; duty cycle control, allowing the user to change the nominal 50 percent duty cycle of the signal to any desired value; and dc offset control that adds a variable dc offset voltage to the offset set signal.

Circle (80) on Reply Card

### Solder extractor

Model EX 550 solder extractor, from Automated Production Equipment, Medford, NY, delivers close control of heat with 15-65W and 2-3cfm vacuum airflow through the same desoldering tip. A footswitch operates vacuum and the desoldering handpiece tip provides both heat and vacuum. This solder extractor is suitable for applications requiring removal of electronic components in the production line or design laboratory. Model EX 550 has a 300W temperature control vacuum flow-control valve and tube filtering transducer.

Circle (81) on Reply Card

### Cable ties

Flexloc reusable cable ties from Visual Departures, New York, are suitable for bunching cables attached to computers and peripherals, home entertainment systems, A-V, electronic and electrical hardware. The quick-release lock enables you to use the cable ties time after time.

Made from tough, flexible nylon (Type 66), Flexloc has a tensile strength of 50 pounds. Each 10-inch fastening strap is self-locking with a ribbed backing that permits

diameter adjustments up to 2 $\frac{3}{4}$  inches and secures the bundle until release.

Circle (82) on Reply Card

### Resistance box

The TE 1065 decade resistance box from Zi-Tech, Palo Alto, CA, is an adjustable resistive load capable of dissipating up to 10W per resistor and is designed for load simulation purposes. Rotary

switches allow precise setting of resistance values in the range of 0.1 $\Omega$  to 120k $\Omega$ . Each resistor is rated at 10W and the set value can be clearly discerned. Mid-scale accuracy is 1 percent.

With its high power per resistor rating, the TE 1065 can be used for many types of load simulation. It is of particular value to persons testing amplifiers and similar types of equipment.

Circle (83) on Reply Card

**ES&T**

For Quality 3 $\frac{1}{2}$  or 4 $\frac{1}{2}$  Digit Hand-Held DMMS

Ask for  
**Simpson**<sup>®</sup>

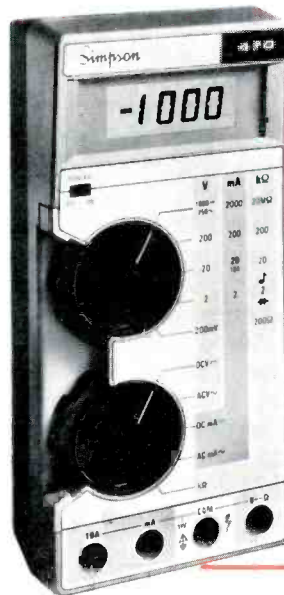

MANUFACTURED  
**Both**  
IN U.S.A.

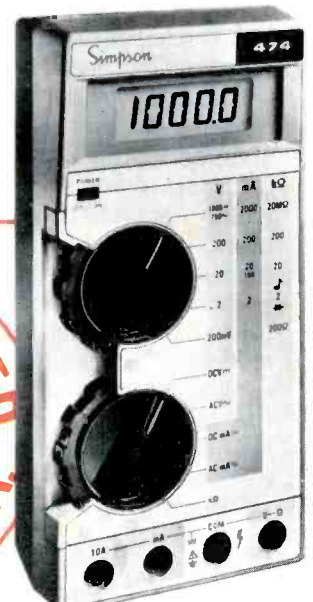

4 $\frac{1}{2}$  Digit 474<sup>TM</sup>  
.03% Basic DC Accuracy  
**\$219**

3 $\frac{1}{2}$  Digit 470<sup>TM</sup>  
.15% Basic DC Accuracy  
**\$139**

**FULL FUNCTION DMMS WITH THESE MOST WANTED FEATURES . . .**

- ✓ Full Measurement Capability
- ✓ 6 kV Transient Protection
- ✓ Double Fusing System
- ✓ Audible Continuity Indication
- ✓ Diode Test Function
- ✓ User Engineered Range/Function Selector Knobs
- ✓ Large, Easy-to-Read LCD Display
- ✓ High Impact ABS Case
- ✓ 2-Way Tilt Stand
- ✓ Extended Battery Life
- ✓ UL Recognized Test Leads
- ✓ Full Line of Optional Accessories
- ✓ Full Simpson Warranty

**AT LEADING ELECTRICAL/ELECTRONICS DISTRIBUTORS**



**SIMPSON ELECTRIC COMPANY**

A Katy Industries, Inc. Subsidiary  
853 Dundee Avenue, Elgin, Illinois 60120-3090  
(312) 697-2260 • Telex 72-2416  
Cable SIMELCO

Circle (14) on Reply Card

# 10 typical Samsung TV problems

By Homer Davidson

Servicing foreign-built color TV receivers has become easier during the past few years because critical components are usually available, and service data can be obtained for most models. Exact replacements for transistors and ICs are often advertised in electronic magazines. And the Howard W. Sams Company is offering Photofacts for more foreign-built models. For example, one Samsung color receiver is featured in this article, and seven Photofacts are listed for various Samsung models.

Samsung model CT-331AZ 13-inch color TV receiver is the subject of this article; it is covered in Photofact 2064-1. The following 10 typical service problems for the Samsung CT-331AZ will help technicians repair that model, while giving examples of troubleshooting that can be applied to similar models.

## 1—No sound or picture

Check first for an open F801 3A fuse or S801 on/off switch. If these are normal, measure the dc

**Figure 1.** When the model CT-331AZ Samsung color receiver is completely dead, without sound or raster, test for 120Vac first at F801, then at S801, terminal 22 of the remote board, remote-board terminal 21, current-limiter resistor R801, current-limiting choke L801, and finally at the D801 anode. D801 is an SCR that provides some regulation by variation of the time during each vertical cycle that D801 is gated into conduction. Longer conduction times increase the regulated voltage at the +123V output, while shorter conduction times decrease the +123V regulated voltage. This regulator is followed by a dc-voltage regulator.

voltage at the collector (case) of the Q402 horizontal-output transistor. A zero reading might indicate a loss of ac-line voltage to the low-voltage power supply, or a defect in the low-voltage supply. Check for 120Vac at the anode of rectifier D801 (the SCR which also performs the major regulation).

If no ac voltage is at the D801 anode, the remote-receiver system might be failing to provide normal continuity through the wiring and the relay contacts (Figure 1). Listen for a click of the relay each time the receiver is turned on. If the relay clicks, but no ac voltage reaches the D801 anode, suspect burned or corroded relay contacts or bad soldered connections on the remote circuit board. Check for ac voltage at terminal 22 first and then at terminal 21. A 120Vac reading at terminal 22 and zero at terminal 21 indicates an open in the remote wiring. If normal ac

voltage is found at terminal 21, follow it to R801, L801 and the D801 anode. An open anywhere stops the low-voltage operation.

A quick test of the remote-control relay is to connect a jumper temporarily between remote terminals 22 and 21. If the power is restored and the receiver operates, the defect definitely is in the remote wiring, and probably the relay.

Of course, if nearly 120Vac is measured at the D801 anode but no voltage is at the +112V regulated source, the defect is in one of the two regulators. Remember, the conduction time of D801 is varied by a sawtooth signal applied to the D801 gate. (The sawtooth signal is produced from a sample of the same 120Vac voltage that is applied to the Q801 anode.)

Longer conduction time of D801 increases the dc voltage at its cathode. Loss of gate sawtooth

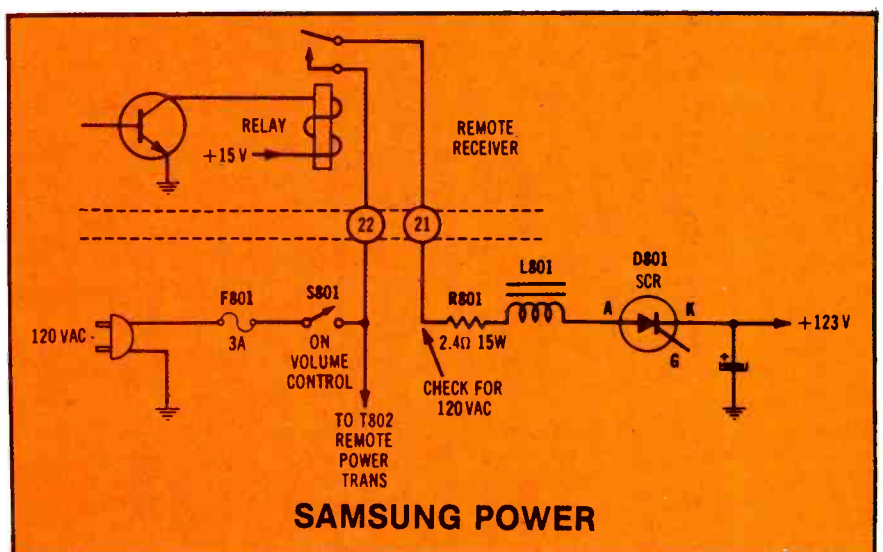



stops all Q801 conduction and removes the +123V that should be at its cathode. If Q801 conducts as though it is a normal diode, the cathode voltage would rise to about +140V.

Evidently, the D801 SCR regulation is not sufficient by itself, because a second dc-voltage-drop regulator (Q801) reduces the +123V to +112V with better regulation. If Q801 shorts between emitter and collector (the most common defect), the +112V source would rise to about +120V, which should activate the safety circuit.

These tips should enable you to find most power-supply defects.

## 2—Incorrect low voltage

Low B+ voltage can be caused either by excessive current drain in the horizontal-output transistor or a weakness of the low-voltage circuit. Remove the horizontal-output transistor and notice if the +112V source is slightly high. If so, check the horizontal-deflection circuit.

A complete loss of low voltage must be caused by the low-voltage circuit itself or by a loss of ac to D801, as explained previously. If the R851 control does not change the +112V source when rotated, the Q801 second regulator stage must have a defect, or the dc voltage from D801 is too high or too low. Remember to readjust R851 accurately after the defects are found and corrected.

A leaky or open Q801 voltage-regulator transistor and a defective D806 zener diode are responsible for most low-voltage problems (Figure 2). Sometimes the Q801 voltage-regulator transistor tests okay but breaks down under load. If there is question about the transistor, replace it with an ECG173 or a GE-246.

SCRs seldom fail, and they can be checked quickly with adequate accuracy by using the resistance ranges of a VTVM or a DMM with high-power ohms functions, as shown in Figure 3.

When voltage measurements and scope waveforms do not identify the problem, parallel each small electrolytic capacitor in turn with another of the same value.



**Figure 2.** The second regulation is accomplished by Q801, located on the metal chassis (using the metal as a heat radiator or sink). A defective Q801 is common. Accurate testing of Q801 might require its removal from the chassis.

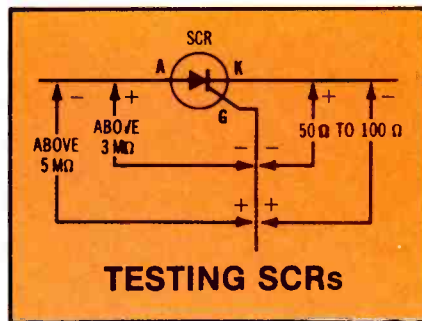

**Figure 3.** After D801 SCR is removed, test it for opens or leakage according to these figures. Be sure the VTVM or DMM has resistance tests of the high-power type, where the voltage across the probes is sufficiently high that it causes conduction in a normal diode or transistor junction.

## 3—No high voltage and no raster

As described in No. 1, measurement of the dc voltage at the horizontal-output transistor's collector usually indicates whether the loss of high voltage is caused by the low-voltage supply or the horizontal-deflection system. When the voltage is higher than usual (perhaps +130V), the low-voltage supply probably is normal but the horizontal-output transistor is non-conducting, either from a transistor defect or because of insufficient drive signal at the base.

Scope the Q402 base, expecting 18VPP (Figure 4). When this signal is zero or insufficient, go back to the Q401 horizontal-driver transistor and scope the base and collector for horizontal square waves. If they are missing, scope IC301 pin 10, expecting to find

1VPP horizontal pulses from the horizontal oscillator, which is powered from the +112V regulated source. Therefore, the oscillator should operate anytime the regulated source has almost the rated voltage.

If IC301 becomes leaky, R407 (Figure 4) will overheat. Check for leakage by unsoldering pin 8 of IC301 from the board wiring and measuring the resistance to ground. A resistance reading of less than about 600Ω indicates a shorted or leaky IC301, which can be replaced by an SK9015.

Remember that excessive current through the Q401 horizontal-driver transistor will burn up R411 (1200Ω) shown in Figure 5, and stop the driver operation. Also, excessive current through 1Ω R441 (which feeds +112V to pin 5 of the T461 flyback transformer) will destroy the resistor and remove all B+ from the horizontal-output transistor. A shorted Q402 horizontal-output transistor or a shorted C417 (the yoke coupling capacitor) are the components most likely to produce such a heavy overload.

## 4—High-voltage shutdown

Shutdown in the Samsung CT-331AZ can be produced by three general things: (1) excessive pulse amplitudes from T461 flyback; (2) excessive current to the picture tube or inside the flyback with its integrated HV diodes signal to IC301 pin 9); or a defect in the shut-down circuit itself (Figure 6).

Excessive dc voltage from the +112V regulated source or an open 0.01μF C413 can produce excessive flyback pulses, and the increased amplitude triggers the latching-type shut-down circuit (inside IC301) that eliminates the base signal for the Q401 horizontal-driver transistor.

Photofact 2064-1 refers to TP-42 and TP-43 used to test the shut-down circuit. However, the Photofact drawing does not show those testpoints. Try to find the testpoints visually before you test or repair the shut-down circuit. The complete method is shown later in step-by-step form. R417 is the adjustment control for the +112V regulated source. It might require

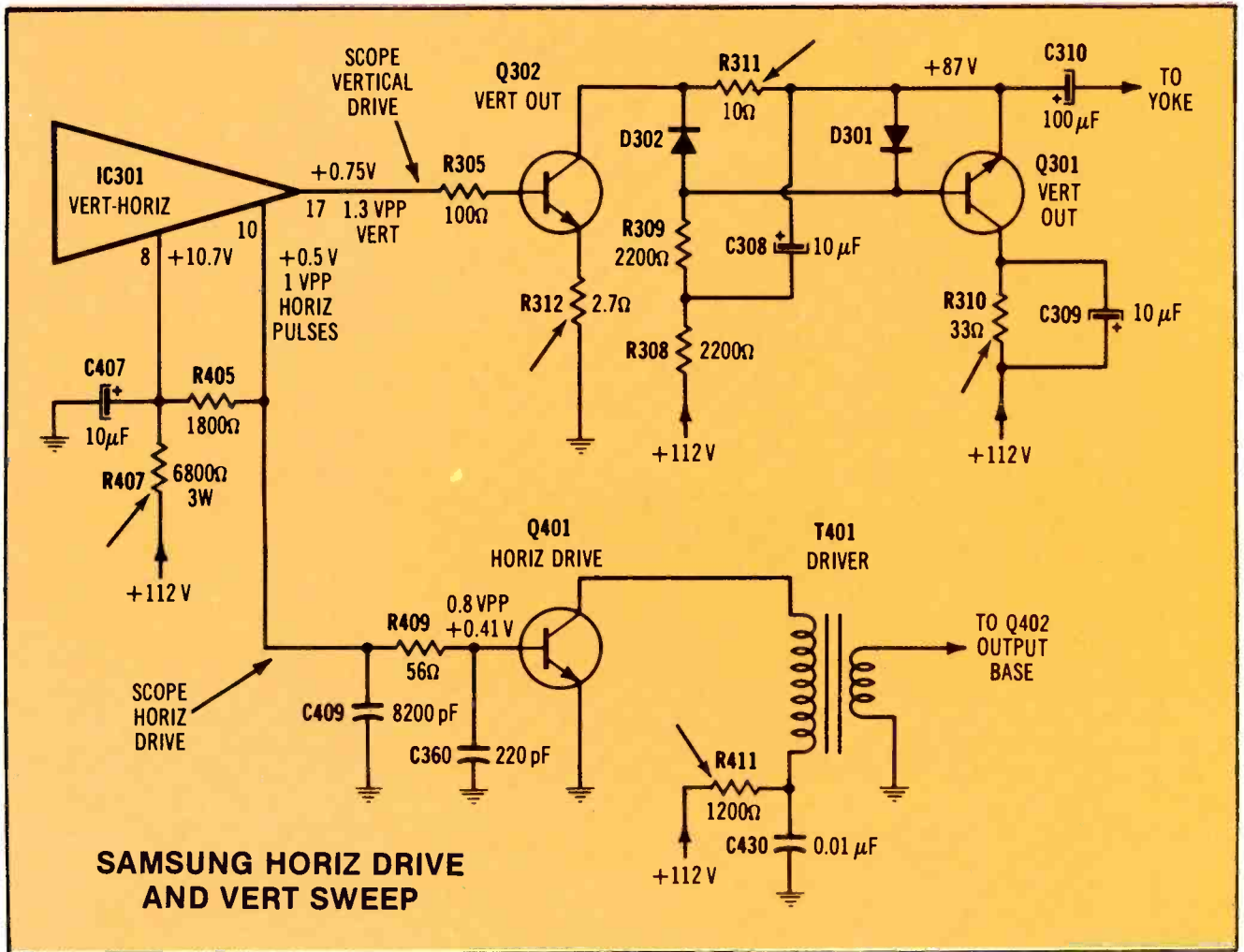

**Figure 4.** The Samsung CT-331AZ has no special start-up circuit. Instead, the horizontal oscillator (in IC301), the Q401 horizontal-driver transistor, Q402 horizontal-output transistor, the vertical oscillator (in IC301), and the two vertical-output transistors (Q301 and Q302) operate from the regulated +112V source. Therefore, they will operate as long as the power is switched on. This schematic shows the horizontal-drive pulses exiting IC301 at pin 10, and the vertical-drive waveform exiting at pin 17. One important signal not shown is the vertical yoke-current waveform that is applied to IC301 in 14. Use your scope to follow these horizontal and vertical signals from the IC301 pin to the output stage. Components often found burned or open include R407, R411, R312, R310 and R311. Check them carefully.

adjustment (or replacement, if it is factory-sealed).

If excessive high pulse voltage is suspected as the cause of shut-down, connect a variable-voltage ac transformer to supply the ac input power. Begin with about 60Vac, and measure the high voltage at the picture-tube anode as the input voltage is increased slowly. If the required +23kV to +25kV is obtained with an input voltage lower than 120Vac, the high voltage is excessive. And it is likely also that all flyback pulse amplitudes are excessive. Find the cause of the excessive high voltage and correct it.

If the receiver goes into an apparent shut-down mode long

before the input voltage reaches 120Vac, but the high voltage is normal for the input voltage, the protective circuit is defective.

In one case, IC301 required replacement before the problem of incorrect shutdown was solved.

### 5 - Insufficient height

Loss of all height or intermittent height can occur almost anywhere in the vertical circuit, such as the IC301 vertical oscillator or the two vertical output transistors. Insufficient height with poor linearity most often comes from defects in the vertical-output circuit that includes the two output transistors.

Scoping the vertical circuit can locate where the signal stops, but

analysis of the waveforms is difficult because a sample of the yoke current is brought back to IC301 pin 14. This is negative feedback that reduces distortion, adds stability and makes a linearity control unnecessary. But a loss of vertical signal (say in the output stage) removes the yoke-current feedback signal, and the missing signal changes the waveform of the vertical drive at IC301 pin 17. And insufficient height accompanied with serious nonlinearity produces a distorted feedback waveform at IC301 pin 14. Therefore, waveform analysis is not very helpful.

Experience has shown most problems can be corrected by



# FREE\* ADVICE

## FOR EVERY ELECTRONICS TECHNICIAN!

Get the valuable information you need to keep up to date in today's rapidly changing electronics business with three new and expanded handbooks prepared as a service to the industry by the Consumer Electronics Group of the Electronic Industries Association. See the coupon below for complete ordering information on this "must" reading for electronics technicians.

### TELEVISION INTERFERENCE HANDBOOK

Designed by professionals to help technicians identify the source of common television interference. Describes the latest procedures and remedies, including the design of frequency traps, to eliminate these problems.



### INTERFERENCE HANDBOOK FOR AUDIO SYSTEMS

Written to assist today's technician identify common audio rectification interference. Outlines the proper methods for installation of circuit traps and modification techniques to eliminate these annoying conditions.

### REPLACEMENT PARTS SOURCEBOOK

The definitive guide for ordering replacement parts from over 60 consumer electronics companies across the country...ranging from the relatively small company to industry giants. Ordering procedures are described, with exact names, addresses and phone numbers. Also includes suggested procedures for inventory control of service parts.

Send this coupon with your order to:

**EIA/CONSUMER ELECTRONICS GROUP**  
Dept. PS, Box 19100  
Washington, D.C. 20036

\* There is a \$1.00 charge to cover postage and handling.

Enclosed is \$1.00 to cover postage and handling for the EIA/CONSUMER ELECTRONICS HANDBOOK(S) checked below.

- Replacement Parts Handbook
- Television Inteference Handbook
- Interference Handbook for Audio Systems

Make check or money order payable to Consumer Electronics Group.

Name \_\_\_\_\_

Company \_\_\_\_\_

Street \_\_\_\_\_

City \_\_\_\_\_ State \_\_\_\_\_ Zip \_\_\_\_\_

Circle (35) on Reply Card

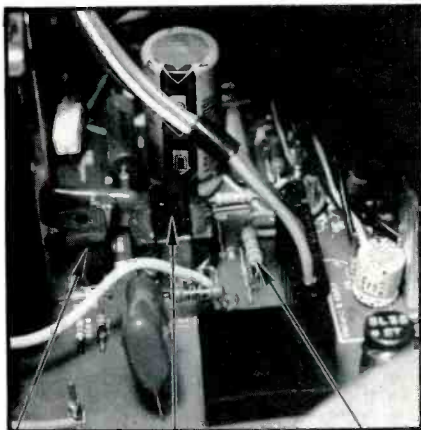

**Figure 5.** Arrows show locations of Q401 (at left), driver transformer T401 (center) and B+ resistor R411 (at right). Excessive forward bias at the Q401 base produces excessive collector current which burns up R411. Examine R411 visually, and replace it if it shows any sign of having been hot.

replacement of Q301, Q302, R312 (2.7 $\Omega$ ), R311 (10 $\Omega$ ) and R310 (33 $\Omega$ ). These power output transistors sometimes break down under load, while testing normal out-of-circuit. Resistances of the resistors are critical and should be checked carefully (Figure 4).

## 6- Intermittent height

Connect the probes of a dual-trace scope to IC301 pin 17 and the negative terminal of C310 output capacitor. If both traces lose their waveforms at the same time the height collapses, the problem is with IC301. Use an ECG1417 as replacement when one is needed.

When the pin 17 waveform is steady but the height collapses, move the probe down the vertical signal path until a point is found where the waveform disappears in synchronism with the vertical collapse. The problem is between that point and the one for the previous test where the waveform did not disappear.

## 7- Vertical flutter

Erratic vertical height that might appear as a vertical flutter can be caused by certain defective components in the low-voltage regulator circuit. Zener diode D806 has a bad reputation for shorting erratically or becoming leaky. When D806 leaks sufficiently, it burns open resistor R813

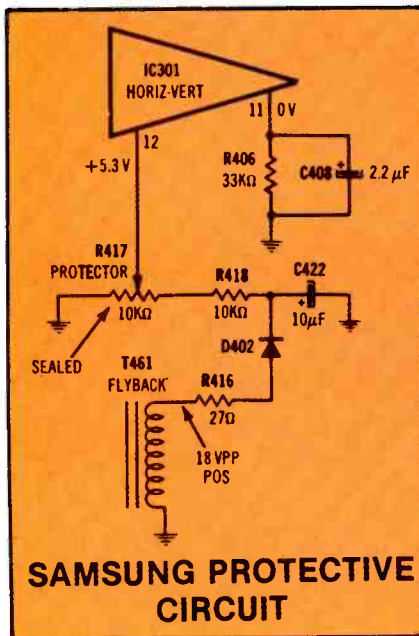

**Figure 6.** All transistors of the Samsung latching-type protective circuit are inside IC301. D402 rectifies the pulse amplitude of one flyback winding. The resulting dc voltage is filtered and stored in C422 before it is applied to R418 and control R417. Adjustable output of R417 is applied to IC301 pin 12. If the pin-12 voltage becomes excessive, the internal circuit latches, thus removing the horizontal-drive signal from pin 10, and this stops the horizontal-deflection operation and with it all sound, high voltage and raster. One connection is not shown on this schematic. A dc voltage representing the picture-tube current is brought to pin 9. Therefore, excessive CRT current also triggers shut-down.

(Figures 7 and 8).

Both components should be replaced at the same time. Also, R813 should be replaced after the Q801 regulator transistor has been found shorted.

When a new regulator transistor is needed, replace Q801 with an ECG-57 or an RCA SK3913.

Misadjustment of regulator control R851 can produce vertical flutter. In some models, this control is sealed. When a sealed control needs adjustment, it must be removed and replaced with a 2000 $\Omega$  screwdriver-adjustment type. Adjust the sealed control for +112V at the Q801 collector.

## 8- Excessive brightness with retrace lines

Symptoms of white retrace lines

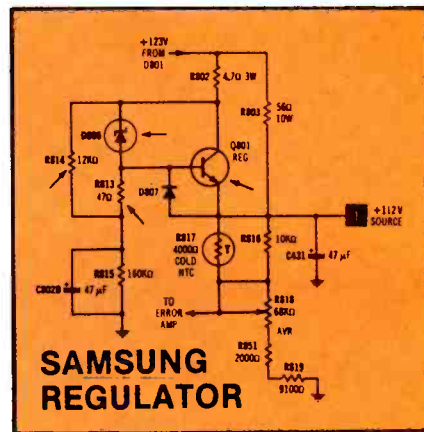

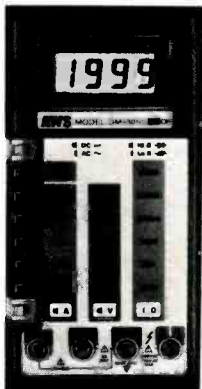

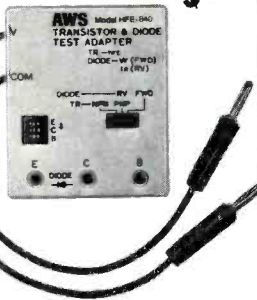

**Figure 7.** Additional regulation in the Samsung is provided by Q801 which is connected to produce automatic variation of its collector-to-emitter resistance that changes the C/E voltage drop so the emitter-to-ground voltage remains relatively constant. Zener diode D806 stabilizes the base voltage about 8V lower than the collector voltage. Therefore, any variation of the emitter-to-ground voltage (from changes of load current, for example) is a change of base-to-emitter bias which in turn changes the collector-to-emitter voltage in the direction that maintains the output voltage (from the emitter) at a relatively stable point. Arrows point to components often known to cause trouble. Although it seems unlikely that a 47 $\Omega$  resistor (R813) could become burned (because higher resistances are at both ends of it), the overload probably comes from surge currents through C802B.

in the raster, little response to adjustments of the brightness control and perhaps a faint picture usually point to a defect in the video circuit, the video-output transistors or the picture tube.

First, measure dc voltages at all picture-tube-socket pins (except focus and screen or G2) and compare them against the schematic voltages. Any radical differences between meter and schematic values will indicate an area with a problem.

Secondly, measure the dc voltages at the three color-output power-transistor collectors (Q901, Q902 and Q903). Normally, these dc voltages should be almost identical with the dc voltages at the corresponding CRT cathodes tested previously. Low voltages of about the same value at the three collectors indicate a loss of the +145V source (Figure 9). These reduced voltages at transistor col-



<p><b>DM-3010 DIGITAL MULTIMETER</b></p>  <p><b>\$80</b></p>	<p><b>SJA-870 JAW ADAPTOR</b></p>  <p><b>\$65</b></p>	<p><b>HFE-840 TEST ADAPTER</b></p>  <p><b>\$29<sup>95</sup></b></p>	<p><b>HVP-860 HIGH VOLT PROBE</b></p>  <p><b>\$49<sup>95</sup></b></p> <p>See Us at Electro/85 Booth 3513</p>
---	--	---	--

## The new AWS DM-3010. It's not just another DMM. It's a complete electrical/electronic testing system.

Today's electrical and electronic testing requirements call for equipment that can handle a wide range of applications. That's why now more than ever you need the new AWS DM-3010 Testing System.

To start off with, the **DM-3010 Digital Multimeter** has an unbelievable \$80 price tag. It offers 34 ranges with push-button control plus features usually found in much more expensive models such as: 10 Amp AC/DC range; UL1244 type test leads; overload protection on all ranges; Hi and Low power ohms in all resistance ranges and more.

Complete the system by simply adding the following accessories as you need them...

**SJA-870 Snap-Around Jaw Adaptor.** Reads 0-1200 Amps AC. Its large jaws fit easily around any conductor up to 2-15/16" in diameter.

**HFE-840 Test Adapter.** If your work requires transistor and diode testing, this pocket-size adapter is a must.

**HVP-860 High Voltage Probe.** Provides safe, easy and reliable readings of 0-50KVDC on low power high impedance circuits.

So compare the DM-3010 Testing System for yourself. You'll find that no other company offers a comparable system at these low prices.

For more information on the AWS DM-3010 Testing System, see your local distributor today or contact A.W. Sperry Instruments Inc., P.O. Box 9300, Smithtown, N.Y. 11787. Call Toll-Free 800-645-5398 (N.Y., Hawaii, Alaska call collect 516-231-7050).

**A.W. SPERRY  
INSTRUMENTS INC.**

Circle (16) on Reply Card

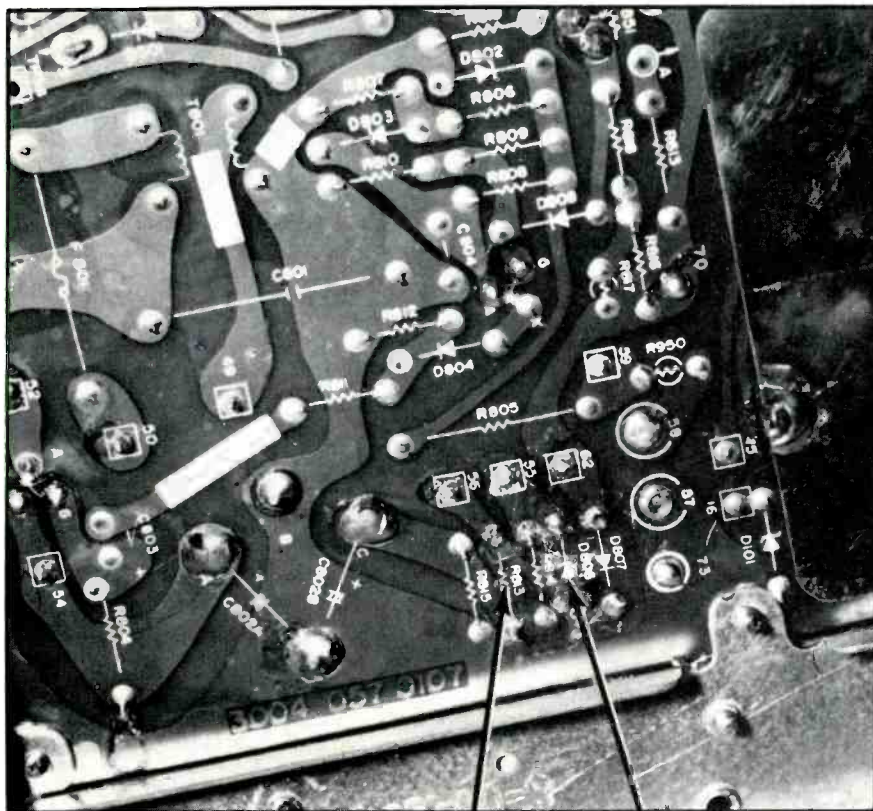

**Figure 8.** Defects in 47Ω resistor R813 and zener diode D806 can produce a cyclical variation of the +112V regulated-source voltage that appears as a vertical flutter. Location of R813 is shown by the left arrow, while the arrow at the right indicates the above-board location of D806.

lectors and CRT cathodes increase the brightness of all three colors, causing white retrace lines and reducing the apparent range of the brightness control.

High collector (and CRT cathode) voltages for all three colors reduce the *brightness*. Collector voltages equal to the +145V source eliminate the raster and picture.

A low voltage at just one color-output-transistor collector increases that color in the picture, and sometimes produces retrace lines of that color. A higher voltage at just one color-output-transistor collector decreases that color in the raster and picture. Use these statements to help in your diagnosis.

Notice from the Photofact schematic that model CT-331AZ uses only one IC (IC501) for all video and chroma stages (except for the three color-output transistors previously discussed). Therefore, scope tracing of all stages is not possible.

Instead, the video signal enters IC501 at pin 5, the chroma signal enters at pin 13, and horiz/vert

blanking enters at pin 24. Red drive signal exits at pin 26, green drive exits at pin 27, and blue drive exits at pin 28. These are the major testpoints, although a few pins have 3.58MHz and other signals that can be scoped for additional tests when desired.

If the input signals are normal, but there are no three color drive signals, do not automatically assume the IC is defective. Test first for +11.64V at pin 1. No voltage or low voltage at this source might indicate a leaky or shorted zener diode D504, or R533 with its normal 180Ω value increased by the heat of overload from a bad D504.

Alternately, low dc voltages at pin 1, pin 10 and pin 3 might indicate a leaky IC501. Check the resistance between pin 1 and ground when the ac power is off. A reading of 1000Ω or lower always indicates a leaky IC. When a new IC is required, use an original part number or a universal SK9016.

### 9 – Distorted sound

Sound distortion is most often found in the two audio-output transistors and the audio-output stage. Although, a defective IC601 IF/detector/audio-driver IC (Figure 10) has been known to

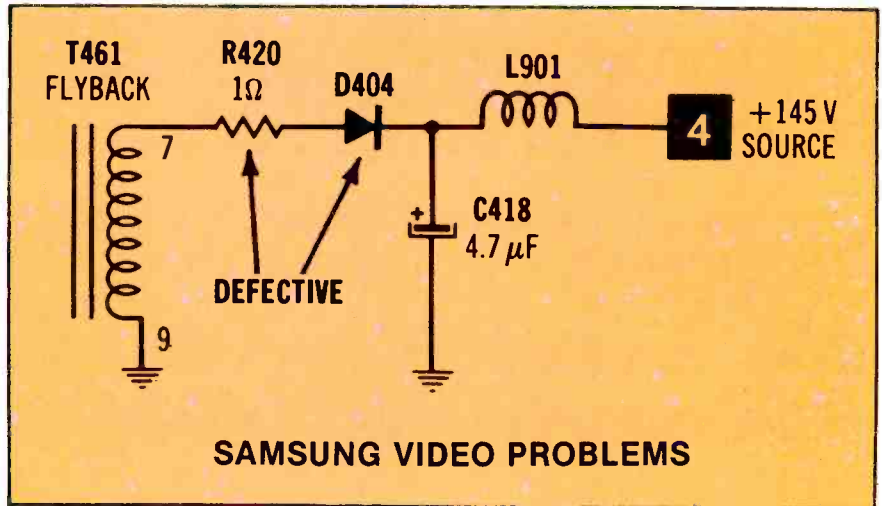

**Figure 9.** Horizontal-deflection pulses are rectified by D404, filtered by C418 and the resulting dc voltage is the collector-supply voltage for the three color-output transistors that drive the picture-tube cathodes. A shorted D404 and an open R420 are common. A loose joint at one or both leads of L901 can cause excessive brightness without video when the joint opens. A partially open C418 can cause one side of the picture to be brighter than the other.

cause distortion or erratic sound.

Scoping the audio path usually is the best and fastest way of finding the point where intermittent operation or audible distortion begins. The audio exits from IC601 at pin 12. Begin there, and scope the negative side of C612 (or the Q602 base), the Q602 collector, the Q601 collector and the positive terminal of C613 that feeds the

output transformer and the speaker. A large change of waveform between one point and the next indicates trouble between the two points.

In one case, the sound was normal at pin 12 of IC601 and at the base of Q602. But distortion was obvious at the Q602 collector. Transistor Q602 was tested in-circuit, where it appeared to be

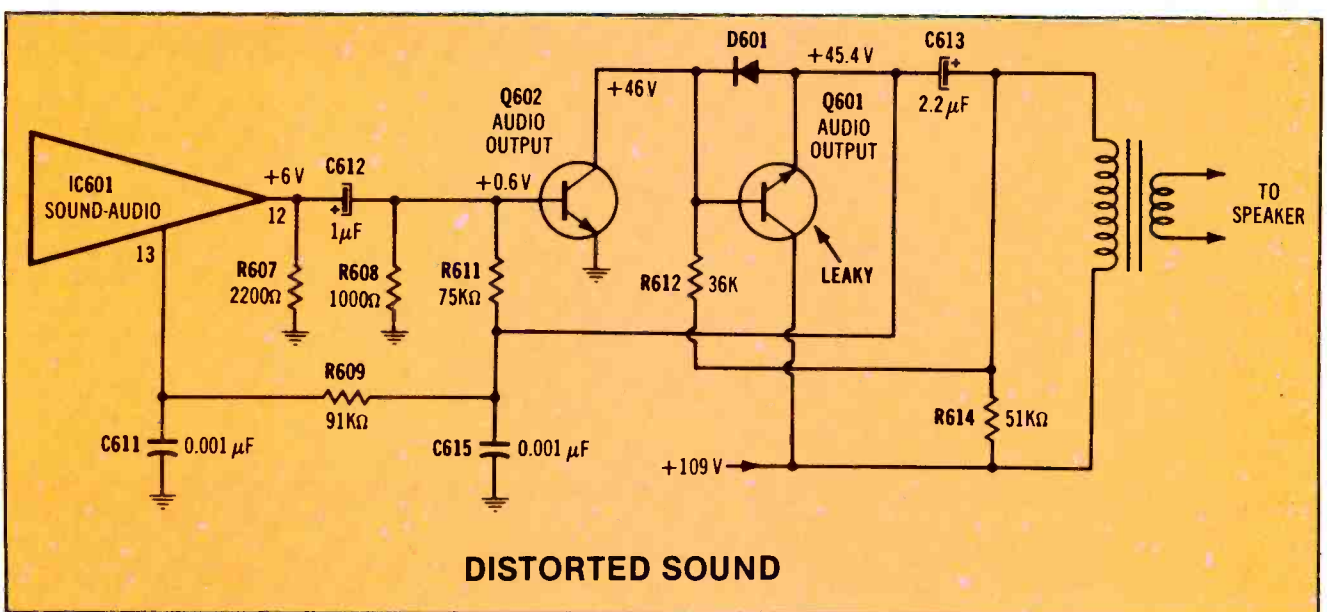

**Figure 10.** First suspects for a symptom of distorted sound are Q601 and Q602 power-output transistors. In one case, an excessive dc voltage at the Q601 emitter was caused by a leaky Q601. The origin of moderate audio distortion can be found easily by scope waveforms.



# Your customer just paid good money for a service call. Don't let him blow it!

All your hard work and your customer's hard-earned money are wasted when a voltage surge hits. All it takes is a nearby lightning strike or the switching of a load within a building. RCA's Voltage Surge Suppressor can prevent this damage to sensitive electronic equipment, and assure you of extra profit on every service job you do.

Available in a 3-way version, SK403, and a single-socket version, SK401, the suppressor plugs into any 15-amp, 125-volt grounding receptacle or cord connector. If constantly overloaded, the suppressor will cut off power to equipment connected to it, guarding against unprotected operation and signalling the



need for a replacement suppressor.

Once they realize how much damage it can prevent, your customers will want to buy RCA's Voltage Surge Suppressor to protect their TVs, computers, sound systems, microwave ovens and other electronic equipment. Every SK403 and SK401 has been tested before leaving the factory. So why blow a perfect opportunity to protect a satisfied customer? Stock up on RCA's profitable Voltage Surge Suppressors today.

**RCA**  
SK Replacement  
Solid State

Call your RCA SK Distributor or write: RCA Distributor and Special Products Division, 2000 Clements Bridge Road, Deptford, NJ 08096, Attn: Sales Promotion Services.

normal. Transistor Q601 tested leaky between all three terminals when in-circuit. Because diode D601 paralleled the base and emitter junction in-circuit, Q601 was removed for tests, showing leakage only between collector and emitter. An ECG-399 transistor was installed in the Q601 position, and the sound became normal without distortion.

## 10—Last-minute adjustments

Immediately before you replace the receiver's back, check the high voltage (should not exceed 26kV) and the low-voltage +112V source. Make certain the protection circuit is functioning correctly. Remember that R851 is the only adjustment for the amount of high voltage, although it actually changes the voltage of the +112V regulated source.

Use the following check list:

- Tune in a TV program, adjusting brightness and contrast for a normal picture without blooming or excessive brightness. *Supply 120Vac to the receiver.*
- Connect a VTVM or DMM to the +112V source at terminal TP91. If

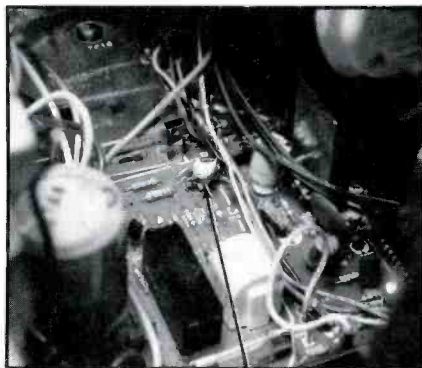

**Figure 11.** Adjustment of R851 (at tip of arrow) varies the +112V source voltage which in turn changes the high voltage. As shown here, the control has been sealed at the factory in some receivers.

TP91 is not visible, measure the dc voltage at the Q801 emitter terminal or the end of R803 that connects to the emitter.

- Adjust control R851 (Figure 11) for a reading of +112V on the meter. If R851 is sealed, go on to the next step.
- Measure with an HV probe the high voltage at the picture-tube anode. Rotate the brightness and contrast controls to minimum (dark raster) and notice the high

voltage. If it does not rise above 26kV, the +112V source voltage is no more than 1V too high or too low, and the picture has full width, there's no need to replace R851 in order to adjust the +112V source. Failure to satisfy all three conditions requires R851 to be adjusted. A new one must be installed if the original is sealed too tightly to allow removal of the sealing material.

- Again, adjust contrast, brightness and station selector for a normal picture. Temporarily, short TP-42 to TP-43 on the main board using a test lead. The receiver should become dead, with no sound, picture or raster.
- Turn off the ac power, remove the test lead and wait for a minute or two.
- Turn on the ac power. Normal operation should be obtained.
- Failure to lose sound and picture when the testpoints are shorted together, or failure to obtain normal operation after the short is removed and the receiver switched on again requires repairs to the protection circuit.

**ES&T** www

# Understanding the floppy disk

Personal computers are becoming a consumer item. With intensified competition, prices are coming down. New computers with enhanced capabilities are being introduced. More good, easy to use software is being produced all the time, and people are beginning to learn the value of software such as data base, word processing and spread sheet programs.

As a result, computers are being used in large numbers of homes throughout the country. Sooner or later, many of these personal computer systems will need some kind of servicing. And because of its electromechanical nature and constant use, the component of those systems that is most likely to need servicing is the disk drive.

For anyone who is not familiar with these devices, the thought of taking a disk drive apart and diagnosing and repairing the problem is intimidating. That's probably just as well, because they are high-precision devices that might suffer greatly from attacks by unenlightened would-be fixers.

On the other hand, if their operation is understood and the proper precautions are observed, many problems can be resolved without a detailed knowledge of their construction and operation. And servicing of minor problems frequently results in enhanced knowledge and confidence that may lead to an ability to resolve more involved problems in the future.

This article is an adaptation of a paper, "The ABCs of Floppy Disk Formatting," produced by Applied Data Communications (ADC), of Tustin, CA, a company that manufactures computer peripheral support equipment, including test equipment for floppy and Winchester disk drives.

In the hope that a better understanding of the construction of the disks themselves and the method by which they store information should enhance the readers' understanding of the drive itself, the article is presented here.

We are currently in the research phase for future computer servicing articles, and plan to publish specific floppy-disk troubleshooting/servicing articles in the near future.

A floppy disk consists of three main parts. These are: the jacket, the jacket liner and the rotating portion, the floppy disk. (See Figure 1.) The jacket protects the disk from dirt and scratches and the liner protects the disk from being scratched by the jacket. More importantly, the liner also cleans the disk. Cleaning the disk significantly contributes to the technical success of the floppy disk.

The rotating portion, the actual disk, stores digital data. It is made by coating a plastic (mylar) film on both sides of the disk with magnetic material. Iron oxide is the most common magnetic material used; but newer disks soon will be using other magnetic materials.

The coating consists of acicular (needlelike) iron oxide, very finely ground, mixed with binders and lubricants. The small size of these iron oxide particles is a contributing factor to the linear bit density (number of bits per inch) of the material. The tiny iron oxide particles are permanent magnets. When exposed to an external magnetic field, they assume a magnetic orientation imposed by the field, which can be in one of two directions at right angles to the head gap.

In the read/write system of a floppy disk drive, the read/write head and the floppy disk form a magnetic system. (See Figure 2.) When writing on the disk, the read/write head supplies the external magnetic field that orients the magnetic particles on the floppy disk.

During the write process, the read/write head is supplied current, in one of two directions, of sufficient magnitude to completely orient the magnetic particles on the disk in one of the two possible directions.

When the direction of the current supplied to the head changes, the direction of the particles' magnetization changes. This direction change is called a *flux reversal*, and it is used to store digital information. More than 80,000 flux reversals can be written on one track of a standard 8-inch disk.

## Encoding

*Encoding* has rules for writing



flux reversals so that they represent digital data. In this discussion, we will refer to *bit cells*. A bit cell is a small physical area on the disk occupied by one binary digit, or bit. The encoding rules will define how flux reversals will be written in bit cells to represent digital data, i.e. ones and zeros.

### FM encoding

FM, applied to encoding of information on a disk, stands for frequency modulation, just as in radio. The reason for naming this type of encoding FM is because two frequencies are involved. One frequency is at the bit rate, when a series of binary zeros are written. The other frequency is at twice the bit rate, when a series of binary ones is written. The encoding rules for FM are:

1. A flux reversal is written in the

**Figure 1.** A floppy disk is a circular piece of Mylar film, coated with an iron oxide coating that is free to rotate within a protective jacket. Information is stored on the disk by applying a magnetic flux to small areas of the disk called bit cells.

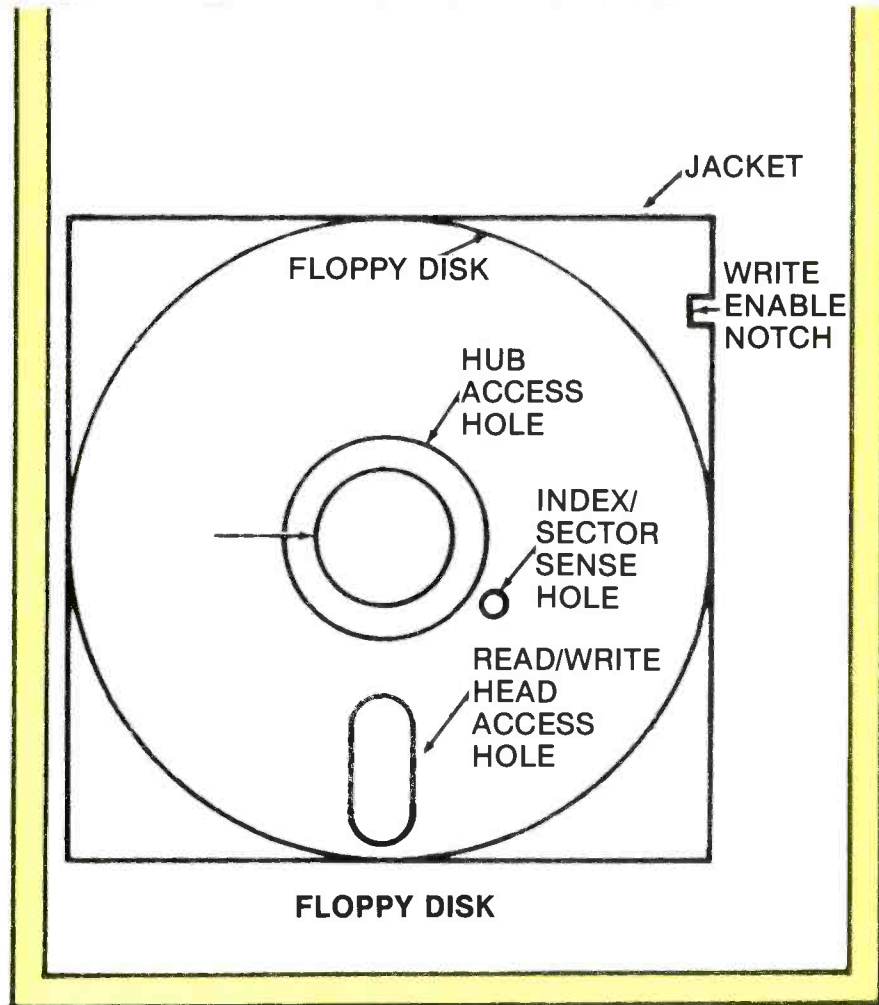

# SPRING SPECIALS!

## Jerrold Cordless Cable T.V. Converter

MODEL LCC-58 (Special)



**SPECIAL!**

**\$69<sup>95</sup>**  
ANY QUANTITY



### SYLVANIA/RCA Triplers

ECG-500/SK3304

ECG-523

ECG-526/SK3306

**\$10<sup>99</sup>** EA.

SANYO  
2SC1308K



**\$1.49** EA./100 LOT  
\$1.69 EA. 30-99  
\$1.99 EA. 10-29

RG-59/U 75 OHM  
Co-Axial Cable  
Copper Braided  
Shield

White or Black

Bare copper  
conductor  
Braided bare  
copper shield



**\$44<sup>50</sup>**/1000 ft.

F-59 CONNECTOR  
SEPARATED FERRULE



**6c** /5000 LOT  
**7c** /1000 LOT  
**11c** /100 LOT

MATCHING  
TRANSFORMER

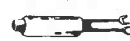

**29c** /500 LOT  
**44c** /100 LOT  
**59c** EA.

2 WAY-75 OHM  
U/V SPLITTER



**59c** /100 LOT  
**89c** /50 LOT  
**\$1.49** EA.

# OMNITRON

ELECTRONICS  
770 Amsterdam Ave. New York, NY 10025

Write for FREE 136 page Catalog

### SHIPPING CHARGES

For Orders	ADD
\$25-100	\$6.50
\$100-\$500	\$8.50
\$500-\$750	\$10.50
\$750 and up	\$15.00
Parcel Post	\$20.00

MASTER CARD • VISA

Send Purchase Order, Check,  
Money Order or C.O.D.

or Call Toll Free

**800-223-0826**

in N.Y. State (212) 865-5580

Circle (17) on Reply Card

middle of each bit cell which contains a binary one.

2. A flux reversal is written at the beginning of every bit cell.

FM is called self-clocking because each bit cell has a flux reversal at the beginning. These flux reversals are commonly called clock flux reversals or clocks. Flux reversals in the middle of the bit cells are called data flux reversals.

(See Figure 3A.) Clock flux reversals at the beginning of every bit cell make FM easy to decode. By definition, one bit cell can contain two flux reversals.

### MFM encoding

MFM stands for modified frequency modulation. This is because it was derived from FM and the high and low frequency do not

change. Thus the system bandwidth requirements do not change. The encoding rules for MFM are:

1. A flux reversal is written in the middle of each bit cell which contains a binary one. (The same as FM rule 1).

2. A flux reversal is written at the beginning of a bit cell if there will be no flux reversal in the middle of that bit cell (the cell contains a logical zero) and there was no flux reversal in the middle of the previous bit cell.

A study of the encoding rules for MFM will prove that no bit cell can contain more than one flux reversal. (See Figure 4A.) This means that with the same linear flux reversal density as in FM, MFM can use twice the number of bit cells, meaning twice the number of bits. Thus MFM is commonly called *double density*. MFM is not self-clocking and as a consequence is more difficult to decode.

There's another system, called modified modified FM (MMFM), but it is not used much in floppy disk systems today.

### GCR

GCR stands for group encoding, which means that a group (more than one) of binary bits is translated to flux reversals to be recorded. Typical examples are four-bit to five-flux reversal and five- or six-bit to eight-flux reversal conversions. These forms of encoding can have very good decoding margins but usually require more system bandwidth.

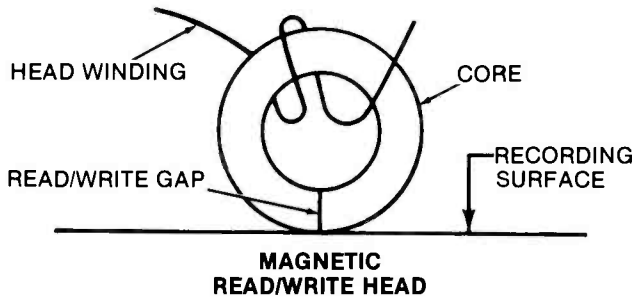

Figure 2.

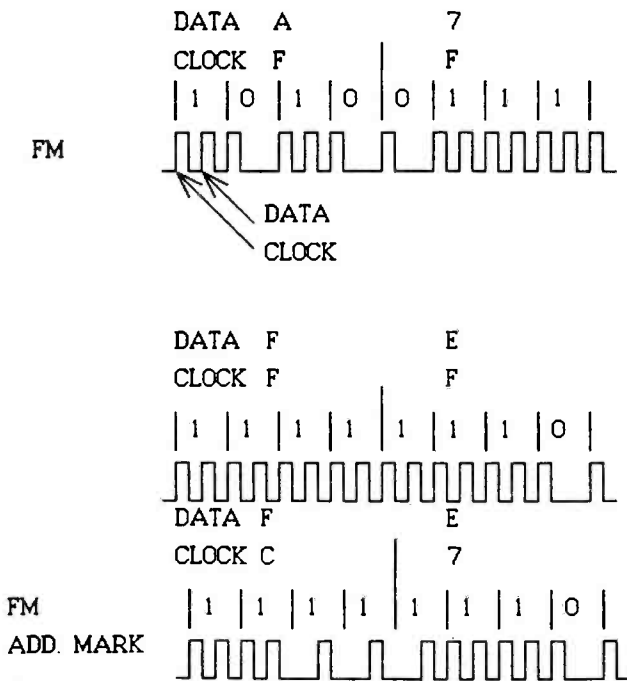

Figure 3.

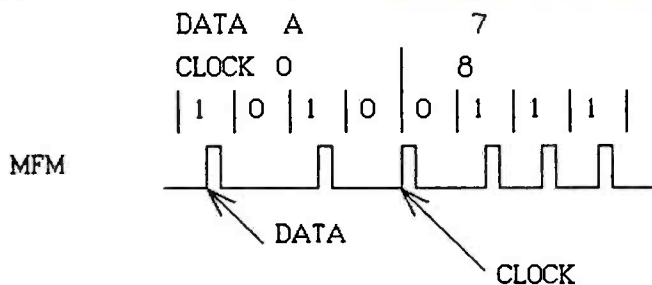

Figure 4.

Figure 2. The read/write head supplies the magnetic field that applies the magnetic flux to the magnetic particles on the disk, much like the manner in which audio is recorded on an audio tape or video on a video tape.

Figure 3. A train of pulses illustrates how flux reversals are recorded on the disk in FM coding. 3B shows the inclusion of address marks as required in soft-sectored disks. (See text for detailed explanation).

Figure 4. In modified FM (MFM) no bit cell will have more than one flux reversal, so more information can be stored on the disk. This is "double density".



**SOFT SECTORED TRACK  
FORMAT LAYOUT**

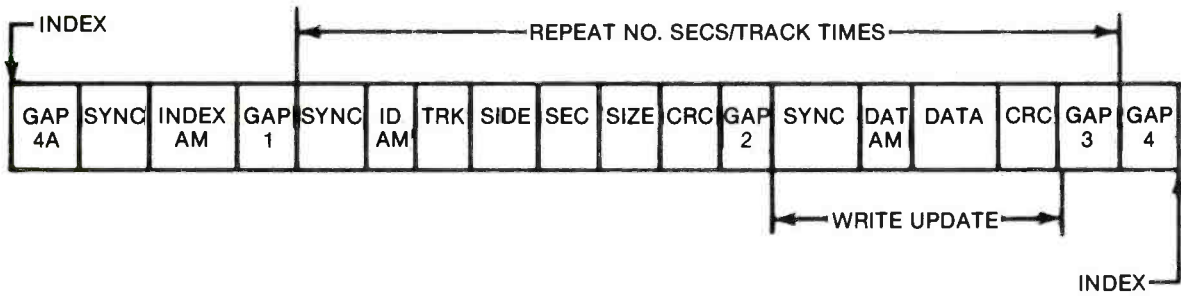

**Sectorization**

The entire track of an 8-inch floppy disk can hold 5200 bytes in single density and 10416 bytes in double density. A full track of a 5¼-inch floppy disk can contain 3125 bytes in single density and 6250 bytes in double density.

These numbers are too large to be handled conveniently by most systems. To make the record sizes more manageable, the disk is divided into pie shaped areas called sectors. The two common methods

used to divide the disk into sectors are called hard and soft sectoring.

**Hard sectoring**











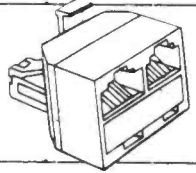

Hard sectoring is a physical process that places markers evenly spaced around the disk, such that an electronic signal is generated which defines the beginning of each sector. In floppy disks, the markers are holes, punched in the disk, which are detected by a light emitting diode/photo transistor pair.

**Figure 5.** Soft-sectored track format layout.

This system is logically simple to handle but is inflexible and requires precise alignment of the hole sensors with respect to the read/write head to guarantee drive-to-drive compatibility.

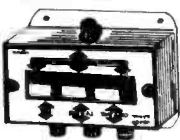
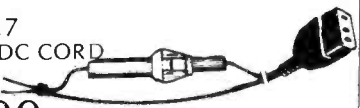
**Soft sectoring**

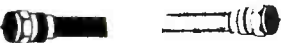
Soft sectoring is done all-electronically by writing two records per sector. The first record in the

<p>20-410 F59U 100 for <b>\$10.00</b></p> 	<p>20-005 GOLD "F to F" 3ft 10 for <b>\$10.00</b></p> 	<p>21-919 N-CONNECTOR DOUBLE FEMALE 10 for <b>\$15.00</b></p> 
<p>20-415 DOUBLE FEMALE 10 for <b>\$2.00</b></p> 	<p>12-373 SPST SWITCH 10 for <b>\$5.00</b></p> 	<p>60-182 DUAL ADAPTOR 10 for <b>\$9.00</b></p> 
<p>20-554 2 WAY SPLITER 10 for <b>\$6.00</b></p> 	<p>19-817 MIC CABLE 5 WIRES 1 SHIELD 6ft 10 for <b>\$8.00</b></p> 	<p>50-410 4 for <b>\$10.00</b></p> 
<p>20-512 COAXIAL SWITCH 2 for <b>\$5.00</b></p> 	<p>19-827 3 PIN DC CORD 10 for <b>\$5.00</b></p> 	<p>06-251 1KV 2.5A DIODE 200 for <b>\$15.00</b></p> <p>Equivalent to 1R-250, Mallory M2.5, HEP 170, 1N1565A, 1N1568A, 1N490 series.</p> 
<p>20-067 NICKEL "F to F" 3ft 10 for <b>\$5.00</b></p> 	<p>19-845 CB MIC 5 for <b>\$15.00</b></p> 	<p>3AG FUSE ASST 100 ea, 2A, 3A, 5A 300 for <b>\$9.00</b></p> 

MINIMUM ORDER \$10.00  
SHIPPING CHARGE  
UP TO \$100 - \$3.25  
C.O.D. FEE - \$2.00

ASK FOR OUR 32-PAGE  
FREE CATALOG  
**800-421-2841**  
**213-538-8333**

**FUJI-SVEA**  
P.O. BOX 3375  
TORRANCE, CA 90510

Circle (18) on Reply Card

**Small size.  
Small price.**

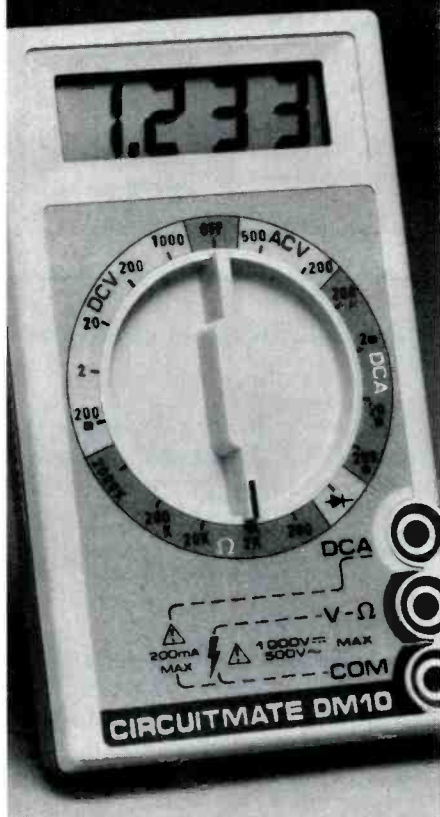

## DM10 . . . \$39.95\*

Don't settle for an analog multimeter. Now, for the same low price you can have a reliable digital multimeter that's easier to use, easier to read, and is three times more accurate.

- DCV accuracy 0.8% of reading
- 1/2" LCD digits
- 5 Functions (ohms, DCA, ACV, DCV, Diode check)
- Overload protection (250V in ohms)
- 250 Hour battery life.

This is the ideal carry-one-anywhere meter. Tool box, glove box, shirt pocket. Whenever you need to make a measurement, you're ready.

Also available, featuring a continuity beeper, is the DM10B for only \$49.95\*

Both models include a 9V battery, safety test leads, and operator's manual.

Get one now at your local Beckman Industrial distributor. \*Suggested list price.

Beckman Industrial  
A subsidiary of Emerson Electric Co.  
630 Puente Blvd.  
Brea, Calif. 92621

**Beckman Industrial!**

sector is called ID and contains the track and sector address of the following data record.

The major problem in soft sectoring is getting into read synchronization and detecting the beginning of records. As in hard sectoring read, sync can be achieved by writing known sync patterns. Byte sync at the beginning of a data record is established by writing a special byte called an Address Mark.

To summarize, soft sectoring requires two records per sector. Each record must be preceded by a sync pattern and an address mark. An additional refinement is the addition of a two byte CRC (cyclical redundancy check characters) at the end of records to assure the records have been read correctly.

### Soft sectored track formats

In soft sectored operation, the disk must be formatted or initialized by writing every track with ID and empty data records before the disk is ready for general system use. After the IDs have been written during initialization, they are never overwritten unless the disk is reformatted.

In general system use, an ID is read, the head is moved if necessary to the correct track, then more IDs are read until the ID for the correct data sector is read. The system then reads or writes the data record immediately following this ID record.

There are gaps filled by gap bytes between all the records and at the start and the end of the track. The track begins at the leading edge of the index pulse that is generated by detecting one hole in the disk as sector pulses are generated for hard sectored disks.

Some of these gaps have significant physical functions. The gap between the end of the ID record and the beginning of the data record provides clearance so that the erase head is past the end of the ID record when write current is turned on to update the data record. This gap is called gap 2.

The gap between the end of a data record and the beginning of the next ID record (called gap 3) is a buffer for speed variations. Gap 3 is created with a minimum size

such that if the data record is updated at the fastest possible instant on the fastest possible drive (still within tolerance) that the data record will end just before the beginning of the next ID record.

In this case, gap 3 will have disappeared. The required length for gap 3, when formatting, can be calculated based on the drive speed tolerance and the data record size.

### Address marks

Address marks are a key factor in the success of soft sectored formats. To define address marks, both the data content and clock flux reversals must be defined. The data and clock flux reversals are defined by specifying their hexadecimal values.

For example, the ID address mark in IBM FM has an FE hexadecimal data value and a C7 hexadecimal clock value. (See Figure 3B.) This clock value, according to the encoding rules, should be FF hexadecimal. FF hexadecimal is all ones which means a clock flux reversal should be in every bit cell.

There are four address marks defined for IBM FM. These are: index, ID, data and deleted data. The deleted data address mark has not been mentioned before. It also could be called a special data address mark. A data record preceded by a deleted data address mark has some sort of unique status in the system. It is marked in a special manner with the deleted data address mark.

### A key to servicing

The floppy disk is the permanent storage medium for most personal computers. The disk drive is, therefore, a key component in any personal computer system. Furthermore, because of the very nature of computers, a disk prepared with the correct diagnostic routines can help to pinpoint problems not only in the disk drive, but in any part of the system.

An understanding of what a floppy disk is and how information is stored on the disk will be very helpful to anyone who, sooner or later, becomes involved in personal computer servicing.

**ES&T**

Circle (19) on Reply Card



## Cable amendment action proposed

An amendment to the Cable Legislation Act of 1984 that would preserve free market competitiveness among retailers may be realized due to the efforts of the National Electronics Sales and Service Dealers Association's (NESDA) legislative committee and George Jackson, a NESDA member from Florida.

The Cable H.R. 4103 Law does not prohibit cable firms from becoming involved in the selling, leasing and maintenance of home electronics devices. The comparative strength of cable companies and their direct access to consumers presents a threat to small, independent business shops.

Rep. Bill McCollum (FL), joining with NESDA's legislative committee in advocating an amendment to H.R. 4103, says, "It is unconscionable for the government to allow these small independent businesses that have served so well in the past to be overrun by anti-competitive practices from large cable companies."

In a letter to Timothy Wirth (D-CO), chairman of the U.S. subcommittee on communications and author of H.R. 4103, McCollum says, "The future of an industry controlled by the monopoly of the cable companies in retail and maintenance, as well as the actual cable access, will not prove to be in the best interest of the public."

Cliff Shaw, chairman of NESDA's legislative committee, is urging manufacturers, distributors, members of the association and non-members to contact their state representatives and ask their support for Congressman McCollum's amendment to the H.R. 4103 Law.

For more information, contact Wallace Harrison, director of communications, NESDA, 2708 West Berry Street, Fort Worth, TX 76109; 817-921-9061.

# MODULAR PROBES FOR SALE

For All Oscilloscopes  
To 300MHz  
X1 to X100  
Attenuation

*Pictured  
Accessories  
Included*



## INSTANT REPAIR

Probe tip, Head, BNC and Cable all screw into place easily and quickly.

**TEST PROBES, INC. TPI**

Your Probe Specialists

Coline U.S. Sales & Stocking Source P.C. Box 2113, La Jolla, CA 92038 (619) 459-4197

## COMPARE PRICE — COMPARE PERFORMANCE

Model	Attenuation	Bandwidth	Price
M12SW	X1-X10 Switchable	X1-10MHz X10-250MHz	<b>\$69.00</b>
M12X10	X10	250MHz	<b>59.00</b>
M12X10AP	X10 with Readout	250MHz	<b>65.00</b>
M15X100	X100	250MHz	<b>89.00</b>
M15X10HF	X10	300MHz	<b>75.00</b>
M12X1	X1	30MHz	<b>36.00</b>

Circle (20) on Reply Card

# Miniature Hand Tools

**Acu-Min®**  
Precision Miniature  
Tools for Industry

- Slotted Screwdrivers
- ⊕ Cross Recess Drivers
- English Hex Drivers
- Metric Hex Drivers
- Open End Wrenches
- Socket/Nut Drivers
- Spline Drivers



Used World-wide by Professionals

- |               |             |                 |
|---------------|-------------|-----------------|
| • Industry    | • Aerospace | • Ordnance      |
| • Instruments | • Test Labs | • Audio Visual  |
| • Assembly    | • Re-work   | • Field Repairs |



by *Moody* TOOLS INC. (401) 885-0911

42-60 Crompton Avenue, P.O. Box 230, East Greenwich, R.I. 02818

When **A**ccurate **M**iniature tools are required, specify **Acu-Min** by Moody

Circle (21) on Reply Card

# What do you know about components?

## PRINTED CIRCUITS and ZENER DIODES

By Sam Wilson

### Antenna knobs

I'm always glad to learn new things about components—even simple components such as a car antenna. A few weeks ago, a technician friend pointed out something I hadn't thought about regarding that relatively simple component part. Did you ever notice that little knob on top of all car antennas? It isn't for looks.

When a car moves on a pavement, its tires scrub against the road. That generates an electrostatic voltage of many thousands of volts. When you approach a pay station on a turnpike, a thin wire rubs along the bottom of the car to discharge that voltage so the person in the toll booth doesn't get zapped.

If it weren't for the little round knob on top of the car antenna, the voltage would leak

off through the antenna and into the air. In other words, there would be a corona discharge that would cause static in the radio.

If you've ever tried to stop corona in a TV high-voltage section, you know that sharp points are likely problem areas. The little knob on top of the antenna eliminates the sharp point.

### Printed circuits, thick films and thin films

Because so many components are being made with the thick film and thin film processes, it is a good idea to review what those terms mean. First, though, let's take a look at printed circuit boards.

Two methods of making printed circuit boards are shown in Figure 1. For a limited production (about 100 units), the silk screen method of Figure 1A is often used.

Everything except the conducting paths is blocked out on the screen. Material that resists etching is scraped across the screen. It oozes through the screen and deposits onto the copper clad board in the pattern of conducting paths. Figure 2 shows how a squeegee is used to spread the resist across the tight screen placed against the copper.

After the resist dries, the board is dipped into acid that eats away the copper at all points, except where there is a resist pattern. When the resist is washed away with the appropriate solvent, the copper foil pattern is all that is left on the insulating board.

For high quantity production, the photographic method is used. See Figure 1B. Light is focused through a mask onto the surface of the copper cladding, which is

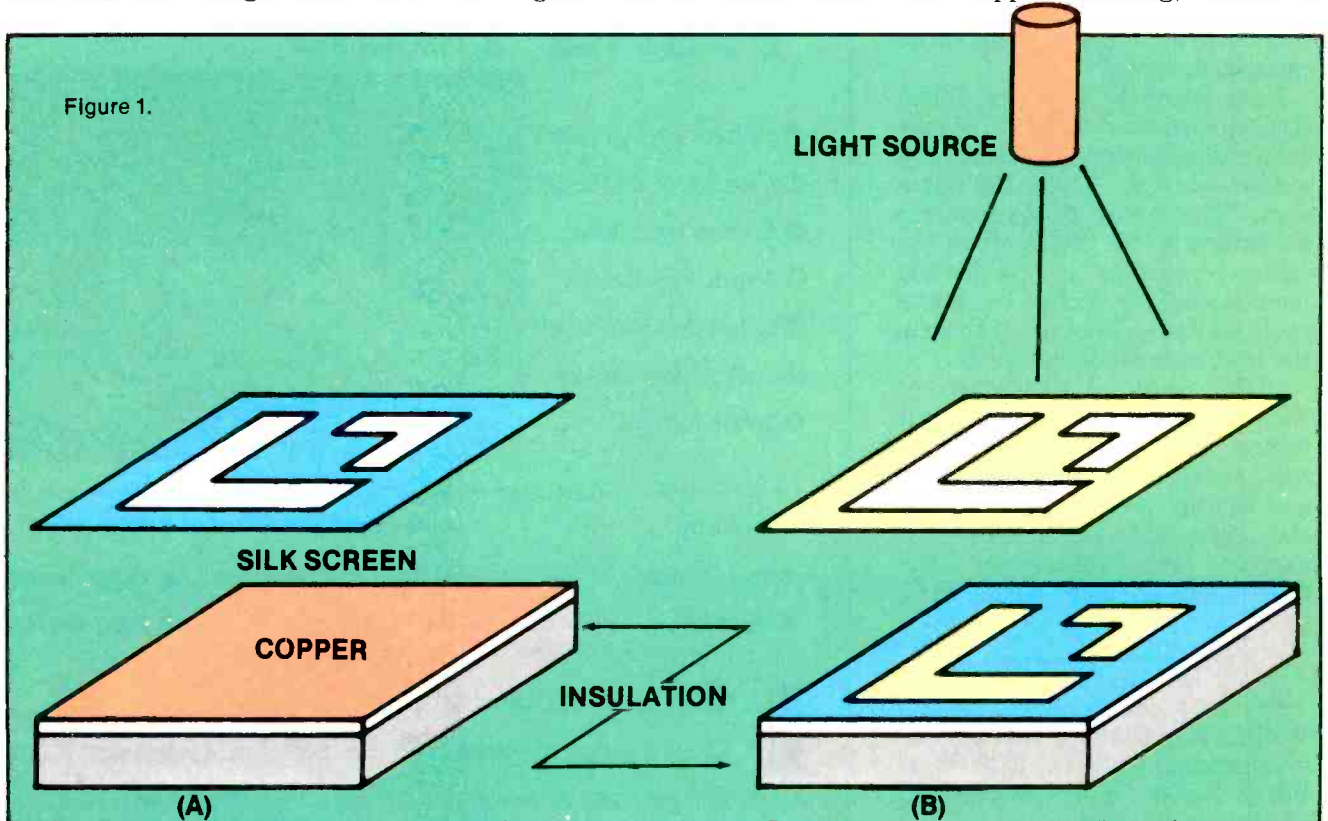



covered with a photosensitive material. After this exposure, the board is developed with chemicals in a process similar to making photographic prints. All of the photosensitive material is removed except where it has been exposed. Exposed material acts like the resist in the silk screen process.

The next step is to spray the board with acid. The acid eats away all of the unwanted copper, leaving only the conducting paths. In a final step, the exposed photographic material is washed away.

The copper pattern on the printed circuit board may be up to 0.03-inch thick ( $3 \times 10^{-2}$  in.). The procedures described for making printed circuits are similar to the procedures used for making thick film and thin film circuits.

If you look at a thick film circuit under a strong magnifier, you will notice it is similar in appearance to a printed circuit board. Tiny components are mounted on the surface, and the conducting paths make it look like a miniature printed circuit board. Thick film circuits are made small enough to be mounted in integrated circuit packages.

The procedure illustrated in

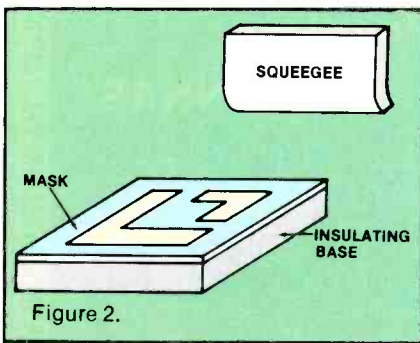

Figure 2.

Figure 2 is used. However, in this case, a conducting material is deposited upon the *substrate* (which is the insulating base). The substrate and deposited material are heated to a temperature of higher than  $750^{\circ}\text{C}$  to fuse the conducting material onto the substrate.

An important difference here is that the process may be repeated several times using different patterns. Some parts of the overall pattern are made with resistive materials. So, the thick film pattern consists of both conductors and resistors.

Because *thick* film conducting paths are only about 0.0005-inch ( $5 \times 10^{-4}$  inch) thick, the name is misleading.

In thin film production, a mask is placed over a substrate material. And, in a vacuum, conducting material is passed over the mask in the form of a vapor or fog. It passes through the openings onto the substrate to form the conducting paths. The thin film conducting paths are only a few angstroms thick. A typical value would be 0.000000015 inch ( $15 \times 10^{-9}$  inch).

### Using the zener diode

The zener diode has been discussed before, but this time it will be viewed from the standpoint of application. With a calculator and a little patience, you can design a zener-regulated power supply. Figure 3 shows the basic circuit.

The idea behind this circuit is that a small change in voltage across the zener diode causes a large change in the current through it. Suppose, for example,

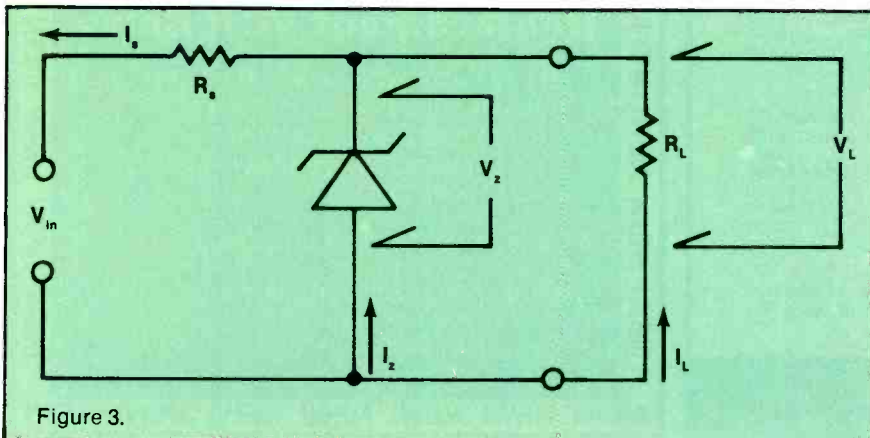

Figure 3.

# New Telephone Test Instruments from B&K-PRECISION

Easy-to-use . . . Fast . . . Dependable

## Complete Telephone Product Analyzer—Model 1050 \$1695

The only complete system for analysis and servicing of corded, cordless phones, auto dialers and answering machines.



## Cordless Telephone Tester Model 1047 \$895

All you need for full-frequency testing and alignment of base and portable units.



## Telephone Product Tester Model 1045 \$395

An in-store or in-field tester. Customer can check corded or cordless phone and auto dialers operation for all basic functions. Minimizes return of non-defective phones!



## Telephone Line Analyzer Model 1042 \$19.95

Tells if problem is in the phone or externally in the line, ringing circuit or line cord. Ideal for personal, business and field service. Merchandising blister pack.

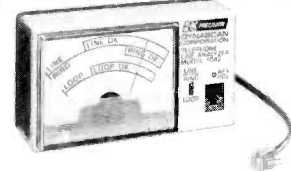

Available for immediate delivery at your local B&K-PRECISION distributor.

**BK PRECISION**  
**DYNASCAN CORPORATION**

6460 West Cortland Street  
Chicago, Illinois 60635 • 312/889-9087

International Sales: 6460 W. Cortland St., Chicago, IL 60635  
Canadian Sales: Atlas Electronics, Ontario  
South and Central American Sales:  
Empire Exporters, Plainview, NY 11803

Circle (36) on Reply Card

that the input voltage increases. Normally that would increase the voltage across the load resistance ( $R_L$ ). However, the increase in current through the zener diode causes a greater voltage drop across the series resistor ( $R_s$ ), and lowers the voltage across  $R_L$ . The overall result is that the voltage across  $R_L$  is nearly constant.

It is possible the input voltage is steady, but that there is a change in the output voltage due to a change in the load current. That change, in turn, increases the current through the zener. The resulting increase in voltage drop across the series resistor reduces the output voltage to the desired value.

If the input or output voltage decreases, there is a reduction in zener current. The voltage across  $R_s$  is reduced, and the output voltage is raised to the desired value. So, the zener circuit will regulate against changes in either the input or the output.

There are three possible conditions, and the design of the circuit is slightly different for each.

1. The input voltage may change, but the load is relatively constant.

2. The input voltage may be relatively constant, but the output current (and voltage) may change from time to time.

3. Both the input and output voltages are likely to change.

The following symbols are used in the simple equations.

$R_s$  - the series resistance in ohms

$V_L$  - the desired output voltage. This is also the rated voltage of the zener diode.

$V_{in}$  - the input voltage

$I_Z$  - the current through the zener diode

$I_L$  - the load current

$P_Z$  - the power dissipated by the zener diode

*Important! Double the value of  $P_Z$  to get the power rating of the zener diode.*

Here are the equations -

For good regulation, the zener current must be at least 10 percent of the current through  $R_s$ . These

equations have taken that requirement into consideration.

1. Regulation against input voltage changes with the load relatively constant

$$R_s = [V_{in}(\text{Min}) - V_L] / 1.1I_L$$

$$P_z = \{ [V_{in}(\text{Max}) - V_L] / R_s - I_L \} V_L$$

2. Regulation when the input voltage is relatively constant but the load current (and output voltage) tries to change.

$$R_s = (V_{in} - V_L) / 1.1I_L(\text{Max})$$

$$P_z = \{ [(V_{in} - V_L) / R_s - I_L(\text{Min})] \} V_L$$

3. Regulation when either the input or output voltage is likely to change.

$$R_s = [V_{in}(\text{Min}) - V_L] / 1.1I_L(\text{Max})$$

$$P_z = \{ [V_{in}(\text{Max}) - V_L] / R_s - I_L / R_s - I_L(\text{Min}) \} V_L$$

In all cases, the power dissipated by  $R_s$  is:

$$P_s = (V_{in} - V_L) (1.1I_L)$$

Double this value for the power rating.

**BSI**

## OPTIMA ELECTRONICS

TO ORDER CALL TOLL FREE 1-800-327-0224

### POPULAR CAPACITOR ASSORTMENT BAGS (PC Mount)

- |   |                 |        |
|---|-----------------|--------|
| <input type="checkbox"/> mfd (1),(2,2),(3,3),(4,7),(10),(22),(33),(47), (100),(220),(330),(470) . . . . . | -12 pcs. @ 50V  | \$3.25 |
| <input type="checkbox"/> mfd (47),(1),(2,2),(3,3),(4,7),(10),(22),(33),(47) . . . . .                     | - 9 pcs. @ 160V | \$3.30 |
| <input type="checkbox"/> mfd (1),(2,2),(3,3),(4,7),(10),(22),(33),(47) . . . . .                          | - 8 pcs. @ 250V | \$3.95 |
| <input type="checkbox"/> mfd (1),(2,2),(3,3),(4,7),(10),(22),(33) . . . . .                               | - 7 pcs. @ 350V | \$3.75 |
| <input type="checkbox"/> mfd (1),(2,2),(3,3),(4,7),(10) . . . . .   | - 5 pcs. @ 450V | \$2.95 |

Call and ask for our current flyer.

### HORIZONTAL OUTPUT TRANSISTORS

- |   |  |                |
|---|--|----------------|
| \$2.50 ea. Min. 10,<br>1 yr. Warranty   | <input type="checkbox"/> BU208 (165) . . . . . | \$1.65 min. 10 |
| <input type="checkbox"/> 1308K Sanyo    | <input type="checkbox"/> TA7230P . . . . .     | \$1.95         |
| <input type="checkbox"/> 2SD1341P Sanyo | <input type="checkbox"/> LA4445 . . . . .      | \$2.95         |

### MONTHLY SPECIALS

#### TRANSISTORS & I.C.'s...MIN. 10, CAN MIX

- |   |  |   |
|---|--|---|
| <input type="checkbox"/> 2SC1116 . . . \$3.95 | <input type="checkbox"/> 221-103 . . . \$7.25  | <input type="checkbox"/> DM133 . . . \$5.95   |
| <input type="checkbox"/> 2SC1114 . . . \$3.75 | <input type="checkbox"/> 221-132 . . . \$3.40  | <input type="checkbox"/> DA101 . . . \$5.75   |
| <input type="checkbox"/> MN8303 . . . \$3.95  | <input type="checkbox"/> 221-140 . . . \$10.95 | <input type="checkbox"/> HA1388 . . . \$5.25  |
| <input type="checkbox"/> 2SC1124 . . . \$ .95 | <input type="checkbox"/> 221-158-01 . . \$4.75 | <input type="checkbox"/> HA1396 . . . \$5.50  |
| <input type="checkbox"/> 2SD871 . . . \$4.25  | <input type="checkbox"/> 221-175 . . . \$10.95 | <input type="checkbox"/> HA1398 . . . \$4.95  |
| <input type="checkbox"/> CX101G . . . \$10.50 | <input type="checkbox"/> 221-178 . . . \$7.00  | <input type="checkbox"/> UPC1181 . . . \$1.00 |
| <input type="checkbox"/> CX103 . . . \$10.50  | <input type="checkbox"/> 221-179-01 \$10.95    | <input type="checkbox"/> UPC1182 . . . \$1.00 |
| <input type="checkbox"/> CX143A . . . \$10.50 | <input type="checkbox"/> 221-190 . . . \$10.95 | <input type="checkbox"/> UPC1185H . . \$3.50  |
| <input type="checkbox"/> UPC1368H2 \$3.95     | <input type="checkbox"/> 221-193 . . . \$7.95  | <input type="checkbox"/> 2SC2580 . . . \$2.95 |
| <input type="checkbox"/> UPC1367C \$3.75      | <input type="checkbox"/> 185-9-01 . . .        | <input type="checkbox"/> 2SA1105 . . . \$2.95 |
| (Subs CX557A)                                 | (triac) . . . \$1.50                           |   |

#### STEREO #'s

#### GENERAL

- |   |                 |
|---|-----------------|
| <input type="checkbox"/> HI-DIV 3 . . . . .                                       | \$3.99 min 10   |
| <input type="checkbox"/> Tun-O-Wash (24 oz.) . . . . .                            | \$3.65          |
| <input type="checkbox"/> Freez-it (8 oz.) . . . . .                               | \$2.25          |
| <input type="checkbox"/> F59A-59U Connector Crimp-on . . . . .                    | 300 for \$30.00 |
| <input type="checkbox"/> Beta Video Heads . . . . .                               | \$53.20         |
| <input type="checkbox"/> VHS Video Heads . . . . .                                | \$48.10         |
| <input type="checkbox"/> Panasonic Dual Antenna-Packaged (AT-19) min. 5 . . . . . | \$2.99          |
| <input type="checkbox"/> TV/Game Switch (#AB21) min. 10 . . . . .                 | \$ .89          |

#### Quantity Prices Available

Letters of credit and all checks placed on deposit with Bank of Hallendale, FL. VISA & Master Charge accepted. Min. order \$75. FOB Dania, FL. Catalog \$3, refundable upon order.

SEND CHECK OR MONEY ORDER TO:

### OPTIMA ELECTRONICS

2022 Tigertail Blvd., Dania, FL 33004  
Phone (305) 920-3550 TOLL FREE: 1-800-327-0224

Circle (22) on Reply Card

NEW! NEW! NEW! NEW! NEW! NEW! NEW!

# New Products Most Popular ANTENNAS

FOR:

- \* PORTABLE TV's
  - \* AM/FM CASSETTE STEREO (boom boxes)
  - \* WIRELESS TELEPHONES
  - \* SCANNERS
- ALSO - EASY TO READ  
CROSS REFERENCE

## Replacement VCR Belts

ALL POPULAR KITS and INDIVIDUAL BELTS

- \* 36 KITS and 112 INDIVIDUAL BELTS
- \* REPLACEMENTS FOR CASSETTE
- \* REPLACEMENTS FOR 8 TRACK PLAYERS and RECORD CHANGERS

ALSO - EASY TO READ CROSS REFERENCE

WORKMAN ELECTRONIC PRODUCTS, INC.

75 Packinghouse Road • P.O. Box 3828  
Sarasota, Florida 33578 • Phone (813) 371-4242  
TWX 810-864 0401 Workman Sara

NEW! NEW! NEW! NEW! NEW! NEW! NEW!

Circle (23) on Reply Card



# Readers' Exchange

**For Sale:** Approximately 400 Sams Photofact folders from 53-1460. Make offer for one or all. *Donald Lewis, Route 1, Central City, NE 68826; 308-548-2616*

**For Sale:** More than \$1400 worth of tools, test equipment, books and unused parts. Plus latest 24 issues of *ES&T*. Best offer over \$250. Send large s.a.s.e. for information. *Otmer Basham, 214 S. Craig Ave., Covington, VA 24426*

**For Sale:** Out of production and difficult to find tubes; Sylvania SS-501 and R4410, Argon discharge tubes used in old models of big ship echo sounders, 6C6, 6D6, Sylvania 632-B, and many others. Write for requirements. *Ed Pitsinger, Unitronix, P.O. Box 247, Galveston, TX 77558; 409-763-2207*

**Wanted:** Flyback transformer for RCA CTC 38A color TV, part No. 62-21759. *James Knutson, Box 373, Waterville, Quebec, Canada, JOB 3H0.*

**For Sale:** Sams Photofact folders 399 to 2066 in six steel filing cabinets (four drawers). Also, Sams eight volumes 101 to 180. And RCA, Zenith, etc. manuals and volumes. Test equipment, tubes, tools. Send s.a.s.e. for complete price lists. *Mack Kunzman, Jamke TV/Radio, 1051 Bale Lane, Calistoga, CA 94515*

**Needed:** Schematics and service information for Brentwood 9009 printing calculator and for Texas Instruments TI-5050M printing calculator. *Glen Spidal, 1325 SE Oak, #11, Hillsboro, OR 97123*

**For Sale:** EICO 955 vacuum tube operated capacitor checker, 1 to 50 MFO range, excellent condition with manual, \$45; RCA RF sine wave signal generator, type WR-50B, vacuum tube operated, 85kHz to 40MHz, excellent condition with manual, \$45. Knight vacuum tube operated volt/ohm meter by Allied Radio, good condition with manual, 1953 model, \$30. *Jerome Stanisiz, 163 Richard Ave., Elmhurst, IL 60126; 312-832-7831.*

**For Sale:** Sencore TC 28 tube and transistor tester, \$100. Mark IV tuner subber ac/dc, \$50. EICO 944 yoke and flyback tester, \$30. Sencore BE156 dc bias supply (new), \$25. VIZ WP25A isolation transformer, \$50. *V. Granzella Jr., Box 190, Wheatland, MO 65779; 417-282-6506*

**For Sale:** Tekfax 105-13-14-15. Tekfax/Profax 1978-Dec. 1984. More than 600 schematics, \$24. TAB color TV service manuals, 18 volumes, Admiral-Zenith, \$14. Sams AR-30-35-67-81, \$3 for all four. Retired. *Bob Begun, 1056 Fraser St., Aurora, CO 80011; 303-366-3980*

**For Sale:** Sencore VA48 analyzer, like new, only used once, includes TR219 horizontal attenuator, manuals leads and probes, \$1000 (includes shipping). *G. Jones, 3312 Werber St., Orlando, FL 32806; 305-859-6573.*

**Needed:** Dual volume control and switch (new or used) for Panasonic AM/FM stereo tuner amplifier, model No. 7671, (Sams 960-7). *William J. Maida, 341 Isabella Drive, Longwood, FL 32750.*

**For Sale:** RCA CRT test jig model 10-J-106 with 38 assorted chassis adapters, \$300 plus shipping. *Linda Rollins, 2991 Clay, Mora-Mi Apt. 45, Paducah, KY 42001.*

**Needed:** Schematic/service manual for CB transceiver, 40 channel, model Pony 410, Mfg. Far East Filtron Co. Heath SM-2420 or SM-4130 frequency counter and Microcraft CSIF code reader. *Caswell Davis Jr., 601 Delmar, Apt. 2, San Antonio, TX 78210.*

**For Sale:** B&K Precision model 1077B, \$359 plus shipping. *M.E. Andrews Jr., Box 91, Exeter, RI 02822.*

**Needed:** Answering machine service information and schematics. Will pay for copying, will buy or will exchange for cordless telephone or TV information. Please send list. *TV Shop, 22 Central Ave., Mechanicville, NY 12118; 518-664-8631.*

**For Sale:** Heathkit IM distortion analyzer model IM-5248, \$125 plus UPS. Also, Sprague model TO-6A capacitor analyzer, like new \$150 plus UPS. *A.J. Lemke, Al's Service Center, 10004 206th Ave. NE, Redmond, WA 98053.*

**Needed:** Schematic or service manuals for 30 track tape recorder type FA-5394/1 through 5, made by Sound Scriber Corp. for the FAA under contract No. FA-2270. Will pay for manuals. *Mark Reeder, Michris Electronics, 288C, Route 73, Berlin, NJ 08009; 609-768-9383.*

# PREPARE

*For The Future*

## 1985 National Professional Electronics Convention



INFORMATIVE SPEAKERS  
MANAGEMENT SEMINARS  
TECHNICAL TRAINING  
NAT'L. SERVICE CONFERENCE  
NEW PRODUCT DISPLAYS  
SPONSORED MEALS  
TENNIS/GOLF OUTINGS

Sponsored by the National Electronics Sales & Service Dealers Association and the International Society of Certified Electronics Technicians

**Hartford CT • Parkview Hilton • August 5-10**

Send for more information and an application to  
NPEC, 2708 W. Berry St., Ft. Worth, TX 76109. Ph (817) 921-9061

Name \_\_\_\_\_  
Address \_\_\_\_\_  
City \_\_\_\_\_ State \_\_\_\_\_ Zip \_\_\_\_\_

## COMPACT ECONOMICAL DESOLDERING

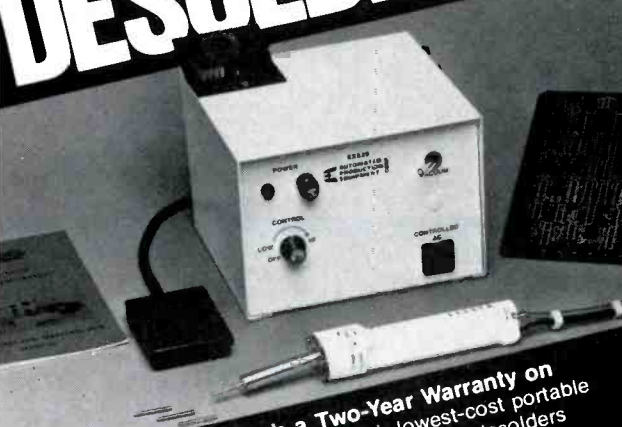

**It's so Dependable, there's a Two-Year Warranty on the Pump.** The EX-525 may be A.P.E.'s lowest-cost portable solder extractor, but it's full of features: • easily desolders components from multi-layer PC boards • pump is vibration-isolated for quiet operation • Model 550 for use with shop air • EX-1000 handpiece is non-clogging and temperature-regulated by panel controls.

You need the A.P.E. EX-525 in your shop. Call or write today for all the details. **Automated Production Equipment Corp., 142 Peconic Ave., Medford, N.Y. 11763 • 516-654-1197, TWX: 510-228-2120**

**DEPEND ON A.P.E.**

Circle (24) on Reply Card

**Wanted:** Schematic and parts list for commercial trades institute of Chicago, vacuum tube VOM model VT-20. *John Marsh, 55963 Onaga Trail, Yucca Valley, CA 92284.*

**Wanted:** TV/VCR equipment for new shop, Sams and manufacturers manuals, Sencore VA62-SC61 and other Sencore and B&K equipment. *Howard Hitzeman, 123 Crestwood Lane, Largo, FL 33540; 813-581-3250.*

**For Sale:** Winegard SC70355 satellite receiver with 36-power supply and actuator, new, \$810. *Robert Piper Jr., Rural Route 3, Benton, IL 62812; 618-724-9050.*

**Wanted:** Sams Photofact folders from 1200 to near present. Complete unbroken series only. Will inspect and pick up within 300 miles of my location. No file cabinets needed. *C. Hugh Harrell, P.O. Box 6691, Newport News, VA 23606.*

**For Sale:** Hewlett-Packard 334A distortion analyzer, excellent condition, \$1500 or best offer. *Brian Findlay, 4 Barnesdale Road, Nashua, NH 03062; 603-882-9812.*

**For Sale:** B&K Precision 415 generator, \$75 plus \$5 for shipping. *Joe Larsen, Joe's Repair Service, 60835 N. Highway 50, Montrose, CO 81401.*

**For Sale:** Hewlett-Packard RF power meter with 8478B thermistor mount, \$95. Heath IM-2202 DMM, \$60. Both like new with cables and manuals. B&K color generator, very good condition with cables, no manual, \$50. *D.G. Piacentini, 12 Joyce Road, Plainview, Long Island, NY 11803; 516-935-8096.*

**For Sale:** Sencore SG165 stereo AM/FM analyzer, new (still in carton), retiring, \$995. *Al Nikora Sr., 5298 Argyle Court, Sterling Heights, MI 48078; 313-268-6938.*

**Wanted:** Adapter to play 45RPM 7-inch records on a Garrard model 60MK II record player. *Paul Capito, 637 W. 21st St., Erie, PA 16502.*

**Wanted:** Schematic for Panasonic 25-inch color television model CT 5221/CH#62HMN. *Howard Waldren, 3 Vincent Place, Oakdale, NY 11769.*

**For Sale or Trade:** QST 1971-Aug.-Dec., 1972-Jan.-Aug., Nov., Dec., 1973-Feb., April, June, July. Make offer. *William J. Maxida, 341 Isabella Drive, Longwood, FL 32750.*

**Wanted:** Schematic and information for a J.C. Penney MHF stereo model 1802A. *M.W. Smith, 400 Brandon Road, Richmond, VA 23224.*

**For Sale:** Complete Video servicing package: Sencore models SC61, VA48, CR70, PR57, LC53 and TF46, all in mint condition. Includes accessories, manuals and scope cart. Also, 360 Sams Photofact folders, filing cabinet and other miscellaneous service literature. Leaving service business, must sell as a package. Asking \$5500. *Frank Ward, Route 2, Box 575, Woodville, MS 39669; 601-888-4687.*

**Wanted:** Ryder radio manuals 17, 19, 21 and 23. Also 1920s radio tubes 199s, WDIIs 200As, 201As, and Atwater-Kent radios any condition. *Charlie Alford, 222 N. San Jacinto Ave., San Jacinto, CA 92583.*

**Needed:** Schematic for Magnavox model 355B, style C101-219, chassis No. CR202A. Also, one audio circuit part for Admiral 5R36N, chassis No. 5R3, original part No. 63-B6-14. *Lew Wollaston Radio & TV, 1504 Big Horn, Alliance, NE 69301; 308-762-3003.*

**For Sale:** B&K 501A curve tracer, \$130, B&K 2040 CB RF signal generator, \$250. B&K 1040 CB service master, \$150. Everything complete and in first-class condition. *Rolla H. Long, Long's TV, 720 Goschen St., Salt Lake City, UT 84104; 801-533-8093.*

**For Sale:** FC45 frequency counter, \$250. Sencore PS163 scope, \$300. Sencore VA48 (updated and calibrated), \$800. EICO 633 CRT tester with adapters, \$80. UPS included. *Bill Bechtold, 7429 Frederick, Omaha, NE 68124; 402-397-2461.*

**For Sale:** Century CRT-2 tester rejuvenator, \$35. Heathkit color bar generator model TG-62, \$40. TECH signal generator model TE-20, 220V, \$35. *Gad Barzily, 84-39 120th St., Kew Gardens, NY 11415.*

**For Sale:** Sencore DVM 36 pocket portable DMM, like new, complete with manual, probes, ac adapter and instruction cassette, \$65 plus \$2 shipping. Please send a U.S. postal money order. *Norman Palus, 308 E. Lutton St., New Castle, PA 16101.*

**For Sale:** Video Tune-Up program disk for Commodore computer (64-SX-64). Program generates video test patterns and runs an automatic alignment test. Used but is 100 percent operational, \$15. Made by Solas Products. *Mark Kruse, Videonics Inc., 911 Township Line Road, Norristown, PA 19401; 215-862-5028.*

**QUALITY PARTS AT DISCOUNT PRICES!**

<p><b>SUB-MINIATURE D TYPE CONNECTOR</b></p>  <p>SOLDER TYPE SUB-MINIATURE CONNECTORS USED FOR COMPUTER HOOK UPS</p> <p>DB-15 PLUG \$2.75 DB-15 SOCKET \$4.00 DB-15 HOOD \$1.50 DB-25 PLUG \$2.75 DB-25 SOCKET \$3.50 DB-25 HOOD \$1.25</p> <p><b>"PARALLEL" PRINTER CONNECTOR</b></p>  <p>SOLDER STYLE 36 PIN MALE USED ON "PARALLEL" DATA CABLES</p> <p>\$5.50 EACH</p>	<p><b>L.E.D.'S STANDARD JUMBO DIFFUSED</b></p> <p>RED 10 FOR \$1.50 GREEN 10 FOR \$2.00 YELLOW 10 FOR \$2.00</p> <p><b>FLASHER LED</b></p> <p>5 VOLT OPERATION RED JUMBO SIZE \$1.00 EACH</p> <p><b>BI POLAR LED</b></p> <p>2 FOR \$1.70</p>	<p><b>2 AMP SOLID STATE RELAY</b></p>  <p>SIZE: 1 1/2" x 1-7/8" x 3/8" HIGH</p> <p>CONTROL: 3.6-6 VDC TTL compatible LOAD: 120 Vac @ 2 amp</p> <p>\$2.50 each 10 for \$23.00</p>
<p><b>MINIATURE TOGGLE SWITCHES</b></p> <p>ALL ARE RATED 5 AMPS @ 125 VAC</p> <p>S.P.D.T. (on-on) \$1.00 EACH S.P.D.T. (on-off) \$1.00 EACH</p> <p>PC STYLE NON-THREADED BUSHING 75¢ EACH 10 FOR \$7.00</p> <p>PC LUGS THREADED BUSHING \$1.00 EACH 10 FOR \$9.00</p>	<p><b>SOLID STATE BUZZER</b></p> <p>STAR #SMB-06L 6 VDC. TTL COMPATIBLE</p> <p>\$1.00 EACH 10 FOR \$9.00</p> <p><b>120V INDICATOR</b></p> <p>NEON INDICATOR RATED 120 V 1/3 W MOUNTS IN 5/16" HOLE 75¢ EACH RED LENS 10 FOR \$7.00 100 FOR \$65.00</p>	<p><b>13 VDC RELAY</b></p>  <p>CONTACT: S.P.N.C. 10 AMP @ 120 VAC ENERGIZE COIL TO OPEN CONTACT COIL: 13 VDC 650 OHMS SPECIAL \$1.00 EACH</p>

**SEND FOR NEW 1985 48 PAGE CATALOG FREE!**

**ALL ELECTRONICS CORP.**  
905 S. VERMONT • P.O. BOX 20406 • LOS ANGELES, CA 90006  
TOLL FREE ORDERS • 1-800-826-5432  
(IN CALIFORNIA: 1-800-258-6666)  
AK, HI, OR INFORMATION • (213) 380-8000

- QUANTITIES LIMITED
- MINIMUM ORDER \$10.00
- USA: \$3.00 SHIPPING NO C.O.D.
- FOREIGN ORDERS INCLUDE SUFFICIENT SHIPPING
- CALIF. RES ADD 6.12%

# Business Opportunity

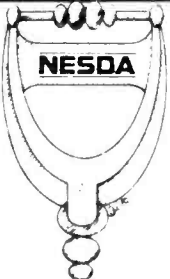

**It's plenty tough being an electronics sales and service dealer these days.**

That's why we're working so hard to make it easier for you to operate a cost-effective business.

NESDA offers business contacts, technical and management certification, substantial savings on bank-card and insurance rates — and that's just the beginning!

NESDA members are kept informed about industry developments and are offered the most comprehensive managerial and technical training programs available. Besides, NESDA is your representative at the national level — including your voice to manufacturers and the agencies of the federal government.

**Opportunity knocks . . . Answer it!**

National Electronics Sales & Service Dealers Association

For more information and an application, write to:  
NESDA, 2708 W. Berry St., Ft. Worth, TX 76109; Ph (817) 921-9061

Name \_\_\_\_\_  
Bus. Name \_\_\_\_\_  
Address \_\_\_\_\_  
State \_\_\_\_\_ Zip \_\_\_\_\_ Phone \_\_\_\_\_  
Member of State  Local  Assn. \_\_\_\_\_

Circle (25) on Reply Card



**For Sale:** Dual trace model 422 Tektronix scope, \$400. *Angelo Alessi, 29 Cross St., New Windsor, NY 12550; 914-562-9152.*

**For Sale:** B&K model 1077B analyst. Also, B&K 415 alignment generator. Both in excellent condition, \$200 each. *Bob Evans, 2318 Big Horn Ave., Cody, WY 82414; 307-587-5251.*

**Needed:** Schematic and/or a replacement for the IC on GM theft deterrent module No. D2 666. *R.C. Chatfield, 363 S. Bluefield Place, Tucson, AZ 85710.*

**For Sale:** B&K 1077B analyst, \$350. B&K multimeter 290, \$125. B&K transformer checker 520, \$75. *Stan Hayman, 19707 Turnberry Way, N. Miami Beach, FL 33180.*

**For Sale:** Soar 50MHz dual trace scope, \$750. Sencore VA48 video analyzer, \$800. Sencore CR70 CRT analyzer/restorer, \$700. Other items for sale, too. All equipment in like-new condition with accessories and manuals. Shipping included. *Mike Powers, 312 E. Chestnut, Clarinda, IA 51632; 712-542-5847 or 712-542-2161.*

**For Sale:** Heathkit IT-2250 auto ranging capacitance meter, \$40. Subber Mark IV-CUV UHF/VHF tuner sub. ac battery, \$45. Conar color bar generator, \$25. B&K Precision scope, 10MHz model 1466, \$400 firm. *R.E. Carron, 3503 Hudson Circle, Manhattan, KS 66502; 913-776-4100.*

**Needed:** Service manual/schematic for Thomas Electronic Organ. Will buy or copy and return. *Stanley Kowalski, 220 E. Frederick St., Ironwood, MI 49938; 906-932-1410.*

**Pot-luck Sale:** Mixed radio and TV tubes, new and used, \$1 each plus shipping, minimum quantity, 50. *Jerry Stanisiz, 163 Richard Ave., Elmhurst, IL 60126; 312-832-7831.*

**For Sale:** Sencore CA55, like new, \$375. Sencore DVM 38, used less than one hour, \$400. **Wanted:** Two EAF 801 tubes for old Grundig stereo. *Dick Lopez, 10212 New Hampshire Ave., Silver Spring, MD 20903; 301-439-5333.*

**Wanted:** Factory operation manuals for Hickok model 610A television, FM alignment signal generator and Paco model Z-80 audio signal generator. **For sale or trade:** B&K model 1460 triggered sweep scope and Heathkit IG-18 sine-square generator. Please send price, cost and/or offer. *Archer/Brighton TV Electronics, c/o Stuart Konarski, 7816 S. Kolmar, Chicago, IL 60652.*

**Wanted:** Knight 83YX123 sweep generator with manual, and manuals for Knight 83Y125 VTVM and 83Y135 signal tracer. Tekfax volumes 100, 102-105 and 115 to end. *C.T. Huth, 130 Hunter St., Tiffin, OH 44883.*

**For Sale:** Sencore harmonic generator, \$15; B&K 820 digital capacitance meter (works intermittently), \$40; B&K 1827 frequency counter, new, \$75; Sencore RC substitutor, \$25, B&K 1471B dual trace scope (one channel inoperative), \$200. *V. Granzella, Jr., Box 190, Wheatland, MO 65779; 417-282-6506.*

**Wanted:** Sams Photofact folders. Will pay postage and 75¢ each for sets 1200-1499, \$1 each for 1800-2100. Will consider buying complete set, and other service data. *Willy's Electronics, P.O. Box 56595, North Pole, AK 99705; 907-488-1307.*

**For Sale:** B&K CRT tester model 456, never used. Included are operating manual, two set-up charts (old and new) and six adapter sockets. \$75 plus shipping. Send s.a.s.e. for information. Also, high impedance, low capacitance scope probe for precision scope. New from B&K, model SP-5A, original carton. \$10 plus postage. *Jag's Radio & TV, Jos. A. Gontarz, 14 Rudolph Rd., Forestville, CT 06010.*

**For Sale:** Sencore VA48 Video analyzer, \$800; Sencore Super Mack CRT tester/restorer CR31A, \$400. Both excellent. *Larry R. Bell, 5506 Mesa Ridge Lane, Columbus, OH 43229; 614-882-8055.*

**For Sale:** Heathkit AJ32 tuner with amp - both, \$150. National NC 173 all-band radio, needs power transformer, \$50; Lectrotech V7 Vectorscope, \$100; Heathkit IG14 post marker generator, \$100; Army lab signal generator and audio oscillator, \$100 each. *William Timm, 2400 Progress, Eureka, CA 95501; 707-445-8345.*

**Need:** Schematics, manuals and parts information for Advent projection-type large screen televisions, models VB125 and 710. Will pay copy/shipping expenses, or will copy and return. *Bill Hamilton, 13 Overbrook Drive., Kirksville, MO 63501; 816-665-1427.*

**Need:** Schematic for Masterworks stereo cassette player/recorder, model M-400. Solenoid dS-10B, DC 100V, 800Ω. Schematic and owner's manual for Masterworks SQ AM/FM 8-track, serial No. H340-03374, model not known. Desire name and address of anyone knowing where to get parts, schematic or repair. For these and other items needed, contact *M.J. Stanton, 1725 Rear Lafayette St., Scranton, PA 18504.*

## CA28 UNIVERSAL PICTURE TUBE ADAPTER

NOW YOU CAN USE YOUR CRT/RESTORER/  
REJUVENATOR/CLEANER ON ANY COLOR CRT  
YOU DO NOT NEED TO BUY A NEW CRT TESTER.  
SAVE HUNDREDS OF DOLLARS  
"THIS IS THE ONLY ADAPTER YOU WILL NEED"  
— USE ON NEW IN-LINE & ONE-GUN TUBES —

If your tester is the CLEANER/RESTORER type or the REJUVENATE type, you can use the function on your present machine or any Color Tube listed from a 9" to a 26," including foreign types. Checks Quintrex, Japanese Miniature Base, Japanese In-Line, Sylvania, and GE 90 Degree InLine, New Sony Trinitron, Zenith Special In-line, European 110 degree In-line, Sylvania 100 degree Color Tri-Potential, RCA 90 degree In-line, 110 degree Color, 90 degree Button Base, Large Trinitron, Small Trinitron.

Use with CRT Tester/Restorer/Rejuvenator.  
CHECKS: QUINTREX-IN-LINE — TRINITRON — TRI  
POTENTIAL — PINLESS — JAPANESE — EUROPEAN  
90°; 100°, 110° ALL CRT's

VIDEO GAMES — COMPUTER TERMINALS, COLOR T.V.  
SIZES 9" thru 26" SCREENS.

**MONEY BACK GUARANTEED**

to solve all your CRT Testing problems, Obsolescence Proof Perpetual Set-Up  
Manual, CA28 Adapter Kit with Sockets.



\*\*CHECKS OVER 2500 COLOR TYPES\*\*  
\*\*\*REPLACES OVER 65 ADAPTERS\*\*\*  
B&K, BELTRON, SENCORE,  
CONAR, HEATHKIT  
REM, EICO, RCA, ALL OTHERS

Call Toll Free  
1-800-331-9658

Comes with complete EASY-to-follow  
Instruction Manual and Picture Tube Index.

### A MUST FOR THE TV TECHNICIAN

CALL US OR WRITE

COD. Send Check or Money Order. CA-28 Kit \$61.95, add \$2.00  
shipping and handling. Visa & Mastercard accepted.

DANDY MANUFACTURING CO.  
2323 Gibson, Muskogee, Oklahoma 74403  
918-682-4286

Circle (26) on Reply Card

# Over 270 soldering options

right at your  
fingertips.

With Sterling® you can  
combine 15 miniature  
soldering irons with  
23 different tips to  
match your exact  
soldering need.

Irons range from 575°  
to 850°F; 5 to 25  
watts; and 4.5 to 24  
volts.

Send for the name  
of your nearest  
distributor and get a  
free mini-catalog on  
the mini-irons that  
are mighty on  
performance.



WAHL CLIPPER CORPORATION  
Sterling, Illinois 61081 • (815) 625-6525

Circle (27) on Reply Card

# PRB . . . OFFERS THE PROFITABLE SYSTEM FOR SELLING VIDEO RECORDER BELTS



The PRB stock number describes the required belt. You just size the belt on our handy MEASURE-A-BELT gauge and you'll have all the info needed to find your belt. The PRB System is fast, easy and profitable!

For details on our profitable belt system and the complete line of PRB electronic components just call toll free . . .

National 1-800-558-9572	In Wisconsin 1-800-242-9553
Business Number 1-414-473-2151	TLX 4994411 PRB USA
In Canada call collect: 1-613-225-5003	

**PRB**  
PROJECTOR RECORDER BELT

200 Clay Street, Whitewater, WI 53190

Circle (28) on Reply Card

## ATTENTION TECHNICIANS

- ★ JOB OPENINGS
- ★ MONTHLY TECHNICAL TRAINING PROGRAM
- ★ BUSINESS MANAGEMENT TRAINING
- ★ LOW COST INSURANCE
- ★ CERTIFICATION
- ★ TECHNICAL SEMINARS

All of this in a nonprofit international association for technicians

FIND OUT MORE:



R.R. 3 Box 564  
Greencastle, IN 46135

## Literature

A 6-page folder from **Ballantine Laboratories**, Boonton, NJ, catalogs and details an extended new family of rugged, modular probes for oscilloscopes and meters. Ballantine has adapted many of the military design parameters required for such devices to its commercial line.

Charts and photographs detail specifications for the full line of Ballantine probes. The catalog also details specifications and applications for a high voltage RF detector probe, model 10851A.

Circle (100) on Reply Card

**AEMC**, Boston, MA, has released the 1985 edition of their catalog, *Testing and Measuring Instruments for the Professional*. The catalog covers the AEMC product line of electrical test and measurement instruments and related products, including lightmeters, temperature probes, and environmental recorders. Product features and applications, complete specifications, photographs, sizes and weights, ordering information and available accessories for each product are included.

Educational materials are included on easily located, color-coded pages. Background information is incorporated to help the user understand general operating principles and to aid in assessing test results for validity and accuracy. Topics include insulation resistance testing, ground resistance measurement and correction, clamp-on current probe selection, and ground fault detection.

Circle (101) on Reply Card

**RCA Distributor and Special Products Division**, Deptford, NJ, has issued an updated catalog on RCA remote controls for video instruments. This catalog encompasses current RCA remote controls and superseded types. Photos for visual identification and cross-references by type number and by instrument number are included. The catalog is available from RCA

Parts Distributors or through RCA Distributor and Special Products Division.

Circle (102) on Reply Card

**M.M. Newman Corporation**, Marblehead, MA, offers a wall chart featuring standard slide-on tips available for Antex model C, G, and CTC miniature soldering irons. The Antex Tip Chart features more than 35 standard styles and sizes of slide-on tips made from a special copper alloy and plated with iron, nickel and gold.

Complete with actual size illustrations, the 8½" x 11" Antex Tip Chart provides the diameter; tip shapes, including spade, chisel, needle and reshapeable blanks, plating material and corresponding part numbers for ordering.

Circle (103) on Reply Card

A free booklet on how to take care of a computer to prevent data loss and downtime is available from **Read/Right Products**, a part of **The Texwipe Company**, Upper Saddle River, NJ. Entitled *The Care and Feeding of Your Computer*, the 16 page, illustrated booklet points out that computers require care because the mechanical components, such as the disk drive, printers and most keyboards, may fail unless they are kept clean. Static electricity is another serious problem that can lead to data loss.

The types of contaminants that cause problems in disk drives, CRT screens, keyboards, printers and computer housings are discussed. The booklet also explains cleaning procedures and briefly mentions that Read/Right Products offers a full line of cleaning kits and individual products for office equipment and computers.

Circle (104) on Reply Card

**BBC-Metrawatt/Goerz**, Broomfield, CO, has published three booklets designed to help buyers evaluate and compare low-cost analog and digital multimeters. The three booklets point out many of the factors to consider when buying a multimeter, and include a handy checklist of features to use when shopping for low-cost handheld DMMs.

Circle (105) on Reply Card



# Answers to quiz

Continued from page 16.

1. B. This is an example of the *reciprocity theorem*. The amount of voltage, circuit layout and resistance values are not a concern in this case.

2. C. In both cases, the gain is 1.

3. B

4. D. It is the symbol for a constant-current diode.

5.

A	B	L
0	0	1
0	1	0
1	0	0
1	1	1

6. A

7. C.  $\overline{A} \overline{B}$  is the same as  $\overline{A + B}$

8. B. A snubber is a series R-C circuit connected across the SCR. It prevents an inductive kickback from turning on the SCR even though its gate is not in a conduction mode.

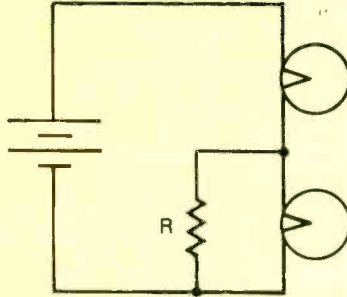

9. and 10. Figure *a* shows the circuit. The voltage across R is 6V and the current through it must be 0.15A. By Ohm's law:

$$R = V/I = 6/0.15 = 40\Omega$$



SINCE 1950

- LEADING SPOKESMAN
- TRADE INFORMATION DISPENSER
- WATCHDOG
- NATESA SCOPE
- STANDARDS YARDSTICK
- CONSUMER RELATIONS
- PROBLEM SOLVER
- CONCISE PRACTICAL BUSINESS OPERATIONS MANUAL
- SERVICE CONTRACT MANUAL
- CUSTOMER PLEASING PROFIT PRODUCING ORDER FORMS
- PARTS PROCUREMENT EXPEDITOR
- SERVICE BUSINESS
- DIVERSIFICATION PLANS
- TECHNICIAN DEVELOPER

6210 So. Pulaski Rd. • Chicago, Illinois 60629

## Classified

Advertising rates ... ed Section are 75 cents per word, each insertion, and must be accompanied by payment to insure publications.

Each initial or abbreviation counts a full word.

Minimum classified charge is \$15.00.

For ads on which replies are sent to us for forwarding (blind ads), there is an additional charge of \$25.00 per insertion to cover department number, processing of replies, and mailing costs.

Classified columns are not open to advertising of any products regularly produced by manufacturers unless used and no longer owned by the manufacturer or distributor.

### FOR SALE

**SUBSCRIPTION TV MANUAL**, covers all three major scrambling systems, only \$12.95. Includes theory, circuits, waveforms and trouble shooting hints. Save your VIDEO GAME CARTRIDGES on EPROM with out EPROM duplicator. Plans \$9.95. Catalogue \$2.00, refundable. RANDOM ACCESS, Box 41770A, Phoenix, AZ 85080. 1-85-tfn

**AUTOMOBILE RADIO** and tape replacement parts. Delco, Chrysler, Philco-Ford, Motorola, Panasonic and many others. Large inventory. Laran Electronics, Inc., 3768 Boston Road, Bronx, NY 10469. (212) 881-9600. National (800) 223-8314, NY State (800) 446-4430. 1-85-tfn

**WE LOCATE** hard to find TV schematics. Immediate reply. Send \$13.50 with make and model to WB ELECTRONICS, P.O. Box 1314, Falls Church, VA 22041. 4-85-1t

**BOOTLEGGERS BIBLE** for CB Modification \$12.95, CB Radio Repair \$10.95. Linear Amplifier Planbook \$14.95, kits, etc. Catalog \$1.00 refundable - APS, POB 263 Newport, R.I. 02840 401-846-5627. 12-84-tfn

**COLOR PICTURE TUBE** Rebuilding Equipment. In excellent condition, everything to build good tube. Training available. John Smith, Box 34, Fountain, CO 80817. 4-85-2t

**INDIVIDUAL PHOTOFACT FOLDERS** (Not sets) #1 to #1400 \$3.00 first-class postpaid. Loeb, 414 Chestnut Lane, East Meadow, NY 11554. 4-85-3t

**SAVE BIG BUCKS ON INTEGRATED CIRCUITS AND TRANSISTORS. WHOLESALE PRICES. LARGE INVENTORY. WRITE: JILCO INTERNATIONAL, 439 MAIN ST., SUITE 2B, EAST ORANGE, NJ 07017. 2-85-4t**

**SCRAMBLED TELEVISION**, encoding/decoding. New book. Theory/circuits, \$9.95 plus \$1 shipping. Workshop, Box 393ES, Dept. E, Bethpage, NY 11714. 1-85-tfn

**RCA WV87B VTVM** \$35.00, Triplett 3433 AM/FM signal generator \$50.00. Eico 377 sine/square wave generator \$45.00. You pay shipping. PH702-456-9048. 4-85-1t

**BELDEN RG6/U Coaxial Cable, #9058.** This is the best. Duobond II/Brald/Duobond Plus. Normally available in 1000 ft. rolls only. Three incredible shields. Foil over foam core gives 100% shielding. 77% aluminum braid. Foil wrapped over the two inner shields (Duobond Plus). 100 ft. \$24.00, 200 ft. or more 10% discount. Crimp Connectors for RG6/U cable with attached 1/2" crimp ring, (with purchase of cable only). 10 for \$3.00, 50 for \$9.00, 100 for \$15.00, check or money order. Postpaid. (609) 877-7480. DANIELSON ELECTRONICS, 6 Garnet Lane, Willingboro, NJ 08046. 3-85-2t

**SONY - PANASONIC - RCA - ZENITH EXACT REPLACEMENT PARTS - SONY PARTS AND TRINITRON SPECIALISTS. LARGE INVENTORIES. CALL 516-678-1700 OR WRITE WITH PART NEEDED. GREEN-TELE-RADIO, 172 SUNRISE HIGHWAY, ROCKVILLE CENTER, NY 11570. 1-85-tfn**

**VIDEO HOOK-UP DIAGRAM MANUAL** - Shows how to hook-up TV, VCR, Satellite, Stereos, Multi-sets. \$6.00. NorthStar Video Services, Dept. E, P.O. Box 1992, Hollywood, FL 33020. 3-85-3t

**FULL LINE of TV converters. Wireless and manual compatible to Jerrold and Oak Systems. This month's special the Technica 140CHL stereo and video compatible out-put wireless converter. The only unit with a wireless volume control adjustment only \$159; cable 15dB Amp in-line type only \$20. RED COAT ELECTRONICS, new address and phone: 104-20 - 68th Dr., Forest Hills, NY 11374, Tele: (212) 459-5088. Catalogue \$3 for specials. 10-84-tfn**

**TUBES** - Receiving, Industrial and Semi-conductors, factory boxed. Free price list. Low; low prices. **TRANSLERONIC INC.**, 1365-39th St., Brooklyn, NY 11218E, 800-221-5802, 212-633-2800. 1-85-tfn

**TV TROUBLE ANALYSIS TIPS.** Over 300 symptoms/remedies by circuit area; tough ones over the years. Save time and money. Send \$12.50 to CHAN TV, 8151 Grandview Rd., Chanhassen, MN 55317. 1-85-tfn

**MAKE TELEPHONE answering machine servicing simple & professional.** Without tying up your phone lines, our ring simulator will activate any machine on the market. You can hear the outgoing message, give your message, and also have the availability to check machines that have remote capability. Send your check for \$85.00 made payable to PSI, INC, to cover cost of machine shipping and handling or call (201) 845-6669. PSI, Inc. is located at: 34, Route 17 North, Paramus, New Jersey 07652. 4-84-tfn

**TUBES FOR TV AND RADIO** - 35¢ ea. Washington TV Service, 1330 E. Florence Ave., Los Angeles, CA 90001. 11-84-12t

**SAVE TIME ON COLOR TV REPAIRS.** Over 3,000 tips on 31 brands. 116 pages manual, \$21.00 PP. Send check or M.O. to: A.F. FERNANDEZ, P.O. Box 546110, Surfside, Florida 33154. 4-85-2t

**SINE WAVE QUESTIONS?** Trouble shooting, alignment manual; \$6.00. SW Pay TV patent secrets; \$10.00. Both; \$14.00. STV Authorization/control information; \$2.00. Signal, Box 2512-E, Culver City, CA 90231. 4-85-1t

## FOR SALE (CONT.)

**HOW TO LOAD AND UNLOAD** a console TV of 200 pounds in a van or truck. This can be done easily by a 70-year old man alone. For information, write to FAMILY TV, 5802 N. Armenia, Tampa, Florida 33603. 3-85-31

**MOTOROLA MX-350** including Nicad and rubber duck antenna. Needs repair. \$150.00 PH702-456-9048. 4-85-11

**COMPLETE** video servicing package, SENCORE models: SC61, VA48, LC53, CR70, TF46, PR57. All excellent condition. All available asscs. 400 SAMS with cabinet and other service literature. Must sell. \$5200.00 neg. Phone 1-601-888-4687. Write Frank Ward, Rt. 2, Box 575, Woodville, MS 39669. 4-85-11

## HELP WANTED

**AUDIO/TV. TECHNICIAN NEEDED:** Top pay for experienced Audio and/or TV repair technician in sunny California. Write or call The Audio/Video Clinic, 3623 State St., Santa Barbara, Calif. 93105 (805) 682-6822. 4-85-11

## SITUATION WANTED

**AUDIO/VIDEO TECH** Desiring position. All locations considered. Write PO Box 294, Philadelphia, MS 39350. Knowledgeable in Car Stereos, Stereos, TV's, VCR's. 3-85-21

## EDUC.-INSTRUCTION

**UNIVERSITY DEGREES!** Economical home study for Bachelor's, Master's, Doctorate. Prestigious faculty counsels for independent study and life experience credits. Free information—Richard Crews, M.D. (Harvard), President, Columbia Pacific University, 1415 Third St., Sept. 2B84, San Rafael, CA 94901; Toll Free: 800/227-0119; California: 800/552-5522; or 415/459-1650. 4-85-11

**HELP NEEDED:** Need help with C.I.E. Course 16 compensation will be paid. Please write to P.O. Box 504, North East, MD 21901. 4-85-11

## WANTED

**PICTURE TUBE REBUILDING EQUIPMENT,** working or not, write or call: Chicago Television, 633 North Semoran Blvd., Orlando, Florida 32807. Ph. 275-9543. 11-84-9t

**WOULD LIKE TO BUY** one or more of the following '66-'69 Sylvania color television sets: Model Nos. CF460, 461, 462, 463, or 464 also. Model Nos. CF503-1, 504, or 505K. Need not be in working order. Call collect (312) 876-1900 Rosemary Groenwald. 4-85-11

## BUSINESS OPPORTUNITIES

**THIS IS PARADISE!** In mountains of Northern California, 4 hours from San Francisco. Electronic repair business, selling for health reasons. Building/Business/Living Quarters/Equipment \$165,000. (916) 872-1962. 3-85-2t

**AUDIO REPAIR SHOP**—Going out of business. Soundtechnology, B&K, Fluke test equipment; 4500 service manuals; Many OEM and replacement parts and supplies; Best offer over \$7500. Call 301-744-1544 for details or write B&B Electronics, 5310 Edmondson Ave., Catonsville, MD 21229. 4-85-11

**PICTURE TUBE REBUILDING EQUIPMENT,** one man operation, full training and technical assistance. Buy with confidence from experts in the field. Call or write: Chicago Television, 633 N. Semoran Blvd., Orlando, Florida 32807, Ph. 305-275-9543. 11-84-9t

**TV SALES & SERVICE BUSINESS:** Sunny San Diego, same beach location for 13 years. Price \$66,000 plus stock, down \$22,000. Call Lauer, Lauer, Penn & Associates, (619) 296-5000. 4-85-11

**FOR SALE:** TV sales and Electronics Service Business—2100 square feet. Located in northeastern Wisconsin. Buildings, parts inventory, test equipment, and service manuals included in price. Two rented apartments upstairs for extra income. Owner retiring—Call 414-834-2135. Firm at \$47,000.00. 4-85-11

**ATTENTION ELECTRONIC TECHNICIANS**



Highly Effective Home Study BSEE Degree Program for Experienced Electronic Technicians  
Our New Advanced Placement Program grants Credit for previous Schooling & Professional Experience. Advance Rapidly! Our 40th Year!  
FREE DESCRIPTIVE LITERATURE!  
Cook's Institute of Electronics Engineering  
P.O. BOX 20345, JACKSON, MS 39209

Circle (29) on Reply Card

**CREATION VIDEO LABS**

**VCR ALIGNMENT TAPES \$79.95**

Specify VHS or BETA  
Allow 4 to 6 Weeks Delivery  
Send Check or Money Order To:  
**CREATION VIDEO LABS**  
P.O. BOX 7022  
ELGIN, IL 60121

Circle (30) on Reply Card

**ELECTRONIC SYSTEMS NEWSLETTER**

Monthly publication written especially for the Hobbyist/Experimenter: Projects, Sources, New Ideas. FREE DETAILS

**AF Publishing Co.**  
Dept ST1  
P.O. Box 524  
So. Hadley, Mass. 01075

Circle (31) on Reply Card

**VOLTAGE REGULATORS**

POSITIVE TO-220 PKG  
7805  
78M405  
7806  
7808  
7812  
78M12  
7815  
7818  
7824  
78M24



**20V each**  
6 for \$1

NEGATIVE TO-220 PKG  
7902  
7905  
7906  
7912  
7915  
7918

**PRECISION ELECTRONICS CO.**  
P.O. BOX 894  
UNION NEW SPRING ROAD  
801-888-6666

MINIMUM ORDER \$15.00  
ALL STATES FACTORY PRICES  
QUANTITIES LIMITED  
\*ALL RESIDENTS ADD 6% SALES TAX

Circle (32) on Reply Card

**tv & radio tech's guide to pricing**



Everyone benefits... pricing by "The Book"

**1-800-228-4338**  
MON. THRU FRI. 8-5 / C.S.T.

Circle (33) on Reply Card

**7 MILLION TUBES FREE CATALOG**

Includes all Current, Obsolete, Antique, Hard-To-Find Receiving, Broadcast, Industrial, Radio/TV types. **LOWEST PRICES**, Major Brands, In Stock.  
**UNITY Electronics Dept. E**  
P.O. Box 213, Elizabeth, NJ 07206

Circle (34) on Reply Card

**ELECTRONIC**  
Servicing & Technology

**Advertising Sales Offices**

**NATIONAL SALES MANAGER**  
Greg Garrison  
P.O. Box 12901  
Overland Park, KS 66212  
Phone: (913) 888-4664

**LONDON, ENGLAND**  
Nicholas McGeachin  
Suite 460, Southbank House  
Black Prince Rd.,  
London SE1 7SJ England  
Telephones:  
Central Line  
(01) 582-7522  
Direct Line  
(01) 587-1578  
Telex: 295555 LSPG

# Advertisers' Index

Reader Service Number	Page Number
31	A.F. Publishing Co. . . . . 64
25	All Electronics Corp. . . . . 60
24	Automated Production Equipment Corp. . . . . 59
36	B&K Precision Dynascan Corp. . . . . 57
19	Beckman Instruments . . . 54
6	Chemtronics, Inc. . . . . 25-26
6	Consolidated Electronics Inc. . . . . 1
	Contact East . . . . . 25-26
29	Cooks Inst. Elec. Engrg. . . 64
7	Cooper Group . . . . . 3
30	Creation Video Labs . . . . 64
26	Dandy Mfg. Co. . . . . 61
12,13	Diehl Engineering . . . . . 9,13
	ETA . . . . . 62
8	John Fluke Mfg. Co., Inc. . . . . 5
18	Fuji-Svea . . . . . 53
	Gregory Thomas, Inc. . . 37-38
	Jensen Tools Inc. . . . . 37-38
1,2	Leader Instrument Corp. . . . . IFC,27-28
3	MCM Electronics . . . . . IBC
21	Moody Tools . . . . . 55
	NATESA . . . . . 63
	NESDA . . . . . 59,60
	NRI Schools-Electronics Division . . . . . 25-26
17	Omnitron Electronics . . . . 51
22	Optima Electronics . . . . . 58
	PACE, Inc. . . . . 27-28
11	Philips ECG . . . . . 15
32	Precision Electronics . . . 64
28	Projector Recorder Belt Corp. . . . . 62
15	PTS Corp. . . . . 21
	RCA Distributor and Special Products . . . . . 23,49
	RCA Distributor and Special Products . . . . . 37-38
4,5	Sencore, Inc. . . . . BC
14	Simpson Electric Co. . . . . 41
16	A.W. Sperry Instruments Inc. . . . . 47
33	Sperry Tech, Inc. . . . . 39-40,64
	TAB Books . . . . . 39-40
	Tentel . . . . . 27-28
20	Test Probes, Inc. . . . . 55
34	Unity Electronics . . . . . 39-40,64
27	Wahl Clipper Corp. . . . . 61
23	Workman Electronic Products, Inc. . . . . 58



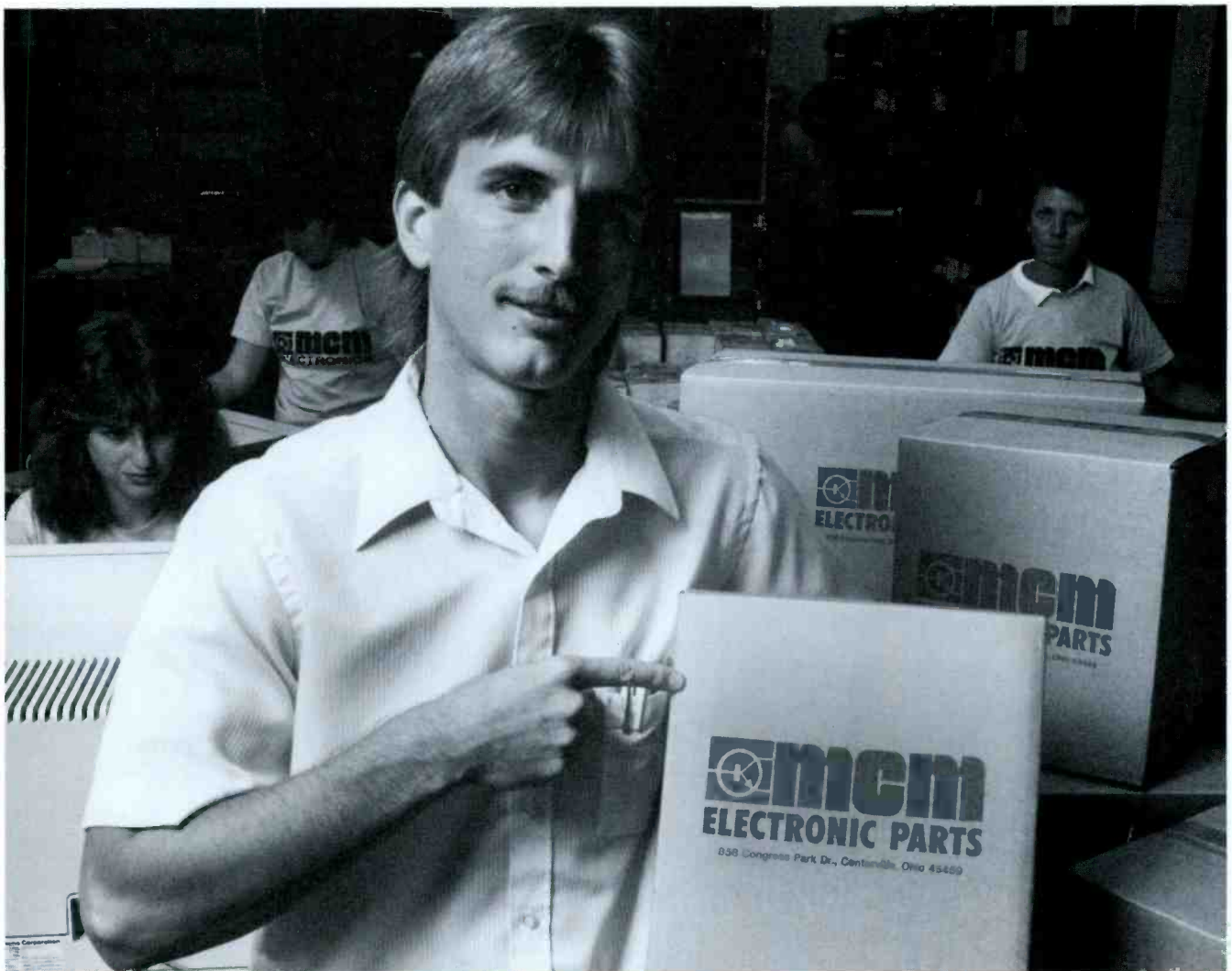

# “FAST DELIVERY... YOU CAN COUNT ON US!”

At MCM we know when you need electronic parts, you need them *FAST*. That's why we have **EXPRESS DELIVERY SERVICE**. Our NEW Computer Aided Ordering System moves your order through *FAST* and *ACCURATE!*

You can count on our **EXPRESS DELIVERY SERVICE** for dependable delivery to your business, on time, every time.

So the next time you need the Right Parts at the Right Price, *Shipped Right Away...* call us at MCM! You can count on us!

**CALL OR WRITE TODAY  
FOR YOUR FREE  
128 PAGE CATALOG!  
OVER 4800 ITEMS!**

**CALL TOLL FREE  
1-800-543-4330**

(In Ohio, 1-800-762-4315)



---

## **mcm** ELECTRONICS

858 E. Congress Park Drive, Centerville, Ohio 45459

Circle (3) on Reply Card

SOURCE NO. ES-3

# The people who gave you the Video Service Standard of the 70's. Now Introduce the all new standard for the 80's—MODEL VA62.



## Cut your video service time in half

The Sencore VA48 TV Analyzer, introduced in 1976, quickly became the industry standard for video service. It is now used by more than 22,000 technicians nationwide who have averaged an overall 54% reduction in service time, according to a recent survey of VA48 owners.

**But Times Change:** Today's video circuits include projection TV, 4-head VCRs, SAW filters, comb filters, integrated flybacks, cable-ready tuners,

and many more circuits you just can't service effectively with the VA48. That's why we now have the VA62—the only video analyzer that equips you for all of these new video circuits—and then some.

**In a Nutshell:** Here's what makes the VA62 unique:

- It's a TV analyzer—Fully updated for the latest circuits.
- It's a VCR analyzer—Makes VCR analyzing a snap (using two inexpensive accessories) . . . and it meets all manufacturers' requirements.
- It's cable-ready—Test all the latest digital tuners.
- It has unique patterns—Special test patterns, plus standard pat-

terns simplify troubleshooting.

- It's obsolete proof—It can be updated as needed for new circuits or formats . . . quickly and inexpensively.

**Guaranteed Results:** The VA62 can cut your service time in half on all video circuits—new and old. We guarantee it or we'll refund your money at the end of 30 days.

**Update Today:** If you're ready to update your bench to service the new circuits of the 80's, write or call toll-free today for a complete color brochure.

**TOLL-FREE 1-800-843-3338**  
In Canada Toll-Free 1-800-665-4871  
South Dakota, Alaska, and Hawaii call collect at 605-339-0100.

Please send complete VA62 details:

Name \_\_\_\_\_  
Address \_\_\_\_\_  
City \_\_\_\_\_  
State \_\_\_\_\_ Zip \_\_\_\_\_  
Phone \_\_\_\_\_

(Mail to Sencore, 3200 Sencore Drive, Sioux Falls, SD 57107)

# SENCORE

For Information Circle (4) on Reply Card  
For Demonstration Circle (5) on Reply Card