

ELECTRONICTM

Servicing & Technology

DECEMBER 1983/\$2.25

Interpreting waveforms

Audiocassette recorder adjustment



Satellite TV

Glaedelig Jul Vesele Vanoce FEB
Vrolijke Kerstmis Boas Festas
ZALIG KERSTFEEST JOYEUX NÖE
no Natale Tröhliche Weinacht
GAT Glad Jul Seasons Greetings
Wesolych Swiat Feliz Navidad
ハッピー挨拶 HAPPY CHANUKAH

Seasons Greetings
from the world's largest independent electronics
rebuilder. Your patronage over the past year is
sincerely appreciated, and we extend our best
wishes for your success and prosperity
in the coming new year.



PTS CORPORATION

Circle (1) on Reply Card

MCM ELECTRONICS

THE ONLY ELECTRONIC PARTS COMPANY YOU'LL EVER NEED*

QUALITY PARTS AT EVERYDAY LOW PRICES

HIGH VOLTAGE TRIPLER



\$14⁹⁰

ERS 526A

Replaces: ECG 526, Zenith 212-141-02/
212-141-03/212-141-04/212-141-05/
RCA SK3308/THOR VMT-08

We also have these other triplers available: ERS 500,
521, 522, 523, 528, 529, 531, 534, 535, 538, 539, 549,
550, 556, 557, 564, 565

SPECIAL!

HORIZONTAL OUTPUT

ERS 238

\$2³⁵ 100-up

\$2⁵⁰ 1-99



SPECIAL!

Replaces most horizontal outputs on
the market today 1500v 7A 50w

2 year guarantee!

TUBES

	1-9	10-29
3A3C	\$5.10	\$4.59
6JE6	8.80	7.92
36KD6	7.80	7.02
6BK4	6.20	5.58
6GH8A	2.25	1.49



MCM carries a full line of receiving tubes at the best
prices around. Names like: Westinghouse, G.E.,
Rathenon, Sylvania and others.

FOCUS DIVIDERS

\$5⁶⁷ 10-29

\$6³⁰ 1-9

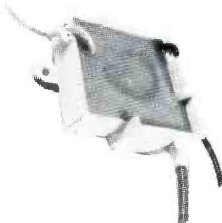

ERS-HI-DIV-1

ERS-HI-DIV-2

ERS-HI-DIV-3

ERS-HI-DIV-4

FREE 1984 Catalog *

FLYBACK TRANSFORMERS

MCM carries a full line of flybacks and yokes. See the main catalog for listings.



Sanyo

4-2751-48500
#33-870

\$17⁸²



Sanyo

4-2751-48600
#33-875

\$17⁸²



Sharp

8FT-043B
#33-865

\$18⁷⁵



Sharp

RTRNF1106CZZ
#33-750

\$28⁹⁵



RCA

119834
906224-501
#Fly-312

\$24⁵⁴



RCA

115876/906170-504
114704/906170-502
#Fly-308

\$25⁰⁰



Admiral

79D195-1/1B

#Fly-654

\$33³³



Admiral

79D197-1

#Fly-685

\$30⁶¹



Admiral

79D199-1C

#Fly-684

\$29²²



Quasar

2470809B08

#Fly-632

\$26³⁸

mcm
ELECTRONICS
RIGHT PARTS, RIGHT PRICE,
SHIPPED RIGHT AWAY.

* Call Today for Your New FREE 108-pg. Catalog #7 and
see our complete line of over 4,000 parts.

CALL FREE 1-800-543-4330 (In Ohio 1-800-762-4315)
TOLL 858 E. CONGRESS PARK DR. CENTERVILLE, OH 45459

Circle (4) on Reply Card

www.americanradiohistory.com

The how-to magazine of electronics...

ELECTRONIC

Service & Technology

December 1983
Volume 3, No. 12

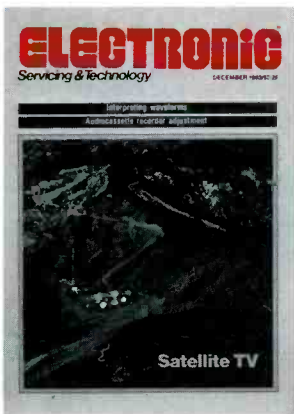

The West Coast Earth Station for RCA Americom's satellite-communications system is in the rugged Santa Susana mountains northwest of Los Angeles. See related story on page 12. (Photo courtesy of RCA)

12 Satellite TV: Still up in the air

By Nils Conrad Persson, editor

Direct Broadcast Satellite (DBS) is designed to provide TV programming directly to individual homes through signals transmitted by satellites. This article looks at the current status of satellite television and explains some of the terminology.

18 Test Your Electronic Knowledge

By Sam Wilson, IS CET test director

This month's questions are similar to those on the associate-level CET test section related to power supply.

20 Audiocassette recorder adjustment

By Kirk Vistain

Mechanical and electrical adjustment procedures are detailed in this article on servicing cassette recorders.

42 Evolution of Waveforms – Part I

By Carl Babcoke, CET

A waveform of the proper waveshape, amplitude, and repetition rate indicates correct operation, and no analysis is required. An incorrect waveform raises questions about what defect is indicated. This article shows successive waveform changes when pulses are passed through various lowpass and highpass filters; reasons for the changes are then discussed.

48 More about decibels, epsilon and radians

By Sam Wilson, IS CET test director

Some practical problems are worked in this article, which discusses radians and rotating phasors, in order to extend the concepts given in previous articles.

Departments

- 6 Editorial
- 7 Feedback
- 8 Technology
- 31 Profax
- 39 Symcure
- 51 News
- 54 Photofact
- 54 Readers' Exchange
- 55 Literature
- 57 Books
- 58 Products

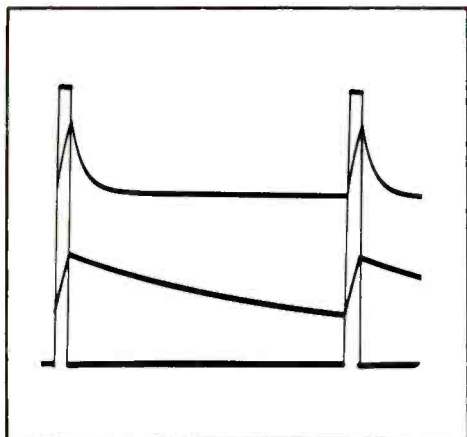

Page 43

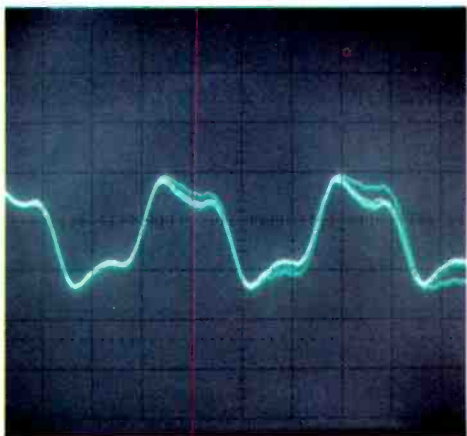

Page 52

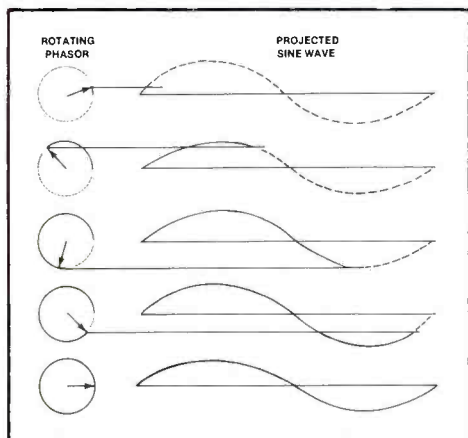

Page 50

Next month...

Electronic telephones are among the best-selling new products, with features such as automatic redial, memory dialing, and push-button convenience that make conventional phones seem old-fashioned. Wireless telephones have most of these advanced features plus the convenience of operation without restricting wires. The basic circuits and their operations are described in this article.

Video vanity

The inventors of television could not have foreseen the huge effects of their brain child on the world. A multibillion dollar industry has been established to produce and distribute television programs. Television has become the single most important advertising medium in the world. Important events anywhere on the globe are transmitted worldwide, as they happen, via cable and satellite. The surface of Mars, the rings of Saturn, even the farthest reaches of the solar system have been more closely examined through the eye of the TV camera.

There is one area of application of television, however, where development just has not lived up to its promise: teleconferencing. Billions of dollars are spent every year on air fares, auto rentals, hotel bills and meals for business travel. Countless hours of productive time are wasted at airports, in the air and on the road. The technology exists right now to bring people together via television but it's barely being used. Why?

According to a report issued last spring by International Resource Development, a consulting firm in Norwalk, CT, a persistent theme in teleconferencing experiments is that users are "not comfortable" with the technology, or "don't find it really conveys the 'presence' of the remote participants." The researchers suspect that much of their resistance to teleconferences comes about because potential users have certain expectations about television. According to an IRD staff member, "TV screens are expected to display carefully dressed, carefully coifed actors with scripted and rehearsed roles and activities." By

contrast, the participants in a teleconference tend to "have their ties askew, don't always look at the camera, and may pick their noses and seem unsure what to say. To their dismay, some executives find that the teleconferencing medium portrays them as nerds."

Exploring the possible solutions to the teleconferencing problems, the researchers have suggested three avenues to greater use of teleconferencing:

- Use of teleconferencing for carefully scripted and professionally produced presentations for new-product introductions, etc. These work well and save time and money.
- Careful practice and training by potential users, so that they know how to best project their personalities and ideas over the new medium.
- Much greater development of the technology, including the use of huge screens or "screen walls" (which don't look like TV screens) and perhaps even 3-dimensional tele-holography.

Of course, if teleconferencing catches on, it will be a blow, although probably not a serious one for the transportation and hotel industry. On the other hand, it might result in some significant energy savings in an energy-deficient world. In any event, it would almost certainly be of benefit to anyone who is involved in any way with TV equipment.

Nils Conrad Persson

ELECTRONIC Servicing & Technology

Editorial, advertising and circulation correspondence should be addressed to: P.O. Box 12901, Overland Park, KS 66212-9981 (a suburb of Kansas City, MO); (913) 888-4664.

EDITORIAL

Bill Rhodes, *Editorial Director*
Nils Conrad Persson, *Editor*
Carl Babcoke, *Consumer Servicing Consultant*
Rhonda Wickham, *Managing Editor*
Jane Cigard, *Associate Editor*

ART

Kevin Callahan, *Art Director*
Joni Harding, *Graphic Designer*

CIRCULATION

John C. Arnst, *Director*
Evelyn Rogers, *Manager*
Dee Manies, *Reader Correspondent*

ADMINISTRATION

R. J. Hancock, *President*
Cameron Bishop, *Publisher*
Eric Jacobson, *Associate Publisher*

ADVERTISING

Greg Garrison, *National Sales Manager*
Liz Turner, *Production Manager*
Robyn Kahn, *Marketing Coordinator*



Member, Audit Bureau
of Circulation



Member, American
Business Press

ELECTRONIC SERVICING & TECHNOLOGY (USPS 462-050) (with which is combined Electronic Technician/Dealer) is published monthly by Intertec Publishing Corp., 9221 Quivira Road, P.O. Box 12901, Overland Park, KS 66212-9981. Second Class Postage paid at Shawnee Mission, KS 66201. Send Form 3579 to P.O. Box 12952, Overland Park, KS 66212-9981.

ELECTRONIC SERVICING & TECHNOLOGY is the "how-to" magazine of electronics. It is edited for electronic professionals and enthusiasts who are interested in buying, building, installing and repairing home-entertainment electronic equipment (audio, video, microcomputers, electronic games, etc.).

SUBSCRIPTION PRICES: one year \$15, two years \$26, three years \$34 in the USA and its possessions. Foreign countries: one year \$20, two years \$30, three years \$40. Single copy price \$2.25, back copies \$3.00. Adjustment necessitated by subscription termination to single copy rate. Allow 6 to 8 weeks delivery for change of address. Allow 6 to 8 weeks for new subscriptions.

PHOTOCOPY RIGHTS: Permission to photocopy for internal or personal use is granted by Intertec Publishing Corp. for libraries and others registered with Copyright Clearance Center (CCC), provided the base fee of \$2 per copy of article is paid directly to CCC, 21 Congress St., Salem, MA 01970. Special requests should be addressed to Cameron Bishop, publisher. ISSN 0278-9922



INTERTEC PUBLISHING CORP.

©1983 All rights reserved.



CB is not dead

Editor Nils Conrad Persson apparently does not have a CB base station in his office, nor a mobile unit in his car. I must dispute his claim in his September editorial that CB is dead.

At least in my part of the country, all channels are still putting the needle to the top, and it is difficult to get through on a channel from dawn to dusk. Even at night most channels are active most of the time. The trouble with CB is that "the people who found out that they had nothing to say" are the same people that are monopolizing the channels. They talk and talk, but say nothing. Then there are the "mindless linear operators" who drown out everyone with their mon-conversation.

A lot of people are still using (or are trying to use) the CB in the way it was intended. Many gave up because they could not get through on a channel. When the market was flooded with inexpensive sets, the door was opened for all the "children" to be able to afford a CB.

At present, my CB business is quite profitable, but an article on CB in *ES&T* once in a while would give me encouragement for the future of my business.

**Chet's CB Service
Bethlehem, PA**

REACT response

REACT is a national organization in CB radio. Our members are dedicated to monitoring the emergency channel 9 and to using personal radio, primarily CB, to assist various programs in the community. I suggest that the CB "boom and bust" cycle was unique.

CB radio as we know it was authorized by the FCC in 1958. It was not until the Arab oil embargo of 1974 and the 55 mph speed limit coincided to make people interested in communicating the availability of fuel and location of highway patrol radar units that

CB became more popular.

The advent of compact, low current drain and easy-to-use, solid-state equipment made the boom possible. The boom was accelerated by the FCC's authorization of 40-channel CB, discontinuation of license fees, and the obsolescence and subsequent price drop of 23-channel units. The increase in price of the 40-channel units was largely responsible for reducing sales volume. Furthermore, even though the prices increased, the full margin of profitability has never been realized, in my opinion.

A great contributor in all of this is the fact that CB radio is virtually all imported. Thus, when the specification change was announced by the FCC in August 1977, effective Jan. 1, it caught suppliers' merchandise literally "on the water." Thus, the ability to adjust production to marketing realities becomes much more difficult. Much longer lead times exist as a result of importing products vs. controlling manufacturing in a domestic production situation. We should be aware of that in the entire consumer electronics area.

We must be aware of the economic impact of government regulatory decisions. Most importantly, the timing of such actions must be compatible with industry custom and seasonality of efforts.

**Gerald H. Reese,
executive director
REACT International Inc.
Northbrook, IL**

In the conclusion to that editorial, I advised that because of the potential for boom and bust conditions in sales of other electronics equipment, as occurred in the CB area, that such a possibility "bears careful consideration by anyone who purchases, sells or services electronic equipment." That was, and still is good advice.

Editors should heed their own advice, however. I should have given more careful consideration to what I was saying. I assumed that because sales of CBs are down sharply, that use is also down sharply: a totally unwarranted, if seemingly logical, conclusion. Thanks to the two letter writers for setting me straight.

**Conrad Persson
ES&T Editor**

ES&T STATEMENT OF OWNERSHIP

Statement of Ownership, Management and Circulation (Act of August 12, 1970; Section 3685, Title 39, United States Code).

1. Title of publication: Electronic Servicing & Technology
 - 1A. 462-050
2. Date of filing: Sept. 22, 1983
3. Frequency of issue: Monthly
- 3A. Number of issues published annually: 12
- 3B. Annual subscription price: \$15.00
4. Location of known office of publication (Street, city, county, state, zip code): 9221 Quivira Rd., Overland Park, Johnson County, Kansas 66215.
5. Location of the headquarters or general business offices of the publishers (not printers): 9221 Quivira Rd., Overland Park, Johnson County, Kansas 66215.
6. Names and complete addresses of publisher, editor, and managing editor. Publisher (Name and Complete Mailing Address): Cameron Bishop, 9221 Quivira Rd., Overland Park, Kansas 66215. Editor (Name and Complete Mailing Address): Nils Conrad Persson, 9221 Quivira Rd., Overland Park, Kansas 66215. Managing Editor (Name and Complete Mailing Address): Rhonda L. Wickham, 9221 Quivira Road, Overland Park, KS 66215.
7. Owner (If owned by a corporation, its name and address must be stated and also immediately thereunder the names and addresses of stockholders owning or holding 1 percent or more of total amount of stock. If not owned by a corporation, the names and addresses of the individual owners must be given. If owned by a partnership or other unincorporated firm, its name and address, as well as that of each individual must be given. If the publication is published by a nonprofit organization, its name and address must be stated.) Intertec Publishing Corp., 9221 Quivira Rd., Overland Park, KS 66215.
8. Known bondholders, mortgagees, and other security holders owning or holding 1 percent or more of total amount of bonds, mortgages or other securities (If there are none, so state): None.
9. Paragraphs 7 and 8 include, in cases where the stockholder or security holder appears upon the books of the company as trustee or in any other fiduciary relation, the name of the person or corporation for whom such trustee is acting, also the statements in the two paragraphs show the affiant's full knowledge and belief as to the circumstances and conditions under which stockholders and security holders who do not appear upon the books of the company as trustees, hold stock and securities in a capacity other than that of a bona fide owner. Names and addresses of individuals who are stockholders of a corporation which itself is a stockholder or holder of bonds, mortgages or other securities of paragraphs 7 and 8 when the interests of such individuals are equivalent to 1 percent or more of the total amount of the stock or securities of the publishing corporation.
10. This item must be completed for all publications except those that do not carry advertising other than the publisher's own and are named in sections 132,231, 132,232 and 132,233, postal manual (Sections 4355a, 4354b, and 4356 of Title 39, United States Code).

	Average No. Copies Each Issue During Preceding 12 Months	Single Issue Nearest To Filing Date
A. Total No. Copies Printed (Net Press Run)	56,275	53,650
B. Paid Circulation		
1. Sales through dealers and carriers, street vendors and counter sales	43	171
2. Mail subscriptions	52,887	52,226
C. Total Paid Circulation	52,930	52,397
D. Free Distribution (including samples) by mail, carrier delivery or other means	2,089	828
E. Total Distribution (Sum of C and D)	55,019	53,225
F. Office use, left-over, unaccounted spoiled after printing.....	1,256	425
G. Total (Sum of E and F should equal net press run shown in A)	56,275	53,650

I certify that the statements made by me above are correct. (Signature of editor, publisher, business manager, or owner.)

CAMERON BISHOP





COMPUTERIZED SYSTEM TROUBLESHOOTS DIESEL-ELECTRIC LOCOMOTIVES

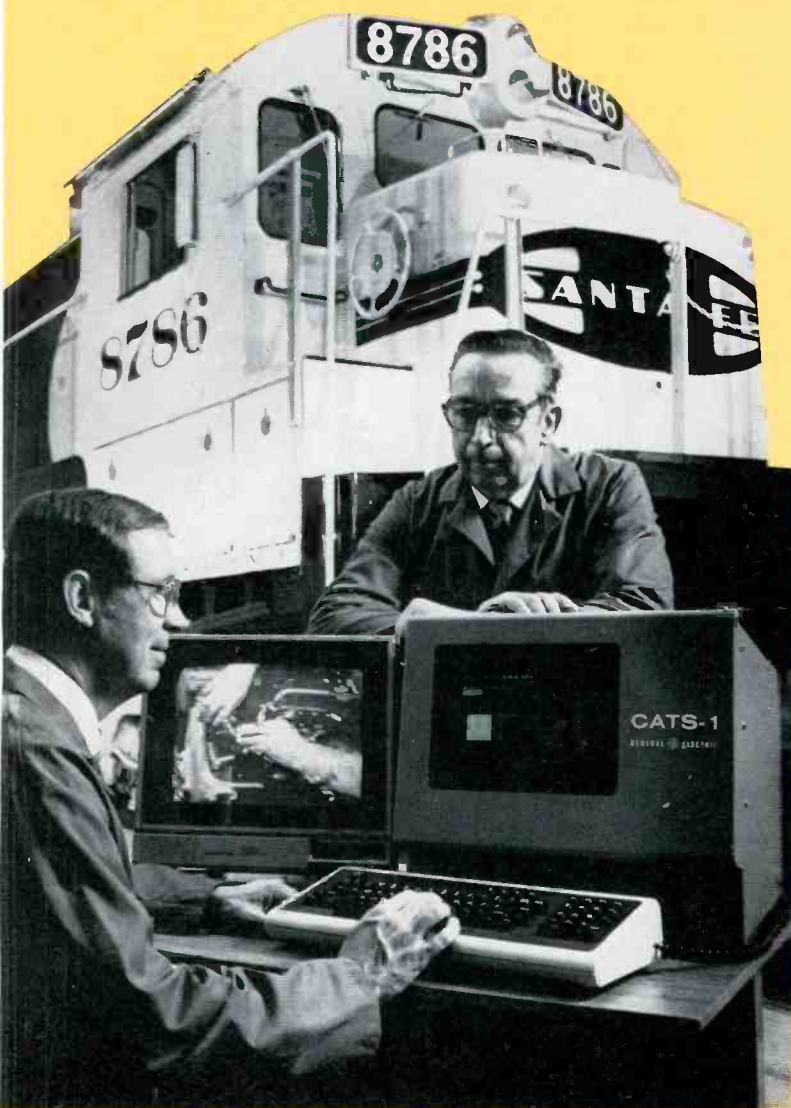

General Electric Company has developed a computerized troubleshooting system that combines recent advances in the fast-growing field of artificial intelligence with the accumulated expertise of a senior engineer. The portable electronic tool consists of a small computer and associated hardware and will soon be put to work by the company's Transportation Systems Business Operations troubleshooting GE-built locomotives at railroad service shops throughout the country.

Artificial intelligence is a technology that involves "teaching" computers to mimic human thought processes. GE's troubleshooting system is an example of one branch of this emerging science, known as *expert systems*. Creating such systems involves programming a computer with the knowledge, experience and decision-making process of human experts in a given field.

GE's expert system troubleshoots by "reasoning" much the way an experienced locomotive engineer would. The computer's database was generated by a team of Research and Development Center computer specialists that spent several months interviewing GE's top locomotive field service engineer, David I. Smith—an expert with more than 40 years of experience in troubleshooting diesel-electric locomotives. The GE team then devised a custom software program to put Smith's accumulated expertise into the computer.

Because the electronic troubleshooter is adaptable to a wide range of assignments, "such a knowledge-based system could eventually change the way we go about fixing almost everything, bringing the expert's knowledge and experience to a wide variety of tasks in the industrial and commercial arena," says Dr. Roland W. Schmitt, GE's senior vice president for corporate research and development.

Currently, the mechanical and electrical systems employed in giant diesel-electric locomotives are

Information and photos courtesy of General Electric



look closer at a DSM!

Here's a flat-panel scope, a transient recorder, and a 32-range DMM in a compact 4 lb. box.

Now you can use one instrument to capture 2 μ s transients, evaluate their waveform characteristics on a flat-panel LCD, and simultaneously measure their true RMS values.

It's all made possible with the first in a new class of instruments from BBC, the Digital Scope Multimeter, Model M 2050 DSM. By applying precision European engineering to the measurement needs of design and service engineers, BBC is revolutionizing test and measurement.

Large Flat-Paneled Scope Display

The LCD provides excellent resolution, 128 dots by 64 dots, for waveform displays. It measures 4-5/8 in. (118 mm) x 1-5/8 in. (42 mm). Simultaneous display capabilities let you use the scope portion of the LCD to evaluate signal characteristics while the DMM portion displays the true RMS signal value. Your measurement evaluations will be more accurate and consistent.

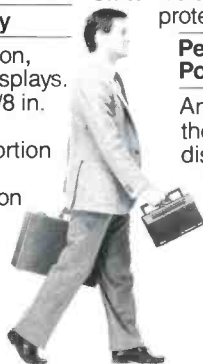

Transient Recording

Two independent memories of 512 words (horizontal dots) with 8-bit vertical resolution let users capture information about events ranging from 2 μ s to 1-hr in duration. Five selectable trigger points (0, 25%, 30%, 75%, and 100%) give users options as to how much data is stored before and after the triggering event.

True RMS Multimeter Measurements

You get 15 voltage ranges (to 650V), 15 current ranges (to 10A), and two resistance ranges (200 Ω and 20k Ω). True RMS and Averaging RMS modes are switch selectable. All ranges are overload-protected (Spikes to 6,000 V or 60A).

Performance Packed and Portable

An impact resistant case protects the M 2050 DSM. When open, the display angle is easily adjustable. When closed, the display and the controls are protected, the meter shuts itself off, and the tilt bail becomes a carrying handle.

Affordable and Available

The price of the M 2050 DSM is only \$1,795.00 (for the optional analog output, add \$200.00). Rechargeable batteries for 8 hours of portable operation are available for \$35.00

BBC's M 2050 DSM and other innovative instruments are available via select distributors throughout the U.S. If your instrumentation supplier doesn't carry BBC yet, we'll gladly tell you who does. Call toll free:

1-800-821-6327
(In CO, 303-469-5231)

BBC-Metrawatt/Goerz
6901 W. 117th Avenue
Broomfield, CO 80020, Telex 45-4540

Engineering Excellence in Test and Measurement



Circle (7) on Reply Card

**DESOLDER-IT,
CLEAN-IT, COAT-IT,
FREEZ-IT... SEND FOR IT!**
Our new electronic problem solving catalog
and Free Chem-Wik® samplers!



Chemtronics
681 Old Willels Path
Hauppauge, NY 11788
800-645-5244
In NY 516-582-3322
Telex 968567

Circle (8) on Reply Card

OPTIMA ELECTRONICS

TO ORDER CALL TOLL FREE 1-800-327-0224

G.E., SYLVANIA, ZENITH, RCA, 75% OFF LIST NEW-BOXED

- | | | | |
|-------------------------------|---------------|-------------------------------|---------------|
| <input type="checkbox"/> 3A3 | 5 FOR \$15.75 | <input type="checkbox"/> 6LF6 | 5 FOR \$34.44 |
| <input type="checkbox"/> 6MJ6 | 5 FOR \$34.88 | <input type="checkbox"/> 6LB6 | 5 FOR \$31.50 |
| <input type="checkbox"/> 6JE6 | 5 FOR \$32.75 | <input type="checkbox"/> 6CJ3 | 5 FOR \$14.69 |
| <input type="checkbox"/> 3DJ3 | 5 FOR \$17.44 | <input type="checkbox"/> 6JS6 | 5 FOR \$29.00 |
| <input type="checkbox"/> 6GH8 | 5 FOR \$12.44 | <input type="checkbox"/> 6BL8 | 5 FOR \$12.25 |

All Tubes Not Advertised, Write in at 75% Off List.

Sleeves Only. Singles 72% Off List

HORIZONTAL OUTPUT TRANSISTORS ECG REPLACEMENT TRIPLERS

\$1.95 ea. Min. 10, 2 yr. Warranty

- | | | | |
|-----------------------------------|---------------------------------|---|---|
| <input type="checkbox"/> RKS1172B | <input type="checkbox"/> RKS238 | <input type="checkbox"/> 500A ..\$11.50 | <input type="checkbox"/> 526A ..\$14.95 |
| <input type="checkbox"/> RKS1308K | <input type="checkbox"/> RKS165 | <input type="checkbox"/> 523 ..\$13.50 | <input type="checkbox"/> 529 ..\$15.50 |

TRANSISTORS & I.C.'s...MIN. 10, CAN MIX

- | T.V. #'s | Pop. I.C. #'s | STEREO #'s |
|---|---------------------------------------|--|
| <input type="checkbox"/> 2SC1114 ..\$3.75 | <input type="checkbox"/> 712 ..\$1.40 | <input type="checkbox"/> DM133 ..\$5.95 |
| <input type="checkbox"/> MN8303 ..\$3.95 | <input type="checkbox"/> 713 ..\$1.40 | <input type="checkbox"/> DA101 ..\$5.75 |
| <input type="checkbox"/> 2SC1034 ..\$5.95 | <input type="checkbox"/> 714 ..\$1.50 | <input type="checkbox"/> HA1377A ..\$3.25 |
| <input type="checkbox"/> 2SC867A ..\$3.50 | <input type="checkbox"/> 731 ..\$1.50 | <input type="checkbox"/> HA1388 ..\$5.25 |
| <input type="checkbox"/> 2SD870 ..\$4.75 | <input type="checkbox"/> 790 ..\$1.50 | <input type="checkbox"/> HA1396 ..\$5.50 |
| <input type="checkbox"/> 2SD871 ..\$5.50 | <input type="checkbox"/> 791 ..\$1.95 | <input type="checkbox"/> HA1398 ..\$4.95 |
| <input type="checkbox"/> AN5210 ..\$6.50 | <input type="checkbox"/> 792 ..\$1.95 | <input type="checkbox"/> UPC1181 ..\$1.75 |
| <input type="checkbox"/> AN5310 ..\$3.95 | <input type="checkbox"/> 793 ..\$2.25 | <input type="checkbox"/> UPC1182 ..\$1.75 |
| <input type="checkbox"/> AN5320 ..\$3.25 | <input type="checkbox"/> 819 ..\$1.50 | <input type="checkbox"/> UPC1185H ..\$2.95 |
| <input type="checkbox"/> AN5435 ..\$2.95 | <input type="checkbox"/> 820 ..\$2.10 | <input type="checkbox"/> 2SA1105 ..\$2.95 |
| <input type="checkbox"/> 2N3055 ..\$.95 | <input type="checkbox"/> 848 ..\$2.95 | <input type="checkbox"/> 2SC2580 ..\$2.95 |

GENERAL

- | | |
|--|-----------------|
| <input type="checkbox"/> 1308K Sanyo | 10 for \$22.50 |
| <input type="checkbox"/> 2.5 Amp. 1000 PIV Rect. | 100 for \$ 8.75 |
| <input type="checkbox"/> VEH0070 VIDEO HEAD (4 hrs.) | \$49.95 |
| <input type="checkbox"/> Pop. HI DIV-3...focus block divider | \$35.00 |
| <input type="checkbox"/> Mabuchi Motors for cassette recorders & tape decks (CW & CCW) | \$ 7.95 |
| <input type="checkbox"/> 6 ft. Cheater Cords SPT2 (Heavy Duty - UL App. 7 Amp. 125V. P & NP) | 10 for \$ 7.95 |
| <input type="checkbox"/> 800-860 Zenith Safety Cap | \$ 3.95 |
| <input type="checkbox"/> Pop. Mag. Safety Caps 250663-11-17-19-20 | \$ 3.95 |
| <input type="checkbox"/> Pop. GE Caps 25x60-75-78-79 | \$ 3.95 |
| <input type="checkbox"/> ZEN. Mod. 9-103-04 Audio | \$ 7.95 |

Quantity Prices Available

Letters of credit and all checks placed on deposit with Bank of Hallendale, FL. VISA & Master Charge accepted. Min. order \$75. FOB Dania, FL. Catalog \$3, refundable upon order.

SEND CHECK OR MONEY ORDER TO:

OPTIMA ELECTRONICS

2022 Tigertail Blvd., Dania, FL 33004

Phone (305) 920-3550 TOLL FREE: 1-800-327-0224

Circle (9) on Reply Card

fully understood by a handful of human experts. When these systems malfunction, it is often necessary to wait until the expert can arrive on site to assess the situation, or until the locomotive can be moved a long distance to bring it to the expert.

By contrast, the new diagnostic technology could put a computerized expert at every railroad repair shop, eliminating delays and boosting maintenance productivity.

With GE's locomotive troubleshooting system, even a novice engineer can uncover a fault by spending just a few minutes at the computer terminal. The system can even lead its user through the required repair procedures, presenting detailed computer-aided drawings of parts and sub-systems and specific how-to instructional demonstrations that are stored on a videodisc.

GE's troubleshooting system begins by asking its user a series of questions displayed on a CRT screen. The system first displays a menu of possible symptoms. When the user selects a particular symptom, the computer program prompts a series of more detailed questions, such as, "Is the fuel filter clean?" or "Are you able to set fuel pressure to 40 pounds per square inch?"

The heart of the system is its knowledge base of facts (piece of evidence that describe the problem) and rules (conditional statements that help to define the solution to the problem). Similar to repair personnel, the GE system relies on flexible, human-like thought processes ("If this and this are true, then do this...") to diagnose problems, rather than on rigid procedures expressed in flowcharts or decision trees. To incorporate this approach, the system's central knowledge base contains more than 500 "if...then" rules generated from discussions with the real-life expert.

At appropriate points during the question-and-answer session, the user can call up detailed drawings, photos or movies of the locomotive's various components and their locations, and display them on the screen. Finally, the troubleshooting system identifies the cause of the malfunction and, if necessary, generates the specific repair instructions on a video monitor.

Hardware components of the system include a standard 16-bit microcomputer for information processing, additional memory for storing the expert knowledge, a CRT terminal for interfacing with the microcomputer, a printer for information retrieval, and a videodisc player and monitor for demonstrating repair procedures. The computer program for the system was prototyped in LISP, the standard computer language for artificial intelligence research, but the final system was redesigned in FORTH, a highly "portable" computer language adaptable to a wide range of minicomputers and microprocessors.

GE researchers are now working on developing a generic software program that would extend the applications of this technology to a wide variety of electrical and mechanical systems.

ES&T

REACH FOR RELIABILITY



REPLACEMENT
SK
SOLID STATE

RCA

RCA Distributor and
Special Products Division,
Deptford, NJ 08096



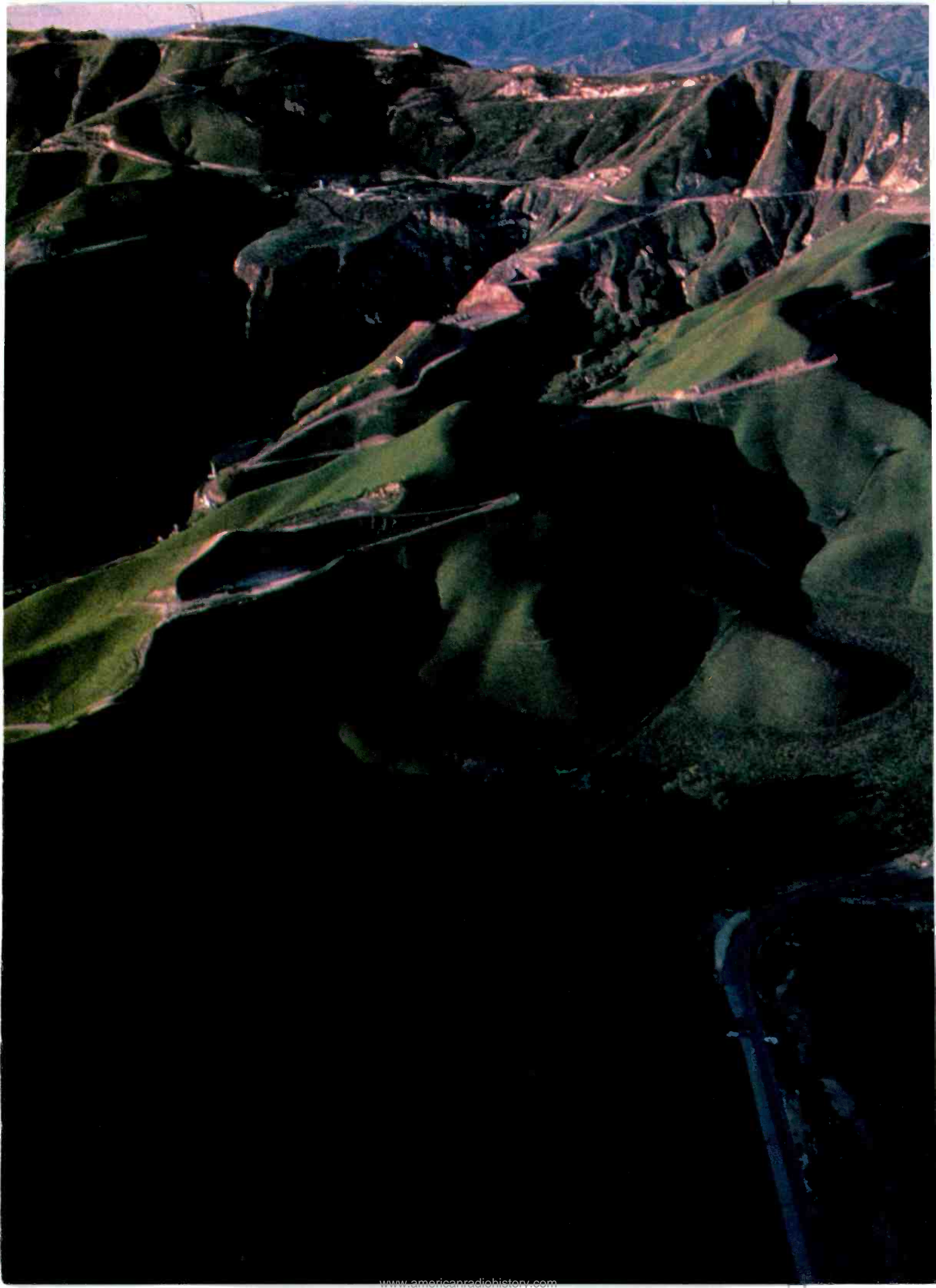



Satellite TV: Still up in the air

By Nils Conrad Persson, editor

In an article in *Wireless World* in February 1945, Arthur C. Clarke made the bold suggestion that if an artificial satellite were to be placed in orbit around the earth above the equator at the correct altitude and speed, it would circle the earth at precisely the same speed at which the earth rotated beneath it. This would make the satellite appear stationary above a point on the earth, and it could be used to communicate over half the surface of the earth. This was an amazing prediction in view of the fact that this was 12 years before the primitive artificial satellite, Sputnik, orbited by the Soviet Union, rocked the Western world with the realization that we had

lagged behind in space technology.

The first geostationary commercial satellite, operational in 1965, was Early Bird, which relayed telephone, teletype and TV programming across the Atlantic. Early Bird was capable of handling a single TV channel or 240 telephone channels. The success of subsequent satellite launchings is well known. Today the United States and Canada are making use of more than 15 geostationary satellites.

WESTAR I, a Western Union satellite, was launched in 1974. This was the first U.S. domestic communication satellite. Most of the communications relayed by the satellite consisted of telephone and data, but TV signals were occasionally handled. In the next several years, other satellites were launched, and more TV program-

ming began to be carried via satellite. On Oct. 18, 1979, the FCC announced that it would no longer require licenses for satellite earth station equipment, thus making it legal for individuals to own their own satellite earth station.

Increasing popularity

Today, most nationally televised programs broadcast in the United States, whether commercial or pay TV, are at sometime in their distribution cycle relayed via satellite. Anyone who has an earth station can receive any of these programs. Earth station equipment is not cheap, but the cost has been steadily declining, and today earth station equipment for less than \$3000 is common.

There are a number of reasons that people will shell out several thousand dollars for one of these

antenna systems. One reason is that certain people are willing to pay large sums in order to possess the latest in technology. But there are thousands, perhaps millions of homes that, for one reason or another, receive inadequate TV service. For example, there are many communities or individuals who live outside of good TV broadcast reception areas, or who live in the shadow of a mountain, or who are able to receive only one or two stations. There are other TV viewers who receive a number of broadcast channels adequately, but because they live in relatively sparsely populated areas, do not have access to cable TV.

Currently, there are no TV programs relayed via satellite that are intended by the originators to be received directly from the satellite by private individuals. All current-

These companies, gleaned from a number of sources, are some of the manufacturers or distributors of satellite TV reception equipment.

Birdview Communications
P.O. Box 963
Chanute, KS 66720

Boman Industries
Satellite Division
9300 Hall Road
Downey, CA 90241

Channel Master Division of Arnett
Ellenville, NY 12428

Conifer Corporation
1400 W. Roosevelt
P.O. Box 1024
Burlington, IA 52601

DSC Service Center, Ltd.
International Headquarters
4401 Walden Ave.
Lancaster, NY 14086

Earth Terminals
One Microwave Plaza
Cincinnati, OH 45242

Galaxy Video Electronics
YDS Enterprises
6007 N. 61st Ave.
Glendale, AZ 85301

General Instruments Corporation
RF Systems Division
1 Taco St.
Sherburne, NY 13460

Heath Company
Benton Harbor, MI 49022

Hero Communications of Florida
Behar Enterprises
1783 W. 32nd Place
Hialeah, FL 33012

Hoosier Electronics
Satellite Earth Station
P.O. Box 3300
#9 Meadows Center
Terre Haute, IN 47803

Intersat Corporation
#2 Hood Drive
St. Peters, MO 63376

KLM Electronics
P.O. Box 816
Morgan Hill, CA 95037

Kaul-Tronics
Box 292
Long Rock, WI 53556

Lindsay America
Consumer Electronics Division
477 East Willow St.
Williamsport, PA 17701

National Microtech
P.O. Drawer E
Grenada, MS 38901

Paradigm Mfg.
Satellite TV Systems
6911 Eastside Road
Redding, CA 96001

Regency Electronics
7707 Records St.
Indianapolis, IN 46226

R. L. Drake Company
540 Richard St.
Miamisburg, OH 45342

Saga Trading
8950 Villa LaJolla Drive
Suite 1200
LaJolla, CA 92037

Satellite Sales
688D Alpha Drive
Cleveland, OH 44143

Solar Electronics
156 Drakes Lane
Summertown, TN 38483

Tele-Star Satellite Communications
67-05 Main St.
Flushing, NY 11367

Total Television, Corporate
17537 N. Umpqua Hiway
Roseburg, OR 97470

Triton Marketing Corporation
679 Remsen Ave.
Brooklyn, NY 11236

Winegard Satellite Systems
Winegard Company
3000 Kirkwood St.
Burlington, IA 52601

SPACE
(The Society for Private and
Commercial Earth Stations)
1920 N St. N.W.
Suite 510
Washington, DC 20036

THINKING TVRO?

Take A Look At Winegard!



Excellent picture quality and low cost. That's what you get with Winegard's SC-5000S home satellite television system.

You'll discover that Winegard's 8-foot package incorporates all the latest in TVRO solid-state design and engineering for a dramatic difference in satellite TV reception. All the features that your customers want are there!



Why Buy Winegard Home Satellite TV Reception Products?

All Your Satellite Product Needs From One Source • Competitive Pricing • Easy to Handle, Ship and Inventory • All Satellite Products Backed By A Full-Year Warranty • Easy-To-Install • Complete And Professional Factory Support And Service • Rigid Quality Control Standards For Satellite TV Products

SC-7032S RECEIVER FEATURES:

- Rapid Scan Control
- Fine Tune
- Polarity Switch
- Channel Select Control
- Audio Tune
- Satellite Select
- Signal Strength Meter
- Remote Control Optional

SC-8009 ANTENNA FEATURES:

- 8-ft. Durable Spun Aluminum Reflector with Weather Resistant White Epoxy Finish
- Easy Handling and Shipping
- Complete Arc Coverage
- Choice of Rugged Pedestal or Post Polar Mounts
- Prime Focus Feed with Automatic Electronic Polarity Switching
- 90mph Wind Survival



WINEGARD COMPANY • 3000 KIRKWOOD STREET • BURLINGTON, IOWA 52601 • (319) 753-0121

Write for information about SASA, the professional satellite TV installers network.

Glossary

Satellite TV has generated a whole new vocabulary. Here are some of the more common terms.

Bird

Slang for a communications satellite.

DBS

Direct Broadcast Satellite. This term describes a system, expected by some to be operational within about a year, in which TV program material is broadcast directly from satellites to small antennas at the homes of individual subscribers.

Downconverter

Because the satellite signal is at microwave frequencies, it is necessary to convert the signal down to standard TV frequencies. This is the job of the downconverter.

Earth station

A facility capable of receiving and displaying on a TV set TV signals from a communications satellite. This consists of the antenna, LNA, downconverter and all equipment used to support and aim the antenna and to conduct the signal to the TV set.

Feedhorn

The satellite signal is at microwave frequencies. The element at the focus of the antenna that captures and conducts the signal to the LNA is a microwave waveguide roughly in the shape of a horn.

Footprint

The area on the earth's surface over which the satellite signal may be received.

Geosynchronous

(Or Geostationary) This term describes a satellite orbit that is at a precise altitude and speed above the equator, so that the speed of revolution about the earth matches the earth's speed of rotation. The satellite thus appears to be fixed over a point on the earth's surface.

LNA

Low-Noise Amplifier. This is a component of both TVRO and DBS systems used to boost the extremely small signal reaching the feedhorn of the antenna to a level usable by the home TV system. The amplifier itself must have low-noise characteristics in order not to obscure this small signal it is amplifying.

Scrambling

A method of garbling the broadcast signal so that only TV systems equipped with a "descrambler" will be able to receive the signal. HBO and Showtime have announced their intention to scramble their signals so that TVRO owners will not be able to receive them.

TVRO

Television Receive Only. This is a term used to designate satellite earth stations that are capable of receiving but not transmitting TV signals from communications satellites. These stations may be commercial equipment or home receiving equipment.

Transponder

The component of a satellite that receives the signal originated on earth, translates it to a lower frequency and retransmits it back down to earth stations.

ly available satellite TV programs are simply being relayed via satellite from the originating location to local broadcast stations or to local cable TV companies. In many cases, the local entity may not be airing the program at the same time they receive it, but may

Direct Broadcast Satellite (DBS)

Subscriber paid Direct Broadcast Satellite systems are expected to have these characteristics. (Information taken from a brochure published by Satellite Television Corporation).

Direct Broadcast Satellite (DBS)

Description:

- Multiple channels of pay television broadcast directly from high-power satellites to small, affordable antennas at subscribers' homes.

Market:

- Primary market is uncabled areas in both rural and urban parts of the country.
- By 1986, at least 20 million homes without access to cable television.

Satellites:

- Satellites will have high-power traveling wave tube amplifiers, many times more powerful than those of communications satellites currently in use.
- Shaped-beam antenna system concentrates the signal, further increasing the effective signal power.

Home Equipment

- Signal will be received by small, outdoor dish antennas, typically 2 to 2½ feet in diameter.
- LNA/converter affixed to dish antenna will amplify the signal and convert to an intermediate frequency.
- Indoor set-top unit with built-in descrambler can be attached to standard TV set.
- Each indoor unit will be individually addressable from a central computer.

Programming:

- Broad range of entertainment and information programming including movies, sports, educational, children's, theater and special interest.
- System will be capable of providing special shows on a pay-per-view basis.

Subscriber Cost:

- \$100 installation.
- About \$20 per month for the basic program service.
- Home equipment (dish antenna, LNA/converter, indoor unit) can be leased for \$10-15 per month or purchased for several hundred dollars.

be taping it for later playback.

Because it is not possible for the satellite transmission to be selective, anyone with the proper receiving equipment—antenna, tuner and amplifier—in the path of the satellite's transmission is able to intercept the program. That's what TVRO (Television Receive Only) is all about. DBS (Direct Broadcast Satellite) on the other hand, is specifically designed to provide TV programming directly to individual homes through signals transmitted by satellites. DBS will be either commercial sponsor supported or a pay-type arrangement, requiring a monthly subscription fee to receive continued service.

Satellite Television Corporation (STC), a COMSAT subsidiary, for example, has plans to begin offering, in the fall of 1984, a 5-channel pay-TV service to the northeastern United States. This initial service area will extend from Norfolk, VA, north to Burlington, VT, and west to Pittsburgh. There are about 20 million TV households in that area, five million of which do not have access to cable TV. Several major cities will be within the coverage area, including New York, Boston, Philadelphia, Baltimore, Washington and Richmond. STC plans to expand their system in 1988 with the launch of high-power DBS satellites now under construction. At that time, a 6-channel pay-TV service will be offered to the entire eastern half of the country.

DBS still up in the air

An article in the Sept. 22, 1983 issue of *Electronic Media* reported on a recent industry seminar on CBS: *DBS III*. According to that article, "most experts say the industry is still very tentative." There are a number of factors still posing impediments to DBS: financing, programming, and satellite and earth station equipment.

Because the technologies of satellite TV and its applications are so new and will be changing rapidly, *ES&T* will be providing continuing coverage of developments in the coming months. We hope that the partial listing of TVRO equipment suppliers, the vocabulary and the description of DBS accompanying this article are of value.

ES&T

We've got some great names up our sleeve.



CONSUMER
ELECTRONICS
CORP.

PRODUCT SERVICES OPERATION



**MAGNAVOX
ODYSSEY
PHILCO
SYLVANIA**

AUDIO • VIDEO

A North American Philips Company

SUCCESSFUL SERVICE SLEETS

The Product Service Operation—always ready to support the brands with factory authorized parts, training seminars, technical materials and everything in-between.

N.A.P. Service Parts supports servicers thru a nationwide network of regional parts depots and local parts distributors.

N.A.P. Field Services supports servicers with specialized training, consumer affairs, and field engineers.

N.A.P. Technical Services provides technical training programs, service manuals, schematics and technical service tips.

N.A.P. Product Services
P.O. Box 555, Dept. 741
Jefferson City, TN 37760

1-615-475-3801, Ext. 7348

Circle (11) on Reply Card

Test your electronic knowledge

By Sam Wilson, ISCET test director

These questions are similar to questions used on the various CET tests. All questions on the actual CET test are multiple choice, and a grade of 75% or better is required for passing. These questions are related to the Associate-level test section of questions on power supply. The answers are on page 56.

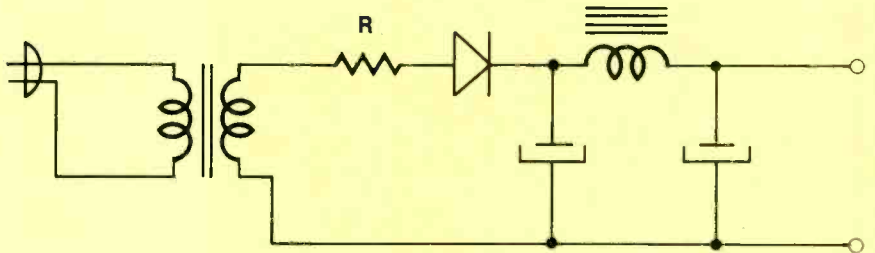
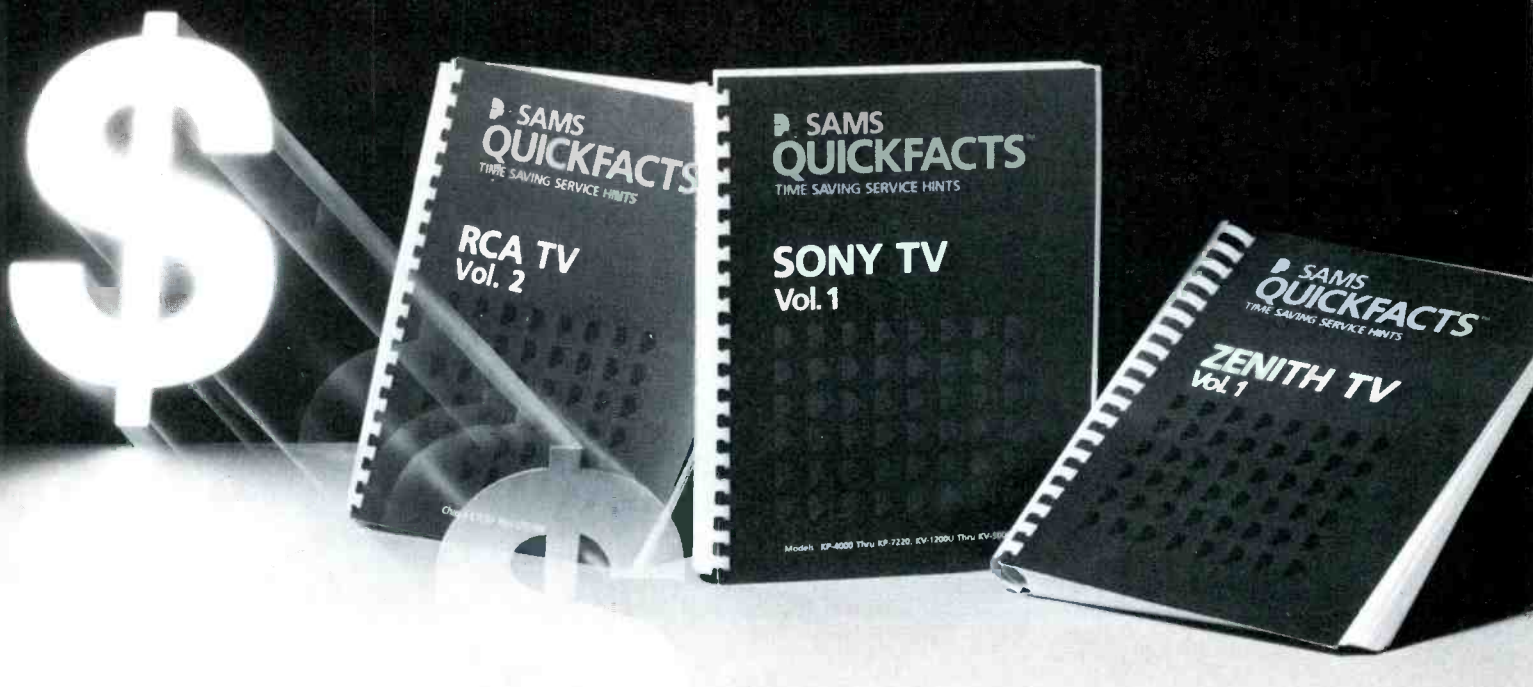

Figure 1

1. A power supply that changes dc to ac is called
 - A. an inverter
 - B. a converter
 - C. a rectifier
 - D. a crowbar.
2. The power that *appears* to be dissipated by an inductor in an ac resistor-inductor circuit is measured in
 - A. volt-amperes
 - B. watts
 - C. RELS
 - D. VARS.
3. A measure of the ease with which ac current can flow through an inductor is called
 - A. admittance
 - B. susceptance
 - C. conductance
 - D. reactance.
4. *Laminated iron* is used for power transformer cores to
 - A. reduce hysteresis loss
 - B. reduce eddy current loss
 - C. reduce copper loss
 - D. All of the above.
5. A Faraday shield is used in a power transformer to
 - A. prevent (or reduce) electrostatic coupling between the primary and secondary windings.
 - B. prevent (or reduce) electromagnetic coupling between the primary and secondary windings.
 - C. prevent (or reduce) any coupling between secondary windings.
 - D. None of the above.
6. Which of the following is a name used as a protective circuit in a power supply?
 - A. Sledge hammer
 - B. Trip hammer
 - C. Screwdriver
 - D. Crowbar.
7. Which of the following rectifier circuits cannot have a ground (or common) that is connected to the ground (or common) of the input power source? (Assume that only transformerless supplies are under discussion.)
 - A. Half-wave rectifier
 - B. Half-wave doubler
 - C. Full-wave doubler
 - D. All of the above.
8. A high-voltage supply is used to accelerate electrons as they move from the cathode to the screen. At the same time, a sawtooth waveform is used to produce a horizontal sweep. If there is a sudden 25% drop in the high voltage, the sweep width will
 - A. increase
 - B. decrease.
9. Which of the following might be used as a series-pass circuit in a voltage regulator?
 - A. Indianapolis
 - B. Darlington
 - C. Totem pole
 - D. 741 OP AMP.
10. Which of the following best describes the purpose of R in the circuit of Figure 1?
 - A. Regulation
 - B. Constant current
 - C. Parasitic suppression
 - D. Surge limiting.

ES&T



MAKE A FAST BUCK WITH QUICKFACTS™

Now for a limited time, you can take an additional \$5.00 off the already-reduced prices on Sams QUICKFACTS™!

Sams QUICKFACTS is the only PHOTOFACT®-based, quick and easy, one-stop reference to TV service repair. It provides you 1,500 money-making, time-saving tips on repairing the major TV brands, including:

circuit category, making it easy to identify problem component areas. In addition, detailed schematics help you quickly locate and replace defective parts. You work faster and more effectively. And that means improved service for your customers and greater profits for you.

TWO WAYS TO SAVE

Get \$5.00 off the already-reduced price on Sams QUICKFACTS by simply cutting out the certificate below and presenting it to your local Sams distributor. If you don't have a Sams distributor, order direct and mail Sams the form provided. Order as many QUICKFACTS volumes as you like but limit one coupon per customer, please.

Save big on Sams QUICKFACTS today and start making the big bucks in TV servicing!



**SAMS
BOOKS AND
SOFTWARE**

Trade Name	Volume No.	Price
Zenith	5900	\$34.95
Magnavox	5901	\$34.95
RCA, Vol. 1	5902	\$39.95
RCA, Vol. 2	5903	\$39.95
General Electric	5904	\$39.95
Sears	5905	\$39.95
Sylvania	5906	\$39.95
Sony	5907	\$39.95
J.C. Penney, Vol. 1	5908	\$39.95
J.C. Penney, Vol. 2	5909	\$39.95
Philco	5910	\$34.95
Admiral	5911	\$34.95
Quasar	5912	\$34.95
Panasonic	5913	\$34.95

Each QUICKFACTS volume covers a single brand name with all chassis numbers organized by

\$5.00 OFF

ANY SAMS QUICKFACTS VOLUME.

(Limit one coupon per customer. Non-transferrable. May not be duplicated. Not valid after 2/29/84.)

ATTENTION: DISTRIBUTOR

Return to Howard W. Sams & Co., Inc. for credit.

MAIL TO: HOWARD W. SAMS & CO., INC., 4300 West 62nd Street, P.O. Box 7092, Indianapolis, IN 46206

Please send me the following QUICKFACTS:

Quantity	Volume No.	Price	Total	SHIP TO:
_____	_____	_____	_____	Account No. _____
_____	_____	_____	_____	Expiration Date _____
_____	_____	_____	_____	Name (print) _____
_____	_____	_____	_____	Signature _____
Subtotal _____				Address _____
Subtract \$5.00 times Qty. of books _____				City _____ State _____ Zip _____
Add Local Sales Tax Where Applicable _____				Call 800-428-3696 or 317-298-5566 for the name of your local Sams distributor or to order by phone. Ask for Operator 466.
Add Shipping and Handling 2.00 _____				
Total Amount of Order _____				

Payment Enclosed: Check Money Order
 VISA MasterCard

Offer good in USA only and expires 2/29/84. Prices subject to change without notice.

AD466

QUICKFACTS and PHOTOFACT are trademarks of Howard W. Sams & Co., Inc.

Circle (12) on Reply Card

Audiocassette recorder adjustment

By Kirk Vistain

One of the more common items seen on the audio servicing bench is the cassette recorder. Most repairs are garden-variety clean and lube routines, or the occasional replacement of a bad Dolby Noise Reduction IC. Occasionally, a head must be changed or internal controls readjusted to get the machine back up to its operating potential. This article will discuss these adjustments.

A generalized approach is most appropriate because the devices and circuits of different brand names are similar and the basic concept is applicable to a wide range of models.

Typical cassette recorder adjustments can be summarized as:

Mechanical

- A. Head Height and Azimuth (AZ)
- B. Takeup Tension (TU)
- C. Pinch-Roller Pressure (PR)

Electronic

- A. Playback Level Calibration (PBLEV)
- B. Playback Equalization (PBEQ)
- C. Bias Trap (BTRAP)
- D. Bias Adjustment (BIAS)
- E. Record Level (RECLEV)
- F. Record Equalization (RECEQ)

Required equipment

The following pieces of test equipment are needed:

1. Sine or function generator with a minimum flat output range from 20Hz-20kHz, and THD of 1% or better. A swept-function generator would be ideal.

2. ac millivoltmeter (MVM) with response from 15Hz-100kHz, and a sensitivity of 3mV or better. A 2-channel meter is helpful.

3. 15MHz or better oscilloscope. Dual-channel, triggered, is preferred.

4. Wow and flutter meter, with drift function. If this is unavailable, a frequency counter will serve for speed tests.

5. Stereo receiver and speakers to aurally monitor the tape.

6. THD meter, not necessary, but convenient.

7. The usual hand tools, multimeter, etc.

Accessories

1. Test Tapes (See Chart 1, p. 25)
 - a. Azimuth
 - b. Frequency response
 - c. Flutter (3kHz)
 - d. Playback ("Dolby") level
 - e. Blank tape; either what the manufacturer recommends for the machine, or the type for which the customer wants his deck adjusted.
2. Mechanical appliances (See Chart 1)
 - a. Torque gauge
 - b. Mirror or "viewer" cassette
 - c. Pinch-roller pressure gauge
 - d. Non-magnetized miniature tools for head adjustment.

It is an advantage to have a

swept-function generator for frequency response alignment, particularly on 2-head decks, the most common type. The only real problem is a lack of markers to indicate the frequency at any particular point in the sweep. An inexpensive and useful marker adder for this application can be built for less than \$25. Plans for the device appeared in the May 1982 issue of *The Audio Amateur*, P.O. Box 576, Peterborough, NH 03458.

A regular non-swept function or sine generator can be used. The procedure then is somewhat slower, because only one frequency can be recorded at a time. More rewinding and playing back is required.

A mirror cassette is handy for viewing the actual movement of the tape past the heads and through the pinch-roller/capstan drive mechanism to verify tape handling. A good substitute can be made out of a normal cassette. Get a good quality C-90 tape and cut out plastic above the head and capstan openings. Figure 1 shows a prepared cassette.

Do not scrimp on this tape just because you are going to cut it up. Cheap cassettes can give false indications. A Maxell UD series, or TDK type AD works well. Not having a mirror in it will reduce its utility some, but this is offset by the fact that you are using the same kind of tape the customer does. The Nortronics AT200 is a good overall test cassette that combines test tones for level set,

frequency response, azimuth, wow and flutter, and a calibration curve.

A separate Dolby level tape is a good investment. The 400Hz Dolby tone is much more rugged than the high frequencies used for azimuth and frequency response tests.

Another option is to buy a set of test cassettes from one of the recorder manufacturers. This ensures that you will be able to adjust that manufacturer's decks according to his procedures. However, it can be expensive and cumbersome because separate tapes are usually specified for each test. Frequency response calibration for these tapes is seldom available.

The reference level on the Nortronics AT200 is 250nWb/M, which is also Dolby reference.

Some manufacturers specify their own special reference. Pioneer, for example, uses a level of 160nWb/M for calibrating its latest decks. To further the confusion, manufacturers calibrate the meters differently as well. Some meters will read zero when the Dolby tone is played, others are designed to read +3. Variations occur even among different models of the same model line. There is a generalized method that serves for most situations that will be covered later.

Adjustment sequence

A 2-head machine is a common type of deck that uses the same head for recording and playback. Much of the electronics also serves a dual function. Its primary advantage is that it is less expensive than a 3-head machine, which has separate record and play heads (often enclosed in a common housing) and separate record and playback amplifiers.

Its disadvantages are theoretically poorer performance because the head design must be a compromise between the needs of recording and playback, and the inability to monitor the tape during the recording process. This requires that you rewind the cassette

and play it back to determine the results of the recording.

Many people erroneously believe that the output of the cassette recorder during recording is from the tape. It isn't, unless the machine has three heads, and the monitor switch is set for tape. Otherwise, all you are hearing is a signal picked off the record amplifier before the circuitry that drives the head.

A special (and failure-prone) multipole slide switch takes the responsibility for switching the circuitry for the selected function. Three-head machines have totally separate playback and record amplifiers so both functions can be performed simultaneously.

Because the cassette recorder is composed of several interdependent systems, adjustments should

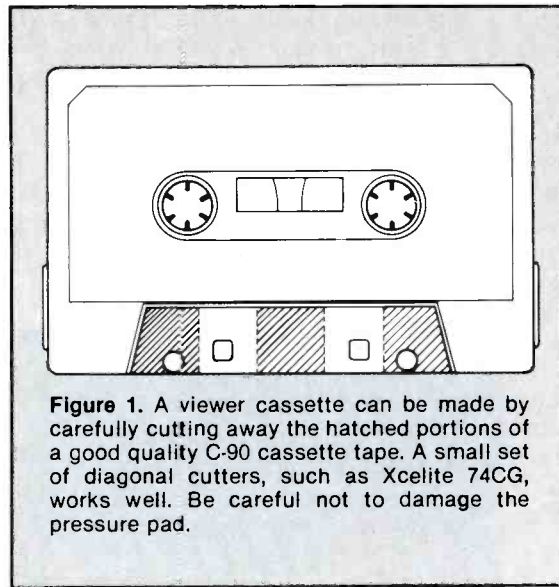

Figure 1. A viewer cassette can be made by carefully cutting away the hatched portions of a good quality C-90 cassette tape. A small set of diagonal cutters, such as Xcelite 74CG, works well. Be careful not to damage the pressure pad.

be performed in a set sequence. This is similar to the procedure used to converge a color television.

Figure 2 shows the proper sequence for a typical cassette recorder. Mechanical systems are aligned first because a misadjusted pinch roller or takeup clutch could cause the machine to "eat" a tape.

The signal circuits are aligned next. Slight touchup adjustments are sometimes required at the end of the sequence. Go back and check all previous adjustments to ensure they are still correct.

Mechanical adjustment

The wise technician will always ensure that drive surfaces are clean and all defective rubber is replaced before embarking on mechanical alignment.

Takeup-reel torque

Using a torque cassette is preferable to using a beam-type gauge. That way, torque can be tested without any significant disassembly. More important, it exercises the machine in a manner similar to the way in which it is actually used.

Sometimes, even though a good torque reading was derived using a beam-type scale, the cassette deck will malfunction when reassembled because some part of the cabinet interferes with the drives. The torque cassette avoids this.

A reasonable reading for takeup torque is 40-50g/cm (grams per centimeter). The tape will start to bunch up toward the end of play, when the reel is nearly full at much lower than this. An excessively high torque will tend to pull the tape from between the capstan and pinch roller, possibly stretching or creasing it. Cheaper machines and many car stereo cassette players are designed with a higher than optimum takeup torque. The reasoning presumably, is that wear will slowly reduce torque to an acceptable level. This is one reason why tapes are more commonly damaged in this type of equipment than in quality home cassette machines.

The actual methods of adjustment vary. Sometimes, there is no provision for changing takeup torque. All you can do is test it and replace parts if the reading is wrong. This seems to be increasingly common.

A typical adjustment scheme is shown in photos 3A and 3B. The small spring in the photo controls how hard the clutch drive pulley is pushed against the capstan belt. By varying this pressure, while monitoring with a torque cassette, the proper takeup torque can be

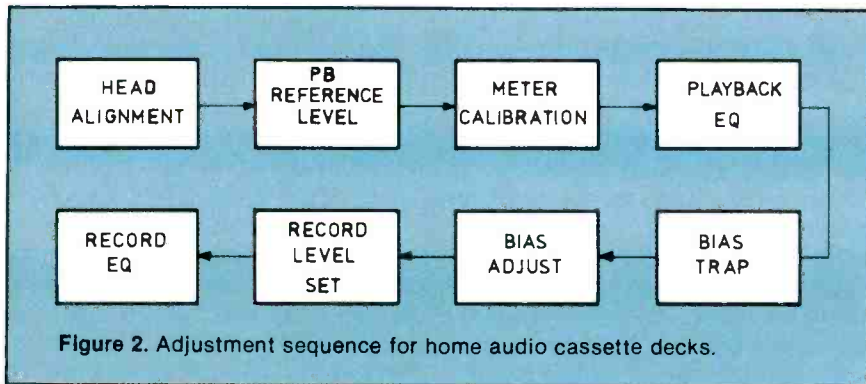

set. Some designs provide several holes in the chassis where you can secure the spring for different settings.

Pinch-roller pressure

This is the amount of force necessary to push the pinch roller out of contact with the capstan shaft. Too much or too little can cause tape skew and fouling. Fortunately, the tolerance range is rather broad.

Figure 4 shows the pinch-roller assembly of a Teac 360S. Adjustment is accomplished by bending the tab to vary the amount of spring expansion. Although the drawing does not indicate it, try to get the working end of the gauge as close as possible to the pinch-roller axle to avoid errors.

Engage the play function and push the roller assembly with the gauge until it is no longer driven by the capstan. Then allow the roller to just start turning again and take the measurement. Look for 400 to 500 grams.

Head height and azimuth

Only the most expensive decks have a head height adjustment. It is more common for the height to be fixed by a stud on the chassis. If you need to set it, use a mirror cassette to monitor tape travel while adjusting the head. The tape should pass squarely through the guides with no curling at the edges.

The purpose of the azimuth adjustment is to align the head gaps so they are perpendicular to the direction of tape travel. This ensures that high frequencies will be properly reproduced, assuming of

course, that the machine on which the tapes were recorded was properly aligned.

Before putting the test tape into the deck, be sure to clean the head(s) and demagnetize them. If the azimuth tape gets "eaten," or partially erased by residual magnetism of the play/record head, it will be useless.

A test setup is shown in Figure 5. Playing the 6.3kHz (or thereabouts) test tone, turn the azimuth screw to maximize line output as monitored on the MVM. This screw can be found on the opposite side of the head from the fixed screw.

Fine adjustment is accomplished

while viewing a Lissajous pattern on the scope (Figure 6), which monitors the phase difference between channels. Less is better. Zero degrees is the goal, but a tolerance of ± 45 degrees is more realistic.

It is important to verify that minimum phase difference and maximum output coincide. A head could be so far out of adjustment that the phase difference would be 0, but the high frequency output would be 6dB or 10dB down. It is also possible to have the high-frequency output at a maximum, but the channels 90 to 180 degrees out of phase, which produces an annoying vagueness to the stereo image.

Flip the tape over and play the other track. Compare the readings to those obtained from the first run. Large discrepancies may point to a fault in the drive system. After azimuth adjustment, use a mirror cassette to verify proper tape travel.



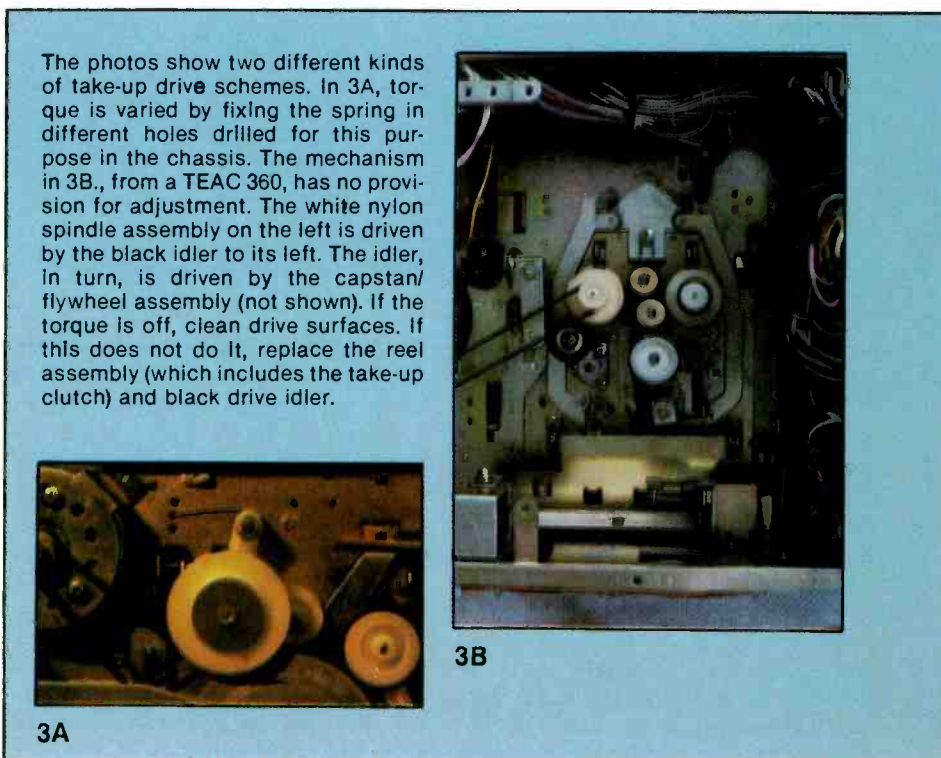

Speed and flutter

Before aligning deck electronics, be sure that it will be running at the correct speed and that the tape drive is sufficiently uniform. This

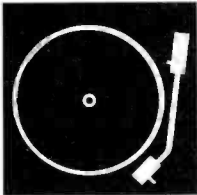

SPECIAL PUBLICATIONS NOW AVAILABLE FROM SONY!

- A collection of books on key concepts, in-depth theory of circuit operation and troubleshooting-aid for the following three categories of Sony products: AUDIO, BETAMAX, TV.
- The material is presented concisely. These books, although written for the average to advanced technicians, can be used as a self-help guide by anyone who is interested in Sony consumer products.

	MODEL & DESCRIPTION	PART NUMBER	PRICE
	TV Products		
	Alpha-1 Chassis New Circuit Operation	2CTV781-6	\$5.00
	Alpha-1 Chassis Troubleshooting Guide	2CTV1080-1	5.00
	30P Chassis New Circuit Operation	2CTV681-1	10.00
	30P Chassis Troubleshooting Guide	2CTV1181-1	7.50
	Betamax Products		
	SL-5400 System Control and Troubleshooting Guide	2BETA180-1	\$3.00
	SL-2500 New Circuit Operation	2BETA982-1	5.00
	SL-5800 New Circuit Operation	T-999-114-41	3.00
	AG-400 Auto Changer Circuit Operation	2BETA1182-1	3.00
	HVC-2000 Circuit Operation	2CC1281-3	10.00
	HVC-2400 Circuit Operation	T-999-114-31	5.00
	Trinicon Color Cameras	2CC383-1	10.00
	Audio Products		
	PS-X65, -X75 Circuit Operation and Troubleshooting Guide	2HF181-5	\$5.00
	PS-X700, -X500, -LX5 Circuit Operation and Troubleshooting Guide	2HF1282-2	5.00
	CRF-1 Theory of Operation	2HF1082-4	3.00
	STR-VX6, -VX5, -VX4, -VX3, -VX2, -VX1 Circuit Operation	2HF1181-1	5.00
	STR-V55, -V45, -V35, -V25 Circuit Operation	2HF481-2	5.00
	ST-J75 Circuit Operation and Troubleshooting Guide	2HF781-4	5.00
	RS-20 Circuit Operation	2HF782-3	3.00
	PCM-F1 Troubleshooting Guide	9-959-013-11	3.00
	CDP-101 Troubleshooting Guide	9-959-021-11	3.00
		Miscellaneous	
RF Interference Handbook		T-999-096-31	\$5.00
Digital Electronics		2G183-1	8.00
Remote Control System		2RM383-1	3.00

SONY®

TO ORDER: Send check or money order payable to "Sony Corporation of America" and mail to:
Sony National Parts Center, 8281 NW 107th Terrace, P.O. Box 20407, Kansas City, MO 64153

FOR FURTHER INFORMATION: Contact Lloyd Barningham,

Tel. (816) 891-7550

Circle (13) on Reply Card

December 1983 *Electronic Servicing & Technology* 23

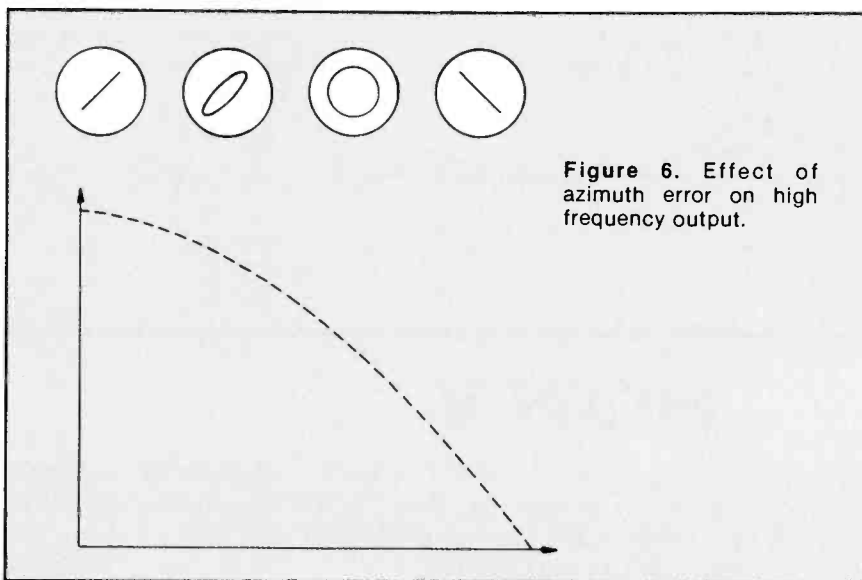
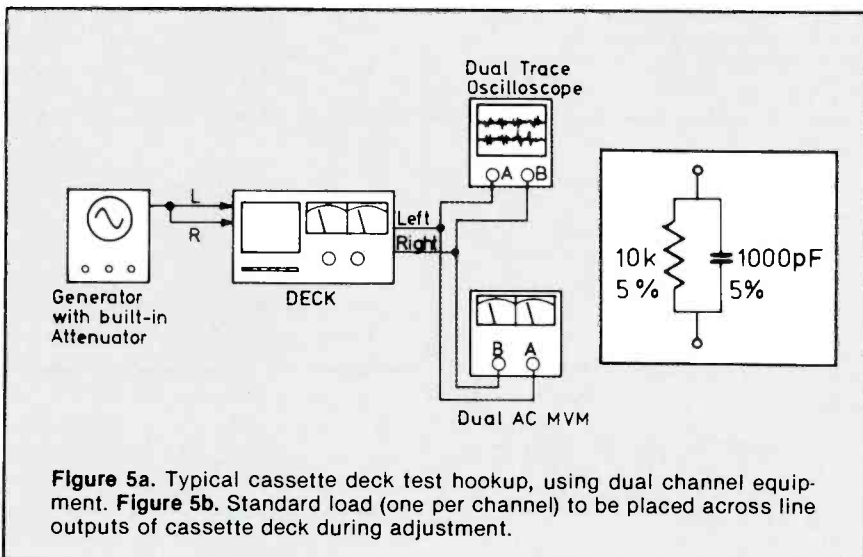
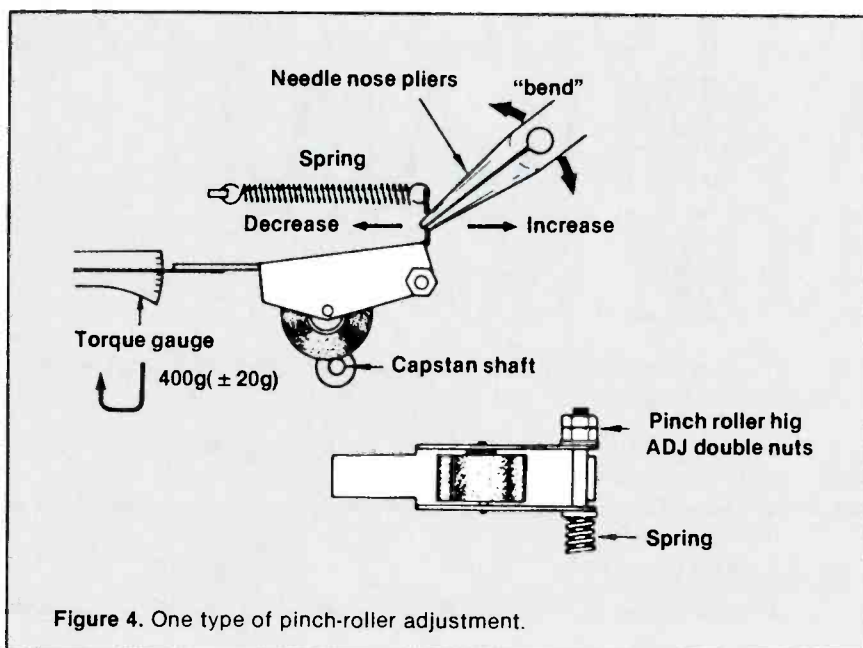

requires a flutter meter and a frequency counter, commonly combined in modern versions of this instrument. (See the December 1980 issue of *ES&T* for "Testing Wow and Flutter.") A test tape with a calibrated 3kHz sine wave is also necessary.

Better decks have a speed accuracy of $\pm 1\%$, with a combined wow and flutter reading of less than $0.12\% \text{Wrms}$. Wow and flutter $0.3\% \text{Wrms}$ is quite audible, while the best machines read as low as 0.04% . In order to adequately test the system, measurements should be made at the beginning, middle and end of the tape.

If the speed is slightly off, and the machine has a dc servo-motor, the speed-pot (internal) can be adjusted. If a hysteresis-synchronous motor is used (increasingly uncommon), speed errors may be caused by gummed bearings in either the motor or capstan, a defective drive belt, or improper pinch-roller pressure. The latter will probably also cause a poor wow and flutter reading. No adjustments are available.

The best decks use a tachogenerator regulation scheme. A small coil in the motor generates an ac signal, proportional to speed. This is compared to a reference derived from a crystal oscillator, making for good stability and negligible drift. A speed adjustment is usually available on an external board, in case a motor or crystal is replaced.

Electrical adjustments

Just as a power amplifier must be properly terminated during a test, so must the line output of a cassette recorder. IHF-A-202 specifies that a signal amplifier be loaded with a parallel combination of a $10\text{k}\Omega$ resistor and 1000pF capacitor. Both should have a 5% or better tolerance.

It is assumed that the input impedance of the meter and/or scope that you are using is at least 10 times higher than the specified load. This combination works well in most cases. If the manufacturer specifies something else, use it.

Unless otherwise stated, all adjustments are to be performed

with the recorder set for NORMAL tape, with Dolby noise reduction shut off.

Electrical adjustments are generally performed in the following order:

1. Output Level Set (OL)
2. VU Meter Calibration (METCAL)
3. Playback Frequency Response (PBEQ)
4. Bias Trap (BTRAP)
5. Bias Adjustment (BIAS)
6. Recording Level Set (RECAL)
7. Record Equalization (RECEQ)

Output level set

The first thing to be set is the output level while playing back a standard 400 or 333Hz test tone. Output level varies somewhat from machine to machine, with most units calibrated somewhere in the area of 400-500mV. Because proper Dolby noise reduction depends on this setting, and because any mistake here will compound trouble down the line, it is important to set the machine to the manufacturer's specification.

Because of the level-sensitive nature of the noise reduction circuitry, most calibration procedures call for monitoring the signal level at some point in the Dolby section. This is the typical procedure for Pioneer, TEAC, Sharp and Hitachi. Sony uses the lineout jacks as a test point.

A further complication arises because "standard" tapes are recorded with various flux levels, with each manufacturer specifying his own favorite. Conceivably, several tapes would be needed to cover all brands. Fortunately, a de facto standard does exist: Dolby level. This is a 400Hz tone recorded full track, with a flux level of 250nWb/meter.

Assuming proper calibration, a Dolby level cassette will play back at +3VU or the double-D mark on a machine's meters. It can also be used on machines specifying another reference if a correction factor is calculated.

You need to know the flux level of the specified tape, which sometimes, but not always, is given in the service manual. For example, Pioneer's current calibration level is 160nWb/m. Us-

VU vs. DB

When talking about tape decks, many people seem to toss the terms "VU" and dB" about interchangeably. Understandably a certain amount of confusion occurs.

Decibel (dB) is a term that describes ratios. For voltage, the equation is $20 \log(V1/V2)$. Most technicians are familiar with this expression. Odds are your ac voltmeter is calibrated in dBm, with 0.775V corresponding to the 0dB reference.

For steady state signals, i.e., continuous sine-waves, $1dB=1VU$. "VU" is an acronym for "volume unit." The differences between them are obvious only when metering program material, such as voice or music.

Unlike the dB meter, for which no ballistics are specified, a VU meter is designed with a defined transient response. In other words, a 300mS toneburst of 1kHz sinewaves, repeated once per second, should read the same on a true VU meter as a continuous signal of equal amplitude.

A quick study will indicate that few "VU" meters found on cassette decks meet this criterion. The term is merely a carryover from studio equipment. Headroom is restricted on cassette machines, so a faster-responding meter makes for less distorted recordings if used properly. True VU meters are too highly damped.

	Sony	Panasonic	Others
Azimuth	P-4-A81	QZZCFM	Nortronics
Frequency response	QZZCFM	AT200
Wow & flutter	WS-48	QZZCWAT	AT200
Playback level	P-4-L81	QZZCWAT	AT200
Torque cassette	CQ201B	QZZSRKCT	Hartak X-87
Mirror cassette	CQ009C	QZZCRD

Chart 1. Selected test cassettes.

ing the formula for decibel, the output should read $20 \log (160/250)$ or 4dB below Dolby level. A 200nWb/m tape, such as Sony's P4-L-81, would produce a signal at -2dB.

If you do not have a layout of what trimmer potentiometers correspond to which adjustment, a rule-of-thumb states that the pot closest to the spot where the head wires are connected to the preamp board is likely to be the PBCAL. The PBEQ is also close to this point, but because it will have little or no effect on the low frequency of the level tape, it is easy to identify. Trimmer layout of a TEAC A800 is shown in photos 7A and 7B.

Some cassette decks have an output control that varies the signal level to the final line driver, and, occasionally, the meters. This is not to be confused with the internal PBCAL, which calibrates the signal before the Dolby circuits. The output control is a user convenience. Unless stated otherwise, it should be wide open for calibration. Leave it there throughout the entire adjustment procedure.

With service data

Play back the reference level tone on the test tape and adjust PBCAL to obtain the specified signal voltage at the test point. Most cassette decks manufactured in the last 10 years are calibrated so that the meters read +3VU when the Dolby level tape is played. Many meters sport the

familiar double-D trademark at this point.

Barring a malfunction, the internal meters should read close to the Dolby level by the time you are finished with the PBCAL. If the reading is off by more than about 1dB or 2dB, go back to the service manual and ensure that you have set the level properly. If you have, proceed to METCAL.

Without service data

In the worst-case condition, with no service data, and no idea what the manufacturer specifies, there is an alternative. It assumes that the deck's meters were properly calibrated at the factory and have not been disturbed by failure or misadjustment. Further, it assumes that the deck's user output control, if it has one, does not affect the meters.

Play the Dolby level tape and adjust the PBCAL trimmers so that the internal meters read the double-D symbol. Check the line output for an interchannel deviation of 1dB or less. If you use this method, do not disturb the METCAL.

METCAL

With the level tape in the machine, set it for playback, check the output level once again, and adjust the METCAL trimpots for the Dolby mark (or other as specified by service data) on the internal meters of the tape deck. These pots may be scattered all over, so it is difficult to say where

they will be on any particular machine. You will know when you have found them because they will change the VU meters without changing the actual output level. Left and right trimmers may not always be next to each other.

PBEQ

The PBEQ trimmer matches the response of the 5% circuitry found in most home equipment, as best it can, to the standard equalization curves. (3180 and 120 microseconds for Normal, 3180 and 70 microseconds for "Chrome"). The service manual will generally contain a chart specifying performance with a particular test tape. Do not expect these specs to look as good as those quoted in the advertising, which uses *overall* frequency response. Record adjustments can be used to make this look much "better" than playback performance with a standard tape.

Some designs place the EQ trimmer in a feedback loop, which contours the high frequency response. Some others wire it up like a simple tone control at the output of the preamp stage. (See Figure 8.) However it is hooked up, the idea is to adjust it so that the flattest frequency response is obtained when the test tape is played. Performance limits are specified in the service manual. Roughly speaking, if you can get out to 6.3kHz with a variation of ± 3 dB, you are doing fine.

Best performance is obtained by compromise. Avoid over-equalizing. It is seldom a good idea to adjust for "peaky" response. This sounds more unnatural than a uniformly reduced high end. Check several high frequency points on both sides of the tape to ensure that no severe peaks or dips are apparent.

Generally, ignore the bass region when aligning a home deck. While it is true that there may be some large deviations from ideal performance below several hundred Hertz, because of contour effects and fringing as well as test tape limitations, a low frequency adjustment is seldom available. Failures do not usually manifest themselves in this region; it is of little interest to the servicer.

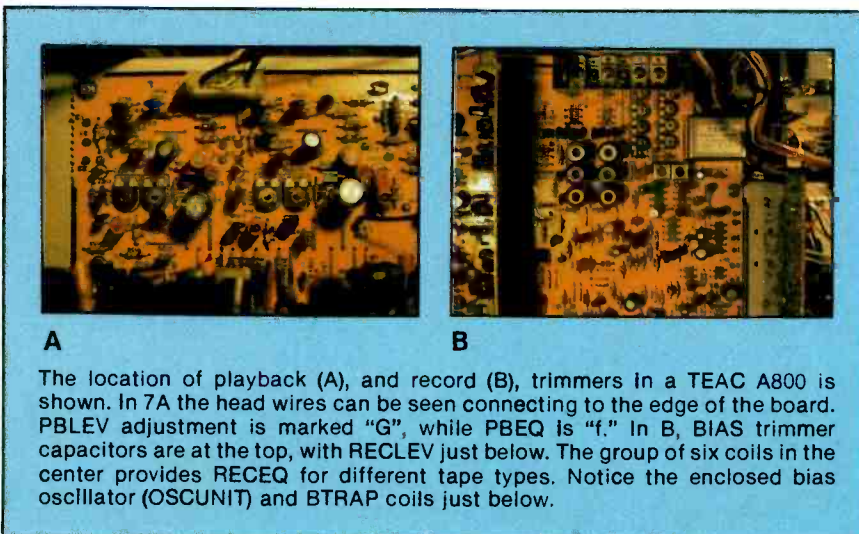

A B
The location of playback (A), and record (B), trimmers in a TEAC A800 is shown. In 7A the head wires can be seen connecting to the edge of the board. PBLEV adjustment is marked "G", while PBEQ is "f." In B, BIAS trimmer capacitors are at the top, with RECLEV just below. The group of six coils in the center provides RECEQ for different tape types. Notice the enclosed bias oscillator (OSCUNIT) and BTRAP coils just below.

OMNITRON CHRISTMAS SPECIALS

USE * NUMBERS FOR SPECIALS

Silicon H.V. Triplers HIGH VOLTAGE MULTIPLIERS

Minimum 3/may asst.

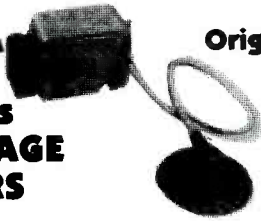

Original ECG SYLVANIA Triplers

ECG-500A ECG-523 ECG-526A

212-139	212-141	212-141-02
212-139-01	212-141-01	212-141-03
212-139-02	212-141-01	212-141-04
#ETD-20	#ETD-21	#ETD-22
\$10.99	\$10.99	\$10.99

SANYO

TOSHIBA



2SC1308K
#ETD-5B

2SC1172B
#ETD-5C

\$1.49 /50 up
\$1.99 10-49

Cordless Telephone

X-18 **\$99.95**

X-19 **\$79.95**

less intercom



- Range 600 ft. with 2-way intercom
- Both receive and send calls from remote location
- High-Low rechargeable battery indicator

Econ-O-Phone

\$12.95



X-20

- Economical desk or wall phone—2 in 1!
- Last number redial
- Mute Switch
- Works with push button and rotary systems

Jerrold 60 Channel Cordless Cable TV Converter

\$89.95 reg. \$189.95

MODEL DRX3-105



X-2100

BK PRECISION 3 1/2 Digit DMM

\$63.75

Reg. \$75.00
Model 2806

NEW!

X-25

- 0.7% DCV accuracy
- 500 hours continuous battery life
- Auto-ranging/manual ranging on Volt and Ohm scales
- 10 A AC and DC ranges
- 3 1/2 digit LCD display with annunciators
- Single rotary switch operation
- Low battery indicator
- Diode check
- Audible continuity check
- Transient and overload protected
- High energy fuse
- Ruggedized case with safety designed test lead system
- Complete with test leads, batteries, spare fuse, and instruction manual



BK PRECISION 3 1/2 Digit DMM

\$97.75

Reg. \$115.00
Model 2807

NEW!

X-26

- 0.5% DCV accuracy
- 500 hours continuous battery life
- Auto-ranging/manual ranging on Volt and Ohm scales
- 10 A AC and DC ranges
- Convenient single rotary switch function/range selector
- 3 1/2 digit LCD display with annunciators
- Low battery indicator
- Diode check
- Audible continuity check
- Transient and overload protected
- High energy fuse
- Ruggedized case with safety designed test lead system
- Complete with test leads, batteries, spare fuse, and instruction manual

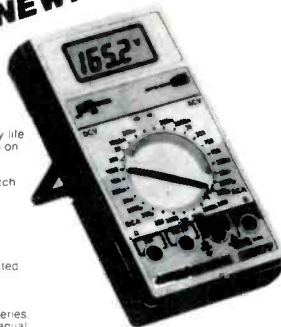

LCD 3 1/2 DIGIT DMM

\$49.95

Model 30B-150

NEW!

X-2200

- 0.5" LDC display
- DC input impedance 10MΩ
- DC 100μV, 100mA, 0.1 ohm resolution
- DCA up to 10A
- Auto polarity

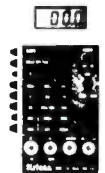

10 MHz Dual Trace Scope

\$435.00

Reg. \$545.00
Model 1476A

BK PRECISION

dual trace
10mV/div
sensitivity
video sync
separators
includes probes
X-28

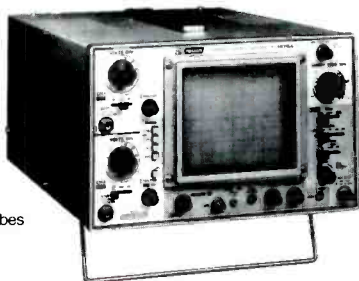

30 MHz Dual Trace Scope

\$635.00

Reg. \$795.00
Model 1479B

BK PRECISION

dual trace
5mV/div
sensitivity
10:1 reference/
direct probes
included
X-29



Weller/Xcelite Tool Kit

\$399.95

Reg. \$499.95
Model TC-100/ST

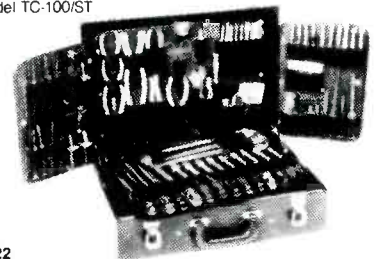

Send Purchase Order, Check, Money Order or C O D

or Call Toll Free
800-223-0826

in N.Y. State (212) 865 5580

SHIPPING CHARGES

For Orders	ADD
\$25 - 100	\$6.50
\$100 - \$500	\$8.50
\$500 - \$750	\$10.50
\$750 and up	\$15.00

MASTER CARD • VISA

Write for FREE 112 page Catalog

OMNITRON

ELECTRONICS

770 Amsterdam Ave., NY 10025

Circle (14) on Reply Card

December 1983 Electronic Servicing & Technology 27

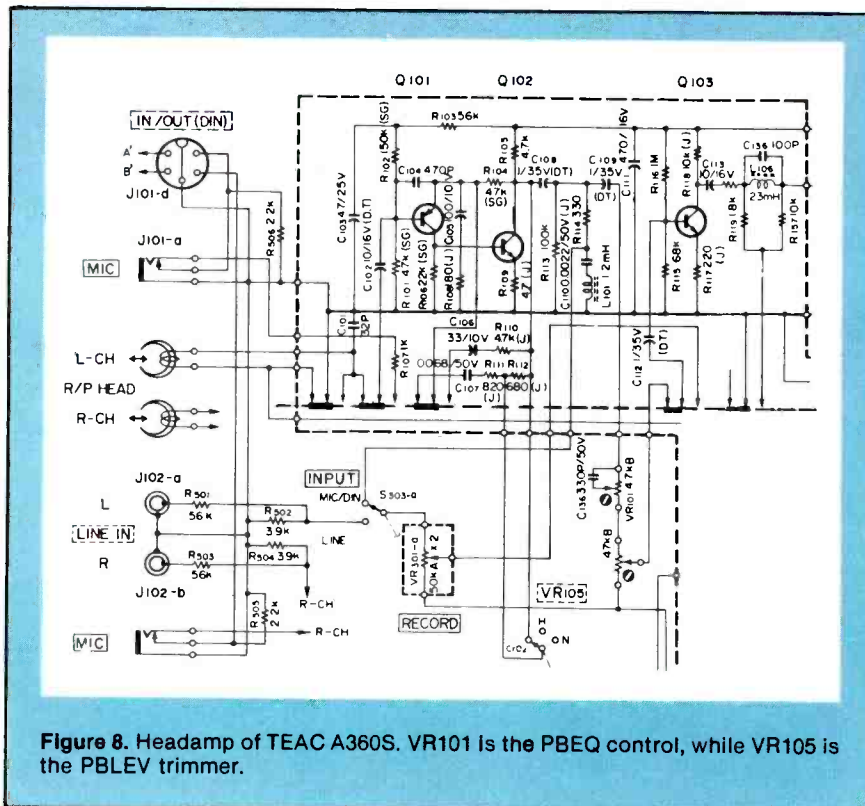

Now go back and quickly determine that none of the settings have changed. It always pays to double check when dealing with a medium so susceptible to dust and momentary dropouts. Check several high frequency points on the tape, playing back both sides of the tape, to ensure that no severe peaks or dips are apparent.

Just one more note: Depressing as it may be, test tapes are not immortal. High frequencies deteriorate with age and use. Even if you only use the tape in machines that have been conscientiously cleaned, demagnetized, and adjusted, the highest frequencies may have losses of several decibels after about 50 plays.

Buy two tapes at once, test them, and keep a record of their performance. Then put one in safekeeping and use it to periodically check the other one, which will be the working tape.

Record adjustments

It may seem inappropriate to talk of philosophy and cassette decks in the same article. All the same, there are two opposing schools of thought on the subject

of record alignment. One claims that the goal of the adjustment process is the best *overall* record/play performance. This is the procedure prescribed by the manufacturers of most home cassette decks. The other camp claims that overall response should mimic the results of *playback* with the standard test tape. This enhances interchangeability.

It's easy to understand the manufacturers' feelings on this point. Because adjustments to the recording process can help compensate for inefficiencies in playback, specifications for overall response look much better than playback only.

Audio marketing has long been a numbers game, and anyone who quoted playback specifications would invariably lose, because few machines can boast of ± 3 dB performance even out to 6.3kHz, much less the typical overall quote of 14kHz or more. Any honest audio technician who quoted the post-repair specifications on the service invoice would be in big trouble with the owner.

Adjusting for best overall response is perfectly OK, even pre-

ferable, assuming two things. First, the tapes made on the unit will normally be played back only on that unit. Second, the owner is willing to trade today's performance for the fact that the tapes he is making now will probably not sound as good when he plays them back on his next machine. His new deck will almost certainly have different performance anomalies than the one on which his earlier tapes were made, so they will not play back with the same fidelity.

Such a method presumes that the recorder is a closed system, and that maximum performance is desired within that system, even at the expense of interchangeability.

The alternative is for those who value interchangeability, such as people with several cassette machines, those engaged in studio pursuits or purists. Some other advantages accrue to this way of alignment. First, because you won't be trying to squeeze every last hertz out of the machine, bias settings can be made to favor low distortion instead of sizzling high end. Equalization will probably be milder, adding to headroom.

For anyone who does live recording, this is a great advantage. Frequency response has long been the favorite specification of ad men, but anyone who has listened critically to cassette recordings would tell you that distortion is much more annoying than a reduced high end.

How do you decide which course to take? Ask the owner. You don't have to go into every little technical detail with him. He almost certainly won't have the foggiest idea what you're talking about. But you can get a notion of what use he'll put the machine to, whether he's considering upgrading, and whether he's a casual or serious user. With this information, you are prepared to best meet your customer's needs.

Adjusting for best overall r/p performance

Although playback alignment is done with standard test tapes, record settings are made to accommodate a particular brand and type of blank tape. This may be one that the customer prefers, or

one that the manufacturer recommends for the machine. The goal of record adjustment is to get the playback of a recorded tape as close as possible to the original input signal.

Before beginning, check the bias and equalization switches on the deck. Are they set for the type of tape you'll be using? Most cassette labels are printed with the proper settings. Be sure the Dolby is off.

Adjustments for normal tape are done first. Fine tuning for any other desired type is done afterwards, so leave all switches in the normal position. Chart 2 summarizes typical tape categories.

BTRAP

In order to record with minimum distortion on magnetic tape, it is necessary to mix an ultrasonic ac

signal (bias) with the program audio as it is recorded. This bias signal is often an order of magnitude (10X) greater than the audio. Because it would interact detrimentally with noise reduction and the record amp, it is trapped out by an LC network. See Figure 9.

Values of the reactive components are chosen so that audio frequencies pass with little alteration. The trap presents a high impedance to the bias signal, which keeps it out of the circuitry "upstream."

You will probably need the service manual for this one, because it is not always obvious which of several adjustable coils is the bias trap. A quick test will tell you if all this is necessary. Put the machine into record and read the leakage on a scope or meter. It should be at

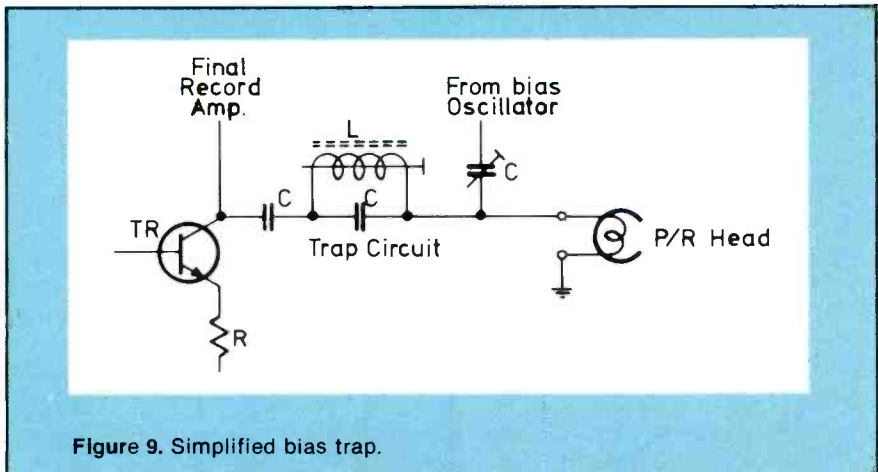

Figure 9. Simplified bias trap.

Tape type		BIAS	EQ (μs)	
Normal, Fe, Ferric	I	Low	0dB**	120
Chrome, CrO2*	II	High	2.5dB	70
Ferrichrome, FeCr	III	Low	0dB	70
Metal	IV	Very high	6dB	70

NOTES
 *Actual chromium dioxide tape is rare. This setting is used for ferric tapes designed to make the most of high bias and mild EQ.
 **These are relative figures, derived empirically.

Chart 2. Summary of cassette tape types

WESTON Auto Function Auto Ranging 3-1/2 Digit DMM

- 0.1% Accuracy
- Drop-proof—water resistant



Specifically designed for first-level field service engineers, automatically selects and measures AC or DC voltage based on input. (0.01–199.9VDC; 0.01–600VAC). Three auto-ranged resistance ranges (0.01–1999KΩ), and audible diode and continuity test. Features a fully sealed, immersible, drop-proof case and comes complete with test leads, battery, operating manual, and a leather-grained vinyl carrying case. 2-year warranty. 3.25" x 5.5" x 1.38". Weighs 12 oz. Model 7320: \$159 postpaid.

**24-Hour Delivery.
100% Satisfaction Guarantee or Full Refund**

To place your order call our HOT-LINE number 800-225-5370. In MA call 617-272-5051. Master Card, Visa and American Express accepted.

contact east
7 Cypress Drive, Burlington, MA 01803

Circle (15) on Reply Card

TOLL FREE ORDERS • 1-800-826-5432
(IN CALIFORNIA: 1-800-258-6666)

AK, HI OR INFORMATION • (213) 380-8000

5 KEY ASSEMBLY
\$1.00 EACH
CONTAINS 5 SINGLE-POLE NORMALLY OPEN SWITCHES MEASURES 3 3/4" LONG

6 KEY ASSEMBLY
\$1.25 EACH
CONTAINS 6 SINGLE-POLE NORMALLY OPEN SWITCHES MEASURES 4 1/4" LONG

120V INDICATOR
NEON INDICATOR, RATED 120 V 1/3 W. MOUNTS IN 5/16" HOLE... RED LENS.
75¢ EACH
10 FOR \$7.00
100 FOR \$65.00

SEND FOR FREE NEW LARGER 48 PAGE CATALOG

MINIATURE 6 VDC RELAY
SUPER SMALL SPDT RELAY. GOLD COBALT CONTACTS.
RATED 1 AMP AT 30 VDC. HIGHLY SENSITIVE. TTL DIRECT DRIVE POSSIBLE. OPERATES FROM 4.3 TO 6 V. COIL RES 220 OHM.
1 3/16" x 13/32" x 7/16"
AROMAT # RSD-6V
\$1.50 EACH
10 FOR \$13.50

13 VDC RELAY
CONTACT: S.P.N.C.
10 AMP @ 120 VAC
ENERGIZE COIL TO OPEN CONTACT
COIL: 13 VDC 650 OHMS
SPECIAL PRICE \$1.00 EACH

MINIATURE TOGGLE SWITCHES

ALL ARE RATED 5 AMPS @ 125 VAC

S.P.D.T. (on-on) P.C. STYLE NON-THREADED BUSHING 75¢ EACH 10 FOR \$7.00	S.P.D.T. (on-on) SOLDER LUG TERMINALS \$1.00 EACH 10 FOR \$9.00 100 FOR \$80.00	S.P.D.T. (on-off-on) SOLDER LUG TERMINALS \$1.00 EACH 10 FOR \$9.00 100 FOR \$80.00
S.P.D.T. (on-off-on) NON-THREADED BUSHING P.C. STYLE 75¢ EACH 10 FOR \$7.00	S.P.D.T. (on-on) P.C. LUGS, THREADED BUSHING \$1.00 EACH 10 FOR \$9.00 100 FOR \$80.00	D.P.D.T. (on-on) SOLDER LUG TERMINALS \$2.00 EACH 10 FOR \$19.00 100 FOR \$180.00

ALL ELECTRONICS CORP.
905 S. VERMONT • P.O. BOX 20408 • LOS ANGELES, CA 90006

• QUANTITIES LIMITED • FOREIGN ORDERS: INCLUDE SUFFICIENT SHIPPING
• USA: \$2.50 SHIPPING • CALIF. RES. ADD 6 1/2%
NO C.O.D. 100%

Circle (16) on Reply Card

least 40dB below reference level. Otherwise, adjustment is required.

Bias

This is the most critical of the record adjustments. It affects overall frequency response, level and distortion. The proper setting is a trade-off. Figure 10 demonstrates this relationship.

As bias is increased slowly from 0, output level of the recorded signal (assuming a frequency of 1kHz or less) follows. Distortion, on the other hand, begins to drop.

At a certain point, peak low frequency response will be obtained, and further increases in bias will actually reduce output. The high frequencies are more severely affected than the low ones, so slight increases in bias can significantly alter response at the high end of the spectrum without affecting the low.

Throughout this procedure, you'll follow an "adjust-record-playback" (ARP) sequence for two head machines. With a three-head deck you have the pleasure of seeing the results of your adjustments as you make them.

Rough bias

First you want to rough tune bias to just beyond the point that will produce peak output at 1kHz. Output should be about 0.5dB down at this point. I recommend feeding a signal at 0VU to the deck for this test.

It doesn't hurt to clip a scope probe across the record head to view the bias signal. That way you can determine in which direction to turn the bias trimmer. It's not always obvious. While most machines use a variable resistor for bias, some use a variable capacitor.

Bias-adjustment components are usually marked. In any case, they are relatively easy to find, since the bias oscillator is often sequestered in a corner of the main board, or on its own board, so that the slight RFI it generates does not interfere with other circuits. Following the wire from the erase head is an easy way to locate it.

When rough bias adjustment is completed, I recommend checking record level to see if you're close.

Record a 1kHz sinewave at 0VU, and play it back to be sure it is reproduced within 2dB of the input level, as measured at the deck's line output jacks or on the internal meters. If it is, proceed to fine bias adjustment. If not, go to the section RECLEV and dial it in.

Fine bias

In general, bias is set properly when the resulting frequency response curve is flattest. Adjust the generator for a 1kHz output at -20VU. This low level prevents saturation and tape overload, which could invalidate test results. Record the sinewave for several seconds, then change frequency to 10kHz, keeping generator output constant. (This is no problem with

a good generator because its output should be flat throughout the audio range.)

Rewind the tape and play back the test run. The goal is to adjust bias so that the output levels of the 1kHz and 10kHz signals are within 1dB of each other.

If the 10kHz tone is too low, reduce bias. If too high, increase it. As a rough guide, a 1dB change in bias will alter the 10kHz output the same amount, but in the opposite direction. You may have to go through the ARP routine several times to get it just right. Spot check response at 5kHz to be sure you don't have a big (>3dB) hump there. Above 10kHz, you will probably notice a dropoff in

(continued on page 52)

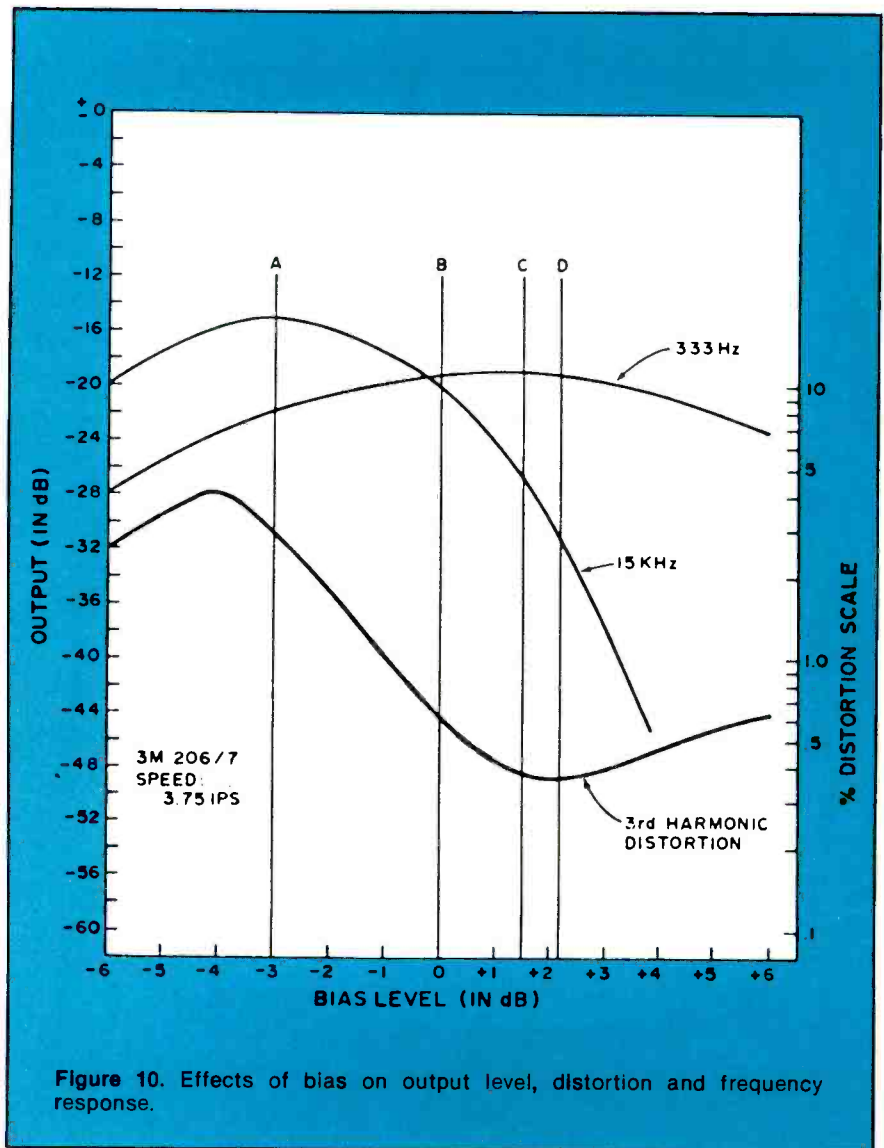
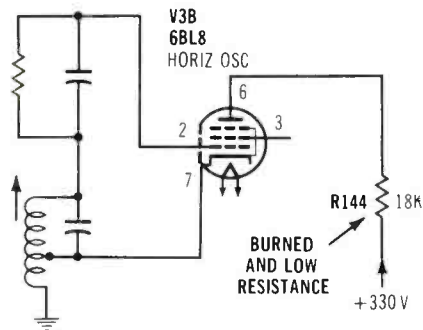

Figure 10. Effects of bias on output level, distortion and frequency response.

Chassis — Sylvania D12
PHOTOFACT — 1045-2

1



Symptom — No high voltage and insufficient drive at output tube
Cure — Check R144 plate resistor of oscillator, and replace it if the value is low

Chassis — Sylvania E21
PHOTOFACT — 1587-1

2

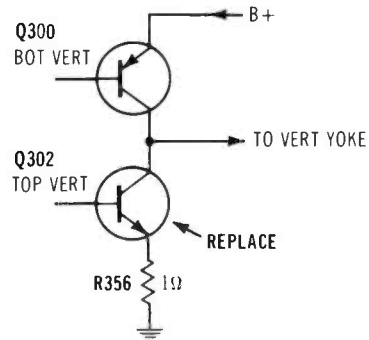

Symptom — Very little height
Cure — Test vertical-output transistor Q302 by replacing it (even if it checks okay)

Chassis — Sylvania E20
PHOTOFACT — 1595-1

3

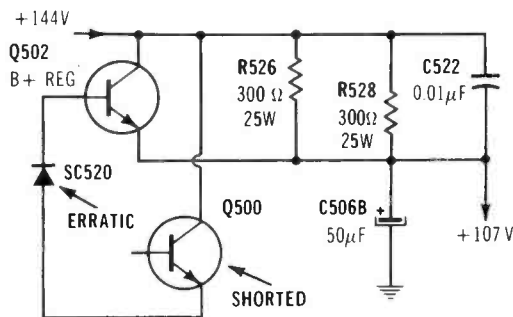

Symptom — Overloaded picture, or erratic shutdown of HV
Cure — Check Q502 and SC520, and replace if shorted or intermittent

Chassis — Sylvania
PHOTOFACT — E01 1285-3

4

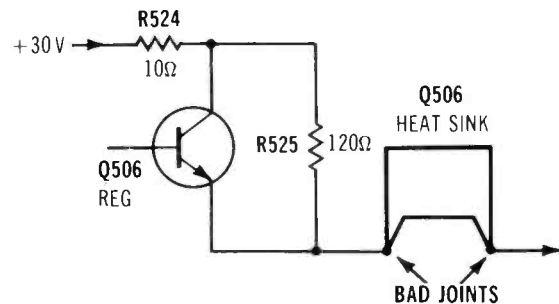

Symptom — No height, loss of +20V to vertical circuit
Cure — Check for bad soldering joints at the Q506 heat-sink lugs, and resolder if needed.

Chassis — Admiral 10M55
PHOTOFACT — 1830-1

5

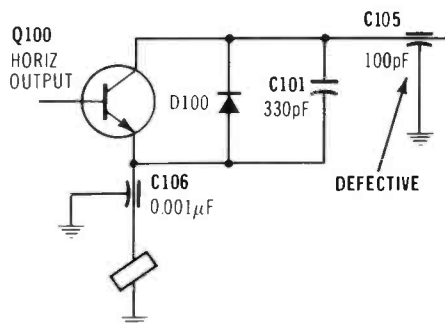

Symptom — Line fuse blows, but the Q100 horizontal-output transistor is okay
Cure — Check feedthrough capacitor C105, and replace it if shorted

Chassis — Admiral 10M55
PHOTOFACT — 1830-1

6

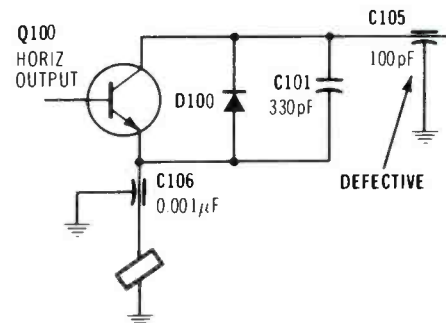

Symptom — Delayed failures of Q100 and line fuse
Cure — Check feedthrough capacitor C105, and replace it if shorted (also Q100)

Interpreting waveforms

By Carl Babcoke, CET

Square waves have been used for years to show the approximate bandwidth of an amplifier. No precise measurements can be obtained, but a glance at the scope screen enables a technician to estimate the high-frequency and low-frequency response relative to the repetition frequency. This method has value, and it will be detailed in the next article.

However, scope analysis of waveforms can provide a techni-

cian with far more than just a guess at the amplifier's frequency response. For example, if a certain waveform in a color television is supposed to be a low-amplitude rounded sawtooth, but actually shows a high-amplitude spike, what is the most likely component failure? A technician who knows how highpass and lowpass filters change a waveform will not be forced to guess at the answer.

The following examples involve various resistance/capacitance lowpass filters and show the

pulse-waveform changes that result from the filters.

Instruments and testing method

Because previous experiments I've performed suggested that a filter resistance between 10K and 20K is best for simple filters operated from audio-generator signals, I built a high-accuracy resistor. I constructed it from several resistors connected in series and parallel to form a precision 20K resistance, as measured by a Beckman DMM.

For the various capacitive values, I used an old EICO component-substitution box. Marked values around the rotary switch ranged from $0.0001\mu\text{F}$ to $0.22\mu\text{F}$. Of course, these are not exact values, so I used a B&K-Precision model 820 digital-readout capaci-

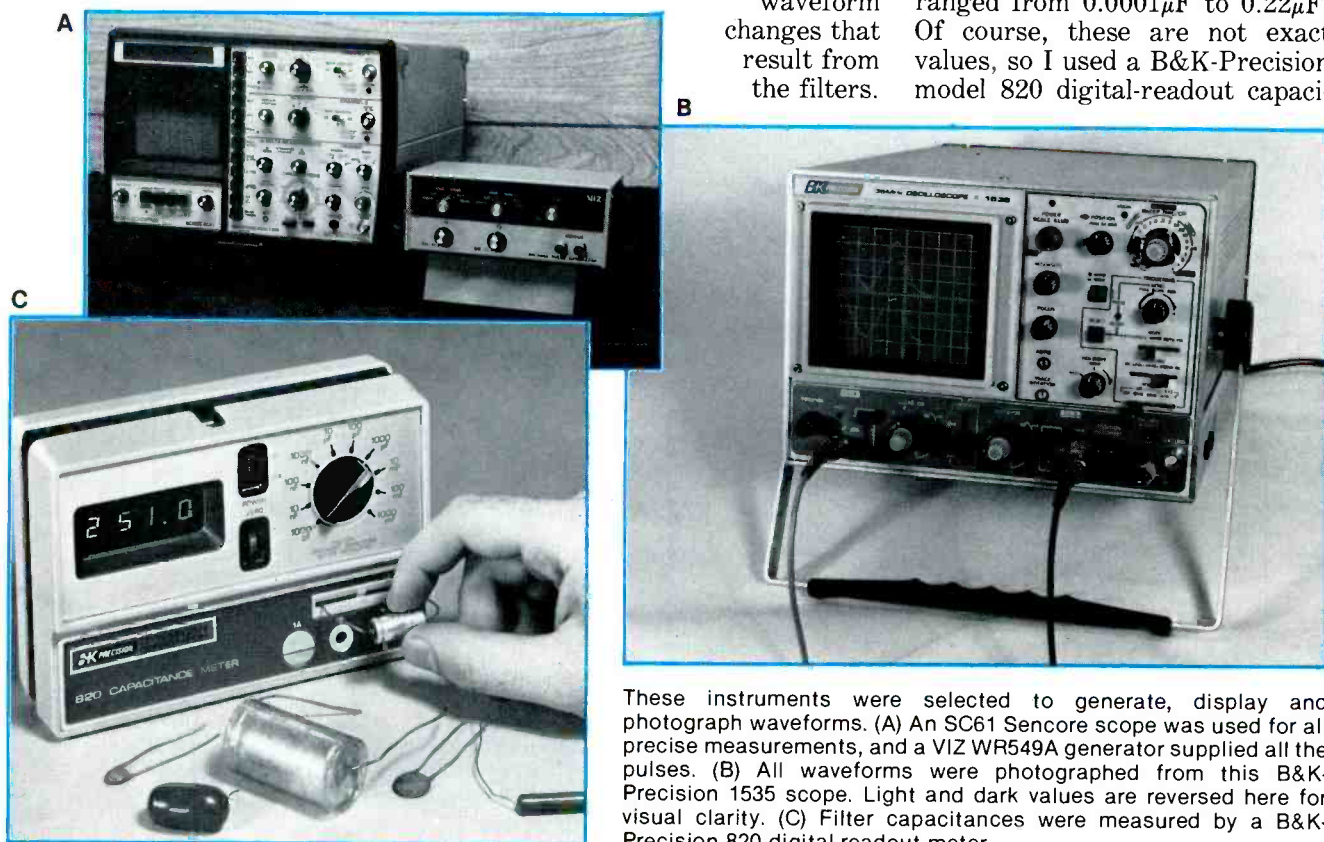

These instruments were selected to generate, display and photograph waveforms. (A) An SC61 Sencore scope was used for all precise measurements, and a VIZ WR549A generator supplied all the pulses. (B) All waveforms were photographed from this B&K-Precision 1535 scope. Light and dark values are reversed here for visual clarity. (C) Filter capacitances were measured by a B&K-Precision 820 digital-readout meter.

tance meter to test each capacitance (including that of the connecting leads), and these readings were written down for later reference. The time constant of each filter was calculated by multiplying the precision 20K resistance by the measured capacitance. In other words, only the capacitance value of the filter was varied to produce pulse-waveform changes.

All pulses were produced by a VIZ model WR-549A pulse generator (Figure 1), an excellent low-cost, small pulse generator. It can be adjusted by two switches and two rotary controls for positive or negative pulses of almost any width and repetition rate. However, there is one problem: When the switches and controls are adjusted to obtain a specific pulse width, the repetition rate changes greatly. Of course, a scope can be used to determine the rep rate: Just measure the time between the beginning of one pulse and the beginning of the next one, then divide this time into one. Unfortunately, making a dozen or more such measurements to arrive at the desired frequency can be time consuming and frustrating. A frequency counter could be used, if it can measure lower audio frequencies with good accuracy, but not all counters have that capability.

A better solution was to use a Sencore model SC61 waveform analyzer, which basically is an excellent 60MHz scope with several extra features. One valuable addition is a digital readout of dc voltages, peak-to-peak ac voltages, repetitive frequencies of any wave-shape, delta times and delta-calculated repetitive frequencies. All these measurements are made using just one scope probe (per channel), and they can be displayed on the LCD digital readout while waveforms are on the CRT screen.

Therefore, the VIZ pulse-generator output and the filter output were displayed on the dual-trace scope screen while I measured the pulse repetitive frequency simultaneously with the LCD frequency-counter mode. It was fast and simple to rotate the generator controls for the precise 200Hz rep rate with a pulse width as narrow as

possible while showing sufficient fine detail.

A 200Hz repetition rate means that each cycle requires 0.005s (5ms). Scope measurements confirmed that figure, and also showed a pulse time of 235 μ s vs. a base line time of 4765 μ s (0.004765s). Therefore, each pulse occupied less than 5% of the cycle, a fairly narrow pulse relative to typical pulses in a TV receiver.

One problem remained: The Polaroid scope camera was permanently mounted on a model 1535 B&K-Precision scope. Model 1535 has an illuminated screen for making calibrated-waveform photographs, and the screen can be removed when the grid lines are not wanted. On the other hand, the SC61 Sencore scope had an internal non-illuminated graticule that poses some photographic problems while providing good accuracy by eliminating all parallax errors.

Therefore, the SC61 was employed for all precise measurements (including those from the LCD digital readout), while the model 1535 provided waveforms for all photographs.

Pulse characteristics

Pulses are susceptible to waveform changes caused by resistances, capacitances and inductances in the circuit. Even the stray capacitances of adjacent wires or the inductance effects of bent-wire conductors can have serious effects, especially with narrow, fast-repetition pulses such as those in computers.

The choice of repetition rate and component values used in this article were chosen to minimize accidental waveform distortions caused by the wiring.

If a sinewave signal of the same repetition rate were used instead of pulses, the filter output waveform would always have a sine-wave shape, but the amplitude and phase would change according to the filter time constant.

Changing from sinewaves to pulses also requires some differences in terminology. With sinewaves, only the word *frequency* is needed to describe all attributes other than amplitude. Pulses can

be recurring regularly, but they might not. Their description must make that clear.

These terms are most often used with square waves and pulses:

- *Rise time* is the time for the leading edge (left side on a scope waveform) to move upward between 10% and 90 % of the total amplitude.
- *Duration* is the time between rise time and fall time.
- *Decay or fall time* is the time for the trailing edge (right side of pulse) to move downward between 90% and 10% of the total amplitude.
- *Pulse width* is the sum of rise time, duration and fall time.
- *Rest time* is the time between successive or adjacent pulses.
- *Pulse repetition time (PRT)* is the time between a specific point on one pulse and the corresponding point of the previous or following pulse.
- *Pulse repetition frequency (PRF)* is the number of regularly recurring pulses per second. (Note: $1/PRT = PRF$.)
- *Duty cycle* is the relationship between pulse width time and repetition time. For example, a pulse duration of 1ms and a repetition time of 10ms produces a 10% duty cycle.

Square waves and pulses can be either ac (having a positive and a negative peak) or dc (having all positive peaks or negative peaks, but not both). This will be explored later, but the location of the zero-voltage line in these pulses is not a factor.

Lowpass filters

Integration involves lowpass filters of specific characteristics. All integrators are lowpass filters, but not all lowpass filters are integrators. Therefore, these resist/capacitance filters will be called lowpass filters.

Although a lowpass filter progressively attenuates all frequencies that are higher than the cut-off point, that viewpoint will not be used here. Instead, the effects on pulse signals will be analyzed from the principles of capacitor charging and capacitor discharging. This analysis will be made

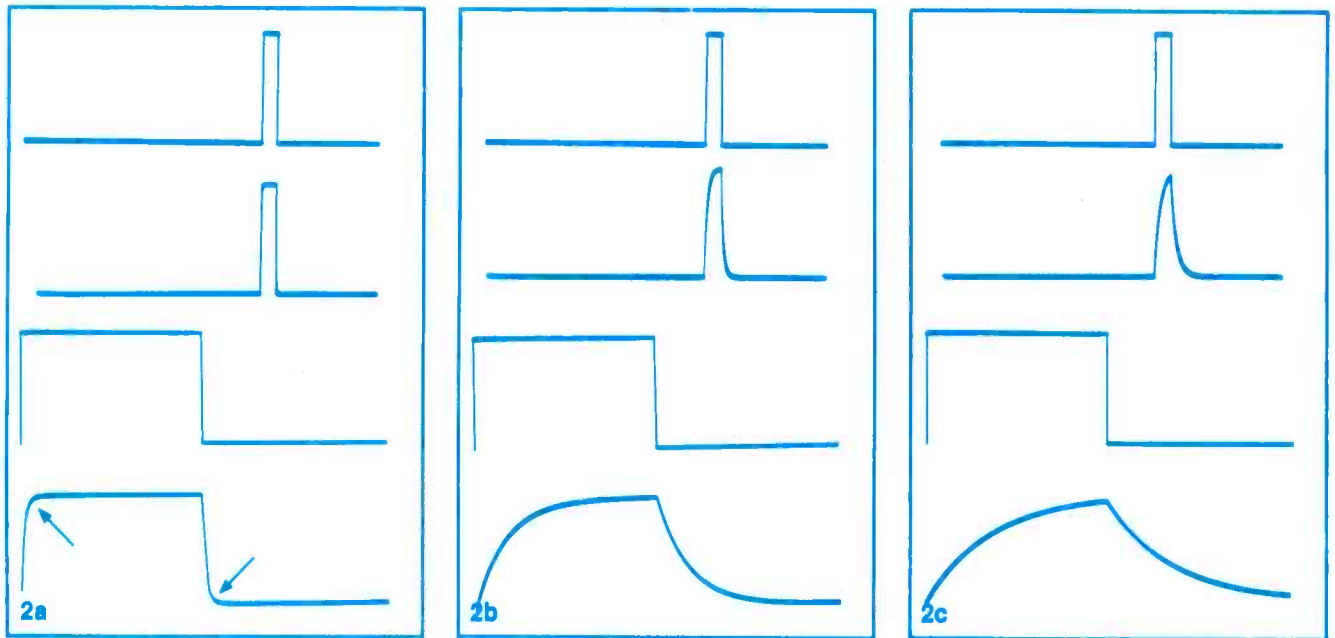

later. First it is necessary to show the progressive changes of pulse waveshapes as the capacitor value of the lowpass filter changes.

Figure 2 shows six sets of waveform photographs, with black and white values reversed for clarity. Some sets have two photographs, with the second one showing pulses expanded for clarity by the scope adjustments. Because the rapid rise and fall times cannot be photographed (they are nearly invisible because the beam moves so fast), all vertical lines have been touched up. Otherwise, no changes have been made to the waveforms. The top waveform in all cases is the generator signal at the filter's input, while the bottom waveform is the output of the filter.

The total capacitance in Figure 2a was $0.00053\mu\text{F}$, which, multiplied by the $20,000\Omega$ precision resistor, produces a time constant of $10.6\mu\text{s}$. Notice in both lower scope traces that little change has occurred. Rise and fall times were slowed enough so that part of each line was visible on the scope. Notice from the photograph of the enlarged pulses that the rising edge (near the top) and the falling edge (near the base line) have been rounded. But the rising edge near the base line and the falling edge near the pulse top are relatively unchanged. This shows where

most of the pulse degradation will occur when the time constant is increased.

In the following lowpass filter waveforms, watch the upper-left corner of each pulse for changes. Also, look for one other effect: decreases of height when longer-time-constant filters are used.

Figure 2b waveforms were produced with a capacitance of $0.00209\mu\text{F}$, which increased the filter time constant to $41.8\mu\text{s}$. Again, most changes occurred at the upper-left and lower-right corners of the filtered pulse. However, a glance at the horizontally expanded pulse shows the rising vertical line has been changed to a parabolic curve. This curve is almost identical to the classical capacitor-voltage charging curve featured in many text books. In the same way, the falling line has become a capacitor-voltage discharging curve. Very little loss of pulse height has occurred; the waveform has about 95% of the original amplitude.

Figure 2c capacitance was $0.0055\mu\text{F}$ for a time constant of $110\mu\text{s}$. This pulse has become a lopsided spike. Two corners remain sharp, although the flatter waveform tends to obscure the sharp corners. Actually, both charging and discharging curves

appear to be changing to something other than parabolic, such as straight lines. In the following waveforms, however, both remain parabolic but, as they show shorter sections of the parabola, they appear to straighten. Short sections at either end of a parabola will seem straight. Also, the rising edge has joined the falling edge below the maximum input-pulse amplitude, which has the effect of removing part of the pulse at the top. The remaining amplitude is only 88% of the original height, so about 12% has been sliced off.

Figure 2d has a longer time constant of $452\mu\text{s}$ from a capacitance of $0.0226\mu\text{F}$. The predicted trend is unmistakable now. The rising parabola is stopped while it is relatively straight. Of course, the falling curve will trace a complete parabola because five time constants (or more) elapse before the next pulse arrives. This is shown by the non-expanded curves in the top photograph. However, the rising edge clips off about 56%, leaving only 44% of the original amplitude.

Figure 2e increased the capacitance to $0.0546\mu\text{F}$ and a time constant of $1092\mu\text{s}$. The 81% decrease of amplitude (leaving only 19%) is apparent in the center scope trace, which was made at the same gain setting as the original pulse,

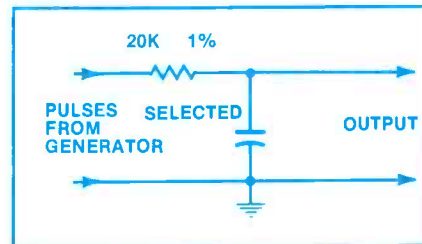
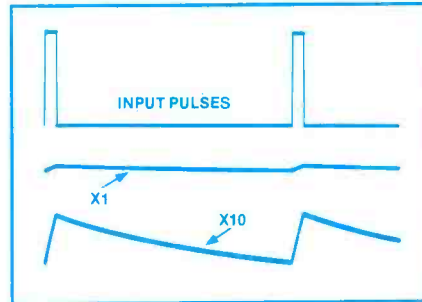
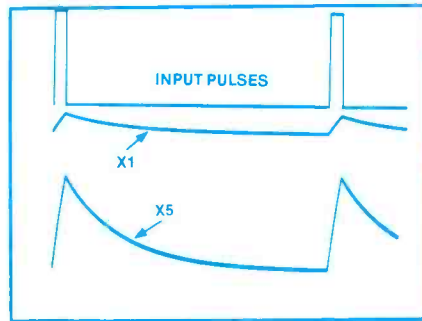
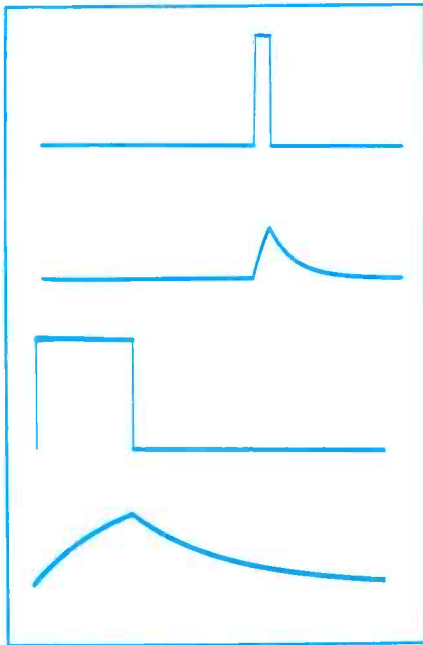

shown above it. At the bottom, the same waveshape is amplified five times to show the nearly straight rising curve. It is evident that the falling edge now is almost a straight line, and the overall shape is approaching a sawtooth.

Figure 2f shows the almost-linear sawtooth formed by a $0.2128\mu\text{F}$ and a time constant of $4256\mu\text{s}$. Obviously, a larger capacitance could produce a very linear sawtooth. Only about 5% of the amplitude remains (a loss of 95%), because that is the inevitable price paid for such high filtering, when no amplification is provided. In practical circuits, the capacitor is placed in the negative-feedback loop of an op-amp. Good linearity with straight lines can be obtained, and the op-amp gain cancels the usual filter loss.

The simple lowpass-filter schematic is shown in Figure 2g. Notice that it is similar to many RF-removal or high-frequency-decrease passive filters used in most radios and televisions. An excessive time-constant lowpass filter used in a video detector, for example, blurs the video pulses. Such excessive filtering might change sharp-cornered pulses into the rounded ones of Figures 2a or 2b.

Width of pulse

An important point about saw-

teeth produced by filtering pulses is shown in Figure 3. Superimposed on tall pulses are parabolic curves created by partial filtering (near the top) and two near-sawtooth waveforms. Notice that the pulse's vertical rise and fall lines (added later for clarity) pass exactly through the comparable points of the filtered waveforms.

In other words, the rise time of a sawtooth waveform that has been produced by heavy filtering (integration) of pulses will exactly equal the pulse width or duration. If a more-vertical rising edge (shorter rise time) is desired, the width of the initiating pulses must be narrowed (shorter duration time).

Positive or negative pulses

Figure 4 shows how sawteeth made from pulses can be inverted. The top trace illustrates sawteeth made by filtering positive-going pulses (Figure 2). Each positive pulse rapidly charges the filter's capacitor to a positive voltage, and

the positive voltage slowly discharges until replenished by the next pulse. If sufficient time is provided between pulses, the positive voltage discharges to the original zero voltage. Notice that the pulse duration equals the capacitor-charging time that forms the rising edge. The pulse and rising-edge times are the same. Negative pulses reverse this procedure. Each negative pulse

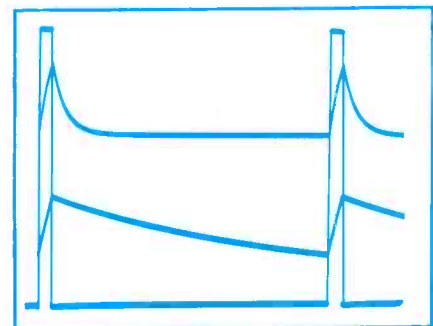

Figure 3. These two filtered waveforms are superimposed on the input pulse waveform to show that the pulse width becomes the rising edge of all waveforms produced from that pulse.

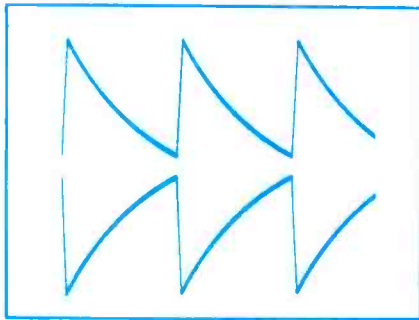

Figure 4. Positive-going pulses can be integrated to form the fast-leading-edge and slow-trailing-edge sawtooth waveform shown by the top trace. The bottom scope trace shows the fast-falling edge and the slow-rising edge of sawteeth produced by negative-going pulses.

charges the capacitor to a negative voltage. After the pulse has passed, the negative voltage slowly decreases to zero (or as near zero as the rep rate allows) before the next pulse arrives.

Of course, pulses and sawteeth can be inverted by amplification in a tube, transistor, IC or op-amp, if that is desired.

Sawteeth with pulses

In the Figure 5 schematic, a clip-lead short placed across the grounded resistor produces only sawteeth at the filter's output. If the resistor short is removed and placed across the capacitor, the output waveshape changes to pulses that are identical to the filter-input pulses except for the reduced amplitude from the voltage-divider action.

According to this experiment, the capacitor produces sawteeth and the resistor produces pulses. Therefore, both components together should provide a combination of pulses and sawteeth at the filter output. As shown by the Figure 5 waveforms, this is true.

When the resistance of the *pulse* resistor is varied, the pulse amplitude in the sawtooth/pulse output signal changes approximately in step. Doubling the resistance also doubled the pulse amplitude.

Figure 5 also shows the inverted waveforms that result from filter inputs of positive-going pulses (top trace) or negative-going pulses. Notice that the tips of all pulses have the same tilt as the leading

edges of the corresponding sawteeth. Apparently this is true because the pulses are placed on the leading edges.

Similar combinations of pulses and sawteeth were used in many older tube-equipped TV receivers to drive the vertical-output tube. A short-duration pulse of oscillator tube current produced what would have been a negative-going pulse at the plate. However, a series-connected resistor and capacitor combination (between plate and ground) change the plate waveform into sawteeth with pulses. In such circuits, the values of both components are critical if optimum results are needed.

Lowpass questions

In the Figure 2 waveforms, what factors control the amounts of pulse distortion? Two factors determine the effect of lowpass filters on narrow pulse waveforms. One is the repetition rate (held constant in this example). The other is the time constant of the filter. The time constant is the capacitance value multiplied by the resistance value. In textbooks, time constant is concerned with the charging and

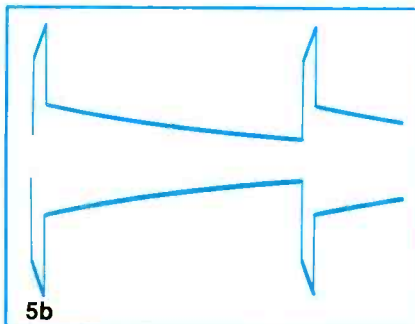
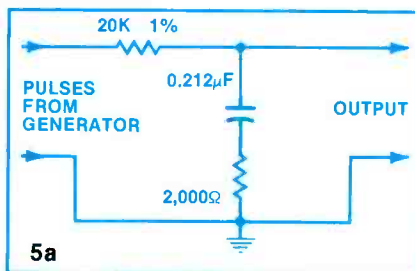

Figure 5. Adding a resistor between capacitor and ground (a) adds pulses to the sawtooth of Figure 4 (b). The amplitude of the pulses vary in step with the resistor value; a larger resistor produces higher-amplitude pulses.

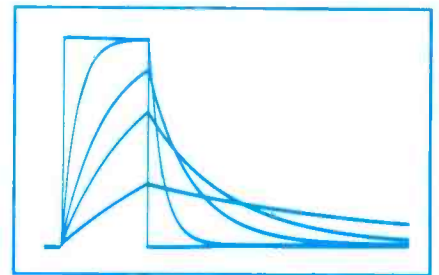

Figure 6. Four filtered waveforms superimposed on a widened pulse should make clear how the lowpass filter waveforms change with increasing time constants. From the top the time constants are approximately 1, 2.3, 10 and 92. Except for the height, the one-time-constant curve at the top is similar to the textbook drawings of a one-time-constant waveform.

discharging rates of capacitors when supplied with dc voltages through known-value resistors. After capacitor charging for one time constant, the capacitor voltage reaches 63.2% of the supply voltage. After five time constants, the capacitor voltage is nearly 100% of the supply voltage. After capacitor discharging of one time constant, the voltage falls to 36.8% of the original charged voltage, and it is considered zero after five time constants. However, in this article we are concerned primarily with pulse waveforms.

Pulse waveforms can be analyzed by capacitor charging and discharging theory if the base line is considered zero voltage and the top of the input pulse is considered supply dc voltage. Then the theoretical rules apply.

For example, a completely charged parabolic curve requires five time constants. The pulse width was $233\mu\text{s}$ for five time constants, so one-fifth of 233 (46.6) equals the time constant in microseconds. Looking back through Figure 2, we find one time constant of $41.8\mu\text{s}$ in Figure 2b. Of course, 46.6 is not precisely 41.8, but the expanded waveform appears very similar to the charge curves drawn in textbooks.

Figure 6 shows four charge curves superimposed on one expanded pulse. From top to bottom, the time constants are approximately 1, 2.3, 10 and 92. Of course, the top curve closely resembles the

textbook time-constant curve. Notice the height losses for all time constants larger than one. This illustration should help us visualize pulse changes from lowpass filters.

In Figure 2f, how are sawteeth produced from pulses? Although perfectly linear sawteeth are not shown in Figure 2f, the waveform can be used to analyze the action.

Sawteeth are produced when the pulses are filtered by a long time constant. The reason is that straight lines can be approximated from a parabola if they are taken from a very short section of the parabola. Notice in Figure 6 how the curved lines begin to straighten as the time constant becomes longer.

Another important point is that the upward slope of the filtered leading edge always has equal duration to that of the filter's input pulse.

What is the relationship between capacitor voltage and current in a lowpass filter? Figure 7 shows the input pulse and two curves expanded over 10 time constants. The capacitor voltage is the waveform at the filter's output. Capacitor current can be scoped by adding a small resistor between cap-

acitor and ground (see schematic) and connecting the scope across it. A value of 180Ω was used in this case.

Capacitor voltage and current change in opposite directions. A discharged capacitor has zero voltage and zero current. When voltage first is applied to a time constant circuit, the capacitor current is maximum (the amount depends on the resistance, the capacitance and the amount of source voltage) and the capacitor voltage is virtually zero. As the current enters the capacitor, its voltage increases. This capacitor voltage increase opposes the supply voltage, so the current decreases. Finally, the capacitor has supply voltage across it and zero current into it.

Current never flows *through* a capacitor because the dielectric prevents it. Instead, the electrical effect is as though current flows into a capacitor during charge and flows out of it during discharge. These conditions are illustrated by the scope curves of Figure 7.

Highpass filters vs. pulses

For the waveforms of Figure 8, the same components were used as in Figure 2 (lowpass filters) but rearranged as a highpass filter

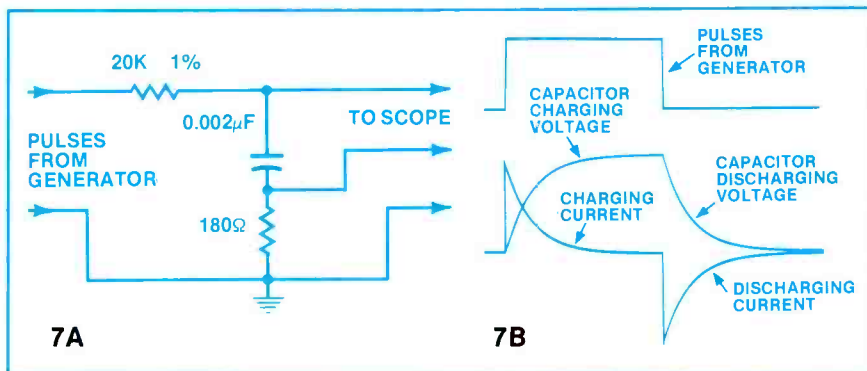

Figure 7. Capacitor charging voltage, discharging voltage, charging current and discharging current areas of the curves are identified by arrows. The time constant is about one, so 10 time constants are represented by the square wave's one cycle. Notice that the voltage curves are typical of waveforms from lowpass filters, while the current curves are typical of waveforms from highpass filters. However, *only one filter was used to make both curves simultaneously.* The current curves were obtained by adding a 180Ω resistor between capacitor and ground of the lowpass filter. Then the scope's second probe was connected to the resistor. There is a strong reason why *the lowpass-filter capacitor current and the highpass-filter output voltage waveforms are identical.* The output waveform of a highpass filter is a true (but uncalibrated) indicator of capacitor current. The current starts at zero and rapidly goes to maximum before beginning the slower parabolic curve down to zero. That initial surge of current has surprised many technicians who believe the industry half-truth that "a capacitor passes ac not dc."

(Figure 8g schematic). Again, the pulse changes will follow a pattern, if we compare the waveforms in sequence.

Figure 8a shows the 200Hz repetition rate pulses at the filter's input (top trace) and the tilting effects of the $0.2128\mu\text{F}$ input capacitor vs. the $20,000\Omega$ precision resistor (time constant of $4256\mu\text{s}$).

There is one unexpected puzzle. The rising and falling edges of the input pulses have exactly the same amplitude as the rising and falling edges of the filtered pulses. However, the peak-to-peak amplitude of the filtered pulses is slightly higher than the input pulse amplitude. The reason is the tilt of both the pulse tips and the base line, giving an amplitude increase of about 7%.

Figure 8b shows the changes made by a $0.0992\mu\text{F}$ capacitor and a time constant of $1984\mu\text{s}$. The tilt of the pulses and the base line increased the total amplitude by about 11%. A slight curvature of the entire base line can be seen.

Figure 8c shows the effects of a $0.055\mu\text{F}$ input capacitor, giving a stant. Tilts of the pulses and the base line have increased, and the overall amplitude has increased by about 21%.

Figure 8d was produced by a $0.0088\mu\text{F}$ input capacitor, giving a time constant of $176\mu\text{s}$. It now is clear that the base line has a parabolic curve, and a slight bend is visible in the pulse tips. The big surprise is the overall amplitude, which has increased by about 63%.

Figure 8e pulses were changed by a small $0.0055\mu\text{F}$ input capacitor, giving a $110\mu\text{s}$ time constant. This base line is straight except for a parabolic curve at the left, and the falling (capacitor discharging) edge of the positive pulses begins to show a parabolic shape. Also, the filter output is about 83% higher than its input.

Notice that the discharge end of the positive-going spike joins the pulse's falling edge before it reaches zero voltage. That is because the pulse width is $233\mu\text{s}$ and five times the filter time constant is $550\mu\text{s}$. Remember that five time constants are required to bring the

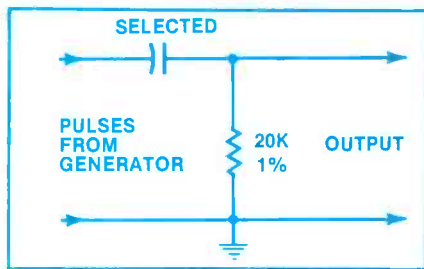
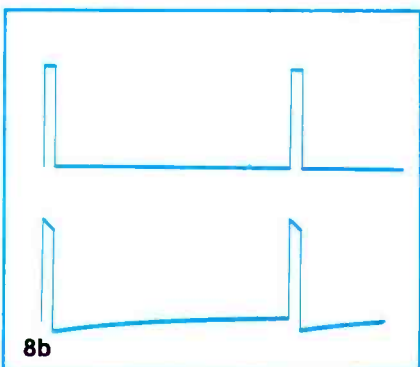
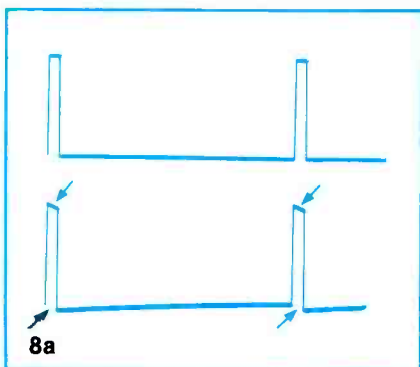

Figure 8. These waveforms show in sequence the pulse waveform changes as the highpass filter time constant is reduced in six steps. (a) A time constant of $4256\mu\text{S}$ ($0.2128\mu\text{F}$ coupling capacitor and a 20K load resistor) produces only a slight tilt of the pulse tips and the base line. (b) Decreasing the time to $1984\mu\text{S}$ increases the tilts. (c) A $1100\mu\text{S}$ time constant again increases the tip and base-line tilts. (d) A jump to $176\mu\text{S}$ time constant increases the tilts to curves. It is clear now that the base line has a parabolic curve. (e) A $110\mu\text{S}$ time constant changes the tip tilt to a partial parabola (although the pulse time ends before the curve reaches zero). And the base tilt has become a narrow (fast) leading edge and a slower parabolic trailing edge. (f) A very short $10.6\mu\text{S}$ time constant produces a positive parabola at the time of the pulse's rising edge and a similar negative parabola when the pulse's trailing edge arrives. In theory, each parabolic spike has the same amplitude as the input pulse does, but the pulse tips are so rapid they cannot be seen. Notice that lowpass filters reduce the output signal's amplitude, while highpass filters increase the output signal's total amplitude.



discharge voltage down to zero.

The schematic in Figure 8f-2 has one pulse expanded horizontally by the scope to show the symmetrical positive and negative spikes (narrow parabolic waveshapes). Previous examples did not allow sufficient time during the pulse duration for the rising edge's spike to finish its downward parabolic curve. However, the negative spike from the falling edge completed its entire parabola because this waveform occurs in the longer time between input pulses.

According to these photographs of the scope screen, the $10.6\mu\text{S}$ time constant increased the amplitude by about 59%, which is a smaller increase than obtained with the previous $176\mu\text{S}$ time constant. Actually, both are incorrect, because the scopes could not reveal the true spike amplitudes. When the scope brightness was increased to a maximum and the trace was focused sharply, very faint lines could be seen, but they were not bright enough to register on a photograph. Therefore, the correct amplitude at the Figure 8f filter's output was double (100% higher) the input pulse's amplitude.

This observation agrees with electronic theory. Regardless of the coupling capacitor's value, when the input pulse occurs, all of the voltage, initially, is across the 20K resistor. As the capacitor charges, the output voltage decreases to zero as the capacitor

voltage increases to the supply voltage. Therefore, the filter's output voltage decreases in a parabolic curve, with the time constant determining the elapsed time before the voltage reaches zero. With a $10.6\mu\text{S}$ time constant, the positive voltage reached zero long before the pulse duration was finished. There was a short length of base line before the pulse's falling edge produced a negative-going spike of amplitude equal to the previous positive-going spike. The falling edges of both positive and negative spikes traced a complete parabolic shape.

Highpass questions

Why is each pulse tip (Figure 8b) tilted down to the right? In a high-pass filter, capacitor current is at a maximum immediately after pulse occurs. Capacitor current then begins to decrease as the capacitor charges. This causes the voltage at the (output) resistor to decrease. How fast this voltage decrease occurs depends on the filter's time constant. An extremely long time constant would not decrease the voltage enough to be visible, so no tilt would be seen. A short time constant would decrease the voltage rapidly, creating an extreme tilt. When the trailing edge arrives, the capacitor current flows in the opposite direction, and again the input and output trailing edges have identical heights. Remember that the time constant must be long and the capacitor must remain uncharged if tilt is to be prevented on the flat peaks of pulses and square waves. The tilt increases in direct proportion to how much charge the capacitor

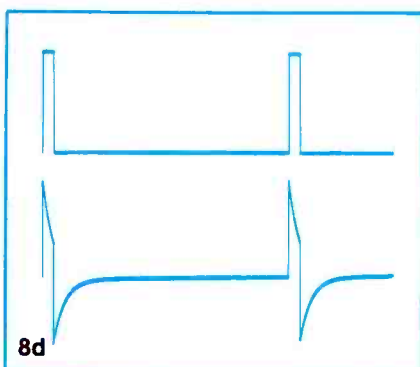
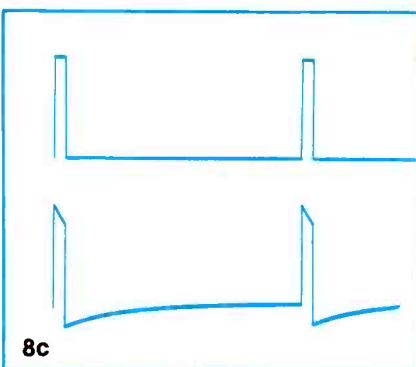

receives.

Therefore, charging of the input capacitor of a highpass filter produces a tilted output waveform.

Why is the Figure 8b base line tilted down to the left? The base line at the right of each pulse is moved lower than the rising edge's starting point because the amplitude of both rising and trailing edges must be equal. However, the trailing edge's beginning was less positive than the end of the rising edge. So adding the trailing edge's full amplitude to that beginning forces the end of the trailing edge to be negative relative to the beginning of the rising edge. Then the base line must begin from that negative point and form an inverted parabola as it rises to the zero line (Figure 9).

Why is the Figure 8b pulse tip tilted more steeply than the base line? Part of the problem is an optical illusion. The pulse tip is more narrow than the base line; therefore, any tilt is more noticeable on the tip. But a more important reason is that the pulse's total amplitude is about seven times the base-tilt amplitude.

Figure 10 illustrates the problem by displaying the same waveform at two inverted amplitudes via the dual-trace scope.

Summary

The characteristics of capacitors are responsible for the peculiar results obtained from simple high-pass and lowpass filters. A basic knowledge about capacitors comes automatically when the detailed actions of these filters vs. pulses are known completely.

When a pulse is changed to the

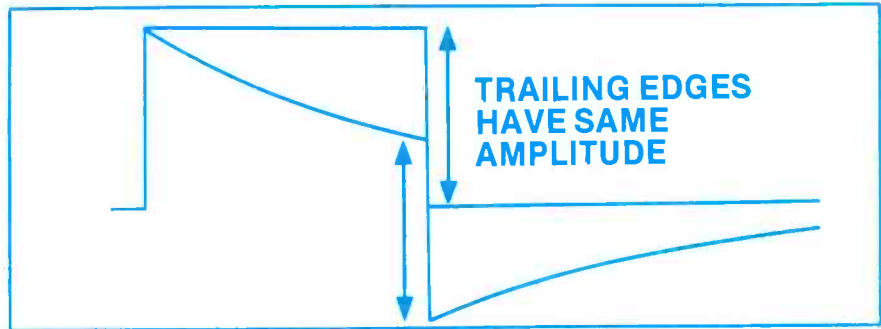
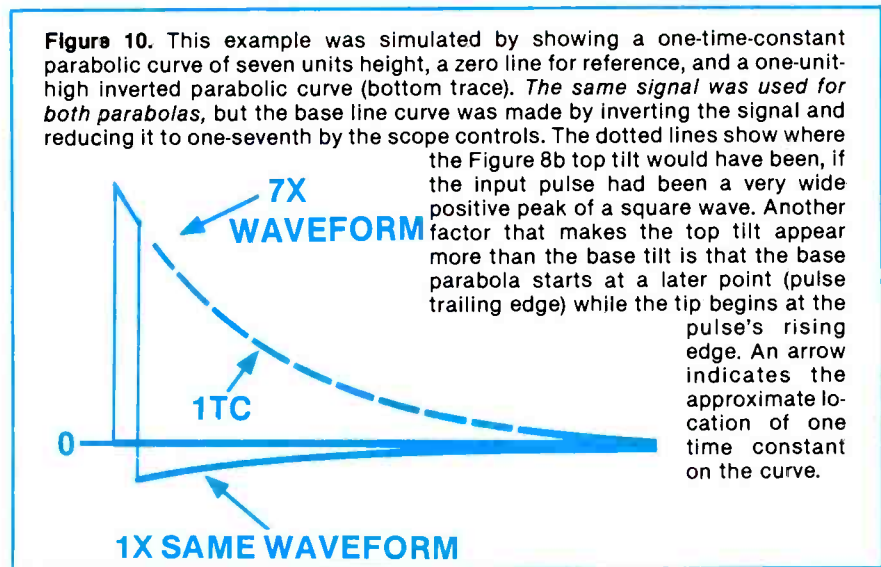

Figure 9. Tilt of the pulse's tip at the output of a highpass filter is caused by capacitor charging. The base tilt is formed by the output pulse's trailing edge, which *must* have the same height as it would without the filter. Therefore, the base line begins from a negative point and must follow the parabolic (inverted because of negative polarity) curve up to zero base line.



maximum possible by a single-section, lowpass filter, the output waveform is a linear sawtooth, having a rise time equal to the duration time of the originating pulse. Increasing the time constant produces the same sawtooth waveshape, but at a reduced amplitude.

When a pulse is changed to the

maximum by a single-section high-pass filter, the output waveform will be two parabolic pulses (one positive, one negative) located at the rising and falling edges of the originating pulse. Reducing the time constant from that value does not change the waveshape, but merely narrows the pulses.

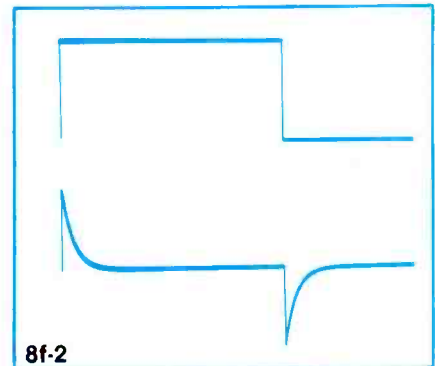
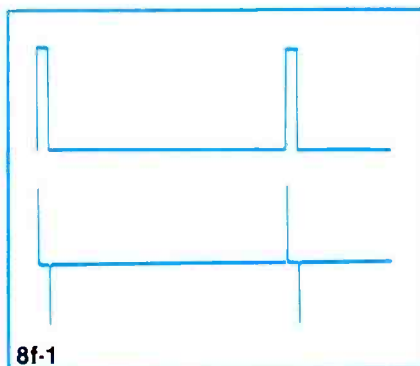
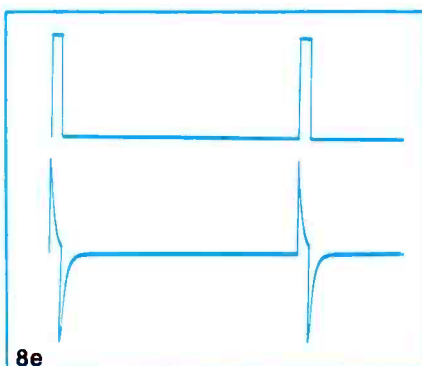

More about decibels, epsilon and radians

By Sam Wilson,
IS CET test director

Some practical problems will be worked in this article in order to extend the concepts given in previous articles. These are not necessarily problems that technicians work during their normal pursuit of a living. Instead, they are for the purpose of showing how the parameters are related.

The next subject to be covered is the reason for π appearing in so many basic equations for electricity

$$(X_c = \frac{1}{2\pi FC}, \quad X_L = 2\pi FL, \text{ etc.})$$

To begin that study, it will be necessary to discuss radians and rotating phasors.

The concept of dBm

Remember that a decibel rating is always a comparison between two values. For example, the dB gain of an amplifier is obtained by comparing the output and input power levels of that amplifier. The levels are compared by writing their ratio P_2/P_1 .

Assuming the input and output resistance values for the amplifier are NOT the same, the easiest way to find the dB gain is to start by calculating the input power (P_1) and the output power (P_2). Then, the dB gain is $10 \log (P_2/P_1)$.

Knowing the dB gain of an amplifier does not tell you anything about the input and output power. Consider these amplifiers:

Amplifier A

Input Power = 1W
Output Power = 2W
Decibel Gain = 3dB

Amplifier B

Input Power = 0.01W
Output Power = 0.02W
Decibel Gain = 3dB

Both amplifiers have the same amount of dB gain, but the actual power values of Amplifier A are 100 times greater than those of Amplifier B. A dBm rating is used to show relative values of power by using one milliwatt of power as a reference. Another way of saying this is that all dBm values are compared to one milliwatt.

A sample problem will show how the dBm rating is obtained, and how it compares with the dB gain of an amplifier. The equation for dBm is:

$$10 \log (P/0.001)$$

where P is the power in watts. A certain amplifier has an input power of 0.015W and an output power of 0.195W. Find the dB gain, and the dBm values for input and output power.

Solution

$$\text{dB gain} = 10 \log (0.195/0.015) = 11.14\text{dB}$$

$$\text{Input dBm} = 10 \log (0.015/0.001) = 11.76\text{dB}$$

$$\text{Output dBm} = 10 \log (0.195/0.001) = 22.9\text{dB}$$

The dBm unit is especially useful for measuring the output of a signal generator or function generator. In such cases, it is often necessary to maintain a constant output power when making measurements.

Capacitor Discharge

In a previous article, it was shown that epsilon (frequently written ϵ) is the base for the Napierian system of logarithms. As a general rule, logarithmic responses related to growth or decay are written with logs (or powers) of epsilon.

There is an important basic rule of logarithms. It applies to all logarithms, regardless of the base used:

$$\begin{aligned} \text{If } \log_a N = X \\ \text{then } a^X = N \\ \text{For example: } \log_{10} 2 = 0.3 \\ \text{and } 10^{0.3} = 2 \end{aligned}$$

The rule of logarithms is important because it shows that powers of a base number (such as epsilon) are simply a different way of expressing a logarithmic response.

In the last issue, the equation for the voltage across a charging capacitor was given as:

$$\begin{aligned} v_c &= V(1 - 1/\epsilon^{t/RC}) \\ \text{or} \\ v_c &= V - V/\epsilon^{t/RC} \end{aligned}$$

This is the equation for a charging capacitor, with the switch in Figure 1 at position A.

When the switch is in position B, the capacitor discharges through R. The equation for the voltage across the discharging capacitor is

$$V_c = V/\epsilon^{t/RC}$$

where V is the initial voltage across the capacitor before

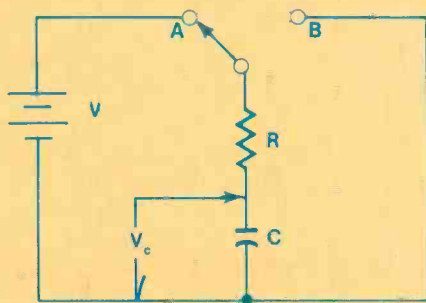

Figure 1

discharging begins, and t is the amount of time elapsed since the switch was closed.

An important special case occurs when $t = R \times C$. That makes the exponent of e equal to 1. So:

$$v_c = V/e^1$$

$$v_c = V/2.71828$$

$$v_c = 0.3678V$$

This means when $t = RC$ the voltage across the capacitor has dropped about 37% of the initial voltage. In other words, $R \times C$ equals the *time constant* that is defined as the time required for the voltage to drop to 37% of the original voltage.

The equations for the charging and discharging voltage across a capacitor make it possible to find the exact value of voltage (V_c) for any instant of time.

Here is an example:

A certain $0.5\mu F$ capacitor is charged to 70V. It is to be discharged through a 670K resistor. What will be the voltage across the capacitor 0.2 seconds after the discharge begins?

Solution

Given $t = 0.2$
 $R = 670K$
 $C = 0.5\mu F$
 $V = 70$

Find v_c .

Note that $R \times C = 670 \times 10^3 \times 0.5 \times 10^{-6} = 0.335$

so: $t/RC = 0.2/0.335 = 0.597$

Using the equation for v_c :

$v_c = V/e^{t/RC} = 70/e^{0.597} = 38.5V$

The concept of radians

To start the discussion on radians, refer to Figure 2. The circle has a radius equal to r . If you take that radius and lay it along the circumference, as shown, the arc will mark off an angle (in the center of the circle) of one radian.

If you measured along the circumference of a half circle using the radius as a unit of length as

shown in Figure 3, you would find that it will go exactly π times. (That's not surprising. The circumference of a circle is $2\pi r$. For a half circle it is $1/2 \times 2\pi r = \pi r$. If you divide a half circle by the radius you get $\pi r/r = \pi$. The result is that there are 3.14 radians (or, π radians) in a half circle.

Figure 2

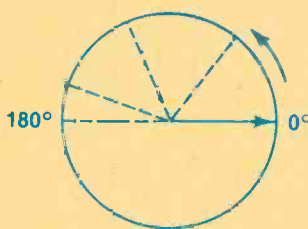
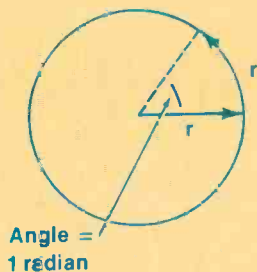

Figure 3

Keep in mind that the radian is an *angle* measurement. You can convert radians to degrees or degrees to radians using the following equations:

$$\text{Number of radians} \times 180/\pi = \text{Number of degrees}$$

$$\text{Number of degrees} \times \pi/180 = \text{Number of radians}$$

Because there are π radians in 180° , it follows that there are 2π radians in 360° . Also, one radian equals $180^\circ/\pi$, or about 57.3° .

Angular motion

There is one additional subject that must be discussed before we talk about the reason for π in so many electronics equations. That subject is angular motion.

One way to express the speed of a motor shaft is to say it turns at so many *revolutions per second* (r/s). More often, the rating used is revolutions per minute (r/min), but the standard unit of time in science is the second. So, this discussion will use r/s for a turning rate.

Suppose a shaft is turning at a rate of one revolution per second. Because one revolution is equal to 360° , or 2π radians, the speed can be given as 2π radians per second. The following equation is used to

Isolate Regulate Evaluate

New B&K-PRECISION isolated-variable AC power supplies do it all!

These new AC supplies are designed to handle a wide range of engineering and service applications. With either supply you can:

ISOLATE products under test from the power line. A *must* for safe testing of transformerless (hot chassis) equipment.

REGULATE the voltage applied to the unit under test from 0-150 VAC. Perfect for stimulating "brown-outs" or over-voltage conditions. Also essential for supplying accurate input voltage to equipment being performance tested.

EVALUATE how equipment will perform under varying input voltages. The 1655 also lets you measure power line leakage.

Model 1655 \$350.00



- Handles 3 amps continuous; 4 amps intermittent
- Built-in leakage tester for OSHA, UL, CSA tests
- Soldering iron temperature control
- Dual isolated outputs

Model 1653 \$165



- Handles 2 amps continuous
- Large calibrated dual-scale meter
- Sturdy construction
- Compact size

The 1655 and 1653 are available for immediate delivery at your local B&K-PRECISION distributor. For additional information or the name of your local distributor call

1-800-621-4627.

B&K PRECISION
DYNASCAN CORPORATION

6460 West Cortland Street
 Chicago, Illinois 60635 • 312 889-9087
 International Sales: 6460 W. Cortland St., Chicago, IL 60635
 Canadian Sales: Atlas Electronics, Ontario
 South and Central American Sales:
 Empire Exporters, Plainville, NY 11803

Circle (17) on Reply Card

convert revolutions per second to radians per second:

$$\text{Radians per second} = 2\pi \times \text{revolutions per second}$$

That equation is an important key to understanding the use of π in equations.

A phasor is an arrow that represents the magnitude and phase of a quantity. Figure 4 shows a rotating phasor that represents a sine wave. The tip of the phasor projects a sine wave on a time base.

The standard direction of a phasor is counterclockwise as shown. It takes one full rotation to make one complete cycle of sine wave. Therefore, to make a 60Hz wave, the phasor that represents the wave must rotate 60 times each second. For each rotation of the phasor, it moves through an angle of 2π radians. It follows that it makes a total of $2\pi \times 60 = 120\pi$ radians every second. So, the frequency of the wave can be called 60 cycles per second, 60Hz, or 120π radians per second.

The *angular velocity* (ω) is the number of revolutions the phasor makes each second. Think of it as the number of *radians per revolution* (2π) multiplied by the number of *revolutions per second* (f):

$$\omega = 2\pi f \text{ radians}$$

The angular velocity of a sine wave tells how many radians per

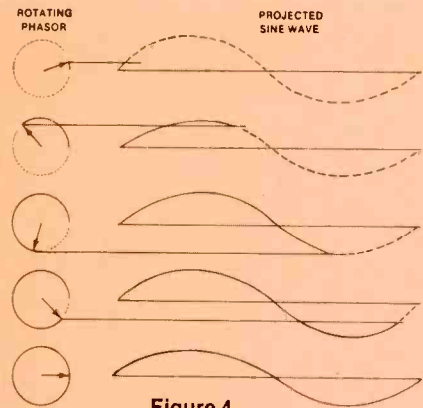

Figure 4

second the rotating phasor covers. It is used in the equations for resonant frequency, capacitive reactance, inductive reactance, and

many other equations used in electricity and electronics. They will be dealt with in greater detail later in this series.

The concept of a rotating phasor representing a sine wave is important in understanding ac waveforms. Every waveform—no matter how complex—can be represented this way. However, it takes practice to visualize the rotating arrow as a waveform. If you want to play a game in your mind, mentally visualize the phasor rotating 90 million times each second. Then, imagine that it speeds up and slows down just a little bit. Let's say it changes its speed about 400 times each second.

Once you have that rotating phasor firmly in mind, project it on a time base as shown in Figure 4. You have just created a 90MHz FM signal that is modulated by a 400Hz audio signal.

It's a different way of looking at an FM signal, and it is useful. Using this concept it is a relatively simple matter to write an equation for an FM signal.



TECHNICIANS USE PRIMEFAX BECAUSE IT WORKS.

Primefax • the computer-assisted television repair system. Now, more than a year of field experience is proof that Primefax works. And with this experience, the Primefax system has been improved. • The Primefax data base has doubled. • A printed copy of failure histories puts the information where you need it. • Use the Primefax computer terminal or use your own. • The Primefax system has been tested by major national television manufacturer repair services.

Primefax... a management tool for productivity... the only way to increase profits today.

Primefax

Texas: (512) 344-5999 • Elsewhere: 1-800-531-5953
4325 Fredericksburg Road • San Antonio, TX 78229

TECHNICIANS & SERVICEMEN
COMPONENTS FOR YOUR MAINTENANCE & REPAIR WORK
SPECIAL: OUR LOW LOW PRICES
REPLACEMENT FOR ECG® TYPES

TYPE NO.	YOUR COST	TYPE NO.	YOUR COST
85 FOUR	for .99	125 SEVEN	for .99
102A THREE	for .99	159AP FOUR	for .99
123A FIVE	for .99	177 EIGHT	for .99
123AP SIX	for .99	199 FIVE	for .99

SUPER SPECIAL (MIN. 5 PC. EACH)

TYPE NO.	YOUR COST	TYPE NO.	YOUR COST	TYPE NO.	YOUR COST
12485		165 2.25		37590	
12845		17165		50655	
12945		18445		500A 8.95	
13080		18545		523 9.95	
15240		238 2.25		526A 10.20	
15340		276 6.95		529 13.75	
15460		29195		712 1.25	

JAPANESE TYPES (MIN. 5 PC. EACH)

2SC867A	2.75	HA1366W	1.85	STK0029	3.80
2SC1114	3.25	HA1377A	2.90	STK0080	9.99
2SC1308K	1.95	LA4102	1.25	TA7205AP	1.50
AN214Q	1.45	M51515BL	2.95	TA7208P	1.85
AN239A	4.60	STK433	3.95	TA7222AP	1.95
BA532 . . .	1.80	STK435	3.95	UPC1181H	1.25
GH3F89	STK437	6.25	UPC1182H	1.25
HA1342A	2.30	STK439	6.50	UPC1185H	2.99

COD ORDERS WELCOME (\$25 MIN. ORDER)
For Complete Component Catalog Call or Write
DIGITRON ELECTRONIC
110 HILLSIDE AVENUE, SPRINGFIELD, N.J. 07081
Toll Free: 800-526-4928 In NJ: 201-379-9016

* ECG IS A TRADE MARK OF PHILIPS ECG.
DIGITRON ELECTRONIC IS NOT ASSOCIATED IN ANY WAY WITH PHILIPS ECG.

Circle (18) on Reply Card

Circle (19) on Reply Card

News

STC president predicts 40 million subscribers for DBS

Satellite Television Corporation President Richard S. Bodman has predicted that direct broadcast satellite (DBS) services "could become bigger than anyone believes. When DBS companies are offering entertainment, information and transactional services, the subscriber total could easily reach 30 to 40 million."

He cautioned, however, "No one should think for a moment that this is a business that a company can enter cheaply and quickly... to succeed in this very competitive business, a company must hit the market with a mature product. This is not a business that should rely on trial and error with the consumer as a guinea pig."

STC, which is developing its satellite-to-home, pay-TV service to begin in the fall of 1984, will initially provide subscribers with entertainment and information programming. Providing entertainment services to underserved areas will be the foundation of the DBS industry, Bodman said. STC will launch its specially designed high-power satellites in 1986 to provide a high-quality DBS signal to the entire eastern half of the United States. Until that time, STC will use an existing satellite that is being modified to permit signals to be concentrated on the Northeast.

RCA engineers receive patent for etching method

A patent has been issued to two RCA engineers for a novel method of etching very tiny holes in the shadow masks of color tubes used to display computer data.

The shadow mask of a color display tube is a thin piece of metal that has many thousands of holes etched into it. Smaller and more precisely etched holes in the mask help provide higher resolution required by display tubes for computer readouts.

The patent was granted to RCA engineers Raymond A. Alleman and Donald M. Weber, who say their invention relates to an unusual process of etching precisely sized apertures into a continuous moving strip of metal, where the widths of the apertures may be smaller than the thickness of the strip. The etched product may be used to make shadow masks for color display tubes for computers, word processors, electronic office equipment and other precision-etched devices. The invention is being considered for manufacturing when there is a demand in the market for more sophisticated displays and monitors.

GE announces "Homenet" format

General Electric has announced a format for computerized "communication" with consumer products and services that the company hopes will be adopted as an industry standard.

Homenet is a specific "language" of computer communication rules and codes (also known as a "local control network") that will allow the coordination and control of electronic and electrical devices in the home from several locations, or by telephone from outside the home.

The Homenet format was originally applied to the GE Home Control System, a computer-based home automation system with video screen and keypad that allows control and monitoring of heating and air conditioning, security and fire systems, lights, appliances and entertainment systems.

Home controllers such as the GE system use existing house wiring and electrical current to send signals to appliances, thereby requiring no special wiring. A key advantage of the Homenet format is its two-way addressability, allowing appliances and sensors to send signals back to the computer for the purpose of monitoring their status. In addition to the existing house wiring, or power line carrier, Homenet is also designed to work over twisted wire pairs, coaxial cables, infrared and radio media.

ES&T

ESR METER

checks electrolytics
IN-CIRCUIT and is TV shop
FIELD-TESTED:

The most fantastic instrument I've ever bought—Billings, Mt. Used it 3 months; it only missed once—Marinette, Wis. (Typical). Squeal & no sync: 3 bad caps in B+ & AGC; Many Thanks—Taos, N.M. Please ship another; very satisfied—Glen Rock, Pa. It's fantastic—St. Joseph, Mo. Please rush; heard good reports—Hicksville, N.Y. One tremendous meter—Alexandria, Minn. Send your Super meter; heard about it—N. Olmstead, Ohio. Love that ESR Meter—Acton, Mass. Used it intensively for 30 days; it's been 100% effective—Pittsburgh, Pa.

Ideal for preventive maintenance: measures electrolyte dryness & shows up intermittent opens.

60-day Satisfaction Guarantee.

Send check or M.O. or call

(313) 435-8916 for COD

Or write for free brochure to:

Creative Electronics

ESR Brochure \$ 99.00
1417 N. Selfridge postpaid
Clawson, Mich. 48017 USA & CAN.

Circle (20) on Reply Card

UNIVERSAL CRT ADAPTER

- Update your present CRT Tester
- Win the socket war **forever**
- Test virtually **every** color CRT
Trinitron—Inline—One gun—
Pinless
- Test/Restore/Rejuvenate
- Use with "ANY-MODEL" CRT
Tester
- Obsolescence proof: perpetual
set-up charts available.
- Distributors inquiries welcome
- \$59.95 & \$2.00 shipping &
handling
M/Card—Visa—Check—COD

CA28 Adapter Kit
w/setup manual

Dandy Mfg. Co.

1313 N. Main
Muskogee, OK 74401
918-682-4286

TOLL FREE ORDER DESK
1-800-331-9658

Circle (21) on Reply Card

(continued from page 30)
 response. Few machines make it out to 15kHz, within 3dB, regardless of what the specifications claim.

This process is made less tedious and more comprehensive by the use of a swept-function generator. A 300-15kHz sweep, with markers at 5kHz and 10kHz, works well. That way you can be sure the bias reduction required to optimize high frequency response does not result in that annoying peak in the upper midrange that produces "cassette sound." Use of this method reduces the number of ARP sequences needed. In other words, you get the job done in less time, boosting productivity.

Because the adjustments are done at -20VU you can decrease

the bias too far and not notice it, so check to see that the machine is not underbiased. Record a 1kHz sine wave at 0VU and play it back to be sure distortion has not crept over 1.5 to 2%THD.

If a distortion meter is not available, observe the reproduced sine wave on the scope and look for the "squashed" peaks that are tell-tale signs of distortion. The 3% THD point should generally be found at or above the Dolby reference level.

RECEQ

In order to compensate for inefficiencies of the record head and tape, a high-frequency boost must be applied during recording. This is similar to the pre-emphasis used for FM and other broadcasts, and is termed record equalization.

Unlike PBEQ, which should follow the DIN curve, RECEQ is dependent upon the type of tape used for recording. Record equalization (sometimes called "peaking") is accomplished by the use of a series resonant LC circuit whose tuning can be varied to peak the high frequencies fed to the record head by the desired amount.

This is done by adjusting the coil's ferrite core. Do not use a ferrous tool for this, or your adjustment will change as soon as you remove it. A GC #9440 "New Transistor IF Core Alignment Tool" works with most machines.

These adjustments have their greatest effect between 10kHz and 12kHz for normal tape, and 12-15kHz for chrome. When going

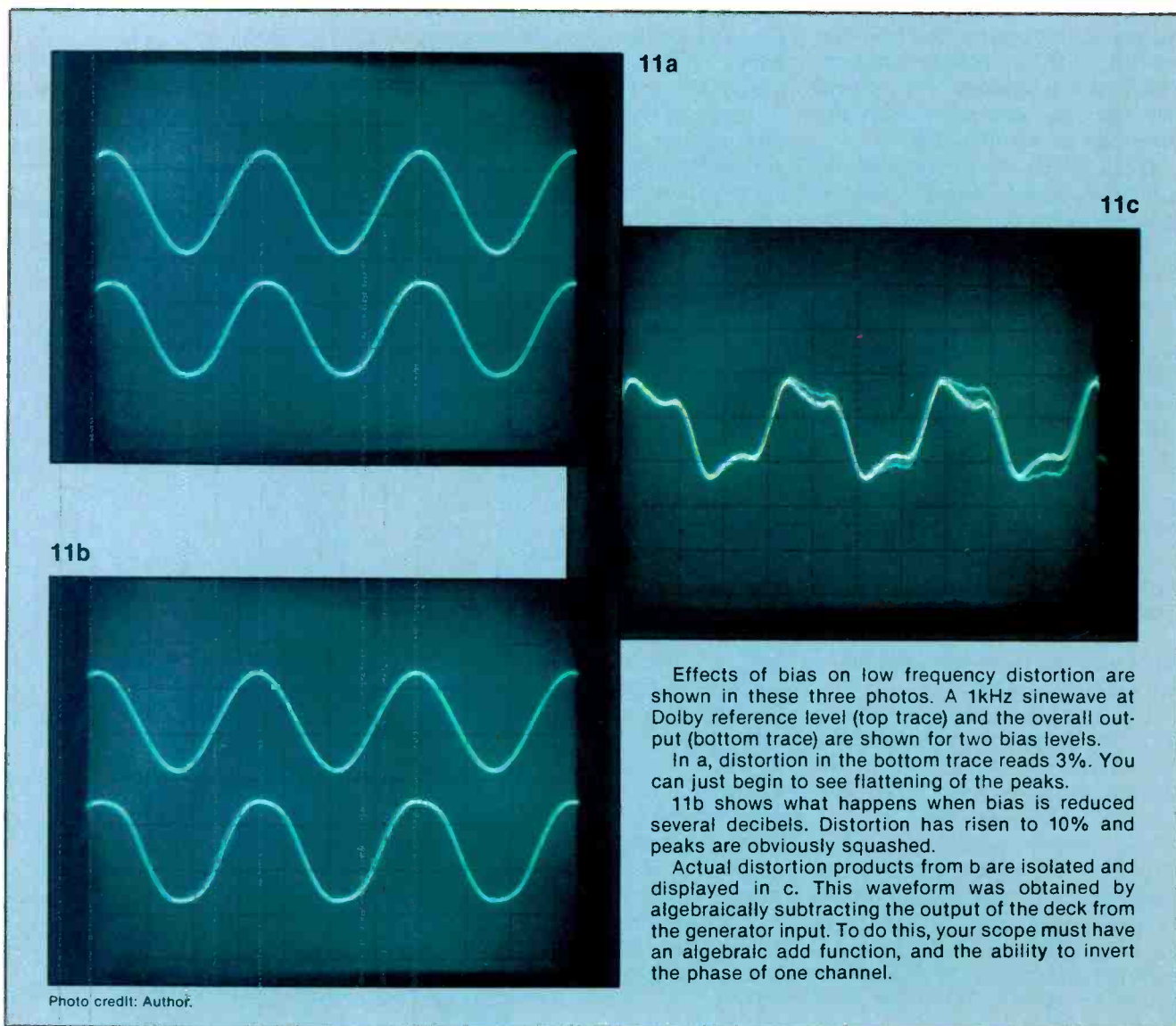

for best overall response, they are used to extract that last few hertz out of the machine. Adjustment range is typically no more than a few decibels.

Sometimes RECEQ coils are marked and sometimes not. The service manual really comes in handy here.

RECLEV

The final alignment is that of record level. You must ensure that the signal is at the same amplitude coming off the tape, as going on. You can use the meters on the deck for reference, assuming they have previously been calibrated. Record a 1kHz signal at 0VU, rewind, and play it back. It ought to read 0VU. If not, adjust the record level trimmers. Try for an accuracy of 1VU or better.

This is an important adjustment. If it is wrong, Dolby noise reduction will not work properly. It shouldn't be too hard to find these trimmers by the process of elimination; you've already identified most of the other ones. Now make a final overall performance check, and tweak up any adjustments that need it.

Miscellaneous notes

Throughout this piece, we have been assuming several things:

1. We are setting a typical Japanese home cassette deck for normal tape. (Some expensive decks have several more adjustments, best done by adhering to the service manual).
2. We are working on a 2-head machine.
3. We are aiming at best overall r/p performance.

Generally, playback alignment is completed for all tape types when the machine is adjusted for normal tape. RECEQ, RECLEV, and BIAS must often be adjusted for each specific type of tape.

Procedures for types II, III and IV tapes are the same as those described, with the exception that RECEQ affects higher frequencies (12-15kHz). All appropriate switches must be set for the tape type, and the proper trimmers should be used.

This is not to say that you must

always align a deck for every tape setting. In most instances, the customer will use only one brand and type of cassette, and the machine can be optimized for this one alone, with a quick check made to ensure that the other settings are at least in the ballpark.

Three-head machines are usually more expensive and have a wider variety of internal adjustments. The head assembly is more complex so the manual comes in handy. Remember that the goal of head adjustment is to get the tape past the heads without curling, skewing, or azimuth error.

Finally, if interchangeability is of concern, record calibration should be performed to make a recorded tape that will play back identically to the test tape. In this instance, bias should be increased to a value that will drop the maximum output level (MOL) at 400Hz by 0.5dB. RECEQ is used to tailor high frequency response for best match to playback performance.

Knowing when to quit

A sage once said, "Perfectionism is just another excuse for not getting the job done." It helps to keep that in mind. Seldom will you be able to get a machine absolutely perfect in terms of distortion, frequency response and level. Even more difficult is getting both channels to track each other.

Those of you with experience with color TV will be familiar with this concept. Converging the central 80% of the screen is considered good work. Spending long hours trying to eliminate every little bit of color fringe in the corners is counterproductive. It's the same with cassette machines. When to quit is really a matter of technical judgment, best left to the individual. However, the following criteria may be helpful:

1. Overall frequency response within 1dB out to 10kHz. (-20VU input level).
2. Overall distortion less than 3% at Dolby reference level.
3. Speed within 1.5%.
4. Flutter and wow less than 0.1% Wrms.
5. R/P level within 1.5dB.
6. Interchannel deviation within 1.5dB as to level.

ES&T

CONSUMER PRODUCTS
DISTRIBUTING COMPANY, INC.
3330 Pagosa Ct., Indpls., IN 46226

**ONE OF THE LARGEST
SONY PART DISTRIBUTORS**

SUPER SPECIALS

10%-20% off all Color CRTs
ALL COLOR CRTs ARE IN STOCK

	ICs and Transistors	
	Reg.	Special
SG-613	16.20	13.00
2SC-867A	5.24	4.50
2SC-1114	9.11	7.50
2SA-1027R	2.69	2.00
MN-8303	5.24	4.50
2SC-1364	2.69	2.00

Many Others On Special

Video Heads
Motors
Transformers

EVERYTHING
ON
SALE

Over 9,000 Parts In Stock
NO MINIMUM ORDER AMOUNT
We Carry Only Genuine Sony Parts



In Indiana Call
1-317-897-4602
Out of Indiana
Toll Free
1-800-428-8353
OFFER EXPIRES
3-23-84

Circle (22) on Reply Card

ATTENTION TECHNICIANS

- ★ JOB OPENINGS
- ★ MONTHLY TECHNICAL TRAINING PROGRAM
- ★ BUSINESS MANAGEMENT TRAINING
- ★ LOW COST INSURANCE
- ★ CERTIFICATION
- ★ TECHNICAL SEMINARS

All of this in a nonprofit international association for technicians

FIND OUT MORE:



R.R. 3 Box 564
Greencastle, IN 46135

Readers' Exchange

For sale: B&K model 820 digital capacitor meter, \$99; B&K 1983 model 1477 15 meg dual trace triggered sweep scope, \$499; B&K model 466 CRT tester/rejuvenator with all current sockets, \$275. All equipment with leads and factory operation manual, schematics and parts lists. *Goetsch Electronic Servicing, 12698 Shorewood Drive S.W., Seattle, WA 98146; 206-241-0507.*

Needed: Scope PIX KC2321P31M (OC-090428) Fairchild 767H Mod. 105 or substitute; schematics for Western 666 VOM, Digitex United System Corporation, 262A multimeter. *S. Uricek, 9674-106th St., Surrey B.C., V3R 4N7 Canada.*

For sale: A 1G-5257 TV post-marker/sweep generator. Never been used, \$175. *Bob Petry, 3739 Dakota, Flint, MI 48506; 313-743-5596 (after 3 p.m.).*

Needed: Sencore VA48, PR57, TF46 and LC53 in good condition with manuals and probes, will travel reasonable distance from Pittsburgh, PA, to view and pick up. *Abdel-Hamid H., 5631 Phillips Ave., Apt. 9, Pittsburgh, PA 15217; 412-421-2530.*

For sale: Heathkit frequency meter model #1B-101; Hammarlund transistor receiver HQ 215; Tektronix oscilloscope dual trace model 545. *George Maleski, Laura Lane, Bedminster, NJ 07921.*

Needed: Output transformer or servicing information for Fisher model C-33, chassis 460A. *KVL Industries, Ken van Lint, 1032 Skylark Drive, La Jolla, CA 92037; 619-454-5978.*

Needed: Schematics and/or service manuals for Sylvania CD-4 disc demodulator model DQ 3700 and Realistic stereo amplifier model SAF40D. *Charles R. Wells, 2085 Barcelona Drive, Florissant, MO 63033.*

For sale: *Electronic Technician/Dealer* April 1961 to March 1982, \$100; *Electronic Servicing* April 1969 to October 1981, \$50; 65 miscellaneous Sams #3-559, \$50 or all for \$160 plus freight. *Armen Karagosian, 3855 E. Terrance, Fresno, CA 93703; 209-227-1801.*

For sale: Sencore PS163 dual trace triggered sweep scope, usable to 15MHz, excellent condition with two probes, manuals. Will accept reasonable offer. *Frank J. Wojcik, 33 Hughes St., Maplewood, NJ 07040.*

Needed: Operating manual for Tektronix scope type 506, model 129B. It has type 9A1 dual trace and 3B1 time base plug-ins. *David A. Young, 42 Imbrook Lane, Aberdeen, NJ 07747.*

Needed: Horizontal board for Toshiba model C321, chassis TAC-7630, module number PW-640C; uses two tubes 8FQ7, 21JZ6. *Don Myers, Myers Electronics, 9061 N. 37 Ave., Phoenix, AZ 85021.*

Needed: New or used CRT in good condition. 19DQP4 or substitute. *Jiranek TV, Farmington, IA 52626.*

Needed: Copy of manual and operating instructions for Superior Instrument Co. goniometer model TV-50A. Will pay for expenses. *Al Nikora Sr., 5298 Argyle Court, Sterling Heights, MI 48078.*

For sale: HAL MKB-1 Morse keyboard, \$85; EICO model 944 (factory wired) yoke and flyback tester, \$49; MFJ 721 CW/SSB audio filter, \$35. Everything in mint condition with manuals and money back guarantee. *John Augustine, 530 N. 9th St., Reading, PA 19604; 215-372-5438.*

Needed: *Introduction to Solid State TV Systems* by Jerrold L. Hansen, published by Prentice Hall about 10 or more years ago. Quote condition of book and price. *S.O. Sellers, 7308 Franklin Drive, Bessemer, AL 35023.*

For sale: B&K 2040 CB signal generator, \$400; B&K 1040 CB servicemaster, \$200. Like new condition with manuals, both for \$480 plus UPS charges. Send SASE for closeout listing. *W-H Electronics, P.O. Box 14703, Omaha, NE 68124.*

Wanted: Parts and a complete Hallicrafters model SX-62 radio for parts. *Paul Capito, Capitol Radio Service, 637 W. 21 St., Erie, PA 16502.*

Needed: Schematics and service manuals for an RCA radio marine direction finder model AR-8712 and a Hallicrafters radio S 38 B. *Henry Schandling, 1250 Saunders Drive, Elizabeth City, NC 27909.*

For sale: Heathkit IG-5240 color generator, \$50; Micronta 351 (Max 50) frequency counter, \$50; Simpson 0509, 50KV high voltage probe, \$10. Send money order or cashier's check. We will pay shipping. *Reading's Electronics, 111 W. 2nd St., Marshfield, WI 54449; 715-387-2121.*

Needed: A book or collection of articles about theory and troubleshooting procedures concerning horizontal output and high voltage circuits, including tube types. *Shannon O. Sellers, 7308 Franklin Drive, Bessemer, AL 35023.*

Needed: Schematic and/or instruction manual for Mercury VOM and capacity tester model 400. Will buy or copy and return. *Larry Larsen, 109-13 96th St., Ozone Park, NY 11417.*

For sale: Sams Photofacts #1 through 1451. *Jensen Radio and TV, 719 6th Ave., Devils Lake, ND 58801.*

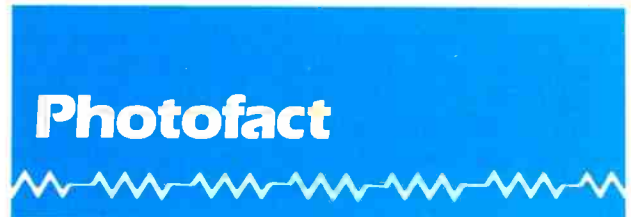

These Photofact folders for TV receivers and other equipment have been released by Howard W. Sams & Co. since the last report in ES&T.

AOC	
Chassis M1B1-3A, M2B1-3A, A1	2195-1
ATARI	
CX-2600A	2196-2
CX-2600	2197-3
HITACHI	
Chassis NP81X, X-2	2200-1
PHILCO	
Chassis K-10	2197-1
Chassis K-20	2199-1
REALISTIC	
12-1538	2195-3
SAMPO	
Chassis C3-19E	2194-1
Chassis CS-19CS	2198-1
Chassis C3-13C	2199-2
SEARS	
564.42700250/51/52/53	2194-2
472.23472350	2199-3
SHARP	
FF19882	2200-2
WARDS	
GEN12114A, B	2197-2
WELLS GARDNER	
13K4801/806/851/856	2200-3
ZENITH	
Y2526NE, NE2/532PN, PN2	2195-2
SY2521W, W2/523E, E2/525CH, CH2/	
527NE, NE2/533PN, PN2/535E, E2/	
539X, X2/541X2/543E, E2/	
547PN, PN2, PN72/549E, E2/	
551E2/589AR, AR2/593P, P2	2196-1
S1940W3, W6	2198-2

ES&T

Literature

Hewlett-Packard describes its family of RF signal generators in a new 8-page product brochure providing key features and benefits of each instrument. The brochure includes selection guides based on both applications and specifications for each of the programmable and manually tuned generators and a spectral-purity-comparison graph.

Circle (102) on Reply Card

The **RCA** directory, "Replacement Parts for RCA Video Cassette Recorder Instruments, Cross Reference from Manufacturer's Identification Numbers to RCA Stock Numbers," has been updated and is now available from RCA parts distributors. This cross reference includes 36 pages of parts listings for RCA VCRs. Some of these parts are also used in certain models of Magnavox, NAP, Quasar, Panasonic, Sylvania and other makes of VCRs.

Circle (103) on Reply Card

Most ac meters, even high-precision models, are only accurate when measuring sinewaves. Such meters can make errors on the order of 20% or more when measuring non-sinusoidal waveforms common in electrical equipment these days.

If your multimeter has not been designed to read the true-rms value of ac, you may be making such errors and not know it. A free 8-page brochure from **John Fluke Manufacturing** uses oscillograms of various waveforms illustrating some typical measurement errors you could expect if your meter doesn't measure true-rms. It also discusses when to use a true-rms meter and when an averaging meter would be more appropriate.

Circle (104) on Reply Card

A 24-page, full-color catalog of computer books, including 12 new books and five DiskGuides is available from **Osborne/McGraw-Hill**. The entire product line,

which includes general interest books, user guides, programming handbooks, assembly language and technical reference titles, is described.

Circle (105) on Reply Card

The new decade box catalog from **ZI-TECH** includes 12 resistance units and two capacitance units. The decade resistance boxes cover many possible applications. A wide range box of eight decades gives resistance values from 10mΩ to 1MΩ in 10mΩ steps. There are also two low-cost units, each covering six decades. The catalog also gives full details of the preciline modular decade boxes. This line mechanically interlocks and seven individual boxes are available, each covering one decade. These boxes can also be used as potential dividers, and there are accessories for constructing bridges of different configurations.

The two capacitance boxes also offer stable and accurate values, covering the range from 10pF to 100μF. The resistance boxes all offer accuracies of 1% or better.

Circle (107) on Reply Card

The 1984 edition of the *Buyer's Guide* is available from **Sencore**. The guide shows the entire line of Sencore test equipment including several instruments and accessories not shown before. Included are oscilloscopes, FET/transistor testers, LC testers, frequency counters, digital multimeters, variable isolation transformers, CRT analyzers, and video and audio test equipment.

Circle (108) on Reply Card

A new wall chart that facilitates the task of identifying the correct ECG replacement transistor, especially for types not cross-referenced, has been published by the Distributor & Special Markets Division of **Philips ECG**.

The silicon transistor selector guide covers 197 NPN and complimentary PNP devices and is a handy adjunct to the ECG Semiconductor Master Replacement Guide 212L. Devices are grouped by case styles and give corresponding ECG types in order of increasing breakdown voltage.

Circle (106) on Reply Card

PREVENT HI-TECH HEADACHES

Our Isolators eliminate equipment interaction.



clean up interference, curb damaging power line spikes and lightning bursts.

ISO-1 Isolator

3 isolated sockets; quality spike suppression; basic protection. . . \$76.95

ISO-3 Super-Isolator

3 dual isolated sockets; suppressor; commercial protection. 115.95

ISO-17 Magnum Isolator

4 quad isolated sockets; suppressor; laboratory grade protection. . . 200.95

ESP Electronic Specialists, Inc.

171 S. Main St., Box 389, Natick, MA 01760

Toll Free Order Desk 1-800-225-4876

MasterCard, VISA, American Express

Circle (23) on Reply Card



SINCE 1950

- LEADING SPOKESMAN
- TRADE INFORMATION DISPENSER
- WATCHDOG
- NATESA SCOPE
- STANDARDS YARDSTICK
- CONSUMER RELATIONS
- PROBLEM SOLVER
- CONCISE PRACTICAL BUSINESS OPERATIONS MANUAL
- SERVICE CONTRACT MANUAL
- CUSTOMER PLEASING PROFIT PRODUCING ORDER FORMS
- PARTS PROCUREMENT EXPEDITOR
- SERVICE BUSINESS
- DIVERSIFICATION PLANS
- TECHNICIAN DEVELOPER

5930 So. Pulaski Rd. • Chicago, Illinois 60629

MOVING?

If you're planning a move in the near future, don't risk missing an issue of *Electronic Servicing & Technology*. Please give us 6-8 weeks notice if you're planning on changing your address. Just write in your new address below and mail this coupon, WITH YOUR SUBSCRIPTION MAILING LABEL, to:

ELECTRONIC
Servicing & Technology

Subscriber Services
P. O. Box 12901
Overland Park, KS 66212

Name _____

Address _____

City _____

State _____ Zip _____

Answers to quiz

(from page 18)

1. A A converter changes dc to dc and rectifier changes ac to dc.
2. D The word VARS means Reactive Volt Amperes.
3. B
4. B Hysteresis loss is reduced by the proper selection of core materials. Copper loss is reduced by selecting a larger wire size for the windings.
5. A A Faraday shield is an example of an electrostatic shield.
6. D
7. C
8. A Because the electrons are not moving as fast, they are easier to deflect. That results in a wider sweep.
9. B A Darlington transistor combination has a *beta* equal to the product of the *betas* of each transistor. If the transistors are identical the result is β^2 .
10. D The resistor limits the charging current through the diode when the circuit is first energized. Hence, the name *surge limiting resistor*.

GET THE SAME VIDEO TRAINING THE PEOPLE AT SONY GET.

Now you can be trained by Sony even if you aren't employed by Sony.

Because we're making our vast library of training videotapes available to you. The very tapes that teach our own engineering, service and sales personnel.

The tapes cover the products and concepts of video and its related technologies. You can learn the basics of video recording. Color systems. Digital video and electronics. Television production. And more.

Plus you can learn how to service cameras, VTR's, and other video products. As professionally as Sony does.

The tapes are produced entirely by Sony and contain up-to-the-minute information. They communicate clearly and simply. And some of them are even programmed for interactive learning.

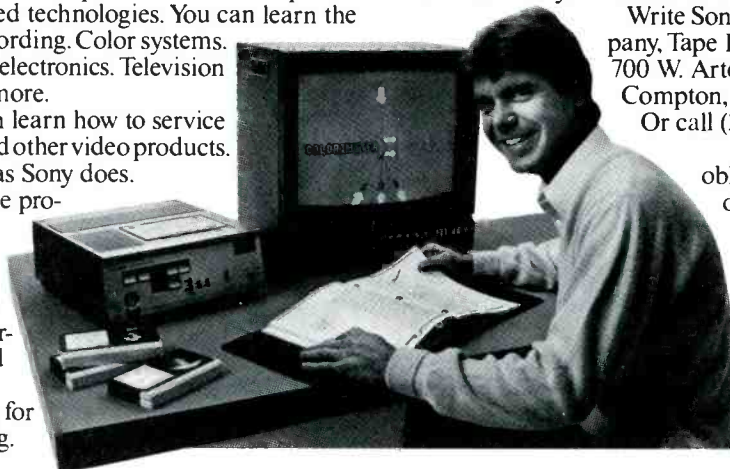

And learning through video can be done at your own pace, in the convenience of your home, shop or school. Reviewing is quick and easy. And the tapes are always available for reference.

Send for your catalog, which lists more than 250 titles. In your choice of 3/4" or 1/2" formats.

Write Sony Video Products Company, Tape Production Services, 700 W. Artesia Boulevard, Compton, California 90220. Or call (213) 537-4300.

Of course, there's no obligation. Except the obligation you have to yourself: to find out about the best training available in one of the country's fastest-growing, most lucrative fields.

SONY
Video Communications
Sony is a reg. trademark of Sony Corp.

Circle (37) on Reply Card

Books

Know Your Oscilloscope, 4th edition, by Robert G. Middleton; Howard W. Sams & Company; 192 pages; \$9.95 paperback.

Oscilloscope users, whether new, part-time, or experienced, will find practical data covering a broad range of uses in this revised edition. Chapters discuss oscilloscope basics, cathode-ray tubes, input impedance, sensitivity, the general requirements of power supplies, voltage regulation, power supply systems, sweep systems and synchronization, vertical amplifiers, different types of oscilloscope probes and supplementary equipment.

The author also discusses the adjusting and servicing of an oscilloscope, the basic methods of taking frequency and phase measurements, some methods of amplifier testing, and some typical digital equipment.

Published by Howard W. Sams & Company, 4300 W. 62nd St., Indianapolis, IN 46268.

Illustrated Guide to Basic Electronics, by John P. Steiner; Prentice-Hall, Inc.; 322 pages; \$19.95 hardbound.

This comprehensive, fully illustrated guide provides a hands-on approach to understanding the principles of basic electronics through everyday practical applications. Beginning with a simplified course on electricity, the book guides you step-by-step from using a multimeter to measure current and resistance, to designing simple circuits, to understanding how a digital circuit operates inside a microcomputer. It shows how to identify components, and how to test each one for suspected defects.

A four-step troubleshooting technique is given that shows how to (1) identify the symptom, (2) locate the defective block, (3) determine which component or components in the block are defective, and (4) repair and test the unit. Special features include a complete table of electronic symbols to identify electronic com-

ponents, schematic diagrams for each project, and five flowcharts to troubleshoot almost any piece of electronic equipment.

Published by Prentice-Hall, Inc., Englewood Cliffs, NJ 07632.

How to Identify and Resolve Radio-TV Interference Problems; Superintendent of Documents; 36 pages; \$5.00.

This booklet from the FCC reviews eight types of reception problems, showing color photographs and detailing various solutions. Five transmitting antennas that can cause radio and TV interference are identified. The booklet tells how to work out interference problems with the transmitter owner and includes procedures for installing a high-pass filter in a TV antenna. FCC complaint procedures are also provided, with a sample format to follow.

If interference is not the problem, several other remedies for poor reception are also outlined. One section explains in technical terms how to eliminate the more likely sources of interference one step at a time.

Published by Superintendent of Documents, Dept. 36-CT, (stock number 004-000-00398-5), Washington, DC 20402.

Proven Techniques for Troubleshooting the Microprocessor and Home Computer Systems, by James W. Coffron; Prentice-Hall, Inc.; 246 pages; \$14.95 paperback.

This book reflects the author's considerable experience in developing good support literature devoted to microprocessor troubleshooting. The chapters cover microprocessor system architecture, the Creative Microprocessor Systems (CMS) hardware trainer; static stimulus testing the 8080, 8085, 6800 and Z80 microprocessors; using an "address catcher" mobile I/O port, the debug ROM, a current probe, and digital pulser probe; troubleshooting with logic state analysis; signature analysis as a troubleshooting technique; modifying a system for easier troubleshooting; overview of a microprocessor troubleshooting system; and troubleshooting a TRS-80 home computer system.

Published by Prentice-Hall, Inc., Englewood Cliffs, NJ 07632.

ES&T

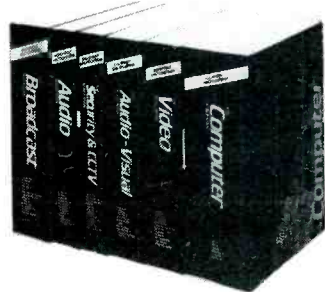

Professionals, Here are your Black Books

- Over 1500 Manufacturers
- 25,000 Products
- 8½" x 11" Catalog Format
- Perfect Binding for Durability
- Pictures, Descriptions, Features, Options, Specifications, Prices
- Up-to-date as of August 1983

Telephone Orders Accepted With
Purchase Order or Credit Card

Call Toll Free (800) 255-6038

HIGH TECH MARKETING CO.
P.O. Box 2056
Shawnee Mission, KS 66201

Exclusive Distributors for BILL DANIELS CO., INC.

Circle (24) on Reply Card

**It's no puzzle
to order Oelrich
Service Forms**



For TV-radio and two-way radio service —
legal forms for Calif., Florida and Utah.
Now at parts jobbers or write for cat. B64.

OELRICH PUBLICATIONS
4040 N. Nashville Ave., Chicago, IL 60634
Now call toll-free! 800-621-0105

Circle (25) on Reply Card

tv & radio
tech's guide
to pricing

Everyone benefits...
pricing by "The Book"

1-800-228-4338

MON. THRU FRI. 8-5 / C.S.T.

Circle (26) on Reply Card

7 MILLION TUBES FREE CATALOG

Includes all current, obsolete, antique, hard to find, receiving, broadcast, industrial, radio/TV types. LOWEST PRICES, major brands in stock. **UNITY Electronics**, Dept. E, P.O. Box 213, Elizabeth, N.J. 07206.

Circle (27) on Reply Card

**Use ES&T
classified ads**

Products

Multimeters

John Fluke Mfg. Co. designed the Fluke 70 series of hand-held multimeters with both signal and analog displays. A simple analog bar graph moves up and down a 32-segment scale, updating 25 times per second, 10 times faster than the digital display. At a glance the user can note trend indications for peaking and nulling measurements or continuity checks. The 3200-count digital display gives the multimeters the



same resolution as a typical 4½-digit multimeter for displays above 2000 counts. When measuring a 220V line, a 24V power supply or a 20mA current loop, the increased count provides an extra digit of resolution over traditional 2000-count meters, which must change ranges for these measurements.

Designed in accordance with world safety standards, the safety features include double fusing, voltage and resistance overload protection and safety-designed test leads. The Fluke 70 series models measure dc voltage to 750V, ac voltage to 1000V, current to 10 amps, and resistance to 32MΩ.

Circle (68) on Reply Card

Testing device

A P Products has introduced Probe-It, plunger-actuated clips for testing electronic connections. Press the Probe-It cap to extend the hook contact placed on the lead

or wire under test. Releasing the cap provides hands-free troubleshooting and circuit testing. The hook contact retracts into the plastic tip when removed from the lead, minimizing the possibility of shorting components.

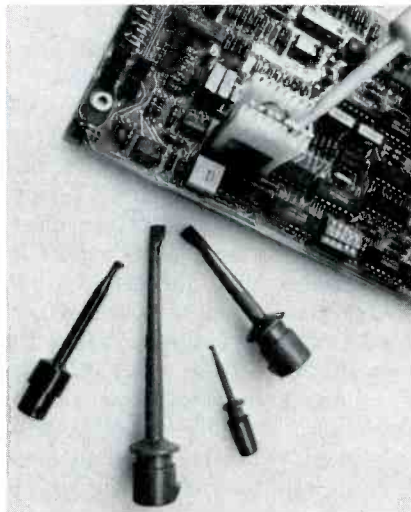

Probe-Its are available in four sizes to fit many connection needs. Micro Probe-It facilitates testing on high-density boards because its small hook contact provides positive connection to the most delicate leads. Mini Probe-It's larger hook contact is ideal for most general-purpose, single-point connections. Standard Probe-It handles testing of higher power circuits and larger devices. Maxi Probe-It's hook contact is the same as Standard but has an extra-long tip for easier access to hard-to-reach leads. All Probe-It models can be soldered to ordinary stranded hook-up wire making any length test lead required.

Circle (62) on Reply Card

Power system

Gould Power Conversion Division has introduced a new version of its 500W rated Uninterruptible Power System (UPS). The on-line



system provides continual voltage regulation and noise elimination to personal computers, point-of-sale

systems and other sensitive loads, as well as battery reserve during complete power outages. The model GSU 3056 includes an internal 10min battery or can be used with external 48V batteries for periods up to several days.

Circle (79) on Reply Card

Oscilloscope

The new 336 portable digital oscilloscope from Sony/Tektronix is a combination non-storage and digital-storage oscilloscope. When used in the store mode, it measures signals to 50MHz equivalent time bandwidth, with memory length of 8 bits by 1024 words. When used in the non-storage mode, it measures signals to 50MHz bandwidth. This gives the user maximum flexibility in analyzing and storing low-rep-rate signals on the digital channel, making conventional measure-

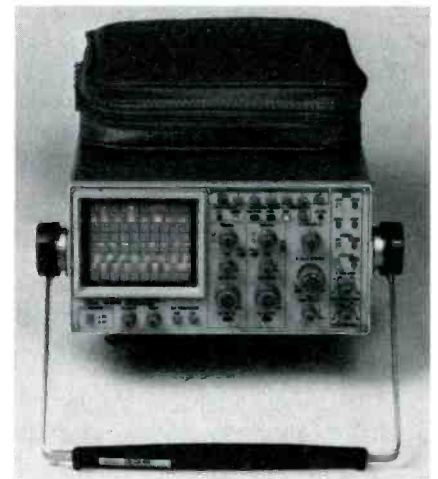

ments on the analog channel and in comparing real time with stored signal information simultaneously. Microprocessor control makes a wide range of waveform processing possible. A user can add, subtract or multiply the signals of Channel 1 and Channel 2. He can calculate the rms, peak to peak and average of acquired waveforms. The menu system and the alphanumeric CRT readout make the 336 easy to use.

Alphanumeric information displayed on the CRT includes the vertical and horizontal scale factors, the delay time position, and voltage and time readouts of cursor positions. In either the store or view mode, cursors can be used to make simultaneous voltage and time measurements on the digi-

tized waveform displays. In effect, this creates a "window" on the waveform in which the user can do processing. The measurement results appear as a CRT readout.

Circle (64) on Reply Card

Earth station systems

Winegard Company has introduced two new earth station packages to its line of satellite TVRO equipment. Model SC-5000 consists of an 8-foot, spun-aluminum parabolic antenna, heavy-duty polar mount with buttonhook feed, 120-degree LNA with Polarotor, deluxe receiver with antenna-mounted downconverter, 150-foot cable and all hardware. The SC-5001 package is identical to the SC-5000 except the LNA is a more sensitive 100-degree model.



The dish is made of heavy-gauge spun-aluminum, with parchment-white, painted finish. Gain is 37.5dB and F/D ratio is 0.375. The dish uses a prime focus feed with automatic polarity selection. Depth of the dish is 14.5 inches; focal length is 36 inches. The heavy-duty, pedestal-type polar mount is constructed of 10- and 11-gauge steel that bolts to the dish at four points and has an azimuth adjustment jack with a turnbuckle adjustment for the latitude declination angle. A manual satellite selector control is standard with the mount.

Circle (61) on Reply Card

Voltage regulators

Powermark Division of *Topaz* has introduced a new portable ac voltage regulator for protecting

sensitive electronic equipment against problem-causing voltage fluctuations. This regulator features a duplex output receptacle and a 6ft line cord for easy plug-in installation. Rated for



operation at 1kVA, it is ideal for use with microcomputers, word processors, electronic test equipment, digital process controllers, or any other device that needs stable ac power in order to operate properly.

Circle (83) on Reply Card

Desoldering tool

The PA 1707 "Solder Scooter" desoldering tool from *Paladin Corporation* combines the speed of powered desoldering with the economy of single stroke hand pumps. The PA 1707 has a ceramic

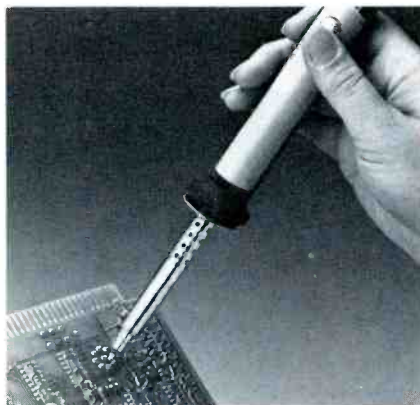

substrate heater, replaceable tips and an easy-to-clean solder debris reservoir. It is designed for use by hobbyists and for other low-volume applications such as field service and rework.

Circle (65) on Reply Card

Digital multimeter

The 4½-digit, hand-held digital multimeter from *Simpson Electric* is specifically designed for critical testing of electronic equipment. The 474 DMM resolves 10µV,

TeleMatic

PROFESSIONAL COLOR TV SERVICE EQUIPMENT

NOW AVAILABLE...



SONY

TEST JIG ADAPTERS

Yoke and Picture Tube for Popular Sets



UPDATE KIT

Modernizes any test jig

Model 10J107

WRITE FOR FREE CATALOG

Sold through distributors only

TeleMatic Div. of U.X.L. Corp.
108-02 Otis Ave., Corona, NY 11368

Circle (28) on Reply Card

FCC LOWERS REQUIREMENTS GET YOUR RADIO TELEPHONE LICENSE

FCC changes make obtaining High-Level Radio Telephone License much easier now. Eliminate unnecessary study, with our short cuts and easy to follow study material. Obtaining the General Radio Telephone License can be a snap! Sample exams, also section covering Radar Endorsement. A small investment for a high-paying career in electronics. \$19.95 ppd. *Spi-Ro Distributors, P.O. Box 1538, Henderson, N.C. 28793.*

Circle (38) on Reply Card

To get more information...

on items advertised or described in this publication, use the Reader Service Card.

As a free service for our readers, we forward your inquiry to the product's manufacturer. Reader Service Card is pre-addressed.

0.01Ω and 0.1 microamps.

The 474 offers broad measurement capabilities—10μV to 1000.0Vdc, 10μV to 750.0Vac, 0.01Ω to 19.999MΩ, 0.1μA to 10.000A ac/dc current. It has a wide temperature/humidity operating range—up to +55°C at 70% humidity; up to 90% at +35°C.

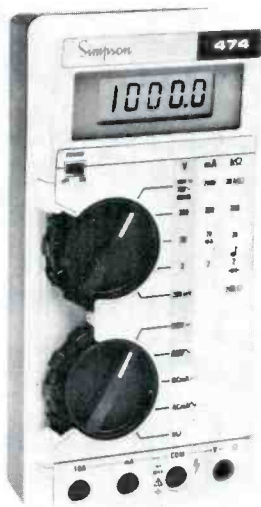

Instant audible and visual continuity indication is provided for quick “go-no go” circuit checks. A diode test function provides “good-bad” semiconductor junction evaluations. The 474 has a double internal fusing system and is also transient protected up to 6kV for 100μs. A built-in tilt stand provides for convenient bench use or for hanging upright. Convenient positive thumbwheel knobs select all ranges and functions. A single 9V battery provides up to 200 hours of operation.

Circle (63) on Reply Card

Soldering iron stands

The *Weller* line of stands is designed for protection of controlled-output soldering iron barrels and tips and includes three basic models for portable use or bench attachment. The PH60 and PH100 stands feature heavy non-

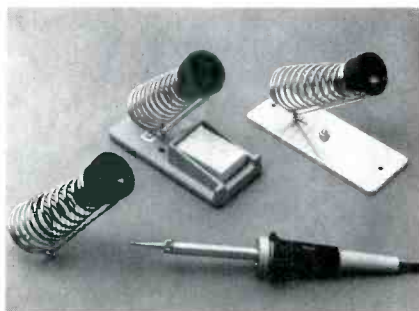

sliding cast bases with built-in sponge receptacles for irons with barrel diameters to 19/32-inch. For either free-standing or mounted use, the PH25 without sponge accepts 25W and 40W irons, and the SFA60/100 series for bench or wall mounting handles irons to 100W.

Circle (67) on Reply Card

Electronic accessories

Larsen Electronics has added two more accessories to its product line. The new CS-1 series coax cable stripper has no razor blades, so it can't nick the center conductor or leave loose strands to cause shorts. The HS-1 antenna hole saw is specially designed to avoid possible damage to vehicle headliners. It is intended for installing permanently mounted mobile antennas, and limits hole depth to 1/8in.

Circle (82) on Reply Card

Temperature-controlled soldering station

The SA-3 series temperature-controlled solder stations from *OK Industries* are designed for all precision soldering applications. A special tip-mounted sensor and sophisticated control circuitry ensure fast response and stability within 5% over the broad range of 210° to 930°F (100° to 500°C).



The SA-3 series is available for either 115V or 230V 50/60Hz input, comes with a special 24V, 48W, low-leakage iron and is grounded for MOS and CMOS applications. The unit has lighted power heater indicators, proportional temperature control, a temperature-indicating meter, iron holder and tip-cleaning sponge.

Circle (60) on Reply Card

Floppy disk drive tester

The *Teaco* Model 1024 is a handheld, pocket-sized, floppy disk drive tester that is suitable for use on the new microdrives, 5¼-inch minifloppy drives, and 8-inch drives with standard interface. Its operation is straightforward, allowing the operator to concen-



trate on the drive and not on the operation of the tester. The 8-ounce unit provides status indication of all signal lines from the drive under test and supplies the necessary signals to the drive, enabling service personnel to exercise and troubleshoot faulty drives down to the component level.

Circle (66) on Reply Card

Soldering irons

Three new low-priced consumer soldering irons with Thermo-Duric heaters have been introduced by the *Ungar* Division of *Eldon Industries*. Thermo-Duric heating elements were developed for in-

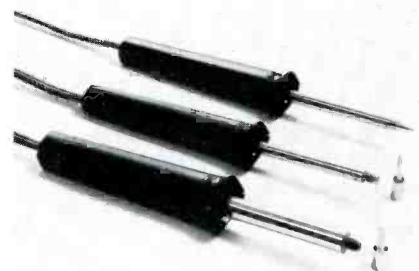

dustrial soldering systems, so the new consumer line has soldering qualities and dependability appropriate for electronic technicians and prices to attract hobbyists and do-it-yourselfers.

Circle (75) on Reply Card

ES&T

Marketplace

1983 I.C. MASTER 2-VOLUME EDITION

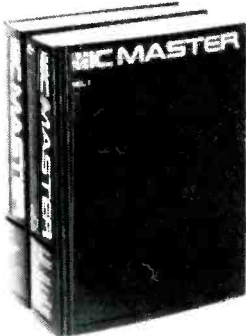

The only publication with the answers to your questions on integrated circuit and microcomputer board selection

55,000 entries in the world's most comprehensive function-for-function, pin-for-pin I.C. replacement guide.

3500 pages organized by function, type, and key parameters to make finding the device which best satisfies a need fast and easy.

For a FREE 6 page brochure about the I.C. Master, call, write or circle reply card.

Active Electronics
P.O. Box 8000
Westboro, Mass. 01581

Toll Free: 1-800-343-0874
Mass. Call: (617) 366-0500
Circle (29) on Reply Card

FREE KIT Catalog
Test Equipment-Kit or Assembled
FUNCTION GENERATOR Kit \$59.95
Auto-Ranging Cap-meter kit \$79.95
Phone 209-772-2076
Circle number or phone for catalog.

DAGE SCIENTIFIC INSTRUMENTS
BOX 144 VALLEY SPRINGS CA 95252
Circle (30) on Reply Card

Your
ad gets
quick
results.
Advertise
in
classifieds.

Maybe We're To Discrete About Our Discrete Products

Diode Specials

In Lots of 100

1N4148	\$3.60/100	1N4004	\$3.60/100
1N4001	3.00/100	1N4005	4.00/100
1N4002	3.25/100	1N4006	4.50/100
1N4003	3.40/100	1N4007	5.50/100

Transistor Specials

PN2222A	\$8.00/100	2N3906	\$12.00/100
PN2907A	8.00/100	2N3055	.65 ea.
2N3904	12.00/100		

Carbon Film Resistors

1/4 Watt 5% Tolerance

Now Only \$1.50/100

All 5% Values Available

Specializing in:

Resistors
Transistors
Diodes
SCRs
Full Wave Bridges

STOCKED
IN
DEPTH

And the Old and Exotic!

Call Liz and ask
about her parts today!

We also purchase excess inventories.
Call Martha about your parts today!

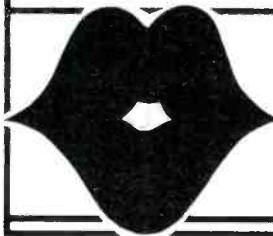

"Have You Kissed Your Computer Lately"

Components Express, Inc.



1380 E. Edinger • Santa Ana, Calif. 92705 • 714/558-3972

TWX 910-595-1565 • ADVACON SNA • International Orders Welcome

Terms of Sale: Cash, Checks, Credit Cards, M.O., C.O.D. FOB Santa Ana.

Calif. residents add 6% sales tax.

Circle (31) on Reply Card

MICRO MART

508 Central Ave.
Westfield, N.J. 07090
(201) 854-6008

UHF-TV PREAMP

(As featured in Radio Electronics March/
May articles, 1982)

This inexpensive antenna mounted pre-amp can add more than 25 dB of gain to your system. Lots of satisfied customers and repeat orders for this high quality kit, which includes all component parts, PC Board, Case, Power Supply and Balun \$34.50 Assembled Version \$57.50

ATTENTION TV SERVICE TECHS (Special New IC Purchase)

28 Pin luminance/chroma integrated circuit as used in CTC-108(1982) chassis. Equivalent to IC U-701. Replaces RCA #145868. MICRO-MART#6008
Price: \$10.95 (1-4)
\$9.95 (5-9), \$8.95 (10 pcs)

REPLACEMENT IC BARGAINS

Any of the following for \$1
221-42, 221-69, 221-96,
221-105, 221-106, 56D4 (ECG
Equiv. 714), 76-2 (ECG
Equiv. 742), LM1310, LM1800

Terms: MICRO-MART accepts Visa, MC and telephone COD's.
Minimum order \$10.00. Shipping— U.S. orders, \$2.00.
Canada and other countries \$3.50
NJ residents add 5% sales tax.

MICRO-MART • 508 CENTRAL AVE.,
WESTFIELD, NJ 07090 • (201) 854-6008

Circle (32) on Reply Card

SAVE TIME

For fast, accurate service, please remove the Peel-Off Label (which is used to address your magazine) and affix it to the Reader Service Card, the Address Change Card, or to any correspondence you send us regarding your subscription.

WE HAVE A LOT TO BRAG ABOUT AT ORA ELECTRONICS

ONE HOUR SHIPPING

Other companies brag about 24-hour shipping, but we at ORA Electronics have the best shipping time in the industry. ONE HOUR — that means that you can have that important part in your hands as early as the next day.



HIGH IN-STOCK RATIO

ORA Electronics has the highest "in stock" ratio in the industry (95%). The average stocking ratio in the business is 75%. That means less back orders or "out of stock" items when you order from us!



BETTER SERVICE

Nobody offers better service than ORA Electronics — that includes packing, order handling, customer service and quality control. Our employees are highly trained and experienced to better serve you.



LOWER PRICES

Other companies lower the price on some items and advertise them heavily. We at ORA Electronics have a lower overall price—and yes, you'll like OUR total better!



FREE SHIPPING

Only ORA Electronics offers free shipping for prepaid orders (in the continental U.S.A.). For COD, charge and open account orders, we charge only actual shipping costs, no handling charges whatsoever!

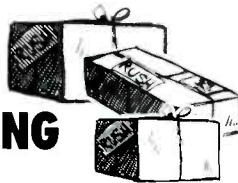

TWO YEAR WARRANTY

All ORA Electronics' semiconductors and many other products are guaranteed for two full years. ORA Electronics has the longest warranty in the industry because we know what we sell: prime grade parts, and they are tested for quality.



ORIGINAL PARTS

ORA Electronics offers you only original semiconductors, no "replacements" or "substitutes" or "almost the same" parts. Some other companies re-label their parts. When you order from us, you can be sure that every semiconductor you buy is a prime grade, ORIGINAL, tested part.



POPULAR CATALOG

ORA Electronics' catalog is the most copied catalog in the industry. It's the easiest to follow, the prices are not confusing, and a comprehensive index is included. Send for your free copy today!



Call toll free: (800) 423-5336.
Calif. toll free: (800) 382-3663.
Non-order info: (213) 701-5850.
Local: (213) 701-5848.



"OUR SERVICE MAKES THE DIFFERENCE"
18215 PARTHENIA ST., NORTHRIDGE, CA 91325

Circle (34) on Reply Card

Opportunity knocks.

The professional world of the Electronics Service Dealer is rough. That's why we're working so hard to make it easier for you to operate a cost effective business. NESDA offers substantial savings on bank-card and insurance rates, business contacts, technical and management certification, and that's just the beginning.

Our members are kept informed about industry developments, and are offered the most comprehensive managerial and technical training programs available. **Opportunity knocks. Don't let it pass you by.**

For more information about the National Electronics Service Dealers Association, write to: NESDA, 2708 W. Berry St., Ft. Worth, TX 76109.

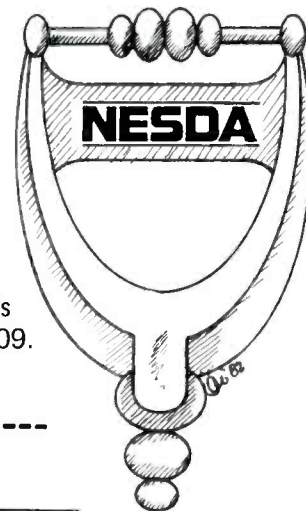

NAME _____

FIRM NAME _____

FIRM ADDRESS _____ Member of State Local Assn.

CITY _____ STATE _____ ZIP _____ PHONE _____

Order Your INTERTEC Mailing Labels NOW and

SAVE!

To take advantage of these savings, your list rental must be completed and billed by **December 31, 1983**, or discount offers do not apply.

- 1. 10% DISCOUNT FOR USE OF UP TO 10,000 SUBSCRIBER NAMES**
 - 5,000 name minimum
 - Sample mailing piece required
- 2. LARGER 15% DISCOUNT WHEN YOU RENT MORE THAN 10,000 NAMES**
 - Sample Mailing piece required.

Because we want your business NOW, we're making you an offer we've never made before. INTERTEC PUBLISHING CORP. has successfully served various markets (including this one) for over 95 years. Each magazine's subscriber list offers unparalleled direct marketing opportunities.

List of Publications: **Broadcast Engineering, Electronic Servicing & Technology, Grounds Maintenance, Implement & Tractor, Land Mobile Product News, Lawn & Garden Marketing, Video Systems.**

For further information, call Rosanne Navran, Directing Marketing Co-ordinator, TODAY!



INTERTEC
PUBLISHING
CORP.

(913) 888-4664

P.O. BOX 12901
OVERLAND PARK, KS 66212

Classified

Advertising rates in the Classified Section are 50 cents per word, each insertion, and must be accompanied by payment to insure publication.

Each initial or abbreviation counts a full word.

Minimum classified charge \$10.00.

For ads on which replies are sent to us for forwarding (blind ads), there is an additional charge of \$3.00 per insertion to cover department number, processing of replies, and mailing costs.

Classified columns are not open to advertising of any products regularly produced by manufacturers unless used and no longer owned by the manufacturer or distributor.

HELP WANTED

VIDEOCASSETTE & TV RECEIVER SERVICE TECHNICIANS

The National Broadcasting Company has immediate openings for electronics professionals to troubleshoot, localize, repair and install videocassette units, TV receivers and antennaplex systems in an office building complex. Individuals should possess minimum 2-3 years hands-on experience, including the following:

- ¾" u-matic videocassette units, preferably Sony.
- ½" VHS videocassette units, preferably RCA.
- Color TV receivers, preferably RCA.
- Master antennaplex systems.

Selected candidates must be well groomed and possess excellent interpersonal skills for effective interface with all levels of management. BS in Electronic Technology or Engineering preferred.

NBC offers salary commensurate with experience and excellent company-paid benefits. For prompt consideration, submit resume with salary history to:

**Ms. V. Branker/EST, Suite 1678
NBC, 30 Rockefeller Plaza
New York, New York 10020**
an equal opportunity employer

FOR SALE

COMPLETE JERROLD WIRELESS REMOTE/DESCRAMBLER—full warranty, \$159.00. Complete Oak descramblers, full warranty, \$169. Trap/filters in line type, \$49, 2 min. installation, SG613 transistors, only \$6.99. Original Toshiba 2SC1172B, only \$1.99 with hardware. 100/450, 80/480, 200/300, 40/450, 25 1st only \$1 each mixed or single lot. Super special while they last 800-860 41 each safety caps Zenith type, 10 lot only \$2.50. Bulk 2SC1172B only 50 lot, \$1.69. Redcoat Electronics, 104-20—68th Drive, Forest Hills, NY 11374, (212) 459-5088. 5-83-tfn

CABLE CONVERTERS, DECODERS. Free catalog! APS, POB 263, Newport, RI 02840. 6-83-12t

SUBSCRIPTION TV MANUAL, covers all three major scrambling systems, only \$12.95. Includes theory, circuits, waveforms and trouble shooting hints. Save your VIDEO GAME CARTRIDGES on EPROM with our EPROM duplicator. Plans \$9.95. Catalogue \$2.00, refundable. RANDOM ACCESS, Box 41770A, Phoenix, AZ 85080. 8-83-tfn

2SC1172B's, 50 LOTS—\$1.69; 2SC1308K's, original Sanyos, 50 lots—\$1.99; Cheater cords, 25 lots—35c; pol- and non-polarized, 1,000 ft. reels of RG 59 U. Coax Cable—\$39/roll. Minimum order \$75. Redcoat Electronics, 104-20 68th Drive, Forest Hills, NY 11375, 212-459-5088. 10-82-tfn

ELECTRONIC SURPLUS: CLOSEOUTS, LIQUIDATIONS! Parts, equipment stereo, industrial educational. Amazing values! Fascinating items unavailable in stores or catalogs anywhere. Unusual FREE catalog ETCO-011, Box 762, Plattsburgh, NY 12901. 6-78-tfn

Electronics

Electronics Technician

TV/VCR/Audio

RCA Service Company, the nation's leading consumer and commercial electronics servicing organization is seeking experienced individuals to service TV, VCR and Audio systems. Openings currently exist throughout the Western Region.

Because we're involved in television, VCR and audio technology, this opportunity can lead to specific training in either one or all of these fields, with a chance to excel. Digital or microprocessor experience desired.

We offer an excellent starting salary and complete benefits program. For immediate consideration, call or write, specifying geographic preference, to:

**A. Poloway
RCA Service Company
6363 Sunset Blvd.
Suite 600
Hollywood, CA 90028**

(213) 468-4077

Equal Opportunity Employer

RCA 
A Tradition On The Move!

FOR SALE (CONT.)

TUBES—Receiving, Industrial and Semi-conductors, factory boxed. Free price list. Low; low prices. **TRANSLETERONIC INC.**, 1365-39th Street, Brooklyn, NY 11218E, 800-221-5802, 212-633-2800. 5-82-tfn

TV TROUBLE ANALYSIS TIPS. Over 300 symptoms/remedies by circuit area; tough ones over the years. Save time and money. Send \$12.50 to **CHAN TV**, 8151 Grandview Rd., Chanhassen, MN 55317, 5-82-tfn

PRINTED CIRCUIT boards from your sketch or artwork. Affordable prices. Also fun kit projects. Free details. **DANOCINTHS INC.** Dept. ES, Box 261, Westland, MI 48185. 5-81-tfn

SONY-PANASONIC-RCA-ZENITH-EXACT REPLACEMENT PARTS-LARGE INVENTORIES-SEND PART OR MODEL NUMBERS-WILL UPS OR COD-GREEN TELE-RADIO DISTRIBUTORS, 172 SUNRISE HIGHWAY, ROCKVILLE CENTRE, NY 11570. 5-82-tfn

AUTOMOBILE RADIO and tape replacement parts: Delco, Chrysler, Philco-Ford, Motorola, Panasonic and many others. Large inventory. **Laran Electronics, Inc.**, 3768 Boston Road, Bronx, NY 10469. (212) 881-9600, out of New York State (800) 223-8314. 5-79-tf

COLOR PICTURE TUBES direct from manufacturer. Prices from \$55 to \$75 exchange. One year warranty. Send your old tube ups to **ATOLL Color Tubes**, 6425 West Irving Park, Chicago, Illinois 60634. Phone: 312-545-6667. We also sell equipment for rebuilding CRT's. 12-83-3t

CB RADIO BOOKS, kits, modifications. Catalog \$1.00 refundable. APS, POB 263, Newport, RI 02840. 6-83-12t

FOR SALE (CONT.)

INDIVIDUAL PHOTOFAC FOLDERS (not sets) under #1200. First class postpaid \$3.00. **Loeb**, 414 Chestnut Lane, East Meadow, NY 11554. 11-83-3t

SAMS PHOTOFACTS 10-1780, practically complete except a few earlier ones missing. File Cabinets included. Bids accepted, with right to reject. **Percy Orm Estate**, Rt. 2, Pratt, KS 67124, 316-672-5381. 12-83-1t

HYGAIN 9 mike with cord and plug. Fits all model 2679, 2679A, 2679X. \$43.95. Prepaid UPS. Mastercard-Visa welcome. **W-H Electronics**, P.O. Box 14703, Omaha, NE 68124. 12-83-1t

SCRAMBLED TELEVISION, encoding/decoding. New book. Theory/circuits, \$9.95 plus \$1 shipping. Workshop, Box 393ES, Dept. E, Bethpage, NY 11714. 7-80-tfn

TUBES FOR TV AND RADIO—35c ea. **Washington TV Service**, 1330 E. Florence Ave., Los Angeles, CA 90001. 1-83-12t

ATTENTION TECH/SHOP OWNERS—Profits getting smaller with increasing cost of parts? Take advantage of our buying power and huge inventory on well known electronic products and replacement parts. Prices below dealer cost. Write for information. **United Services Assoc.**, Old Grand Union Shopping Ctr., Rt. 9W, Stony Point, N.Y. 10980, 914-942-2173. 7-83-tfn

SPRING SPECIALS on Popular Electrolytics—40/450V—75c; 80/450V—85c; 100/450V—95c 200/300V—\$1.05. Quantity 20 lot only. Minimum order of \$50. **SUPER SPECIALS**. Bulk Zenith safety capacitors 800-860, 12 lot only \$2.50 each. **REDCOAT ELECTRONICS**, 104-20 68th Drive, Forest Hills, NY 11375, 212-459-5088. 10-82-tfn

BUSINESS OPPORTUNITIES

LEARN TO REPAIR HOME VIDEO GAMES IN YOUR OWN SHOP! Did you know that more than 9 million HOME VIDEO games have been sold? Now you can learn to repair! Atari, Coleco, Intellivision, or Atari 400/800 computers in your own shop. Our courses are taught on VIDEO TAPE (Beta or VHS) and come with a manual containing all the necessary technical information you will need to do repairs. For more information or to order, call: Electronic Institute (800) 221-0834 (outside N.Y.) or (212) 377-0369 (in N.Y.) Customized live in shop training courses are also available, call for more information and price schedules. 7-83-tfn

TV TUNER REBUILDING BUSINESS, LOS ANGELES, CALIFORNIA 23 years same location, other interests, requires sale very reasonable, (213) 342-4745. 7-83-tfn

RESIDENTIAL SECURITY ALARM sales are exploding and the Rampart Associate Program offers you ENORMOUS PROFIT POTENTIAL PLUS EXCITING RESIDUAL INCOME. Rampart's success and reputation are a result of a total business format approach for the residential, small commercial market and its new low cost system, the Rampart REACTOR, with central station monitoring. We provide product, marketing and management training with complete backup. Start part time, full time. No experience necessary; just a strong desire to succeed and help your customers. Investment only \$2,850. With only 6% of the market penetrated, now's the time to get yourself started in what Time Magazine calls the "runaway growth industry." Call Mr. Roberts 1-800-823-8002 or write, Rampart Ind. Inc. One Oxford Valley, Langhorne, PA 19047. 11-83-tfn

SPEAKER RECONING: Most makes, sizes, models. For prompt service send to Mercury Speaker Reconing, 2018 W. Division St., Chicago, Illinois, 60622; (312) 278-2211. 9-83-tfn

BUSINESS OPPORTUNITIES

NORWALK, CALIFORNIA ESTABLISHED TV AND STEREO SERVICE AND SALES very busy money maker, excellent location, low rent, very good lease, 2300 square feet, 10 minutes to beaches and Los Angeles. \$40,000 includes inventory, large enough for living quarters, owner retiring, phone 213-863-1919. 11-82-tfn

RETIRING: Small western Colorado town. Home, business, small orchard, only shop in area. General Electronic Sales and Service, Zenith and Satellite Receivers. Sales 90K. 1-303-856-3001. 12-83-11

HIGH PROFITS - LOW INVESTMENT: with our CRT rebuilding equipment. Complete training and technical assistance. Guaranteed result. Atoll Television, 6425 W. Irving Park, Chicago, Illinois 60634; PH 312-545-6667. 12-83-3t

WANTED

WANTED FOR CASH: 50, 53, 6AF6, 6HU8, 304TL, 4CX1000A, 4-1000A, all transmitting, special purpose tubes of Eimac/Varian. DCO, Inc., 10 Schuyler Avenue, North Arlington, New Jersey 07032. Toll Free (800) 526-1270. 5-82-tfn

TELEVISION SERVICE SHOP in Florida or California. Call or write ATOLL TV, 6425 West Irving Park, Chicago, IL 60634; Ph. 312-545-6667. 11-83-3t



Reader Service Number	Page Number
29	Active Electronics 61
16	All Electronics 29
17	B&K Precision 49
7	BBC-Metrawatt/Goerz . . . 9
8	Chemtronics, Inc. 10
31	Components Express, Inc. 61
36	Consolidated Electronics, Inc. 66
22	Consumer Products . . . 53
15	Contact East 29
20	Creative Electronics . . . 51
30	Dage Scientific Instruments 61
21	Dandy Manufacturing Co. 51
19	Digitron Electronic . . . 50
	ETA 53
23	Electronic Specialists, Inc. 55
24	High Tech Marketing Co. 57
4	MCM Electronics 3
32	Micro Mart 61
	Natesa 55
11	North American Philips . 17
25	Oelrich Publications . . . 57
14	Omnitron Electronics . . 27
9	Optima Electronics . . . 10
34	ORA Electronics 62
1	PTS Corp. IFC
18	Primefax, Inc. 50
	RCA Distributor and Special Products . . . 11
12	Howard W. Sams & Co. . 19
2,3	Sencore Inc. BC
13	Sony Corp. of America . . 23
37	Sony Video Communications . . . 56
26	Sperry Tech, Inc. 57
38	Spi-Ro Distributors . . . 59
28	Telematic Div. of U.X.L. Corp. 59
27	Unity Electronics 57
10	Winegard Co. 15
	Zenith Radio Corp. IBC

Symcures Wanted

Electronic Servicing and Technology needs a broader variety of television Symcures. Especially needed are reports of Quasar, General Electric, Sylvania (or Philco), Sony Sears and Magnavox.

Symcures are, by definition, solutions to problems that have been encountered during the repair of *more than one* television set of the same make and model, and that may reasonably be expected to be a source of *recurrent* failure.

Please give the brand, model number, Photofact number, a brief description of the symptoms, a rough hand-drawn schematic of the area containing the defect, and a short description of the cure (including whether the defective component was open, leaky, shorted or intermittent).

ES&T editors will adapt the material to the Symcure format and have Photofact-style schematics prepared.

Send seven Symcures each time. Only six will be published, but the extra gives the editor a spare for one already printed in the past (or otherwise not suitable to the format). \$30 will be paid for each page of six actually published (remember to include full name and address).

Send to: Symcure Department
Electronic Servicing and Technology
P.O. Box 12901
Overland Park, Kansas 66212

WE DELIVER!

We deliver should mean alot to **YOU**. At **CEI**, delivery is one of our main goals. We know that you want your parts on time, that's why we get your parts out fast.

When your order is placed, we'll try to process and ship your order the very next day. With Consolidated Electronics, there are no long delays waiting for your order to arrive. We've been commended and are proud of our service.

Our service extends to you more than just delivery. For example, every quality part has a **TWO YEAR WARRANTY**. We also offer **FREE SHIPPING AND HANDLING***. When you call **CEI** you'll know that **WE DELIVER!** Let **CEI** be **"YOUR COMPLETE ELECTRONIC PARTS SOURCE!"**

*If order is 5 lbs. or less. Good only in the continental U.S. With purchase order of \$75.00 or more

Consolidated Electronics, Incorporated

705 WATERVLIE T AVE. DAYTON, OHIO 45420 • (513) 252-5662



CEI



CALL TOLL FREE!

1-800-543-3568
NATIONAL WATS

1-800-762-3412
OHIO WATS LINE

Circle (36) on Reply Card



See here for the many ways folks can now say

MERRY CHRISTMAS

with a timely gift from the big, wide wonderful world of

ZENITH VIDEO/AUDIO ACCESSORIES

Now, with Christmas just around the corner, Zenith introduces a whole host of video/audio accessories. And every one of them about as sensible and rewarding a gift as you could wish on anyone...including yourself.

Chief among them, perhaps, in terms of TV convenience is the Zenith Video Organizer that lets you switch — with pushbutton ease! — from one program source to another without manually changing cable connections.

Individually packaged and clearly labeled, too, are such TV accessories as dust covers, video tape ID kits, cassette storage modules, signal splitters, attenuators, terminators, A-B switches, "F", mini and other types of plugs and jacks in virtually any combination...plus cables in a variety of lengths, each with gold-electroplated connectors.

Also included in this, the biggest, broadest-ever Zenith line of video, audio and telephone accessories, are indoor and outdoor antennas...super lightweight stereophones...and the Zenith Spike Suppressor to protect the TVs, home appliances, and solid-state electronics in your home from damaging high-voltage surges.

Now's the time to stock up on these new Zenith video/audio accessories. They're perfect for your customers' Christmas shopping lists. Yours, too, for that matter. Call your Zenith distributor's Parts Manager now. And tell him Santa sent you!

ZENITH

The quality goes in before the name goes on.®

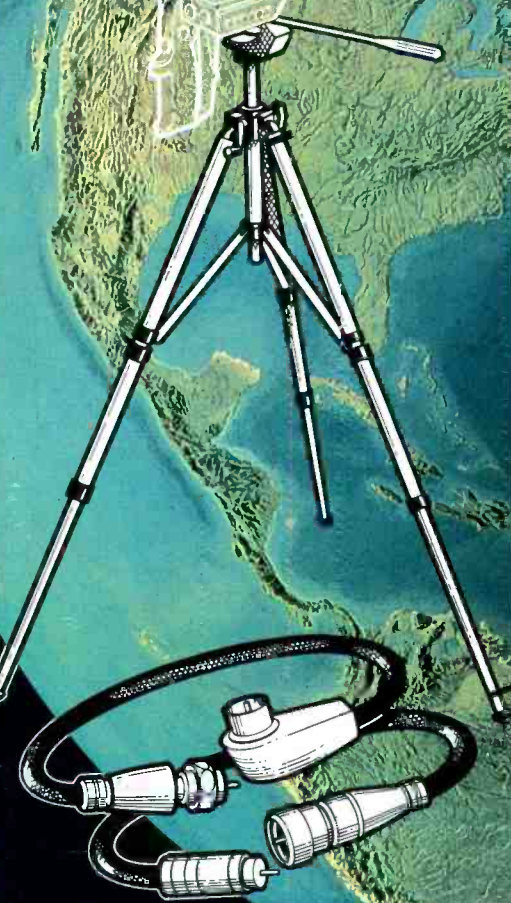
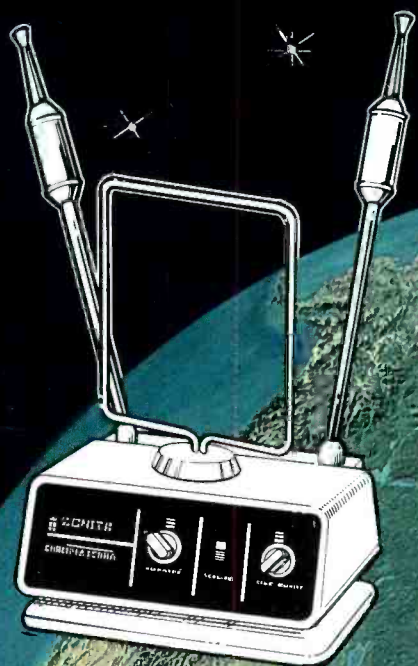

© Rand McNally & Co., R.L. 83-GP-11

Double Your Troubleshooting and Testing Productivity . . . Or Your Money Back!

Six-digit readout: Automatically tracks every CRT test. We call it digital autotracking. It's patent pending.

Bright dual-trace CRT: 60 MHz (-3 dB); 100 MHz (-12 dB).

Delta PPV, Time, Freq: Measure any part of a waveform for PPV, time or frequency using Delta measurements. Just dial in the waveform section you want to measure and push.

Simplify Freq ratio tests: Automatically compare input/output ratio of multiply/divide stages from 1:1 to 1:999,999 with the push of a button.



Autotracking DCV, PPV, Freq: Measure DCV to 5%; PPV to 2%; freq. to .001%. Just push a button for either Channel A or B.

One probe input: One probe input per channel for all measurements - digital and scope - with 5 mV to 2000 V measuring range. (2 lo-cap probes provided.)

Super sync: ECL provides rock-solid sync trigger circuits with only 4 controls; includes TV sync separators for video work.

U. S. Patent Pending
Financing Available

The first scope with push button digital readout. If you use general purpose oscilloscopes for troubleshooting or testing, we can double your present productivity with the SC61 Waveform Analyzer, the first instrument to turn every conventional scope measurement into an automatic digital readout.

No more graticule counting. Connect only one probe to view any waveform to 100 MHz. Then, just push a button to read DCV, PPV, frequency and time — automatically!

There are no graticules to count or calculations to make, which speeds every measurement.

The digital readout is from 10 to 10,000 times more accurate as well.

Plus you have everything you want to know about a test point, at the push of a button, which speeds troubleshooting tremendously.

A special Delta function even lets you intensify parts of a waveform and digitally measure the PPV, time or frequency for just that waveform section.

And it's neat. No more tangled leads, piles of probes or dangling cords. The SC61 is an entire test station in one unit.

The one and only. There are other scopes with digital readout, but none of them completely automate every conventional scope measurement so you can automatically analyze any waveform without counting one single graticule. Totally automatic waveform analyzing at the push of a button. It will make all the difference in your productivity.

Double your productivity. When we say the SC61 will double your productivity, we're being conservative. We've seen cases of

three, four, even ten time increases in productivity with this first-of-its-kind, automated oscilloscope. Every situation is different, however, so try the SC61 and judge for yourself. Here's our offer.

Money back guarantee. If the SC61 does not at least double your productivity during the first thirty days, you may return it for a full refund, including freight both ways.

Call today. Get the entire SC61 Waveform Analyzer story. Call toll-free today, and ask for our eight page color brochure. It could be the most productive call you make this year!

**Phone Toll-Free
1-800-843-3338**

Alaska, Hawaii, Canada and South Dakota call collect (605) 339-0100

SENCORE
3200 Sencore Drive, Sioux Falls, SD 57107

For Information Circle (2) on Reply Card
For Demonstration Circle (3) on Reply Card