

ELECTRONIC

Servicing & Technology

JULY 1982/\$2.25

Car radio tune ups

Noteworthy CB circuits

**The shuttle:
ham radio
special event**



RR 1 BOX 3089
MILFORD

PA

18337

A18337-----LP01 0890 APR86 ES0
0 01 C 0 090080 X
JOE LUPQ JR

Judy Buckmaster
Customer Service



**Your questions
and problems get
our "We Care"
attention.**

At PTS, we think your questions and problems deserve to be heard. That's why in customer service we give you personal attention that says "We Care".

It's part of our commitment to doing the best job we can. We're dedicated to helping you overcome your problems, and that's why we have a customer service department.

When service is our only business, we put it as close as a phone call.

Only one company has the "We Care" spirit in customer service.

Only One.



PTS CORPORATION

Circle (1) on Reply Card

For the name of the PTS Distributor or Servicenter nearest you write PTS Corporation, P.O. Box 272, Bloomington, IN 47402

ELECTRONIC

Service & Technology

Editorial, advertising and circulation correspondence should be addressed to: P.O. Box 12901, Overland Park, KS 66212-9981 (a suburb of Kansas City, MO); (913) 888-4664.

EDITORIAL

Bill Rhodes, *Editorial Director*
Nils Conrad Persson, *Editor*
Carl Babcoke, *Consumer Servicing Consultant*
Rhonda Wickham, *Managing Editor*
Tina Thorpe, *Associate Editor*

ART

Kevin Callahan, *Art Director*
Kim Nettie, *Graphic Designer*

CIRCULATION

John C. Arnst, *Director*
Evelyn Rogers, *Manager*
Dee Manies, *Reader Correspondent*

ADMINISTRATION

R. J. Hancock, *President*
Cameron Bishop, *Publisher*

ADVERTISING

Greg Garrison, *National Sales Manager*
Jeanette Staley, *Production Manager*
Mark Raduziner, *Marketing Coordinator*

Regional advertising sales offices listed near Advertisers' Index.



Member, Audit Bureau
of Circulation



Member, American
Business Press

ELECTRONIC SERVICING & TECHNOLOGY (USPS 462-050) (with which is combined PF Reporter) is published monthly by Intertec Publishing Corp., P.O. Box 12901, 9221 Quivira Road, Overland Park, KS 66212-9981. Second Class Postage paid at Shawnee Mission, KS 66201. Send Form 3579 to P.O. Box 12901, Overland Park, KS 66212-9981.

ELECTRONIC SERVICING & TECHNOLOGY is the "how-to" magazine of electronics. It is edited for electronic professionals and enthusiasts who are interested in buying, building, installing and repairing home-entertainment electronic equipment (audio, video, microcomputers, electronic games, etc.).

Subscription prices to qualified subscribers: one year \$15, two years \$26, three years \$34 in the USA and its possessions. Foreign countries: one year \$20, two years \$30, three years \$40. Single copy price \$2.25; back copies \$3.00. Adjustment necessitated by subscription termination to single copy rate. Allow 6 to 8 weeks delivery for change of address. Allow 6 to 8 weeks for new subscriptions.

PHOTOCOPY RIGHTS: Permission to photocopy for internal or personal use is granted by Intertec Publishing Corp. for libraries and others registered with Copyright Clearance Center (CCC), provided the base fee of \$2 per copy of article is paid directly to CCC, 21 Congress St., Salem, MA 01970. Special requests should be addressed to Cameron Bishop, publisher.
ISSN 0278-9922



INTERTEC PUBLISHING CORP.

©1982 All rights reserved.

Our new model 128 has a beeper and a whole lot more. After you've seen it we think you'll agree that this is the best all around field service DMM available. It beeps on all three functions—V, Ω and A—and on all ranges for each function. Applications are virtually unlimited. It "displays" a standard digital readout, an audible tone for rapid over/under checks and an over/under arrow.

The sound choice.

Unique 128 design enables you to verify forward conduction and reverse blocking of semiconductor junctions, test LEDs and check multiple junction components. Even with the beeper on, the 128 maintains 10M Ω input resistance. You can calibrate both the beeper threshold and the A/D without disassembling the instrument.

The 128 is human engineered with a large, 0.6" display, rugged ABS case and display window, 350-hr battery life and overload protection.

Much less versatility can cost much more than \$139.

The 128 is the sound choice because it's the smart buy. Contact your local Keithley representative or distributor.

KEITHLEY

Keithley Instruments, Inc.
28775 Aurora Road/Cleveland, OH 44139
(216) 248-0400/Telex: 98-5469

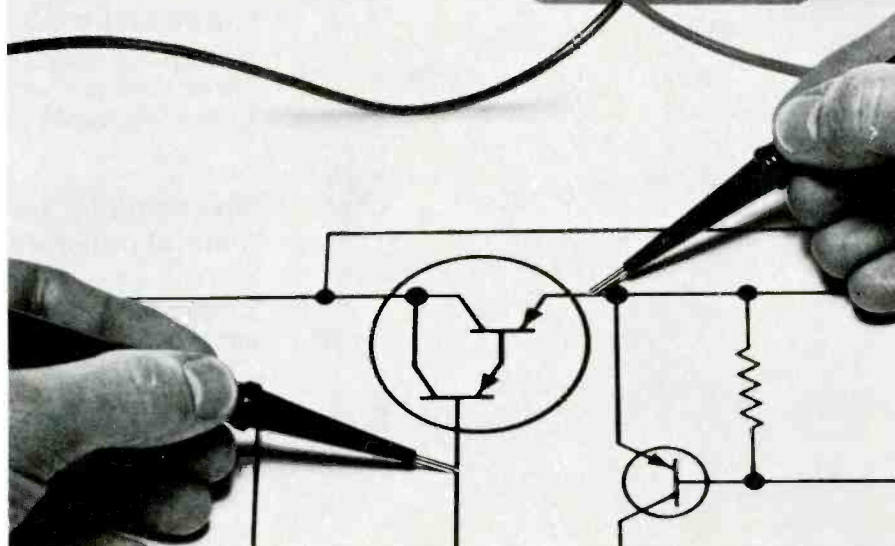

Circle (4) on Reply Card

The how-to magazine of electronics...

ELECTRONIC

servicing & Technology

July 1982

Volume 2, No. 7



The Columbia space shuttle has become the focus of many people around the world, but is of special interest to amateur radio operators. See story on page 8. (Photo courtesy of NASA.)

8

Calling CQ, DE WA0OVC

By Carl Bentz

A licensed First Class radio-telephone engineer explains why he has become involved in amateur radio.

12

Innovation in electronics

By Alan Burkitt, *Computing magazine*

Inventor Clive Sinclair has introduced low-cost computers and flat-screen televisions to the British market.

26

The space shuttle: A ham radio special event

By Nils Conrad Persson, *editor*

While the Columbia circles the earth, amateur radio operators all over the world try to contact the Johnson Space Center Amateur Radio Club in Houston.

30

The basics of tape recording

By Carl Babcoke, *CET*

This is the first of a series of articles on adjustments and repairs of tape-recording equipment and audiocassettes.

36

Car radio tune ups

By Homer L. Davidson

Common test methods for car radio repairs are supplemented by nine case histories of typical component failure.

44

Noteworthy CB circuits

By Harold Kinley, *CET*

Three circuits that incorporate special features in unique ways are featured.

50

Searching for buried treasure: A metal detector primer

By Daniel Tavares, *Silver Dollar Electronics*

Rising gold prices and inflation have brought a boom in the metal-detector branch of the electronics industry.

54

Absolute Center Search System: The newest weapon against wow and flutter

Nakamichi's \$7000 computing turntable is out of most people's price range, but involves interesting technology.



Page 12

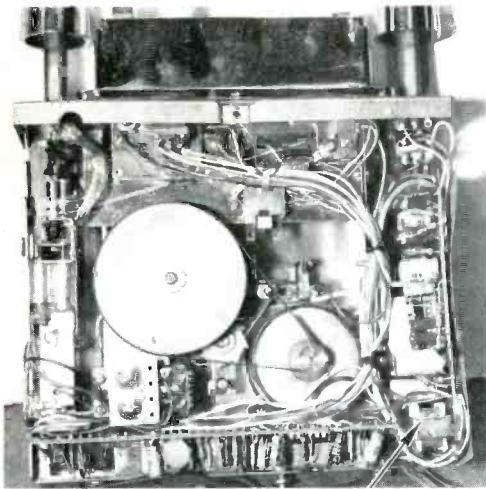

Page 36



Page 50

Departments

- 4 Editorial
- 5 Scanner
- 6 Association News
- 20 Book Reviews
- 22 Calendar of Events
- 24 Symcure
- 43 Reader's Exchange
- 58 New Products
- 62 New Literature

Next month...

What is an industrial robot? To many people, the word robot brings to mind R2D2-like creatures that will put thousands of humans out of jobs. Actually, industrial robots are machine tools that are limited in what they can be programmed to do. This article describes the various types of industrial robots available today and their common applications.





good reasons

1. RCA SK Devices

More and more electronic technician dealers are reaching for reliable RCA solid state replacements . . . the line of integrity, with unsurpassed engineering excellence. Our warranty return rate is less than 0.5%, which helps reduce costly service call-backs. And SK devices are readily available, to help you do more jobs, more profitably.

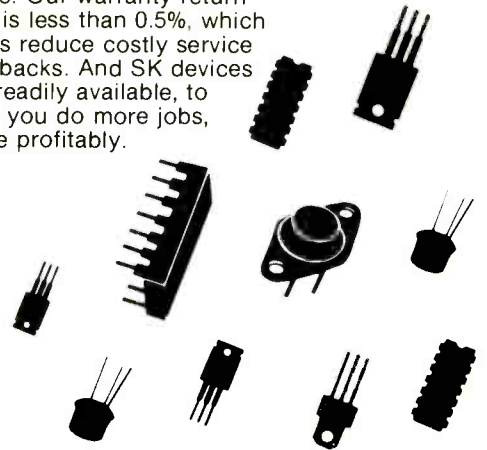

EDITORIAL

Electronic technology has vastly increased the ability to communicate over long distances. We have gotten to the point where we take for granted the telephone; that amazing system that can almost instantaneously connect us with anyone else, nearly anywhere in the world. Communications satellites make it possible for television to broadcast events taking place half a world away, as they happen. The Voyager space program transmitted electronic messages millions of miles from Jupiter and Saturn. That information was reconstructed here on Earth to give us views of those planets with detail undreamed of by Galileo, Kepler and Brahe.

Amateur radio and citizens' band radio have, in different ways, contributed greatly to the ability of private individuals to communicate over considerable distances. Two-way mobile radios have helped businesses, government agencies and rescue organizations save time, fuel and often lives by speeding the dispatch of vehicles.

In spite of remarkable technological achievements in telecommunications, which have apparently done so much to bring people together across geographical distances, it seems that we have not learned to truly communicate. As an example, during the early stages of the British/Argentine dispute over the Falkland

Islands, a newspaper or magazine article mentioned that communications technology had progressed so far that the British forces on the battlefield would probably be able to be in direct and immediate contact with their leaders thousands of miles away, back in England, via communications satellite. And yet, the Falklands problem precipitated because the principals involved had failed to communicate across a table a few feet wide.

A strong case can probably be made that many of these modern, sophisticated communications devices not only fail to help us truly communicate, but in fact sometimes actually impede communication. Have you ever tried to talk to someone with one of those little radios or tape recorders on his belt and earphones stuck in his ears? And what has happened to intra-family communications since television, the "electronic fireplace," has taken the place of the real thing?

This is not meant to be an indictment of electronic communications equipment. They're wonderful, effective tools. But they're extremely complex tools whose use requires knowledge. We just need to try much harder to learn how, and when, to use them.

Nils Conrad Persson

to reach for reliability.

2. RCA SK Series Replacement Guide

It's the book to turn to for top-performing transistors, rectifiers, thyristors, high-voltage multipliers and integrated circuits. 1800 SK and KH types let you make over 178,000 solid state replacements.

That's interchangeability. The guide features a convenient, dual-numbering system—including REN, ECG and TM systems in corresponding SK numbers where applicable.



3. RCA's latest SK SKoop

Get all the latest news and service updates in the SK SKoop newsletter. Published periodically, it keeps you in tune with any changes in the RCA SK lineup, including product additions, deletions and modifications. The SK SKoop is full of handy service tips, technical information and helpful application advice. It's yours free, and right at your fingertips. Pick up your copy from the counter display at your local RCA SK Distributor.

With dealer support like this, it makes sense to visit your RCA SK Distributor and reach for reliability.

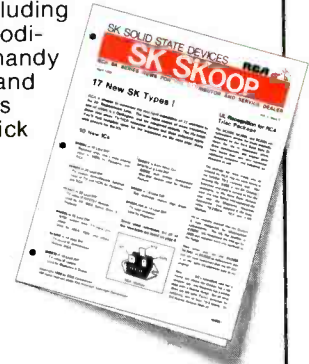

RCA SK Replacement Solid State

RCA Distributor and Special Products Division, Deptford, N.J. 08096

**ELECTRONIC
SCANNER**

Yearbook features industry summaries and forecasts

According to the *Home Video Yearbook*, published by Knowledge Industry Publications Inc. of White Plains, NY, consumer home video expenditures for principal segments of the U.S. market are estimated at \$3.76 billion for 1980, a figure that is expected to more than triple to reach \$12.5 billion by 1985.

The U.S. market is only part of the worldwide boom in cable television, video hardware and programming. *The Home Video Yearbook* points out, for example, that German consumers spent \$440 million on video in 1980, while Japanese consumers are buying VCRs at the rate of 1.3 million per year.

The volume is available for \$75 from Knowledge Industry Publications Inc., 701 Westchester Ave., White Plains, NY 10604, 1-914-328-9157. Telex VISTA Inc. WHP 131514.

ICS offers computer courses across country

Integrated Computer Systems will offer courses for fall that include computer network design and protocols, structured design and programming, and computerized robots. The courses, priced at \$845 each, will be held in several locations across the country, from September to December.

For more information, contact Ruth Dordick, Integrated Computer Systems, 3304 Pico Blvd., P.O. Box 5339, Santa Monica, CA 90405, 1-213-450-2060.

1981 U.S. electronic factory sales up 10.5%

An increase of 10.5% in 1981 U.S. factory shipments of electronic equipment, systems and

components over the 1980 total has been announced by the Electronic Industries Association. Total sales reached \$114 billion in 1981, compared to \$103 billion in 1980.

The association noted that while the United States experienced an overall trade deficit of \$27.5 billion in 1981, the electronic industries produced a \$3.9 billion trade surplus.

EIA is the national trade association representing all segments of electronics manufacturing, from the home TV set to the most sophisticated electronic systems used in national defense and space exploration.

Interstate Electronics to hold voice-recognition conference

Interstate Electronics Corporation will hold the industry's first vendor-sponsored International Voice Recognition Users Group Meeting. The event will be held June 21-22 at the Nordic Hills Conference Center in Itasca (Chicago area), IL.

The conference objective is to stimulate discussion of voice-recognition technology, hardware, software and application environments.

The 2-day conference will include two workshops with nine speakers presenting application papers. The workshop will be moderated by Alan Strass of General Electric Company; Robert Van Peurse, Kodak Company; Richard Bergeon of Abbott Labs and Don Davenport of Boeing Computer Services.

Communications courses offered for summer

The continuing engineering education department of George Washington University is offering a selection of courses in communications for July through September.

The topics include frequency synthesizers, synchronization in spread-spectrum systems, telecommunications traffic engineering, telecommunications acquisition and management, spread-spectrum communications systems, mobile communications engineering and digital telephony.

For more information, contact Continuing Engineering Education, George Washington University, Washington, DC 20052.

MIT offers intensive microprocessor course

Methodologies used to achieve efficient microprocessor software design will be presented in "Microprocessor applications: Software and hardware techniques," an intensive course to be presented at the Massachusetts Institute of Technology on July 12-

18, and July 26-August 1.

Seven full days of intensive instruction in advanced programming practices, program debugging techniques, hardware/software interfacing, and system testing and evaluation will be offered. Emphasis will be placed on top-down program design, subroutine organization and program documentation.

Substantial hands-on laboratory work will be included, applying and reinforcing the ideas presented during the course. Through the laboratory work, participants also can observe the characteristics and limitations of real-time, high-performance assembly language and software. Participants should have a basic knowledge of 8-bit microprocessor hardware and software.



Eight named to life membership by electronic VIP Club

Life membership in the Electronic VIP Club has been bestowed upon eight more accomplished individuals.

New manufacturer members are Homah C. Collie, Jr., Thordarson Meissner; James N. Mills, McGraw-Edison Company, Bussman Division; Oscar B. Rudolph, AMP; and Glenn Young, Motorola Semiconductor Products.

Distributors elected are Len Benckenstein, Southwest Electronics, Stafford, TX; Robert R. Daugherty; Swieco, Fort Worth, TX; and Oliver Goold, GBL/Goold Electronics, Elk Grove Village, IL. Jim Jordan, Moxon Electronics, Anaheim, CA, is the new rep member of the club.

The E-VIP club regularly recognizes the contributions of individuals to the industry through

association work and creative industry leadership. For more information, contact the executive vice president, Sanford Levey, at 4900 N. Elston Ave., Chicago, IL 60630, 1-312-283-4800.

CompuFix provides technical information to NESDA members

Members of the National Electronics Service Dealers Association (NESDA) will soon be able to obtain instant technical information on their computer terminals as a result of an agreement reached May 1 between NESDA officers and CompuFix (formerly known as Compu-tel) to provide this service to NESDA members on a monthly fee basis.

The CompuFix network consists of a data base of technical tips inputted by the group of service dealers who formed this company last year. Electronic servicing information is being added to the data base at a rate of 500 tips per week. Presently, the system has close to 10,000 tips available for instant access in over 600 cities in the United States via a phone call.

Other data to be available in the system include parts pricing and

service contract management for the retail service dealer. Technical tips are currently available for TV sets, videotape recorders, videodiscs, TV games, audio products and auto sound.

For more information about NESDA member benefits, including the CompuFix, contact J.W. Williams at NESDA, 2708 W. Berry, Ft. Worth, TX 76109 1-817-921-9061.

EIA president appointed Peace Corps advisor

Peter F. McCloskey, president of the Electronic Industries Association (EIA), has been sworn in as a member of the Peace Corps Advisory Council. Appointed to the council by President Reagan, McCloskey will review Peace Corps policies and operations and provide recommendations to the Peace Corps director.

As president of EIA, he oversees the activities of the national trade association, representing the full spectrum of U.S. manufacturers in the \$114 billion electronics industry.



7+11 SWD PARTS KITS

MITSUMI VARACTOR UHF TUNER Model UES-A56F **\$34.95**

Freq. Range UHF470 - 889MHz
Antenna Input 75 ohms
Channels 14-83 Output Channel 3

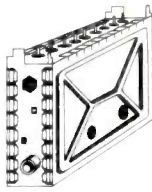

KIT NO.	PART NO.	DESCRIPTION	PRICE
1	VT1-SW	Varactor UHF Tuner, Model UES-A56F	\$34.95
2	CB1-SW	Printed Circuit Board, Pre-Drilled	18.95
3	TP7-SW	P.C.B. Potentiometers, 1-20K, 1-1K, and 5-10K ohms, 7-pieces	5.95
4	FR35-SW	Resistor Kit, 1/4 Watt, 5% Carbon Film, 32-pieces	4.95
5	PT1-SW	Power Transformer, PRI-117VAC, SEC-24VAC, 250ma	6.95
6	PP2-SW	Panel Mount Potentiometers and Knobs, 1-1KBT and 1-5KAT w/Switch	5.95
7	SS14-SW	IC's 7-pcs, Diodes 4-pcs, Regulators 2-pcs, Heat Sink 1-piece	29.95
8	CE9-SW	Electrolytic Capactor Kit, 9-pieces	5.95
9	CC33-SW	Ceramic Disk Capacitor Kit, 50 W.V., 33-pieces	7.95
10	CT-SW	Variable Ceramic Trimmer Capacitor Kit, 5-65pfd, 6-pieces	5.95
11	L4-SW	Coil Kit, 18mhs 2-pieces, 22µhs 1-piece (prewound inductors) and 1 T37-12 Ferrite Toroid Core with 3 ft. of #26 wire	5.00
12	ICS-SW	I.C. Sockets, Tin Inlay, 8-pin 5-pieces and 14-pin 2-pieces	1.95
13	SR-SW	Speaker, 4x3" Oval and Prepunched Wood Enclosure	14.95
14	MISC-SW	Misc. Parts Kit Includes Hardware, (6/32, 8/32 Nuts & Bolts), Hookup Wire, Ant. Terms, DPOT Ant. Switch, Fuse, Fuseholder, etc.	9.95
When Ordering All Items, (1 thru 14), Total Price			139.95

UHF ANTENNAS and ACCESSORIES

MDS-AMATEUR-ETV 32 ELEMENT YAGI ANTENNA

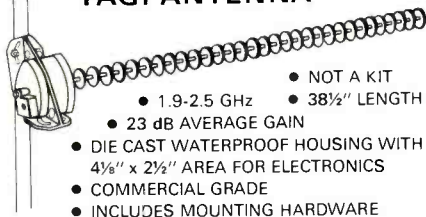

- NOT A KIT
- 1.9-2.5 GHz
- 38 1/2" LENGTH
- 23 dB AVERAGE GAIN
- DIE CAST WATERPROOF HOUSING WITH 4 1/2" x 2 1/2" AREA FOR ELECTRONICS
- COMMERCIAL GRADE
- INCLUDES MOUNTING HARDWARE

MAE-1 32 Element YAGI Antenna \$19.95

ZYZX

VHF-UHF WIDEBAND ANTENNA AMPLIFIER

MODEL ALL-1
50 MHz — 900 MHz
12 dB GAIN ± 0.5dB

A Revolutionary New One Stage HYBRID IC Broadband Amplifier

This unit is not available anywhere else in the world. One unit serves many purposes and is available in Kit or Assembled form. Ideal for outdoor or indoor use. I/O impedance is 75 ohms. Amplifier includes separate co-ax feed power supply. Easily assembled in 25 minutes. No coils, capacitors etc. to tune or adjust.

ALL-1 Complete Kit with power supply \$24.95
ALL-1 Wired and Tested with power supply \$34.95

Our New STVA 14.5 dB GAIN, 14 ELEMENT CORNER REFLECTOR YAGI ANTENNA



STVA-3 Yagi Antenna, 14.5 dB, 75 ohm, Chan. 60-68 \$16.95
STVA-4 Yagi Antenna, 14.5 dB, 75 ohm, Chan. 44-52 \$16.95
STVA-1 Yagi Antenna, 11.5 dB, 75 ohm, Chan. 42-54 \$9.95

RG-59/U 75 ohm Low Loss Coax Cable \$.12 p/ft
F-59 Coaxial Connectors, ea. .39
MT-1 Special UHF 75-300 ohm Matching Transformer, ea. 1.45

Switch to Bambi!

Electronically

Bambi Electronic Video Switch ... makes switching of your VCR/VTR, Pay TV Decoders, Cable TV, Video Discs, Video Games, Closed Circuit TV, Antennae and Microcomputer as easy as pushing buttons.

The Bambi Electronic Video Switch is an electronic switching network which can accept up to six different sources of video signals and provide the flexibility of directing the inputs to any or all of the three outputs.

Now you can eliminate ... the drudgery of disconnecting and reconnecting your video equipment each time you use it ... the tangled mess of cables which are impossible to trace out ... not being able to use more than one function at a time.

Bambi lets you enjoy using your video equipment the way it should be ... electronically and on line at the push of a button.

Model BEVS-1

\$129.95

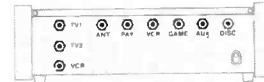
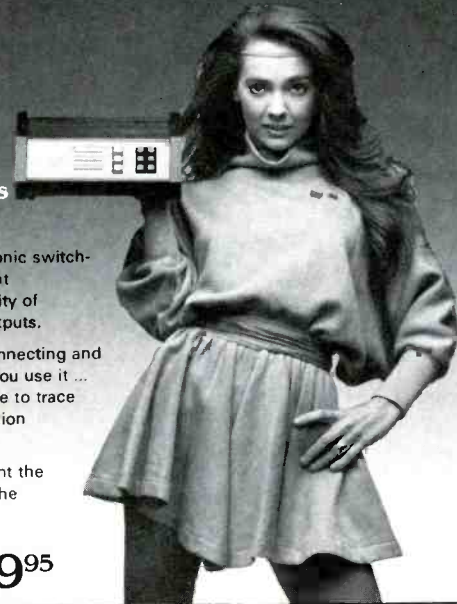

Bambi's front panel was designed with the user in mind. Computer styled construction, with soft-touch keyboard (rated for over 10 million operations), arranged in matrix form allows easy input/output selection without referring to charts. Functions selected through the keyboard are immediately displayed on the 18 LED status indicators.

Check the quality of Bambi against that of much higher priced competition. All solid state electronic switching provides low attenuation (3dB), wide frequency response (40-890 MHz), and excellent isolation between signal sources (each I/O section individually shielded for 65dB min. isolation).

Bambi's Specifications:

- Input/Output Impedance 75 ohm
- Signal Loss 3dB ±1dB
- Noise 4dB ±1dB
- Input Return Loss 12dB min.
- Isolation 65dB min.
- Power Req. 117VAC 60 Hz, 2W
- Dimensions 10 1/2" W x 6 1/4" D x 3 1/4" H
- Weight 4 1/2 lbs

SWD-1 VIDEO CONVERTER

FOR CABLE TV



The SWD-1 Video Converter is utilized on cable TV systems to remove the KHz's signal from a distorted video (channel 3 in/out) and also pass thru the normal undistorted/detected audio signal. Rocker switch selects operating mode to remove KHz's distortion from the video or pass all other channels normally. Simple to assemble—less than 30 minutes. Pre-tuned. Input/output Channel 3. Impedance 75 ohms. 117VAC.

SWD-1 Video Converter Kit \$69.95

VTR ACCESSORIES

SIMPLE SIMON VIDEO STABILIZER



Simple Simon Video Stabilizer, Model VS-125, eliminates the vertical roll and jitter from "copy guard" video tapes when playing through large screen projectors or on another VTR. Simple to use, just adjust the lock control for a stable picture. Once the control is set, the tape will play all the way through without further adjustments. Includes 12V power supply.

VS-125 Video Stabilizer, wired \$54.95

SIMPLE SIMON VIDEO SWITCHING BOX



The Affordable Video Control Center

Excellent in isolation and no loss routing system. Simple Simons VSB-300 Video Switching Box enables you to bring a variety of video components together for easy viewing/dubbing. Also you gain the ability to record one channel while viewing another. Unit includes two F-type quick connector ended cables.

VSB-300 Video Switching Box, wired \$19.95

7+11 PWD PARTS KITS

INTRODUCING OUR 7+11 PWD PARTS KITS



KIT No.	PART NO.	DESCRIPTION	PRICE
1	1VT1-PWD	Varactor UHF Tuner, Model UES-A56F	\$34.95
2	2CB1-PWD	Printed Circuit Board, Pre-drilled	18.95
3	3TP11-PWD	PCB Potentiometers 4-20K, 1-5K, 2-10K, 2-5K, 1-1K, and 1-50k (11 pieces)	8.95
4	4FR-31-PWD	Resistor Kit, 1/4W, 5% 29-pcs, 1/2 W 2-pcs	4.95
5	5PT1-PWD	Power Transformer, PRI-117VAC, SEC-24VAC at 500ma	9.95
6	6PP2-PWD	Panel Mount Potentiometers and Knobs, 1-1KBT and 1-5KAT with switch	5.95
7	7SS17-PWD	IC's 7-pcs, Diodes 4-pcs, Regulators 2-pcs, Transistors 2-pcs, Heat Sinks 2-pcs	29.95
8	8CE14-PWD	Electrolytic Capacitor Kit, 14-pieces	6.95
9	9CC20-PWD	Ceramic Disk Capacitor Kit, 50 WV, 20-pcs.	7.95
10	10CT5-PWD	Variable Ceramic Trimmer Capacitor, 5-65pfd, 5-pieces	4.95
11	11L5-PWD	Coil Kit, 18mhs 3-pcs, 22µhs 1-piece (prewound inductors) and 2 T37-12 Ferrite Toroid cores with 6 ft. #26 wire	6.00
12	12ICS-PWD	IC Sockets, Tin Inlay, 8 pin 4-pcs, 14 pin 1-pc and 16 pin 2-pcs	2.95
13	13SR-PWD	Enclosure with PM Speaker and Pre-drilled Backpanel for mounting PCB and Ant. Terms	14.95
14	14MISC-PWD	Misc. Parts Kit, Includes Hardware, (6/32, 8/32 Nuts & Bolts), Hookup Wire, Solder, Ant. Terms DPOT Ant. Switch, Fuse, Fuseholder, etc.	9.95
15	15MC16-PWD	Mylar Capacitors, 14-pcs and Silver Mica Capacitors 2-pieces	7.95
When Ordering All Items, (1-15), Total Price			159.95

SIMPLE SIMON ELECTRONIC KITS,™ Inc.

Calif. Orders:
3871 S. Valley View, Suite 12
Dept. E
Las Vegas, Nevada 89103
Tel: (702) 322-5273

All Other Orders:
11850 S. Hawthorne Blvd.
Dept. E
Hawthorne, Calif. 90250
Tel: (213) 675-3347

Available by Mail Order Only
Send Check* or Money Order. Minimum Order: \$16.95. Add 10% Shipping and Handling on orders under \$40.00. For orders over \$40.00, add 5%. Minimum Shipping and Handling \$2.00. Cat. \$1.00 — VISA and Mastercard Acceptable — *Check orders will be held 30 days before shipping.

RADIO **WAØVVC** Confirming our AUG 2 1972
 QSO of 217
 on 7241 MHz
 Your station is 130R
 Remarks TAX FOR FR
 GSC AND GSC CHAND
 GOOD GIB THAT WAS COMING
 THROUGH QUITE HEAVY GRN
 Bill

TO AMATEUR RADIO
 STATION **WAØVVC**
CARL BENTZ
 314 South Main
 KANSAS CITY, KANSAS
 66103

RADIO **WAØVVC** CONFIRMING OUR
 QSO OF MAR 2 1972 AT 129 GMT
 ON 7.230 MHz
 XMITR 180W PEP
 RCVR 80.40 Dipole
 ANT
 REMARKS
 Thanks for my first
 Kansas on 40M for
 SB W.A.S.
 BCNU on 10!

AMATEUR RADIO **WAØVVC**
 OPERATOR: **CARL**

RADIO **WAØVVC** CONFIRMING OUR
 QSO ON 23 MHz
 ON 7.230 MHz
 XMITR 180W PEP
 RCVR 80.40 Dipole
 ANT
 REMARKS
 Thanks for my first
 Kansas on 40M for
 SB W.A.S.
 BCNU on 10!

AMATEUR RADIO **WAØVVC**
 OPERATOR: **Carl Bentz**
 314 South Main
 Kansas City, Kansas
 66103

RADIO **WAØVVC** Confirming our
 QSO of 6-4 1972
 on 7147 MHz
 TRANSMITTER
 RECEIVER
 ANTENNA
 REMARKS
 PSE OBL TNR
 LEO



Calling CQ, DE WAØVVC

By Carl Bentz, A.R.S. WAØVVC,
licensed First Class Radio-Telephone Engineer

Ever since I received my first amateur radio license in May 1966, people have asked me why I became a ham. I doubt that my answer has ever satisfied their curiosity, but I think that it takes only a little thought to realize the possibilities of worldwide communications capabilities. I find it fascinating to be a part of a vast organization that has been a part of developing new communications techniques, as well as improving established modes.

I have worked with civilian and

military communications groups to get traffic through when other links were not available or were so busy that an important message would be delayed. And were family wishes otherwise, I would be available during inclement weather to assist in a local network that aids in spotting tornados, a means by which amateur-radio and civil-defense people cooperate to provide an early warning system.

The amateur radio service is only a part of the world of 2-way radio, but it is more interesting

than the business band. Hamming provides an interactive operation, something not available in public service and aeronautical communications systems. Although licensing is required and can be a hassle, this control allows a far greater operating latitude than even illegal CB operators will find.

Just as with the vast multitudes that joined in the CB craze several years ago, there are bad apples in the amateur radio field. But unlike with CB, there are steps that may be taken to get rid of those who

To Radio WADOVC
 Confirming our QSO of

In the event of a national emergency, hams may be of greater value than the nationwide network of broadcast stations and the emergency broadcast system.

break rules issued by the federal government. Many operators do take part to serve society when communications have otherwise broken down. During natural disasters, such as earthquakes, hurricanes and floods, hams have often chipped in to pass messages to friends and relatives, as well as directed emergency services into locations needing aid when telephone lines are destroyed. In the event of a national emergency, the amateur operator may be of greater value than the nationwide network of broadcast stations and the emergency broadcast system. Hams and civil defense people currently hold practice exercises to better understand the needs and requirements of communications in such a disaster.

There is no general profile that can be drawn for this group of men, women and children. There are few trends between occupations and hamming, though one will discover an expectedly large percentage of hams who are also licensed staff engineers in radio and TV broadcast stations. One or two traits seem to be common among this army of people—a desire to communicate and aid others with their special capabilities, and a curiosity that keeps them striving to improve those capabilities. That curiosity has brought about major advances in communications technology in several cases.







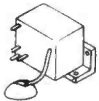

The world of amateur radio probably began about the same time as the experimentation by Guglielmo Marconi. His early transmissions with spark-gap transmitters left a great deal to be desired. As everyone soon discovered, the spark gap was inefficient in terms of frequency spec-

trum used per contact. Tuned circuits, using capacitive and inductive components, narrowed the spectrum of a transmission, which allowed many users of available frequencies.

Today many think that the mode of operation was crude, but those early contacts using telegraphic code, a system that was heavily used by the railroad industry, were quite efficient. In fact, Morse Code is still the most reliable means of getting a message through man-made and natural noise and inter-

ferences. By keying the carrier signal on and off, corresponding to dots and dashes, the characters of the code are placed on the airwaves. At the receiving end, the recovered radio waves are mixed with another signal, locally generated, to make the dots and dashes audible.

As amplitude modulation became a reality in broadcasting, it became a part of amateur operation. But because restrictions were being placed on the frequencies hams were able to use, AM tech-

INTER-TEC		INTER-TEC	
SUMMER SPECIALS			
2SC867A		\$3.29	
2SC1172B		\$2.95	
2SC1308K		\$2.29	
2SD313.....		\$.45	
AN214		\$1.65	
HA1377.....		\$3.45	
M51515BL.....		\$3.75	
TA7205		\$1.40	
UPC1181		\$2.25	
UPC1182		\$2.25	
High Voltage Tripler  HVT-523 \$11.99	Universal "Piggy- Back" Antenna  ATU- 538 \$1.95	Cooling Spray 15 ozs.  TCS-15 \$2.20	
300 Ohm Splitter  UVF- 300 90¢	Piezo Tweeter  PZT-35 \$5.75	75 Ohm Splitter  UVF-75 95¢	
Tuner Cleaner 16 ozs.  TTC-16 \$2.00	Matching Transformer  TMT-300 46¢	High Voltage Tripler  HVT-500 \$9.99	
PHONE OR WRITE FOR OUR NEW CATALOGUE TODAY!			
INTERNATIONAL TRANSISTORS AND ELECTRONIC COMPONENTS P.O. Box 1483 Union, N.J. 07083		NATIONWIDE: 800-526-4958 NEW JERSEY: 201-688-0300	

Circle (7) on Reply Card

niques used too much of their bandwidth for a contact. Interference was excessive as signals overlapped. Also, radio phenomena results in some unusual problems. Just because someone at Location A can easily hear a signal from Location B, it is not always the case that the signal from B will be heard at A. However, both could well be apparent at Location C, and in fact interfere with other signals at C. Something had to be done to conserve the bandwidth of any one communications link.

To Radio

WA00VC

Confirming our QSO of

OSCAR, short for orbiting satellite carrying amateur radio, is an intriguing method that allows the ham to communicate to the satellite on one frequency and receive on another.

And so, in the 1950s, when the military needed an improved mode of contact between aircraft and their bases, they turned to a technique that amateur radio operators had developed. Someone had theorized that the carrier of a radio signal was not absolutely necessary. Similarly, it was suggested that both of the sidebands of a radio signal were not strictly essential to reception of a radio signal. Remember that modulating a carrier for AM, or mixing audio with a carrier, results in a sum and difference of the frequencies, which appears as an upper and a lower sideband, or new frequency, above and below the carrier. The two are mirror images, containing the same information.

If the carrier were to be removed in the transmitter, and the signal was still transferred through the air, then a new carrier could be inserted within the receiver. Proof that double-sideband suppressed carrier transmissions would work was found. The next step required filtering to remove one or the other of the sidebands, a mode called single-sideband suppressed

carrier transmission. Not only did the SSB mode, referred to as A3J transmissions, work, but also it was less prone to total disruption by noise conditions, required less than half the frequency spectrum and, because the energy usually wasted in an unnecessary carrier was not used, the single sideband use was more energy efficient. The circuitry was more complicated than AM transmitter wiring, but SSB mode is in use on almost every available amateur band today.

In those early days of playing with the sidebands of a transmission, another suggestion was made and tried: Why not generate two independent sidebands, then combine them for transmission, without a carrier? At the receiver use crystal circuitry to achieve the needed stability and treat the two sidebands separately, processing them through totally independent receiver circuits. Receiver costs of the process were excessive, but the concept did result in very early transmission of dual-channel material—stereo. High fidelity was not present, because communications equipment is usually limited to pass only those voice frequencies that lie between 300Hz and 3kHz. Studies have found that frequencies outside that 2.7kHz bandwidth offer little intelligibility. That independent-sideband, suppressed carrier operation (ISB) would be of some use later to the amateur operator.

Frequency modulation, a technique developed commercially by Armstrong for broadcasting, offered a new challenge to amateurs. Generally limited to shorter distances than other modes, FM provided a rather noise-immune mode of contact. If many operators tried to use wideband FM ($\pm 75\text{kHz}$ from a carrier), as the commercial FM stations use, interference between contacts would be unbearable. Hams continued to develop methods of decreasing bandwidths.

Finally, the business and public service bands were developed, based on the technological improvements. It was discovered that for line-of-sight communications, FM could be transmitted and received using small *vertical* antennas that could easily be installed on a vehicle. FM thus be-

came the primary mobile mode of radio communications for hams as well as for more commercial services. Using deviations of 5kHz and less, many transmissions could be simultaneously held within a relatively limited frequency band.

Another type of frequency modulation was also of value to amateurs and other groups. Frequency-shift keying (FSK) actually varies the carrier from one "fixed" frequency to another, producing a 2-tone signal for radio teletype or RTTY transmission. RTTY is a quasi-digital mode that results in a printed output. One tone, called the *mark*, and the second, *space*, could be produced according to a coding scheme set forth as the Baudot teletype code. Each character is assigned a specific combination of five mark and/or space time intervals. Each also includes a *start bit* and a *stop bit* to aid in synchronizing the teletype machines.

Heavily used at one time for military and news service traffic, the original frequency shift of 850Hz was finally deemed a waste of spectrum. As filter techniques improved, and integrated circuits provided very small sharp active filter circuits, the carrier shift was reduced to 170Hz and then less. The narrow bandwidth signals resulted in greater noise immunity and greater frequency efficiency, even at higher word-per-minute speeds. Additional advancements in data encoding from the computer industry have finally placed the ASCII computer coding in the hands of amateurs as well, rather than the older Baudot system, for greater character sets and better communications.

Amateur operators have not been limited to those modes already mentioned. Television is available to them—both slow scan, which takes about 8 seconds to form a complete picture, and the typical fast scan used for broadcast. With the slow scan operators, there has been some transmitting of audio on one sideband and video on the other single sideband. Without the independent-sideband operation, there would be no audio for the slow scan pictures. Obviously, in an 8-second time frame, motion must be very limited.

If repeaters can be used for vehicle-to-vehicle links, then why

To Radio *WADOVC*
Confirming our QSO of

When the military needed an improved mode of contact between aircraft and their bases, they turned to a technique that amateur radio operators had developed.

not let the repeater be airborne? Considering the sky to be a current limit, OSCAR, short for orbiting satellite carrying amateur radio, is an intriguing method that allows the ham to communicate to the satellite on one frequency and receive on another. While hams have talked worldwide by CW and SSB modes, Oscar 8, the latest in the series launched in 1980, permits the FM mode to be used for long distances.

Even more exotic links have been developed, such as meteor scatter, using the ionized air left by a meteor trail. With this method, short contacts are made by bouncing the signal off that momentary discontinuity in the atmosphere. Moon bounce, using the moon as a passive reflector, has been tried successfully, and discussions of sporadic E layers and temperature inversions are also atmospheric means of making long distance contacts.

For many years, an amateur's shack was comprised of a great deal of homemade equipment, called "home brew rigs." Few manufacturers felt that it would be economical to develop and build the equipment that an amateur operator wanted. It was the era of home construction projects that saw the ham playing a major role in technological development.

As new circuitry ideas and components began to replace tube technology, things began to change. The number of hams has increased, and with the phase out of tubes, there has been a phasing out of the apparent ability of most amateurs to build, or even repair, their equipment. Most of the receivers and transceivers based on PLL (phase-locked-loop) techniques must be returned to the fac-

tory for occasional repair. Perhaps only one in five of the licensed hams will be capable of servicing the occasional failure.

Equipment from U.S. and Japanese manufacturers now has flooded the market. Such exotic things as broadbanded amplifiers at the end of solid-state systems, scanning systems with automatic off-set switching for VHF mobile equipment, automatic tuning to match the attached antenna and a host of other microprocessor facilities has placed the amateur in a

tenuous position. Progress must continue, and with it, amateurs must also progress in their abilities. If they can develop single sideband equipment from a concept and reduce power consumptions to make battery operation feasible for portable units, taken to both poles for contest contacts and with the folks back home, surely they can also overcome the new technology barriers, or find someone who can.

ES&T

Get **MORE** in capacitor types and ratings at a Sprague Q-LINE™ Distributor

No matter what type of capacitor you're looking for, look for it on a Q-MART® capacitor display. You'll find exactly what you want. That's because the Sprague Q-LINE features a computer-selected inventory of most-frequently-used capacitors. And blister-pak packaging keeps the capacitors clearly visible and fully protected.



For detailed information on all Q-LINE products (capacitors, switches, chassis boxes, optoelectronic devices, DIP/SIP components, resistors, wiring components, etc.) write for 40-page Catalog C-652 to Sprague Products Co., Distributors' Division of the Sprague Electric Co., 65 Marshall St., North Adams, Mass. 01247.

Where MORE is more than a promise.



Circle (8) on Reply Card

Innovation in electronics

British firm
introduces
low-cost computers
and flat-screen televisions



Clive Sinclair holds his new miniature television, Microvision, the commercial realization of a concept that has been around for nearly 30 years.

Advances in technology frequently have the effect of making products smaller, less expensive, or both. These occurrences result in proliferation of the devices and new challenges in servicing them.

Sinclair Research startled the electronics community a few years ago when it announced availability of a microcomputer at a cost of less than \$150, fully assembled, and in kit form for less than \$100. Now the company has developed a hand-held "flat-screen" TV that is expected to go on the market in England soon.

There are other companies involved in the production of small TV sets. Sony, for example, has recently announced their hand-held flat-screen TV. (You can see it in the New Products section of the June issue of **Electronic Servicing & Technology**.) No doubt sets such as these will soon be showing up at TV service shops. Is anyone prepared to diagnose and fix them?

The following article discusses the approach taken by Sinclair to bring high-technology electronic products to market, describes some of the products now available from that company, and speculates about some that may be in the works.

By Alan Burkitt, Features Editor,
Computing magazine, London

In London last April, a roomful of journalists applauded when Clive Sinclair sat down after introducing his third new personal computer in little more than two years. It is remarkable that normally restrained journalists should behave such as this at any time; it is extraordinary that the person so received should be the 41-year-old Sinclair.

Only a few years ago, Sinclair was widely regarded as another failed entrepreneur. He had produced some inventive products but had made them badly. He had been given large sums of government money that evaporated in mounting losses

In July 1979, he abandoned the ruins of his first company, Sinclair Radionics, and formed Sinclair Research. Its first product, the ZX80 personal computer, was launched only seven months later, and from that moment, Sinclair's reputation and fortune have been rising considerably.

The new company achieved sales of \$8.4 million* in its first full financial year, ending March 1981, and earned before-tax profits of \$2 million. Unaudited results for the second year show sales of \$48.6 million and profits of \$18 million.

The new company achieved sales of \$8.4 million in its first full financial year and earned before-tax profits of \$2 million.

Graph goes on rising

The company, still 95% owned by Sinclair himself, will have its third year boosted by the new ZX Spectrum, (claimed to be competitive with the Commodore Vic 20) and by a flat-screen pocket TV receiver due to go on sale for about \$90 by Christmas.

Also, Sinclair's company is

developing a low-cost office work station for the rapidly reviving British mainframe computer maker ICL. Production is scheduled to start some time in 1983.

So far Sinclair Research has avoided the problems of cash shortage commonly experienced by fast growing operations by contracting out all production. This policy has also meant the new company has not been hit by the biggest problem in Sinclair's first company: lack of reliability. Poor production engineering of its audio systems, calculators, digital watches and pocket televisions overwhelmed Sinclair Radionics. As users sent back their units for repair or replacement, the company's reputation fell, and Sinclair has had to labor hard to overcome the memory of those troubles.

His new venture was formed when the government-owned National Enterprise Board, which had a majority shareholding in Sinclair Radionics, decided that the original company should pull

*All dollar amounts given were converted from pounds sterling at the rate of \$1.80 to the pound, the rate in effect on Friday, May 7, 1982.

OMNITRON: The Source for Quality at Low Cost

Silicon
H.V. Triplers

**HIGH VOLTAGE
MULTIPLIERS**



SYLVANIA Triplers

ECG-500A

212-139
212-139-01
212-139-02

\$12⁹⁵ ea.

ECG-523

212-141
212-141-01

\$15⁰⁰ ea.

ECG-526A

212-141-02
212-141-03
212-141-04

\$16⁹⁹ ea.

REMEMBER!

Sylvania
Tubes
70% + 10%
OFF
LIST

**Sylvania ECG
Replacement
Semiconductors
and Components**
Full line in stock.
The best quality
semiconductor.

**RG-59/U 75 OHM
Co-Axial Cable
Copper Braided
Shield**

White or Black

\$44⁵⁰/1000 ft.

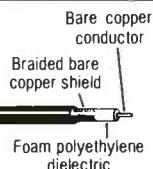

F-59 Connector
with Separate Ferrule
10¢/100 lot

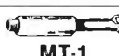

Matching Transformer
75-300 Ohm

MT-1

44¢ ea./100 59¢ ea.



2 Way - 75 Ohm Coupler

MT-2 89¢ ea./100 \$1⁴⁹ ea.



2 SC1172B

\$1⁹⁹

VERY POPULAR

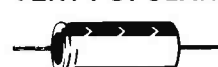

80 MFD x 450 Volts... .99
100 MFD x 450 Volts...1.09

SOLDER (60/40 Rosin Core)
1 lb. .062 dia.
(regular size)
\$7⁹⁹ SOL-1



SILICON RECTIFIER 2.5 Amp/1000 PIV
100/\$9⁹⁵ SL-100

GLOBAR DISC - 120 Ohms Cold
107191 RCA 99¢

10 ASSORTED CIRCUIT BREAKERS
10/\$7⁹⁹ Good Assortment
CB-10

CHEATER CORDS
Polarized C Clip
Price: 39¢ 24620

Standard C Clip
Price: 39¢ 24623

REPLACEMENT RODS

4 Section LAR-4 69¢
5 Section LAR-5 89¢
6 Section LAR-6 99¢
7 Section LAR-7 99¢

G.E. OM-300

\$1⁴⁹

PANASONIC OM-500

\$1⁵⁹

OMNITRON

ELECTRONICS

770 Amsterdam Ave., New York, NY 10025

▶ Also ask for Free 100 Page Catalog ◀

Send Purchase Order, Check or Money Order
or Call Toll Free 800-223-0826

in NY STATE (212) 865-5580

ALL ORDERS SHIPPED UPS/COD F.O.B., N.Y.C.

MASTER CARD • VISA

out of consumer products and concentrate on instrumentation. From the beginning of Sinclair Research, its founder has steered away from production and has concentrated on product development and marketing.

Sinclair's major step for 1982, the flat-screen pocket television, will be the realization of a project that is nearly 30 years old and which Sinclair himself has been associated with for 10 years.

Microvision uses a technique developed in the early 1950s at Imperial College, London, by the late Denis Gabor, the Hungarian-born physicist known for his invention of the concept of holography.

With funds from the government-backed National

Research Development Corporation (NRDC), Gabor planned to make screens 8 feet across. But the idea never went into production, and was dropped until Sinclair picked it up in the early 1970s, with NRDC support for the development.

Deflection plates

Gabor's screen used a conventional cathode beam, but its axis was parallel to the screen. A set of deflection plates bent the beam 90° toward the screen, and other plates handled the horizontal and vertical scanning. Sinclair's tube, to be built at the rate of one million a year by Timex, is virtually the same in principle, except that it will have a 2-inch diagonal screen.

The folded electron optics would distort the picture, so to minimize the effects, the height of the picture is reduced by half in relation to the width, and the correct dimensions are restored optically by a plastic Fresnel lens in front of the screen.

The whole tube measures on 4"x2"x3/4", and the Microvision unit is approximately 6"x4"x1". It will weigh only a few ounces, and is designed to operate with most of the common TV transmission standards in use today. It will also have a built-in FM radio tuner.

Only a monochrome version is planned at the moment, and it looks as though a different approach will be taken for color.

"The high brightness attainable

Filling the gaps in the market for personal computers

Made in Scotland

The bulk of Sinclair's manufacturing is handled at the Dundee, Scotland, Timex factory. The factory has produced all 400,000 models of the ZX81 computer sold so far and will be responsible for both the ZX Spectrum and the Microvision pocket television.

But there is one parallel with Sinclair's old way of doing business: mail order. Sinclair, who started his career as a technical journalist, set up Sinclair Radionics in 1962 to produce radio and amplifier kits for sale to hobbyists through mail-order advertisements. One-half of his British sales of the ZX81 have been through mail order—the rest through an exclusive retail deal with a store chain. He is now aiming at initial sales of the ZX Spectrum of 20,000 a month, entirely through mail order.

Earlier this year, the Timex production deal led to the watchmaking company signing a manufacturing and marketing contract for the North American market. The ZX81, and probably the ZX Spectrum when exports begin in late 1982, will be sold under joint names. Sinclair's marketing operation in Boston will eventually concentrate on Microvision.



A plug-in RAM pack adds 16kBytes of random access memory to the ZX-81.

The ZX Spectrum took Sinclair watchers by surprise. Most had not expected a new computer until late 1982 or early 1983, an opinion that Sinclair confirmed on more than one occasion. But the need for an upgrade path for ZX81 was becoming apparent.

A first step

The ZX81, launched in March 1981 as Sinclair's second computer, filled a gap in the market. At a British price

of £70 (\$126), it is cheap enough to be bought by those who have no knowledge of computers, but are intrigued enough to take a first step, without the risk of large losses if it turns out to be a mistake. But it was obvious that many of these initiates would soon exhaust the potential of the machine, even with the plug-in RAM pack, which adds 16kBytes of random access memory to the standard 1kByte.

The ZX Spectrum, which like the company's two previous computers is built around the Z80A microprocessor, comes in two versions: with 16kBytes of RAM for \$225 and with 48kBytes for \$315. There is no built-in screen, so the unit must be connected to the antenna input of a TV set.

As the name suggests, the Spectrum works in color, while previous models produced a monochrome signal. It also has a sound generator, and there is a standard typewriter-size keyboard instead of the somewhat hard-to-use flat units of the ZX80 and ZX81.

There is a port for the existing Sinclair printer, and it will be possible at a later stage to operate other printers via an RS232 interface, according to the manufacturer.

Later this year Sinclair will be launching a range of microfloppy disc drives, although no details are available. The company promises that it will be possible to use up to eight microdrives, and as many as eight ZX Spectrums will be able to share facilities.



The deflection system that bends the cathode beam through 90 degrees makes a flat screen possible.

with the thin tubes makes them ideal for use with projection systems," a company spokesman said. "Sinclair foresees a 3-tube projection television with a 50-inch-diagonal, full-color display."

Wall screen

The optics and electronics would fit into a small unit, which would project on to a wall screen. The tube is suitable for projection because the image is viewed from the side of the phosphor struck by the electron beam. "The other side of the screen can be connected directly to a heat sink," Sinclair said.

Flat-screen and computer technology will probably be combined next year with the planned work station under development for ICL. It hopes to market this integrated terminal and digital telephone along with the DNX 2000 private, automatic-branch telephone exchange, which is ICL's version of a switch designed and built by Mitel.

ES&T

137 new RCA flameproof metal resistors.

**Now . . .
780 Types
For More Applications**

With values from 0.1 ohm to 22 megohms, RCA Flameproof Metal Resistors cover the great majority of resistor replacement needs in TV, video, and industrial servicing.

- Can replace composition, carbon film, wire-wound and other metal types.
- Tolerance ratings of $\pm 2\%$ on most values. Ratings of $\frac{1}{4}$, $\frac{1}{2}$, 1 and 2 watts.

Get your RCA Flameproof Metal Resistors in convenient, colorful packages from your RCA Distributor today. Or, for further information, write: RCA Distributor and Special Products Division, 2000 Clements Bridge Road, Deptford, N.J. 08096. Attn: Sales Promotion Services.

RCA Flameproof
Metal Resistors

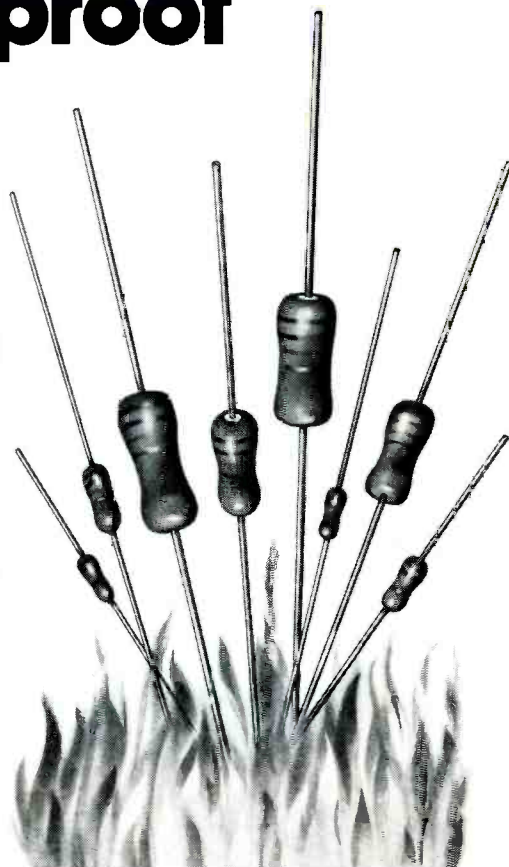

Replace Your Conventional Scope With The Sencore SC61 The First Scope With Pushbutton, Automatic Readout.

\$3275

GSA # GS00S27505

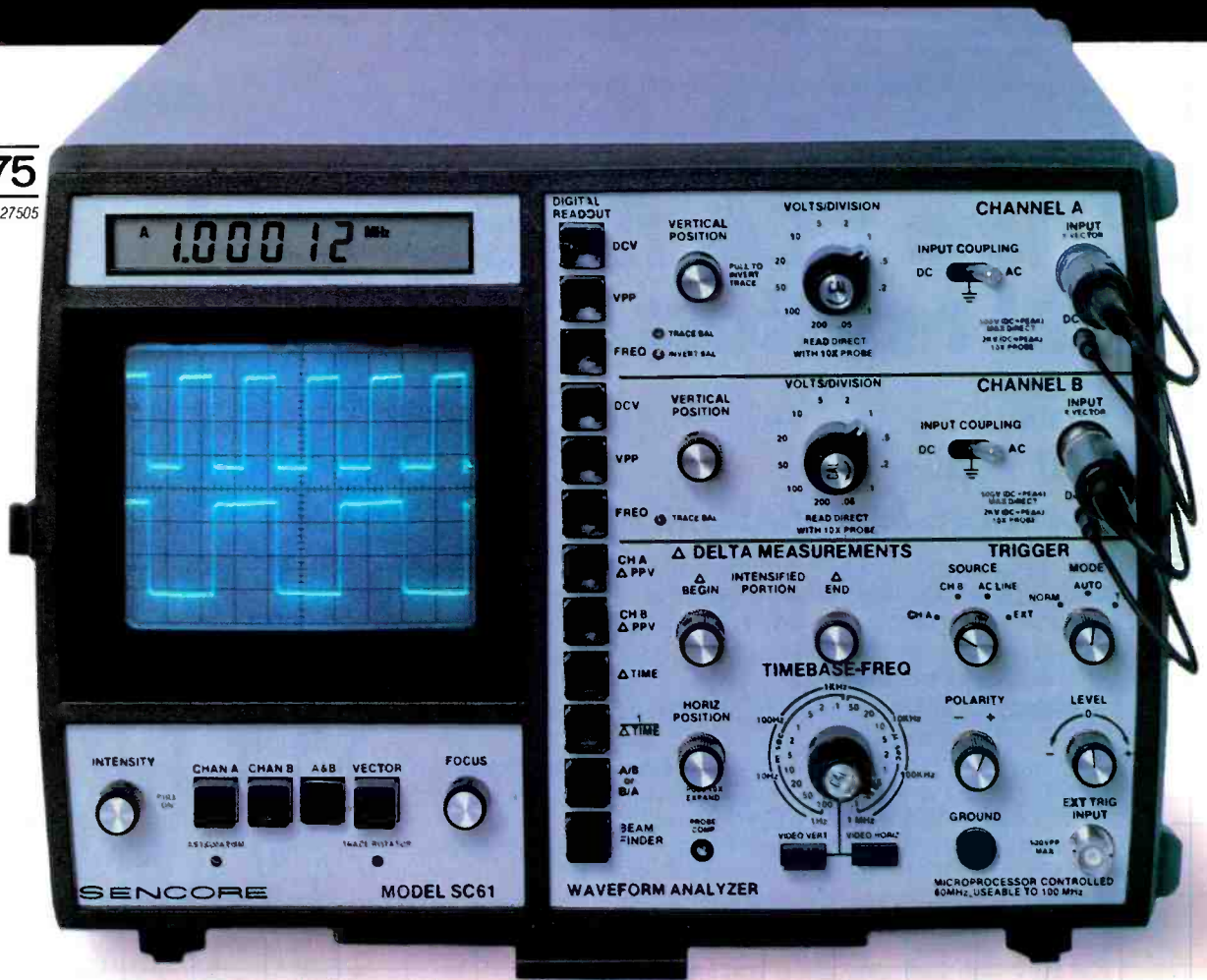

Sencore SC61 60 MHz Waveform Analyzer.

Cut Your Scope Time In Half Or Your Money Back.

Cut your scope time in half? We know that's a bold claim. But once you've tried the SC61 we know you'll agree it's a conservative claim. Why? Because the speed, accuracy, and ease of operation of the SC61 makes every conventional oscilloscope as outdated and cumbersome as the analog meter. Now all you do is just push a button and read.

The First Scope With Automatic Readout At last the oscilloscope has gone digital. No more graticule counting, calculating, or estimating your measurements. You can now make waveform measurements digitally accurate, digitally fast, at the push of a button.

Make All Measurements With One Probe Make no mistake. The SC61 is not a "piggyback" unit, but a completely integrated waveform monitoring system. You connect only one probe and the Autotracking™ display digitally tracks the waveform on the screen. You just push a button when you want to read DC volts, P-P volts, or frequency.

An Exclusive Breakthrough It took four patent pending circuits to completely integrate the scope and digital display. The end result is a breakthrough in scope technology that virtually obsoletes conventional scopes. Here's why.

It's 10 Times Faster The SC61 is 10 to 100 times faster than any conventional scope. How? Because all you do is push a button instead of counting graticules, calculating, or switching probes. Increased speed means increased productivity.

It's 10 Times More Accurate No matter how carefully you try to measure a waveform with a conventional scope, you will only be 5% to 15% accurate due to parallax and interpretation errors. Today's circuits demand greater accuracy than that. The SC61's digital readout is 10 to 1000

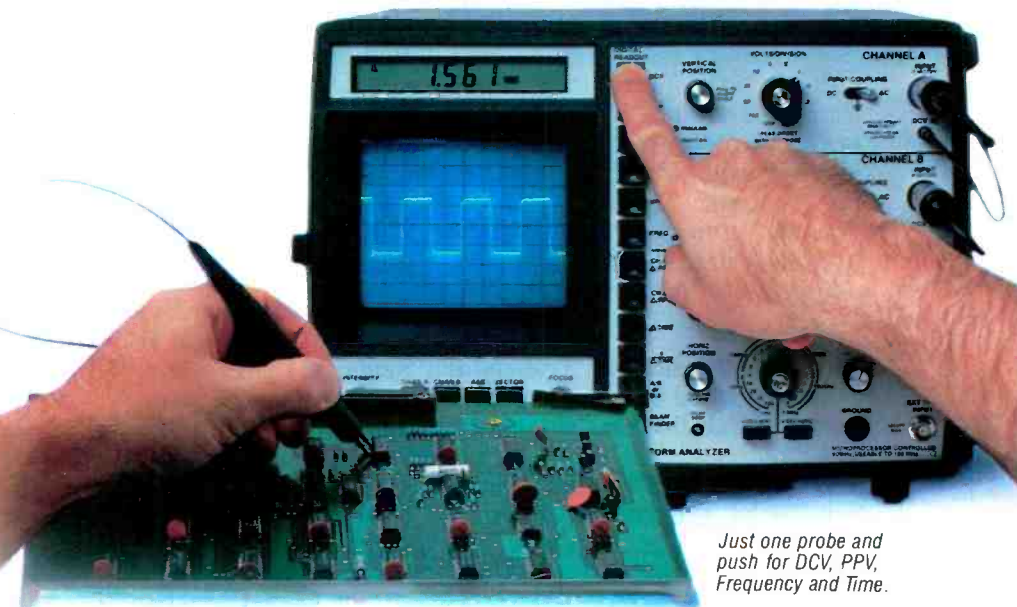

Just one probe and push for DCV, PPV, Frequency and Time.

times more accurate to meet these testing needs.

It's Easier To Use The digital readout is simplicity itself. Just push and read. You'll make fewer errors because every measurement now becomes exact. Now you can concentrate on the circuit rather than the scope.

Measure Part Of A Waveform Intensify any waveform portion with the exclusive "Delta Bar," push the button, and read PPV, time, or frequency for just that portion of the waveform. Ideal for measuring timed circuits, signal delays, pulse widths, and more.

Guaranteed To Cut Your Scope Time In Half When we say the SC61 will cut your scope time in half, we're being conservative. It's possible to reduce your scope time 75%, even 90% with this first-of-its-kind oscilloscope. But don't take

our word for it. Try an SC61 and judge for yourself. Here's our offer.

30 DAY MONEY BACK GUARANTEE

If the SC61 does not at least double your scope productivity during the first 30 days, you may return it for a full refund, including freight both ways.

Update Today Just like DVM's have replaced analog meters, the SC61 will replace conventional scopes (under 100MHz) and for the same reasons: increased speed, accuracy, and reliability. Update today with this new automated scope technology. It's the scope you've been waiting for.

To Order Or To Receive
A Complete Color Brochure,
Phone Toll-Free Today.

800-843-3338

Qualified Sales Engineers are ready to talk with you about SC61 performance and applications. Ask for Dept. 130.

For Information Circle (11) on Reply Card
For Demonstration Circle (12) on Reply Card

SENCORE

3200 Sencore Drive, Sioux Falls, SD 57107 605/339-0100 TWX: 910-660-0300

Alaska, Hawaii, Canada and South Dakota call collect at 605/339-0100



BOOK REVIEWS

Editor's note: Periodically *Electronic Servicing & Technology* presents reviews of books dealing with subjects of interest to our readers. Please direct inquiries and orders to the publisher at the address given in each review rather than to us.

Towers' International Transistor Selector, third edition, by T.D. Towers; Tab Books; 280 pages; \$19.95.

This is an expanded and updated version of the classic reference guide in the field. It covers over 20,000 American, British, European and Japanese transistors with electrical and mechanical specifications, manufacturer "house codes" and listings of available substitutes for each one.

The book gives details on each transistor when there's only a type number to go by, plus where to locate the needed device and get accurate advice on making substitutions—a particularly important feature when dealing with obsolete or hard-to-locate components.

Towers includes full descriptions of each transistor, including ratings, special characteristics, case details, terminal identifications, applications data, manufacturers (with their addresses) and substitution equivalents (both European and American). Each device is listed in alphanumeric order for fast and accurate reference.

No matter what type of project is involved, whether the reader is a hobbyist, experimenter, professional engineer or technician, he'll find practical hands-on info on any transistor. Gain or beta, high frequency characteristics, bias current at which gain has been measured, voltage ratings and applications data are given in clear, concise form with all abbreviations and terminology fully explained in an easy-to-follow appendix.

Commonly used devices like the germanium and low-powered silicon transistors (which many larger manufacturers have stopped producing) are listed under the original manufacturers along with listings under the smaller companies that have stepped in to meet the still-considerable demand for these units.

Published by Tab Books, Blue Ridge Summit, PA 17214.

Regulated Power Supplies, by Irving M. Gottlieb; Howard W. Sams; 424 pages; \$19.95.

The regulated power supply—a unit which maintains a dc output voltage, despite line and load variations—is fully examined in this book, which presents the internal architecture and operation of the latest solid-state regulators. The author explains when regulated power supplies are needed and how to incorporate them into individualized needs. Modern, practical circuitry, including linear and switching circuits and late ICs, are discussed. Diagrams are used throughout to further clarify the text.

After reading this book, service technicians will be able to better understand regulated power supplies—what they are, and why and how they work. Radio amateurs, experimenters, audio buffs and computer users can use this book as a tool for learning about regulated power supplies and selecting the ones best suited for their own applications.

Published by Howard W. Sams & Company, 4300 W. 62nd St., Indianapolis, IN 46206.

Use of the Dual-Trace Oscilloscope, a Programmed Text, by Charles H. Roth, Jr.; Prentice-Hall; 246 pages; \$19.95 hardbound, \$15.95 paper.

This text is designed for a basic electrical engineering laboratory course. Each of the first four parts of the book includes a preparation section, which explains the procedures to be used, and a laboratory section, which consists of laboratory work in that area.

Topics include displaying

waveforms as a function of time, observing signals with ac and dc components, the differential amplifier mode, loading and use of the probe, making accurate measurements with the scope, checking scope calibration, and measurement of phase angle.

Published by Prentice-Hall, Englewood Cliffs, NJ 07632.

Designing and Creating Printed Circuits, by Walter Sikonowiz; Hayden; 164 pages; \$8.95.

This in-depth guide to the design, layout, manufacture and assembly of printed circuits examines the printed circuit manufacturing process in detail—pointing out its shortcomings as well as its numerous advantages. The author uses 40 diagrams and 28 photographs of actual parts to help explain the most current advances in methods and design criteria.

Topics are introduced and discussed in a step-by-step approach, beginning with general design principles and materials, and continuing through image transfer, electroplating, etching, machining operations and final assembly and testing. The importance of cleaning and neutralizing operations is also stressed.

A special appendix is included for printed circuit board manufacturers which lists military and industrial standards and specifications.

Published by Hayden Book Company, 50 Essex St., Rochelle Park, NJ 07662.

Photovoltaic Product Directory and Buyers Guide (DE81030186); U.S. Department of Energy; \$13.50.

Household appliances and other electrical equipment in the home and office can now be effectively converted to solar power, according to this U.S. Department of Energy technical report.

Photovoltaics (PV) is the use of solar cells to supply power to equipment. The directory includes a comprehensive listing of sources of PV products and their applications. It explains PV systems, shows what equipment is available, helps in the design of a

personal system, helps select from available products, gives direction to sources for expert help in handling applications and provides information on PV user experiences.

Also, the guide provides information on financial incentives available from state and federal governments when solar equipment is installed, and includes a list of addresses of suppliers.

Published by National Technical Information Service, 5285 Port Royal Road, Springfield, VA 22161.

Modern Dictionary of Electronics, by Rudolf F. Graf; Radio Shack; \$8.95.

This dictionary covers more than 20,000 terms unique to electronics and related fields and provides meaningful, concise definitions. In addition, the book includes illustrative line drawings, tables of the International System of Units (SI) and listings of schematic symbols, the Greek alphabet and what the Greek letters symbolize in electronics.

Published by Radio Shack, 1800 One Tandy Center, Fort Worth, TX 76102.

Your Own Computer, second edition, by Mitchell Waite and Michael Pardee; Howard W. Sams; 224 pages; \$7.95.

In this book, the authors have removed much of the complexity and mystery that surrounds the micro-computer and have succeeded in producing a simple, easy-to-understand book about these devices.

This new edition provides the newcomer with the knowledge and confidence needed to use today's personal computer. The text has been updated and explained to include a chapter that objectively compares 30 popular personal and small business computers now on the market.

Personal computing applications for your home, office or classroom are explained. The chapter on programming has been expanded in this edition to help you understand the heavy emphasis on computer software.

Published by Howard W. Sams & Company, 4300 W. 62nd St., Indianapolis, IN 46268.



When you price by "The Book" everyone benefits!

Eliminates undercharging...controls overpricing...treats both customer and shop owner fairly!

The Parts Pricing Book

200 pages of fast moving parts...with a selection of mark-up you feel is correct for your shop...computerized with automatic up-dating service...\$69.50

The Labor Pricing Book

Tech's Guide to Pricing will not only change your customer's attitude and perception...It will change yours as well...\$29.50

CALL TOLL FREE: 800-228-4338

8/5 C.S.T. MONDAY/FRIDAY

sperry tech inc. P.O. Box 5234 Lincoln, Nebraska 68505

tv & radio
tech's guide
to pricing

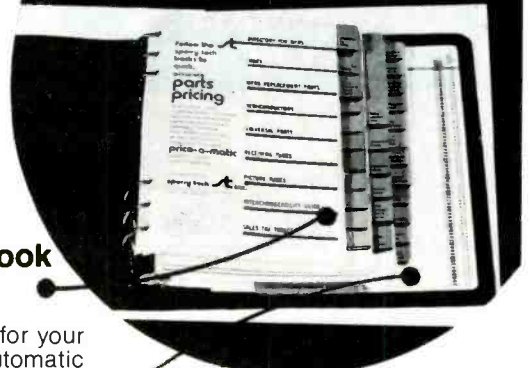

When you appear on the job with organized pricing material...you create an image of both technical and business skills!

Circle (13) on Reply Card

CRAIG

Star View

Systems™

STAR VIEW MODEL 12K

- Complete System
- Easy to Install
- Reasonably Priced
- UPS Shippable
Weight 125 Pounds
- More than 100
Channels Accessible

THE STAR VIEW 12K SYSTEM KIT CONTAINS:

- 12 Foot Antenna
- Azimuth Elevation Mount
- 24 Channel Receiver
- 120° Low Noise Amplifier
- Feed Horn
- Cables & Connectors
- No Modular Included

(May be ordered separately for \$79.95)

\$2595.00

Available through your local Craig Star View dealer • Call or write for information • Dealership inquiries welcome • Price subject to change without notice.

H&R COMMUNICATIONS, INC. Subsidiary of Craig Corp.
Route 3, Box 103G Call 800-643-0102
Pocahontas, Arkansas 72455 or 501-647-2291

Circle (14) on Reply Card

CALENDAR OF EVENTS

August

2-7

Joint convention of National Electronic Service Dealers Association, International Society of Certified Electronic Technicians, The Texas Electronics Association, the Louisiana Electronic Service Dealers Association and Television Service Association of Arkansas at the Hilton in New Orleans, LA. Contact The National Electronic Service Dealers Association, 2708 W. Berry St.,

Ft. Worth, TX 76109, 1-817-921-9061.

24-25

Indycon '82 microcomputer and electronic components conference, Indianapolis Convention Center. Sponsored jointly by Institute of Electrical and Electronic Engineers, Electronic Representatives Association and the National Electronic Distributors Association. Contact F. Schechter, Show Manager, 8326 Trace Circle, Indianapolis, IN 46260, 1-317-875-7711.

26-29

National Association of Television & Electronic Servicers of America (NATESA) Annual Convention, Indian Lakes Resort, Bloomingdale, IL. Contact Frank J. Moch, 5930 S. Pulaski Road,

Chicago, IL 60629, 1-312-582-6350.

September

14-16

Wescon '82, Anaheim Convention Center, Anaheim, CA. For more information call 1-800-421-6816.

14-16

Mini/Micro Computer Conference and Exhibition, Disneyland Hotel, Anaheim, CA. Contact Electronic Conventions, 999 N. Sepulveda Blvd., El Segundo, CA 90245, 1-800-421-6816 (in California, 1-213-772-2965).

October

11-13

EIA Fall Conference, Century

FINALLY. COMPUTERS AS A NEW TOOL FOR T.V. REPAIR.



Primefax puts computer-assisted repair capability in your shop today.

Primefax drastically reduces the number of sets requiring extensive trouble-shooting procedures.

Through the use of today's technology, Primefax maintains—in a central computer—a database of problem-solving solutions for television set malfunctions.

Primefax is a compilation of the most current, applicable technical information acquired from hundreds of valuable sources . . . and updated daily.

With a Primefax Computer Terminal installed in your shop, you can do your job more quickly and more

accurately. You have more satisfied customers, and your profits are increased substantially.

Reduced call backs • faster turn-around • reduced chance of repeated failure • more thorough service and complete repair at reasonable cost.

The more Primefax is used, the more profit you realize.

CALL US OR WRITE. No matter how you compute it, Primefax means profit for you. It's worth looking into.

In Texas, call (512) 344-5999 • Out of Texas, call 800-531-5953

Primefax

4825 Fredericksburg Road • San Antonio, Texas 78229

Circle (15) on Reply Card

Symcures Wanted

Electronic Servicing and Technology

needs a broader variety of television Symcures. Especially needed are reports of Quasar, General Electric, Sylvania (or Philco), Sony Sears and Magnavox.

Please give the brand, model number, Photofact number, a brief description of the symptoms, a rough hand-drawn schematic of the area containing the defect, and a short description of the cure (including whether the defective component was open, leaky, shorted or intermittent).

ES&T editors will adapt the material to the Symcure format and have Photofact-style schematics prepared.

Send seven Symcures each time. Only six will be published, but the extra gives the editor a spare for one already printed in the past (or otherwise not suitable to the format). \$30 will be paid for each page of six actually published (remember to include full name and address).

Send each group of seven potential Symcures to:

Symcure Department
Electronic Servicing and Technology
P.O. Box 12901
Overland Park, Kansas 66212

Plaza Hotel, Los Angeles, CA. For more information, contact the Electronic Industries Association, 2001 Eye Street N.E., Washington, D.C. 20006.

vention, Dallas Convention Center. Contact Electronic Conventions, 999 N. Sepulveda Blvd., El Segundo, CA 90245, 1-800-421-6816 (in California, 1-213-772-2965).

November

1-2

15th Annual Connector Symposium, sponsored by the Electronic Connector Study Group with cooperation of more than 50 connector manufacturers, Franklin Plaza Hotel, Philadelphia, PA. Contact Electronic Connector Study Group, P.O. Box No. 167, Fort Washington, PA 19034.

30-Dec. 2

Midcon/82 High-Technology Electronics Exhibition and Con-

January

18-20

Southcon/83 High-Technology Electronics Exhibition and Convention, Georgia World Congress Center, Atlanta. Contact Electronic Conventions, 999 N. Sepulveda Blvd., El Segundo, CA 90245, 1-800-421-6186 (in California, 1-213-772-2965).

ES&T_{inc.}

Coming in

ELECTRONIC
Servicing & Technology

Shock hazard at the workbench. Few technicians are aware that a shock current as low as 100mA passing through the chest area can be fatal. This article describes how most shocks are encountered and how hazards can be avoided.

COMPARE OUR LOW PRICES

IDENTICAL REPLACEMENT FOR ECG®

AT 50% TO 80% OFF

SUPER SPECIAL (MIN. 10 PCS.)

TYPE NO.	SUGG. RESALE	YOU PAY
85.....	.88	.35
123A.....	1.32	.28
124.....	2.30	.90
130.....	3.80	.90
152.....	2.20	.60
153.....	2.50	.70
154.....	3.30	.99
165.....	13.50	2.40
238.....	15.75	2.40
291.....	2.57	1.20
292.....	2.91	1.25

SPECIAL

MULTIPLIERS, TRIPLERS, JAPANESE TYPES (Min. 5 Pcs.)

500A.....	10.25	2SC867A.....	3.30
523.....	12.25	2SC1034.....	7.25
526A.....	12.80	2SC1114.....	3.85
529.....	15.50	2SC1308K.....	2.40
HIDIV-1.....	3.20	SG613.....	6.90
HIDIV-3.....	3.65	STK056.....	12.95

3 YEARS WARRANTY ON ALL EXR TYPES

COD ORDERS WELCOME (Min. Order \$25)

CALL TOLL FREE 800-526-4928

WRITE OR CALL FOR OUR 1982 PRICE LIST

DIGITRON ELECTRONIC Corporation

110 Hillside Ave., Springfield, N.J. 07081

DIGITRON IS NOT ASSOCIATED IN ANY WAY WITH PHILIPS ECG

Circle (16) on Reply Card

Our lowest price solder extractor isn't cheap.

People get suspicious when they see "lowest priced." Especially in a precision piece of equipment. They immediately think it's garbage.

Despite the reasonable price our EX-525 gives you vacuum by an oilless, piston pump, not diaphragm. It easily removes components from double sided and multi-layer PC boards. The EX-525 comes with a great technical manual and 2 year warranty.

The EX-525 is inexpensive, but it isn't cheap.

AUTOMATED PRODUCTION EQUIPMENT CORP.

142 Peconic Avenue

Medford, New York 11763 - U.S.A.
(516) 654-1197 • TWX: 510-228-2120



Circle (17) on Reply Card

Chassis – Zenith System 3
PHOTOFACT – 1828-2

1

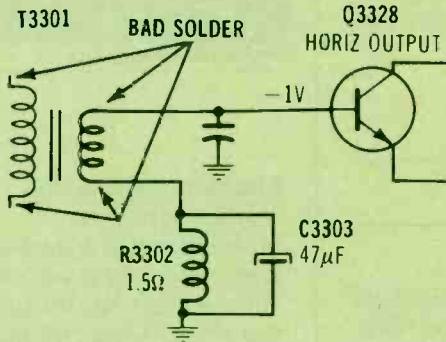

Symptom – Narrow picture with horizontal foldover
Cure – Check soldering of four T3301 terminals; resolder if necessary

Chassis – Zenith 12GB
PHOTOFACT – 1603-2

2

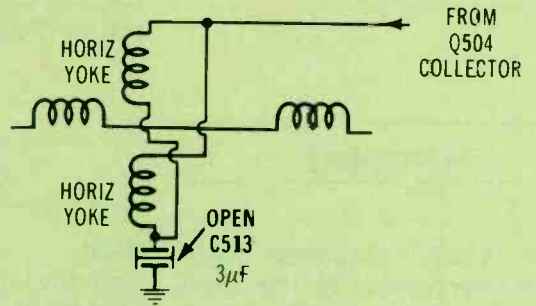

Symptom – One vertical white line (no horizontal sweep) and 3kV of high voltage
Cure – Check yoke-coupling capacitor C513 and replace it if open

Chassis – RCA CTC96A
PHOTOFACT – 1870-2

3

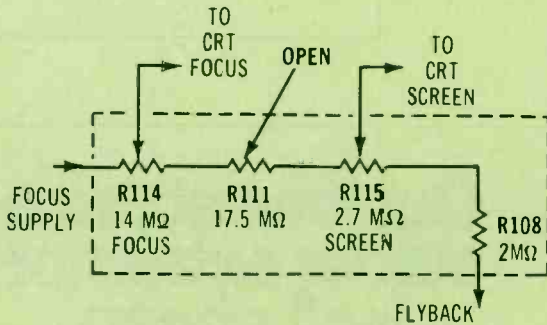

Symptom – Poor focus; insufficient brightness
Cure – Check R111 and other focus resistors and replace any that are out of tolerance

Chassis – Packard Bell 1C620WL
PHOTOFACT – 1320-3

4

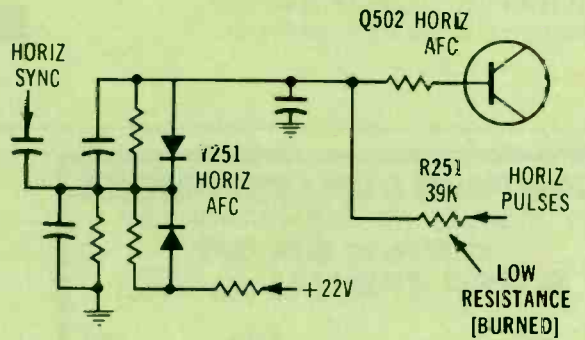

Symptom – Horizontal locking is critical
Cure – Check resistor R251 and replace it if out of tolerance

Chassis – Philco 20KT41B
PHOTOFACT – 1122-2

5

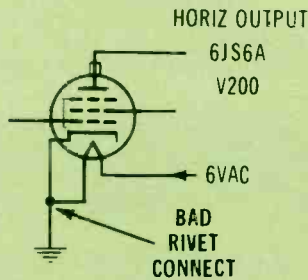

Symptom – Erratic high voltage and width
Cure – Check for erratic continuity through rivet (ground the wire separately)

Chassis – Panasonic CT-301
PHOTOFACT – 1346-2

6

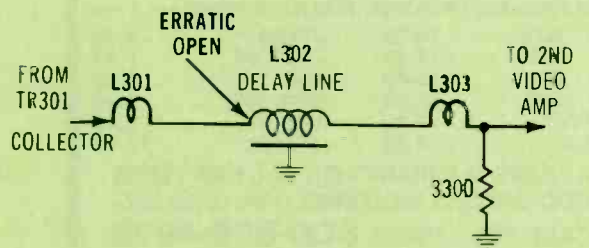

Symptom – Intermittent loss of luminance
Cure – Check for erratic delay-line resistance and replace it if it opens

Modular Components... The Soldering Choice is Yours

With Ungar's 3000 Series Heaters, Handles and Tips

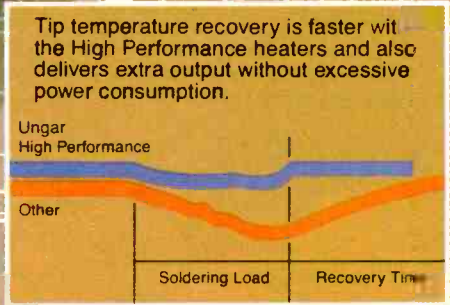
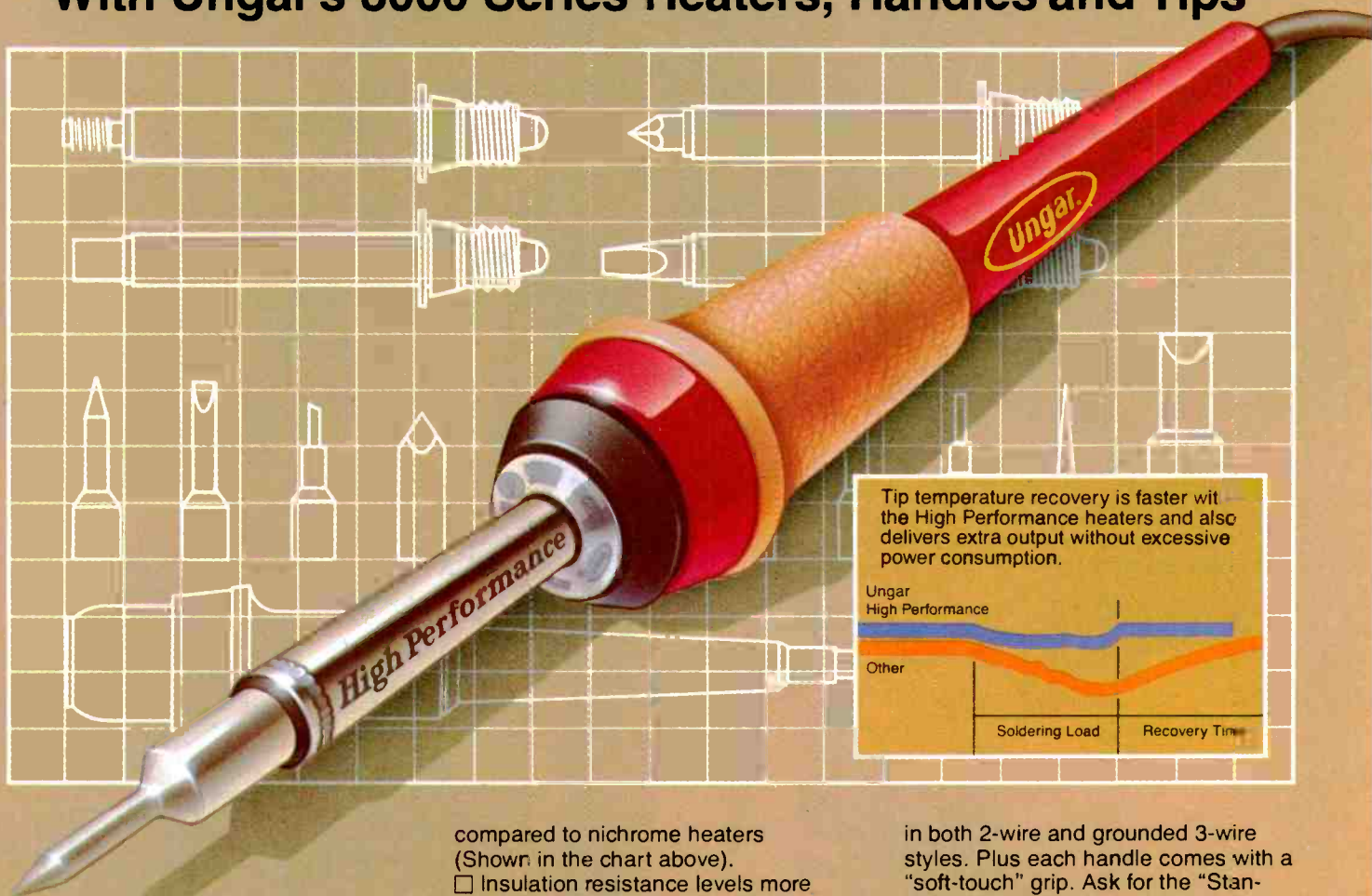

When it comes to making a choice, Ungar gives you lots to choose from. We have one of the broadest lines of soldering components available to precisely meet your needs.

Take our lineup of heaters, handles and tips, for example. We've got you covered with a variety of heat ranges and tips so you can custom-design the soldering iron to fulfill your requirements.

15 NEW THERMO-DURIC™ HIGH PERFORMANCE HEATERS

Our 3000 Series heaters are the state-of-the-art in soldering today. Their improved performance is thanks to modern "thick film" technology, which has allowed the design of our exclusive, revolutionary THERMO-DURIC™ heater element.

The benefits include:

- Faster heat-up—typically 1.5 minutes vs. 2.5 minutes.
- Quicker temperature recovery

compared to nichrome heaters (Shown in the chart above).

- Insulation resistance levels more than ten times greater than wire-wound elements. This means significant reduction in leakage currents that can damage sensitive micro-electronics.
 - Lower power consumption—our 50 watt heater outperforms a conventional 80 watt iron.
 - Less energy consumed at no-load idle temperatures—typically 15% less!
 - Better results with thread-in and thread-on tips.
- And that's not all!

You can choose from a wide selection of body styles. Ranging from integral tip models to the thread-in and thread-on styles. Plus each style is available in wattage ratings to cover soldering temperatures from approximately 700°F to 1,000°F.

HANDLES—WE OFFER YOU THREE CHOICES

To complement our 3000 Series heaters, we have three handles. They are perfectly balanced for added comfort and reduced fatigue. They're available

in both 2-wire and grounded 3-wire styles. Plus each handle comes with a "soft-touch" grip. Ask for the "Standard Line" of Ungar handles to match up with the ultimate in heaters, the 3000 series!

SELECT FROM 15 TIPS

No matter your requirements, we've got the tip for you! Available in both thread-in and thread-on styles to mate with our 3000 Series heaters.

AND IT'S ALL MODULAR!

That's the beauty of the Ungar system. Every piece is modular, so if one unit wears, instead of buying a totally new soldering iron—simply replace that one component. Fast, Easy, and Economical. You have unparalleled flexibility to combine handle, heater and tips to create any one of 234 custom irons.

To find out more about this amazing lineup from Ungar, call the Ungar Hotline, toll-free 1-800-421-1538, in California, call collect, 1-213-774-5950.



Division of Eldon Industries,
Compton, California 90220
In Canada, Markham,
Ontario, Canada L3R 1H5



The space shuttle: A ham radio special event

By Nils Conrad Persson, editor

While astronauts Jack Lousma and Gordon Fullerton were racing miles above the globe last March, amateur radio operators from all over the world were feverishly trying to contact radio station W5RRR. In the vernacular of hams, these operators were trying to QSO (contact) the Johnson Space Center Amateur Radio Club in Houston. The reward for making such a contact would be receipt through the mail of a Special

Event QSL (confirmation) card from W5RRR.

At the same time, many other hams were piling up calls to amateur radio clubs at Marshall Space Flight Center, Huntsville, AL; John F. Kennedy Space Center in Cape Canaveral, FL; and Jet Propulsion Laboratories in Pasadena, CA, other organizations that were taking part in the flight, called STS-3 (for Space Transportation System—Flight #3). While

most of us refer to the “space shuttle” program as just that, NASA people term the program the Space Transportation System, which encompasses not only the manned vehicle (the orbiter) and its booster, but all of the ground support as well. Thus, because last March’s flight was the third such flight, it is termed STS-3.

Amateur-radio special events are not confined to space flights. For example, during the recent

Space shuttle voice frequencies

Function/system	Orbiter transmit	Orbiter receive
STDN PM-1 } S-band STDN direct	2287.5MHz	2106.4MHz
STDN PM-2 } and S-band TDRS	2217.5MHz	2041.9MHz
AFSCF PM-1 } S-band SCF	2287.5MHz	1831.787MHz
AFSCF PM-2 }	2217.5MHz	1775.733MHz
EVA communications	296.8MHz or 259.7MHz	259.7MHz or 298.6MHz
Ku-band comm (Ku-band TDRS)	Ku-band — 15.0085GHz	Ku-band — 13.775GHz
ATC voice (VHF)	243, 259.7 or 296.8MHz	243, 259.7 or 296.8MHz

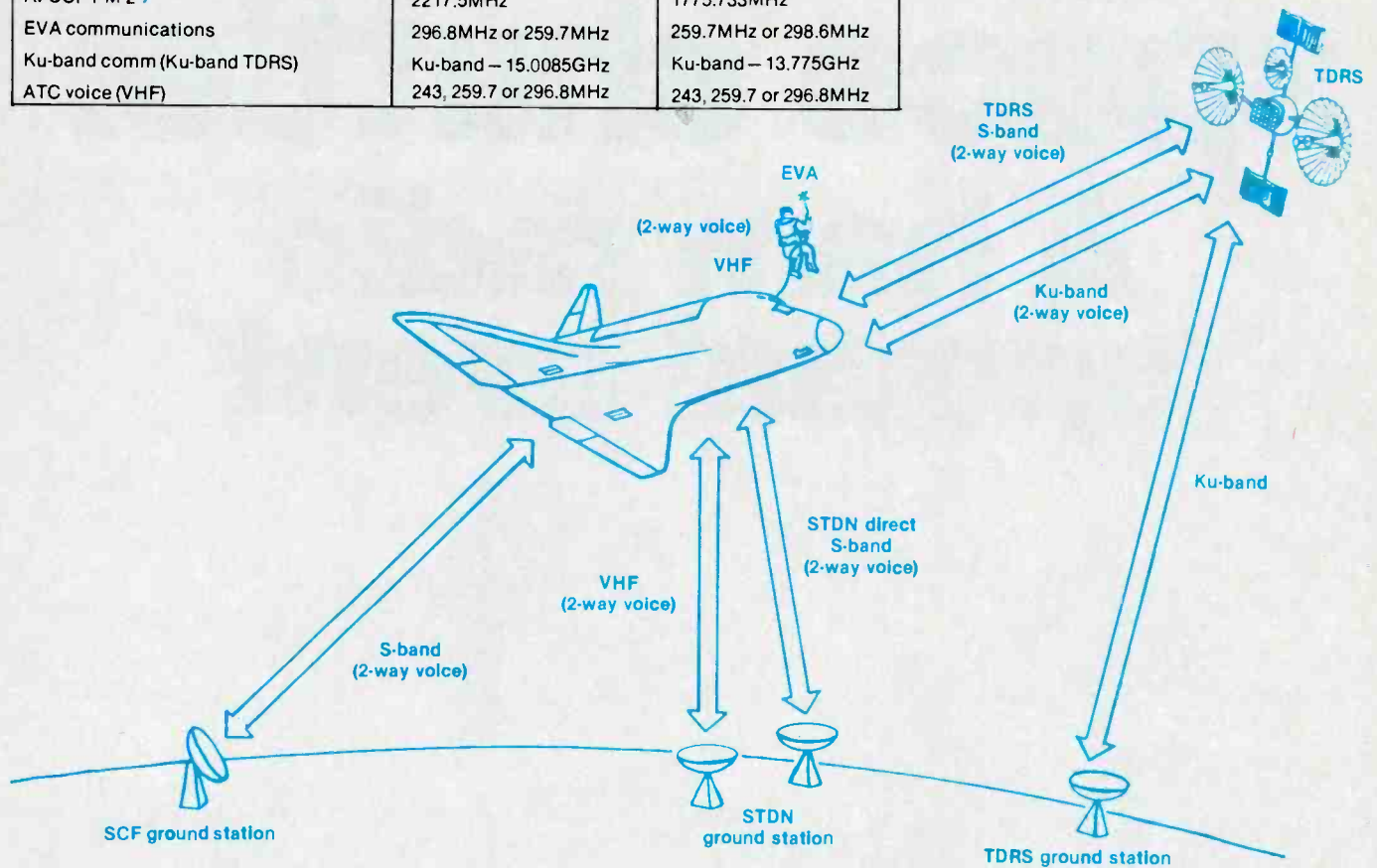

Space shuttle astronauts are in voice contact with ground stations via frequencies as shown. The TDRS satellite link shown is not yet operational.



The space shuttle knifes through the sky on its way to a smooth touchdown after a successful flight.

Winter Olympics in Lake Placid, NY, an amateur radio club in the Lake Placid area set up a special-event station. Contact with that station during that period of time reaped the reward of a Winter Olympics, special-event QSL card.

Dale Martin, amateur radio call sign KG5V and president of the Johnson Space Center Amateur

Radio Club, has been an electronics technician in the Johnson Space Center's Technical Services Division for five years. For nine years before that, he was a technician in the Communications Center.

According to Martin, during the March 1982 shuttle flight, more than 5000 contacts were made by

amateur operators with W5RRR. Some of those 5000 found themselves distinguished by contacting *NBC News* announcer Roy Neal, himself an amateur radio operator, who was visiting the club station.

Houston listens to STS

During an STS flight, the Johnson Space Center public af-

The basics of tape recording



This portable machine, which operates with cassettes, is typical of smaller audiotape recorders.

By Carl Babcock CET

Magnetic recordings affect the daily lives of almost all adults in the United States, either directly or indirectly. There are cassette audiotape recordings of voices and music, VTRs are being used in homes, and virtually all TV programs originate from videotapes made on broadcast-type recorders.

But there are dozens of less obvious applications, including instrumentation recordings of data, disc storage for digital computers, cassette-stored digital information for typesetting systems, recorded answering messages for phone users or telephone companies, and digital mastering of analog phonograph music records.

This series focuses on cassette audiotapes and the record/play machines for them. You will learn the general conditions that affect noise and frequency response of the machines and tapes.

Another subject that has received little or no coverage in books and technical magazines is the high-speed copying of cassettes in specialized duplicators. These duplicators record both for-

ward and reverse audio tracks in one forward pass of the machines, followed by high-speed rewind (if desired). Specific suggestions will be given for preventing common duplication defects and producing excellent copies.

Also, an in-depth discussion of premium cassette tapes will analyze the characteristics of various formulations and how to make easy tests that identify the type and brand best suited for individual recording needs.

This first article covers the basics of magnetic recording and playing, typical recorded-track dimensions, head construction, the effects of various head gaps and other preliminary material. These subjects are necessary for proper understanding of the more advanced principles that follow, but the basics will emphasize practical and interesting facts, with a minimum of physics and abstract theory.

Basic magnetic recording

The electric recording and playing of varying magnetic fields ap-

pears to be very simple. First, a varying magnetic field is formed by an audio current flowing in a coil of wire that is wound on a piece of soft iron. Next, this varying field is recorded on a long, narrow, soft-iron bar by moving it steadily in the coil/iron magnetic field. Afterward, the long bar retains some of the magnetic pattern. *This is magnetic recording.*

Playback of these magnetic variations is performed in a similar (but reversed) method. A sensitive set of earphones is connected to the same coil of wire, on the piece of soft iron, while the magnetized long bar again is moved past the same end of the coil/iron assembly. The coil receives a signal from the bar's magnetism, and it can be heard in the earphones. *This is magnetic playback.*

Of course, the piece of iron with its winding is a crude recording/playback head, while the long bar is the forerunner of magnetic recording tape.

Unfortunately, the described system has two unacceptable shortcomings. The volume heard

in the earphones is weak because there is no active amplification, and the audio distortion is intolerable. A slightly similar recording/playing system was demonstrated by Poulsen about 1900. It created a sensation then, but magnetic recording did not become practical until improvements were made over the years.

Improvements

Several changes to the simple system just described have improved the recording/playing efficiency. The soft-iron assembly (with the coil) first was replaced by a laminated core (to reduce eddy-current losses), and now the laminations are fabricated from various kinds of special magnetic materials that resist abrasion wear.

Also, the original, straight solenoid shape of core and coil has been improved by shaping the core laminations into an oval or circular shape (see Figure 1), with a narrow gap at front and back. The coil now has two windings in series (to minimize pickup of external signals, such as hum), with one on each core section. The front gap



Magnetic recording tape has been manufactured in many different forms. At the upper left, a 7-inch reel of 1/4-inch tape is shown with a length of either 1200ft or 1800ft. A similar 5-inch clear-plastic reel is at the upper right. At the lower left is an obsolete RCA-type large cartridge using 1/4-inch tape. The housing includes supply and takeup reels with tape, plus internal brakes. Two newer audiocassettes are shown at the lower right. Each cassette has 1/8-inch tape on supply and takeup internal reels.

filled with non-magnetic material, giving the effect of an air gap, but preventing the front gap from filling with iron scraps from the recording tapes.

In the 1930s, the iron-bar recording medium was superseded by round iron wire. However, there were problems with winding snarls and spillage when the wire broke, splicing was not easy, and frequency response was not good. A more pliable material of better magnetic qualities was needed. The first flat magnetic tape was developed by German scientists during World War II. A ferrous compound commonly known as *jeweler's rouge* was the coating.

However, none of these improvements reduced the in-

Recording bias

The almost-rectangular B/H curve of magnetic recording tape can be varied somewhat by choices of magnetic materials, which explains some performance differences among various tapes. But this cannot eliminate the distortion. Instead, something was needed to move the recorded signal to a relatively linear section of the B/H curve.

Such an offset of the recorded signal can be accomplished by adding a small, non-varying magnetic field to the recording head. Perhaps the simplest way is to force a small dc current through the head during recording, or a small permanent magnet could be buried inside the head. But the current method has several advantages. First, the magnetic strength can be adjusted easily by a variable control operating from the supply voltage. Also, the current (and the resulting magnetic field) can be eliminated when the recording head is switched to operate as a playback head. This offset magnetic-field method is called *dc bias* because dc current usually is employed.

When the head current is properly adjusted, dc bias can reduce the recording distortion (by moving the recording to a more linear part of the curve), but a serious side effect is a prominent pink-noise hissing and scratching heard during playback. About -20dB below standard 0dB playback level was measured in one small machine. That amount of noise is certainly audible during playback by small portable machines, but it is intolerable in high-fidelity tape decks with good audio systems. Those systems can achieve signal-to-noise ratios up to 56dB. Obviously, *dc bias is not suitable for quality recording.*

Therefore, dc bias is used only in low-priced portable cassette audio

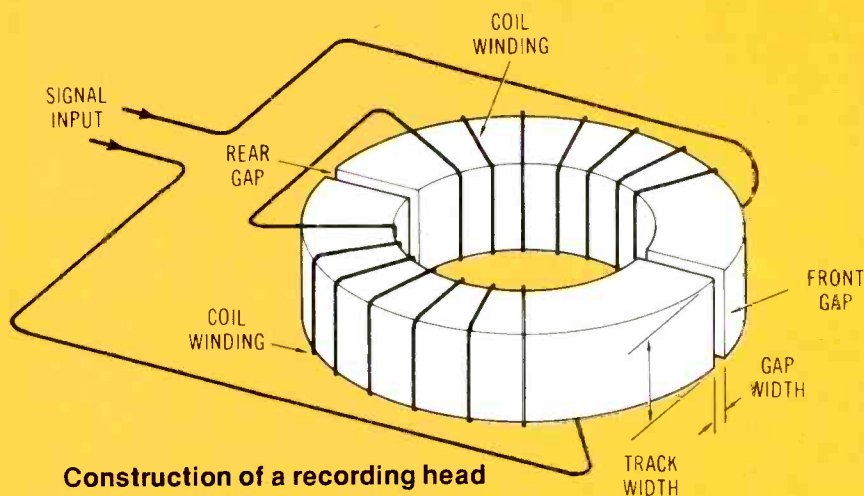

Construction of a recording head

Figure 1 Each recording or playing magnetic head is constructed with identical windings around two halves of the core material, which is made of laminations. These halves are not joined solidly together; instead, a gap is provided at front and back. These gaps are filled with non-magnetic material to prevent clogging with tape scrapings. The rear gap is a dummy, while the front gap rides solidly against the tape coating. During recording, this construction concentrates the flux. When the head is used for playing, the tape magnetism is sensed efficiently, while the balanced construction minimizes pickup of unwanted external signals, such as hum. Width of the gap is one important factor limiting the high-frequency response during playback.

touches the recording tape, so its width and straightness has a tremendous effect on the performance, particularly the high-frequency response. Both gaps are

tolerable audio distortion. This distortion results from the non-linear curve of magnetic induction (B), vs. magnetizing force (H), the B/H curve.

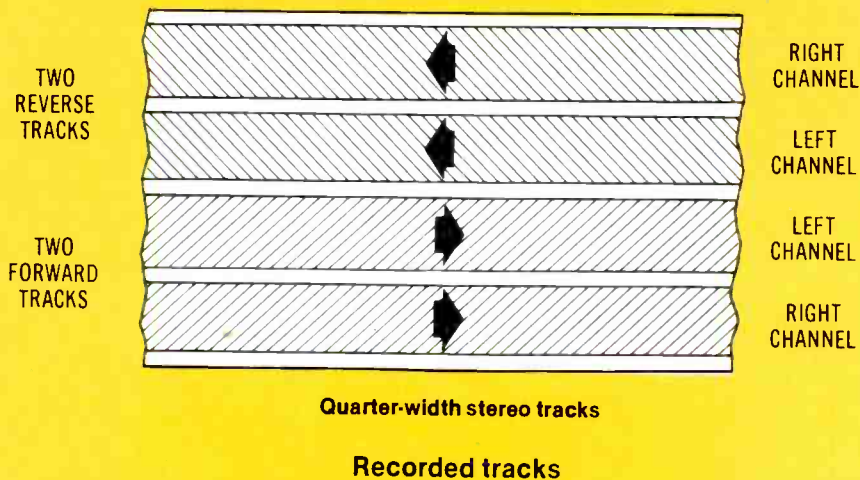
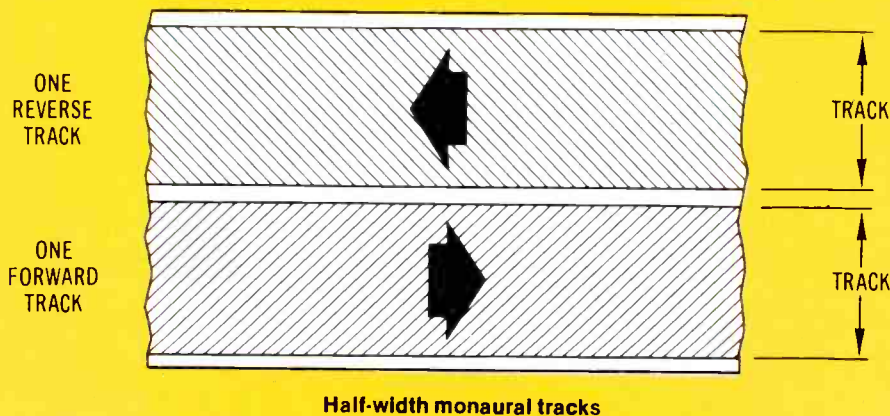
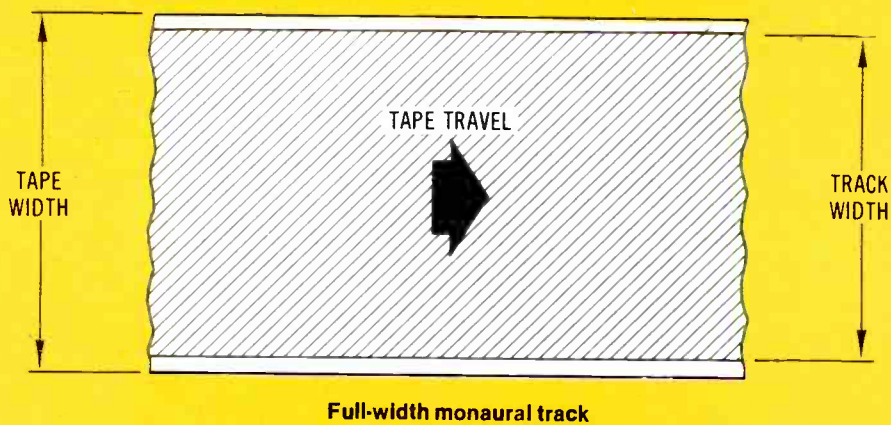

Invisible magnetic tracks are formed during recording as the tape passes the recording head. There are many standards for tracks; a few basic types are illustrated here.

recorders. Of course, the bias noise on tapes recorded by these machines will be heard loudly when played on other recorders, even those of top quality. Quiet tapes recorded on better machines will play without excessive noise on dc-bias models, because the dc-bias is used only during recording. This is true only if the playing head is degaussed regularly and kept free of all permanent magnetism,

which tends to build up rapidly because the bias current is stopped abruptly at the end of each recording.

Recording with ac bias

With ac bias for tape recordings, a specific current of an ultrasonic sinewave signal (usually of 40kHz to 150kHz frequency) is added to the audio signal at the recording head (Figure 2). Recorders with

good performance can achieve less than 1% total-harmonic distortion (THD) at industry-standard 0dB level for combined recording and playback.

Incidentally, the precise amount of ac bias during recording affects both the distortion and the high-frequency response to a large degree.

Also, it is vital to understand that ac bias is not mixed non-linearly (Figure 3). This is different for other mixers, such as superheterodynes, that mix incoming station frequency with the oscillator signal to produce a third frequency. In recording, no sum-and-difference frequencies can be tolerated. This is the reason the ac-bias signal always is fed directly to the recording head without traveling through any tube or transistor stage of the amplifier.

The ac recording bias produces far less noise than does dc bias. For example, an ac-bias record/play cycle can achieve a signal-to-noise ratio of about -55dB. Distortion of the bias waveform (Figure 4) increases the noise, but the amplitude of ac bias does not vary the tape noise. In fact, there is only a very small difference in noise level among various brands and types of recording tape. Noise level with ac bias is virtually the same for all tapes.

Erasing previous recordings

One advantage of recording on tape (vs. recording on phonograph discs) is that the invisible recorded tracks can be erased by degaussing, allowing reuse of the tape.

Erasing of magnetic recordings is done by subjecting the area to a strong magnetic field that gradually is reduced to zero strength. This can be done to an entire tape by a bulk eraser, or to only one track by an erasing head on the machine.

Erasing can be done easily by pressing a permanent magnet against the moving tape. Alternately, a conventional head also can function as an erase head when a strong dc current flows through the windings. Both methods are called *dc erase*. Either a permanent magnet or an electromagnetic erasing head is used in each low-priced portable recorder.

A dc erase with unvarying

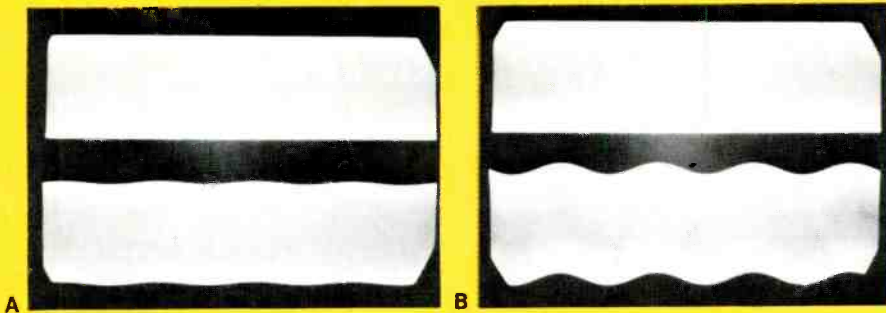

Figure 2 For low-distortion recordings, the ac-bias current must be larger than the audio current in the head. These scope waveforms show voltage and current relationships of bias and audio. Photograph A top trace (scanned at audio—not bias—rate) shows the bias-voltage amplitude without audio. The lower trace is the same except normal recording audio voltage is added. Notice the audio-voltage small amplitude. Photograph B shows the equivalent *current* waveforms, made by scoping the voltage drop across a 100 Ω resistor in series with the head. The top trace is the head bias current, while the lower trace shows the head current when audio is present. Notice that the audio current is larger compared to the bias current than is the audio voltage versus the bias voltage. That's because the head impedance is higher for bias than for audio. Remember that magnetic flux is dependent on current primarily, while the voltage amplitude is not very important.

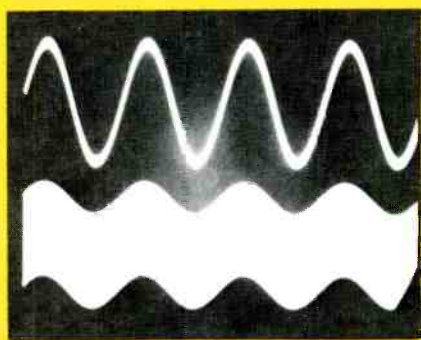

Figure 3 Bias and audio signals remain separate during magnetic recording. One signal does not modulate the other. No non-linear components are there, and no sum-and-difference signals can be tolerated. These statements are verified by the scope traces. The top trace is the audio sine wave recording signal, while a mixture of bias and audio is shown by the bottom trace. Notice the same phase is traced by audio at top and bottom of the bias signal. Contrast this waveform with a drawing or waveform of amplitude modulation; there is a definite difference.

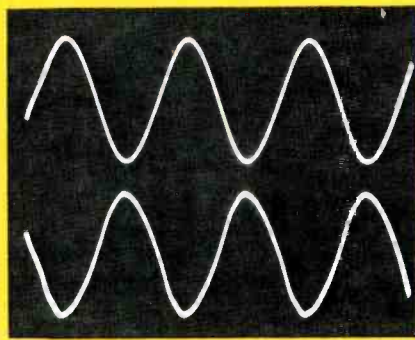

Figure 4 The specific amount of ac-bias current determines: 1) the percentage of distortion, 2) the high-frequency response during playback and 3) the volume remaining on the tape following playback. Usually, a compromise is necessary since the optimum for each attribute is obtained at a different bias amplitude. Also, distortion in the ac-bias signal increases the noise level during playback. Bias sine waves of low distortion are shown by the top trace, while the bottom trace reveals some distortion of the bias current.

magnetism (the change to zero flux occurs when the tape leaves the magnet or head) leaves a slightly higher noise level on tapes than does ac erase. However, the difference is not so great as between dc bias and ac bias. A fair compromise for small machines is to include dc erase but ac recording bias. Of course, the very lowest noise is obtained by ac erase and ac bias.

Ac erasing is accomplished by sending a strong ultrasonic current through the windings of a

magnetic head. Only bulk erasing gives a lower playback noise level. Many of the higher-quality erasing heads have two gaps.

Although the amounts of current required for ac-erase and ac-bias functions are vastly different, both *should* be taken from the same oscillator. This allows the bias-oscillator circuit to be less complicated, while it removes all possibility of audible beats formed between erase and bias signals that have different frequencies or are not perfectly synchronized.

Limitations of head response

Playback heads contribute far more to frequency response problems than do recording heads. The natural characteristics of playback heads produce frequency response curves that rise about 6dB per octave (an octave is the interval between a frequency and one half or double that frequency) from the lowest bass frequency up to the practical high-frequency cutoff. For example, if the maximum 2-wavelength peak is set at 20kHz, the uncompensated level at 20Hz would be around -60dB. Obviously, such poor response cannot be tolerated.

Because the *recording head* (core and windings) is an inductance, identical recording levels for all frequencies require equal head currents for all audio frequencies. Usually this condition is called *constant current*, which is somewhat ambiguous since the head current clearly must vary directly with the amplitude of the analog recording signal. In practice, a relatively constant current is produced by placing a resistor (of about 10 times the head impedance) between the audio amplifier and head (see Figure 5).

When a signal of flat frequency response is applied to the constant-current resistor and the recording head, a flat-response magnetic signal is recorded on the tape. The first large problem arises with the playback.

As illustrated by Figure 6, a playback head will intercept different amounts of magnetic flux, giving different output amplitudes, according to the width of the head gap versus the wavelength of one recorded cycle on the tape. Notice that the head's signal amplitude varies in *direct* proportion to the magnetic flux between the head gap's two sides. Of course, an inductance is affected only by varying magnetic fields, so the previous statement assumes a changing flux rather than a stationary flux.

Wavelengths are specified in Figure 6 rather than signal frequencies because the signal frequency vs. the head-to-tape speed determines the signal's *physical* wavelength on the tape. Not all heads have the same gap width, nor do all machines have the same tape speed. Therefore, wave-

lengths must be the unvarying element.

Signal output from the playback head can be generated only when an opposite polarity of magnetic flux is applied to each gap edge of the head. When a sinewave with wavelength equal to the head gap is at the head gap, no output signal is possible because the same polarity and amplitude of flux is applied to each side of the gap. Notice that this is true regardless of the changing sinewave phase as it passes the gap.

Maximum head output occurs when a sinewave of wavelengths equal to twice the head gap is at the gap, because maximum positive flux is at one edge and maximum negative flux is at the other when the phase is as shown. As the tape moves, the sinewave phase changes, but negative is always at one edge and positive is at the other until that cycle is finished. Therefore, the output is a sinewave with maximum output, relative to these other conditions described next.

Equalization can extend the high-frequency response slightly above the head maximum point, but the response falls rapidly, so this is not practical beyond a moderate improvement.

Frequencies with wavelengths longer than the head-gap distance have reduced amplitude output. Look at the sinewave called *low* in Figure 6. The waveform's gradual slope permits only a small positive and a small negative flux at the gap, so the signal amplitude is low. Other frequencies are attenuated various amounts according to their positions between the two previous examples.

Frequency compensation

The rising type of uncorrected playback response has one disadvantage and one advantage. The attenuation below the high-frequency peak follows a straight and linear line at -6dB per octave. Therefore, it is possible to incorporate low-frequency compensation (bass boost) in the playback amplifier, achieving flat response down to a moderate bass frequency.

However, the amount of bass boost is large, and a serious problem arises when the 2-headgap-wavelength peak frequency is increased (by a narrower gap and

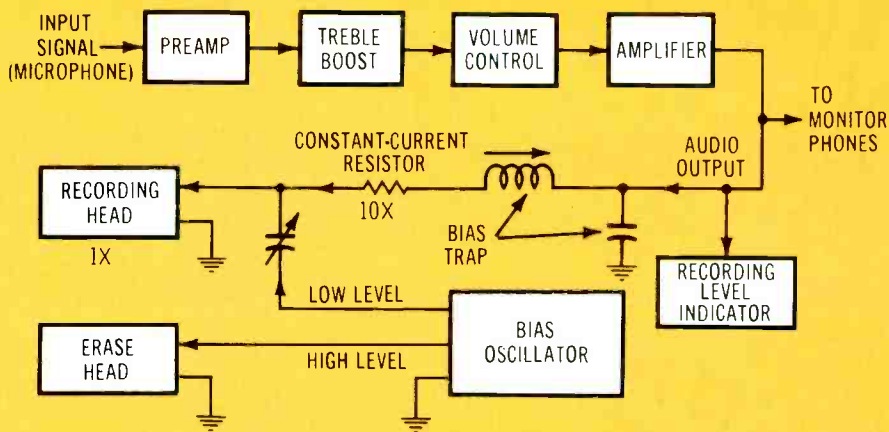

Tape recording

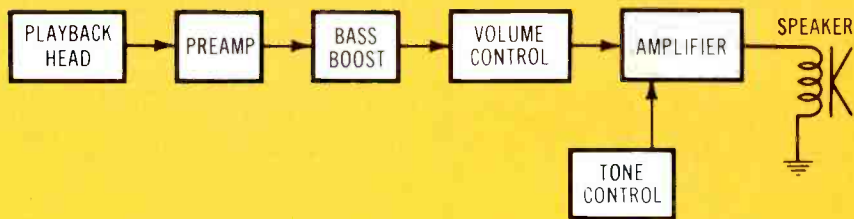

Tape playing

Figure 5 Essential requirements for recording and playing magnetic tapes are shown by the block diagrams. Treble boost is supplied to overcome high-frequency losses and to improve the noise level (top). Amplitude of the recording signal can be monitored by a meter or digital readout. A tuned trap (as shown) or an R/C filter minimizes the bias amplitude fed back to the amplifier from the recording head. Constant current for recording is produced by the loss resistor, which often has a resistance about 10 times that of the head impedance. Many recorders provide a servicing adjustment for the bias current. Sometimes the adjustment is merely a variable capacitance, as shown. Notice that a higher amplitude of the ac bias is sent to the erase head, which removes any previous recordings immediately before the new recording. During playing (bottom), the equalizing values are changed to produce bass boost (increased low frequencies). This compensates for the reduced pickup of signal by the playback head at bass frequencies.

faster tape speed) to extend the high-frequency response. This decreases the low output at bass frequencies even more (perhaps 20Hz) until it approximately equals the noise level of all practical preamplifier circuits. In other words, compensation *can* provide flat response from the desired high-fidelity ideal of 20Hz to the head-null point, but with the tradeoff of excessive noise in the signal.

This basic limitation can be minimized by low-noise preamplifiers, but compromises usually are necessary in addition. For example, the high-frequency null point is placed no higher than is absolutely necessary, and the bass cutoff is raised to a point (perhaps 50Hz) that will allow excellent reproduction of all music,

except perhaps the lower octave of pipe-organ pedals.

Other limitations

Several other factors limit the high-frequency response of a tape system. High frequencies on the tape are susceptible to partial self-erasure, perhaps because individual narrow cycles of flux can flow together and thus cancel.

Another serious limitation is *saturation compression* of flux in the tape coating. When the magnetic coating saturates, increasing the recording power above that amplitude does *not* increase the tape magnetism, nor does it raise the playback volume of the affected cycles. Better-quality coatings minimize the problem (thus justifying expensive tapes for some uses), but satura-

tion compression is a serious practical limitation, particularly with cassette-tape systems.

Higher frequencies suffer increased saturation compression. I learned about high-frequency (treble) response on cheap tapes by using a graphic equalizer to boost the treble to +20dB. Even with this amount of treble boost, the playback sound showed little increase of high frequencies.

These examples illustrate an important truth about magnetic tapes: Recorded amplitudes above the saturation point cannot be forced on any tape coating. Increased amplifier power and more efficient recording heads cannot change that limitation. Higher overall amplitudes or flatter high-frequency responses are possible only from better tape-coating formulas.

On the brighter side are two positive factors:

- Most music has much lower

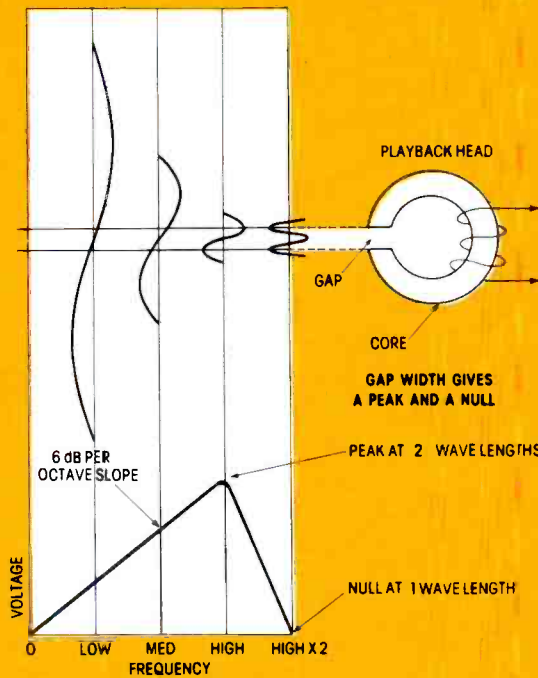
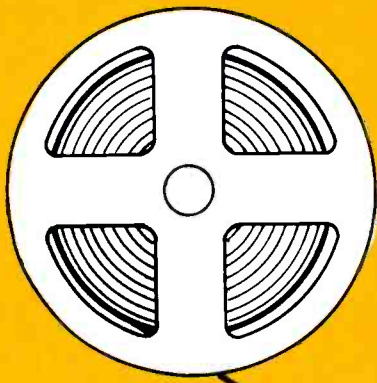

Figure 6 The null at one wavelength, the maximum of two wavelengths and the -6dB falling response below that can be explained by the flux between the two edges of the head gap. At one wavelength, the same polarity and amplitude of flux appears at *both* edges of the gap; therefore, the head interprets this as zero flux. At two wavelengths, the maximum amplitude of opposite polarity flux appears between the head gaps, producing maximum electrical output from the head winding. Lower frequencies allow lower amplitude of flux across the head gap, thus the electrical signal is reduced. These are fundamental attributes of all magnetic heads.

portable forced sound that is not as unpleasant as some other distortions. Saturation of high frequencies is usually audible only as a lack of sufficient treble in recorded voices of music. There is no noticeable distortion or unpleasant tone quality.

high-frequency response.

If you are a high-fidelity addict, the information will guide you in obtaining the best possible quality from your machine.



3-head reel-to-reel type

Comments

This discussion of tape-recording shortcomings and limitations, with the special circuits required to minimize them, is not a condemnation of tape equipment or the audible results obtained from typical machines. When high-quality tape is used with a recorder of good

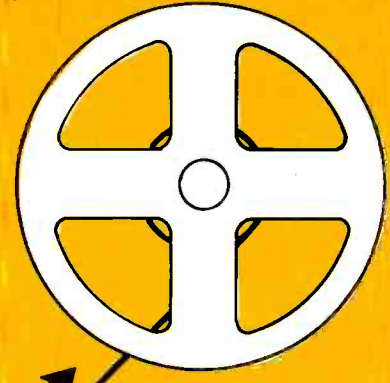

amplitude and power in the high frequencies, and this allows high-frequency boost during recording to compensate for some of these treble losses.

- Distortion from saturation compression is not so raucous and dissonant as is distortion from amplifier overload or head saturation. Saturation of tape coating is symmetrical on both positive and negative peaks, thus the distortion is mainly third harmonic. The third harmonic of 10kHz, for example, is 30kHz, which is outside the system bandwidth and thus cannot be heard. In practice, therefore, low-frequency saturation (from excessive gain) has an uncom-



All recorders have this general tape travel and location of the heads and tape guides. Cassettes have both reels inside the housing. Also, many recorders have a single head that is electrically switched for record or play operation.

specifications, the quality of music and voice playback can be excellent.

Instead, the limitations and problems are highlighted to help technicians troubleshoot tape-machine defects more quickly. For example, when the complaint against a machine is insufficient treble, a technician's job is made easier if he understands *all* general conditions that reduce the

Next installment

Details of the audio-cassette system and facts about typical cassette recorders will be presented in the next installment. Future subjects will include descriptions of commercial test tapes, methods of adjusting azimuth, interpretations of manufacturers' graphs of tape characteristics and how to make quick tape-frequency-response tests.

If you have specific questions about cassette tape recording, mail them to the author in care of **Electronic Servicing & Technology**.





Car radio *tune ups*

Although specific features and circuits vary widely in different makes and models of auto radios, there are several general test procedures that help with all models.

These test methods are described, along with case histories that illustrate typical component failures.

Radio receivers have been in cars for more than 50 years and they become more popular each year. In the early years, auto radios were not standard equipment in new cars; radio-repair shops installed radios, antennas and essential noise-reduction components. In the 1930s, most auto radios were large boxes mounted on the car firewall, under the instrument panel, and tuning and volume adjustments were made by armored flexible cables that connected each radio with its matching control head (perhaps mounted below the dash or on the steering column). Tuning covered only the standard AM broadcast band.

Some new radios, by comparison, are one-piece units so small that they can be mounted behind the instrument panel, with nothing showing except a dial and the knobs. An increasing number of new car radios have no movable tuning dial with pointer. Instead a LCD or LED digital readout shows the actual operating frequencies.

The majority of new models cover FM and AM broadcast



By Homer L. Davidson

bands. Many of these also have internal multiplex circuits, twin power-output circuits and two sets of speakers for FM-stereo receptions. Some models offer AM/FM-stereo radio reception plus a cassette or 8-track tape-player mechanism inside the same case.

Servicing of an auto radio requires familiarity with the circuits and the common problems, in addition to knowing the testing techniques. A 12Vdc power supply, an adequate assortment of test instruments and enough suitable tools are also essential.

Preliminary inspection

Much servicing time can be saved by first performing a brief but thorough inspection.

After 12V power and an antenna have been connected, place an ear near the external test speaker (or internal speaker if it has one) and listen intently while turning the radio power on and off by the radio switch. Usually a faint click or a dull thump will be heard if the output solid-state stage is operating. Next, turn the volume control up and down rapidly, several times. If

a small swishing or crackling noise can be heard with each movement, but the noise ceases when the control is left at an intermediate setting, it is likely that the entire audio circuit is working normally and the defect probably is in the IF stages.

On the other hand, a steady "pink" noise proves the IF stages (and probably the mixer stage) are normal. Inability to tune in a station indicates the RF or oscillator is dead.

When stations can be heard, but the noise level is excessive (and usually the volume is weak), the defect probably is in the RF stage or the antenna and its wiring.

After additional experience with both normal and defective operation, you should be able to pinpoint the defect more accurately. Part of this analysis is based on whether the radio tests are made on AM or FM. FM operation usually has one or more IF stages than AM. Therefore, the steady pink noise obtained by a dead oscillator, for example, is much louder for FM than for AM (when an FM station is properly received, the inherent

AM rejection of FM quiets the noise).

Another type of analysis is provided by stereo audio channels. If the left channel has a defect, for example, the gain, distortion, voltages and other conditions of the good channels can be compared to those of the defective channel. These comparison tests should be used when possible.

After these preliminary tests have directed suspicion to a certain stage, test that area carefully, using dc-voltage analysis, signal tracing, signal injection and other appropriate tests to locate the defective component.

Efficient troubleshooting of auto radios depends strongly on isolation of the defect to a specific stage or section by observation of the symptoms plus a few simple tests. When full advantages are taken of these tests and techniques, most repairs of auto radios can be made rapidly and profitably.

The following nine case histories provide specific examples of problems encountered often in car radios.

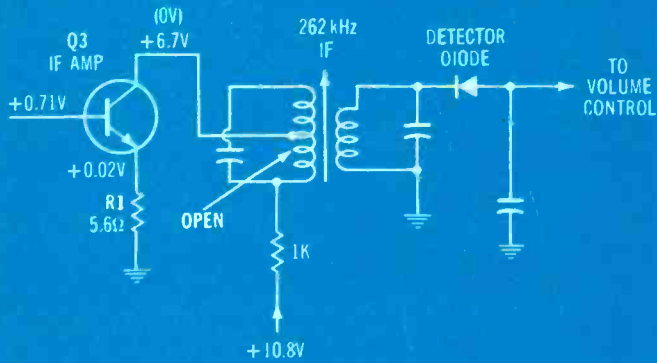

DEAD FORD RADIO

Figure 1 In the DAF-18806 Ford radio (Photofact AR-202), dc-voltage measurements located zero collector voltage of Q3. Then resistance measurements proved the IF transformer primary winding was open. The voltage in parenthesis is the measured voltage, while the others are schematic voltages for a normal chassis.

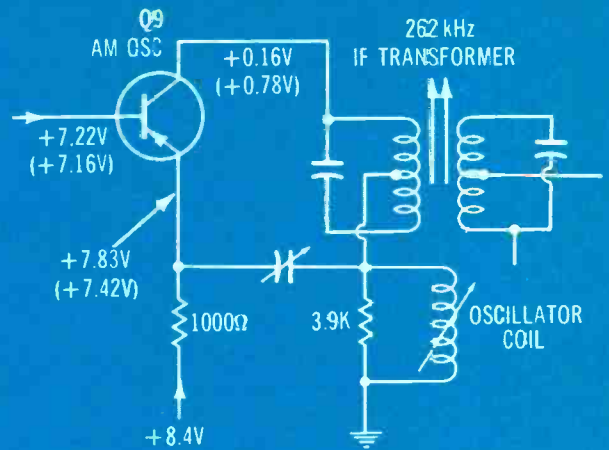

MOTOROLA WRONG VOLTAGES

Figure 2 The dc voltages at Q9 oscillator/mixer transistor in a Motorola 5FM485 at first appear to show only the usual deviation from a schematic. However, when the emitter voltage was subtracted from the base voltage, the transistor bias was proved insufficient. Voltages in parenthesis are measured ones, while the others are schematic voltages for a normal unit.

9 case histories:

1. Ford with dead IF

Only the usual scratching or swishing noise could be heard when the volume control was rotated rapidly on the Ford model DAF-18806 car radio. No pink noise of the IFs or RF/converter stages could be heard. An open or leaky converter transistor usually allows a loud pink noise.

When the volume control's "hot" lug was touched with a metal screwdriver blade, the typical buzz was heard. This proved the audio between volume control and speaker was operating correctly, and that the defect was between the converter stage and the volume control.

Voltages of all IF transistors were measured, and zero voltage was found at the Q3 IF-transistor collector. B+ should pass through the primary winding of the 262kHz second-IF transformer to the Q3 collector. At the supply end of the wind-

ing, the dc voltage was slightly higher than usual, indicating a loss of current through the 1K resistor.

The function of the digital multimeter was changed from Vdc to ohmmeter, and the second or third resistance test identified an open primary winding (Figure 1). Usually an open winding requires replacement of the entire coil and shield, although if an appropriate replacement is not available, the open winding sometimes can be repaired. The open is likely to be at one of the connecting lugs, where it can be repaired. Pry back the metal tabs holding the transformer assembly to the metal shield and remove the shield. Under a bright light, examine the lugs where the wires are soldered, using a magnifying lens or a combination magnifier/light. With a hex adjusting tool or small screwdriver blade, gently try to move each wire at its lug, because most opens occur here. If a broken wire is found, tin it

and solder the wire to the lug again.

For best results, the IF alignment should be checked after the radio is playing normally. In this case, a new IF transformer and a slight touchup provided excellent performance.

2. Motorola without AM

Because the FM reception was normal in the Motorola 5FM485 and weak pink noise could be heard on AM, several voltage measurements were made at and around the AM oscillator transistor (Figure 2). Although the voltages were incorrect, the discrepancies were small, and they might have been overlooked.

Oscillator transistors (and others with unbypassed signals on the emitter) should not have their forward biases measured directly between base and emitter, as in other stages. Connection of a digital-multimeter ground probe to the emitter

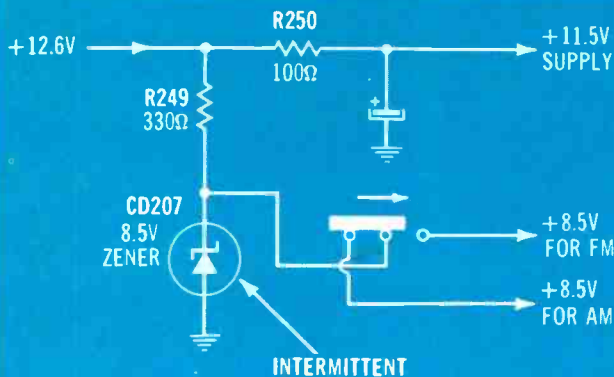

AUDIOVOX VOLTAGE PROBLEM

Figure 3 Loss of AM in an Audiovox C-977 was accompanied by an increase of the +8.5V supply. Schematic voltages are correct for a normally operating radio. An intermittently open zener was responsible.

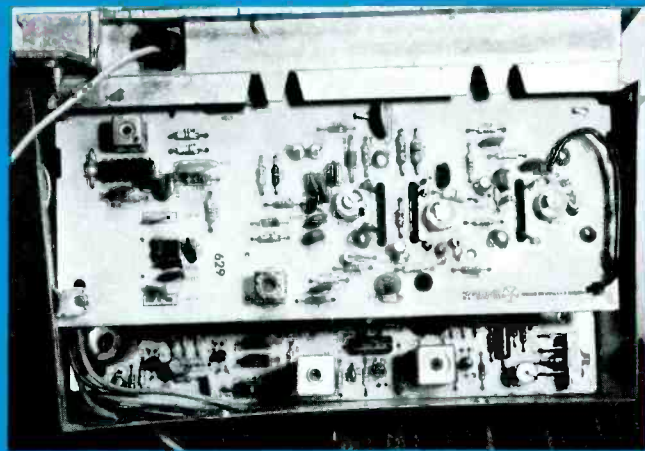

Figure 4 Some auto radios are difficult to test or work on because the FM section is mounted over the other board, as shown here in a Clarion model PE-676A.

often detunes the stage or eliminates the oscillator operation. Therefore, the forward bias of this Q9 transistor required two readings. The emitter-to-ground voltage (+7.42V) was subtracted from the base-to-ground voltage (+7.16V), giving a true B/E bias of -0.26V. Unfortunately, Q9 was a PNP silicon type needing -1.61V of forward bias (+7.22V - +8.83V), so it was clear the transistor had insufficient or cutoff bias. On the other hand, the collector-to-ground dc voltage was too high (+0.78V instead of +0.16V), indicating excessive collector current. In other words, the bias indicated no C/E current because of insufficient forward bias, but the collector current indicated excessive C/E current. Both conditions cannot exist at the same time.

Collector-to-emitter leakage inside transistor Q9 can account for these contradictory readings. The increased emitter

current reduces the emitter voltage, thus decreasing the forward bias, while the C/E leakage current *appears* to be normal base-controlled transistor current.

When Q9 was removed from the board, it was found to have a partial short between collector and emitter. Installation of a GE-82 universal-replacement transistor restored normal AM reception.

3. Audiovox intermittent AM

In an Audiovox model C-977 car radio, the FM reception was dependable, but the AM operation was intermittent. These symptoms point to nothing specific; the problem might originate in any stage that is *not* shared with FM operation. Of course, both AM and FM use the same audio stages, so they are not in question. Also, the AM and FM signals go through the same IF stages. Therefore,

it appeared the erratic operation came from the AM RF and oscillator stages.

Several measurements were made of the various supply voltages (Figure 3) before it was noticed that the +8.5V supply increased each time the AM went dead. When the AM stopped, it could be restored by reducing the supply voltage from the abnormal +10.5V to the correct +8.5V value.

A search of the schematic revealed zener diode CD207, and it seemed a good suspect. A radio was operated until the AM stopped, then diode CD207 was sprayed with canned coolant. The voltage instantly dropped to normal and the AM operation began again. Remember that selective heating and cooling of individual resistors, capacitors, diodes, ICs and transistors often can trigger or stop intermittent operation. This is a valuable time saver in those cases where it works.

Zener diode CD207 was

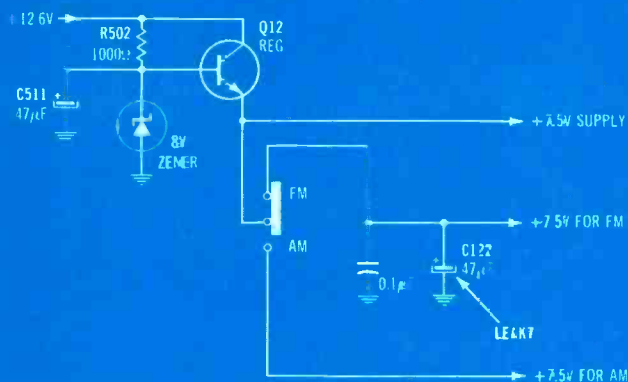

CLARION SUPPLY PROBLEM

Figure 5 A leaky C122 in the Clarion radio reduced the FM supply voltage, thus eliminating the FM operation.

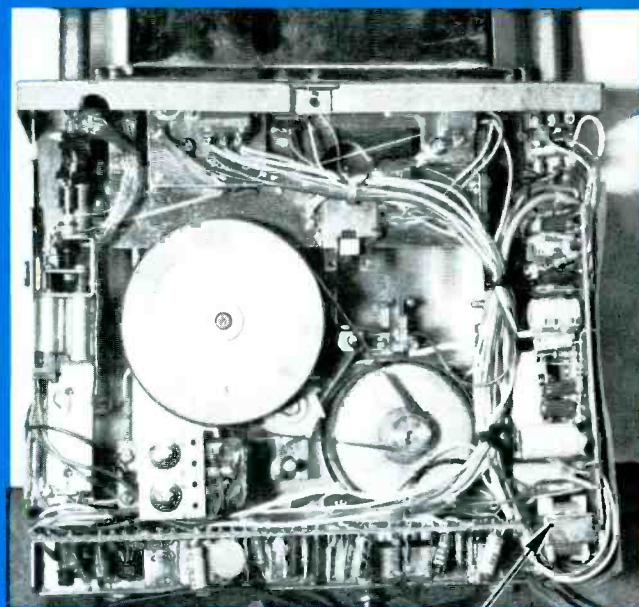

Figure 6 An arrow points to the location of the hidden output IC in a Kraco model KD-58SC. Tests are difficult in such inaccessible areas.

replaced with a universal 8.2V zener, and the AM intermittent was repaired.

4. Clarion without FM

Servicing FM problems often requires a longer time than for AM problems. For one reason, the FM section might be located inconveniently on top of the AM and audio sections (Figure 4).

In addition, greater care must be used in finding suitable replacement transistors and other components for the FM tuner section. Always replace a plastic-case original with a plastic-case replacement and a metal-cased transistor with a metal-cased replacement. Otherwise, the different internal capacitances can degrade the performance.

In the Clarion model PE-676A radio, almost zero voltage was measured at the collectors of the RF and oscillator transistors. However, the voltages were approximately correct in the AM stages. The schematic (Figure 5) showed both AM and FM supply voltages coming from the same Q12 regulator, according to position of the

bandswitch. Voltage at the Q12 emitter was normal when the radio was switched to AM, however, the emitter voltage dropped to almost zero when the radio was switched to FM. Obviously, whatever was reducing the voltage was located in the FM circuit. With 12V power removed from the radio, the resistance of the FM supply was less than 2Ω to ground. Cuts were made in the circuit foil to determine which components were producing the low-resistance excessive load.

Finally, all components were cleared except filter capacitor C122, which tested leaky. FM reception and the +7.5V supply returned to normal after a new C122 was installed and the foil opens repaired.

5. Intermittent Sanyo tweeters

The customer's complaint about the Sanyo model FT-1495 was that both channels simultaneously lost treble response at unpredictable times. It is virtually impossible for speakers of both stereo channels to become erratic at iden-

tical times. Therefore, some other defect must be responsible for the erratic high-frequency response, and that defect must affect both channels the same. Two possibilities are the tweeter-level control and the wiring to it.

After some searching, we found the tweeter control (along with several other controls) soldered to a separate circuit board. When the tweeter control was rocked from side to side gently, the treble sounds from the tweeters would cut in and out. This proved the previous suspicion that the control or its wiring was bad.

Resistance tests verified an internal control short to ground, which is rare. This tweeter control must be replaced by an original manufacturer's part. Tweeter operation was normal after a new control was installed.

6. Kraco with weak right channel

The right-channel sound was weak for both radio and 8-track audio in the Kraco model KD-

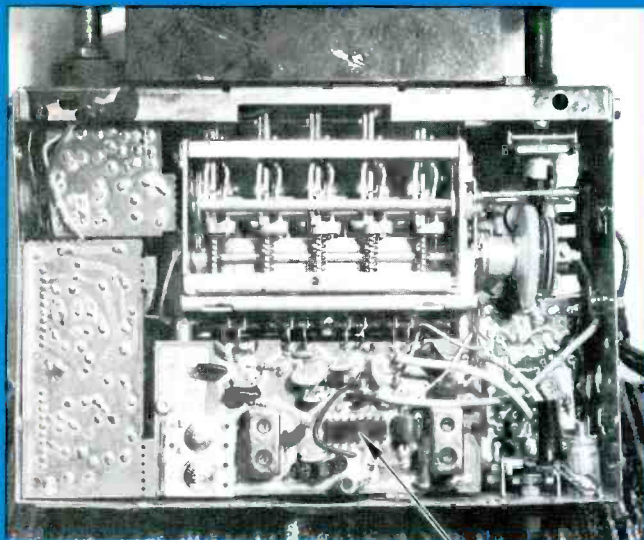
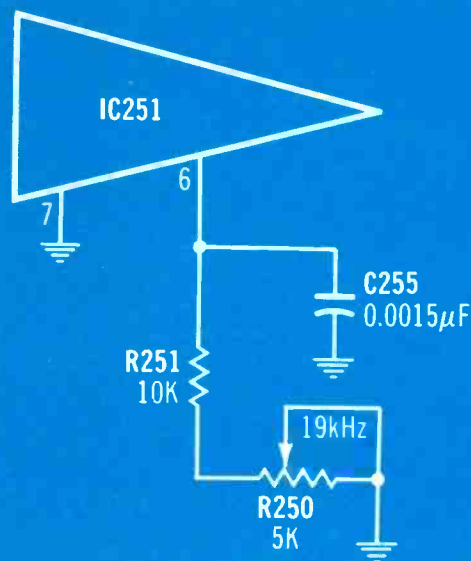

Figure 7 An arrow points to IC-251 in the Craig model 3146 auto radio. The IC was intermittent from vibrations or movements.



CRAIG BAD IC

Figure 8 The Craig of Figure 7 required readjustment of the stereo-subcarrier level by R250 after IC-251 was replaced.

58SC (Figure 6). Excessive distortion also was present in the right channel, although the left channel operation was normal.

An excellent procedure for testing stereo amplifiers is to compare voltage and signal levels of the two channels, using the good one as the standard. At the volume control, both signals were good. The audio signals at the two inputs of the IC also were normal, but at the IC's output terminals, the right-channel signal was very weak and badly distorted. The dc voltages of the IC were tested and compared, with the conclusion that the IC itself was defective.

After the IC was replaced by an original-equipment UPC-1185H type, both channels produced loud, undistorted volumes.

7. Craig intermittent stereo

The FM operation of a Craig 3146 was normal in the monaural mode, but in stereo, the audio was intermittent and the stereo-indicator light would

flash erratically. When C255 was moved slightly, the stereo light would come on steadily, indicating that either C255 or IC-251 (Figure 7) was defective.

Sometimes spraying a transistor or IC with coolant or applying heat will cause the suspected component to malfunction (or if it is malfunctioning, force it to operate normally). Rapid fading in and out of the signal seemed to rule out the usual voltage and signal-level tests.

When a pencil was used to apply pressure to the IC top, the stereo signal became highly erratic, indicating a defective IC. A universal GEIC-76 integrated circuit was installed, and the 19kHz carrier touched up by adjustment of R250 (Figure 8). Afterward, no intermittent operation of the FM-stereo mode was observed.

8. Noisy and distorted Clarion sound

Noise and distortion were the complaints about the Clarion model RE-328 auto radio. After listening to the radio in the car,

the technician decided the audio section had a defect or the speaker cone was bad. A test speaker was connected in parallel with the radio speaker, but the sound from the test speaker had the same noise and distortion. Therefore, the radio was removed from the car and operated on the auto-service bench.

An external audio amplifier was used to trace the audio quality from volume control to speaker. No distortion was found until the speaker was reached. Prime suspects of the audio-output stage are burned resistors and defective transistors.

Two burned bias resistors were located by visual inspection. The corresponding output transistor was removed; it tested leaky. When one of two output transistors is proven defective, it is wise to replace both at the same time. Therefore, the two 2SB481 old transistors were replaced by universal ECG-131 types, and the burned resistors were replaced with equivalent new ones. These repairs eliminated the former noise and distortion.

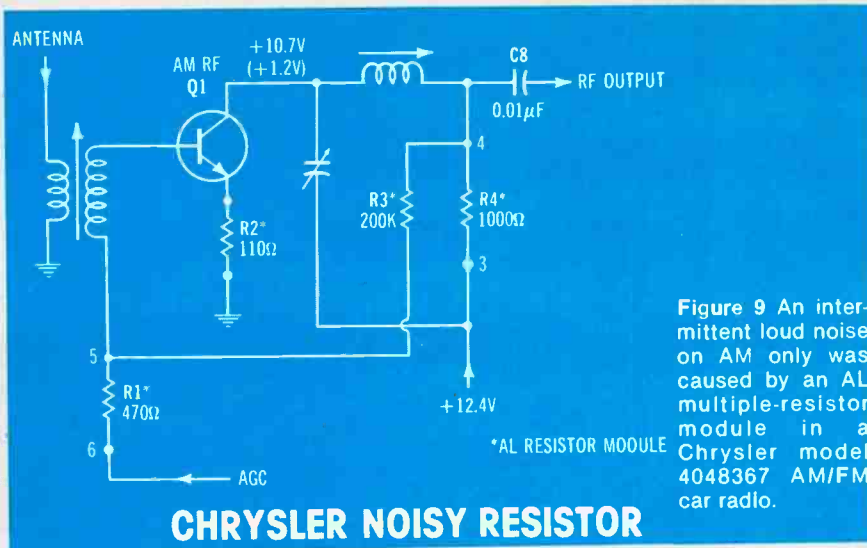

Figure 9 An intermittent loud noise on AM only was caused by an AL multiple-resistor module in a Chrysler model 4048367 AM/FM car radio.

CHRYSLER NOISY RESISTOR

9. Chrysler with delayed noise

Loud noise on AM began in this Chrysler model 4048367 auto radio only after several hours of continuous operation. In fact, the radio sometimes played for days without the noise. FM operation was not affected.

Excessive voltage or a heat

buildup usually is the trigger for such complaints. The symptoms pointed toward the AM oscillator and RF-amplifier transistors or the audio stages. However, the audio stages were cleared of suspicion by examining the signal at the volume control with an external amplifier and speaker during one period when the noise was there. The

noise was originating in the AM front end.

Both AM oscillator and RF transistors were replaced as a test. Components around the transistors were alternately warmed and cooled, but there was no change. No noise was heard during heat runs for almost a week, but finally, the noise began and appeared to be permanent.

Voltage tests when the noise was present showed erratic dc voltages at the Q1 collector (Figure 9). At one time, the normal +10.7V reading dropped to only about +1.2V, while the supply voltage of +12.4V remained steady. Although the resistances of the AL resistance module were normal when the power was turned off, it was the chief suspect. This special module is number 3597230 and it can be obtained only from distributors of Chrysler radio products. A new module was ordered and installed, and the AM noise was gone.

ES&T

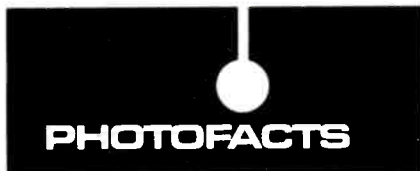

These Photofacts for TV receivers have been released by Howard W. Sams & Co. since the last report in ES&T.

GENERAL ELECTRIC	
Chassis XE-A	2085-1
HITACHI	
CT19H9, CT1915/919	2082-1
JC Penney	
685-1026-00 (855-2978)	2078-1
685-1027-00 (855-2952)	2080-1
685-2057F,-00,	
685-4204F,-00/05F,-00/065,-00	2081-1
MAGNAVOX	
BB3910SL01	2076-1
PANASONIC	
CT-9001/011/021/031/041	2075-1
CT-9051/071	2078-2
PHILCO	
Chassis E32-6/7	2088-1

QUASAR	
Chassis TS-995	2079-1
Chassis 12TS-627	2081-2
RADIO SHACK	
TC-220 (16-220)	2085-2
SAMSUNG	
BT-316NR/318NR	2085-3
SANYO	
Chassis PM-40N01	2076-2
SEARS	
564.40270150	2075-2
564.44101150	2087-1
SHARP	
C1335A	2076-3
C1935A	2080-2
13F40	2083-1
19F90	2086-1
13F26	2088-2
SONY	
TV-415	
AC-127W (ac adapter)	2077-1
Chassis SCC-338A-A	2080-3
SYLVANIA	
Chassis E32-21/22	2086-2
Chassis E31-1/2	2083-2

ES&T



Needed: Schematic for a Candle radio, model TK-2653, manufactured by Tokyo Transistor Industry Company. Can send C.O.D. *Rivera's Radio TV Service, P.O. Box 1460, Carolina, Puerto Rico 00628.*

Needed: IC driver #SE540L/7711, for Johnson Electronics stereo receiver M S/A-10 or information on the company. Will buy manual or copy and return. *TV Central, 870 Pio Nono Ave., Macon, GA 31204, 1-912-743-1451.*

Needed: Schematic diagram for Infonics cassette recorder, model 102. *Andrew Horeczko, 1600 W. 22nd St., San Pedro, CA 90732.*

Needed: Manuals for NRI Professional signal tracer, model #33 and RCA color bar generator, model #WR 64-A. *Kenneth Miller, 10027 Calvin St., Pittsburgh, PA 15235, 1-412-242-4701.*

Needed: Eico model 1064 battery eliminator and charger; model 1078 metered ac supply, 0-140V; and schematic and service manual for an EMC model 700 RF/AF crystal marker/generator. *Caswell Davis Jr., 601 Delmar, Apt. 2, San Antonio, TX 78210.*

Needed: Sams Photofact TR-82; Supreme's Vol. R-2, R-3 and TV-1; and Tekfax Volumes 1, 2 and 3. *C.T. Huth, 146 Schonhardt St., Tiffin, OH 44883.*

Needed: 110V motor for Panasonic reel-to-reel tape recorder, #RS-766US, motor #4AC 15AL. Also a set of Rider radio manuals. *Alpha's TV, 5151 S. 12th Ave., Tucson, AZ 85706, 1-602-294-0421.*

Needed: Sencore PR57 Powerite and TF46 Super Cricket. Must be nice and reasonable. *Bob L. Pierce, 1822 Sun Valley, Jefferson City, MO 65101, 1-314-635-9439 or 634-4291.*

Needed: Source for coils used in Hammarlund model HW180A receiver, or model HQ180A suitable scrapping, if price is right, via UPS. Can use three. *C.R. Wilson, 61 Warwick St., Portland, ME 04102.*

Needed: Service information or schematic for Hammarlund HQ150 receiver, Accurate Instrument model 153 signal tracer and generator, and Kenwood TR7200A. State price. *Able TV, Route 4, Box 764, Panama City, FL 32405.*

Needed: B&K 467; will pay up to \$200 for good con-

dition and operating literature. Also Sencore VA48, up to \$700. *Dave's Radio & TV, Box 103 Breton, Alberta, Canada TOC OPO, 1-403-696-2493.*

For sale: B&K 415 sweep/marker generator with leads and manual. Works perfectly; \$200. *John MacGregor, 1107 Braintree Drive, Schaumburg, IL 60172.*

For sale: Sams Photofacts schematics from #1 to over #300, in binders, plus more extras; \$50, you pay shipping. Write for complete list. *George Otto, 1045 Magnolia Ave., Beaumont, TX 77701.*

For Sale: Sencore VA48, used less than 1 hour. *Call Gary Nordin, 207 N. Wells, Edna, TX 77957, 1-512-782-3191.*

For sale: Heathkit model IP-17 HV-regulated power supply, \$75; Mercury model 1000 dynamic conductance tube tester, \$90; and Eico model 1140 series-parallel RC combination box, \$20. *William Shevtchuk, 1 Lois Ave., Clifton, NJ 07014, 1-201-471-3798.*

For sale: B&K model 465 CRT checker, overhauled in November 1981 (have proof). Complete with SP-65 B&K converter. Several sockets for b&w and color television, complete with 1981 set-up chart and manual. All for \$105 plus postage and insurance. In good condition. *Jag's Radio & TV, 14 Rudolph Road, Forestville, CT 06010.*

For sale: Tekfax: from October 1968 (#1183) through 1977 are complete, 1978-1979 have some missing, and 1980-1981 are all incomplete. Also have #101 TV, radio schematics, copyright 1957, Electronic Technician. Make an offer. *Benjamin Halifin TV, 603 Ivey Ave., Colonial Heights, VA 23834.*

For sale: Tektronix model 5403 mainframe, dual-trace, 60MHz scope with CRT readout. Includes 5A48 dual-trace vertical amplifier plug-in unit, 5B42 A and B delayed time base generator plug-in unit and two probes. Excellent condition, \$1600. *Robert Goodman, P.O. Box 452, Alexandria, LA 71301.*

For sale: WR-59-B RCA sweep generator, WR-39-B RCA calibrator, 415 B&K sweep and marker generator. Includes manuals and leads. Make an offer. *C.O. Thurlow, 60 Christian St., White River Junction, VT 05001.*

For sale: Jackson tube tester, model 648S with latest chart, 1975; \$75. *H.W. Oats, Route No. 5, Harding Highway, Lima, OH 45801, 1-419-229-2322.*

For sale: Simpson model 431 Chroma-Line color pattern generator. Brand new, never used; \$75 (half price) or best offer. Free shipping. *Alan Schwartz, P.O. Box 6690, Santa Barbara, CA 93111.*

ES&T

Noteworthy CB circuits

By Harold Kinley, CET

There are dozens of special CB circuits that manufacturers come up with either to incorporate a special feature into their unit or to incorporate standard features using different approaches. This article covers two circuits that are used to incorporate special features into CB sets and a third circuit that achieves amplitude modulation by a different means than used by most manufacturers.

First, let's look at the special scanner circuitry used in the JC Penney model 981-6221 CB transceiver. This scanner circuit makes it possible to simultaneously monitor Channel 9 and any one of the other CB channels. Two switches are provided on the front panel to control the scanner, one called the Channel 9 switch and the other called the Normal switch. If the Normal switch is in the Normal position and the Channel 9 switch is in the Channel 9 position, the scanner will be active. The scanner will also be active if both these switches are in the Off position. If the Normal switch is in the Normal position and the Channel 9 switch is in the Off position, the scanner will be determined by the channel selector switch. Conversely, if the Normal switch is in the Off position and the Channel 9 switch is in the Channel 9 position,

the scanner will be stopped on Channel 9.

With these two switches properly set, the scanner will continuously switch the receiver back and forth between Channel 9 and the channel selected by the channel selector switch. When a signal is present on either channel, the scanner stops and the receiver is locked to that channel as long as the signal is present. An LED indicator is provided to indicate when Channel 9 is "up."

From the partial schematic in Figure 1, notice that channel selection is accomplished by varying the binary combinations on programming pins 1-6 of the uPD861C, so channel programming requires only placing the appropriate pins at binary 1 (approximately 5V). The other pins are automatically pulled down to binary 0 (near ground) by the on-chip pull-down resistors. Table 1 shows the proper binary combinations required on the program pins to program Channel 9. Notice that only two of the program pins (1 and 4) are at the binary 1 level on Channel 9. On the schematic in Figure 1, notice that these two program pins (1 and 4) are connected through diodes D3 and D4 to the output of NAND gate 3. Also, notice that these two program pins (1 and 4) are con-

nected to the channel selector switch through diodes D1 and D2. Diodes D3 and D4 serve to isolate the output of NAND gate 3 from the program lines as long as the output of NAND gate 3 is low or binary 0. Diodes D1 and D2 serve to isolate the channel selector switch from these program lines so long as the output of NAND gate 4 is low or binary 0.

NAND gates

The "heart" of the scanner is a quad 2-input NAND gate like the 7400 type. Two of the NAND gates (labeled gates 1 & 2) are connected to form an astable multivibrator. The frequency of the multivibrator is determined by the values of C11, R18, C10 and R19. Because $C11 = C10$ and $R18 = R19$, the output waveform at pin 6 (NAND gate 2) will have a 50% duty cycle with a time period of approximately 0.8s. The waveform is shown in Figure 2.

NAND gates 3 and 4 and the associated circuitry form what is called a bistable flip-flop with symmetrical triggering. The triggering input (at the junction of C7 and C8) is connected to the output of NAND gate 2 (at pin 6). The bistable flip-flop toggles or changes state on the trailing edge of each pulse, which appears at the

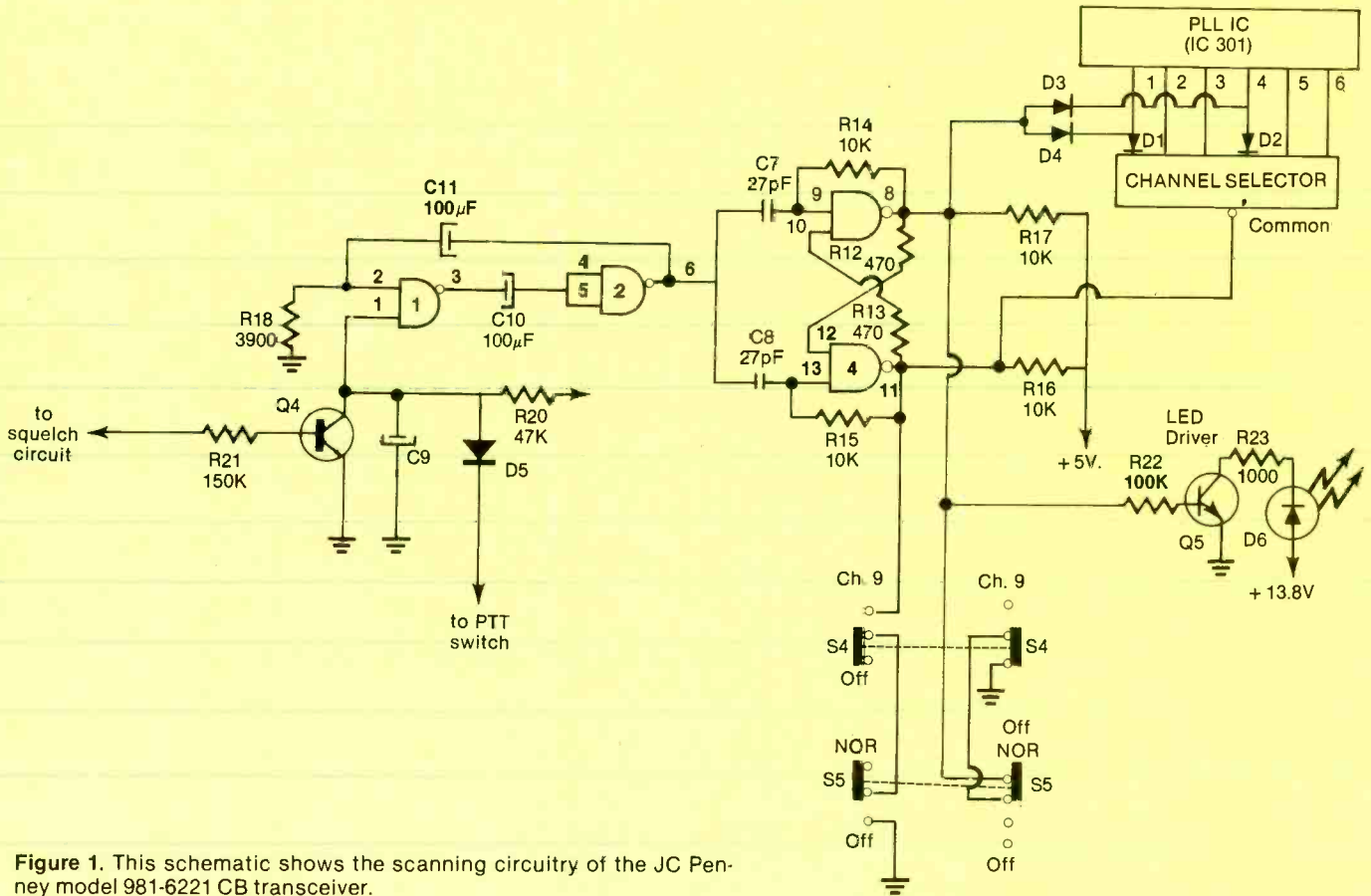

Figure 1. This schematic shows the scanning circuitry of the JC Penney model 981-6221 CB transceiver.

Table I.

Channel	Pin Number					
	1	2	3	4	5	6
9	1	0	0	1	0	0

triggering input. Assuming the output of NAND gate 3 (at pin 8) is at binary 0, the output of NAND gate 4 will have to be at the binary 1 level. After one pulse on the triggering input, the flip-flop will toggle, making the output of NAND gate 3 binary 1 and the output of NAND gate 4 binary 0. The low level output of NAND gate 4 will kill the supply voltage to the common terminal of the channel selector, and at the same time the high level on the output of NAND gate 3 will forward bias diodes D3 and D4, thus placing binary 1 on program pins 1 and 4. Diodes D1 and D2 are now reverse biased and thus prevent the high level on pins 1 and 4 from being routed to any of the other program lines through the channel selector switch. Channel 9 is now "up". With the output

A partial truth chart showing the binary levels of programming pins for Channel 9.

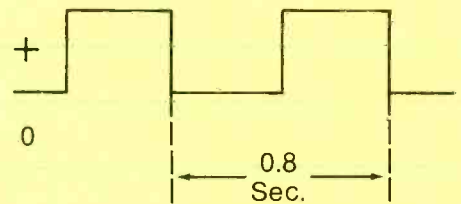

Figure 2. The approximate waveform at pin 6 of NAND gate 2.

of NAND gate 3 high, Q5 will be forward biased, thus turning on D6, the LED that indicates that Channel 9 is "up".

On the trailing edge of the next pulse on the triggering input, the situation will reverse itself. This time the output of NAND gate 3 will go low and the output of NAND gate 4 will go high. Diodes D3 and D4 will be reverse biased, preventing the low level on the output of NAND gate 3 from affecting the program lines. At the same time, the supply voltage will

Table II

Normal Switch	Channel 9 switch	Condition
Normal	Channel 9	Scanning
Off	Channel 9	Channel 9
Normal	Off	Channel selector determines channel
Off	Off	Scanning

This chart shows all possible positioning of the Normal and Channel 9 switch and the effect on the receiver channel.

be restored to the channel selector switch common terminal, thus allowing the position of the channel selector switch to determine the channel programming.

The multivibrator will continue to run freely until either Channel 9 or the other channel becomes active. When either of the channels becomes active, transistor Q4 (the scan hold transistor) will become forward biased through the squelch circuit, thus killing the voltage on pin 1 of NAND gate 1. This inhibits the multivibrator from producing any more output pulses. Thus the scanner is locked to the active channel as long as the signal is present. When the signal disappears, transistor Q4 will lose its forward bias from the squelch circuit and the proper voltage will return to pin 1 of NAND gate 1, thus enabling the multivibrator to again produce pulses on its output. These pulses then toggle the bistable flip-flop, restoring the scanning action.

Pin 1 of NAND gate 1 is also used to stop the scanner in the transmit mode through diode D5. In the receive mode, diode D5 is reverse biased, but when the push-to-talk switch is pressed the cathode of D5 is grounded, pulling

the voltage on pin 1 to a low level and stopping the scanning.

Switch positions

The chart in Table 2 shows how the positions of the Channel 9 switch and the Normal switch affect the scanner. With the Normal switch in the Normal position and the Channel 9 switch in the Channel 9 position, the scanner will not be inhibited. With only the Normal switch in the Off position, the output of NAND gate 4 will be grounded through the two switches. Thus the output of NAND gate 4 will go low, causing the output of NAND gate 3 to go high. This locks the scanner to Channel 9, and as long as the switches are in this position, the pulses on the triggering input will have no effect. With only the Channel 9 switch set to Off, the output of NAND gate 3 will be grounded through the two switches. Thus, the output of NAND gate 3 will go low, causing the output of NAND gate 4 to go high. This locks the scanner to the channel the channel selector switch is set on, and again the pulses on the triggering input have no effect. With both switches in the Off position, neither gate 3 nor gate 4 output will be grounded,

and the triggering pulses will again be allowed to toggle the flip-flop, resuming the scanning action.

The SCR vs. SWR

Any technician with experience repairing CB transceivers can tell you that a large percentage of CB transmitter breakdowns are caused by a high VSWR, due to antenna or transmission line trouble. Most CB radios are not equipped with any kind of warning indicator to signal the operator that a high SWR condition exists. So the usual result is a blown-out final transistor and often the driver transistor, too. When I find defective final transistors and/or driver transistors in CBs, I caution the owner that his antenna should be checked before using the CB again, or another blowout may occur.

Any device that cautions the operator when a high SWR condition exists is worth the extra expense, considering the cost of repairs. Some CB manufacturers have incorporated built-in SWR meters in some of their sets, which enable the operator to periodically check the SWR level. If he likes he can leave the meter switched to

the SWR position all the time and continuously monitor the SWR level. Many radios are also available with LED indicators that warn the operator of antenna or transmission line trouble. I believe the LED indicators probably serve most operators better because, from what I've seen, most operators of CB sets with built-in SWR meters never take the time to learn to use them. The LED indicator is automatic, requiring no adjustments on the part of the operator.

In model 1-630 CB, Royce went a step further and incorporated a circuit that will automatically kill the transmitter output, should the SWR level increase above a safe level. This prevents transistor blowout (Figure 3). A high SWR is caused by a severe mismatch between the transmitter output and the antenna or feedline (coax). Such a mismatch causes power to be reflected back down the transmission line from the antenna towards the transmitter. The reflected power is detected by the circuitry encircled on the schematic.

Reflected power causes a

positive voltage to develop at the top end of VR14. The arm of VR14 is connected directly to the gate of the SCR. When the voltage on the gate reaches a specified level, the SCR will "fire," resulting in heavy conduction between the cathode and the anode. Forward bias for the transmitter buffer (TR36) is supplied through R157, which is also connected to the anode of the SCR.

Normally the SCR is cut off so it has no effect on the bias circuit for TR36, but when a high SWR condition is present, the gate of the SCR will reach a high enough positive voltage level to cause the SCR to fire. This results in heavy conduction from ground through the SCR and R157 to the +8V supply point. Because a conducting SCR has a low voltage drop between its cathode and anode, this virtually

kills the bias supply of TR36, because it places one end of R157 at near ground potential. With a loss of forward bias, the transmitter buffer can't function, and no transmitter output can be developed. Because the gate of the SCR loses all control once the firing is done, the loss of transmitter output cannot cause the SCR conduction to cease. The SCR will continue to conduct as long as the +8V supply point remains hot, which is as the transmitter is keyed. Once the transmitter is unkeyed, the +8V supply point is removed via the T/R relay, and the SCR will cease to conduct.

The sensitivity of the SWR protection circuit can be adjusted by VR14. To adjust the sensitivity,

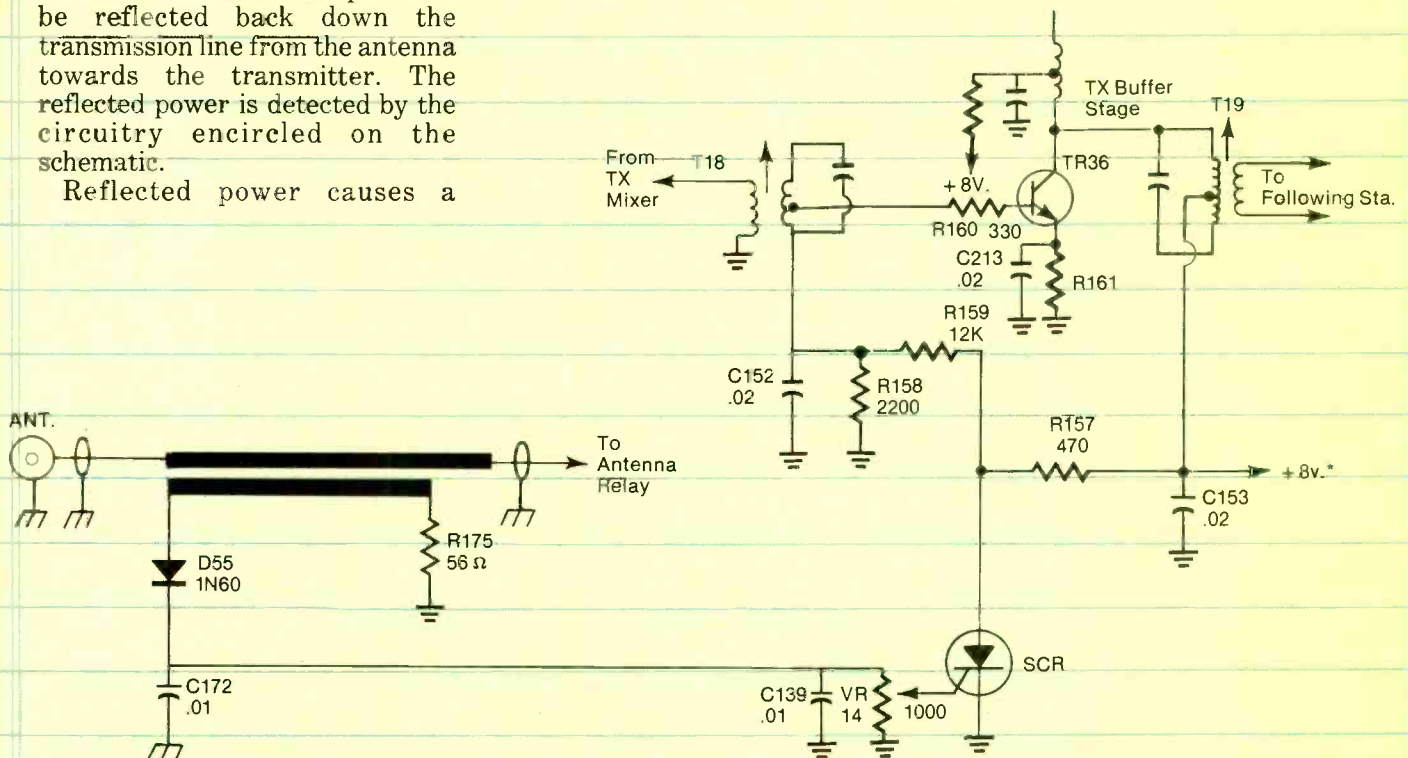
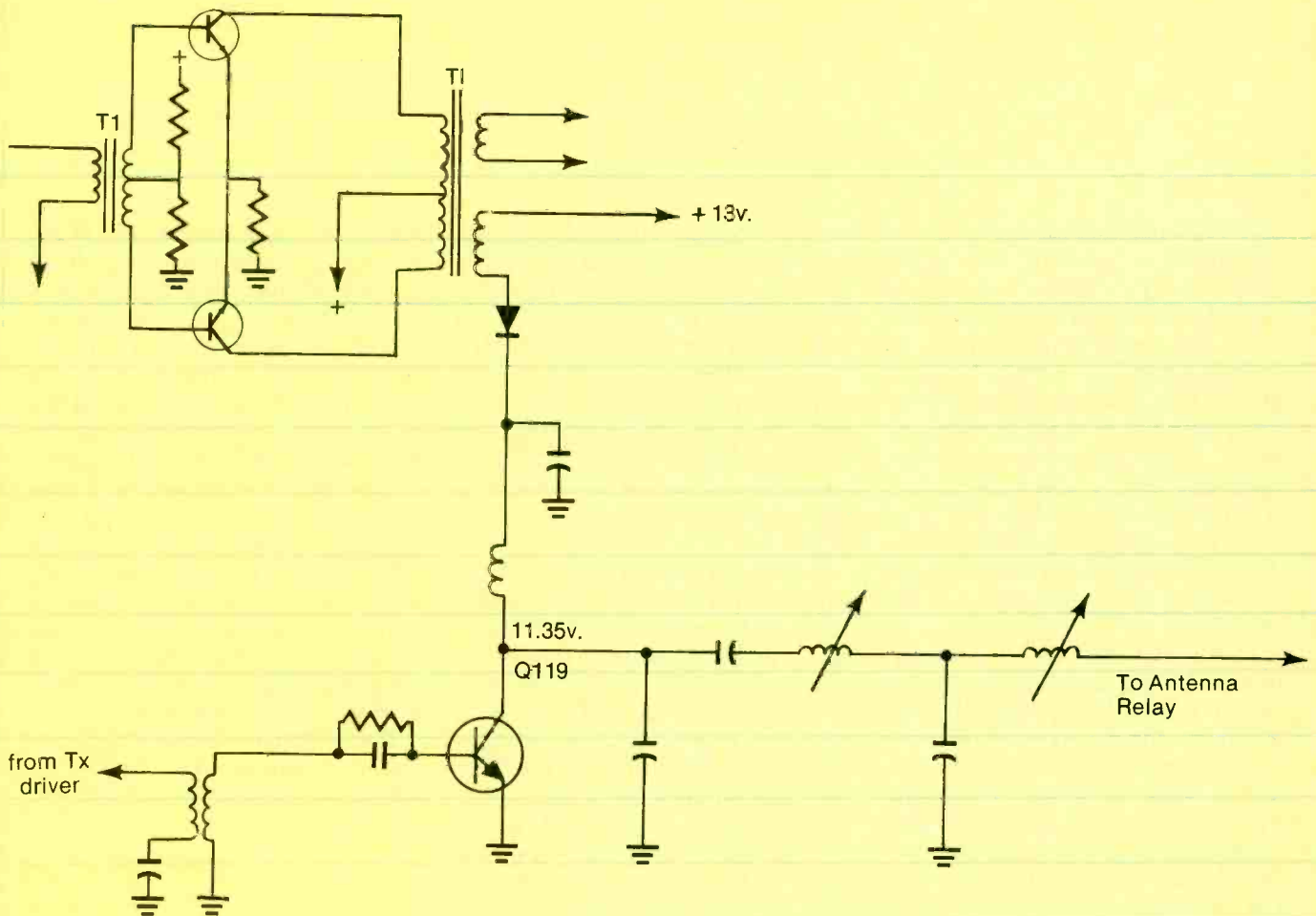

Figure 3. A reflected power-sensing circuit used in the Royce 1-630 CB transceiver.



the manufacturer calls for connecting a 150Ω, non-inductive, 5W resistor from the antenna jack to ground. This simulates an SWR level of 3:1. The transmitter is then keyed and VR14 adjusted so the SCR triggers with normal modulation.

Transformerless amplitude modulation

Almost without exception, in the past the modulating signal in CB transceivers has been applied through a transformer to modulate the final RF stage. The partial, simplified schematic in Figure 4 shows a typical modulator and modulated stage. The modulating audio signal is developed in the lower secondary winding of modulation transformer T1, and is applied in series between the collector of the final RF transistor and the voltage supply source. On one half cycle of the audio, the audio signal will be

“series aiding,” thus increasing the voltage applied to the collector of the final RF transistor. On the other half cycle, the audio signal will be “series opposing,” thus decreasing the voltage applied to the collector of the final. To achieve 100% modulation, the positive and negative peaks of the modulating audio signal must be equal to the quiescent voltage applied to the collector of the final. The quiescent voltage is the steady dc voltage applied to the final with no modulating signal present. If the quiescent voltage is 10V on the final collector, then to achieve 100% modulation, the modulating signal must reach +10V on the positive peak and the negative peak must reach -10V.

Recently many CB manufacturers have switched to a “transformerless” modulator circuit. The basic arrangement for the transformerless modulator circuit is shown in Figure 5. Basic-

ly, a transistor is substituted for the modulation transformer. Because a transistor alone cannot step up the voltage above the quiescent level (as a transformer can), the voltage applied to the collector of the final is set at about half of the available supply voltage. The supply voltage to the collector of the final is applied through the emitter-to-collector path of the modulator transistor Q301. With the modulating audio signal applied to the base of Q301, the effective resistance between the emitter and collector will vary with the audio signal on the base. When the audio signal on the base is positive going, the effective resistance between the emitter and the collector will be reduced, increasing the voltage on its emitter and thus to the collector of the final. When the audio signal on the base is negative going, the effective resistance between the emitter and collector will be increased,

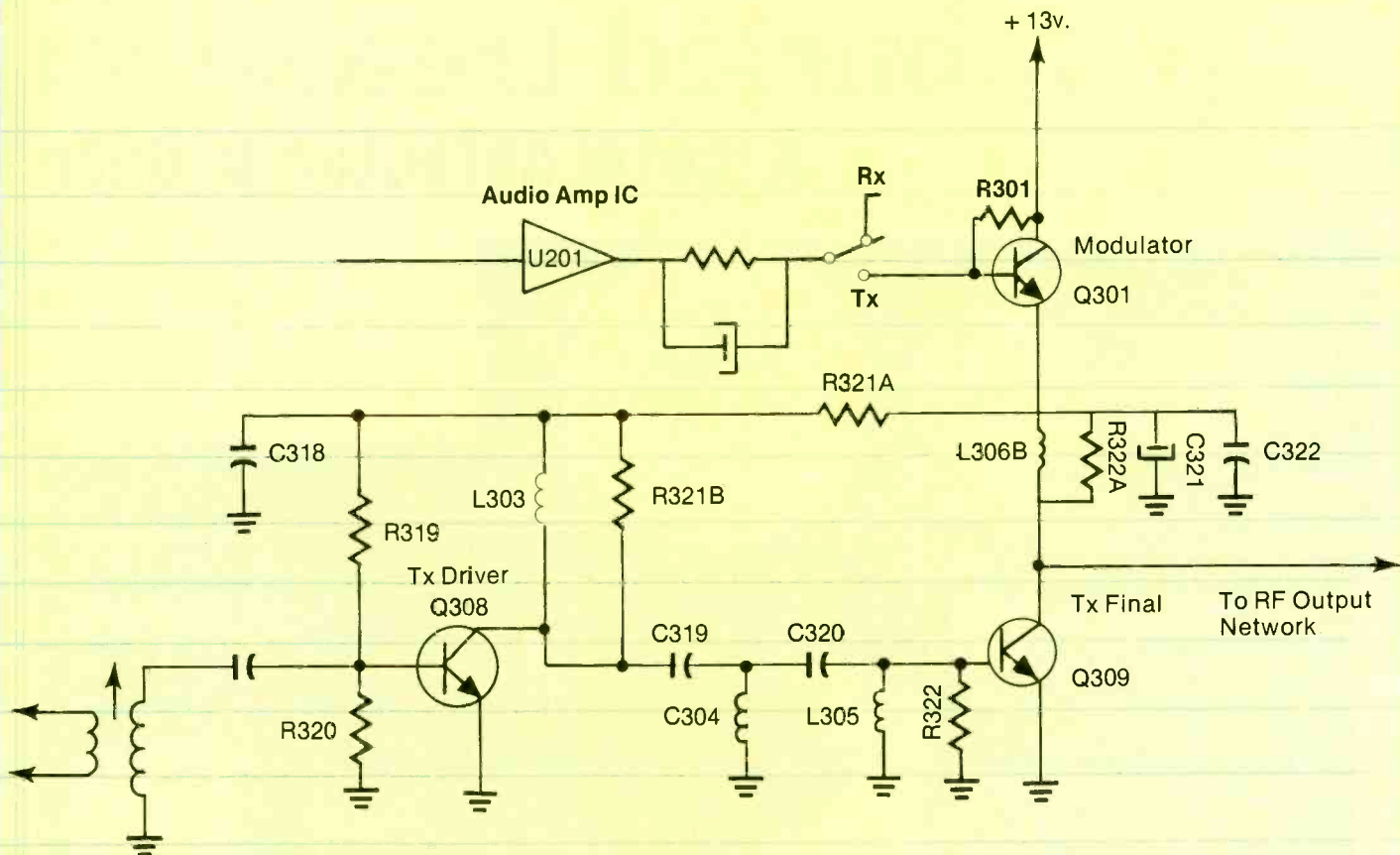

Figure 5. This transformerless modulator circuit is used in the Pace model 8113 CB transceiver.

reducing the voltage on its emitter and thus to the collector of the final. Therefore, the final stage is modulated by the audio signal on the base of Q301.

Quiescent voltage

As mentioned, the quiescent voltage on the collector of the final is about half of the available supply voltage. FCC regulations specify that the dc power input to the final shall be limited to a maximum of 5W. Because power is equal to the product of voltage and current, if the voltage to the collector of the final is halved (as it is with the transformerless modulator, as compared to the transformer-type modulator) then the collector current must be doubled to maintain the same power input. With 6.3V on the collector of the final, to get 5W dc input to the collector, the collector current must be approximately 0.79A. The collector current of Q309 (the final) must also

flow through the emitter/collector of Q301 (the modulator). This means that during the quiescent state, the modulator transistor dissipates approximately 5.3W of power. This is derived by multiplying the emitter-to-collector voltage (6.7) times the collector current (0.79A). So, when the transmitter is keyed without modulation applied, the modulator is consuming as much power as the final transistor. This is a large percentage of waste, but considering the relatively small amount of power in terms of actual wattage, the waste of power is considered a fair tradeoff for the simpler and cheaper modulator. Of course, if the power input to the final transistor was a very large amount, the power wasted by the transformerless modulator would no longer be a fair tradeoff because the power wasted by the modulator would then be too great.

The power wasted by the typical transformer modulator, as shown in Figure 4, can be calculated. For practical purposes the secondary winding of T1 replaces the emitter-to-collector path of Q301 in the transformerless modulator. The collector voltage of the final transistor is given as 11.35V. For 5Wdc input the collector current would have to be 5 divided by 11.35, or 0.44A. This 0.44A has to flow through the secondary winding of T1, which has a dc resistance of 0.5Ω. Then the power wasted by the secondary of T1 is $(P = I^2R) = 0.44^2 \times 0.5 = 0.097W$ in the quiescent condition. Compare this with the 5.3W of power wasted by modulator Q301 in the transformerless modulator. You're not likely to find this type of modulator in high-power applications, but for low-power applications such as CB transceivers, this modulator is quite practical.

ES&T

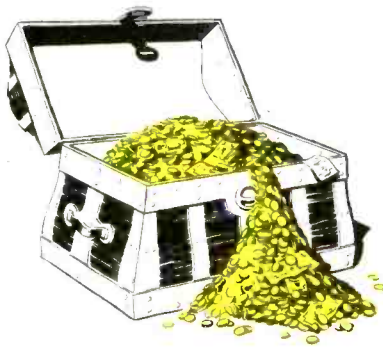

Searching for buried treasure: A metal detector primer

By Daniel Tavares,
Silver Dollar Electronics,
New Bedford, MA

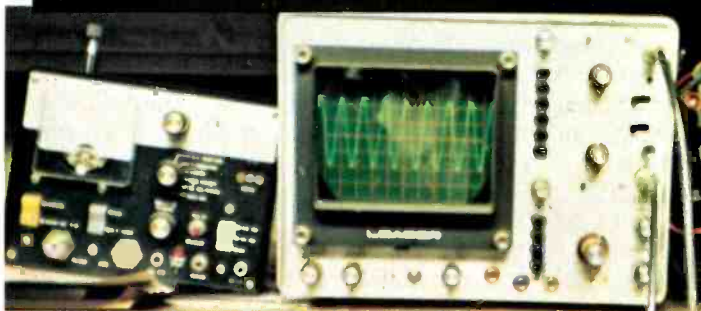
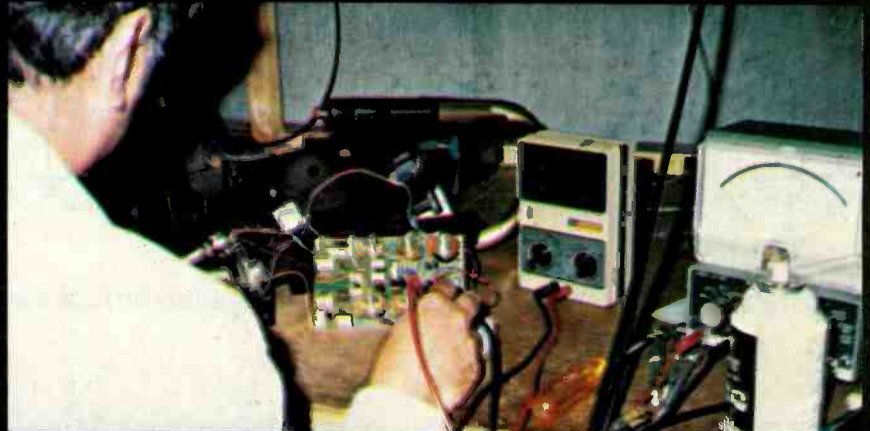

Top: Three popular coil sizes are 7, 8 and 12 inches. Different manufacturers have them available in almost any diameter from $\frac{7}{8}$ inch to 3 feet. **Above left:** The author uses a hip-mounted version with a 12-inch coil. **Above:** Once removed from the case, most machines are neatly laid out with easily accessible components. **Left:** A typical sine wave pattern from the transmit oscillator is shown here. A normal reading is 10V peak to peak, and in the case of the Deep Search IV, is used by every other circuit in the detector. **Below left:** Although a good scope is the most important piece of test equipment needed to service metal locators, a voltmeter is another necessity. No special equipment is required and any shop equipped for television or audio repair has the necessary equipment.

Rising gold prices and inflation have had at least one positive effect: causing a boom in the relatively little-known, metal-detector branch of the electronics industry. While these gadgets may seem like magic, or at least a miracle of modern technology, they have been in use since World War I.

During that time the many unexploded artillery shells lying about the countryside tended to make farming hazardous. A French physics professor, M. Gutton, devised a method of discovering these shells. It consisted of a pair of large coils mounted on a 2-wheeled carriage and operated on an induction balance system discovered by David Edward Hughes in 1879 (Figure 1).

Interestingly, this type of device was apparently already in use by surgeons to locate bullets in battle casualties.

Today's machines are, of course, much smaller, more powerful and more complex. Detectors currently in production can be collapsed to a length shorter than a single coil of those early devices and are more sensitive, can find objects deeper and can even tell you if an object is worth digging for.

How they work

Metal detectors still use an induction balance system, although the internal workings have changed since the first commercial machine was introduced by Fisher Research Labs in 1931. There are

several systems being employed today, but the three most common types are the BFO, TR and VLF.

The BFO, or beat frequency oscillator, responds to targets by changing frequency. It is fading from the scene as it is outclassed by other detection methods available in the last decade.

The TR, or transmit receive, announces a target by an increase in volume.

Very-low-frequency (VLF) types are the most important today, and nearly all detectors made in the United States use this method because of the ease with which they can be operated in mineralized soil. They are actually TR types made to operate at lower frequencies.

Other types of detectors all have major drawbacks and consequently are rarely seen.

All machines use a searchcoil consisting of two or more coils in a single housing that scans as close to the earth's surface as possible. Incidentally, these are almost always white in color, so the reflection of the sun's rays helps keep the coil stable. The transmit coil produces a magnetic field that is radiated in all directions with the strongest concentration being directly above and below the searchcoil (Figure 2).

When this field passes over metal, it generates eddy currents on the target's surface. The magnetic field caused by these eddy currents also radiates in all directions and is sensed by the

receive coil. This changes the coupling between coils and produces an audible signal.

The heart of a detector is its transmit oscillator. Most are either a Colpitts or Hartley type, with the more recent machines designed to work in the 5KHz to 15KHz range.

To help us see what takes place in a metal detector's circuitry, we have selected a Deep Search IV model, made by Tesoro of Phoenix, AZ. It is a medium-priced entry to the field, with all the features needed to show what takes place in a metal detector.

The transmit oscillator

The oscillator in the Tesoro detector is designed to operate at 12.5KHz with transistors Q1 and FET Q2 as the main components along with the searchcoil (Figure 3). Searchcoils are normally part of the tank circuit for better efficiency. Once the unit is switched on, the transmit oscillator works continuously, producing a 10V PP sine wave that is used by every circuit in the detector.

As the coil passes over a target, it disturbs the field, disrupting the balance in the receive coils (L2 and L3). This causes a voltage increase that is first amplified by the ac preamp IC 2, then passed through R23 and R24 to demodulator ICs 3 and 4.

While this is taking place, the oscillator output is also sent to transistors Q8 and Q9. These two components form the unit's phase-shifting circuits. Transistor Q8 is used for ground balance, and ground adjust is set by holding the coil about 3 feet off the ground and lowering it to about an inch from the surface. Should the audio level rise, the adjustment must be turned counter-clockwise to lower it. If the sound drops, this control is turned the opposite way. It is set properly when the audio remains constant from 3 feet to ground level. This should be done on a spot that is free of metal.

This circuit permits the detector to be operated in terrain that contains minerals, such as salt or magnetic iron, which can play havoc with a detector's response. By proper phase shifting via R47, mineralization can be tuned out by comparing the receive signal with the phase-compensated oscillator

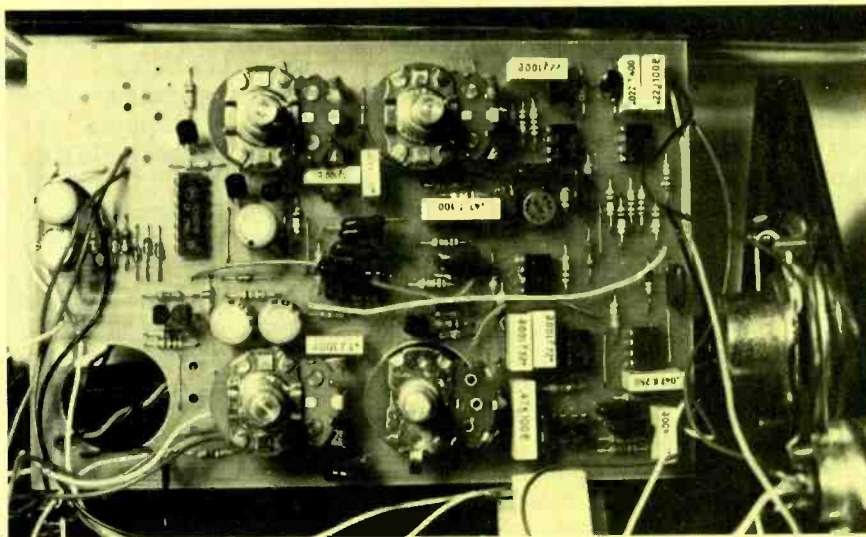

One glance at this circuit board shows that today's metal locators are not toys. While most have straight forward designs, knowledgeable technicians are needed to service them.

signal. This works well and permits the use of metal detectors in areas where they had previously been almost useless.

Some types of machines use a 10-turn control here, and detectors brought in with the complaint of no ground cancellation may require nothing more than an extra turn or two.

Tuning out junk

Transistor Q9 is used for discrimination between good (coins, jewelry, etc.) and unwanted targets, such as aluminum foil and bottlecaps. This is accomplished by discrimination adjust R54 and works by phase comparison also. Although this is a most desirable feature, there are drawbacks. Unfortunately, as you increase the discrimination level, you suffer a loss in depth. At the higher rejection settings, such as pull tabs, small rings will be nulled out because their small surface area doesn't allow enough eddy current generation. Because of their alloy, nickels are also phased out. In their case only, the WW II issues are picked up due to their silver content. Fortunately, research has resulted in continuing improvements so that today's machines are vastly superior to those made several years ago.

Depending on the position of S2, the phase-shift signal will follow the circuit path through IC 8 and is used as a reference waveform by ICs 3, 4, 6 and 9.

The detected voltages at ICs 3 and 4 are fed the phase shifted signal at pin 5. The output of demodulator IC 3 will then produce a positive or negative voltage, depending on the phase setting of the discriminator control R54 and the target being detected. A good target will increase the dc reading, while a rejected one will form a negative voltage that is dc coupled to IC 5, which serves as a dc amplifier and an impedance buffer to prevent loading of the audio signal. ICs 4 and 6 operate on current rather than voltage phase.

The tuning control, R38, is adjusted to the threshold of sound. Practically all detectors are made to be operated with a low level of continuous audio buzzing. This prevents the machine from being accidentally mistuned, which could

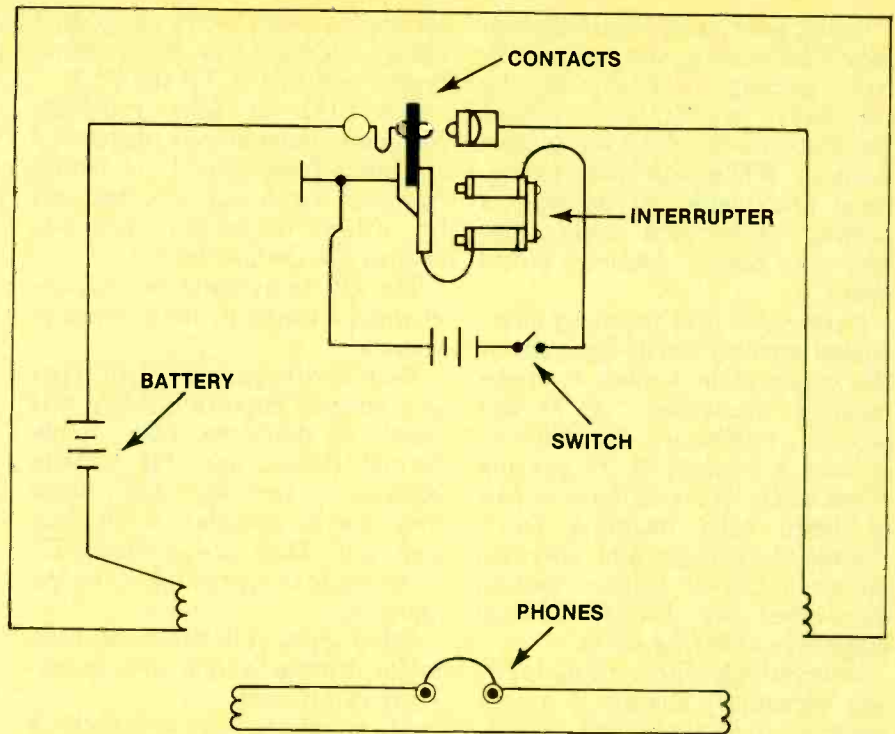

Figure 1. This diagram of a shell locator used in WWI, based on the Hughes induction balance system, was devised in 1879.

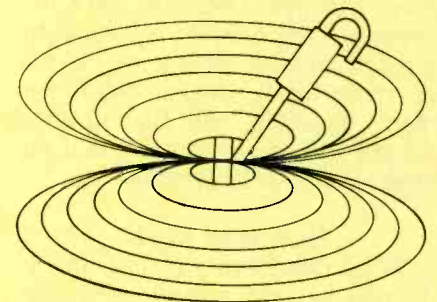

Figure 2. A magnetic field radiates in all directions from the searchcoil, with the heaviest concentration directly above and below the coil. A target will give the strongest indication in the center of the field.

mean the loss of desirable targets. If the sound level changed, the operator would know it was time to retune the unit.

The sensitivity control, R34, is used to keep the tuning level constant when in the discriminate mode. Since ground cancelling and discriminate operation cannot be used at the same time, ground conditions can cause a wide variance in the tuning level while the metal locator is switched on discriminate. By lowering the input to pin 5 of IC 5b, some of this variation can be eliminated, permitting the machine to be used with much less difficulty by keeping the background audio smoother.

Going back to the output of IC 5a, we find that a portion of it is sent to the push tune switch, S3. Should the tuning change for any reason other than actual physical manipulation of the tuning pot,

depressing the handle-mounted S3 will return the detector to its proper setting through the sample-and-hold circuitry of IC 7. Some types of metal locators also feature electronic switching to change modes via the retune button.

The audio portion of the machine is developed by tapping the oscillator through isolating resistor R7, feeding Q3 to amplify the waveform up to about 12V to supply IC 1. This is a binary divider, and pins 5, 6 and 9 are used to supply the tone for the audio output stage. A square wave is developed at pin 12 and this is rectified to supply the negative 10Vdc required by the detector.

Finally, Q6 and Q7 form the audio output. The unit can be run with the built-in speaker, but this machine, like all others, is intended for use with headphones. The speaker should be as close to the ear as possible, or the faint

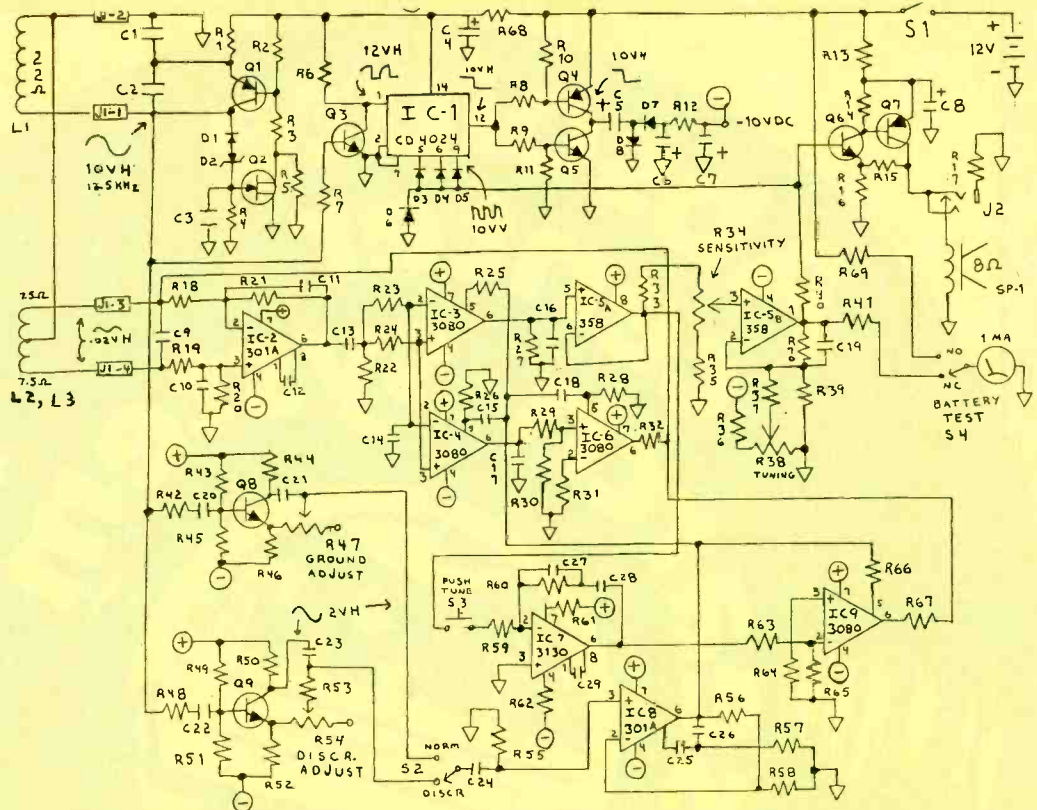

Figure 3. The Tesoro model DS-IV schematic. Waveforms are marked at a vertical or horizontal rate.

whispers that signify the deeper and usually more valuable targets are lost in the background of everyday noises.

What to expect

How deep will any of these machines detect? There isn't any pat answer, and you should put as much faith in any claims about a particular metal locator's performance as you would in an antenna manufacturer's claim for reception distance. There are many variables. For one, ground conditions in different parts of the country may cause a detector to perform better in one area than another. When the earth is damp, such as after heavy rains, it will penetrate deeper. The size and material of the detected object will have a bearing on depth. Also, due to the oxidation of the metal, the longer something is buried, the easier for a machine to detect it. It goes without saying that a detector must be properly adjusted; a mistuned machine will not find much.

On an average, 8 inches is about the maximum depth for coins, although most are probably picked up at about half that depth. Again, this is not an absolute fact; more experienced users or ideal ground conditions can produce better

results. Larger objects can be detected several feet down, and some metal locators are designed expressly for larger objects, such as locating treasure caches or tracing underground pipes.

Searchcoil size will also affect penetration. The larger coils will go deeper to find larger items, but are generally not effective on coins and rings at greater depths. Smaller sizes are more sensitive and usually easier to pinpoint with. The size considered optimum for general use is 7½ to 8 inches in diameter. It has excellent sensitivity without the weight and battery drain of the larger coils.

Common problems

Coils are a common source of detector ills. While they occasionally develop shorted turns, the normal fault is a broken wire. Considering it is in constant motion, often bumping against rocks or trees, it isn't surprising. Should the break be at the plug end, there is no problem, but unfortunately it often happens inside the coil housing. Because these are sealed, they are difficult to take apart for repair, especially if you intend to keep them waterproof. In this case it is probably best to return them to the manufacturer. An open coil will often result in a pegged meter

and maximum audio in either mode.

Never forget to check battery condition to avoid the problem of no power supply.

Other troubles to consider are water, dirt and sand in the retune button and controls, which causes erratic operation. Units immersed in salt water should be rinsed thoroughly in fresh water and dried out to prevent corrosion. Many better detectors have their circuit boards sprayed with a clear sealant to help minimize moisture and humidity problems.

As in all phases of electronics, competition is keen, and manufacturers are constantly trying to improve their products. Space-age technology has made today's commercial machines more versatile and reliable than the "mine sweepers" we see in old war movies.

One thing is certain: The hobby is growing, and with the vast number of machines available, service will be required.

The author wishes to acknowledge Jack Gifford of Tesoro and Ettore Nannetti, their New York distributor, for their assistance in preparing this article.

ES&T

Absolute center search system



Turntable can be fitted with two tonearms, one 12-inch and one 9-inch length, or two of normal length, to provide for maximum versatility.

The newest weapon against wow & flutter

Courtesy Nakamichi U.S.A. Corporation

What costs \$7000, weighs more than 80 pounds, and comes close to totally eliminating wow and flutter from phonograph record playback? It's the Nakamichi TX-1000 computing turntable with Absolute Center Search System. And, although you probably won't be rushing out to buy one, unless you happen to be the type of person who shops at the local Rolls-Royce dealer for cars or flies to London's Saville Row to have suits made, you might find the technology behind this turntable interesting.

Phonograph-record technology has improved dramatically since the first stereophonic recordings were released in 1958. There were the remarkable 4-channel recordings of the early 1970s, and today we see a multitude of direct-to-disc and digitally mastered recordings that are capable of superb sound quality. Phono-reproduction equipment itself has undergone drastic changes as well. There are many turntable systems available that are well engineered in terms of rotational accuracy, speed stability, functional control and tracking accuracy. However, as with tape-reproduction equipment in which the final quality of reproduction largely depends upon how accurately tape characteristics are matched to those of the tape deck (vis a vis bias, level, equalization and azimuth), the ultimate reproduction quality of any phono disc/turntable combination depends upon whether these two essential elements function together as one precision reproduction unit.

Absolute center search system

One important factor in achieving accurate phono reproduction is wow and flutter. This undesirable element can be reduced to negligible levels in the turntable by increasing the platter's moment of inertia (that is, by making the platter larger and/or heavier). This technique does, in fact, achieve

remarkably low wow and flutter levels in the turntable itself, but the real test of wow and flutter performance occurs when a record is placed on the platter and the cartridge stylus lowered into the groove.

Wow and flutter can be reduced to negligible levels in the turntable by increasing the moment of inertia.

The standard diameter of the phonograph-record center hole is $7.24 + 0.09/-0.00$ mm (IEC Standard 98A), while the average diameter of turntable spindles varies from 7.05 to 7.15mm. The combination of the smallest spindle diameter with the largest allowable center hole produces a spindle-to-record gap of as much as 0.28mm and results in a concentricity error of 0.14mm. Add to this the maximum allowable record-hole-concentricity error of 0.2mm (IEC Standard 98A), and we end up with a total center error

of 0.34mm. Even with a turntable that has no wow and flutter itself, the amount of wow created by this concentricity error is considerable and depends upon the groove radius.

Until now, concentricity wow has been an inescapable problem with phonograph-record reproduction. Conceptually, the solution is quite simple. With the record placed on the turntable, the platter spindle is relocated (center search platter) so that the record grooves are perfectly concentric with the platter's axis of rotation. The true center thus located is called the "absolute center."

The drive motor and main platter of the TX-1000 form an integral unit, while a laterally movable secondary platter (the center search platter) rides on top of the main platter. Under the main platter are motors and control mechanisms to accurately position the center search platter along two axes (X and Y), thus permitting relocation of the center search platter spindle in relation to the main platter's axis of rotation.

Absolute Center Search System

When the switch is initially turned on, the drive-motor spindle and center search platter spindle are aligned along the same axis (the nominal center). The record to be played is placed on the center search platter and the appropriate record size selected (30, 25 or

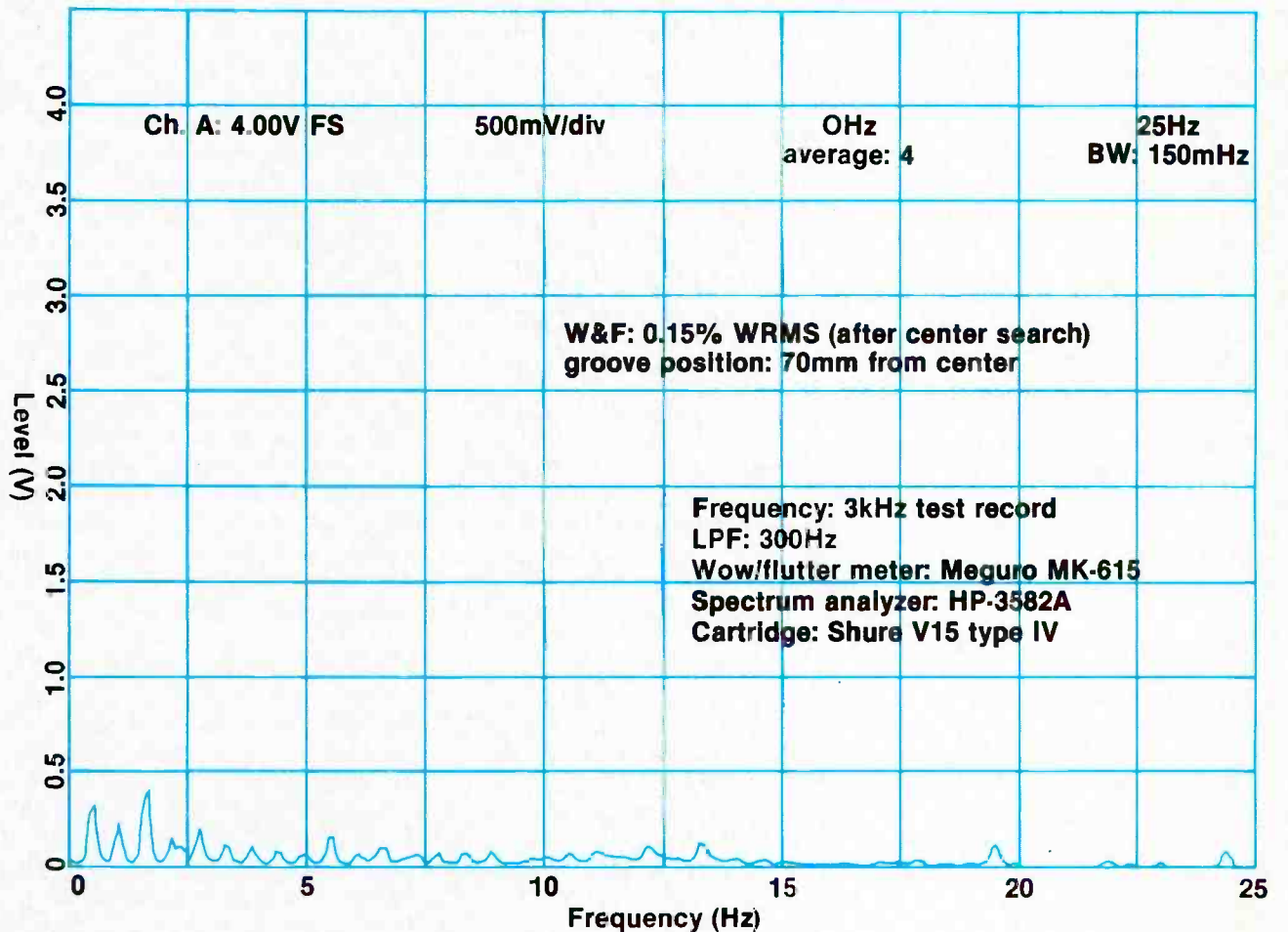
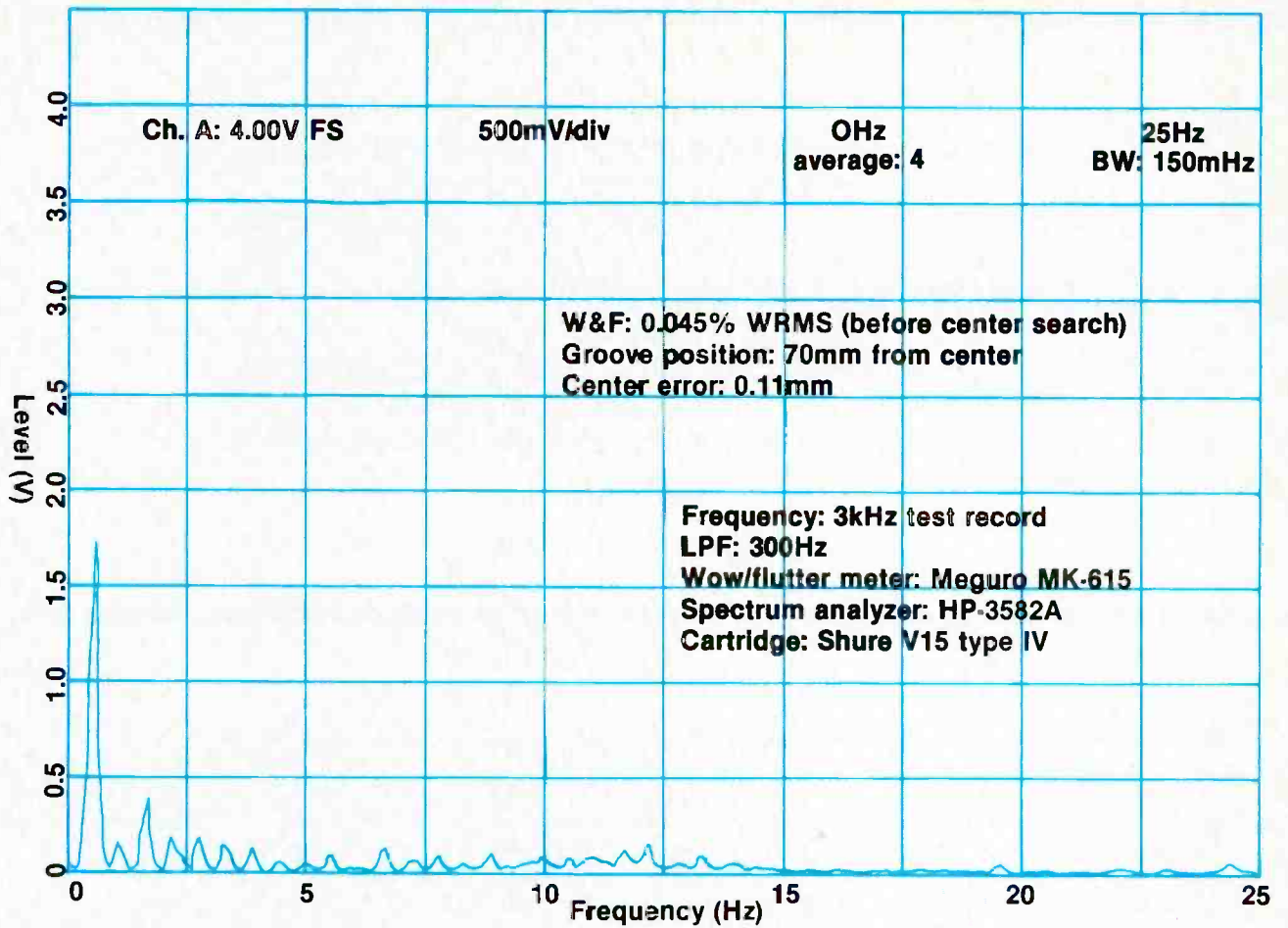

17cm). To initiate absolute center search operation, the center search button is pressed. This activates the elevation motor of a special sensor arm. The sensor arm rises 50mm and then swings out of its housing and across the record until its stylus is positioned above the record's final lead-out groove. The elevation mechanism lowers the sensor arm 16mm, permitting the sensor stylus to trace the lead-out groove.

Movement of the sensor arm (corresponding to record concentricity error) is detected by a special infrared LED/shutter/photo-diode system linked to the arm. The concentricity error is thus converted to a dc voltage, which undergoes analog-to-digital conversion so it can be processed by the turntable's 3-bit microprocessor system. The microprocessor

The movement of the platter is graphically indicated on the LED display and when it has been located, the absolute center indicator lights.

outputs the appropriate "center-error" signals to the digital center error display and to the X- and Y-axis center-correction motors.

Via a system of pulleys, belts, worm gears, and control arms, the X- and Y-axis motors move the center search platter with respect to the main-platter axis until the concentricity error is eliminated. The movement of the center search platter is graphically indicated on the absolute center search LED display, and when absolute center has been accurately located, the absolute center indicator lights. At this time, the sensor arm rises, returns to its housing, and finally recedes to its original position in the turntable base.

The absolute center search mechanism precisely aligns the

record grooves with the disc's effective axis of rotation, eliminating "tonearm weave" as the disc rotates. "Once around" wow is almost completely absent, and precise phono reproduction with a minimum of wow and flutter is achieved.

Drive motor

With concentricity wow eliminated, it is all the more important that conventional sources of disc-reproduction wow, flutter and noise are minimized. To accomplish this, the unit employs a brushless, coreless, slotless, Hall-element, direct-drive motor that excels in the following critical phono-reproduction parameters:

1. Wow and flutter (cogging, torque variation)
2. S/N (cogging, torque variation, servo feedback ripple)
3. Rotational speed stability
4. Torque characteristics
5. Response
6. Mechanical and electronic noise

Special attention has been paid to cogging-related wow/flutter and signal-to-noise ratio.

Conventional brushless motors suffer rotational disturbances due to rotor magnetization, magnetic field strength variation, magnetic saturation and non-uniform magnet/coil gaps. Because of the special magnetization pattern used, the varying magnetic flux density generated by rotation of the rotor magnet causes a Hall element located in an appropriate fixed position in relation to the rotor to output a sine wave. This sine wave signal is then amplified and applied to the motor's drive coils to produce even, unvarying torque. This relationship can be expressed by the following equation in which θ is an angle travelled by the rotor and $\Delta\theta$ is any instantaneous rotor position during travel:

$$\sin^2 \theta + \sin^2(\theta + 2/3\pi) + \sin^2(\theta + 4/3\pi) = 3/2$$

As can be seen from the equation, no matter what the value of θ , the result is constant. If the Hall element detector is placed at the proper distance from the rotor magnet, a virtually perfect sine wave output is obtained. As a result, "cogging" (stepped motor

rotation) is eliminated, and wow and flutter is reduced to a minimum.

If the Hall element detector is placed at the proper distance from the rotor magnet, a virtually perfect sine wave output is obtained, and wow and flutter are reduced to a minimum.

Servo circuit

The drive motor is controlled by a PLL synthesizer servo system. Employing a quartz-crystal oscillator, VCO (voltage-controlled oscillator) and phase comparator, this system maintains perfect speed accuracy and provides full quartz lock, even when the pitch control (in 0.1% increments) is activated.

Nominal center switch

Pressing this switch causes the center search platter spindle to align with the motor spindle for operation as a conventional turntable system. The position feedback potentiometers connected to the X- and Y-axis control arms are factory adjusted to provide virtually perfect "nominal centering." Once nominal center has been located, the nominal center indicator lights.

Tonearm mounting

The turntable can be fitted with two tonearms—one long (12-inch) and one normal (9-inch) length, or two of normal effective length—to provide maximum versatility for the advanced audiophile.

A number of optional tonearm bases that accept many of the most popular high performance tonearms will be made available.

ESU_™



Logic analyzer

Connecticut microComputer announces the model LA-12 logic analyzer. The LA-12 is designed for any engineer, repair shop, experimenter, programmer or troubleshooter involved in the design, development, debugging, test or repair of TTL digital circuits. Portable and completely self-contained, the LA-12 does not require an oscilloscope or terminal for viewing the data.

Circle (54) on Reply Card

Circuit-Strip

Circuit-Strip, from A P Products, duplicates the advantages of their Super-Strip in a more economical size. This new strip combines the plug-in ease of a 0.1" x 0.1" solderless tie-point matrix with the convenience of distribu-

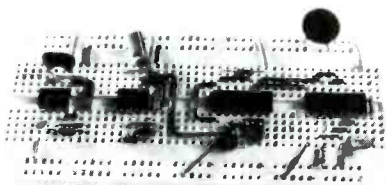

tion buses for power, ground and signal lines, but with about 75% of the capacity of its Super-Strip.

Circuit-Strip features include a molded-in alpha-numeric grid for faster and easier identification of every tie-point in a circuit.

Circle (47) on Reply Card

VHF channel converter

Blonder-Tongue Laboratories has announced the availability of a new VHF crystal-controlled, single-channel converter designed for MATV headend installations. Designated MCX-V, the converter is electrically and mechanically compatible with B-T's MCA-b-type

channel processor and BPF-a bandpass filter.

The MCX-V is designed to convert any VHF channel to another VHF, Subband, IF, Midband or Superband channel. It can also be used to convert a subband or IF channel to VHF.

Circle (48) on Reply Card

Continuity and voltage tester

The model 120-113 continuity and voltage tester from Desco Industries is ideally suited for testing wire wrap connections. The 120-113 comes with standard 12-gauge socket connections on each end, which will slip over wire wrap pins for positive contact

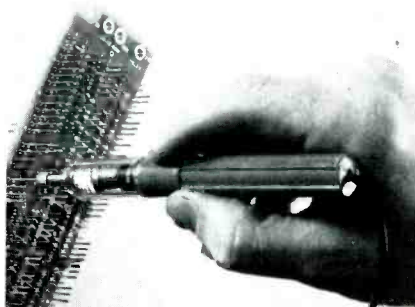

without danger of touching adjacent pins and getting incorrect readings.

Circle (41) on Reply Card

Microprocessor exerciser

A money- and time-saving microprocessor exerciser by Hewlett Packard uses signature analysis (SA) technique to test products not initially designed for SA.

The HP 5001B needs no soft-

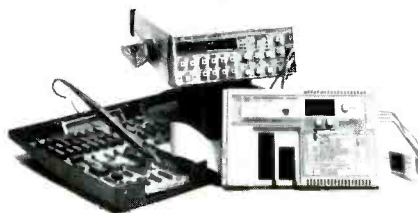

ware or ROM space for troubleshooting and provides the stimulus for immediate testing of 6802 and 6808 microprocessor-based products. Operating features include 51 pre-programmed test stimuli for troubleshooting the micropro-

cessor, ROM, RAM, I/O, buffers, decoders and other bus-related components, and an external stimulus port for exercising the product's input ports or special logic.

Circle (43) on Reply Card

Volt-ampere meter

Engineered Systems & Designs has announced the introduction of



a new volt-ampere meter, the VAM meter. Both ac and dc volts and currents can now be measured quickly and accurately with a hand-held meter.

The meter combines both true RMS and peak hold functions, features not usually found together in a hand-held instrument.

Circle (39) on Reply Card

Field-tunable antenna

Centurion International has introduced a field-tunable replacement antenna for hand-held radios in the range of 66-88MHz.

The flexible antenna is available with any of the 25 different con-



necter configurations in the standard Centurion line.

Centurion field-tunable antennas are protected by a neoprene jacket with flexibility from -55°C to 100°C . The approximate length is 10 inches.

Circle (37) on Reply Card

Portable oscilloscope

With the introduction of the V-209 20MHz, dual-trace oscilloscope, *Hitachi Denshi America* continues to expand its new field-service scope line.

The 10-pound V-209 offers a $3\frac{1}{2}$ -inch rectangular CRT, a standard, internal, rechargeable battery and sensitivity of 1mV/div. at 10MHz. Other features include a

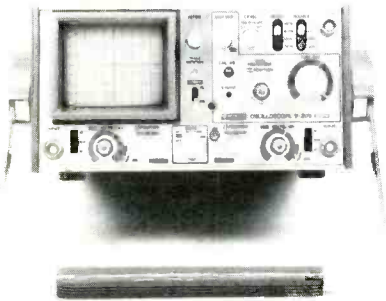

built-in TV sync separator circuit, auto-focus and a front panel layout that groups controls into functionally related clusters.

Circle (30) on Reply Card

Signature analyzer

Non-Linear Systems has announced the introduction of a new miniature circuit and component tester, the model TR-1 Tracker.

The Tracker is a portable, battery/line- or line-only-operated unit that contains a CRT to display, pictorially, the graphic signature of a component or net-



work and thereby determine if it is good. In networks, faulty components can be identified.

Circle (32) on Reply Card

Assembly aid

The new HPCB-15 assembly aid from *OK Machine and Tool Cor-*

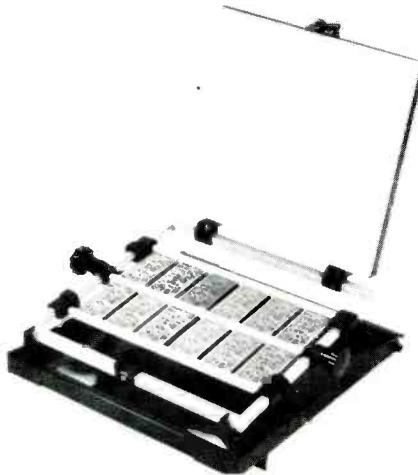

poration is a "2-handed" holding fixture for aiding all types of electronic and mechanical assembly work. It features two alligator clips for reliable holding action, plus easy clamping and release. Both clips are mounted in ball joints, and the connecting bar is mounted in a third ball joint, enabling complete articulation and flexibility.

Circle (33) on Reply Card

Semiconductor curve tracer

A semiconductor curve tracer is available from the *B&K-Precision Product Group* of *Dynascan Corporation*. The instrument, designated model 501A, is designed to work in association with an oscilloscope to display characteristic curves for a wide variety of discrete semiconductor devices.

The 501A displays the unique characteristic curves for each type of semiconductor device. By examining these curves, the user can determine all significant operating characteristics of the device under test. Test parameters measured include gain (beta), cutoff current, leakage current, output admittance and breakdown voltage. The instrument can be used to evaluate



bipolar and FET transistors, diodes, SCRs, diacs, triacs and other devices.

Circle (38) on Reply Card

Wiggler and prybar

Edsyn's WP286 Wigapry is a combination lead wiggler and miniature prybar. This desoldering aid has a small hole in the tapered end that enables the tool to be placed directly over a desoldered component lead. With a little wiggling, the lead is free.

The other end is shaped like a

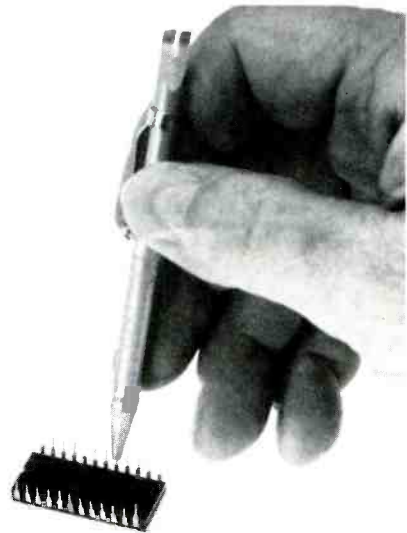

prybar for leverage and can be used to gently pry components or dip ICs off of circuit boards.

Circle (35) on Reply Card

Flexible screwdriver

This tool operates at all angles and ratchets in either direction.

The *Summit* "Aliver Driver" is a rotating head that accommodates any one of the four driving bits

furnished: a No. 1 Phillips; a No. 2 Phillips; a 3/16-inch slot and a 1/4-inch slot.

A flexible steel drive shaft, which runs through the flexible chrome housing shaft, powers the head.

At the foot of the serrated handle is the ratcheting mechanism, with a 3-position selector to provide right-turn ratcheting, left-turn ratcheting or neutral setting for standard fixed turning.

Circle (34) on Reply Card

Soldering iron heat element

A newly designed soldering iron heat element, from the *Ungar Division of Eldon Industries* for controlled-temperature systems, reaches operating temperature faster and with less energy than earlier models, according to the manufacturer.

The "Thermo-Duric" element is non-magnetic, and heaters equipped with it conduct static



electricity from the tip to the ground wire of the power cord. Both factors prevent static electricity damage to microcircuits.

Circle (36) on Reply Card

Oxide-free solder creams

Multicore has expanded its line of solder creams and now offers more than 260 different formulations.

A variety of alloys is available, including the standard tin/lead, tin/lead/silver and tin/silver, in addition to several proprietary alloys such as Savbit, which prevents copper leaching.

Each alloy is also available in a choice of five flux types, including the Xersin formula that eliminates the need for cleaning. Each flux



formulation is also available in several different solids percentages.

Circle (40) on Reply Card

Opportunity knocks.

The professional world of the Electronics Service Dealer is rough. That's why we're working so hard to make it easier for you to operate a cost effective business. NESDA offers substantial savings on bank-card and insurance rates, business contacts, technical and management certification, and that's just the beginning.

Our members are kept informed about industry developments, and are offered the most comprehensive managerial and technical training programs available. Opportunity knocks. Don't let it pass you by.

For more information about the National Electronics Service Dealers Association, write to: NESDA, 2708 W. Berry St., Ft. Worth, TX 76109.

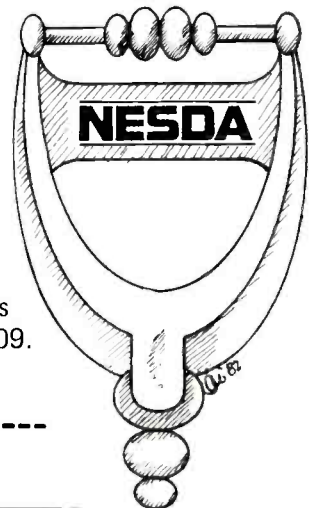

NAME _____

FIRM NAME _____

FIRM ADDRESS _____ Member of State Local Assn.

CITY _____ STATE _____ ZIP _____ PHONE _____

Adhesive coating

Master Bond AC82 is a novel, cost-effective, one-component, conductive adhesive coating specially designed for EMI/RFI shielding applications. It offers shielding over a wide frequency range, environmental resistance and durability, at a modest cost.

Master Bond AC82 can be easily applied to adhere to most surfaces, including plastics, without need of pretreatment. Application methods include air or airless-type spraying equipment, brushing, dipping and silkscreening. The uniform continuous coatings characterized by electrical conduc-

tivity and electromagnetic shielding effectiveness are resistant to weathering, abrasion, humidity and corrosion.

Circle (46) on Reply Card

Cassette deck

The K-960 cassette deck from Yamaha Electronics is a 2-head, 2-motor, high-end, metal-capable cassette deck. The unit features dbx and Dolby noise reduction, Yamaha's low-impedance pure plasma process sendust record/play head, IC logic control and continuously adjustable bias control.

Circle (45) on Reply Card

Emergency CB radios

Now that the CB craze of a few years ago has faded, manufacturers are looking into new markets for their products. Several of these companies have recently developed emergency CB radios that are stored in the trunk or under the car seat and used in an emergency only.

General Electric designed its Help! CB radio for people who want the security of a CB, but do not want a permanently installed unit. The model 3-5900 avoids three common problems that conventional CBs bring: installation costs, theft and complexity of operation.

To operate the full-power, 40-channel transceiver, the user inserts the adapter into the car's cigarette lighter socket, attaches the magnetic antenna to the roof and selects the channel.

The Midland Ready Rescue emergency radio works in a similar way, but can also be used with a battery pack. According to Jerry McCoy, Midland's national sales manager, more than half of the emergency calls answered by auto clubs are for flat or dead batteries, so a power source other than the cigarette lighter may be necessary.

The GE Help! radio features a 2-function electronic bar meter, a digital LED channel readout, a built-in condenser microphone and a magnetic antenna with a 10-foot cord. The Midland model 77-810 features a push-to-talk bar, a helical antenna that attaches to the unit or magnetically to the car roof, a built-in microphone, squelch control and an 8-foot cord for the power adaptor.



General Electric Help! radio

Circle (135) on Reply Card



Midland Ready Rescue radio

Circle (136) on Reply Card

PAT. # 4,259,705

WARNING!

Electric Power Pollution, Spikes, Interference & Lightning HAZARDOUS TO HIGH TECH EQUIPMENT!!



MicroComputers, VTR, Hi-Fi, Lasers, Spectrometers are often damaged or disrupted due to Power Pollution.

High Tech components may interact!

Our patented ISOLATORS eliminate equipment interaction, curb damaging Power Line Spikes, Tame Lightning bursts & clean up interference.

Isolated 3-prong sockets; integral Spike/Lightning Suppressor. 125 V, 15 A, 1875 W Total, 1 KW per socket.

ISO-1 ISOLATOR. 3 Isolated Sockets; Quality Spike Suppression; Basic Protection \$69.95

ISO-3 SUPER-ISOLATOR. 3 DUAL Isolated Sockets; Suppressor; Commercial Protection \$104.95

ISO-17 MAGNUM ISOLATOR. 4 QUAD Isolated Skts; Suppressor; Laboratory Grade Protection \$181.95

Master-Charge, Visa, American Express

TOLL FREE ORDER DESK 1-800-225-4876

(except AK, HI, MA, PR & Canada)

SATISFACTION GUARANTEED!

Electronic Specialists, Inc.

171 South Main Street, Natick, MA 01760

Technical & Non-800: 1-617-655-1532

Circle (18) on Reply Card

APPLIANCE REPAIR BOOKS



Thirteen Handbooks written in easy-to-understand language by experts in the service field with illustrations and diagrams! Acclaimed by instructors and professionals alike! How to diagnose and repair air conditioners, refrigerators, washers, dryers, ranges, microwave ovens, dishwashers, vacuum cleaners, electrostatic air cleaners, RV gas appliances, hair dryers, motors, water heaters, coffeemakers, can openers, floor polishers, steam irons, food mixers, lawn care appliances, electric knives, electric and digital clocks and many others. Also fundamentals of solid state, setting up a shop, using test instruments and more Only \$2.65 to \$4.90 ea.

SEND FOR FREE PRICE LIST

Gamit, Dept. ES

P.O. Box 789

Lombard, Illinois 60148

Circle (19) on Reply Card

ATTENTION TECHNICIANS

- ★ JOB OPENINGS
- ★ MONTHLY TECHNICAL TRAINING PROGRAM
- ★ BUSINESS MANAGEMENT TRAINING
- ★ LOW COST INSURANCE
- ★ CERTIFICATION
- ★ TECHNICAL SEMINARS

All of this in a nonprofit international association for technicians

FIND OUT MORE:



R.R. 3 Box 564
Greencastle, IN 46135

**It's no puzzle
to order Oelrich
Service Forms**



For TV-radio and two-way radio service —
legal forms for Calif., Florida and Utah.
Now at parts jobbers or write for cat. B64.

OELRICH PUBLICATIONS

4040 N. Nashville Ave., Chicago, IL 60634
Now call toll-free! 800-621-0105

Circle (20) on Reply Card

**Your
ad gets
quick
results.
Advertise
in
classifieds.**



The Engineering Department of the **Electronic Industries Association** has revised RS-370-A. Now RS-370-B, the new standard is titled, *Designation System for Semiconductor Devices*. This revised standard includes several new items and has been completely rewritten. The first major addition is a new letter symbol C so that a Joint Electron Device Engineering Council (JEDEC)-type designation may now be 2C1234. This indicates that if a chip were properly mounted in the package registered for the 2N1234, it would display characteristics similar to the 2N1234.

The second major addition is the method for assigning the first numeric symbol for type designations of optoelectronic devices. These devices must be assigned numbers in a different manner than non-optoelectronic devices.

Circle (72) on Reply Card

Brownell Electro has published a new Instrument and Control Division product catalog. This 192-page catalog shows the com-

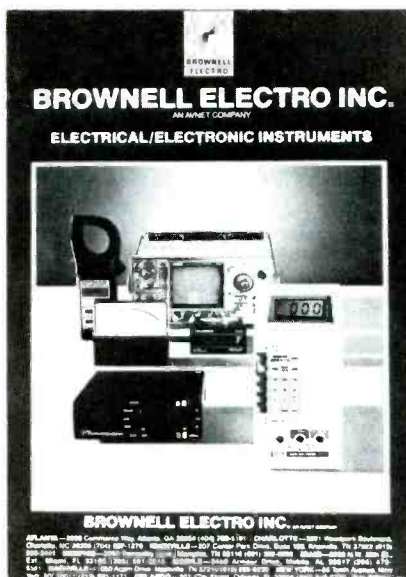

plete line of portable bench and specialty instruments and analog and digital panel instruments that Brownell Electro stocks in depth.

Circle (75) on Reply Card

A new brochure from **Alpha Electronics** details their complete product line, including more than 55,000 varieties of electron tubes, integrated circuits, semiconductors, connectors and components stocked and ready for off-the-shelf delivery. Eimac, RCA, Philips ECG and General Electric are just



a few of the lines of transmitting, receiving and industrial tubes and semiconductors distributed by Alpha Electronics.

Circle (74) on Reply Card

The Distributor Products Division of **New-Tone TCG** has produced a new, comprehensive, cross-reference supplement covering electronic arcade games and video monitors. This supplement crosses over 750 manufacturers' part numbers to the TCG replacement device for such manufacturers as Atari, Bally, Cinematronics, Exidy, Gottlieb, Gremlin, Midway, Stern, Williams and others. Each page is separated by manufacturer and product category for easy location.

Circle (73) on Reply Card

ARS Electronics has announced the publication of their *Directory of Radio Collectors and Suppliers*. The directory contains almost 2000 listings, including phonograph and TV collectors.

Hartford Beitman, president of ARS, noted that the new directory includes clubs, radio museums, publications of interest to collec-

tors, libraries carrying old service information and the manufacturer's service outlet addresses.

"We wanted to provide as much resource information as possible to help users of the directory find what they need," said Beitman. A large foreign section listing collectors and suppliers in other countries is also provided.

Circle (77) on Reply Card

Marlee Electronics Corporation has just published a new 12-page brochure on their Entraguard entry-control security systems. The brochure covers a complete new line of Entraguard products, which use microprocessor technology.

Highlighted products range from budget entrance security systems to deluxe, multifunctioned, multipurpose systems, including digital security access controls that use a keyboard instead of a magnetic card or key.

Circle (78) on Reply Card

A new 40-page catalog from **Electronic Specialists** presents their line of scientific and electronic interference control products. Protective devices, line voltage regulators and ac power interrupters are also included. Descriptive sections outline particular problems and suggested

solutions, and typical applications and uses are highlighted.

Circle (76) on Reply Card

Apex Machine and Tool Division, Cooper Industries has issued a new catalog on its line of industrial screwdrivers, nut runners and awls. Apex offers a complete line of hand drivers, including magnetic holders for replaceable tips, long and short sizes, slotted, Phillips, Frearson and Posidriv points, with wooden and plastic handles. Some have hollow handles for convenient storage of bits and sockets, and all are designed for assembly or maintenance applications.

Circle (79) on Reply Card

Joseph Electronics recently announced publication of a new Industrial Catalog No. 040. The 464-page catalog features comprehensive listings for more than 100 product lines. Special emphasis is placed on test equipment.

As a bonus the new catalog includes the exclusive Joseph Electronics Data Handbook. This 32-page insert is filled with the most frequently needed electronic tables and formulas.

Circle (80) on Reply Card

Quam-Nichols Company has issued a new full-line catalog describing its loudspeaker products and accessories. The 12-page Catalog 82 lists Quam's industrial, automotive, communications, general purpose, musical instrument and commercial sound products. Included are loudspeakers for data processing signaling and safety, as well as auto-stereo loudspeakers, grilles and do-it-yourself auto stereo speaker kits. Among the new commercial sound products listed in the catalog are ceiling baffles and pre-assembled loudspeaker/transformer/baffle assemblies.

Circle (81) on Reply Card

Speco Division, Components Specialties has announced new literature describing their back-

ESR METER

checks electrolytics
IN-CIRCUIT and is TV shop
FIELD-TESTED:

The most fantastic instrument I've ever bought—Billings, Mt. Used it 3 months; it only missed once—Marinette, Wis. (Typical). Squeal & no sync: 3 bad caps in B+ & AGC; Many Thanks—Taos, N.M. Please ship another; very satisfied—Glen Rock, Pa. It's fantastic—St. Joseph, Mo. Please rush; heard good reports—Hicksville, N.Y. One tremendous meter—Alexandria, Minn. Send your Super meter; heard about it—N. Olmstead, Ohio. Love that ESR Meter—Acton, Mass. Used it intensively for 30 days; it's been 100% effective—Pittsburgh, Pa.

Ideal for preventive maintenance: measures electrolyte dryness & shows up intermittent opens.

60-day Satisfaction Guarantee.

Send check or M.O. or call
(313) 435-8916 for COD

Or write for free brochure to:

Creative Electronics

ESR Brochure \$ 99.00
1417 N. Selfridge
Clawson, Mich. 48017 postpaid
USA & CAN.

Circle (21) on Reply Card

OPTIMA VALUE SALE

TO ORDER CALL TOLL FREE 1-800-327-0244

G.E., SYLVANIA, ZENITH, 75% OFF LIST NEW-BOXED

- | | | | |
|-------------------------------|---------------|--------------------------------|---------------|
| <input type="checkbox"/> 3A3 | 5 FOR \$13.69 | <input type="checkbox"/> 6JE6 | 5 FOR \$28.44 |
| <input type="checkbox"/> 6BK4 | 5 FOR \$25.38 | <input type="checkbox"/> 6LB6 | 5 FOR \$27.38 |
| <input type="checkbox"/> 6CJ3 | 5 FOR \$12.75 | <input type="checkbox"/> 6LF6 | 5 FOR \$29.94 |
| <input type="checkbox"/> 6FQ7 | 5 FOR \$10.56 | <input type="checkbox"/> 17J28 | 5 FOR \$14.88 |
| <input type="checkbox"/> 6GH8 | 5 FOR \$10.81 | <input type="checkbox"/> 38HE7 | 5 FOR \$26.13 |

All Tubes Not Advertised. Write in at 75% off

list. Sleeves Only. Singles 72% off list

HORIZONTAL OUTPUT TRANSISTORS

- | | | | |
|-----------------------------------|--------|----------------------------------|--------|
| <input type="checkbox"/> 2SC1172B | \$1.95 | <input type="checkbox"/> ECG 238 | \$1.95 |
| <input type="checkbox"/> 2SC1308K | \$1.95 | <input type="checkbox"/> ECG 165 | \$1.95 |

Quantity Prices Available

ECG REPLACEMENT TRIPLERS

- | | | | |
|-------------------------------|---------|-------------------------------|---------|
| <input type="checkbox"/> 500A | \$11.50 | <input type="checkbox"/> 523 | \$13.50 |
| <input type="checkbox"/> 522 | \$11.50 | <input type="checkbox"/> 526A | \$14.95 |

HI-DIV-3 (Rep. 800-616) Focus Divider \$3.95

TRANSISTORS & I.C.'s...MIN. 10, Can Mix

- | | | | |
|---|--------|-------------------------------------|--------|
| <input type="checkbox"/> 2SC1114 | \$3.75 | <input type="checkbox"/> 731 | \$1.50 |
| <input type="checkbox"/> 2SC1034 | \$5.95 | <input type="checkbox"/> 740 | \$2.00 |
| <input type="checkbox"/> 2SD870 | \$4.75 | <input type="checkbox"/> 791 | \$1.85 |
| <input type="checkbox"/> DA101 | \$5.75 | <input type="checkbox"/> 792 | \$1.85 |
| <input type="checkbox"/> HA1377 | \$3.25 | <input type="checkbox"/> 793 | \$2.35 |
| <input type="checkbox"/> HA1388 | \$5.25 | <input type="checkbox"/> 808 | \$1.50 |
| <input type="checkbox"/> M51515BL | \$3.25 | <input type="checkbox"/> 819 | \$1.50 |
| <input type="checkbox"/> M51517L | \$2.95 | <input type="checkbox"/> 820 | \$2.10 |
| <input type="checkbox"/> LA4440 | \$2.95 | <input type="checkbox"/> AN214Q | \$1.50 |
| <input type="checkbox"/> STK439 | \$6.00 | <input type="checkbox"/> GH3F Diode | \$1.00 |
| <input type="checkbox"/> 2SD478 - REP. ECG 375, Min. 10 | | | 69¢ |

GENERAL

- | | |
|--|-----------------|
| <input type="checkbox"/> 2.5 Amp. 1000 PIV Rect. | 100 for \$ 8.75 |
| <input type="checkbox"/> VEH0070 Video Head | \$49.95 |
| <input type="checkbox"/> AN16 Trinitron Dual Ant. for Sony | \$ 7.50 |
| <input type="checkbox"/> F59 Connectors w/ ferrule | 100 for \$11.95 |
| <input type="checkbox"/> Matching transformers | 10 for \$ 4.90 |
| <input type="checkbox"/> 6 ft. Cheater Cords | 10 for \$ 7.95 |
| (Heavy Duty - UL App. 7amp. 125V. P&NP) | |
| <input type="checkbox"/> 800-860 Zen. Safety Cap | \$ 3.95 |

Quantity Prices Available

Letters of credit and all checks placed on deposit with Bank of Hallendale, FL. VISA & Master Charge accepted. Min. order \$75. FOB Dania, FL. Catalog \$3. refundable upon order.

SEND CHECK OR MONEY ORDER TO:

OPTIMA ELECTRONICS

2022 Tigertail Blvd., Dania, FL 33004

Phone (305) 920-3550 TOLL FREE: 1-800-327-0224

Circle (22) on Reply Card

**Now, more than ever
...Men who KNOW say...**



IS THE ANSWER

**HELP NATESA HELP YOU
BY DOING YOUR PART**

Are YOU the operator of an ethical, professional caliber tv-radio-home electronics service business?

Write for details on how you can gain great benefits and participate in the destinies of this great industry.

NATESA
5930 S. Pulaski Road
Chicago, Illinois 60629

MOVING?

If you're planning a move in the near future, don't risk missing an issue of *Electronic Servicing & Technology*. Please give us 6-8 weeks notice if you're planning on changing your address. Just write in your new address below and mail this coupon, WITH YOUR SUBSCRIPTION MAILING LABEL, to:

ELECTRONIC
Servicing & Technology

Subscriber Services
P. O. Box 12901
Overland Park, KS 66212

Name _____

Address _____

City _____

State _____ Zip _____

ground and commercial sound programs. This literature graphically displays a complete line of PA amplifiers, 8-inch speakers, wall baffles, ceiling grilles, line transformers and audio accessories.

Circle (82) on Reply Card

The **Antenna Specialists Company** has just released a full-line catalog of base and mobile antennas and accessories for the land mobile industry. More than 300 products are described, covering the entire spectrum from low-band to 800MHz. Major new products

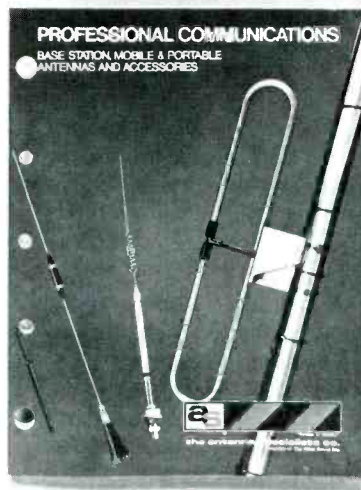

include the company's Dura-Flex elastomer shock-mount antenna line and the newly acquired line of Avanti no-ground plane, on-glass antennas.

Circle (83) on Reply Card

A 6-page catalog (Form 1F6541 Rev. 1/82) issued by **RCA Distributor and Special Products Division**, covers its line-up of back-of-the-set replacement antennas for TV sets. A feature of the catalog is the illustration of the antenna bases in actual size to facilitate identification of the antenna to be replaced.

The catalog shows exact replacement antennas for RCA TV sets and replacement arms for popular set antennas in general use.

Circle (58) on Reply Card

Klein Tools has announced a new booklet that covers the proper

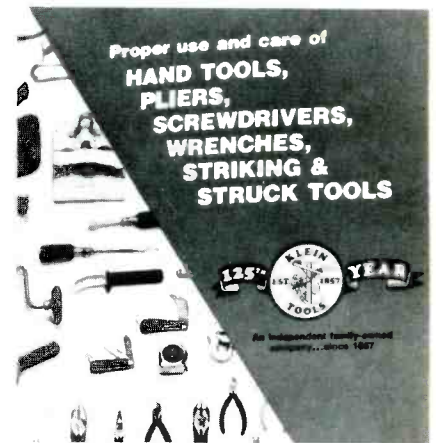

use and care of hand tools, including pliers, screwdrivers, wrenches, striking and struck tools, vises, clamps, snips, tool boxes, chests and cabinets.

The 88-page booklet contains hundreds of illustrations that cover how to select the proper tool for various jobs, care and maintenance of tools and many of the hazards that can result from misuse of tools.

Circle (101) on Reply Card

Hysol Division, the Dexter Corporation, is offering a 4-page brochure featuring Hysol portable hot-melt adhesive systems for low-, medium- and high-volume product assembly and packaging applications. The brochure provides information compiled to assist customers in selecting the proper gun and glue for specific substrates.

The brochure includes technical information on 15 Hysol hot-melt formulations for virtually any application.

Circle (90) on Reply Card

Catel has released a new data sheet on their Catel 245M stereo synthesizer. The product creates lifelike pseudo-stereo from mono signals, without causing change in spectral balance, audible noise or distortion to the mono signal. It is easily adjusted with two dimension controls: one for the lower mid-range and the other for the upper mid-range. The 245M is compatible with the Catel SM-2200 stereo generator.

Circle (91) on Reply Card

ES&T

Service Manuals

The ever popular
SMALL ENGINES Service Manual



Fix your own small air cooled engines
Covers virtually all makes & models

- 336 pages
- 8x11" softbound

\$9.95

Chain Saw



- Over 300 pages
- 8x11" softbound

\$9.95

**Small Engine/
Chain Saw
FLAT RATE**

Save your shop \$ \$ \$

\$8.95

Manuals cover nearly all makes/models

✓ Check these other important manuals

- Large Air Cooled Engines **\$8.95**
- Snowmobile **\$8.95**
- Small Tractor Vol. 1 **\$7.95**
- Small Tractor Vol. 2 **\$7.95**
- Light Utility Tractor **\$3.95**

Get more details from our **FREE catalog...Ask for it!**

Do it yourself and **SAVE!**

Walking Lawnmower

- 128 pages
- 8x11" softbound

\$8.95

Riding Lawnmower

- 192 pages...
- big 8x11" format

\$8.95

Technical Publications invites you to join the thousands that are doing it themselves and saving

\$ \$ \$ \$ \$ \$ \$

Outboard Motor Vol. 1

- 236 pages
- 8x11" softbound
- Motors below 30hp

\$8.95

Inboard/Outdrive

- 272 pages
- 8x11" softbound
- (The only full coverage service manual for inboard/outdrives on the market)

\$8.95

Outboard Motor Vol. 2

- 232 pages
- 8x11" softbound
- Motors 30hp and above

\$8.95

Inboard Engine and Drives

- 84 pages
- 8x11" softbound
- We've got the Flat Rate

\$5.95

TECHNICAL PUBLICATIONS

P.O. Box 12901 Dept. ES
Overland Park, KS 66212
(913) 888-4664



Indicate number, expiration date and type of card

No COD outside US

POSTAGE PAID when payment accompanies order

THE MARKETPLACE

Advertising rates in the Classified Section are 50 cents per word, each insertion, and must be accompanied by payment to insure publication.

Each initial or abbreviation counts a full word.

Minimum classified charge \$10.00.

For ads on which replies are sent to us for forwarding (blind ads), there is an additional charge of \$3.00 per insertion to cover department number, processing of replies, and mailing costs.

Classified columns are not open to advertising of any products regularly produced by manufacturers unless used and no longer owned by the manufacturer or distributor.

For Sale

FREE

THE GREAT ELECTRONIC THINGS & IDEAS BOOK!

HUNDREDS OF UNUSUAL PARTS, GADGETS & IDEA ITEMS, UNAVAILABLE IN STORES OR CATALOGS ANYWHERE! Bargain prices on everything! New items in every issue! Rush postcard for your copy!

ETCO ELECTRONICS
Dept. 311
Plattsburgh, N.Y. 12901

Circle (23) on Reply Card

AUTOMOBILE RADIO AND TAPE REPLACEMENT PARTS: Delco, Chrysler, Philco-Ford, Motorola, Panasonic and many others. Large inventory. **Leran Electronics Inc.**, 3768 Boxton Road, Bronx, NY 10469 (212) 881-9600 out of New York state (800) 223-8314. 5-82-tf

ELECTRONIC SURPLUS: CLOSEOUTS, LIQUIDATIONS! Parts, equipment stereo, industrial, educational. Amazing values! Fascinating items unavailable in stores or catalogs anywhere. Unusual **FREE** catalog ETCO-011, Box 762, Plattsburgh, N.Y. 12901. 6-78-tf

SCRAMBLED TELEVISION, encoding/decoding. New book. Theory/circuits. \$9.95 plus \$1 shipping. Workshop, Box 393ES, Dept. E, Bethpage, N.Y. 11714. 7-80-tf

PRINTED CIRCUIT boards from your sketch or artwork. Affordable prices. Also fun kit projects. Free details. **DANOCINTHS INC.** Dept. ES, Box 261, Westland, MI 48185. 5-81-tfn

SONY-PANASONIC-RCA-ZENITH-EXACT REPLACEMENT PARTS-LARGE INVENTORIES-SEND PART OR MODEL NUMBERS-WILL UPS OR COD-GREEN TELE RADIO DISTRIBUTORS, 172 SUNRISE HIGHWAY, ROCKVILLE CENTRE, N.Y. 11570. 5-82-tf

REPLACEMENT COLOR YOKES-DEALERS ONLY. Zenith 95-2501-2532-2887 etc. \$22.95. Magnavox 36180-1 etc. \$24.95. Sylvania \$24.95. American-made fuses in bulk. Request circular on your letterhead. **David Sims Enterprises, Inc.**, 665 East Jericho Tpke., Huntington Sta., NY 11746. 800-645-5030, NY State (516) 549-3925-1592. 5-82-tfn

PICTURE TUBE REBUILDING EQUIPMENT capable of producing four high quality tubes per day (WILL TRAIN TO OPERATE). Call or Write Atoll Television, 6425 Irving Park, Chicago, Illinois 60634, ph. 312-545-6667. 5-82-3t

SPRING SPECIALS on Popular Electrolytics - 40/450V - 75c; 80/450V - 85c; 100/450V - 95c; 200/300V - \$1.05. Quantity 20 lot only. Minimum order of \$50. **SUPER SPECIALS.** Bulk Zenith safety capacitors 800-860, 12 lot only \$2.50 each. **REDCOAT ELECTRONICS**, 104-20 68th Drive, Forest Hills, NY 11375. 212-459-5088. 7-82-tf

TUBES - Receiving, Industrial and Semi-conductors, factory boxed. Free price list. Low, low prices. **TRANSELETRONIC INC.**, 1365-39th Street, Brooklyn, N.Y. 11218E, 800-221-5802, 212-633-2800. 5-82-tf

2SC1172B's, 50 LOTS - \$1.69; 2SC1308K's, original Sanyos, 50 lots - \$1.99; Cheater cords, 25 lots - 35c; pol- and nonpolarized, 1,000 ft. reels of RG 59 U. Coax Cable - \$39/roll. Minimum order \$75. **Redcoat Electronics**, 104-20 68th Drive, Forest Hills, NY 11375. 212-459-5088. 7-82-tf

VALUABLE REFERENCE SOURCE! MICROPROCESSORS FROM A TO Z. Tells you what a microprocessor is, how it works, how to use it AND how to apply this knowledge when you're dealing with the installation, use, troubleshooting and programming of microprocessors. **Special Closeout Price** only \$6.95 per copy. Send your order and payment to: **Microprocessors, Book Sales, Dept. EST, One East First Street, Duluth, MN 55802.** 6-82-2t

SATELLITE TELEVISION SYSTEMS - 11' Polar Mount Antenna, 120K LNA, Gillaspie or Automation Tech. Receiver and 100' of cable. \$2895. 11 to 16 FT Systems available for Residential and Commercial application. Commercial Leasing available. **DEALERS AND DISTRIBUTORS WANTED.** Call/Write for **FREE** information. Catalogs \$3.00. **SIGNALS SYSTEMS**, Box 8836, Detroit, Michigan 48224. 313-361-5146. 6-82-2t

TGC REPLACEMENT SEMICONDUCTORS - 73 to 83% off list price. Send orders or price sheet requests on company P.O. or letterhead. **Electronic Parts Co.**, 1015 S. Escondido Blvd., Escondido, CA 92025. (714) 741-2300. 4-82-tfn

RG-59/U COAX ASSEMBLIES, F-59 connector on each end, packaged - 3'-89c; 6'-\$1.05; 8'-\$1.10; 12'-\$1.20; 20'-\$1.50; 25'-\$1.60; 50'-\$3.25; 75'-\$3.95; 100'-\$5.95. Call or write for our free catalog. **CZ Labs**, 55 Railroad Avenue, Garnerville, NY 10923. 914-947-1554. 5-82-tfn

TEST EQUIPMENT, tools, parts, aids. Save. Free catalogue. **Color-Tech Electronics**, P.O. Box 12916, Rochester, N.Y. 14612. 7-82-tf

INDIVIDUAL PHOTOFAC FOLDERS under 1100. Postpaid \$3.00. **Loeb**, 414 Chestnut Lane, East Meadow, NY, 11554. 7-82-3t

WHOLESALE COMPUTERS & SOFTWARE - Atari • Texas Instruments • NEC • Xerox • Wang • Toshiba • etc. Send SASE and Tax # with letterhead. **Incredible Electronics Company**, Box 117, Troy, NY 12180 (518) 272-0300. 7-82-tf

WHOLESALE PANASONIC - Televisions-stereos, shortwave radios, telephone answering devices, etc. Send SASE and business card or call (518) 382-0400 (wholesale dept.) **American/Japanese Television Company**, P.O. Box 502, Schenectady, NY 12301. 7-82-tf

HEATHKIT IG-5257 TV Post Marker/Sweep Generator \$175.00; **HEATHKIT IO-4101 Vectorscope/Color Alignment Generator** \$100.00. Both 2 year old, excellent condition, guaranteed 90 days **NORTHWOODS ELECTRONICS**, P.O. Box 159, Lac du Flambeau, Wisc. 54538. 7-82-tf

MOST POPULAR CRITICAL SAFETY COMPONENTS: Magnavox 250663-11 and 250663-17; G.E. EP25x60 and EP25x75, \$3.49 each, 10 for \$32.00. 430Mfd @ 200 WV (Mallory) axial electrolytics \$2.45 each, 10 for \$22.00. **NORFOLK ELECTRONICS**, P.O. Box 91, 55 Railroad Avenue, Garnersville, N.Y. 10923. 7-82-6t

FOR SALE: Sencore SG165 Stereo Analyzer. Never been used. Complete with cables, adapters, and manual. \$600.00 or best offer. **Will Vos** 509-663-5121 (M-F) or write 124 N. Kentucky, East-Wenatchee, WA. 98801. 7-82-tf

TV TROUBLE ANALYSIS TIPS. Over 300 symptoms/remedies by circuit area; tough ones over the years. Save time and money. Send \$12.50 to **CHAN TV**, 8151 Grandview Rd., Chanhassen, Mn. 55317. 5-82-tfn

Help Wanted

TV and 2-way Technicians wanted. \$15K to \$22K per year. Benefits include employee stock purchase plan. In the largest Retail Service Center in Northwest Kansas. Friendly community, good schools, short drive to the Rockies. Equal Opportunity Employer. **Miller's Electronics Inc.**, Goodland, KS 67735. 913-899-2386. 10-81-tfn

Wanted

WANTED FOR CASH: 53, 7F7, 7N7, 6AF6, 6HU8, 304TL, 4CX1000A, 4-1000A, all transmitting, special purpose tubes of Eimac/Varian. **DCO, Inc.**, 10 Schuyler Avenue, North Arlington, New Jersey 07032, Toll Free (800) 526-1270. 5-82-tfn

Business Opportunity

TV TECHNICIAN! Increase your income up to \$60,000 yearly. Rent-lease-sell TVs new-used, even from comfort of your home. Basic Preliminaries \$10.00. **Perrys TV Systems**, Hwy 181, Box 142, Route #1, Bremen, KY 42325. 12-81-tf

MECHANICALLY INCLINED INDIVIDUALS: Assemble electronic devices in your home. Knowledge or experience not necessary. Get started in spare time. Turn your spare or full time into cash. **NO investment.** Write for free details. **ELECTRONICS DEVELOPMENT LAB**, Box 1560ES, Pinellas Park, FL 33565. 5-82-tfn

LEARN TO REPAIR ATARI'S: Did you know that more than 2 million Atari Home Video games have been sold and that most of them are now out of warranty? Why not learn how to repair these games and expand your shop's earning potential. At **Electronic Institute of Brooklyn** we have put together a Video Taped course for the T.V. technician which will take the mystery out of repairing Atari games. These repairs can be done using equipment you probably already own. Included in the course are the video tape, schematics for the two different boards, technical literature for the IC's, and a list of sources for replacement parts. We have condensed months of research into a neat package that will enable you to start repairing Atari's right now! Our course is available on VHS or Beta system tapes. For more information or to order **CALL TOLL FREE 1-800-221-0834** or (212) 377-0369. **Electronic Institute of Brooklyn**, 4823 Ave. N, Brooklyn, N.Y. 11234. 7-82-4t

TV SALES & SERVICE: Well established shop with excellent potential in rural southern California community - easy terms (805) 649-1566 evenings & weekends. 7-82-tf

SEMI-RETIRE ON TABLE ROCK LAKE! Established TV sales and service with comfortable apartment. Priced to sell! **Gaslight Real Estate**, Box 16, Lakeview Missouri 65737. Ask for **Bonnie** (417) 272-8176. 7-82-tf

FORCED TO SELL DUE TO FAILING HEALTH, all test equipment and parts used to service B&W and colored TVs. Inventory, based on pre-inflation costs, available upon request. Phone 702-853-1840 or write owner, 14475 Huron Trail, Reno, Nevada 89511. 7-82-tf

WANTED: PEOPLE WHO NEED MONEY. To start or purchase a business. Any purpose, any amount! Send specifics to: **PT Enterprises**, Box 157, Excelsior, MN 55331. 7-82-tf

ADVERTISERS' INDEX

Reader Service Number	Page Number
17 Automated Production Equipment Corp.	23
21 Creative Electronics	63
16 Digitron Electronics Corp.	23
ETA	62
23 ETCO	66
18 Electronic Specialists, Inc.	61
19 Gamit Enterprises	61
14 H & R Communications, Inc.	21
7 Inter-Tec	9
4 Keithley Instruments Div.	1
NATESA	64
NESDA	60
20 Oelrich Publications	62
9 Omnitron Electronics	13
22 Optima Electronics	63
1 PTS Corp.	IFC
15 Primafax	22
RCA Distributor & Special Products	4-5, 15
11, 12 Sencore	16-19
2, 3 Sencore Inc.	BC
6 Simple Simon Electronic Kits, Inc.	7
13 Sperry Tech. Inc.	21
8 Sprague Products Co.	11
24 Ungar	25
Zenith Radio Corp.	IBC



New from Zenith!

Two-way protection from high voltage surges for the appliances and electronics you sell or service!

A brief, high voltage surge – or spike – can occur in any electrical system and, at amplitudes lower than 600V, cause little or no damage.

But at greater amplitudes, a spike can do real damage. And the greater the high voltage surge – resulting from nearby lightning, for example – the greater the risk of harm, especially to solid-state devices.

That's why Zenith now introduces the Spike Suppressor: to protect the susceptible TV receivers and household appliances you sell or service from damaging high voltage surges!

And the Zenith Spike Suppres-

sor protects not one, but two ways.

First, the new Zenith Spike Suppressor absorbs most line voltage spikes so only a safe voltage level reaches the protected equipment.

Second, heavy or prolonged voltage surges cause the Zenith Spike Suppressor to cut off power completely for added protection and to signal the need for a replacement.

That's double-duty protection against spikes and reason enough for you to stock and sell the Zenith Spike Suppressor. Your bottom line's another. So call your Zenith distributor now!

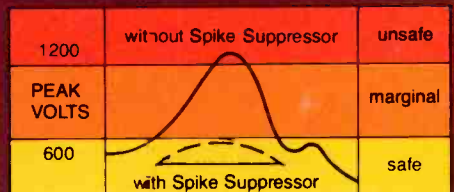

In this graph, the solid curve represents the excess voltage or "spike" imposed on an electric system and, represented by the dotted line, the protection provided household appliances as the Zenith Spike Suppressor absorbs the excess voltage and prevents it from surging thru the system.



The quality goes in before the name goes on.®

Now Cut Your TV-VCR Service Time Absolutely In Half.

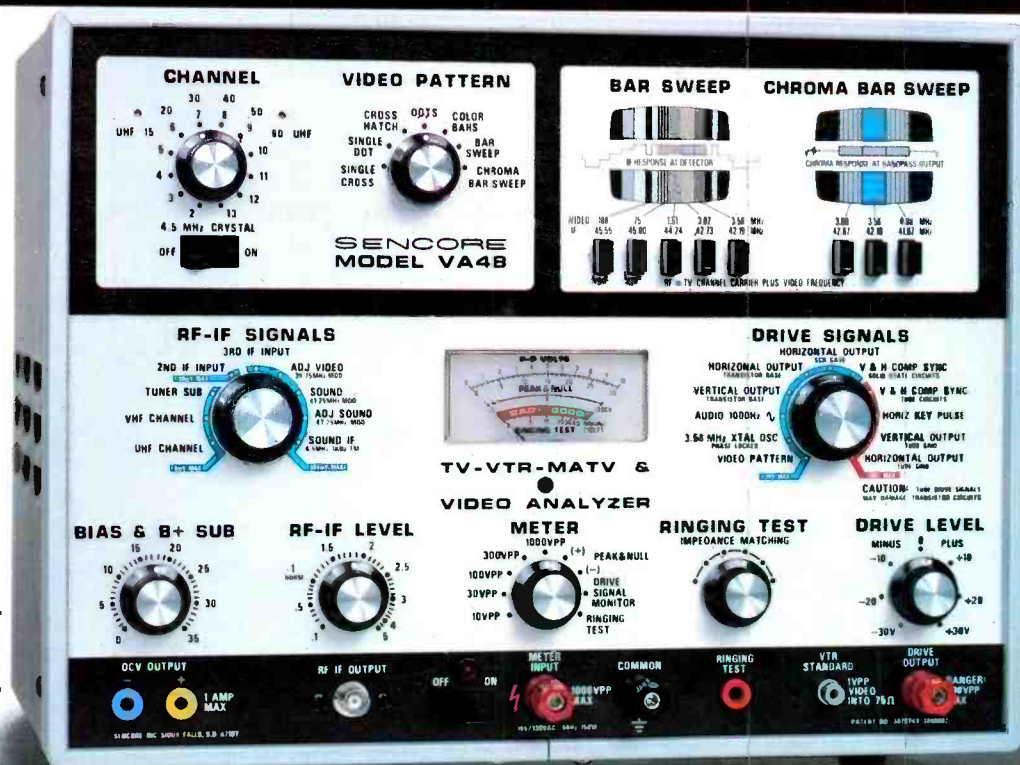

\$1395

Cut your time in half. You WILL cut your service time in half with a Sencore VA48 Video Analyzer. Over 1500 VA48 owners nationwide report an average time savings of 54%! These techs quickly and easily learned the VA48's Signal Substitution Method of troubleshooting. It's the key to DOUBLING your service output.

Signal Substitution is the key. Our double-patented Signal Substitution Method lets you inject known good signals from the VA48 into any stage of a TV or VCR. If you get a good picture, you know everything is working from that point forward. You back up stage by

stage until the defect appears on the screen. You then know you are injecting into the defective stage. It's just that simple, and only the VA48 provides ALL signals necessary to inject from antenna to CRT. It literally cuts your service time in HALF.

Join the thousands . . . 22,000 VA48 users know this video analyzer is the new standard of the industry. So do manufacturers who are specifying the VA48's patented Bar Sweep patterns on their schematics. Look in Sams Photofact schematics. The VA48 Bar Sweep is there, too.

Money back guarantee. We're

so sure you'll cut your TV-VCR service time in half, we offer your money back in 30 days if you're not absolutely satisfied. PLUS, when you order now, you'll receive a FREE copy of Bob Goodman's new \$18.95 best seller, "Practical TV Troubleshooting With A Video Analyzer." It's yours to keep FREE regardless.

Call toll-free. Call now to order or to talk about the VA48 features with a qualified Sencore engineering representative.

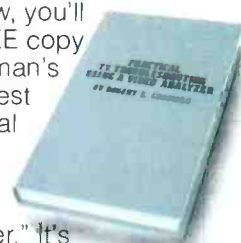

SENCORE

3200 Sencore Drive, Sioux Falls, SD 57107 605/339-0100 TWX: 910-660-0300

For More Information or To Order Phone Toll-Free **1-800-843-3338**

In Alaska, Hawaii, and Canada, phone collect: 605/339-0100

For Information Circle (2) on Reply Card
For Demonstration Circle (3) on Reply Card