

For industrial maintenance and consumer servicing professionals

October 1981 □ \$2.25

# Electronic Servicing

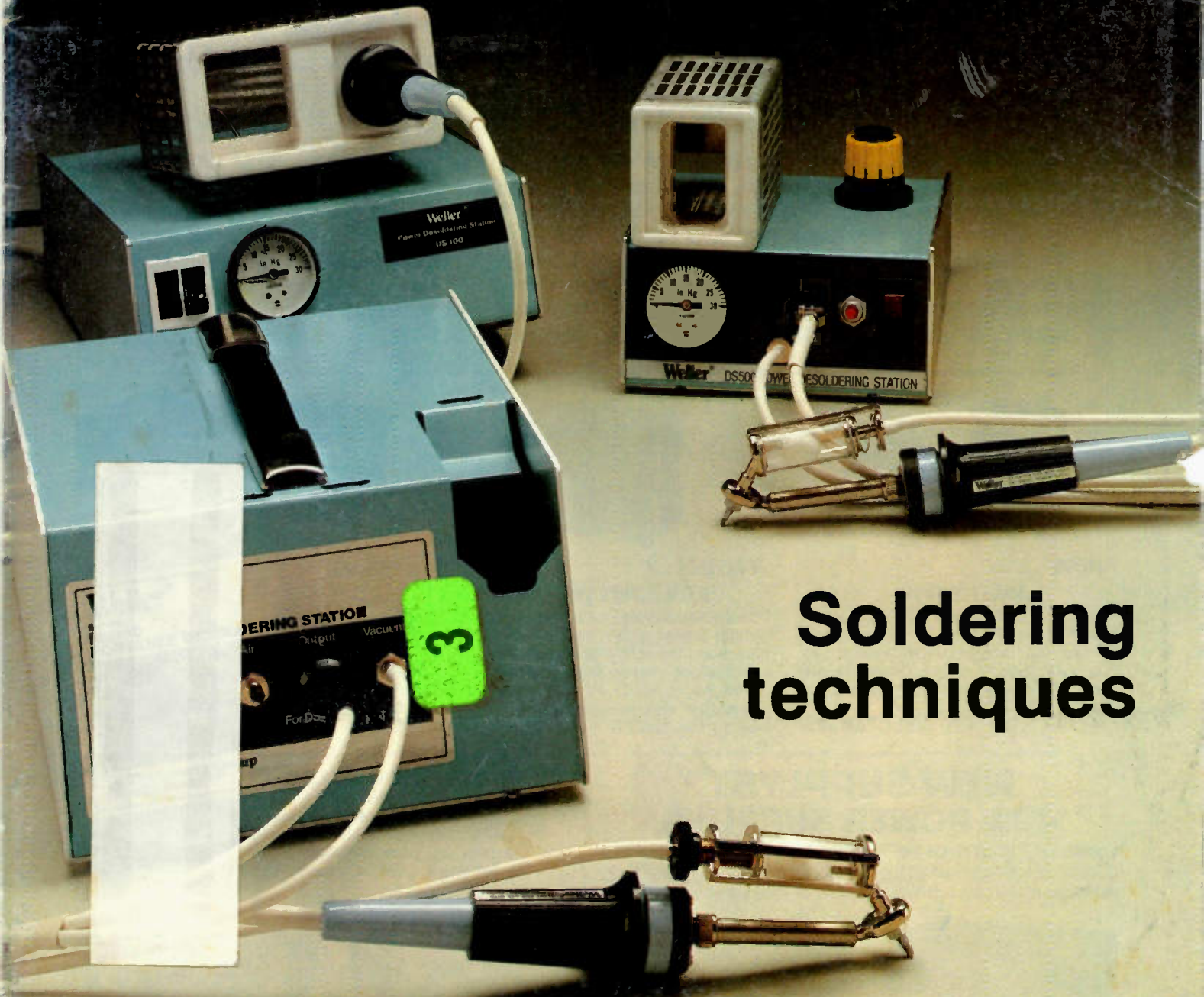

**Soldering  
techniques**

**Color TV  
servicing**

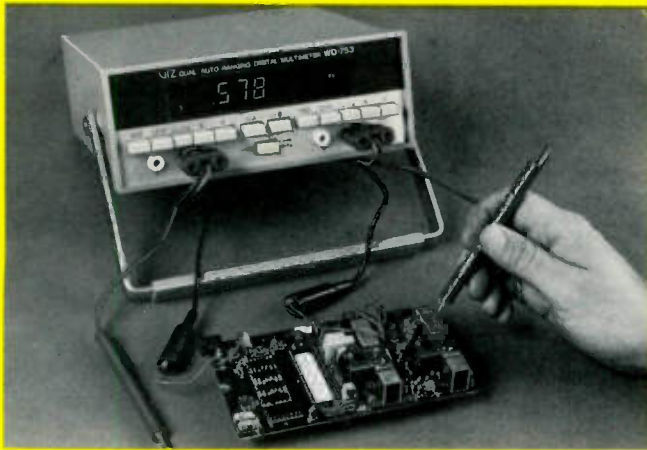

# LOOK! 8 NEW DIGITALS FROM VIZ

*They can make your job a lot easier.*

## NEW ... DUAL INPUT, AUTORANGING 3½ DMM

It does the job of two autoranging DMMs but costs about 30% LESS. Talk about convenience. You can measure or monitor voltage, current or resistance from two points in a circuit. Extra bright digital LED display. Accurate to 0.1% DCV, ±1 digit. Auto-zero, auto-polarity, autoranging. Just push panel buttons to preprogram the instrument to

perform the function you want. Measure any value from 1 millivolt to 1000V DC (750V AC). Measure audio frequencies to 20kHz (up to 10V). From 1 microamp to 2A DC or AC. High or low power ohms from 1 ohm to 20 MΩ. You'll soon find it to be the most used instrument you own! **WD-753 \$384.95.**



### NEW ... MULTI-COUNTER

A dual input counter with frequency range from 5 Hz to 125 MHz. For audio, video, CB and other high-frequency applications. Four gate times from .01 to 10 sec. Sensitivity 15 mV. Accuracy 3 ppm ± 1 count. **WD-755**

**\$279.95**



### NEW ... DIGITAL POWER LINE MONITOR

Easy-to-read 3 digit LED display has large bright 0.8-in. digits. Indicates brown-out condition. Instantly shows line voltage fluctuations. Range from 0 to 500 VAC. Freq. 50 Hz to 60 Hz. Current limit 8A. Compact—approximately 4 x 5 x 3 in. **WD-121**

**\$89.95**



### NEW ... DOUBLE SLOT SUPPLYST POWER SUPPLY

Outputs at 5V or 13VDC, precision adjustable ±1½V, 0 to 7.5A, current limiting. Lab quality test logic or mobile equipment. Read digitally volts and amps or use as 0 to 99V DC external voltmeters on two large 3-digit LED displays. **WP-709**

**\$299.75**

## NEW SUPPLYST™ 40W POWER SUPPLIES

Laboratory quality power sources, each with two built-in 3 digit meters to measure or monitor voltage or current. Adjustable current limiting. Choice of four supplies:



Single output  
0-20V, 0-2A

**WP-711 \$244.95**



Single output  
0-40V, 0-1A

**WP-712 \$256.95**



Dual output  
0-20V, 0-1A. 0-20V, 0-1A.

**WP-713 \$324.95**



Triple output 0-20V, 750mA.  
0-20V, 750mA. 5V, 4A.

**WP-714 \$368.95**

Want full technical details and a demonstration? Call toll-free, 1-800-523-3696, for the VIZ distributor nearest you.

### VIZ RELIABILITY

VIZ is a 50 year-old company. Our instruments are fully warranted, parts and labor, for a year. All items tested to NBS standards. We offer service and parts availability for a minimum of ten years. Over 15 repair depots in U.S.A.

# VIZ

**Look to VIZ for value, quality, availability.  
Over 70 instruments in the line—PLUS full accessories.**

VIZ Mfg. Co., 335 E. Price St., Philadelphia, PA 19144

## Electronic Servicing

Editorial, advertising and circulation correspondence should be addressed to: P.O. Box 12901, Overland Park, KS 66212 (a suburb of Kansas City, MO); (913) 888-4664.

### EDITORIAL

Bill Rhodes, *Editorial Director*  
 Carl Babcoke, *Consumer Servicing Consultant*  
 Rhonda Wickham, *Managing Editor*  
 Lynn Chamberlain, *Associate Editor*

### ART

Dudley Rose, *Art Director*

### CIRCULATION

John C. Arnst, *Director*  
 Evelyn Rogers, *Manager*  
 Dee Manies, *Reader Correspondent*

### ADMINISTRATION

R. J. Hancock, *President*  
 Cameron Bishop, *Publisher*

### ADVERTISING

Greg Garrison, *National Sales Manager*  
 Jeanette Staley, *Production Manager*  
 Mark Raduziner, *Marketing Coordinator*

Regional advertising sales offices listed near Advertisers' Index.



Member, American Business Press



Member, Audit Bureau of Circulation

**ELECTRONIC SERVICING** (USPS 462-050) (with which is combined PF Reporter) is published monthly by Intertec Publishing Corp., P.O. Box 12901, 9221 Quivira Road, Overland Park, KS 66212. Second Class Postage paid at Shawnee Mission, KS 66201. Send Form 3579 to P.O. Box 12901, Overland Park, KS 66212.

**ELECTRONIC SERVICING** is edited for technicians who repair home-entertainment electronic equipment (such as TV, radio, tape, stereo and record players) and for industrial technicians who repair defective production-line merchandise, test equipment, or industrial controls in factories.

Subscription prices to qualified subscribers: one year \$12, two years \$19, three years \$24 in the USA and its possessions. Foreign countries: one year \$17, two years \$27, three years \$35. Subscription prices to all others: one year \$25, two years \$50 in the USA and its possessions. Foreign countries: one year \$36, two years \$72. Single copy price \$2.25; back copies \$3.00. Adjustment necessitated by subscription termination to single copy rate. Allow 6 to 8 weeks delivery for change of address. Allow 6 to 8 weeks for new subscriptions.

**PHOTOCOPY RIGHTS:** Permission to photocopy for internal or personal use is granted by Intertec Publishing Corp. for libraries and other registered with Copyright Clearance Center (CCC), provided the base fee of \$2 per copy of article is paid directly to CCC, 21 Congress St., Salem, MA 01970. Special requests should be addressed to Cameron Bishop, publisher.  
 ISSN 0013-497X/81 \$2



INTERTEC PUBLISHING CORP.

©1981 All rights reserved.

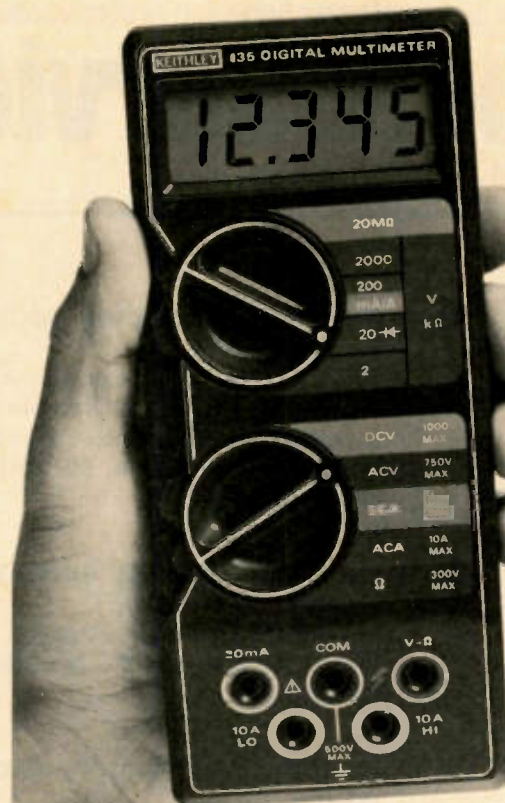

## Easily the best.

In terms of resolution and accuracy, the Model 135 is easily the best handheld DMM available at any price. It's the only handheld offering 4½ digits. That gives it 10 times better resolution than the best 3½-digit DMM and provides 3 to 4 times more useable accuracy. Resolution isn't all you get. You get an easy-to-use instrument that's rugged and reliable enough to live in the read world. You get Keithley packaging.

Its large, crisp LCD makes it

easy to read. Rotary switches and a color-coded faceplate make it easy to use. Once-a-year calibration and long battery life make it easy to own. Easy to buy at \$235.

## Best in price, best in performance.

There is a DMM designed specifically for your application in the Keithley line. Your Keithley distributor has instruments in stock for your convenience. Call today for complete information and a demonstration.

## Sound Choice.

New Model 128 Beeper DMM. Audible/visual indication on all 5 functions of this 3½-digit DMM lets you test faster, and the user adjustable threshold and special diode test function make it a sound choice. Unique features, \$139.



## Bench Bargain.

Model 176, Portable Bench DMM. Full 5-function LCD 4½-digit bench DMM offers 0.05% basic DCV accuracy. Keithley ease of use features include range and function annunciators, 1000 hour battery life and optional line operation. A bargain at \$269.



# KEITHLEY

Keithley Instruments, Inc.

28775 Aurora Road/Cleveland, Ohio 44139/(216) 248-0400

Circle (3) on Reply Card

# Electronic Servicing

October 1981 □ Volume 31, No. 10

---

## Features

- 6**    **Servicing videodisc equipment, part 2**  
*By Kirk Vistain*  
Topics covered include theory of operation for RCA model SFT-100 videodisc player, simplified explanations of the electronic circuits and mechanical systems, plus interesting facts about CED discs.
- 15**   **Heathkit satellite earth station**  
*By Carl Babcoke, CET*  
The latest Heath electronics kit tops them all in price and sheer size — it's a satellite TV receiving system.
- 18**   **Zenith power supply and horizontal sweep, Part 2**  
*By Carl Babcoke, CET*  
Further exploration of the unique circuit that regulates the Zenith horizontal sweep and all scan-rectified power supplies on the M10 module.
- 28**   **Soldering and desoldering equipment roundup**  
Soldering and desoldering product descriptions, as provided by manufacturers. Use the Reader Service Card to obtain more information.
- 38**   **Technology trends in consumer electronics**  
Excerpts of a speech given by Ing. Klaus Welland assessing future technical and technological trends.
- 

## Departments

- |   |            |    |                   |
|---|------------|----|-------------------|
| 3 | Scanner    | 34 | Reader's exchange |
| 5 | Photofacts | 43 | Product report    |
- 

## About the cover

A portable desoldering station, designated the Model DS600, features a self-contained vacuum/air pump for at-site repair operations. This and other equipment used for soldering and desoldering are features in this month's roundup beginning on page 28. *Photo courtesy of Weller, The Cooper Group.*

# electronic scanner

## Multi-year contracting passes House

The Electronic Industries Association recently praised members of the House of Representatives for their passage of legislation designed to implement the benefits of multi-year contracting (MYC) for the Department of Defense.

EIA President Peter F. McCloskey called the recent action of the House "a major step in revitalizing our defense industrial base and one which ultimately provides for a more effective and efficient procurement process."

## Pioneer sued for patent infringement

Bang & Olufsen of America Inc. has filed suit against U.S. Pioneer Inc. and Pioneer of Japan for patent infringement on tangential

tracking turntables. A tangential tracking turntable is one in which the entire tonearm moves in a straight line perpendicular to the record instead of pivoting as conventional tonearms do.

All parties involved are manufacturers of stereo equipment. The suit was filed in U.S. District Court, Northern District of Illinois.

## Leonard Nimoy to represent Magnavox

Leonard Nimoy, star of television and theater, will become Magnavox's official spokesman for all advertising communication, according to Rita E. Hutner, vice president of advertising and public relations.

The company chose Nimoy because of his association with scientific technology, created by his

role as Dr. Spock in the science fiction series, *Star Trek*.

## Sales of color TV tubes up

U.S. sales of color-TV picture tubes, excluding imports, increased 0.2% from 2.875 million units in the first quarter of 1980 to 2.879 million units during the same period in 1981, according to the Electronic Industries Association's Marketing Services Department.

Within this total, sales to the initial equipment sector rose 2.3%, while renewal sales rose 1.6% and exports decreased 20.6%. Imports showed a 43.9% gain, resulting in a 2.0% expansion of the total U.S. market for color TV picture tubes.

## Atari Video Computer System service network formed

Atari Inc. has announced the formation of a nationwide independent

## We wrote the book on reliability...

... the RCA SK Series Replacement Guide, featuring RCA's line of reliable solid state replacements, the line of integrity with unsurpassed engineering excellence. The accuracy of the Guide's cross-reference directory enables you to replace with complete confidence. So, reach for reliability with RCA SK Series replacements. We wrote the book on it. Pick up a copy at your local RCA SK Distributor.

Replace over 170,000 industry types with 1400 RCA types.

# RCA SK Replacement Solid State

RCA Distributor and Special Products Division, Deptford, NJ 08096.

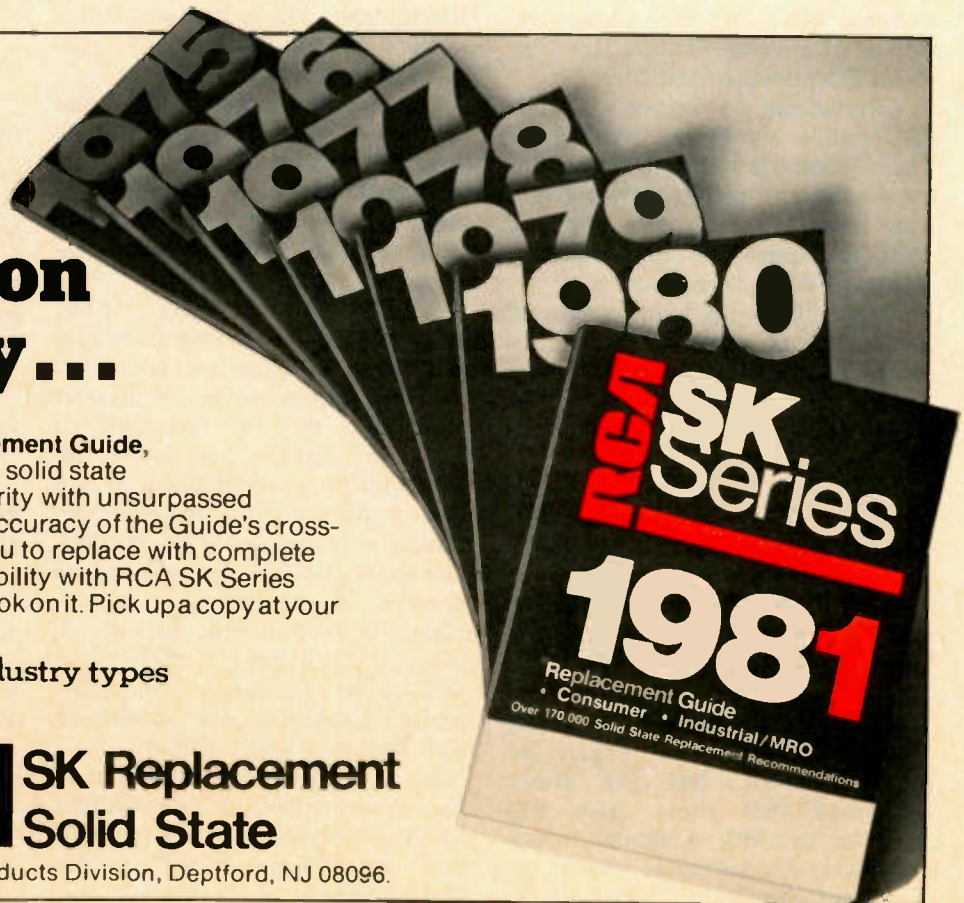

## Scanner

service network to provide convenient warranty service for the Atari Video Computer System (VCS). The network, which will include 500 service locations by the end of 1981, will be composed of independent electronics retail and repair centers, trained and authorized by Atari to service the Atari VCS. In addition, the centers will become retail outlets for Atari VCS hand controllers: joysticks, paddles and keyboards.

Previously, all VCS service had been performed by Atari's own regional service centers located in Somerset, NJ and Sunnyvale, CA. These centers will continue to operate as support for the independent service network. They will be joined by two more Atari regional centers in Chicago and Dallas later this year.

### Manufacturers face product "burn-out"

In consumer electronics, competitive market conditions and fluctuating consumer demand contribute to the vulnerability of a manufacturer's market share and profit growth, according to an August 1981 NARDA magazine report of a recent Venture Development Corporation study.

Capitalizing on innovative product trends sometimes weakens a manufacturer's ability to realize annual sales and profit growth goals, the report stated, thus enabling "product burn-out" to become a recognized industry problem.

Dealers handling home electronic products can expect a temporary boom in intrusion detection device sales. An annual growth rate of 30% for home security products is projected for 1981.

As current leader in terms of products and dollar volume, the entertainment electronics area (nonprogrammable electronic games) is most likely to fall victim to the boom and bust syndrome—short product life cycles.

Shipments of portable cassette/headphone units will increase dramatically through 1982, the report stated, but the study predicted that these sales will stabilize by 1983. A similar fate is not likely for videodisc players, at least not during the 1980s. How-

ever, competition among different disc formats, and between discs and videocassette recorders, will certainly keep manufacturers on their toes.

### July distributor shipments steady, bookings drop

Shipments by industrial distributors in July held virtually even with the previous month's data, while bookings-to-billings slipped 12%, the National Electronic Distributors Association reported.

According to NEDA's monthly Distribution Business Index (DBI), bookings in July declined 22% from June, reflecting the softness in business being reported by some companies. This was the first month since October 1980 that the bookings ratio has fallen below 1.00.

### AT&T to provide satellite distribution for futuristic TV network

National Entertainment Television Inc. (NET), has announced an agreement with American Telephone and Telegraph Company under which AT&T will provide distribution via communications satellite of NET's new TV programming service.

The agreement brings the total number of customers for AT&T's proposed new service to five, the maximum proposed by AT&T at this time. The other four are NBC, CBS, ABC and Robert Wold Company.

NET will exploit three technologies: the communications satellite; microprocessors for remotely programming TV decoder boxes for pay-TV reception of scrambled signals; and low-power TV, employing satellite feeds to provide a diversity of programming choices to community TV stations. The service will also be provided via satellite to regular TV stations, cable TV, and multiple distribution service (MDS) pay-TV carriers, as well as to apartment complexes, hotels, hospitals, and individuals with backyard earth stations.

NET programming is slotted to start in spring 1982, using the AT&T Satellite Television Service (pending FCC approval of AT&T's tariff), and planned to air 24 hours a day.

### EDS registration statistics released

Exhibitors in the 1981 Electronic Distribution Show soon will receive copies of the complete 1981 EDS registration and attendance roster. The roster lists the more than 2200 distributor and sound contractor personnel who attended the show, representing more than 1100 companies.

The total number of customer-type personnel attending EDS '81 was 2293. This breaks down to 1848 distributors and 445 sound contractors from 48 states, Puerto Rico and 15 foreign countries.

The roster provides information on the distributor's area of specialization, estimated annual volume of sales and the verification process used to establish the distributor's or sound contractor's status. All the information in the roster is arranged alphabetically by state.

Copies of the roster are available to non-exhibitors at \$200 per copy. Non-exhibiting manufacturers may apply the \$200 fee to their space costs for EDS '82, if their space reservations are received by December 31, 1981.

The 1982 Electronic Distribution Show and Conference is scheduled for Thursday, Friday and Saturday, April 29, 30, and May 1, at the New Orleans Hilton Hotel, New Orleans, LA. For further information on the Registration and Attendance Roster and on EDS '82, contact the Electronic Industry Show Corporation, 222 S. Riverside Plaza, Suite 1606, Chicago, IL 60606. Telephone: (312) 648-1140.

### Bill Kist & Associates receive sales rep award

The annual Mesa Electronics Sales Ltd. Sales Representative of the Year Award was recently presented to Bill Kist and Associates of Great Neck, NY. The award, presented this year at the Summer 1981 Consumer Electronics Show, is given to that sales representative firm that has demonstrated the greatest expertise in all aspects of professional salesmanship during the past year. □

<b>GOLDSTAR</b> CR-407 .....	2021-1
<b>JCPenney</b> 685-2007E,-10 (855-1210) .....	2020-1
<b>MAGNAVOX</b> Chassis T809-10AA, AB .....	2025-1
<b>MIDLAND</b> 15-032 .....	2019-4
<b>PHILCO</b> Chassis E24-20/21 .....	2023-1
<b>RADIO SHACK</b> TC-210 (16-210) .....	2025-2
<b>RCA</b> FEC440W/43W .....	2024-4
Chassis KCS205BA, BB .....	2023-2
<b>REALISTIC</b> 12-1520 (CHRONOMATIC 213) .....	2019-3
16-100 .....	2021-2

<b>SEARS</b> 564.44300050/44350050/44400050 .....	2019-1
564.54000050 .....	2022-1
564.54300050 (TeleCaption) .....	2023-3
<b>SONY</b> Chassis SCC-285A-A, B-A .....	2021-3
Chassis SCC-284A-A .....	2024-2
<b>SOUNDESIGN</b> 3850A .....	2022-3
3970A .....	2024-3
<b>TEKNIKA/CITEK</b> Chassis ECC-14146 .....	2024-1
<b>WARDS</b> GGY-16210D/211A/214A/217C/ 219A/220A/230A .....	2019-2
GGY-12900C/911A .....	2022-2
GGY12920D .....	2024-5
<b>ZENITH</b> M1938W, WXS, S1920W9 .....	2020-2

## NOT SO FAST

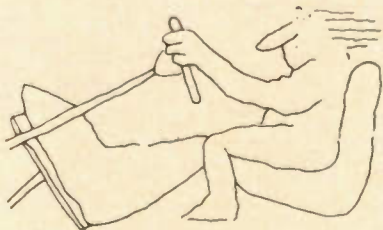

You'll get about 20 more miles from every tank of gas if you slow down from 70 to 55 mph on the highway. For a free booklet with more easy ways to save energy and money, write "Energy," Box 62, Oak Ridge, TN 37830.

**ENERGY.**  
**We can't afford to waste it.**

U.S. Department of Energy

## Tuners To Go

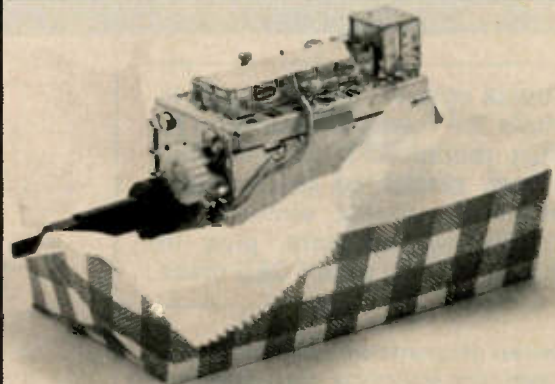

Now you don't even need to wait a single day for delivery of quality rebuilt PTS tuners. They're ready and waiting for you! Pick up a carry-out wherever you see the **EXPRESS TUNER EXCHANGE** sign.

Sure beats waiting.



PTS ELECTRONICS, INC.  
General Headquarters P.O. Box 272  
Bloomington, IN 47402

Circle (4) on Reply Card

# servicing videodisc equipment part 2

By Kirk Vistain and Carl Babcoke

Topics covered in this article include the theory of operation for RCA model SFT-100 videodisc player, simplified explanations of the electronic circuits and mechanical systems, plus interesting facts about CED discs.

Newest Magnavision (above) videodisc player from Magnavox is equipped with a wireless remote control unit.

Figure 1 (above right) Viewed from above and without its covers, the RCA SFT-100 videodisc player has this appearance. The arrow at upper left points approximately to the stylus location. The upper-right arrow identifies the arm-servo motor and gears. PW500 is located by the arrow at lower left, while the lower-right arrow points to the function lever that has off, play and load/unload positions.

Figure 2 (right) Recording of CED-type videodiscs follows this general block diagram.

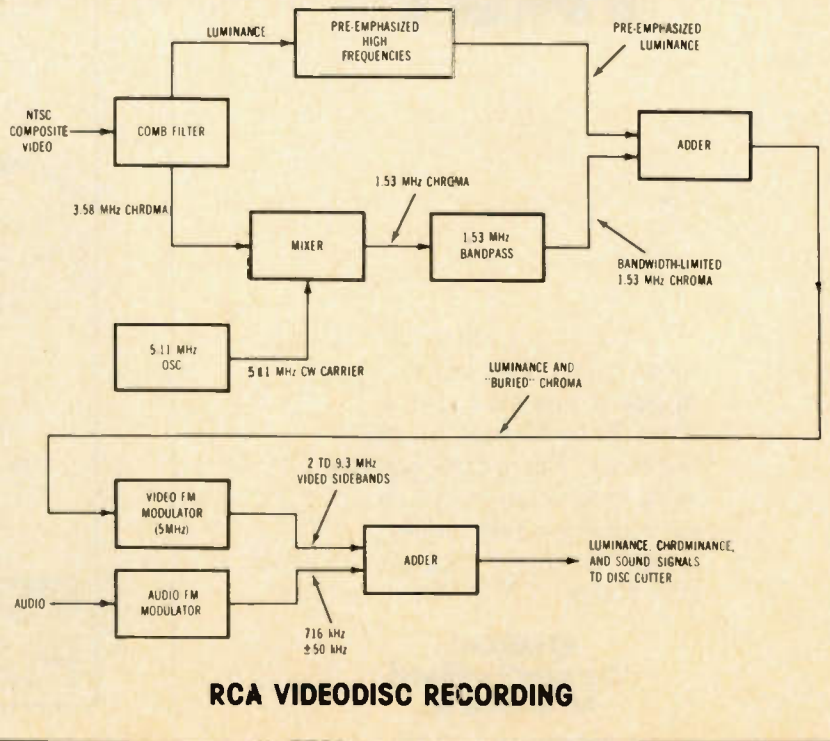



Some general specifications of the RCA-developed *capacitance-electronic disc* (CED) videodisc system were presented in Part 1 of this article last month. Figure 1 shows model SFT-100, the only RCA videodisc player released so far. Model SFT-100 is in wide distribution, and the RCA distributors are holding many servicing seminars to instruct technicians of dealers and authorized service stations about proper servicing techniques.

#### Audio records vs. videodiscs

There is a similarity between audio conventional records and CED videodiscs. Both involve a recording stylus that is moved laterally across the disc as the turntable rotates. This produces a spiral groove in the disc material. Although only a *single* spiral groove is formed, an examination of a small area appears to show many separate curved grooves. That is why all discs are rated by a specific number of grooves-per-inch across the surface radially.

With audio records, the groove is modulated by electrical audio power that moves the stylus up-and-down (vertical mode), from side-to-side (lateral mode), or a combination of both. Stereo audio records use both vertical and lateral modes in a 45°/45° direction; a system that operates with two separate audio signals. Playback is the reverse of recording, with the groove undulations forcing the playback stylus to move in an approximate duplication of the cutting stylus motions during recording.

Although audio records and videodiscs have several similarities (both are round flat discs with modulated grooves and a hole in the center), there are more differences. With playback of audio records, the stylus mounting must have enough flexibility to allow easy vibration of the stylus (giving audio signals without shaking the cartridge and arm with each movement), while having enough stiffness to move the heavy cartridge/arm combination in step with the spiraling center of the groove. In other words, all mechanical power to move the stylus alone (for audio) and to move the entire arm (so it follows the groove) is exerted by the groove against the stylus.

That is not true of the CED videodisc playback. Stylus motion

does not produce the signal, nor is the large and heavy arm assembly moved by the force between stylus and groove. Instead, an easily moved stylus tracks the groove, but when the spiral moves the stylus off center of two sensors, a motor-driven assembly moves the arm until the needle again is centered with the sensors. The stylus has only 0.065 grams of tracking force.

#### Recording CED discs

Recording and playing must be a complementary process. Therefore, the following information is presented for the insight it gives about the playback requirements of the CED system of videodiscs.

Grooves of CED discs are vertically recorded with constant-amplitude frequency-modulated signals, as shown by the Figure 2 block diagram.

NTSC composite video is separated into luminance and chrominance signals by a comb filter. The normal 3.58MHz chroma signal is heterodyned to 1.53MHz in a mixer circuit by a 5.11MHz CW carrier. After bandwidth limiting in a bandpass filter, the 1.53MHz chroma is combined with the pre-emphasized luminance signal in an adder. The 1.53MHz chroma occupies an area of the luminance, but it is interleaved with the luminance (similar to the interleaving of NTSC signals). Therefore, it can be separated from the luminance by another comb filter in the playback electronic circuits. This 1.53MHz signal is called "buried" chroma.

Output of the linear adder circuit consists of the combined luminance and the buried 1.53MHz chroma. This video signal is used to frequency-modulate a 5MHz (resting frequency) oscillator. Also the program audio frequency-modulates a 716kHz oscillator. Then the 5MHz output and the 716kHz output are combined in another linear adder. Output of the adder is the total signal for recording on a master videodisc.

CED videodiscs are rotated at precisely 450 revolutions-per-minute (rpm) during recording and playing. That is 7.5 rotations per second. By comparison, audiodiscs rotate at 0.555rps for 33rpm records, 0.75rps for 45rpm, and 1.3rps for 78rpm.

Also, these 7.5 rotations play or record 30 complete video frames (or

## ESR METER

checks electrolytics  
IN-CIRCUIT and is TV shop  
FIELD-TESTED:

The most fantastic instrument I've ever bought—Billings, Mt. Used it 3 months; it only missed once—Marinette, Wis. (Typical). Squeal & no sync: 3 bad caps in B+ & AGC; Many Thanks—Taos, N.M. Please ship another; very satisfied—Glen Rock, Pa. It's fantastic—St. Joseph, Mo. Please rush; heard good reports—Hicksville, N.Y. One tremendous meter—Alexandria, Minn. Send your Super meter; heard about it—N. Olmstead, Ohio. Love that ESR Meter—Acton, Mass. Used it intensively for 30 days; it's been 100% effective—Pittsburgh, Pa.

Ideal for preventive maintenance: measures electrolyte dryness & shows up intermittent opens.

60-day Satisfaction Guarantee.

Send check or M.O. or call  
(313) 435-8916 for COD

Or write for free brochure to:

*Creative Electronics*

ESR Brochure \$ 99.00  
1417 N. Selfridge postpaid  
Clawson, Mich. 48017 USA & CAN.

Circle (5) on Reply Card

"Not too long ago  
I was speechless.  
Now I'm teaching Ben  
how to talk."



Donald Stevenson Benjamin Evans

Cancer of the larynx is one of the most treatable cancers. If discovered in time, 9 out of 10 patients are curable. Of these, two-thirds learn to speak again, thanks to a rehabilitation program of the A.C.S. Early detection and prompt treatment can save your life and your voice.



**American Cancer Society**  
2,000,000 people fighting cancer.

THIS SPACE CONTRIBUTED AS A PUBLIC SERVICE.

## Videodisc

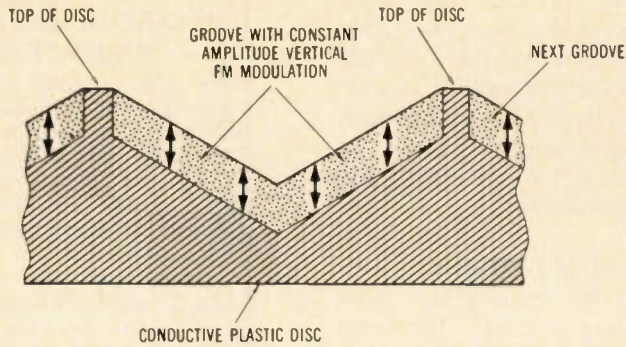

### CROSS-SECTION VIEW ALONG ONE GROOVE

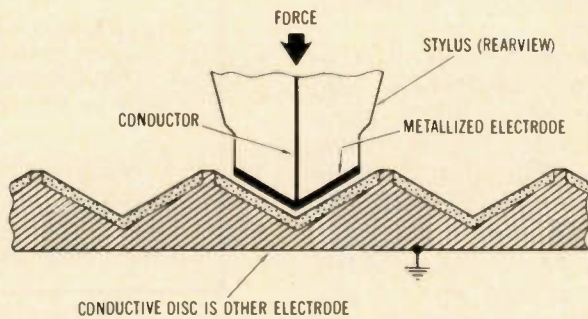

### STYLUS AND DISC ARE CAPACITOR PLATES

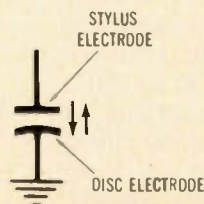

### VARIABLE CAPACITANCE

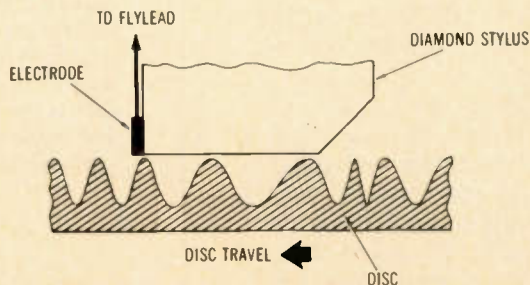

### SIDE VIEW OF STYLUS AND FM-MODULATED GROOVE

**Figure 3 (left)** During recording of CED master discs, the cutting stylus traces a tiny groove with constant-amplitude vertical recording of the FM signal. During playback, however, the playback stylus does not vibrate or follow individual cycles.

**Figure 4 (center left)** The playback stylus rides on top of the groove's sine waves. (A) A variable capacitance is formed between the metallized electrode on the stylus and the undulations of the conductive material of the videodisc. (B) The capacitance symbol illustrates the action of electrode and disc.

**Figure 5 (bottom left)** The playback stylus is longer than several of the longest wavelengths (wider sine waves) that have been recorded on the videodisc. Therefore, the playback stylus does not vibrate or follow individual cycles. Notice the signal sine waves have the same height (amplitude) but varying repetition rates (widths). Note: This is not a literal representation, because the stylus bottom and the groove both have a "V" shape, as shown in Figure 4.

60 fields) consisting of 15,750 lines of video (black-and-white TV standard). One revolution contains 4 complete video frames (or 8 video fields) having 2100 video lines.

Recording of each CED disc begins at the rim, and the cutting head with stylus moves toward the center (outside-in recording), while the disc is rotated in a clockwise direction (viewed from the top). This is similar to the recording of conventional audio records, but there are important differences. Grooves of audiodiscs are spaced about 0.004 inches apart with a "land" area in between them (a maximum of perhaps 250 grooves per inch). The grooves of CED videodiscs almost touch, and they are so narrow that about 40 could be placed in the space of one audio groove. Each 1-inch radius has about 10,000 grooves.

As stated before, the CED cutting needle moves up and down over a constant distance, but the repetition rate is varied by the video/audio FM signal (Figure 3). In other words, the varying frequency produces physical sine waves (in the conductive plastic) that vary in width (or the number of sine waves per unit of

## Videodisc

groove length, as shown in Figure 5).

### Playing CED discs

The playback stylus (Figure 4) glides along the tops of the FM sine waves, without having any appreciable movement from the sine waves. Instead, the FM undulations of unvarying depth are sensed as a capacitance variation between a tiny deposited-metal electrode (on the trailing side of the stylus) and the disc, which is made of conductive material.

Figure 5 shows a drawing as seen from the disc's outside edge (as if viewed from the rear of the CED player). The stylus does not move up and down, because the sine waves have constant amplitude. Instead it glides along more or less on the tops of the sine waves, while the capacitance between the metal electrode and the conductive disc material varies at an FM rate. (Incidentally, *minor* variations in average capacitance—such as those occurring if the stylus is not seated firmly in the groove—have no detrimental effect on picture or sound.) In the arm electronic circuits, this capacitance variation changes the resonant point of a tuned line, which in turn varies the amplitude of a fixed-frequency oscillator. The amplitude variation is demodulated by a diode, and the output is composite video plus the FM sound carrier. Notice that the capacitance variation between stylus and conductive disc is not used *directly* to recover the original video/sound modulations.

### CED videodisc caddy

CED videodiscs are more susceptible than laserdiscs to signal interruptions from dust, dirt and etching from skin oils on the disc's surface. In laserdiscs, the spirals of pits are not on the surface (as the CED grooves are), but are under a plastic coating. Also, the beam is focused on the pits, so any dirt on the outside surface is out-of-focus.

Therefore, RCA developed an ingenious videodisc caddy that contains the disc at all times, except when the disc is played. Inside the caddy (that resembles a conventional audio-record jacket) is the videodisc nestled in a plastic framework that RCA calls a *spine*.

When a videodisc is to be played, the caddy (with its spine and videodisc) is inserted into the machine until the spine latches onto the machine. At the same time, the friction locks that hold the spine tight in the caddy are released, allowing the caddy to be withdrawn but leaving the spine and videodisc inside. Notice that *the videodisc is not handled at any time*.

A chain of actions occurs during and after this caddy insertion. The turntable has been lowered, making

room for the caddy, and the inserted caddy moves the arm mechanism to the rear. During this time the stylus has been retracted. After the caddy is withdrawn, the turntable begins to revolve and rises until it lifts the videodisc off the spine. Then the stylus is lowered to the disc surface and the playing begins. Two LEDs on the front panel indicate whether Side 1 or Side 2 is playing.

Of course, the previous sequence of events has been greatly condensed. The manufacturer's manual

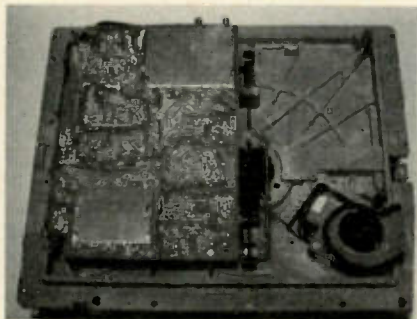

A bottom view of the RCA SFT-100 without the covers shows little except the large PW3000 circuit board on the left, the long antenna-switching rod in the center and the motor at the lower right.

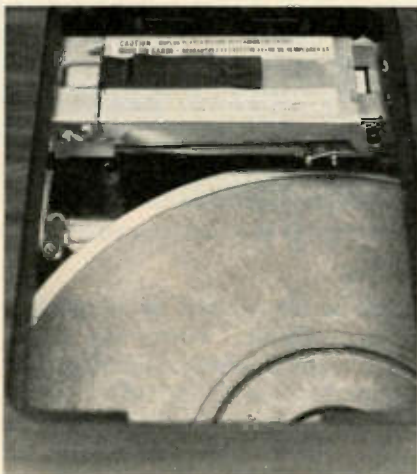

When the access hatch is opened in the SFT-100 videodisc player, part of the turntable can be seen (below), along with a section of the arm assembly with a catch on the door that is opened to replace the stylus assembly.

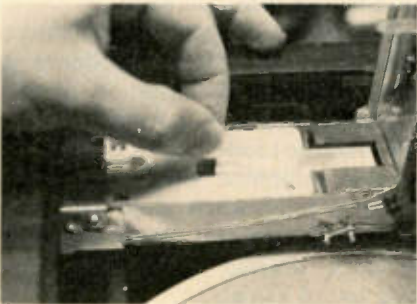

To replace the CED stylus assembly, open the access hatch, unsnap the lid catch on the arm assembly, grasp the tab on the stylus cartridge and lift straight up, as shown here.

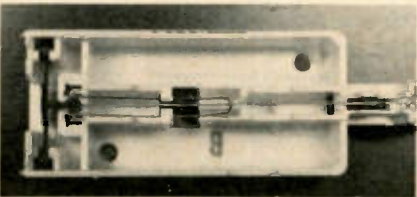

This is a close-up photograph of a CED stylus cartridge, with connection to the armstretcher on the left, and the stylus and flylead at the right end.

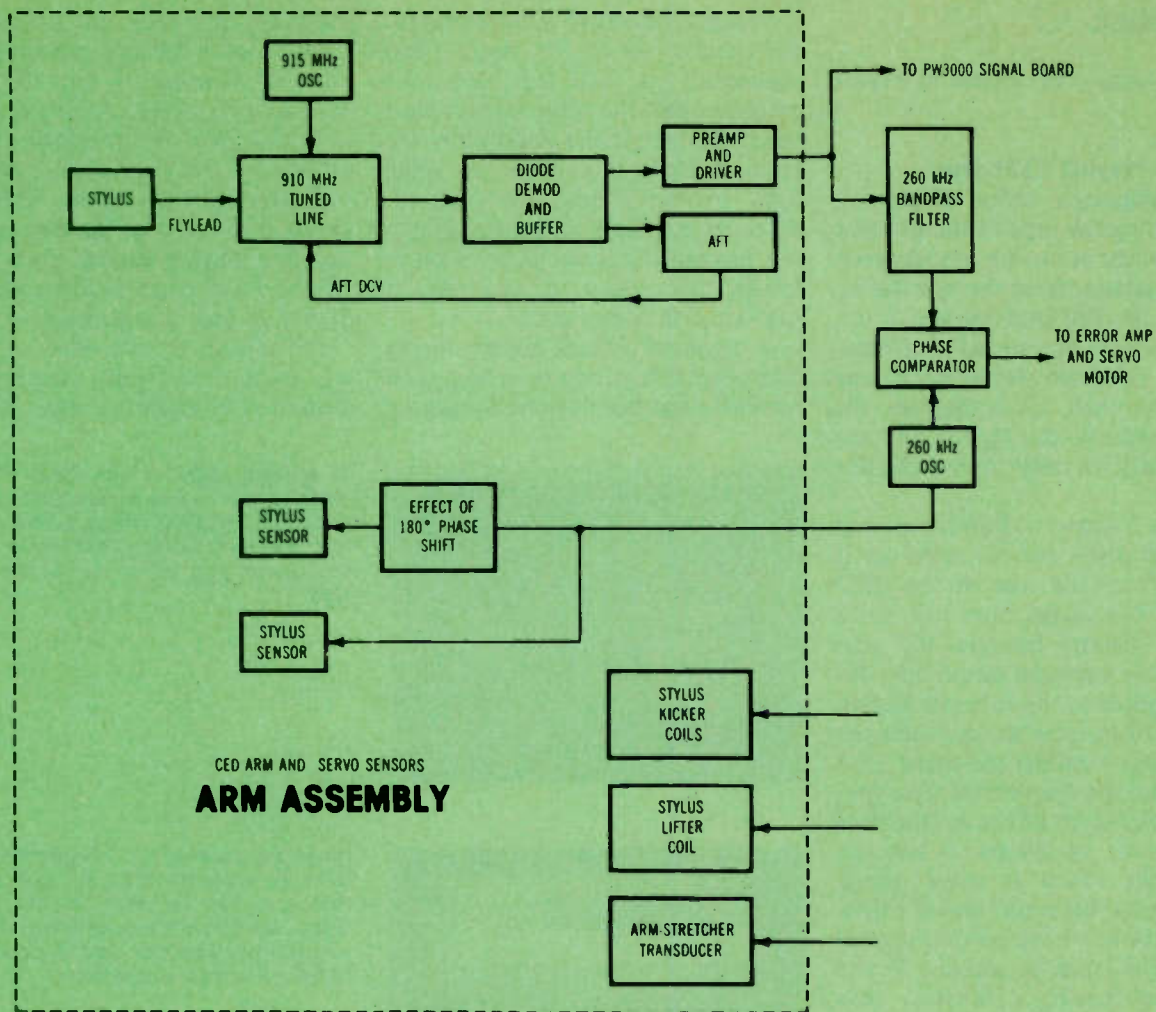

**Figure 6** The circuit elements on the left (inside the dotted lines) are located on the arm assembly, while those on the right are on the PW900 preamp board.

should be studied thoroughly before any repairs or adjustments are made.

#### Stylus and arm

The Figure 6 block diagram shows several simplified arm and stylus functions. The stylus electrode is one plate of a capacitor, and the disc surface is the other, while *the undulations vary the spacing between the plates, thus giving variable capacitance*. This varying capacitance is transferred by the flylead to electronic circuits in the arm. Four tuned lines are there; two are used by the 915MHz oscillator, one supplies signal to a diode video detector that gives amplitude demodulation and one tuned line (between two others) is connected to the flylead and the varying capacitance coming from the stylus.

Total capacitance of the stylus and the AFT varactor diode resonate the one tuned line to 910MHz. Therefore, a moderate amount of the 915MHz oscillator

signal is transferred to the video-detector diode. When the stylus capacitance increases, the tuned line might resonate to 905MHz, reducing the detector signal. Or when the stylus capacitance decreases, the tuned line could resonate to 915MHz, thus a stronger signal reaches the video detector.

Therefore, this capacitance change at the stylus produces a similar amplitude variation of the 915MHz signal at the diode detector, and the diode output is a replica of the combined video and audio FM carriers, when then are processed, filtered and demodulated to produce normal composite video and sound signals.

AFT operates on the variable-capacitance tuned line to maintain the resonant point at the frequency that provides best linearity.

An important point should be made here. *Any* capacitance variation applied to the stylus electrode or to the connecting flylead also will produce an amplitude change at the

diode-detector output. This principle is used to control the servo mechanism that moves the arm system so the stylus remains perfectly centered between two sensor-signal transmitters (varactor diodes).

The arm also includes two varactor diodes mounted near both sides of the flylead. Of course, varactor diodes change internal capacitance according to the amount of reverse voltage across them. Therefore, equal amounts of 260kHz signal are applied to these varactor diodes, which have their polarities reversed by grounding (for ac signal) the anode of one and the cathode of the other. An increase of signal increases the capacitance to ground of one diode and decreases the capacitance to ground of the other. This is the equivalent of operating them with reversed (180°) phase.

Now, when the stylus is perfectly centered between these varactor sensors, the increased capacitance at one side is canceled by an equal decrease of capacitance on the other

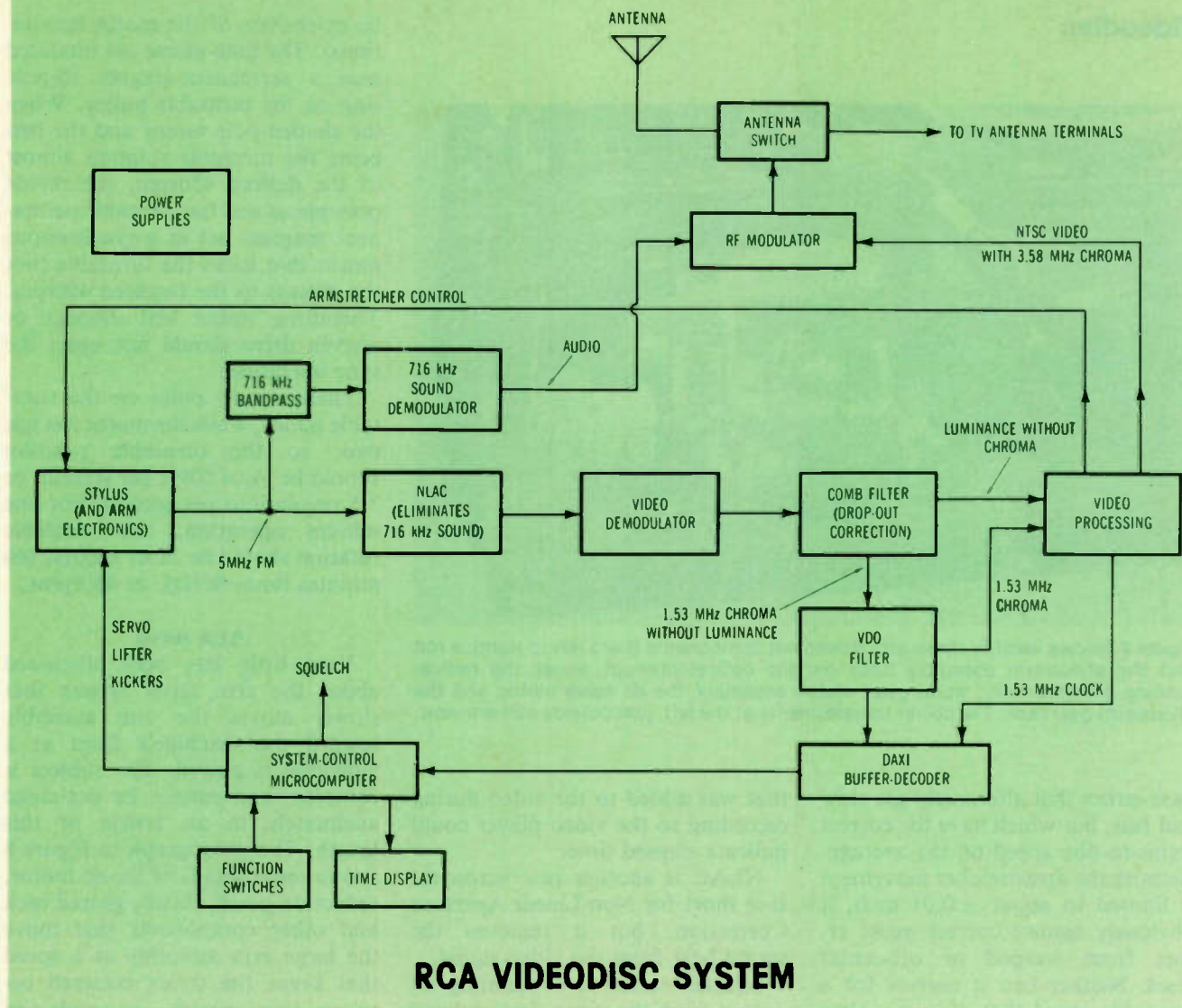

## RCA VIDEODISC SYSTEM

Figure 7 These blocks show (in highly condensed form) the operation of model SFT-100 RCA videodisc.

side. Therefore, the capacitance change picked up by the stylus is not modified; no 260kHz capacitance variation is added to the signal, and no arm movement is needed.

On the other hand, if the groove pressure moves the stylus off center of the varactor diodes, the cancellation of 260kHz capacitance change is unbalanced, and a capacitance variation at a repetition rate of 260kHz is added to the stylus capacitance signal. *The phase of this unbalance is determined by the direction the stylus is away from true center.* After amplitude demodulation by the diode, this capacitance variation is changed to a 260kHz waveform that is mixed with the video-audio FM signals.

A phase-comparator circuit compares the phase of the 260kHz oscillator (that supplied the varactor diodes) against the phase of the 260kHz waveform obtained from the video-audio FM signals. An

error-correction dc voltage from the comparator determines when the arm-servo motor shall run clockwise or counter-clockwise to center the stylus between the varactor diodes.

Other components on the arm assembly are the stylus-kicker coils and the armstretcher transducer. The stylus-kicker coils are energized to move the stylus to another groove if an arm defect or a defective videodisc causes a continuous repeat of one groove. Also, they are used to move the stylus during rapid-access forward or rapid-access reverse. Each activation of a kicker coil moves the stylus two grooves.

Although RCA does not refer to it that way, an armstretcher is a rapid-acting servo that moves the stylus rapidly along the groove when errors occur between disc rotation and the recorded video or chroma signals. Its function is similar to that of a tangential servo in a laserdisc player. Without an armstretcher,

the symptoms might be horizontal instability or erratic complete loss of color. An armstretcher corrects time-base errors between 1Hz and 300Hz.

### Overall SFT-100 operation

The block diagram in Figure 7 shows the general functions and interconnections of the RCA SFT-100 videodisc player. Many of the functions are evident without further comments. However, the diagram does not reveal much about time-base correction or how the 1.53MHz chroma becomes 3.58MHz chroma before it is recombined with the luminance.

Actually, there is a direct connection between those two subjects. Broadly speaking, low frequency (slow) time-base errors are corrected by the armstretcher, which physically moves the stylus forward or backward in the groove. This is effective in canceling low frequency time-

## Videodisc

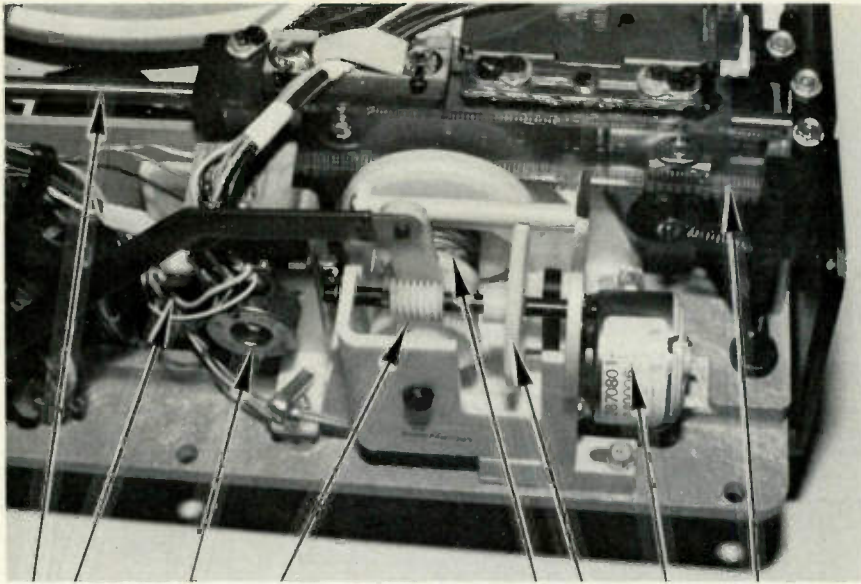

**Figure 8** Arrows identify these arm movement components (from left to right): a dc servo motor; the stylus-arm assembly; the radius-sensing potentiometer; worm gear; clutch assembly; the optical-interrupt wheel; and the stylus-arm gear rack. The power transformer is at the left, just outside camera view.

base errors that alternately are slow and fast, but which have the correct stylus-to-disc speed on the average. Because the armstretcher movement is limited to about  $\pm 0.01$  inch, it obviously cannot correct gross errors from warped or off-center discs. Neither can it correct for a turntable speed that *always* is slow or fast, because the armstretcher is not designed to follow the turntable in a circular motion.

Rapid time-base errors that affect mainly chrominance, are corrected in the up-converting of the chroma from 1.53MHz to NTSC 3.58MHz. This is accomplished by comparing the phase of a local crystal-controlled 3.58MHz oscillator with the phase of the up-converted 3.58MHz chroma. The error dc voltage from this phase detector controls the phase of the 5.11MHz VCXO oscillator that up-converts the chroma from 1.53MHz to normal 3.58MHz. Therefore, rapid phase changes in the disc chroma is canceled.

Both of these time-base corrections come from the same general circuit, but with filters and other design features to channel slow corrections to the armstretcher and fast corrections to the 5.11MHz VCXO oscillator.

Another mystery is the meaning of the acronym DAXI. This comes from Digital Auxiliary Information

that was added to the video during recording so the video player could indicate elapsed time.

NLAC is another new acronym. It is short for Non-Linear Aperture Correction, but it removes the sound beat from the video signal.

Squelch refers to eliminating all output from the video demodulator during load/unload, rapid-access forward, rapid-access reverse and pause functions. This prevents any snow, noise or flashes from appearing on the monitoring TV screen at these times.

Perhaps the simplest section of the SFT-100 videodisc player is the turntable drive. An ingenious method provides the functions of a shaded-pole motor plus a synchronous motor that locks the turntable rotation to the 60Hz line frequency. It also allows the use of belt drive between motor and turntable; an arrangement that—used without the unique feature—is not likely to provide stability.

The motor is a 2-pole shaded-pole 120Vac type that normally runs at about 3400 to 3500rpms (slightly less than synchronous speed). An elastic silicon-rubber belt between the motor pulley and the turntable pulley rotates the turntable at *approximately* 450rpm.

However, the motor also has two magnetic pole-pieces (that appear to

be extensions of the motor laminations). The pole-pieces are mounted near a permanent-magnet 16-pole ring on the turntable pulley. When the shaded-pole motor and the belt bring the turntable rotation almost to the desired 450rpm, the motor pole-pieces and the turntable permanent magnets act as a synchronous motor that locks the turntable (not the motor) to the required 450rpm. Therefore, minor belt slippage or uneven drive should not upset the sync operation.

There are 16 poles on the turntable pulley, while the motor has but two, so the turntable rotation should be  $\frac{1}{8}$  of 60Hz per second, or 7.5 revolutions per second. For one minute operation, the turntable rotation should be  $\frac{1}{8}$  of 3600Hz (60 minutes times 60Hz), or 450rpms.

### Arm servo

Very little has been discussed about the arm servo system that slowly moves the arm assembly toward the machine's front as a videodisc is played. The subject is complex, and cannot be explained adequately in an article of this length. The photograph in Figure 8 shows some details of the dc motor, reduction gears, clutch, geared rack and other components that move the large arm assembly at a speed that keeps the stylus centered between two sensors, as explained before.

A microcomputer integrated circuit on the PW500 control board controls the arm servo and many other mechanical systems.

### Comments

Before a technician makes any repairs or performs any adjustments on the RCA SFT-100 videodisc player, it is strongly recommended that all available literature is studied about this model or a seminar is attended. The electronic circuits and mechanical systems appear to be about as complex as those in videocassette tape recorders. Both are more complex than a color TV receiver.

Reports from the field indicate that most problems (at present) are caused by *improper operation* of these videodisc players. They should not be operated by children without supervision.

Refer to the Sycures this month for several typical problems and cures that have been reported. □

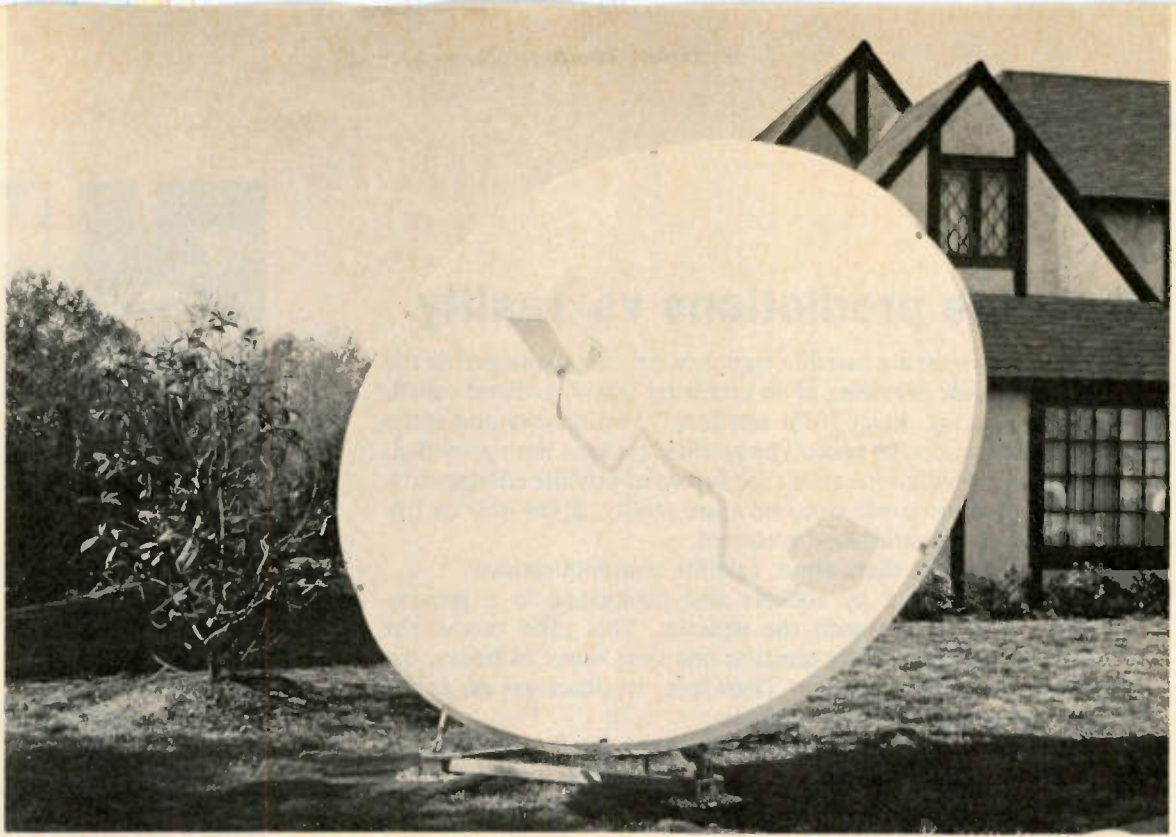

# Heathkit Satellite Earth Station

By Carl Babcoke, CET

For decades, Heath of Benton Harbor has been a well-known name in the marketing of electronics kits. But the latest Heath kit tops all previous ones in price and sheer size. It is a satellite-TV receiving system called the Heathkit Earth Station.

Reception of TV programs relayed through a satellite system became a reality in November 1975, when three programs were available for use by a cable TV company. Now there are 12 satellites in geosynchronous orbit over the equator at 22,300 miles from the earth.

That is phenomenal growth, reflecting the huge demand for relay of signals over these expensive satellites. Most satellites can handle up to 24 channels; not all channels, however, carry TV signals. Some are used for telephone relays and other communications. The demand for satellite channels exceeds the supply, with some present owners of channel rights being offered a large profit to sell.

Transporting TV programs over satellite channels has several impor-

tant advantages: As the distance from earth-to-satellite-to-earth is about the same for all parts of America; the pictures usually are sharper and with reduced snow compared to other relay systems; the reception is more reliable because bad weather and time of day have little effect on the satellite signals; and many more channels can be obtained, typically 24 per satellite. Of course, only one satellite can be used without readjustment of the receiving antenna.

Many individual TV stations and CATV systems have their own satellite-receiving antenna and apparently are satisfied by the quality of signals obtained. The catch is the total cost of the earth station.

## Individual installations

The prospect of a multitude of channels providing excellent picture quality with imperceptible snow has appealed to many individuals. Some have written **Electronic Servicing** asking for construction details. Before this year, however, most satellite components for individual use were viewed as little more than experimental, with flimsy construction and borderline performance.

Also many legal questions about bootlegging of satellite signals in-

tended for others had not been settled. At this time, the FCC has an almost hands-off policy, but some operators of satellite channels apparently intend to charge individuals for use of their signals.

## Heathkit earth station

Sections of the Heath Earth Station kit are factory assembled; others are only partially preassembled. Heath estimates construction of the antenna system will require three persons for one day, after the concrete foundations are completed. Assembly of the satellite-receiver kit should require about 20 to 30 hours by one person. The remote unit is completely assembled. No special tools are required.

These three major components are supplied by Heath:

- A 3-meter parabolic "dish" antenna from Scientific-Atlanta Inc. has six aluminum reflector panels that are precision die-stamped (Figure 1). An optional extender kit can increase the diameter to 12 feet, if additional signal is needed in some localities. Adjustment of only one strut is required for reorientation to another satellite. Gain of the antenna is rated at 39.5dB for the 10-foot size, or 40.5dB for the extended version. The antenna should remain

## Satellite predictions vs. reality

The basics of receiving satellite signals were first explained in the July 1973 *Electronic Servicing* in an article by David A. Ferré called, "Home TV reception direct from satellites." Frequencies and other technical specifications of prototype satellite systems were provided, along with some predictions about the future of satellite communications. Many of those predictions now are reality, a few will be fulfilled in time, and several were incorrect.

Briefly, here are the facts about satellite communications:

- A satellite is sent up by rockets and positioned in a geosynchronous orbit in line with the equator. This orbit moves the satellite around the world's position one time every 24 hours, the same time as earth's rotation. Therefore, to observers on earth, the satellite appears to be motionless.
- A transmitter on earth beams a signal to the satellite (uplink).
- Equipment on the satellite receives and amplifies uplink signal, converts it to another frequency and transmits it down to another point on earth (downlink).
- At the earth system, the weak signal is received by an antenna of huge gain. It is down-converted to a lower frequency and sent to a special satellite receiver. Output of the special receiver is sent to a conventional TV receiver, broadcast station, cable system or other user.

**Then and now**—If details and frequencies are omitted, block diagrams of both 1974 and 1981 satellite uplink and downlink systems are identical. Many specifics, however, are different.

In 1974, the frequencies were in the 3GHz section of the "S" band, usually requiring a 30-foot antenna. Operation in the 12GHz Ku band was expected in the future, thus allowing comparable results with a 3-foot antenna. The Heathkit in 1981 receives 3.7GHz to 4.2GHz signals with a 10-foot antenna.

In 1974, a maser amplifier was recommended. It must be cooled to about 1°K by liquid helium. Some systems today operate with a GaAs FET amplifier.

The prediction that one first use for satellites would be supplying cable TV systems came true in 1975 when three cable channels became available. Another prediction, that cable systems would eventually be free for the viewer and supported by advertising, has not yet happened. The thought that eventually local TV stations would be eliminated, with satellite feed of cable systems supplying most viewers, has also not occurred. On target was the prediction that many individuals would install their own downlink systems and enjoy superior TV quality. That is happening now.

"Satellite TV update" by David Ferré appeared in the August 1976 issue of *Electronic Servicing*. It told of \$500 earth terminals by Toshiba for the Japanese 12GHz satellite to be launched in 1977. In India, \$1000 earth terminals daily receive TV programs from the ATS-F satellite. Another news item told of Satellite Business Systems proposal to launch an *all-digital* satellite in 1979.

Satellite services still are in the early stages, and many changes will occur over the years. Many cable companies and individual TV stations now have earth terminals for non-local programs. There is no indication of saturation in new technical developments or applications for satellite services. □

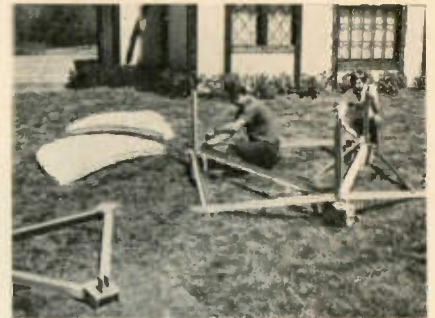
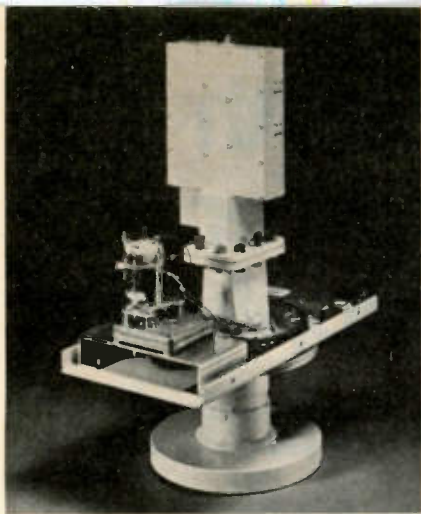

Figure 1 Installation of the antenna for the Heathkit Earth Station begins with the construction of three concrete piers for the steel foundation. The panels are then bolted together to form a parabolic dish that is mounted to the framework. The LNC electronic unit and its lines are mounted, and the entire assembly is tilted up and oriented to receive the desired satellite signals.





**Figure 2** The rotatable microwave feed assembly and electronic components of the Heathkit LNC are shown here after removal of the housing. This assembly is placed at the focal point of the parabolic reflector to receive the signal. Output IF signal (in the UHF band) goes through coaxial cable to the receiver.



**Figure 3** The Heathkit Satellite Receiver is an attractive unit that can be placed on top of most TV receivers. Output of the Satellite Receiver goes to the antenna terminals of a standard TV receiver. The unit is larger than some videocassette tape recorders, and features many new technical conveniences such as direct-access electronic tuning with remote control.

operational with winds up to 60 MPH, with survival to 90 MPH.

- An antenna-mounted, low noise amplifier/down-converter (LNC in Figure 2) provides gain of 53dB to 59dB while giving a 270MHz-770MHz (television UHF band) intermediate-frequency output that is sent through 150 feet of coaxial cable to the satellite receiver. Dc power from the receive is required. Input signal from the parabolic antenna has a frequency range between 3.7GHz and 4.2GHz at a level from -75dB to -90dB. An internal geared motor automatically rotates the antenna feed assembly to select either vertical or horizontal polarization. The 120K (1.5dB) low-noise amplifier has a GaAs FET transistor.

- The satellite-TV receiver kit (Figure 3) has a Scientific-Atlanta UHF receiver section, Heath electronics, and a Zenith Space-Command wireless remote control to provide 24-channel synthesized electronic tuning. A memory allows instant switching between any two preselected channels. A keypad on the receiver panel allows direct access, as does the remote unit.

#### Satellite system prices

In 1974, a prototype system with a 30-foot antenna might have been priced in the \$90,000 bracket. By mid-1976, a proven system for CATV use, also with a 30-foot parabolic antenna, cost about

\$65,000. Professional systems continue to sell for high prices, but antenna-converter packages now are offered to individuals at prices from \$5000 to \$12,000.

When compared to this range of prices, the Heathkit at \$6995 appears to be a reasonable compromise between price and performance. Although no test results are available at this time, the specifications indicate good performance. Certainly, the equipment appearance is excellent.

#### Heath survey kit

A few locations are not suitable for satellite reception because of mountains, trees, buildings and other obstructions. Therefore, Heath offers a site-survey kit to help potential buyers determine if the proposed antenna site is adequate.

The survey package includes a kit for construction of a simple inclinometer, a compass, 40-page site-selection manual, a sample programming guide, a full-color descriptive booklet, and ordering information for the satellite system.

Although the survey package costs \$30, the price is credited if a Heathkit Earth Station is purchased.

#### Earth station availability

Heathkit Earth Stations are expected to be listed in the Fall 1981 Heath catalog and available at all Heath regional stores. □

## APPLIANCE REPAIR BOOKS



Thirteen Handbooks written in easy-to-understand language by experts in the service field with illustrations and diagrams! Acclaimed by instructors and professionals alike! How to diagnose and repair air conditioners, refrigerators, washers, dryers, ranges, microwave ovens, dishwashers, vacuum cleaners, electrostatic air cleaners, RV gas appliances, hair dryers, motors, water heaters, coffeemakers, can openers, floor polishers, steam irons, food mixers, lawn care appliances, electric knives, electric and digital clocks and many others. Also fundamentals of solid state, setting up a shop, using test instruments and more. Only \$2.65 to \$4.90 ea.

SEND FOR FREE PRICE LIST

Gamit, Dept. ES

110 W. St. Charles Road,  
Lombard, Illinois 60148

Circle (6) on Reply Card

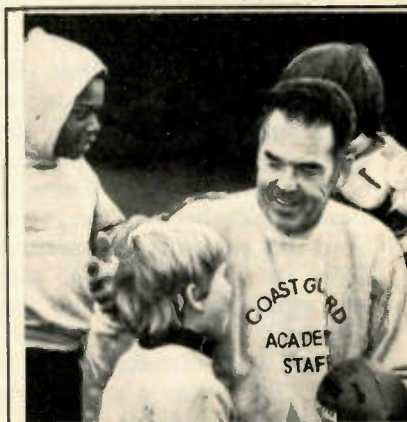

## OTTO GRAHAM HAS MADE A COMEBACK.

Otto Graham, one of football's greatest quarterbacks, has made a successful comeback: from colorectal cancer. He and almost 2 million others are living proof your contributions count.

**CANCER CAN BE BEAT.**

American  
Cancer Society 

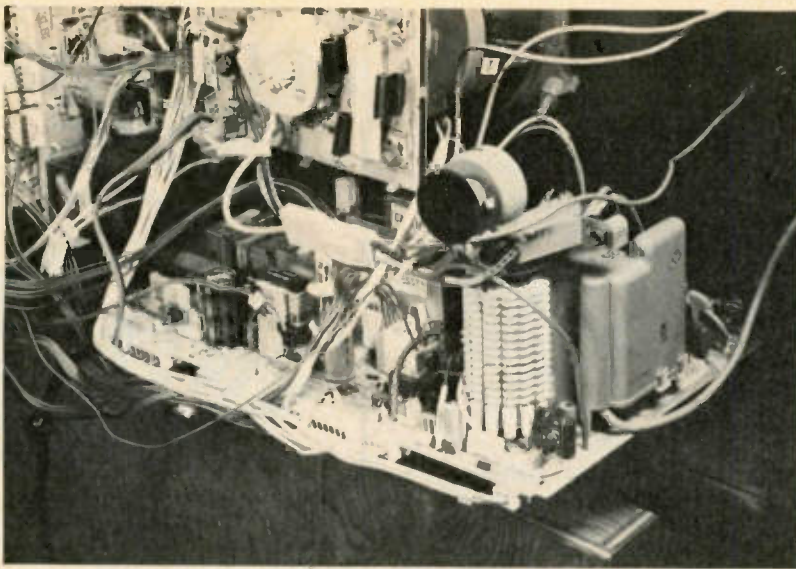

**Figure 1** Power-on tests are possible in the M10 Zenith module when the cable connectors are removed, the module is unfastened and removed from the framework, placed on the framework, and the cable connectors reattached, as shown.

# Zenith power supply and horizontal sweep, part 2

By Carl Babcoke, CET

Many waveforms and simplified diagrams explain the unique diode-switched sweep regulation in the Zenith horizontal-deflection system on the M10 module. This is the last part of the Zenith series; it contains valuable information for all television technicians, regardless of the brands they service.

In Zenith System-3 color receivers, the M10 module (Figure 1) performs these two basic functions: supplying dc power to the entire receiver, and producing horizontal deflection. There is no clear division between the two functions. As explained in previous articles, only two dc-voltage supplies are operated from line power (Figure 2). One is the *hot* 150V supply for the horizontal-output transistor. The other is a *cold* ground 15V supply used for start-up and other tasks. Neither supply is regulated; the voltage varies up and down with line-voltage and load changes.

All other dc power is obtained by rectification of pulses from the horizontal-output transformer, and these supplies have *cold* grounds.

Regulation of the horizontal sweep and high-voltage signals in other brands of large-screen color receivers is accomplished by voltage regulation of the dc supply to the output transistor collector. Zenith System-3 receivers regulate width, high voltage and all low-voltage supplies by a sophisticated circuit that varies the output transistor's

collector-current duty cycle, accompanied by diode switching.

## Hot and cold grounds

As shown in the Figure-2 block diagram, two separate grounds are used. One is called a *hot* ground (triangle symbol in these schematics) because it is a ground (actually the negative return bus) for the +150V *hot* supply produced by bridge-diode rectification of line voltage, and it is *hot* to both sides of the ac line (including earth ground). With a digital multimeter ground lead

connected to this *hot* ground, a reading of +75Vdc and 64VRMSac can be obtained to one side of the ac line. Also, a reading of +75Vdc and 56VRMSac is measured to the other side of the incoming ac line. Clearly, this ground is *hot* to almost everything. Therefore, great care must be used when connecting it to instruments that have their power plug's third prong connected to the metal cases. Also, to avoid painful and dangerous shocks, technicians never should touch the *hot* ground.

The second ground circuit, represented by the conventional

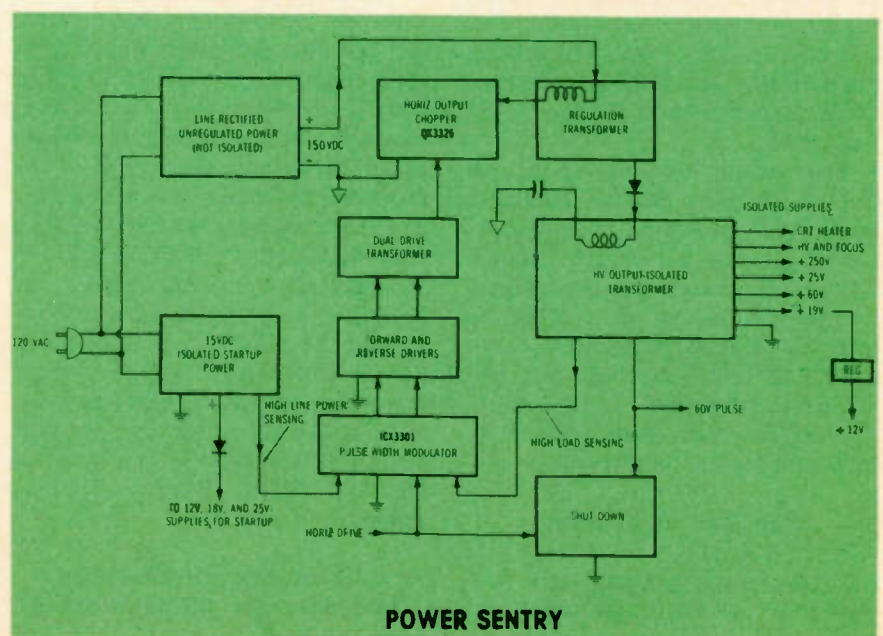

**Figure 2** Basic functions of the M10 module and the separation of *hot* and *cold* grounds are shown by this block diagram.

ground symbol, is called a *cold* ground because it is not connected to the line voltage or to the cable input ground on the tuner. Thus it can be safely connected to grounded antenna leads and test instruments.

The TX3352 HV transformer/flyback in Figure 2 acts as an isolation transformer that separates the *hot* supply at its primary winding from the *cold* ground and the low-voltage supplies produced by rectification of horizontal pulses from the secondary windings.

Notice that the *cold* title applies only to the ground. For example, the high voltage returns to *cold* ground, but the *hot* 25kV is not *cold*. The same remark applies to the other dc voltages, such as focus voltage, +250V for the color-output transistors, and the low-voltage +60V, +25V and +18V supplies.

Other blocks in Figure 2 show the relationships between the pulse-width modulator, two driver transistors, a horizontal-output transistor (used also as the power chopper), the regulation transformer and the HV transformer.

Arrows and call-outs in Figure 3 show locations of important components on the M10 module.

### Corrections

Corrections and explanations must be made for two inflated readings from previous articles about System-3. In the September issue, a voltage of +160V was shown for the *hot* non-isolated line-rectified supply, while +16V was reported for the *cold* start-up voltage. These are correct only for a line voltage of about 125V RMS. Because isolation transformers flatten the tips of the line-voltage sine waves, most of our lab tests are made when the instruments are powered directly from the ac line. Great care is used during these tests to prevent shocks or equipment damage. Measurement errors can approach 10%, depending on the type of ac-converter in the meter used to measure the receiver's line voltage.

Unfortunately, the line voltage was higher than normal during these preliminary tests. With an unclipped line voltage of 120V RMS, the *hot* supply measured about +150V, and the start-up supply measured about +15.4V.

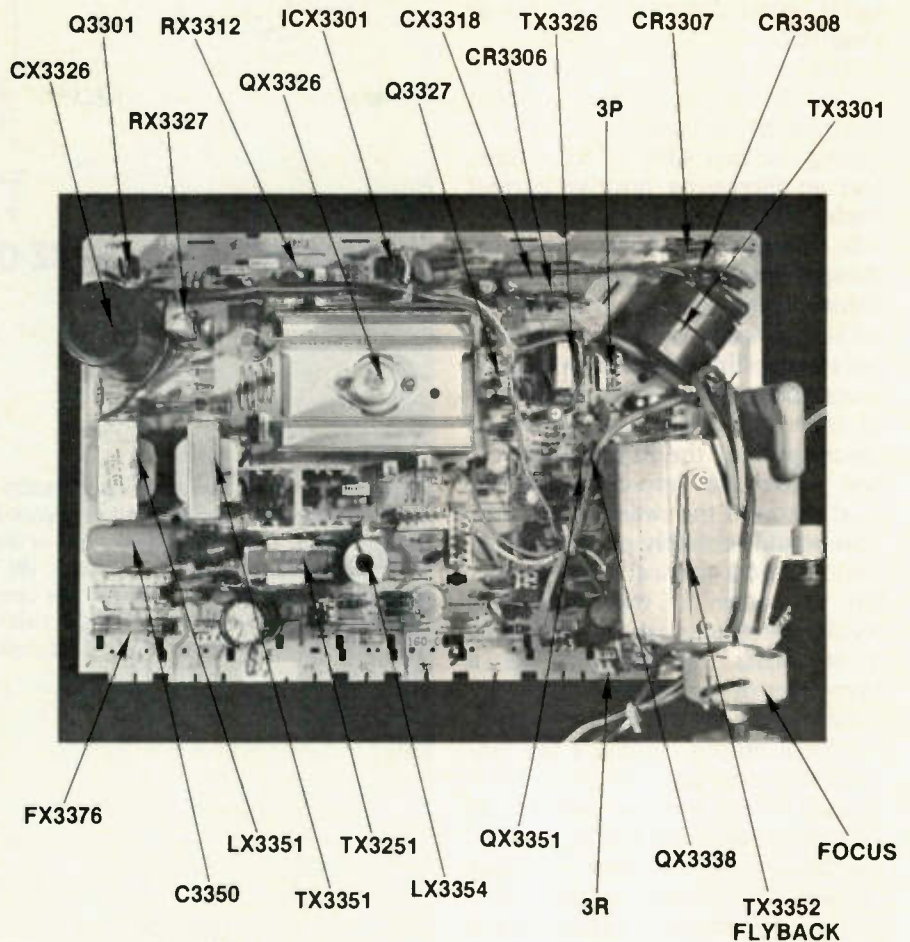

Figure 3 Arrows point to many important components on the Zenith M10 module.

### Basis of Zenith regulation

Basically, the Zenith Power Sentry voltage-regulation system operates by this electronic truth: Increased amplitude of horizontal-sweep pulses can be obtained by a longer duty cycle for the output-transistor collector current. In other words, more sweep power is obtained when the output transistor current flows for a longer time during each horizontal cycle. Conversely, shortening the duty cycle decreases the sweep power and the pulse amplitude.

Therefore, regulation of pulse amplitude and horizontal deflection can be automatically accomplished by a circuit that varies the output transistor's duty cycle.

Unfortunately, it is not that simple to design a practical circuit that provides effective regulation without introducing serious non-linearity problems. The most serious problem is that the horizontal yoke in conventional solid-state sweep circuits (Figure 4A) already is constantly supplied with current during both trace and retrace times. Where

## Power supply

can a longer conduction current be inserted?

The Figure 4A conventional horizontal-output stage supplies negative damper current to the yoke during the first 45% of trace time, and an increasing positive current during the last 55% of trace time. The transition from negative damper current to positive transistor current must occur smoothly, without overlap or gap, to prevent poor sweep linearity. Extending the transistor conduction to about 70% of trace time, for example, would cancel part of the negative current and move the zero-current point (real center of the sweep) to the left. This would probably produce either foldover or a vertical white line at left of center in the raster. No regulation system can be acceptable if it varies the linearity as a byproduct of the regulation.

Before leaving the Figure 4A conventional output circuit, a few important facts need to be emphasized. There is just one path for dc current to reach the horizontal-output collector—from the B+ supply through the primary of the high-voltage transformer (often called "flyback") to the collector. Notice the four paths to ground: collector-to-emitter through the transistor; through the damper diode; through the tuning capacitors; and through the yoke with its series capacitor. Therefore, it follows that appreciable current through any one of those four paths reduces the full B+ at the collector to an extremely low voltage.

During the second half of trace time, the transistor draws an increasing current, and the collector-to-ground dc voltage is about 1V. When the transistor's base signal waveform suddenly goes to zero, the transistor becomes open, and the collector current instantly stops.

Strong current has been flowing through the flyback winding, and through the yoke from the voltage previously stored in its series capacitor. The collapsing magnetic fields attempt to keep the current flowing in the same direction. But the transistor is open, and the damper diode is reverse biased, so it too is open. The only path is into the tuning capacitors, and the incoming "positive" current triggers a reso-

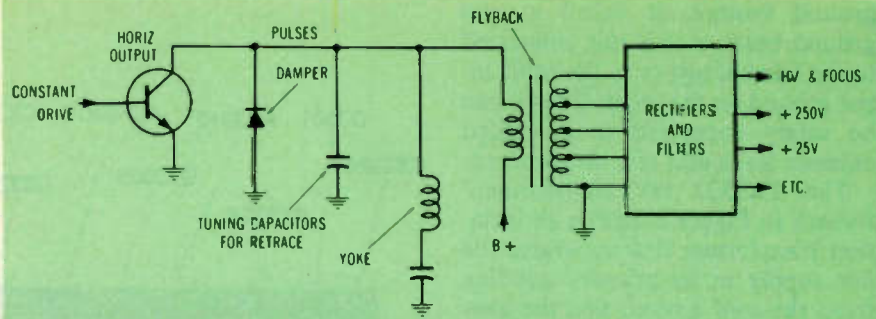

### CONVENTIONAL HORIZ OUTPUT

A

Figure 4 Conventional and Power Sentry horizontal-output stages are contrasted by these schematics. (A) With conventional transistorized horizontal-output systems, the collector/emitter path of the transistor parallels the damper, retrace tuning capacitors, yoke and flyback. (B) The Zenith circuit allows regulation of the pulse amplitude by variations of the output-transistor duty cycle. A regulation transformer (TX3301), however, and two switching diodes (CR3306 and CR3308) are required to separate the QX3326 collector current and the CR3307 damper-diode current.

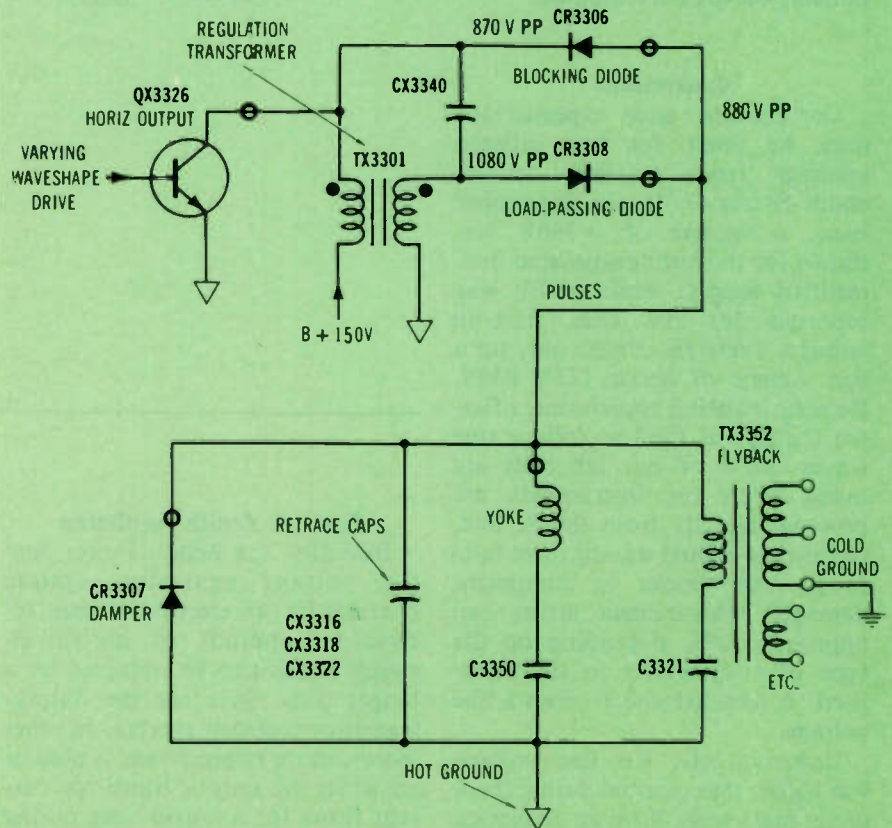

### ZENITH POWER SUPPLY

B

# GET THE CORNERS WITH **TUBE-R-ASER**

Color Picture Tube Degausser

by **T A B E R**

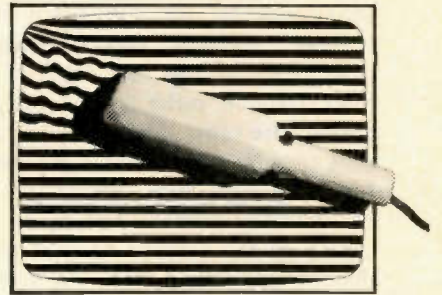

8" deep penetration design  
Purifies the corners where  
others fail

Fits in your tool box

TABER Mfg. and Engr. Co. **\$49<sup>95</sup>**  
2081 Edison Avenue  
San Leandro, CA 94577  
(415) 635-3831

Circle (7) on Reply Card



When you need to fill a position,  
you'll have a qualified graduate  
that you helped educate.

**GIVE TO THE  
UNITED NEGRO COLLEGE FUND.  
A MIND IS A TERRIBLE THING  
TO WASTE.**

Photographer: Dwight Carter  
A Public Service of This Magazine &  
The Advertising Council  
© 1981 United Negro College Fund, Inc.

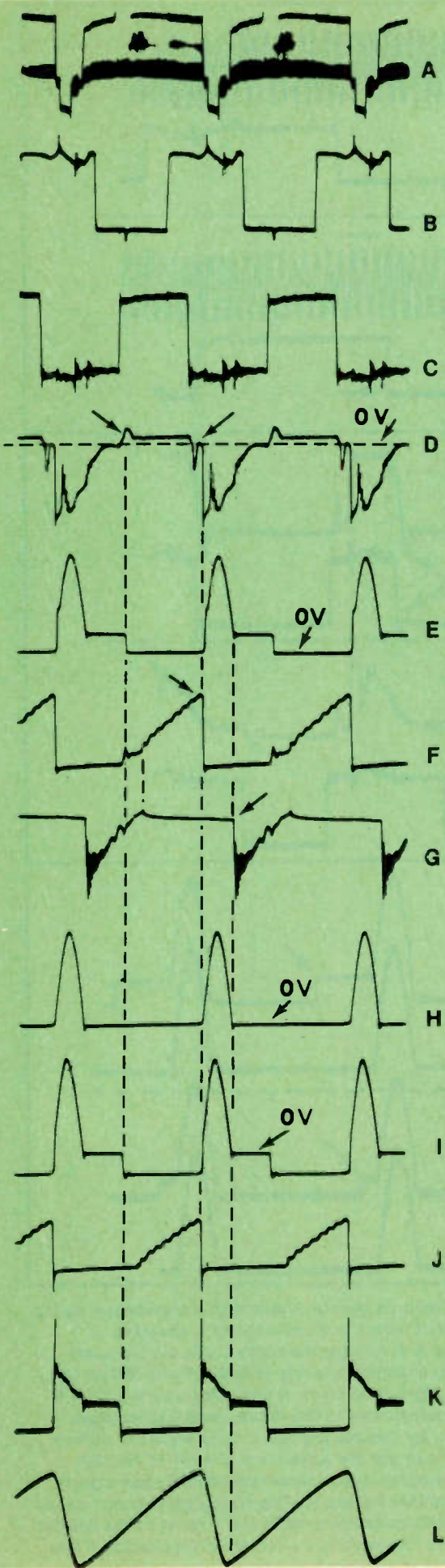

**Figure 5** These Zenith sweep waveforms have been photographed and carefully positioned to preserve identical phase relationships, although the heights do not indicate relative amplitudes. The three long, vertical dotted lines mark the beginning of QX3326 conduction (left line), the ending of QX3326 conduction (center line) which starts retrace, and the end of retrace (right dotted line). These are the scope traces: (A) composite video for reference; (B) horizontal drive from the M2 module; (C) base signal of Q3301 driver transistor; and (D) the QX3326 base-drive signal. The horizontal dotted line marks zero volts; (E) the QX3326 collector-voltage signal (also the CR3306 cathode waveform), with zero volts at the base line; (F) the sawtooth QX3326 collector current; (G) CR3307 damper-diode current, placed near the collector current, because both deflect the CRT beam; (H) the yoke and flyback pulses at CR3306 anode and CR3308 cathode; (I) waveform from TX3301 to the anode of CR3308. Notice that zero voltage (also average voltage) is at the step; (J) CR3306 diode current; (K) CR3308 diode current (small amount); and (L) horizontal deflection-yoke current. For clarity, the nearly invisible vertical lines of several waveforms have been enhanced.

## Power supply

nant action (called ringing) between the yoke and the total tuning capacitance. Refer to pages 26 and 27 in the January 1976 issue of *Electronic Servicing* for an illustrated explanation.

Currents through the yoke and flyback charge the retrace-tuning capacitors to an extremely high voltage, perhaps 1000V peak-to-peak. This is the first half of the huge flyback pulse at the output. During the same time, the yoke current rapidly moves the CRT beam from the right edge, where the end of collector current left it, to the center of the screen. At that point the current is zero, while the voltage pulse is maximum.

Next the tuning capacitor voltage begins to force current through the yoke and the flyback winding in a reverse (negative) direction, which moves the CRT beam from the center to the left edge of the screen. At this point (end of the flyback pulse's second half), the current is maximum negative and the voltage is zero. Two quarter-cycles of ringing have occurred, and the ringing action naturally attempts to continue, with the capacitance and the yoke inductance alternately acting as voltage and current sources to force positive and negative current through the yoke until losses eliminate the ringing.

The circuit, however, has an automatic brake to stop this retrace ringing. When the current reverses and the voltage attempts to become negative, the damper diode is forward biased, and it clips what otherwise would have been a huge negative-going pulse. Energy from the clipping produces maximum *negative* yoke current, which slowly decreases as the energy dissipates. This yoke current moves the CRT beam from the left edge to the center of the screen, where the current has dwindled to zero. That is where the transistor *positive* yoke and flyback current begins to increase slowly, starting another cycle.

One important point might have been missed in the many details: Only during retrace time does the transistor collector and damper cathode have more than about  $\pm 1V$ . When the transistor conducts the dc voltage at the collector, it is about

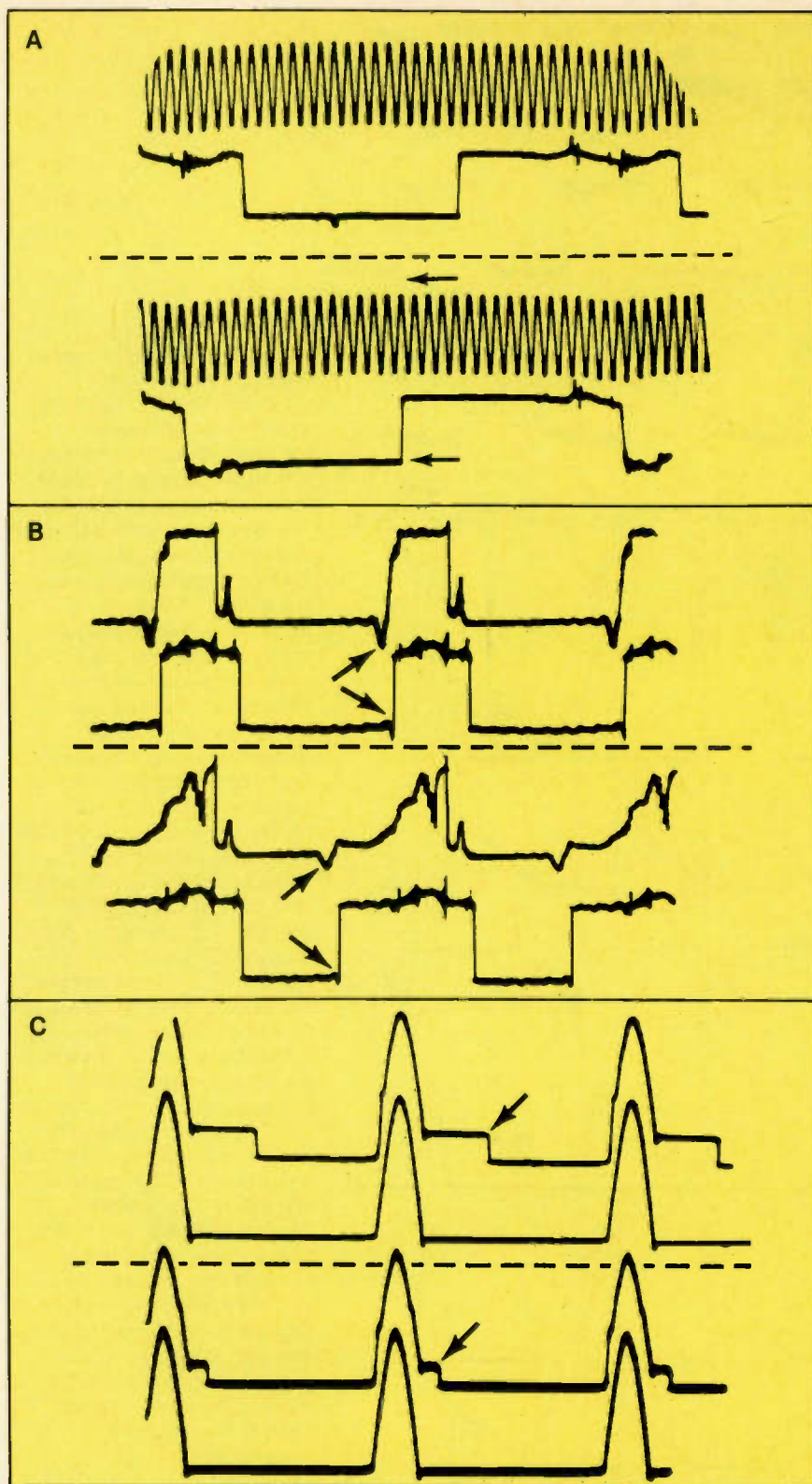

**Figure 6** Some horizontal drive waveforms change phase and/or waveshape during regulation operations. The top pair of traces in all photographs show the waveform phases at 120Vac normal line voltage; the bottom pair are the same pair of waveforms after undergoing changes by a line voltage of only 85Vac. (A) Both the 503kHz master oscillator signal (top trace of each pair) and the square waves at the output of the M2 module moved to the left at lower line voltages. A scope trace of about  $6\mu S$  was used for this photograph only to show the 503kHz sine waves. (B) Top traces of each pair are the waveforms at pin 1 of ICX3301 pulse-width modulator, while both bottom traces show the QX3326 base signals. Arrows point to the important areas that moved. (C) Top traces here could be the CR3306 cathode or the CR3308 anode waveforms, while the bottom traces are the output pulses at the damper. Notice that nothing moved except the width of the step, as pointed out by arrows.

+1V. During damper-diode current time, the collector and the damper cathode measure about -1V. Only during retrace time can the voltage rise, as it does in the huge ringing positive pulse. Notice that this large pulse came from the yoke and the total tuning capacitance; it did *not* originate at the transistor collector. That statement becomes vital when the System-3 Power Sentry regulation is analyzed.

#### Zenith's solution

Zenith has solved the linearity problems by adding a switching diode between the output-transistor's collector and the damper cathode. The CR3306 diode separates the collector current from the CR3307 damper-diode current. Additional components are required to switch the current and voltage paths at the proper times, so the complete circuit (Figure 4B) is slightly more complicated.

The Figure 5 waveforms show several vital waveforms during normal operation. Some of the waveforms were given last month, but the arrangement in Figure 5 has an important feature: The relative phases between these various waveforms are correct. All were photographed while the scope was locked to *one* sweep waveshape via the external-sync input. In other words, the scope was not locked to each individual waveform, so all have proper phase. This allows accurate analysis of the exact times during each cycle that these events happen. One method is to place a ruler straight up and down over the points of interest.

Secondly, several current waveforms are included in Figure 5. Other waveforms have zero-voltage points marked on them. This valuable information is essential to the proper understanding of any complex circuit operation.

Technicians, before you read any further, examine the Figure-4 schematic and the Figure-5 waveforms and explain in detail how the regulation operates, within the limitations stated previously.

#### Regulation varies some phases

Each variation of the load on high-voltage/power-supply transformer TX3352 (flyback) or change of incoming line voltage demands action by the regulation circuit to

restore the normal pulse amplitude at the input of TX3352. A by-product of this regulation is a corresponding variation of the phase of individual cycles in several signals. It is required by operation of the pulse-width modulator that determines the point in each cycle where the QX3326 transistor conduction begins. Horizontal locking uses separated station sync as the standard and forces the flyback horizontal pulses to have the same phase.

The Figure-6 waveforms illustrate some phase changes of the intermediate horizontal signals that occur between normal operation at 120Vac (top waveform in each photograph) and low line-voltage operation at 85Vac (lower waveforms). The scope again was locked through the external-sync input to station sync to provide a constant reference.

Some phase changes appear as sideward movements of the whole cycle. As the line voltage was gradually reduced, the cycles would move in step to the left. Other phase changes move the leading edge of a pulse, but not the falling edge (a change of duty cycle). Although neither type of phase changes affects the pulse phase at damper cathode and the HV transformer primary, *both vary the widths of "steps" in the regulator transformer waveforms*, scoped at the CR3306 cathode and the CR3308 anode, which are easily accessible.

#### Zenith regulation works well

Regulation of the Zenith system was checked by varying the line-voltage to the receiver while the high voltage and one low-voltage source were monitored. Compared to the voltages at 120Vac, a line voltage of 85Vac (-29%) produced a drop of -4% in high voltage, while the 18V supply measured -8.5%. With a line voltage of 137V (+15%), the high voltage tested +4%, and the 18V supply checked +3.4%. That is good performance.

The picture width apparently varied more than the dc voltages. Photographs later in the article show width variations.

It is clear that the sweep/power system operates correctly, and with good regulation. The Figure 4B circuit must be analyzed next to determine in detail how it operates at 120Vac, without any attempt being

NATESA  
5908 S.  
Troy  
Chicago  
IL 60629



#### ARE YOU A PRO?

...the not for profit association championing independents' right to compete, and delivering valuable benefits continuously since 1950.

- LEADING SPOKESMAN
- TRADE INFORMATION DISPENSER
- WATCHDOG
- LOBBYIST
- YARDSTICK OF STANDARDS
- CONSUMER RELATIONS
- COUNSELOR
- PROBLEM SOLVER

We are not freeloaders. So our check for \$60.00 dues is attached. As our special premium, please ship the indicated \$15.00 Manual.

- Practical Business Manual  
- OR -  
 Service Contract Manual

It's no puzzle  
to order Oelrich  
Service Forms

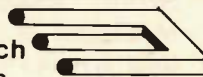

For TV-radio and two-way radio service -  
legal forms for Calif., Florida and Utah.  
Now at parts jobbers or write for cat. B64.

#### OELRICH PUBLICATIONS

4040 N. Nashville Ave., Chicago, IL 60634  
Now call toll-free! 800-621-0105

Circle (8) on Reply Card

This year,  
heart disease  
and stroke  
will kill another  
200,000  
Americans  
before age 65.



American Heart  
Association

WE'RE FIGHTING FOR YOUR LIFE

## Power supply

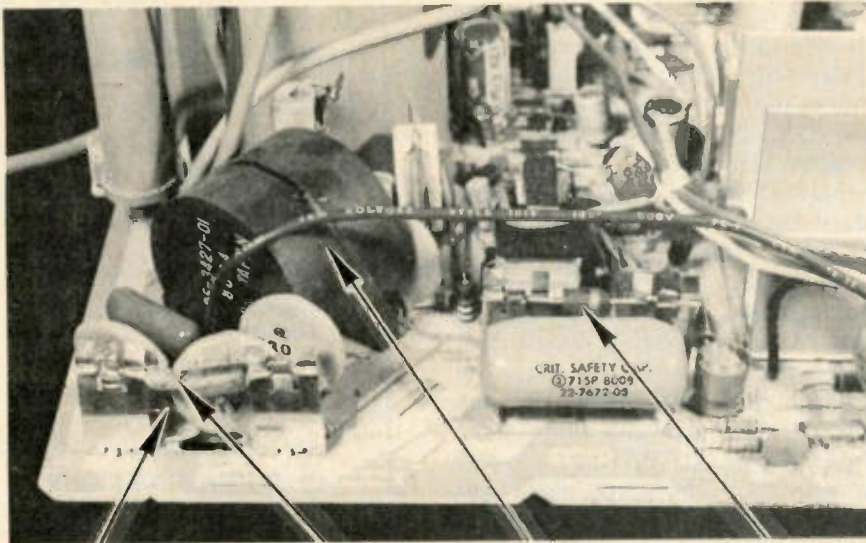

CR3308      CR3307 DAMPER      TX3301      CR3306

Arrows and callouts identify four components that are the heart of the Zenith regulation.

made at first to understand the regulation actions.

Several similarities are shared by the conventional and the Zenith schematics in Figure 4. The Zenith circuit, however, requires (for regulation) a varying waveshape base drive to the output transistor QX3326 that changes the collector-current duty cycle. This variation is not apparent in a static test at 120Vac with constant brightness.

Also, Zenith has separated the horizontal-output transistor from the damper diode and tuning capacitors, yoke and flyback by adding a TX3301 isolation/regulation transformer and two switching diodes, CR3306 and CR3308.

Operation of these three extra components is not readily apparent. One published discussion explains the need for a variable duty cycle, but the diodes are barely mentioned, and no actual waveforms are shown. Other schematics show wrong switching diode polarities and reversed *hot* and *cold* grounds in the output stage. The lack of detailed circuit-operation information probably reflects the idea that few component-level repairs are expected to be made on M10 modules.

### Steps for circuit analysis

There are several ground rules for analyzing unknown electronic cir-

cuit operations. Here are some suggestions:

- Examine all available explanations of the circuit's overall purpose. Ask and answer: What is it supposed to do?
- Carefully consider all evidence (printed or verbal) about specifically how the circuit accomplishes the objective.

- If the operation remains in question, use the previous information as a starting point for practical tests to prove or disprove the theoretical ideas.
- When the circuit contains diodes, combine voltage and current waveforms to determine where diode conduction occurs during each cycle of signal. A diode always "knows" when its anode becomes more positive than the cathode by +0.5V or more, because anode/cathode conduction occurs. This is true of all silicon diodes except zeners.
- Locate the zero-voltage horizontal line in all important waveforms.
- One at a time, disconnect or short across all components (in cases where the opens or shorts do not cause catastrophic failures of other components), and notice any changes to picture, raster or important waveforms.
- Combine two, three or four scope traces as needed when the precise phases are important.
- Test all important dc voltages (mistakes occasionally happen in schematics).
- Write out all vital steps in the circuit operation, as indicated by the previous information.

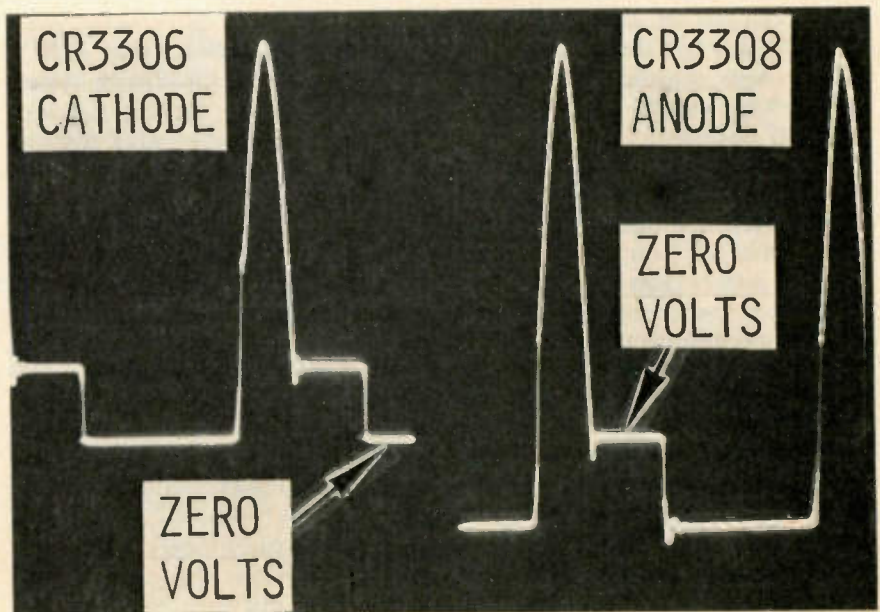

These dc-voltage levels are vital to the diode switching. The waveform is not dual-trace type; instead, the centering control was moved to position only one side or the other of each waveform. Dc coupling was used in the same channel for both waveforms. The scope lead was changed from one point to the other.



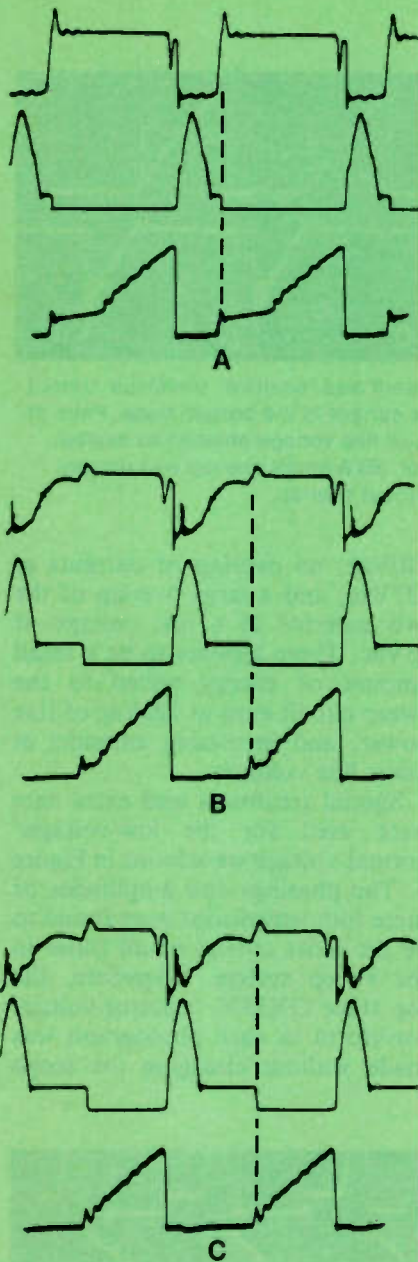

**Figure 7** In all photographs, top trace is the QX3326 base-drive voltage waveform, center trace is the collector-voltage waveform, and the bottom trace is the collector current. (A) A line voltage of only 85V started QX3326 conduction early in the cycle. The dotted line shows that time in all three traces. (B) Normal operation at 120Vac is shown. (C) A high line voltage of 137Vac narrowed the current waveform by starting QX3326 conduction later. Notice in all three examples that a wider current sawtooth was accompanied by a narrower step, and vice versa. The sum of both is the total trace time between retrace pulses. Therefore, the right end of the step also marks the beginning of QX3326 collector current.

### Analyzing the Zenith circuit

Many of these previous steps were employed during analysis of the Figure 4B Zenith circuit.

Diode CR3306 is the only dc-current path from the horizontal-output collector to the yoke, and current *must* flow through this path. Conclusion: CR3306 is forward biased and conductive only when current from the yoke and its "S" series capacitor flows to the collector, using the old convenient concept of positive forces instead of electron negative forces. This is proved by the current waveforms.

Diode CR3306 also is responsible for the step at the right of the pulse in the QX3326 collector waveform. This area of a conventional waveform is clipped to about -1V by damper conduction. But CR3306 is open at this time, and the damper conduction cannot remove the step, which is the +150V supply voltage for QX3326 collector.

The step in the QX3326 collector waveform interferes with regulation, because it varies with line voltage. Therefore it must be removed from the yoke/flyback waveform. Regulator transformer TX3301 is required to "store" the extra energy obtained from the longer duty cycle of QX3326. This energy cannot be connected directly to the yoke/flyback circuit because it would cancel part of the negative damper current. One requirement, then, is that the TX3301 secondary be disconnected during positive-pulse time plus the step time, which includes damper-conduction time. This important switching is performed by CR3308.

One of the few published explanations showed CR3308 feeding *pulses* to the load (yoke, flyback and damper). It must again be stated emphatically that the large pulse does *not* come from the horizontal-output collector. Instead, the rapid cutoff of collector current triggers a tuned ringing of the yoke/flyback combined inductances versus the retrace tuning capacitors (CX3316, CX3318 and CX3322, in this case). Thus, the collector pulse comes from the yoke/flyback ends of CR3306 and CR3308. In fact, the QX3326 collector would have little pulse amplitude except for CR3306, which is forward biased by the ringing positive pulse from the

### NATIONAL ELECTRONICS SERVICE DEALERS

Are you standing idly by while ideas that can be money in your pocket fly away?



Membership in NESDA is one of those ideas.

#### WHAT DO YOU GET FROM NESDA?

1. Insurance
2. Special Bancard Rates
3. ServiceShop Magazine
4. Electronic Service Industry Yearbook
5. Service Industry Information
6. Legislative Programs with State and National Government
7. Advocate for Better Warranty Practices
8. Business Information



Don't let your bucks get lost in the shuffle.

Send in your check today.

On the bottom line it will mean extra \$\$\$ in your pocket.

#### JOIN NESDA

And Your State Association  
Send for more information:  
NESDA, 2708 W. Berry St.  
Fort Worth, TX 76109



#### FREE CATALOG

##### HARD-TO-FIND PRECISION TOOLS

Lists more than 2000 items: pliers, tweezers, wire strippers, vacuum systems, relay tools, optical equipment, tool kits and cases. Send for your free copy today!

JENSEN TOOLS INC.

1230 SOUTH PRIEST DRIVE · TEMPE, ARIZONA 85281

Circle (9) on Reply Card

People of all ages die of heart disease and stroke.

Give the gift of love.



American Heart Association

WE'RE FIGHTING FOR YOUR LIFE

## Power supply

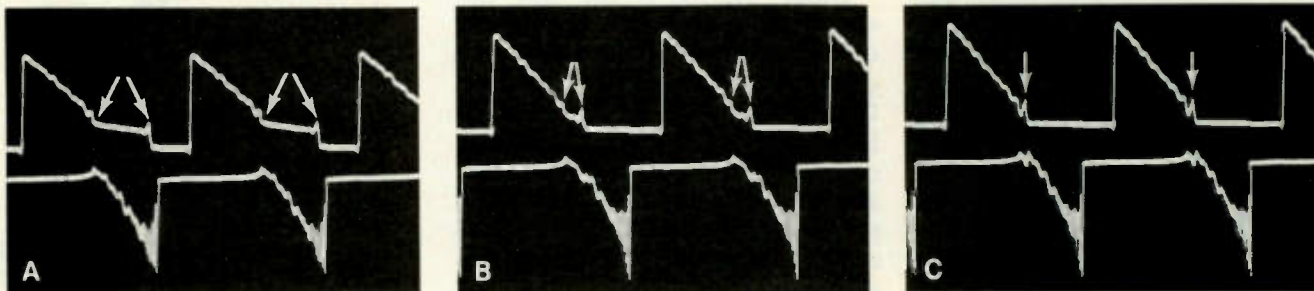

**Figure 8** A horizontal deflection yoke provides picture width from "negative" damper current and "positive" transistor current. Top trace of each photograph is the QX3326 collector current, while the CR3307 damper current is the bottom trace. Pairs of arrows show the overlap of transistor and damper currents. (A) These currents at 85Vac of line voltage showed an overlap almost as wide as the damper current, indicating maximum power boost by the regulator. (B) A small overlap was present even at the normal 120Vac. (C) At 137Vac, the two currents were complementary and without overlap.

yoke/flyback section, and so passes the pulse to the QX3326 collector. The current, however, is almost zero, for two reasons.

There is no appreciable load at the QX3326 collector to absorb current coming through CR3306. Also, the QX3326-collector pulse and step appears with increased amplitude at the TX3301 transformer secondary winding that connects to the CR3308 anode. The transformer changes the zero-voltage point of the waveform to the step's top line. All step amplitude below that point is reversed bias for CR3308, so only a small step current flows, and almost no voltage waveform passes on to the yoke/flyback section. These statements are verified by waveforms.

After the amplitude increase in TX3301 and the step removal by CR3308, the remaining pulse-only waveform is approximately equal to the ringing waveform at the CR3308 cathode. Therefore, the CR3308 pulse current is also small until called on to provide additional regulation power from the extended duty cycle of the QX3326 collector current.

Notice that only ac power can pass through TX3301. It must be assumed that regulation is effective for the high voltage and all other Vdc supplies (from flyback power), but less effective in regulating picture width.

### Waveforms explain voltage regulation

The necessity for most circuit actions has been explained. The following selected waveforms from

more than 100 photographed during this analysis prove almost all statements previously made.

Figure-7 waveforms show the QX3326 transistor base-voltage waveshape, collector-voltage waveshape, and collector-current waveshape at line voltages of 85Vac, 120Vac and 137Vac. Notice that QX3326 is biased into conduction sooner in each cycle for lower line voltages. Therefore, more total power is available for horizontal pulses.

A comparison of horizontal-transistor and damper-diode currents in Figure 8 shows a small overlap near the center of trace at

120Vac, no overlap of currents at 137Vac, and a large overlap of the two currents at a line voltage of 85Vac. There appears to be a small amount of energy added to the sweep circuit even at 120Vac of line power, and increasing amounts at lower line voltages.

Special treatment and extra care were used for the low-voltage/normal-voltage waveforms in Figure 9. The phasings and amplitudes of these four waveforms were found to be the most critical of all those in the sweep system. Therefore, the top trace QX3326 collector-voltage waveform in each photograph was made without changing the scope

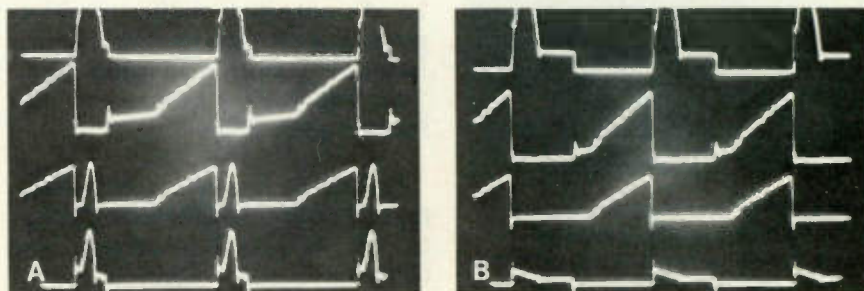

**Figure 9** The phase of these four waveforms are vital to the Zenith regulation. Tops of the QX3326 collector pulses were pushed off screen to save space, because they were not of interest. Trace second from the top is the QX3326 collector current. Third trace from the top is CR3306 current, while the bottom trace is the CR3308 current. All six current waveforms were made by the same current probe and by the same scope channel without any gain change; the heights indicate the relative amount of current. (A) The line voltage was 85Vac, chosen for almost maximum regulation power. One surprise was the extra pulses of current in the CR3306 and CR3308 waveforms, but they might not be important. (B) These waveforms are the normal ones produced by a line voltage of 120Vac. Notice that the CR3306 current sawteeth always were narrower and lower in amplitude than the QX3326 collector-current sawteeth. Also, both CR3306 sawteeth waveforms had the same width (duty cycle), proving that the QX3326 collector current during the damper conduction was used for regulation by TX3301 and never reached the yoke and damper diode. Notice too the small CR3308 current.

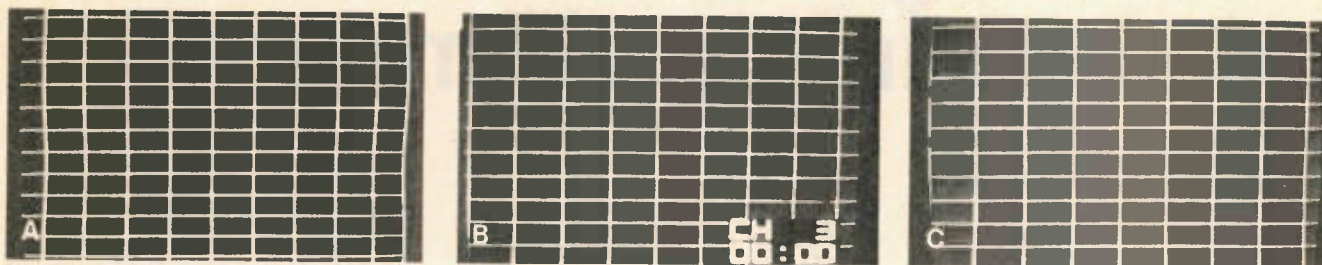

**Figure 10** These photographs from the Zenith screen show the vertical and horizontal sizes and linearities at three line voltages. (A) Line voltage of 85Vac allowed a slight shrinkage on all four sides, with some vertical retrace showing at the top and about  $9\frac{1}{2}$  grid spaces produced between the vertical lines. (B) Normal 120Vac line voltage gave a good bright picture that adequately covered the screen, with about  $8\frac{1}{2}$  spaces between lines showing. (C) An increase to 137Vac enlarged the picture slightly, with about  $8\frac{1}{4}$  spaces showing between the lines.

gain. Also, the three current waveforms in each photograph were made by the same scope channel, and without any change in scope gain. So not only the relative phases but the relative amplitudes can be easily determined.

Notice that the CR3306 current always has a lower amplitude and a shorter duty cycle than the QX3326 collector-current waveform (second from top). This proves some current is coming to the collector by the primary winding of TX3301 regulator transformer. Notice, too, that the width of the CR3306 duty cycle does not increase at lower line voltages as the collector current does.

As mentioned before, the CR3308 current at normal 120Vac line power is small, only about one-fourth of the CR3306 current.

One surprise in the 85Vac line-voltage tests was the extra, narrow pulses of CR3306 and CR3308 current during the retrace period. They do not appear to be necessary for regulation. It was noted that the relative heights of the CR3308 anode and the CR3306 cathode pulses varied slightly as the line voltage was changed. Perhaps this unbalance causes the extra current pulses, and their presence or absence is of no consequence.

#### Shorted and open diodes

A few tests that simulated partial shorts and opens in CR3306 and CR3308 were attempted, with virtually no success.

A  $470\Omega$ , 10W resistor connected in parallel with CR3306 made no discernible difference in the picture,

although the resistor ran hot and the CR3308 current dropped slightly. An erratic connection at the resistor, however, triggered shutdown. A  $10\Omega$  resistor connected in parallel with CR3306 triggered instant shutdown.

The same  $470\Omega$ , 10W resistor across CR3308 again made little difference in waveforms or raster. A  $10\Omega$  resistor connected in parallel with CR3308 produced a continuous putt-putt (motorboating) sound and extremely low pulse amplitude, as monitored by a scope. The power was hurriedly turned off.

One end of CR3306 was disconnected to simulate an open, causing motorboating for four or five seconds before the 2A line fuse blew. Several tests located a shorted QX3326 output transistor, a shorted CR3308, and an open FX3376 slow-blow fuse. Replacement of these components restored normal operation and sweep waveforms.

After a measure of courage returned, two more tests were attempted. CX3340 ( $0.01\mu\text{F}$ ) was disconnected without any visible change of picture and only slight changes in sweep-output pulses. Without the capacitor, slightly less minor ringing was found at the corners of the step. Evidently this capacitor is not vital to the sweep operation or to the regulation.

One lead of CR3308 was unsoldered to simulate an open diode, and 85Vac of power applied as a precaution against further damage. Audible motorboating, a large collector pulse without a step, and an extremely small pulse at the damper cathode were the symptoms. Power

was turned off immediately to prevent damage.

It seems clear that the Zenith Power Sentry circuit will not operate at all with an open or short in either or both CR3306 and CR3308 switching diodes.

#### Width variations

The pictures in Figure 10 shows a crosshatch pattern on the Zenith screen during line-voltage tests.

Operation with a line voltage of 85Vac produced a slight reduction of both height and width. Some horizontal bending was present.

Compared to the normal width at 120Vac, slightly more width was obtained when the line voltage was increasing to about 137Vac.

When the line voltage was reduced below about 75Vac, the screen showed unstable double-triggering lines instead of a raster, and a ragged squeal was heard.

Dependable starting was obtained at all voltages between 85Vac and 137Vac.

#### Conclusions

The sample Zenith System-3 color receiver provided an excellent picture and rock-stable operation during these many months of tests. Regulation of all *cold* voltage supplies and picture width was good over larger variations in line voltage than ever should be encountered in customer's homes.

Many of the circuits are new and unique, requiring technicians to study and understand their operations. It is recommended that magazines containing this series should be stored together and referred to when the need arises. □

# Soldering and desoldering equipment roundup

In today's rapidly changing technology, the service technician is frequently called upon to deal with some difficult and challenging soldering situations. Parallel to this,

soldering and desoldering manufacturers are continually improving their equipment to help the technician keep pace and correct these problems quickly and efficiently.

To make the technician's job easier, ES has compiled some soldering and desoldering product descriptions that have been provided by manufacturers. To obtain

more information and specification sheets for the hand-held soldering and desoldering equipment featured in this roundup, circle the appropriate number on the Reader Service Card.

Other manufacturers who offer soldering equipment are listed also. Their addresses are provided for direct contact about their products.

## Chemtronics Inc.

*Chem-Wik Professional Desoldering Braid* is safe and effective because it is manufactured with pure copper braid, which permits the user to see the absorption of solder as it travels up the wick. Some braids are coated with a corrosive flux that degrades circuitry, causing problems with resistive

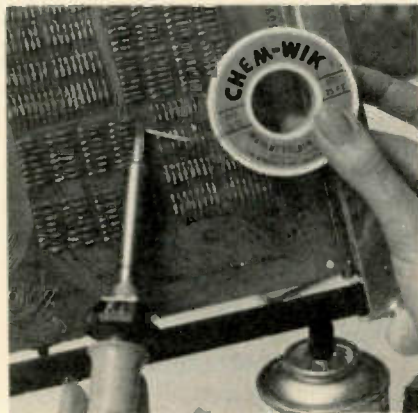

joints and unwanted current paths down line.

Another characteristic of this wick is its pure rosin, water-white flux. This coating is completely free from halogens and corrosive chlorides that can leave harmful deposits on the work. The rosin is ultrasonically applied to impregnate the wick with a uniform and smooth flux. This results in minimal flux residue and instant solder absorption with less heating of sensitive components.

Chem-Wik is available in five gauges: .025-, .050-, .075-, .100- and .150-inch for all desoldering applications, and in 5-, 25-, 50- and 100-foot lengths.

Circle (20) on Reply Card

## ESICO Inc.

Features of ESICO's miniature soldering irons include Vitacore soldering tip, three layers of high grade mica, nickel wire leads, metal sheath, and two rope precision wound layers of nickel chrome resistance wire in a stainless steel case.

Built around the mica-wound element, each iron is engineered for quick heat production, transfer and recovery. Stainless steel stems ensure cooler handles. Solder tips are machined from commercially pure copper to assure maximum heat transfer. Flexible cords resist oil, heat and abrasion.

Standard ESICO irons operate on 120ac and dc but are also available in 240 and other voltages. Irons are available with either two or three conductor cordsets. Heating elements and other components are easily replaced.

Circle (21) on Reply Card

## GC Electronics

The *Snap Vacuum Solder Remover* allows for instant desoldering, and the powerful vacuum action snaps molten solder instantly

from board and component leads. The Teflon nosepiece withstands many desoldering operations, prevents solder from adhering to tool and creates fewer static problems. The nose unthreads quickly for fast cleaning.

Circle (22) on Reply Card

The *GC/Spirig 6S Wick* is an advanced alloy solder absorbing wick for rapid and complete desoldering. It is produced under a patented process in which the individual copper strands are alloy-coated before braiding.

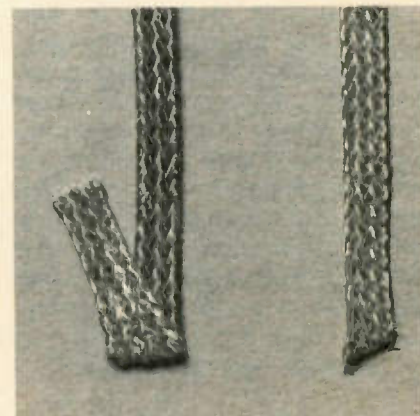

Desoldering is accomplished by simply pressing the wick with a hot iron upon the joint. Solder is instantly melted and drawn into the wick. Wicking starts twice as fast as with conventional braid. This wick helps to avoid damage and life-

reducing heat shocks to components, printed circuit boards and wire insulation.

This product has a virtually unlimited shelf life.

Circle (23) on Reply Card

### Kenco Alloy & Chemical Company

The Kenco line of soldering chemicals includes all grades of rosin fluxes, organic water soluble fluxes and both new halide-free rosin and water soluble fluxes. Also available are petroleum and synthetic tinning oils, saponifier cleaners and a line of azeotropic chlorinated solvents for vapor degreasing and cold cleaning applications.



Complete and compatible rosin aqueous system is available as the Aqua-Sure Process.

Circle (24) on Reply Card

### Micro Electronic Systems Inc.

The Model P/N 5021 is a combination of an effective flux fume absorber and a fluorescent lamp for soldering and desoldering stations. The difference between this unit and others that are available is that it does not simply place the fumes and smoke somewhere else but traps

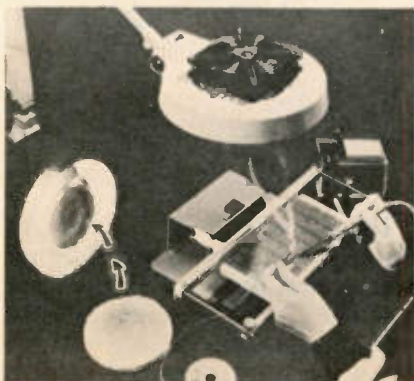

Circle (26) on Reply Card

them in a polarized polyamid filter.

The unit will circulate air around the work station, purify the air of contaminants, reduce the likelihood of operator headaches, provide better light, making it easy on the eyes.

Circle (42) on Reply Card

### M. M. Newman Corporation

The *Antex industrial Model C and G* soldering irons allow for an improvement in electronic assembly work. The tip slides on directly over the heating element for the most efficient use of power.

With the tip in this position, both heat-up time and recovery time are exceptionally fast: It takes about 45 seconds. The construction assures quick recovery time after soldering each joint. With the 3-pronged plug, the tip is directly grounded, making the iron safe for most delicate circuitry.

The tips cannot freeze onto the heating element. There are no threads to bind or set screws to freeze. To replace or change tips, simply remove the old one and slide on a new tip.

The non-charring thermo setting plastic handle will not melt even if touched by another hot iron. The 3-wire cord is round ultra-flexible and lightweight. Without the cord, the iron weighs  $\frac{3}{4}$  of an ounce.

The model C is 15W, 115V achieving 650° to 700°F tip temperature. The model G is 18W, 115V achieving 700° to 750°F tip temperature.

Circle (25) on Reply Card

The *Antex X-25 Soldering Iron* has all the advantages of the models C and G but it is built for heavy-duty use. This iron also has the heating element in the tip for thermal efficiency, and the slide-on tip cannot stick or freeze.

The tips are bigger with more mass to have the thermal inertia required for soldering larger connections.

The handle is made of thermo setting plastic that will not burn or melt if it comes in contact with another hot iron.

The iron comes standard with a 3-prong grounded plug which directly grounds the tip of the iron to prevent damage to voltage sensitive parts.

The *Antex Precision CTC* is a 40W soldering iron. The unit features a heat capacity equivalent to that of a conventional 50W unit, because the soldering tip slides on directly over the heating element, resulting in maximum thermal efficiency.

A thermocouple in the tip of the iron combined with a sliding potentiometer in the soldering station provides and maintains precise temperature control from 140°F to 815°F with positive feedback.

The TCSU-1 station contains solid-state circuitry that converts line voltage to 24V. Zero crossing electronic switching eliminates RF interference and magnetic fields.

Circle (27) on Reply Card

The *Antex XTC* temperature-controlled, 50W soldering iron is also designed for use with the TCSU-1 station. This offers the user the same advantages of accurate temperature control without the expense of more equipment.

Circle (28) on Reply Card

### OK Machine and Tool Corporation

The DP-1 Desolder Pump offers full industrial performance and features at an economy price. The



DP-1 features all metal construction with precision components for maximum reliability and ease of operation. Compact size allows for comfortable 1-hand operation. Suction is precisely regulated for efficient solder removal without damage to delicate circuitry. Self-cleaning on each stroke, the DP-1 is quickly disassembled without special tools for maintenance or repairs. Rugged Teflon tip is easily replaced.

Circle (29) on Reply Card

## Soldering/desoldering

### Sylvania

The *Model SS200 Fountain Filter Iron* is a compact and easy-to-operate desoldering system. The unit removes solid-state components from double- and single-sided PC boards quickly and without damage. The see-through fountain filter stores a large quantity of waste solder to save production time and do away with most clogging. The unit empties easily whenever necessary.

The model consists of a console vacuum unit, vacuum hose with replaceable filter, power cables, dual 50/25W limited energy iron with in-handle vacuum switch, iron cradle and two replaceable tips. The unit is 115Vac, 50/60Hz (200W with pump operating).

Circle (30) on Reply Card

### Triton Manufacturing Company

*Hot-Lips* is a hand-held electrical resistance tool for all kinds of intricate soldering operations. Its heat cycle is quick and easy to use.

The tool's light weight and plier action help even the inexperienced to produce perfectly soldered connections every time. The tool is held comfortably in palm or finger tips, squeezed lightly to close the lips gripping parts to be soldered. A little more squeeze clicks closed the circuit for instant heat exactly where it is needed.

The tool is widely used for both production assembly as well as repair work in electric motors, in instruments, on electronic circuit assemblies, even in jewelry-making. Works well too, for desoldering, even light spot annealing and welding.

Six volts safe, a remote transformer power supply furnished with the tool eliminates shock hazards and potential damage to sensitive magnetic circuits such as

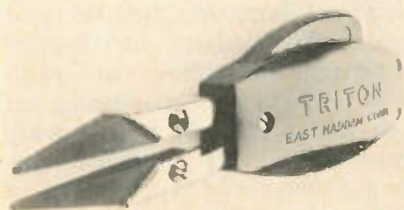

those found in many instruments. Its instant-heat on, instant-cool off means minimum power use; no idling at high temperatures.

Circle (31) on Reply Card

### Ungar

The *Hot Vac Desoldering System Model 4000* has a variable solid-state control that adjusts the tip temperature from 500° to 1000°F.

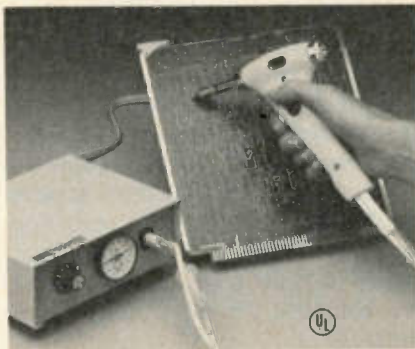

A non-magnetic load-modulated heater provides instantaneous temperature recovery. An electronic circuit assures the transient spikes are fully suppressed, thereby making the system safe for desoldering voltage sensitive components.

Collected solder is stored in a built-in visible reservoir that may be emptied, even when the heater is hot.

The self-contained vacuum pump operates only when the handle switch is actuated. Sound is further reduced by a low-noise exhaust system and a new method of pump mounting, which reduces noise and vibration.

The complete 120V, 60Hz, 2.5A rated system includes power and vacuum supply, grounded handle assembly, integral holder, four soldering tips, a cleaning tool, a 10-pack handle filters and a Kleen-Tip sponge and tray.

Circle (32) on Reply Card

The *Hot Vac Model 2000* has a solid-state control that adjusts the tip temperature from 500°F to 1000°F and adapts the 2000A to a wide variety of applications. The load-modulated non-magnetic heater provides instantaneous recovery. Transient spikes are fully suppressed. The high-flow vacuum is actuated by an easily operated switch built into the biomechanically designed handle.

The unit uses normal shop air (40-120 psi through a high efficiency vacuum transducer which is controlled by a low maintenance solid-state circuit and solenoid valve. Quiet operation is assured with a muffled exhaust; the unit can also be fitted for remote exhaust in clean room applications. A built-in vacuum gauge monitors proper operation. The unit is 120V, 60Hz, 2.0A rated. It is a fully grounded system. The complete station includes four tips, one tip cleaning tool, and a free-standing holder with a Kleen-Tip sponge and tray.

Circle (33) on Reply Card

### Vaco Products Company

The Vaco-Total Terminal Kit offers quality performance in the combination of strength, conductivity, corrosion resistance, positive electrical contact and powerful wire grip featured in all Vaco terminals. It offers selections with an assortment of 15 insulated terminal styles for a total of 164 terminals.

The unit also offers convenience in a compact, clear plastic case which has separate compartments for each of the 15 various terminal styles. A hang-up tab is provided for easy hanging and storage.



The No. 89976 kit is ideal for automotive, air conditioning, refrigeration and appliance repairs, radio, TV, and hi-fi connections and general maintenance.

Circle (40) on Reply Card

### Wahl Clipper Corporation

The *Miniature Low Wattage Soldering Station* is a 6W, 360°C (690°F) operation with 14 interchangeable tips available from 1/25- to 5/32-inch in a variety of materials, finishes and shapes. The

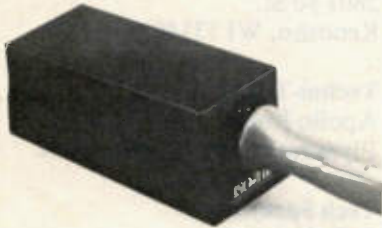

unit has double-insulated transformer blocks to stray electrical currents. The pencil-thin iron is 6 inches long and weighs 1/4 ounce.

The station includes iron, tip cleaning sponge, sponge well, spring holder, indicator lamp and internal safety fuse. The iron is supplied with 1/32-inch long-life nickel-plated copper alloy chisel tip. Iron-plated tips as well as other shapes and sizes are available. Tips resist seizure and can be changed quickly without special tools.

Circle (34) on Reply Card

The *Industrial 30* soldering iron is lightweight, cool and comfortable to use. It is built for long-life service expected of an industrial-quality iron.

The features included in the unit design are: a circuit diode and heavy gauge heating element wire for extended life, a 3-wire grounded burn-resistant cord, stainless steel shaft and aluminum spacer to prevent tip seizure, a clip-on hanger, an indicator light showing when the iron is plugged in, and 10 different tips to meet different job requirement.

The *Industrial 30 Iron* is a 27W high performance, constant temperature iron (360°C, 690°F).

Circle (35) on Reply Card

The *Production 50* heating element can be adjusted to provide 200°C to 400°C (400°F to 750°F) with accuracy maintained of  $\pm 2\%$

operating temperature is easily adjusted in the handle of the iron with the allen key wrench supplied with each iron.

Iron reaches pre-set temperature in about 45 seconds. Indicator light in handle shows when iron is plugged in. Furnished with 3-wire grounded burn-resistant cord.

Shaft is made of stainless steel. An aluminum washer helps prevent tips seizing. Handle stays cool and comfortable for operator satisfaction.

A wide selection of long lasting iron-plated tips are also available.

Circle (36) on Reply Card

### Wall-Lenk Manufacturing Company

The *Wallbrand Triple E Models 19 and 20* irons are designed to be replaced rather than repaired should a breakdown occur. The throwaway design requires less machining than irons that are intended for disassembly and repair. This adds to a cost savings.

Both the 25W model 19 and the 42W model 20 are made of heavy-duty industrial-quality materials with stainless steel barrel and set screws. The unit is lightweight and balanced with a polycarbonate handle.

Circle (37) on Reply Card

The *Wallbrand Model BP-100* cordless soldering iron operates on a rechargeable nickel cadmium battery. The unit heats in about 5 seconds with an off-on button. It has a small tip for pinpoint work requiring heat of 700°F or more.

A recharger is included and can be plugged into a 110 to 120V, 60 cycle ac outlet. The unit can solder up to 100 joints per charge, depending on the wire size. It can also be used while recharging.

Circle (38) on Reply Card

### Weller

Controlled output soldering stations include the *Model WTCPN* with tip selection temperatures of 600°F, 700°F and 800°F, and the *DS100* (also desoldering) at the same range. The *DS500*, a desoldering station for production re-work and repair, is available in 700°F and 800°F versions.

Circle (39) on Reply Card



An advanced technology soldering unit, the *Model EC2000*, is an electronically controlled model capable of maintaining a constant pre-set tip temperature from 350°F to 850°F with settings and readings shown on an LED digital display.

Circle (40) on Reply Card

A portable desoldering station designated the *Model DS600* features a self-contained vacuum/air pump for at-site repair operations.



The unit, with a 700° temperature-controlled head and eight available tiplests, also provides push-button vacuum control, power supply circuit breaker, positive sealing head and other advanced operating features. The low maintenance system operates on 120V.

Circle (41) on Reply Card

## Soldering/desoldering

Other manufacturers offering soldering equipment may be contacted by writing to these addresses.

**Alpha Metals Inc.**  
600 Route 440  
Jersey City, NJ 07304

**American Electrical Heater Company**  
6110 Cass Ave.  
Detroit, MI 48202

**Bow Solder Products**  
900 Hobson St.  
Box 488  
Union, NJ 07083

**Chemalloy Electronics Corp.**  
P.O. Box 10  
Santee, CA 92071

**Circon Corp.**  
Dept. EM  
749 Ward Drive  
Santa Barbara, CA 93111

**Dupont Company**  
Electronic Materials  
1700 Market St.  
Wilmington, DE 19898

**E. I. Dupont/Demours & Company**  
10414 NE Mours Bldg. 322 #326  
Wilmington, DE 19898

**Eagle Electronic Mfg. Company**  
45-31 Court Square  
Long Island City, NY 11101

**Edsyn Inc.**  
15958 Arminta St.  
Van Nuys, CA 91406

**Electro-Science Labs**  
Dept. EM  
2211 Sherman Ave.  
Pennsauken, NJ 08110

**Englehard Industries**  
Electro Materials  
70 Wood Ave. S  
Iselin, NJ 08830

**Enterprise Development Corp.**  
5127 E. 65 St.  
Indianapolis, IN 46220

**GE Industrial Heating Business**  
1 Progress Road  
Shelbyville, IN 46176

**Gardiner Solder Company**  
4820 S. Campbell  
Chicago, IL 60632

**Glenmarc Mfg. Company**  
330 Melvin Drive  
Northbrook, IL 60062

**Heath Company**  
Schlumberger Ltd.  
Benton Harbor, MI 49022

**Hexacon Electronic Company**  
161 W. Clay Ave.  
Roselle Park, NJ 07204

**ITT Industrial/Automation**  
41225 Plymouth  
Plymouth, MI 48170

**Johnson Mfg. Company**  
114 Lost Grove Road  
Box 96  
Princeton, IA 52768

**Kahle Engineering**  
3322 Hudson  
Union City, NJ 07087

**Kester Solder Company**  
Litton Industries  
4201 Wrightwood Ave.  
Chicago, IL 60639

**L&R Mfg. Company**  
577 Elm St.  
Kearny, NJ 07032

**3M Company**  
Electronic Products  
3M Center  
St. Paul, MN 55101

**Oneida Electronic Mfg.**  
Dalton Smith  
Baldwin St. Ext.  
P.O. Box 678  
Meadville, PA 16335

**Philips ECG/Sylvania**  
1025 Westminster Dr.  
Williamsport, PA 17701

**Projector-Recorder Belt Corp.**  
200 E. Clay St.  
Box 176  
Whitewater, WI 53190

**Snap-On Tools Corp.**  
2801 80 St.  
Kenosha, WI 53140

**Techni-Tool Inc.**  
Apollo Road  
Plymouth Meeting, PA 19462

**Tech Spray Inc.**  
P.O. Box 949  
Amarillo, TX 79105

**Union Carbide/Linde Div.**  
270 Park Ave.  
New York, NY 10017

**United Solder Wrap**  
2608 Electronic Lane  
Dallas, TX 75220

**Unitek Corp.**  
Equipment Division  
1820 Myrtle Ave.  
Monrovia, CA 91016

**Vertex Electronix**  
150 Schmitt Blvd.  
Farmington, NY 11735

**Viking Instruments Inc.**  
73 Ferry Road  
Chester, CT 06412

**Wik-It Electronics**  
1134-E Aster Ave.  
Sunnyvale, CA 94086

**Workman Electronics Products**  
IPM Tech Box 3828  
Sarasota, FL 33578

**X-Acto**  
45-35 Van Dam St.  
Long Island City, NY 11101

□

As more and more soldering can be classified as miniature soldering it becomes necessary to look more closely at the methods and procedures used in miniature soldering.

Slide-on tips that slide directly over the heating element offer some dramatic advantages.

First, they consume less energy (electricity) than conventional irons

because more heat is transferred into the tip due to the tip being over the heating element. This means more heat is put into the tip and less into the air and the face of the



operator. Besides more efficient use of power, the slide-on tip allows a thinner profile between the handle and the tip. This improves visibility and also makes it easier to work under a microscope.

Operators hired to do miniature soldering should have an eye examination both for vision and color perception. This should be done in the early stages of training, and if vision is found to be faulty great frustrations can be avoided.

When doing fine soldering a routine schedule for cleaning all lenses should be established. One cannot see clearly through a dirty pair of glasses, loop, magnifying glass or, especially, a dirty microscope. Besides the standard causes of dirty lenses, soldering itself causes dirty lenses as the fumes from the flux used in soldering are deposited on the lenses. This is but one more reason to use as little flux as possible. Microscopes are particularly prone to flux residue being deposited on the lens because, typically, the microscope lens is closer to the soldering than any other lens would be.

The distance from the handle of a soldering iron to the tip is important, not only in determining the balance or feel of an iron, but also, the further away the tip is from the hand, the less control. Slide-on tips minimize the distance from the handle to the tip, thus making control better.

In miniature soldering, it is often helpful to steady the hand that is holding the soldering iron on the bench top to eliminate any movement or shaking. Where this is done, the spade shape tip seems to be more popular than the chisel shape tip because of the elliptical shape of the working surface. If you were using a chisel shape tip, you would find that you would always be soldering with the corner of the chisel; thus if you are not familiar with the spade tip you may want to try it when using small tips.

The recovery time becomes more and more critical as one uses smaller and smaller tips. The reason for this is there is more surface area in relation to the mass of the tip because the length of the tip stays constant. This means that the smaller the diameter the harder it is to heat the end of a tip. This also means that recovery time is slowed down. With a slide-on tip where the heating ele-

ment is inside the tip close to the working end, this problem is reduced.

With larger soldering irons the recovery rate is not really terribly important because the mass of the tip can be very great in relation to the size of the joint being soldered. But with miniature soldering, the mass of the tip in relation to the joint is much more nearly the same; thus, much of the heat in a very small tip is drained off to solder one joint. Now the recovery time becomes very important. The recovery time with a slide-on tip is very fast, due to the position of the heating element which is in close proximity to the tip.

A simple method of comparing recovery rates of soldering irons is as follows: Take two irons with the same size tip and when they are completely cold, plug them both in and see how long it takes for each of them to melt solder.

The more miniature the soldering, the more important the condition and shape of the tip become. When using a small tip, it is even more important to tin the tip generously on the first heat-up. When returning the iron to the stand it is important not to wipe the solder off the tip. If you do remove solder from the tip at this point, the chances of the tip oxidizing and thus having solder roll off the tip in the future, are greatly

increased. If the tip needs wiping, do it when you take the soldering iron out of the stand to use it.

The rapid development of semi-conductors and also metal oxide semiconductors (MOS) have made it helpful to have strict temperature control of the soldering tip. It is also mandatory that no static electricity charges be induced into the MOS circuitry. Strict temperature control, within about 2% of setting, and without inducing any unwanted peak voltages or magnetic fields, can be achieved by electronically controlled circuits and switching at zero voltage. Damage done by static electricity that is often unnoticed until too late can be prevented by using conductive material in the workplace and connecting the operator to a ground. Also, the tip of the soldering iron should be connected to a safe ground. The tip of the ANTEX temperature-controlled iron is directly connected to the TCSU-1 station, which then should be connected to a safe ground. Please note that the electric utility ground may not be a sufficient ground for soldering MOS circuitry. The ANTEX TCSU-1, positive feedback, temperature controlled, positively grounded soldering iron has been designed specifically to meet these requirements.

*(Courtesy of M. M. Newman Corporation, Antex Division)*

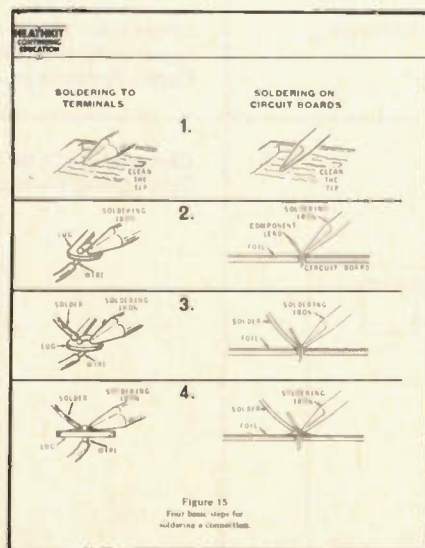

These are tips from the continuing education course manual. This diagram shows four basic steps for soldering a connection. *(Courtesy of Heath Company).*

### Soldering: A Self-Instructional Manual

Heath Company is offering a practice soldering course for the novice or professional kitbuilder. The kit comes complete with circuit board, components and solder.

After completing this course, the student will have a 2-transistor light oscillator that he has built himself. This kit is ideal for individuals, schools and industry. The student only needs to have a soldering iron and small hand tools to complete the course.

The price of the unit is \$16.95. For more information, circle 15 on the Reader Service Card.

Chassis – RCA SFT-100 Videodisc player  
PHOTOFACT – Not available

1

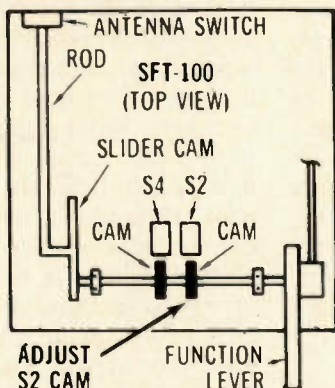

**Symptom** – Displays remain lighted when function lever is at off position  
**Cure** – Check operation of the S2 main ac-power switch (snap type), and reposition the actuating cam if needed

Chassis – RCA SFT-100  
PHOTOFACT – Not available

2

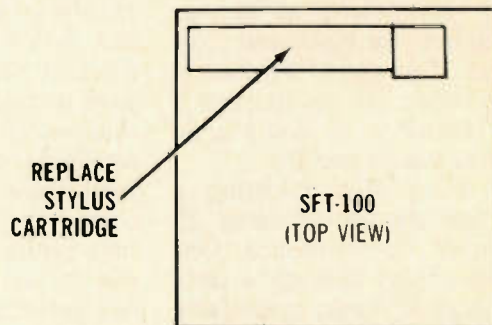

**Symptom** – No radio-frequency carrier emitted for TV receiver; no picture  
**Cure** – Check and readjust slider cam so that the antenna-switching rod properly activates the antenna switch

Chassis – RCA SFT-100  
PHOTOFACT – Not available

3

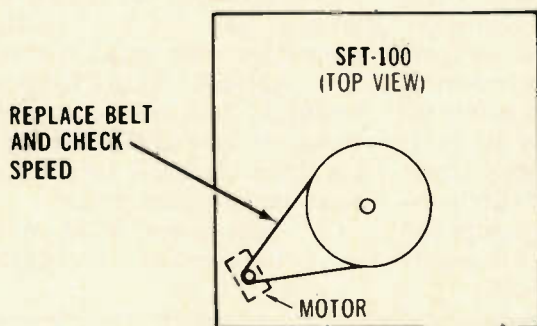

**Symptom** – Video and audio repeats; stylus skipping grooves  
**Cure** – Replace stylus cartridge assembly

Chassis – RCA SFT-100  
PHOTOFACT – Not available

4

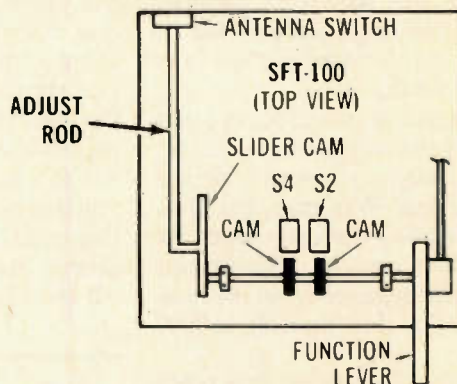

**Symptom** – Visual search is inoperative or operating incorrectly; time display not tracking  
**Cure** – Replace stylus cartridge assembly

Chassis – RCA SFT-100  
PHOTOFACT – Not available

5

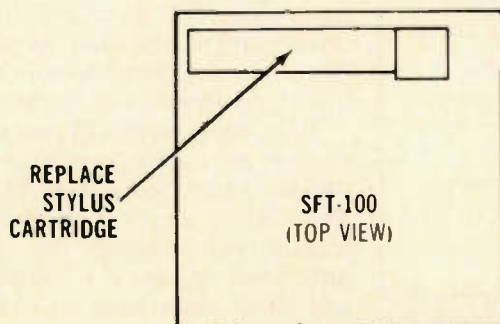

**Symptom** – No color, and horizontal is out-of-lock  
**Cure** – Replace the drive belt, then use a strobe to check turntable speed (450 rpm)

Chassis – RCA SFT-100  
PHOTOFACT – Not available

6

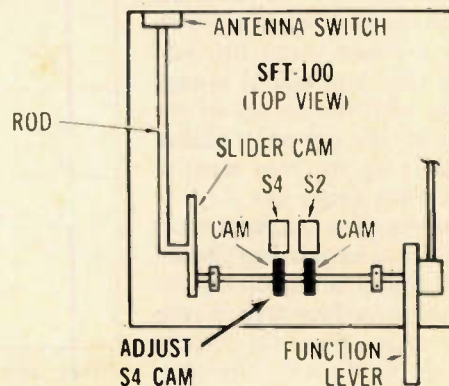

**Symptom** – Motor and turntable do not rotate during playing time  
**Cure** – Check and readjust the cam that actuates the S4 ac-play switch

# reader's exchange

**Note:** Beginning with the November 1981 issue, Reader's Exchange column will again run items for sale along with items needed by readers. There will be no charge for the sale notices.

**Needed:** Schematic for intercom model 777, manufactured by Music Call of Los Angeles. *Mesa Radio and Ref. Service, 3461 E. 54th St., Los Angeles, CA 90043.*

**Needed:** Output transformer for Philco radio part 32-8120 M. *Merl Eggert, Port Hope, MI 48468.*

**Needed:** Used Sadelco field-strength meter, also called Blonder Tongue, Winegard, etc. *Kenneth Proctor, 1588 Fort St., Brick, NJ 08723.*

**Needed:** Hickok model 539B tube tester. *Paul Capito, 637 West 21st St., Erie, PA 16502.*

**Needed:** A-430 output transformer for a Dynaco tube amp. Mark VI. *Steve Elosh Jr., 231 Gladstone, Campbell, OH 44405.*

**Needed:** Schematics for Dynaco Mark IV Amp and FM Dynatuner, both mono. Will prepay cost of good photocopy. *William Bernstein, 215 Middle Neck Road, Bldg. 7, Great Neck, NY 11021.*

**Needed:** CRT adapter model MH3, distributed by Col-electronics. *Kermit Clark, 4965 Northland, St. Louis, MO 63113.*

**Needed:** Field-strength meter, Sencore FS 134, Winegard FS-3DVU or FS-719B, ChannelMaster 7276C or 7277C or comparable type meter. *Johnson Electronics, 510 4th St., Kenyon, MN 55946.*

**Needed:** Celluloid slides for B&K 1076 analyst and a Lectrotech TO-60 oscilloscope. Will trade for a B&K 1077-B. *Ken Miller, 10027 Calvin St., Pittsburgh, PA 15235.*

**Needed:** TEKFAQ Vol. 9, 12 and 14, and SYNCURE Vol. 1. *C. T. Huth, 146 Schonhardt St., Tiffin, OH 44883.*

## Electronic Servicing. is Available in MICROFORM

FOR INFORMATION  
WRITE:

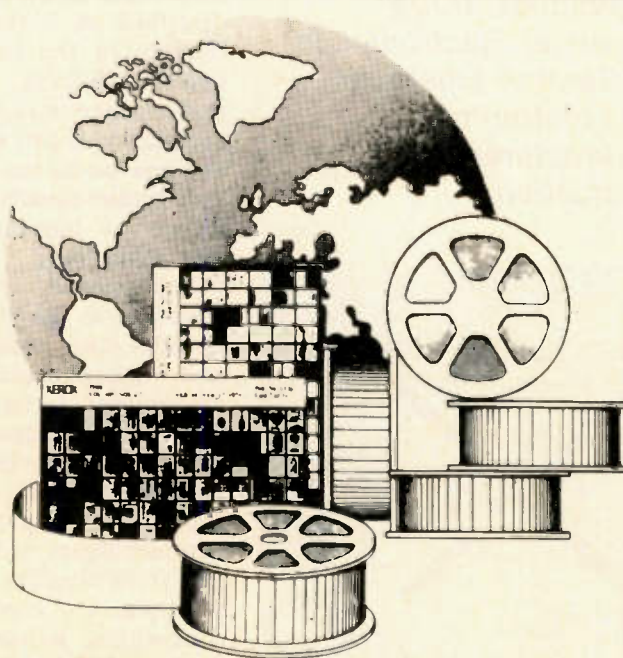

## University Microfilms International

300 North Zeeb Road  
Ann Arbor, Mich. 48106  
U.S.A.

18 Bedford Row  
London, WC1R 4EJ  
England

# TECHNOLOGICAL TRENDS IN CONSUMER ELECTRONICS

*These are excerpts of a speech given by Ing. Klaus Welland at the International Audio and Video Fair held Sept. 2, 1981 in Berlin. Welland is a member of the board of development of Telefunken Fernseh und Rundfunk GmbH and spokesman for the Technical Commission I of the Product Group Consumer Electronics in the German Electrical and Electronics Manufacturers' Association.*

In assessing future technical and technological trends, it should be kept in mind that consumer electronics does not exist in isolation but is influenced in numerous ways by external factors. It is therefore worthwhile to include these factors concerning their future in any consideration we might give to these trends. We should also determine just where consumer electronics stands at the present time (Figure 1).

## Consumer electronics today

The market, with its free competition, trade and consumers, can be described as a classic influencing factor. On the one hand design, quality, reliability, favorable price/performance ratio and the degree of acceptance of new equipment, ideas and new media are decisive factors. This applies equally to the success or failure of innovative engineering and technology.

The second major factor is described as the "legislators." This includes state institutions, national and international bodies and associations. In response to suggestions from the consumer electronics field, and as a result of demands from the market, they create the legal conditions governing the use of new techniques such as direct reception from satellites, wideband cable transmissions, cable TV and new transmitting standards. From time to time, they must also intervene in a regulatory sense to insure that processes in use continue to be compatible with new developments. It is also the task of the "legislators" to establish safety standards and minimum technical demands for consumer electronics equipment.

The third factor, which is becoming increasingly influential, is the

components industry, particularly the semiconductors sector. It is only with the increasing solid-state integration of components that the consumer will have a chance of obtaining the technology possible today and in the future at affordable prices.

## Software

Consumer electronics, together with external factors, has also acquired a new aspect—software such as computer programs for controlling equipment, production and testing procedures. It is rapidly acquiring greater importance, because without its assistance it is virtually impossible to implement any of today's innovations. To name just a few examples, one could include self-programming receivers, fault correcting system for pulse code modulation transmission as well as automatic test assemblies in laboratories and in production. Consumer electronics will have to develop sources of innovative software.

The interconnections between consumer electronics and the surrounding field can be described on the basis of changes in engineering and in technologies that can be expected to follow far-reaching innovations.

## Analog/digital conversion

For consumer electronics, the 1980s will be the decade of the "analog/digital conversion." The beginning of this process became apparent with the introduction of microprocessors for controlling operational functions of equipment, while processing of the "wanted signal" remained unaffected. Now pulse code modulation (PCM),

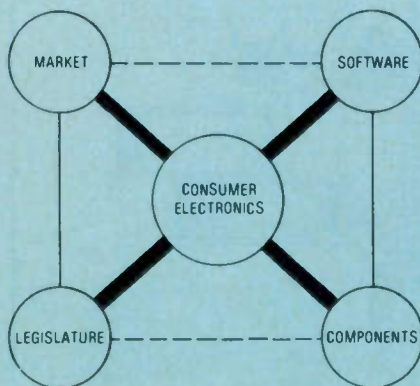

Figure 1 The position of consumer electronics.

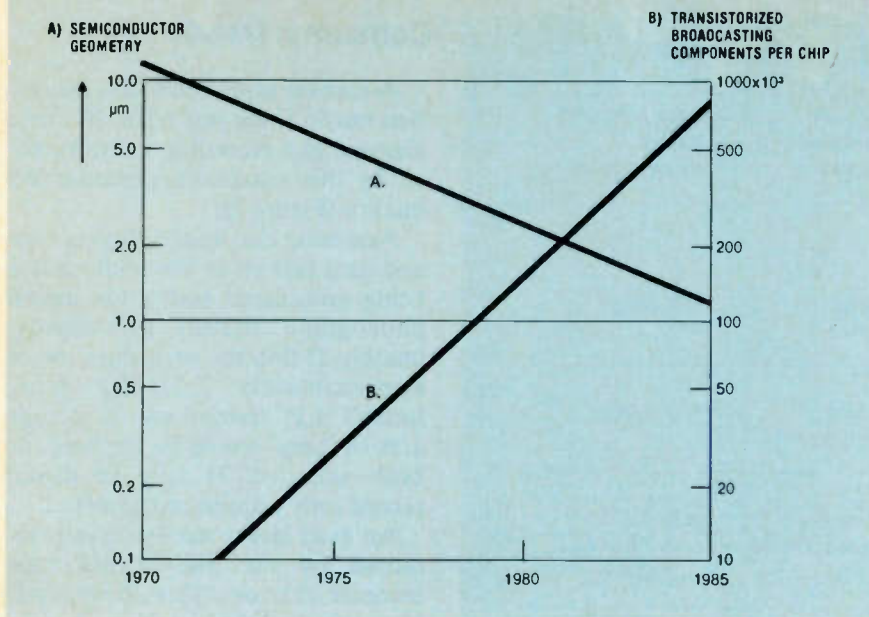

Figure 2 Trend — semiconductor technology

already in use in commercial telecommunications has been rediscovered by consumer electronics.

Until now the cost of this equipment was simply too high, despite the advantages of freedom from interference, nonsensitivity in the face of non-linear distortion and the possibilities for correcting faults in the received signal. There was absolutely no compatibility with the customary means of transmission and the requirements for wide transmission channels. These obstacles have either been eliminated to a major degree or rendered insignificant through the introduction of new techniques of transmission and storage.

Parallel to the already well-known transmission channels, legislators will be assigning new wideband frequency ranges, such as satellite channels in the 12GHz waveband and wideband communication channels, starting in the mid-1980s, (for example, fiber-optic networks), and will be making sure (it is hoped) that there is a uniform transmission standard on an international basis. On another front, the semiconductor industry is making use of more refined geometries, higher degrees of integration and falling costs per transistor function to create the conditions for more complex yet reasonably priced ideas for equipment (Figure 2).

In the final analysis, the software required for the maximum use of

PCM is already available to a large extent. This includes programs for coding, multiplexes, fault identification and correction, digital/analog conversion and analog/digital conversion.

This in turn will provide a market for a new generation of sound equipment, offering consumers quality of reproduction that has never been experienced.

#### Superior sound quality

The first such source of this superior sound quality is the digital phono disc, which is about to be introduced. With the aid of density storage methods obtained from videodisc technology, it is now possible to store more data on a record than was possible under the usual analog method. Records can now be produced with one hour's playing time on each side and yet with a smaller diameter than current singles. Among the advantages of PCM are the enormous signal-to-noise ratios (>80dB) and channel separation (>80dB), the complete lack of distortion, wow and flutter in reproduction, and more sophisticated operating features. These features include the capability of searching out a certain section of the record in less than five seconds, alphanumeric display of the content of the records and easy handling of the record itself. These features are virtually the same with all the intended PCM phonograph record systems.

It is the intention to provide approximately 20 PCM stereo radio programs nationwide using satellite transmitters, large communal aerial installations or wideband networks. These will fulfill the same reproduction quality criteria as achieved with the digital record. The PCM tuners required to receive such broadcasts will offer users similar advantages in operation as the record players—station or program search with alphanumeric or even acoustic command facilities and optical display of the name of the station or program being received.

Consequently digital technology will be used in every stage right up to the loudspeaker; previously simple mechanical adjustments (volume, tone, balance) will now become data processing operations and as a result of the direct conversion of PCM into pulse duration modulation (PDM), the power amplifier becomes a power switch offering great efficiency with low energy consumption. It is then the loudspeaker that remains the only weak link in the transmission chain of maximum value audio signals. Much greater demands will be imposed on the loudspeaker because of extremely high dynamics and undistorted signal build-up and decay times.

To complete the range of facilities of a PCM hi-fi unit, a PCM magnetic tape unit will have the opportunity to be competitive only if other adequate, maximum quality sound sources are available in addition to the digital phonograph record, that is, PCM radio broadcasts or prerecorded PCM cassettes, assuming such a unit can be manufactured at a reasonable cost.

## Consumer trends

A mental experiment can be carried out to show just what dramatic changes in a recording are demanded by this maximum reproduction quality (Figure 3):

Assuming one hour's playing time and data rate set in line with what is being considered today for digital phonograph records (of approximately 2Mbit/sec or a data set of approximately 7.2Gbit) using today's LP technology a storage area of 2.6m<sup>2</sup> would be required, or both sides of 24 LPs (a digital record only requires 0.011m<sup>2</sup>).

An even larger storage area is required by the old ¼-inch tape recorder, 27.1m<sup>2</sup>. This corresponds to a tape length of 4.3km or eight full tape reels with a diameter of 18cm. Even compact cassettes require a storage area of 11.6m<sup>2</sup> or 17 C60 cassettes, even though their tracks are narrower.

It should not be assumed, on the basis of this comparison, that PCM technology will in the future consume enormous amounts of tape for storage purposes. The intention is only to show that completely different ancillary conditions must be created for the maximum effectiveness of PCM audio technology than has previously been achieved for analog technology. Even using video recorders for PCM sound recording results in a certain wastage of storage area, because playing times of PCM and video recordings are virtually identical, despite the lower data rate required compared with video recordings. Adjustment of the requirements of PCM could permit approximately three times more playing time.

A recorder system with equipment and cassettes roughly the size of today's cassette deck would be superior to a video recorder with a PCM audio adaptor. Carefully extrapolating today's knowledge of pickup and tape technology (Figure 4), it is conceivable that PCM signals could be recorded onto a compact cassette with no loss of playing time, and without leading to a reduction in reproduction quality compared with the digital record. Four track heads would be required with a somewhat narrower gap between them compared with current video pickup heads, or special heads for vertical magnetization, which would then have only one or

	relative storage area m <sup>2</sup> /h	units of known sound carriers	data rate with binary transmission
digital phonograph record	0.011	1 side of record	~ 2Mbit/s
LP record	2.6	24 LPs (both sides)	~ 0.1Mbit/s
¼-inch tape	27.1	4.4km tape 8 track 18cmØ	~ 0.2Mbit/s 2x2 tracks 9.5cm/s
compact cassette	11.6	2.9km tape 17 C60 cassettes	~ 0.1Mbit/s
video recorder (PCM improved)	0.31	~ ⅓ of a 60 min. videocassette	~ 2Mbit/s
compact cassette (PCM improved)	0.36	1 C60 cassette (both sides)	~ 2Mbit/s 2x4 tracks 4.75cm/s

Comparison: current analog storage facility – PCM storage facility.  
Data set: 7.1Gbit (binary signal).

Figure 3 Trend – PCM sound carrier.

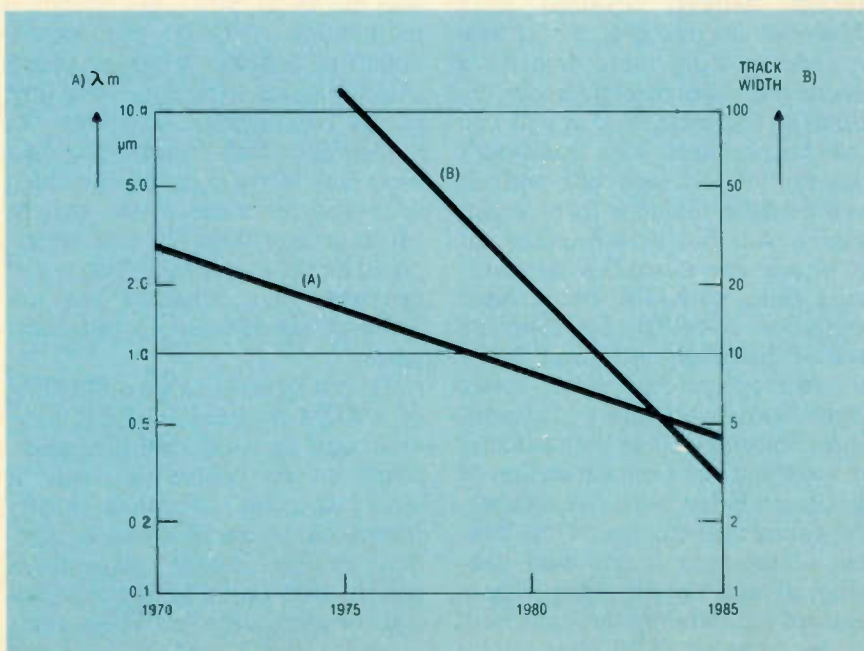

Figure 4 Trend – video recorder recording

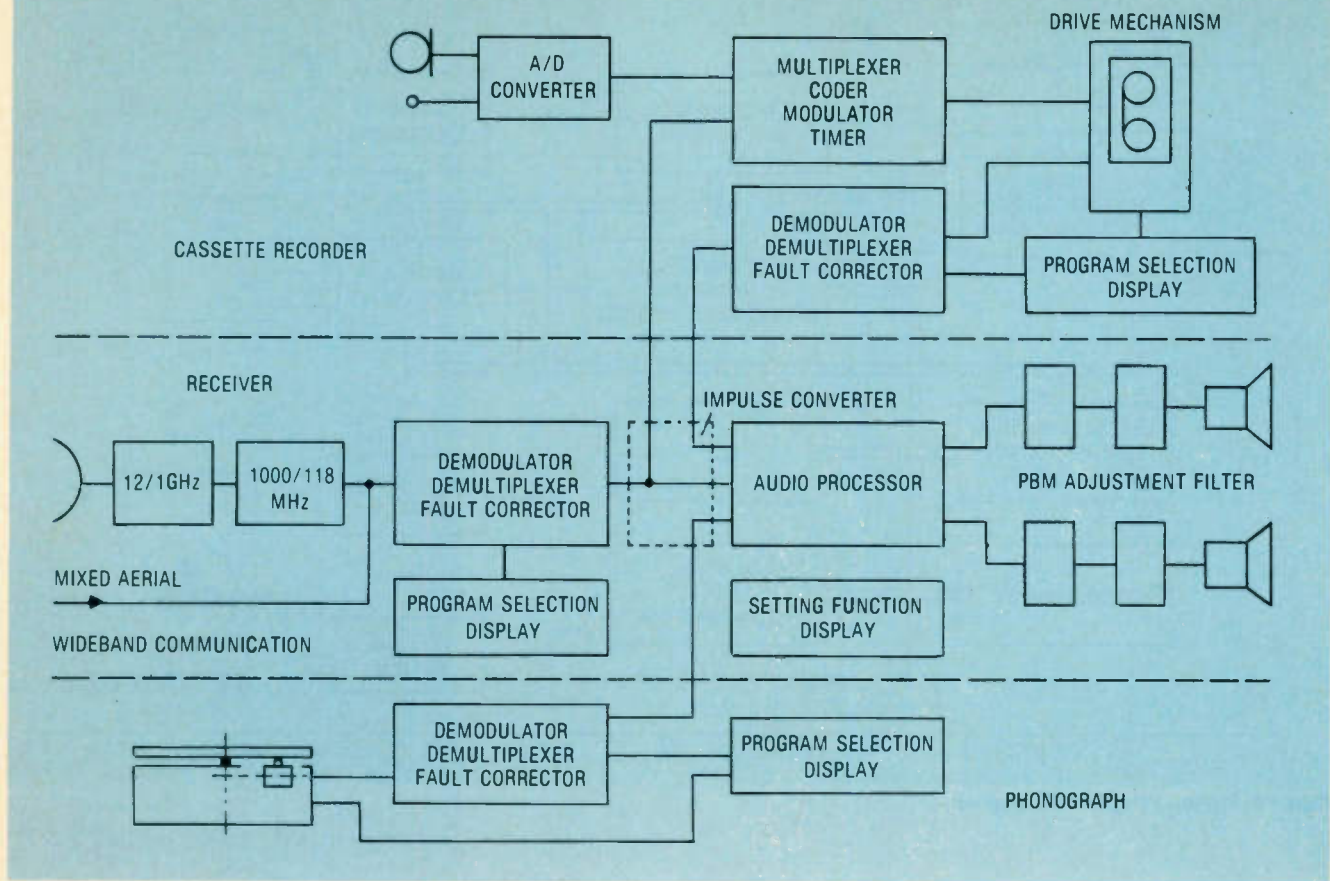

Figure 5 Trend – PCM hi-fi unit

possibly two tracks in each playing direction.

It goes without saying that the same ease of operation available with PMC record players could be enjoyed with a PMC cassette recorder, such as exact search device and alphanumeric display of the cassette content. On the other hand, modulation control, switching to accommodate various kinds of tape, compander selection and similar analog features would be unnecessary in the feature.

The most effective combination of such PCM hi-fi equipment is displayed using a block circuit diagram in Figure 5.

The assumption that all sound sources would use the same transmission code could be fulfilled, but the properties of the individual transmission channels (expected fault rate, types of fault and channel width) and of the technical expense that they involve would determine the best possible transmission code in each case. Although we need not be concerned that the conversion from one to another code would have to make use of a multiple, quality-reducing digital/ana-

log/digital conversion, a convertor would at least be required that could convert from one to another scanning frequency. The technical expense involved in this depends on the choice of frequencies and their relation to one another, as well as from the relevant standardization bodies.

The complete changeover from the previous analog technology to the new PCM technology will certainly not take place all that rapidly because of the many hi-fi units of the older design still in operation. At least a decade should be allowed.

#### TV sets and digital

Digital technology is also finding its application in TV sets. Although uses can be found for such items as remote control, channel selection and timers, i.e. the control sector, in coming years signal processing will also be digitalized. However, at first this will occur at a lower level—a logical conversion to PCM similar to that being carried out in the audio sector is not being planned. This is because the data rate is about 40 times greater than that involved with sound transmission.

Nevertheless, digital signal processing will bring advantages, although it calls for a double conversion from analog to digital and back to analog in the TV set. These advantages are:

- greater reliability,
- improved picture quality,
- easier operation,
- reduced energy consumption,
- simplified use of the TV set for additional peripheral operations, and
- “self-alignment” of the sets during manufacture.

It can be seen from the block diagram (Figure 6) that the TV signal is processed in an analog manner up to and including the stage of video and sound modulation, and is then digitalized in analog/digital convertors with differing data rates. Virtually all the subsequent signal stages of the set, including tuner adjustment, are regulated by the central control unit (CCU); a microprocessor makes it up with memories and the necessary intermediate stages.

As a result of the signal programming provided and a continuous comparison of nominal and true

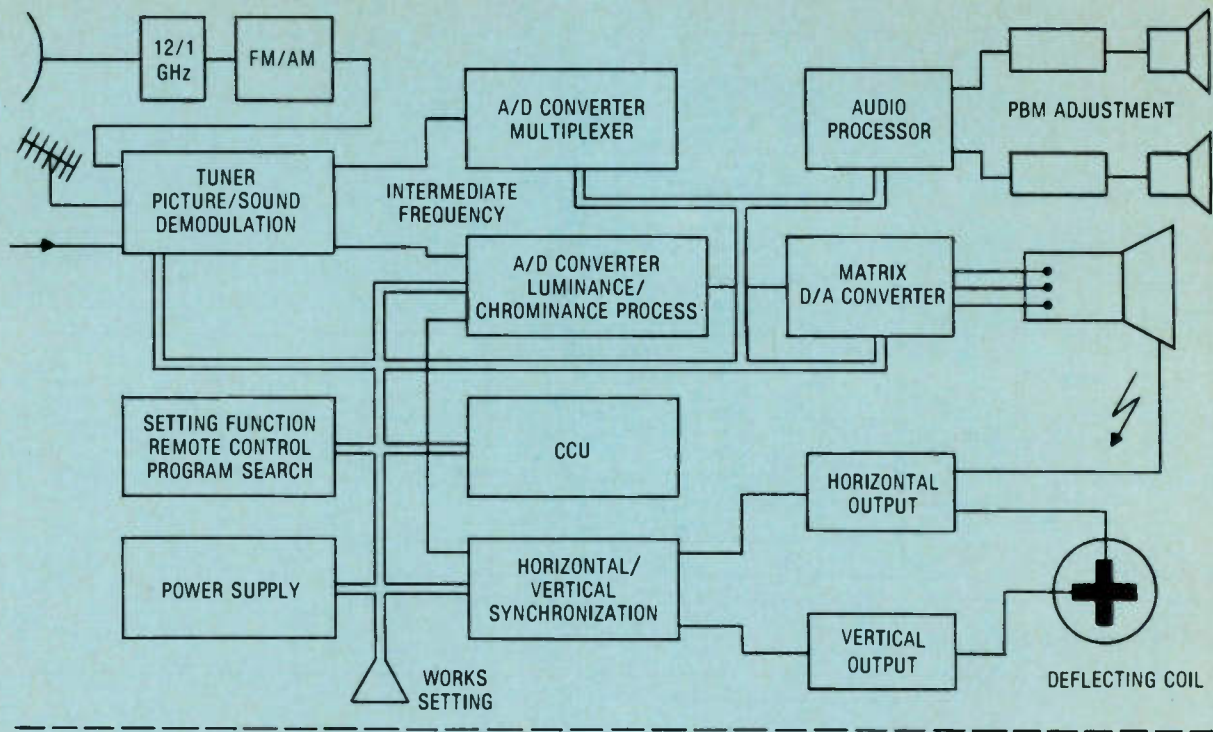

Figure 6: Trend — "Digital" TV receiver

## Consumer trends

values, changes in picture and sound reproduction as a result of aging can be retained within certain limits. Final alignment during manufacturing for the prescribed picture and sound adjustments is achieved by self-programming of the set.

In the transition from analog to digital technology, it should be pointed out that there should not only be a change of attitudes in development and production laboratories as well as in test departments, but the trade itself should make suitable readjustments relative to the advice and support of the industry. This not only applies to service technicians who must be trained but also for the equipment in servicing workshops.

Synchronous to the technological progress indicated in Figure 2, video recording and storage techniques will evolve on an analog basis into smaller cassettes, i.e., increased memory capacities. This is an advantage particularly for color cameras for private use, which will compete strongly with 8mm amateur films, not only with regard to picture quality and operating costs, but also as a result of the ease of operation and immediate monitoring of the picture.

Although the customary norm for a TV signal and for one hour's playing time requires tremendous data sets amounting to more than 250Gbit, digital magnetic tape storage for consumer electronics equipment is now available. Using special coding (D PCM), it has been possible to reduce the data rate to approximately one third without any appreciable loss of picture quality.

In addition to the efforts to reduce the required data rate for "consumer digitalization" of current color TV signals by means of various ingenious codes, discussions are also taking place about a high resolution, flicker-free color TV system employing more than 1000 lines.

Such a system could acquire added importance in particular if there was an increase in the amount of text information being transmitted, as well as for the reproduction of large-scale TV pictures. New means of transmission must be made available for such purposes due to the incompatibility of existing systems. These new methods could be provided by direct reception to satellite broadcasts or using wideband communication networks. The component manufacturers have declared a readiness to develop high

resolution color picture tubes, either using the aperture mask system with three times the hole density or even single beam tubes.

Even if the major changes in the engineering and technological fields of consumer electronics originate from digitalization in the coming years, particularly of transmission signals, a whole series of innovations should nevertheless be taken into consideration, because these will exert an influence not only on the design of equipment but will also place demands on the behavior of the consumer. Some examples are:

- videodiscs,
- identification of programs and stations using sound and picture broadcasting,
- traffic guidance systems,
- cable TV,
- wideband communications networks with return channel (Bigfon),
- single sideband AM radio, and
- large-picture television.

Today we do not anticipate any problems in the technical implementation of such developments. Success depends not only upon if individuals are in a position to make effective and conscious use of them, but also if the legal channels for such innovations are created. □





### Phase sequence and open phase indicator

A.W. Sperry Instruments Inc. announces the introduction of the AWS PSI-8031, dual-purpose tester for both phase sequence and open phase indication. The PSI-8031 indicates phase sequence using a rotating disc containing a large red dot. When viewed through the three round windows on the front panel, the red dot will rotate in a clockwise direction, indicating proper phase sequence.

For open phase checking, three lamps located on the front panel are used. Proper phase sequence will cause all three lamps to light. If phase sequence is not correct, the rotating disc will not turn and the lamp corresponding to the open phase will not light.

The AWS PSI-8031 is sealed against dust, has no exposed metal parts, is self-contained in a shock-resistant plastic housing and has a 60-inch linecord. A push-button ON switch and color-coded, insulated alligator clips make for easy use. The unit is palm-size, lightweight and readily portable. It can be used on a variety of 3-phase power sources from 110Vac to 600Vac. The PSI-8031 is an essential instrument for all who work with 3-phase motors, transformers and rotating equipment.

Circle (13) on Reply Card

### Emergency CB radio

The new Ready Rescue emergency 40-channel CB radio from Midland International is designed to provide security with a simple, portable means of communication for those

who want help within seconds in any kind of emergency. Use it in town or on the highway for any emergency, or for road and weather information.

The unit, with 4W output power, comes with a high-impact molded



carrying case, magnetic base helical antenna and a cigarette lighter power adaptor with 5-foot cord. It also has a built-in antenna adaptor, which allows the antenna to be mounted directly on the product for short-range communications. This feature is helpful in situations in which leaving the vehicle could be dangerous or inconvenient.

The helical antenna also can be attached to a magnetic mount base and placed on top of the vehicle for longer-range use.

Circle (16) on Reply Card



### Resistor organizer

Century's Econo-Pak resistor organizer model GL-25 offers 840  $\frac{1}{4}$  W, 5%, carbon film resistors

ranging from 0.68 to 4.7M (20 pieces each of 42 types). The resistors come in a durable plastic case measuring 6"x7"x3".

Circle (12) on Reply Card



### Power meters

A.W. Sperry Instruments Inc. announces the introduction of the SPM-2011 and SPM-2012 digital snap-around power meters.

The AWS power meters are 3-function, hand-held, self-contained instruments that measure true rms values of ac volts, amps and power, instantly and safely, without having to shut down the line or equipment. Large, digitally displayed LCD readings are easy to read and all front panel controls are at the user's fingertips.

Ranges for the SPM-2011 are ac volts 200/600Vrms; ac amps 2/20Arms; ac power 2/20kW; for the SPM-2012, ac volts 200/600Vrms; ac amps 20/200Arms; and ac power 20/200kW. Features include a specially designed circuit to measure true rms values; autoranging on all functions; auto-zeroing on all ranges; double surface protection for LCD; push-push data hold switch to freeze reading; analog output terminal for connecting to a recorder; specially designed safety test lead plugs; overrange indication; and low battery warning.

Circle (14) on Reply Card

# themarketplace

Advertising rates in the Classified Section are 35 cents per word, each insertion, and must be accompanied by cash to insure publication.

Each initial or abbreviation counts a full word.

Minimum classified charge \$3.00.

For ads on which replies are sent to us for forwarding (blind ads), there is an additional charge of \$3.00 per insertion to cover department number, processing of replies, and mailing costs.

Classified columns are not open to advertising of any products regularly produced by manufacturers unless used and no longer owned by the manufacturer or distributor.

## For Sale

**FREE**

**THE GREAT ELECTRONIC THINGS & IDEAS BOOK!**

HUNDREDS OF UNUSUAL PARTS, GADGETS & IDEA ITEMS, UNAVAILABLE IN STORES OR CATALOGS ANYWHERE! Bargain prices on everything! New items in every issue! Rush postcard for your copy!

ELECTRONICS Dept. 311 Plattsburgh, N.Y. 12901



Circle (10) on Reply Card

**AUTOMOBILE RADIO** and tape replacement parts. Delco, Chrysler, Philco-Ford, Motorola, Panasonic and many others. Large inventory. Laran Electronics, Inc., 3768 Boston Road, Bronx, NY 10469, (212) 881-9600, out of New York State, (808) 223-8314. 5-79-1f

**TV & RADIO TUBES**, 36 cents EA!! Free color catalog Cornell, 4221 University, San Diego, California 92104. 8-76-1f

**ELECTRONIC SURPLUS: CLOSEOUTS, LIQUIDATIONS!** Parts, equipment stereo, industrial, educational. Amazing values! Fascinating items unavailable in stores or catalogs anywhere. Unusual FREE catalog ETCO-011, Box 762, Plattsburgh, N.Y. 12901. 6-78-1f

**SCRAMBLED TELEVISION**, encoding/decoding. New book. Theory/circuits, \$9.95 plus \$1 shipping. Workshop, Box 393ES, Dept. E, Bethpage, N.Y. 11714. 7-80-1f

**FOR SALE:** Zenith sales and service shop near major highway complete with truck. 5 minutes to beach in Los Angeles area. \$25,000 plus inventory. Call Jim at 213-375-2233. 8-81-3f

**RECONDITIONED ROTORS** for TV, FM, CB antennas. Tele-Comm, Box 2910, Champaign, IL 61820. 8-81-4f

**OSCILLOSCOPES: SPECIAL SALE-HP & TEK 50MHZ DUAL TRACE**, \$595. Reg. \$695. Limited Quantities. Reconditioned, calibrated, guaranteed, free cat. A-OK ELECTRONICS, 1445 NW 9th St., Homestead, FL 33030, (305) 247-6349. 8-81-3f

**PRINTED CIRCUIT** boards from your sketch or artwork. Affordable prices. Also fun kit projects. Free details DANOCINTHS INC. Dept. ES, Box 261, Westland, MI 48185. 5-81-1fn

**FOR SALE**—2 antique Johnson White Lace radios, 5 channel. Call 712-278-2565. 10-81-1f

**TV REPAIR SHOP**, established (9 years), equipment, fixtures, lighted signs, alarm, burglar bars, \$10,000 cash. Houston, Texas 713/460-0778. 10-81-2f

**FOR SALE:** Commodore VIC-20 Personal Computer—\$259.95. CAL Computer Systems, Jetmore, KS 67854, Phone 316-357-6520. 10-81-1f

**B&K TELEVISION ANALYST** Model 1077B, brand new, \$375.00. Frank Edwards, Phoenix, AZ. 602-942-7603. 10-81-1f

**TUBES FOR TV AND RADIO**—35¢ ea. Washington TV Service, 1330 E. Florence Ave., Los Angeles, CA 90001. 10-81-5f

**EXCELLENT USED TEST EQUIPMENT:** Heath IG57 sweep generator \$75; Sencore TC161 tube tester \$30; High Voltage probe \$20; Parts subber \$10; Current model Zenith CRT test jig cost \$450, now \$200 with adaptors for nearly every major brand; Superior TV50 signal generator \$25; B&K 415 Sweep marker generator \$240; B&K 1077B analyst \$240; Freight collect. Fessenden T.V., 116 N. 3rd Street, Ozark, MO 65721, (417) 485-2501. 10-81-1f

**B&K TV ANALYST 1077-B** \$350.00, **B&K Tube Tester 747-B** \$200.00. Free \$50.00 worth of semiconductors with purchase. Gordon Gray, 16 Sheffield St., Pepperell, MA 01463. 10-81-2f

**FOR SALE—Heathkit 1G-57A Sweep Generator** \$150.00, 10-101 Vectorscope \$160.00. Corky's TV Service, 408 Merrill Pl., Elmhurst, NY 14904. 607-733-2375.

**PICTURE TUBE REBUILDING EQUIPMENT** capable of producing four high quality tubes per day (WILL TRAIN TO OPERATE). Call or Write Atoll Television, 6425 Irving Park, Chicago, Illinois 60634, ph. 312-545-6667. 10-81-6f

**FOR SALE:** B&K 415 Sweep Generator. Used twice, \$300, 24 Jefferson Ave., Morristown, NJ 07960. 10-81-1f

**FOR SALE:** 234 Sams Photofacts Auto Radio—Series 19 through 252, \$150.00 plus shipping. Paul TV, 7548 Belmont Ave., Chicago, IL 60634, 312-889-1245. 10-81-1f

**UHF VARACTOR TUNERS** with Internal AGC \$17.95 Dealer Net plus Shipping and C.O.D. Charges. Brand new units. Schematic drawing with each order, Channels 14 through 83, Output channels 2 and 3. Dimensions: 2.28" x 3.78" x 1.05" and 75 ohm. United Tuner Service, 1201 West Second Street, Bloomington, IN 47401, 812-339-2179. 10-81-1f

**FOR SALE:** Sam's Folders 48 thru 1121 near complete \$2.00 each, \$1.75 take all; prefer sell complete. Bowman's, 106 W. Grant, Shenandoah, Iowa 51601, 712-246-2705. 10-81-1f

## Help Wanted

**TV and 2-way Technicians wanted**, \$15K to \$22K per year. Benefits include employee stock purchase plan, in the largest Retail Service Center in Northwest Kansas. Friendly community, good schools, short drive to the Rockies. Equal Opportunity Employer. Miller's Electronics Inc., Goodland, KS 67735. 913-899-2386. 10-81-1fn

## Wanted

**NEEDED**—Sam's Photofacts, 254-13, 333-2, 436-13. H. Kerr, Rt. 1, Box 190, Grapeview, WA 98546. 10-81-1f

## Business Opportunity

**TV TECHNICIAN!** Increase your income up to \$60,000 yearly. Rent-lease-sell TVs new-used, even from comfort of your home. Basic Preliminaries \$4.00. Perry's TV Systems, Hwy 181, Box 142, Rt. 1, Bremen, KY 42325. 12-80-1f

**ESTABLISHED STEREO SERVICE CENTER** and small electronic parts distributorship located in sunny San Diego area. Steady business in service, and over-the-counter parts, plus merchandise sales. Business self-runs, except for bookkeeping and banking. Priced right, terms available (714) 578-9534. 10-81-3f

**"CALIFORNIA, SAN JOAQUIN VALLEY**, Television & Electronic Service and Sales. Established over twenty years. Agent, 4921 Blackstone Ave., Fresno, CA 93726." 10-81-1f

**TELEVISION SALES & SERVICE**, Sony & Zenith. Well established, 14 years. Good Gross. Poor health must sell. Owner will finance at 11%. Idaho-Oregon Realty, 35 So. 8th St., Payette, ID 83661, (208) 642-4494. 10-81-1f

**NATIONAL SERVICE MGR.** National distributor of highly engineered and designed consumer products seeks an experienced manager. We require an individual with a degree and several years experience in electronic repair and service management. This position is located in an attractive Chicago western suburban area and will have national responsibility for over 250 independent service organizations. Salary to \$40K per year plus bonus. Qualified candidates please send resume in confidence to: Dept. 525, Electronic Servicing, Box 12901, Overland Park, KS 66212. 10-81-1f

# advertisers' index

Creative Electronics .....	7
ETCO .....	44
Gamit Enterprises .....	15
Jensen Tools, Inc. ....	25
Keithley Instruments Div. ....	1
NATESA .....	23
NESDA .....	25
Oelrich Publications .....	23
PTS Electronics, Inc. ....	5
RCA Distributor & Special Products ...	3
Taber Manufacturing & Engineering Co. ....	21
Viz Manufacturing Co. ....	IFC
Zenith Radio Corp. ....	BC

## Electronic Servicing

### Advertising Sales offices

#### NATIONAL SALES MANAGER

Greg Garrison  
P.O. Box 12901,  
Overland Park, KS 66212  
Phone: (913) 888-4664

#### LONDON, ENGLAND

John Ashcraft & Co.,  
John Ashcraft  
12 Bear St., Leicester Square  
London, WC2H 7AS, England  
Phone: 930-0525 Telex: 895-2387

#### AMSTERDAM, Holland

John Ashcraft & Co.  
John J. Lucassen  
Akerdijk 150A  
1171 PV-Badhoevedorp, Holland  
Phone: 0-2968-6226 Telex: 18406 HARKE NL

#### TOKYO, JAPAN

International Media  
Representatives, Ltd.  
2-29 Toranomon 1-chome,  
Minato-ku, Tokyo 105, Japan  
Phone: 502-0656

#### NORWOOD, AUSTRALIA

Williamson & Associates Pty. Ltd.,  
John Williamson,  
P.O. Box 419,  
Norwood 5067, Australia  
Phone: 42-7074



For the man that would rather fix it himself –

# Technical Publications has service manuals designed for you!

SES-13 Small (Air Cooled) Engines Service Manual. \$9.95 (336 pages). You can service your own engines on lawnmowers, tractor sprayers and other power equipment. Special section on fundamentals, troubleshooting, preventive maintenance. Step-by-step instructions.

WLMS-1 Walking Lawnmower Service Manual \$7.95 (128 pages). The **complete** guide to the care and repair of your walk-behind, push-type lawnmower. Exploded views and diagrams.

CSS-6 Chain Saw Service Manual. \$8.95 (over 300 pages). Here's everything you need to know to tear down, repair, reassemble and adjust most popular chain saws. A truly **complete** chain saw manual.

GSM-1 Small AC Generator Service Manual \$7.95. A brand new manual that contains maintenance, service and troubleshooting procedures, as well as wiring schematics for most generator models. Covers electrical powerplants under 8kW that generate alternating current and are driven by air cooled engines.

OS1-8 Outboard Motor Service Manual Volume 1 \$8.95 (236 pages). Covers motors below 30 hp.

OS2-8 Outboard Motor Service Manual Volume 2 \$8.95 (232 pages). Covers motors with 30 hp and above. Both Volumes 1 and 2 provide detailed fundamentals on periodic servicing.

**Put these books to work on your own equipment... (Or service outside equipment for profit!)**

- Small (Air Cooled) Engines Service Manual
- Walking Lawnmower Service Manual
- Chain Saw Service Manual
- Small AC Generator Service Manual
- Outboard Motor Service Manual (Vol. 1)
- Outboard Motor Service Manual (Vol. 2)

Remittance must accompany orders of less than \$25.00. Postage paid when payment accompanies order. Allow four weeks for delivery.

How to send money: The best way to send money is your own personal check, post office money order, express money order or by bank draft or check. DO NOT SEND CURRENCY OR STAMPS.

- Check Money Order Enclosed
- Ship C.O.D. (No C.O.D.s outside of U.S.)

Missouri and Kansas Residents add 4% sales tax. Tennessee Residents add 6% sales tax.

Write for a free catalog covering our entire line of service manuals and wheel-type tractor service manuals.

- VISA
- MASTERCARGE

Credit Card Number \_\_\_\_\_

Expiration Date \_\_\_\_\_

Please Print:

Name \_\_\_\_\_

Street \_\_\_\_\_

City \_\_\_\_\_

State \_\_\_\_\_ Zip \_\_\_\_\_

Signature \_\_\_\_\_

 **Technical Publications**

Division  
Intertec Publishing Corp.  
P.O. Box 12901, Dept. ES  
Overland Park, KS 66212  
(913) 888-4664

# Strike it rich

in the fastest growing segment  
of the TV business

with a line of VCR and Video Disc Player  
accessories as strong as its name.

Now, Zenith brings you an assortment of the fastest-moving VCR and Video Disc Player accessories, each individually packaged and labeled to sell on sight from the 54" x 36" floor display as shown. Prominently displayed are such accessories as dust covers, video tape ID kits, cassette storage modules, signal splitters, attenuators, terminators, A-B

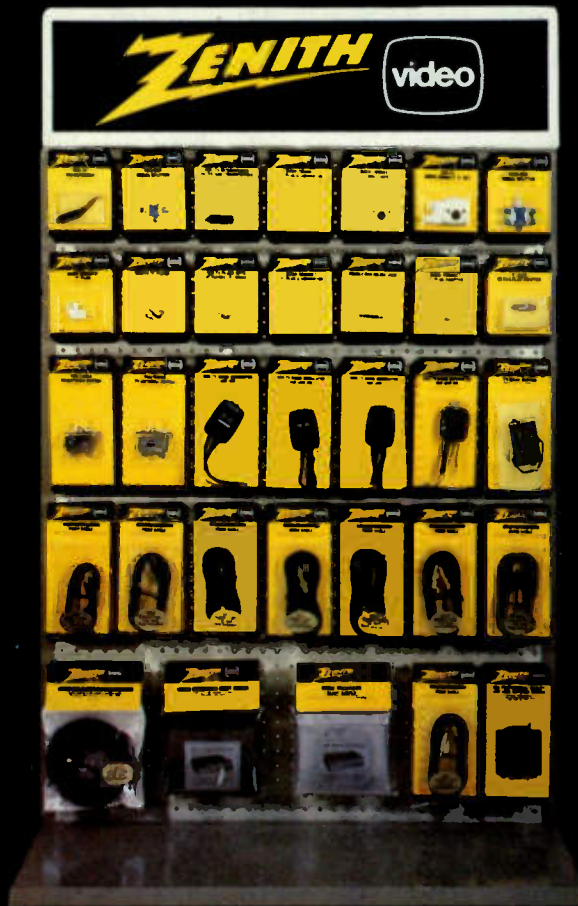

switches, "F", mini, and other types of plugs and jacks in virtually any combination, plus cables in a variety of lengths each with gold-electroplated connectors. All with the built-in acceptance of TV's leading name for quality home entertainment products. Call your Zenith distributor now for his strike-it-rich VCR and Video Disc Player Accessory Program.

**ZENITH**  
The quality goes in before the name goes on<sup>®</sup>

Zenith Radio Corporation/Service, Parts & Accessories Division/11000 Seymour Avenue/Franklin Park, Illinois 60131

Circle (2) on Reply Card