

For industrial maintenance and consumer servicing professionals

March 1981 □ \$2.25

Electronic Servicing

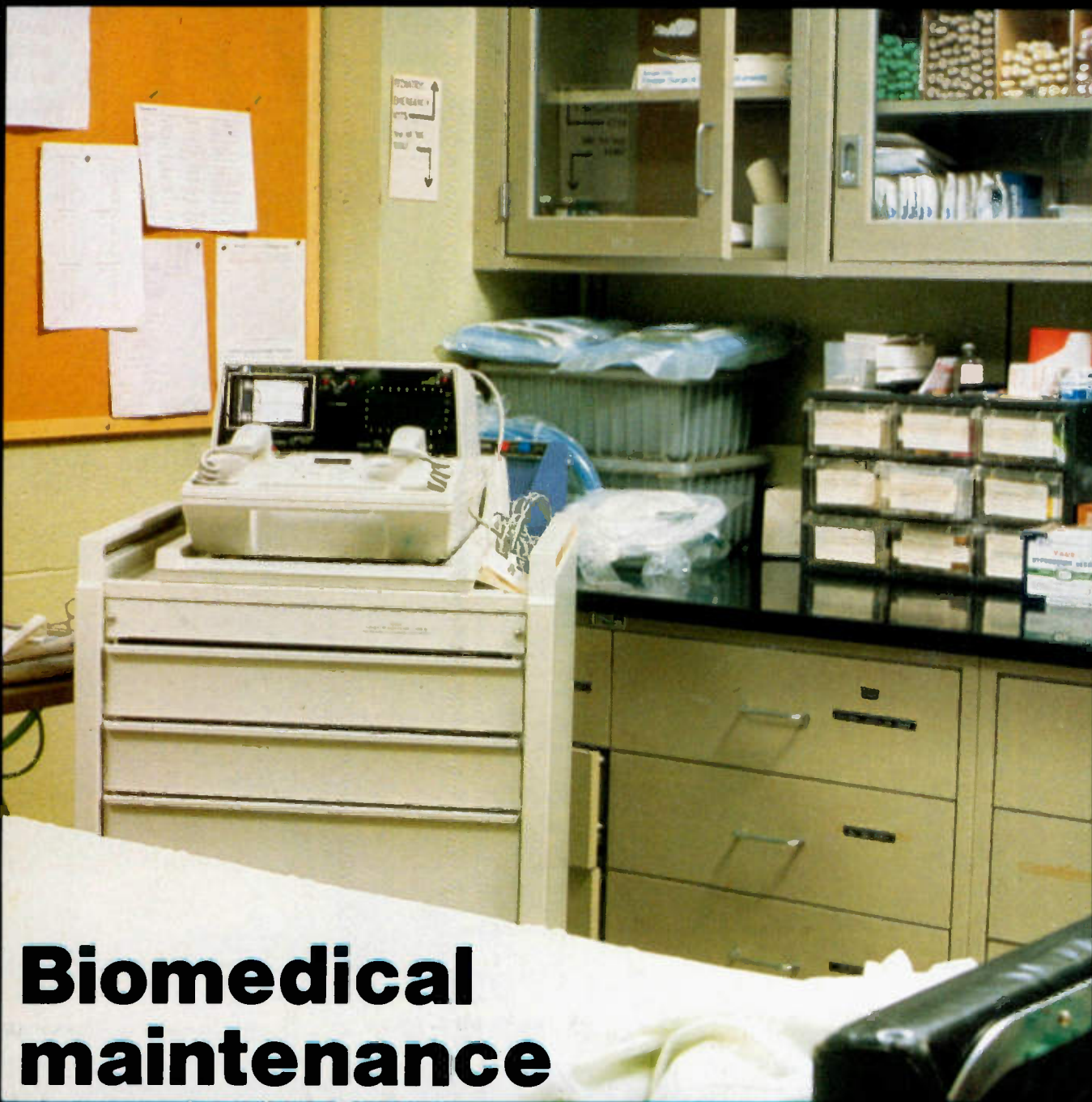

**Biomedical
maintenance**

Zenith tuners and IF



LOOK INSIDE THE SP-170.

1.
Safety fuse used with spare fuse.

2.
Compartmented and isolated power supply with "Lock-in" protection.

3.
Ohm pot mounted and connected directly to PCB.

4.
Easily accessible adjusting resistors.

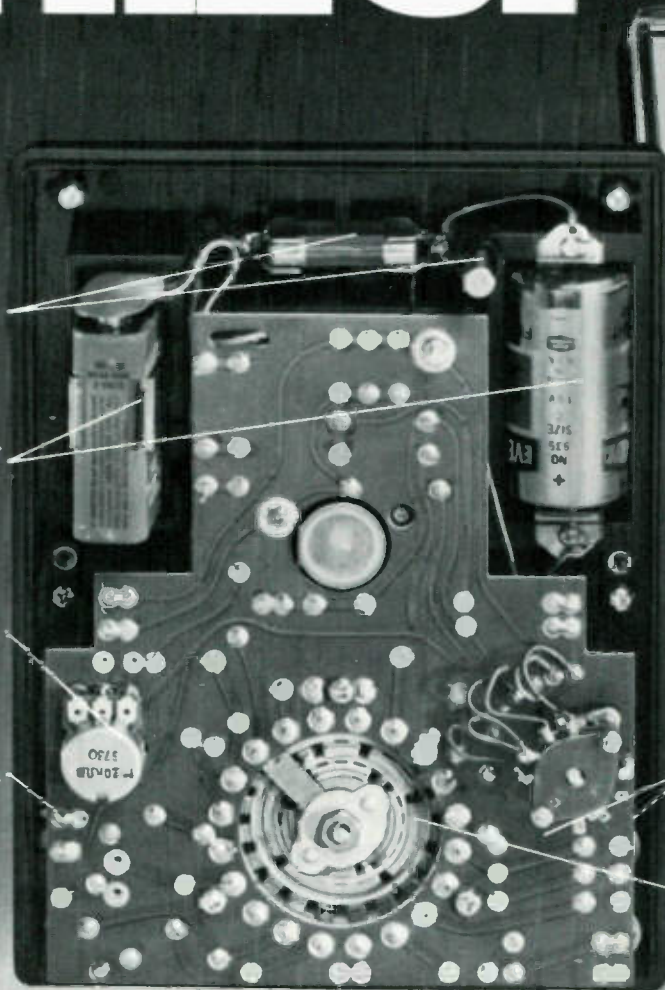

5.
Wave soldered advanced PCB design, with beefed-up ribbon dimensions and moisture resistant coating.

6.
Rigid train deck switch design, with positive ball-detented action.

FOR THE MEASURABLE ADVANTAGE

We've turned our versatile SP-170 Multi-Tester inside out, and as you can see, we're not afraid to get caught with our cover off. All we cover up is superior engineering and workmanship.

For your toughest trouble-shooting jobs, the SP-170 measures AC/DC voltage, DC current, or resistance; and features 24 ranges. Lightweight and compact with a rugged ABS plastic case, it has a safety-designed front panel with an easy to read two-color scale and a 21-position selector switch. Some of the

key features are pointed out above, but what you don't see is our six-month guarantee with your first repair or calibration free.

We challenge you to uncover your Multi-Tester and compare it to ours. Then you'll see why the SP-170 gives you the measurable advantage. For more information write or call your distributor or contact A.W. Sperry Instruments Inc., 245 Marcus Blvd., Hauppauge, New York 11787, 800-645-5398 Toll-Free. (N.Y., Hawaii, Alaska call collect 516-231-7050).

A.W. SPERRY INSTRUMENTS INC.
The Measurable Advantage.

Circle (1) on Reply Card

Electronic Servicing®

Editorial, advertising and circulation correspondence should be addressed to P.O. Box 12901, Overland Park, KS 66212 (a suburb of Kansas City, MO); (913) 888-4664.

EDITORIAL

Bill Rhodes, *Editorial Director*
Carl Babcoke, *Consumer Servicing Consultant*
Kevin Klous, *Managing Editor*
Mary Thornbrugh, *Associate Editor*

ART

Linda M. Pocsik, *Graphic Designer*

CIRCULATION

John C. Arnst, *Director*
Evelyn Rogers, *Manager*
Dee Manies, *Reader Correspondent*

ADMINISTRATION

R. J. Hancock, *President*
George Laughead, *Publisher*

ADVERTISING

Greg Garrison, *National Sales Manager*
Mary Blrbaum, *Production*

Regional advertising sales offices listed near Advertiser's Index.



Member,
American Business Press



Member,
Audit Bureau
of Circulation

ELECTRONIC SERVICING (USPS 462-050) (with which is combined PF Reporter) is published monthly by Intertec Publishing Corp., P.O. Box 12901, 9221 Quivira Road, Overland Park, KS 66212. Controlled Circulation Postage paid at Shawnee Mission, KS 66201. Send Form 3579 to P.O. Box 12901, Overland Park, KS 66212.

ELECTRONIC SERVICING is edited for technicians who repair home-entertainment electronic equipment (such as TV, radio, tape, stereo and record players) and for industrial technicians who repair defective production-line merchandise, test equipment, or industrial controls in factories.

Subscription prices to qualified subscribers: 1 year—\$12, 2 years—\$19, 3 years—\$24, in the USA and its possessions. Foreign countries: 1 year—\$17, 2 years—\$27, 3 years—\$35. Subscription prices to all others: 1 year—\$25, 2 years—\$50, in the USA and its possessions. Foreign countries: 1 year—\$36, 2 years—\$72. Single copy price \$2.25; back copies \$3.00. Adjustment necessitated by subscription termination to single copy rate. Allow 6 to 8 weeks delivery for change of address. Allow 6 to 8 weeks for new subscriptions.



INTERTEC PUBLISHING CORP.
© 1981. All rights reserved.

The one tool that pays for itself first time out.

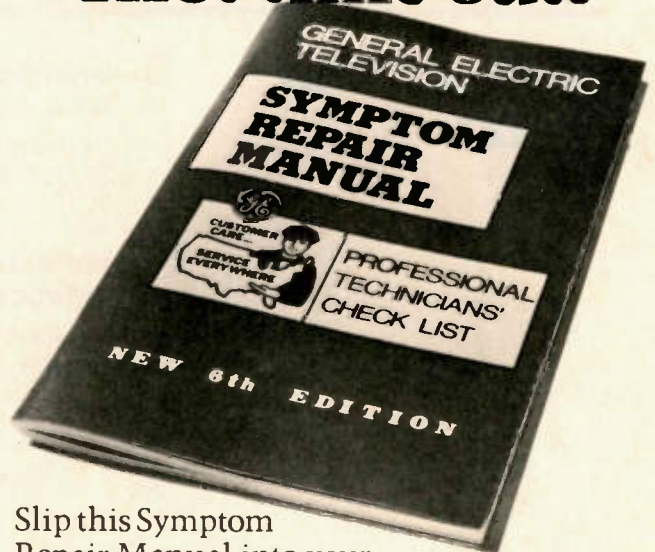

Slip this Symptom Repair Manual into your tool caddy. It lists all sorts of symptoms for individual GE TV chassis and tells you what to check and in what order. You can save hours of frustrating (and unprofitable) diagnostic time.

The new Sixth Edition manual packs the combined experience of hundreds of service technicians into a 5½" by 8½", 104 page package. It's free to subscribers of GE Technical Data, but non-subscribing technicians may obtain a copy by paying a \$2.00 handling fee. You can make that back in the first few minutes it saves.

"DUTCH" MEYER

GENERAL ELECTRIC COMPANY
PORTSMOUTH, VA 23704

ES

Please check items desired:

- One Symptom Repair Manual (\$2.00 Enclosed)
 Two Symptom Repair Manuals (\$3.00 Enclosed)

Enclosed is Check Cash or
 Money Order (No C.O.D. Please)

Name _____

Service Company _____

Address _____

City _____ State _____ Zip _____

IT'S OUR BUSINESS TO MAKE YOUR BUSINESS EASIER.

GENERAL  ELECTRIC

Electronic Servicing

March 1981 □ Volume 31, No. 3

Industrial MRO

5 Biomedical Electronics: New career field comes of age

*By John R. Raiger, CCE, CET, director of clinical engineering,
St. James Hospital, Chicago Heights, IL.*

13 Maintenance tips on the BVU-200 videocassette recorder

*By John J. Lapham, senior broadcast engineer, KOMO-TV4,
Seattle*

Consumer Servicing

19 Understanding and adjusting comb filters

*By Jim Smith, CET, Sencore national accounts manager,
and Greg Carey, Sencore chief field engineer.*

This article (adapted from a Sencore publication) describes the operation and adjustment of comb filters in two television receivers.

25 Zenith tuners and IF

By Gill Grieshaber, CET, Gill's Color TV, St. Joseph, MO.

Functions of circuits on the M1 module in Zenith's System-3 color receivers are discussed and illustrated.

Departments

4 Scanner	40 Test Equipment
34 Symcure	42 Product Report
37 Catalogs and Literature	43 Readers Exchange
38 Troubleshooting Tips	43 Photofacts

About the cover

Shown is a Hewlett-Packard Defibrillator, which is featured in *Biomedical Electronics: New career field comes of age*, page 5.

EXPAND YOUR SERVICING CAPABILITIES WITH SAMS BOOKS.

Any qualified service technician can cash in on the booming home, business and industrial electronics markets. With the right reference data and self-instructional books, you can quickly learn what it takes to service and adjust videocassette recorders, medical electronic instruments, electronic test equipment, office equipment...even the popular new personal computers. Howard W. Sams—the company that keeps you current on radio, television and CB's—can bring you up-to-date in electronics.

PHOTOFACT®

NEW VCR SERIES

Learn videocassette recording servicing and repair with the new Photofact Specialized Series. The same reliable Photofact information you've come to rely on for TV, Home Radio, Auto Radio and CB is now available for VCR's. Full photo coverage for easy identification of all components and wiring. CircuTrace® testpoints and functions. Standard notation schematics. Parts lists showing exact replacement. All mechanical and electrical adjustments. Actual oscilloscope waveform photographs...and more.

VCR-1 covers SONY VIDEOCASSETTE RECORDERS SL-7200 and SL-2700A. \$16.95.

RCA, ZENITH, JVC, MAGNAVOX, PANASONIC—Contact Sams or your Sams Photofact Distributor for information on VCR Photofact Manuals for these manufacturers.

REFERENCE

MODERN DICTIONARY OF ELECTRONICS (5th Edition)

Contains approximately 20,000 terms, including the latest in the fields of communications, reliability, semiconductors, medical electronics, microelectronics, fiberoptics, and computers. Includes separate coverage of schematic symbols, the International System of Units (metric) and a table of the Greek Alphabet. 832 pages. No. 21314. \$18.95.

REFERENCE DATA FOR RADIO ENGINEERS (6th Edition)

A valuable guide for anyone involved with radio and electronics. Includes information on active-filter design, optoelectronics, and optical communications... plus, micro-miniature electronics,

space communications, navigation aids, transistor circuits, reliability and life testing, waveguides and resonators, modulation. Has hundreds of charts, nomographs, diagrams, curves, tables and illustrations. 1344 pages. No. 21218. \$30.00.

1980 SEMICONDUCTOR REPLACEMENT GUIDE

180,000 up-to-date listings. 1,120 pages. Covers bipolar transistors, field effect transistors, diodes, rectifiers and integrated circuits. U.S., European and Far Eastern type numbers and manufacturers' parts numbers cross-referenced to General Electric, Mallory, Motorola, Raytheon, RCA, Sprague, Sylvania, Thorndarson, Workman and Zenith replacement parts. No. 21576. \$17.95.

SERVICE SHOP MANAGEMENT HANDBOOK

Complex electronic repair problems and government regulations have combined to frustrate service shop owners. This book tackles the business problems confronting the service shop owner and manager and provides practical, businesslike advice. 280 pages. No. 21602. \$9.95.

SERVICING

ADVANCED COLOR TELEVISION SERVICING

304 pages. No. 21517. \$14.95.

COLOR-TV SERVICING GUIDE (3rd Edition)

112 pages. No. 21437. \$6.95.

TV SERVICING GUIDE ARRANGED BY TROUBLE SYMPTOMS

126 pages. No. 20361. \$5.50.

TRANSISTOR-TV SERVICING MADE EASY

160 pages. No. 20776. \$4.95.

SOLID-STATE SERVICING

160 pages. No. 20888. \$7.50.

MOBILE RADIO SERVICING MADE EASY

144 pages. No. 21178. \$4.95.

SCANNER-MONITOR SERVICING GUIDE

96 pages. No. 21306. \$4.95.

CB RADIO SERVICING GUIDE (3rd Edition)

160 pages. No. 21074. \$4.95.

RECORD CHANGER SERVICING GUIDE (2nd Edition)

96 pages. No. 21423. \$4.95.

TAPE RECORDER SERVICING GUIDE (2nd Edition)

112 pages. No. 21594. \$5.50.

BASIC ELECTRICITY/ELECTRONICS TROUBLESHOOTING COURSE

128 pages. No. 21590. \$8.95.

SERVICING ELECTROCARDIOGRAPHS

224 pages. No. 21210. \$12.95.

ORDER FORM

HOWARD W. SAMS & CO., INC.
4300 West 62nd Street, P.O. Box 7092
Indianapolis, IN 46206
(317) 298-5400

Indicate quantity in boxes above and complete ordering information below:

Sub Total _____

Add local sales tax where applicable _____

GRAND TOTAL _____

PAYMENT ENCLOSED
 CHECK MONEY ORDER
 MASTER CHARGE VISA

Exp. Date _____

Account No. _____

Interbank No. (Master Charge only) _____

Minimum Credit Card Purchase \$10

Name (print) _____

Signature _____

Address _____

City _____ State _____ Zip _____

Prices subject to change without notice. All books available from Sams Distributors and Bookstores. Offer good in U.S. only. In Canada, contact Lenbrook Industries Ltd., Scarborough, M1H 1H5, Ontario, Canada

Howard W. Sams & Co., Inc.

electronic scanner

news of the industry

EIA Business Council elects new officers

The Electronic Industries Association's International Business Council recently elected its 1981 officers at its annual general membership meeting, which was held in Los Angeles.

Chairman of the council for 1981 will be John B. Copeland, Motorola. Charles J. Berthy, Ledex, and Robert L. Mullen, The Singer Company, were elected vice chairmen.

EDS '81 attracts new exhibitors

Twenty-two new manufacturer participants will participate in the 1981 Electronic Distribution Show in Atlanta, according to the Electronic Industry Show Corporation.

The new participating companies include: Seal-O-Matic Corporation; Duracell International Inc.; Bose Corp.; Instrumentation & Control Systems Inc.; Augat Inc.; Intelesca; Hameg Inc.; Prentice-Hall Inc., General Book Marketing Division; American Device Mfg. Co.; XPORT Trading; Holmberg Electronics; Electric Switches Inc.; Scientific Technology Inc.; Dale Electronics Inc.; Magnum Electric Corp.; Jeron Electronic Systems Inc.; Precision Electronics; A. W. Sperry Instruments Inc.; Electronic Components Groupe; and Horian Engineering Inc.

A.W. Sperry appoints seven new representatives

A. W. Sperry Instruments Inc. has announced the appointment of seven new representatives to handle their electronic test equipment line. They are: Steve Fisher Sales Corp., 221 Degraw Ave., P.O. Box 438, Teaneck, NY 07660; Pecore Associates Inc., 5226 Baltimore National Pike, Suite 4, Baltimore, MD 21229; Rohr-Wanger Sales Inc., 1169-D. W. Oakland Ave., P.O. Box 2842 CRS, Rock Hill, SC

29730; Professional Marketers Inc., 5223 Carmilfra Dr., Sarasota, FL 33581; Electronic Salesmasters Inc., 24100 Chagrin Blvd., Beachwood, OH 44122; Chet Wells & Co., 3912 London Ln., Box 18794, Fort Worth, TX 76118; and The Corrigan Agency, Mandeville West Complex, #4 Lovers Ln. Unit E, Mandeville, LA 70448.

NEDA report calls fiscal '80 a successful year for distributors

United States industrial electronic distributors enjoyed a generally successful fiscal 1980, according to data released by the National Electronic Distributors Association. As part of its annual Distributor Performance Survey, NEDA collects, analyzes, and reports industry financial data for firms primarily engaged in OEM industrial distribution.

This year's report contains data from 31 distributors based on fiscal years closing within 1980. These firms accounted for about \$750 million in annual sales. All measures reported were medians of the group.

According to NEDA, after tax profit was 2.41%, and after tax return on equity was 19.1%. Median growth from the previous year was 21.4%, and the 18 largest firms in the sample reported a median growth of 32.4%. Average gross margins were 26.2%.

Inventory turnover, based on cost of goods sold, was 4.5 times. The "turn and earn profitability index" (the product of gross margin times turnover) was 126.

In productivity measures, the firms reported \$159,000 of sales per employee, and \$41,000 of gross profit per employee. The companies averaged \$870,000 of sales per outside salesperson. Total payroll costs consumed 49.2% of gross profit dollars, and total operating expenses accounted for 21.4% of sales and 80.5% of gross profit.

Debt was reported at 236% of net

worth, with interest expense equaling 1.47% of net sales. Current assets were 1.7 times current liabilities.

Participants in the survey received reports showing the best, the median, and the worst performers in each category, based on the measure itself and on a ranking of the survey participants according to return on total assets. They also received the data showing results for the large companies vs. the small companies.

The raw data was collected and the results tabulated by an outside consulting firm to maintain confidentiality of individual companies' responses.

National Sound and Communications Association relocates

The National Sound and Communications Association has announced relocation of offices to 5105 Tollview Dr., Suite 201, Rolling Meadows, IL 60008. The new telephone number is (312) 577-8350.

Video product sales to retailers increase

Continuing the strong performance of 1980, total United States market sales to retailers of major video products soared again in 1981. According to industry statistics compiled by the Marketing Services Department, Electronic Industries Association's Consumer Electronics Group, January 1981 sales of color TV receivers were 885,268 units, a gain of 39.1 percent over 636,316 units sold in January 1980. Monochrome television sales to retailers in January 1981 also increased to 459,242 units, a gain of 41.1 percent over 325,376 units sold in January 1980. Home videotape recorder sales totaled 79,767 units in January 1981, an increase of 97.2 percent over 40,443 units sold to retailers in the first four weeks of 1980.

BIOMEDICAL ELECTRONICS: New career field comes of age

By John R. Raiger, CCE, CET
Director of clinical engineering
St. James Hospital
Chicago Heights, IL

This Hewlett-Packard Defibrillator contains technology that an experienced biomedical technician should be familiar with: analog input for EKG being digitally stored for nonfade display, high-voltage electrical generation, mechanical chart recorder and a microprocessor controller to indicate the amount of energy a patient actually received.



The sophistication of diagnostic and therapeutic medical instrumentation has with its advanced servicing requirements enabled the development of a new career field, the biomedical equipment technician.

It has been during the last 10 years that skilled personnel have been required to install, calibrate and repair the sophisticated monitoring instruments. The introduction of coronary care units along with advances made by spin-offs from the space programs have introduced highly technological equipment to the health care field. A person entering a hospital will encounter some form of electronics whether in nurse call, laboratory, radiology (X-ray) or monitoring. In

this article, types of electronic equipment encountered in the medical environment will be discussed that are in the realm of the electronics technician. A description of responsibilities of the biomedical engineering department (sometimes known as clinical engineering) will be included.

A biomedical department may contain one biomedical technician in a small community hospital, or perhaps two technicians and an engineer for a moderately sized facility. As hospitals become larger, offering more services to the patients, so too the biomedical or clinical engineering department must grow and specialize. Hospitals larger than 400 beds often have a department containing a director,

one or two biomedical engineers, each who in turn supervise several technicians and clerical support (Figure 1). Major medical centers will specialize even further and have a biomedical electronics department serving only surgery, a department serving only radiology and another covering clinical laboratory, maternity or therapeutic services, such as physical therapy, respiratory therapy and hyperbaric chamber.

Often the electronic devices other than the diagnostic or therapeutic items are handled by a separate electronics servicing group. Figure 2 lists the types of electronic devices in a health care facility as serviced either by the electronics department or the biomedical department. Al-

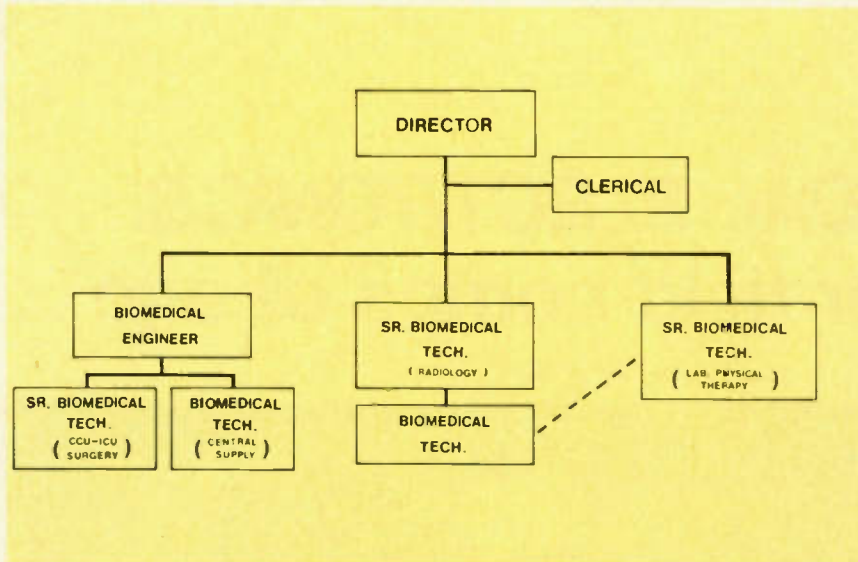

Figure 1 An example of the corporate structure of a clinical engineering department.

though this is a typical delineation of responsibility, many smaller institutions may have areas of responsibility mixed. The primary difference between the listing under biomedical compared with that under electronic falls under the subject of liability.

Liability here means improper diagnosis or treatment given to a patient from an instrument as a result of the servicing calibration or adjustment performed by the medical equipment service technician. To reduce the personal exposure and risk associated with servicing medical instruments, the technician must ensure that:

A. The device meets or exceeds manufacturer's specification.

B. The device is technologically current and still in use by the majority of health care facilities.

C. All repairs utilize manufacturers exact replacement parts or better, installed in a professional manner.

The technicians can no longer use short-cut methods of bridging open components or using approximate part substitutions as one might in the repair of consumer products. The service technician should be familiar with the proper operation of the device being serviced and the medical implications involved with improper repair. A life, the technician's career and the maintenance business are all at stake.

Biomedical technicians can be found working in one of four types of maintenance program options:

1. With original equipment manufacturers to repair and maintain the equipment they manufacture.

2. With an independent service vendor that is a privately owned company established to service biomedical equipment. This is comparable to a local television repair shop.

3. Shared services, which is a service organization formed by several hospitals to serve their common need of equipment repair.

4. In-house service, in which all

Electronics department

- Television:
 - patient entertainment
 - closed-circuit
- Nurse call
- Public address system
- Fire alarm
- Radio paging system

- Security 2-way radios
- Master clock system
- Physicians register
- Automatic boiler controls
- Pneumatic tube system
- Parking gates
- Temperature controllers

Biomedical department

- Patient monitors:
 - EKG and rate
 - blood pressure
- Electrocardiograph:
 - 1-channel
 - 3-channel
 - Holter (long-term recorder)
- Infusion pumps
- Defibrillators
- X-Ray generators
- Ultrasonic therapy
- Laboratory devices:
 - Hematology
 - Chemistry
 - Pathology
- Fetal monitor
- Incubators
- Electro-surgical generators

Figure 2 A list of the types of electronic devices in a health care facility as serviced by either the electronics department or the biomedical department.

the service responsibilities are maintained by employees in the hospital or medical center. This is by far the most advantageous service method to a hospital and an ideal situation in which an electronics technician can learn about a wide variety of medical devices.

The responsibilities of a biomedical technician are considerably

more than repair and servicing of equipment. The technician may become involved with the concept or desire to improve medical services. In conjunction with the purchasing and engineering departments and the medical staff, contact with vendors will be made to help make a proper purchase evaluation. Items under consideration will be inspected for performance, electrical safety, conformance to manufacturer's specifications and compliance with existing codes and standards. In addition, serious consideration will be given to compatibility with existing systems and to ease and economy of maintenance or repair.

Following the incoming inspection, the technician will assist in the visual inspection of medical instruments to guard against physical damage, missing parts or accessories, loose parts or unsoldered electrical connections. The technician will also check for complete documentation including detailed operating and service manuals, schematics, parts list and calibration information. An electrical safety check is to be completed and compared with current codes and

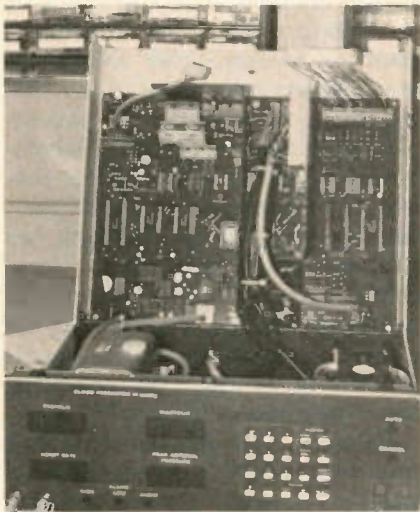

Figure 3 This Sentry noninvasive blood pressure monitor uses a 6800 for control and alarm functions as a nurse can set the limits to match the patient.



Figure 4 An understanding of digital logic is important in the calibration and servicing of modern medical instruments.

NOW, a mini-scope with the features most wanted by field engineers!



B&K-PRECISION MODEL 1420 \$825

This new 15MHz dual-trace mini-scope was designed by B&K-PRECISION engineers to respond to the special needs of field engineers... a mini-scope with lab-scope features.

It easily fits into a standard attache case with plenty of storage room for a DMM, tools and accessories. The 1420 can be powered from the AC line, 10-16VDC or an optional internal battery pack.

The rugged 1420 features dual-trace operation and an honest 15MHz response, with useful response beyond 20MHz. An efficient rectangular CRT displays waveforms with good readability under all field service conditions.

There is no sacrifice of features or performance for compact size. The 1420 has 18 sweep ranges from 1 μ S/div. to 0.5S/div. in a 1-2-5 sequence; variable between ranges. Sweep magnification is X10, extending the maximum sweep rate to 100nS/div. For use with computer terminals or video circuits, a video sync separator is built in. Automatic selection of chop and alternate sweep modes is provided, as is front-panel X-Y operation.

The Model 1420 measures only 4.5 X 8.5 X 12", weighs 7.75 lbs., with batteries and comes with two 10:1 probes.

FOR IMMEDIATE DELIVERY contact your local distributor or call TOLL-FREE, 800/621-4627 for a 16-page catalog brochure on the complete B&K-PRECISION oscilloscope line.

BK PRECISION

DYNASCAN CORPORATION

6460 West Cortland Street
Chicago, Illinois 60635 • 312/889-9087
Int'l. Sls. 6460 W. Cortland St., Chicago, IL 60635
Canadian Sales: Atlas Electronics, Ontario.

Circle (4) on Reply Card

standards. The performance test will confirm the manufacturer's claims and upon acceptance members of the biomedical engineering department will often be involved in the training of medical personnel

on the specifics of the new equipment.

Good assurance of quality and recommendations by accrediting agencies require periodic inspection of medical instruments. Of concern

are increased electrical leakage and reduced performance caused by age or use. Generators and stimulators, including defibrillators, must have their output inspected to ensure proper performance. The frequency of inspection varies from once a year to 12 times a year, depending on the type of device and its relation to life support.

Because a hospital contains almost every level of sophistication in electronic equipment, there are positions to match the abilities of many electronic technicians. Increasingly, equipment in patient-monitored areas and clinical laboratories is under microcomputer control. The noninvasive blood pressure monitor (Figure 3), which has become popular in surgery, intensive care units and emergency rooms, utilizes the popular 6800 for control. A strong digital logic background is valuable in servicing these instruments (Figure 4).

Because the signals obtained from the human body are low-level analog voltages, experience with differential and analog amplifiers will also prove useful. These are usually found in patient monitors, laboratory equipment and central station displays.

It is wise to be familiar with the function of the instrument and the terminology used by the medical professionals before making the service call. The technician must be able to talk with the doctor or nurse on their level to establish credibility.

Many of the devices in a hospital can be relocated to the shop for servicing. A portable X-ray machine can easily be brought into the shop for adjustment, although actual X-ray emissions must occur in a lead-lined area. Figure 5 shows a technician repairing the cable that controls the rotating anode. Likewise, portable monitors and electronic controllers can be serviced in the biomedical department (Figure 6). Some major systems can only be adjusted at the user location. The technicians in Figures 7 and 8 are opening up an X-ray generator in

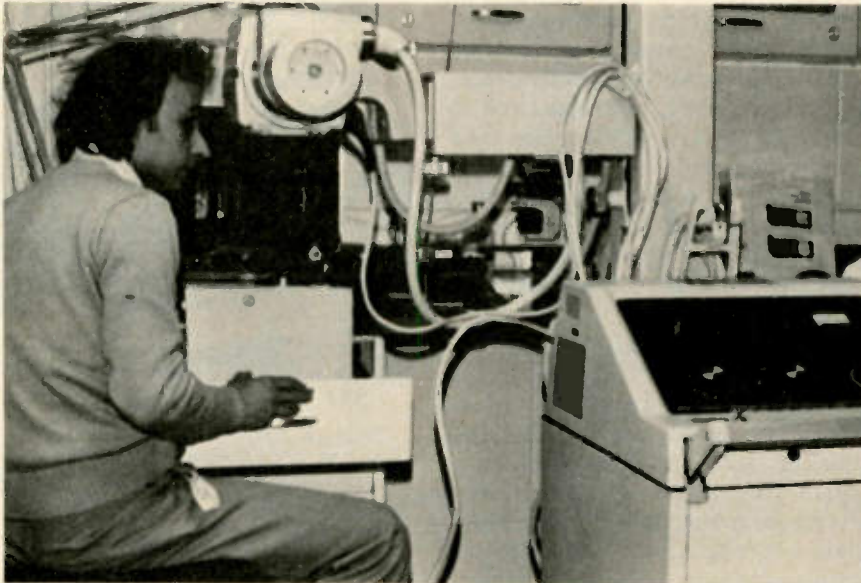

Figure 5 This biomedical technician moved a portable X-ray machine to the shop for servicing.



Figure 6 Small instruments are easily repaired in the shop using available test equipment and spare parts inventory.



Figure 7 A technician opens an X-ray generator in preparation of inspection and callbration.

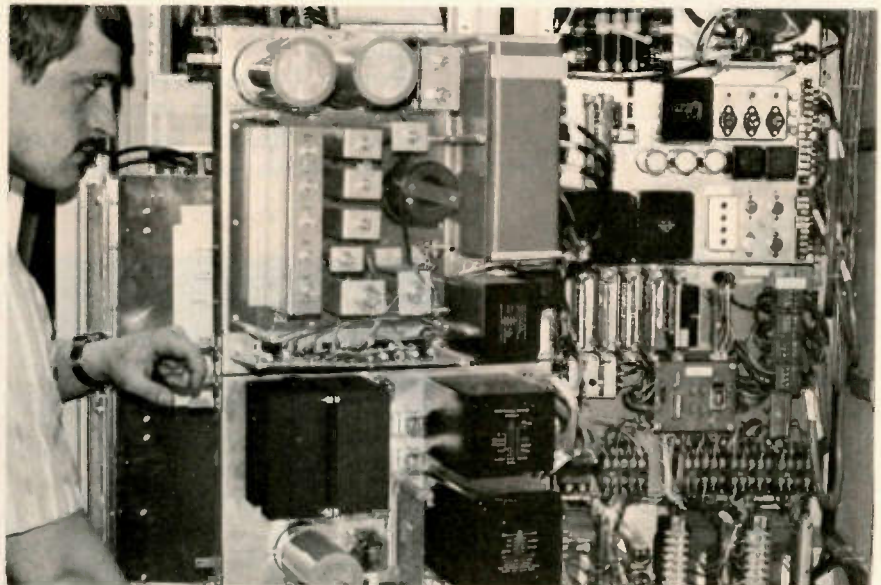

Figure 8 Major biomedical systems must be serviced in the user area as in this X-ray equipment.

**People
of all ages die of
heart disease
and stroke.**

**Put your money where
your Heart is.**



**American
Heart
Association**

WE'RE FIGHTING FOR YOUR LIFE

**We've
got**

**Now—the first handheld
4½ available from stock
at your local distributor.**



Model 130: 5 functions, 0.6" LCD, 0.5% basic accuracy, 10A current range, easy to use, rugged design\$115

Model 131: 0.25% basic accuracy, rugged design, easily accessible fuse and battery, increased bandwidth\$134

Model 135: The first 4½-digit handheld DMM on the market at the lowest price ever, 0.05% basic accuracy\$219

Prices U.S.A. only.

KEITHLEY

Keithley Instruments, Inc.
28775 Aurora Road, Cleveland, Ohio 44139
(216) 248-0400

Circle (5) on Reply Card

HOW TO GET BETTER MILEAGE FROM YOUR CAR...

Obey the 55 mph speed limit.



Keep your engine tuned.

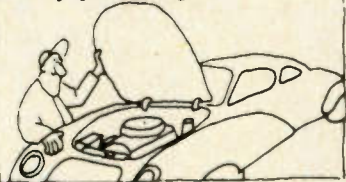

Avoid hot rod starts.

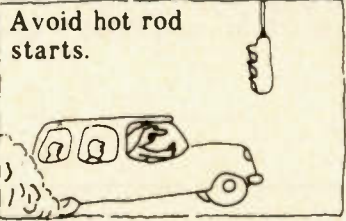

Drive at a steady pace.

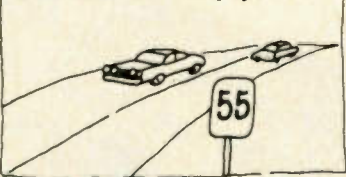

Don't let the engine idle more than 30 seconds.

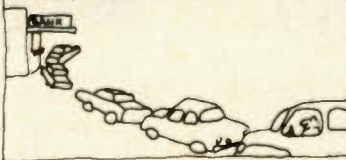

And when buying, don't forget the fuel economy label is part of the price tag, too.



For a free booklet with more easy energy-saving tips, write "Energy," Box 62, Oak Ridge, TN 37830.

ENERGY.
We can't afford to waste it.

U.S. Department of Energy

Biomedical

preparation for inspection and calibration.

Proper documentation of performance and safety inspections is important. Record keeping must include details on the symptoms,

in-house technicians are in demand. In the Midwest, a qualified electronics technician can expect to earn \$16,000-\$22,000 annually. The codes and standards associated with medical equipment are readily



Complete documentation and service records are an important responsibility for the biomedical technical.

the tests used to find the problem and the solution needed to provide repair. This is valuable in isolating operator errors and identifying recurring problems. The electronics technician will find much similarity in the problems associated with medical equipment and industrial/consumer products. However, the application of superb craftsmanship, complete documentation and the knowledge of physiological effects are the primary differences between a biomedical and an electronic technician. The technician in Figure 8 is documenting a recent service call.

The opportunities for qualified electronic technicians in a hospital currently exceed the supply. Traditionally, pay scales in the health care field could not compare with those of industry, but because the cost of a service call to a hospital averages one dollar per minute,

available, and a thorough understanding is required to command the higher salaries. An ideal entrance to biomedical electronics is through the hospital's electronics department. Alternatively, an interested person could work for a biomedical department as an assistant to an experienced engineer or technician who can assume final responsibility. Many junior colleges near metropolitan areas now offer courses in biomedical technology that include on-the-job training.

Further information regarding employment opportunities, standards and certification may be obtained from The Association for the Advancement of Medical Instrumentation, Suite 602, 1901 N. Ft. Myer Drive, Arlington, VA 22209; or The Midwest Biomedical Society, P.O. Box 416, Palos Park, IL 60464. □

Maintenance tips on the BVU-200 videocassette recorder

By John J. Lapham Jr.
Senior broadcast engineer
KOMO-TV4, Seattle

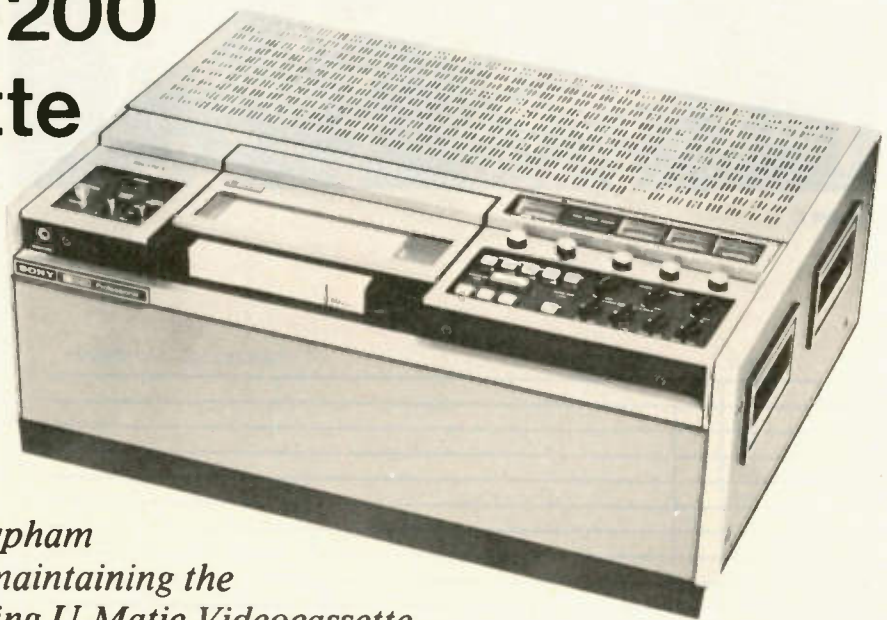

Routine maintenance on VTRs is crucial to maintain top quality performance. Lapham has extensive experience in maintaining the Sony 3/4-inch BVU-200 Editing U-Matic Videocassette Recorder in KOMO's new operations in Seattle.

Sony BVU-200 tape machines are the backbone of the KOMO-TV news and news magazine operation. Keeping these machines in acceptable operating condition is vital to the interests of the station. And keeping these machines on line calls for more than good luck. At KOMO a strong maintenance routine is the key to long machine life with few catastrophic breakdowns.

Access to a Sony BVU-200 Technical Manual is necessary to perform many of the routines described here. Numbers boldfaced in the text refer to sections in the technical manual.

Daily routine

Clean surfaces for tape travel are critical. The daily cleaning of these surfaces, (Figure 1) is the first step in keeping the 200s in good operating condition. Texwipes and alcohol are used to clean these surfaces. Also, use the tip of a

wooden stick to clean the ridge guide along the drum assembly. This ridge clogs with oxide residues and causes the tape to ride off the ridge (Figure 2).

1000 hour routine

A detailed maintenance log is kept on each machine, and all problems that bring a machine into the shop are recorded in this log along with the maintenance performed. The hours meter on the back of the machine is monitored and when 1000 hours is reached the machine is brought into the shop for a complete overhaul. This overhaul is extensive and requires anywhere from 24 to 40 hours of shop time.

The Sony technical manual is extensive in its coverage of maintenance of the BVU-200. Yet, not everything is necessary at any one time. Some steps need only be performed when a part is replaced.

A mechanical alignment maintenance form was devised to serve as a guide for the 1000 hour overhaul (Figure 3). But before any mechanical alignment is done, several preparatory steps are taken.

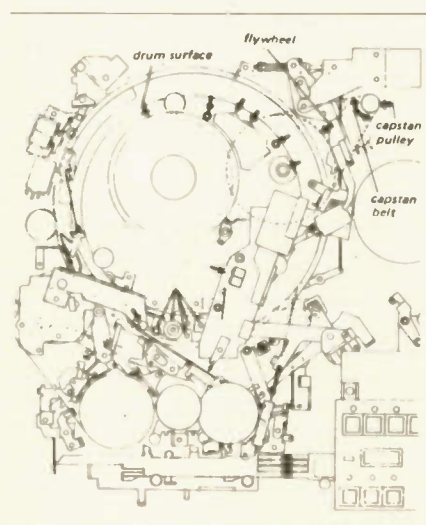

Figure 1

Drawings courtesy of Sony.



Figure 2

The first step is to strip the machine down and blow it clean with compressed air. After this, clean all tape travel surfaces with alcohol. Also use alcohol to clean any surfaces belts travel over.

Ensuring correct power supply voltages, Figure 4, is the next step. Measure all of them. It is useless to try any servo adjustments without first ensuring correct power supply voltages.

The parts inventory at KOMO is extensive and includes upper head drums, all solenoids, motors, and virtually every part that has been found to fail. Beyond that is a standard minimum number of parts that are always changed during the overhaul process (Figure 5).

Replacing recommended parts

The take-up reel has a clutch disc inside, which by 1000 hours can be quite worn. This causes the forward torque to fall outside of acceptable limits. A quick check is to grasp the table at the top and bottom (Figure 6) and rotate the bottom clockwise and counter-

S/N		
ADJ.	REMARKS	MECHANICAL ALIGNMENT
11-1		
11-2		
12-1		
12-2		
13-1		
13-2		
13-3		
13-4		
13-5		
14-1		
14-2		
14-3		
15-1		
15-2		
16-1		
16-2		
17		
18		
19-1		
19-2		
20-1		
20-2		
21		
22-1		
22-2		
22-3		
23-1		
23-2		
24-1		
24-2		
24-3		
24-4		
25		
26-1		
26-2		
26-3		
27		
28		
29-1		

DATE :

Figure 3 Sample alignment form.

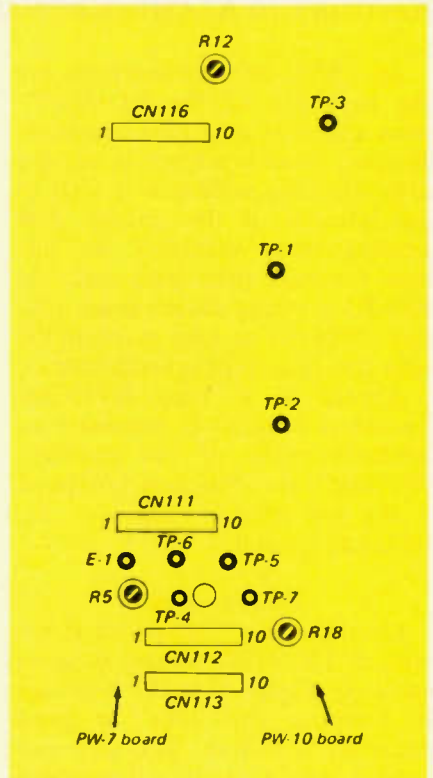

Figure 4 Power supply test points.

clockwise. In one direction there should be considerable resistance. A forward torque check during calibration will further reveal the condition of the table. Generally, the table is replaced.

The midway pulley assembly should also be replaced. Earlier assemblies had bronze bearings; the new units come with ball bearings, (Figure 7).

Another part in the same area, (Figure 8) is the FF-REW pulley assembly. Sometimes the inner disc squeezes out. This can be seen (Figure 9). The pulley is removed by first removing the FF-REW idler assembly and then slipping the pulley out from underneath. Pay particular attention to all bearings and washers when replacing the unit. If the pulley assembly is replaced, also replace the FF-REW idler wheel.

New brake band assemblies are mounted on a bracket that does not have gear teeth. The old units still have the gears. It is a simple matter to remount the new bands on the old brackets. After installing the new brake band, adjust the position of the supply tension regulator pin setting (Figure 10). Refer to section 13 of the technical manual for more detail.

Note that replacement of the 23V photo lamp (Figure 11) is merely precautionary. It's an inexpensive part and replacement now will probably guarantee one less service call later.

As shown in Figure 12 after 1000 hours the brushes become worn and replacement is recommended unless little wear is noted. Belts should also be replaced.

After thousands of uses, the slide function lever aperture becomes worn and distorted (Figure 13), especially when the machine comes from an ENG edit station. The widening of the aperture affects the alignment of the FF/REW/PLAY/EJECT links and can cause the machine to jam between modes. Replacement of this lever is simple and completes the parts replacement portion of the 1000-hour overhaul.

Recommended parts replacement for BVU-200 rebuild*

X-3642 044 5	Table assembly, take-up reel
X-3642-052-2	Pulley assembly
X-3642-061-1	Brake, band assembly
X-3642-067-0	Brake, p
X-3642-154-0	Brake shoe
X-3642-166-0	Brake shoe, stop
1-518-263-11	Lamp 23V 130ma
3-607-104-03	Brush
X-3642-050-2	Idler assembly, FF-REW
X-3645 087-1	Pinch roller
3-642-546-01	Belt, drive
3-642-547-01	Belt, capstan
3-648-002-02	Belt, drive FF-REW
3-648-004-02	Belt, drive motor
3-642-110-00	Lever, slide function

**Exact part numbers may vary with BVU-200 serial numbers.
Make a similar list for your particular unit(s).*

Figure 5

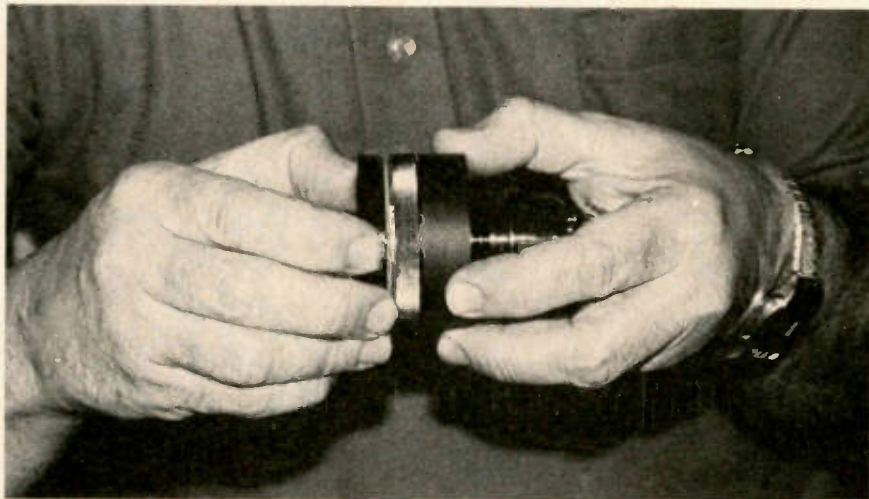

Figure 6

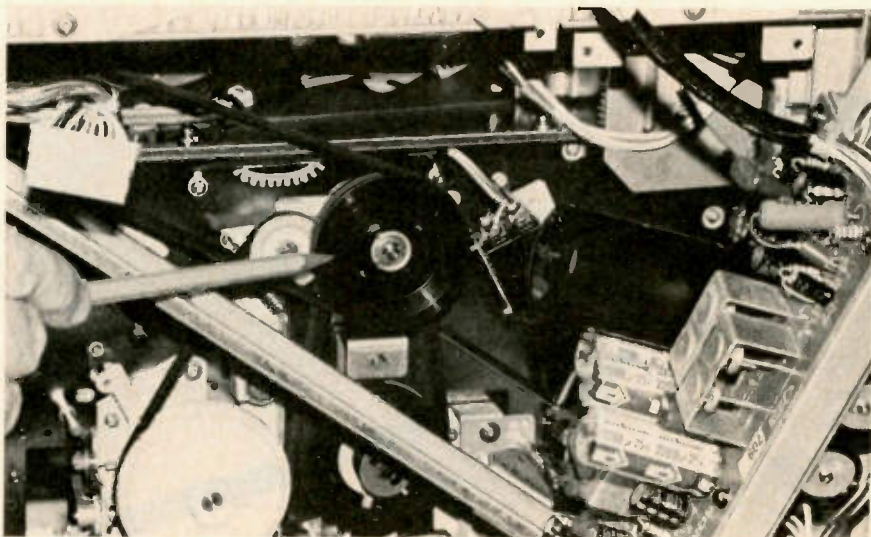

Figure 7 Midway pulley assembly. Note the FF/REW pulley underneath.

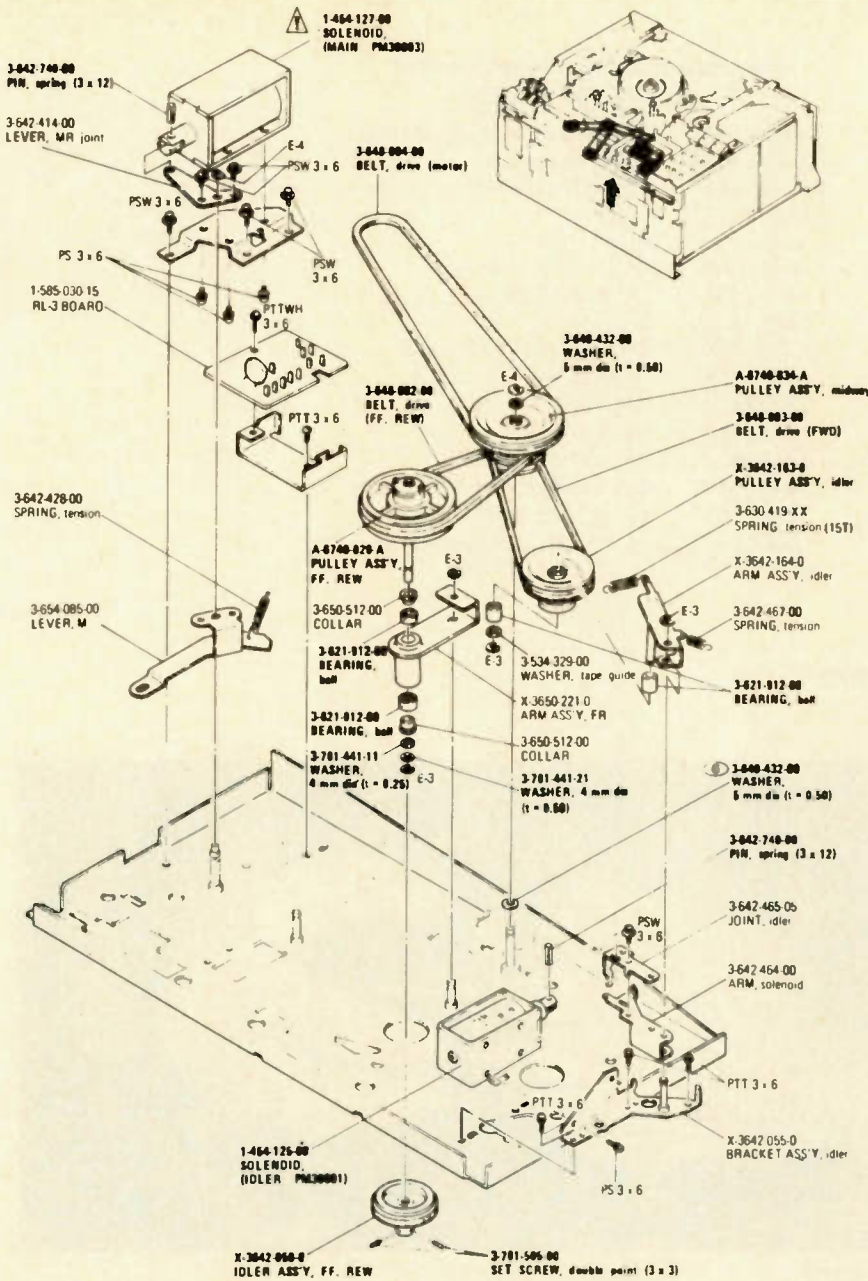

Figure 8 Diagram from the recorder manual lists part replacement numbers.

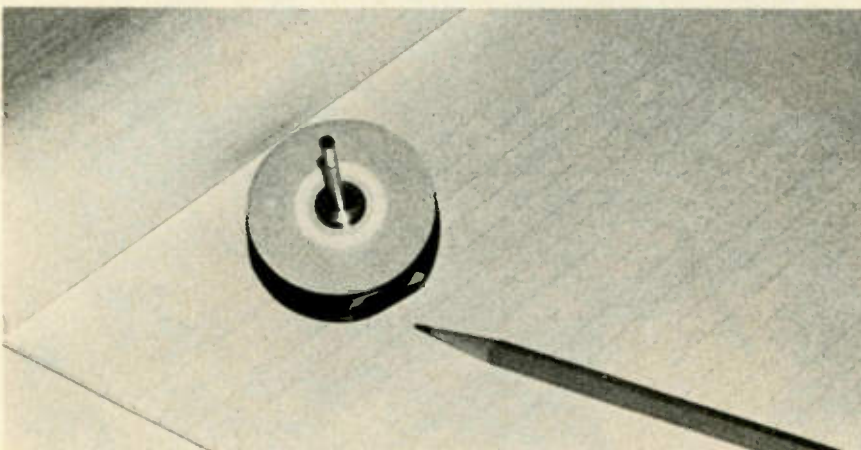

Figure 9 Note the warped disc protruding from the pulley assembly.

Mechanical alignment

All numbers on the mechanical alignment sheet refer to sections in the Sony BUV-200 technical manual.*

11-1,2. Take-up and supply table height adjustment (Figure 15). If this has never been checked before, now is a good time to do it.

12-1,2. Main solenoid adjustment (Figure 14) and idler solenoid adjustment (Figure 16). Adjustment is straightforward. Just be sure to loosen all of the solenoid mounting screws before attempting to reposition it. Before doing this, though, remove the solenoid plunger and clean both the plunger and receptacle with fine steel wool.

13-1,2,3,4,5. Proper braking action is critical to correct operation of the BUV-200, especially if the machine is going to be used in an editing station. Also take a close look at the supply reel brake assembly (Figure 17). Note the condition of the springs and also the S brake stopper. It is a good idea to have a supply of both the springs and the stopper on hand because both of these parts seem prone to failure—the stopper by bending and cracking at the base and the spring by breaking.

Note: The code numbers in this section refer to Model 200 systems of a limited range of serial numbers. Manuals for other serial numbers, and for the Model 200A, differ in certain sections. However, the graphics and generic terms can be correlated with the proper sections of any manual, regardless of the specific code numbers used.

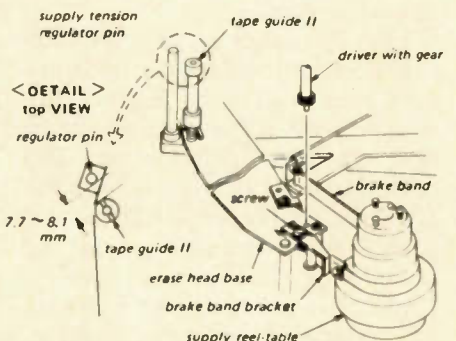

Figure 10

14-1,2,3. These adjustments are seldom off but occasionally the margin gear needs adjusting (Figure 18).

15-1. The forward slack switch position adjustment (Figure 19) is important to check because of the slapping around the pinch aux plate takes.

16-1,2. Pinch roller alignment adjustment (Figure 20). If the pinch roller hasn't been changed lately, remove it and take a good look. In some cases the bearings have obvious signs of wear. It is KOMO's practice to change the roller several times between overhauls. Badly worn pinch rollers cause "flag waving" and other picture tearing problems. Pinch roller alignment is critical if tape damage is to be avoided.

17. Supply tension regulator pin position adjustment (Figure 10). This may have been done when changing the brake band. If not, do it now.

18. Tape advancing power adjustment. Check per manual.

19-1,2. Pinch roller, pinch lever adjustments. Check per manual.

20-1,2,3. For 20-1 forward torque check, the manual says to change the take-up table if the proper reading can't be achieved. If that doesn't do it, check the adjustment of the P brake.

21. R tension regulator position adjustment. Check per manual.

22-1,2,3. Tape hold-back tension alignment. Check per manual.

23-1,2. Fast forward rewind torque alignment. These are seldom a problem. As mentioned earlier, sometimes the disc slips out of the FF/REW pulley. Frequently this can be heard as a slapping sound when the machine is in the FF/REW mode, especially when slowing to a stop.

24-1,2,3,4. Reel servo alignment. Correct power supply voltages are a must before proceeding with this set-up.

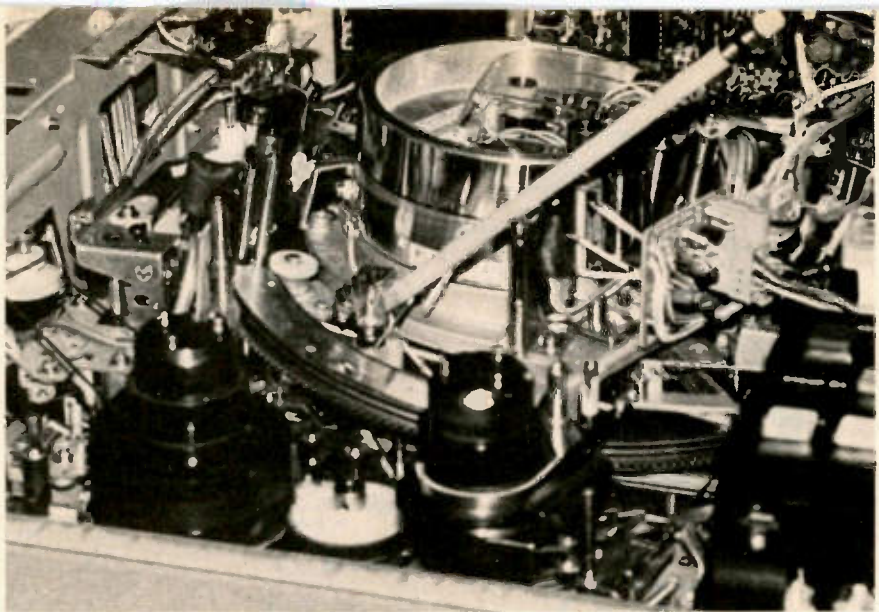

Figure 11

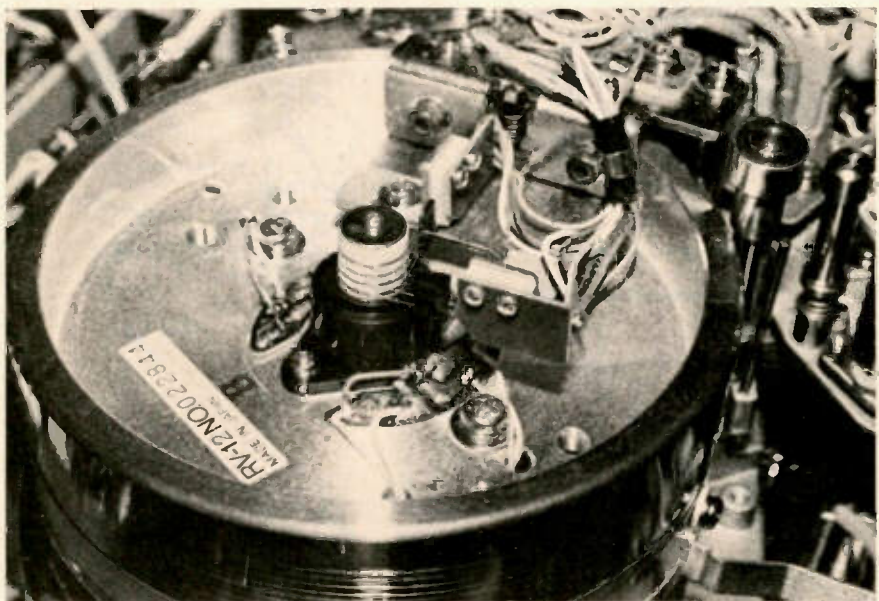

Figure 12

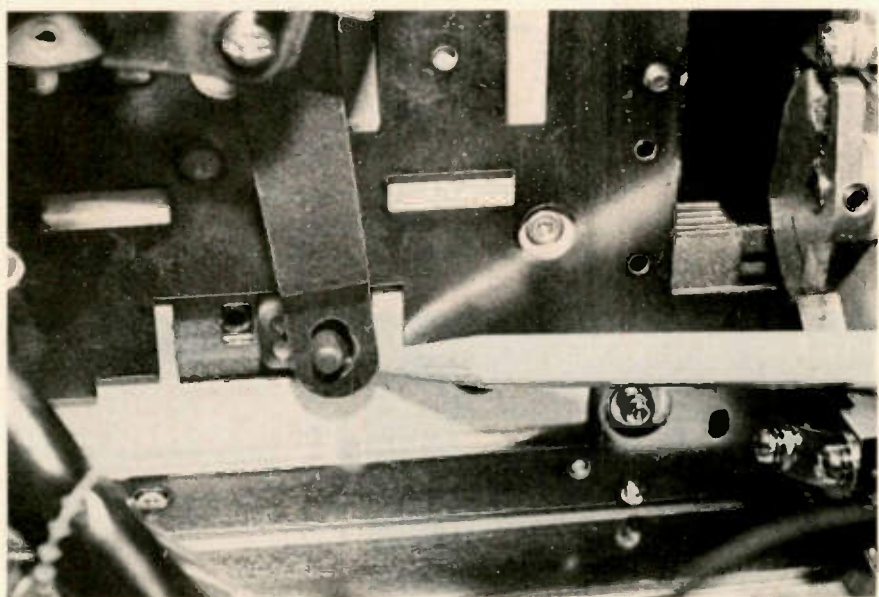

Figure 13 Note the damage around the link opening.

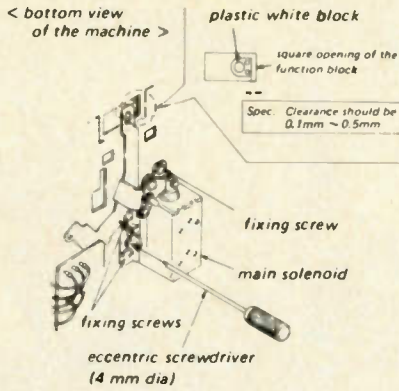

Figure 14

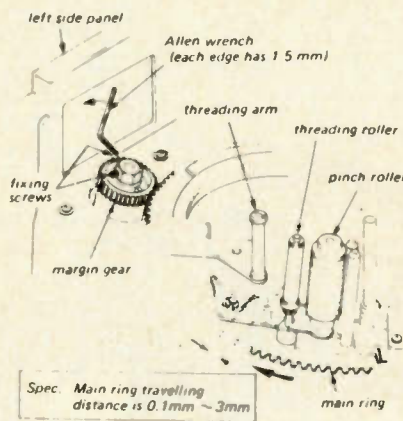

Figure 18

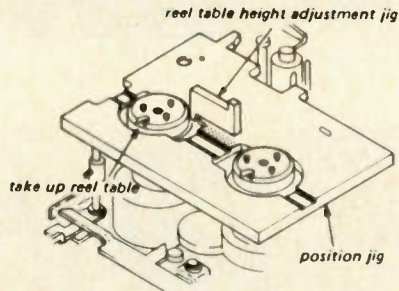

Figure 15

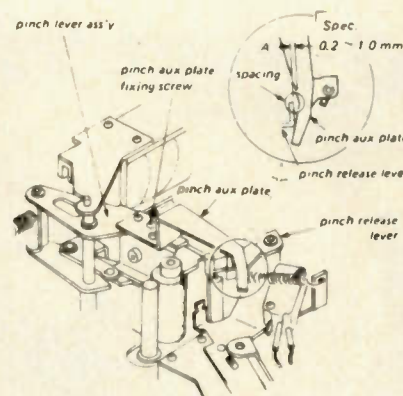

Figure 19

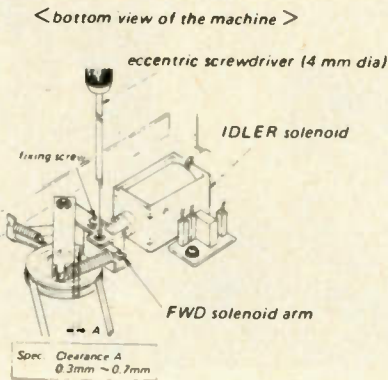

Figure 16

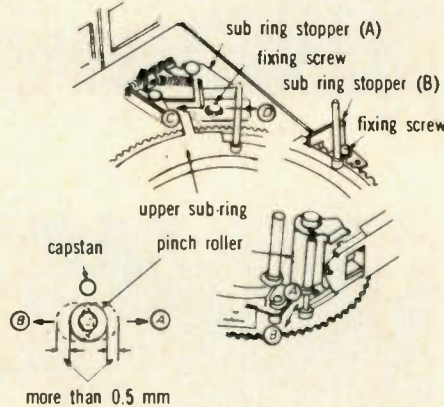

Figure 20

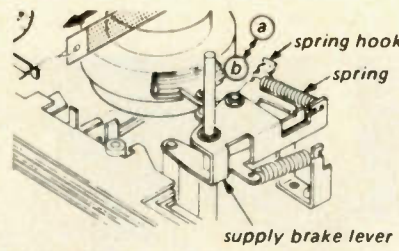

Figure 17

25. Brake solenoid position alignment. Check per manual.

26-1,2,3. Tension solenoid alignment. Not unusual to find adjustments needed here.

27. Tape speed alignment. Clean surfaces for the tape and capstan belt, and a new capstan belt are usually all that is needed here. Sample this frequency at a 10-second count rate on the frequency counter.

28. Tape run alignment. It's a good idea to read the entire section of the manual on this procedure. Have plenty of light available and check the tape along its entire path in every mode of operation. This is the one area in which it pays to go slowly.

29. Tracking alignment. Read the book carefully before working on this. Unless a part has been replaced these adjustments should be OK.

Video heads

Sony recommends changing video heads (upper drum assembly) every 1000 hours. KOMO doesn't always do that. One test of head performance is the presence of "black bearding" in 100% white areas of video. This phenomenon shows up often in outdoor scenes where objects are heavily backlit by the sky. It also is present as black streaks in vidifont keys. If the recorder is producing this "bearding" problem, most likely the upper head drum assembly needs replacement.

Final

With the completion of the above adjustments the machine is then checked with an oscilloscope and an RRS-15B alignment tape for head switching position and drum phasing. Also, deviation is checked with a calibrated video test signal. Audio input and output levels are checked too. Reversing the hours meter (Figure 21) completes the overhaul process. Although minor adjustments are always necessary between overhauls, seldom have any serious problems occurred. □

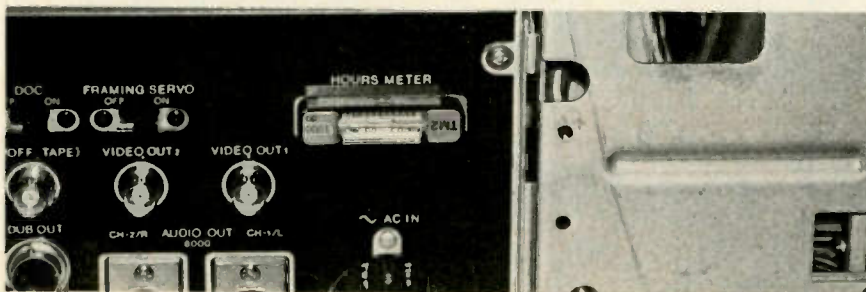

Figure 21 Hours meter in upside down position.

Understanding and adjusting comb filters

Many new color-TV receivers and videocassette recorders have comb filters. The following information (adapted from a Sencore publication) describes the operation and adjustment of comb filters in two television receivers.

By Jim Smith, CET
Sencore national accounts manager
and Greg Carey,
Sencore chief field engineer

All drawings and waveforms provided by Sencore.

The large gray object is the glass-type acoustical delay line used in Zenith color receivers with Peak-Resolution Picture (PRP) comb filters.

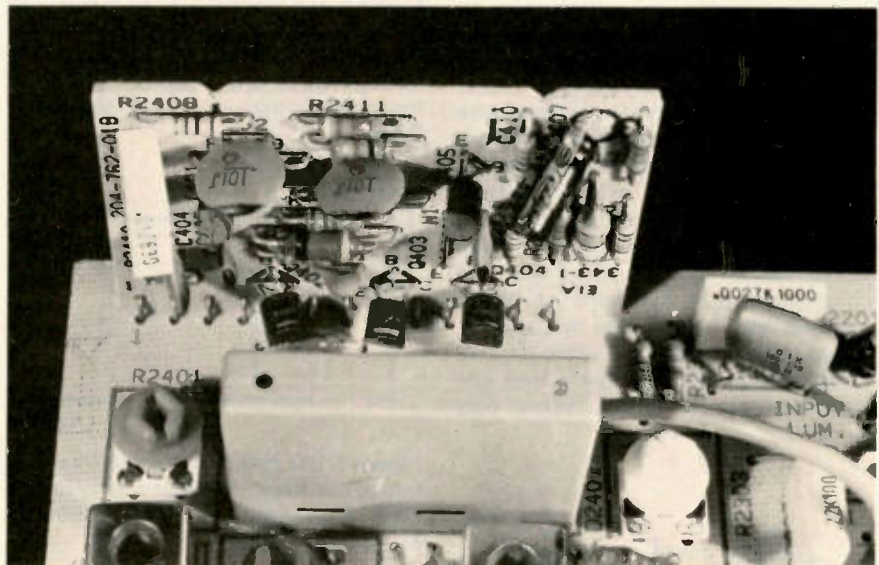

Comb filters improve the picture quality of many new color TV receivers and videocassette tape recorders. Before the use of comb filters, it was imperative to restrict the high-frequency response of the luminance signal in these machines for two reasons.

Undesirable beat-frequency distortion products are generated by chrominance and luminance signals that overlap in frequency. These beats add a grainy roughness to the picture.

Also, sharp-edged picture elements in the luminance signal contain strong harmonics in the 3.08MHz to 4.08MHz (chrominance) range. If these harmonics reach the chroma channel, they are demodulated as false colors. This produces

swirls of colors on herringbone-weave jackets or striped ties. These unwanted colors appear and disappear erratically as the camera zooms or changes position, varying the harmonic content of the video signal.

Unfortunately, the grain and false rainbows can be seen sometimes even when the luminance bandwidth is restricted to about 2.5MHz by traps and peaking components. The narrow bandwidth produces a noticeable degradation of fine detail in the picture.

The comb filter eliminates almost all of these problems, and introduces no undesirable side effects. First, it allows full bandwidth of luminance signal to reach the picture tube, while preventing color beats. Second, most of the erratic rainbows from fast picture edge-

transitions are eliminated. A minor third advantage is the wider chroma bandwidth that allows color to be seen in smaller areas of the picture.

Currently, Magnavox, RCA and Zenith are using comb-filter circuits in some of their top-of-the-line color receivers. Comb filters also are used in videocassette recorders to separate luminance and chrominance signals, and to reduce certain types of color interference. These comb circuits provide superior color and monochrome performance compared with conventional circuits.

The three comb circuits, however, operate in different ways. Following an explanation of basic comb filters, the Magnavox and RCA differences will be discussed and the alignment/checkout procedures given.

Photograph by Carl Babcoke

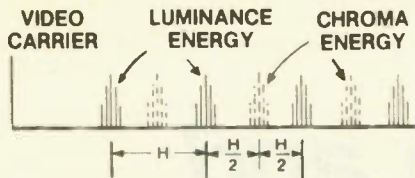

Figure 1 Energy of the luminance signal concentrates in small areas at multiples of the horizontal frequency, thus leaving room to interleave the chroma sidebands between luminance segments.

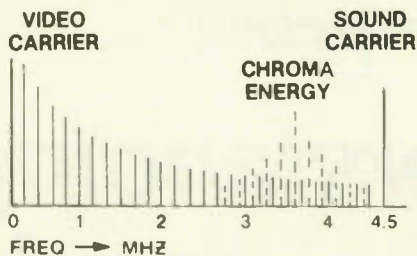

Figure 2 This full-frequency spectrum shows the interleaving of chroma and luminance. Both are present between about 2.8MHz and 4.2MHz, and beats can occur between them.

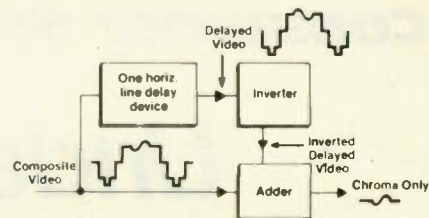

Figure 3 The first step of comb-filter operation is formation of a chroma-only signal by cancellation of the luminance in composite video.

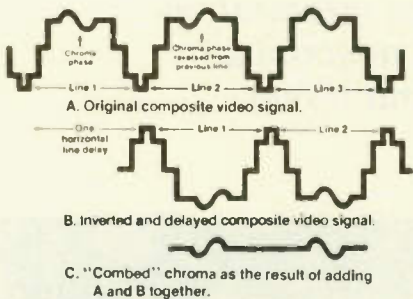

Figure 4 Cancellation of opposite-phase luminance signals extracts chroma from composite video. (A) The original video is negative-going and with a certain chroma phase. (B) After inversion and a delay of one horizontal line, the luminance is positive-going, but the chroma phase is the same as before because each successive line has inverted chroma phase. (C) When the two previous lines of video are added, the luminance signals cancel, leaving only chroma.

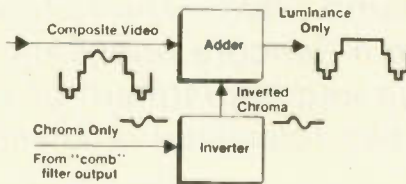

Figure 5 The second step of comb-filter operation is formation of a luminance-only signal by inverting the previously combed chroma and using it to cancel the chroma that is in the composite video.

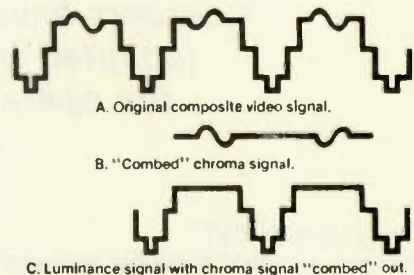

Figure 6 Removal of the chroma to produce luminance-only video is accomplished by phase cancellation. (A) The original composite video with a certain chroma phase is added to (B) combed chroma of opposite phase. (C) The chroma signals cancel, leaving only the luminance. Notice that the luminance bandwidth has not been restricted to remove the chroma.

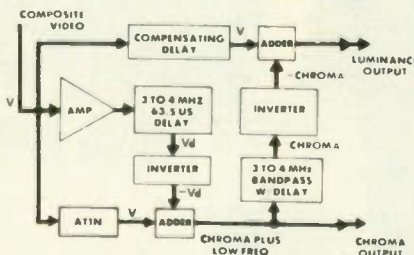

Figure 7 The Magnavox comb filter has this block diagram. A glass delay device gives a one-line delay over a 3MHz to 4MHz bandwidth.

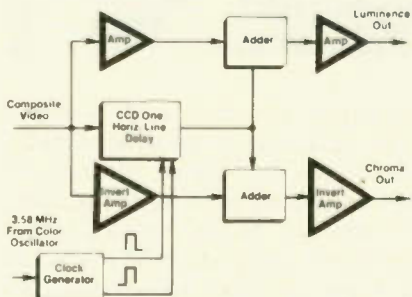

Figure 8 A CCD integrated circuit provides the required one-line delay in each RCA comb filter.

Comb filter

Basic comb-filter operation

The operation of the basic comb filter is based on four important characteristics of the transmitted NTSC composite-video signal. These characteristics are:

1. The luminance (black and white) information does not fill the entire energy spectrum between the video carrier and the upper 4.2MHz

limits allowed by the FCC for the luminance signal. The energy of luminance information is actually found in small packages at each odd multiple of the horizontal-sweep frequency. If the energy spectrum of a composite video signal were viewed using a spectrum analyzer, a frequency response that looks like a picket fence with spaces between each energy package would be viewed. The luminance signal actually occupies less than one-half of the spectrum space between DC and 4.2MHz. In the NTSC system, the chroma information is also in similar energy packages, except each chroma package falls into the spaces between the luminance energy packages (Figure 1).

2. In order for the chroma information to fall into the unused

spaces created by the luminance information, its frequency was made one-half of an odd multiple of the horizontal-sweep frequency. The color subcarrier (3.579545MHz) is the horizontal sweeping frequency (15734.264Hz for color) multiplied by 455 (an odd multiple of the horizontal frequency). The result is that the phase of the color signal changes 180° from one horizontal line to the next. This is called "phase alternation" of the color information.

3. Most of the transmitted luminance information has a vertical format, meaning that successive horizontal lines of video are almost identical and, therefore, can be added together without noticeably changing the picture.

4. All segments of the video

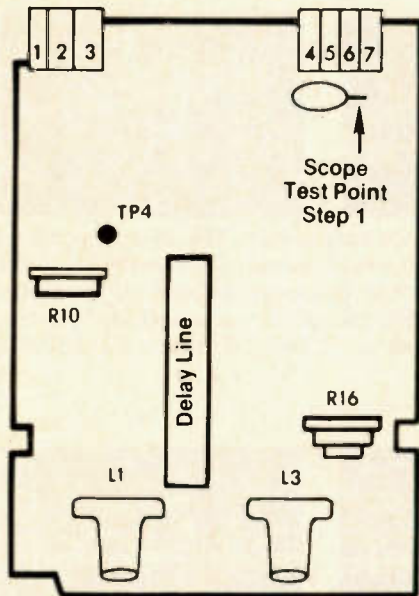

Figure 9 These components of the Magnavox comb-filter module are used for adjusting or troubleshooting.

signal from the TV station are phase-locked to each other. Therefore, the horizontal sync, color burst, luminance and chrominance signals all have a definite phase relationship at the beginning of each horizontal line.

A drawing of the complete video spectrum showing the interleaving of the chroma and luminance information is shown in Figure 2. The energy bursts appear similar to the teeth of a comb. For this reason, the circuit that is used to separate the chroma and luminance is called a "comb" filter.

Basic operation of the comb filter can be broken into two sections. First, the luminance information is removed (or combed) from the composite video signal to leave only the chroma signal and its sidebands. Second, the combed chroma is used to remove the color from the original composite video, leaving only the luminance information. These two simple steps provide the clean chroma and luminance information required for a high resolution picture on the CRT. The discussion will begin with the removal or combing of the luminance from the composite video to obtain the chroma-only signal.

Composite video is applied to the input of a delay device that delays the signal by one complete horizontal scanning line. The chroma information at the output of the delay device will be out of phase with the non-delayed chroma ap-

plied to the adder circuit because the color information is phase alternated and changes phase for each succeeding horizontal line. The first line is actually delayed and is compared with the second line of video information.

The delayed signal then is inverted so the chroma information of the two signals will now be in phase. Because the luminance does not change phase from line to line, inverting the signal now will make the delayed luminance signal out of phase with the non-delayed signal applied to the adder circuit. When the inverted (and delayed) signal is mixed with the non-inverted (and non-delayed) signal in the adder circuit, the chroma information will add. The luminance information is out of phase and will cancel. This leaves only the combed chroma signal at the output of the adder stage. Figure 3 shows a block diagram of the circuit; Figure 4 has comparison drawings of the waveform phases.

Now that the chroma signal has been combed (with the luminance information combed out), this signal can be used to remove the color information from the composite video. The combed chroma signal is inverted so that it is now out of phase with the chroma information in the composite video. The inverted, combed chroma signal then is added to the composite video so that the chroma information cancels, leaving only the luminance. In effect, the combed chroma is used to comb the color from the composite video (Figure 5 diagram and Figure 6 waveforms).

The overall result of the combing process is a high resolution luminance signal, with all of the chroma canceled out, that may be passed on to the video amplifiers. Notice that nothing has been done to the frequency response of the luminance signal. This means that the video amplifiers may have a wider bandpass, resulting in more picture detail on the CRT without color-beat interference. Also, a clean chroma signal is passed on to the demodulators for further separation into red, green, and blue. The tendency to produce rainboding on pin-striped suits (and similar objects) is greatly reduced because the only signals passed to the chroma circuits are the ones with an exact phase-reversal between horizontal

APPLIANCE REPAIR BOOKS



Thirteen Handbooks written in easy-to-understand language by experts in the service field with illustrations and diagrams! Acclaimed by instructors and professionals alike! How to diagnose and repair air conditioners, refrigerators, washers, dryers, ranges, microwave ovens, dishwashers, vacuum cleaners, electrostatic air cleaners, RV gas appliances, hair dryers, motors, water heaters, coffeemakers, can openers, floor polishers, steam irons, food mixers, lawn care appliances, electric knives, electric and digital clocks and many others. Also fundamentals of solid state, setting up a shop, using test instruments and more Only \$2.65 to \$4.90 ea.

SEND FOR FREE PRICE LIST

Gamit, Dept. ES

110 W. St. Charles Road,
Lombard, Illinois 60148

Circle (7) on Reply Card

NATESA
5930 S.
Pulaski Rd
Chicago
IL 60629



ARE YOU A PRO?

...the not for profit association championing independents' right to compete, and delivering valuable benefits continuously since 1950.

- LEADING SPOKESMAN
- TRADE INFORMATION DISPENSER
- WATCHDOG
- LOBBYIST
- YARDSTICK OF STANDARDS
- CONSUMER RELATIONS
- COUNSELOR
- PROBLEM SOLVER

We are not freeloaders. So our check for \$60.00 dues is attached. As our special premium, please ship the indicated \$15.00 Manual.

- Practical Business Manual
- OR -
 Service Contract Manual

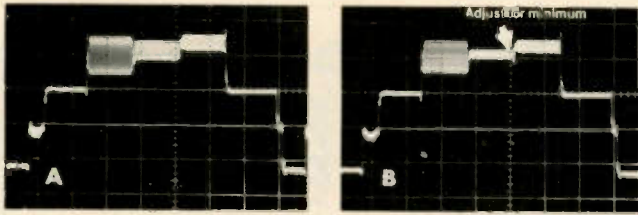

Figure 10 On the Magnavox module, adjust R16 and L3 for minimum amplitude of the 3.56MHz bar when the scope is connected to module pin 7. (A) Incorrect adjustments fail to decrease the 3.56MHz-bar amplitude. (B) The 3.56MHz bar of the VA48 chroma-bar pattern should be at minimum amplitude, as shown.

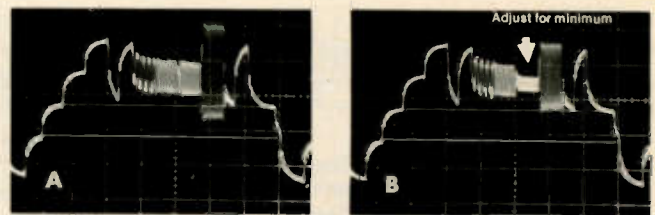

Figure 11 With the scope connected to TP4 on the Magnavox comb filter, adjust R10 and L1 for minimum amplitude of the 3.02MHz bar of the VA48 bar-sweep pattern. (A) Excessive amplitude of the 3.02MHz bar indicates incorrect adjustments. (B) Correct adjustments of L1 and R10 reduce the 3.02MHz amplitude as shown.

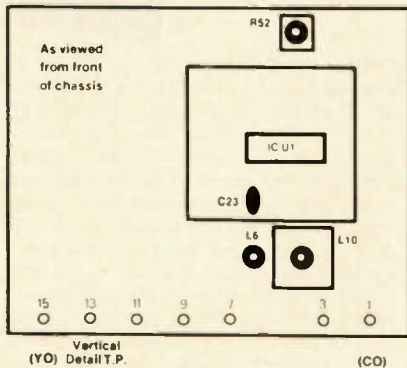

Figure 12 These components and adjustments are on the RCA comb-filter circuit board.

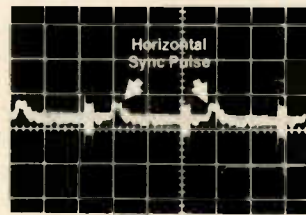

Figure 13 Horizontal-sync pulses during adjustment of the RCA comb filter indicate incorrect adjustments of defective components.

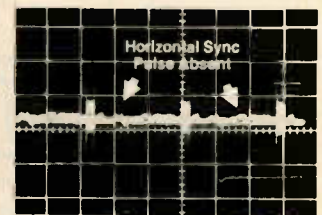

Figure 14 Elimination of horizontal-sync pulses proves correct adjustment of R62 on the RCA board.

Comb filter

lines. All other luminance signals in the 3.08 to 4.08MHz band are canceled.

There is one very important fact about the operation of the comb filter when considering alignment and troubleshooting of the circuit. The comb filter circuit will operate properly only if the signals being applied are properly phase-locked to each other like those from the TV transmitter. The chroma information must be phase alternating and phase locked to the horizontal sync so that the signals will add and subtract properly. Non-phase-locked signals, such as those from a color bar generator, will not properly align the circuit because the phases are random. The results will be poor separation of the chroma and luminance information.

Not only will non-phase-locked signals result in improper operation and alignment of the comb filter, but the resulting waveforms will not show how the circuit is operating. It will be impossible to determine if the circuit is functioning correctly or if there is a circuit defect. The Sencore VA48, on the other hand, provides the properly phase-locked signals that allow aligning and troubleshooting of the comb filter

circuits.

Comparing Magnavox and RCA circuits

Although the two comb filter circuits accomplish the same end results, there are several differences between them. The main difference is the manner in which the composite video is delayed for one horizontal line.

The Magnavox circuit (Figure 7) is very similar to comb filters used in videocassette recorders. It uses discrete transistors and has four adjustments for proper phasing: two in the chroma and two in the luminance channels. The delay device used is a glass acoustical-delay line that passes signals between 3 and 4MHz. This means that combing only takes place between 3 and 4MHz, while signals below 3MHz are passed virtually unchanged. The lower-frequency luminance must be removed in a bandpass filter to complete the signal separation process. The combed and filtered signal is then used to comb the color from the composite video, leaving high resolution combed luminance to be passed to the video amplifiers. The Magnavox comb filter inverts the output of the delay line before adding the delayed signal to the composite video and again before

the combed chroma is added back to the composite video.

In comparison, RCA's comb filter (Figure 8) uses a special Charge-Coupled Device (CCD) integrated circuit to delay the composite video. The CCD is not frequency sensitive and delays the entire video spectrum so a bandpass filter is not required. The CCD requires a clock signal of 10.7MHz; which is obtainable by tripling the frequency of the 3.58MHz color oscillator. The internal switching of the CCD is thus phase locked to the composite video signal applied to its input. All the circuitry, with the exception of several output and buffer transistors, is contained in one integrated circuit chip. There are no phase adjustments required in the RCA comb filter.

Aligning the Magnavox comb filter with the VA48

The Magnavox comb filter has four adjustments (Figure 9). No alignment procedure is provided in Magnavox literature because they should not drift from the factory setting enough to cause any trouble. Sencore's experience, however, is that some technician or well-meaning set owner will sooner or later attempt to set the adjustments for improved operation. Adjusting the comb filter without the proper test

signals will result in poor operation. This may require the comb filter module to be replaced when it is merely out of alignment.

Having an alignment procedure allows confirmation of whether the comb filter is operating properly. An adjustment that has no effect (or the wrong effect) indicates a circuit problem other than simple alignment. *Alignment of the comb filter should never be attempted without a phase-locked color and black/white signal such as the Bar Sweep and Chroma Bar Sweep signals from the VA48.*

The VA48 has the properly phase-locked signals required to align the comb filter. Most color generators, including some low-cost NTSC generators, do not have phase-locked signals which may result in improper comb filter alignment. Phase locking can be quickly confirmed by observing the edges of the color bars on any color TV. The edges should look like tiny gear-teeth and be standing perfectly still. If the teeth are moving along the edge, the color generator does not have phase-locked color.

Use this procedure to align a Magnavox comb filter:

1. Inject the Chroma Bar Sweep pattern into the UHF input on the VHF tuner. Connect the scope to pin 7 of the comb filter module (layout in Figure 9).

2. Viewing from the rear of the set, adjust R16 fully counterclockwise. Adjust L3 to bring the slug to the outer edge of the coil form. Slowly adjust the slug back into the form until the 3.56MHz bar in the Chroma Bar Sweep pattern is reduced to its lowest amplitude. The scope gain may be increased to observe the action of L3.

3. Adjust R16 to null the 3.56MHz bar to minimum (Figure 10 waveform).

4. Move the scope to TP4 on the comb filter module (located just behind R10) and set the VA48 to the Bar Sweep pattern.

5. Adjust R10 fully counterclockwise. Adjust L1 for minimum amplitude of the 3.02MHz bar.

6. Adjust R10 to null the 3.02MHz bar to minimum. The scope gain may be increased to observe the null of L3 for the best setting (Figure 11).

This completes alignment of the Magnavox comb filter circuit. To check operation of the comb filter,

tune in an air signal and observe the large color areas for noise. If any noise is seen, recheck the settings of the adjustments in the circuit. The adjustments are critical and must be done properly for proper separation of the chroma and luminance information.

The alignment procedure may be used to aid in the troubleshooting of the Magnavox comb filter circuit. The lack of a signal at the test point or the non-action of a control will lead you to the area of trouble in the circuit. The chroma section of the filter must be working before the alignment or troubleshooting of the luminance section is begun. A poor separation of the chroma will cause poor separation of the luminance, even though the luminance section may be working perfectly.

Aligning the RCA comb filter with the VA48

The RCA comb filter circuit has three adjustments: A 10.7MHz tripler, a combed chroma ("C") adjust and a vertical-detail output adjust. The adjustments are made easily using the Sencore VA48 phase-locked signals and a dual-trace scope. The adjustments should be made in the proper sequence to ensure best operation of the comb filter.

To adjust the 10.7MHz tripler coils:

1. Connect the VA48 to the antenna terminals, set the VA48 and receiver tuner to the same channel and tune in the Bar Sweep pattern on the screen.

2a. Make a loop of wire using four turns about the size of a dime and connect one end to the scope probe and the other end to the scope ground lead. Place this over L6 (Figure 12) or C23. C23 is under the shield on the comb-filter board. Do not make direct contact with the 10.7MHz tripler circuit because the probe capacitance will detune the circuit.

Or use this alternate method:

2b. Connect the Sencore PL207 RF Pick-Up Loop to the input of the scope. Place the loop near the comb filter PC board on either side of L6.

NOTE: Be sure that either pick-up loop is placed in a location that will allow it to remain station-

NATIONAL ELECTRONICS SERVICE DEALERS

Are you standing idly by while ideas that can be money in your pocket fly away?

Membership in NESDA is one of those ideas.

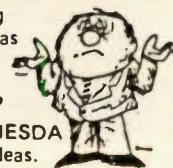

WHAT DO YOU GET FROM NESDA?

1. Insurance
2. Special Bancard Rates
3. ServiceShop Magazine
4. Electronic Service Industry Yearbook
5. Service Industry Information
6. Legislative Programs with State and National Government
7. Advocate for Better Warranty Practices
8. Business Information



Don't let your bucks get lost in the shuffle.

Send in your check today.



On the bottom line it will mean extra \$\$\$ in your pocket.

JOIN NESDA
And Your State Association
Send for more information:
NESDA, 2708 W. Berry St.
Fort Worth, TX 76109



IT'S NO PUZZLE TO ORDER

OELRICH SERVICE FORMS

FOR TV-RADIO & 2 WAY RADIO SERVICE LEGAL FORMS FOR CALIF. FLA. UTAH NOW AT YOUR PARTS JOBBER OR WRITE FOR CATALOG B64

OELRICH PUBLICATIONS

4040 N. NASHVILLE AVE. CHICAGO, ILLINOIS 60634

Circle (6) on Reply Card

Come to Grips!

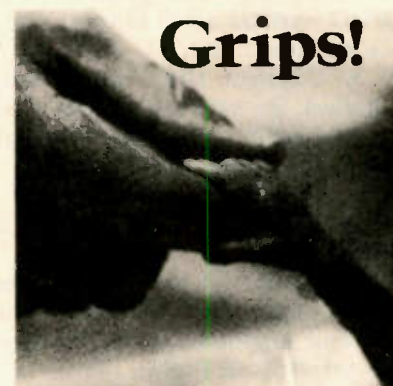

Help prevent birth defects

SUPPORT
MARCH OF DIMES



THIS SPACE CONTRIBUTED BY THE PUBLISHER

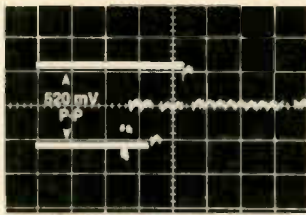

Figure 15 The IF-preset control, 4344, must be adjusted for a 520mV sync signal at the Q504 collector. This adjustment is critical.

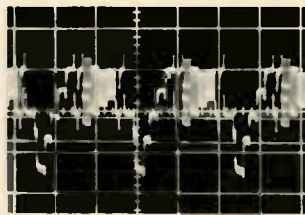

Figure 16 When the bar-sweep pattern is used with a normal RCA, the video detector waveform should look like this.

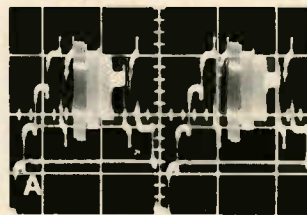

Figure 17 At terminal 3 of the RCA comb-filter board, the (A) waveform is correct for the bar-sweep pattern, and the (B) waveform is normal for the chroma-bar-sweep pattern.

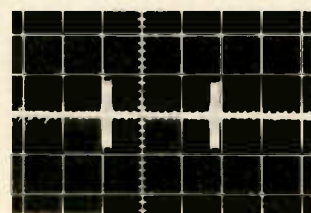

Figure 18 With scope connected to pin 1 of the comb-filter board, the bar-sweep pattern should show only the 3.56MHz bar.

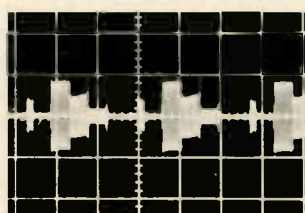

Figure 19 With scope at the same pin 1, the chroma-bar sweep pattern should be as shown.

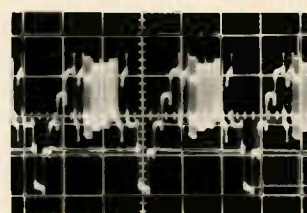

Figure 20 At pin 15 of the comb-filter board, the bar-sweep pattern should have this waveform.

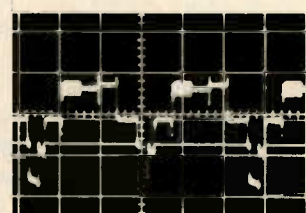

Figure 21 At the pin-15 YO (luminance output) of a correctly operating RCA comb filter, the chroma-sweep pattern should have almost no chroma amplitude.

Comb filter

ary. It must not be allowed to move during the adjustment because it could produce a misleading indication of the adjustment.

3. Adjust coil L10 and L6 on the comb filter for maximum amplitude of the observed signal. Note that the actual amplitude is not important because the pick-up loop cannot be calibrated.

Chroma comb ("C") adjust:

4. Connect the scope probe to the VDO (vertical detail output) pin 13 on the comb filter PC board.

5. Connect the second scope channel (or external trigger input) to the collector of the horizontal driver transistor, Q407.

6. Set the Timebase switch to 10μsecs/division and lock in the signal.

7. Adjust R62, the Chroma Comb ("C") adjust the minimum horizontal sync amplitude in the waveform (Figure 13 and Figure 14).

IF (comb filter) preset:

8. Move the second scope channel (or the external-trigger input) to the collector of the vertical output transistor, Q504.

9. Set the Timebase switch to 0.2msec/division setting and lock the vertical signal in on the scope.

10. Adjust the IF preset control, R344, located on the main PC board between the IF shield and

the comb filter PC board, to obtain a 520mV peak-to-peak signal amplitude of the VDO signal as shown. This adjustment is critical and must be set carefully (Figure 15).

Checking operation of the RCA comb filter circuit

The operation of the comb filter may be quickly checked using the VA48 Bar Sweep and Chroma Bar Sweep patterns and the scope to confirm the alignment of the filter. The following quick check may also be used as a troubleshooting tool to locate the defect in an improperly operating comb filter. A check of the patterns will quickly tell whether the filter is properly aligned or whether there is a circuit problem and where the problem may be.

1. Check the Bar Sweep pattern at the video detector. It should appear similar to that shown in Figure 16. A lack of video signal may appear as an inoperative comb filter circuit.

2. Check the Bar Sweep and Chroma Bar Sweep patterns to the comb filter input at terminal 3 on the comb filter PC board. Note the 3.02 and 3.56MHz bars in the Bar Sweep pattern have been peaked and is a normal condition at this test point (Figure 17).

3. Check the 3.58MHz sine wave

input at pin 7. The signal should be at least 1 volt peak-to-peak in amplitude for proper operation.

4. Check the chroma only signal at pin 1 (CO) on the comb filter PC board. The Bar Sweep pattern should appear as that shown in Figure 18 with only the 3.58MHz bar being present. The Chroma Bar Sweep pattern should appear with all bars present as shown in Figure 19.

5. Check the luminance signal at pin 15 (YO) on the comb filter PC board. The Bar Sweep pattern should appear as shown in Figure 20. The 3.56MHz bar should show almost no signal information. The Chroma Bar Sweep pattern, as shown in Figure 21, should show almost no chroma information.

If one of the waveforms is incorrect, that section of the comb filter should be checked for proper alignment or a circuit defect. Always be sure to check the chroma-only signal first. The lack of combed chroma may appear as chroma in the luminance-only signal. This may draw attention to the luminance section instead of the chroma section, where the actual problem may be. If the IC is replaced, be sure to perform the alignment procedure and check the operation of the comb filter by observing the waveforms as indicated. □

Figure 1 Two arrows point out the upper and lower rear corners of module M1, which is crowded between telephone-interface module 9-149 on the left and M2 module on the right. Part of the tuner-control circuitry can be seen in the background at the far left.

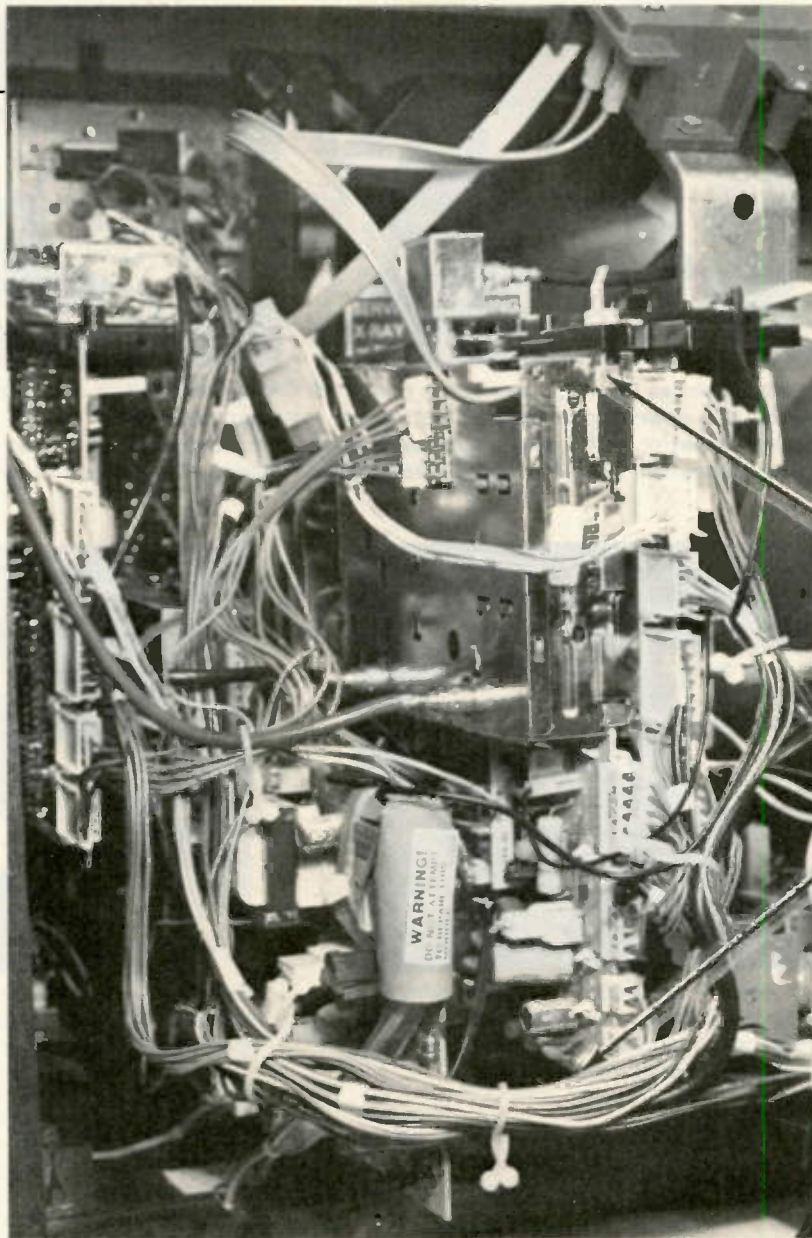

Zenith tuners and IF

By Gill Grleshaber, CET, Gill's Color TV Service, St. Joseph, MO

Functions of circuits on the M1 module in Zenith's System-3 color receivers are discussed and illustrated.

In Zenith's model SM1973P 19-inch color receiver, the M1 module contains both tuners, the complete IF and video-detector system, sync separator, AGC and the master-scan oscillator (that with dividers provides horizontal and vertical scan drive signals).

Functions of the M1 module (Figure 1) are explained with schematics, voltages and waveforms. Troubleshooting methods are covered briefly because most repairs

are under warranty now, and the modules are exchanged rather than being repaired in the field.

Information about plugs and edge connectors is needed first.

Polarized plugs and sockets

A visual search showed 47 plugs on the cable wiring. Therefore, many different styles or shapes of plugs are needed to prevent incorrect connections. Although many plugs appear to be identical, they

are coded so it is not possible to connect them properly to a wrong point.

Figure 2 shows both ends of two connecting cables between the CRT-socket module M5 and the horizontal/power-supply M10 module. Notice that the module has a single identification while the cable connector has two. One identification is needed at each end of the cable.

These cable plugs and matching

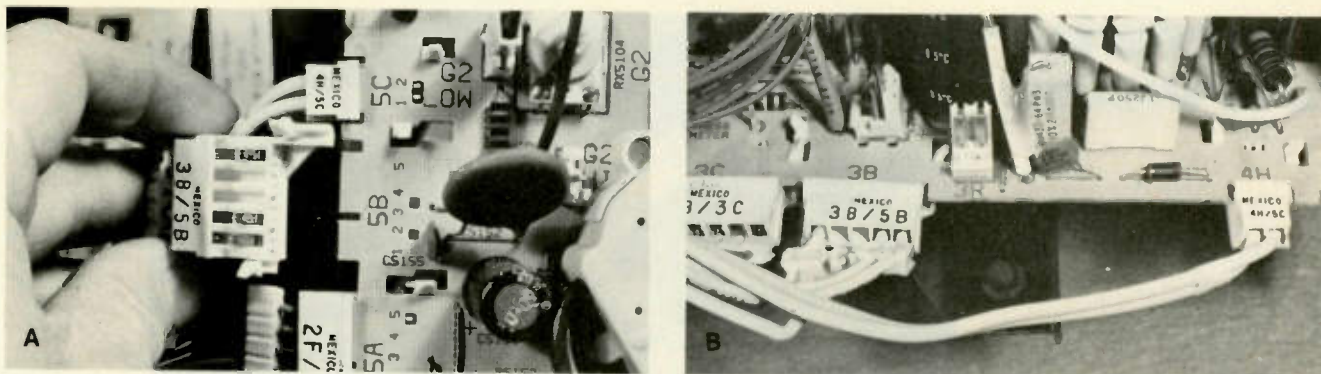
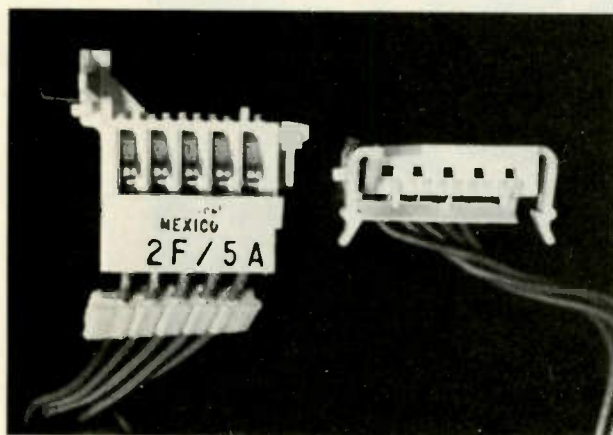

Figure 2 Photograph A shows two edge connectors on the M5 CRT-socket module. Photograph B shows the other end of the same cables on the M10 power-supply module. Notice that the two-pin connector has 5C printed on the M5 module, 4H/5C printed on the cable connector, 4H/5C on the other cable connector and 4H marked on the M10 module. Each cable is marked with the origin *and* destination, while the modules have only one number beside each connector.



The two ends of one five-wire edge-connector cable are positioned to show the contact springs (left connector) and the flexible clips (at right) that hold the connectors securely to the module. These connectors are identical.

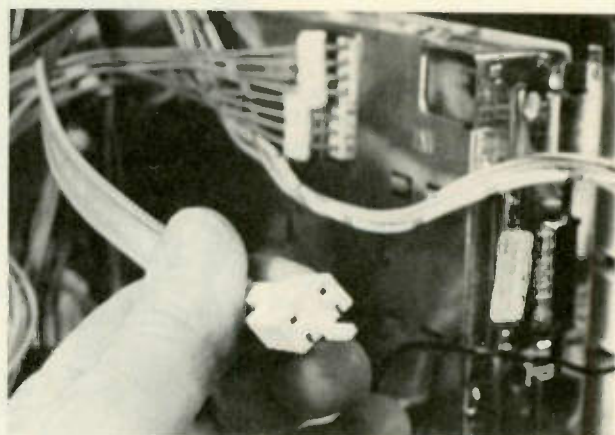

Figure 3 Connector for the 300 Ω UHF input signal is polarized but merely slips on the module pins; it does not lock in position as the edge-connectors do.

Zenith

contacts on the modules are called *edge connectors*. Previous Zenith modules could be lifted straight away from the chassis pins during removal. *These plugs do not slide straight off the modules*. To remove a plug, the two plastic-spring clips (part of the plug) must have pressure applied to move them apart. While this pressure is applied, the clips must be pushed out of the holes in the module. This tilts the plug, and the tilt must be increased before the plug can be disengaged from the edge of the module and then removed.

To reinstall an edge-connector plug, place it so the module edge enters a slot in the plug (which is at an angle to the module surface) and the plastic spring clips are in line with the module's matching holes. Then, while the module is held in one hand (to prevent module dam-

age), pressure is applied to the spring tips, forcing them into the proper holes (which spreads the tips apart) until finally the tips snap inward against the module, holding the plug tightly and parallel to the module.

A different type of plug brings the UHF signal into module M1 (Figure 3). It is a polarized two-pin plug that is installed by sliding the plug over the module pins. To remove the plug, pull out on the plug.

Two four-pin connectors are reached through the tuner shield (Figure 4). They bring in tuner-control voltages from the electronic-tuning control system. Although the connectors appear to be identical, plastic pins have been broken off to prevent insertion in the wrong plug. Both the tuner-mounted male plug and the female cable connector have been coded, as shown in the photograph.

Several top and bottom views of the M1-module edge connectors are shown in Figure 5. At first glance, it seems 1D and 1C (or 1B and 1A) are identical and could be interchanged incorrectly. And it might be possible to force them into the other's position. However, each cable connector has its own arrangement of mounds that must fit into matching square holes in the module before the connector clips can be inserted far enough to secure the connector. The small square holes in the module can be seen in the Figure 5 photographs.

M1 module circuit functions

Some of the circuits and major components of M1 are identified in Figure 6. M1 is shown with the top shields removed. Both tuners, the tuner-control section and the synchronous-video-detector area normally are shielded.

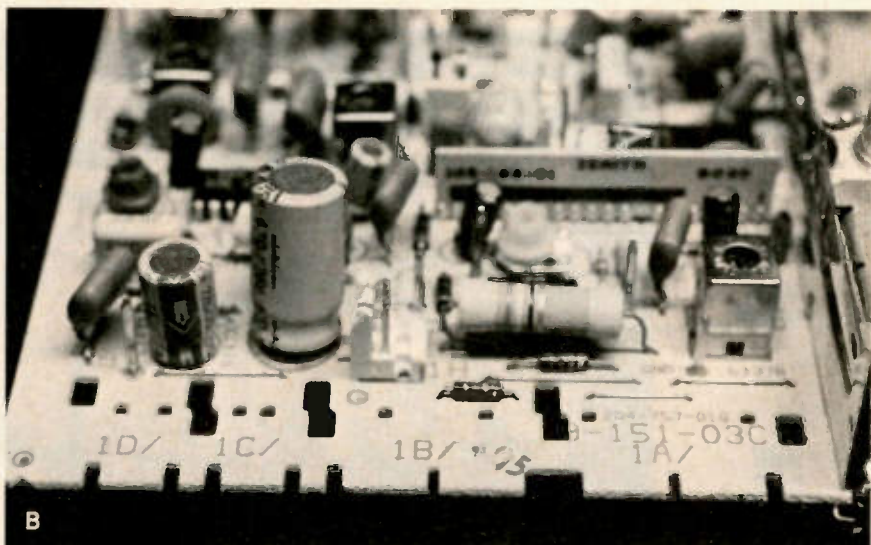
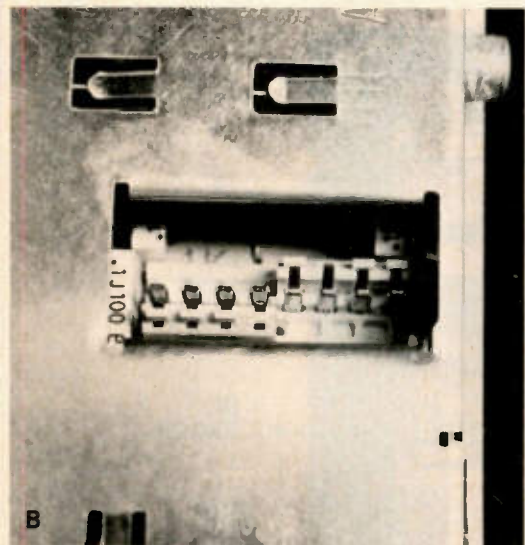
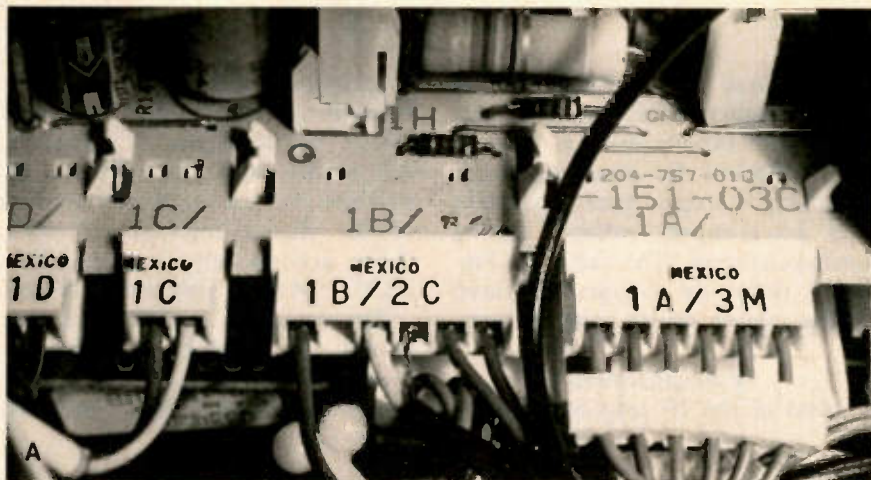
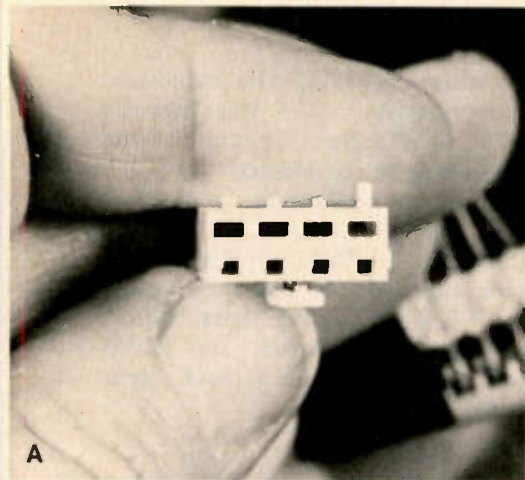

Figure 4 The 1K and 1J connectors that connect the tuners with the tuner-control circuits each are coded by factory removal of all but one plastic finger. (A) Only #4 keying finger remains on the 1K plug; the #4 barrier has been removed from the 1K module socket (photograph B, left socket). Pin 3 is keyed on the 1J socket and plug.

Tuners

The VHF and UHF tuners appear to be conventional varactor-tuned types with diode bandswitching. Tuning voltages come from the phase-locked-loop tuner-control circuitry.

Phono-type jacks deliver samples of VHF and UHF oscillator frequencies to the tuner-control circuits. The green shielded cable carries the UHF; the black cable has the VHF sample. A frequency counter connected to these phono jacks can read the exact frequency during servicing measurements.

Connections to the tuner-control system are made through connec-

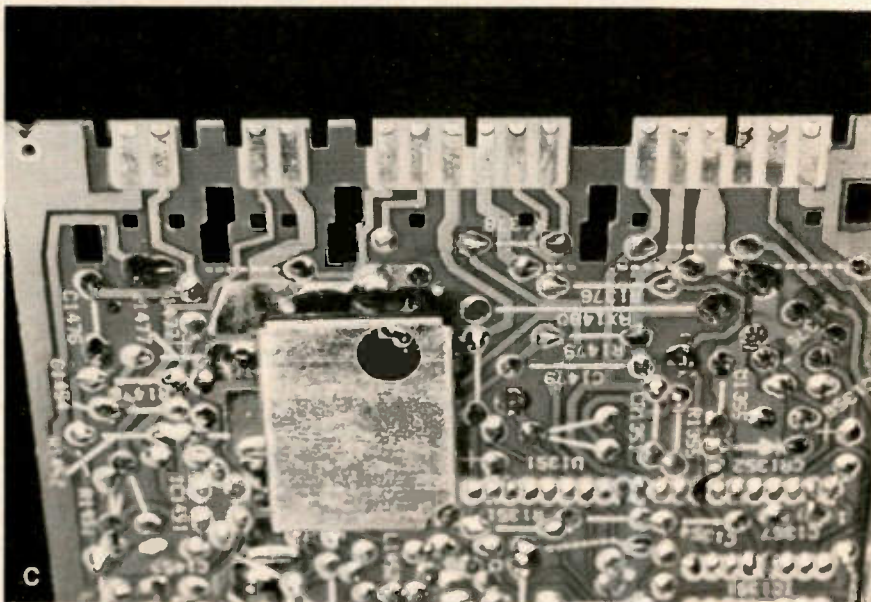

Figure 5 Four edge connectors are used on module M1. They are similar to the one shown in a previous photograph. (A) To save module space, the spring tips are staggered. One plug tip is nearer the module edge; its mate is farther. Between the larger rectangular holes for the locking tips are two smaller square holes. Small extrusions on the plastic plug shell must fit in these holes that are spaced differently for nearly identical connectors. Except for this coding precaution, various similar plugs could be incorrectly interchanged (1D and 1C, for example). Examine the installed connectors of photograph A with the module without connectors (B). Connector strips on the bottom side are shown in C.

Zenith

tors 1K and 1J, as shown in the block diagram of Figure 7. These connectors can be used as convenient testpoints for checking band-switching voltages, tuning voltages and power-supply voltages during troubleshooting. The table in Figure 8 shows dc voltages measured in the sample Zenith color receiver.

IF amplification

Most of the IF response-shaping

is accomplished in a Surface-Wave-Injection-Filter (SWIF) labeled U1202 in the Figure 9 schematic. All tuning and trap effects are provided by the shape and spacing of the filter's internal materials; there are no adjustments. This U1202 SWIF is very small (Fig10).

The output of the SWIF is sent to the IF amplifier IC1202 integrated circuit for amplification. One transistor (Q1201) is provided

to remove the 41.25MHz sound-carrier frequency, and this prevents the 920kHz beat from appearing in the picture.

Only two adjustable coils affect the response curve. L1102 in the tuner and L1205 at pin 7 of IC1202 are adjusted for maximum gain, L1102 for maximum signal with a strong station carrier, and L1205 for maximum with a weak input signal.

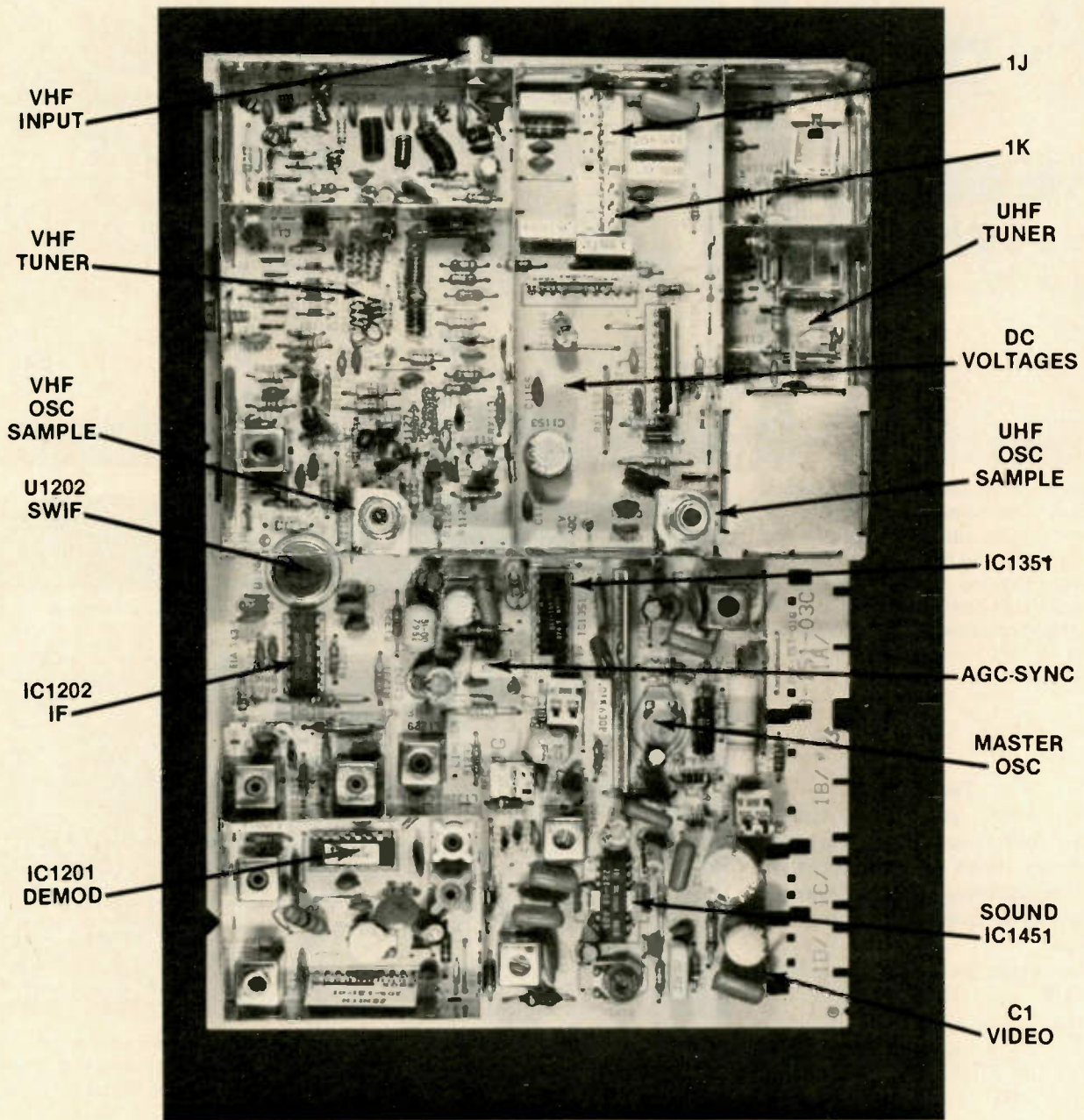

M1 MODULE

Figure 6 Arrows point to important areas or components on the M1 module.

From the C1210/C1209 impedance-matching network, the IF signal is sent to IC1201 pin 4.

Synchronous video demodulation

Conventional diode detection (or demodulation) in televisions and radios is merely a peak-reading rectifier circuit that removes most of the carrier because the detector output follows the tips of the carrier sine waves without returning to zero volts between each diode conduction. The output signal has a waveshape of the modulation plus a small ripple of the carrier which can be removed easily by a low-pass high-frequency-rejection filter. The circuitry is simple; however, there are some disadvantages. Linearity is poor near zero amplitude. And diode characteristics cause sum-and-difference distortion products that produce unwanted signals.

In contrast, synchronous demodulation is similar to color demodulation. A stable carrier of the same frequency as the signal carrier is used to demodulate without forming sum-and-difference distortion.

Figure 11 shows the schematic of the Zenith synchronous video-demodulation circuitry that produces

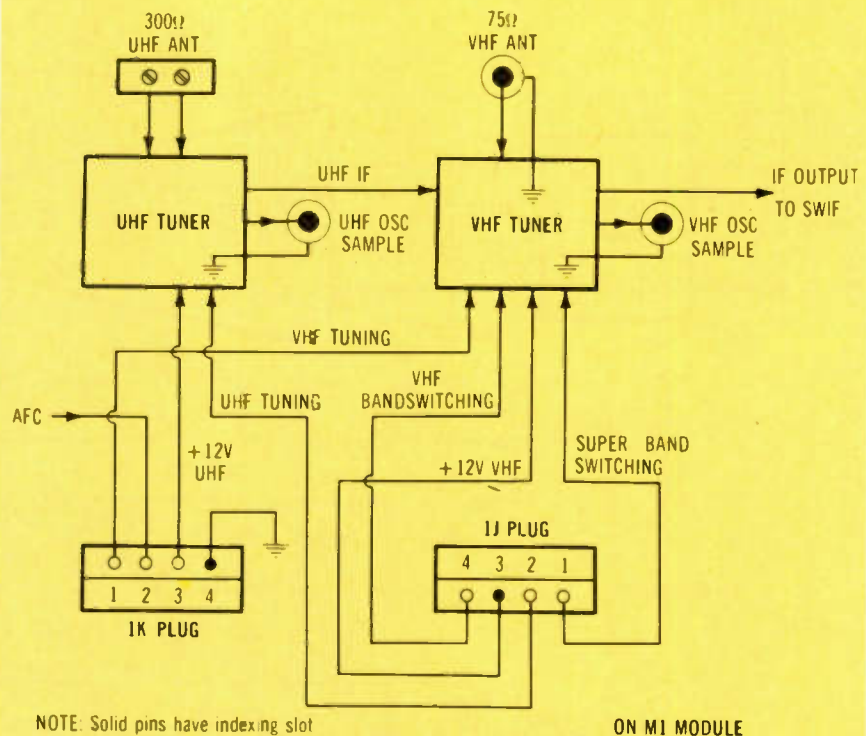

ZENITH VARACTOR TUNERS

Figure 7 Excellent testpoints for troubleshooting are the 1K and 1J plugs that are reached through a hole in the tuner shield (see Figure 4). The plugs are drawn here as they appear on the module, with pin 4 of 1K next to pin 4 of 1J (when in the cabinet, 1J pin 1 is at the top). Typical voltages are shown in the next illustration.

TUNER-CONTROL VOLTAGES

CHANNELS	1K Socket				1J Socket			
	PIN 1 VHF TUNING	PIN 2 FROM AFC	PIN 3 + 12V UHF	PIN 4 GROUND	PIN 4 VHF BAND SWITCH	PIN 3 + 12V VHF	PIN 2 UHF TUNING	PIN 1 SUPER BAND SWITCH
VHF TV 2	+ 1.4V	+ 4.1V	00V	00V	- 23V	+ 11.6V	+ 1.4V	- 23V
VHF TV 6	+ 9.5V	+ 4.3V	00V	00V	- 23V	+ 11.6V	+ 9.5V	- 23V
VHF TV 7	+ 11.6V	+ 4.1V	00V	00V	+ 10.4V	+ 11.6V	+ 11.6V	- 20V
VHF TV 13	+ 21.7V	+ 3.8V	00V	00V	+ 10.4V	+ 11.6V	+ 21.7V	- 20V
UHF TV 14	+ 1.8V	+ 4.1V	+ 11.6V	00V	+ 10.4V	+ 1V	+ 1.8V	- 20V
UHF TV 83	+ 19.8V	+ 4.2V	+ 11.7V	00V	+ 10.4V	+ 1V	+ 19.8V	- 20V
CATV (CABLE)								
Midband 14	+ 3.3V	+ 4.7V	00V	00V	+ 10.5V	+ 11.6V	+ 3.3V	- 20V
Midband 22	+ 10.7V	+ 4.0V	00V	00V	+ 10.5V	+ 11.6V	+ 10.7V	- 20V
Superband 23	+ 8.8V	+ 1.8V	00V	00V	+ 10.5V	+ 11.6V	+ 8.8V	+ 10.4V
Superband 36	+ 21.2V	+ 3.8V	00V	00V	+ 10.5V	+ 11.6V	+ 21.2V	+ 10.4V

Figure 8 These voltages were measured in the sample Zenith receiver for the channels shown, and they can be used for comparisons during servicing. For example, the tuners can be tested without the control circuits by removing the 1K and 1J plugs and applying appropriate voltages to the various pins.

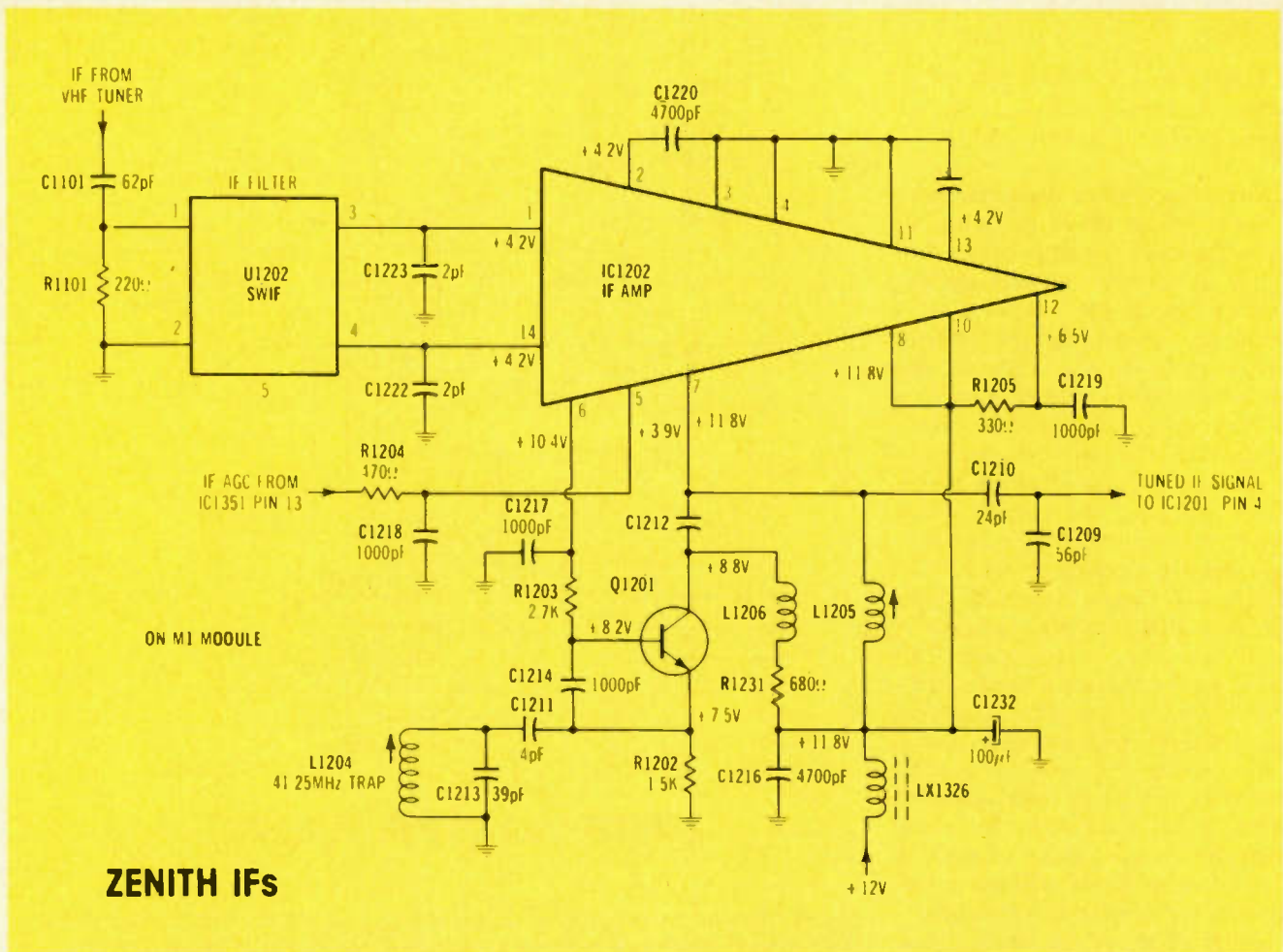

Figure 9 This is the IF amplifier IC with its components. The only adjustments are the L1204 trap and the L1205 IF transformer.

Zenith

the sound-IF signal (C2) which is rich in 4.5MHz beat, and a separate C1 video signal (with all 4.5MHz signal removed). The C1

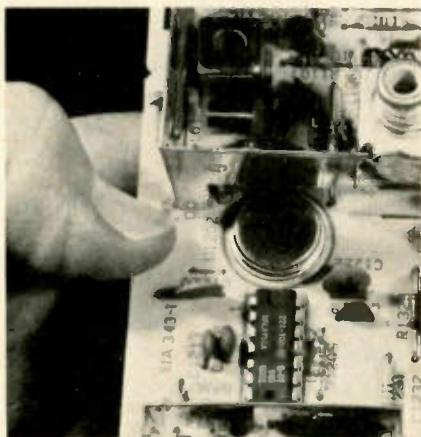

Figure 10 The U1202 SWIF IF-tuning device (round component in front of the thumb) is only slightly larger in diameter than one conventional IF transformer, but it replaces several tuning transformers and traps.

and C2 designations follow the Zenith tradition.

One improvement found during waveform analysis was the stability of the C1 video signal. When a diode detector is used in a television receiver, the detector-output waveform moves up and down constantly as the picture part of composite video changes. Also, changes of incoming signal strength vary the dcV level and move the waveform up and down.

With the scope switched for dc-coupling mode, the Zenith synchronous demodulation C1 waveforms always kept the horizontal-sync pulse at the same graticule line regardless of the channel selected, the signal level or the modulation level. This is the first TV receiver in which this effect has been observed. It is also the first one using synchronous demodulation that has been tested. This improves the stability of scope waveforms, particularly observation of the VITS and VIR vertical-inter-

val test signals. One benefit to the viewers is that the brightness (Zenith calls it black-level) control should not require any adjustments after an initial rotation.

Another benefit of synchronous demodulation (but one that cannot be demonstrated easily) is the lack of beat-product distortion that otherwise would cancel some advantages of the wide-bandwidth comb filter. Synchronous demodulation and the comb filter operate together to improve the visible picture.

Here is one servicing precaution: Do not attempt to align or look at the alignment curve by using conventional sweep-alignment equipment. A sweep generator does not provide the steady picture carrier that is essential for synchronous demodulation. Because of the SWIF (that cannot be adjusted) and only two noncritical adjustments, it is not likely the IF's will require any field alignment. The synchronous demodulator has five adjustments (in addition to the usual 4.5MHz

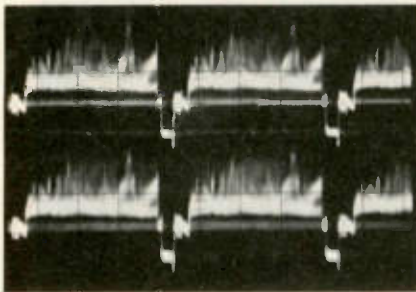
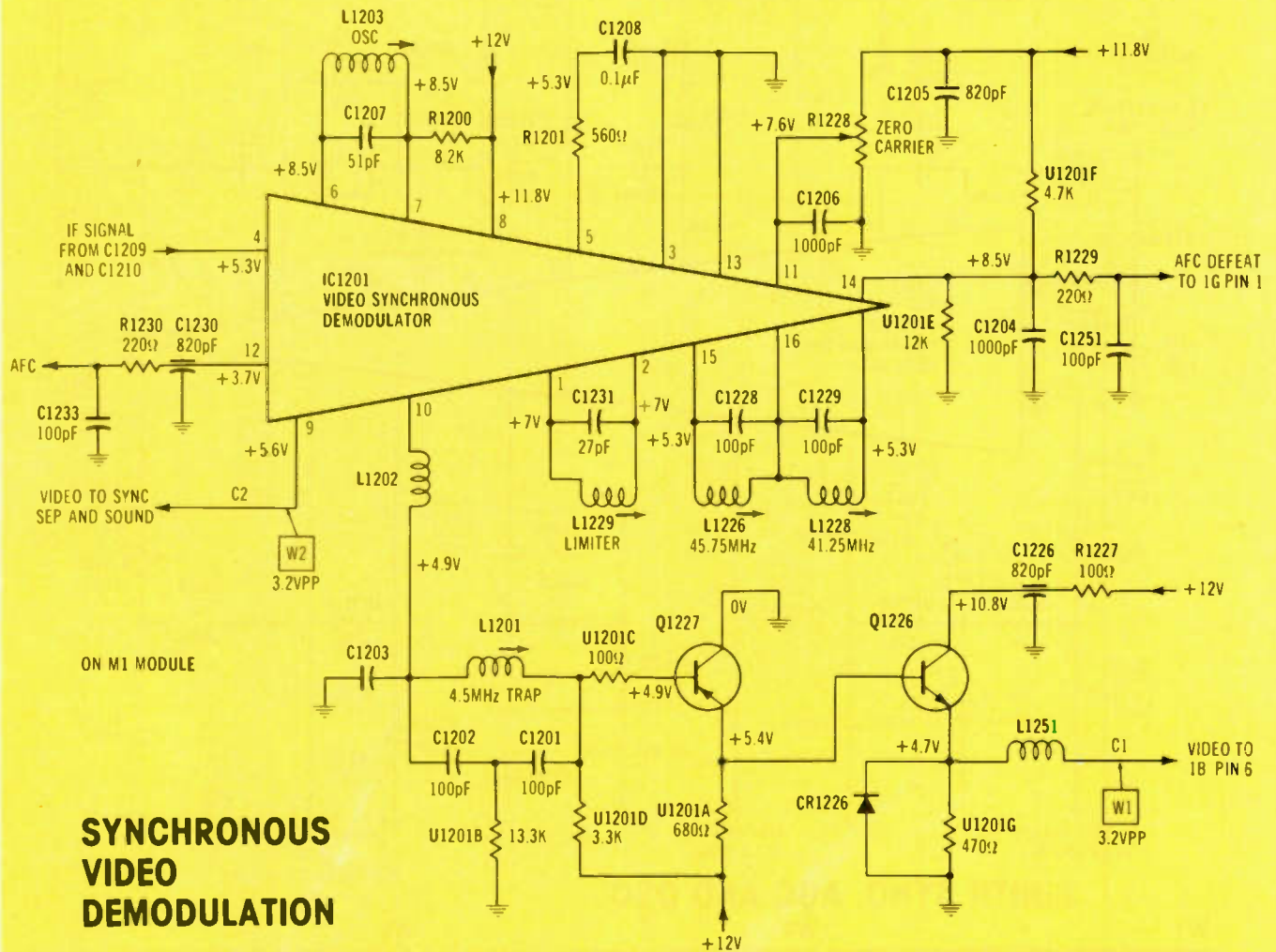

Figure 11 Synchronous demodulation requires more components than are needed for the usual diode-type video detector, but gives improved performance. This circuit cannot be viewed or aligned properly by conventional sweep-alignment techniques. The C1 (upper trace) and C2 (lower trace) waveforms are almost identical except the C2 sound/sync waveform has some 4.5MHz sound signal that widens the base lines.

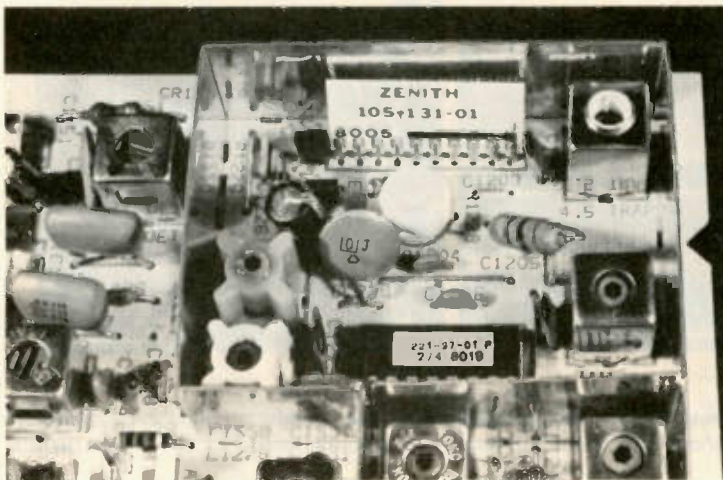
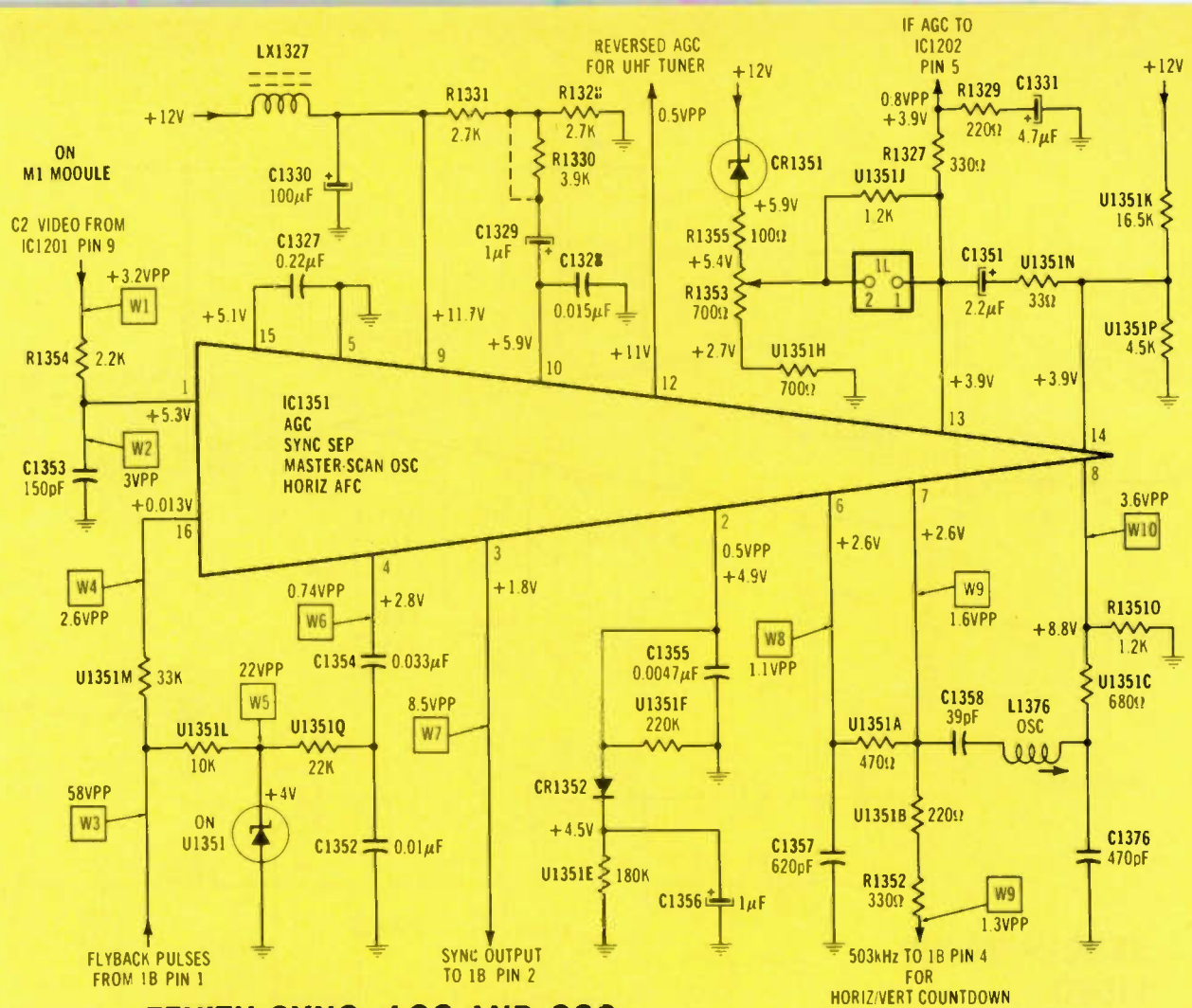
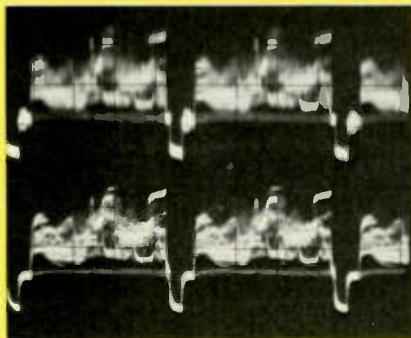

Figure 12 The IC1201 video synchronous demodulator circuit is in a corner of M1 inside a shield. A thick-film multiple-resistor unit (U1201) is the white component at the top.



ZENITH SYNC, AGC AND OSC

W1



W3

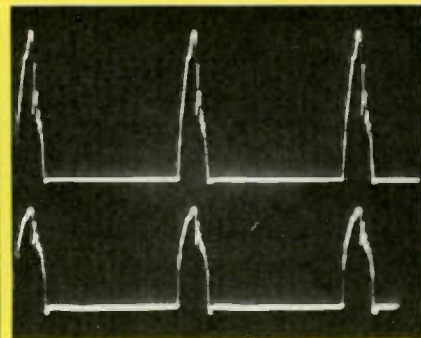

W5

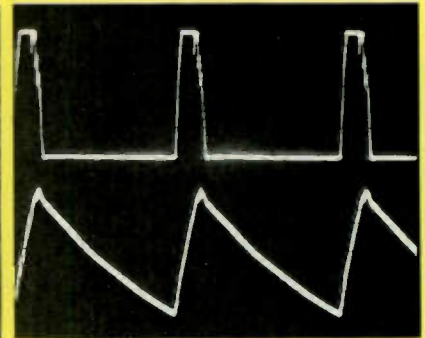

W2

W7

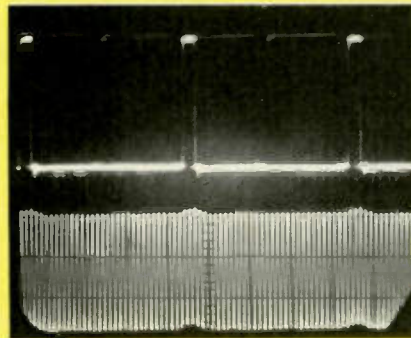

W4

W9

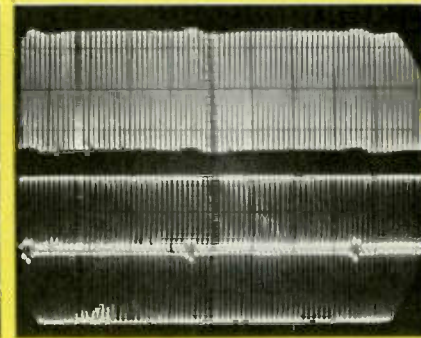

W6

W9A

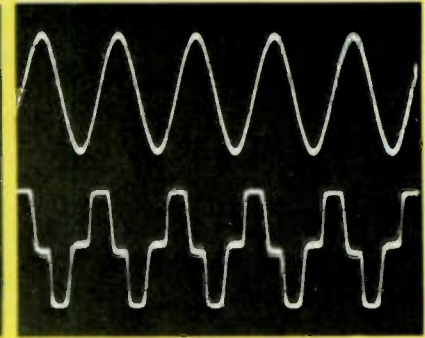

W8

W10

W10A

Figure 13 This schematic of IC1351 includes dc voltages, peak-to-peak acV measurements and waveforms (where appropriate). All waveforms were scoped at horizontal rate except W9A and W10A, which required shorter scope sweep times to show details in individual cycles of the 503kHz signals.

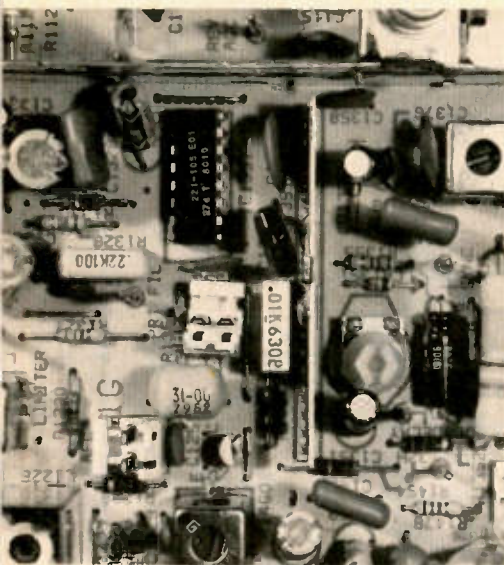

Figure 14 IC1351 is shown at the upper left, surrounded by components for the AGC and sync-separation functions. Components of the master-oscillator are at the right of the white vertical line (another thick-film resistor component).

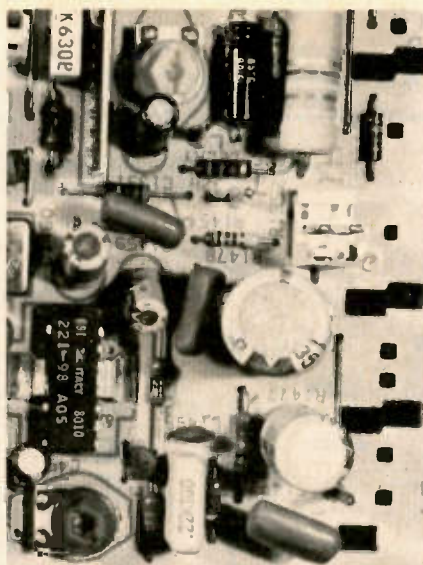

Figure 15 Components and IC1451 of the sound-IF and audio circuits are in the lower-left corner of M1 (as it mounts in the cabinet). One IC handles all sound-IF, detection and audio functions.



Figure 16 Convenient access to most areas on the M1 module is possible from its mountings and then the plugs and connectors are re-installed. Be certain that insulation is provided to prevent shorts to adjacent metal components.

Zenith

trap), and a special method must be used for alignment.

A closeup view of the shielded demodulation-circuit area is in Figure 12. One unusual component is the thick-film multiple resistor (U1201). It contains seven resistors, including some of high precision. In the picture, U1201 is the white component with the many leads near the back shield.

AGC and sync separation

A schematic of the many IC1351 circuits is shown in Figure 13; the accompanying waveforms help explain the various functions. Composite video from the C2 sound/sync signal enters IC351 at pin 1 (waveforms W1 and W2). After sync separation, composite sync exits at pin 3 (waveform W7).

Horizontal pulses (W4) enter the IC at pin 16, probably for the keyed AGC. Clipped pulses (W5) are integrated into sawteeth (W6) that enter IC1351 at pin 4. These probably are used in the horizontal phase detector.

The master scan oscillator also is in IC1351. However, the oscillator does not operate at 15,734Hz or 31,468Hz (as other models do), but at 503kHz (W8). After frequency division by 32 in the M2 module, this becomes 15,734Hz for horizon-

tal drive. Further division provides the vertical frequency.

Internal control from the phase detector varies the 503kHz master-oscillator frequency until perfect frequency and phase matching occurs between the pin-4 horizontal-frequency sawteeth (from horizontal deflection) and the pin-3 horizontal-frequency sync pulses (from the station video).

AGC dc voltages for the IF and tuner RF stages also are developed inside IC1351. The IF AGC voltage can be measured at IC1351 pin 13 or IC1202 pin 5.

Figure 14 pictures the area of M1 module around IC1351.

Sound circuits

The complete sound and audio circuits are in the lower-right corner of module M1 (Figure 15). One IC (IC1451) performs all sound-IF and audio functions.

Servicing

Because many IC's and so few transistors are employed, preliminary troubleshooting should consist of measuring dc-supply voltages and scoping the input and output signal waveforms of each stage where this is possible. Typical dcV, PPP and waveforms are given for almost every point in the schematics. These should be used as standards.

Whether to replace a module or repair it is a decision to be made according to the warranty status and other considerations.

The tuners can be tested without the control circuitry by removing the 1K and 1J plugs and applying the proper dc voltages from external supplies. This applies also to the tuning voltage which can be varied around the channel voltages of Figure 8 until each station is tuned properly. If this cannot be done, the tuner itself probably is defective.

Module M1 in Zenith model SM1973P is crowded tightly between the telephone-interface module and module M2. Few measurements except C1 video and the edge-connector voltages can be made conveniently with M1 in that position. However, it is possible to disconnect all cables, remove M1 and then reconnect all cables as shown in Figure 16. Warning: Be certain to insulate the wiring side of the module to prevent shorts with other modules. Of course, all plastic cable ties should be re-installed (after M1 is replaced) to maintain the factory cable positions.

Next month

Functions of the M2 module, including the comb filter, will be the subjects of the next article in the Zenith series. □

Chassis—Zenith 19CC19
PHOTOFACT—1215-3

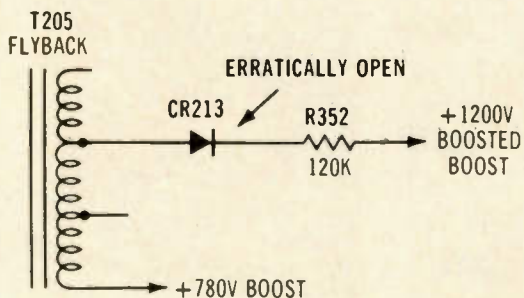

Symptom—Noise streaks and darker picture
Cure—Check diode CR213 for intermittent open, replace if defective

Chassis—Zenith 19DC12
PHOTOFACT—1311-3

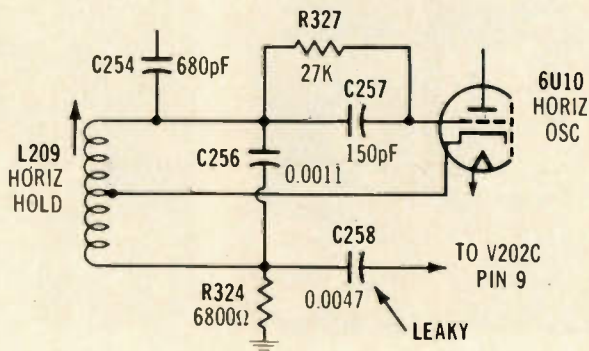

Symptom—Width shrinks on both sides
Cure—Check coupling capacitor C258, replace it if leaky

Chassis—Zenith 19CC19
PHOTOFACT—1215-3

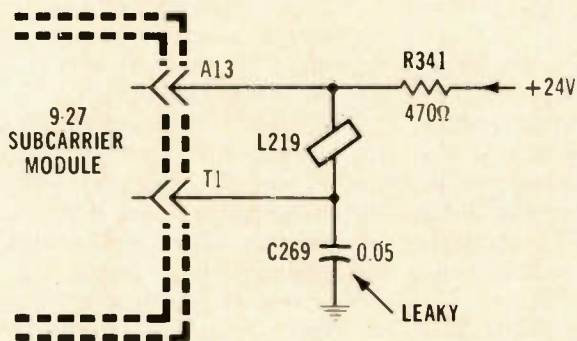

Symptom—Color out of lock; dcV low at module 9-27 pins A13 and T1
Cure—Check capacitor C269, replace it if leaky

Chassis—Zenith with SC1000 remote control
PHOTOFACT—1681-2

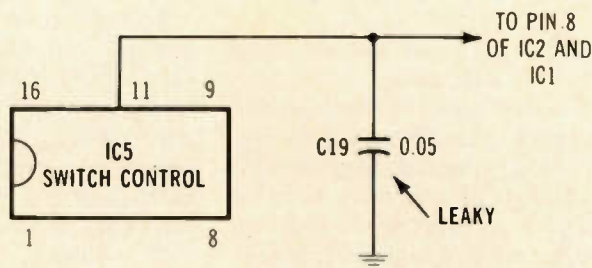

Symptom—Odd-number channel lamps do not light; reception is normal
Cure—Check capacitor C19, replace it if leaky or shorted

Chassis—Zenith 19CC19
PHOTOFACT—1215-3

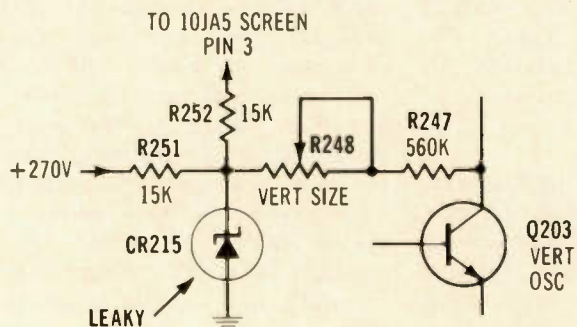

Symptom—Insufficient height
Cure—Check zener diode CR215, replace it if leaky or shorted

Chassis—Zenith with SC1000 remote control
PHOTOFACT—1681-2

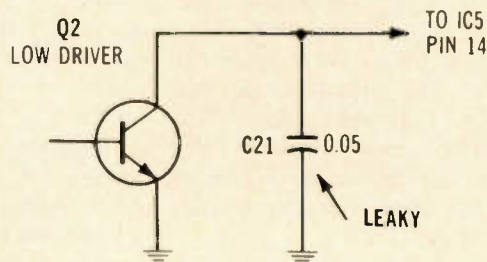

Symptom—Channel selection does not stop at odd-numbered channels
Cure—Check capacitor C21, replace it if leaky or

catalogs literature

A.W. Sperry Instruments has issued a full line, short form catalog and price sheet. The short form catalog (MES-200) contains detailed specifications for the A.W. Sperry line of digital and analog Snap-Around ammeters, digital and analog multi-testers, insulation testers, voltage indicators and accessories. The accompanying price sheet (RPL-18C) lists the suggested trade prices along with instructions on how to purchase A.W. Sperry instruments.

Circle (15) on Reply Card

Sentry Manufacturing Company is offering a *Microprocessor Crystal Guide*. This guide provides information on frequencies available and



their application. Sentry can also manufacture most frequencies not listed in the guide.

Circle (16) on Reply Card

ITT Pomona Electronics has published a 108-page catalog of test accessories for use in electronic equipment. The 1981 Pomona Electronics catalog includes more than 450 photographs and 30 drawings of test accessories including banana plugs, jacks and patch cords, phone tip jacks, plugs and connecting cords, test clips, probes and hold-

ers, binding posts, black boxes and sockets.

Circle (17) on Reply Card

A catalog of hard-to-find tools for electronic assembly and precision mechanics is offered by **Jensen Tools**. It features 15 pages of test equipment and contains more than 2000 tools of interest to field engineers, technicians, instrument me-

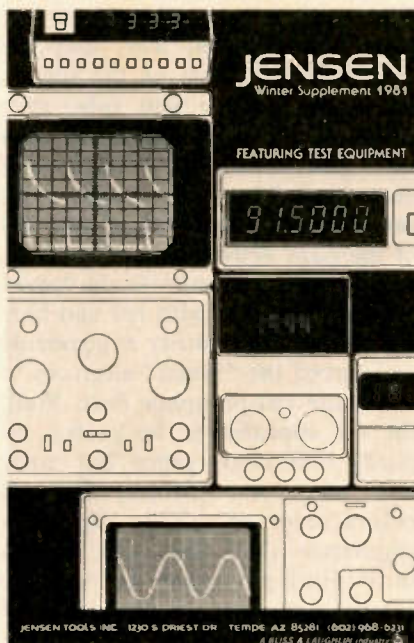

chanics, locksmiths, watchmakers and electronic hobbyists. Major product categories are: test equipment, micro-tools, soldering equipment, tweezers, screwdrivers, cutters, drafting supplies, power tools and a complete line of tool kits and tool cases.

Circle (18) on Reply Card

A revised 1980-81 illustrated short form catalog from **Test Probes Inc.** describes their expanded line of probe kits and test lead sets. Sixteen models are featured, including oscilloscope probes, RF/demodulator probes and test lead sets. Specifications and a list of options and accessories are included.

Circle (19) on Reply Card

A 24-page condensed catalog by **Jonard Tools** features descriptions of more than 500 various spring adjusters, tension and thickness gauges, burnishers, tool kits and precision hand tools. Price lists and ordering information are included.

Circle (20) on Reply Card

An 8-page catalog describing their line of digitally programmable power sources is available from **Kikusui International**. The catalog contains complete specifications on 15 models including both voltage and current programmable instruments. Also included is a description of a new Kikusui device that interfaces their digitally programmable power sources with IEEE-488 controllers.

Circle (21) on Reply Card

Heath has published a catalog describing more than 60 test instruments for use by beginning hobbyists, students, service technicians and engineers. The instruments include hand-held and bench digital



frequency counters, oscilloscopes, signal tracers, power supplies, capacitance and resistance substitution boxes, IC and FET transistor testers, generators, VTVMs, VOMs, multimeters, distortion analyzers and watt meters.

Circle (22) on Reply Card

troubleshooting tips

Reversed colors Zenith 24MC32 (Photofact 769-4)

With the television cabinet lying on one side, thus allowing access to the chassis wiring after the metal bottom plate was removed, I tried to adjust the gray scale by sliding the setup switch and rotating the screen controls. To my amazement, turning up the red-screen control brought up the green line, turning up the blue control increased the red, and rotating the green control made the blue brighter.

At first I assumed that someone had reversed the screen-grid-controls wiring. But a careful examination of the B-boost circuit and all three screen controls proved the controls were connected to the proper pins of the CRT socket. The picture tube was almost new and had given no trouble previously.

When the receiver was placed in the normal bottom-down position, all screen controls controlled the correct colors. Tests then were made with the receiver upside down and on each side. In all positions, except the normal one, the colors were wrong. Of course, it is impossible to obtain correct color hues when the CRT colors are reversed.

None of us has an explanation. Some tubes are known to short if placed in certain positions, but that hardly appears to be true here. Can anyone explain what happened?

Wilbur Cressy
Chicago, IL

Editor's Note: The problem is totally *incorrect color purity* in the picture tube. These older picture tubes (about 1965) were susceptible to purity changes when the alignment of picture tube and Earth's magnetic field were disturbed by rotation of television cabinets. In fact, we instructed all dealer technicians to adjust the receiver purity and convergence on the exact spot where the television was to be

operated. The worst position for a picture tube was rotated 90° in either horizontal or vertical direction. A problem similar to yours happened to me years ago. This Zenith was placed horizontally on its side for convenient access to the wiring, but *the complaint was loss of color*. A color-bar generator and scope proved the color signals were reaching the CRT grids, but the screen *showed* virtually no color. The receiver was placed on the floor in the usual way, and the color became visible on the screen. When the cabinet and tube were turned 90°, the electron beam from each gun fell on *all three dots* of each triad. Therefore, a near-white raster was obtained with any (or all) of the guns active. In another case, a technician had mistakenly turned on the green gun (with red and blue off) during color purity adjustments and forced the "green" electrons to strike the red-phosphor dots. Well, the set appeared to be perfect on purity and convergence but color bars and color pictures had all colors reversed. These examples emphasize that the color of an individual phosphor dot on the screen depends on the type of phosphor and **not** on the electron gun that strikes it. A red dot will be red whether struck by electrons from the blue, green or red gun. And a red, blue or green gun electron beam that strikes **between** three delta color dots can appear to produce white. Fortunately, newer color tubes are not this critical, and they can be moved without degradation of purity.

Narrow width Magnavox T932 (Photofact 1017-1)

When the customer brought this TV to the shop, the complaint was *insufficient width*. First suspect for narrow width in tube-type color

receivers is the horizontal-output tube, so the 31JS6 was replaced immediately. However, the 17DW4 damper plates glowed red and the circuit breaker tripped. Two more new 31JS6 tubes were tried, but the results were the same.

Finally, we installed the original tube, obtaining correct operation except for the narrow picture. It was clear that the new tubes were different in some way from the original.

Comparisons between chassis wiring and the various tubes proved the original 31JS6 (made in Japan) had nothing connected to pin 7, and the television manufacturer had used pin 7 as a tie point for the oscillator-to-grid coupling capacitor and a grid resistor. Unfortunately, in our brand of replacement tubes, pin 7 was connected to the heater wiring. Using a replacement tube, therefore, eliminated the grid drive, removing the negative bias from the output grid and causing a huge plate current.

The solution was simple: Pin 7 lug was cut off the output socket, and the stub of lug with its resistor and capacitor was moved away from the original location to prevent shorts. The rigidity was sufficient to hold them in place.

After this modification, any tube could be used, regardless of any internal connections to pin 7.

Mac Kellman
Video Master TV
Brooklyn, NY

Loss of high voltage Wards Airline GGV-12944C (Photofact 1403-3)

Preliminary tests for the lack of raster showed fuse F404 was open. A new fuse restored the sound, but not the raster. Tests of the horizontal-output circuit found an open flyback winding.

When the flyback was replaced, a

raster with color blobs was obtained. However, the picture was missing. After a few seconds, the 1A fuse blew. I connected a 1A circuit breaker across the fuse terminals to save the expense of blown fuses during these tests. The degaussing circuit was eliminated by connecting a 7.5Ω fusistor in place of the degaussing coils.

Replacing the focus assembly did not help. Each time power was applied, the high voltage would rise to normal, and then decrease slowly until the test breaker tripped to remove all power.

I began a routine check of all voltage supplies powered by horizontal-sweep pulses from the fly-back. At Circuitrace point 16, the voltage measured slightly negative instead of the expected +10.95V. At point 13, the voltage was normal. This suggested a possible vertical-sweep problem; tests in that circuit quickly found a shorted Q267, one of the complementary pair of vertical-output transistors.

Installation of a new Q267 and a fuse restored a good picture without color impurity. No overloads occurred during a long heat run.

The original symptoms were very misleading. Previous symptoms of a shorted vertical-output transistor always included a drastic reduction of height. This raster appeared to have full sweep but with severe impurity. It is possible the sweep was excessive or nonlinear. A short test with a crosshatch pattern should have been made.

James M. Thurston
Thurston Electronic Service
Fort Wayne, IN

Send your tip to:

Troubleshooting Tips
Electronic Servicing
P.O. Box 12901
Overland Park, KS 66212

GAS SAVER



You can save a lot of gasoline—and a lot of money—if you use the phone *before* you use your car.

By calling ahead, you can be sure the restaurant is open . . . the store has what you want . . . or the friend you want to visit is home—*before* you waste time, gas and money on an unnecessary trip. On the average, you waste about a dollar's worth of gas on every unnecessary trip—and just two wasted trips a week can cost you more

than \$100 worth of gas a year.

Saving energy is easier than you think, and with the rising energy costs we're facing today, it's never been more important. So the next time you pick up your car keys and head for the door, ask yourself whether a phone call could save you the trip—and the wasted gas.

For a free booklet with more easy energy-saving tips, write "Energy," Box 62, Oak Ridge, TN 37830.

ENERGY. We can't afford to waste it.

U.S. Department of Energy

test equipment report

Signature analyzer

B&K-Precision has introduced its SA-1010 signature analyzer. The new instrument is designed to simplify and reduce the cost of troubleshooting complex digital and microprocessor-based products. The SA-1010 allows semi-skilled technicians to troubleshoot microprocessor-based products down to the component level, by making simple



comparisons of digital signatures. The instrument is designed for use in field service and in-plant applications.

One feature of the SA-1010 is that it can dramatically reduce board float. Instead of the common practice of swapping boards in the field to locate a suspected problem, a field engineer can use the SA-1010 to localize the problem and replace only the board or components found to be defective. When the data probe of the SA-1010 is applied to a circuit node, the instrument converts the lengthy bit stream present into a unique four-digit hexadecimal type display. To locate a problem, the field engineer traces through the circuit comparing the observed signatures to those identified on a schematic diagram or service manual of the product under test. When a node is reached that has a correct input signature and incorrect output signature, the problem has been isolated. For a fast field check of the board only, signatures

can be observed at the board interconnection points and compared with data in a simplified field test procedure.

In the plant, the SA-1010 can reduce the cost of incoming inspection, quality control and repair. The unit requires minimal operator training and can be used to fully check a sophisticated microprocessor-based board in minutes.

The SA-1010 is a multi-family instrument, usable with TTL, MOS and CMOS logic circuits. For user convenience, a 1MHz TTL lock synchronizing output is on the rear panel. The instrument is supplied with detachable probe assembly, control and data pods, and vinyl pouch for storage of probes and manual.

Circle (23) on Reply Card

Volt-OHM-Ammeter

The **A. W. Sperry** model SPR-930 Snap-Around Volt-OHM-Ammeter features +3% of F. S. accuracy over full frequency spectrum of 50-400Hz. This feature eliminates any further calibration. The SPR-930 features positive acting detented range switch and dial drum mechanism, spring-loaded



ball pivot jaw action for smooth and durable operation, and grip fast textured housings. A rotary scale presents one range at a time, reducing reading error. The unit is furnished with a carrying case, twist and lock safety leads, ohmprobe fused battery attachment for Ohms, operating instructions and warranty card.

Circle (24) on Reply Card

Voltage isolator

Tektronix has introduced the A6902 Isolator. The A6902 is a dual channel, DC-15MHz, optical

and transformer coupled voltage isolator allowing a safely grounded test instrument to perform floating measurements at a high sensitivity (20mv) in the presence of common mode signals as high as $\pm 1500V$ DC + PK AC. It has fully calibrated attenuators for each channel providing 20mv/div to 200V div sensitivities. The Isolator operates with any general purpose



oscilloscope or other test instrument providing an equivalent 10mv/div sensitivity. The A6902 Isolator is priced at \$2300. Included as standard accessories are two pairs of detachable voltage probes carried as part of the instrument in permanent side pouches.

Circle (25) on Reply Card

3½-digit digital VOM

The **Triplett** model 3410 handheld single range switch, six function 24 range digital VO is an enhanced version of the popular model 3400. It offers a 1000V ac/dc range, overload protection up to 600V on all current ranges with special 2A/250V and 3A/600V fuse arrangement and protected up to 1000V on ohms and voltage ranges



without fuse blow. The unit also features a typical battery life of 500

hours with an 8 hours-to-spare low battery indicator. An easy-reader 3½-digit, ½-inch LCD display has overrange blanking indication plus auto-polarity and auto-zero features. The single range selector switch is conveniently color-coded for the six functions with 24 ranges, plus Hi and Low Power Ohms. The 3410 is priced at \$140. Price includes 36-inch test leads, screw-on insulated alligator clips, 9V battery, spare 9A fuse and retaining screw, wire tilt stand, one year warranty and instruction manual.

Circle (26) on Reply Card

Digital tip temperature meter

Micro Electronic Systems announces their KWIK-CHEK digital tip temperature meter and soldering iron holder. The unit measures temperatures up to 800°C with a



resolution of 1°C and an accuracy of less than 1%±1°C. The KWIK-CHEK features an LCD readout, and can be used with any soldering iron.

The unit is priced at \$180.

Circle (27) on Reply Card

DTMF test set

The Conway DTMF-5000 pocket calculator-sized DTMF test set is designed for operating simplicity. It has the features of most expensive bench model test sets. The high visibility 8-digit display shows all 16 DTMF tone combinations. The unit decodes up to 20 characters per second and is complete with display

latching. The crystal-controlled keyboard generates all 16 DTMF tone pairs plus the eight discrete tones used in telephone touch signaling.

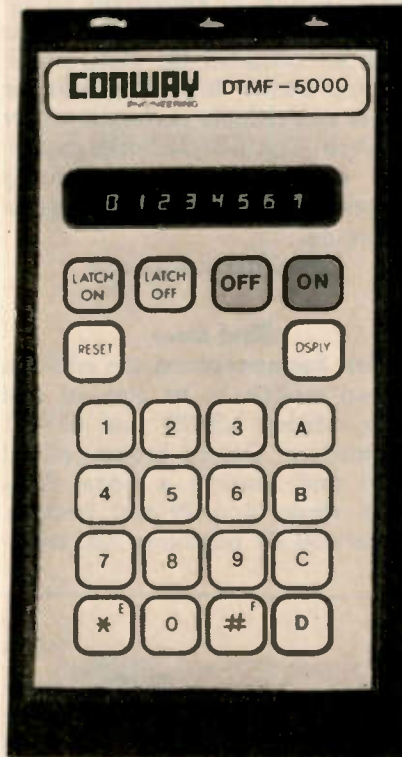

The Conway DTMF-5000 is supplied with a rechargeable battery, carrying case, patchcords, earphone and charger.

Circle (28) on Reply Card

Compar-a-trace

Huntron Instruments announces the Huntron Compar-A-Trace model HTR 1005B-1S, an instrument for troubleshooting solid state com-



ponents and circuits. The unit features timed dual-channel switching or single channel operation for

comparison testing of analog or digital devices in, or out of, circuit. Visual displays indicate the condition of devices or circuits under comparison as they are tested without circuit power applied. A graticule faceplate supplies a reference standard for visual comparison of firing voltages for diodes, discrete components or ICs.

Single unit price of the Compar-A-Trace is \$965.

Circle (29) on Reply Card

Autorangeing multimeter

Now available from Radio Shack is the Micronta autoranging 3½-digit LCD digital multimeter model 22-196. The unit features a range-hold function and out-of-range and low-battery indicators. All ranges



are overload protected. The unit requires one 9V battery or an ac adapter.

The Micronta DMM is priced at \$99.95. Price includes test leads, instructions and carry handle/stand.

Circle (30) on Reply Card

product report

Wire cut and strip tool

The O.K. Machine and Tool ST-100 strips wire without nicking, and automatically generates the proper strip length for wire-wrap-

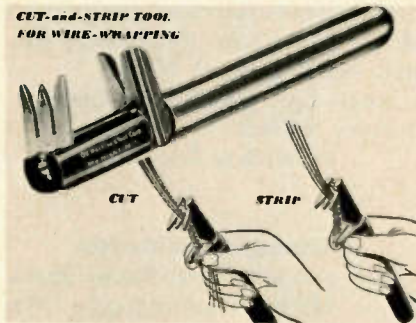

ping. The tool features hardened steel cutting blades and sturdy construction. The stripping blade is replaceable. The ST-100 is available for wire sizes from 20-30 AWG.

Circle (31) on Reply Card

Computer-grade capacitors

A line of aluminum electrolytic computer-grade capacitors is available from the Electronic Components Division of **Panasonic**. Designated as the GY/GS Series, the units are intended for many applications where high capacitance values and reliable performance are required. The GY/GS Series capacitors are equipped with sturdy mounting straps for vibration-proof mounting.

Circle (32) on Reply Card

inches. Model 655-ZT measures 10x13x2½-inches.



Tool cases

Platt has announced the addition of two models to its line of tool cases. Models 650-ZT and 655-ZT are made of Oxford brown padded vinyl and feature a heavy-duty nylon zipper and 29 tool pockets. Model 650-ZT measures 10x13x1½-

The cases are priced at \$21 (650-ZT) and \$22 (655-ZT). Quantity discounts are available.

Circle (33) on Reply Card

Electronic Servicing. is Available in MICROFORM

FOR INFORMATION
WRITE:

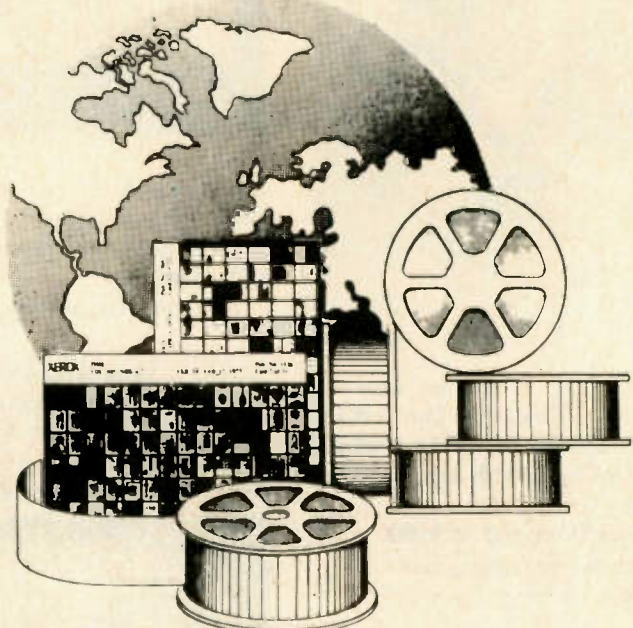

University Microfilms International

300 North Zeeb Road
Ann Arbor, Mich. 48106
U.S.A.

18 Bedford Row
London, WC1R 4EJ
England

reader's exchange

Needed: Service information for Sams M.H.F.8. Will buy, or copy and return. *Jensen Radio & TV, 833 Jacobsen St., Marinette, WI 54143.*

Needed: Schematics for a Fisher M-scope electronic switch leak detector and pipe and cable finder. *Schafer Electronics, 2855 Chartiers Ave., Pittsburgh, PA 15204.*

Needed: A copy of Sams *Study Guide for Journeyman CET Examinations* (No. 21410). *S. O. Sellers, Rt. 11, Box 160, Bessemer, AL 35023.*

Needed: Philco power transformer No. 32-8924-1; Philco def. yoke No. 76-14302-1, or Thordarson No. Y-164; and CRT 5UPI for Sencore PS127 scope. *B. Fritz, 3210 St. Lawrence Ave., Reading, PA 19606.*

Needed: Resonant reed relays for Johnson Messenger 215; part No. 567-5001-16. *Osceola Electronics, 226 S. M66 Hwy., Marion, MI 49665.*

Needed: Schematic and service date for United Research Corp. burglar alarm model No. ESP-300. Will buy, or copy and return. *Alejandro Vazquez*

Schiaffino, Avenue Juarez No. 56, Colima, Col., Mexico.

Needed: Power transformer for Motorola model T1044B scope; and used Sony CRT 150AKB22/SD-59. *Winston Berzas, Rt. 12, Box 533, Lake Charles, LA 70605.*

Needed: Model 250 Conar scope in good condition with probes and manual. *B. C. Crump, 218 S. Spruce, Kermit, TX 79745.*

Needed: Picture tubes (No 9AP4 and 12AP4); and any parts literature for pre-1945 televisions. *Jeff Lindaro, Morris TV, 1 Padanaram Rd., Danbury, CT 06810.*

Needed: Power transformer for Philco tube type stereo model No. M1689CH. Transformer part No. 32-10006-3. *Rich Freeland, 5017 Barrie St., NW, Canton, OH 44708.*

Needed: Schematics for a 1974 GTE key board model No. 629AAAA0141, code No. 2056. *John A. Franklin, 183 Lampart Blvd., Staten Island, NY 10305.* □

photofactTMbulletin

BOHSEI	
TR-005	1976-1
CORONADO	
TV2-2073A-4	1975-1
GENERAL ELECTRIC	
Chassis EC-D	1976-2
JC PENNEY	
685-2056E,-00 (855-1971), 685-2060E,-00 (855-1897), 685,4500E,-00 (855-2085)	1973-1
PANASONIC	
Chassis 19D01-A	1970-1
QUASAR	
Chassis ADTS-/DTS-979	1970-2
Chassis ADTS-/GTS-981	1971-2
RCA	
Chassis CTC99E (1981 Production)	1975-2

SANYO	
21T66,A	1971-2
SHARP	
C1975, C1985	1972-1
SONY	
Chassis SCC-265A-A, Remote Control Transmitter RM-701	1974-1
TOSHIBA	
Chassis TAC960/65	1970-3
CA940,C/44,C	1971-3
TRUETONE	
WEG2079A-08 (24-2079-2)	1971-4
GEC2002A-18 (24-2002-4), GEC2003A-18 (24-2003-2), GEC2004A-18 (24-2004-0)	1974-2
ZENITH	
M2310W/314E/316M/318P/320PN, M4320P/322E	1972-2

Advertising rates in the Classified Section are 35 cents per word, each insertion, and must be accompanied by cash to insure publication.

Each initial or abbreviation counts a full word.

Minimum classified charge \$3.00.

For ads on which replies are sent to us for forwarding (blind ads), there is an additional charge of \$3.00 per insertion to cover department number, processing of replies, and mailing costs.

Classified columns are not open to advertising of any products regularly produced by manufacturers unless used and no longer owned by the manufacturer or distributor.

For Sale

AUTOMOBILE RADIO and tape replacement parts: Delco, Chrysler, Philco-Ford, Motorola, Panasonic and many others. Large inventory. Laran Electronics, Inc., 3768 Boston Road, Bronx, NY 10469, (212) 881-9600, out of New York State, (808) 223-8314. 5-79-tf

TV & RADIO TUBES, 36 cents EA!! Free color catalog. Cornell, 4221 University, San Diego, California 92104. 8-76-tf

ELECTRONIC SURPLUS: CLOSEOUTS, LIQUIDATIONS! Parts, equipment stereo, industrial, educational. Amazing values! Fascinating items unavailable in stores or catalogs anywhere. Unusual FREE catalog. ETCO-011, Box 762, Plattsburgh, N.Y. 12901. 6-78-tf

SCRAMBLED TELEVISION, encoding/decoding. New book. Theory/circuits, \$9.95 plus \$1 shipping. Workshop, Box 393ES, Dept. E, Bethpage, N.Y. 11714. 7-80-tf

CRT REBUILDING EQUIPMENT. Great Profits. (815) 459-0673 after 7 PM. George, 1909 Louise, Crystal Lake, IL 60014. 2-81-6t

MIRROR IN THE LID, and other PRE-1946 Television sets wanted for substantial cash. Also interested in 12AP4, MW-31-3 Pre-War picture tubes, parts, literature on Pre-War Television, Arnold Chase, 9 Rushleigh Road, West Hartford, Conn. 06117 (203) 521-5280 2-81-4t

DESPERATELY NEED: Information on "Telcon" projection TVs from 1947, RCA "Test Lamp" for 1940's projection TVs. Arnold Chase, 9 Rushleigh Road, West Hartford, Conn. 06117 (203) 521-5280. 2-81-4t

Circle (8) on Reply Card

TUBES FOR TV AND RADIO—35¢ ea. Washington TV Service, 1330 E. Florence Ave., Los Angeles, CA 90001. 3-81-9t

WE ARE OVER STOCKED. We have Philco I.C.s for sale. 46 - 5002-8, \$7.15 ea. 46 - 5002-21, \$7.70 ea. We'll pay postage with cash or check order. Hallmark Electronics, 239 Roanoke Ave., Roanoke Rapids, N.C. 27870. 3-81-1t

CATHODE RAY TUBES for Tektronix oscilloscopes, \$30 each, mailing paid. T51P28, T32Ps, 3WP2, T317P31, 5CBP2, 5BGP. 407 Morningbird Court, Niceville, Florida 32578 3-81-1t

For Sale: Amazing new product, Windshield Washer Additive Cleaner. Mix yourself. Year's supply stores in glove compartment. Package \$3.50 plus \$1.50 postage. Guaranteed. Bonat, Dept. E, P.O. Box 1166, Buffalo, N.Y. 14211 3-81-1t

Business Opportunity

TV TECHNICIAN! Increase your income up to \$60,000 yearly. Rent-lease-sell TVs new-used, even from comfort of your home. Basic Preliminaries \$4.00. Perrys TV Systems, Hwy. 181, Box 142, R1, Bremen, KY 42325 12-80-tf

ESTABLISHED TV REPAIR SHOP for sale, good reputation. Plenty of business. P.O. Box 16268, Jacksonville, FL 32216. 11-80-5t

FIX IT FAST WITH PHOTOFAC[®]. Photofac[®] 1981 Index lists available service data for over 110,000 TVs, Radios, CB's, Auto Radios, Scanner-Monitors, and VCR's produced since 1946. Send \$2.50 plus 50 cents shipping to Howard W. Sams Co., Dept. X 0115, 4300 W. 62nd St., Indpls., IN 46268. 3-81-3t

WELL ESTABLISHED T.V. sales & service—Good location on beautiful Vancouver Island. Write Thomson's T.V. & Audio Ltd., 2818 Jacklin Rd., Victoria, B.C. V9B 5A4—or phone 604-478-7741. Owner retiring. 3-81-1t

ESTABLISHED T.V. SALES, SERVICE & Antenna Business. Same location for eleven years. Untapped potential. A great opportunity for the right person. Contact Vince Brekel, Box 486, Benkelman, Nebraska 69021 or Phone 308-423-2420 or 423-5359. New industry moving into area. 3-81-1t

TV TECHNICIANS—Save 50% on your ECG Replacements using your latest ECG Dealer Price List (Dec. 1980) as your guide. Top quality, 2 Yr. Warranty Semi-Conductors. \$10.00 Minimum Order, Shipped C.O.D., UPS. TRICO TV SALES, 172 Jersey Avenue, Port Jervis, N.Y. 12771, (914) 856-3313. 2-81-3t

WANTED: Lists of your old, slow-moving or overstocked parts. Turn dust into cash. Free details. Write Linear Systems, 139 4th Ave. S.E., Spring Grove, MN 55974 3-81-1t

To get more information...

on items advertised or described in this publication, use the Reader Service Card.

As a free service for our readers, we forward your inquiry to the product's manufacturer. Reader Service Card is pre-addressed.

advertisers' index

B&K Precision/Dynascan Corp.	7
ETCO Enterprises	44
Gamit Enterprises	21
General Electric	1
Keithley Instruments Inc.	11
Natesa	21
Nesda	23
Oelrich Publications	23
RCA Distributor & Special Products	IBC
A.W. Sperry Instruments Inc.	IFC
Zenith Radio Corp.	BC

Electronic Servicing.

Advertising Sales offices

NATIONAL SALES MANAGER

Greg Garrison,
P.O. Box 12901,
Overland Park, KS 66212
Phone: (913) 888-4664

LONDON, ENGLAND

John Ashcraft & Co., John Ashcraft,
12 Bear St.
Leicester Square, London, WC2H 7AS
England
Phone: 930-0525
Telex: 895-2387

AMSTERDAM, HOLLAND

John Ashcraft & Co., John J. Lucassen,
Akerdijk 150A, 1171 PV-Badhoevedorp
Holland
Phone: 0-2968-6226

TOKYO, JAPAN

International Media Representatives, Ltd.
2-29, Toranomon 1-chome, Minato-ku
Tokyo 105, Japan
Phone: 502-0656

NORWOOD, AUSTRALIA

Williamson & Associates, John Williamson,
No. 2 Edmund St., Norwood, S.A. 5067
Australia
Phone: 42-7074



RCA kicks in a \$10 discount on the Sidekick.

The RCA Sidekick. It's the rugged, large-capacity case for carrying the RCA Parts you need most for in-home TV servicing.

Now — for a limited time only — you can get your RCA Sidekick at a special \$10 discount from participating RCA Parts Distributors.

Only the Sidekick offers you these useful features:

- Space for 164 RCA standardized parts boxes.
- Five pull-out drawers including storage bin for tools, manuals and drop cloth.
- No-spill lock feature that keeps drawers in place.
- Rugged ABS plastic construction, riveted for extra strength and durability.

The RCA Sidekick makes in-home TV servicing faster and easier because it "organizes" your inventory and eliminates the need for separate kits for different TV chassis. Take this coupon to your participating RCA Parts Distributor today. You'll get \$10 off the price of the sensational RCA Sidekick.

This coupon worth \$10

toward purchase of one RCA 1F6200 Sidekick Carrying Case.

Dealer: Present this coupon to a participating RCA Parts Distributor for \$10 discount credit toward purchase of one RCA Sidekick Case. Offer not valid where prohibited. Limit: One \$10 discount per customer. (Offer expires 5/31/81.)

Distributor: See separate instructions and limitations for honoring this discount coupon.

Dealer Name _____

Street _____

City _____ State _____ Zip _____



RCA Distributor and
Special Products Division

a line of antennas as strong as its name
for the sales that bloom in the Spring



CHROMATENNA II

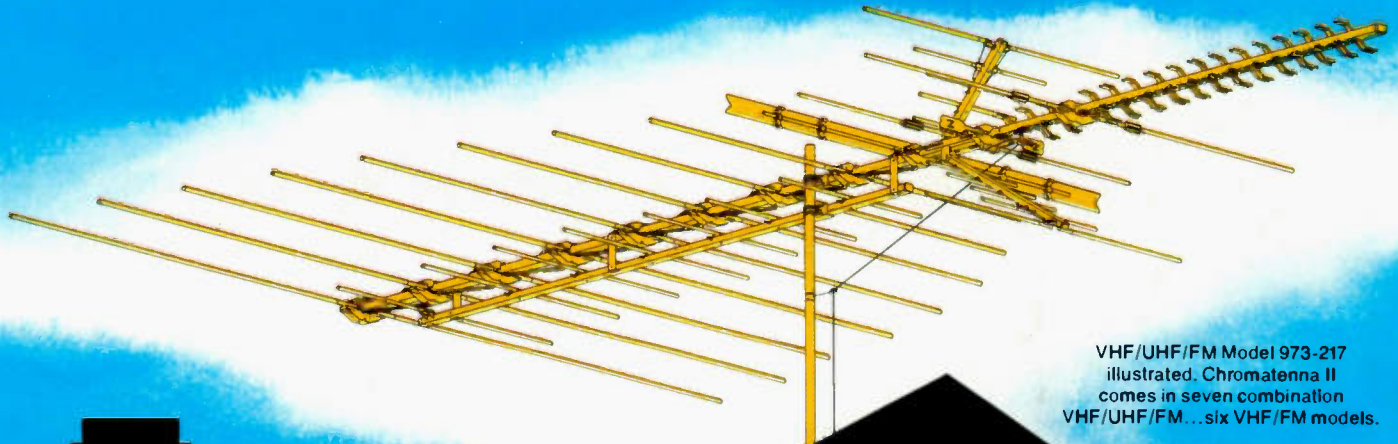

VHF/UHF/FM Model 973-217 illustrated. Chromatenna II comes in seven combination VHF/UHF/FM... six VHF/FM models.



Transmission Line Termination bleeds off static charges thru antenna system ground. Terminal stub improves front to back ratio on lower channels.



Aluminum Construction of all key metal parts works to eliminate rusting—provides long life. **Golden-Color Alodine Finish** is conductive—helps improve electrical performance!



High-Impact Plastic Insulators double-lock each element to the boom for extra bracing and durability.



FM Block reduces FM gain up to 12dB. Remove to receive full FM gain.



Corner Reflector Bracket enlarged and re-located in most models.



Zenith Dipole on UHF. (Combination models only.)



VHF Colinear Directors provide extra signal boost on both low and high band VHF.



Loading Straps—metal plates close to first VHF element insulators provide compensation for Lo and High band by tuning the first driven element with extra capacity.



Wide-Spaced, Heavy-Duty Feed Lines help prevent shorting from heavy build-ups of snow or ice.



Dual Isolator Bars insure no loss of UHF to VHF signal transfer. (Combination models only.)



Strain Relief Insulator accommodates either 300-ohm twin-lead, foam lead or Coax downlead.



U-Bolt Mounting provides a larger clamping area; larger locking nut with teeth an integral part assures a more rugged U-BOLT arrangement.



Optional Break-away UHF Wing Directors provide maximum gain of standard UHF channels with optional coverage of Hi UHF channels and translator frequencies when broken off. (Combination models only.)



Electrically Matched Terminals With Stainless Steel Screws eliminate mismatch... protect against rusting, and provide positive electrical contact with improved no-strip serrated washers for the take off terminals.

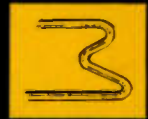

Proximity Spaced Signal Balancer (Z elements) provides automatic taper control of periodic driver, improves impedance matching and signal leveling on both Lo and High band channels. Improves Channel 7 pattern.



Sleeved Elements of heavy-duty construction afford extra bracing and protection.



Rugged 1" Square Boom provides extra strength compared to many round-type booms.



Hi-Bracket with angled ends for added strength.

Zenith has quality easy-to-install antenna kits — UHF only, VHF YAGI and Stereo FM antennas as well as a complete line of reception aid equipment. See your Zenith distributor for news of his exciting money-making Spring programs and Catalog No. 902-2019!



Zenith Radio Corporation/Service, Parts & Accessories Division/11000 Seymour Avenue/Franklin Park, Illinois 60131

Circle (3) on Reply Card