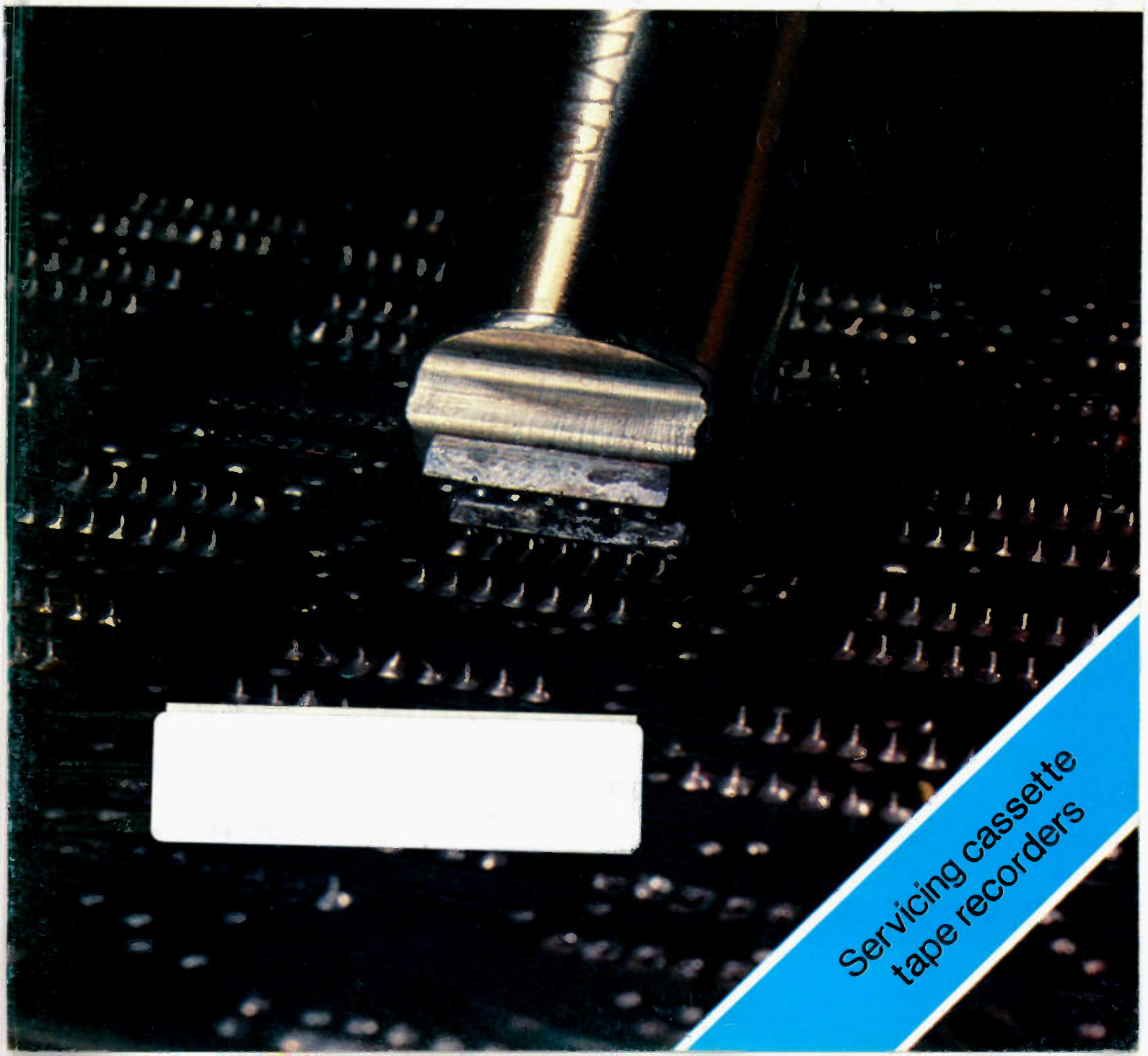


# Electronic Servicing

## Soldering and desoldering roundup

Fast soldering techniques



Servicing cassette  
tape recorders

ITEM NO.  
WK-7

CMOS SAFE

# IC INSERTION/EXTRACTION KIT

**KIT INCLUDES**

- MOS-1416 14-16 CMOS SAFE INSERTER
- MOS-2428 24-28 CMOS SAFE INSERTER
- MOS-40 36-40 CMOS SAFE INSERTER
- EX-1 14-16 EXTRACTOR
- EX-2 24-40 CMOS SAFE EXTRACTOR

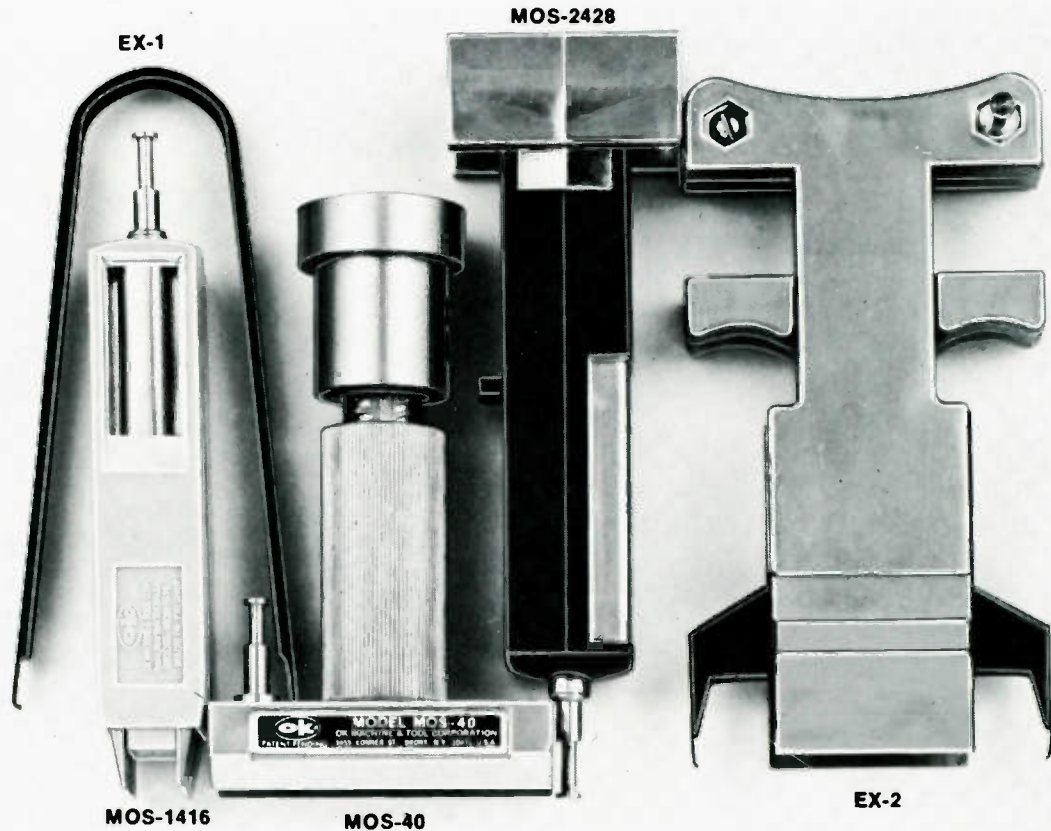


**OK MACHINE & TOOL CORPORATION**  
3455 CONNER ST., BRONX, N.Y. 10475 U.S.A.  
PHONE (212) 994-6600 TELEX NO 125091



PRINTED IN U.S.A.

PATENT PENDING



WK-7	COMPLETE IC INSERTER/EXTRACTOR KIT	\$29.95
------	------------------------------------	---------

### INDIVIDUAL COMPONENTS

MOS-1416	14-16 PIN MOS CMOS SAFE INSERTER	\$ 7.95
MOS-2428	24-28 PIN MOS CMOS SAFE INSERTER	\$ 7.95
MOS-40	36-40 PIN MOS CMOS SAFE INSERTER	\$ 7.95
EX-1	14-16 PIN EXTRACTOR TOOL	\$ 1.49
EX-2	24-40 PIN CMOS SAFE EXTRACTOR TOOL	\$ 7.95

MINIMUM BILLING \$25.00. ADD SHIPPING CHARGE \$2.00. NEW YORK RESIDENTS ADD APPLICABLE TAX.

**OK MACHINE & TOOL CORPORATION 3455 CONNER ST., BRONX, N.Y. 10475 (212) 994-6600/TELEX 125091**

Circle (1) on Reply Card



## Electronic Servicing

Editorial, advertising and circulation correspondence should be addressed to P.O. Box 12901, Overland Park, KS 66212 (a suburb of Kansas City, MO); (913) 888-4664.

### EDITORIAL

Bill Rhodes, *Editorial Director*  
Carl Babcoke, *Consumer Servicing Consultant*  
Kevin Klous, *Managing Editor*  
Mary Thornbrugh, *Associate Editor*

### ART

Dudley Rose, *Art Director*  
Linda S. Franzblau, *Graphic Designer*

### CIRCULATION

John C. Arnst, *Director*  
Evelyn Rogers, *Manager*

### ADMINISTRATION

R. J. Hancock, *President*  
George Laughead, *Publisher*

### ADVERTISING

Greg Garrison, *National Sales Manager*  
Mary Birnbaum, *Production*

Regional advertising sales offices listed near Advertiser's Index.



Member,  
American Business Press



Member,  
Audit Bureau  
of Circulation

**ELECTRONIC SERVICING** (USPS 462-050) (with which is combined PF Reporter) is published monthly by Intertec Publishing Corp., 9221 Quivira Road, Overland Park, KS 66212. Controlled Circulation Postage paid at Shawnee Mission, KS 66201. Send Form 3579 to P.O. Box 12901, Overland Park, KS 66212.

**ELECTRONIC SERVICING** is edited for technicians who repair home-entertainment electronic equipment (such as TV, radio, tape, stereo and record players) and for industrial technicians who repair defective production-line merchandise, test equipment, or industrial controls in factories.

Subscription prices to qualified subscribers: 1 year—\$12, 2 years—\$19, 3 years—\$24, in the USA and its possessions. All other foreign countries: 1 year—\$15, 2 years—\$25. Subscription prices to all others: 1 year—\$25, 2 years—\$50, in the USA and its possessions. All other foreign countries: 1 year—\$34, 2 years—\$68. Single copy price \$2.25; back copies \$3.00. Adjustment necessitated by subscription termination to single copy rate. Allow 6 to 8 weeks delivery for change of address. Allow 6 to 8 weeks for new subscriptions.



INTERTEC PUBLISHING CORP.  
© 1980. All rights reserved.



Now you've got us  
where you want us...  
right in the palm  
of your hand!

**First practical,  
personal size  
microfiche reader.**



Installation  
schematics



Customer service

Micro Forty Four. Puts a world of information at your fingertips—on service calls, in the field, outside office or in home. And, naturally, it comes from the leading manufacturer of micrographic readers. The design is a marvel of simplicity. Flip up viewing hood and our advanced optical system projects a bright, clear image on the full 5-1/2" diagonal screen. Operates on batteries, 110V or car lighter. Weighs less than 1-1/2 lbs. Fits a tool case.

Micro Forty Four is a small miracle, ideal for service personnel. Call or write now for information on the affordable new personal size Micro Forty Four Reader from Micro Design: the Reader Leader

**MICRO DESIGN**

DIVISION OF BELL & HOWELL CO.  
857 W. State Street  
Hartford, Wisconsin 53027  
(414) 673-3920

Circle (4) on Reply Card

Next month in

## Electronic Servicing®

### Industrial Maintenance

- Planning an industrial maintenance shop
- Reports from the Test Lab

### Consumer Servicing

- Servicing audio cassette tape recorders, part 2
- Testing wow and flutter

# Electronic Servicing

---

## **Industrial MRO & Consumer Servicing**

### **4 Soldering and desoldering equipment roundup**

*Compiled by the Electronic Servicing staff*

Descriptions of hand-held soldering and desoldering equipment are featured, and reader service numbers are supplied.

### **7 Techniques for fast, efficient soldering**

*By John R. Ashton, product writer, EDSYN Inc.*

---

## **Industrial MRO**

### **15 Reports from the Test Lab**

*By Carl Babcoke, CET*

The B&K-Precision model 1535 scope is featured.

---

## **Consumer Servicing**

### **19 Practical scope tips, part 2**

*By Gill Grieshaber, CET*

The final article of a two-part series describes less conventional operations of scopes.

### **25 Typical CB radio repairs**

*By Harold Kinley, CET*

Case histories of CB radio repairs are presented along with efficient troubleshooting methods.

### **31 Servicing audiocassette tape recorders, part 1**

*By Homer L. Davidson*

First of a two-part series covering typical electronic problems and test methods.

---

## **Departments**

3 Scanner  
14 Symbure  
40 Products

42 Catalogs and Literature  
43 Readers Exchange

---

## **About the cover**

An EDSYN DE047 Diplomat solder extractor is pictured.

*Photograph courtesy of EDSYN Inc.*



# electronicscanner

news of the industry

## Regional exposition planned in South

Two regional expositions serving the electronics/microelectronics manufacturing industry across Southern United States have been scheduled for spring 1981, according to the Kiver Organization, a Cahners Exposition Group Company. Both are open to all persons actively engaged in the production and test of printed circuits and microelectronic devices.

The first of the two events is the Southwest Printed Circuits & Microelectronics Exposition '81, April 1-2, 1981, Market Hall, Dallas. Electronics engineering and manufacturing specialists from major production areas in Texas, Oklahoma, Arkansas, Louisiana, New Mexico and elsewhere have been invited to see manufacturing exhibits and displays geared to the region's electronic output. A special

conference program updating visitors' technological skills will be presented.

The Southeast Printed Circuits and Microelectronics Exposition '81 will be April 15-16, 1981, at the Sheraton Twin-Towers Convention Center in Orlando. This exposition will focus on the equipment, services and technology needed in electronic manufacturing centers in Florida, Georgia, Alabama, North Carolina and South Carolina.

For more information, contact: The Kiver Organization, Industrial and Scientific Conference Management, 222 West Adams St., Chicago, IL 60606. Telephone: (312) 263-4866.

## Thordarson contest winners awarded

Phase two of the Thordarson Meissner EDS'80 Letter Writing

Contest produced outstanding comments regarding the Electronic Distribution Show.

Max Frankel, Frankel Electronics, East Hartford, CT, was awarded first prize of \$500. An excerpt from Mr. Frankel's letter said, "Nothing makes for better business relations than knowing your supplier personally, especially when the necessity arises later to discuss various ideas on the telephone. A closeness develops that is possible in no other way, and the feeling becomes apparent that he stands side by side with you in the promotion and success of your business."

Judges of phase two of the Thordarson contest were: David Fisher, executive vice president, Electronic Industry Show Corporation; Toby Mack, executive vice president NEDA; and Edward Walter, publisher, *Electronic Industry Weekly*. □

## What would make your business better? We would

You've seen what franchising did for real estate. Franchise companies took struggling independent realtors and put them in the limelight. The result: a greater share of the marketplace.

tronics 2000 is doing the same for the electronics service business. We're selecting a limited number of dealers in each community, giving them our name and high-level training in administrative and marketing techniques. And we're advertising as a single organization. In short, we're building a franchise organization that will stand out in a crowd.

Are you eligible to join? Yes, if you own a service dealership or are planning to start one and if you meet our technical requirements. But you must apply before the quota for your area has been filled.

tronics 2000 could be the lifeline you've been looking for. Call us. Today.

# tronics 2000

5229 South Highway 37 • P.O. Box 2003 • Bloomington, Indiana 47402 • 812/824-8424  
Circle (34) on Reply Card

WORLD'S MOST PRACTICAL SOLDER HANDLING TOOLS



## Complete Vacuum DESOLDERING System

# NOW!

 is the time to *increase* **PRODUCTIVITY!**

To help **you** do just that EDSYN<sup>®</sup> is making a limited introductory offer of a 21st century VP171 **VACUUM SYSTEM** plus a FREE DS117 **SOLDAPULL** AUTO VAC DESOLDERING TOOL

a saving for you of - **\$43.95**

But this saving is only *the beginning*, when you find how this **POWER** combination will increase **your PRODUCTIVITY!** **HURRY**, while supply lasts!



Circle (5) on Reply Card

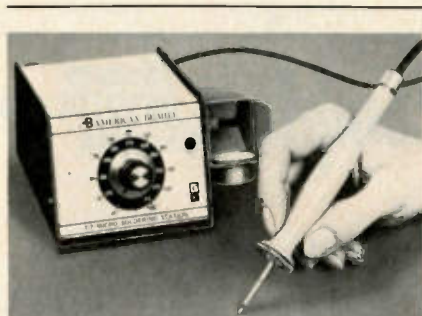
November 1980 *Electronic Servicing* 3



# Soldering and desoldering equipment roundup

To obtain additional information and specification sheets for the hand-held soldering and desoldering equipment featured in this roundup, circle the appropriate number on the Reader Service Information Card.

Compiled by the **Electronic Servicing** staff



#### **American Electrical Heater**

*Model T-7* micro soldering station is a 12W instrument that provides stepless direct-dialing of tip temperatures from 175° to 910°F. Solid-state circuitry maintains the desired temperature. A dial indicates both Fahrenheit and Celsius temperatures. Work is protected from voltage-leak damage by a grounded, low-voltage, line-isolating transformer and grounded soldering tip. The soldering iron is lightweight, with a 4-foot flexible, oil-resistant cord. A tip cleaner and a safety cradle for the handpiece are incorporated in the console.

Circle (40) on Reply Card



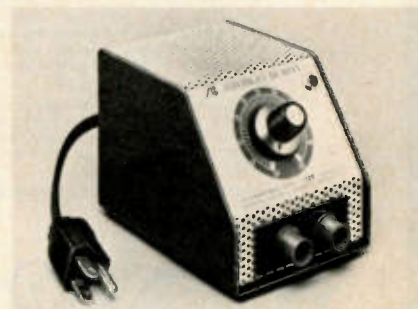
*Model V-3800* soldering station maintains any tip temperature between 350° and 750°F within 5% of dialed setting. The 40W station features a heat sensing collar that continuously monitors tips temperatures. The V-3800 uses a variety of regular 3/16" x 2-1/4" (.48 x 5.72 cm) plug-type tips. Grounded, line-isolating circuitry protects work from voltage leak damage. A built-in tip cleaner has a reservoir with a wick that delivers water to the wiping sponge, keeping it moist for two or three days per filling. A safety cradle protects the operator, automatically centers resting iron and maintains best idling temperature.

Circle (41) on Reply Card



*Model 105127* resistance soldering tool handles connections up to 1/2-inch in diameter. The tweezer-type tool has .125-inch diameter copper-clad, stainless steel electrodes and operates on 15-250W of power.

Circle (42) on Reply Card



*Model 105-A3* resistance solder-



ing power unit provides stepless dialing of power from 0-100 and 0-3V. Resistance-type tools for use with the 10S-A3 include tweezer-type and single carbon soldering handpieces, micro soldering probes and solder reflow tools for medium electrical to micro electronics applications. Tweezer-type and V-notch thermal wirestrippers are available to strip 24-gauge wire or finer, up to 12-gauge.

Circle (43) on Reply Card

#### EDSYN

Model 950 CL080 LONER soldering instrument features a temperature sensor, 50W forward-flow heat element, heat-resistant handle, temperature control knob and power indicator. The solid state instrument includes a five year guarantee.

Circle (44) on Reply Card



#### Enterprise Development

Model 530S soldering iron features a safety light in the unbreakable polycarbonate handle, a T-55 soldering tip and a burn-resistant cord. A handle switch is available to select *off*, *low* or *high* heat. The iron operates at 120V and provides dual heat at 40W (900°F) and 20W (750°F). An optional attachment converts the unit to a desoldering iron.

The price of the 540S is \$21.68.

Circle (45) on Reply Card

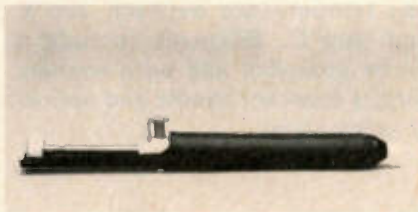


Model 510 desoldering iron fea-

tures a safety light on an unbreakable polycarbonate handle, a 0.63 I.D. tip and a burn-resistant cord. A handle switch is available to select *off*, *high* and *low* heat. The iron operates at 120V, 40W; idles at 20W; and converts to a soldering iron with a 1/4-inch shank plug-type tip.

The price of the 510 is \$27.72.

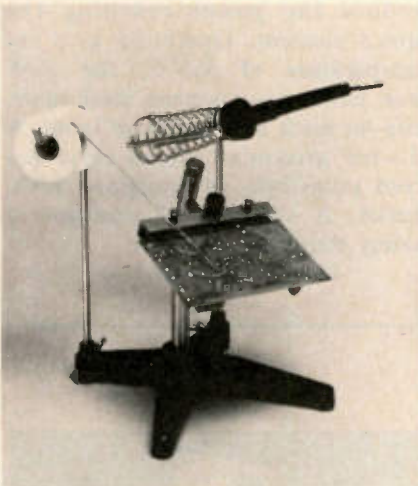
Circle (46) on Reply Card



#### GC Electronics

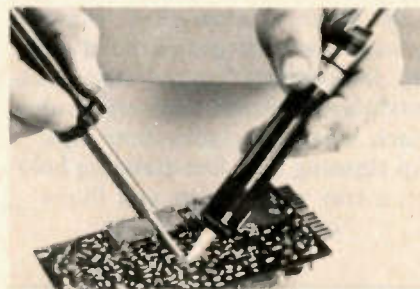
Model 12-2100 solder remover tool snaps molten solder from board and component leads by vacuum action. The unit features one-hand operation, replaceable vacuum seals, Teflon nosepiece and all-metal construction.

Circle (47) on Reply Card



Model 22-300 solder station accommodates soldering iron, printed circuit board and solder spool. Adaptable for right or left hand use, the stand features cushion grips that provide PC board positioning at any angle, a heat-resistant solder iron collar and a sturdy die-cast base.

Circle (48) on Reply Card



#### O.K. Machine & Tool

DSP-1 desolder pump features metal construction, compact size and a replaceable Teflon tip. Suction is regulated for solder removal without damage to circuitry. The DSP-1 is self-cleaning and disassembles without special tools.

The DSP-1 is priced at \$9.95.

Circle (49) on Reply Card



#### Ungar

Models 50T6, 50T7 and 50T8 Ungarmatic temperature controlled soldering stations provide high protection soldering capacity with the overheat protection of closed-loop temperature control. The stations feature thread-together modular construction and interchangeable tips and heaters. The units are available in three preset temperatures: 600, 700 or 800 degrees F. Each station includes: a power supply with on/off switch, indicator light and 3-wire power cord; a handle with flexible 3-wire heat-resistance secondary cord; a tray with tip cleaning sponge; an iron holder; and a controlled heater with 1/16-inch screwdriver tip.

Circle (50) on Reply Card

Model 200 Hot Vac desoldering station utilizes normal shop air (40-120psi) through a vacuum transducer that is controlled by a solid



## Roundup

state circuit and solenoid valve. The unit features a muffled exhaust, built-in vacuum gauge, solid state tip temperature control and load-modulated instant recovery heater. Each station includes four tips, a tip cleaning tool, free-standing holder, a tray with sponge and filters.

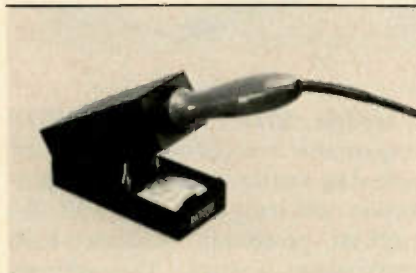
Circle (51) on Reply Card



### Vertex Electronics

Model PA1700 and PA1701 desoldering tools feature a sturdy metal body that resists cracking or breakage, Teflon tips and an all metal vacuum system. A spring action allows the plunger to float on top of solder debris and preserve the full vacuum force at all times.

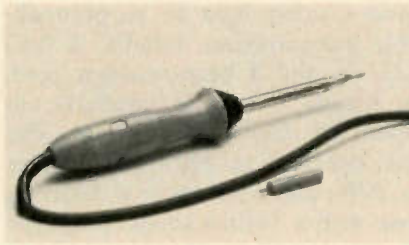
Circle (52) on Reply Card



### Wahl Clipper

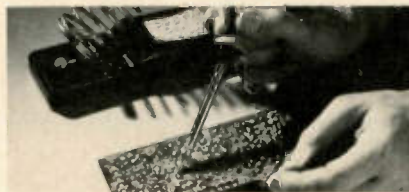
Double-duty soldering iron stand is designed for use with the Production 50 and Industrial 30 soldering irons. When closed, the stand is designed for use with the Production 50 and Industrial 30 soldering irons. When closed, the stand contains the soldering iron shaft and tip within the closed metal compartment, allowing an iron that has not completely cooled to be stored without damage to adjacent components. When open, the stand functions as a standard soldering stand, holding the iron within reach between uses. A tip wiping sponge and well and two holes for extra tips are inside.

Circle (53) on Reply Card



Production 50 industrial soldering iron maintains a selected temperature within  $\pm 2\%$  accuracy. The 50W iron is supplied set at 320°C, but can be adjusted at the bench to any temperature between 200°C and 400°C. Features include a 3-wire grounded and burn-resistant cord, a stay-cool handle and optional safety stand.

Circle (54) on Reply Card



7250 Iso-Tip Industrial 30 soldering iron features a special diode to reduce the power reaching the iron's element. Operating at a tip temperature of 365°C, the 27W iron features a stainless steel shaft, clip-on hook and indicator lamp. A 3-wire grounded, burn-resistant cord plugs into any standard 120V outlet. A selection of tips and a safety stand are available.

Circle (55) on Reply Card



### Weller

Model DS100 power vacuum

soldering/desoldering station features closed loop temperature control system for protection of sensitive components, and employs low-voltage tool inputs for added safety margins. Operating on line voltage and factory air (30-130psi) or cylinder, the station system includes vacuum adjustment and gauge, quick connect/disconnect receptacle for pencils, on/off switch and indicator light, remote suction foot switch, five assorted tips and instruction booklet.

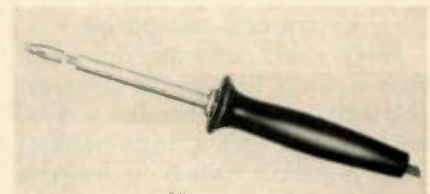
Circle (56) on Reply Card



### Wellman

Penline 120V soldering iron features a rubber-jacketed supply cord, Lexan plastic handle, quick-change plug-in heating units, rapid heat-up and recovery. A selection of interchangeable tips is available.

Circle (57) on Reply Card



Lightweight II 120V soldering iron features a contoured handle, threaded heating units and new efficiency heater design for effective heat transfer. The Lightweight II weighs 6 ounces. A selection of interchangeable tips is available.

Circle (58) on Reply Card

Midget 6V soldering iron features low-voltage operation, rapid recovery tip construction and a threaded heating unit. The midget weighs 1 3/4 ounces. A selection of interchangeable tips is available.

Circle (59) on Reply Card



## Techniques for fast, efficient soldering

By John R. Ashton  
Product writer, EDSYN Inc.

The service technician is presented with some difficult soldering problems not normally encountered on a controlled environment production line where parts are clean and solder well with minimal fluxing or cleaning preparation. Consumer products are not so nice to work on. A television might be untouched for five years or more before major servicing is required. During that time, dust, cigarette smoke and other contaminants will

have accumulated inside. Or, a microwave oven may have a significant amount of kitchen grease on the electrical connections, which makes resoldering difficult.

Cleanliness is essential for consistent, reliable solder connections. Metal surfaces must be free from grease and oil. When in doubt, make them clean with alcohol or mild degreasing solvent. Soldering flux alone will not remove grease. Metals, especially copper, tend to react with the oxygen in air or water to form a layer of almost invisible corrosion that interferes with a good solder bond.

Because many soldering fluxes are available that can remove oxide film, it can be confusing when deciding what type is needed. If common electronic parts that use copper or brass metals, tin/lead or cadmium plated coatings, etc., are being soldered, type R rosin flux or a mildly activated type RMA rosin flux will suffice for clean new parts. For heavily contaminated parts or items left on the shelf for six months or longer, a fully activated type RA flux is needed. For those difficult-to-solder metals, such as Kovar, aluminum and stainless steel, it is best to consult a solder supplier for the proper flux. It must be stressed that an acid flux should never be used for electrical soldering. The acid is highly corrosive to wiring and distributes a conductive residue over the surface of a circuit board that is difficult to remove. Flux core solder is a convenient way to automatically dispense flux, as shown in Figure 1. Because flux core solder is available in both rosin and acid core types, always check the composition on the spool carefully before using.

Should any problems arise with dewetting, such as mottling or balling of the molten solder, first remove the old solder with braid or a desoldering tool to eliminate as much of the contamination as possible. Next, apply a small amount of liquid flux and resolder.

For professional soldering results, select a high quality tool that offers a wide selection of interchangeable tips as shown in Figure 2. Don't try to solder a bus bar with a miniature spade tip or an IC with what seems like a plumber's wedge. Small .062 diameter circuit pads, 1/4 watt resistors, plastic TO-92 case transistors, etc., don't need much heat, so a mini-spade or probe tip

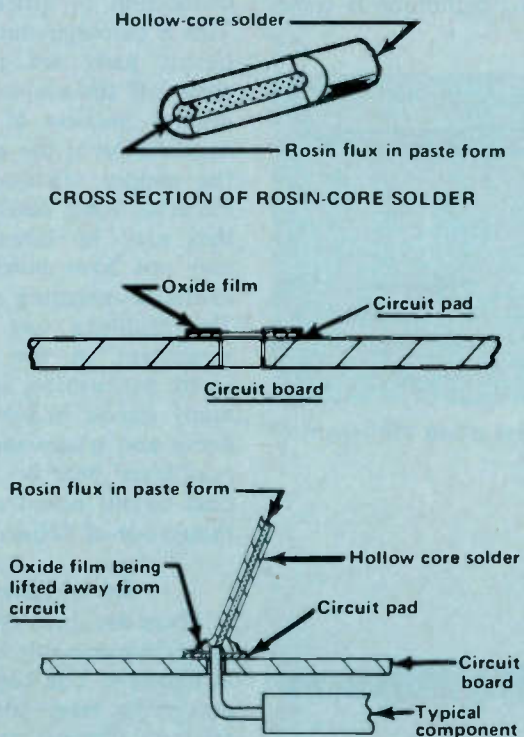


Figure 1 Action of melting rosin-core solder to remove oxide film.



## Soldering techniques

is fine. But 1/8" diameter pads, power resistors, diode bridges, etc., need a tip that can provide more heat transfer to the work as well as better thermal reserve, such as is possible with a medium spade. Bus bars and ground plane connections need lots of heat so it's OK to bring out the big tips for these.

### Thermal reserve

The thermal reserve capacity of a soldering tip is basically its ability to solder successive connections without dropping drastically in temperature after each connection. Larger tips are more resistant to temperature drop because they contain more copper, which can store up more heat energy. The heat transfer capability of a tip is determined by the contact area between the tip and the component lead or circuit pad. Very large connections that need more heat energy should be soldered using a tip with a wide face. Miniature connections can easily be overpowered by such a rapid heat inrush and, therefore, mini-spade or probe tips are better. The soldering tool and tip combination should be matched so that a high enough tip temperature and sufficient thermal reserve will be available. Generally,

any size soldering tool selected should be capable of bringing the tip temperature up to a minimum of 600 degrees within one minute. This will provide some indication of the efficiency of the tool and its ability to get heat into the tip as fast as possible. The ideal tip temperature range for electronic soldering is 650-780 degrees. Temperatures exceeding 825 degrees require that the technician be highly skillful and able to get off the connection the instant the solder melts.

If a sophisticated device is desired, consider getting a temperature controlled soldering tool. Rated at 50W, the model shown in Figure 3 is self-contained and has a see-through handle. A knob allows the tip temperature to be set anywhere from 450 to 750 degrees. The tool does the rest. When the tip temperature rises or falls below the set point, a light will blink on and off as power to the heating element is automatically adjusted. A soldering tool of this type allows the technician the versatility to solder anything from a micro component to a 12 AWG ground bus with the same tool. All that is needed is a change to the appropriate tip size.

Aside from such basics as cleanliness, tool selection and heat range, soldering technique is some-

what more abstract. A highly skilled technician can complete the average solder connection in one to three seconds. Even with a high tip temperature of 800 degrees, the skilled person can sense exactly when the solder begins to melt and quickly lift off of the connection. It has been found that there is less of a chance of heat damage to a component or circuit pad if the dwell time is one to three seconds at 750 degrees as compared with a longer dwell time of five or six seconds at 600 degrees. At 600 degrees, thermal energy has more time to travel through the component leads and soak the component interior with heat, which can cause damage.

### Desoldering & heat

Desoldering is as much a part of the service technician's job as is soldering. In some cases, such as when replacing components on a circuit board, desoldering can be the most important part of a successful repair job. One of the primary things to watch out for is excessive heat.

This can be the result of keeping the tip on the connection too long while the desoldering tool is being positioned and subsequently triggered. Attention must be directed toward getting on and off the connection as quickly as possible. This is extremely important because circuit pads are more prone to come off the second or third time around because of the increasing degradation of the adhesive holding the copper cladding to the base material. Also, delicate components that may be intended for re-use may not have much tolerance for excessive reheating and resoldering. The problems just mentioned are significant in the computer and word processing industry where many circuit boards are extremely dense and where some of them are multilayer boards. A fully assembled circuit board can cost several thousands of dollars.

### Desoldering aids

There are three types of desoldering aids commonly in use, as shown in Figure 4. The bulb type has been around for many years; however for modern applications, the bulb is sluggish in action and not well-suited for production desoldering. Desoldering wick is a popular aid

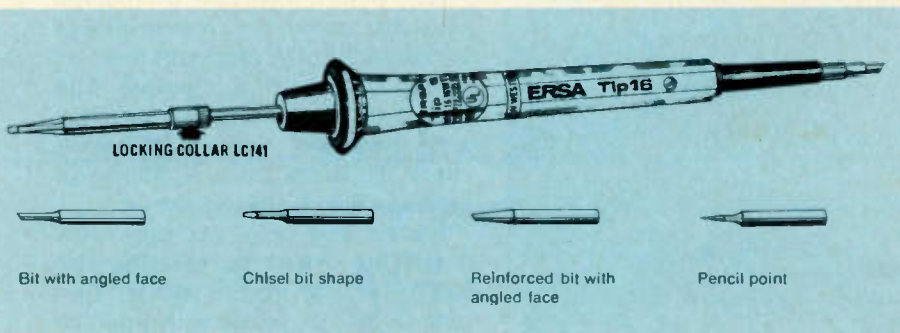


Figure 2 The ERSA TIP 16 soldering tool tip is adjustable along the length of the element shaft for manual variation of tip temperature.

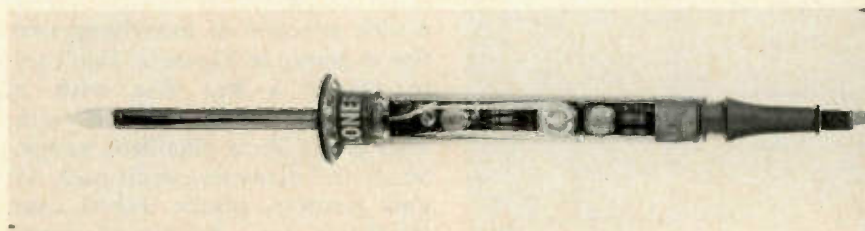


Figure 3 LONER temperature-controlled soldering instrument.



useful in removing solder from large circuit pads, solder bridges, icicles and other surface work. Wick does have some limitations when it comes to getting solder completely out of a plated-through hole. Desoldering wick is an expendable product that is snipped off a little at a time after each connection. To achieve the best cost-effectiveness, it is recommended that a premium grade be selected that will promote rapid capillary wicking.

Perhaps the most popular type of desoldering aid found on many workbenches is a portable spring loaded tool called a *solder sucker* by those who use it. The more common types fit easily in the tool box, are self-contained and need no external power source. Pushing the plunger shaft inward loads the tool and depressing a small trigger button or lever releases the plunger to create an instant vacuum pulse at the desoldering tip. This type of tool is especially useful in getting solder completely out of a plated-through hole so that a new component can easily be inserted.

#### Pad lifting

A problem sometimes attributed to both the solder wicking and impulse vacuum method of solder removal is the lifting of pads. Some people are reluctant to use wick because of occasional pad lifting; others say that spring-loaded desoldering tools are too powerful and lift pads. Regardless of the type of desoldering method used, the main culprit is too much heat and the contributing factor of improper technique. A spring-loaded desoldering tool has ample power to remove molten solder, however it does not have sufficient lifting force to pull securely affixed pads from the circuit board surface. On the average, the spring-loaded tool will generate an initial pulse of up to 18 inches of mercury, which is equivalent to approximately 8.75 pounds per square inch. Because the inside diameter of the desoldering tip is only equal to .0123 square inches, the greatest pulling force at the tip is 1.71 ounces. However, when actually desoldering a circuit pad, it is not possible to achieve anywhere near this pulling force because of the raised component lead, through hole leakage, etc.

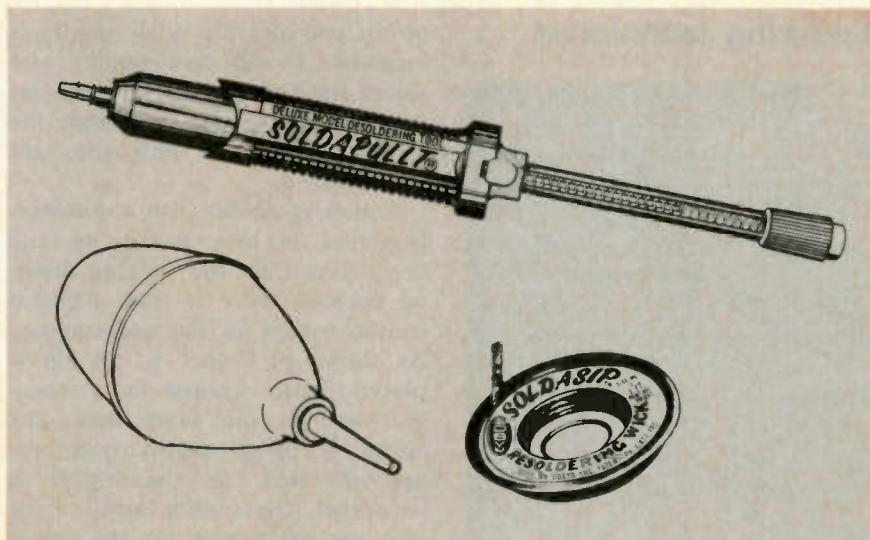


Figure 4 Typical spring-loaded desoldering tool, a vacuum bulb and desoldering wick.

There are three primary causes for pad lifting when using desoldering wick: (1) pressing down too hard with the soldering tip as shown in Figure 5A can cause excessive heat transfer to the pad. Pressing down hard with a probe or pointed tip can also crumple the

pad, tending to drive it into the hole as shown in Figure 5B; (2) Any movement of the pad will break the adhesion bond. Excessive side pressure of the tip as shown in Figure 6 can also cause immediate slippage of the pad; (3) Finally, as shown in Figure 7, if the wick is left too long

## ISO-TIP<sup>®</sup> for soldering control and convenience



#### temperature control

50W iron maintains any temperature between 400-750°F with  $\pm 2\%$  accuracy to solder delicate components without damage. Allen key for temperature adjustment included. Heats in 45 seconds, indicated by thermostatically controlled lamp. Production 50 — No. 7200



#### cordless convenience

High capacity nickel cadmium battery power lets you take low-voltage soldering anywhere! Complete recharge in 3-4½ hours. Partial recharge in less time. Isolated tip design with a wide range of "snap-in" tips available. Quick Charge — No. 7700

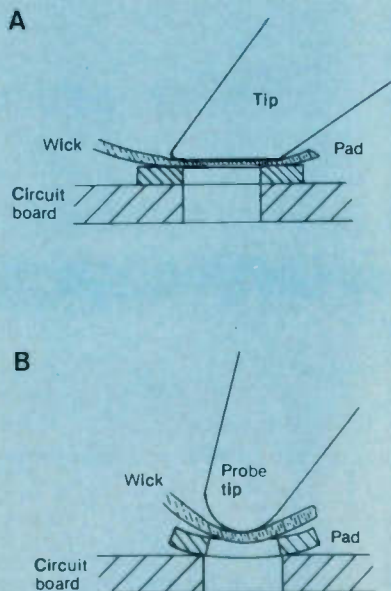
Available at most electronic parts distributors.

**WAHL CLIPPER CORPORATION**  
 ORIGINATORS OF PRACTICAL CORDLESS SOLDERING  
 Sterling, Illinois 61081 • (815) 625-6525  
 "Manufacturing Excellence Since 1919"

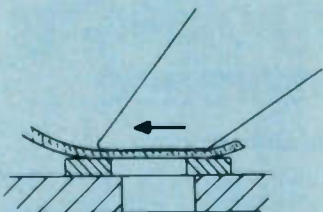
Circle (6) on Reply Card



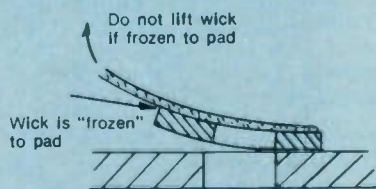
## Soldering techniques



**Figure 5** (A) Heavy pressure with a tip mashes wick flush on pad, which causes too rapid heating of the pad. (B) Pressing down too hard with a probe or pointed tip can also crumple the pad, tending to drive it into the hole.



**Figure 6** Excessive side pressure with a tip can break heated pad loose from the circuit board surface.



**Figure 7** Tearing of the pad from board surfaces will result if wick is allowed to cool and stick to pad.

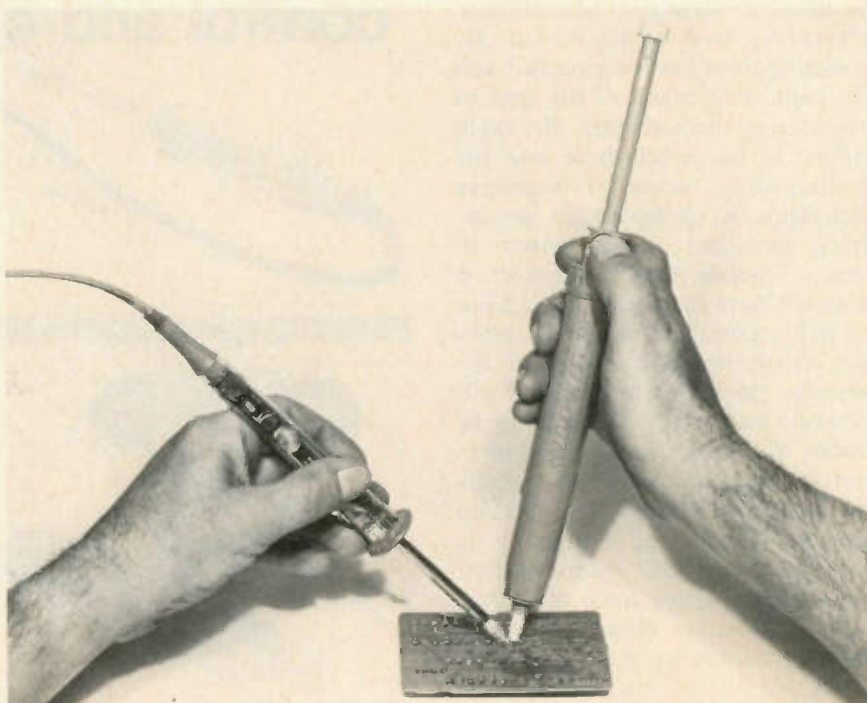
on the pad after the soldering tip is removed, it will cool rapidly and solder itself to the pad. When this happens, lifting the wick from the circuit board will pull the pad along with it.

Removing solder with a desoldering tool is less harsh on the connection than the wicking method because there is little physical contact except for the soldering tip. As shown in Figure 8, the tip is placed lightly against the connection and at the same time, the solder is being melted from the opposite side. As the trigger is depressed, the sudden rush of air into the tip scoops up the solder and it is retained inside the tool barrel. The sudden rush of air and the removal of the heated solder immediately begins to cool the joint, which helps to protect the circuit pad. The best way to complete the desoldering cycle in as little time as possible is to place the desoldering tip very close to the connection and then bring the soldering tip to the opposite side. As soon as the solder begins melting, depress the trigger and remove both tools simultaneously.

Bent or clinched component leads should first be desoldered to remove as much solder as possible. This will allow only a slight film of

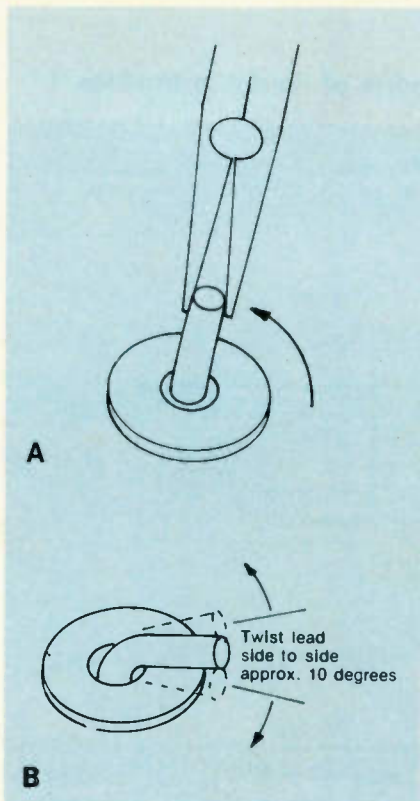
solder to remain, which can easily be broken. After desoldering, grasp the lead with a needle-nose pliers and slowly rotate the lead back and forth several times as shown in Figure 9. Only a slight movement is necessary and this is easier on the pad rather than the tearing that would occur if the lead were sharply pulled upward without any preparation. Next, gently pull the lead upward as shown in Figure 9B and wiggle it back and forth gently in the hole to break any solder film adhesion in the hole. Many plated-through holes have been ruined by not checking first whether the lead is free. Normally, only 3 or 4 ounces of pull at most is necessary to pull the lead out of the hole if everything is OK.

For production repair shops, a vacuum powered tool is available that needs no manual loading. Repetitive connections such as IC pins and multipin connectors can be desoldered one by one just as fast as the pins are heated. The pump shown in Figure 10 is a special venturi type that creates a vacuum from the compressed air supply found in many factories. The pump shown automatically shuts itself off whenever the vacuum in its tank reaches a preset level. It also is quiet and needs no



**Figure 8** The tip is placed lightly against the connection and at the same time, the solder is melted from the opposite side. As the trigger is depressed, the solder is scooped up and is retained inside the tool barrel.



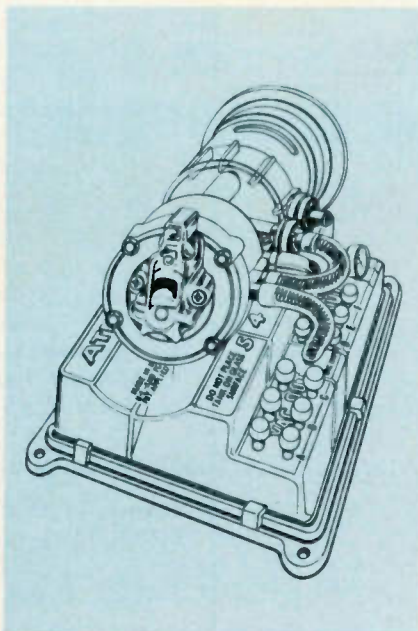


**Figure 9** (A) After desoldering, grasp the lead with a needle-nose pliers and slowly rotate the lead back and forth several times as shown. (B) Next, gently pull the lead upward as shown and wiggle it back and forth gently in the hole to break any solder film adhesion.

electrical hookup.

Static electricity is becoming more of a problem for service people because of the increased use of MOS-LSI integrated circuits in both commercial and consumer equipment. MOS stands for Metal Oxide Semiconductor and LSI stands for Large Scale Integration. Together, they make up a complex, high-density electronic package that has internal insulating layers so thin that any buildup of static electricity on plastic tools, synthetic clothing, etc., can damage the device if allowed to come in contact with it.

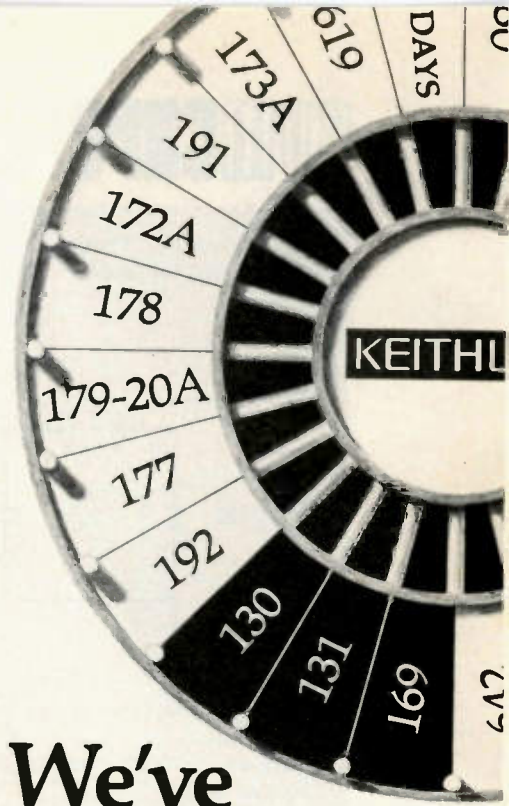
The circuit manufacturers are aware of this problem and package ICs in special static conductive carriers and bags. Service personnel should always use protective devices such as grounded wrist straps, conductive bench and floor mats, and static conductive tools. Because desoldering tools are available in both the normal and static conductive versions, be sure to check the label or imprinting on the tool to see if it is the low static version



**Figure 10** This venturi type pump automatically shuts off whenever the vacuum in its tank reaches a preset level.

when working on static sensitive devices. Generally, its appearance may indicate this by having a dark colored tip and end cap as well as either a metallic looking plastic sleeve or a black sleeve.

There are many other types of production and repair tools not specifically outlined in this article, such as combination tools that can both solder or reheat solder and vacuum it up at the same time, or other tools that can heat and desolder all the pins of a DIP IC simultaneously. These are production tools that ultimately save the user money. The goal toward competitive consumer product servicing is to be able to rescue those lower ticket price items that otherwise might be abandoned in favor of purchasing a new one. The OEM manufacturer also has the challenge to remain competitive by reducing electronic salvage costs to a minimum. This can only be accomplished by making service personnel and technicians more valuable through the use of advanced tools.



# We've got your number.

**Model 130**  
0.5% accuracy  
10A range

**\$115**

**Model 131**  
0.25% accuracy

**\$134**



**Model 169**  
Portable/Bench.

**\$169**

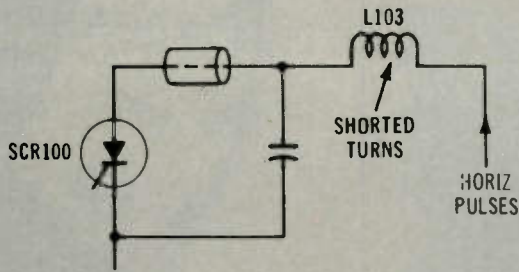
Prices U.S.A. only.

## KEITHLEY

Keithley Instruments, Inc.  
28775 Aurora Road  
Cleveland, Ohio 44139  
(216) 248-0400 Telex: 98-5469  
Circle (7) on Reply Card

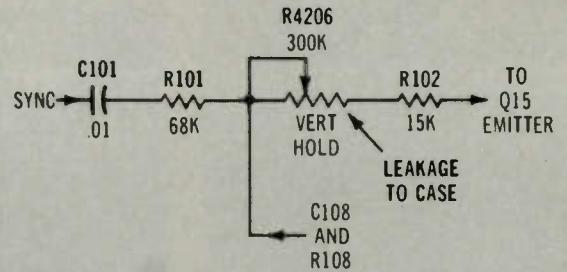


Chassis—RCA CTC101  
PHOTOFACT—1986-2



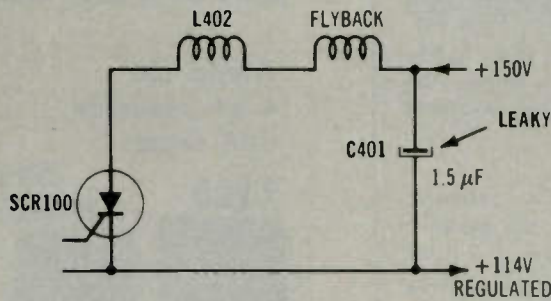
**Symptom**—No sound and no picture; in shut-down condition  
**Cure**—If SCR100 and flyback IHVT check normal, replace L103

Chassis—RCA CTC97  
PHOTOFACT—1862-1



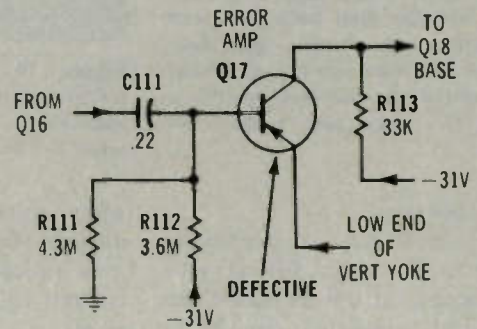
**Symptom**—No height  
**Cure**—Check R4206 vertical hold control for leakage; or replace it

Chassis—RCA CTC92  
PHOTOFACT—1788-2



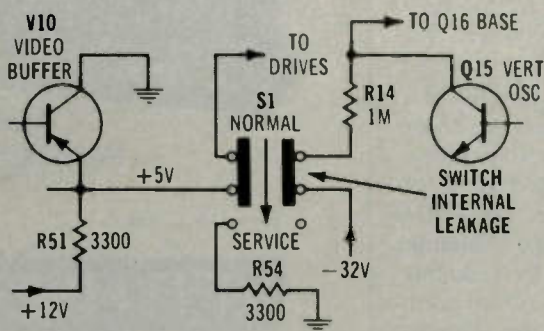
**Symptom**—No sound and no picture; in shut-down condition  
**Cure**—Check C401 for leakage, and replace it if defective

Chassis—RCA CTC87  
PHOTOFACT—1778-2



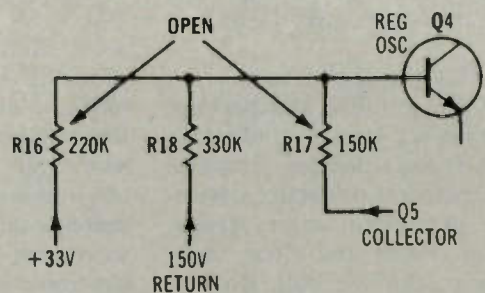
**Symptom**—No height  
**Cure**—Check transistor Q17, and replace it if a junction is defective

Chassis—RCA CTC87  
PHOTOFACT—1778-2



**Symptom**—No height  
**Cure**—Check service/normal switch S1 and replace it if it has internal leakage

Chassis—RCA CTC87  
PHOTOFACT—1778-2



**Symptom**—No sound and no picture; in shut-down condition  
**Cure**—Check regulator resistors R16 and R17, and replace them if open



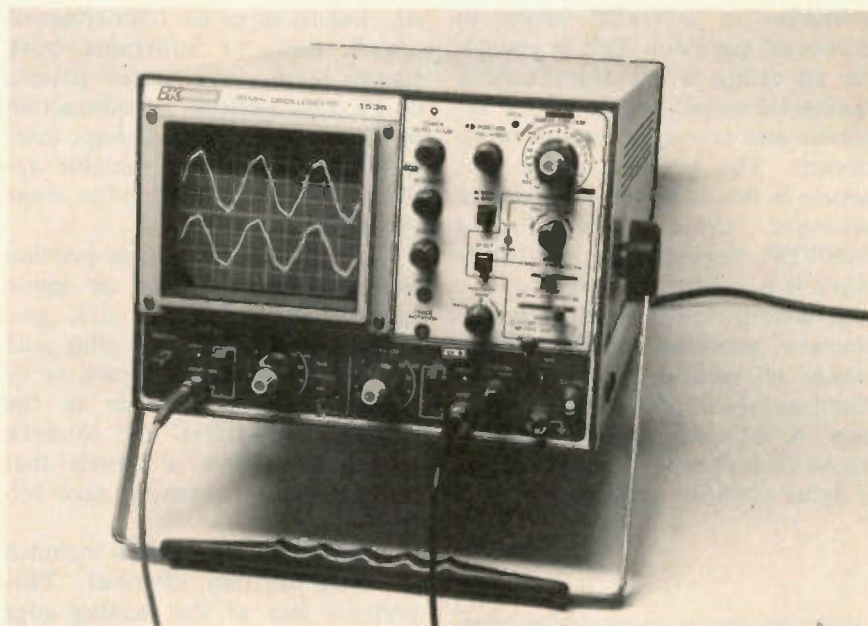
## Reports from the test lab

Each report about an item of electronic test equipment is based on examination and operation of the device in the **ELECTRONIC SERVICING** laboratory. Personal observations about the performance, and details of new and useful features are spotlighted along with tips about using the equipment for best results.

By Carl Babcoke, CET

### B&K-Precision 1535 scope

Under the B&K-Precision brand, the Dynascan Corporation offers a complete line of scopes ranging from a 3-inch recurrent-sweep economy model, a 15MHz three-inch battery/ac-operated portable, and on through others to three top-of-the-line models. It is unusual for a company to have more than one top model. However, these three B&K-Precision scopes can perform all conventional functions in addition to providing certain features for specialized fields. For example, model 1479A is a 30MHz model with signal-delay line, a PDA CRT and an RF detector. The bandwidth and RF detector allow efficient testing of radio communications, including the 27MHz CB band. Model 1530 also has a 30MHz



**Figure 1** B&K-Precision model 1535 oscilloscope has a 5.1-inch CRT with 8X10cm calibrations. It is a 35MHz dual-trace model with all the features needed for servicing industrial, consumer-entertainment-electronic and digital-circuitry equipment. The front panel is laid out conveniently, with vertical-channel controls along the bottom, CRT controls in the center above, and sweep controls on the right.

bandwidth, but it offers variable holdoff, single sweep and a second delayed horizontal sweep for extreme magnifications. These features make model 1530 suitable for digital servicing and design measurements.

The last of the three top scopes is model 1535, which is the subject of this report. Evidently, it is designed for all general industrial and consumer-product servicing in addition to showing stable digital waveforms.

### General features

Model 1535 (Figure 1) is a 5-inch 35MHz triggered scope with 2mV vertical sensitivity and a signal-delay line. Horizontal-sweep times have been decreased to accommodate the extended bandwidth. A versatile triggering system (including separate triggering for each vertical channel) provides stable waveforms under unusual or difficult circumstances. Regulated power supplies allow operation between line voltages of 105V and 130V without change of calibration. The

regulation also prevents trace blooming at high brightness. Many other important features and functions are explained in detail.

### Vertical channels

Dual-trace operation of the two identical vertical channels is accomplished by two kinds of time sharing. Position of the time/cm knob selects chopped or alternate dual-trace mode, although a *norm/chop* button allows an override when desired.

In the ac mode, frequency response is 5Hz to 35MHz (-3dB) for each channel, and the response is dc to 35MHz (-3dB) in the dc-coupling position. Twelve steps of the volts/cm vertical-sensitivity switches (Figure 2) provide calibrated amplitude measurements between 10VPP/cm and 2mVPP/cm. When the X10 position of a scope probe is used, the maximum sensitivity is 20mV (0.02V), and this is sufficient for all except the input signal of low-level audio transistors. With the maximum 10VPP/cm rating and



## Test Lab

the X10 probe, each centimeter represents 100V, which (multiplied by the eight vertical centimeters of the graticule) limits a full-screen waveform to 1000VPP (when in calibrated position). This is enough for all except a few transistorized horizontal-output stages in TV receivers and tube-type vertical-sweep circuits. The practical scope tips article in this issue reveals a way to measure those signals over 1000VPP, during those few times when it is needed.

A concentrically mounted potentiometer provides variable adjustments of vertical height, at the disadvantage of uncalibrated readings. A red *uncal* LED is mounted above each channel-input plug, and it lights when the variable control is

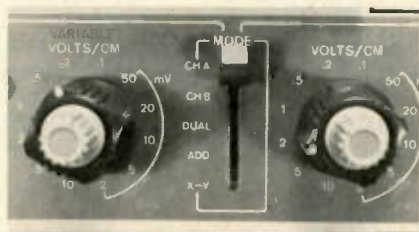


Figure 2 Each *volts/cm* vertical sensitivity control has 12 positions covering 10VPP per centimeter to 2mVPP per centimeter. The X10 probe multiplies these by 10. A variable (uncalibrated) control provides continuous waveform heights. Between the sensitivity switches is the mode switch. When the channel-B signal is inverted (changing *add* to subtraction), six modes are possible.

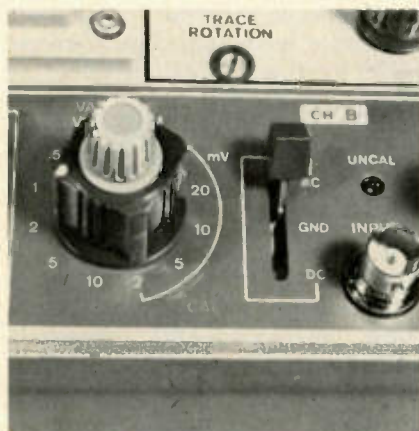


Figure 3 Channel A and Channel B have coupling switches that pass only ac, pass both ac and dc, or provide a grounded zero-voltage input.

not at the maximum CW position that gives calibrated measurements.

Between the two *volts/cm* sensitivity switches is a five-position vertical-mode switch (Figure 2) which selects either channel A (*ch A*), channel B (*ch B*), both channels (*dual*), adds or subtracts both signals (*add*), or a vector pattern (*X-Y*). This addition or subtraction of the two signals into a single-trace waveform has several valuable applications, as explained in the scope tips article.

Each channel has a three-position switch (Figure 3) for *ac* mode (passes ac and block dc), *gnd* (disconnects the input plug and grounds the amplifier input), or *ac* (passes both ac and dc to the vertical amplifier). All modern scopes have such a switch that provides more convenient zero references.

A wideband delay line is included in each vertical channel. This prevents loss of the leading edge and part of the first displayed pulse or squarewave (Figure 4) by delaying the vertical signal until the horizontal sweep has time to begin moving. This feature has special importance with pulses.

Figure 5 shows the inversion switch for channel B. It is added to the vertical-position control. Also shown are the calibration-waveform testpoint and the input jack for triggering from an external source.

**Probes**—Two probes are included with the scope. One has gray plastic and the other is black, to allow easy identification. Each probe (Figure 6) has a kit of adapters (including

the retractable insulated hook), while the probe body has a sliding X1/X10 switch and an adjustment screw for the X10 low-capacitance function. These probes should be adjusted as shown in Figure 6.

### Triggered sweep

Model 1535 has a variety of controls and adjustments that permit a skillful operator to lock almost any waveshape properly. A triggering *source* switch (at the bottom of the Figure 7 photograph) selects the triggering signal from: channels A and B alternately; channel A; channel B; and full-amplitude external signal from the *ext trig* jack or 10% of that signal. The alternate function is new, and the 10% external amplitude is very useful.

Immediately above the source switch is one of similar appearance: the *coupling selector*. It determines the filtering of the signal used for triggering, and it can minimize instability from noise or hum. One position provides an internal sync separator for solid locking of video waveforms. This is a very important function. Figure 8 shows the VITS and VIR frames of a television signal. The time exposure photograph required about 25 seconds, and the sharpness proves the good stability obtained by using the internal sync separator.

Above the coupling switch is the triggering *mode* selector, with these choices: *single* trace; *normal* triggering (there is no trace without triggering); *auto* triggering (always shows a trace or waveform); and *fix* (triggers at the average voltage point of all waveforms and always has a trace). Figure 9 shows the excellent locking and the variation of triggering points when the coupling switch was changed during *fix* triggering of a sine wave.

Associated with the single-trace function is the *reset* button (at left) which can initiate a single trace when pressed. This function is useful when photographing long-duration sweeps (Figure 10) because direct observation shows only a vertical dot or line moving slowly to the right.

A *trig'd/ready* LED is lighted when waiting for a single trace or when triggering is constant. The *level* control determines the point on the signal at which triggering

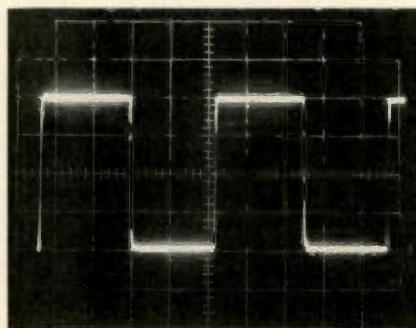
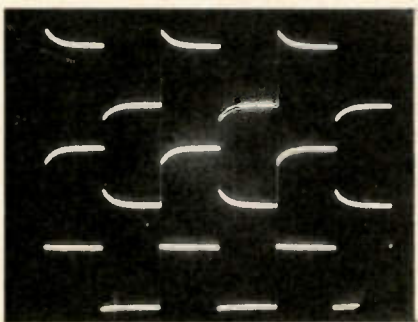


Figure 4 A signal-delay line in each vertical channel allows the leading edge of the first pulse or squarewave to be seen. This waveform is a 200kHz squarewave, and it is reproduced perfectly by B&K-Precision model 1535.

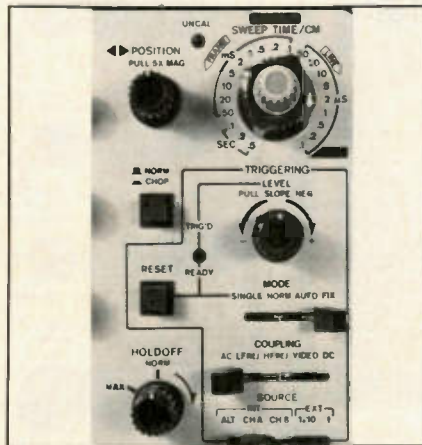




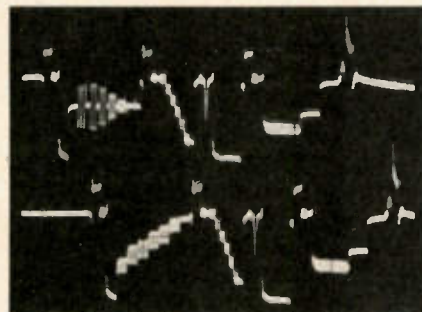
**Figure 5** A polarity-inversion function has been added to the channel-B positioning control. Also shown are the calibration-waveform output, the instrument ground post and the external triggering input plug.



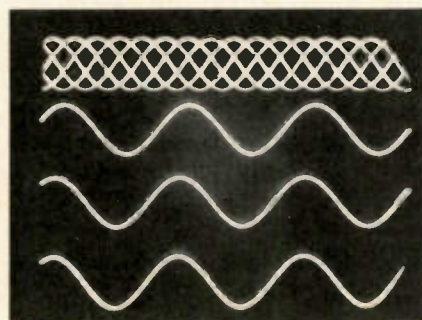
**Figure 6** B&K-Precision model 1535 is sold with two probes of contrasting colors. A sliding switch selects X1 or X10 attenuation (the X10 position provides higher input resistance and lower tip capacitance), and a small hole allows access to the X10 probe adjustment. A kit has materials for changing to an insulated hook (pictured) or short tips for IC and other connections. Top waveform trace shows overcompensation of probe, center trace shows insufficient compensation, and the lowest trace illustrates proper probe compensation.



**Figure 7** Controls for determining the sweep time per centimeter are at the upper right corner of the 1535 panel. Underneath are the triggering controls that allow stable waveforms under many unfavorable conditions. Three special features are the auto and fix slope triggering, the single trace function and a variable holdoff that adjusts the sweep-idling time.

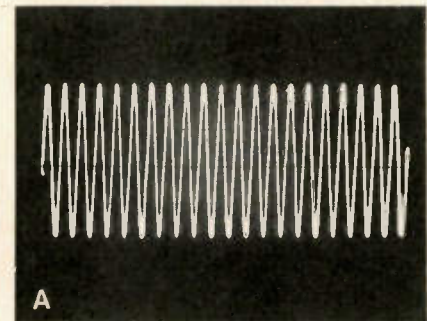


**Figure 8** This time exposure of TV VITS and VIR signals illustrates the stability and bright, sharp waveforms produced by model 1535.

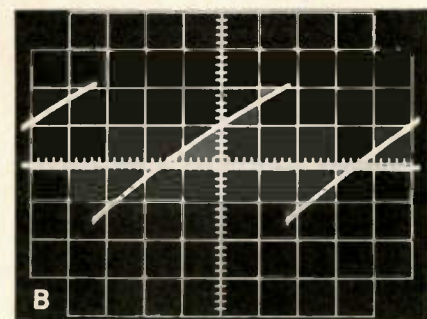


**Figure 9** In the *fix* triggering mode,

the sweep triggers at the average point of the signal that reaches the triggering circuit. Therefore, the coupling-switch position slightly changes the triggering point. The top trace is not triggered properly because the low-frequency rejection position removes most of the 1000Hz signal. The second trace shows the effect of high-frequency rejection. In the third trace, the video-sync separator moved the triggering point higher. The bottom trace shows that triggering is near the positive peak when the coupling was dc. The *fix* mode locks most waveforms securely without extra adjustments.



**A**



**B**

**Figure 10** Extremely long sweep times obscure visual observation of waveforms; the waveform is only a dot that moves up and down. Often, a photograph made with a single sweep is the best answer. (A) A single sweep of 0.1S/cm shows 20+ cycles of a 20Hz signal. (B) The *tic-tic* signal in an RCA CTC99 is shown to be a 70VPP sawtooth when swept by a single 0.02S/cm deflection. This signal would not lock in the usual way, perhaps because of the 10Hz frequency. Model 1535 has single sweep.





Figure 11 This is a closeup of the sweep-time/cm and 5X magnification controls mentioned briefly in Figure 7. The shortest sweep time is  $0.1\mu\text{S}$ , which divided by the 5X expansion provides the equivalent of  $0.02\text{ S/cm}$  (or  $20\text{ns/cm}$ ) sweep.

occurs. Pulling out the knob changes the action from triggering on the positive slope to triggering on the negative slope.

**Time/cm control**—At the upper right corner is the sweep-time/cm control (Figure 11) that determines the time for the sweep to travel each centimeter on the CRT screen.

The 21 ranges begin with a long  $0.5\text{S/cm}$  sweep and end at a short  $0.1\mu\text{S/cm}$ . In addition, the 5X magnifier (at left of time control) increases the sweep width by five times, giving the effect of a  $0.02\mu\text{S/cm}$  minimum sweep time. This can show two cycles of a  $20\text{MHz}$  signal across the screen. Only a fifth of the screen can be seen at a time, but the position control can move the waveform sideways, revealing any fifth of the waveform. Of course, the trace brightness is reduced when the 5X magnification is used.

A variable sweep-time/cm control provides a continuous (but uncalibrated) increase of the selected sweep time. A nearby uncal LED is lighted when this control is not fully CW at the position for correct time calibration.

The holdoff control is provided for viewing multi-pulse digital signals. After sweep is over in a conventional triggered scope, there is no sweep until it is triggered again by the next identical signal level. There is no specific resting time; it depends on the signal. But all digital pulses have essentially the same amplitude. Therefore, it is

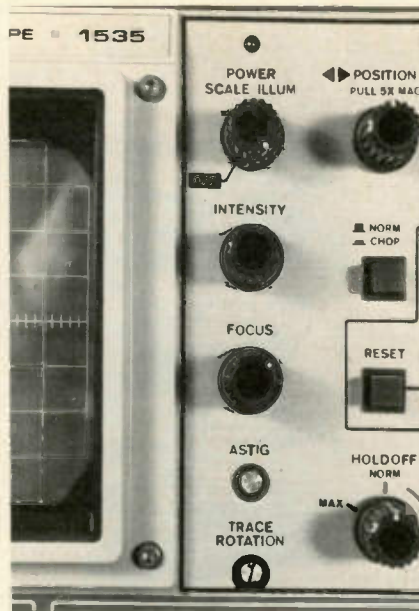


Figure 12 Controls for the CRT are at right of the CRT bezel. P31 phosphor and  $6\text{kV}$  acceleration voltage provides bright and sharp waveshapes.

possible for the undesired next digital pulse after the end of sweep to trigger the sweep again. The holdoff time can be adjusted until the desired beginning pulse of a pulse train does the triggering. Of course, the time/cm variable control can be adjusted so it prevents triggering at the wrong pulse, but the calibration will not be accurate.

Digital pulse trains were not available for testing and photographing this feature.

### CRT and controls

Figure 12 shows the location of the CRT controls alongside the bezel. The power knob controls the ac power, and further CW rotation increases brightness of the graticule lines. Figure 13 shows waveforms with and without the graticule lighted. Intensity and focus controls adjust brightness and sharpness.

Two screwdriver adjustments are provided. The astig (astigmatism) control is operated with the focus control to obtain the smallest and most symmetrical dot (use the X-Y position to obtain one dot). The trace-rotation control is a leveling adjustment for the base lines. Without an input signal, switch to auto or fix mode (for traces) and

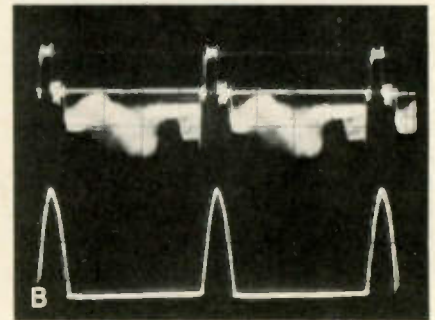
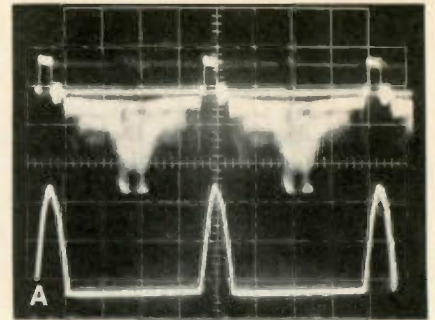


Figure 13 (A) When calibrated peak-to-peak measurements are needed, the scale-illumination knob should be rotated CW. (B) This is a similar dual-trace video and horizontal-pulse display from a TV receiver when the scale illumination knob was turned CCW to eliminate the graticule lighting.

adjust the trace-rotation control for trace lines parallel to the graticule horizontal lines.

Higher acceleration voltage to the CRT produces a brighter scope trace and improved sharpness. Many conventional scopes have only  $2\text{kV}$ . Model 1535 has  $6\text{kV}$ , which accounts for the outstanding visual performance. Also, the scope CRT has post-deflection acceleration (PDA) construction and bright blue P31 phosphor. These usually are found only in expensive laboratory models.

### Comments

Model 1535 scope was used for all waveforms in the recent Electronic Servicing series of articles on servicing RCA CTC99-chassis color televisions. It performed perfectly for many months with excellent stability and sharp waveforms. In addition, all measurements attempted in the phase-locked loop (PLL) tuner control were successful. Model 1535 can be recommended for all industrial and consumer-entertainment equipment troubleshooting. □



# Consumer Servicing

## Practical scope tips part 2

### Polishing skills for bench servicing

Scope waveforms have many other valuable functions in addition to showing two cycles of a waveshape for waveform analysis and amplitude measurement. Several of these less conventional operations are described.

By Gill Grieshaber, CET  
Gill's Color TV Service

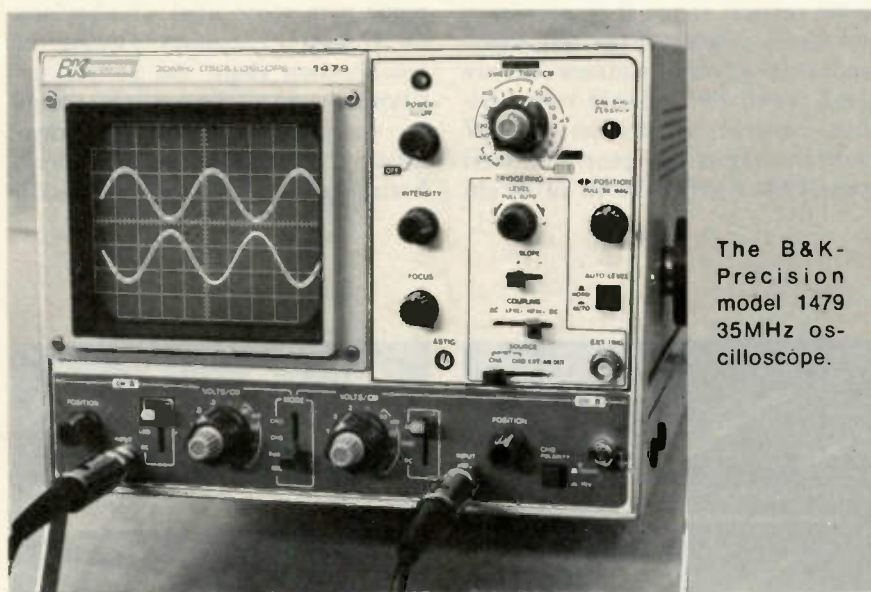
Part 1 of this series described how to obtain a stable, well-focused waveform with the customary two cycles of any signal within the frequency range of the scope. The majority of service-diagnosis scope measurements can be satisfied by these standard two-cycle nonexpanded waveforms. But, scope operation can become more valuable and interesting when other modes and tests are employed.

#### Measuring higher amplitudes

A scope with a least-sensitive vertical range of 5VPP per division can make calibrated peak-to-peak measurements only up to 400VPP (or 400Vdc) when an X10 probe is used. (Multiply 5V by 10 for the probe, X8 for the number of vertical divisions on the graticule, and this equals 400VPP for full height.) The variable volts/division control can be adjusted CCW to permit viewing about 2½ times that maximum (about 1000VPP total), but without any calibration.

Although calibrated measurements above 400VPP (or 800VPP for scopes with a 10VPP range) seldom are needed, they are important. One example is finding the sweep-pulse amplitude at the horizontal-output-transistor collector in a television. The solution is to calibrate the scope's vertical channel temporarily to a higher range by using the variable control and a test signal.

Figure 1 shows two methods. With dual-trace operation (Figure 1A), one channel remains unchanged as a standard while the other is recalibrated. Both probes are connected to the same test signal (which does not require adjustment of its amplitude). The



The B&K-Precision model 1479 35MHz oscilloscope.

scope's calibration waveform usually is adequate, or an audio generator can be used. The temporary recalibration can be made on ranges other than the one required for the measurement. Recalibrate on the 1VPP or 0.1VPP range and later measure on the 5VPP range.

With both X10 probes connected to the test waveform, select a range that provides almost full-screen height. Both adjustable volts/division controls must be in the maximum CW (permanent-calibration) position at the beginning. Make certain the waveform heights are identical for both traces. Next, rotate CCW the variable volts/division control (of the channel to be used for the stretched measurement) until its signal has exactly half the height of the standard waveform. The range now is calibrated at twice the marked volts/division rating, and the range selector can be rotated CCW to the least-sensitive position for the reading. Use only the probe and channel that have been recalibrated.

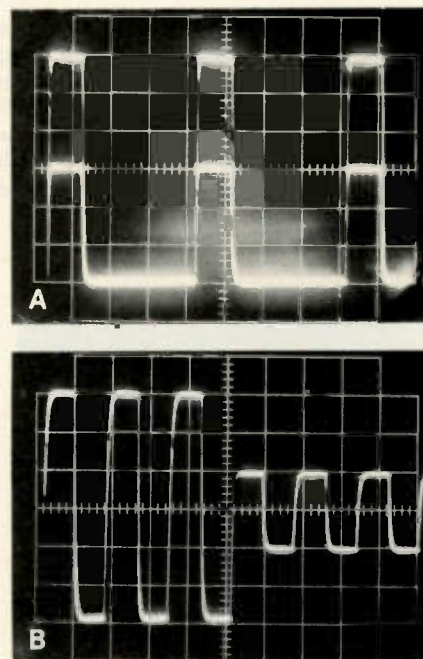


Figure 1 A temporary recalibration of the vertical-channel's least-sensitive range permits measuring waveforms with amplitudes above the scope's maximum. Two methods are shown, one for dual-trace and a second for single-trace operation.



## Scope tips

brated. Read the PP amplitude in the usual way (multiply the number of divisions high by 10, times the marked range setting) and then multiply by two.

A second method (Figure 1B) can be used with any scope and almost any stable test signal. However, it is easier if the test-signal source has an adjustable level control, because only one signal amplitude can be viewed at any time. Select any scope vertical range that permits a full-screen display of the test signal (audio sinewaves or squarewaves are ideal). With the variable volts/division control at maximum CW position, adjust the generator level control for eight divisions of height

on the scope screen. Next, rotate the variable volts/division control CCW until the waveform height is exactly half the initial height. The vertical channel now is calibrated temporarily at twice the marked volts/division rating. Read the PP amplitude in the conventional way and multiply that result by two to obtain the actual amplitude.

A few simple precautions are necessary if best accuracy is desired. Drift of vertical gain should be minimized by operating the scope with some kind of waveform for at least 15 minutes. During the recalibration steps, the vertical-positioning control (or controls) should be operated to locate the waveform's top or bottom on a graticule horizontal line. This allows easier

reading of the number of graticules and fractions occupied by the waveform.

Remember that the scope and probe have limits on the input amplitude possible without damage. Many scopes specify that no more than 300Vdc or PP should be applied directly to the scope input jack. Multiplied by an X10 probe, this appears to imply a top safe amplitude of 3000VPP at the X10 probe input. However, there are other considerations, such as the insulation of the probe and shielded wire, and the possibility of excessive surge current to the scope internal amplifiers when a signal with a small ac component riding on a large dcV is applied during ac-coupling mode.

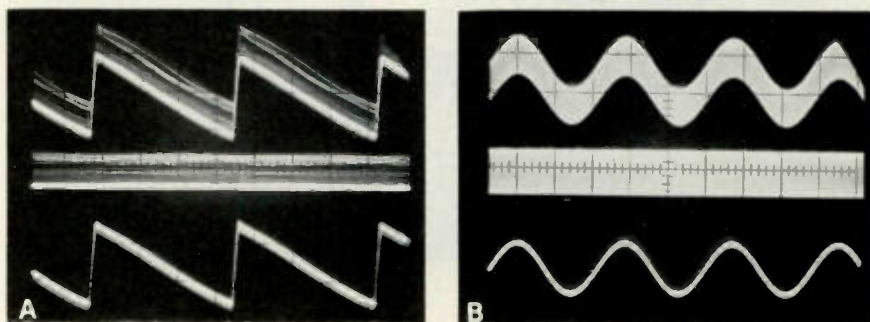
Check specifications of the scope before applying more than 1200V of combined dc and PP voltages. A few scopes are rated up to 2000V, but some have much lower ratings.

### Removing unwanted signals

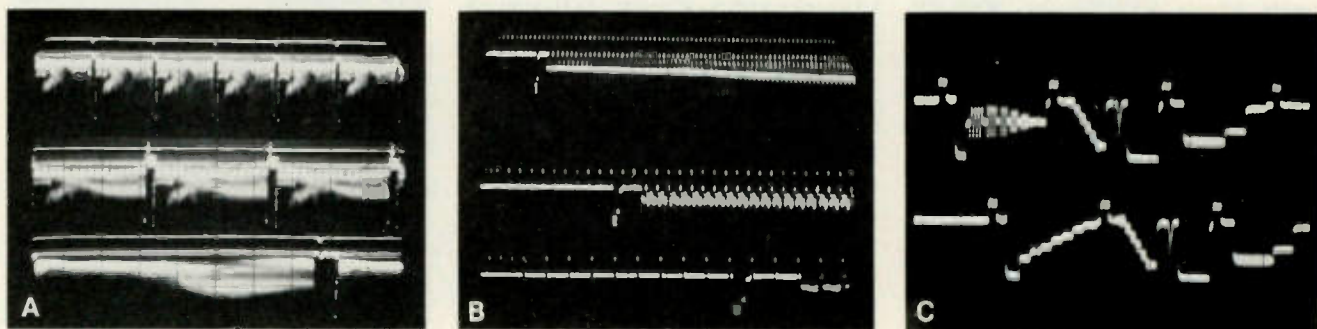
Many scopes have triggering filters that minimize low-frequency or high-frequency extraneous components in the signal fed to the triggering circuit. This provides more stable locking in many cases.

Signals displayed on the CRT screen often have thick lines from unwanted signals that have frequencies either higher or lower than the desired signal. Filters can minimize the unwanted signals but usually distort the signal waveform.

Dual-trace scopes sometimes can be used to phase out the unwanted signals, as shown in Figure 2. The



**Figure 2** Removal of interfering signals by phase cancellation sometimes can be accomplished by obtaining a pure sample of the interference (center trace) for channel B, and then adding or subtracting the two signals by the *add* or *A&B* mode. (A) Top trace is vertical-yoke current with horizontal pulses. Center trace shows a sample of horizontal pulses in channel B. Bottom trace is an audio sine wave with hum or supersonic oscillation superimposed on it. Center trace is the channel-B sample of the interference. Bottom trace shows the removal of most interference.



**Figure 3** Position of the time/div switch determines how many cycles of waveform are shown. (A) Several video vertical fields (top and center trace) help show hum or low-frequency interference. More detail is possible with slightly more than one cycle (bottom trace). (B) A 0.5mS sweep (top trace) shows part of the vertical-retrace interval at the left and horizontal-sync pulses elsewhere. Center trace of 0.2mS begins to show details of the vertical-retrace area. Bottom trace of 0.1mS has spread the retrace area over most of the CRT screen. (C) Operation with 0.1mS sweep, X5 width magnification and careful positioning shows the VITS and VIR signals of both vertical fields. Care must be used since the trace is very dim and the video moves up and down constantly. The X5 magnification increases the scope's horizontal deflection so only 1/5 of the waveform is seen on the screen at any time. Moving the waveform sideways reveals any fifth.



principal signal is connected to channel A and a sample of the interference is connected to channel B. Then, the *add* or *A&B* dual-trace mode is selected. This combines both signals into one added or subtracted waveform. Adjust the channel B sensitivity and phase (if the scope has a phase-inversion switch) until thick lines from the interference are reduced to a minimum. This method gives excellent results when a pure sample of the interfering signal can be obtained. If the interference is 60Hz hum picked up by unshielded wiring, the channel B probe can be connected to an ungrounded wire or piece of metal. Some experimentation might be necessary.

### Expanded waveforms reveal details

Triggered scopes can expand waveforms vertically (by excessive vertical sensitivity) or horizontally. Horizontal expansions (or magnifications) can be accomplished through three methods. Two are described here.

Figure 3 shows how a waveform can be magnified horizontally by selection of shorter sweep times. There is little value in expanding a sine wave because the waveform merely becomes a curve. But expansion of squarewaves, digital pulses or composite NTSC video often reveals hidden details.

A long sweep time of 10ms/division shows about six TV-vertical fields. Details cannot be seen, but the display is excellent for revealing hum or other low-frequency disturbances. A sweep time of 2ms/div begins to show the 262.5 TV-horizontal lines that make up each field, but no useful details are shown until 0.2ms/div displays about 32 TV-horizontal lines. Further magnification to 0.2ms/div is required to show details of the vertical-retrace interval. When the X5 width magnification is selected and the positioning adjusted, the VITS and VIR signals occupy most of the screen.

Extreme magnifications of 0.1ms/div often bring problems of instability, particularly with video waveforms that vary constantly in amplitude and vertical position on the screen. Triggering must be supplied from a sync separator, either inside the scope or in the TV being tested. Careful manual trig-

gering adjustment is essential, and some experimentation probably will be necessary to find the best stability with each scope.

Many scopes (that have internal sync separators) automatically supply TV-vertical sync for 0.1ms/div and longer scope-sweep times, and TV-horizontal sync for 50 $\mu$ s and shorter sweep times. Selection of the next faster sweep time (50 $\mu$ s/div) forces the scope to show TV-horizontal lines of video (Figure

4) instead of increased expansion of the previous TV-vertical-retrace waveform. Eight lines are shown with 50 $\mu$ s/div.

Further decreases of scope-sweep time also decrease the number of visible TV-video horizontal cycles. The general shape of the color burst can be seen at 10 $\mu$ s/div and 5 $\mu$ s/div, but a shorter sweep of 2 $\mu$ s/div shows more than one division width of burst, and 1 $\mu$ s/div widens the sync pulse and burst to

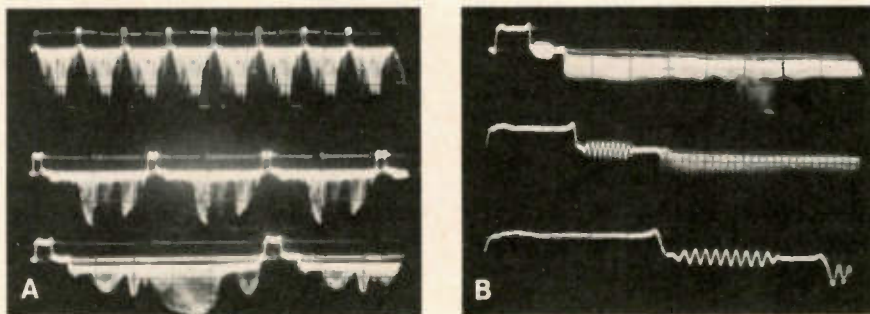


Figure 4 Details of TV video horizontal lines of video and sync pulses can be widened by decreasing the scope-sweep time. (A) The number of cycles (horizontal lines) is decreased from eight (top trace at 50 $\mu$ s), to 3+ (center trace at 20 $\mu$ s/div), and to about 1½ video lines (bottom trace at 10 $\mu$ s/div). (B) Scope sweep time of 5 $\mu$ s/div (top trace) shows less than one video line. Sweep of 2 $\mu$ s/div (center) widens the sync pulse and back porch (with color burst) of blanking to about half CRT screen width. Bottom trace at 1 $\mu$ s/div shows only the sync pulse and blanking's back porch on the screen. Only the left side benefits from this kind of expansion.

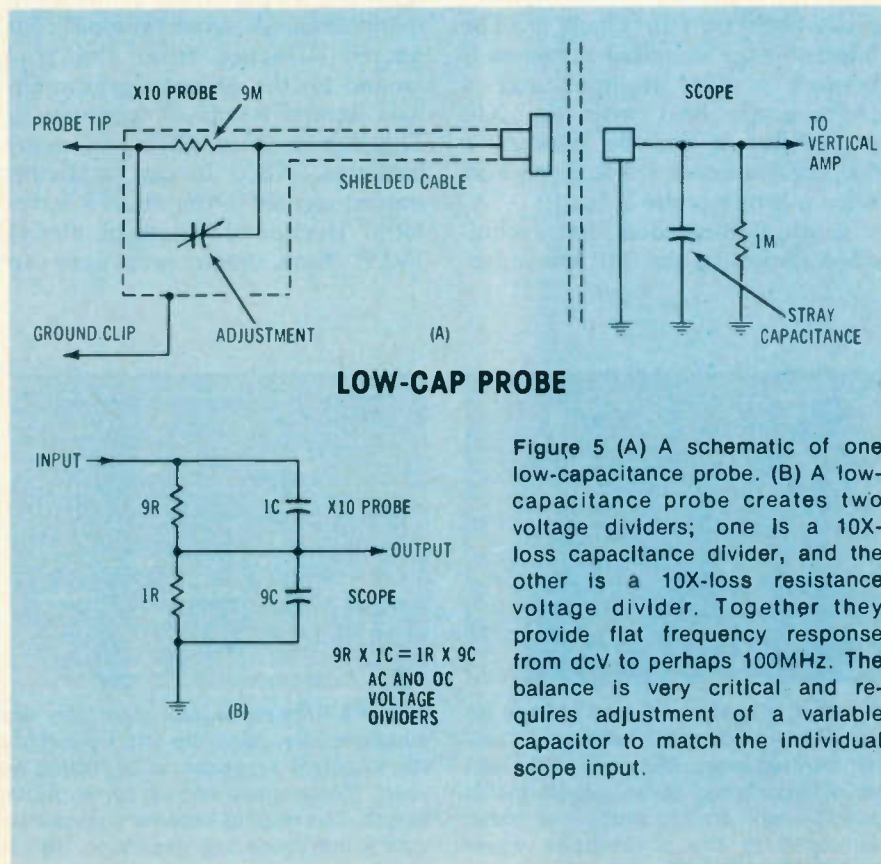


Figure 5 (A) A schematic of one low-capacitance probe. (B) A low-capacitance probe creates two voltage dividers; one is a 10X-loss capacitance divider, and the other is a 10X-loss resistance voltage divider. Together they provide flat frequency response from dcV to perhaps 100MHz. The balance is very critical and requires adjustment of a variable capacitor to match the individual scope input.



## Scope tips

almost full screen width. There seems no point in additional magnification, although more is possible.

The burst appears sharper at  $2\mu\text{s}/\text{div}$  and  $1\mu\text{s}/\text{div}$  than at the slower sweeps because of an interlaced-scanning side-effect. When triggering occurs on alternate cycles (two or more cycles on screen), both field 1 and field 2 are superimposed although only one field does the triggering.

### Low-capacitance probes

Low-capacitance or X10-loss probes offer several major advantages over a shielded direct scope probe. First, loading on the circuit undergoing test is greatly decreased. A direct probe has  $1\text{M}\ \Omega$  dc load, compared with  $10\text{M}\ \Omega$  for the X10 probe. A direct probe has a total capacitance between  $80\text{pF}$  and  $100\text{pF}$ , and a typical X10 probe has  $10\text{pF}$  to  $15\text{pF}$ ; an X10 probe (Figure 5) can be connected to a greater variety of circuits without serious degradation of the signals there.

Also, the extreme low-frequency response with ac-coupling mode is better with an X10 low-capacitance probe, as shown in Figure 6. The internal  $0.1\mu\text{F}$  coupling capacitor is between a  $10\text{M}\ \Omega$  input and a  $1\text{M}\ \Omega$  scope load with the X10 probe. But it can be between a  $600\ \Omega$  input and a  $1\text{M}\ \Omega$  scope load when a direct probe is used.

It is recommended that technicians always use the X10 low-capac-

itance scope probe, except for those rare exceptions when the waveform has insufficient height on the CRT screen.

### Preventing ringing

Scope probes are susceptible to ringing when waveforms have extremely fast rise and fall times. A shielded probe wire is similar to a transmission line that is not terminated properly. That's why many expensive scopes have  $50\ \Omega$  inputs that match the shielded cable. Designers and manufacturers take extensive precautions to prevent ringing in new model scopes; the weak point is the signal probes.

A technician cannot do anything about a commercial probe, but there are two precautions that can eliminate most ringing problems. First, connect together the grounds of scope and equipment undergoing tests only by the short ground wire and clip at the scope probe. Figure 7 shows ringing produced by improper grounds when the signal was a  $200\text{kHz}$ -repetition square wave.

Also, take care when selecting a point of a circuit for the scope-probe ground. Solid-state circuits usually have lower impedances than tube circuits do. Because of that, common-ground voltage drops (ground loops) are encountered more often. A scope ground connected 4-inches from the true ground for the desired signal might have several bends or loops in it. This can produce ringing in many instances. Also, it can add unwanted signals to the desired waveform. Horizontal pulses of almost  $1\text{VPP}$  have been measured in

several color televisions between different points on a common ground.

In summary, always use the short ground at the scope probe (do not use a second ground wire in addition) and connect it to the circuit at the best ground for that specific signal or stage.

### Dual-trace benefits

Dual-trace scopes are not new, and many of the benefits have been described before. Figure 8 shows two valuable dual-trace tests. Relative phase between two signals of identical frequency can be measured easily. However, some care must be taken to make certain both traces are triggered correctly. For some scopes and certain waveforms, it is possible for one trace to be triggered at the wrong time. This usually is an erratic condition and can be eliminated by slight readjustment of the triggering-level control or a change of filtering to the triggering signal. Solid triggering provides correct phase.

The two traces of Figure 8B show the horizontal-output tube grid sawtooth (large trace); the smaller sawtooth waveform is the cathode current. By moving the current waveform up and down the larger drive waveform, a point is reached at which the curve of the drive waveform intersects the current waveform between the zero-current base line and the beginning of the upward ramp. This intersection marks the point at which plate/cathode current begins (the tube has been cut off until then). With the  $20\text{V}/\text{div}$  range, the cut-off point

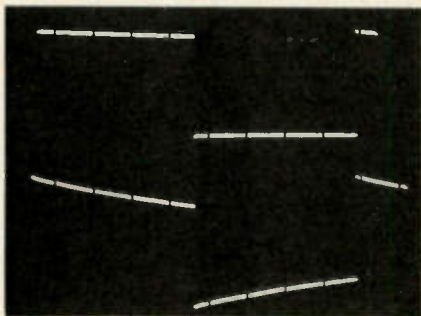


Figure 6 Because of the change of scope-and-probe total resistance, better low-frequency response with less tilt of square and pulse waveforms is possible with an X10 probe (top trace) compared to the direct-probe waveform (lower trace).

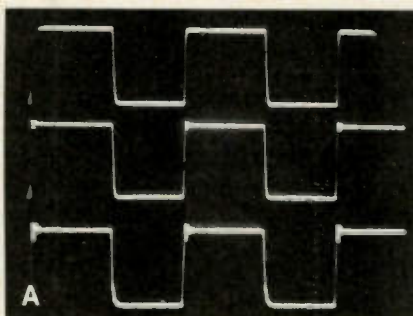
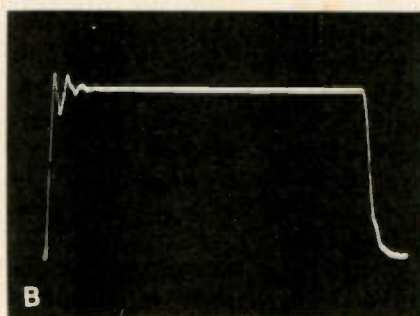


Figure 7 Ringing on fast-repetition square and pulse waveforms usually can be eliminated by using the short ground wire at the scope probe. (A) Top trace is the excellent response to a  $200\text{kHz}$  square wave when the probe ground was used. Center trace shows some ringing when the probe ground had excessive length. The ringing became unacceptable (bottom trace) when a separate ground connected scope and generator. (B) Magnification of the previous bottom trace shows the large amount of ringing.





(measured from zero volts at the sawtooth's tip) is -48V. During the first part of the grid-drive waveform, no plate/cathode tube current flows until the instantaneous grid/cathode signal rises to -48V, and then the current increases to maximum at the sawtooth tip, which is clamped by grid/cathode current to zero volts. One of the lessons here is that the total PP amplitude of the drive signal is important. However, the waveshape of the signal below the -48V point is of no consequence. Any part of an input signal that is below the cut-off point is ignored by tube or transistor. An extension of this analysis plus a few waveform and voltage measurements can pinpoint many drive and deflection problems.

Any technician using the dual-trace mode for a time is certain to value it highly.

#### Peak-to-peak readings are universal

RMS and average ac readings are valuable only for sine waveform line voltage power in applications in which the loads are pure linear resistances. Any attempt to use RMS and average ac values with modern electronic equipment will end in confusion. There is no clear one-to-one relationship between RMS ac voltages and dc voltages. The highest dc voltage from peak-reading rectification of a sine waveform is 1.414 times the RMS ac voltage. Thus 100V RMS can produce 141.4Vdc by rectification. Peak-reading rectification of a 100V peak produces 100Vdc. (In

both cases, diode voltage-drop and resistance losses decrease the dc voltages.)

Technicians are urged to use only dc voltages and peak-to-peak ac voltages. A scope capable of ac and dc measurements shows the signal waveshape in addition to all other data provided by dc and RMS meters. Also, some simple scope adjustments can add dc and average-ac lines to the waveforms.

Think exclusively of peak-to-peak ac measurements. For example, 120Vac RMS can be multiplied by 2.828 to yield 339.36VPP. It's easy to remember standard line voltage as 340VPP. Heater voltage of 6.3Vac RMS becomes 17.816VPP, which rounds to 17.8VPP.

If the PP value is given for a sine waveform, and the RMS value is needed for reference, multiply the PP reading by 0.354 to yield the equivalent RMS voltage. For example, a stereo-radio pilot carrier measuring 30VPP is 10.62Vac RMS. Usually, RMS values should *not* be used with nonsinusoidal waveshapes.

Technicians need only those few formulas to handle all measurements. This recommendation to ignore all ac measurements except PP is based on several facts. Modern solid state electronic equipment presents no steady resistive load to the power line. All operating power comes from dcV rectified from the ac-line power only at the tips of each sinewave. Consequently, the dcV value varies in direct proportion to the power line's total amplitude, and *not* the RMS or

average value. *Peak-to-peak readings of the power-line voltage provide a direct and accurate relationship to the amount of dc voltage obtained by rectifying it.*

Many individual power sources in newer television receivers operate by rectifying samples of the horizontal-sweep pulses. This rectification is affected directly by the peak amplitude; for pulses, there is a large difference between the positive-peak amplitude and the negative-peak amplitude. Consequently, the value of the rectified dcV depends on the amplitude of the peak selected (by diode polarity) for the rectification.

These factors are easier to harmonize because of one important fact about the dc-coupling mode of a triggered scope: *The graticule calibrations are identical for dc voltages and peak-to-peak ac voltages.* A 10Vdc voltage deflects the CRT beam exactly the same number of graticule divisions as a 10VPP ac waveform does.

Peak-to-peak voltage is the measurement made from the extreme tip of the positive peak down through the zero line and to the extreme tip of the negative peak. Above the zero line is the positive peak, and below the zero line is the negative peak.

Sections of less than both peaks (partial waveform) can be measured by the same graticule calibrations and division values. In this case, however, the partial measurement cannot be called peak-to-peak. There is no term for this precise condition. For want of a term, it is often termed PP or peak, but both

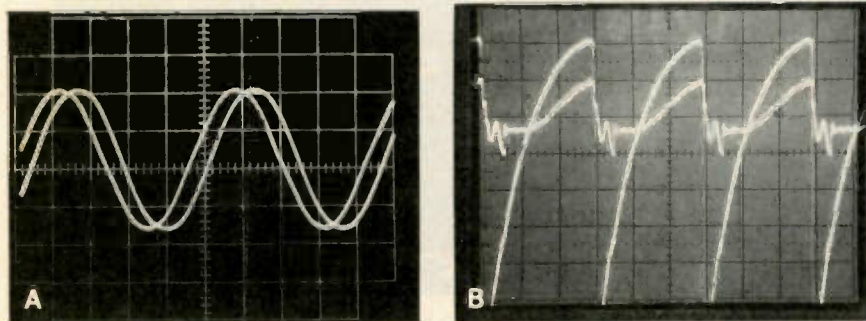


Figure 8 Dual-trace operation can reveal relative-phase differences (A) or show when coincidence occurred between two actions. (B) The large sawtooth waveform is the drive waveform at the control grid of a horizontal-output tube, and the smaller distorted sawtooth waveform is the cathode current measured with a current probe. By sliding the current waveform up and down, a point can be found where the grid waveform touches the first beginning of cathode current. This point (measured from zero voltage at the top of the grid waveform) is the cut-off point of the tube.

**Heart disease and stroke will cause half of all deaths this year.**



**American Heart Association**

WE'RE FIGHTING FOR YOUR LIFE

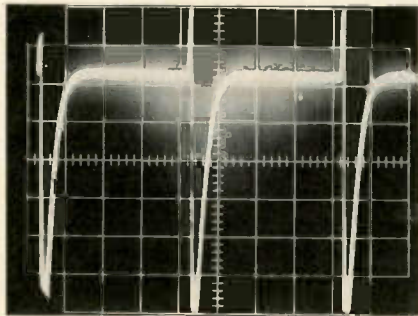


## Scope tips

are incorrect. Perhaps it should be called *partial peak-to-peak voltage* or PPPV.

A complex waveform is shown in Figure 9. An RMS meter can provide a reading that has little value in electronics except for comparisons with similar waveforms. A scope can measure the total PP amplitude, in addition to allowing separate measurements of the positive-going pulse or the negative-going pulse. As previously suggested, these should be rated in partial-peak-to-peak volts (PPPV).

Note: one new color TV specifies a 25VPP horizontal-sweep signal at



**Figure 9** Complex waveforms can be measured by the total amplitude of both peaks (eight scope divisions in this example) stated in peak-to-peak volts (same CRT calibrations as for dcV). Or any section can be measured. It is suggested that these partial amplitude sections (such as the spikes) be rated by partial-peak-to-peak volts (PPPV), to separate it from whole peaks or PPV.

the picture-tube-heater terminals. A VOM or other meter with only RMS or average-reading ac voltage ranges is almost useless for measuring this heater supply. Either a scope or a DMM having a PP ac function should give the proper readout.

### Measuring dc voltages

Dc voltages can be tested easily, along or mixed with a waveform, as shown in Figure 10. With the ac-coupling mode and a stable waveform on the screen, the coupling switch is moved to the dc mode. Any vertical movement of the entire waveform indicates a dcV is present. Select a point on the waveform and measure how many divisions and fractions the point moves when the switch position is alternated.

A dc voltage without a waveform is measured in a similar way. With the coupling switch set at the ground position and the probe connected to the voltage source, change the coupling switch to the dc position and notice how many divisions (and in which direction) the line moved. If the movement is very small, the volts/div setting is not sufficiently sensitive, and it must be turned CW to a range giving almost full scale movement.

Remember, the variable volts/div control must be rotated fully CW for correct calibrations. Multiply the divisions and fractions of movement by 10 (if the X10 probe is used), and multiply again by the volts/div switch setting. If the line or waveform moves upward when

the coupling switch is changed to dc, the voltage is positive. If the line or waveform moves downward, the dc voltage is negative.

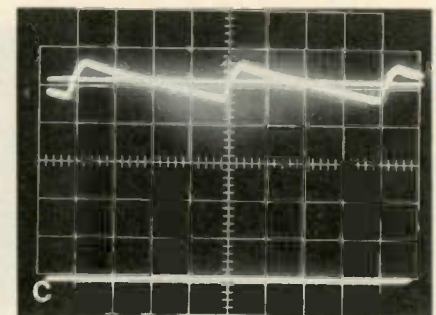
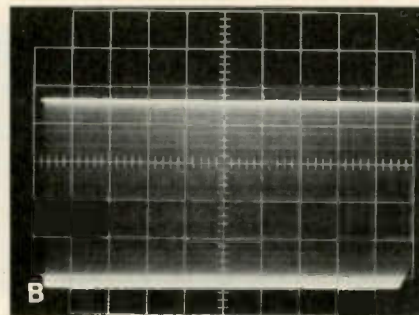
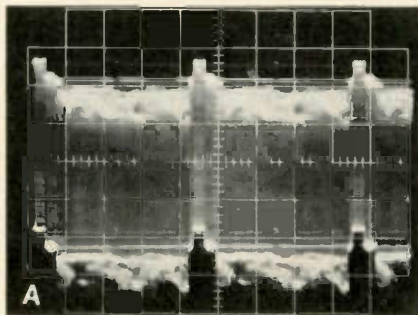
Determining the precise reading is easier if the vertical positioning control is adjusted to place the point of reference (at top or bottom of movement) on a graticule line.

The dual-trace function allows a refined method of simultaneously measuring the waveform and adding either or both average-voltage and zero-voltage lines to it (Figure 10). The method is simple, but it usually requires some juggling of ranges and positioning controls to obtain the best results.

### Comments

A multimeter *usually* provides dcV readings of higher accuracy than those from scopes. However, when a scope already is being used during tests, it is much faster to obtain the dc component of a waveform by adjusting one switch than to change to a multimeter for a few dcV measurements and then back to the scope for amplitude and waveform information. There are some circuits for which scope dcV readings are more accurate. In one automatic-color circuit, several types of meter produced wildly different dc voltages. Only a scope with low-capacitance probe gave correct voltage readings.

The immense values of scope dc measurements are realized when used correctly during waveform analysis and in attempts to determine exactly how certain circuits work. □



**Figure 10** Three ways to measure dc voltages with a scope. (A) The distance traveled up or down when the scope coupling switch is changed from ac to dc is the amount of dcV mixed with the waveform. (B) The number of graticules the base line moves when changing from ground to a dcV source shows the value of the dc voltage. Both previous examples were photographed during waveform or line movements from bottom to top, to show the action. (C) Any two of these traces can be produced at one time by dual-trace operation. For the average-voltage line (the one through the sawtooth waveform), position both lines together when the coupling switch is at ground position. Then without changing the positioning, move the coupling switch to ac for the previously determined waveform. For the zero-voltage line (at bottom) in relation to the sawtooth with dc (power-supply signal), place both coupling switches at ground position, then move channel A switch to the dc position. The values are read by the number of calibration lines.



## Typical CB radio repairs

By Harold Kinley, CET

Several typical repairs of CB radios are described by an experienced technician, who reveals as a by-product several efficient methods of troubleshooting.

The following case histories of CB radio repairs are presented in detail so other technicians can use the information to solve similar

problems in other brands and models.

### Transmits but does not receive

A model SBE Console II (16CB chassis in Photofact CB-63) base station was brought to the shop and the complaint was that the radio could transmit but received nothing. I connected the radio to ac-line power and an antenna while I found the correct schematic in a

Photofact manual. The smell of burning components arose soon, and the fuse blew.

I removed the cover, and my eyes and nose led me to a burned resistor (R602) in the power-supply section. Burned resistors and blown fuses usually result from supply-voltage short circuits, so I checked the resistance at the 9.5V source (CircuitTrace 8, Figure 1). The ohmmeter reading indicated a dead short. The first suspect was the D44 zener

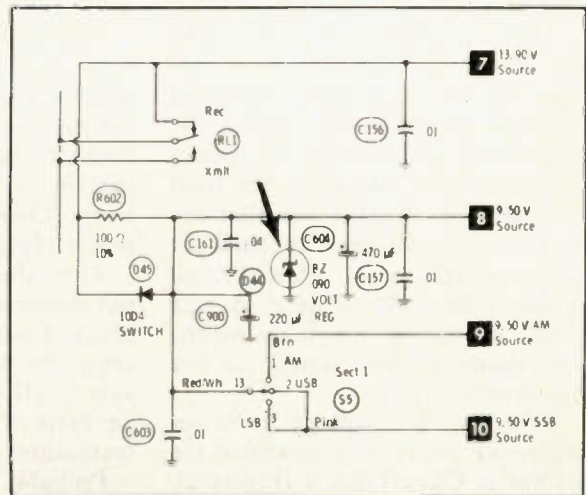


Figure 1 Zener diode D44 shorted (after being overloaded by high source voltage) and eliminated the receive mode. Resistor R602 was burned by the D44 short. (SBE model SBE-16CB, Photofact CB-63)

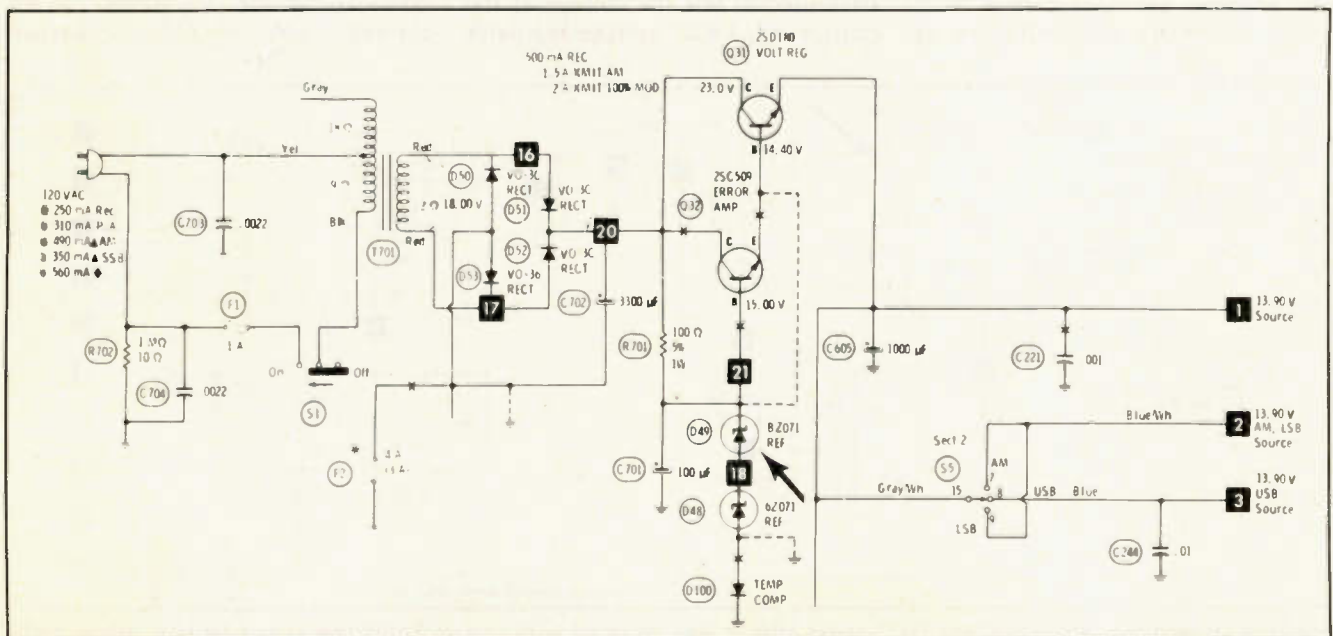


Figure 2 In the same SBE CB radio, an open zener (D49) increased the 13.9V supply to about 20V, causing excessive transmitter power and the failure of D44.



## CB repairs

diode. After it was disconnected from the supply, it was found to be shorted.

After installation of a new D44 and R602, the radio received stations on AM and single-side-band (SSB) modes. However, keying the transmitter produced an RF power output of 6.5W, far above the legal 4W. My first thought was that the output stage had been adjusted for increased RF power. However, all tuning coils had undisturbed wax seals, indicating no adjustments. The customer had stated no one had serviced the radio.

Excessive B+ voltage produces higher RF power, so I measured the voltage at CircuiTrace 1 (Figure 2). The reading was about 20V, which is far above the 13.9V specified on the schematic. I looked on the chassis for a voltage-adjusting control (most base stations have them), but none was provided.

A likely suspect was Q31, a power transistor that regulates by varying its collector-to-emitter resistance. Supply voltage enters at the collector and the regulated voltage exits at the emitter. Forward bias for Q31 comes from the Q32 error amplifier, and its bias in turn is provided by D49 zener, D48 zener and D100 (which is added for temperature compensation).

Transistor Q31 checked out normal when removed for accurate tests with a homemade curve tester and a scope. Dc voltage tests were made following reinstallation of

Q31, and its base voltage was high (about +21V). Q32 acts as an emitter-follower to drive Q31's base. The Q32 base measured about +22V, also high.

The Q32 base should be regulated at +15V by the two zeners and the diode, so I concluded that one or more of them must be open. D49 was disconnected first for tests outside. It was open. Replacing zener D49 restored the proper power supply voltages.

After these repairs, the RF-output power was 4W and the receiver checked out normal. Before considering the repair complete, I measured all supply voltages, and performed a complete check of transmitter and receiver specs.

Probably the open zener that increased the main supply voltage had overloaded the other zener (D44), causing it to short from the excessive current.

### Radio completely dead

According to the customer, the Pearce-Simpson LYNX-23 (Photofact CB-49) was dead. It had done the same thing before and was repaired at another shop.

This model is a base station, but has provision for operation from a 12Vdc supply (Figure 3). Suspecting the problem was in the internal power supply, I connected my bench dc supply to the radio. It transmitted and received perfectly; the power supply was at fault.

The fuse was not blown. Next, I attempted to test the voltage at the emitter of TR22 voltage-regulator

transistor. There was none. But at the TR22 collector, the dcV was above normal. Logically, the transistor is either open or it is biased to cut-off. After removal, the transistor was found to be open.

It was obvious the transistor was a replacement (GE-28). The Photofact transistor guide listed an SK-3054 as a good substitute, along with the GE-28, but the GE-28 is rated at 12W with a collector current of 3A, and the SK-3054 is rated at 50W with a collector current of 7A. Because the one of smaller ratings had failed, it seemed prudent to use the other for replacement.

The SK-3054 was installed, bringing good performance with all lamps lighted. Just to be on the safe side, I measured the current drain in the various modes. A dc ammeter with alligator clips on the lead wires was connected across the dc on/off switch. A jumper wire was paralleled across the ac switch to provide power. This is my favorite method of checking dc current without breaking the circuit. The dc ammeter becomes the on switch.

A 1000Hz audio tone was fed to the audio, and the volume control adjusted for 1W of audio as measured on my B&K-Precision 1040 Servicemaster. The current drain was 580ma. With the radio in standby-receive mode, the current dropped to 210ma. When the transmitter was keyed (but had no modulation) the RF-power meter showed 3.6W at 660ma current

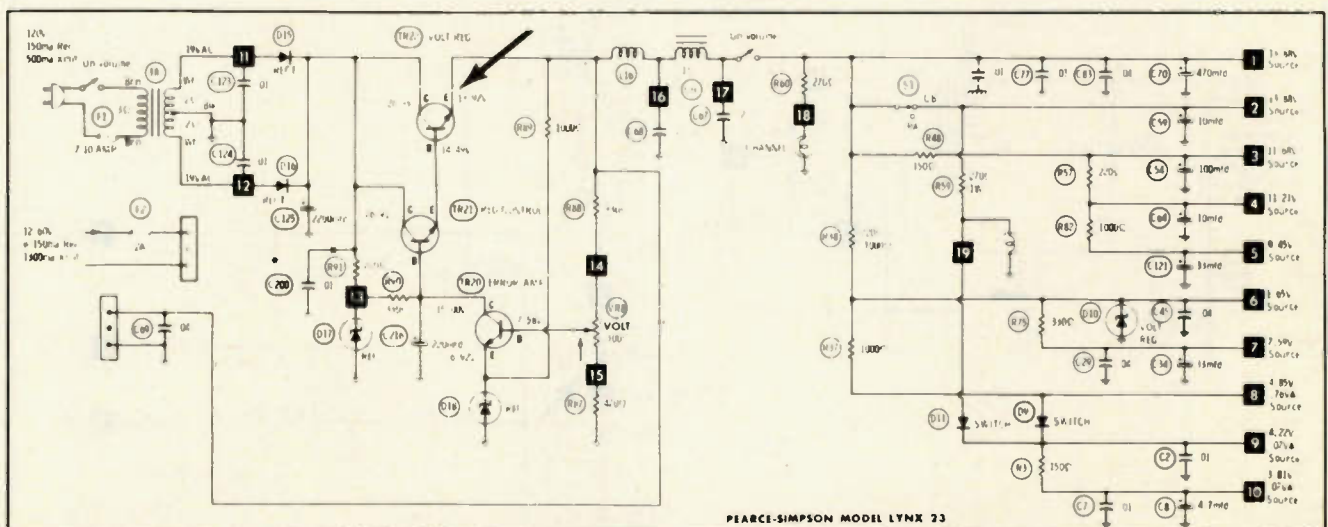


Figure 3 Voltage-regulator-transistor TR22 failed after it was replaced with one of borderline specifications. When TR22 was open, the radio was totally dead, even the dial lamps were not lighted (Pearce-Simpson model LYNX-23, Photofact CB-49)







## CB repairs

that has a removable top. The can was fastened to the main board by four screws, and connections to the mother board were made through feedthrough terminals on the can. First, I used an RF probe, checking for RF at the TR1 buffer transistor collector. There was none. Using a dc voltmeter, I tried to measure the TR1 voltages. None of the TR1 leads had any dc voltage. B+ for the stage eventually came from the +4.84V supply at CircuiTrace 1, and there was no voltage there. Because this is the supply for the entire PLL circuit, it was obvious why nothing worked.

The +4.84V supply comes from an IC-type voltage regulator, IC3. Sufficient positive voltage came to the input of IC3; it must have been defective. The IC is number F78L05, but none of the cross-index books showed a sub.

I wondered whether the radio would work correctly if the required +5V was supplied from an external source. When it was connected with the supply, the radio operated fine.

I ordered the regulator IC, installed it and the radio was ready to go.

### Bad microphone cable

A customer with a RYSTL model CBR-1700 (Photofact CB-99) thought the microphone cable was bad and caused intermittent problems. When the radio was connected properly on the test bench, the transmitter was dead, but the receiver worked fine. Movement of the microphone cable caused the

red LED transmit indicator to light, but the output meter showed no RF-power output.

It's a good idea to repair the known problems first. I started with the microphone cable. First, the cable was cut off about 2 inches from the connector. The wires were not broken in the section removed, so I cut off another 2 inches. This section had a broken keying wire. I installed a new plug (these are not reusable) and carefully placed the wires on the correct pin. However, there was no RF output power when the transmitter was keyed. Finally, I discovered that rotating the channel selector while the transmitter was keyed produced RF power. But the operation was not permanent. Each time it was keyed, the RF output failed to start until the channel selector was turned to any other channel. When it worked, the RF power was 5.5W.

Experience has taught me that failure to start usually meant the transmitter oscillator was tuned to a critical point that prevented reliable starting. After examining the schematic (Figure 5), I decided to adjust T1 (the plate transformer of the 10MHz oscillator) while the key was down but the RF was missing. Slow careful adjustment of T1 started the oscillator and gave an RF output of 5W. Changing channels, and then keying to make certain the output began, proved the adjustment gave reliable starting.

The next step was to check all transmit frequencies. All odd numbered channels (except 23) were on frequency, but the even numbered

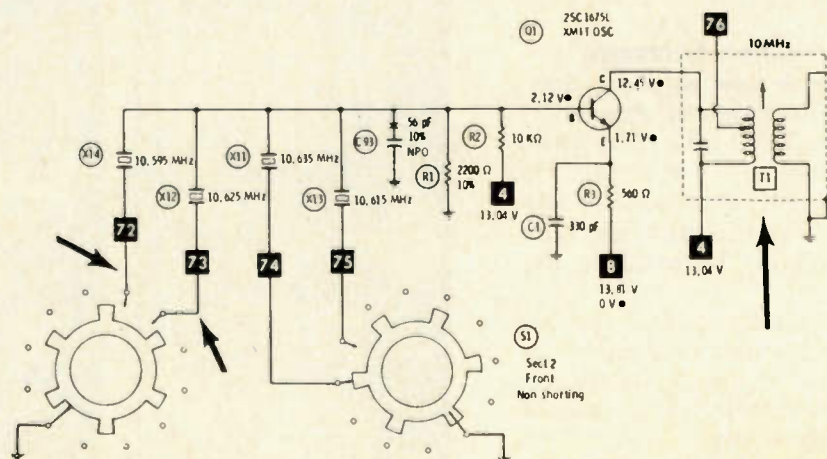
ones were far out of tolerance. I studied the crystal synthesizer chart to find what the even channels had in common. Even channels used either crystal X12 or X14. Therefore, the problem must have involved them, and the only common part was the selector switch and its wiring.

With the channel selector on channel 2, I checked for continuity between crystal X12 and ground. There was none. Turning on the radio power, I temporarily connected a jumper from the cold end of X12 to chassis. The output frequency changed to 26.975MHz, the correct channel 2 frequency. Neither X12 nor X14 was being grounded through the switch. I carefully traced and found a hair-line crack in the board with the switch wires. It would have taken a prohibitive amount of time to disassemble the switch and repair the foil wires, so I added two insulated wires across the board. All channel frequencies were correct, but the output still had excessive wattage. The output power was adjusted down to 4W, and the problems were solved. A final checkout proved the radio was normal.

### Doesn't transmit or receive

The Johnson MESSENGER model 250 base station (Photofact CB-60) would not receive or transmit, although it had supply voltages. When a test signal was fed into the antenna connector, nothing could be heard in the radio speaker until the generator level reached 100 $\mu$ V. Even then the sound was

**Figure 5** A cracked circuit board opened the continuity between X12 and X14 and the channel switch. Also, T1 required a slight adjustment to provide dependable starting of the 10MHz oscillator. (RYSTL model CBR-1700, Photofact CB-99)





faint. This is extremely low sensitivity.

Because I recently had acquired an RF probe for my VOM, I decided to trace the RF signal through the transmitter. With the key down, no RF was found at the base of Q17, the RF-output transistor. At the Q15 RF-amplifier collector (Figure 6), I found no measurable signal, nor at the Q15 base.

I found just a trace of RF in the Q14 synthesizer-mixer collector. Changing to dc-voltage measurements, I discovered almost zero voltage at the Q14 emitter. Between CircuiTrace and ground was nearly zero ohms, rather than the normal 390 Ω. Removal of the emitter voltage overbiases the base, resulting in very low gain. C46 was suspected of being shorted. However, while examining the area, I noticed what appeared to be a small piece of wire protruding from underneath transformer T7. It was too tight to be dislodged, so I removed T7 and found a piece of solder stuck to one of the pins and shorting to the transformer can

(which is grounded). After the stray solder was removed and the transformer was reinstalled, the radio worked perfectly on both transmit and receive.

### Radio transmits, does not receive

According to the customer, the

radio was dead when received, but transmitted as it should. The first diagnostic step on this Ray Jefferson radio (CB-110) was to feed the full output of a signal generator into the antenna connector on channel 13. No sound came from the speaker, and the S-meter gave no movement. The lack of meter

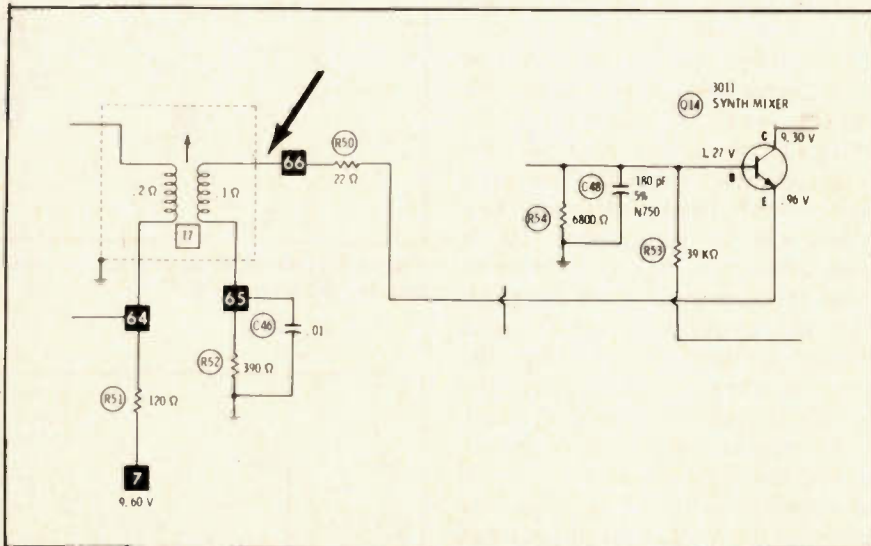
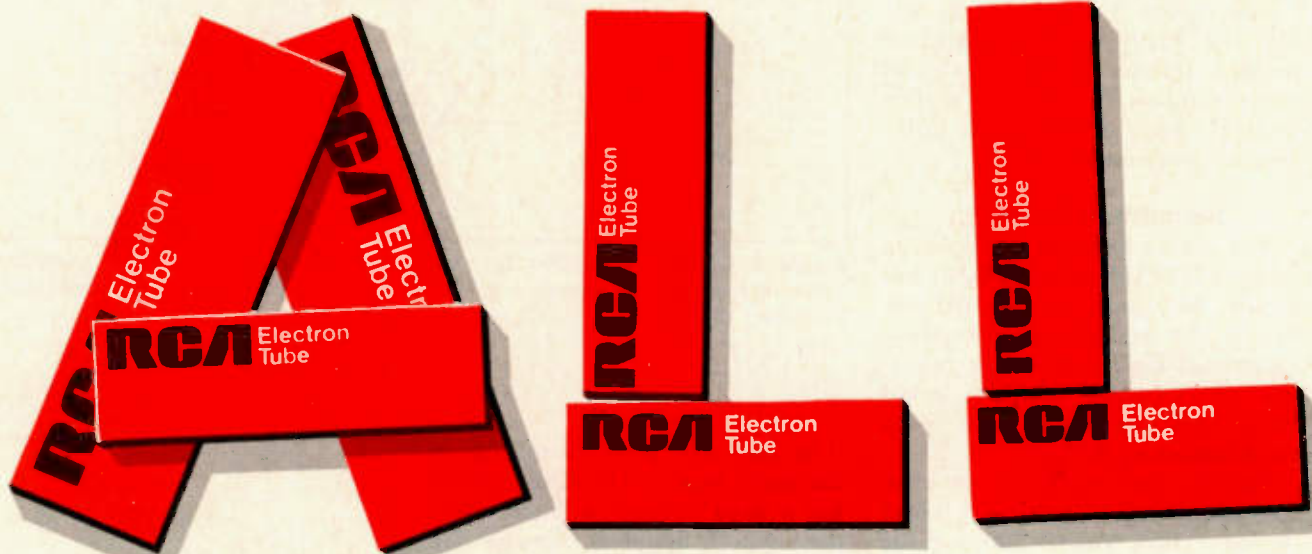


Figure 6 A total loss of receive and transmit modes was caused by a loose piece of solder under XT7. (Johnson MESSENGER-250, Photofact CB-60)



## the Receiving Tubes you'll ever need for most replacements.

With RCA you get the exact replacement tubes you need along with quality you can depend on. Whatever receiving tube you need, you'll find it at your RCA Distributor. Miniatures, Novars, Compactrons, Nuvistors, Glass Tubes, Metal Tubes . . . over 1,000 types, produced to RCA's exacting standards.

Plus many RCA service aids and business aids to add to your efficiency and promote your business . . . tube caddies, service tools, technical literature and a wide assortment of in-store signs and displays.

See your RCA Distributor for all your tube needs.

RCA Distributor and Special Products Division, Deptford, N.J. 08096.

# RCA Receiving Tubes





## CB repairs

indication suggested the dead stage was between the receiver RF input and the detector. When 455kHz was applied to CircuiTrace 22 (the filter unit at Q4's base in Figure 7), no signal came through. The same lack of results occurred when the 455kHz signal was injected at the Q5 (last IF) base.

Dc-voltage tests at Q5 revealed no collector voltage, but almost 9V was measured at CircuiTrace 27, which is the other end of the collector transformer. The only component between those two points was IF transformer T6; it must have been open. A replacement IF transformer was installed, and the generator signal came through at full volume. After the new transformer was aligned, the sensitivity measured  $0.8\mu\text{V}$  (normal).

A routine performance check proved the radio would not transmit on channels 9, 10, 11 or 12, and a study of the crystal synthesis chart showed crystal X3 (Figure 8) was used for those same channels. I removed crystal X3 and checked it on my crystal-activity tester, which showed the crystal was defective.

The crystal was not one usually stocked here, so the customer decided to use the radio without those channels. A complete performance check showed all other functions were satisfactory.

### Intermittent reception

The receive function of a Johnson model 123SF (Photofact CB-87) was erratic, but there was no pattern. When the reception was dead, sometimes keying and then releasing the transmit function would bring back the audio. This made troubleshooting difficult.

Finally, the reception problem continued long enough for a series of tests. There was no audio at the base of Q9 audio amplifier (Figure 9), according to the signal tracer. However, at CircuiTrace 51 (output of the detector diode), the audio signal was loud and clear in the speaker. The audio was not traveling between those two points, which included the audio-switching circuit.

Diode CR6 is used as a voltage-controlled on/off switch that either conducts completely to pass the audio from CircuiTrace 75 to 76, or

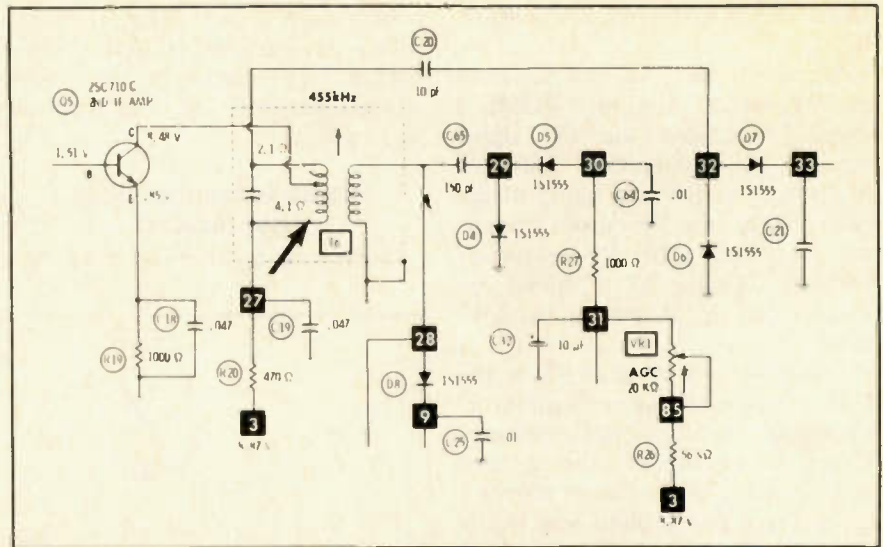


Figure 7 Loss of all sound signal and meter indication was caused by an open primary winding in T6.

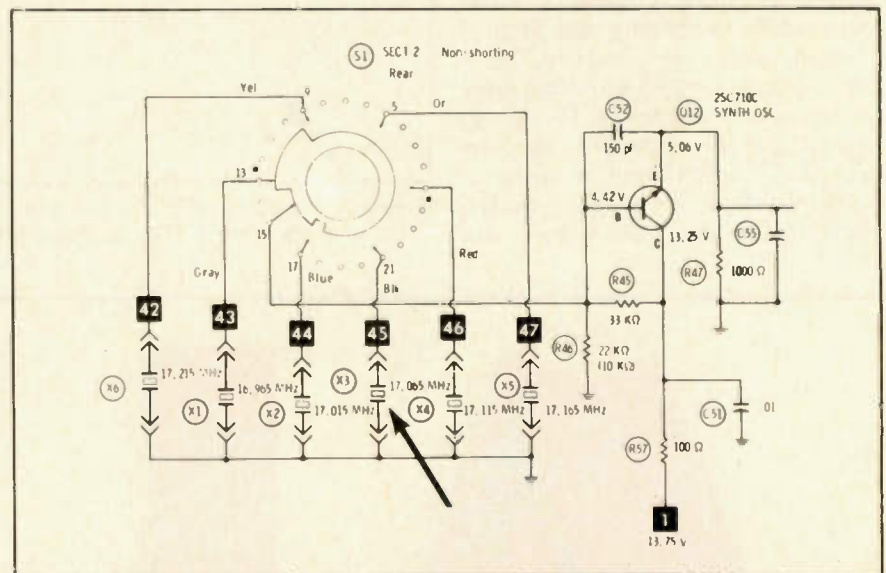


Figure 8 Crystal X3 proved to have substandard activity which eliminated transmit function on channels 9, 10, 11, and 12. (Ray Jefferson model 9000, Photofact CB-110)

it is open and prevents passage of the audio signal. The CR6 cathode has a fixed voltage of about +6V; the anode is supplied through R16 (100K  $\Omega$ ) from a supply of +10.3V when in the receive mode or zero in the transmit mode. Therefore, CR6 should have about 6V of reversed bias during transmit and saturation forward bias during receive.

Dc-voltage tests showed the CR6 cathode had too much positive voltage to allow dependable saturation bias. I installed another 150K  $\Omega$  resistor in parallel with R14, and the erratic audio during receive mode was corrected.  $\square$

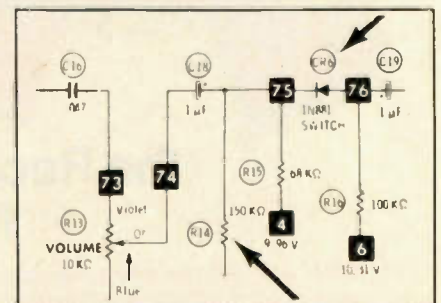
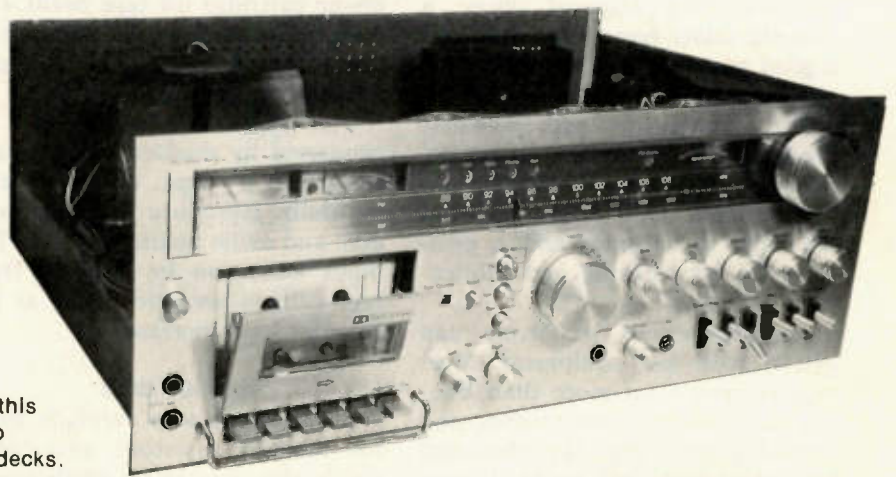


Figure 9 Excessive positive voltage at the cathode of switching diode CR6 prevented sufficient saturation forward bias for dependable switching. The receive audio was erratic. (Johnson model MESSENGER-123SJ, Photofact CB-87)





Typical of many combination AM/FM/stereo plus cassette tape recorder/player is this unit by JC Penney. Models without the radio tuners and power amplifiers are called tape decks.

## PART 1

# Servicing audiocassette tape recorders

By Homer L. Davidson  
Davidson Radio & TV  
Ford Dodge, IA

*Cassette tape recorders have electronic circuits and mechanical components. Both sections can develop defects that require repairs. Part I covers typical electronic problems and test methods.*

Cassette tape recorder/player machines are manufactured in many forms. Most common are the portable types in monaural or stereo versions with internal speakers and microphones. Because the small sizes and crowded layouts add to the problems of locating a bad stage or component, few of these machines are worth repairing. Unless a shop specializes in tape recorders and does a large volume of warranty repairs, a typical repair could exceed the \$30 to \$50 price paid for a new recorder. Only machines originally selling for more than \$100 should be accepted for repair.

Larger and costlier models are constructed to allow more space

and better accessibility for troubleshooting. Also, the cost of repairs is a smaller percentage of the selling price.

To restore the original sound quality of the deluxe models in a minimum amount of time, audio technicians need to know the theory and all the shortcuts. The following tips should help.

### Tools and test equipment

Test equipment and tools for cassette servicing are almost the same as those needed for other audio repairs. Here is a partial listing:

- *An audio generator* having outputs of 20Hz to 20kHz sinewaves of 0.5% or better distortion plus good squarewaves. A calibrated output level is helpful. One type has a selector switch plus a calibrated variable control.
- *A scope.* The requirements are not rigid; any scope of 500kHz or wider response is satisfactory. Of course, a top-of-the-line 35MHz triggered scope offers many advantages, and it can be used for color TVs also.
- *A digital multimeter,* preferably

with 10M  $\Omega$  input on ac voltage. Make certain the ac-voltage frequency response is flat up to 4kHz or higher. This is satisfactory for all audio measurements except frequency-response runs.

- *A digital capacitance meter* for accurate out-of-circuit tests, plus an ESR tester for in-circuit tests. The ESR Meter by Creative Electronics is recommended because of the many electrolytic capacitors in tape machines that initially should be measured in-circuit to save time.

- *A total-harmonic distortion (THD) meter* and an intermodulation-distortion meter. These are excellent for pleasing the "Golden Ear" customers.

- *A variable-voltage 0-to-30Vdc 2A power supply* is handy for temporary substitution of a dead supply, or for operation through a limiting resistor to vary a bias voltage during tests.

- *Two matched test speakers* with a 0.25A fuse in each hot lead.

- *A frequency counter* is a practical luxury for measuring bias-oscillator frequencies or checking tape speed by the audio-tone frequency.

- *The usual hand tools.* The essen-



## Servicing recorders

tials include: an assortment of Phillips and regular screwdrivers; a variety of nutdrivers; miniature long-nose and diagonal pliers; a vacuum solder-removal device; and a good temperature-controlled soldering iron.

- For mechanisms and cassettes, the following are needed: a cassette-head demagnetizer; a splicing kit for damaged tape; a pre-recorded test tape in cassette; and a complete kit for cleaning and lubrication.

An experienced technician can get by with less equipment. Most repairs involve no more than finding the defective components and replacing them. But the additional test instruments will speed diagnosis and help provide the tighter specs for those who demand and appreciate them.

### External amplifier

Another item rarely called test equipment is a self-contained external amplifier. It can be used as an excellent audio-signal tracer. A small PA amplifier with a microphone and high-impedance inputs is adequate. It should be a cold-

chassis type (with a power transformer) and be connected to an external speaker in a baffle.

The ultimate is such an amplifier that has an input for low-level phono cartridge (or tape head) with correct equalization, in addition to a microphone input and a low-gain auxiliary or phonograph input.

This type of amplifier can be connected by shielded leads to any stage of a tape recorder and faithfully reproduce whatever volume and audio quality is there. The input leads can be changed from high-gain to low-gain inputs as the recorder level increases.

### Service data

A technician who carefully looks for burned resistors and other visible signs can often repair power supplies or power-output stages in tape machines without a schematic. All other repairs demand a complete set of service information. The crowded condition of most circuit boards makes visual tracing of circuit wiring almost impossible. For fast troubleshooting, a technician must have a schematic and a parts layout with the wiring shown. Even when the machine has discrete transistors, it is difficult to identify

the function of any transistor from its appearance and location on the circuit board.

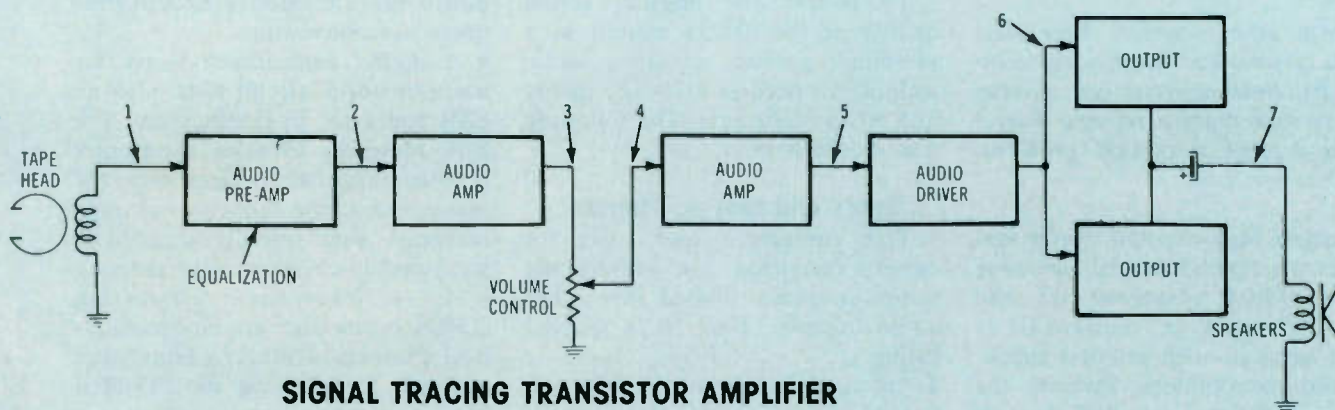
Part of the problem is illustrated in Figure 1. The output from a transistor might be taken from the emitter (without level increase over the base) or it might come from the collector (usually with gain). It is inefficient to fumble around at random searching for the signal.

The situation is more serious when the amplifier employs one or more integrated circuits (ICs). Figure 1B shows major test points for an IC-equipped amplifier. Without a schematic and physical layout, it is not possible to know which pins should have signals.

Some stereo machines (Figure 2) have a single thick-film integrated hybrid circuit containing the driver and push-pull output stages of both channels. Obviously, service data is essential for these cases.

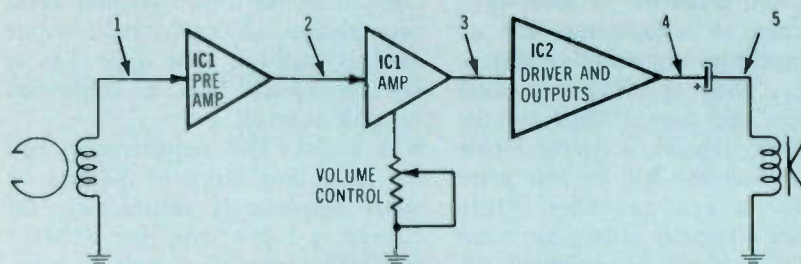
### Symptoms

Typical symptoms of malfunctioning amplifiers in cassette tape recorders include no sound, distorted sound, weak sound, whistles, supersonic oscillation, hum, hissing or frying noises, loud popping noises, intermittent volume, inter-



**SIGNAL TRACING TRANSISTOR AMPLIFIER**

**Figure 1** Test points for signal-injection or signal-tracing tests are marked by arrows. If a schematic is not handy, types with discrete transistors (top diagram) are easier to test than those with ICs (lower drawing). Some machines have several ICs and no transistors.



**SIGNAL TRACING IC AMPLIFIER**



mittent distortion and overload that occurs at less than the rated wattage.

Mechanism problems can be incorrect steady speed, erratic speed (wow), lack of tape movement, failure to rewind, breaking of the tape or jamming of the cassette with loose tape. These mechanical symptoms will be discussed next month.

### Tape decks vs. complete machines

A cassette machine that records and plays back but does not have power amplifiers or speakers is called a *tape deck*. Usually it is connected to a hi-fi system containing a record player, preamplifier with loudness and tone controls, and a power amplifier that feeds large speaker systems. Some cassette mechanisms are part of a system that has AM, FM and FM-multiplex radio functions and a complete stereo amplifier and speaker system.

The techniques of troubleshooting cassette tape recorders are the same whether the mechanism and associated electronic circuits are in a cabinet by themselves or are just a section of a larger complete system. In all cases, the bias oscillator, meter amplifiers and the preamplifiers with equalization are not used for other functions in the system.

### Symptoms: no sound and no power

When the cassette tape recorder

is dead (no pilot lamp lighted), the suspicion falls on the 120Vac circuits and the power supply. Test the ac cable, on-off switch and the power transformer primary winding for proper continuity.

If the cassette recorder is part of a larger system, attempt to operate the other functions, such as the radio or the phonograph. Often the problem is not in the cassette wiring.

Power transformers can be ruined by shorted silicon power-supply rectifiers or shorted power-output transistors. An open primary or burned smell of the power transformer should call for amplifier and power supply tests before the transformer is replaced.

A defective voltage regulator (Figure 3) usually kills several functions, perhaps all in both stereo channels.

Check all fuses. Most major overloads or shorted output transistors will blow the fuse.

Some larger amplifiers have a red wire that brings dc voltage to each output stage. Seldom are both channels shorted at the same time. Therefore, the red power wires should be disconnected separately from the power source and tested for shorts or excessive current.

Power-output stages with direct coupling to the speakers and with direct-coupled driver stages are likely to produce a trail of damaged components. In those amplifiers that have it, a shorted coupling capacitor between the output stage and the speaker can cause one of

the output transistors to short, burn any emitter or collector resistors of that transistor and overload the power supply or blow a protective fuse. If the overload is allowed to continue too long, the speaker voice coil can be burned and ruined. Of course, all these defects must be repaired before power is applied again.

### No sound from one stereo channel

If one stereo channel apparently operates perfectly but the other is dead, the good channel can serve as a model during tests of the bad channel. This is valuable when the layouts are identical for the channels.

There are two general methods of testing. One involves signal tracing; the other compares dc voltages of the two channels.

**Signal tracing**—The easy way to find the stage at which the signal disappears is to connect the external test-amplifier input probe to the speaker coupling capacitor of each channel. The same signal should be at both ends of a good capacitor (or a shorted one); an open capacitor has a signal at the input but not the output end.

Open electrolytic capacitors between the push-pull output stage and the speaker are fairly common. This should be the first test.

If no signal is found at either end of the speaker capacitor in the bad channel, the probe should be moved to the driver stage output and then the input. Signal at the output but not at the input proves that stage has the defect.

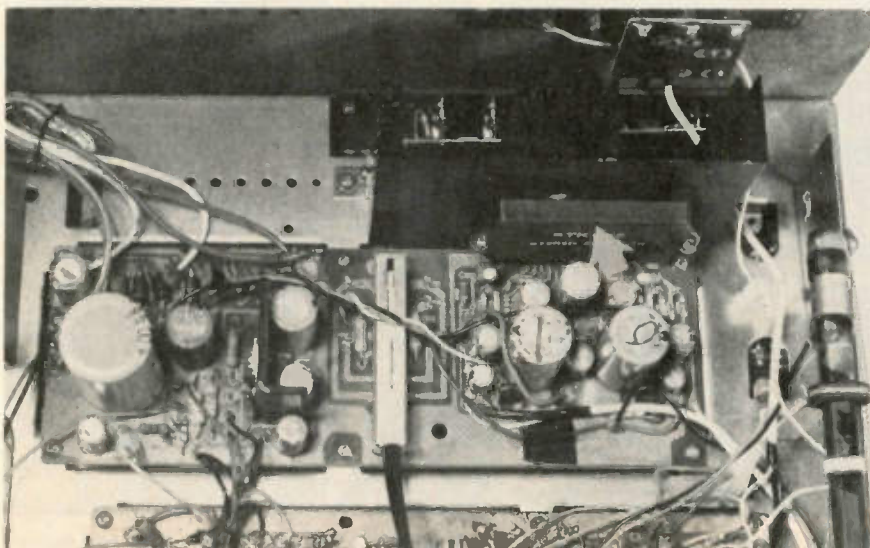


Figure 2 Some models have thick-film ICs that contain the drivers and output stages for both stereo channels. A Sharp model RT-1199 is shown here.

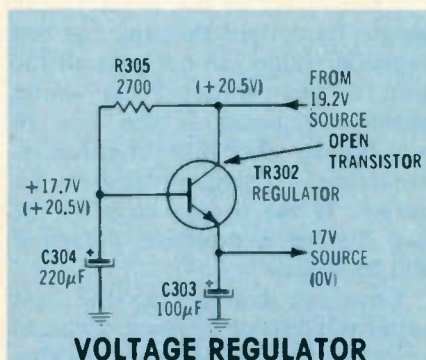


Figure 3 An open transistor or other defect in a voltage regulator can eliminate several functions in a combination cassette/radio.



## Servicing recorders

A dead stage following good ones often increases the signal level and the distortion in those previous stages. Negative feedback is connected between the speaker signal and a previous stage, such as the driver or pre-driver. A dead output stage eliminates the negative feedback and thus increases the gain of stages upstream of the dead stage.

Continue moving the external amplifier probe (and increasing the test-amplifier gain) toward the recording/playback head until the dead stage is found. Then switch to dc-voltage and resistance tests to identify the defective component.

Of course, a scope (or even a high-sensitivity ac-voltage meter) could be used instead of the external amplifier to find the dead stage. However, the external amplifier allows a listening test to be made rapidly. Human ears are not very efficient at detecting 1% distortion against 2% distortion. But they can give an excellent idea of the *approximate* sound volume and quality (including hum, noise and distortion) much faster than any electronic test instrument.

**Another signal-tracing method—**The good channel often can be substituted for the external amplifier during signal-tracing tests.

With the controls adjusted the same for both channels, bridge a coupling capacitor between the counterpart test points of the two amplifiers. Specifically, connect a  $1\mu\text{F}$  plastic-film capacitor in series with a  $470\ \Omega$  resistor. Use the combination to bridge the two amplifiers.

Again, start at the input to the output transistors. Perhaps the test capacitor value will not pass all the bass in the music. Some sound should be heard if the loss of volume in the bad channel is occurring in a stage previous to the output. If the output stage of the bad channel is defective, no sound will be heard.

Continue connecting the test capacitor/resistor between identical points of the two channels, moving toward the input after each test that gives sound through the bad channel. When a point is reached at which the test capacitor/resistor does not produce sound in the bad

channel, the defect is between this point and the one used for the previous test.

If all stages were isolated at input and output by coupling capacitors, the test would be infallible. Unfortunately, direct coupled stages can be misleading. A defect in one changes the dc voltage in its companion. A radical change of bias can prevent any conduction in the good stage. Keep the judgments flexible until this possibility can be explored.

**Compare dc voltages—**Another test is a comparison of dc voltages in the good channel with the equivalent ones in the bad channel.

**Check speaker fuses—**Some amplifiers provide fuses between the output signal and the speakers, and some speakers have fuses to protect the voice coils from overloads. These fuses should be tested first, if no sound (no minimum hum) can be heard in a speaker.

Modern transistor amplifiers can tolerate an open circuit at the speaker terminals, but some are overdriven and are ruined rapidly by a short circuit across the output. Keep these facts in mind.

A speaker with an open voice coil cannot produce any sound. Verify that each speaker has the correct dc resistance and does emit sounds, before going too far into tests of the amplifier. In a stereo system, just interchange the two speakers and notice if the problem changes channels. If it does, one of the speakers is bad.

### Testing output transistors

Any output transistors suspected of defects should be removed from the board, chassis or heat sink for tests out-of-circuit (Figure 4). Circuit resistances invariably are too low to permit accurate tests in the machine. False readings sometimes occur from the conduction of direct-coupled driver transistors.

Start the out-of-circuit tests by measuring the forward and reversed resistances of the base-to-emitter and base-to-collector junctions. Then check for shorts or leakages between collector and emitter. Any shorts or opens revealed by these simple tests prove the transistor is defective and needs to be replaced. Transistors that pass the resistance tests should be checked for dc beta before they are reinstalled.

Catastrophic failures occur more

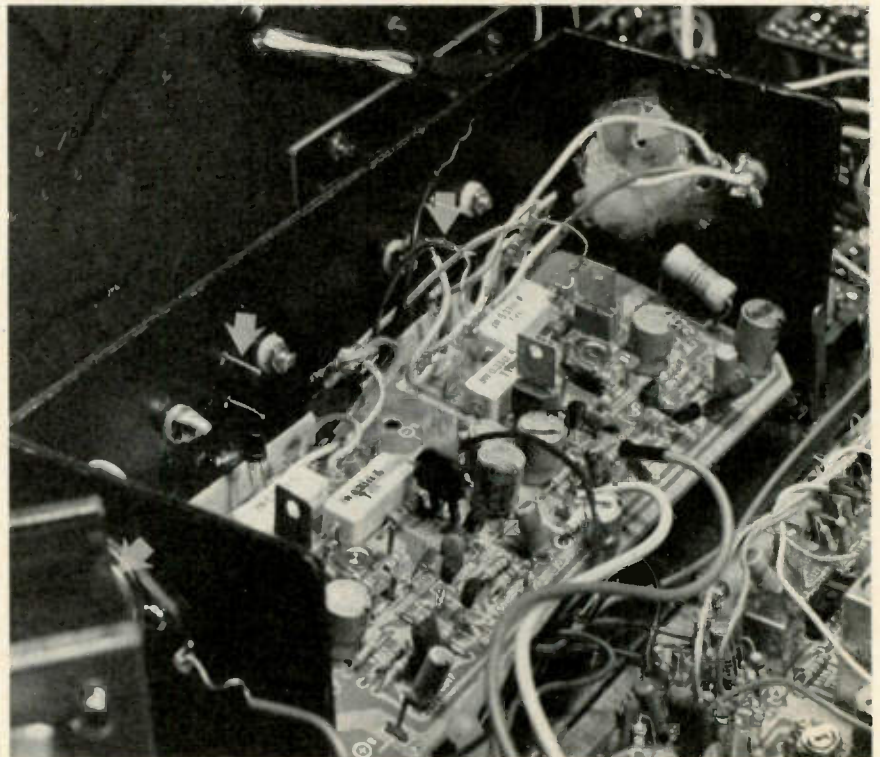


Figure 4 All suspected power-output transistors should be removed for out-of-circuit tests. Always add silicone grease to the transistor and mica insulator before reinstallation of a power transistor in its socket.



often in audio-output transistors than with the smaller transistors that operate from lower power. Many of them are mounted in sockets that permit easy removal and reinstallation. Output transistors should be the first components tested in a dead channel or one exhibiting high distortion.

### Excessive distortion

Distortion can exist in many degrees. In one sense, any distortion that can be perceived by listeners is too much. The discernment of distortion by listeners varies according to the bandwidth. Wide frequency response *seems* to increase distortion, while narrowing the bandwidth appears to decrease distortion. That's why some people prefer the *mellow* sound obtained by turning down the treble control.

Figure 5 shows components of the output stage that can cause distortion. Notice that *all* components are possible sources of distortion.

The general cause of distortion is nonlinearity. Audibly, the symptom is the addition of frequencies not present in the original. With scope waveforms, the distortion changes the waveshape. Therefore, one good method of testing is to apply sinewaves or triangular waves (squarewaves do not show clipping distortion) at the input of the stage or stages to be tested and then follow the signal from input to output using a scope.

In most cases, the first stage that exhibits a change of waveform is the one with a defect. Remember that all amplifier stages have an overload point. If the input signal amplitude is increased above this overload point, the stage must distort the signal. The level applied should be chosen so overload will not occur.

Two types of waveform distortion are shown in Figure 6. However, there are many others. The first distortion—called crossover or notch distortion—can be produced only by transistors in conventional class-B push-pull output stages. Usually, the cause is insufficient bias for either or both transistors. Each transistor is expected to contribute one peak of the waveform; together they produce a distortion-free waveform. One characteristic of notch distortion is that

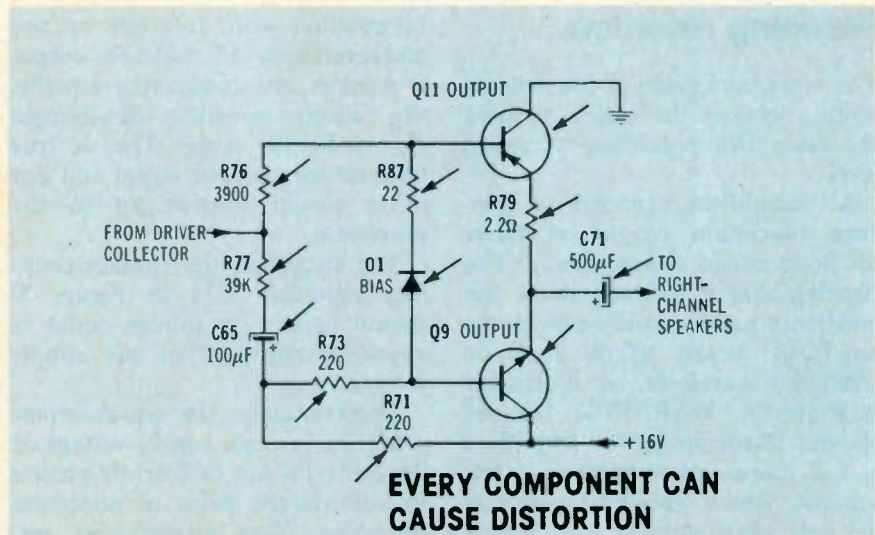
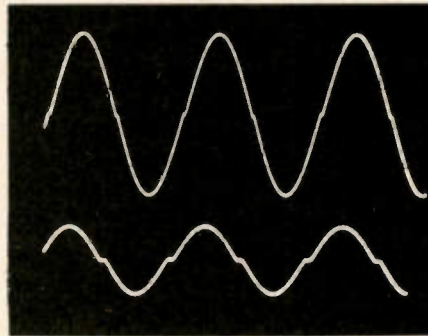
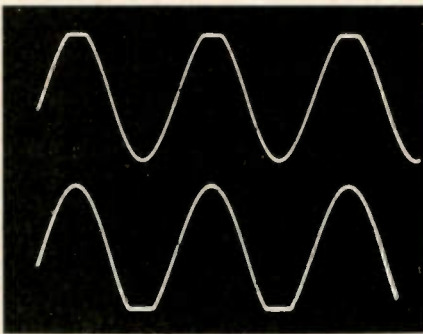


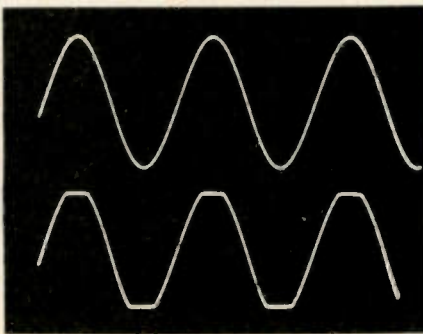
Figure 5 Any component of a push-pull output stage can cause distortion if it becomes defective. The output stage should be tested first when the sound is distorted. Diode D1 and R87 offset the bias of one transistor to eliminate notch distortion. Always check D1 for a short or an open. The dc voltage at the two emitters should measure approximately half of the supply voltage. Use this test as a quick evaluation of the output stage.



A



B



C

Figure 6 These are waveforms of several kinds of distortion. (A) Notch or crossover distortion (notice notches at center of sine waves) is produced by insufficient output-transistor bias. Both traces were made with the same scope adjustments; only the generator level was changed. Notice that the notch distortion *appears* larger in the bottom trace because the sine wave decreased while the notch remained the same (B) Clipping at one peak but not the other when the amplifier is producing slightly more than rated power is an indication of unbalance, probably because of the driver stage. (C) Correct balance should show no clipping below the overload point (top trace) or identical clipping of positive and negative peaks (bottom trace).







identification of anything that triggers the intermittent into beginning or stopping.

Alternate applications of cooling spray and heat often start or stop the intermittent. After it is certain that heat is the trigger, the heating and cooling should be applied to a narrowing circle until it can be pinpointed to one component.

Capacitors are a common cause of intermittents. C411 in Figure 7 evidently had intermittent leakage because the voltage at the collector of Q401 and the emitter of Q402 increased to about +46V when C411 leaked. Bias applied to the output transistors was changed by the leakage.

Other capacitors have erratic equivalent-series resistance (ESR). Many electrolytic filters and coupling capacitors have intermittent ESR that changes the volume without usually causing distortion. Refer to the ESR meter described earlier with the recommended test equipment.

Many intermittent problems also change the supply voltages, so those voltages should be monitored to determine whether the voltage change is the cause of the intermittent or is its effect.

Another source of many intermittents is the various controls and potentiometers (Figure 8). Front-panel-mounted variable controls can be tested merely by turning them and listening for intermittent operation.

Preset controls mounted on cir-

cuit boards cause more problems because rotating them might upset factory adjustments. Prying each one gently with an insulated screwdriver or alignment stick often forces them to start the problem. Sometimes these controls can be cleaned satisfactorily with tuner spray and rotation of the shaft, followed by proper adjustment.

Corroded function switches also can produce erratic operation. Try to clean them with tuner spray, and replace them if cleaning is not effective.

### Hum and motorboating

Hum and motorboating usually are the results of open filter capacitors. Audio hum can be generated from bad grounds on the boards. Hum and noise become louder if the amplifier is oscillating at a supersonic frequency. Most of these bad capacitors can be identified with the digital capacitance meter and ESR meter mentioned.

### Crackling or popping noise

Transistors and resistors are the most common sources of these noises. Application of canned coolant to individual components often reduces the noises enough to identify the one causing the problem. Signal tracing also reveals the defective stage.

### Next month

Typical problems with cassette-tape transport mechanisms will be the main topic next month.

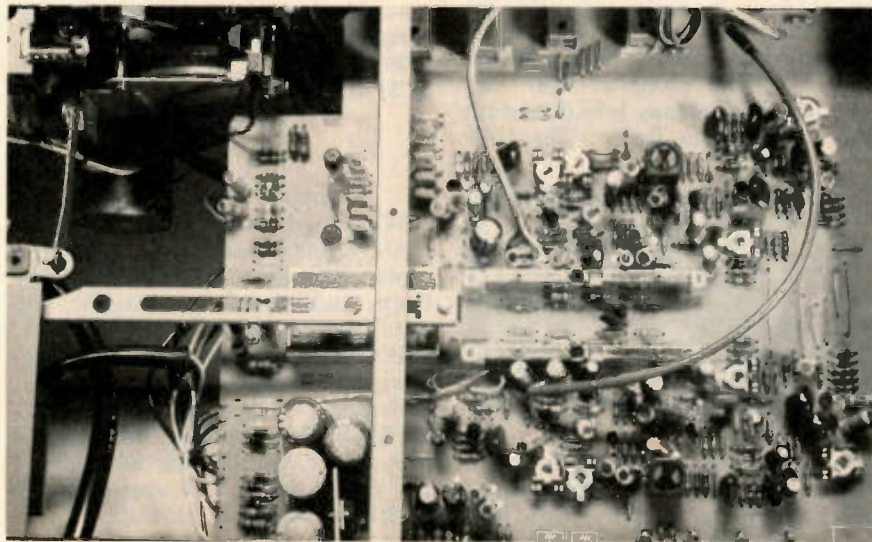


Figure 8 Play/record switches (U-shaped bracket at right-center) and preset-adjustment controls (scattered over the board) are responsible for many cases of intermittent operation. These should be cleaned with tuner fluid or replaced when they give noise or erratic volume.

## Low cost tool for design and trouble-shooting

### Pocket Size Slide-Switch Resistance Substitution Unit

still only \$58



- Over 11 million ohm values
- 1% accuracy resistors
- Unique in convenient size
- Rugged construction

Small enough to take anywhere in your pocket, this aluminum-housed unit delivers a very broad range of resistance steps. Excellent for both development and repair work.

Half-watt 1% tolerance resistors give an accurate range from 1 to 11,111,110 ohms, in one-ohm steps. Has three binding posts, one to ground case.

Available now from stock. Order Catalog No. 7092-236. 5% discount for cash with order.

Ask your dealer, or contact:



**PHIPPS & BIRD, INC.**

Manufacturers of Scientific Instruments  
P.O. Box 27324 • Richmond, VA. 23261  
804/264-7590

Circle (9) on Reply Card

## DON'T LET INFLATION BLOW IT!

### Use your "Dollars and Sense."

Send for this free booklet, and information on how to obtain bulk copies.



George W. Hayden  
The Advertising Council  
825 Third Avenue, New York, N.Y. 10022  
Please send me a free copy of "Dollars and Sense," and information for ordering bulk copies.

NAME \_\_\_\_\_  
TITLE \_\_\_\_\_  
ORGANIZATION \_\_\_\_\_  
STREET \_\_\_\_\_  
CITY \_\_\_\_\_  
STATE \_\_\_\_\_ ZIP \_\_\_\_\_  
SIGNATURE \_\_\_\_\_



A public service message of The Advertising Council and The U.S. Departments of Agriculture, Commerce, Labor and Treasury. Presented by this magazine.



# product report

## PCB repair kit

The Pace Cir-Kit selector pack is a self-contained repair kit for field repair or replacement of lifted, damaged or missing pads and tracks on printed circuit boards. Cir-Kit includes a selection of pre-tinned and scored eyelets, Trak-Pads,



which are prepared and pre-tinned sheets of various sized replacement pads and tracks, an abrasive stick for cleaning both the work area and the Trak-Pads to be used, and tools and accessories for cold setting the eyelets.

The Cir-Kit selector pack is available for \$79 per kit.

Circle (23) on Reply Card

## Work bench

The Penco Open Type work bench offers a choice of four top constructions and 12 sizes. The benches feature a pressed wood over steel



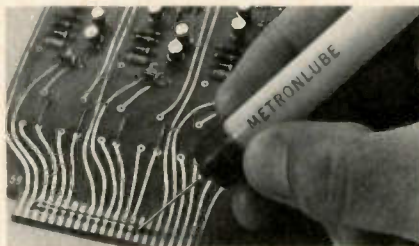
top. Standard accessories include: stringers, shelves, back and end stops, risers, electrical outlet strips, case and drawers with one tray and bench drawer mounting kits.

Circle (24) on Reply Card

## Contact lubricant

Metron Marker introduces the

availability of Metronlube, their contact lubricant, in the Metron Marker pen, a squeeze-type instrument with a needle-like applicator. Metronlube is colorless, chemically neutral, water repellent and weather-proof. Metronlube is suitable for mechanical uses from -55°C. to 250°C. The standard needle ap-



plicator of the Metron Marker pen has an orifice of .021-.013 for the applicator. Flow is controlled by pressure on the pen body.

Metron Marker pens filled with Metronlube are sold individually at \$4.45 each and in quantities of five or more at \$4.15 each. The applicator tip is 50 cents per pen.

Circle (25) on Reply Card

## Distribution amplifier

Blonder-Tongue has announced the availability of two high gain, low noise distribution amplifiers. The Masterline MUVB-35 is designed for UHF, VHF and FM installations, and the MVB-35 is made for VHF/FM use. The MUVB-35 has separate VHF gain controls for high and low bands and the patented ICEF circuit, which combines low distortion with a low noise figure. The UHF



section features a solid state inter-stage attenuator type gain control, which provides stability with low noise. The MUVB-35 can be used with either a combined UHF/VHF antenna or with separate UHF and VHF antennas through a switchable input mode. The MVB-35 has sepa-

rate gain controls for high and low bands. The unit can be used in both weak and strong signal areas. Both units also feature a switchable FM bandstop filter to prevent overload from strong FM stations.

Circle (26) on Reply Card

## Frequency counters

Heath has introduced two digital frequency counter kits. The IM-2400 hand-held counter features a 50Hz-512MHz frequency range. The



portable IM-2410 offers a single input for its 10Hz-225MHz frequency range. The IM-2400 is priced at \$139.95, and the IM-2410 is priced at \$119.95.

Circle (27) on Reply Card

## Outdoor antenna line

Winegard has introduced TV MAN, a line of antennas designed to replace Winegard's Gold-Star, Color Beam and Premier antennas. The antenna line features VHF/FM, VHF/UHF/FM, and UHF antennas. There are seven VHF/FM models, including two do-it-yourself kits; 11 VHF/UHF/FM models, including 3 kits; two FM antennas, including 1 kit, 1 UHF and L VHF antenna; and an RV and scanner antenna.

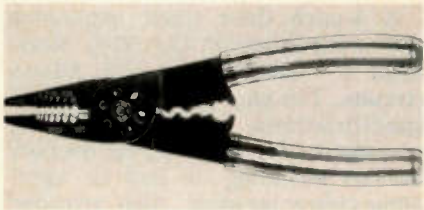
Circle (28) on Reply Card

## Wire tool

Jonard has introduced the PL-15



crimper, which features scissor action wire cutting and wire stripping. The tool has a 45° angle slope away from the sharp cutting edge that holds the insulation in place for



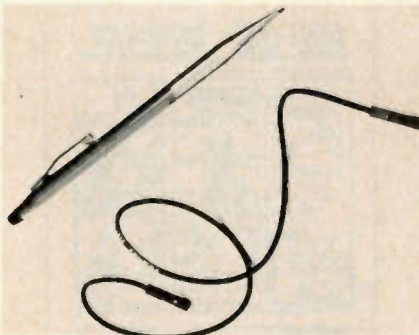
smooth stripping action. It is gauged to the same range of wire sizes as crimpers 22-20 to 22-10, and cuts six different bolt sizes from 4-40 to 10-24.

The PL-15 crimper is 8 inches long and priced at \$8.90.

Circle (29) on Reply Card

#### Miniature probe

A miniature test probe to in-line minigator clip patch cord has been announced by IIT Pomona Electronics. Model 4717 has a 2.03mm diameter pin tip on one end, insulated with glass-filled nylon, with a built-in finger guard. The opposite



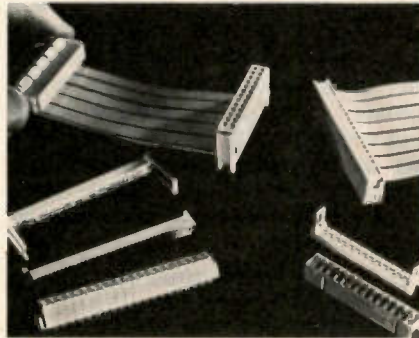
end has a vinyl insulated minigator clip. The wire is 20AWG tinned copper stranding 41x36 with polyvinyl insulation 2.21mm O.D. 48-inch length. The patch cord assembly is rated at 5A continuous duty, 3000WVdc and is available in black or red.

Circle (30) on Reply Card

#### Socket connectors

Two series of insulation-displacement socket connectors for mass termination of 50-mil flat ribbon cable have been introduced by Belden. Both are offered in sizes

from 10 to 60 pins. The 8S series is designed for low-profile applications and daisy-chaining. The 9S series,

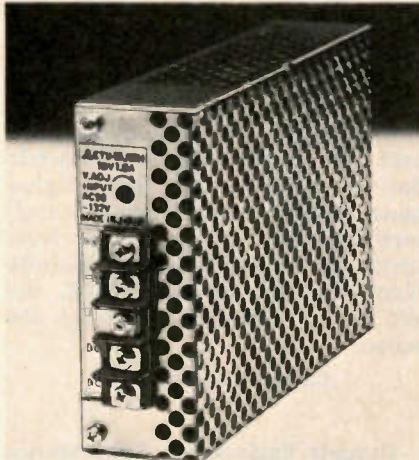


available in through-end and closed-end configurations, incorporates a strain relief to protect cable terminations when repeated insertion and extraction cycles occur.

Circle (31) on Reply Card

#### Switching power supplies

A line of low-power switching power supplies is now available from Panasonic. Designated as J Series, the new supplies offer small size, light weight, and high conversion efficiency. Four units make up the J Series: 5Vdc at 4A, 12Vdc at 1.8A, 15Vdc at 1.5A, and 24Vdc at



1A. The power supplies are designated as 20-watt units. The units carry a 3-year warranty, offer higher operating temperatures and full rated output up to 50°C with normal convection cooling.

A J Series power supply in single quantity is priced at \$44.90. Quantity discounts are available. □

Circle (32) on Reply Card

## APPLIANCE REPAIR BOOKS



Thirteen Handbooks written in easy-to-understand language by experts in the service field with illustrations and diagrams! Acclaimed by instructors and professionals alike! How to diagnose and repair air conditioners, refrigerators, washers, dryers, ranges, microwave ovens, dishwashers, vacuum cleaners, electrostatic air cleaners, RV gas appliances, hair dryers, motors, water heaters, coffeemakers, can openers, floor polishers, steam irons, food mixers, lawn care appliances, electric knives, electric and digital clocks and many others. Also fundamentals of solid state, setting up a shop, using test instruments and more. Only \$2.65 to \$4.90 ea.

SEND FOR FREE PRICE LIST

Gamit, Dept. ES

110 W. St. Charles Road,  
Lombard, Illinois 60148

Circle (11) on Reply Card



#### FREE CATALOG

HARD-TO-FIND PRECISION TOOLS

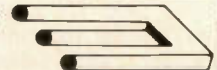
Lists more than 2000 items: pliers, tweezers, wire strippers, vacuum systems, relay tools, optical equipment, tool kits and cases. Send for your free copy today!

JENSEN TOOLS INC.

1230 SOUTH PRIEST DRIVE - TEMPE, ARIZONA 85281

Circle (12) on Reply Card

IT'S NO PUZZLE  
TO ORDER



#### OELRICH SERVICE FORMS

FOR TV-RADIO & 2-WAY RADIO SERVICE LEGAL FORMS FOR CALIF., FLA., UTAH NOW AT YOUR PARTS JOBBER OR WRITE FOR CATALOG B64

OELRICH PUBLICATIONS

4040 N. NASHVILLE AVE. CHICAGO, ILLINOIS 60634

Circle (13) on Reply Card

## Helping children everywhere live



For information about this life saving research please write 539 Lane Avenue, Memphis, Tennessee 38105.

Danny Thomas, Founder

**ST. JUDE CHILDREN'S RESEARCH HOSPITAL**



## NATIONAL ELECTRONICS SERVICE DEALERS

Are you standing idly by while ideas that can be money in your pocket fly away?

Membership in NESDA is one of those ideas.



### WHAT DO YOU GET FROM NESDA?

1. Insurance
2. Special Bancard Rates
3. ServiceShop Magazine
4. Electronic Service Industry Yearbook
5. Service Industry Information
6. Legislative Programs with State and National Government
7. Advocate for Better Warranty Practices
8. Business Information



Don't let your bucks get lost in the shuffle.

Send in your check today.

On the bottom line it will mean extra \$\$\$ in your pocket.

### JOIN NESDA

And Your State Association

Send for more information: NESDA, 2708 W. Berry St. Fort Worth, TX 76109



# catalogs literature

A consumer electronics service technician *Replacement Parts Handbook* has been published by the parts subcommittee of the **Electronic Industries Association's** consumer electronics group service committee. The 69-page booklet offers inventory control and ordering system, including necessary forms and order sheets. It also provides a list of locations where parts are available for the consumer electronics of EIA/CEG member companies.

Circle (15) on Reply Card

**Multicore Solders** has published a 4-page brochure providing complete information on soldering aluminum. The brochure contains background information, complete application, technical data, joint design recommendations and soldering techniques.

Circle (16) on Reply Card

**ITT Cannon Electric** has revised its *Mas/Ter-IDC catalog*. The 18-page IDC-2 catalog includes photographs and illustrations of insulation displacement connectors. Features of the catalog include charts on contact arrangement, standard characteristic data and ordering instructions.

Circle (17) on Reply Card

A 60-page, 4-color *Catalog 5000* lists the complete **Simpson Electric** line of stock analog and digital panel meters, meter relays, controllers and test instruments. New products in the catalog include Simpson's 260 Series 7 VOM, the 420 function generator and the 454 scope.

Circle (18) on Reply Card

**Dranetz Engineering Laboratories** has announced the publication of a 12-page product catalog (Catalog J) that describes its line of instrumentation for measurement, analysis, and/or recording of power-system parameters of impedance, admittance, transfer function, voltage, current and phase. The catalog includes a description of the company's Power Line Disturbance Analyzers, and Sequence of Events Re-

orders. A listing of free technical literature, engineering notes and applications literature is appended.

Circle (19) on Reply Card

A 4-page data sheet explaining the capabilities of the 3539 static RAM is available from **GTE Microcircuits**. The new data sheet lists all specifications and operating parameters for the 2048-bit memory devices including ac and dc operating characteristics. Also provided are charts diagramming read and write cycles and packaging and ordering information.

Circle (20) on Reply Card

**Brownell Electro**, distributors of Dow Corning's silicone sealants, adhesives, impregnants, greases and lubricants, has published two product guides. The publications feature a flow-chart format and are written in basic terms to make its facts available to both the requisitioner and purchasing agent.

Circle (21) on Reply Card

**NATESA**  
5908 S.  
Troy  
Chicago  
IL 60629



## ARE YOU A PRO?

...the not for profit association championing independents' right to compete, and delivering valuable benefits continuously since 1950.

- LEADING SPOKESMAN
- TRADE INFORMATION DISPENSER
- WATCHDOG
- LOBBYIST
- YARDSTICK OF STANDARDS
- CONSUMER RELATIONS
- COUNSELOR
- PROBLEM SOLVER

We are not freeloaders. So our check for \$60.00 dues is attached. As our special premium, please ship the indicated \$15.00 Manual.

- Practical Business Manual  
- OR -  
 Service Contract Manual



The Fall 1980 **Standard Handling Devices** catalog features equipment for in-plant and warehouse transporting, lifting, dumping, hoisting, pulling, conveying, storing and drum handling. New products such as ladders, scaffolding, waste receptacles, casters, conveyors, cabinets, containers, office furniture and shop equipment are featured. Complete prices and specifications are included along with technical and engineering information.

Circle (22) on Reply Card



# reader's exchange

There is no charge for a listing in *Readers Exchange* for items "Needed," but we reserve the right to select and edit all copy. Due to the limited amount of space for this department, "Needed" listings must contain no more than three items. If you can help with a request write directly to the reader, not to *Electronic Servicing*. "For Sale" listings will be charged for and included in the regular classified section of *Electronic Servicing*. Please consult that section for price and ordering instructions.

**Needed:** Flyback (Horiz. output) transformer for Bradford color television model no. 1143B31, Bradford part no. 334P03402. J.L. Mason, 8708 Jade Coast Dr., San Diego, CA 92126.

**Needed:** Meter for a Mercury tube and transistor tester model 2000, or information as to where one may be obtained or repaired. Joseph E. Pokorny, 919 South 36th, Lincoln, NE 68510.

**Needed:** Good, used 19DQP4 and 19VARP4 b&w picture tubes. M.B. Danish, Mike's Repair Service, P.O. Box 217, Aberdeen P.G., MD 21005.

**Needed:** Schematic for a Beudic AM radio model 7BV made for a 1967 Volkswagen. It is listed in Sams AR 46. Will buy, or copy and return. Johnnie Jones, RR2, Shelbyville, MO 63469.

**Needed:** Code-a-phone coupler model X00-148 or 129 or 130. Also, a pocket coder for model 440 code 3, or other used Code-a-phone parts. State price. James Goodman, 874 Truman Ct., Newark, OH 43055.

**Needed:** Tape head for Bell & Howell model no. 2295 reel-to-reel. Part no. 032335 4-track stereo combination rec/play/erase. Please state condition and price. Gary Castellini, 3567 Lincoln Ave., Vineland, NJ 08360.

**Needed:** Sams Photofacts TR-28, TR-117 and service alignment manual for ICP model 8TP-726 AM-FM-stereo unit. C.T. Huth, 146 Schonhardt St., Tiffin, OH 44883.

**Needed:** Schematic for an antique Atwater Kent model 20. Eli Girouard, P.O. Box 47, Hillsboro, OH 45133.

**Needed:** Schematic and/or service manual for Monarch solid state stereo tuner amplifier model SAT-460X. R.N. McEntire, 325 Tram Rd., Columbia, SC 29210.

**Needed:** Schematic for Triplet model 630 VOM, 20,000 ohms per volt. Will pay for schematic, or copy and return. Jack Burgess, Box 124, West Blocton, AL 35184.

## Would you pay \$20 a month for a highly skilled technician?

Here's your opportunity!



An Industry 1st!

Our exclusive COMPUTECH manual is an organized, easily accessible source of solutions to those frustrating "tough-dog" service problems. Most importantly, this manual is expanded and updated each month to keep you in step with the rapidly changing television industry.

COMPUTECH can save hours of frustrating and unprofitable diagnostic time!

- approximately 6500 symptoms and solutions to "tough-dog" problems.
- indexed numerically by SAMS number.
- symptoms listed alphabetically for faster access.
- monthly updating provided.
- contains step-by-step procedures to locate the most difficult problems.
- standardizes your trouble shooting techniques.
- excellent training aid.
- saves YOU time and guesswork.

Over the past two years "COMPUTECH" has combined hundreds of hours of experience by professional technicians with the unique advantage of a computer to produce an attractive, easy to read, 8½"x11" binder that contains the type of information needed to make TV servicing faster, easier, and more profitable.

**COMPUTECH — AT TODAY'S PRICES...  
YOU CAN'T AFFORD NOT TO!**

COPYRIGHT © 1980

Call us direct (801) 277-2655  
or mail this coupon today.

<b>COMPUTECH</b> 4685 Holladay Blvd. Salt Lake City, Utah 84117 Phone (801) 277-2655	ES
Due to the importance of its monthly updating, COMPUTECH can only be obtained on a subscription basis at \$240 a year.	
Enclosed is _____ check, _____ money order, or _____ C.O.D. requested.	
Name _____	
Service Company _____	
Address _____	
City _____ State _____ Zip _____	



4685 Holladay Blvd.  
Salt Lake City,  
Utah 84117  
Phone (801) 277-2655

Circle (14) on Reply Card



Advertising rates in the Classified Section are 35 cents per word, each insertion, and must be accompanied by cash to insure publication.

Each initial or abbreviation counts a full word.

Minimum classified charge \$3.00.

For ads on which replies are sent to us for forwarding (blind ads), there is an additional charge of \$3.00 per insertion to cover department number, processing of replies, and mailing costs.

Classified columns are not open to advertising of any products regularly produced by manufacturers unless used and no longer owned by the manufacturer or distributor.

## For Sale

**AUTOMOBILE RADIO** and tape replacement parts: Delco, Chrysler, Philco-Ford, Motorola, Panasonic and many others. Large inventory. Laran Electronics, Inc., 3788 Boston Road, Bronx, NY 10469, (212) 681-9800, out of New York State, (800) 223-8314. 5-79-tf

**TV & RADIO TUBES**, 36 cents EA! Free color catalog. Cornell, 4221 University, San Diego, California 92104. 8-78-tf

**PICTURE TUBE REBUILDING EQUIPMENT** capable of producing four high quality tubes per day (WILL TRAIN TO OPERATE) \$3600. Call or write Atoll Television, 6425 Irving Park, Chicago, Illinois 60634, ph. 312-545-6667. 9-80-3t

**ELECTRONIC SURPLUS: CLOSEOUTS, LIQUIDATIONS!** Parts, equipment stereo, industrial, educational. Amazing values! Fascinating items unavailable in stores or catalogs anywhere. Unusual FREE catalog. ETCO-011, Box 762, Plattsburgh, N.Y. 12901. 6-78-tf

**TV RENTAL SYSTEMS!** Complete & guaranteed. Manual or computerized. Send \$2.00 for complete details. Parry's rental systems, 133 Brenda Street, Milton, Florida 32570. 2-80-tfn

**PRINTED CIRCUIT** boards from your sketch or artwork. Affordable prices. Also fun kit projects. Free details DANOCINTHS INC. Dept. ES, Box 261, Westland, MI 48185. 5-80-8t

**CAPACITOR KITS, FACTORY DIRECT!** Subminiature Aluminum Electrolytics and Solid Tantalum. Send \$3 for catalog, prices and 3 samples. Beat distributor costs, keep stock up, costs low! ACT NOW! Cash or check; no C.O.D.'s. J. G. STEELE CO., Inc., Box 422, McKenzie, TN 38201, Ph. (901) 352-5109. 9-80-3t

**TELEPHONE CALLS** recorded automatically, unattended, build yourself for less than \$10.00. Detailed plan \$2.50. Garrett Electronic, 6451-A Imperial Ave., San Diego, California 92114 8-80-6t

**19" COLOR TV's**, used commercial models, RCA XL-100 and others. 10 lot minimum. Kamcor, 88 So. Washington Ave., Bergenfield, N.J. 07621. 10-80-3t

**SCRAMBLED TELEVISION**, encoding/decoding. New book. Theory/circuits, \$9.95 plus \$1 shipping. Workshop, Box 393ES, Dept. E, Bethpage, N.Y. 11714. 7-80-tf

**MICROWAVE OVENS** Save to \$290, Amana, Litton, Norelco, Quasar, Sharp, Toshiba, Decas, 9245 Huebner, San Antonio 78240. 11-80-1t

**1248 B&K COLOR GEN.** 466 CRT tester, 60.7 tube tester DUM 38 Sencore \$175. Richard Price, 73090 McKay, Romeo, MI 48065. 11-80-1t

**ESTABLISHED TV REPAIR SHOP** for sale, good reputation. Plenty of business. P.O. Box 16268, Jacksonville, FL 32216. 11-80-5t

**ZENITH TV PARTS** and modules. 146 pieces, call or write for list. Ken Post, Rte. 2, Zumbrota, Minn. 55992, (507) 732-7216 after 6:00. 11-80-2t

**FOR SALE:** Inventory—tubes, transistors, old radio tubes, capacitors, resistors, test equipment, Sams, Tab books, CRT's, RCA MK II test jig, 100 vims. of Sams A.R. plus misc. Send SASE for list. Alfred's TV Service, P.O. Box 332, Hollister, Missouri 65672, Ph. 417-334-7598. 11-80-1t

**TEKTRONICS** 453 portable 50mc dual trace scope. Calibrated delay sweep, manual, and probes. VG condition, \$850. First Class Electronics, 23-01 30 Dr., LIC, N.Y. 11102, (212) 721-0295. 11-80-1t

**FOR SALE:** Sencore TC 162 DVM 35, 3 mos. old \$300.00. 125 tuners, \$1.00 each plus shipping. Dan's TV, P.O. Box 42, Osakis, Minnesota 56360, Phone (612) 859-2851. 11-80-1t

**EXPERIENCED TUNER TECHNICIAN** needed in the Fort Worth/Dallas area. \$5.00 per tuner to start. Minimum of 3 years experience required. (817) 834-8201. 11-80-2t

**FOR SALE:** Sencore VA48. Like new—\$600; also 29 different Sams and my RCA service manuals, \$60. Keith TV Repair, 214 53rd, Albion, Nebraska 68620. 11-80-1t

**WANTED:** Pre-1941 TV sets, pre-1930 tubes and radio equipment. David L. Smith, Rt. 2, Box 698, Rustburg, Virginia 24588, 804-821-2088. 10-80-2t

**39%**  
ADD \$2.50 FOR POSTAGE

**30 CHANNEL CABLE TV CONVERTER**

**FREE!**  
UNUSUAL 96 PAGE ELECTRONIC PARTS & IDEAS CATALOG!

ORDER No. 196AE047

**ETCO** ROUTE 9N,  
PLATTSBURGH, N.Y. 12901  
Tel.: (518) 561-8700.

Circle (33) on Reply Card

## Help wanted

**TELEVISION TECHNICIANS**—Experience necessary, top pay, medical benefits, paid vacations. Enjoy a new "Life Style" in a beautiful, friendly, smog free, full service desert community. Send your resume to 225 E. Ridgecrest Blvd., Ridgecrest, California 93555. Telephone 714-375-1361 ask for Service Manager. 3-80-tfn

## Business Opportunity

**GOING OUT OF BUSINESS:** TV tubes, transistors, modules, manuals, and test equipment, used. For list send self addressed stamped envelope, Welke T.V. RR, Woodlake, NE 69221 11-80-1t

## To get more information...

on items advertised or described in this publication, use the Reader Service Card.

As a free service for our readers, we forward your inquiry to the product's manufacturer. Reader Service Card is pre-addressed.

# advertisers' index

Cleveland Institute of Electronics .....	35
Dictaphone Corp. ....	35
ETCO .....	44
Edsyn, Inc. ....	3
Gamit. ....	41
Jensen Tools, Inc. ....	41
Keithley Instruments, Inc. ...	13
Lindgren RF Enclosures ...	27
Micro Design .....	1
Natesa .....	42
Nesda .....	42
OK Machine & Tool .....	IFC
Oelrich Publications .....	41
Phipps and Bird Inc. ....	39
RCA Distributor & Special Products .....	29
State Electronics .....	43
Tronics 2000 .....	3
Wahl Clipper Corp. ....	11
Weston Instruments .....	IBC
Zenith Radio Corp. ....	BC

## Electronic Servicing®

Advertising Sales Offices

**NATIONAL SALES MANAGER**  
Greg Garrison, P.O. Box 12901  
Overland Park, KS 66212  
Phone: (913) 888-4664

**NEW YORK, NEW YORK**  
Joe Concert, 4 West 58th St.  
New York, NY 10019  
Phone: (212) 888-1977

**LOS ANGELES, CALIFORNIA**  
Herbert A. Schiff  
3055 Wilshire Blvd., Suite 350  
Los Angeles, CA 90010  
Phone: (213) 387-0639

**LONDON, ENGLAND**  
John Ashcraft & Co., 12 Bear St.  
Leicester Square, London, WC2H 7AS  
Phone: 930-0525  
Telex: 895-2387

**AMSTERDAM, HOLLAND**  
John Ashcraft & Co., John J. Lucassen  
Akerdijk 150A, 1171 PV-Badhoevedorp  
Phone: 2968-6226

**TOKYO, JAPAN**  
International Media Representatives, Ltd.  
2-29, Toranomon 1-chome, Minato-ku  
Tokyo 105  
Phone: 502-0656



# Hear it.

## Roadrunner Audio Response Digital Multimeter™ \$155.00

The first audio response DMM. The beeping signal gives you fast, error-free measurements of active components and continuity **without looking at the meter.**

Boost your productivity 100% by saving time when you test:

- Continuity • Diodes • Fuses • LEDs • Transistors

Five different audio response levels for all your applications.

# See it.

The Roadrunner is a superb field service tool. Functions that are unavailable on other DMMs are standards on this easy-to-read, compact instrument. It's rugged—built for years of tough, demanding work.

- 6 functions deliver 29 ranges.
- Big 1/2 inch LCD display
- Color coded, easy-to-read front panel and pushbuttons
- Full accessory line
- FREE CASE when you order before January 31, 1981

### Specifications

#### DC Voltage:

.1 mV to 1000V

#### DC Current:

.001 mA to 2A

#### Resistance:

.1Ω to 20mΩ

#### AC Voltage:

.1 mV to 750V

#### AC Current:

.001 mA to 2A



# Try it.

Order today and get a Free Case.

When you order a Roadrunner ADMM before January 31, 1981 your dealer will give you a handsome, rugged FREE CASE in leather grained vinyl—a \$16.50 value at absolutely no cost to you. You'll get a meter that can go the distance, and a case to get it there!

For the Roadrunner dealer near you call collect **(312) 352-3500.**



# WESTON

The Measurement People since 1888.

614 Frelinghuysen Ave., Newark, NJ 07114

Circle (2) on Reply Card

SANGAMO WESTON  
Schlumberger



