

April, 1980 □ \$2.25

Electronic Servicing

Servicing power and horizontal

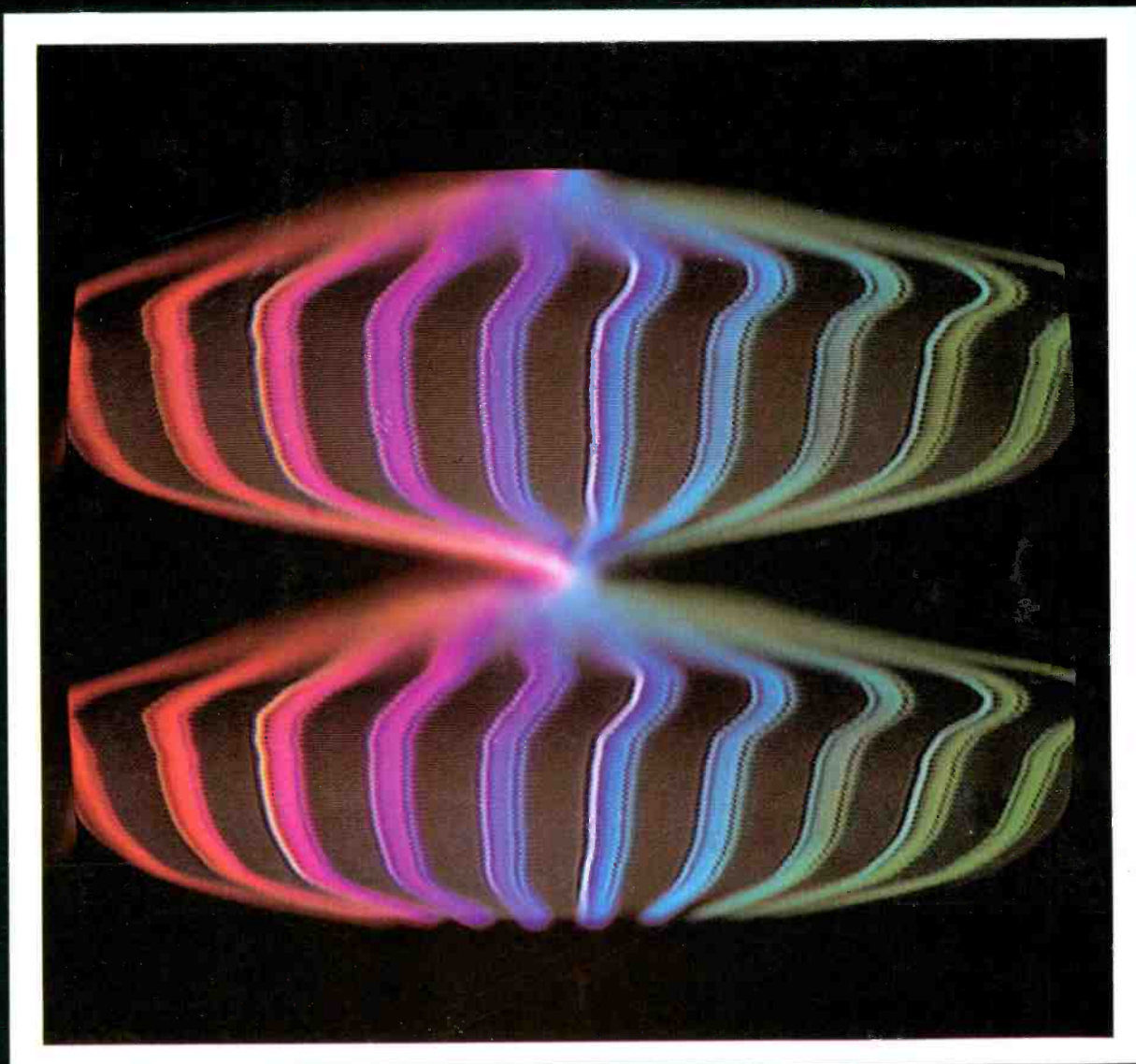

Solving vertical
problems in old TVs



Industrial: Protecting
computers from surges



An Exciting New Parts Concept For In-Home TV Service.

RCA has a better and more flexible system to help TV service people tailor their parts inventory to the types of chassis being serviced. The heart of the new system is a carrying case that we think is ideal. We call it the RCA Sidekick.

Whether you're servicing in-warranty or out-of-warranty chassis, you'll find that the RCA Sidekick is your best friend when it comes to stocking and carrying the right RCA parts.

Now it's no longer necessary to carry a separate kit for each new chassis. When a new RCA chassis comes out, you buy only those parts you don't already have. A handy RCA chart helps you cross reference parts by chassis usage.

The RCA Sidekick holds 164 standard RCA part boxes — enough room for all the parts you'll need with plenty of

room to spare. The large drawer has room for tools, handbook, drop cloth, etc. Everything you need is at your fingertips.

The Sidekick can take a lot of abuse. It's made of strong, lightweight ABS plastic. The drawers can't fall out because of a no-spill lock-in feature.

No one else has anything like it. We're excited and we think you'll be too. For full information see your RCA Distributor or write to: RCA Distributor and Special Products Division, Deptford, New Jersey 08096.

RCA Distributor and
Special Products Division

Electronic Servicing

Editorial, advertising and circulation correspondence should be addressed to P.O. Box 12901, Overland Park, KS 66212 (a suburb of Kansas City, MO); (913) 888-4664.

EDITORIAL

Bill Rhodes, *Editorial Director*
Carl Babcoke, *Editor*
Mary Thornbrugh, *Associate Editor*

ART

Dudley Rose, *Art Director*
Linda S. Franzblau, *Graphic Designer*

CIRCULATION

John C. Arnst, *Director*
Evelyn Rogers, *Manager*

ADMINISTRATION

George H. Seferovich, *President*
George Laughead, *Publisher*

ADVERTISING

Greg Garrison, *National Sales Manager*
Pam Morris, *Production*

Regional advertising sales offices listed near Advertiser's Index.



Member,
American Business Press



Member,
Audit Bureau
of Circulation

ELECTRONIC SERVICING (USPS 462-050) (with which is combined PF Reporter) is published monthly by Intertec Publishing Corp., 9221 Quivira Road, Overland Park, KS 66212. Controlled Circulation Postage paid at Shawnee Mission, KS 66201. Send Form 3579 to P.O. Box 12901, Overland Park, KS 66212.

ELECTRONIC SERVICING is edited for technicians who repair home-entertainment electronic equipment (such as TV, radio, tape, stereo and record players) and for industrial technicians who repair defective production-line merchandise, test equipment, or industrial controls in factories.

Subscription prices to qualified subscribers: 1 year—\$12, 2 years—\$19, 3 years—\$24, in the USA and its possessions. All other foreign countries: 1 year—\$15, 2 years—\$25. Subscription prices to all others: 1 year—\$25, 2 years—\$50, in the USA and its possessions. All other foreign countries: 1 year—\$34, 2 years—\$68. Single copy price \$2.25; back copies \$3.00. Adjustment necessitated by subscription termination to single copy rate. Allow 6 to 8 weeks delivery for change of address. Allow 6 to 8 weeks for new subscriptions.



INTERTEC PUBLISHING CORP.

The one tool that pays for itself first time out.

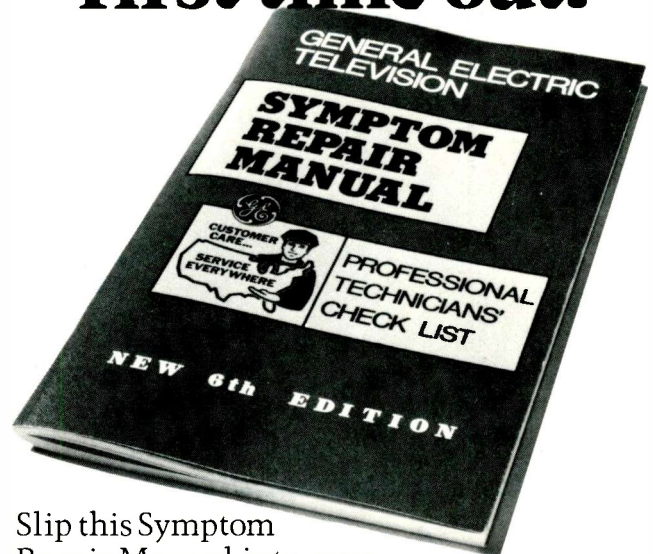

Slip this Symptom Repair Manual into your tool caddy. It lists all sorts of symptoms for individual GE TV chassis and tells you what to check and in what order. You can save hours of frustrating (and unprofitable) diagnostic time.

The new Sixth Edition manual packs the combined experience of hundreds of service technicians into a 5½" by 8½", 104 page package. It's free to subscribers of GE Technical Data, but non-subscribing technicians may obtain a copy by paying a \$2.00 handling fee. You can make that back in the first few minutes it saves.

"DUTCH" MEYER
GENERAL ELECTRIC COMPANY
PORTSMOUTH, VA 23704

ES

Please check items desired:

- One Symptom Repair Manual (\$2.00 Enclosed)
 Two Symptom Repair Manuals (\$3.00 Enclosed)

Enclosed is Check Cash or
 Money Order (No C.O.D. Please)

Name _____

Service Company _____

Address _____

City _____ State _____ Zip _____

IT'S OUR BUSINESS TO MAKE YOUR BUSINESS EASIER.

GENERAL  ELECTRIC

Circle (3) on Reply Card

April 1980 *Electronic Servicing* 1

Maintenance

8 Practical transient protection

By Richard Odenberg, senior staff engineer, Transtector Systems

Damage to LSI computer integrated circuits from line-voltage transients is described, and how future damage was prevented at UCLA.

18 Reports from the Test Lab

By Carl Babcoke, CET, editor

Sencore DVM-56 is a large bench-type digital multimeter with many unusual features, including peak-to-peak ac voltage and microprocessor control.

Servicing

14 Selecting TV antennas

By James E. Kluge, technical editor, Winegard

Many different characteristics contribute to good antenna performance. These basic facts should allow easier selections of antennas for different conditions.

22 RCA troubleshooting charts

By Gill Grieshaber, Gill's Color TV

Special troubleshooting procedures and charts simplify servicing of RCA CTC99 and CTC101 power-supply and horizontal systems.

31 Solving vertical problems in old TVs

By Homer Davidson, Davidson Radio & TV

These tips should help technicians find and repair vertical-sweep defects faster.

Departments

4 Electronic Scanner	40 Readers Exchange
5 Letters to the Editor	41 Catalogs & Literature
6 People in the News	42 Product Report
21 Troubleshooting Tips	43 Test Equipment
30 Symcure	

About the cover

The photograph illustrates power-supply servicing. Photo by Carl Babcoke. Graphic design by Linda Franzblau.

EXPAND YOUR SERVICING CAPABILITIES WITH SAMS BOOKS.

Any qualified service technician can cash in on the booming home, business and industrial electronics markets. With the right reference data and self-instructional books, you can quickly learn what it takes to service and adjust videocassette recorders, medical electronic instruments, electronic test equipment, office equipment...even the popular new personal computers. Howard W. Sams—the company that keeps you current on radio, television and CB's—can bring you up-to-date in electronics.

PHOTOFACT®

NEW VCR SERIES

Learn videocassette recoding servicing and repair with the new Photofact Specialized Series. The same reliable Photofact information you've come to rely on for TV, Home Radio, Auto Radio and CB is now available for VCR's. Full photo coverage for easy identification of all components and wiring. CircuTrace® testpoints and functions. Standard notation schematics. Parts lists showing exact replacement. All mechanical and electrical adjustments. Actual oscilloscope waveform photographs...and more.

VCR-1 covers SONY VIDEOCASSETTE RECORDERS SL-7200 and SL-2700A. \$16.95.

RCA, ZENITH, JVC, MAGNAVOX, PANASONIC—Contact Sams or your Sams Photofact Distributor for information on VCR Photofact Manuals for these manufacturers.

REFERENCE

MODERN DICTIONARY OF ELECTRONICS (5th Edition)

Contains approximately 20,000 terms, including the latest in the fields of communications, reliability, semiconductors, medical electronics, microelectronics, fiberoptics, and computers. Includes separate coverage of schematic symbols, the International System of Units (metric) and a table of the Greek Alphabet. 832 pages. No. 21314. \$18.95.

REFERENCE DATA FOR RADIO ENGINEERS (6th Edition)

A valuable guide for anyone involved with radio and electronics. Includes information on active-filter design, optoelectronics, and optical communications... plus, microminiature electronics,

space communications, navigation aids, transistor circuits, reliability and life testing, waveguides and resonators, modulation. Has hundreds of charts, nomographs, diagrams, curves, tables and illustrations. 1344 pages. No. 21218. \$30.00.

1980 SEMICONDUCTOR REPLACEMENT GUIDE

180,000 up-to-date listings. 1,120 pages. Covers bipolar transistors, field effect transistors, diodes, rectifiers and integrated circuits. U.S., European and Far Eastern type numbers and manufacturers' parts numbers cross-referenced to General Electric, Mallory, Motorola, Raytheon, RCA, Sprague, Sylvania, Thordarson, Workman and Zenith replacement parts. No. 21576. \$17.95.

SERVICE SHOP MANAGEMENT HANDBOOK

Complex electronic repair problems and government regulations have combined to frustrate service shop owners. This book tackles the business problems confronting the service shop owner and manager and provides practical, businesslike advice. 280 pages. No. 21602. \$9.95.

SERVICING

ADVANCED COLOR TELEVISION SERVICING

304 pages. No. 21517. \$14.95.

COLOR-TV SERVICING GUIDE (3rd Edition)

112 pages. No. 21437. \$6.95.

TV SERVICING GUIDE ARRANGED BY TROUBLE SYMPTOMS

126 pages. No. 20361. \$5.50.

TRANSISTOR-TV SERVICING MADE EASY

160 pages. No. 20776. \$4.95.

SOLID-STATE SERVICING

160 pages. No. 20888. \$7.50.

MOBILE RADIO SERVICING MADE EASY

144 pages. No. 21178. \$4.95.

SCANNER-MONITOR SERVICING GUIDE

96 pages. No. 21306. \$4.95.

CB RADIO SERVICING GUIDE (3rd Edition)

160 pages. No. 21074. \$4.95.

RECORD CHANGER SERVICING GUIDE (2nd Edition)

96 pages. No. 21423. \$4.95.

TAPE RECORDER SERVICING GUIDE (2nd Edition)

112 pages. No. 21594. \$5.50.

BASIC ELECTRICITY/ELECTRONICS TROUBLESHOOTING COURSE

128 pages. No. 21590. \$8.95.

SERVICING ELECTROCARDIOGRAPHS

224 pages. No. 21210. \$12.95.

ORDER FORM

HOWARD W. SAMS & CO., INC.
4300 West 62nd Street, P.O. Box 7092
Indianapolis, IN 46206
(317) 298-5400

Indicate quantity in boxes above and complete ordering information below:

Sub Total _____

Add local sales tax where applicable _____

GRAND TOTAL _____

PAYMENT ENCLOSED
 CHECK MONEY ORDER
 MASTER CHARGE VISA

Exp. Date _____

Account No. _____

Interbank No. (Master Charge only) _____

Minimum Credit Card Purchase \$10 AD008

Name (print) _____

Signature _____

Address _____

City _____ State _____ Zip _____

Prices subject to change without notice. All books available from Sams Distributors and Bookstores. Offer good in U.S. only. In Canada, contact Lenbrook Industries Ltd., Scarborough, M1H 1H5, Ontario, Canada.

Howard W. Sams & Co., Inc.

Circle (4) on Reply Card

April 1980 *Electronic Servicing* 3

EIA awards Medal of Honor

Arthur A. Collins, founder of the Collins Radio Company, recently was awarded the EIA Medal of Honor for 1980. Each year a similar award is made to an outstanding individual who has made significant contributions to his industry and his country.

TV line to use DuMont name

By next fall, the DuMont name should appear on a new TV line of 25", 19" and 13" color receivers marketed by Larsam. The DuMont name reverted to National Union after the bankruptcy of Capehart, and now has been acquired by Larsam. These new receivers are to be distributed directly to selected retailers.

Zenith to market videodisc

Zenith has been licensed to manufacture under its own name the capacitance-type videodisc players developed by RCA. Zenith brand videodisc players are expected on the market by the middle of 1981, while RCA SelectaVision players are scheduled for the first quarter of 1981. RCA previously licensed CBS to manufacture and distribute SelectaVision discs. Some unnamed industry figures speculated that these agreements indicate a rush to the RCA system. The only videodisc player for sale at this time is the Magnavox Magnavision (Philips laser-optical system). Magnavox previously was selling Magnavision players and discs in three cities, but now has expanded to five more areas (Cleveland, Phoenix, Minneapolis, Pittsburgh and Buffalo).

Color TV sales increase

Sales of color TVs to retailers in February and the first eight weeks of 1980 exceeded sales in the same period of 1979. February color TV sales increased 2.1%, monochrome TV sales were down 14.5%, and VCR sales increased 67.2%.

Capehart sold to Wakefield

The insolvent Capehart Corporation (now in Chapter 11 proceedings) has been sold to Wakefield industries, headed by Marvin Margolis, the former Capehart president.

Sony introduces automatic changer

Sony Consumer Products has introduced model AG-200 videocassette automatic changer which works with Sony Betamax models LV-1901-D, SL-7200-A, SL-8200 and SL-8600. Three cassettes allow 4.5 hours in Beta-I mode or 9 hours in the Beta-II mode for either recording or playback. Suggested retail price is \$125. Sony also has announced a \$808 Beta VCR.

1981 products exhibited

1981 introductions of the Sylvania and Philco entertainment product lines will be combined for the first time at meetings in a new exhibit, training and convention center in Batavia, NY. The emphasis this year is on shirtsleeve work sessions with less showmanship. Distributors and their salespeople will be invited in small groups for individual attention. Three large rooms of the new facility are for technical sessions, sales training, and product

display. The service training room has individual work benches with chassis, test equipment and other essentials for hands-on training. An audio-visual room has work tables and TV monitors for sales training. Videocassette machines will be used extensively for all types of training.

Zenith denies reports

Zenith previously was reported to be entering the home computer field through the newly acquired Heath subsidiary. Zenith denies these reports. However, Zenith Data Systems will market microcomputers for businesses.

GTE extends tube warranty

GTE-Sylvania now places a lifelong free replacement warranty on Sylvania Color Bright and All-New brands of picture tubes sold after January 1980. Labor and other costs are not included in the warranty which covers each tube for as long as the buyer owns the TV where it was installed.

Rotary controls to be obsolete

Rotary volume and tuning knobs may become as obsolete as buggy whips. Several models of new color TVs have pushbutton on-off, up-down volume and digital tuning. All rotary controls are hidden. One large tuner-amplifier stereo machine has pushbutton switches and only one large loudness knob on the front panel. It is relatively inexpensive to include such state-of-the-art features with microprocessor controls, so the end of moving knobs depends on the adoption of microprocessors in all home-entertainment machines. □

letters to the editor

Letters should be addressed to
The Editor, Electronic Servicing
P.O. Box 12901
Overland Park, KS 66212.
Please include company affiliation.

To the Editor:

Has Readers Exchange been eliminated from your magazine? I missed it in the February issue, but could find no mention of why it wasn't there.

Dennis Cunningham
Vicksburg, MI

Mr. Cunningham:

Readers Exchange was omitted in the February issue due to lack of available space. It will appear regularly, as space permits. In an effort to allow more space for the service, Readers Exchange will be condensed, and only "Needed" items will be listed. Please note the announcement of the coming change on page 40.

To the Editor:

I have trouble analyzing overloads in TVs that blow fuses. Can you tell me a quicker way of finding shorts? Also, where can I obtain a clover-leaf-type convergence-magnet holder for an old RCA CTC15 color TV?

Marcos Vallejos
Marcos South Side TV
Alamogordo, NM

Mr. Vallejos:

Short circuits in dc-voltages supplies can be found easiest by ohm-meter tests. However, it might be necessary to disconnect various loads before finding the one with the short. Overloads in the horizontal-output of TVs are not so easy to locate. If one fuse feeds the output stage only, a 100W ordinary light bulb can be substituted for a fuse during tests. This reduces the voltage to the output transistor according to the load, and usually protects the transistor from failure during the tests. Waveforms and ringing tests usually can find the problem then. The on-going RCA series has a solution for those TVs with circuits similar to the CTC99. Operate all

horizontal stages except the output from an external voltage source and apply only about 40V to the output transistor. There is no known single and uncomplicated answer.

To the Editor:

This is a belated "thank you" for your coverage of the award I received from ETA as "Technician of the Year." Your magazine has always been of high standards and has done much to help move our field forward. Keep up the good work.

George Savage, CET
Doniphan, NE

To the Editor:

I have tried to reach the Telematic Company at the address listed on their products, but have failed. I have a Telematic test jig, which they stated was obsolescence-proof. I need to update the adaptors for this jig. Could you tell me if Telematic is out of business or using another company name?

John Billingsley
TV Repair
Lamesa, TX

Mr. Billingsley:

Telematic is not listed in our manufacturers directory. We do not know if the company is in business.

To the Editor:

Can you tell me the code for all kinds of varistors? I have read many articles about varistors but don't know how to work with them without the code.

L. Poirier
Poirier Radio Service
Jonquiere, P. Q. Canada

Mr. Poirier:

No such general code exists, to my knowledge. Varistors change resistance (and thus current) according to the voltage across them. Therefore, a voltage/current curve is needed for good matching; no single rating can be applied. In the absence of known ratings, it is best to obtain replacements from the set manufacturer.

To the Editor:

I have been a reader for many years and believe there isn't a better magazine. My call for help is to identify tuner strips in TVs. Some have colored bands near one end and windings of different colors. Any information you can give will be appreciated.

Glenn Yost
Mannington, WV

Mr. Yost:

Perhaps the colored bands follow those of resistor code. Red might stand for two and green for five, and so on. Try that on a tuner to see if it applies. Of course, channel 2 strips always have more turns and channel 13 strips always have fewer turns than the others. So, it is not difficult to replace any strips removed for cleaning or repairs. Warning: the strip for one type of tuner might not operate correctly in another, even when they appear to be identical. Perhaps other readers can write to the editor with more information on this subject.

To the Editor:

Do you have the present address of International Components Corporation. We have about 50 of their transistors that we can't cross-reference with any we have.

W.C. Porter
Porter Radio & TV
Gore Bay, Ontario

Mr. Porter:

The latest address we have is International Components Corp., 105 Maxess Rd., Melville, NY 11746.

To the Editor:

Is it possible for me to purchase the schematic and service manual for Admiral TV model 7G7-53-2? It must have a picture layout of the printed circuit and parts.

Al Crispo
Hollywood, FL

Mr. Crispo:

The schematic should be available from Photofact. Send your request to: Howard W. Sams & Co., Inc., 4300 W. 62nd St., Indianapolis, IN 46268. □

people in the news

Robert C. Joseph has been named general manager of Phillips Test & Measuring Instruments. Formerly, Joseph was general manager for Ailtech.

Also at PTMI, **Pat Zagaria** has been appointed product manager of logic analyzers. Formerly, Zagaria was sales manager with Dumont Labs.

Audiovox has announced the appointment of **Ed Renner** to national sales manager of the HI-COMP division. Before joining Audiovox in 1976, Renner was employed with Michelin's marketing division.

Andy Segal has been appointed national sales manager for Empire Scientific. Prior to joining Empire, Segal was a principal of A. D. Segal and Co., an audio sales rep firm.

Jerry Leeper has been promoted to director of international marketing for B&K-Precision. Leeper was formerly director of market development.

Harry H. Hollington has been appointed director of operations of Systron-Donner's instrument division. Previously, Hollington worked for General Electric for 13 years.

Mervin Baranick has been named president of Multicore Solders, a division of B.I.C./Avnet. Baranick will also serve as executive vice president of B.I.C./Avnet. He has been with the B.I.C. organization for 28 years.

Leader Instruments has completed the expansion of its national sales staff with the appointment of **Michael Gomez** as eastern regional manager and **Marc Gottlieb** as western regional manager. Gomez was formerly sales engineer and branch manager with Gould. Gottlieb served as vice president of marketing for Mike Roth Sales.

Daniel J. Geaney, former western zone manager for Allis-Chalmers has been appointed western regional sales manager for Quasar.

Robert E. Carlin has been named general sales manager for Amperex.

Carlin has been with the company for more than 15 years.

The board of directors of Oak Industries has named three company officers to new positions. **Raymond W. Peirce** has been elected president. **Gary T. Barbera**, former group vice president, materials, will assume Peirce's former position, as president of Oak Technology. Barbera will be succeeded by **Charles B. Radloff**, former group vice-president, components, who will serve as group vice president, materials.

Stuart Caine has been promoted to vice president, sales, of the distributor and mass marketing division of Robins Industries. Previously, he served as Robins' national sales manager, distribution and mass marketing division.

Panasonic has announced the appointments of **William E. Berg** and **David Kurpit** to general manager positions. Berg has been named general manager for the service division, and Kurpit will serve as general manager for the consumer parts division. Previously, Berg was assistant manager of the service division, while Kurpit was assistant general manager of the finance division.

Sylvania has named **John J. Doherty** controller of the circuits products division. Formerly, he was controller of the technical systems division, a position he has held since 1977.

Vere L. Hageman has been appointed product manager at GC Electronics. Formerly, he was director of product planning for Oak Technology.

Magnavox Consumer Electronics has named **Eugene Lubchenko** engineering vice president. Formerly, he was director of engineering and development at Philips Electronics Ltd. of Canada. Lubchenko succeeds **John O. Silvey**, who will remain with the firm through 1980.

Shure Brothers has announced

the appointment of **Donald F. Metz** to manager of manufacturing at the company's Arlington Heights plant. Previously, Metz was plant manager at Rauland-Borg in Chicago.

Albert W. "Bill" Roche has been named vice president of operations for Audiovox. Before joining Audiovox in 1979, he was vice-president of operations and finance with Arkay Packaging.

Edward J. McGrath has been elected vice president of ITT. McGrath continues as director-Quality-ITT. Prior to his appointment to that post in August 1979, McGrath was president and general manager of ITT Gilfillan.

Leader Instruments has appointed **Charles I. Ogden** director, national sales. He is the former branch marketing manager for Honeywell Information Systems.

Anthony Grosboll has been named West Coast district manager for the professional video division of US JVC. He joins JVC from Digital Video Systems, where he was Western regional sales representative.

William D. Huggins has joined the corporate staff of Datatron as director of engineering. Formerly, he served in the post of engineering manager for the computer products division of National Semiconductor.

Jerry Cohen has been named manager of technical sales support for the professional products division of Sharp Electronics. Prior to joining Sharp Electronics, Cohen was video products sales engineer at Tektronix.

Francis X. Carroll has been promoted to decision vice president, finance, for the RCA commercial communications division. He succeeds **Leo Slutzky**, division vice president, projects administration.

Eric Long has been appointed director of engineering at Switchcraft. Prior to joining Switchcraft, Long held engineering management positions with Allen Bradley and Cutler Hammer. □

General Electric has just published your favorite book. Again.

We have added over 90 pages of MRO types and related information. And we have presented ICs in easier-to-use fashion than ever before. The latter are now shown in chart form and are grouped under various application headings—such as Preamps—in descending order of power dissipation.

As before, our unique parts ID numbering system tells you at a glance almost all you need to know when making a replacement.

Thus, GE5ZD3.3 stands for a 5-watt, 3.3-volt zener diode by General Electric.

Keeping up with the industry is how General Electric helps you stay in touch. With technical literature like this updated Semiconductor Guide...and with the replacement parts you need for the equipment you service.

For your copy of the book you asked us to publish again, see your authorized GE distributor today.

Tube Products Department—Owensboro, Kentucky 42301

GENERAL  ELECTRIC

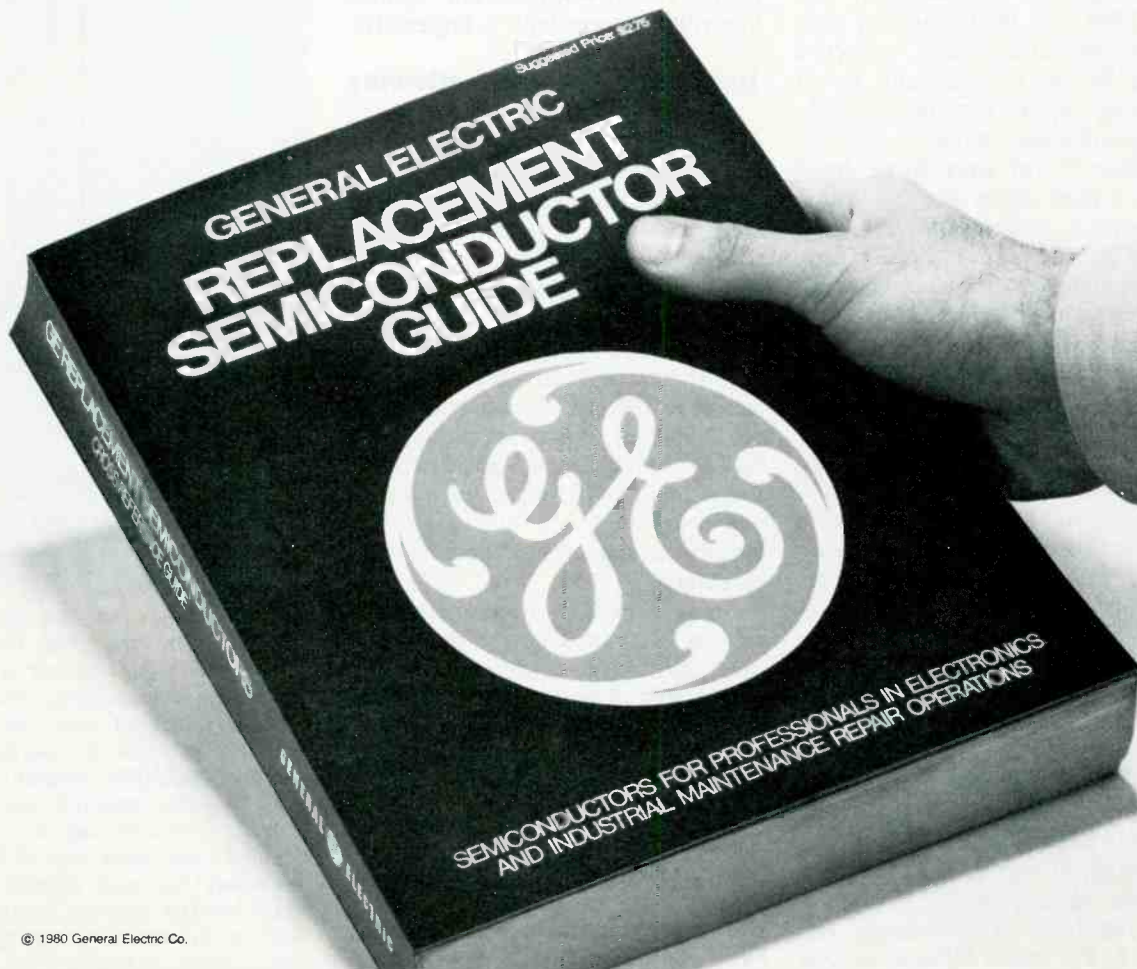

© 1980 General Electric Co.

Practical transient protection

By Richard Odenberg,
Senior Staff Engineer,
Transtector Systems

Damages from line-voltage transients cost incalculable millions of dollars annually. Many of these failures are blamed on equipment malfunctions or poor quality control during manufacturing. Seldom are transients identified as the real cause, because transient voltages are the least understood of all electrical phenomena.

It is impossible to eliminate the many origins of transients at this time. They can be formed by fuse blowing, switching loads, inductive ringing, arcing switches and power contactors, power company switching, lightning and more.

Transient voltages have been known almost since the beginning of electrical power. Motors, light bulbs, tube-operated electronic equipment and ac transformers that first were connected to power lines were not sensitive to transients, so the nature and prevention of transients were not investigated.

Solid-state components that now are essential for many products are vulnerable to overvoltage transients. Figure 1 shows the energy levels that ruin certain types of semi-conductors. Adverse effects from the transients range from momentary upsets of operation—perhaps a wrong calculation from a minicomputer or a false step in a process control—to permanent damage that must be repaired at high cost.

IC failures

Large-scale-integration (LSI) ICs are most susceptible to these upsets or damage. However, a high-power SCR can be ruined by a reverse-bias transient that exceeds the rating. So the list of failures include logic upset, data loss, display

crashes, mistriggering of controllers, and damage or destruction of circuit boards. Repairs are expensive and might require a long downtime while components or modules are ordered.

Internal destruction of ICs can occur instantaneously from a massive overload, or it can result from many less serious transients that degrade the performance before causing a final failure. The Figure 2 and Figure 3 pictures show two types of possible damage in ICs.

For modern solid-state equipment, effective protection against line-voltage transients is imperative.

Transient suppression attempts

Attempts have been made to eliminate voltage transients from the ac-power and signal lines. However, these transients have a wide variation of repetition rates, energy, amplitude, and pulse width. This constitutes a complex problem.

Some devices that have been used in attempts to provide *clean* power are these: uninterruptable power supplies (UPS), isolation transformers, motor-generator supplies, regulation transformers, gas-discharge tubes and spark gaps. Each offers some protection, but also has specific drawbacks of cost or performance.

Some degree of overvoltage protection is claimed by the makers of most electronic equipment. But it has been determined that these devices cannot provide total protection. One reason is that effective transient protection often is sacrificed to obtain a lower price. Additionally, the number and potential threat of transients are different in various areas of the country. Manufacturers, knowing they cannot protect against *all* conditions, attempt to protect for

Automated manufacturing requires computers and process controllers. The medical field uses electronic machines for monitoring and analyzing patient's conditions. Many businesses depend on mini-computers and word processors to improve communications and expedite the handling of records and inventory figures. Color TV receivers now have a variety of ICs including microprocessors. All of these solid-state-equipped machines are susceptible to damage by line-voltage transients. This article gives one approach for solving the problem.

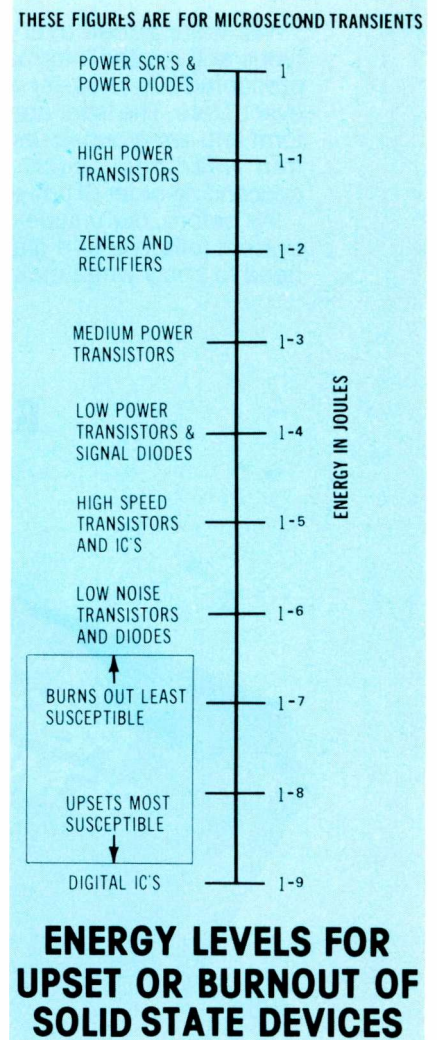

Figure 1 These are the approximate energy levels that either burn out or upset the performance of various solid-state components. One joule is the equivalent of one watt for one second. Therefore, an overload of one watt for .000000001 second (or .000001 watt for .001 second) can interfere with IC performances in digital circuits. At the other end of the chart, one watt for one second (or 1000 watts for .001 second) can ruin power SCRs or diodes. Other ratings are between these extremes. All semiconductors can be damaged by overloads.

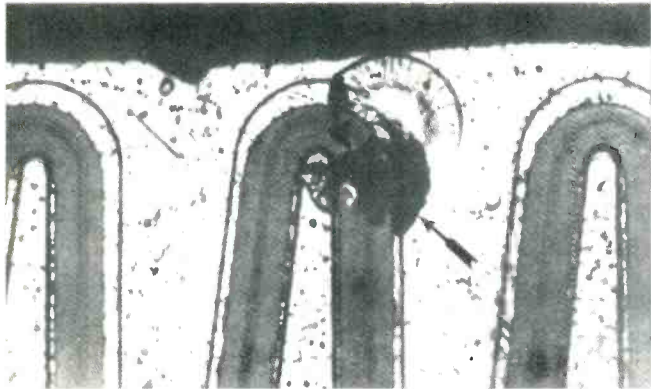

Figure 2 Near the center is the highly magnified blackened area that marks an emitter-to-base short. All photographs are by the courtesy of Trans-tector.

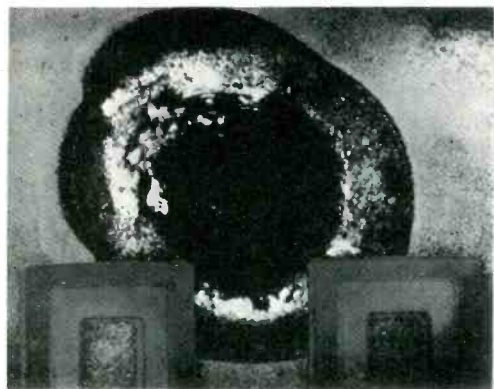

Figure 3 This crater-like puncture of an emitter was caused by an overload. The picture is magnified 620 times.

average conditions (which, in actuality, do not exist).

The devices used in these limited attempts at transient protection do not react rapidly enough for nano-second transients, nor do they have the capability of handling ultra-high energy transients without totally shutting down the equipment.

Problems at UCLA

A typical case of transient damage occurred at the University of California at Los Angeles (UCLA). It has one of the largest and most advanced schools of medicine and public health and requires the best of equipment for the advanced research that is done there.

In 1976, the Nuclear Medicine Department purchased and installed a \$500,000 positron-emission computed tomography device (ECT) that has sophisticated computer hardware (Figure 4). This unit produces images that reflect the true tissue concentration of administered radio-pharmaceuticals in a

NEW!



PRB-1 DIGITAL LOGIC PROBE

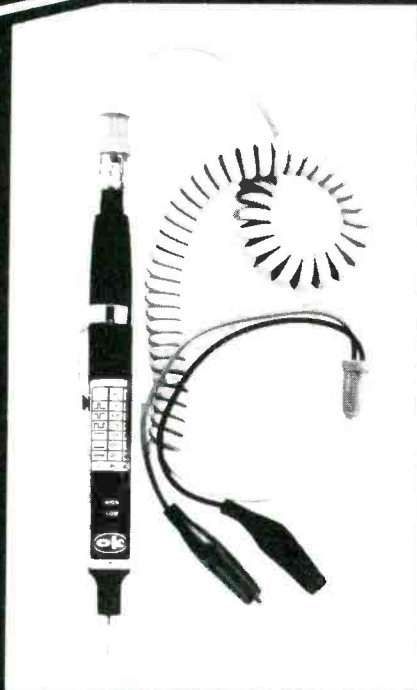

Compatible with DTL, TTL, CMOS, MOS and Microprocessors using a 4 to 15V power supply. Thresholds automatically programmed. Automatic resetting memory. No adjustment required. Visual indication of logic levels, using LED's to show high, low, bad level or open circuit logic and pulses. Highly sophisticated, shirt pocket portable (protective tip, cap and removable coil cord).

- DC to > 50 MHz
- 10 Nsec. pulse response
- 120 K Ω impedance
- Automatic pulse stretching to 50 Msec.
- Automatic resetting memory
- Open circuit detection
- Automatic threshold resetting
- Compatible with all logic families 4-15 VDC
- Range extended to 15-25 VDC with optional PA-1 adapter
- Supply O.V.P. to ± 70 VDC
- No switches/no calibration

\$36⁹⁵*

* ADD \$2.00 FOR SHIPPING (N. Y. CITY AND STATE RESIDENTS ADD TAX)

OK MACHINE & TOOL CORPORATION

3455 Conner St., Bronx, N.Y. 10475 (212) 994-6600 / Telex 125091

Circle (6) on Reply Card

Transients

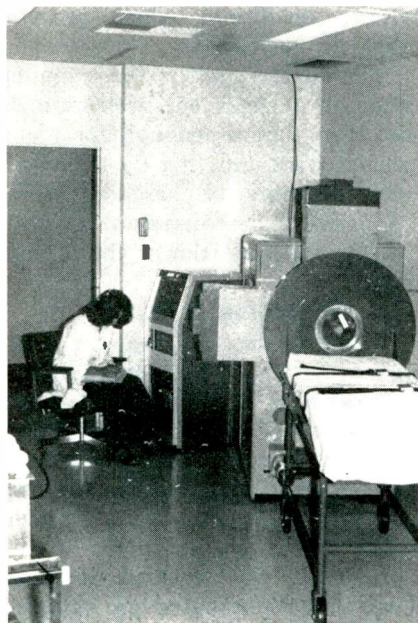

Figure 4 This is one of the UCLA positron-emission computed tomography (ECT) devices with computers that now are protected against line-voltage transients.

single selected plane of the body. The technique is used for the in-vivo measurement of physiological functions and metabolic rates.

According to Tony Ricci, senior development engineer, all worked well for about 18 months, then a continuing series of hardware failures occurred in the nuclear instrumentation modules, with memory alterations and losses in the computer system, along with display crashes and artifacts appearing in the processed images. These occurrences required repeating the affected studies after the equipment was functioning properly.

Ricci called in field service engineers to check the equipment. UCLA bought quite a few expensive plug-in modules during these attempts to solve the problems. Within a short time, repair costs exceeded \$30,000, not including the time and money lost while the equipment was out of service. During this time, the various problems continued.

Further investigation revealed that the radiology department also was having disturbances in electronic equipment.

The first clue that pointed to the power line as the source of problems was erratic behavior of a power-line clock used for timing ex-

periments performed in conjunction with the physiological monitoring equipment. The clock failed several times, would not keep accurate time, and sometimes counted too fast.

Ricci decided to have the UCLA electrician check the ac power line that supplied the clock. Although the electrician did not have precision equipment for monitoring the line, he found indications of transient voltage surges.

Transient solution

UCLA next called in Transtector Systems, a firm specializing in overvoltage protectors. Transtector immediately installed a transient counter on the suspected ac line. The counter recorded as many as 200 transient spikes per day. Some were short bursts of energy lasting a few nanoseconds, and others were high-energy surges lasting for milliseconds.

Short-term spikes can't be eliminated effectively by slower-acting devices (such as voltage regulators, gas-discharge tubes or spark gaps). A metal-oxide varistor might allow the transient amplitude to reach 2500V before clamping could begin. Other types of suppressors cannot handle the longer-term surges carrying thousands of energy watts. (Transtector has some units that can suppress up to 1,500,000 watts of transient power.)

In June, 1978, one Transtector Branch-Service Protector was installed for the main line serving UCLA's nuclear medicine scanning department. Also, a smaller unit was installed for each of the two scanners and their computers.

UCLA report

No problems of component failure, display crashes or memory alteration and loss were experienced after the Transtector suppressors were installed. Even the power-line clock began functioning correctly. The suppressors have been on the ac lines for more than a year without recurrences of the previous problems.

Total cost of the suppressor units was \$2316, which is small compared to \$500,000 for the ECT equipment, \$30,000 for repairs and money lost during downtimes.

Conclusion

This case history, and many similar ones, make clear that systems having ICs and other solid-state components *definitely* need protection from the various kinds of damage that can (and do) occur from power-line voltage transients.

First, the dangers of line transients must be recognized. Second, the remedy must prevent all harmful transients from reaching the protected equipment. This is far better than unnecessary repairs.

Technicians in industrial electronic servicing should consider what systems or individual items of equipment should be protected, and then arrange for installation of the protection devices that are appropriate for the equipment and the local conditions.

Technicians who do contract servicing—especially on any digital equipment—are advised to obtain necessary information for bids and installation. And all other technicians should remember these facts about transient voltages and be prepared to take appropriate action when they see the symptoms. □

About the product

Transtector manufactures a variety of acV surge suppressors. They are high-speed, high-current solid-state devices that perform by drawing current only from transient voltages above 120% of the nominal line voltage. The spikes are clipped by this conduction that occurs only during the transient; at other times the suppressor draws only about one watt per phase. Suppression begins about five nanoseconds after the transient appears. Redundant circuitry operates in stages according to the type of transient. Suppression occurs on both polarities, and for transients generated inside the protected area as well as those riding in on the power line. Models are available for single phase, three-phase delta or Y, and split phase. No adjustments or maintenance are necessary.

Circle (41) on Reply Card

VCR SERVICING PROBLEMS?

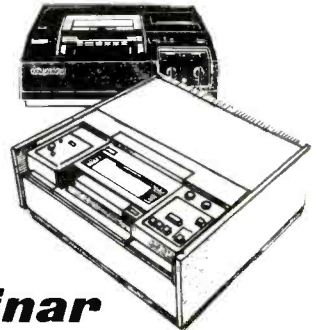
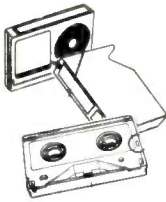

Get Answers From Expert Troubleshooting Writer
FOREST BELT during a 3-day

Home Video Recorder Seminar

Grab this opportunity
to gain VITAL
VCR servicing know-how

1980 Locations

Los Angeles

June 30-July 2

Chicago

July 17-19

Philadelphia

August 18-20

Day 1-General electronics of Beta & VHS formats. Emphasis on practical troubleshooting.

Day 2-Mechanics and digital electronics of threading and unthreading cassette-type VCR's, how to clear jammed cassettes. Live VCR's and test instruments assure you of experience you can apply realistically to troubleshooting.

Day 3-Intimate details of the electronics and mechanics involved in driving and synchronizing the helical-scan head cylinder and capstan, especially VHS and Beta servos.

Get Hands-On Solutions to puzzling VCR troubles

- ✓ QUICKLY
- ✓ EFFICIENTLY
- ✓ EFFECTIVELY

Package Fees Include:

- * Timely training
- * Best teachers
- * Carry-home manual
- * Hands-on experience
- * Certificate of training
- * All workshop materials and functions
- * Hotel room (double-occupancy)
- * Meals

Seminar-Only Fee

Includes:

- * Timely training
- * Best teachers
- * Carry-home manual
- * Hands-on experience
- * Certificate of training

**BE THERE,
ENROLL NOW!**

ENROLL ME in the 3-Day VCR Seminar at: Los Angeles Chicago Philadelphia

3-Day Package \$950 3-Day Seminar Only \$735

Total Enclosed \$ _____ Check # _____ MO \$200 Deposit, Balance Due 30 Days Before Seminar

Charge my Master Charge # _____ Expires _____ Signature _____

(A minimum \$50 Processing Fee will be charged on all cancelled enrollments.)

NAME _____ AGE _____ PHONE (_____) _____

ADDRESS _____ COMPANY _____ TITLE _____

CITY _____ STATE _____ ZIP _____

Class Size Limited

We Honor
Master Charge



Liaison Electronics Seminars (317) 253-7774

P. O. Box 40821 Indianapolis IN 46240

Selecting TV antennas

By James E. Kluge,
Technical Editor,
Winegard Company

Crucial to the best performance of any MATV system is the choice of antenna. Other parts of the system (preamps or amps, downlead, and splitters) either preserve the signal-to-noise ratio and the picture quality obtained from the antenna or they degrade it. Nothing but the antenna can *improve* the reception.

Selection of the best antenna for local conditions is more than half of the solution. Proper location, installation and orientation of the antenna are almost as important.

TV antennas are available in a variety of sizes, shapes and colors. Therefore, selecting the one that provides the best possible performance level always involves trade-offs between size, cost, performance on various channels, and durability. The following discussion should make the selection easier.

Bigger is better

Size of the antenna probably is the single most important factor. When all other parameters are equal, a bigger antenna will outperform smaller ones. Specifically, larger antennas having more elements can capture stronger signals, are more directional, and have a superior front-to-back ratio.

Of course, larger antennas also cost more than similar smaller models. Price must be balanced against other compromises.

Signal level

Primarily, an antenna should intercept all possible electromagnetic energy of the desired frequency and convert it to a voltage that is

sufficient to mask (or make insignificant by comparison) all noise in the system that follows, including each TV receiver.

Antenna selectivity determines the relative signal level of the various desired and undesired frequencies intercepted by the antenna. Some factors that shape this frequency response are the number and spacing of the various elements (rods) plus the sizes of these elements and their lengths. One example is the design of UHF antennas having certain elements that can be broken off at pre-scored lengths. Shortening these elements increases the response or gain to the higher UHF channels. Of course, the change decreases gain at lower UHF channels.

Signal-to-noise ratio

In the absence of any received signal, the noise (snow) observed on the picture tube is the sum of atmospheric noise, radiated noise from the vicinity, preamp or line amp noise, and TV tuner noise.

The antenna must develop a signal that is stronger than the total noise, to produce a satisfactory snow-free picture.

After conducting subjective viewing tests, the FCC TASO committee has determined that a 45dB signal-to-noise ratio provides good pictures without noticeable snow. The theoretical noise floor for a 75 Ω system is about $1.1\mu\text{V}$ (-59dBmV). Therefore, for a 45dB S/N ratio, the antenna must generate a signal voltage level of -14dBmV ($200\mu\text{V}$) or more.

Most locations have atmospheric static and man-made noise that are picked up by the antenna. In addition, the amplifier chain and the TV tuner add their own noise. More than $200\mu\text{V}$, therefore, is required to maintain a snow-free picture. The industry has agreed to a minimum level of $1000\mu\text{V}$ (0dBmV) for MATV systems. And most TV receivers are designed for best performance with a minimum of $1000\mu\text{V}$ at the antenna terminals.



Before making polar-plot and gain measurements at the Winegard Research Laboratory in Evergreen, CO, an engineer-technician team installed an antenna on a rotating mast that is the top of a tilting tower. The tower was pulled upright before the tests.

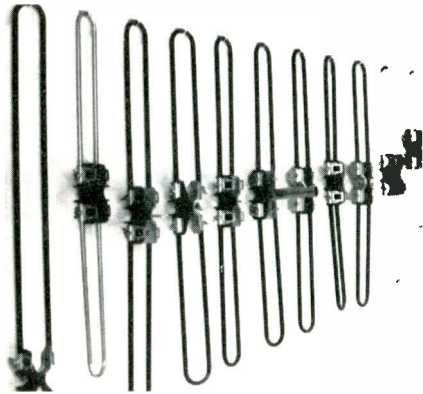

These are a few of the cut-to-channel reference dipole antennas used for gain measurements in the Winegard Laboratory.



Inside the Laboratory, a technician made gain measurements using a signal-level meter. At the right is the machine for making antenna polar plots. The paper is rotated under a pen in synchronism with rotation of the antenna.

thus preserve the antenna S/N ratio.

These higher-gain antennas provide other benefits, in addition to strengthening the signal without adding noise.

Directivity

Antennas have more gain when they are larger and have more elements. An added bonus is that the additional elements also provide a narrower beamwidth angle which (with proper orientation) discriminates against ghosts and undesired signals while supplying higher signal levels for the desired signals.

Front-to-back ratio

Higher front-to-back and front-to-side ratios are an advantage of larger antennas. The response to undesired signals and noise arriving from side or rear should be 20dB to 40dB lower than the desired on-axis signals, and such performance is easier to obtain over a broad range of frequencies when more elements are included.

Higher-gain antennas needed

If an antenna now in use cannot supply OdBmV plus the downlead loss for all available channels, then something must be changed. One possibility is to add a preamplifier or line amplifier, but they add noise of their own.

A preamplifier mounted on the antenna will provide a stronger signal with a minimum of added noise, especially if it is a low-noise type. However, no preamplifier can improve the S/N ratio. Its primary function is to provide enough gain to cancel the downlead loss, and

These Klein tools do a variety of jobs...some cut and strip wire... some crimp both insulated and non-insulated terminals and connectors...and some cut bolts. There's a pair just right for you and the work you do. At your Klein distributor.

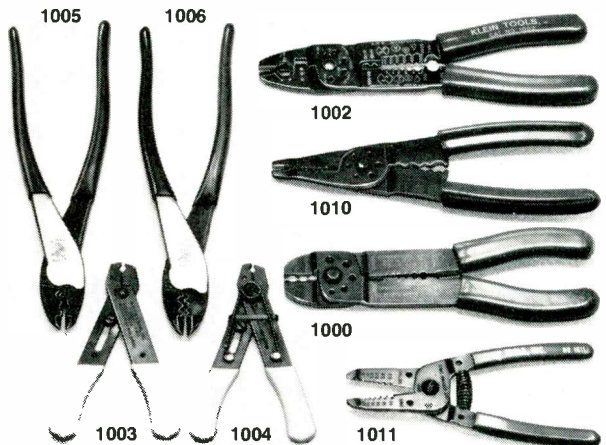

KLEIN
An independent,
family-owned company
...since 1857.



Send
for
Catalog

Klein Tools, Inc. 7200 McCormick, Chicago, Ill. 60645

Circle (7) on Reply Card

ORIGINAL JAPANESE SEMICONDUCTORS & IC

CALL TOLL FREE
NATIONWIDE 800-421-2841
OHIO 800-421-2877

TYPE	25UP 10-24	1-9	TYPE	25UP 10-24	1-9	TYPE	25UP 10-24	1-9	TYPE	25UP 10-24	1-9
25A 234	45	53	25C 756	150	180	25C 1975	130	170	25A 435	450	500
25A 473	45	53	25C 775	140	180	25C 2028	150	180	TA 7045M	200	220
25A 484	180	210	25C 776	200	220	25C 2076	180	220	TA 7055P	200	220
25A 485	180	210	25C 777	300	325	25C 2081	90	110	TA 7061P	90	110
25A 489	110	125	25C 778	200	220	25C 2092	180	200	TA 7066P	180	210
25A 495	25	35	25C 781	200	220	25C 2096	320	340	TA 7069	200	220
25A 497	100	120	25C 782	200	220	25C 2098	200	220	TA 7203P	250	270
25A 509	30	35	25C 783	200	220	25C 2100	130	145	TA 7203P	250	270
25A 537A	150	170	25C 789	80	90	25C 2190	180	180	TA 7205P	180	180
25A 541	30	35	25C 790	80	90	25C 2191	180	180	TA 7205P	180	180
25A 542	30	35	25C 791	200	220	25C 2192	180	180	TA 7205P	180	180
25A 543	30	35	25C 792	200	220	25C 2193	180	180	TA 7205P	180	180
25A 543	30	40	25C 793	200	220	25C 2194	180	180	TA 7205P	180	180
25A 543	30	45	25C 794	200	220	25C 2195	180	180	TA 7205P	180	180
25A 543	30	45	25C 795	200	220	25C 2196	180	180	TA 7205P	180	180
25A 543	30	45	25C 796	200	220	25C 2197	180	180	TA 7205P	180	180
25A 543	30	45	25C 797	200	220	25C 2198	180	180	TA 7205P	180	180
25A 543	30	45	25C 798	200	220	25C 2199	180	180	TA 7205P	180	180
25A 543	30	45	25C 799	200	220	25C 2200	180	180	TA 7205P	180	180
25A 543	30	45	25C 800	200	220	25C 2201	180	180	TA 7205P	180	180
25A 543	30	45	25C 801	200	220	25C 2202	180	180	TA 7205P	180	180
25A 543	30	45	25C 802	200	220	25C 2203	180	180	TA 7205P	180	180
25A 543	30	45	25C 803	200	220	25C 2204	180	180	TA 7205P	180	180
25A 543	30	45	25C 804	200	220	25C 2205	180	180	TA 7205P	180	180
25A 543	30	45	25C 805	200	220	25C 2206	180	180	TA 7205P	180	180
25A 543	30	45	25C 806	200	220	25C 2207	180	180	TA 7205P	180	180
25A 543	30	45	25C 807	200	220	25C 2208	180	180	TA 7205P	180	180
25A 543	30	45	25C 808	200	220	25C 2209	180	180	TA 7205P	180	180
25A 543	30	45	25C 809	200	220	25C 2210	180	180	TA 7205P	180	180
25A 543	30	45	25C 810	200	220	25C 2211	180	180	TA 7205P	180	180
25A 543	30	45	25C 811	200	220	25C 2212	180	180	TA 7205P	180	180
25A 543	30	45	25C 812	200	220	25C 2213	180	180	TA 7205P	180	180
25A 543	30	45	25C 813	200	220	25C 2214	180	180	TA 7205P	180	180
25A 543	30	45	25C 814	200	220	25C 2215	180	180	TA 7205P	180	180
25A 543	30	45	25C 815	200	220	25C 2216	180	180	TA 7205P	180	180
25A 543	30	45	25C 816	200	220	25C 2217	180	180	TA 7205P	180	180
25A 543	30	45	25C 817	200	220	25C 2218	180	180	TA 7205P	180	180
25A 543	30	45	25C 818	200	220	25C 2219	180	180	TA 7205P	180	180
25A 543	30	45	25C 819	200	220	25C 2220	180	180	TA 7205P	180	180
25A 543	30	45	25C 820	200	220	25C 2221	180	180	TA 7205P	180	180
25A 543	30	45	25C 821	200	220	25C 2222	180	180	TA 7205P	180	180
25A 543	30	45	25C 822	200	220	25C 2223	180	180	TA 7205P	180	180
25A 543	30	45	25C 823	200	220	25C 2224	180	180	TA 7205P	180	180
25A 543	30	45	25C 824	200	220	25C 2225	180	180	TA 7205P	180	180
25A 543	30	45	25C 825	200	220	25C 2226	180	180	TA 7205P	180	180
25A 543	30	45	25C 826	200	220	25C 2227	180	180	TA 7205P	180	180
25A 543	30	45	25C 827	200	220	25C 2228	180	180	TA 7205P	180	180
25A 543	30	45	25C 828	200	220	25C 2229	180	180	TA 7205P	180	180
25A 543	30	45	25C 829	200	220	25C 2230	180	180	TA 7205P	180	180
25A 543	30	45	25C 830	200	220	25C 2231	180	180	TA 7205P	180	180
25A 543	30	45	25C 831	200	220	25C 2232	180	180	TA 7205P	180	180
25A 543	30	45	25C 832	200	220	25C 2233	180	180	TA 7205P	180	180
25A 543	30	45	25C 833	200	220	25C 2234	180	180	TA 7205P	180	180
25A 543	30	45	25C 834	200	220	25C 2235	180	180	TA 7205P	180	180
25A 543	30	45	25C 835	200	220	25C 2236	180	180	TA 7205P	180	180
25A 543	30	45	25C 836	200	220	25C 2237	180	180	TA 7205P	180	180
25A 543	30	45	25C 837	200	220	25C 2238	180	180	TA 7205P	180	180
25A 543	30	45	25C 838	200	220	25C 2239	180	180	TA 7205P	180	180
25A 543	30	45	25C 839	200	220	25C 2240	180	180	TA 7205P	180	180
25A 543	30	45	25C 840	200	220	25C 2241	180	180	TA 7205P	180	180
25A 543	30	45	25C 841	200	220	25C 2242	180	180	TA 7205P	180	180
25A 543	30	45	25C 842	200	220	25C 2243	180	180	TA 7205P	180	180
25A 543	30	45	25C 843	200	220	25C 2244	180	180	TA 7205P	180	180
25A 543	30	45	25C 844	200	220	25C 2245	180	180	TA 7205P	180	180
25A 543	30	45	25C 845	200	220	25C 2246	180	180	TA 7205P	180	180
25A 543	30	45	25C 846	200	220	25C 2247	180	180	TA 7205P	180	180
25A 543	30	45	25C 847	200	220	25C 2248	180	180	TA 7205P	180	180
25A 543	30	45	25C 848	200	220	25C 2249	180	180	TA 7205P	180	180
25A 543	30	45	25C 849	200	220	25C 2250	180	180	TA 7205P	180	180
25A 543	30	45	25C 850	200	220	25C 2251	180	180	TA 7205P	180	180
25A 543	30	45	25C 851	200	220	25C 2252	180	180	TA 7205P	180	180
25A 543	30	45	25C 852	200	220	25C 2253	180	180	TA 7205P	180	180
25A 543	30	45	25C 853	200	220	25C 2254	180	180	TA 7205P	180	180
25A 543	30	45	25C 854	200	220	25C 2255	180	180	TA 7205P	180	180
25A 543	30	45	25C 855	200	220	25C 2256	180	180	TA 7205P	180	180
25A 543	30	45	25C 856	200	220	25C 2257	180	180	TA 7205P	180	180
25A 543	30	45	25C 857	200	220	25C 2258	180	180	TA 7205P	180	180
25A 543	30	45	25C 858	200	220	25C 2259	180	180	TA 7205P	180	180
25A 543	30	45	25C 859	200	220	25C 2260	180	180	TA 7205P	180	180
25A 543	30	45	25C 860	200	220	25C 2261	180	180	TA 7205P	180	180
25A 543	30	45	25C 861	200	220	25C 2262	180	180	TA 7205P	180	180
25A 543	30	45	25C 862	200	220	25C 2263	180	180	TA 7205P	180	180
25A 543	30	45	25C 863	200	220	25C 2264	180	180	TA 7205P	180	180</

Antennas

Polar-pattern graphs provide the amplitude-response-versus-direction parameters. And most manufacturers can supply these graphs for all TV channels.

Occasionally, it is necessary to select a large antenna for the better directivity and front-to-back ratio. But the large antenna might cause amplifier overload on strong channels. In such cases, installing a matched-impedance loss pad just before the overloading amplifier will reduce the level sufficiently without degrading the desired directivity and front-to-back pattern.

Antenna shapes

Most antennas are manufactured in one of two basic shapes: flat and wedge. Flat antennas are built in a horizontal plane, while the wedges extend vertically also.

Wedge antenna looks like two V's or W's lying on their sides. However, both wedge and flat types are variations of the basic Yagi-Uda design.

Wedge antennas have a larger capture area for the signals, without requiring an unduly long size. Also, they have higher gain at the low end of each VHF band, while flat antennas tend to have less gain at the band low ends.

Antenna specifications

Mechanical specifications include the number of elements, the dimensions, weight, color, finish, material type and thickness.

Color of an antenna has no effect on performance. Some customers prefer antennas in colors rather than plain aluminum. Any sort of finish satisfies that request. It is important to the *durability*, however, how a color is obtained. A color-dyed finish (often used with less expensive models) has the same durability as plain metal. But if the color is obtained by anodizing of the aluminum, the finish will be hard, durable and resistant to corrosion that shortens the life-span of unprotected antennas. Anodizing is worth more than it costs when an antenna is used for several years.

Electrical specifications are not as easy to measure or determine. Most antenna manufacturers have full specs but seldom publish them

or make them available to antenna installers unless asked.

Antenna installers sometimes evaluate the practical performances of several models before finding one that is satisfactory for a certain locality. Then they probably continue to reorder this model until presented with a strong performance or price incentive. Their choice of a superior antenna would be easier if these installers first narrowed the field by using an evaluation comparison from electrical specifications.

Gain

Gain of an antenna is measured by comparing its signal (under identical conditions) with that from a standard reference dipole which is resonant to the test frequency. This must be done separately for each TV channel.

In this case, identical conditions mean that both antennas are immersed in a field of the same strength and pattern during the measurements.

If a manufacturer wants to inflate the gain rating of an antenna, he can specify the gain in reference to an isotropic radiator. Of course, an isotropic radiator is a theoretical device that cannot be duplicated in practice. An antenna rated this way would appear to have a higher gain by 2.15dB. It seems more practical to rate gain according to measured gain rather than by theoretical gain.

There is another source of confusion between gain ratings. Antenna gain is not constant between the various channels. Therefore, it can be specified in these different ways:

- According to the channel giving the highest gain.

- As an average of all channels.
- As an average mean between the highest and lowest gain.
- Or as a typically ideal gain figure that cannot be realized in practice.

Gain represents only one of several parameters which contribute to an antenna's performance. Therefore, the Winegard Company does not specify the gain, but provides a *Figure of Merit* that summarizes several performance factors. If an installer is interested in more details of performance,

engineering specifications can be obtained for specific models from the Winegard engineering department.

Bandwidth

Bandwidth is not a critical factor now, but it was often a problem in the early days of color TV. Any antenna with a sharp slope or a low-gain area within the station bandwidth could cause weak or smeared color.

Antennas are now classified as single channel, VHF or UHF. They are satisfactorily flat in response across their rated bandwidth and will produce good color quality.

The response of many antennas includes the FM radio band. That's good if the antenna is to be used with both television and FM radios.

GAIN	CH.2	CH.4	CH.6
% over reference dipole	134	114	109
db over reference dipole	7.4	6.6	6.4
beamwidth at half power points	72°	65°	71°
front-to-back ratio	20	20	20

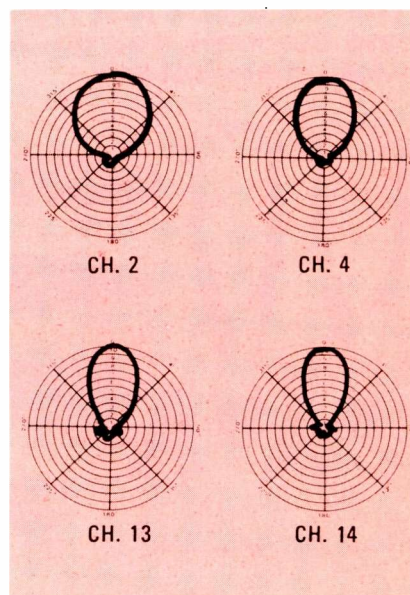

These are excerpts from a Winegard Chromstar engineering-specifications sheet. Polar plot graphs are included for all VHF and four UHF channels, plus other electrical and mechanical specifications.

Otherwise, the FM-band response can cause serious TV interference problems in metropolitan areas that have several strong FM stations. Traps might be required to minimize this interference.

Some Winegard VHF antennas are designed to attenuate FM frequencies. When FM is desired, certain antenna directors can be shortened to increase the gain in the FM band. Instructions are provided with the antennas.

Directivity

Directivity specifications indicate sharpness of the antenna's main front lobe. It expresses in degrees the angle between the half-power (-3dB) points. If multipath ghosts, co-channel or other interferences are a problem, an antenna having a very narrow beamwidth could be the answer.

Perhaps a larger antenna is needed. Or the narrower beamwidth might require horizontal stacking of two identical antennas. On the other hand, vertical stacking of identical antennas will minimize airplane flutter or ground noise.

Front-to-back ratio

Front-to-back ratio indicates the antenna response to signals arriving from the rear as compared to those arriving at the front. A 10-to-1 ratio means that the signal strength at the back of the antenna is only 10%

(-20dB) of the on-axis signal strength. This ratio is slightly different from channel to channel. If beamwidth and front-to-back ratio are primary considerations, polar-pattern charts should be compared and evaluated.

Impedance

Output impedance of the antenna varies with frequency, but seldom more than a 2-to-1 ratio. Better antennas hold the variation to 1.5-to-1. Nominal antenna impedance is designed to be 75 Ω balanced or 300 Ω balanced, depending on the type.

Twinlead transmission line can be connected directly to a 300 Ω antenna. But for 75 Ω coaxial cable, the 75 Ω balanced antenna must be transformed to 75 Ω unbalanced. Some antennas provide a cartridge board or a preamplifier inside a weatherproof housing that's attached to the boom, and it offers a choice of switching to 300 Ω balanced or 75 Ω unbalanced as needed to match the downlead.

Comments

Antenna installers who have unique reception problems are urged to consult the antenna manufacturer's technical staff, who will assist in providing better TV pictures.

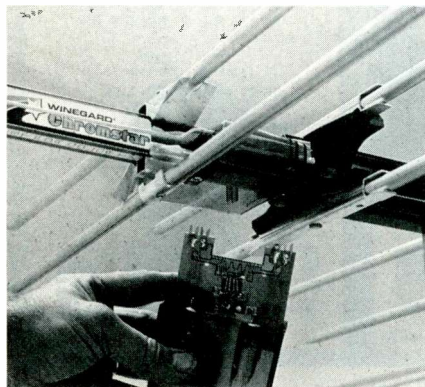

One method of offering choices of balanced or unbalanced impedances and 75 Ω or 300 Ω impedances is a cartridge board mounted in a waterproof housing that attaches to the antenna. The photographs were taken before and after the installation.

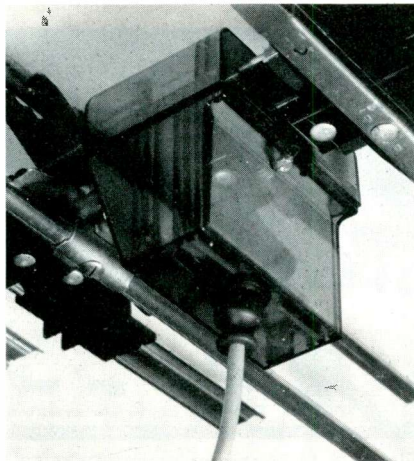

APPLIANCE REPAIR BOOKS



Thirteen Handbooks written in easy-to-understand language by experts in the service field with illustrations and diagrams! Acclaimed by instructors and professionals alike! How to diagnose and repair air conditioners, refrigerators, washers, dryers, ranges, microwave ovens, dishwashers, vacuum cleaners, electrostatic air cleaners, RV gas appliances, hair dryers, motors, water heaters, coffeemakers, can openers, floor polishers, steam irons, food mixers, lawn care appliances, electric knives, electric and digital clocks and many others. Also fundamentals of solid state, setting up a shop, using test instruments and more. Only \$2.65 to \$4.90 ea.

SEND FOR FREE PRICE LIST

Gamit, Dept. ES

110 W. St. Charles Road,
Lombard, Illinois 60148

Circle (9) on Reply Card



SOLID STATE DEVICES

AVAILABLE FOR IMMEDIATE SHIPMENT AT PROFIT SAVING PRICES!

WE FEATURE A QUALITY LINE OF SEMI-CONDUCTOR RE-PLACEMENTS FROM PROJECTOR BELT & RAYTHEON.

- ✓ Guaranteed Quality
- ✓ Same Day Shipment
- ✓ Toll Free Ordering

CALL TOLL FREE

1-800-558-9572

Ask for our Dealer Proven Catalog today!



**PROJECTOR
RECORDER
Belt Corporation**

200 Clay Street, P.O. Box 176
Whitewater, WI 53190

Circle (10) on Reply Card

Reports from the test lab

Each report about an item of electronic test equipment is based on examination and operation of the device in the **ELECTRONIC SERVICING** laboratory. Personal observations about the performance, and details of new and useful features are spotlighted along with tips about using the equipment for best results.

By Carl Babcoke

Model DVM-56 is the first microprocessor-controlled digital multimeter manufactured by Sencore, and it has several very unusual features, including the following:

- A choice of peak-to-peak, average, or true-RMS ac voltage;
- direct-reading true-RMS decibels for the 1mW audio standard;
- true-RMS decibels that are programmed for any selected level;
- dc voltage to 10kV with a special probe and range;
- high-power and low-power resistance tests to 99.99M Ω ;
- basic accuracy of 0.075% \pm 5 digits for dc voltage;
- ac and dc current measurements;
- a choice of display resolution;
- automatic zeroing, auto decimal, and auto polarity;
- display-area LEDs that indicate the prefix for all measurements (for example, mV, V or kV); and
- the *peak & null* mode with LEDs that indicate an increasing reading, a decreasing reading, or a stable reading.

In addition to helping with the analog-to-digital conversion and other chores, the microprocessor provides these functions:

- auto ranging of all functions, but with a *range-hold* button that can lock to any range;
- a button to subtract test-lead resistance during ohms tests, and a way to substitute a different standard level during dBp tests that require another standard. These are activated by the *ohms & dBp* button; and
- blanking the display until the reading has stabilized. This "think-

ing" is indicated by dashes that travel to the right across the readout.

Readout display

DVM-56 has five 0.5-inch 7-segment red LED full digits (Figure 1) that are microprocessor controlled to produce a smooth transition between ranges during autoranging.

A choice of resolution is provided by three interlocked display push-buttons (below the readout). For example, when the 4½, 4, and 3 buttons are pressed in sequence during voltage tests of a 1.5V battery, the readout might display:

1.5539
1.554
1.55

Notice that the first three digits and the decimal did not move. Instead, the undesired digits were blanked. According to the button pressed, this readout could be called 4½-digit, 3½-digit or 2½-digit.

Ranging versus decimal—The decimal is moved one position to the right each time the readout advances one digit beyond 9999. Also, autoranging occurs at one digit higher than 19999. (Most autoranging DMMs move the decimal and change the range at the same point. The decimal moves between a 1.9999V reading and the next

2.000V reading.) The DVM-56 changes the decimal above 9.999V and changes the range above 19.999V. Then the sequence repeats at 99.99V, 199.99V and so on, as shown in these photographs of actual displays.

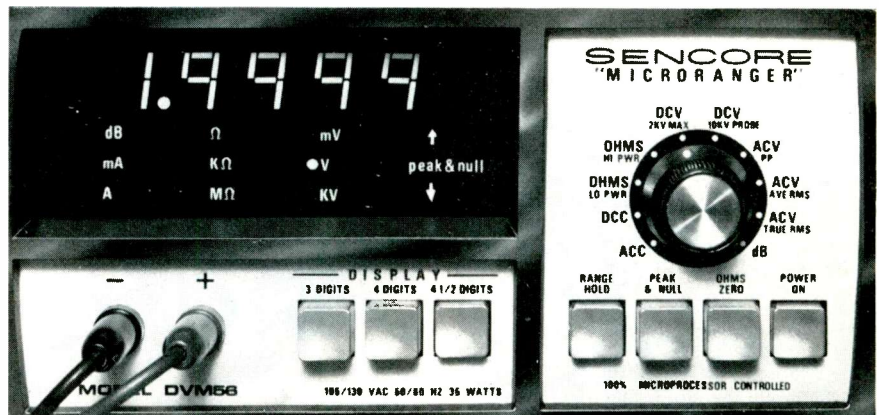
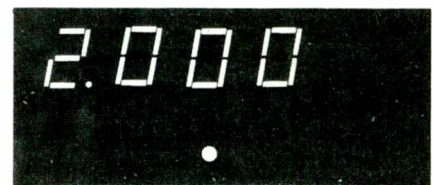
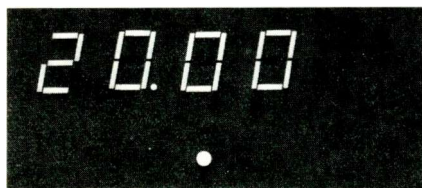

Figure 1 Microranger model DVM-56 by Sencore is microprocessor controlled, has 11 functions including peak-to-peak ac voltage, range hold for the autoranging, peak and null indications, automatic subtraction of test lead resistance and a choice of visible resolution. The 4½-digit LED readout has LEDs to indicate the function and prefix in use.



Notice that the decimal did not move between 19.955 and 20.00.

When the 4½-digit button is in operation and the 4-digit button is pressed, the fifth digit is blanked out only when the first digit is *one*. For all others, no change occurs. If the 20.00V example is on the readout and the 4-digit button is pressed, there is no change. If the 3-digit button is pressed, the fourth digit is blanked out, as in the 20.0V example.

Autoranging to a lower range occurs at every 18000 downward count, regardless of the range or decimal position. Between 19999 upward and 18000 downward readouts is hysteresis that prevents false ranging.

One of the nine LEDs near the abbreviations (below the readout) lights to indicate the range and function that's in use. These are lighted by the microprocessor as part of the autoranging.

Function selector

One rotary switch (Figure 2) selects any of the 11 functions. Underneath the switch are four more pushbuttons.

A *range-hold* button locks the autoranging in the range that is in use when the button is pressed. The operating manual gives methods for finding the desired range. Readings are obtained faster without the slight delay of autoranging.

The next button is the *peak & null*. It activates an analog circuit (for fastest speed) that lights LEDs located next to the + and - arrows of the *peak & null* part of

the display. A reading that is increasing lights the top or positive LED, and a decreasing reading lights the bottom or minus LED. Unchanging readings either alternate between the two, or both are lighted.

Another button is marked *ohms & dBp zero*. These two functions are microprocessor controlled and will be explained in the ohms and dB sections. At the right is the power on-off button.

Dc voltage

The dcV-2kV position of the selector switch provides conventional measurement of dc voltages up to 1999.9V. Input impedance is 15M Ω for all four ranges. The display with its mV, V and kV indications is direct reading in either hold or autoranging. The most-sensitive range reads from 000.1mV to 999.9mV.

Measurements up to 9999V (nominal 10kV) can be made with the TP222 probe that slips over the regular probe, *when the selector is turned to dcV-10kV position*. The decimal is moved one digit to the right, so these measurements also are direct reading, while the input impedance becomes 150M Ω . This slip-over probe is shown in Figure 3, along with a sheet of condensed operating instructions that can be slid out from below the meter.

Sencore advises that the TP222 probe should be used for *all* dcV

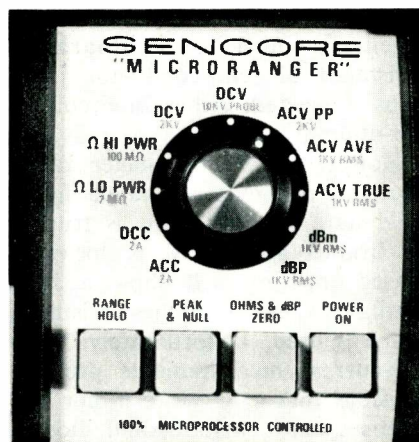

Figure 2 One rotary switch and seven pushbuttons select all functions.



Figure 3 A TP222 probe that slips over the regular test probe allows direct-reading dc voltage measurements up to 9.999kV when the DCV-10KV PROBE function is selected. A plastic card with condensed instructions for operating model DVM-56 can be slid out from beneath the DMM when needed.

measurements. It is true that the accuracy remains adequate for most uses, and the input resistance is higher with the probe. However, one voltage tested 019.2mV without the probe, or 0.038V with it. A battery tested 1.5706V without, or 1.581V with it. A 9V battery measured 10.077V without, or 10.075V with the probe.

Therefore, the Test Lab recommendation is that the TP222 probe should be used for all dcV above about 10V, and that it be removed for lower voltages.

The TP222 probe is strongly recommended for constant use around horizontal-sweep and high-voltage circuits. No damage should occur to the DMV-56 if the TP222 probe is touched accidentally to the plate of a horizontal-output tube or to the damper-tube cathode.

Focus voltage measurements were made in a new RCA color TV. The voltage range was between 6.429kV and 8.893kV, with best focusing obtained at 8.370kV. This is excellent accuracy for such high voltages. In fact, it is better than required.

Ac voltage

Three types of acV measurements are provided. All have input impedances of 1M Ω . Accuracy of the average mode (calibrated in RMS for sinewaves only) is 0.5% \pm 4 digits. For all waveforms, true-RMS accuracy is 0.5% \pm 4 digits, and peak-to-peak accuracy is rated at 1% \pm 4 digits.

Frequency response is important

Test lab

for audio-gain tests, decibels, and peak-to-peak tests. Therefore, all three acV modes were tested for response.

When tested with sine waves against another meter having flat response, the peak-to-peak measurements were flat to above 100kHz with a minor peak at 18kHz. In actual tests, the PPV calibration was very accurate for all waveforms except horizontal-sweep waveshapes narrower than horizontal-sync pulses. Narrower fast-repetition pulses produce slightly low readings, which still are helpful for comparison purposes. This limitation was included deliberately to provide better DMM protection.

Response of the average-acV function was flat, except for a moderate high-frequency increase that reaches +1dB at 20kHz and +3dB at 100kHz.

True-RMS acV function measured less than 0.5dB variation over the 20Hz to 200kHz frequency span.

All three functions were tested on the 19.999VPP or 9.999V-RMS ranges. It is possible that higher ranges might show some slight loss of high frequencies. These performances are considered very good.

Decibels

Two types of decibel measurements are provided. Both use the true-RMS converter, so the response should be the same as previously mentioned for true-RMS ac voltage. Three automatically selected ranges cover from -43dB to +62.2dB, the input impedance is 1M Ω , and the accuracy is rated at 1% \pm 1dB for the 1mW-in-600 Ω standard. The readout is in tenths of a decibel (+42.1dB, for example) for signals larger than 0.13V RMS. Amplitudes below that point have only two digits.

Programmable decibels (dBp) is another feature made possible by the microprocessor. When a specific level is to be selected as reference, a signal of that voltage is used for input. Then the operator presses the *ohms & dBp* button until the readout shows 00.0. Any signals now supplied to the probes will be

displayed as the *difference* between it and the standard. This can be helpful for many kinds of audio testing.

Ac and dc current

Current flow up to 1.9999A can be measured by the front-panel jacks. The optional CS223 shunt allows measurements up to 19.999A when it is added between the DMM and the test leads.

Accuracy for dc is 0.3% \pm 4 digits or 1% \pm 4 digits for ac. Ac current frequency response is the same as true-RMS acV response.

Resistance measurements

A choice is offered of high-power or low-power measurements of resistances. Low-power measurements can be made between 00.01 Ω and 1.9999M Ω , while high-power measurements cover the span between 000.1 Ω and 99.99M Ω . Both have 3% \pm 4 digit accuracy. All ranges are selected automatically, unless locked by the range-hold button.

Most DMMs have the same ranges for high and low power. The DVM-56 high-power ohms function tests higher resistances than does the low-power ohms mode, which can measure lower resistances. Otherwise, they are equally recommended for testing pure resistances. However, both are needed for resistance tests in circuits containing transistors, diodes and ICs.

Low-power ohms should be selected when conduction through these solid-state junctions is not desired (in-circuit, for example). High-power ohms should be the choice when continuity or comparative resistance of semi-conductor junctions is needed, either in-circuit or out-of-circuit.

However, every ohmmeter range shows a different resistance for a solid-state junction. This is true of all brands and types. A forward-biased junction will show a high reading when a higher-resistance range is used. Unfortunately, these low-current measurements produce readings that exaggerate minor differences between individual diodes; therefore, such readings are of minor value. Consistent and de-

pendable readings require junction currents of 1mA or more.

Therefore, when measuring forward-conduction resistances with a DVM-56, the *lowest* high-power ohms range should be used. Select high-power ohms, short together the test probes to obtain the lowest range, and press the *range-hold* button. Now measure the junction resistance. Silicon junctions usually read about 550 Ω (about 0.550V across the junction) and germanium junctions show between 200 Ω and 300 Ω . This test identifies silicon or germanium types and shows the approximate voltage drop for comparisons.

Overrange for any function produces a flashing 8888 display, but the automatic ranging usually eliminates overranging for all measurements except resistance tests.

One more feature is important for low-resistance tests: automatic subtraction of test-lead resistance. Select either high-power or low-power ohms, short together the ends of the test leads, and then press the *ohms & dBp* button until the reading goes to 0000.0. Before subtraction with the sample DVM-56, the minimum resistance reading was about 10 Ω . This proves the need for correction; otherwise, the accuracy for low readings would be unacceptable.

After the minimum resistance has been subtracted from all readings, the action continues until ac power to the DMM is turned off. Therefore, the subtraction routine should be performed each time before low-resistances are measured. The same precaution applies also to reprogramming the dBp function. It must be reset each time the standard is changed or the power turned off.

Comments

The Sencore DVM-56 digital multimeter performed flawlessly during these examinations. It is a large and highly accurate DMM with unusual features that make it appropriate for all lab and bench operations.

Price is \$695, and many options are available.

troubleshootingtips

No picture or sound RCA CTC72 (Photofact 1439-2)

When the TV came to the shop, it was completely dead—no sound, no picture and no raster. The fuse and circuit breaker tested continuity, but only the dial lamp came on. I started testing dc voltages, finding more than +150V at Circuitrace 1. Zero voltage was at Circuitrace 7, 123, 9, 6, 2, 3, 4 and 5. The chassis was set aside for a couple of days.

I decided to give circuit board PW400 a careful visual examination while using a bright light. While I was examining the foil side of the board, my attention was drawn to pin 5 to T402. It had become unsoldered completely.

After pin 5 was soldered neatly to the foil, the TV had normal picture

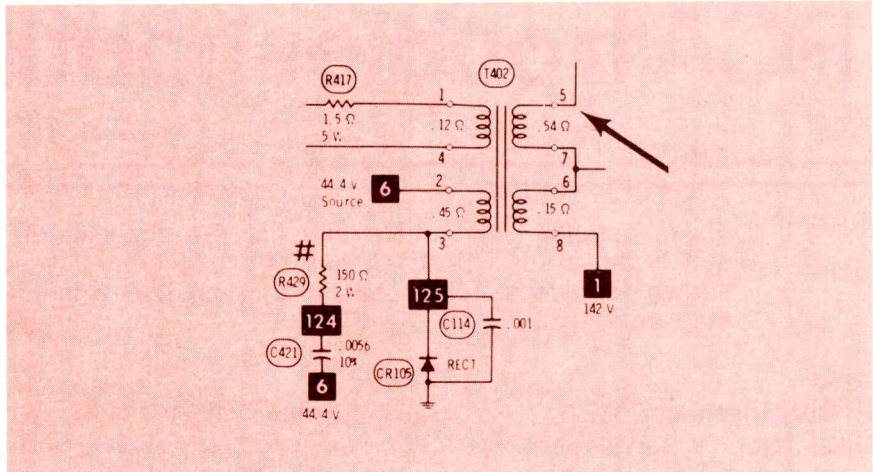

and sound. When this connection was open, the horizontal-sweep circuit was totally dead, and that in turn eliminated all dc voltages from sweep rectification. Next time I'll check for voltage at the MT2

terminal of the intrinsic SCR/rectifier. This will be a faster test for open circuits.

George M. Marechek, Jr.
Cheverly, MD



ATTENTION ALL SERVICERS OF ELECTRONIC GEAR

The MICROPROCESSOR INVASION isn't off in the future, it's here, now, in almost every type of equipment you service and maintain.

Gain first-hand familiarization from electronics servicing author, instructor, expert, FOREST BELT, and microprocessor/digital expert, BOB MANERY, through LIAISON's 3-Day

MICROPROCESSOR ORIENTATION

One Location Only—Indianapolis IN
Nov. 12, 13, 14, 1980

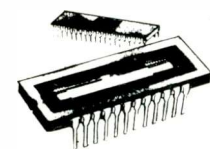

Tips for troubleshooting equipment and systems using this versatile new device



CLASS SIZE LIMITED TO 35 MAXIMUM ENROLL NOW!

Hands-on understanding of microprocessor operation

Experience in testing microprocessors practically

I want to attend the Microprocessor Orientation.

3-Day Package \$950 3-Day Seminar Only \$735 Put me on LIAISON'S mailing list

Total Enclosed \$ _____ Check # _____ MO \$200 Deposit. Balance Due 30 Days Before Seminar

Charge my Master Charge # _____ Expires _____ Signature _____

(A minimum \$50 Processing Fee will be charged on all cancelled enrollments.)

NAME _____ AGE _____ PHONE (_____) _____

ADDRESS _____ COMPANY _____ TITLE _____

CITY _____ STATE _____ ZIP _____

Liaison Electronics Seminars

(317) 253-7774

P. O. Box 40821 Indianapolis IN 46240

Package Fees Include:

- Timely training
- Best teachers
- Carry home manual
- Hands on experience
- Certificate of training
- All workshop materials and functions
- Hotel room (double occupancy)
- Meals

Seminar-Only Fees Include:

- Timely training
- Best teachers
- Carry home manual
- Hands on experience
- Certificate of training

We Honor



Vital To Services Of

- CONSUMER ELECTRONICS
- HOME APPLIANCES
- INDUSTRIAL SYSTEMS
- MEDICAL EQUIPMENT
- BROADCAST & COMMUNICATIONS GEAR

RCA troubleshooting charts

These detailed charts help simplify the analysis of horizontal and power-supply defects in RCA CTC99 and CTC101 color TV receivers. Schematics are shown for two simple adapters that positively identify correct or incorrect start-up signals.

By Gill Grieshaber, CET
Gill's Color TV Service

An important testpoint for CTC99 troubleshooting is C106, the only hot-supply filter capacitor, which is conveniently accessible at one end of the chassis (Figure 1). Some tests involving C106 were given last month, but there are more in these various charts.

Hot-supply tests

Figure 2 is a chart for preliminary tests of the hot supply when the symptoms are one of these: zero dc voltage at C106; insufficient dc voltage with excessive ripple (start-

up failure from an open C106); and excessive dc voltage with abnormally low ripple (shut-down from some unknown cause).

When C106 is open, the peak-reading action is missing, and the hot B+ drops to almost zero between rectified positive peaks. This can be identified by a scope waveform. Or the receiver can be kick-started (by external voltage applied to TP-13) so the unique Figure 3 hum pattern can be viewed on the picture tube.

Additional diagnostic tests of the C106 ac and dc voltages are shown

in the Figure 4 chart for three defects.

The waveforms of Figure 5 compare the normal 120Hz sawtooth ripple with the larger 60Hz ripple that results from an open diode in the bridge.

No sound or picture

Failure to achieve start-up prevents all sound, raster and high voltage. These same basic symptoms are produced also by a shut-down. However, the problems that cause start-up failure are completely different from any that

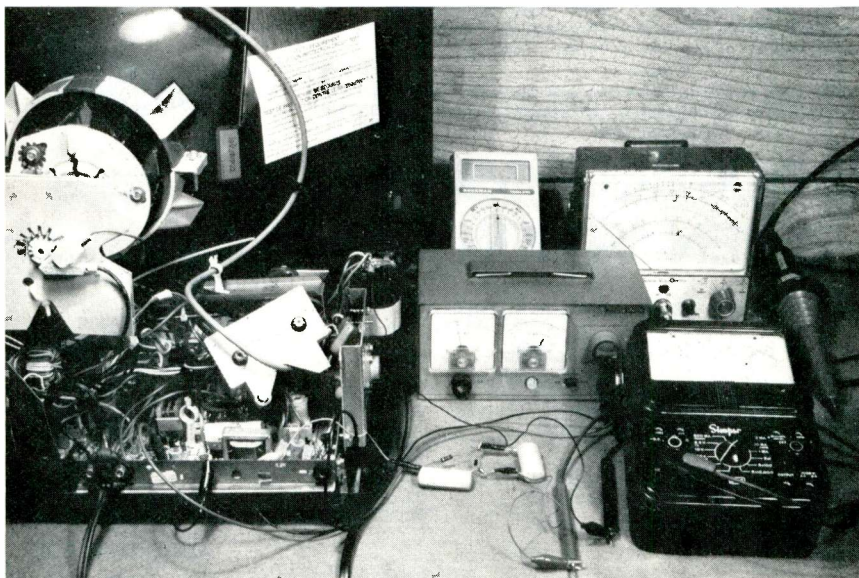

Operation at low line voltages prevents sweep overloads from ruining horizontal-output transistors. These tests are more dependable when the +23V for oscillator and driver stages is provided by a metered external supply. A current meter on the supply helps identify buffer and driver defects by deviations from the normal 200mA. When the peak-to-peak adapter (in front of external power supply) is used for checking start-up ac or for PPV tests, any of the basic multimeters can provide the necessary accuracy.

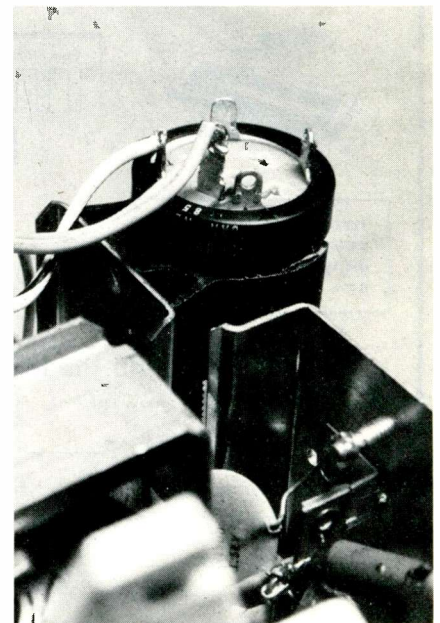

Figure 1 C106 is mounted near the fly-back and output transistor where it is convenient for measurements of ac and dc voltages.

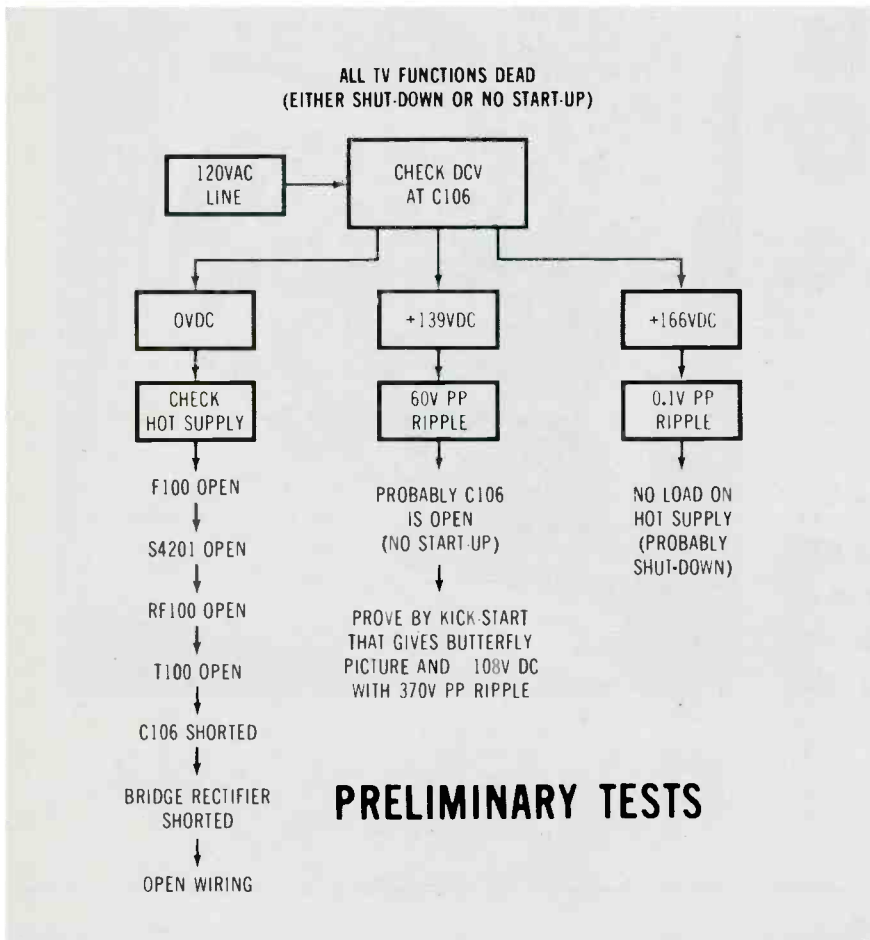

Figure 2 These tests of the C106 voltages can prove whether a dead TV is caused by shut-down, open C106 (failure to start-up) or a defective hot supply.

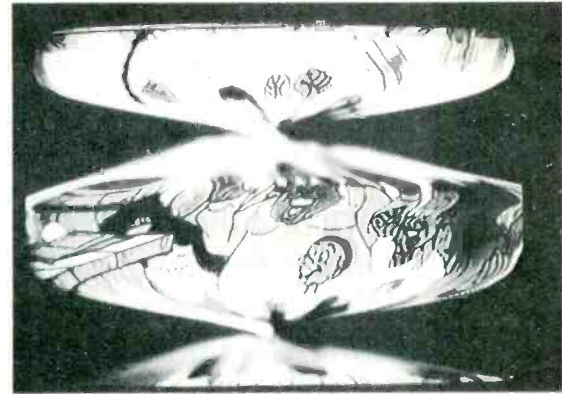

Figure 3 C106 is open if this pattern of two narrow width areas floats up through the picture after a kick-start.

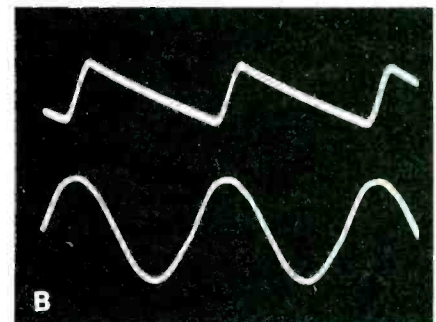
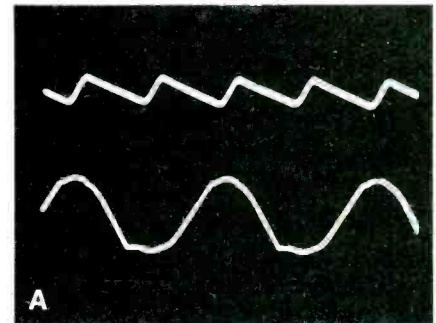

Figure 5 Condition of the hot-supply bridge diodes is indicated by the ripple waveforms. (A) Normal operation produces +155V and 120Hz ripple of about 4VPP at C106. Top trace is the ripple, and the lower trace is 60Hz line voltage for frequency comparison. (B) With a picture on the screen but one open bridge diode, the voltage is reduced to +147.6V with 9VPP of 60Hz ripple at C106. The abnormal 60Hz frequency is proved by the lower-trace line-voltage waveform.

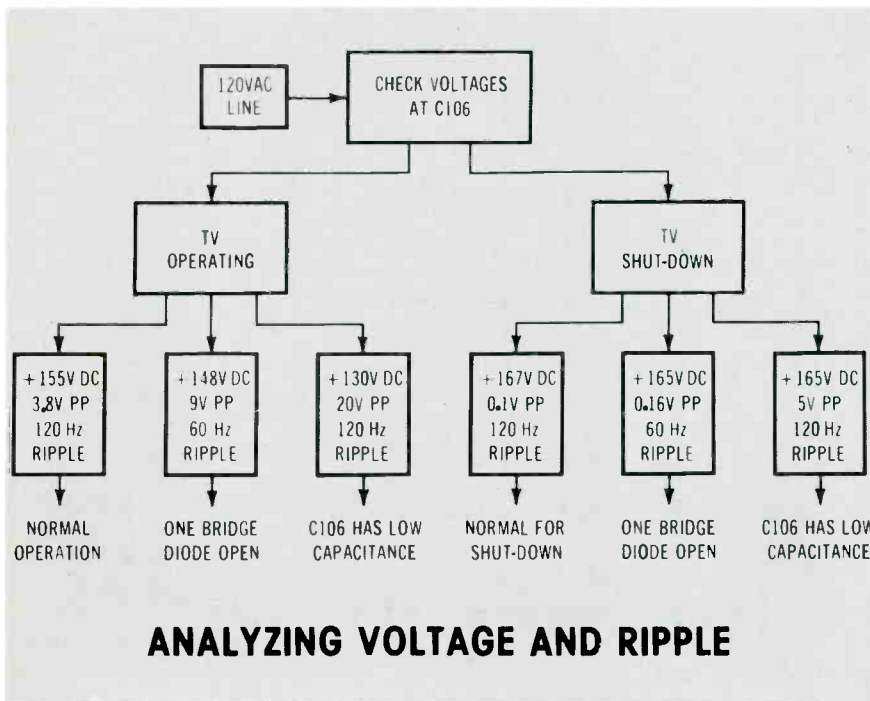
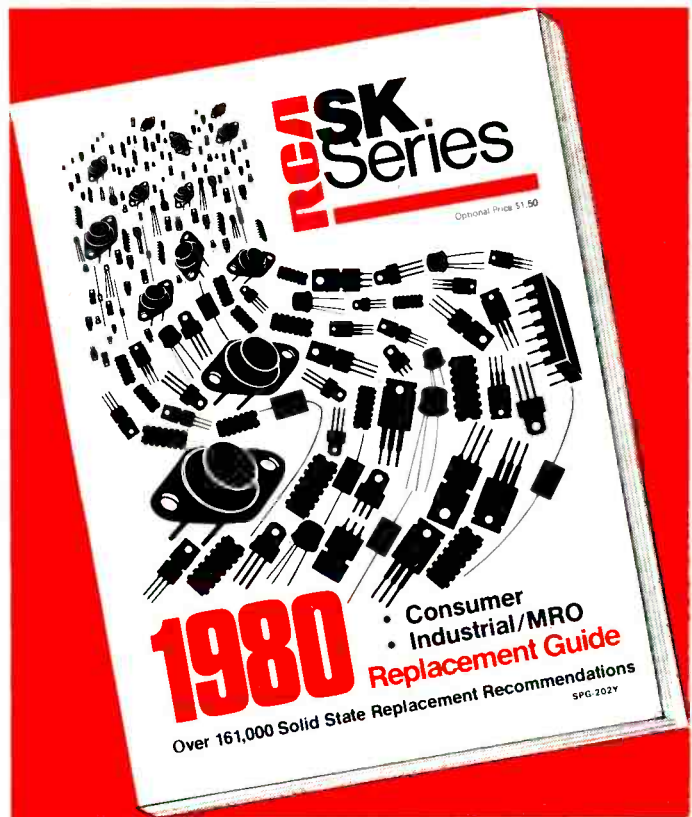

Figure 4 More analysis is possible from the C106 ac and dc voltages.

RCA's 1980 SK Guide puts Sylvania ECG* in its place.

You'll find the comparable ECG number right along with the SK number for the second year in a row in RCA's new SK Solid State Replacement Guide.



This is it...

Troubleshooting charts

continued from page 23

can produce shut-down. It is vital for all technicians to know the test procedures that can prove which is responsible for the dead TV.

Start-up failure versus shut-down and HV failure versus HV without a raster are analyzed in the Figure 6 chart.

Start-up tests—Similarly, the chart in Figure 7 shows specific tests for the start-up circuit. A VTVM with peak-to-peak calibrations provides better readings than other unmodified standard multimeters. However, the addition of a simple adapter (Figure 8) allows either a VOM or a DMM to supply equally good measurements.

Peak storing—A type of sample-and-hold technique is used in this adapter. It is needed because the vital part of the signal decreases rapidly and is difficult to measure. At power turn-on, current from the rectified dc flows through a winding of the start-up transformer and

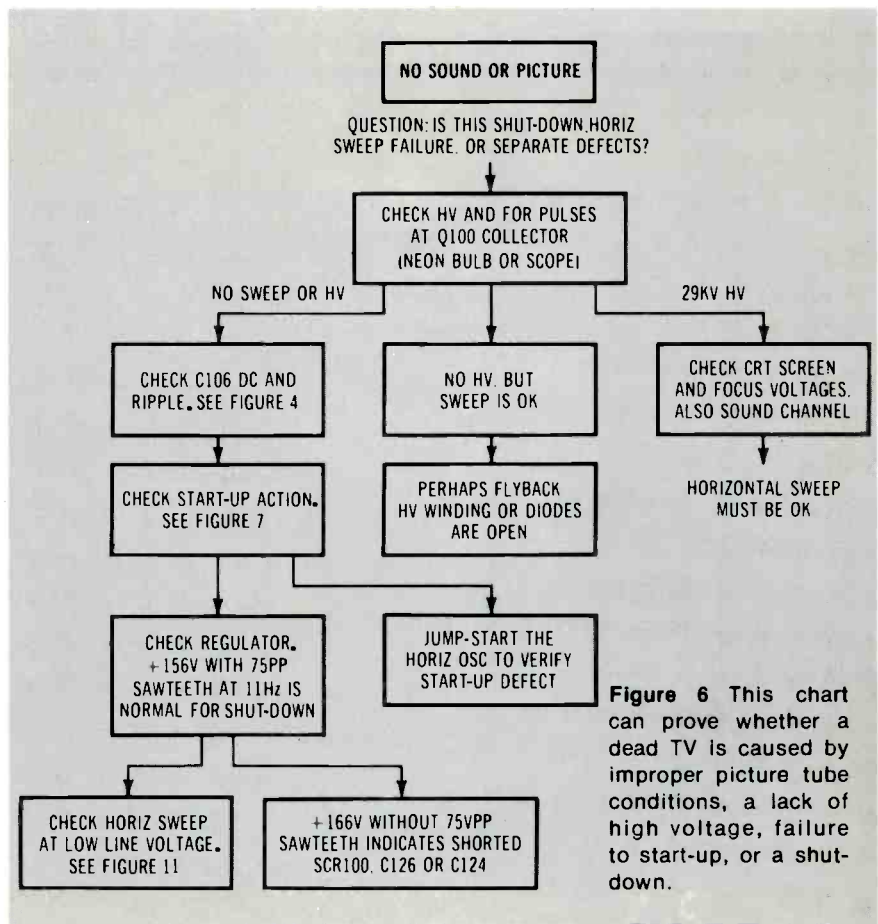

Figure 6 This chart can prove whether a dead TV is caused by improper picture tube conditions, a lack of high voltage, failure to start-up, or a shut-down.

one SK book - all you need to fill your solid state replacement needs.

- **DUAL NUMBERING SYSTEM**
e.g. SK3444/123A
- **EVERYTHING UNDER ONE COVER**
- **PUBLISHED EARLIER THAN EVER**
- **1,080 SK AND KH TYPES REPLACE MORE THAN 161,000 DOMESTIC AND FOREIGN TYPES**
- **MAKE MRO REPLACEMENTS RIGHT FROM YOUR SHELF**

RCA SK's are all manufactured by RCA's Solid State Division or by reputable original solid state device manufacturers. This means built-in quality and fewer costly call-backs for you. Your profit picture gets brighter and brighter with RCA SK's . . . transistors, rectifiers, thyristors, integrated circuits and high-voltage triplers.

See your RCA SK distributor for a copy of the 1980 RCA SK Replacement Guide, SPG 202Y or send your request with check or money order for \$1.50 to RCA Distributor and Special Products, P.O. Box 597, Woodbury, N.J. 08096.

RCA SK Replacement Solid State

*ECG is a trademark of GTE Sylvania

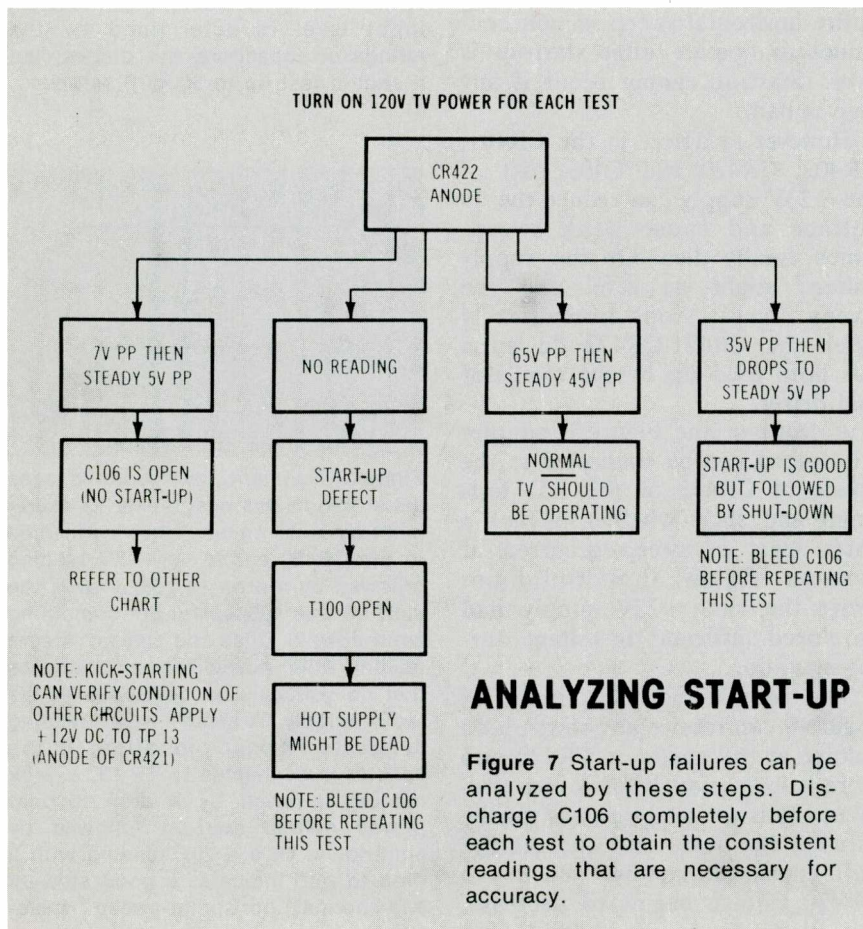

begins to charge filter capacitor C106. When voltage is applied to any capacitor, the charging current is maximum at first. Then it decreases as the capacitor charges to an increasing voltage. Therefore, the start-up C106 current is maximum at turn-on and rapidly decreases (since the dc resistance is low) until it reaches a plateau after a few cycles of the 120-per-second dc pulses.

The initial part of the current surge (changed to voltage by the start-up transformer) is finished so rapidly that RMS analog and average-reading digital multimeters cannot produce a useful measurement. A scope shows a flicker, but the amplitude can't be determined. The best solution, therefore, is to capture this voltage surge at the highest point and store it long enough for an analog or a fast-operating DMM dc range to show a reading. That is the purpose of the Figure 8 adapter circuit, which is similar to the rectifier section of a

Troubleshooting charts

VTVM that produces a dc voltage equal to the input waveform's total ac amplitude. It is one method of measuring peak-to-peak voltage.

Needed for the start-up adapter, however, is the slow discharge of the shunt capacitor's dc voltage following a reading. The time constant equals $0.25\mu\text{F}$ versus the total parallel resistance of shunt-capacitor leakage, series-diode leakage, and the resistance of the meter used for the reading. Therefore, the testing meter has time for a reading that's approximately the true maximum amplitude before the stored voltage drops below a useful level.

Some deviations from the Figure 7 chart voltages must be expected. Lower dc-voltage ranges of VOMs discharge the capacitor more quickly and thus reduce the maximum reading. Stiff damping of the analog pointer might prevent it from reaching the maximum voltage before the voltage begins to decrease. Some DMMs respond too slowly and miss the highest voltage.

However, the largest deviations from the Figure 7 voltages are caused by *C106 not being completely discharged* before the start-up attempt. This is a severe problem when the receiver is in the shut-down state, for the drain is very light then. A full minute or more might be required for the C106 voltage to drop from +166V to about +30V where almost maximum amplitude can be obtained. However, *any* C106 voltage reduces the start-up amplitude.

A good solution for obtaining consistent start-up voltages is to connect a power resistor (perhaps $4\text{K}\ \Omega$ at 10W) across C106 while the tests are in progress. Then wait at least 15 seconds with ac power off before attempting the next start-up.

Although these start-up ac amplitudes are not measured with high accuracy, the readings are far better than those from a VOM or a DMM without the adapter. A VOM, for example, might show about 2V RMS, but with questionable accuracy.

When the Figure 7 tests are performed with a meter and the Figure 8 adapter, one of these conditions should be proved:

- Start-up was normal, and shut-down did not occur during the reading time.
- Start-up was normal, but was followed immediately by shut-down.
- No start-up signal amplitude was obtained; evidently the start-up circuitry or the hot-supply was dead.
- A small start-up signal was obtained, indicating an open C106 or a defect (such as a bad start-up transformer).

Another start-up test

The previous test proves whether or not sufficient start-up signal amplitude was supplied to CR421 and CR422. It does not prove that all other steps of start-up occurred. Dc voltage from CR421 and CR422 is filtered and applied to the oscillator, buffer and driver stages. If this voltage level is sufficient and Q100 has enough hot-voltage, the horizontal-sweep circuit operates and develops several dc-voltage supplies. One of these is the +23V supply for the oscillator and driver stages. If it has enough voltage, the entire horizontal-sweep section continues to operate after start-up is over. (Start-up cannot occur if any step is bad.)

However, a defect in the CR401, CR402, CR420 and C405 part of the +23V supply can reduce the dc voltage and cause weak sweep, which finally dies. Or the supply voltage might be zero, and the sweep circuit stops immediately when the CR421-CR422 dc pulse has been used up by the oscillator and driver.

A scope or the Figure 8 adapter with meter can be connected to the anode of CR405 or the XD test-point and show whether or not a short blast of sweep occurred at turn-on. Again, that would not prove the vital +23V supply had developed sufficient dc voltage during start-up.

The sample-and-hold circuit of Figure 9 can receive any start-up dc voltage at the anode of CR420 and store it long enough for a measurement. Positive voltage passes readily through the diode and charges the $1\mu\text{F}$ capacitor rapidly. When the CR420 voltage begins to decrease, the diode is reverse biased and

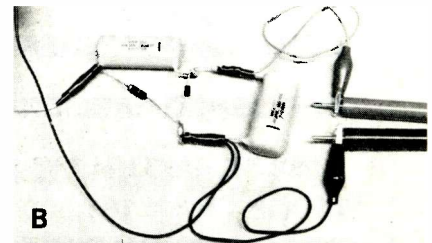
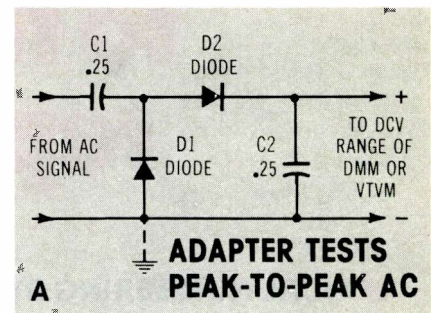

Figure 8 (A) This simple adapter can store dc voltage from an ac transient for a short time. Or it can measure peak-to-peak ac voltages with fair accuracy when a dc meter is the read-out. Use diodes intended for horizontal dampers and good quality 600V capacitors. If maximum PP accuracy is desired—especially at readings lower than 10VPP—add 1.2VPP to each reading. Maximum permissible input level is determined by the ratings of capacitors and diodes, but it should test up to 500VPP safely.

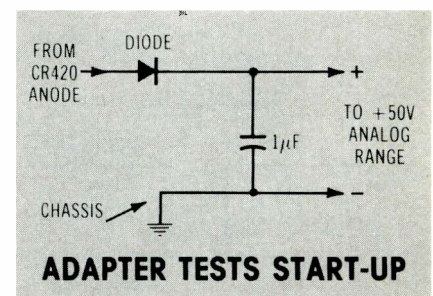

Figure 9 Transient positive dc voltages are stored in this adapter for measurement by a dc meter. When connected to the CR420 anode, a +15V reading followed by a drop to zero proves the start-up was successful but something (shut-down?) killed the sweep. A zero reading after power turn-on indicates that no voltage was developed in the +23V supply. A steady +22V reading suggests normal operation. If the adapter is connected to TP-13, a +8V reading followed by a drop to zero proves normal start-up followed by shut-down. Or a +20V reading with a drop to zero indicates a good start-up and normal horizontal-sweep operation.

becomes open. The capacitor has no load but its own leakage and the meter resistance. Therefore, it holds the voltage for several seconds. (CR420 acts as a switch to disconnect the 23V supply from the oscillator/driver load until the supply voltage exceeds the start-up dc voltage. Then it conducts, switching the 23V supply to the oscillator/driver load.)

A zero reading following an attempted start-up indicates the horizontal-sweep circuit did not operate, or that no voltage was developed in the +23V supply.

A maximum reading of about +15V followed by a slow drop to zero proves the start-up was successful but something (probably a shut-down) then killed the circuit.

Normal TV operation after start-up produces a steady reading of about +22V.

This analysis requires non-defective diodes. Therefore, all those mentioned should be tested for shorts or opens before the analysis is started. Other defective diodes can be identified in the tests with low supply voltage that follow.

Testing at safe voltages

Last month, a method was described for testing the horizontal

sweep and Q100 output transistor at reduced hot voltage that prevents damage from defects, even those overloads that usually ruin the Q100 transistor. Of course, no picture can be seen during low-voltage tests because the CRT heater power and several dc voltages are insufficient. Therefore, all tests must be made with scope and multimeter.

Another benefit of the low-voltage operation is that the shut-down circuit does not activate, since the flyback pulses (even when C117 is open) do not have enough amplitude to trigger shut-down.

Also explained were the connections for obtaining +8V to operate the oscillator and driver stages by connecting a 1000 Ω resistor to the hot supply (Figure 10).

This month, the low-voltage test method has been refined and presented in chart form (Figure 11). The chart can be used for general sweep testing but it's especially recommended following failure and replacement of horizontal-sweep components, particularly those which can ruin a replacement output transistor.

Notice that the chart's judgment of good or bad conditions is based primarily on the amount of high

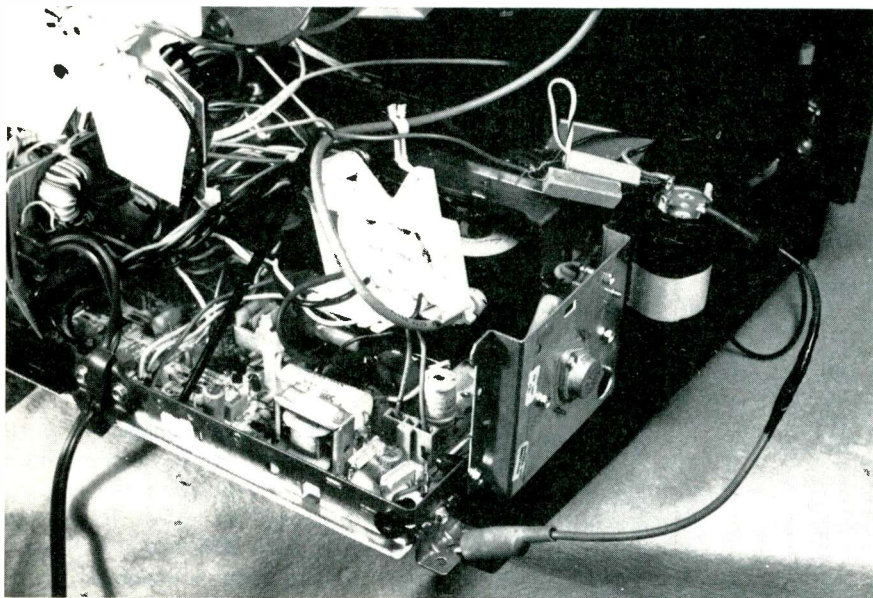

Figure 10 When a 23V external supply is not available, operate with 35V RMS power, connect chassis ground and C106 negative, and connect a 1000 Ω 10W resistor from C106 positive terminal to TP-13 of the start-up circuit. Use a scope to evaluate the amplitude and waveshape of the horizontal-sweep signals.

REBUILD YOUR OWN PICTURE TUBES?



With the Lakeside Industries precision picture tube rebuilding unit, you can rebuild any picture tube, be it black and white or color or 20mm or etc. We offer you the most revolutionized precision equipment of our modern times. This unit is easy to operate and requires only 4 x 8 ft. of space. You can rebuild the finest tube available. The picture will be clear and sharp. Your cost to rebuild a color tube is \$5.50. Your cost to rebuild a black and white tube is \$2.15.

Profit? Imagine building four color tubes per day and if you sold these tubes for \$60.00 each. Total income \$240.00. Total cost \$26.40. Net profit \$213.60. Multiply this figure by five days per week. Your profit \$1,068.00 per week. Cut this figure in half! Build and sell only two color tubes per day. Your profit \$534.00 per week. Facts are facts, figures do not lie.

For further information, please send your name and address to Lakeside Industries, 4071 N. Elston Ave., Chicago, Illinois 60618. Phone: (312) 583-6565.

P.S. No salesman will call.

Circle (11) on Reply Card

ESR METER

checks electrolytics
IN-CIRCUIT and is TV shop
FIELD-TESTED:

The most fantastic instrument I've ever bought—Billings, Mt. Used it 3 months; it only missed once—Marinette, Wis. (Typical). Squeal & no sync: 3 bad caps in B+ & AGC; Many Thanks—Taos, N.M. Please ship another; very satisfied—Glen Rock, Pa. It's fantastic—St. Joseph, Mo. Please rush; heard good reports—Hicksville, N.Y. One tremendous meter—Alexandria, Minn. Send your Super meter; heard about it—N. Olmstead, Ohio. Love that ESR Meter—Acton, Mass. Used it intensively for 30 days; it's been 100% effective—Pittsburgh, Pa. I understand that if I'm not completely flabbergasted, you will refund my money—Sanford, Fla. (Refund not requested).

60-day Satisfaction Guarantee.

Send check or M.O. or call
(313) 435-8916 for COD

Or write for free brochure to:

Creative Electronics

ESR Brochure **\$88.00**
1417 N. Selfridge
Clawson, Mich. 48017 postpaid
in USA

Circle (12) on Reply Card

Troubleshooting charts

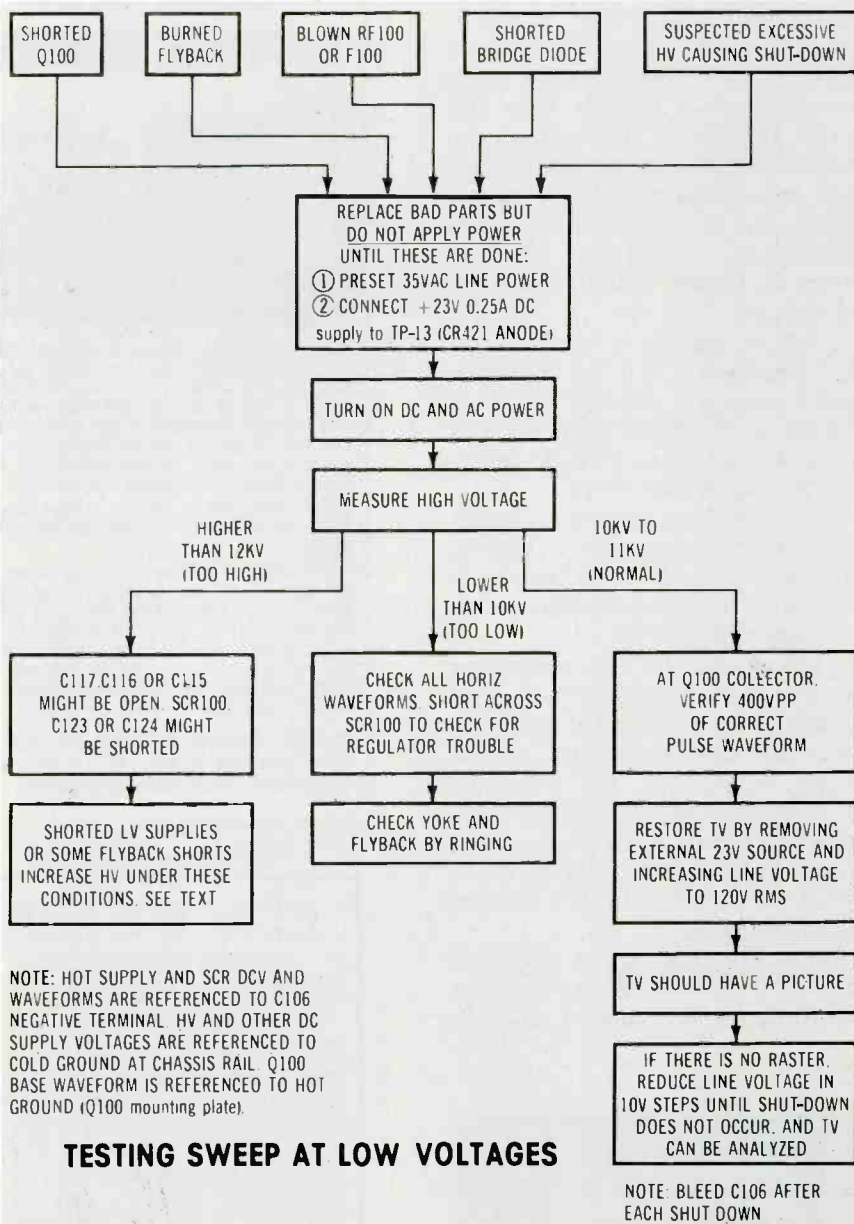

Figure 11 (A) Perform these tests after component replacements but before applying full line voltage. Apply full voltage only after the horizontal waveforms, high voltage, and the typical voltages (chart B) are within tolerance. (B) These voltages fill in the gaps of the other charts. Each one should measure within $\pm 20\%$ before full line voltage is restored.

TYPICAL VOLTAGES	
LINE	35V RMS
C106	+42V
TP 12 (regulated)	+49V
Q100 COLLECTOR	+49V
HIGH VOLTAGE E	10.8KV
HV (SCR short)	13KV
CR401 CATHODE	+8V
CR402 CATHODE	+5V
CR403 CATHODE	+80V
CR404 ANODE	-10V
CR405 ANODE	+7V
CR405 CATHODE	+10V
CR420 ANODE	+8V
CR421 ANODE (ext.)	+22.7V
XT (X ray test)	+15V

DC VOLTAGES DURING LOW VOLTAGE OPERATION

voltage. Secondly, the Q100 collector waveform and its amplitude are evaluated. If the HV and Q100 collector signal are within limits, it is likely that the circuit is operating correctly, and it's safe to change to 120Vac line power.

When using this chart, remember to allow for differences between the readings given in the series and those other technicians measure during troubleshooting. These results were obtained from only one early-production receiver, and other individual machines might have slightly different voltages.

Also, it is difficult to adjust the line voltage for any precise voltage (or to reset it the same each time). Variable transformers are not designed to provide small fractions of a volt during adjustments. Other differences occur because of instrument errors or reading errors. One meter might read high and another low. It often is not possible to test a peak-to-peak voltage and obtain the same reading on a scope and a meter. Scope accuracy is limited by the rated accuracy, any drift, parallax reading errors, and a technician's uncertainty about which waveform points to measure. PP-reading meters sometimes have serious restrictions of frequency response. If the response begins to fall around 20kHz, then all sharp spikes at 15.734kHz horizontal frequency will be rounded inside the meter and the readings will be lower.

Therefore, it is not important for these precise readings to be obtained, but the general ratio should be correct. Perhaps another HV probe and meter would have shown 11.2kV (instead of 10.8kV) for the normal reference HV. All HV references in the chart then should be increased by 0.4kV to correct for that one meter.

Check all voltage sources—Figure 11B is a chart of the approximate voltages obtained when the chassis was operated at 35V RMS (as measured by a DMM). All voltage figures have been rounded off, since the precise values are not important. But if +10V is shown, then either +2V or +18V indicates something wrong.

The dc voltage at a supply source (CR403 cathode or CR420 anode, for example) will be very low if the associated diode is shorted or if the supply line has a serious overload. Existence of a problem is proved by the low voltage, and resistance tests should be sufficient to locate the defective component.

All testpoints of Figure 11B should have approximately the voltages shown. Any missing or wrong voltages must be corrected before full line power is applied.

Some of these testpoint voltages fill in weak spots of the Figure 11A chart. Certain low-voltage supplies when shorted will increase the Q100 collector pulses and increase the HV reading. Others remove the SCR anode waveform and decrease the HV. Therefore, any questions not answered by the large Figure 11A chart can be answered by the second chart.

For example, an open CR401 would prevent any dcV from appearing at the CR420 anode in normal 120Vac operation or in the Figure 11B testpoint measurements. However, the lost voltage might go unnoticed in the Figure 11A large chart measurements because the dcV is supplied by an external source. *It is important that all these testpoints have proper voltage.*

The chart sequences appear to be a lot of trouble, but it is far better to perform them than to turn on the power and have another output transistor ruined by overload.

After all tests shown on the charts have indicated normal operation, it should be safe to apply full power and observe the quality of picture and sound. If shut-down occurs instead, it should be safe—after all these tests—to defeat the action by grounding the CR419 anode. Normal operation *without excessive high voltage* after shut-down action is defeated proves the shut-down (X-ray detector) circuit has a defect and needs repair.

Next month

Some of the subjects next month will include: ringing tests for yoke and in-circuit flyback; effects of some defects on the TV picture; and more scope waveforms that indicate defects of sweep components.

When you price by "The Book" everyone benefits!

Eliminates undercharging...controls overpricing...treats both customer and shop owner fairly!

The Parts Pricing Book

Lists over 160 pages of current parts prices for instant reference. Computerized with automatic up-dating...\$24.50 + up-dating.

The Labor Pricing Book

The new 4th Edition will expand your business mind as never before! Greatly simplified while being expanded to include all the new products, as well as the traditional...\$29.50.

CALL TOLL FREE: 800-228-4338

8/5 C.S.T. MONDAY/FRIDAY

tv & radio tech's guide to pricing

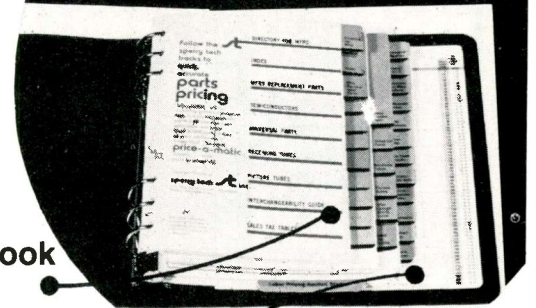

Each book is a great time saver! Pricing parts and labor from **ONE BOOK** ...together they're fantastic!

sperry tech inc. P.O. Box 5234 Lincoln, Nebraska 68505

Circle (13) on Reply Card

HOW TO GET BETTER MILEAGE FROM YOUR CAR...

Obey the 55 mph speed limit.



Keep your engine tuned.

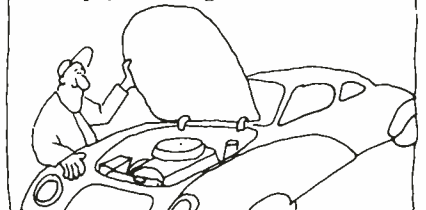

Avoid hot rod starts.

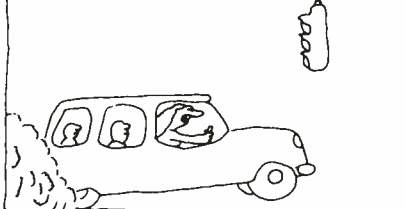

Drive at a steady pace.

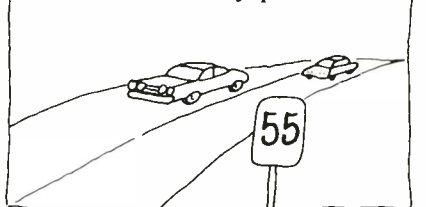

For a free booklet with more easy energy-saving tips, write "Energy," Box 62, Oak Ridge, TN 37830.

ENERGY.
We can't afford to waste it.

U.S. Department of Energy

Chassis—RCA CTC97HC
PHOTOFACT—1862-1

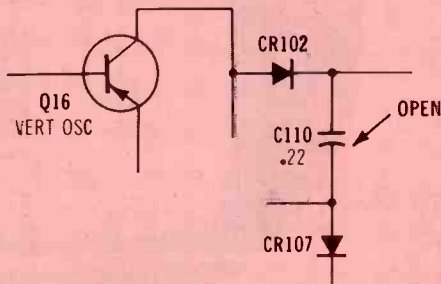

Symptom—No height
Cure—Check capacitor C110, and replace it if open

Chassis—RCA CTC97
PHOTOFACT—1862-1

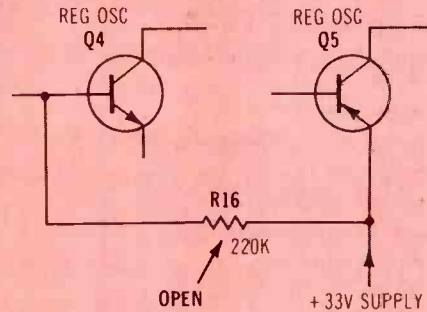

Symptom—Lack of regulation caused shut-down
Cure—Check R16 in regulator circuit, and replace it if open

Chassis—RCA CTC97
PHOTOFACT—1862-1

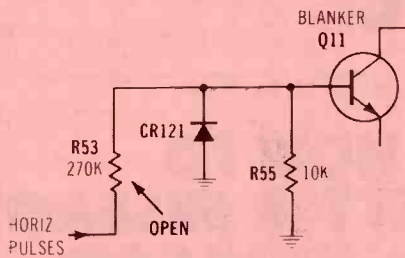

Symptom—Little control of brightness
Cure—Check R53 in blanker circuit, and replace it if open

Chassis—RCA CTC53
PHOTOFACT—1452-3

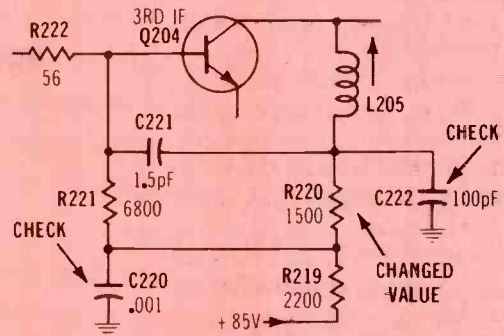

Symptom—Distorted video, almost similar to bad AGC
Cure—Check R220, and replace it if value has changed; also, check C220 and C222

Chassis—RCA CTC91
PHOTOFACT—1783-2

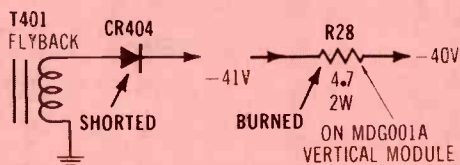

Symptom—No high voltage
Cure—Check CR404 and R28; replace them if defective

Chassis—RCA CTC87
PHOTOFACT—1778-2

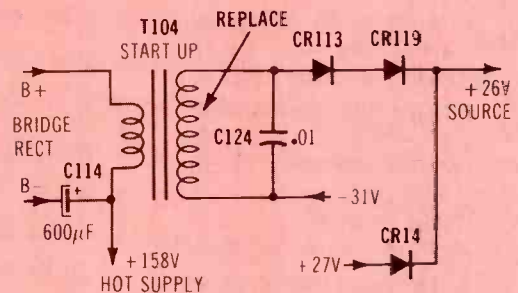

Symptom—Erratic start-up
Cure—Replace start-up transformer T104 on suspicion

Solving vertical problems in old TVs

Many color-TV receivers with tubes continue to be repaired in service shops. These suggestions should help technicians find vertical-sweep defects faster.

By Homer L. Davidson
Davidson Radio & TV

Defects in television tube-type vertical-deflection systems far outnumber those in all other circuits except horizontal-sweep and high voltage. There are several reasons for this. Slight changes of leakage or capacitance in capacitors employed in a few critical areas can cause rolling or foldover of the picture. These symptoms are obvious and cannot be overlooked. In other words, a few resistors and capacitors in each TV can cause problems that are much more severe than the degree of component defect.

Conditions of the sync signal, interference from hum or extraneous signals through the power supplies, and problems in the off-circuit output transformer and yoke can simulate defects in the sweep circuit.

What's more, vertical performance cannot be tested completely by service instruments. Final height and linearity adjustments must be made according to their effects on the TV picture. Many defects that

primarily change height or linearity also often change the frequency. Sometimes the frequency change is so extreme that the vertical cannot be locked. This confuses the diagnosis.

One advantage for troubleshooting these older tube-equipped circuits is the similarity of symptoms and repairs for all brands.

Preliminary steps

The following list of preliminary checks can save time during vertical-sweep diagnosis:

- Look for arc-over spots or burned tube sockets, cracked circuit boards, bad soldered joints, and burned resistors.
- Test all vertical tubes, or replace them with new tubes. Tube testers usually can't identify a tube giving insufficient height, but are helpful for shorts, emission and gas.
- Test all voltage supplies to make certain the voltages are sufficient. (Figure 1).
- Study a crosshatch pattern on the screen to identify all nonlinearities and other symptoms.
- In the area indicated by the crosshatch analysis, check voltages,

waveforms and resistances. Use heat and cold tests if applicable. Follow some of the tips given next.

General tips

A few TV models employed a power pentode tube and half a duo-triode as multivibrator stages (referred to here as output and oscillator). However, the majority used one duo-triode tube (Figure 2), and the size made it easy to identify.

Gently tap each vertical tube with an insulated screwdriver while watching the screen for any change in the picture. Repeat the tapping while observing the tube. Look for any arcs. Replace any tube that arcs or changes the height when tapped. Repeat the test after a new tube is installed. This guards against the possibility of an intermittent socket (rather than the tube) causing a problem, and eliminates many callbacks.

Also, move each tube around with a circular motion. Watch for any change of heater brightness or any height variation on the screen. Some sockets lose contact spring tension from TV heat. Although a

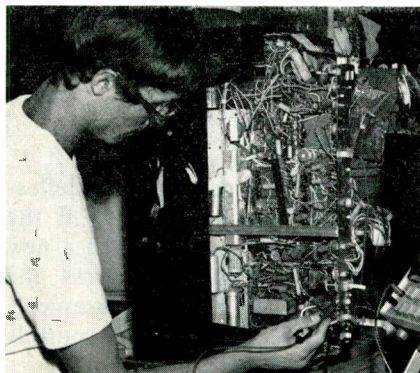

Figure 1 Testing important dc voltages in the vertical sweep section. This is one of the first steps for efficient servicing.

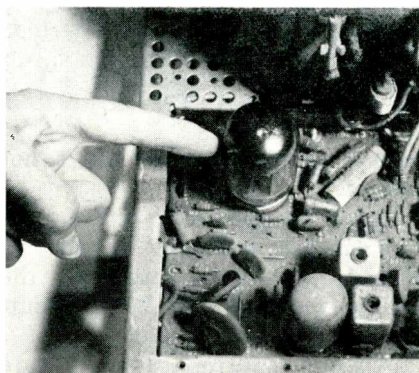

Figure 2 Easy to locate in most older TVs is the duo-triode vertical-output tube. Usually it is the second largest tube on the chassis.

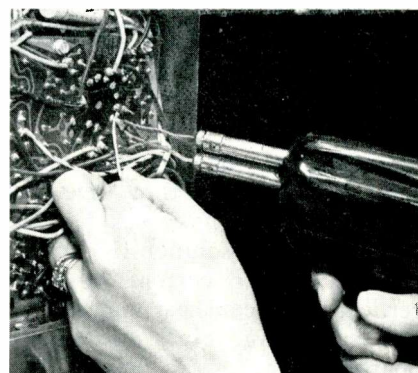
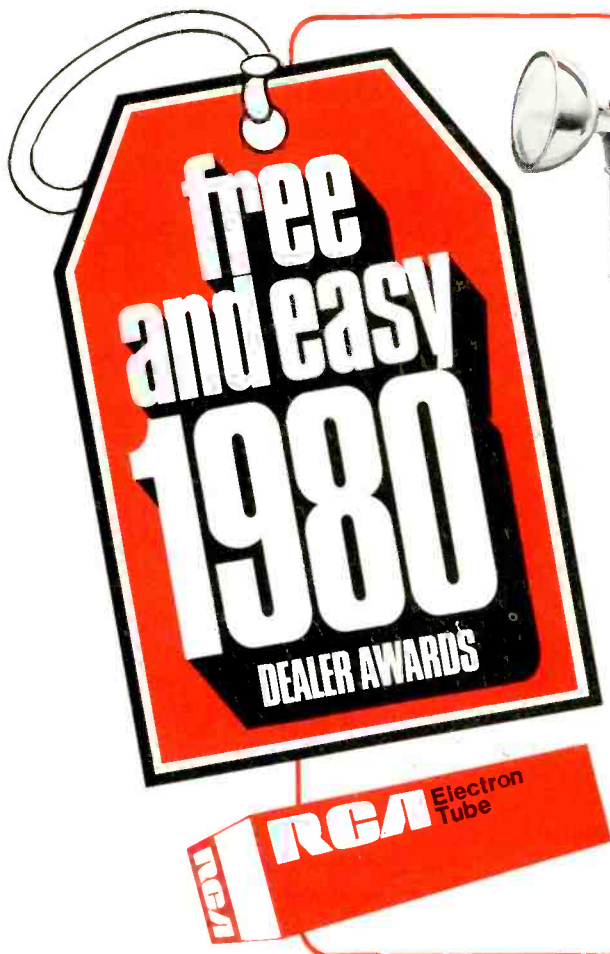

Figure 3 Intermittently open socket contacts can be repaired permanently by replacement of the socket.



FE-6249
Ray-O-Vac
Sportsman No. 303
Sealed Beam
Lantern.
Value: \$25.95



FE-6245
Wilson Rubber
Soccer Ball.
Value: \$12.95

FE-6244
Hamilton Beach
5-Speed Mixer.
Value: \$33.95



FE-6259
Homelite® XL-12
Chain Saw.
Value: \$129.95



FE-6252
Trimarc Concealed
Rod® Getaway
Spinning and
Spincast Set.
Value: \$78.00



Old TVs

continued from page 31

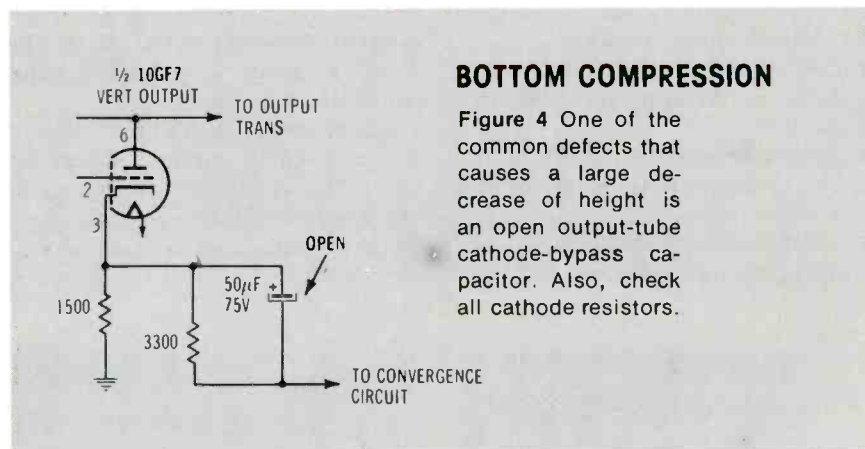

BOTTOM COMPRESSION

Figure 4 One of the common defects that causes a large decrease of height is an open output-tube cathode-bypass capacitor. Also, check all cathode resistors.

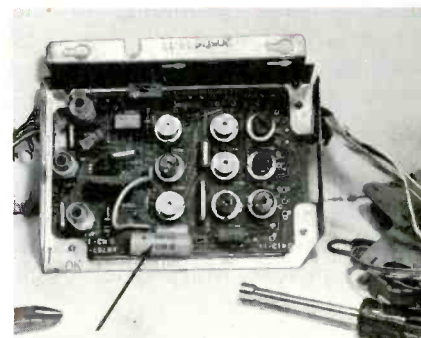

Figure 5 Some color receivers place the cathode-bypass capacitor on the convergence-adjustment board.

rebending of the contacts might solve the problem for a time, the installation of a new socket is the only permanent solution (Figure 3).

Heavy heater current of these vertical tubes can heat and crystallize soldering joints on circuit boards or the metal chassis, thus causing intermittent height. Recurrences and callbacks are less likely to occur if old solder is removed completely and a new joint is made

with fresh 60/40 solder and a hot iron.

When the picture is only two to four inches tall and cannot be locked, the prime suspect is the positive-feedback loop between output plate and input grid.

An open output-tube cathode capacitor (50µF in Figure 4) is a common cause of insufficient height and moderate bottom compression. No adjustment of height and linear-

ity controls can produce full deflection. This capacitor is open if the height increases *greatly* when a new capacitor is connected across the old. After capacitor replacement, the height and linearity controls must be readjusted.

Several models place this cathode bypass on the convergence-adjustment board (Figure 5) where it might be overlooked.

FE-6251
Instapure Water
Filter by Water Pik.
Value: \$29.95



FE-6247
Wilson Connors
Rally Tennis
Racket.
Value: \$27.50



Free gifts available with your purchase of RCA Receiving Tubes.

When you think of receiving tubes, think RCA! When you think of dealer awards, think RCA "Free and Easy 1980." Then get both from your local participating RCA tube distributor. Quality tubes and quality awards go hand in hand at RCA.

Shown here are just nine of the 20 awards available to you. Find out the details when you purchase quality RCA receiving tubes from your participating RCA tube distributor and earn the award of your choice.

RCA Distributor and Special Products Deptford, N.J. 08096

RCA Receiving Tubes



FE-6257
Hanson
Step Stool.
Value: \$22.00



FE-6253
Meco Swinger II
Smoker Grill.
Value: \$79.54

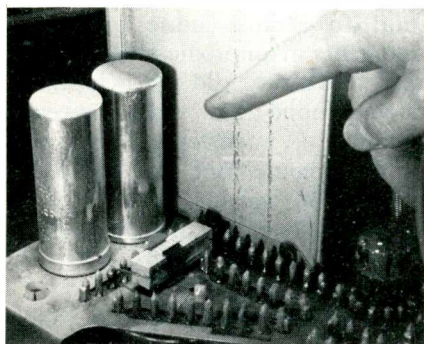

Figure 6 Low-capacitance or leaky filter capacitors sometimes reduce the height or produce hum bars that are more noticeable than the degradation of other functions.

Leaking or open filter capacitors (Figure 6) can be a source of hum bars or bending that travel up through the picture. Scope all lugs of these filters while looking for excessive ripple or horizontal-sweep hash. A single open filter can be proved by paralleling a test capacitor across the suspected one. However, leakage between multiple sections often requires that all sections

be disconnected and substituted at the same time.

Service switches—Although service/normal setup switches have produced a large number of mysterious symptoms, they usually are the last components to be suspected. One or more pairs of contacts might fail to close properly (from corrosion), causing a white raster without video (AGC contacts), some loss of height (leakage between contacts or to ground), or loss of video (in the few that switch video). After all else fails to solve a case of insufficient height, cut or disconnect the wire between this setup switch and the vertical-sweep circuit. Any height increase indicates a bad switch.

Resistors—After carbon-composition resistors become burned from overload, the resistance might be either higher or lower than the original. Older high-value resistors tend to increase in resistance even without any previous overload.

These changed values account for many cases of insufficient height.

Capacitors—An NPO type of zero-drift ceramic capacitor probably is suitable for substitution in vertical circuits. However, these usually are available in small capacitances. Most larger-capacitance ceramics have excessive drift and should not be used. Therefore, do not use any ceramics in the vertical circuit unless the original was ceramic.

Polycarbonate or polypropylene dielectric capacitors have the least frequency drift, although polyester types can be used successfully for almost all replacements. But the oscillator grid coupling capacitor should have nearly zero leakage and a very small temperature coefficient if best stability is to be obtained.

Collapsing sweep—Either a capacitor (combination capacitor and resistor) in the positive-feedback loop or an open output-tube cath-

Old TVs

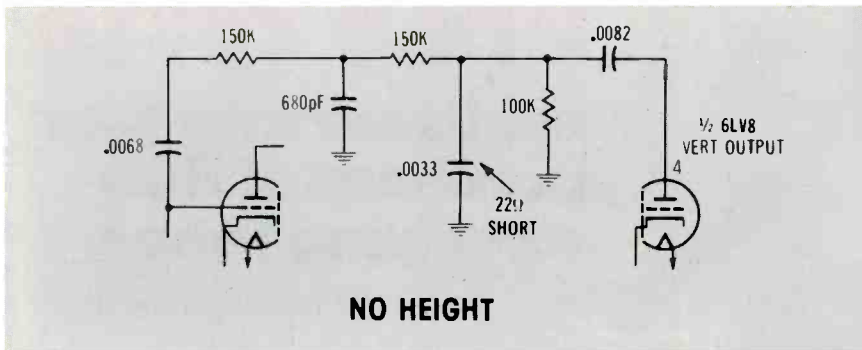

Figure 7 This leaky capacitor in a Philco TV eliminated the positive-feedback signal, and thus stopped the oscillation and the height.

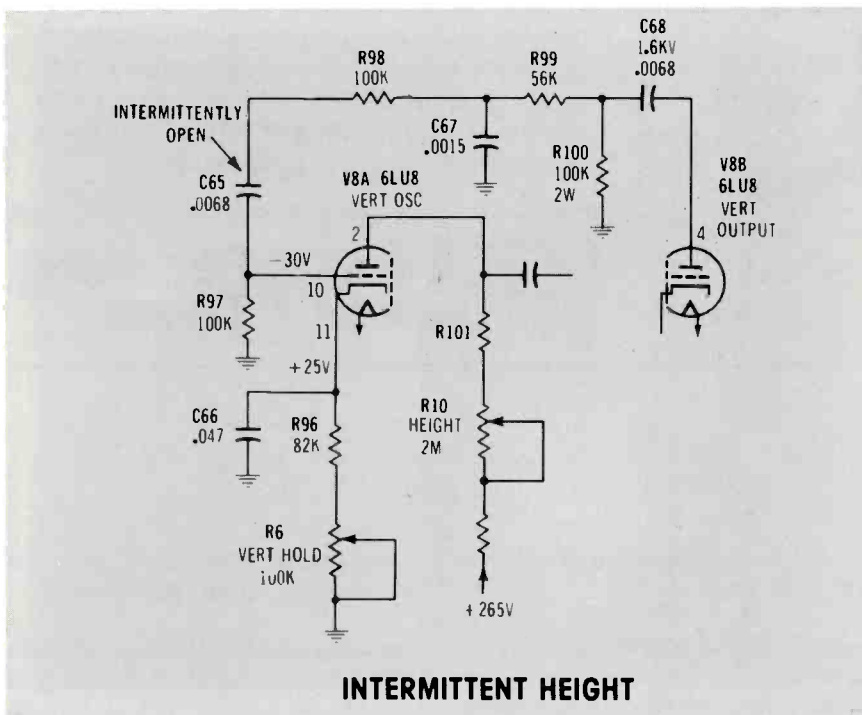

Figure 9 Symptom of an open C65 grid coupling capacitor was a grid voltage of zero and a loss of all height.

ode resistor usually is responsible for a regular and slow alternation between no sweep and almost adequate height.

Philco with no height

A complete loss of vertical sweep in a Philco 17MT80B chassis was traced to a shorted 0.0033 bypass capacitor in the positive-feedback loop (Figure 7).

Symptoms included a low negative voltage at the oscillator grid along with a low plate voltage. Signal injection at the oscillator grid gave deflection, thus proving the amplification path was not defective. Without a positive-feed-

back signal, the multivibrator could not oscillate.

Insufficient height

After a new vertical tube was installed, the sweep still lacked about two inches at top and bottom of the picture. In the model CWS-502 Packard-Bell color TV, the oscillator pin 8 plate voltage measured only 90V. The plate voltage comes from the boost voltage through the height control and limiting resistors (Figure 8).

All plate load resistors tested within tolerance except the 2.7M Ω one, which measured about 8M Ω . This reduced the plate signal

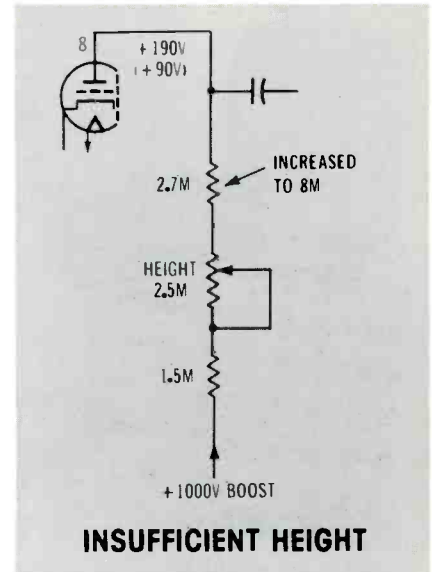

Figure 8 Oscillator plate voltage plays a large part in the amount of height. Check all plate-load resistors and replace any that measure too high.

amplitude and supplied less drive to the output grid. Usually, the vertical linearity is not affected by an increased-value plate resistor.

Intermittent height

Height of the model LG-5301 Admiral picture changed from normal to almost none every few moments at unpredictable times. A new 6L8 tube did not help, and a look around the socket revealed nothing of importance. The intermittent could not be started or stopped by moving the tube in its socket. None of the dc voltages indicated any defect when the height was full.

Finally, the negative grid voltage at the oscillator tube pin 10 (Figure 9) was monitored until the height collapsed and the voltage reading dropped to almost zero.

It seemed likely the circuit had stopped oscillating because of a positive-feedback defect, so canned coolant was sprayed on each feedback component in turn. When the .0068 μ F grid coupling capacitor was cooled, the height collapsed. Replacement with a good-quality polycarbonate type solved the intermittent height.

Regular loss of height

The vertical height would change

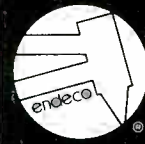

endeco soldering & desoldering equipment

SOLDERING IRONS

Pencil style. Safety light. Two heats — 20w and 40w. 6 tips. Unbreakable handle. 2 and 3 wire neoprene cords.

DESOLDERING IRONS

Pencil style. Safety light. Some operate at 40w, idle at 20w. 8 tip sizes. 2 and 3 wire neoprene cords.

SOLDERING & DESOLDERING KITS



Everything needed to solder or desolder or both. All in a handy lifetime metal box with hasp.

See your distributor or write...

Enterprise Development Corp.

5127 E. 65th St. • Indianapolis IN 46220
PHONE (317) 251-1231

Circle (15) on Reply Card

NATIONAL ELECTRONICS SERVICE DEALERS

Are you standing idly by while ideas that can be money in your pocket fly away?

Membership in NESDA is one of those ideas.



WHAT DO YOU GET FROM NESDA?

1. Insurance
2. Special Bancard Rates
3. ServiceShop Magazine
4. Electronic Service Industry Yearbook
5. Service Industry Information
6. Legislative Programs with State and National Government
7. Advocate for Better Warranty Practices
8. Business Information



Don't let your bucks get lost in the shuffle.

Send in your check today.

On the bottom line it will mean extra \$\$\$ in your pocket.

JOIN NESDA

And Your State Association
Send for more information:
NESDA, 2708 W. Berry St.
Fort Worth, TX 76109

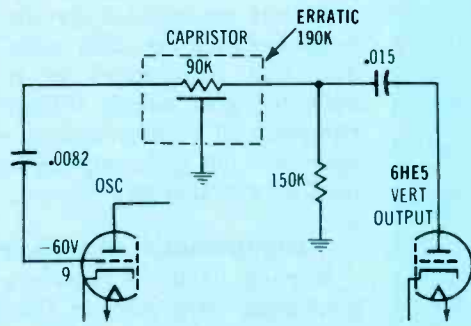

ERRATIC HEIGHT

Figure 10 All capacitor-resistor (capristor) units should be the first suspects because of their poor dependability records. This one caused a rapid recurrent collapse of height.

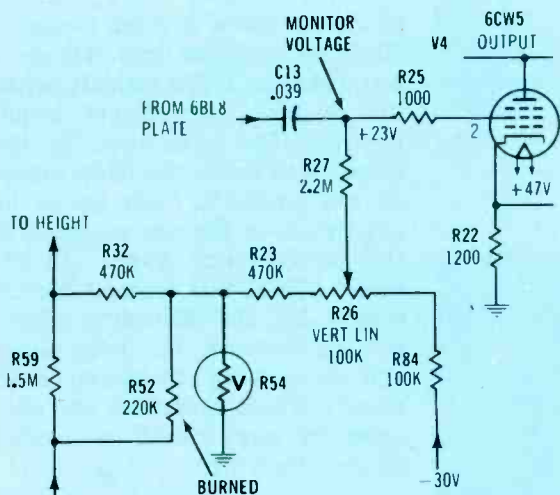

BOUNCING HEIGHT

Figure 11 Bouncing height or erratic rolling can be caused by capacitors or resistors that arc or change value rapidly. Alternate heating and cooling of these parts often triggers the problem so it can be identified.

every few seconds from a full raster to a horizontal line and repeat this continuously although no vertical controls or adjustments were touched.

Scope waveforms and dc-voltage measurements in the Zenith 25MC30 chassis revealed nothing of importance. However, resistance tests found the 90k Ω capristor unit (Figure 10) had increased to about 180k Ω . These combined resistor-capacitor components have given much trouble over the years and should be suspected first.

A new capristor was not available, so a substitute was made from one 82k Ω resistor and two capacitors (one at each resistor end).

Bouncing height

Bouncing vertical sweep sometimes originates in shorted or

arcing turns of vertical-output transformer windings, or in output stage burned and erratic resistors.

A 16TS929 Motorola color TV appeared to fit in the bouncing category. After many tests found nothing wrong, dc-voltage analysis uncovered a varying negative voltage at the pin 2 control grid of the 6CW5 output tube. The voltage should have been positive and unchanging.

Resistor R52 (220k Ω in Figure 11) was charred and tested open, although it probably had arced when in the circuit. This resistor was difficult to locate for it was hidden under wiring and other components. A new resistor cured the bounce.

Rolled downward

The picture on a 9-inch Admiral

Old TVs

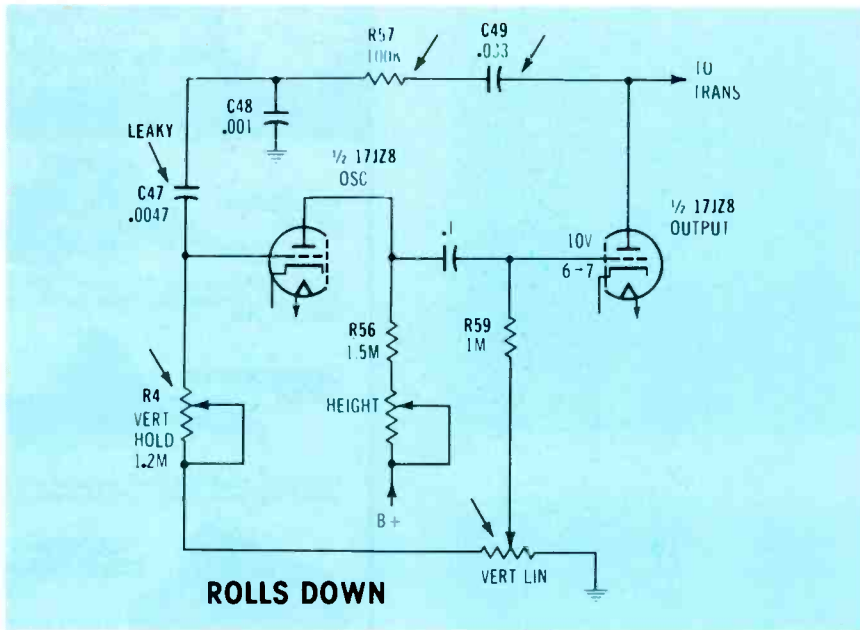

Figure 12 Those components marked by arrows are likely suspects when the hold control can roll the picture only one way.

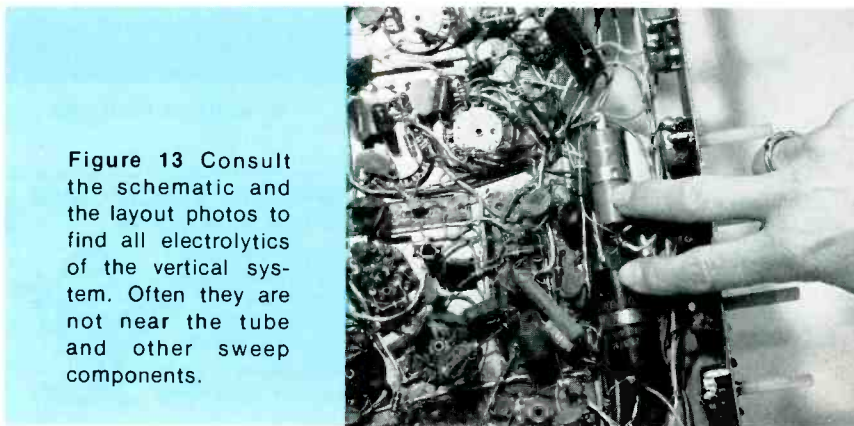

Figure 13 Consult the schematic and the layout photos to find all electrolytics of the vertical system. Often they are not near the tube and other sweep components.

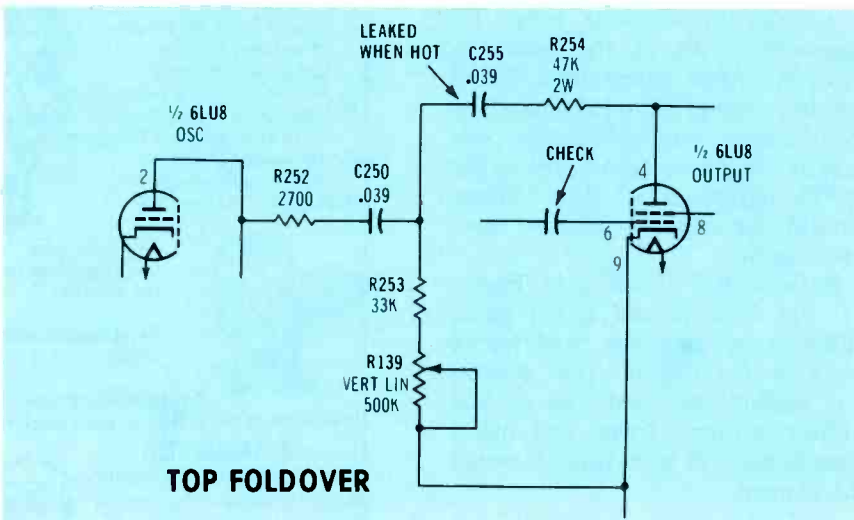

Figure 14 Top foldover after a long warmup was caused by C255 in the negative-feedback vertical circuit of an Olympic TV.

portable TV could be rolled downward but not upward by the hold control. Often in such cases, the defective component is in the oscillator grid circuit (Figure 12). However, all resistors tested within tolerance, but grid coupling capacitor C47 was shorted.

Compression at bottom

Burned cathode resistors and electrolytic capacitors in the vertical-output stage can reduce height at the bottom. Check the resistance between output cathode and ground. Examine each resistor for evidence of overload.

If the resistance and appearance of these resistors is good, connect a $50\mu\text{F}$ test capacitor from cathode to metal chassis. If the cathode capacitor is open, the height should increase. The next step, in that event, is to locate the open capacitor and replace it. Some are on the chassis and a few are mounted on the convergence panel. In the model M267DWD General Electric (Figure 13), the electrolytic capacitor was between the tube socket and the convergence socket on the chassis. These capacitors are often open in any brand or model. Suspect them first.

Top foldover

When power first was applied to the Olympic CTC19 receiver, the height at bottom was insufficient. After operation for about two hours, the top began to fold over.

These symptoms indicated a defect that became worse by the operating heat. Usually, capacitors are the source of heat-related slowly varying symptoms.

When the picture was showing top foldover, coolant was sprayed individually on each capacitor. The foldover stopped after C255 ($.039\mu\text{F}$ in Figure 14) of the negative-feedback network was sprayed.

To prove the diagnosis, C255 was heated and the foldover gradually appeared. Cooling it removed the foldover. A new top-quality capacitor solved the problem.

Unusual non-vertical problem

About two hours after the power was switched on, the vertical deflection of a model 685-2203 Penncrest color TV would jump and then roll.

After the vertical circuit had been tested without results, the problem was found (almost by accident) in the HV hold-down circuit. Normal receiver heat changed the resistance of R107 (Figure 15) and activated the hold-down operation. R107 is factory sealed and cannot be adjusted. Therefore, a new control was ordered and installed. A wirewound control of the same resistance could be substituted, but careful adjustment is required to be certain it would protect without giving false alarms.

This chassis is identical to RCA CTC63XP, so the tip applies also to that model.

Summary

Troubleshooting tube-type vertical sweep can be condensed to these steps:

- Test or replace tube or tubes.
- Inspect the vertical area for defects that can be seen.
- Study the deficiencies as shown by a crosshatch pattern.

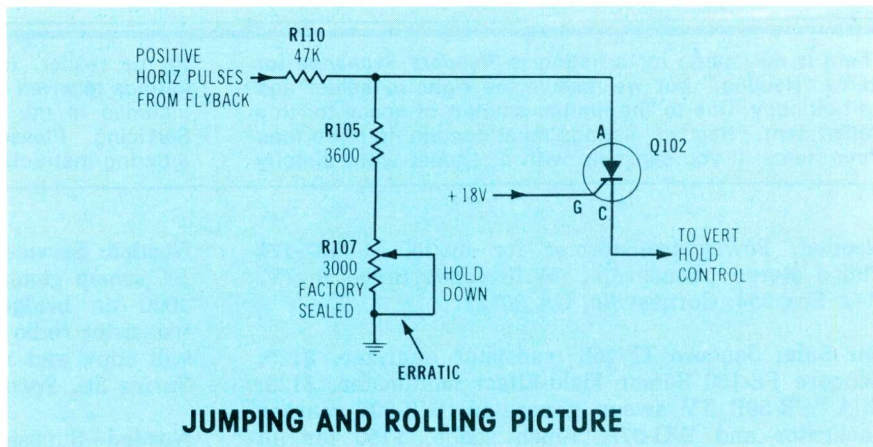

Figure 15 A pulsating and occasionally rolling vertical sweep in a Penncrest (RCA CTC63) was caused by a bad resistor in the hold-down protective circuit.

- Measure dc voltages and compare waveforms with those on the schematic.
- See if any resistors appear burned. Test all resistors.
- Inject a 60Hz signal at key points in the amplification path.
- Suspect all output-tube cathode-

bypass capacitors and all capristor assemblies. As a last resort, suspect set-up switches.

- Apply heat and coolant spray alternately to suspected components.
- Use good quality temperature-stable replacement capacitors. □

**People
of all ages die of
heart disease
and stroke.**

**Put your money where
your Heart is.**

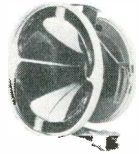

**Thordarson
replacement
flybacks & yokes
fit exactly**

Thordarson flybacks and yokes are exact replacements . . . from mounting holes to wiring color code. Engineered and built better than the original you replace. Satisfy more customers with superior Thordarson performance. Buy from your Thordarson distributor.

THORDARSON

Thordarson Meissner, Inc.
Electronic Center
Mt. Carmel, Illinois 62863

Circle (16) on Reply Card

April 1980 *Electronic Servicing* 39

reader's exchange

There is no charge for a listing in *Readers Exchange* for items "Needed," but we reserve the right to select and edit all copy. Due to the limited amount of space for this department, "Needed" listings must contain no more than three items. If you can help with a request write directly

to the reader, not to **Electronic Servicing**. "For Sale" listings received after May 1, 1980 will be charged for and included in the regular classified section of **Electronic Servicing**. Please consult that section for price and ordering instructions.

Needed: Power transformer for model M-1537-124 Philco stereo phonograph. W.B. Jones Radio & TV, P.O. Box 354, Carnesville, GA 30521.

For Sale: Sencore TF-166 transistor analyzer, \$125; Sencore FE-160 Senior Field-Effect multimeter, \$125; RCA WR-59B TV sweep generator, WR-39B marker generator and WO-57A 3-inch scope, \$150 for all three. All with test leads and manuals. Walter Schofield, 33 Strand St, Fall River, MA 02720.

For Sale: Photofacts folders 3 to 800. Write for price. Marlon Palmer, 2N577 Landrose Lane, Maple Park, IL 60151.

For Sale: Photofact folders 1 to 450; and PF Reporter and **Electronic Servicing** 1966 to 1975, some missing in both items, best offer. Send self-addressed stamped envelope for details. Arthur Blaha, 3855 W. 65th St., Chicago, IL 60629

For Sale: B&K-Precision model 415 sweep/marker generator, and model 1465 B&K-Precision triggered scope, \$400 for both. Slump TV, 1336 E. Vine, Mesa, AZ 85204.

For Sale: Drake TR4-CW-RIT transceiver, 10 months old with power supply, speaker, 34-PNB noise breaker installed, Shure microphone model 444, optional crystals 42.5MHz & 43.6MHz for 28.0MHz to 29.7MHz segment of 10-meter band installed, and three 6JB6 spare Sylvania matching tubes, \$900 shipping prepaid. William Shevtchuk, 1, Lois Ave., Clifton, NJ 07014. Telephone (201) 471-3798.

Needed: Schematic, instructions and alignment data for model 83Y102 Knight-kit, 5-band Star Roamer. Herbert Naugle, 1792 Finch Ct., Hayward, CA 94545.

Needed: Small lightweight service scope, desoldering equipment, analyst, stereo generator, picture tube rebuilder, and bench-stock. Webster Obert, 373 Washington, Victorville, CA 92392.

Needed: B&K-Precision model 415 sweep generator in good condition, reasonable. Thomas Burns, 9 Allegheny Terr., Pittsburgh, PA 15207.

For Sale: B&K-Precision 375 multimeter; Sencore TF-26 Cricket transistor checker; B&K-Precision 960 transistor radio Analyst; RCA WR55A color/bar generator; two B&K-Precision scopes, \$275 for all (firm). Canton TV, 118 Pisgah Dr., Canton, NC 28716.

Needed: TR-82 Photofact. Quote price. McLester Brown, 1197 N. Garfield Ave., De Land, FL 32720.

Needed: Sencore model PM-157 with operation manual. Jerry's Color TV, 2511 Tampa Ave., Cleveland, OH 44109.

Needed: Service and instruction manual for Sylvania TV sweep generator, type 500; B&K-Precision model 1000 ac bridge analyzer, model BR-44; Superior transistor radio tester, model 88. Will buy original, or will copy and return. Arjay Radio Service, 1929 S. Spring St., Springfield, IL 62704.

Needed—Simpson model 650 transistor Add-A-Tester adapter for Simpson model 260 series VOM. Quote price. Patrick Harrigan, 5165 S. Magellan Dr., New Berlin, WI 53151.

Needed: Schematic and/or parts list for Pentron model PR-66 reel-to-reel tape recorder. Will buy, or copy and return. Thomas Haddock, 1938 Willow Ave., Worthington, MN 56187.

Needed: Latest tube data for Mercury model 1100A tube checker; Schematic and/or calibration manual for Clippard model 406 VTVM. Charles R. Wells, 16029 14 Mile Rd., Fraser, MN 48026.

For Sale: B&K-Precision 415 sweep/marker generator, perfect cond. with all cables and books, \$325, plus shipping. Joe Toy Northeast TV Service, 2628 E. Orthodox St., Philadelphia, PA 19137.

Needed: Tektronix scope 455, 465, 475, 485 or T935A, working or not, reasonably priced. Please state age and condition. C.W. Hancuff, R.D. 3, Box 664, Meadville, PA 16335.

Needed: Modification kit (A-108) and/or schematic diagrams for model 1077 B&K-Precision Analyst. Roy Alcorn, 580 Saybrook Ct., Lexington, KY 40503.

Needed: EICO model 944 flyback and yoke tester with manual; reasonable. H.D. Stevens, 31 2nd St., No. Arlington, NJ 07032.

Needed: Two audio driver transformers for V-M stereo model 1498-1. Dickinson TV & Appliance, 41 1st Ave. W., Dickinson, ND 58601.

For Sale: Older Electronic Technicians radio and TV schematics, volumes 3, 4, 5, 6, 7 and 8, all for \$4.50 plus shipping. David Pollock, 178 Pinckney Rd., Little Silver, NJ 07739.

Needed: Service manual, schematic and power transformer for Hickok 770 scope. Will buy, or copy and return. Steve Hill, RT 1, Harrisburg, MO 65256.

For Sale: TV shop equipment—Sencore VA48 and Super Mack CRT tester, B&K-Precision, Conar, tubes, transistors and diagrams. Many other items. Send SASE for complete list and terms. Items sold only as a package. Will deliver within 200 miles of Baltimore, MD. Albert M. Parry, Jr., Box 138, Andrews Rd., Crapo, MD 21626. □

catalogs literature

Additions to the **O.K. Machine & Tool** line of wire-wrapping tools, machines and associated products are included in the latest edition of *Catalog 80-36N*. An illustrated sec-

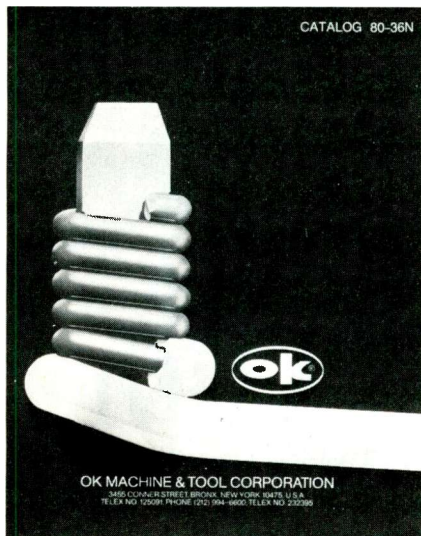

tion on the technology of wire-wrapping is featured. This 60-page catalog has been expanded to include the complete line of industrial and hobby products.

Circle (20) on Reply Card

The full line of **VIZ** electronic instruments is illustrated and described in the company's 44-page catalog for 1980. Complete information is given, including major features of interest to users, detailed description and complete technical specifications.

Circle (21) on Reply Card

General Semiconductor Industries' 1980-81 *Product Catalog* contains a listing of the company's line of TransZorb silicon transient voltage suppressors, NPN switching transistors, zener diodes, temperature compensated diodes, and C²R high-voltage switching transistors. More than 250 new devices are included in the 286-page catalog.

Circle (22) on Reply Card

Global Specialties is offering a 36-page catalog, *Instruments for Testing and Design*. In addition to the company's line of solderless

breadboards, instrument cases, logic probes, frequency counters, test and measurement instruments, this catalog includes a number of new products.

Circle (23) on Reply Card

Electronic Tool has issued a 145-page tool catalog illustrating and describing a line of field-service tool kits, test equipment, hand and power tools.

Circle (24) on Reply Card

A 16-page color catalog of business cases has been issued by **Howe Industries**. In stock items are shown, including tool cases, circuit board cases and instrument cases. More than 40 cases are illustrated and described.

Circle (25) on Reply Card

A 36-page catalog from **RMC-Radio Materials** features an array of capacitors, including monolithic, low-voltage subminiature, temperature compensating, high-voltage and high-dielectric types. Specifications are included.

Circle (26) on Reply Card

Beckman Instruments' three Series 300 3 1/3-digit portable multimeters are described in a 6-page color brochure. The bulletin describes the features of the series, including 10A ac/dc current ranges, 2000-hour typical battery life, a semiconductor test function and exceptional overload protection on all ranges.

Circle (27) on Reply Card

Cornell-Dubilier has issued a fourth edition of its booklet *Servicing and Replacing Ac Motor Starting and Running Capacitors*. The 12-page black and white publication contains illustrations, photos, wiring diagrams, line drawings and tables. The text features analysis of failure modes, capacitor design and reliability, and test procedures. A guide for replacing unidentified capacitors, and a cross reference of data listings are included. □

Circle (28) on Reply Card

NATESA
5908 S.
Troy
Chicago
IL 60629



ARE YOU A PRO?

...the not for profit association championing independents' right to compete, and delivering valuable benefits continuously since 1950.

- LEADING SPOKESMAN
- TRADE INFORMATION DISPENSER
- WATCHDOG
- LOBBYIST
- YARDSTICK OF STANDARDS
- CONSUMER RELATIONS
- COUNSELOR
- PROBLEM SOLVER

We are not freeloaders. So our check for \$60.00 dues is attached. As our special premium, please ship the indicated \$15.00 Manual.

- Practical Business Manual
- OR -
 Service Contract Manual

IT'S NO PUZZLE TO ORDER

OELRICH SERVICE FORMS
FOR TV-RADIO & 2 WAY RADIO SERVICE LEGAL FORMS FOR CALIF. FLA. UTAH NOW AT YOUR PARTS JOBBER OR WRITE FOR CATALOG B64
OELRICH PUBLICATIONS
4040 N. NASHVILLE AVE. CHICAGO, ILLINOIS 60634

Circle (17) on Reply Card

FREE CATALOG
HARD-TO-FIND PRECISION TOOLS
Lists more than 2000 items: pliers, tweezers, wire strippers, vacuum systems, relay tools, optical equipment, tool kits and cases. Send for your free copy today!

JENSEN TOOLS INC.
1230 SOUTH PRIEST DRIVE - TEMPE, ARIZONA 85281

Circle (18) on Reply Card

To get more information...

on items advertised or described in this publication, use the Reader Service Card.

As a free service for our readers, we forward your inquiry to the product's manufacturer. Reader Service Card is pre-addressed.

Paging speaker

University Sound has introduced the MILC speaker, a high-efficiency re-entrant type speaker designed for applications in areas requiring 10W sound levels. The MILC features a



redesigned rear assembly and a new ferrite magnet. The speaker weighs 4 lbs. A Uni-Lock bracket allows the horn to be positioned over an angle of 90° vertically and 360° as desired.

Circle (29) on Reply Card

Transient voltage suppressors

A series of transient-voltage suppressors has been introduced by **W. N. Phillips**. These suppressors include silicon PN-junction devices that conduct only during each separate excessive voltage spike. The conduction reduces the voltage



amplitude. Between spikes, the suppressor has only leakage current. A heavy-duty crowbar circuit removes the line voltage when the overvoltage is constant for a period of time. Eight models are available for various wattage and voltage ratings.

Circle (30) on Reply Card

Indoor antenna

Winegard Company has designed a mini-sized VHF-UHF-FM antenna for use in apartments and homes where an outdoor antenna is not feasible. The model AT-5001 antenna mounts overhead on a gold-color floor-to-ceiling pole that adjusts from 7'6" to 8'3". It receives channels 2-69 in color or b&w and FM-stereo stations.

The suggested retail price is \$44.75. The package includes antenna, wire, VHF-UHF-FM band separator and two plant hanger hooks.

Circle (31) on Reply Card

Voltage regulator

The LR series of Varax ac line-voltage filtered regulators by **Adtech Power** is available in four models of two power ratings. LR-501 and LR-1501 provide 500VA and 1500VA respectively from 115V, 60Hz sources. Models LR-504 and LR-1504 provide the same power from 230V, 50Hz sources.

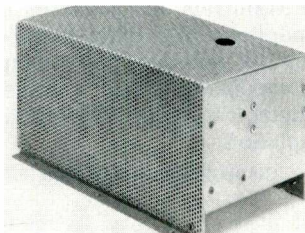

Operating over a 90 to 130Vac input voltage range, the regulated output voltage is adjustable $\pm 3\%$, power efficiency is high and waveform distortion is less than 5%. Line regulation is $\pm 1\%$ and load regulation is $\pm 1\%$.

The LR-501 is priced at \$319.60, and the LR-1501 is \$509.

Circle (32) on Reply Card

Semiconductor reference

The semiconductor division of **Westinghouse** has revised its *Power Semiconductor User's Manual and Data Book*. Expanded from 432 to 608 pages, this indexed reference guide is three books in one: an 80-page user's manual; one data book on high-power rectifiers, transistors, thyristors and assemblies; and a separate data book on fast-switching devices.

The second edition of the *Power*

Semiconductor User's Manual and Data Book is priced at \$13.50.

Circle (33) on Reply Card



Transient protection system

A line of Computer Protection Systems (CPS) has been designed by **Transtector Systems**. All LSI ICs are susceptible to damage from any type of overvoltage, including line-voltage transients. These Transtector units have redundant solid-state circuitry that operates within 5nS to reduce transient amplitudes by conduction across the incoming ac line.

Models are available for use on electric lines between 120V and 575V in one, two or three phase and Delta or Y service.

Circle (34) on Reply Card

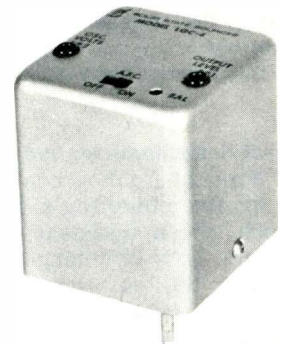

Telecommunications oscillator

The LGR series oscillators from **Solid State Sources** provide 25mW of power in the 5.9 to 8.4 GHz band. The units are complete with built-in AFC. The LCR oscillators draw only 350mA from a -24V supply.

Circle (35) on Reply Card

test equipment report

Logic probe

O.K. Machine and Tool has introduced model PRB-1 digital-logic probe that simplifies troubleshooting of digital circuits. The small self-contained probe requires no adjustments, although it replaces a large, expensive and cumbersome scope for many types of digital servicing.

No switching is needed when changing from one logic family to another. The high LED lights when the probe input exceeds 60% of the supply voltage. When the input is lower than 15% of the supply voltage, the low LED lights. Neither LED lights when there is no input voltage. Pulses of shorter than 10nS can be detected up to 50MHz repetition rate. Short pulses are

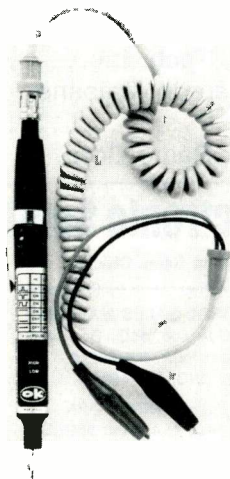

lengthened in duration to 50mS by a pulse stretcher.

The probe has power-polarity protection and overvoltage protection to ± 70 Vdc. Input impedance of 120K Ω does not load the digital circuit. Standby current with neither LED lighted is only 15 μ A, while both LEDs increase the drain to 9.5mA (taken from the digital circuit).

Operating conveniences include a pocket clip, capped and replaceable probe point, and a truth table printed on the probe body.

Circle (36) on Reply Card

Volt-Ohm-Milliammeters

Simpson Electric has announced a new 260 series of VOMs. The units have four new features: recessed, insulated panel connectors with matching reverse-type elbow safety

test leads; a double-fused protection network located in the battery-and-fuse compartment; and an off/transit position on the function switch that protects the meter movement during transit. This position shunts the meter movement and opens the internal connections to the common and + jacks.



The basic 260-7 is priced at \$103. Options include mirror scale, additional relay overload protection and roll-top case. Probes and protective cases are included.

Circle (37) on Reply Card

Dual-trace 25MHz portable scope

Gould has developed the OS1200, a lightweight 25MHz dual-trace scope. The unit features a 5-inch rectangular CRT with internal graticule. The unit's 14ns risetime, 6kV accelerating potential, and signal delay make the instrument useful for digital work involving narrow pulses with fast risetimes and low

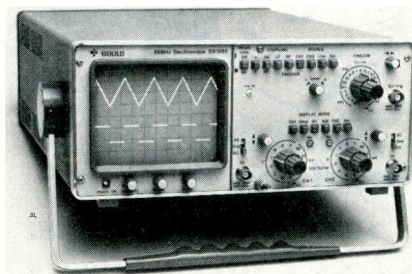

repetition frequencies. Basic time-base speeds range from 200ns/cm to 1s/cm with vernier control over a range of 2.5:1. The dual input

channels have maximum sensitivity of 2mV/cm over the full 25MHz bandwidth.

The price for the Gould OS1200 with probes is \$1299.

Circle (38) on Reply Card

Compact video generator

New from **Hickok Electrical Instruments** is the model 240 video generator. It features both a video and adjustable-RF output, 10-step gray-scale staircase, 3- and 10-bar gated rainbows, a trigger output for use with scopes and a built-in battery check position. The 10-step gray-scale staircase simplifies detection of video compression. The



three-bar gated rainbow permits fast chroma checks and is useful for vectorscope measurements.

The 240 operates from an ac adaptor (included with unit) or two 9V batteries. Two output leads, provided with the unit, are stored in its snap-on protective thermoplastic cover.

The 240 video generator sells for \$159.

Circle (39) on Reply Card

Auto-ranging capacitance meter

A portable autoranging 3 $\frac{1}{2}$ -digit digital capacitance meter is now available from **B&K-Precision**. Model 830 automatically selects the correct range of 10 ranges when an unknown capacitor is measured. Basic accuracy is 0.2%. Ten ranges cover from 1pF to 199.9 millifarads.

The 830 is available for \$199.

Circle (40) on Reply Card

themarketplace

Advertising rates in the Classified Section are 35 cents per word, each insertion, and must be accompanied by cash to insure publication.

Each initial or abbreviation counts a full word.

Minimum classified charge \$3.00.

For ads on which replies are sent to us for forwarding (blind ads), there is an additional charge of \$3.00 per insertion to cover department number, processing of replies, and mailing costs.

Classified columns are not open to advertising of any products regularly produced by manufacturers unless used and no longer owned by the manufacturer or distributor.

For Sale

REPLACEMENT COLOR YOKES—DEALER ONLY. Zenith 95-2501-2532-2638-2667-S-89633 etc. \$19.94. Magnavox 361380-1 \$21.95, Sylvania, GE etc. \$17.95 to \$22.95. Request for price list on your letterhead. David Sims Enterprises, Inc., 665 Jericho Turnpike, Huntington Station, N.Y. 11746, (516) 549-3925. 5-79-tf

AUTOMOBILE RADIO and tape replacement parts: Delco, Chrysler, Philco-Ford, Motorola, Panasonic and many others. Large inventory. Laran Electronics, Inc., 3768 Boston Road, Bronx, NY 10469, (212) 881-9600, out of New York State, (800) 223-8314. 5-79-tf

TV & RADIO TUBES, 36 cents EA!! Free color catalog. Cornell, 4221 University, San Diego, California 92104. 8-76-tf

ELECTRONIC SURPLUS: CLOSEOUTS, LIQUIDATIONS! Parts, equipment stereo, industrial, educational. Amazing values! Fascinating items unavailable in stores or catalogs anywhere. Unusual FREE catalog. ETCO-011, Box 762, Plattsburgh, N.Y. 12901. 6-78-tf

TV RENTAL SYSTEMS! Complete & guaranteed. Manual or computerized. Send \$2.00 for complete details. Perry's rental systems, 133 Brenda Street, Milton, Florida 32570. 2-80-tfn

BUY FACTORY DIRECT: TV parts, semiconductors, antennas, chemicals. Prices below wholesale. Write: Midwest Semiconductor, 4411 W. North Ave., Milwaukee, WI 53208. 2-80-4t

FOR SALE: T.V. ANTENNA INSTALLATIONS + MATV SYSTEMS + SATELLITE/PAY T.V. INCLUDED! SACRAMENTO, CAL. BASED. LARGEST COMPANY HERE. ASKING \$700K + INVENTORY. WRITE VAG78B BOX 1010, WOODLAND HILLS, CA. 91365. 3-80-2t

COMPLETE TV SERVICE INVENTORY: Tubes; transistor, capacitor, resistor kits; misc. parts. Steve Youngberg, Rt. 1, Kerkhoven, MN 56252. 4-80-1t

FOR SALE: TV TROUBLE ANALYSIS TIPS. Over 300 symptoms/remedies by circuit area. Tough ones I found in years of servicing; e.g. poor sync—C66 shorted—Wards—GEN12349A—Sams 995-2. Save time and money. Send \$22.50 money order to CHAN TV, 8151 Grandview Rd., Chanhassen, MN 55317. 4-80-1t

FOR SALE: SAM'S PHOTOFACTS—1 thru 560 in hard binders (a few missing). \$700 takes all. CHAN TV, 8151 Grandview Rd., Chanhassen, Minnesota 55317. 4-80-1t

PICTURE TUBE REBUILDING lathes. Woodland horizontal renecking lathe and vertical regunning lathe with accessories. Best offer. P.O. Box 2277, Fargo, N.D. 58108, 701-282-5330. 4-80-1t

HEWLETT-PACKARD SCOPES: 22 mhz Dual Trace—\$350 50 mhz Dual Trace—\$650. Calibrated & Guaranteed. Free Catalog. 1445 N.W. 9th St., Homestead, Fla. 33030, (305) 247-6349. 3-80-2t

Business Opportunity

TV SALES AND SERVICE in sunny Florida. Same location over 20 years. \$20,000 firm. Interested apply only. Send letter to shop owner, 1516 South Jefferson Avenue., Clearwater, Fla. 33516 3-80-5t

DREAM COME TRUE! Turn-key established television service. Comfortable income. Friendly customers. Pleasant surroundings. Enjoyable living. Available after June 1st. Owner moving to Caribbean island this fall. Boltons, Box 1221, Shawnee, OK 74801. Phone: day, (405) 273-1990; evening, (405) 273-8270. No Friday evening or Saturday calls, please. 4-80-1t

BEAUTIFUL ALBUQUERQUE. Eight year old TV sales & service business. Grossing \$68,000.00. Net approximately \$30,000. Corner location in shopping center with no competition in expanding area. Price \$23,500.00. Westside TV Service, 5509-A Central Ave. NW, Albuquerque, N. Mex. 505-836-0500. 4-80-1t

Advertising Services

TIME AND LABOR-SAVING DEVICES, previously unmarketed. Can increase service profits substantially. Plans range from efficient shop and van layouts to specialty tools, such as telescoping mastjacks and turntable cradles. For plans send \$12.50 to Devices, P.O. Box 204, Rock Port, Mo. 64482. 3-80-3t

HELP WANTED

TELEVISION TECHNICIANS—Experience necessary, top pay, medical benefits, paid vacations. Enjoy a new "Life Style" in a beautiful, friendly, smog free, full service desert community. Send your resume to 225 E. Ridgecrest Blvd., Ridgecrest, California 93555. Telephone 714-375-1361 ask for Service Manager. 3-80-tfn

EXTRA INCOME! NO SELLING! Distribute VIDEO GAMES ad cards from your shop or on-service calls and earn easy commissions! Write: Video, Box 27348, Dept. ES1, Mpls., MN 55427. 4-80-1t

Wanted

WANTED: Sams folders 1400 up. Heath color generator IG-5240/SG-5240. Herbert, 410 N. Third, Minersville, PA 17954. 3-80-2t

WANTED: SAM'S PHOTOFACTS from 1146 up. Will pay \$15.00 for Darrs Service Clinic No. 2. E. D. Jacobs, Roopville, GA 30170, Phone: 404-854-8243. 4-80-1t



You play the leading role in our fight against birth defects support MARCH OF DIMES

THIS SPACE CONTRIBUTED BY THE PUBLISHER

advertisers' index

Creative Electronics	27
Enterprise Development Corp.	37
Fuji Svea Enterprises	15
Gamit Enterprises, Inc.	17
General Electric Tube Div.	7
General Electric TV Dealer	1
Jenson Tools Inc.	41
Klein Tools Inc.	15
Lakeside Industries	27
Liaison	13, 21
NATESA	41
NESDA	37
Oelrich Publications	41
OK Machine & Tool Corp.	IBC, 11
Projector Recorder Belt Corp.	17
RCA Distributor & Special Products	IFC, 24, 25, 32, 33
Howard W. Sams & Co.	3
Sperry Tech, Inc.	29
Thordarson Meissner, Inc.	39
Zenith Radio Corp.	BC

Electronic Servicing®

Advertising Sales Offices

NATIONAL SALES MANAGER
Greg Garrison, P.O. Box 12901, Overland Park, KS 66212; Phone: (913) 888-4664

NEW YORK, NEW YORK
Joe Concert, 4 West 58th St., New York, NY 10019; Phone: (212) 888-1977

KANSAS CITY, MISSOURI
Helen Hull, P.O. Box 12901, Overland Park, KS 66212; Phone: (913) 888-4664

LOS ANGELES, CALIFORNIA
Herbert A. Schiff
3055 Wilshire Blvd., Suite 350
Los Angeles, CA 90010
Phone (213) 387-0639

LONDON, ENGLAND
John Ashcraft & Co., 12 Bear St., Leicester Square, London, WC2H 7AS, England; Phone: 930-0525
Telex: 895-2387

AMSTERDAM, HOLLAND
John Ashcraft & Co., John J. Lucassen, Akerdijk 150A, 1171 PV-Badhoevedorp Holland; Phone: 2968-6226

TOKYO, JAPAN
International Media Representatives, Ltd., 2-29, Toranomon 1-chome, Minato-ku, Tokyo 105, Japan; Phone: 502-0656

ITEM NO.
WK-7

CMOS SAFE

IC INSERTION/EXTRACTION KIT

KIT INCLUDES

- MOS-1416 14-16 CMOS SAFE INSERTER
- MOS-2428 24-28 CMOS SAFE INSERTER
- MOS-40 36-40 CMOS SAFE INSERTER
- EX-1 14-16 EXTRACTOR
- EX-2 24-40 CMOS SAFE EXTRACTOR



OK MACHINE & TOOL CORPORATION
3455 CONNER ST., BRONX, N.Y. 10475 U.S.A.
PHONE (212) 994-6600 TELEX NO 125091



PRINTED IN U.S.A.

PATENT PENDING

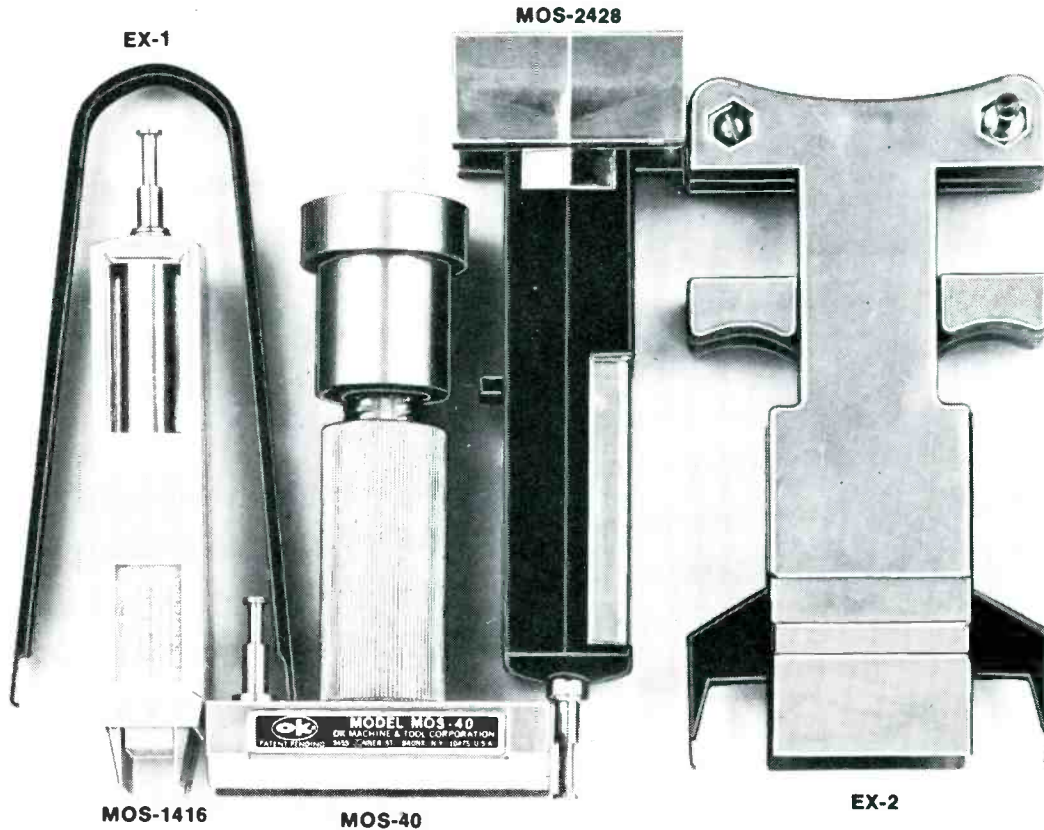

WK-7	COMPLETE IC INSERTER/EXTRACTOR KIT	\$29.95
------	------------------------------------	---------

INDIVIDUAL COMPONENTS

MOS-1416	14-16 PIN MOS CMOS SAFE INSERTER	\$ 7.95
MOS-2428	24-28 PIN MOS CMOS SAFE INSERTER	\$ 7.95
MOS-40	36-40 PIN MOS CMOS SAFE INSERTER	\$ 7.95
EX-1	14-16 PIN EXTRACTOR TOOL	\$ 1.49
EX-2	24-40 PIN CMOS SAFE EXTRACTOR TOOL	\$ 7.95

MINIMUM BILLING \$25.00. ADD SHIPPING CHARGE \$2.00. NEW YORK RESIDENTS ADD APPLICABLE TAX.

OK MACHINE & TOOL CORPORATION 3455 CONNER ST., BRONX, N.Y. 10475 (212) 994-6600/TELEX 125091

Circle (1) on Reply Card

Switch to ZENITH UNIVERSAL TRIPLERS

and get more than just a tripler...
get a complete package.



A95-5314	977-Z9500-A
ECG 500A	977-Z9500-A
ECG 521	800-791
ECG 522	977-Z9522
ECG 523	977-36
ECG 526A	977-Z9526-A
ECG 528	977-41
ECG 529	977-Z9529
ECG 530	977-Z9530
ECG 531	977-Z9531
ECG 532	977-Z9532
ECG 533	977-Z9533
ECG 534	977-Z9534
ECG 535	977-Z9535
ECG 536A	977-Z9536-A
ECG 537	977-Z9537
ECG 538	977-Z9538
ECG 539	977-Z9539

GE 521	977-Z9526-A
GE 522	977-Z9536-A
GE 523	977-Z9522
GE 524	977-Z9531
GE 525	977-Z9532
GE 526	977-Z9533
GE 527	977-Z9500-A
GE 528	977-36
GE 529	977-Z9529
GE 534	977-Z9534
GE 535	977-Z9535
GE 536	977-Z9537
GE 537	977-Z9538
GE 538	977-Z9539
GE 539	800-791
GE 540	977-Z9530

N2A	977-Z9529
N2A-1	977-Z9529
N2A-2	977-Z9529

SK 3301	977-Z9531
SK 3302	977-Z9533
SK 3303	977-Z9522
SK 3304	977-Z9500-A
SK 3305	977-Z9534
SK 3306	977-36
SK 3307	977-Z9529
SK 3308	977-Z9526-A

14B348-1	977-36
14B348-2	977-36
14B348-3	977-36
14B348-4	977-36
14B348-5	977-36

28-32-0X	977-Z9500-A
28-35-01	977-46

32-29778-2	977-Z9500-A
32-29778-3	977-Z9500-A
32-33057-2	977-Z9522

32-33057-3	977-Z9500-A
32-33057-4	977-Z9500-A
32-33057-5	977-Z9500-A
32-33094-1	977-Z9522
32-33094-2	977-Z9522
32-33094-3	977-Z9522
32-33094-4	977-Z9522
32-33094-5	977-Z9522
32-33094-6	977-Z9522
32-35894-1	977-Z9500-A
32-35894-3	977-Z9522
32-35894-4	977-Z9522
32-35894-5	977-Z9500-A
32-35894-6	977-Z9522
32-35894-7	977-Z9522
32-39091-1	977-36
32-39091-2	977-36
32-39091-3	977-Z9522
32-39091-4	977-36
32-39091-5	977-36
32-39091-6	977-36
32-39091-7	977-Z9526-A
32-39091-8	977-Z9526-A
32-39091-9	977-36
32-39704-1	977-Z9522
32-39704-2	977-Z9522

66F-159-1	977-Z9522
66F-159-2	977-Z9522
66F-159-3	
66X0060-1	977-Z9530
66X0060-2	977-Z9530
66X0060-3	977-36
76-14327-1	
76-14327-2	977-Z9522
76-14327-3	977-Z9522
76-14327-4	977-Z9522
76-14327-5	977-Z9522
76-14327-6	977-Z9522
76-14327-7	977-Z9522
76-14327-8	977-Z9522
86-106-3	977-Z9529
86-127-3	977-Z9529
86-127-4	977-Z9529
86-127-5	977-Z9529
86-127-6	977-Z9529
86-127-7	977-Z9529
86-127-8	977-Z9529
86-127-9	977-Z9529
86-127-10	977-Z9529
86-127-11	977-Z9529
86-127-12	977-Z9529
86-127-13	977-Z9529
86-127-14	977-Z9529
86-127-15	977-Z9529
86-127-16	977-Z9529
86-127-17	977-Z9529
86-127-18	977-Z9529
86-127-19	977-Z9529
86-127-20	977-Z9529
86-127-21	977-Z9529
86-127-22	977-Z9529
86-127-23	977-Z9529
86-127-24	977-Z9529
86-127-25	977-Z9529
86-127-26	977-Z9529
86-127-27	977-Z9529
86-127-28	977-Z9529
86-127-29	977-Z9529
86-127-30	977-Z9529
86-127-31	977-Z9529
86-127-32	977-Z9529
86-127-33	977-Z9529
86-127-34	977-Z9529
86-127-35	977-Z9529
86-127-36	977-Z9529
86-127-37	977-Z9529
86-127-38	977-Z9529
86-127-39	977-Z9529
86-127-40	977-Z9529
86-127-41	977-Z9529
86-127-42	977-Z9529
86-127-43	977-Z9529
86-127-44	977-Z9529
86-127-45	977-Z9529
86-127-46	977-Z9529
86-127-47	977-Z9529
86-127-48	977-Z9529
86-127-49	977-Z9529
86-127-50	977-Z9529
86-127-51	977-Z9529
86-127-52	977-Z9529
86-127-53	977-Z9529
86-127-54	977-Z9529
86-127-55	977-Z9529
86-127-56	977-Z9529
86-127-57	977-Z9529
86-127-58	977-Z9529
86-127-59	977-Z9529
86-127-60	977-Z9529
86-127-61	977-Z9529
86-127-62	977-Z9529
86-127-63	977-Z9529
86-127-64	977-Z9529
86-127-65	977-Z9529
86-127-66	977-Z9529
86-127-67	977-Z9529
86-127-68	977-Z9529
86-127-69	977-Z9529
86-127-70	977-Z9529
86-127-71	977-Z9529
86-127-72	977-Z9529
86-127-73	977-Z9529
86-127-74	977-Z9529
86-127-75	977-Z9529
86-127-76	977-Z9529
86-127-77	977-Z9529
86-127-78	977-Z9529
86-127-79	977-Z9529
86-127-80	977-Z9529
86-127-81	977-Z9529
86-127-82	977-Z9529
86-127-83	977-Z9529
86-127-84	977-Z9529
86-127-85	977-Z9529
86-127-86	977-Z9529
86-127-87	977-Z9529
86-127-88	977-Z9529
86-127-89	977-Z9529
86-127-90	977-Z9529
86-127-91	977-Z9529
86-127-92	977-Z9529
86-127-93	977-Z9529
86-127-94	977-Z9529
86-127-95	977-Z9529
86-127-96	977-Z9529
86-127-97	977-Z9529
86-127-98	977-Z9529
86-127-99	977-Z9529
86-127-100	977-Z9529

530165-1	977-Z9522
530165-2	977-Z9522
530165-3	977-Z9522
530165-4	977-Z9522
530165-5	977-Z9529
530165-6	977-Z9529
530165-7	977-Z9534
530165-8	977-Z9534
530165-9	977-Z9534
530165-10	977-Z9534
530165-11	977-Z9534
530165-12	977-Z9534
530165-13	977-Z9534
530165-14	977-Z9534
530165-15	977-Z9534
530165-16	977-Z9534
530165-17	977-Z9534
530165-18	977-Z9534
530165-19	977-Z9534
530165-20	977-Z9534
530165-21	977-Z9534
530165-22	977-Z9534
530165-23	977-Z9534
530165-24	977-Z9534
530165-25	977-Z9534
530165-26	977-Z9534
530165-27	977-Z9534
530165-28	977-Z9534
530165-29	977-Z9534
530165-30	977-Z9534
530165-31	977-Z9534
530165-32	977-Z9534
530165-33	977-Z9534
530165-34	977-Z9534
530165-35	977-Z9534
530165-36	977-Z9534
530165-37	977-Z9534
530165-38	977-Z9534
530165-39	977-Z9534
530165-40	977-Z9534
530165-41	977-Z9534
530165-42	977-Z9534
530165-43	977-Z9534
530165-44	977-Z9534
530165-45	977-Z9534
530165-46	977-Z9534
530165-47	977-Z9534
530165-48	977-Z9534
530165-49	977-Z9534
530165-50	977-Z9534
530165-51	977-Z9534
530165-52	977-Z9534
530165-53	977-Z9534
530165-54	977-Z9534
530165-55	977-Z9534
530165-56	977-Z9534
530165-57	977-Z9534
530165-58	977-Z9534
530165-59	977-Z9534
530165-60	977-Z9534
530165-61	977-Z9534
530165-62	977-Z9534
530165-63	977-Z9534
530165-64	977-Z9534
530165-65	977-Z9534
530165-66	977-Z9534
530165-67	977-Z9534
530165-68	977-Z9534
530165-69	977-Z9534
530165-70	977-Z9534
530165-71	977-Z9534
530165-72	977-Z9534
530165-73	977-Z9534
530165-74	977-Z9534
530165-75	977-Z9534
530165-76	977-Z9534
530165-77	977-Z9534
530165-78	977-Z9534
530165-79	977-Z9534
530165-80	977-Z9534
530165-81	977-Z9534
530165-82	977-Z9534
530165-83	977-Z9534
530165-84	977-Z9534
530165-85	977-Z9534
530165-86	977-Z9534
530165-87	977-Z9534
530165-88	977-Z9534
530165-89	977-Z9534
530165-90	977-Z9534
530165-91	977-Z9534
530165-92	977-Z9534
530165-93	977-Z9534
530165-94	977-Z9534
530165-95	977-Z9534
530165-96	977-Z9534
530165-97	977-Z9534
530165-98	977-Z9534
530165-99	977-Z9534
530165-100	977-Z9534

1464607-6	977-Z9532
1464607-7	977-Z9531
1464607-8	977-Z9531
1464607-9	977-Z9533
1464607-10	977-Z9533
1464984-1	977-Z9532
1464984-2	977-Z9532
1466860-1	977-Z9532
1466860-2	977-Z9537
1466865-1	977-Z9532
1826065-1	977-Z9532
1826065-2	977-Z9532
1826065-3	977-Z9531
S-88569	800-791
S-88593	800-791
S-91721	800-791

212-102	800-791
212-103	800-791
212-104	800-791
212-105	800-791
212-106	800-791
212-108	800-791
212-109	800-791
212-110	800-791
212-128	800-791
212-129	800-791
212-130	800-791
212-131	800-791
212-132	800-791
212-133	800-791
212-134	800-791
212-135	800-791
212-136	800-791
212-137	800-791
212-138	800-791
212-140	800-791
212-140-01	800-791
212-141	977-36
212-141	977-36
212-141-01	977-36
212-141-01	977-35
212-141-01	977-36
212-141-01	977-36
212-141-01	977-36
212-141-02	977-36
212-141-02	977-36
212-141-02	977-36
212-141-03	977-37
212-142	977-46
212-142	977-38
212-142-02	977-46
212-143	977-40
212-145	977-41
212-145-01	977-41
212-145-01	977-42
212-146	977-41
212-146-01	977-41
212-146-01	977-42
212-147	977-43
212-149	977-45
977-42	977-41

Now in stock at your Zenith distributor's — a full line of universal triplers.

Packaged with each Zenith tripler is a cross-reference guide with a no-nonsense numbering system that relates ECG®, GE, and RCA Universal lines and 22 other manufacturers to Zenith part numbers...plus detailed installation and safety instructions...and a wire tie and sealant at no extra cost.

That's why you get more than just a tripler when you switch to Zenith Universal Triplers.

See your distributor for Zenith's Universal Tripler Cross Reference Guide (#902-2011)...and Zenith's Universal Semiconductor Guide with over 150,000 cross-references!

ECG is a registered trademark of GTE SYLVANIA

The quality goes in before the name goes on®

Zenith Radio Corporation / Service, Parts & Accessories Division
11000 Seymour Avenue / Franklin Park, Illinois 60131

57-90	977-Z9530
57-98	977-Z9530
66F-054-3	977-Z9500-A
66F-054-4	977-Z9500-A
66F-112-1	977-Z9522
66F-112-2	977-Z9522
66F-181-1	977-Z9522

93D96-2	977-Z9500-A
93D96-3	977-Z9500-A
93D99-2	977-Z9538
93D99-3</	