

Electronic Servicing

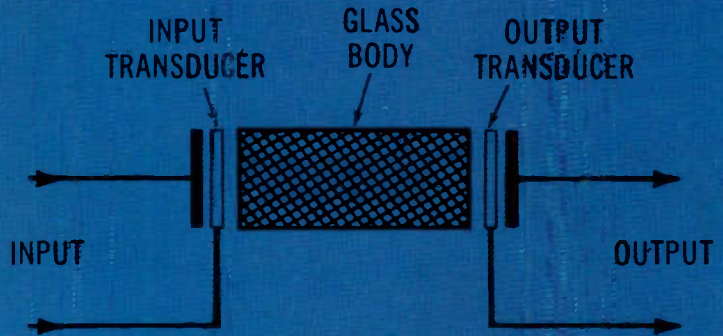

A HOWARD W. SAMS PUBLICATION

*One line
delay device*



THE SIGNAL IS DELAYED BY ONE HORIZONTAL LINE (63.5 μ S)

DOUBLE TRIGGERING

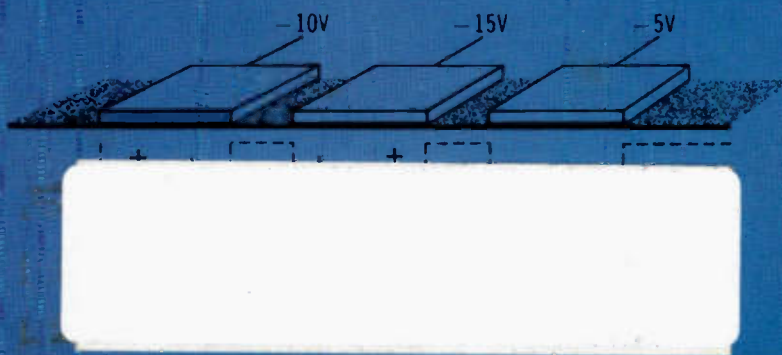
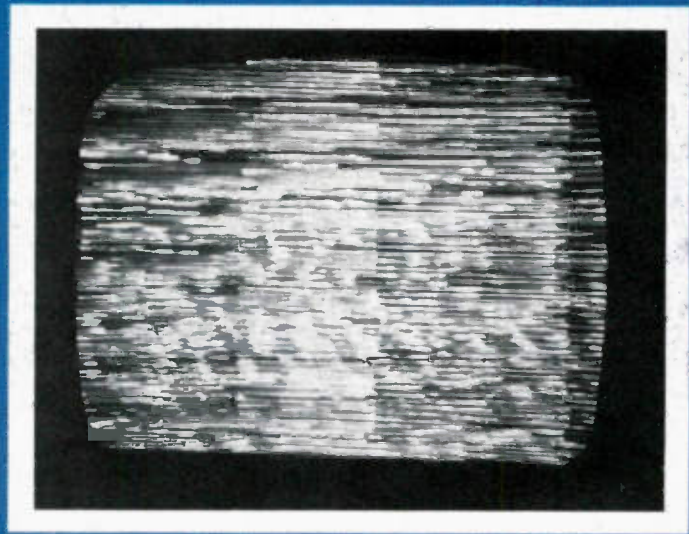

*Bucket
brigade*

The Best of Everything Has It's Price... Even Tuner Service!

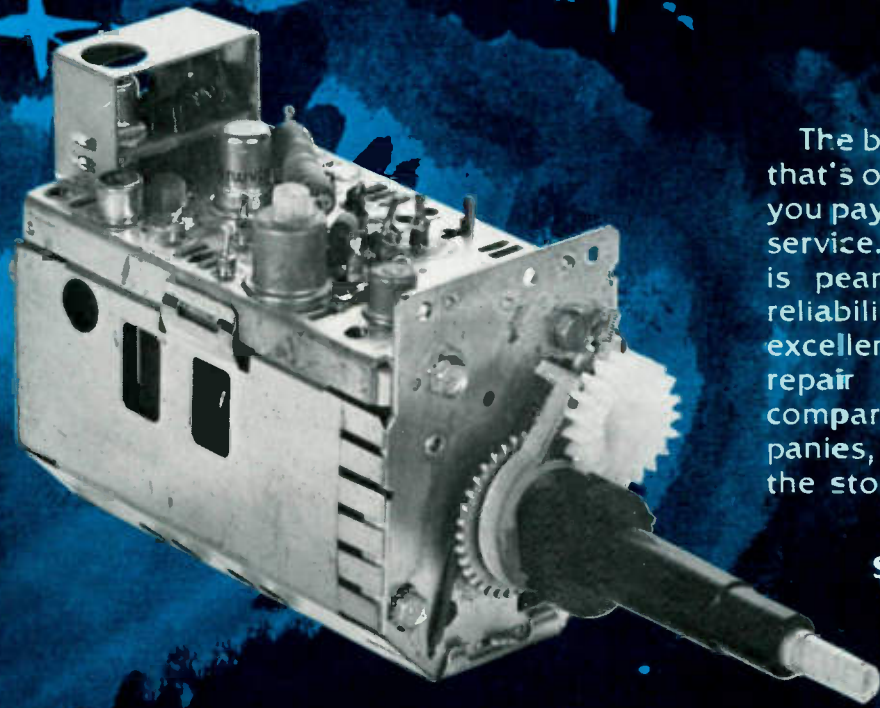

The best tuner repair service . . . that's our goal. You get only what you pay for even with tuner repair service. The price you pay at PTS is peanuts when you consider reliability and the standards of excellence we apply to every repair order. When you are comparing tuner service companies, price alone doesn't tell the story.

SAME DAY SERVICE
ORIGINAL OR
SUPERIOR PARTS
ONE YEAR
LIMITED WARRANTY

We Repair Them **All** . . . Any Make
Or Model . . . Color, Black & White,
Tube, Transistor or
Electronic/Varactor!

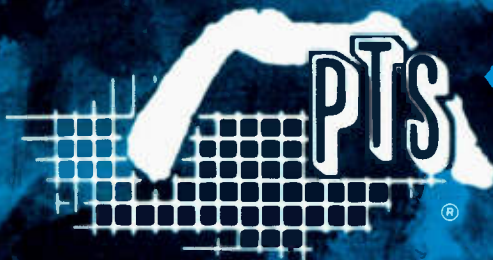

PTS ELECTRONICS, INC.

THERE'S A PTS SERVICENTER IN MOST MAJOR METROPOLITAN AREAS.
CHECK THE LIST AT THE RIGHT FOR THE ONE NEAREST YOU!

Circle (1) or Reply Card

PTS SERVICENTER GUIDE

MIDWEST

Home Office
BLOOMINGTON, IN 47401
 5233 S. Hwy. 37, P.O. 272
 812-824-9331
CLEVELAND, OH 44134
 5682 State Road
 216-845-4480
KANSAS CITY, KS 66106
 3119A Merriam Lane, P.O. 6149
 913-831-1222
MINNEAPOLIS, MN 55408
 815-W. Lake St., P.O. 8458
 612-824-2333
ST. LOUIS, MO 63130
 8456 Page Blvd., P.O. 24256
 314-428-1299
DETROIT, MI 48235
 13707 W. 8-Mile Rd.
 313-862-1783
GRAND RAPIDS, MI 49501
 1134 Walker Northwest
 P.O. 1435
 616-454-2754
CINCINNATI, OH 45216
 8172 Vine St., P.O. 16057
 513-821-2298
MILWAUKEE, WI 53218
 7211 Fond du Lac
 414-464-0789
COLUMBUS, OH 43227
 4005A E. Livingston
 614-237-3820
INDIANAPOLIS, IN 46202
 28 E. 14th St.
 317-631-1551
DAVENPORT, IA 52803
 2024 E. River Dr.
 319-323-3975
OMAHA, NE 68132
 5008 Dodge Street
 402-558-1800
CHICAGO, IL 60659
 5744 N. Western Ave.
 312-728-1800

SOUTH

ATLANTA, GA 30318
 1240 Techwood Drive N.W.
 P.O. 93887
 404-873-1787
JACKSONVILLE, FL 32210
 1918 Blanding Blvd., P.O. 7923
 904-389-9952
WASHINGTON, DC
 Silver Spring, MD 20910
 8880 Brookville Rd.
 301-565-0025
CHARLOTTE, NC 28225
 726 Seigle Ave., P.O. 5512
 704-332-8007
BIRMINGHAM, AL 35201
 210 N. 9th St., P.O. 1801
 205-323-2657
MEMPHIS, TN 38118
 3614 Lamar Ave., P.O. 18053
 901-365-1918
NORFOLK, VA 23504
 3118 E. Princess Anne Rd.
 804-625-2030
NEW ORLEANS
 Metairie, LA 70004
 3920A Airline Hwy., P.O. 303
 504-837-7569
TAMPA, FL 33690
 2703 S. Macdill, P.O. 14301
 813-839-5521
NASHVILLE, TN 37214
 2426 A Lebanon Rd.
 615-885-0688

NORTHEAST

SPRINGFIELD, MA 01103
 191 Chestnut, P.O. 3189
 413-734-2737
PHILADELPHIA
 Upper Darby, PA 19082
 1742-44 State Rd., P.O. 207
 215-352-6609
PITTSBURGH, PA 15202
 257 Riverview Ave., W. P.O. 4130
 412-761-7648
E. PATERSON, NJ 07407
 158 Market St., P.O. 421
 201-791-6380
BUFFALO, NY 14212
 993 Sycamore St., P.O. 1241
 716-891-4935
BOSTON
 Arlington, MA 02174
 1167 Massachusetts Ave., P.O. 371
 617-648-7110
BALTIMORE, MD 21215
 5505 Reisterstown Rd.
 301-358-1186

PACIFIC

SACRAMENTO, CA 95841
 4351D Auburn Blvd., P.O. 41354
 916-482-6220
SAN DIEGO, CA 92105
 5111 University Ave., P.O. 5794
 714-260-7070
LOS ANGELES, CA 90023
 4184 Pacific Way
 213-266-3728
PORTLAND, OR 97213
 5220 N.E. Sandy Blvd.
 P.O. 13096
 503-282-9636
SEATTLE, WA 98188
 988 Industry Dr. (Bldg. 28)
 P.O. 88831 - Tukwila Branch
 206-575-3060
SAN JOSE, CA 95112
 466 Reynolds Circle
 408-289-1117

MOUNTAIN

DENVER
 Arvada, CO 80001
 4958 Allison St., P.O. 672
 303-423-7080
SALT LAKE CITY, UT 84106
 1233 Wilmington Ave.
 P.O. 6218
 801-484-1451
PHOENIX, AZ 85009
 2916 West McDowell Rd.
 602-278-1218

SOUTHWEST

LONGVIEW, TX 75601
 110 Mopac Rd., P.O. 7332
 214-753-4334
OKLAHOMA CITY, OK 73106
 3007 N. May, P.O. 60566
 405-947-2013
HOUSTON, TX 77207
 4326 Telephone Rd., P.O. 26616
 713-644-6793

Electronic Servicing®

Contents

- 19 Servicing Sylvania Color TV, Part 7—Details of sound-IF and audio circuits concludes our coverage of the Sylvania E44 chassis—Gill Grieshaber.**
- 25 Service Management Seminar, Part 8—One valuable tool for measuring the health of your business is "ratio analysis"—Dick Glass.**
- 28 Curing Horizontal Oscillator Drift, Part 2—Problems of horizontal oscillator drift or wrong frequency can be solved more easily when you know which components to suspect—Wayne Lemons.**
- 37 The Basics Of Industrial Electronics, Part 14—Toggles in cascade can count with binary numbers—J.A. "Sam" Wilson.**
- 41 Servicing Betamax Videotape Recorders, Part 4—Comb filters solve the problem of crosstalk during chroma playback—Harry Kybett.**
- 47 Sam Wilson's Technical Notebook—Sam explains the evolution of a simple magnetic memory, and gives interesting information about charge-coupled devices—J.A. "Sam" Wilson.**

About the Cover—Illustrations for several articles were designed by Dudley Rose, our Art Director.

DEPARTMENTS

- | | |
|-------------------------------|-------------------------------------|
| 4 Electronic Scanner | 56 Product Report |
| 8 Troubleshooting Tips | 57 Audio Systems |
| 10 Reader's Exchange | 58 Antenna Systems |
| 14 Puzzle | 59 Catalogs & Literature |
| 16 Symcure | 60 The Marketplace |
| 36 Cartoon Corner | 60 Advertisers' Index |
| 55 Test Equipment | |

Second class postage paid at Shawnee Mission, Kansas and additional mailing offices. Published monthly at 9221 Quivira Road, Overland Park, Kansas 66212 by Interloc Publishing Corp., 9221 Quivira Road, Overland Park, Kansas 66212. Send Form 3579 to 9221 Quivira Road, P.O. Box 12901, Overland Park, Kansas 66212.

©Copyright, 1978, Howard W. Sams & Co., Inc. All rights reserved. Material may not be reproduced or photocopied in any form without written permission of publisher.

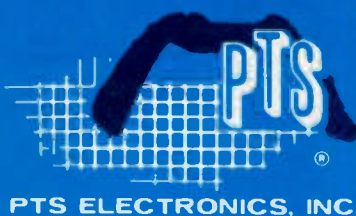

PTS ELECTRONICS, INC.

Smaller makes sense.



In the tradition of mini-computers and mini-skirts, great small products usually evolve from larger packages.

The new 8020A digital multimeter carries on the Fluke tradition of precision bench-top instrumentation, with this handheld, 13-oz. DMM. Same quality and value, smaller package. And only \$169.*

Your 8020A goes on call with you in your pocket, briefcase, or tool kit. Wherever your job takes you and your 8020A, you can count on bench-instrument performance.

Small in size, but big in capability, with features like 2000-count resolution, transient protection to 6000V,

six resistance ranges to 20 M Ω . Plus, an exclusive conductance capability for leakage measurements to 10,000 M Ω !

And, traditional Fluke quality and accuracy are guaranteed for a full year. Parts and service available worldwide. And *that's* meaningful when it's from the recognized leader in DMMs.

Get your hands on one. Call (800) 426-0361, toll free, and we'll tell you the location of the closest Fluke office or distributor.

*U.S. price.

Fluke 8020A DMM for Field Service: \$169.

2507-7105



Circle (3) on Reply Card

Electronic Servicing

Editorial, advertising and circulation correspondence should be addressed to: 9221 Quivira Road, P.O. Box 12901, Overland Park, Kansas 66212 (a suburb of Kansas City, Missouri). (913) 888-4664.

EDITORIAL

CARL H. BABCOKE, Editor
CINDY NELSON, Managing Editor
JOANN VELLA, Editorial Assistant
DUDLEY ROSE, Art Director

EDITORIAL ADVISORY BOARD

LES NELSON, Chairman
Howard W. Sams & Co., Indianapolis
JOE A. GROVES, Technical Consultant
Howard W. Sams & Co., Indianapolis

CIRCULATION

JOHN C. ARNST, Director
EVELYN ROGERS, Manager



Member, American Business Press
Member, Audit Bureau of Circulations

ADMINISTRATION

GEORGE H. SEFEROVICH, President
GEORGE LAUGHEAD, Publisher

ADVERTISING SALES

Overland Park, Kansas 66212
(a suburb of Kansas City, Missouri)
Phone: (913) 888-4664

MARILYN CARROLL, Production
Regional and Advertising Sales Offices
with Advertising Index

ELECTRONIC SERVICING (with which is combined PF Reporter) is published monthly by Intertec Publishing Corp., 9221 Quivira Road, Overland Park, KS 66212.

ELECTRONIC SERVICING is edited for technicians who repair home-entertainment electronic equipment (such as TV, radio, tape, stereo, and record player) and for industrial technicians who repair defective production-line merchandise, test equipment, or industrial controls in factories.

Subscription prices to qualified subscribers: 1 year—\$8.00, 2 years—\$13.00, in the USA and its possessions. All other foreign countries: 1 year—\$11.00, 2 years—\$19.00. Subscription prices to all others: 1 year—\$25.00, 2 years—\$50.00, in the USA and its possessions. All other foreign countries: 1 year—\$34.00, 2 years—\$68.00. Single copy price \$2.25; back copies \$3.00. Adjustment necessitated by subscription termination to single copy rate. Allow 6-8 weeks delivery for change of address. Allow 6-8 weeks for new subscriptions.



INTERTEC PUBLISHING CORP.
Subsidiary of HOWARD W. SAMS & CO., INC.

ELECTRONIC SERVICING

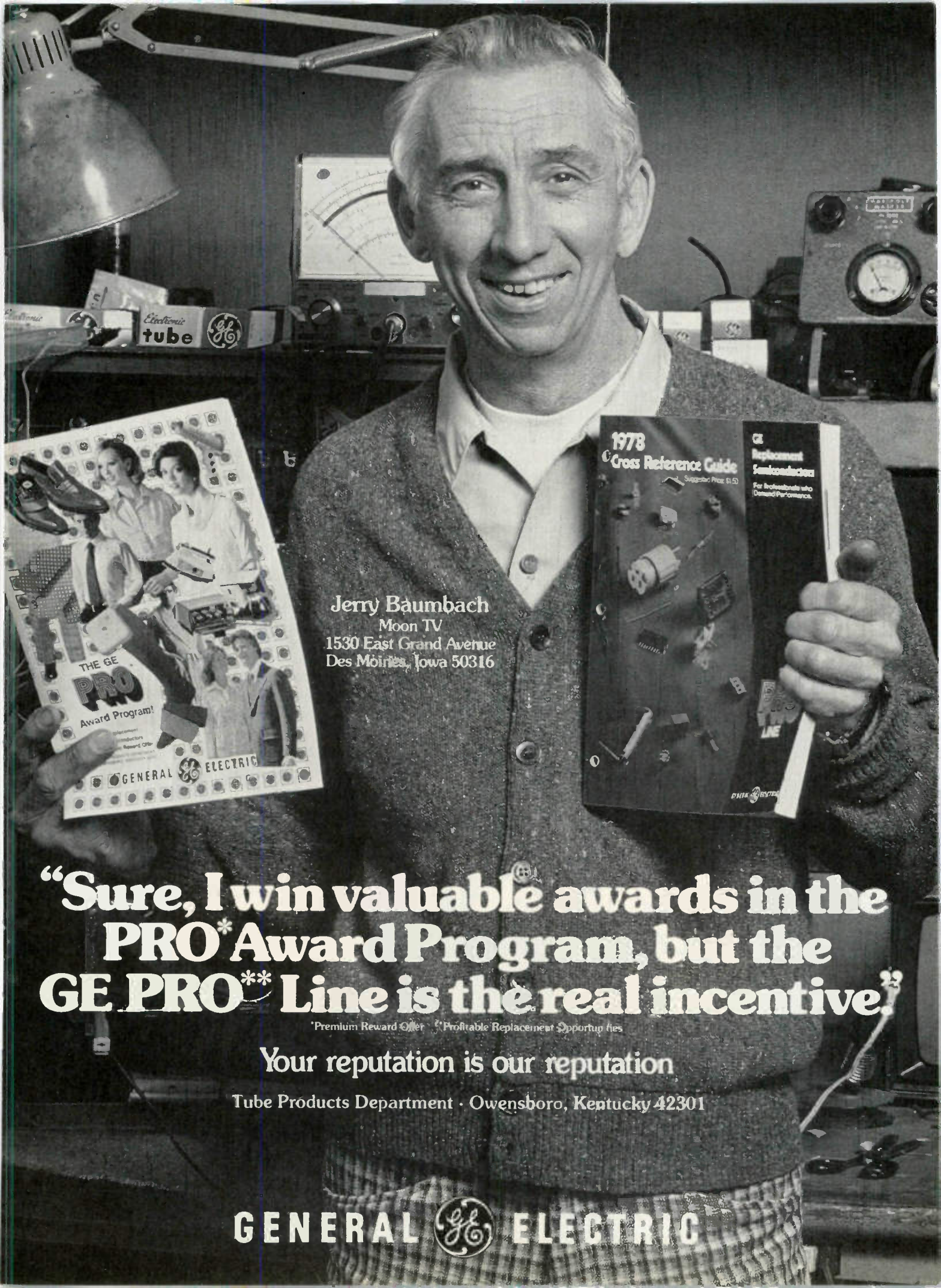

Jerry Baumbach
Moon TV
1530 East Grand Avenue
Des Moines, Iowa 50316

“Sure, I win valuable awards in the PRO* Award Program, but the GE PRO Line is the real incentive.”**

*Premium Reward Offer **Profitable Replacement Opportunities

Your reputation is our reputation

Tube Products Department · Owensboro, Kentucky 42301

GENERAL  ELECTRIC

electronicscanner

news of the industry

Another serious attempt at designing a flat-screen color picture tube is the joint undertaking of GTE Consumer Electronics and Lucitron Incorporated, a new company formed by three engineers previously with Zenith. A monochrome version has been demonstrated, and a color tube is expected to use the same principles.

Digital techniques and equipment are replacing analog in tape recording and communications. Multi-track studio tape recorders now can have far less noise and distortion in machines using digital signals both for recording and for the mixing of many tracks during playback. Higher speed transmission of cross-country data is waiting only on the completion of all-digital networks that don't require modem analog conversion. Digital telephones permit two or three extension phones in a home, without crosstalk. Digital business phones make possible dialed conference calls and automatic direct dialing.

Black readout bars of a wristwatch with a Liquid-Crystal Display (LCD) are switched as needed to imitate the positions of conventional clock hands. This latest digital-watch novelty is in the new Texas Instruments line.

Three RCA chassis designs received high ratings from the NESDA/ISCET serviceability inspection team recently in Las Vegas. CTC92A was given a "good" rating, while the CTC93D and the CTC88AC each received "excellent" ratings.



Shown inspecting an RCA chassis for serviceability are (from left): Don Winchel, CET; Dean Mock, CET; Jack Lang, CET; R. E. Eddy (RCA); Hal Robbins, CET; Frank Grabiec, CET; and Ed Burroughs, CET.

continued on page 6

Only eight TV tubes can make a warehouse out of your backroom.



*Limited warranty. Labor not included.

To offer fast replacement for 385 different TV tubes, you'd have to open a warehouse. Or, you could open eight Sylvania picture tube cartons.

Our eight Universal Color Bright tubes are designed as

direct replacements for 385 bonded safety plate picture tubes. And they're designed so well that they're offered with a five-year limited warranty.*

Call your Sylvania distributor to stock up on Color

Bright tubes. Then, you won't have to wait days for your customer's new tube to be delivered.

You can order a Color Bright for immediate delivery right from your own backroom.

SYLVANIA

Electronic
Components

GTE

Circle (4) on Reply Card

continued from page 4

Super-performance recording tapes and the matching audio recorders might be on the market by this winter. With this combination, a 1-7/8 inch-per-second cassette machine could give response and low noise of present top-of-the-line 7½ IPS reel-to-reel machines. The general methods of achieving this large improvement have been known for several years. But, two serious problems were found. Pure iron (not oxide or alloy) is required to coat the tape base. Unfortunately, pure iron rusts rapidly. Several companies have solved the rusting problem, but the method is a secret. Also, recording heads for these new iron tapes must be supplied with double the power of present heads. Heads that can handle the higher power have been developed. Compatibility is in one direction only. Iron tapes recorded on the new-type machines can be played on any cassette machine; however, iron tapes can't be recorded successfully by present-day machines. Tandberg (recorder maker) and 3M Company (tape manufacturer) were the first to announce the production of these new products. Since then, several others have said they also will produce machines and tapes. Eventually, the new iron tapes are expected to provide equal benefits for computers and video recorders.

Hitachi has agreed to supply Zenith with color video cameras for use with home videotape recorders. The camera will have a single image-pickup tube, with a camera-control unit built into the camera. These cameras are scheduled to reach Zenith in time for the Christmas selling season.

Charge-Coupled Devices (CCD) are said to have a higher memory capability than any other type of semiconductor. An article in *Electronic Design* states that CCD memory capacity is about four times the capacity of Random-Access Memories (RAMs). Since the digital information is stored as a capacitance charge, only low power is required, and a "refresh" is necessary after each readout. (Refer to *Technical Notebook*, in this issue.)

Distance measurements between ground stations and NASA's "Beacon" satellite have detected a movement between the two sides of the San Andreas Fault in California. Ruby lasers are used in a triangulation method to measure distances from two ground stations and the satellite. During the past four years, the ground stations have become closer by 36 centimeters. This is more than the predicted 5 centimeters per year, and raises fears of a possible fissure between San Diego and Los Angeles. An additional ground station is to be added in Utah during 1980 to allow greater accuracy of earthquake predictions.

"Win some; lose some," is the story from California, following the adoption of Proposition 13 which limits the tax on property. A rider attached to the property bill cancelled the repeal of the controversial property-inventory tax. This tax is placed on 50% of the goods and products in distributors' and dealers' inventories. The tax was scheduled to be phased out over the next five years. Now, however, part of the saving from real-estate taxes will be spent on the inventory tax. □



THE FASTEST WAY TO ORDER GENERAL ELECTRIC TV PARTS IS FREE.

General Electric has the magic number. A toll-free hotline connecting you directly with the GE Parts Center in most all areas. And the simple key to using it is charging your order to VISA, Master Charge or an approved GE Open Credit Account.

That's one way we're making your business easier. But it's not the only way. We're continuing to increase stocks throughout our national computer-linked parts distribution system. And striving to fill orders faster than ever before.

To make GE Performance Television even easier to service, we're packing a new Mini Manual into the back of every color set. It gives

you the right schematic diagram, parts list, symptom repair information and safety features for the set you're working on. Which makes your job a lot easier.

For our list of toll-free numbers and everything you need to order GE TV parts fast fill out and send in the coupon below. **It's our business to make your business easier.**

"DUTCH" MEYER
GENERAL ELECTRIC TELEVISION
ONE COLLEGE BOULEVARD
PORTSMOUTH, VIRGINIA 23705

Please send the following:

- Brochure covering GE toll-free ordering numbers.
- Listing of Parts Distributors.
- Master Charge and VISA information.
- GE Open Credit Account information.

Name _____

Service Company _____

Address _____

City _____ State _____ Zip _____

GENERAL  ELECTRIC

troubleshootingtips

Poor vertical linearity General Electric UA (B + W) (Photofact 1353-2)

Linearity at the top of the picture was expanded, while the raster lacked two inches of reaching the bottom, and the sweep ended there with foldover.

Both the height and vertical-linearity controls made noticeable changes, but neither could correct the problem. Also, the vertical-hold control worked okay.

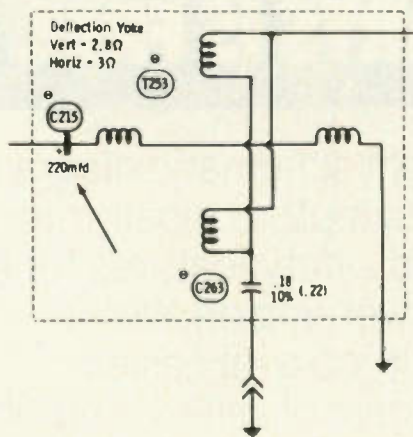

During resistance tests, the linearity and height controls checked within tolerance, as did the oscillator, feedback amplifier, and buffer transistors. Substitution of a new vertical-output transistor produced no change.

Capacitors C208 and C209 shape the sawtooth, C210 affects the sawtooth shape, and C207 couples the output signal back to the oscillator. Therefore, all seemed likely suspects. I disconnected one end of each and substituted new ones; unfortunately, there was no change.

No suspects remained except the output transformer, yoke, and the yoke-coupling capacitor. Taking the easiest one first, I disconnected the C215 capacitor. It checked okay with my ohmmeter; but when a new one was tried, the bad linearity was gone. Probably the total capacitance had decreased, but it was not completely open.

Roger Redden
Beaver, West Virginia

Part of the raster blacked out Panasonic AN-49, etc.

The right half of the raster was blacked-out, and neither vertical nor horizontal would lock properly.

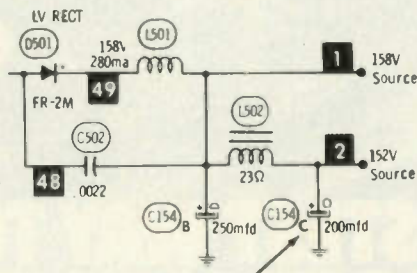

After some futile testing, I found an open filter capacitor, and a new "can" brought back good performance.

I was surprised that a filter capacitor could cause bad shading and poor locking, since most bad filters produce hum bars.

Jim Riley
Vincentown, New Jersey

Editor's Note: Usually a shaded or blacked-out raster can be caused *only* by the one filter that bypasses the B+ going to the damper (the horizontal-output B+ supply). Filters nearer the B+ diode rectifier do produce hum bars. Electrolytics with poor power factor have been known to cause minor shading and picture bending.

Double troubles Sylvania EO1-17

(Photofact 1251-3)

At first, the color TV had no raster, and a lack of light in the

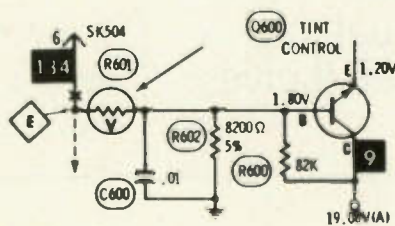

neck of the picture tube indicated a burned-out heater.

But, I wanted to be certain of such an expensive diagnosis, and my picture-tube tester proved the tube was okay.

AC-voltage checks at the CRT heater pins showed no heater voltage. A separate heater transformer supplies the picture tube, and resistance tests proved the primary was open.

After a new transformer was installed, the picture worked normally, except the tint control had very little effect. More tests finally pinpointed a low resistance in R601, the Voltage-Dependent Resistor (VDR) between the tint control and the base of Q600, the tint amplifier. Q600 was overbiased into full conduction so that adjustment of the tint control made no difference.

After R601 was replaced, the entire TV worked as it should.

T. Schilsky
Masonville, New Jersey

No picture or sound Transformerless TV receivers

One common complaint after a storm with lightning is no sound and no picture. However, the technician notices immediately that the tube heaters are working.

Usually, the defect will be a B+ diode rectifier which shorted from a line transient, and this short promptly blows the fuse or the fuse resistor.

Therefore, I recommend that you always replace the B+ diode (or all rectifiers, if there are more than one) before the power is applied after you install a new fuse device.

Some of these diodes will check shorted, but others will be apparently okay (according to an ohmmeter), then continue to cause an overload.

Another source of problems is the diode used for instant-on operation. So, I advise you to replace that diode also during such repairs.

Joseph Rotello, Jr.
Tucson, Arizona

now 3-strong

Xcelite® family of attaché tool cases



TC-150/ST

And here's the newest addition... Model TC-150/ST... containing an intermediate assortment of tools for the technician, serviceman, or field engineer. It contains 52 items in all, including 24 famous Xcelite "Series 99" interchangeable-blade tools, a broad variety of other Xcelite Professional screwdrivers, nutdrivers, pliers, cutters, strippers, measuring tapes, and specialized electronic tools, plus the Weller® Cordless Soldering Iron and recharger, an added convenience where outlets aren't accessible. Tools are mounted in see-thru pockets on removable pallets in a durable, attractive case with Whiskey-tan Marvelon exterior and sun-tan vinyl lining. Plenty of extra space for additional tools, prints and manuals! Solid brass hardware and padded handle are additional quality touches.

It joins the other members of the family... Model TC-100/ST, the "big daddy" of Xcelite's cased tool sets, with the greatest variety—a total of 86 types and sizes of drivers, wrenches, pliers, cutters, strippers... and Model TC-200/ST, the 37-piece set that's unequalled in economy and value.

See the new TC-150/ST at your distributor now. And ask for Xcelite literature, which will give you a detailed listing of the contents of all three Xcelite Attaché Tool Cases.



TC-100/ST



TC-200/ST



The Cooper Group
Electronics Division

WELLER® · WISS® · XCELITE®

P.O. BOX 728, APEX, NORTH CAROLINA 27502, 919/362-7511

reader's exchange

There is no charge for listing in *Reader's Exchange*, but we reserve the right to edit all copy. If you can help with a request, write direct to the reader, not to *Electronic Servicing*.

For Sale: Sencore SM152 sweep/marker generator, \$175; and Sencore TF-1S1 transistor tester, \$60. Both in A-1 condition, with cables and manual. Val Obal, 3201 South 73, Omaha, Nebraska 68124.

For Sale: Rider's early volume I, 1919-27, 200 pages, \$15; RCA service data 1922-32, 200 pages, \$15; Radiola manual 1922-30, 100 pages, \$10; Rider's radio volume XII, \$7.50; new Rider's TV volumes 9 and 14 in original box, \$12.50 each; and new 864, VT24, or 30 tubes, \$5 each. Antique Radio Shop, 3403 Broadway, Long Beach, California 90803.

For Sale: Eighty assorted good, boxed, TV tubes for 1955 to 1968 sets. Will ship insured and postpaid for \$14. S. Stanton, 428 West Roosevelt Boulevard, Philadelphia, Pennsylvania 19120.

For Sale: Conar instrument communications receiver model 500 and communications transmitter model 400, both for \$35 plus transportation. D. Shevtchuk, One Lois Avenue, Clifton, New Jersey 07014.

For Sale: Nearly complete set of Rider's manuals. Make offer for all or part. John Thacker, 7801 Horatio, McLean, Virginia 22101.

For Sale: One tube caddy with 300 tubes (80% are television tubes) valued at \$1,650, will sell for \$450 plus COD and shipping charges. List of tubes furnished on request. City Radio & TV Service, 205 North Donley, Tulia, Texas 79088.

Needed: Remote control microphone (part 570014.1) for Magnavox T911 chassis. Electronic Emergency Ward, 1315 Park Avenue, Plainfield, New Jersey 07060.

Needed: *Electronic Servicing* magazine issues from November 1974 to April 1978. Rejean Mathieu, P.O. Box 1601, Senneterre, Quebec, Canada JOY 2M0.

For Sale: RCA 10J106 color test jig, \$172; B&K-Precision 520B transistor tester, \$90; B&K 667 tube tester, \$90; and other equipment. Richard J. Dugo, 29 Mill Street, Dansville, New York 14437.

Needed: A service and instruction manual for a model 880 Amphenol Stereo Commander. Will buy, or copy and return. The Joseph M. Zamoiski Company, 1101 DeSoto Road, Baltimore, Maryland 21223.

For Sale: Nearly-new B&W picture tube 24CP4A(TP/QP/ADP/VP/XP4), best offer. M. Danish, Mike's Repair Service, PO Box 217, Aberdeen Proving Ground, Maryland 21005.

Needed: Information about charging NiCad batteries. I have eight 2-ampere-hour cells in series for 9.5 volts. What charging rate should I use? Know of any books about NiCad batteries? Elmer L. Mosley, 720 Poplar, Kenova, West Virginia 25530.

Needed: CRT calibration screen for an RCA scope model WO-56A, a low-cap probe model WG-216B, and a WG-291 demodulator probe. George R. Hinkfoth, Route 3, Box 1000, Rhinelander, Wisconsin 54501.

For Sale: B&K-Precision Servicemaster 1040, RF signal generator E200D, and 1801 frequency counter. All slightly used. Art Sannino, 775 Middletown, North Haven, Connecticut 06473.

Needed: Used Motorola Training Institute correspondence course. Tom Bush, 8520 Lake Atkinson Drive, Tallahassee, Florida 32304.

Needed: An operable used deflection yoke, part number 51-17570-2 for a D05-1 Sylvania color TV. Harold V. Ratcliff, Jr., 3424 Winged Foot Court, Dallas, Texas 75229.

For Sale: RCA Radiola III, in excellent working condition; with original service manual, two WD11 tubes, and two sets of earphones. Robert G. Thein, 7215 Route 212, Saugerties, New York 12477.

For Sale: B&K-Precision 151 transistor checker, \$50; Hickok VTVM model 470, \$25; Sencore 167 substituter, \$75; B&K-Precision capacitor Analyst model 801, \$100; and these factory-built EICO instruments: 435 scope, \$100; 377 sine/square generator, \$40; and model 369 sweep/marker generator, \$100. Lionel Murmur, 15 Knox Terrace 2C, Wayne, New Jersey 17470.

For Sale: Delta FET VOM, \$25; Heath 0-12 lab scope, \$25; and Heath CO-1015 ignition scope, \$100. All items in perfect condition; shipped postpaid. David Minsk, 24 Rayton Road, Hanover, New Hampshire 03755.

Needed: Schematic and manual for Tektronix type 533A oscilloscope. Will buy original or copy, or will copy and return. Tech-Craft, 88-57 75th Street, Woodhaven, New York 11421.

For Sale: 130 issues of *Radio Electronics* (1966 to present), 200 issues of *Popular Electronics* (1960 to present), and 94 issues of *Electronics World* (1964 to 1971) all perfect, \$75. Tech-Craft, 88-57 75th Street, Woodhaven, New York 11421.

For Sale: B&K-Precision TV Analyst model 1077B, excellent condition, 1 year old, with all cables and accessories. Price negotiable; must sell. Albert M. Parry Jr., Box No. 138, Andrews Road, Crapo, Maryland 21626.

Needed: Setup or instruction book for a Jackson tube tester model 115. Will buy, or copy and return. Dennis Mohr, 803 North Albert, St. Paul, Minnesota 55104.

Needed: One 11-pin magnal tube socket for a 2AP1 CRT. Homer Tilton, Box 401, 3401 Camellia Drive, Temple, Texas 76501.

For Sale: B&K-Precision 415 sweep marker generator, \$250; 747B tube tester, \$150; 177 VTVM, \$75; 466 CRT checker, \$94. Sencore TC28 tube transistor checker, \$100; UPS-164 charger, \$130; FE149 senior FE meter, \$100. Randall's Radio-TV, P.O. Box 1167, 12020 Southeast Dixie Highway, Hobe Sound, Florida 33455.

For Sale: Hickok 810 transistor radio generator, \$95; Jud Williams model A curve tracer, \$60; Beltron restorer, extra sockets, \$200; CREI (Conar) model 255 triggered scope, \$200; Triplett 3441A scope, \$90; RCA 155C modulation scope, \$50; Simpson 330 tube tester, \$25; Military VOM, \$25; over 2000 tubes, \$1000. Randall's Radio-TV, P.O. Box 1167, 12020 Southeast Dixie Highway, Hobe Sound, Florida 33455.

For Sale or Trade: B&K-Precision 1077B, \$225; B&K 415, \$225; Sencore SG165, \$450; includes all cables probes and manuals, all in perfect condition, and priced without shipping. Tom Denson, 7736 Deerfield Cove, Southaven, Mississippi 38671.

For Sale: Sencore DVM-37 with spare leads and RF probe, excellent condition, \$100. Charlie Perry, 1401 St. Johns Drive, El Paso, Texas 79903.

For Sale: Grantham School of Engineering course, Semester 1, with a like-new Pickell slide rule and leather case, \$29. Smith 3A, 8636 Grand, River Grove, Illinois 60171.

Needed: B&K-Precision 1040 CB Servicemaster, state condition and price. Murray Goldstein, 8842 Grange Hill Road, Sauquoit, New York 13456.

For Sale: Antique model 904 Crosley 9-inch TV-FM with Mallory Rollercoil continuous tuner, with tech data, \$150; was reconditioned before storage, believed OK, as-is. Send \$5 if info wanted first. Also, miscellaneous military surplus test equipment; no list, what do you need? Littell, Rural Route 2, Arcanum, Ohio 45304.

For Sale: Electro power supply, model N; old radios, 1920s through early 1950s. Terry Rohler, 3501 Bath Court, Woodbridge, Virginia 22193.

Needed: Schematic and calibration information for Electronic Designs model 190 test oscillator. Will buy, or copy and return. F. Putman, 5374 South Huron, Littleton, Colorado 80120.

For Sale: B&K-Precision 1470 dual-trace solid-state 10-MHz triggered scope, like new, \$400 FOB. Or trade for B&K 1474 or Leader LB0520. Phil Schrock, 84343 Hilltop Drive, Pleasant Hill, Oregon 97401.

Needed: Flyback transformer for Emerson model 1232 TV. Television Service Company, 121 West 13th, Crete, Nebraska 68333.

Needed: Operating instructions and/or schematic for Superior Instrument Company, model TV-50, Genometer Rf signal generator. Also, schematic for RH Macy & Co. model MB-54 radio/phono circa 1930. Will copy and return. Stan Lopes, 1201 Monument Blvd., Concord, California 94520.

continued on page 12

**To Be
More Than
Exact . . .**

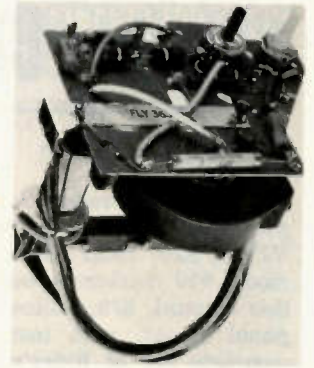

SPECIFY THORDARSON

Improve exactness with Thordarson replacements. Choose from the industry's widest selection of voltage multipliers, flame retardant flybacks and yokes. They conform perfectly to the original. From mounting holes to wiring color code. Plus usually superior to the original they replace because they are quality engineered and built better. And Replacement is fast and easy with accurate, constantly updated Thordarson cross-reference data.

Satisfy more customers with Thordarson exact replacements. Contact your Thordarson distributor and place your order today.

THORDARSON

THORDARSON MEISSNER, INC.

Electronic Center
Mt. Carmel, Illinois 62863



In Canada—GTE Sylvania Canada Corporation

Circle (6) on Reply Card



A Platt tool case won't fall apart at the seams because there are no seams.

Unlike other tool cases, the pockets on a Platt pallet* are molded. There are no seams, stitches or rivets to tear loose. It's a one-piece unit that's practically indestructible.

The case itself comes in tough, lightweight ABS Thermoplastic or rich looking vinyl reinforced by ABS Thermoplastic.

Platt also has rugged hardware. Like an aluminum rim for extra strength. Steel core handles. And tough brass locks.

Inside there are compartments for larger tools, parts boxes and testing equipment. And multiple lid pockets for papers and order book.

Both the case and pallet are guaranteed for 5 years.

Contact us for complete information on Platt's full line of tool cases and your nearest distributor.

platt

*Pat. No. 3,880,285

Cases for business and industry.
2301 S. Prairie Ave., Chicago, Ill. 60616 (312) 225-6670

Circle (7) on Reply Card

reader's exchange

continued from page 11

For Sale or Trade: Sylvania model 500 TV-sweep generator, new in original carton, \$75; EICO 221 VTVM, \$20; EICO 320 signal generator, \$25; Hickok model 610 marker/sweep TV generator, with instruction manual, \$75; Philco VTVM with 9-inch meter for panel mount, with instruction manual, \$40; and a complete set of Rider's TV manuals—volumes 1-27, with index, \$150. Certified TV, 5519 New Utrecht Avenue, Brooklyn, New York 11219.

Needed: Schematic for Sencore caddy-bar junior model number CG22. Active TV, 14547 South Halsted, Harvey, Illinois 60426.

Needed: Service or operating manual for Precise power-lab model 713. Roger Mosley, de Young Museum, Golden Gate Park, San Francisco, California 94118.

Needed: Schematic for Knight solid-state Star Roamer II, five-band receiver. Tiny's Radio & TV, 18606 Gable, Detroit, Michigan 48234.

Needed: Rider's Perpetual Troubleshooters Manuals volumes 1 and 23; Official Radio Service Manuals by Gernsback; antenna books by Williams or LaPort; and RCA service data, volumes 1, 2, 3, etc. Ken Hanson, 3403 Broadway, Long Beach, California 90803.

For Sale or Trade: UTC audio transformers, ADC and WE telephone repeater transformers, B&K-Precision TV Analyst, \$65; Eico 380 color generator, \$75; VU meters, many components and tubes (send for list). Norman Round, 33 Franklin, Lawrence, Massachusetts 01840.

For Sale or Trade: B&K-Precision 1076 TV Analyst in excellent condition, with manual, cables, and accessories. Asking \$150, or trade for field strength meter. Richard Lavalley, 4 Gleason Road, Northampton, Massachusetts 01060.

Needed: One Racon model UT-8H public address speaker. Harold F. Hill, 52 Wa Wa Avenue, Ripon, Wisconsin 54971.

Needed: B&K-Precision 415 sweep/marker generator, 747B tube tester, and 5-inch scope. Should be late models and reasonably priced. Charles Hancuff, Rural District 3, Meadville, Pennsylvania 16335.

For Sale: 33 CX301A Cunningham (new, original cartons), 9 UX200, 16 CX200, 16 UX201A, 11 112A, 9 FM-1000 Philco, 4 299 Philco, 1 UX199, 1 62-5 Majestic, 3 864, 1 373 Sparton, 1 445 Audion, and 3 UX120. All guaranteed to be satisfactory. Goodwin Radio Shop, Odd Fellows Nursing Home, Mattoon, Illinois 61938.

Needed: Address of a wholesaler of power transformers for imported stereos, tape players, AM/FM radio combinations, such as Gran Prix, Sounddesigns, Realtone, etc. Sam Fiorino, 227 South Mulberry Street, Du Quoin, Illinois 62832.

Test with the professionals.

Our Directional RF Wattmeters are the choice of professional RF engineers everywhere. Can discriminate between forward and reflected power in all types of 50 ohm coaxial transmission line. Use plug-in elements for power measurements from 100 milliwatts to 50k watts at frequencies from 2 to 1000 MHz with $\pm 5\%$ accuracy.

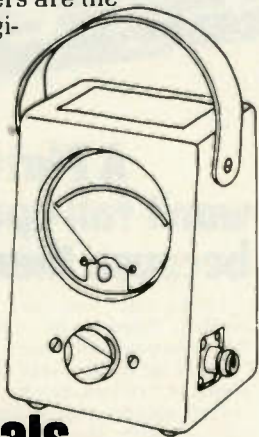

Wattmeters for professionals.

For the name of your local distributor call toll free 800-341-9678



DIELECTRIC COMMUNICATIONS
A UNIT OF GENERAL SIGNAL
RAYMOND, MAINE 04071 • TEL 207-655-4555 • 800-341-9678

Circle (8) on Reply Card



A Public Service of
This Magazine &
The Advertising Council

Would you hire you?

Of course you would. You work hard.
And you're good at it.
Like most Americans. But, if all of us did just a little better, we'd wind up with better products, better services and even more pride in the work we do.

Needed: Amplifier schematic and/or service manual for Seeburg jukebox model HF100G, will buy, or copy and return. Also, a 15" electromagnet speaker for same machine, state price. Danny Brou, 212 Wainwright Road, Pineville, Louisiana 71360.

For Sale: Sencore DVM32 digital multimeter, like new, complete with original isolation probe and all technical literature, \$135. Bruce B. Bright, Jr., 158 Ganahl Place, Fort Bragg, North Carolina 28307.

Needed: Belt for Estey model 20 tape recorder. James Barlow, 50-16 31st Avenue, Woodside, New York 11377.

For Sale: Almost all issues of Popular Electronics (265 issues), 31 issues of Electronics Illustrated, and the last five years of Radio Electronics, Electronic Servicing, and Electronic-Technician/Dealer (without schematics); \$1.00 each copy, plus shipping or best offer. James M. Mansfield, 1615 Egan Drive, Orlando, Florida 32807.

For Sale: Heath 5-MHz scope, model IO-4540, used once, \$135. Salvatore E. Moccia, 27 Williams, Salem, Massachusetts 01970.

Needed: Schematic or service manual for Monsanto Countertimer (frequency counter) model 100B. Will buy, or copy and return. W.E. Linschied, 3171 Bridges Place, Honolulu, Hawaii 96818.

Needed: Operating manual for Hallicrafters S27 VHF receiver. James Humphrey, 1006 East 28th, Los Angeles, California 90011.

Needed: Schematic and/or service data for a Vikoa 40 dB solid-state VHF TV amplifier, model S411 or 5411 (the marking is not clear). Gerken's Inc., 37 Park Avenue, Keene, New Hampshire.

Needed: Parts and schematic for a reel-to-reel tape recorder, Federal Manufacturing & Engineering model 47-A. Kevin Wheeler, 2518 Duncan, Chattanooga, Tennessee 37404.

Needed: Scope CRT (F 7670-0-P31) for a Fairchild Dumont dual-trace scope model 766H. Eugene Thompson c/o Central City Occupational Center, 1646 South Olive Street, Los Angeles, California 90015.

Needed: Instruction books and schematics for Superior Instruments genometer, model TV-50. Will buy, pay for copy, or copy and return. Albert J. Harrel, 806 East 3rd, O'Fallon, Illinois 62269.

For Sale: B&K 1077B TV Analyst, 465 CRT tester, 607 tube tester; Heath IG57A marker/sweep generator, IG37 FM stereo generator; Sylvania CK3000 test jig; and other smaller items of test equipment used in TV repair. All in perfect condition with manuals and accessories. No reasonable offer refused. Bob Reib, 424 Law, Aberdeen, Maryland 21001.

Needed: TA-33 or equivalent tri-band antenna. Kenneth Bullard, 107 Fulton Drive, Kings Mountain, North Carolina 28086.

Needed: Miniature and instrument ball bearings, all makes, sizes, and types. R. H. Sorgel, 450 Raintree Court, Glen Ellyn, Illinois 60137. □



RCA Receiving Tubes Mean Business!

You can get all the receiving tubes you need from your RCA Distributor . . . Miniatures, Novars, Compactrons, Nuvisitors, Glass tubes, Metal tubes . . . Over 1000 types, produced to RCA's exacting standards.

Plus many RCA service aids and business aids to add to your efficiency and promote your business . . . Cad-

dies, service tools, technical literature and a wide assortment of in-store signs and displays.

Now you can deal yourself some gifts with RCA's Top Deal. This RCA receiving tube carton top saving awards program runs through November 30, 1978. It is your reward for buying RCA receiving tubes.

See your RCA Distributor for all your tube needs and ask for an RCA Top Deal Prize Book.

RCA Distributor and Special Products Division, Deptford, N.J. 08096.

RCA Receiving Tubes

VOLTS and NUTS

by Edmund A. Braun

For a change of pace, have fun solving this just-across-word puzzle based on electronics. Each word is connected to the word above by one or more letters but only one is usually shown as a clue. Each correct answer is worth four points; a perfect score is 100. It should prove quite easy to get a high rating except perhaps for someone who thinks "prism" is where they keep convicts; or that "digital computer" refers to someone who counts on his fingers! So pick up your pencil and GO!

- 1 Magnetic material inside a relay or coil winding.
- 2 Pertaining to heat.
- 3 Picture tube in a television receiver.
- 4 Capable of performing.
- 5 Attempts to discover, confirm, or disprove.
- 6 Art of minimizing the effect of enemy electronic countermeasures to permit echoes from targets detected by radar to be visible on the indicator.
- 7 The amount of each of the primary colors that must be combined to match a sample.
- 8 A c.g.s. electrostatic unit.
- 9 Device for the simultaneous transmission of two or more signals over a common transmission medium.
- 10 Clear thermoplastic material having excellent insulative qualities.
- 11 One one-thousandth of a unit of electric current or rate of electron flow.
- 12 An apparatus for measuring quantities of heat.
- 13 Pertaining to tungsten filament prepared to improve electron flow.
- 14 A natural magnet.
- 15 Distance an activator moved from free position to operating position.
- 16 One millionth of a unit of EMF.
- 17 Used, or intended to be used, for all kinds or sizes.
- 18 Use of radio frequency fields to produce deep heating in body tissues.
- 19 Pertaining to increasing in size.
- 20 Device for receiving and storing an electric charge.
- 21 Size.
- 22 Passage of electricity prevented by non-conductor.
- 23 Shifting position of an entire image on the screen of a CRT.
- 24 Number of conductors connected together for purpose of carrying electrical current.
- 25 Color of band on a resistor to denote the quantity one.

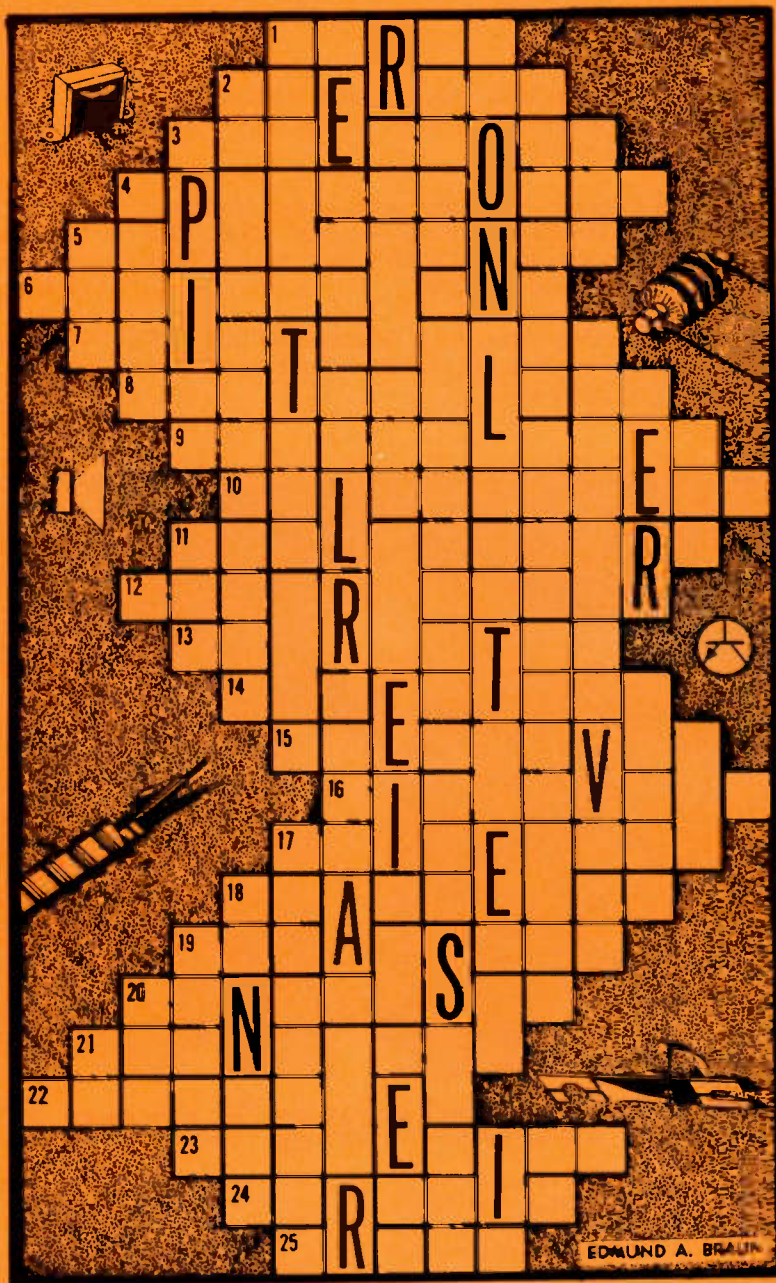

Don't sneak a peek at the solution on page 58.

But feel free to consult the dictionary, atlas, telephone directory, family, friends, neighbors, and the Board of Health. After all, where do you think we get the questions?

WIN EVERYTHING IN SIGHT.



ENTER THE SYLVANIA MILLION TAB SWEEPSTAKES

We're giving away a million tabs to dealers nationwide so they can go on wild shopping sprees in our "Tab Terrific" Awards Catalog.

The 25,000 tab grand prize winner gets to pick at least as many prizes as we've shown in the picture. There are also four second prizes of 10,000 tabs. Eight third prizes of 5,000 tabs. Five-hundred fourth prizes of 500 tabs. And a whopping 2,580 other prizes of 250 tabs.

HOW TO BE AMONG THE CHOSEN MANY

To enter, pull off the inventory control tab from a five-pack of Sylvania receiving tubes, or prepare a reasonable facsimile.

On the back, clearly print your name, address, invoice number and distributor's name. Mail to: Sylvania Award Headquarters, P.O. Box 1000, Fenton, Missouri 63026.

The more times you enter, the better your chances of winning. And if you do win, you can add your sweepstakes tabs to the regular tab program which

electronic
tubes



runs through November.

A DATE TO REMEMBER

Our Sweepstakes runs through the month of September, and entries must be postmarked no later than September 30th. Ask your Sylvania distributor for all the details and a copy of the Awards Catalog.

Then, when you pick out your prizes, it's fun knowing someone else will pick up the tab.

The Sylvania "Tab Terrific" program is available only to dealers and service technicians. Employees of General Telephone & Electronics, GTE Sylvania, their subsidiaries, affiliates, authorized distributors, or their advertising agencies are not eligible to participate. No purchase required. Void in Missouri, Utah, and where prohibited by law.

SYLVANIA

Circle (2) on Reply Card

GTE

Chassis—RCA CTC90D
PHOTOFACT—1710-2

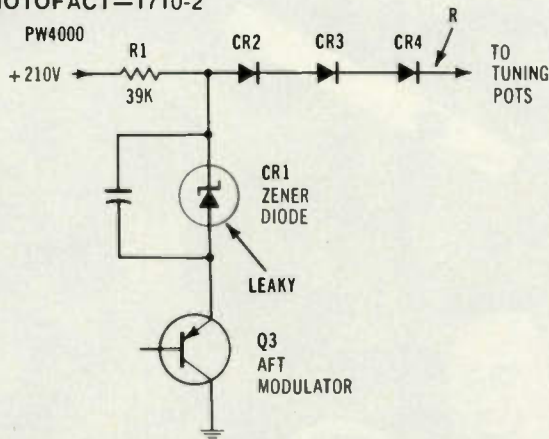

Symptom—Channels drift in frequency
Cure—Check CR1 zener diode, and replace it if leaky

Chassis—RCA CTC86
PHOTOFACT—1703-1

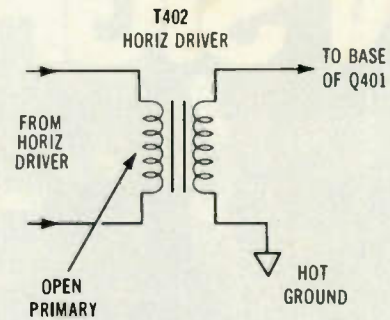

Symptom—Sound is heard, then shut-down occurs (no sound and no raster)
Cure—Check driver transformer T402, and replace it if open

Chassis—RCA CTC85
PHOTOFACT—1698-2

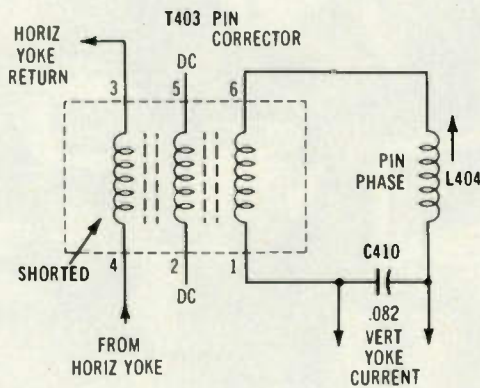

Symptom—Insufficient width
Cure—If supply voltages are okay, replace T403

Chassis—RCA CTC86A
PHOTOFACT—1703-1

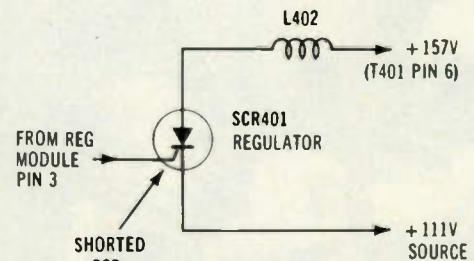

Symptom—Sound begins, then shut-down eliminates sound and HV
Cure—Check regulator SCR401, and replace it if shorted

Chassis—RCA CTC90B
PHOTOFACT—1710-2

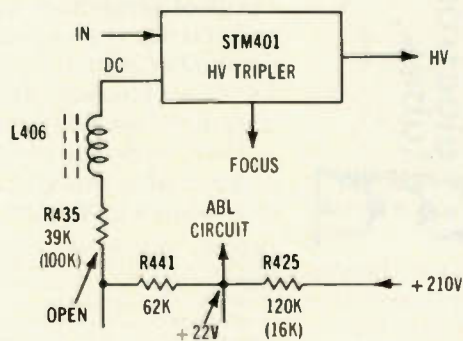

Symptom—No raster; HV okay
Cure—Check R435, and replace it if open

Chassis—RCA CTC85
PHOTOFACT—1698-2

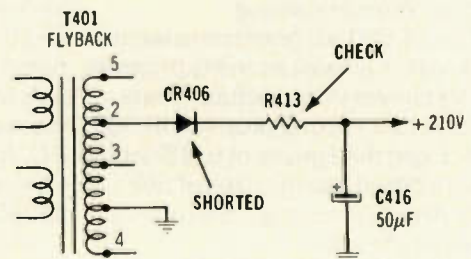

Symptom—Retrace lines, loss of video, raster shrinks, and then shut-down eliminates sound and raster
Cure—Check CR406 and R413, and replace them if defective



Servicing Sylvania Color TV

Part 7/By Gill Grieshaber

This final article about the Sylvania E44 chassis includes details of the sound-IF and audio operation, plus troubleshooting advice about those stages.

In the E44 Sylvania chassis (Photofact 1731-2), all components of the sound-IF and audio stages are located near the front end of the IF module, as shown in Figure 1. Some power-supply parts are mounted behind them (nearer the camera), with the picture-IF circuits at the side, covered by a large shield.

One IC and four transistors are used in these sound circuits. The complementary-output stage includes one medium-power NPN output transistor and its PNP twin, which drive the speaker through a large coupling capacitor (see Figure 2).

Sound-Circuit Operation

An impedance-matching capacitive voltage divider (C236 and C237 in Figure 3) tunes the IF coil, and couples signals from the Q206 third IF collector to the base of Q100, which is under the IF shield.

No 41.25-MHz sound traps are used before this take-off point, so the sound carrier has a strong amplitude here, and the fine tuning is not critical for good sound performance. (The fourth IF stage has two 41.25-MHz traps.)

The picture and sound carriers (from the IF signal) are heterodyned inside Q100 to produce the required 4.5-MHz sound-IF frequency. From the Q100 collector, the sound-IF carrier is coupled through C108 to the L110/C110 4.5-MHz take-off tuned circuit, and then to pins 1 and 2 of IC100. For signal tracing, remember that pin 1 is bypassed, so measure the carrier level at pin 2.

Inside "black box" IC100, the sound IF signal is amplified and limited, before it surfaces next at pin 9, pin 10, and the L120 "quad" detector coil.

After internal FM detection, the demodulated audio comes out at pin 8, travels through the R112 volume control and two coupling capacitors, then returns to pin 14 of IC100 and the internal audio stage (or stages). Finally, the amplified and adjusted audio exits IC100 at pin 12.

No DC control

This circuit description illustrates one point that can be valuable during troubleshooting: **the audio level does not operate by a DC voltage.**

Most solid-state TV receivers (especially those designed to be compatible with remote-control systems) don't adjust the audio gain directly. Instead, the volume control

continued on page 20

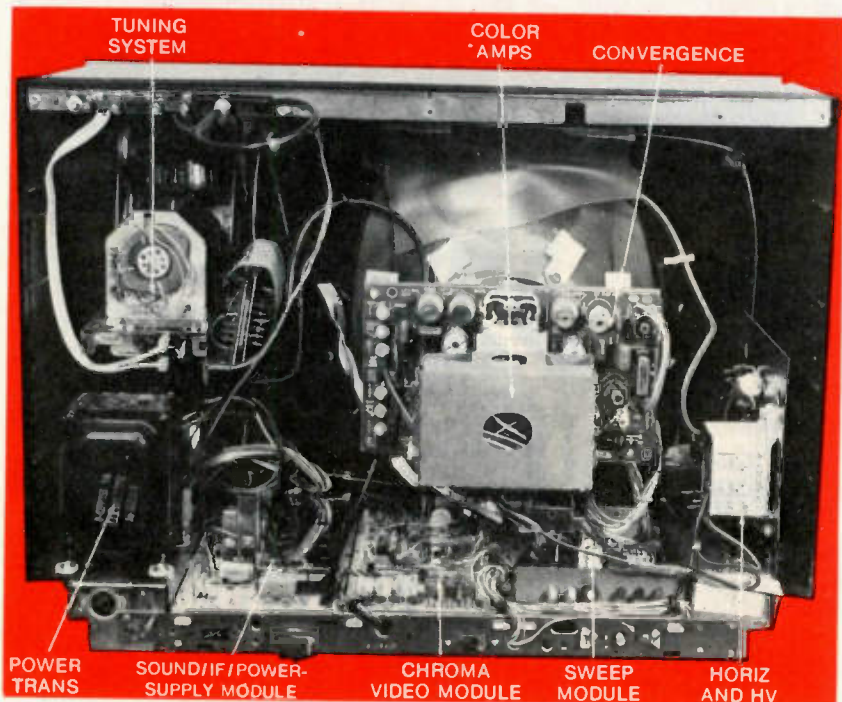

In our final coverage of the E44 Sylvania, here is a reminder of the modules and major assemblies.

Sylvania

continued from page 19

produces a variable DC voltage which is applied to an IC terminal, where it determines the internal audio gain.

But, in the E44 chassis, a conventional audio control adjusts the AC audio level (and thus the sound volume) without the need for any DC voltage. Therefore, IF module pins TA12 and TA15 can

be important test points when you need to check audio gain or distortion.

Do you remember the "screwdriver" test of tube-type audio circuits? Yes, that's the one where you held the metal blade of a screwdriver in your fingers and touched it to the volume control or grid of the first audio tube, while you listened for the buzz. Well, this quickie test can be used at module pin TA15 to produce a moderately-

loud buzz, when the audio stages are normal.

Audio driver

From the output of IC100 at pin 12, the audio signal travels through R121 and coupling capacitor C132 to the base of Q102, which drives the bases of the two output transistors. (Q102 is not a power type, but is small.)

Several items here are significant. First, the ratio of R121 versus R124 (plus the B/E impedance of Q102) forms a voltage divider that greatly reduces the audio gain. More than adequate gain remains, but you need to know about the loss before you measure the gain.

Bias for the base of Q102 comes through R122 from the junction of the two output emitter resistors (R138 and R140). This output DC voltage varies opposite to any changes of the Q102 base bias. Therefore, the DC collector voltage of Q102 is stabilized fairly well.

Current for the Q102 driver transistor comes from the +37-volt supply through R128, R130, diode SC134, and diode SC136 to the collector. The collector is direct coupled to the Q106 base, and also to the Q104 base through SC134 and SC136 in series. These diodes supply the small offset of bias needed to minimize crossover distortion (also called "notch" distortion).

Both Q104 and Q106 are operated as emitter followers, and their two emitter resistors (R138 and R140) supply the output signal that is coupled through C138 to the speaker.

Q104 is a NPN type, and Q106 is a PNP type of the same characteristics. They are connected in series between supply voltage and ground, with the output signal taken from the midpoint of the two emitters. Any increase of the positive voltage at the collector of Q102 (for example) decreases the Q104 base forward bias thus decreasing the current, and increases both the Q106 forward bias and C/E current. Therefore, the output at the emitters becomes more positive. Of course, a decrease of Q102 collector voltage reverses those actions.

Because the C/E paths of both transistors are in series, they would be forced to have equal current at all times (this would destroy the push-pull class "B" operation),

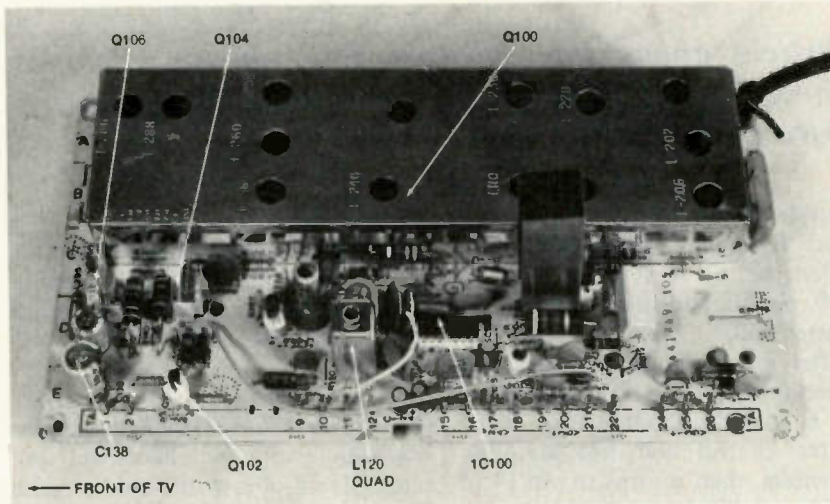
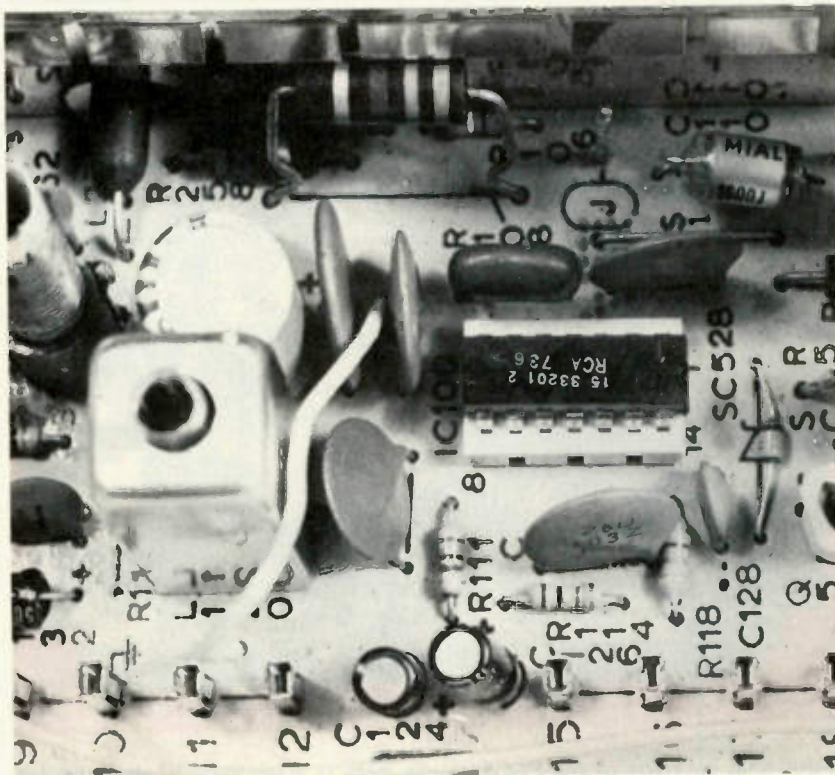

Figure 1 Arrows point out the IC, transistors, and other important components of the E44 sound system.



Near the center is IC100, which functions as the sound-IF amplifier, quad detector, and audio preamplifier. The shielded coil at the left is L120, the sound-detector coil.

except for the action of C138, which serves as a kind of reservoir. It is partially drained by the current of Q106, and replenished with current through Q104. Therefore, the DC voltage at the input of C138 varies around an average voltage of about half the supply voltage. (This voltage is important for troubleshooting.)

If C138 opens completely, all sound is eliminated. Also, the emitter voltages of Q104 and Q106 go wild when the volume is turned loud. But, if the capacitor has a small capacitance, the bass sounds (low frequencies) will be missing in the music.

Troubleshooting The Audio Circuits

Direct coupling is used between the base of Q102 and the output at C138. This makes DC voltage analysis a bit more complicated, since a change of DC voltage in either the driver or the stage also changes the DC voltages in the other stage.

Always measure the supply voltage and the DC voltage at the output of any complementary-symmetry circuit. When a single positive supply voltage is furnished for the two output transistors, the output from the two emitters has a DC level of about one-half of the supply voltage. Therefore, a large coupling capacitor is required to feed the output AC signal to the speaker. (As explained before, the capacitor also functions as a filter capacitor.)

Almost all defects in the driver or output stages change this DC voltage at the input of C138, the output coupling capacitor. In non-defective amplifiers, this DC voltage will be within a volt or two of one-half of the supply voltage. Any voltage readings outside of the tolerance given are a certain sign of a parts defect in the two stages.

It's possible for the half-of-supply voltage to deviate from the correct value by 10%, perhaps, without any obvious audio distortion. (Even then, an accurate distortion test will show it to be excessive.) A more immediate concern is the threat to the output transistors. Both transistors should (after a proper warmup period) feel equally warm to finger touches. When the output DC

continued on page 22

You can be sure

more times in more circuits in more places
than with any other multimeters on the market today

Each Sencore DVM is backed with 15 Megohm Input Impedance for one third less circuit loading on every measurement. That means 50% higher accuracy than other DVMs.

DVM38 \$395
3½ DIGIT .1% DCV ACCURACY
AUTO-RANGING DVM

A "prime" standard at your fingertips for measurements you can trust. Auto-ranging for extended low-level range and ease of operation. 15 Megohm input impedance assures .1% reading accuracy is maintained in solid state circuits. Highly sensitive, yet fully protected to 2000 VDC overloads. Hi-Lo Power Ohms circuit simplifies in-circuit resistance measurements.

DVM37 *New* \$268
3½ DIGIT .1% DCV ACCURACY
PORTABLE DVM

Prime standard .1% accuracy on the bench or in the field for less than \$250. The DVM37 is the most accurate portable DVM you can buy, with 15 Megohm input impedance for 50% more accuracy. Includes automatic features—Auto Zero, Polarity, Decimal, Overrange. Fully protected inside to over 2000V on all functions, including Ohms, and protected outside with super-rugged case. Full ranges for every test. Fingertip "Push-On" switch in probe saves batteries as power is applied only when needed.

DVM32 \$225
3½ DIGIT .5% DCV ACCURACY
PORTABLE DIGITAL MULTIMETER

Bench and field master for digital accuracy measurements anywhere. 0.5% DCV accuracy, backed with 15 Megohm input impedance. Exclusive battery-saving Auto-Display turns the display on automatically when you make a measurement. 2000V input protection on all functions and ranges—including Ohms.

DVM36 \$158
3½ DIGIT .5% DCV ACCURACY
POCKET PORTABLE DVM

Pocket portable lab accurate performance that fits every budget with highest performance-to-price benefits of any meter. .5% DCV accuracy, backed with 15 Megohm input impedance for lowest circuit loading. Full protection to 1000 V on all functions and ranges—including ohms. Drop-proof case. Battery-saving "Push On" button in probe.

DVM35 \$134
3 DIGIT 1% DCV ACCURACY
POCKET PORTABLE DVM

Fast, direct reading digital accuracy for the man on the go. Same features as DVM36, except 3-digit, 1% DCV accuracy, backed by 15 Megohm input impedance that is ten times more accurate than analog meters.



New **DVM37**



DVM32



DVM38



DVM36

In stock at your favorite local
Sencore Full Line Distributor.

SENCORE
DIGITAL MULTIMETER SPECIALISTS
3200 Sencore Dr., Sioux Falls, SD 57107 (605)339-0100

Circle (10) on Reply Card

Sylvania

continued from page 21

voltage is far out of tolerance, one transistor will be hotter than its twin. This is a danger sign that should not be ignored.

A mild deviation from the correct voltage and transistor dissipation might delay the transistor failure by hours or weeks. But, higher supply voltages and a more severe unbalance of dissipation can zap a

transistor within a few seconds. Don't take a chance; **check the voltage first!**

Remember that the output DC voltage is determined by the *average* currents of *both* transistors. *Either* one drawing too much or too little will affect the DC voltage at the output. A shorted transistor often instantly causes its mate to fail from overload. Notice that the emitter current for Q106 and the forward bias for the base of Q102

come through Q104 from the supply voltage. Therefore, if Q104 ever opens, the audio will be dead. Other symptoms of open transistors are given later.

Sequence Of Tests

In the absence of unmistakable visual symptoms (smoke, burned resistors, etc.), troubleshooting tests should be done in this sequence:

- DC voltage measurements, and an analysis of them;

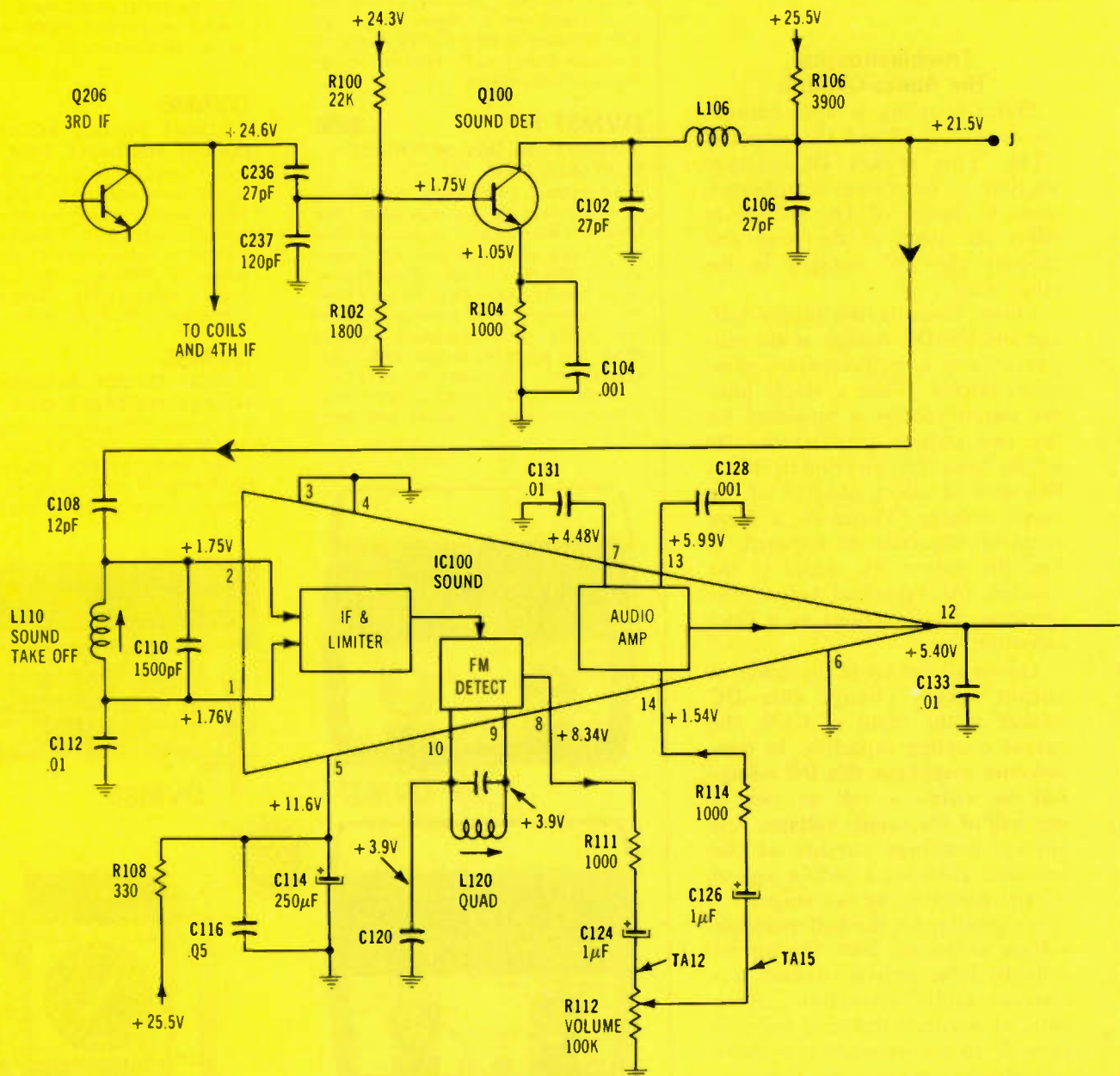

E44 SOUND CIRCUITS

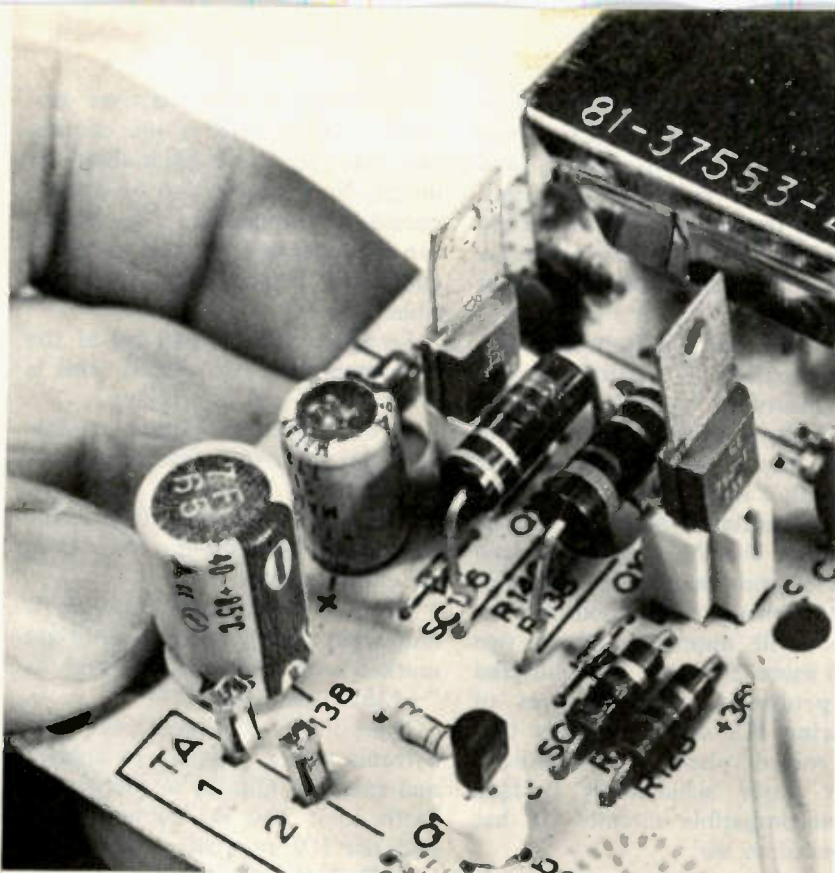
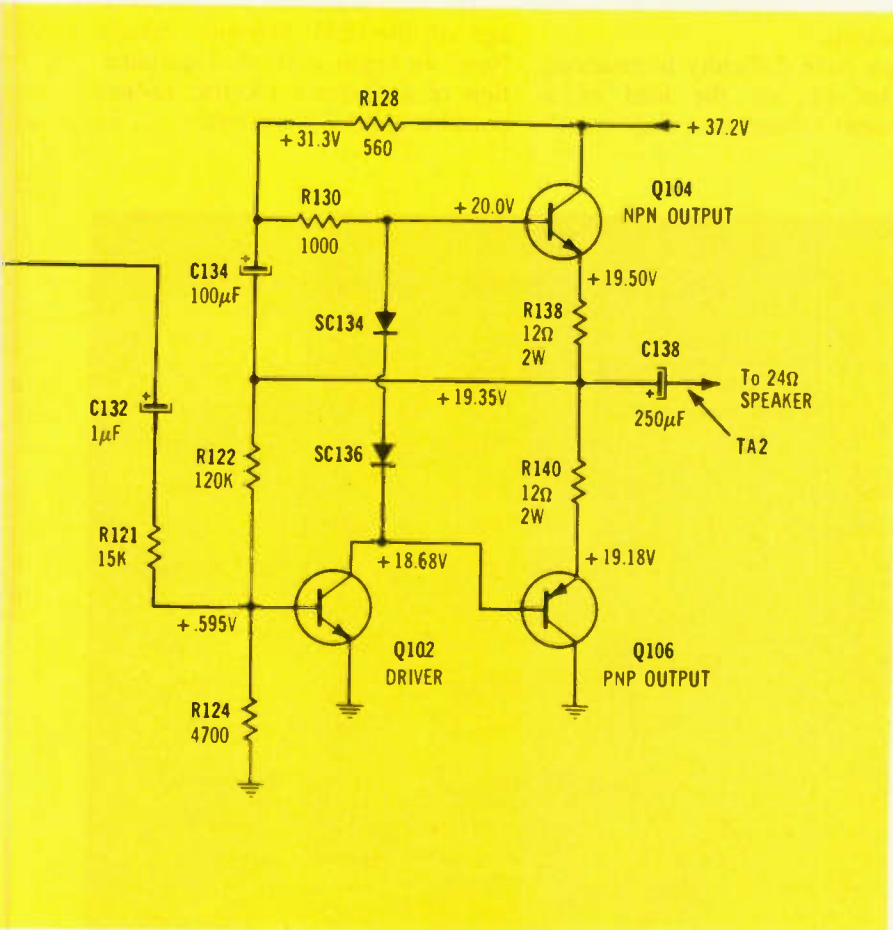

Figure 2 All sound-system transistors plug into sockets, including the complementary power-output transistors.

Figure 3 This is a complete schematic of the E44 Sylvania sound-IF and audio circuits.



- signal tracing with a scope to find out if there is any audio going to the volume control, then checking stage by stage to find the bad one;
- tests of all four transistors (they are in convenient sockets); and
- Resistance tests, perhaps alternated with more DC voltage checks.

Usually, these few steps either will find the bad component, or at least point toward the area of the defect.

Typical AC signal and DC voltages are given next. They will serve as standards to evaluate your readings.

Typical Voltages

Table 1 shows the approximate peak-to-peak voltages measured at important points of the E44 sound circuit. The readings were made when the TV was tuned to a conventional TV program, and with the volume control set for moderate volume. Because the audio was varying constantly, the voltages are only approximate, but they are near the maximum that occurred during each measurement.

Table 2 gives the DC voltages in the driver and output stages during normal and three wrong kinds of operation.

The column that says "diodes shorted" shows the DC voltages when SC134 and SC136 were shorted out, to eliminate the bias offset between the two output transistors. At loud volume, the distortion was not noticeable; but the sound quality was distorted and raspy, when the sound was turned low.

The column labelled "wrong bias" and "insufficient Q102 bias" represents operation with near cut-off bias applied to the base of Q102. This raised the Q102 collector voltage, along with the bases of Q104 and Q106. Q104 therefore was strongly biased into saturation, and Q106 had cut-off bias. Both of these bias conditions raised the output (from the emitter resistors and C138) nearly to the supply voltage. At all volume levels, the gain was low and the distortion was severe.

A nearly-normal set of voltages are shown in the column marked "wrong bias" and "excessive Q102 bias." The value of R122 was reduced, to increase the base voltage of Q102. Although the output

continued on page 24

Sylvania

continued from page 23

DC voltage at C138 was more than 3 volts lower than normal, the operation was not changed drastically, and the distortion was not noticeable with casual listening.

Each of the two output transistors was removed from its socket, one at a time, to determine the symptoms of open transistors. When Q106 was removed, the sound level was weak, and the distortion was terrible. The C138 voltage increased to more than +21 volts. When Q104 was removed, the C138 voltage measured about +17 volts, and no sound could be heard.

Test Equipment Helps

I strongly urge you to use a test

**Table 1 —
Typical Audio Voltages**

IC 100 pin 8	0.8 VPP
IC100 pin 14	0.2 VPP (after vol cont)
IC100 pin 12	2.0 VPP
Q102 base	0.05 VPP
Q102 coll	10.0 VPP

All except the first reading were recorded at medium volume of TV station sound; therefore, they varied with the program.

clip when you measure voltages or signals at the pins of ICs. These test clips are spring loaded, and they contact each IC terminal, bringing the voltages up to the top of the clip where you can connect a meter probe with reduced danger of shorts.

Also, the small hook probes with spring-loaded insulation are the best insurance against burn-outs and damage caused by accidental shorts. Make up an adapter test lead with a hook probe on one end and an insulated alligator clip on the other. Use this special test lead between your meter or generator and the wiring on the module.

You will appreciate these tips much more after you have suffered the problems and expenses of replacing ICs and transistors that you ruined when a conventional meter probe accidentally bridged two incompatible circuits. It has happened to me!

Good Serviceability

Troubleshooting is easy on the sound/power-supply/IF module of the Sylvania E44 chassis.

Not only are the circuits straightforward, but the mechanical layout allows good accessibility to most components.

If you have difficulty in reaching a socket pin or the lead of a component located near the "front"

of the module, just remove one screw at each side of the chassis, and slide the chassis back about six inches. No wires have to be disconnected or unplugged. The chassis can be operated in this position, and most components are accessible.

Secondly, the IC and all of the transistors plug into sockets. This is a luxury you will appreciate.

If necessary, the entire module can be removed for repair or replacement, by taking out four screws and the IF cable, then lifting the module carefully up, away from the pin terminals.

Each of the module terminals is numbered plainly. Also, several are marked with the function, such as "+135V" or "+24V."

Everything considered, the E44 Sylvania was a pleasure to analyze and examine. Quality of the picture (both color and B&W) was good, and the HV regulation was excellent. Both the vertical and horizontal scan circuits covered the screen with good linearity and more than minimum size. Electronically, the E44 seems to have no weak areas.

Next Month

This concludes our present coverage of the E44 Sylvania chassis. Next, we begin a detailed examination of a General Electric 13-inch portable color-TV receiver. □

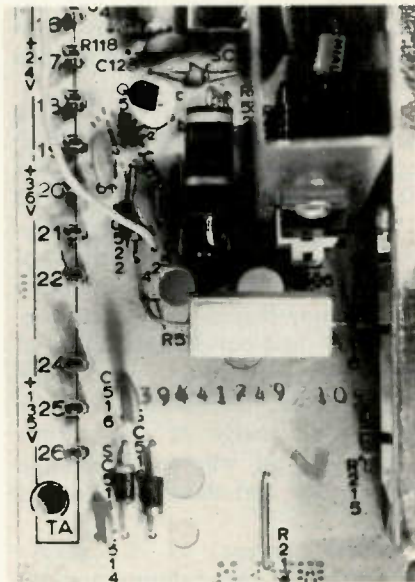

All components and connector terminals of the Sylvania E44 chassis are well marked. Some of the module connector terminals also have the supply voltage identified.

Table 2 — Audio DC Voltages

	Normal	Diodes Shorted	Wrong Bias	Wrong Bias
Q102 base	+00.599	+00.596	+00.390	+00.618
Q102 coll	+18.680	+19.850	+36.700	+15.390
Q104 base	+20.300	+19.850	+37.400	+16.650
Q104 emit	+19.900	+19.450	+37.000	+16.100
Q104 coll	+37.600	+37.500	+37.400	+37.300
Q106 base	+18.900	+19.850	+36.800	+15.220
Q106 emit	+19.400	+19.430	+36.900	+15.800
Q106 coll	00.000	00.000	00.000	00.000
R138/R140	+19.700	+19.450	+36.900	+16.000

Normal Note: Q104 and Q106 bases shorted together Distortion was bad at low volume only.

Insufficient Q102 bias. Low gain and heavy distortion at all levels.

Excessive Q102 bias. Distortion not excessive.



Service Management Seminar, Part 8

By Dick Glass, CET

Ratio analysis is a powerful tool for measuring the performance of your business.

Why Measure?

When advised to calculate the various ratios that measure the health of service businesses, many nearly-bankrupt shop owners have answered, "Why should I measure anything? After all, I sell parts and labor as high as my competitors, keep expenses low, and work long hours. How can I do any better by calculating anything?"

Although this line of reasoning seems logical, it proves to be very wrong in actual practice.

If you were to go boating without a destination in mind, and without having a compass or any landmarks to prove whether or not the boat was on course, it's likely you soon would be drifting into undesirable or dangerous locations. This applies also to your business. Allowing it to drift along according to whatever seems expedient at the moment, without any indications either of improvements or of dangerous trends, permits everyone *but you* to manage your business.

Use Ratio Analysis

By now, you should have definite business goals in mind (this is the "destination"). Next, you need performance measurements of each financial area. One type of valuable measurement is **RATIOS**. The figures for ratio calculations come from your monthly P&L statements and balance sheets, which you should have already.

The value of figuring ratios is that you can use **percentages**, not dollars. With ratios, the size of your business doesn't prevent you from comparing your profits and costs with other similar shops.

Ratios Are Simple

The words "ratio analysis" sound complicated and impressive. We see visions of rows of accountants working busily with computers. Not

so. Today, with only an inexpensive electronic calculator and your own figures, you can figure your ratios—all of them—easily, and in just a few minutes.

You will need your latest annual P&L statement and balance sheet. For examples, we are using the figures for Dick's TV, in Table 1 and Table 2.

Current Ratio

One of the best-known measures of financial strength is the "current ratio." It answers this principal question: "Does your business have enough current assets to meet its current debt, with a margin of safety for possible losses, such as inventory shrinkage or uncollected accounts?" The formula has only three parts: **Current ratio equals current assets divided by current liabilities.**

From the Dick's TV balance sheet (Table 2), the current assets are \$14,000 and the current liabilities are \$7,000. Dividing the liabilities into the assets gives a current ratio of 2.0 (or 2 to 1).

Is this a favorable current ratio? According to the popular rule-of-thumb, it is exactly right, because 2 to 1 is considered to be good. However, the "safe" ratio area differs from business to business, so no one can give an absolute figure. We will supply you with estimates that are as accurate as possible, and you'll learn quickly what is proper for your own business, after you become familiar with ratios.

Now, suppose Dick's current ratio calculated as only 0.5 to 1 (meaning, the dollar amount of liabilities was twice that of the assets). What actions should he take?

First, he must realize that his current ratio indicates serious problems. If business volume decreases, he won't be able to pay his bills, even by selling the inventory and collecting all accounts receivable.

He should take one or more of the following steps:

- borrow money with a loan that matures next year or later;
- convert some fixed assets (such as unused test equipment, or an extra service vehicle);
- increase the equity by adding more of his own cash to the business; or
- increase the profits, retaining the increase in the business.

Probably, the best remedy is the last one—increasing the profits and keeping the increase in the business.

Parts Sales Ratio

One of the most likely causes of unprofitable service is an insufficient percentage of gross profit from parts sales. There are several reasons why parts sales might not be profitable. Some parts list prices from the manufacturers don't allow sufficient markup to take care of the inevitable inventory losses. Perhaps a part is installed as a test, but the labor cost to remove it—if not needed—would exceed the cost of the part. So, the part is left in the machine. The cost *should* be changed to a labor cost, but it probably is ignored, becoming shrinkage of the inventory. Also, warranty replacement parts require handling expenses, without any compensation from markup. All of these situations reduce the profit from parts. You must know the actual percentage of parts profit before you can make effective plans for improving the situation.

Parts profits divided by parts sales (both in dollars) equal the gross parts-profit ratio. Dick's TV had a cost of \$25,000 and sales of \$50,000, for a profit of \$25,000. This is a ratio of 1 to 2 or 0.50, which usually is expressed as a percentage (50%).

Years ago, a 40% profit was considered to be very good. But, service shops now need to have 50% or higher gross profits.

Gross Labor Profit Ratio

In many shops today, a 50%
continued on page 26

Table 1
Dick's TV Service
Profit and Loss Statement
 1-1-77 to 12-31-77

INCOME			
Labor income		\$50,000	
Parts income		<u>\$50,000</u>	
Total sales			\$100,000
COST OF SALES			
Labor sales	\$50,000		
Direct wages	<u>\$25,000</u>		
Gross labor profit		\$25,000	
Parts sales	\$50,000		
Parts costs	<u>\$25,000</u>		
Gross parts profit		<u>\$25,000</u>	
TOTAL GROSS PROFIT			\$50,000
<hr/>			
OVERHEAD EXPENSES (general and administrative expenses)			
Accounting	\$ 2,000		
Clerical and administrative salaries	\$20,000		
Rent	\$ 6,000		
Truck expenses	\$10,000		
Utilities	<u>\$ 2,000</u>		
TOTAL OVERHEAD EXPENSES			\$40,000
NET PROFIT			\$ 10,000

Table 2
Dick's TV Service
BALANCE SHEET
 January 1, 1978

ASSETS		LIABILITIES & NET WORTH	
CURRENT ASSETS		CURRENT LIABILITIES	
Cash	\$2,000	Accts. Payable	\$ 4,000
Accts. rec.	\$4,000	Notes payable	\$ 2,000
Parts inventory	<u>\$8,000</u>	Taxes payable	<u>\$ 1,000</u>
	\$14,000		\$ 7,000
FIXED ASSETS		LONG TERM LIABILITIES	
Autos-trucks	\$5,000	Note payable	<u>\$ 2,000</u>
Furn. & fixtures	\$4,000		<u>\$ 2,000</u>
Test equipment	<u>\$2,000</u>		
	<u>\$11,000</u>	TOTAL LIABILITIES	\$ 9,000
		EQUITY	
		Original cash investment	\$ 2,000
		Reinvested earnings	<u>\$14,000</u>
		TOTAL NET WORTH	<u>\$16,000</u>
TOTAL ASSETS		TOTAL LIABILITIES PLUS NET WORTH	
	<u>\$25,000</u>		<u>\$25,000</u>

labor gross profit would represent a giant improvement. Yet, a 50% profit is barely acceptable. In fact, a **profitable** service business needs a 60%, or higher, labor gross profit. In other words, each technician should bring in an average of no less than 2½ times his wages. Thus, your direct labor costs should not exceed 40%.

Dick's TV gross labor profit ratio is: labor profit (\$25,000) divided by labor sales (\$50,000). The ratio is 0.50, or 50%, which is below the ideal figure.

To remedy this below-optimum condition, Dick has two choices:

- increase the productivity of his technicians (they receive the same wages, but bring in more money); or
- increase the labor rates.

Owner's wages

Too many small shops fail to include any wages for the hours the owner spends working as a technician. If this is not included, it produces a false labor cost and an untrue labor profit.

For example, the calculation that does not include any owner labor cost might show an inaccurate labor gross profit of 50%, whereas it should be 10 %, if his own labor contributions were included.

Overhead Ratios

The prices of parts and labor are extremely important, because they are the **largest** cost items. All other expenses (rent, utilities, insurance, advertising, expendable supplies, etc) are called "overhead" or "operating expenses." Your business efficiency might be measured by the overhead percentage. Lower overhead percentages indicate better efficiency.

Although few service shops appear to waste much money on unnecessary items of overhead, the total of all expenses is a sizable sum, and it should be examined to assure the least possible waste.

The overhead expense ratio is obtained by dividing the total overhead expenses by the total sales. With Dick's TV, the overhead was \$40,000 which was divided by total sales of \$100,000 to produce

an overhead ratio of 0.40 (or 40%). It's advisable that you never allow this percentage to exceed 50%.

Dick should compare his overhead expense percentage each month against that of previous months. Any significant increase should alert him to examine the reasons for the increase. If the percentage drops below 40%, he can assume that the expenses are not out of line.

Expense variations

The percentage of overhead expense will vary drastically from shop to shop. If you are a one-man operation, and using your home for the business (without charging yourself rent or depreciation), the

percentage might be small (perhaps 20%).

At the other extreme, some large shops have overhead costs up to 50%, when the owner's salary is included in the overhead.

Therefore, a "safe" figure is difficult to establish for overhead ratio or expense. Compare your percentage against that of other shops, but be sure the accounting is done by the same method.

Of course, you always can compare your monthly overhead percentage against other months.

Profitability Ratios

After you have paid yourself (and your partner, or other working shareholders) a fair wage for any

direct participation as manager or technician, you should test to determine whether or not the business was profitable. There are several ways of measuring profit. One way is the "return on investment" percentage.

The return on investment ratio equals the net profit (Dick's TV had \$10,000) divided by the net worth (\$16,000). This is 0.625, or 62.5%, which is excellent! Especially, since Dick had paid himself as a manager and technician.

If your return on investment in dollars is lower than the interest you could have drawn on your net worth (if deposited in savings), you have lost money. But, don't feel discouraged. Many owners do much worse.

For example, some shopowners consider their salary to be the business profit. They are misleading themselves. If Dick's sole compensation for the year had been the \$10,000 net profit, then it actually was wages for himself, *leaving no net profit for the business!*

On the other hand, if the \$10,000 is listed as business net profit, the situation is even worse. He had an employee (himself) working for the business without pay. He should have been paid at the same rate as anyone else who performed the same work. If he had been paid \$15,000 per year, than the business would have shown a \$5,000 loss, and not a profit. In that case, the return on investment would have plummeted to a minus 31%.

Remember to keep your salary as manager or technician separate from the business profit. This error has robbed many a shop owner.

Other Ratios

After you have discovered how easy ratios are to work with and to understand, you will want to compare other financial areas. Table 3 lists many of these ratios you will want to calculate in the future. Some are reciprocals of other formulas that you won't need very often.

Use the table to remind you of the important ratios which should be compared regularly.

Remember, your constant use of ratio analysis can spot unfavorable trends in time to solve them. You can work more confidently when you know your business is healthy. □

Table 3

IMPORTANT RATIOS FOR YOUR BUSINESS

		SAFE ZONES
CURRENT RATIO	= $\frac{\text{CURRENT ASSETS}}{\text{CURRENT LIABILITIES}}$	2 to 1
LABOR GROSS PROFIT %	= $\frac{\text{LABOR PROFIT}}{\text{LABOR SALES}}$	60% & UP
PARTS GROSS PROFIT %	= $\frac{\text{PARTS PROFIT}}{\text{PARTS SALES}}$	50% & UP
OVERHEAD %	= $\frac{\text{OVERHEAD EXPENSES}}{\text{TOTAL NET SALES}}$	50% & DOWN
RETURN ON INVESTMENT %	= $\frac{\text{NET PROFIT}}{\text{NET WORTH}}$	15% & UP
INVENTORY TURNOVER	= $\frac{\text{COST OF GOODS SOLD}}{\text{AVERAGE INVENTORY}}$	2.5 & UP
INVENTORY INVENTORY	= $\frac{\text{BEGINNING + ENDING INVENTORIES}}{2}$	1 TECH \$ 9,000 6 TECH \$24,000 12 TECH \$40,000

OTHER RATIOS

TURNOVER OF NET WORTH	= $\frac{\text{NET SALES}}{\text{NET WORTH}}$	3 to 1 IS LOW 6 to 1 IS HIGH
NET WORKING CAPITAL	= $\text{CURRENT ASSETS MINUS CURRENT LIABILITIES}$	\$7,000 PLUS \$1,000 PER TECH
GROSS PROFIT MARGIN %	= $\frac{\text{GROSS PROFIT}}{\text{TOTAL SALES}}$	50%
NET PROFIT %	= $\frac{\text{NET PROFIT}}{\text{TOTAL SALES}}$	10% & UP (after owner salary)
CURRENT LIABILITIES TO NET WORTH %	= $\frac{\text{CURRENT LIABILITIES}}{\text{TANGIBLE NET WORTH}}$	60% & DOWN

Curing Horizontal Oscillator Drift



By Wayne Lemons, CET

Much troubleshooting time can be saved if you know the type of horizontal oscillator, and which components are critical. Time-constant and tuned types are described, and servicing tips are given.

Last month, I recommended a practical method of testing the frequency, drift, and locking of cathode-coupled multivibrators used as horizontal oscillators. That type of oscillator has a tuned ringing coil, to minimize drift and reduce erratic triggering during noisy reception. The same general method can be used effectively with many other types of oscillators.

Several more circuits have been selected as examples of tube-powered horizontal oscillators. We'll explain the differences and similarities of these various types, and make suggestions for faster troubleshooting.

One item of circuit information can be especially helpful for reducing your analysis time to a minimum, and increasing the accuracy of the diagnosis. Is the frequency mostly determined by a tuned circuit or by a time constant? The correct answer (from a schematic) usually leads you directly to the few components that are most likely to change the frequency.

Time-Constant Or Tuned?

Tube-type horizontal oscillators usually can be classified according to which of these two basic methods is used to establish the frequency:

- a time-constant (RC type) network that controls the time of one oscillator cycle; or

- a tuned oscillator coil (LC type).

There is a problem with recognizing these types. At a casual glance, the basic circuits look very much alike. It's difficult to know whether a certain tuned coil is a ringing coil or an oscillator coil. That's why you should know the theory of operation; it will save you time during actual repairs.

Time-Constant Oscillators

Probably the majority of color receivers using tubes have had time-constant horizontal oscillators. However, the schematics never label them as such. A few might be called "blocked-grid" or just "blocking" oscillators. (In one sense, multivibrators are blocking oscillators, too.)

Time-constant oscillators **might** or **might not** have an oscillator coil, for oscillator coils can be tuned or untuned. **An untuned oscillator coil proves the circuit is a time-constant type**, while a **tuned oscillator coil is equally strong proof that it's NOT a time-constant type**.

Another problem of identification is that tuned ringing coils resemble tuned oscillator coils (some oscillator coils also have only two active terminals).

One partial answer is that tuned oscillators have near-sine waveforms at the oscillator coils, while time-constant types show pulses, saw-

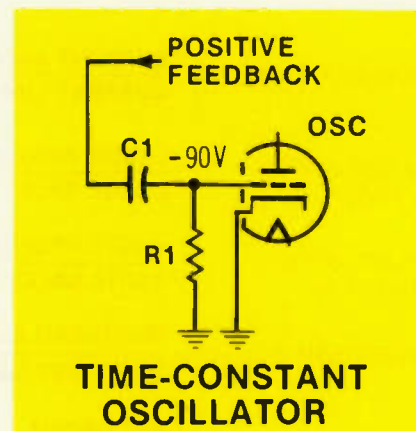

Figure 1 A time-constant oscillator has a repetition rate that's determined mainly by C1 and R1, the RC time-constant components at the grid. A huge positive-feedback signal drives the grid positive and into conduction. This gives a pulse of plate current, followed by elimination of all plate current, as grid rectification supplies a large negative voltage at the grid. No plate current can flow again (nor another cycle begin) until the C1 negative voltage has discharged through R1, and becomes almost zero. Then plate current begins, triggering another huge positive-feedback signal from the remainder of the circuit. Except for the excessive negative voltage, this could have been the grid circuit of a sinewave type of oscillator that has a parallel-tuned LC circuit in the plate-to-grid (or cathode-to-grid) feedback path. Time-constant oscillators might have a coil there, but it is never tuned.

teeth, square waves, or ringing (depending on where the probe is placed in which circuit). Of course, ringing coils have near-sine waveforms at one of the two terminals, so more data is needed.

Another partial identification depends on the oscillator bias. Tuned oscillators have bias that's near the usual class "A" value, while all varieties of time-constant oscillators have reversed or cut-off bias (tubes have high negative grid bias, and NPN transistors have minus or near-zero voltages). In other words, TC oscillators are overdriven.

Time-constant operation

In the partial schematic of Figure 1, let's follow the time-constant operation at the oscillator grid. The incoming signal not only supplies the needed drive, but shunt-type peak rectification of it (by the grid and cathode acting as a diode) produces a negative bias.

To simplify the explanation, we'll omit most of the circuitry except for the "diode" and the time-constant components, C1 and R1.

When the positive-feedback positive-going pulse reaches C1 (which by now is discharged), C1 begins to charge, and the charging current makes the grid positive, causing grid/cathode current. This grid current grounds the grid end of C1, and C1 now charges rapidly to the full pulse voltage. After C1 becomes fully charged, its current flow stops, thus removing the positive grid voltage. In turn, the loss of positive grid voltage stops the grid current, and with it the grid-to-ground short.

The grid end of C1 no longer is grounded, but the feedback end of C1 is grounded through the power supply or resistors; therefore, the grid end of C1 is far less positive than the grounded feedback end. In fact, measured to ground, the grid voltage is highly negative, and it

biases the grid far beyond cutoff. C1 now begins to discharge through R1. When the negative grid voltage rises to almost zero, the tube begins to draw some current. The effect is regenerative (through the positive feedback), and once started it proceeds rapidly through to completion, by producing a large positive pulse at the feedback end of C1, and a positive voltage at the grid.

The circuit has gone through slightly more than one complete cycle, and the cycles repeat over and over until the power is removed.

Effect of R1 and C1 values

If the values of either (or both) R1 and C1 are increased, the time constant is made larger (longer time). This slows down the operation just described, and produces a lower oscillator frequency.

If the values of either (or both) R1 and C1 are made smaller, the time constant is made shorter, each cycle takes less time, and the frequency becomes higher.

By the way, this description of time-constant operation also ex-

plains the peculiar waveform found at the grid of many multivibrator tube-type vertical oscillators. The grid waveform is totally unlike the incoming waveform at the other end of the grid-coupling capacitor (most coupling capacitors have essentially the same waveform at both ends). If you don't understand this grid waveform, write to me, and I'll explain it later. Hint: remember the textbook charging and discharging capacitor curves?

Time-constant voltages

One more factor is vitally important for establishing the frequency of time-constant oscillators. That additional item is the amplitude of the positive-feedback signal at the grid of the oscillator.

Look at it this way: assume that you are timing an operational cycle which is triggered when a higher positive voltage decreases to +1 volt. If you apply +10 volts to the RC time constant, and discharge it through a 10K resistor, the capacitor voltage will fall to the required +1 volt much quicker than if you applied +100 volts.

continued on page 30

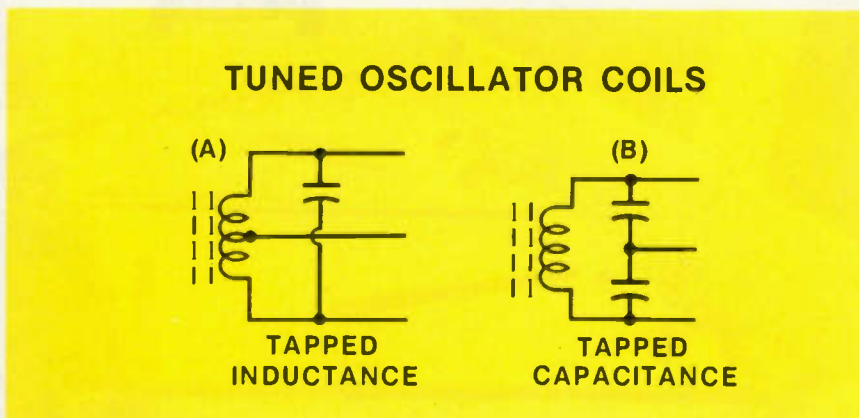

Figure 2 Tuned oscillators require a parallel-tuned circuit with either a tapped inductance or a tapped tuning capacitance. A time-constant oscillator can have an oscillator coil, but it is not tuned by a parallel capacitor. A ringing coil is tuned, but does not have any taps.

Horizontal

continued from page 29

Therefore, increases of positive-feedback amplitude decrease the frequency of a time-constant oscillator.

Most technicians have noted that changing the height in a tube-type TV often causes the vertical to roll, thus requiring an adjustment of the vertical-hold control. This is a practical example of time constants at work, because pulse amplitude depends on the supply voltage.

Of course, the same principle applies to horizontal oscillators, but the amplitude doesn't have an adjustment control. Instead, parts failures can cause wrong horizontal frequencies by raising or lowering the signal amplitude in the oscillator loop. Shorted turns in oscillator coils probably change the frequency more from the amplitude reduction than they do from the change of inductance. Think about it.

Tuned Oscillators

Tuned oscillators often are called "sinewave oscillators," because waveforms at the tuned circuit (and sometimes at the output signal) are near sinewaves. **These oscillators are much more stable than the time-constant types.**

Figure 2 shows one hallmark of a tuned-coil oscillator. Either the oscillator coil must be tapped, or a

WINEGARD WORKS.



tap must be **simulated** by splitting the tuning capacitance into two parts. (Ringing coils are tuned but not tapped.)

Also, one winding of the coil (or one of the tuning capacitors) goes to the oscillator input, and the other winding (or capacitor) connects to the output of the oscillator. There are several ways of doing this, and each will be explained. Of course, an oscillator coil could have

two isolated windings, but few circuits specify this.

Watch for the various types

As we discuss the operation and servicing of these various horizontal oscillators, notice whether each one is a time-constant or a tuned type.

In all of the schematics, the oscillator coil is L1, the tuned circuit capacitor (where used) is C3, the ringing coil and its capacitor

are L2 and C2, and the time-constant capacitor and resistor (where used) are C1 and R1.

Curtis Mathes

In Figure 3, L1 is the oscillator coil (proved by the tap, and the connections to both grid and plate of the oscillator tube). L1 does not have a paralleling tuning capacitor, and the grid voltage is highly

continued on page 33

in Cardiac Care.

It's a life or death matter.

Winegard equipment helps doctors, nurses, and biomedical technicians keep a constant watch on the heartbeats of cardiac patients.

Telemetric equipment, such as that developed, manufactured and installed by Spacelabs, Inc., Chatsworth, CA, uses Winegard TV reception products as components in the continuous monitoring of ambulatory patients' heart rhythms.



In St. Mary's Medical Center, Racine, WI, heart signals are displayed on Micro-computer Arrhythmia Detection Units, products of Spacelabs, Inc. Mobile patients are equipped with low output transmitters, which feed impulses from 18" electrode leads to an antenna. Biomedical Telemetry systems operate in the VHF television band, (174 through 216 MHz) providing vital signs information to the hospital staff on up to 70 Cardiac Care Patients in a single

unused television channel. From the antenna to the monitors. Winegard equipment is totally involved, using various combinations and models of low-noise, high-gain preamplifiers, power supplies, splitters and couplers, depending on size and type of installation. Ambulatory patients stay within a 300 foot radius of the antenna.

Heart telemetry is especially valuable in getting patients up and moving around as part of recovery, and in opening up beds for other cardiac cases. This aids in reducing costs to patients by getting them out of bed at the earliest time.

An important feature of Spacelabs systems is the capability of monitoring units to be programmed to alert the Critical Care Nurse, if heartbeats exceed upper and lower limits determined by the physician, and to print out ECG tapes that carry each patient's code number, time and date. This telemetry system provides diagnostic quality monitoring for the physician, equal to that obtained from hard-wired systems, while permitting patient mobility. Spacelabs, Inc., specifies Winegard off-the-shelf TV reception products as telemetry components

for dependability and performance. Winegard preamps are vital in attaining adequate gain at receiving units. Limited power of transmitters

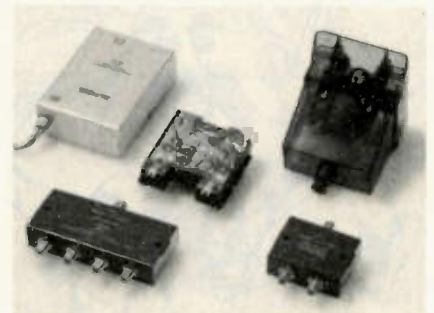

through electrode leads, and the necessarily small size of omnidirectional antennas result in a low signal. Low-noise preamps are important in boosting signals to monitors, and extending workable range of the system. Efficient splitters and couplers are required to combine antenna lines, and to split combined signals to feed various monitors tuned to the different frequencies. Winegard power supplies provide the capacity to power from 3 to 24 preamps. Winegard...at the heart of quality reception, where performance is paramount.

WINEGARD WORKS... Everywhere!



WINEGARD

The Winegard Company • 3000 Kirkwood Street • Burlington, Iowa 52601
Circle (12) on Reply Card

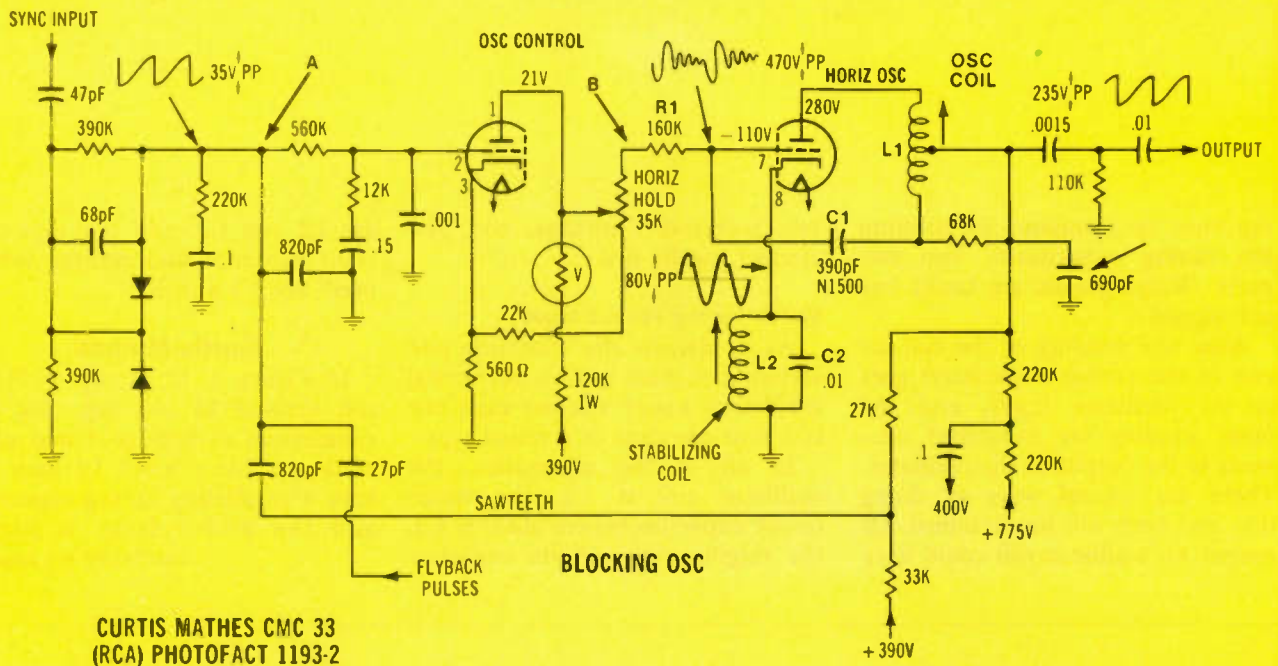
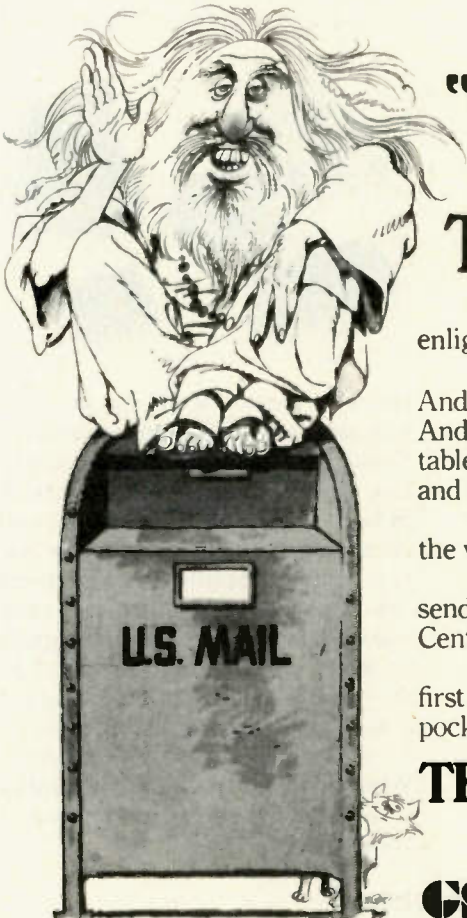

Figure 3 This Curtis Mathes circuit (evidently copied from RCA) has a blocking type of time-constant oscillator. The oscillator coil provides the necessary phase inversion, but it is not tuned. Also, the high negative DC voltage at the grid proves the type of circuit. One variation of a familiar

circuit is the placement of the stabilizing coil between cathode and ground. The usual type of AFPC circuit controls the bias of a DC amplifier, which in turn affects the R1/C1 DC voltage.



"YOU DON'T HAVE TO CLIMB A MOUNTAIN TO GAIN ENLIGHTENMENT."

Just send away for the Consumer Information Catalog and a key to enlightenment will appear in your mailbox.

The Consumer Information Catalog is put out by the Federal Government. And it lists over 200 of their booklets that you can send away for. Most are free. And they can help you with things like how to buy a home, how to grow vegetables, how to deal with headaches, simple plumbing repairs and many other everyday and not-so-everyday problems.

So if you wish to learn about the mystic sensibilities of the wayward ancients, put on your climbing gear.

But, if you wish to know about how to fix a leaky faucet, send for the catalog. Write: Consumer Information Center, Dept. A, Pueblo, Colorado 81009.

Remember, it's free. Which is only right. After all, the first step towards enlightenment shouldn't enlighten your pocketbook.

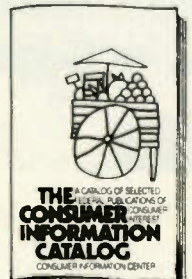

THE CONSUMER INFORMATION CATALOG

A catalog of over 200 helpful publications.

CSA General Services Administration • Consumer Information Center

Horizontal

continued from page 31

negative; therefore, the oscillator is a blocking time-constant type.

C1, the grid-coupling capacitor, and R1, the grid-leak resistor, are the time-constant components that primarily are responsible for the approximate frequency.

Of course, the frequency must be made to vary over a narrow range to allow proper horizontal locking. Positive voltages from the plate of the oscillator-control tube and the hold control are fed to one end of R1. Positive voltage at the end of R1 affects the time constant the same as a change of the positive-feedback amplitude. In other words, a higher positive control voltage at R1 speeds up the oscillator, while a lower positive control voltage slows down the oscillator, giving a lower frequency.

The oscillator-control tube is merely a DC amplifier of the error-correcting DC voltage coming from the conventional duo-diode phase-detector diodes and circuit.

Notice that a sample of flyback pulses is brought through the 27 pF capacitor to be added to the sawteeth (from the plate resistors of the oscillator). These pulses are not required for proper locking, but they shift the picture slightly to the right for better centering.

Stabilizing coil

In this model, the tuned stabilizing (ringing) coil is connected between oscillator cathode and ground. Many versions have the ringing coil in the plate circuit. Benefits of the ringing coil are the same, regardless of the location, but the cathode wiring prevents use of the waveform to determine the correct tuning. An effective adjustment method will be given later. This general schematic originated with RCA, and several models of RCA have essentially the same circuit.

Adjustments

When the circuit has no defects, but needs adjusting, use this method:

- Attach a short jumper lead across the ringing coil (pin 9 of the oscillator tube and ground);
- Disable the AFPC control. One way is to kill the sync at the sync separator. Another is to ground the output of the AFPC diodes (point A);
- Adjust the horizontal-hold control for "zero beat;"
- Remove the ringing-coil jumper and restore the sync or AFPC;
- Usually a very small adjustment of the hold control is all that's necessary for good horizontal locking.

Tip: check for drift while the jumpers are still attached.

Disable the control tube

If excessive drift is observed during the time the jumpers are installed (to disable the sync and the ringing coil), the drift might be originating in the oscillator-control circuit. Although the control-tube output has between +10 and +20 volts, this voltage can be substituted for a test.

Measure the voltage at point B (between the hold control and R1) when the horizontal is locked or has zero beat. Then, connect a regulated power supply to the same point and adjust it for the measured voltage. Allow the receiver to run, while you observe the drift. Since there is no locking now, the frequency **always** will drift. However, you should be able to estimate whether the drift is the same or worse than it was with the jumpers connected. If the drift is less, the problem is in the control stage. If the drift is the same, and still excessive, the defect is in the oscillator.

Troubleshooting tips

When the symptom is intermittent and rapid frequency shift, check the 560-ohm control-tube cathode resistor, and also the hold control. A noisy or erratic control sometimes is difficult to spot.

continued on page 34

**Our
5MHz
3" scope
saves you
time, space
and money**



B&K-PRECISION Model 1403A \$228

From B&K-PRECISION, the model 1403A miniscope is a true example of taking a good idea and making it even better. We've redesigned our most popular small scope to bring you new features and higher performance, but retained the same ultra-compact cabinet. At this low price you can connect it permanently, for frequently used applications, and eliminate set-up time.

- 5MHz bandwidth with 10mV/div. vertical sensitivity
- New high-brightness CRT with P31 phosphor
- Smoked-glass graticule for high contrast display
- Rugged design—will stand up to continuous industrial and dedicated applications
- Ultra-compact—only 5.24 x 7.44 x 11.2" (HWD)
- Direct deflection terminals allow waveform display to 450MHz!
- Internal or external sync
- Ideal for field service applications—weighs only 8.5 lbs.
- Z axis input terminal

We think the 1403A is the most cost-effective small scope available. Compare the specs, features, size, and we're sure that you'll agree.

For immediate delivery, contact your B&K-PRECISION distributor.

B&K PRECISION

DYNASCAN CORPORATION

6460 West Cortland Street
Chicago, Illinois 60635 • 312/889-9087
In Canada: Atlas Electronics, Ontario
Intl. Sls. Empire Exporters, Inc., 270 Newtown Road
Plainville, L.I., NY 11803

Circle (13) on Reply Card

grid of the output tube. Therefore, the value must be exact. A smaller value produces excessive drive, and a larger size provides insufficient drive to the output tube.

The temperature coefficient of C1 (390 pF) is very critical. Use only a type approved for this chassis.

Sears Silvertone

Another blocking time-constant horizontal oscillator is shown in Figure 4. Probably, it too originated with RCA, so these tips can be applied to similar circuits.

However, the stabilizing (ringing) coil is located in the oscillator plate circuit. As the comedian says, "There's some good news, and some bad news." The good news is that a scope can be used to show the best adjustment of the ringing coil. Similarly, the bad news is that double-triggering can result from a wrong adjustment of the ringing coil.

Figure 5 shows three possible waveforms at point C (the oscillator coil tap) produced by different adjustments of the L2 stabilizing coil. The correct waveform has the sharp and rounded tips in a straight line across the top (Figure 5B). This waveform is made from oscillator sawteeth plus sine waves from the stabilizing coil.

In Figure 5A, a misadjusted stabilizing coil has reduced the sine wave amplitude and moved it to the left. Most of the benefits from the stabilizer have been eliminated.

The opposite tuning condition is shown in Figure 5C. Although this much tuning error might not bother the performance, any further raising of the broad tip above the sharp tip probably would cause serious instability (double-triggering or Christmas Treeing). This should be avoided.

Capacitors of conventional construction gradually increase in capacitance as they age for several years. Unfortunately, it's this condition of the stabilizing capacitor (.005) which retunes the stabilizing circuit toward the unstable waveform of Figure 5C.

One solution is to replace the paralleling capacitor with one of

the new high-stability types. The quick and dirty way is to compromise the adjustment, leaving the broad tip lower than the sharp one (Figure 5A).

A horizontal-drive control varies the output amplitude that's sent to the grid of the output tube.

Otherwise, this circuit is similar

to the previous one, so the remarks and troubleshooting will be the same.

Next Month

Specific tips for other types of horizontal oscillators, and a handy troubleshooting chart will be presented in part 3. □

Pro/Comm

INDUSTRIAL GRADE



THE SELECTED RANGE OF 500 INDUSTRIAL GRADE ELECTRON TUBE TYPES FOR OVER 3,000 U.S./FOREIGN REPLACEMENT APPLICATIONS.

Not all electron tubes are interchangeable. There are hundreds of examples. Manufacturers' design specifications demand high performance characteristics:

- high GM • frame grid construction in T.V. tuner applications • matched sections in rugged dual-purpose tubes • coiled heaters vs. hair pins for low noise and hum

We know because we have sold over two hundred million foreign electron tubes to the most demanding manufacturers of complex electronic equipment: hybrid color; TV tuners; instrument and test equipment; communications, audio, marine, video, and avionic equipment.

For all your replacement needs you can depend on **Pro/Comm** at no extra cost and its unconditional tube for tube replacement warranty. **Call ETI toll free at 800-645-9512 and get the details on our Special Service Dealer Tube Caddy Package customized with popular types for Zenith, RCA, G.E., and Japanese T.V. sets.**



ETI ELECTRONICS

ELECTRON TUBES INTERNATIONAL INC.

25 DUBON COURT • FARMINGDALE, N.Y. 11735 • TEL. 516-694-7700 • CABLE LECTROTEL, FDLE • TLX 14-4620

Circle (11) on Reply Card

CARTOON CORNER

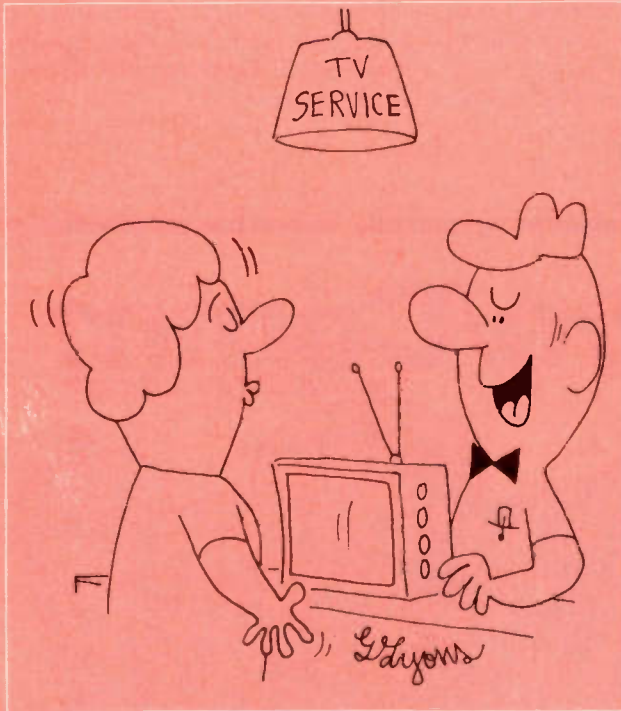

"Sure, I can fix it for half price... which half do you want fixed?"



"I say he's boring enough without being on a microphone with 4 speakers!"



"Why couldn't you take up auto mechanics like other liberated women?"



"I don't usually make house calls, but since you said it was an emergency..."

The Basics of Industrial Electronics, part 14

Counters made with cascaded toggles



By J. A. "Sam" Wilson, CET

Toggles

In digital electronics, a *toggle* is a frequency divider (that is, the output repetition rate is half that of the input). A 1000-Hz input produces a 500 Hz output, for example.

You can make J-K flip flops *toggle*, by connecting the set, clear, J, and K pins to a permanent high (such as the positive supply voltage), and then applying an input signal to the clock terminal. Frequency-divided output appears at the Q pin, and an inverted Q signal at the \bar{Q} terminal.

To simplify toggle diagrams, the J-K flip flop symbol of Figure 1B often is used.

Also, notice that the toggle input is drawn at the **right**. This is contrary to the usual practice of showing inputs at the left and outputs at the right. But, it is done here in anticipation of the use of toggles in counter circuits, where the count for the least-significant number is placed at the extreme right. Other numbers are placed to the left, in consecutive order.

An experiment last month demonstrated the ability of toggles to divide a frequency, and to show that two toggles can be cascaded in series to produce one-fourth frequency.

The next experiment shows how toggles can be made to count in binary fashion.

Experiment #1

Wire the circuit of Figure 2. If possible, arrange the first flip flop and its LED at the right, and the second flip flop at the left as shown. Triggering occurs when the input waveform goes low, as is generally true of Transistor-

Logic (TTL). Arrows on the waveform drawings show points where the two flip flops are triggered.

Figure 3 shows the LED patterns for four binary numbers produced by the Figure 2 circuit. Shaded circles symbolize lighted LEDs (highs), and empty circles indicate unlighted LEDs (lows).

The two columns are labelled with both the binary and decimal equivalent designations. More columns can be added at the left to permit counting to higher numbers. (Four columns allow counting up to 15.)

These four possible conditions of the two LEDs can indicate **four** separate combinations of highs and lows, as shown in the LED Logic Levels column. According to one system of binary counting, the right-column logic level has a value of 1, while the next to the left has a value of 2 (the next two places have values of 4 and 8, as we will find out later).

Therefore, the 00 binary readout equals 0 in decimal, 01 equals 1, 10 equals 2, and 11 equals 3. Thus,

continued on page 38

Industrial

continued from page 37

two columns permit counting from decimal 0 to 3.

Notice in Figure 4, however, that the simple counter of Figure 2 produces four consecutive combinations of logic levels and then repeats them again and again (until the power is removed). Such continuous repeating usually is not desirable. A method is needed for starting and stopping the count. The next experiment describes one such method.

Experiment #2

The count of a counting circuit never should be stopped by eliminating the clock (or input) signal. With flip flops wired as toggles (see Figure 1), change the J or K pin (or both) from logic 1 to logic 0, to stop the count at any point.

A manually-operated start/stop circuit is shown in Figure 5, where the K-pin logic state of both flip flops is determined by the output of a NAND.

Both inputs of a NAND must have the same logic level to produce a low at the output. One input is connected to a high from the power supply; therefore the NAND output will go high (allowing the toggles to count) when the other input is switched low (to ground). Or, it will have low output (stopping the count) when the other input is switched high (to supply voltage).

Of course, the count could be stopped by switching J, both J and K, set, or clear to a low condition.

Wire the circuit of Figure 5 and verify the operation, according to the results just described.

Experiment #3

When a counter is RESET, all digits are returned to the zero state. In other words, the counter is CLEARED.

During a count, the CLR (clear) terminal of a flip flop in a 7476 IC normally is held at logic 1. Switching the CLR terminal to logic 0 causes the flip flop to change to a low output condition.

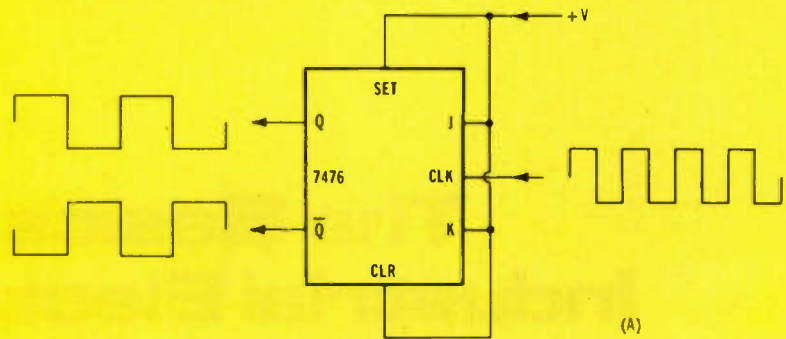

THIS J-K FLIP FLOP IS WIRED TO TOGGLE

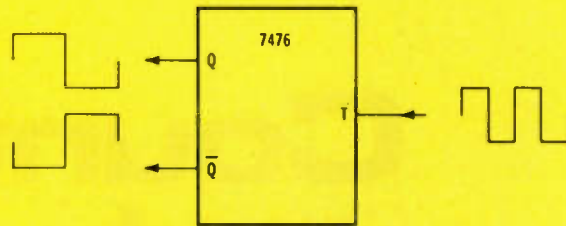

THIS IS THE SYMBOL FOR A TOGGLED FLIP FLOP

Figure 1 (A) Connect a J-K flip flop this way to make it toggle (act as a frequency divider). (B) Many toggled flip flops use this simplified symbol. Notice the inputs are at the right and the outputs at the left, to make the counting operation more clear.

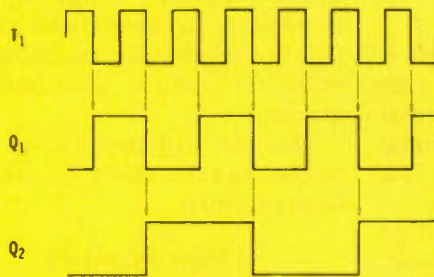
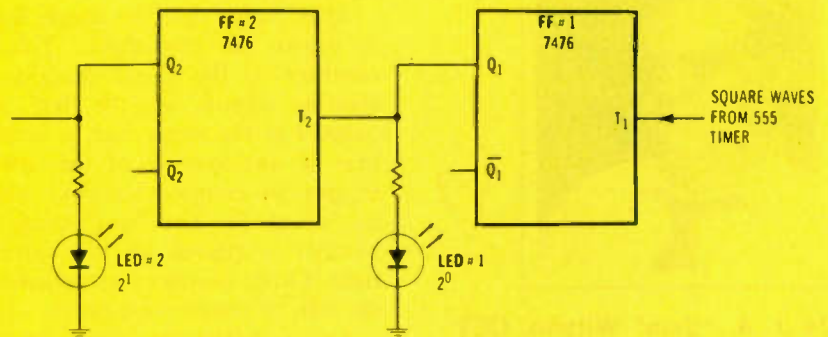

SIMPLE BINARY COUNTER

Figure 2 Two consecutive toggles with LED readouts can function as a binary counter for decimal numbers 0 through 3. Arrows on the waveforms show where the TTL triggerings occur. Each negative edge of the Input pulses forces the flip flop to reverse the prior output state.

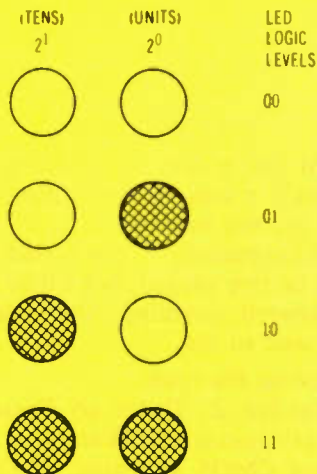

NOTE LOGIC 0 (UNLIGHTED) LOGIC 1 (LIGHTED)

LEDs SHOW BINARY COUNT

Figure 3 Any lighted LED in Figure 2 indicates a high, and an unlighted one shows a low. A high in the left column has a decimal value of 2, and a high in the right column has a decimal value of 1. Can you obtain the decimal equivalents of these four binary counts?

Figure 6 shows a manually-operated reset circuit, one that uses a NAND to switch the CLR terminal state. The operation of the NAND is identical to the one in Figure 5, except the switch is labelled "RESET" when the second NAND input is high, and "COUNT" when the input is low.

When the switch is at the RESET position, the CLR pin is low (grounded), and both flip flops change to the low condition with both LEDs off.

Wire the circuit of Figure 6, and verify that the action is as predicted.

Note: not all flip flops require a logic 0 for clear or reset. In each case, consult the manufacturer's truth table to find the logic levels that are needed for the various kinds of operation.

Letters

Usually, I reply by personal letter to any correspondence that's con-

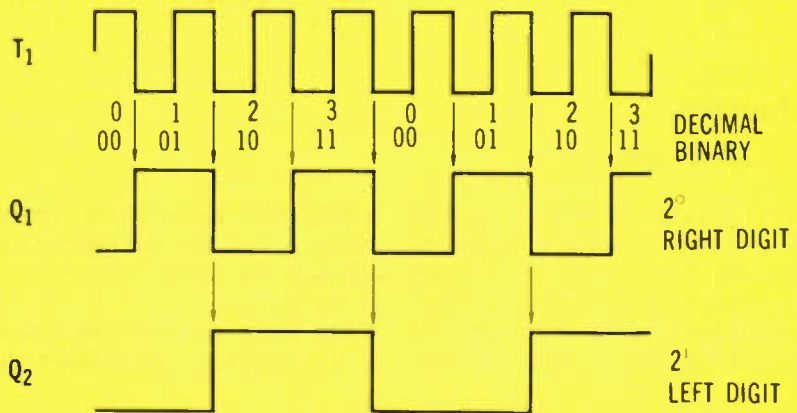

BINARY COUNTING WAVEFORMS

Figure 4 These are the waveforms of Figure 2 with the binary and decimal values added.

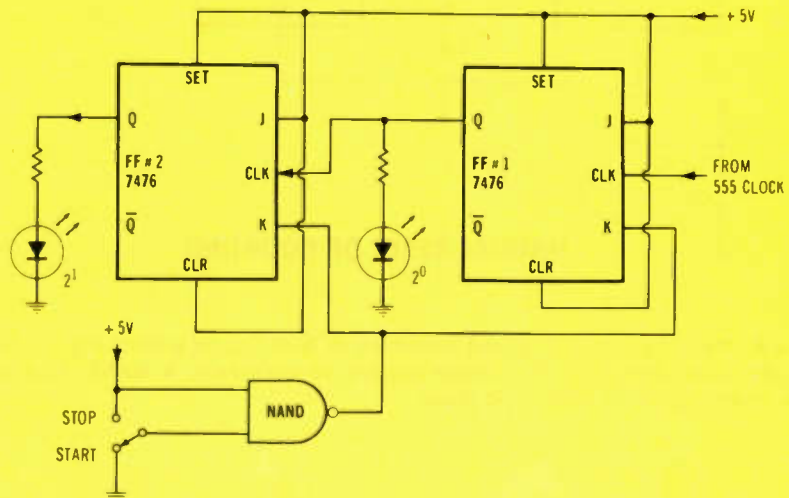

MANUAL STOP OF COUNTING

Figure 5 A low at the K terminals of both toggles stops the count, and freezes the logic levels to the last ones before the stop. A high at the K terminals permits the circuit to count continuously. A NAND is used to change the K terminal logic state.

nected with the industrial series. However, some of the letters should be shared with you readers.

Publications wanted

Mr. Alfred Jutkiewicz of Chelsea, Massachusetts asks, "In your list of publications do you have any about Programmable Logic Controllers (PLC) and ladder diagrams? I want to understand the theory and practical side of them."

Because I don't have a list of publications about that subject (or any subject), I'm hoping one of the readers can help. Send any information in care of ELECTRONIC SERVICING, and I'll forward it to Mr. Jutkiewicz.

Mercury-Vapor Lights

Mr. Harold A. Jones, of Baltimore, Maryland writes that the

continued on page 40

Industrial

continued from page 39

mercury-vapor ceiling-mounted lights in his company buildings never are turned off, even when they are not needed (during daylight hours). There are 60 or 70 lights in each of several buildings. The

reason given by company representatives is that turning them on and off each day would shorten the life of the bulbs.

Mr. Jones questions the economy of this method, and believes there

might be a way of keeping the lamps in a stand-by condition when they are not needed.

Unfortunately, I can't find any data on this subject, but I'll be glad to forward anything other readers can send to me.

Switching flip flops

Reader Z. Daku of Prescott, Ontario wants clarification of TTL versus CMOS switching characteristics.

An error in a previous article probably contributed to the request. On page 57 of the May ELECTRONIC SERVICING, the switching characteristics of NOR and NAND latches were given correctly under the sub-heading "Switching NOR latches" until the middle of the third paragraph from the bottom of the page where this statement appeared: "Therefore, TTL flip flops switch during the leading edge of input pulses, while CMOS flip flops switch on the trailing edge of input pulses." That statement has the facts reversed. **NAND TTL flip flops change output state from the trailing edges (transition from high to low) of input pulses, while CMOS NOR flip flops change output state from the leading edges (rising level from low to high) of input pulses.** The original illustration (Figure 14 of that issue) was correct.

Trouble about a Troubleshooting Question

Many readers objected to my answer for Troubleshooting Question #5 on page 67 of the April ELECTRONIC SERVICING. The schematic is given again in Figure 7, along with the logic levels at each point, which prove the D-type flip flop to be in a low output condition (not high, as stated before).

Would you believe that I was merely testing you to see if you really were doing the troubleshooting questions? I hope so, for my secretary ordered me to stop blaming everything on typing errors. Editors Note: Sam, you should use the same excuse we do when mistakes happen; blame the typesetters! □

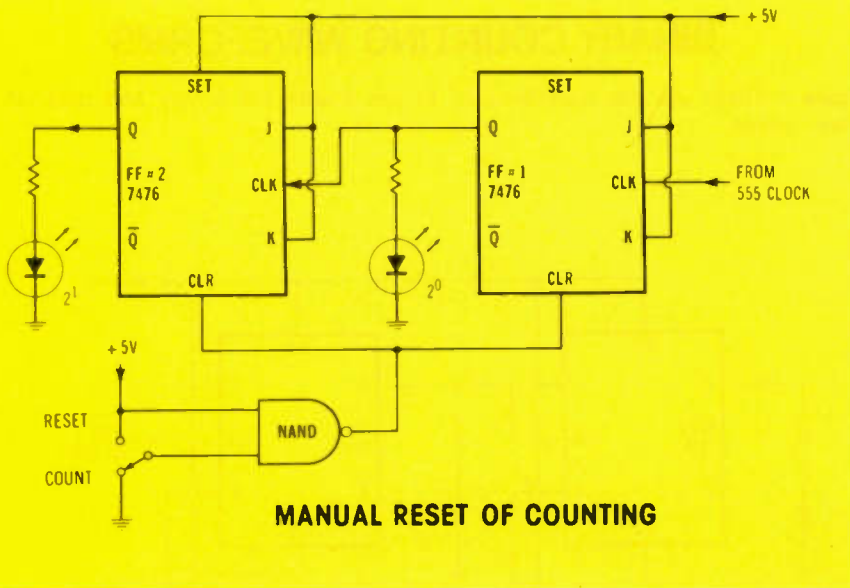

Figure 6 Changing the CLR (clear) terminals of both toggles from high to low stops the count and resets the toggle outputs to logic zero. A NAND does the actual reversing of the CLR logic level.

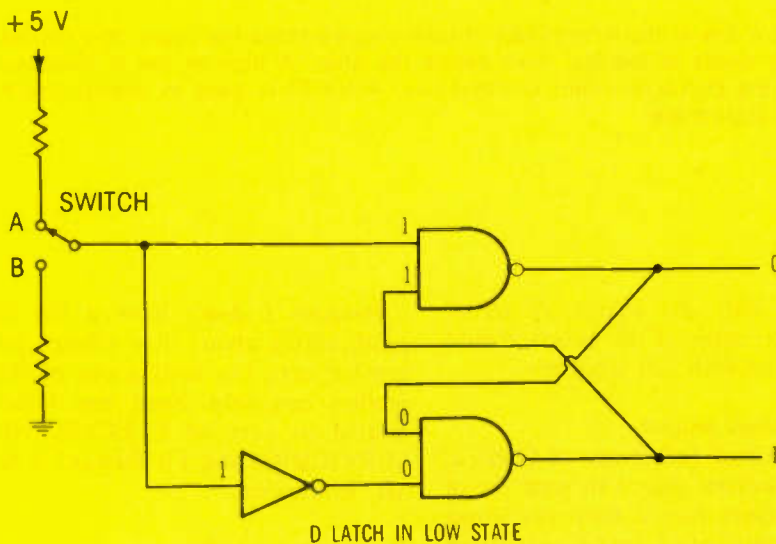

Figure 7 Logic levels at all terminals of the NANDs and the NOT used as a D latch are shown, to illustrate the wrong answer given before.

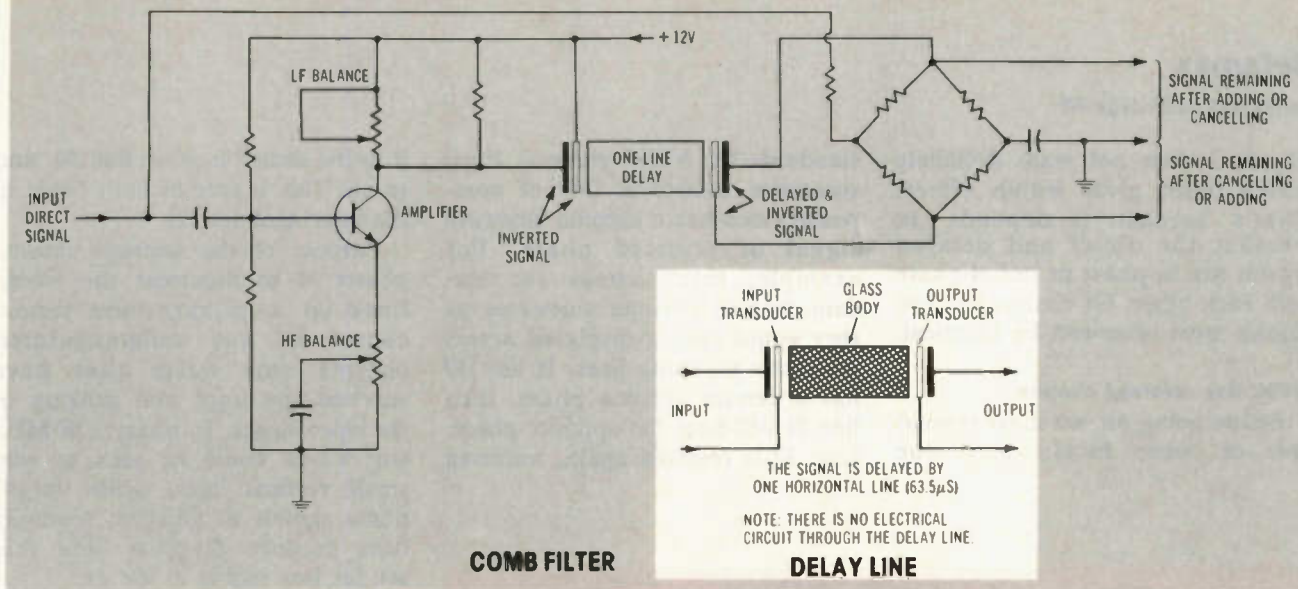

Figure 3 This is a simplified schematic of the Betamax comb filter. An amplifier adds gain that's lost in the one-line delay device (which delays its input signal by the time of one complete horizontal line of video). Both direct and delayed signals are applied to a type of resistive bridge. The sum of the two signals appears at

one output, and the difference between the bridge signals comes out at the other. Whether the signals add or cancel depends on the type of input signal, and on the output point selected. Comb filters have several important uses.

You remember that the opposite was done during recording. In other words, the chroma phase was reversed on alternate horizontal scanning lines when the "A" head was recording. The chroma phase change during recording is cancelled by an opposite phase change during playback, so the final re-created color video has the correct NTSC characteristics. This double phase changing is done to cancel most chroma crosstalk picked up by the two heads from tracks on the tape. This is an important subject, to be explained later in more detail.

Extra functions

Other circuits shown by blocks in Figure 2 supply two more functions. One is the burst-identification circuit, which is necessary because the electronic phase switch **might** be working backwards, and supplying a reversed-phase 4.27-MHz signal to the converter. In that case, the wrong phase of the resulting chroma would make the crosstalk worse, not cancel it.

To prevent this problem, the burst-identification circuit checks the phase of the playback burst against the phase of the 3.58-MHz crystal oscillator. If the phase is wrong, an error voltage is sent to the flip flop from the burst-

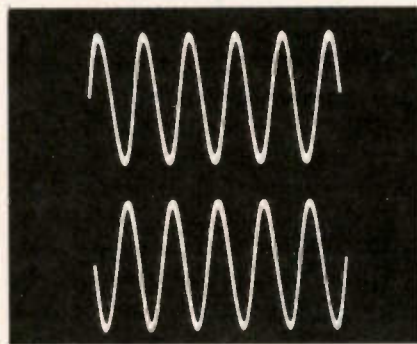

Figure 4 Specifications for NTSC color include opposite phase of the chroma signal in alternate lines of composite video. This is a fact easily overlooked by technicians, because the phase does not require any reversal in a color TV receiver. However, the transmitted reversed phases allow a comb filter to eliminate the chroma from the composite video. This waveform simulates the opposite phase of two adjacent chroma lines.

identification circuit, forcing it to correct the phase.

The phase comparator circuit is included for "fine tuning" the error-correction operation. Output of the PLL is 692 kHz, which is 44 times the horizontal sync rate. But, the before-conversion chroma is 688 kHz, or 43¾ times the horizontal rate. This causes a slight over-correction, and the 3.58-MHz chroma frequency temporarily is slightly wrong. Then the phase comparator checks the output burst

against the crystal-oscillator output, and the DC signal from the comparator pulls the 3.57-MHz frequency slightly, to restore the correct 3.58-MHz chroma frequency with proper correction.

Minimizing the crosstalk

Although the azimuth offset between the two heads is effective in causing one head to be blind to the crosstalk of the other for the higher FM frequencies, it does not remove all of the 688-KHz chroma crosstalk. Additional cancellation is needed. One characteristic of a comb filter is the answer to the problem.

The simplified schematic of a comb filter is shown in Figure 3. An inverting amplifier drives the input transducer of a delay device that delays a video signal by the time of one horizontal deflection line (approximately 63.5 microseconds). The transducer at the output feeds this delayed signal to two arms of a bridge, and the other two inputs of the bridge are supplied with a sample of the direct input signal. An output signal can be taken from either of two points; however, the results are quite different. One point gives cancellation; the other has added signals.

continued on page 44

Betamax

continued from page 43

Figure 3 does not state definitely which point gives which effect. That's because it depends on whether the direct and delayed signals are in-phase or out-of-phase with each other. Of course, the two signals must otherwise be identical.

NTSC has reversed chroma

Before going on, we must remind you of some facts about the

standards for NTSC chroma. Each successive horizontal line of composite video has a chroma sinewave of reversed phase. For example, think about the undemodulated chroma sinewaves as they would appear displayed across the raster scanning lines. If line 30 has a certain chroma phase, then line 31 will have the opposite phase. Line 32 is reversed again, restoring

it to the same phase as line 30, and so on. This is true of both fields in the interlaced frame.

Purpose of the reversed chroma phases is to minimize the visible lines on a picture-tube screen caused by any undemodulated chroma sine waves that have survived the traps and peaking in the video stages. In-phase 3.58-MHz sine waves would be seen as very small vertical lines, while out-of-phase signals at adjacent scanning lines produce diagonal lines that are far less visible to the eye.

Now, this beneficial phase reversal was included deliberately in the NTSC specifications, but it does NOT require complex circuits (such as a separate system that switches in a signal having the opposite phase at the end of each horizontal line). Instead the choice of horizontal and chroma frequencies, and phase-locking them together, accomplishes the opposite phase automatically.

Specifically, color burst must be 3.579545 MHz, which is divided by 227.5 to give a horizontal-scanning frequency of 15,734.2637 Hz. Therefore, if the beginning of one horizontal line of video has a complete sinewave of chroma, the line will end with a half sinewave. Of course, the next horizontal line begins immediately with the second half of the same sinewave, and it ends with a complete sinewave of chroma. The next line starts with a whole sinewave and ends with a half sinewave, and so on through all of the lines of both fields (see Figure 4). Therefore, the chroma sinewaves of adjacent horizontal lines are out-of-phase for the total time. (Note: For simplicity, we are ignoring the times during each horizontal line that NO burst or chroma sideband signal is included in the composite video.)

This standard alternate reversal of the chroma phase makes possible several important functions of comb filters.

Separating luminance and chroma

A comb filter can remove the chroma from the luminance signal, without needing any high-pass, low-pass, or bandpass filters. This

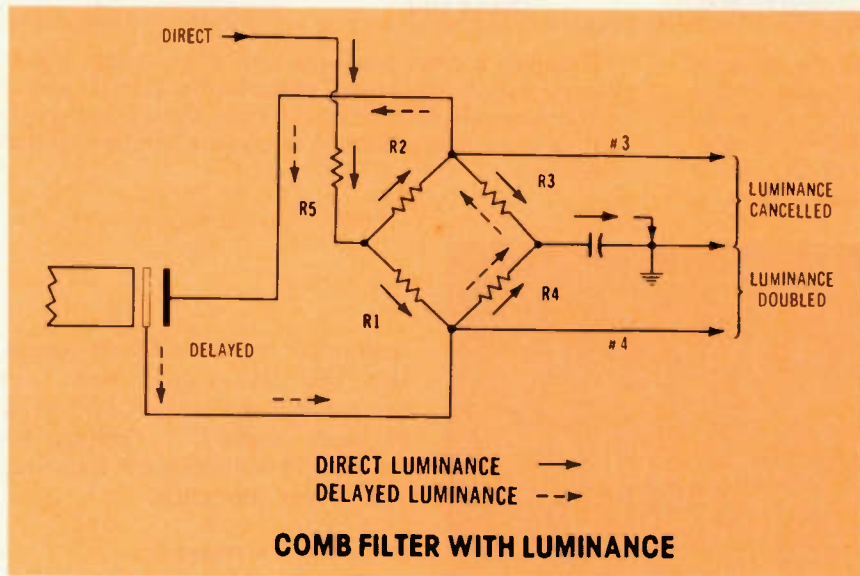

Figure 5 Arrows show currents of the direct and delayed luminance signals. Output is taken either across R3 (output #3) or across R4 (output #4), according to whether added or cancelled signals are needed.

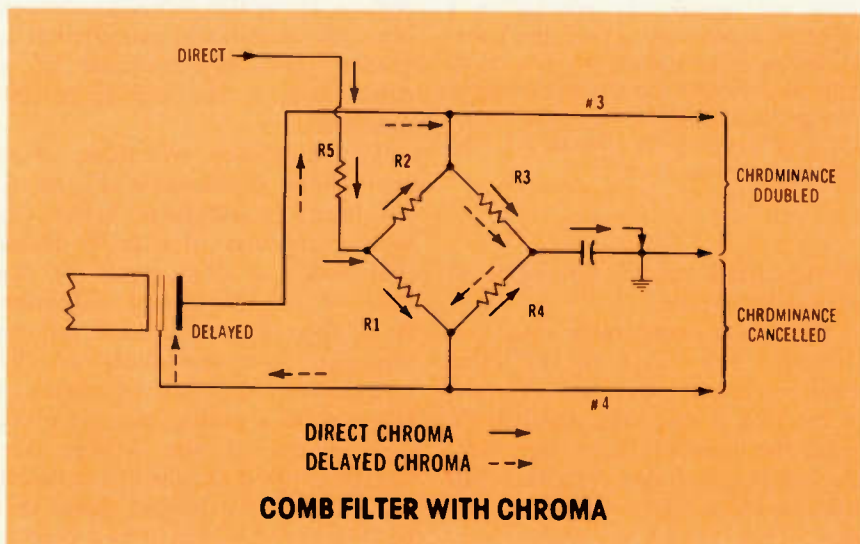

Figure 6 When chroma is applied to a comb filter, the delayed current flows in the opposite direction compared to the operation with luminance (because of the opposite phase of chroma lines), and the added or cancelled signals emerge from the opposite outputs.

allows good separation of the two signals without the limited band-pass and the phase shifts of conventional filters. Don't allow the word filter in "comb filter" to mislead you. It's not an RC or an LC frequency-separation device, but one that separates by stored signals and phase cancellations.

Notice that the output of the delay line in a comb filter is the previous line of video that's been detoured through a slower path so it arrives later by the exact time of one horizontal line (63.555638 microseconds).

This delayed signal sometimes is called a "stored signal"; however, it's not stored in frozen or motionless form. Instead it rushes through the delay line in the normal way. The delayed signal and the direct signal travel along in perfect step along their separate paths, much as two freight trains on parallel tracks. In fact, the precision of these delay lines is so high that the sine wave peaks of the two 3.58-MHz chroma signals are within a few degrees of phase from each other.

Remember, too, that all horizontal lines of luminance have the same phase. There is no reversal, as with chroma.

Luminance addition or subtraction

In Figure 5, a luminance-only signal is applied to the circuit of Figure 3. Solid arrows show the current paths of the direct (non-delayed) luminance signal, and the dotted arrows indicate the current paths of the delayed luminance.

This is not a conventional bridge (which has a single AC or DC input signal, and is adjusted for a zero-level output by cancellation), for one input signal is brought to two inputs, and the delayed signal is fed to the two remaining inputs. A comb filter, therefore, has two input signals, and the output signals are taken from the two resistors nearest ground. In Figure 5, the two alternate outputs are across R3 and R4, since their common point is bypassed to ground by the capacitor.

Assuming that the direct and delayed signals have equal amplitudes at the bridge, the two signals

add together across R4, and subtract across R3. Therefore, the output #4 at R4 will have double amplitude of luminance, while output #3 at R3 will have almost no amplitude because of the cancellation.

If a comb filter could only double or cancel the luminance, it would be of little value. But, there's more. Carefully follow the next explanation about the comb-filter operation with chroma.

Chrominance subtraction or addition When the chrominance sidebands

are sent through a comb filter, the results are opposite the ones just stated for luminance. That's because the luminance signal has the same phase for all horizontal lines of video, while the chroma-signal phase of each line is reversed from the one before and the one after. Therefore, a comparison between a delayed line of chroma having one phase and a non-delayed line of chroma of the other phase can result in cancellation.

This is shown in Figure 6, by the arrows indicating direct and
continued on page 46

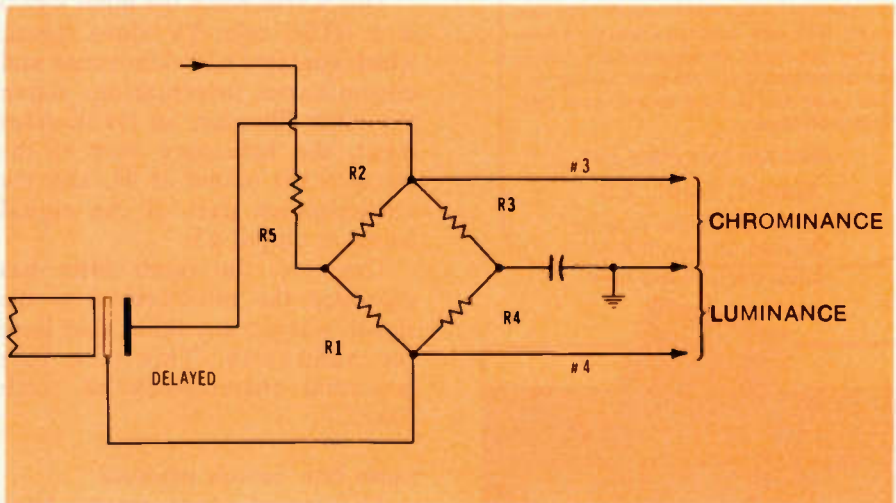

Figure 7 When NTSC video is the input to a comb filter, the luminance (without chroma) emerges at output #4, while the chrominance (without luminance) is developed at the #3 output.

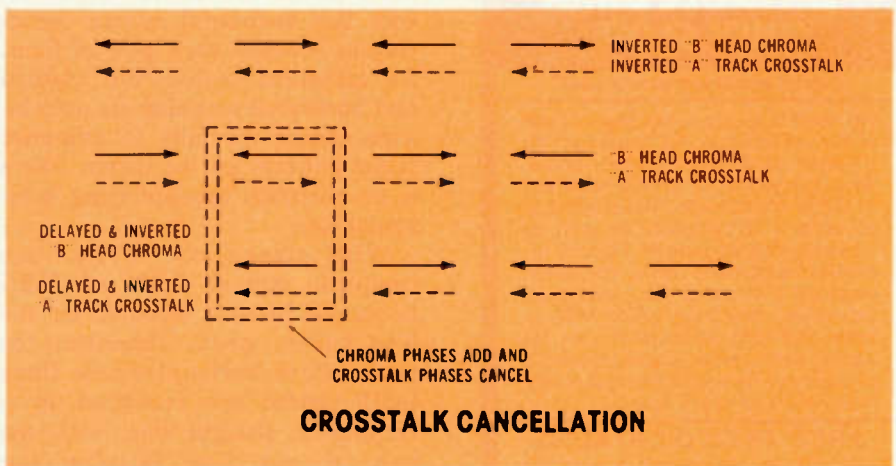

Figure 8 Polarity of the chroma signal is reversed in the Betamax when the "A" head is recording. During playback, the polarity is reversed back again, and the chroma is normal. However, the phase of the crosstalk from adjacent tracks is suitable for cancellation in a comb filter, as shown by the polarity of the arrows that represent horizontal lines.

APPLIANCE REPAIR BOOKS



Thirteen Handbooks written in easy-to-understand language by experts in the service field with illustrations and diagrams! Acclaimed by instructors and professionals alike! How to diagnose and repair air conditioners, refrigerators, washers, dryers, ranges, microwave ovens, dishwashers, vacuum cleaners, electrostatic air cleaners, RV gas appliances, hair dryers, motors, water heaters, coffeemakers, can openers, floor polishers, steam irons, food mixers, lawn care appliances, electric knives, electric and digital clocks and many others. Also fundamentals of solid state, setting up a shop, using test instruments and more. Only \$2.65 to \$4.90 ea.

SEND FOR FREE PRICE LIST

Gamit, Dept. ES

5841 W. Montrose Avenue
Chicago, Illinois 60634

Circle (15) on Reply Card



Completely
factory-
assembled
and calibrated.

NEW EICO 272 PORTABLE DMM ONLY \$69⁹⁵

Digital accuracy at low cost

No need to guess at readings or use scale multipliers. All readings indicated directly on large, bright, easy-to-read digits at high accuracy of 0.5% on dc volts. Measures dc/ac volts and milliamps as well as kilohms. Has 20 ranges. Polarity indicator, automatic zero, automatic overload indication, fully overload-protected. Readings up to 999 on three 0.3-inch LEDs that can be easily seen even under low-light conditions. Price includes test leads, batteries, and spare fuse.

FREE '78 EICO CATALOG

Check reader service card or send 50¢ for first-class mail. See your local EICO Dealer or call (516) 681-9300, 9:00 a.m.-5:00 p.m. EST. Major credit cards accepted.

EICO® 108 New South Rd.
Hicksville, N.Y. 11801

Betamax

continued from page 45

delayed-by-one-line chroma signals. Across R3, the two signals are in phase and add to a double amplitude at output #3.

However, across R4 the two signals have opposite phase and current; therefore the two signals subtract. When the two amplitudes are equal, the chroma level at output #4 is almost zero.

Dividing chroma from luminance

According to the previous explanations, we can conclude that luminance can emerge ONLY from output #4 of the Figure 3 comb filter, and also that chrominance can leave the comb filter ONLY at output #3 (Figure 7).

This is true when the input signal is a NTSC color-TV video signal, which contains both luminance and chrominance information. When the comb filter has an NTSC-video input, the luminance part of the signal is the output at #4, and the chrominance part of the signal leaves at output #3.

Therefore, the comb filter has separated the two portions of the signal, without any filters that limit the bandwidth. This is a very important characteristic of comb filters.

Comb filter cancels crosstalk

TV-trained techs might have trouble visualizing the crosstalk between tracks of video tape recorders. On the screen of a picture tube, the consecutive lines of video are stacked one above the other, with fast horizontal retrace occurring in between each pair of lines. As explained before, the chroma and horizontal scanning frequencies were chosen carefully to minimize visual patterns on the raster. There is no crosstalk between these horizontal lines.

With slant-track VTRs, one complete vertical field (of 262.5 horizontal lines) is recorded on one long narrow track. Therefore, the consecutive horizontal-rate lines (with video) are recorded in a continuous straight line, with the end of one line forming the beginning of the next. (That's similar to a scope pattern of many horizontal lines of video.)

Therefore, any VTR chroma

crosstalk is *not* between consecutive lines, but is between the horizontal lines of one track and the corresponding horizontal lines of the other track. Therefore, the opposite chroma phase of consecutive horizontal lines can't reduce the crosstalk.

Instead, the chroma phase is reversed from the NTSC standard during the time the "A" head **only** is recording. That way, the chroma of the next track (which is crosstalk for the track that's playing) is reversed in phase and can be cancelled in a comb filter.

The upconverted chroma with crosstalk (but without luminance) is passed through the comb filter, where the direct and delayed signals are in phase for the desired chroma, but are out of phase for the crosstalk.

Perhaps the best way of illustrating this operation is shown in Figure 8. The horizontal lines of video are shown as short arrows, and the direction of each arrow indicates the phase. At the resistive bridge, the in-phase chroma signals add together and appear at output #3 without the out-of-phase crosstalk signals which cancel. (The #4 output is not used for this application.)

Comments

This same comb filter that removes the crosstalk from the playback chroma-only signal also is used during recording to eliminate the chroma from the NTSC color video signal, leaving the luminance without chroma.

A similar one-line-delay device is employed in the dropout-compensator circuit, where stored video is substituted for the remainder of any line that has a signal dropout.

These one-line delays are beginning to appear in color-TV receivers, for separation of the luminance and chrominance signals without loss of bandwidth.

Troubleshooting information will be presented later in the series. Watch for it.

Next Month

Servo Mechanisms of home video tape recorders are the main subject in the next part of this series. □



Magnetic Memories Store Digital Logic, and the Basics of Charge Coupling

By J. A. "Sam" Wilson, CET

Storing Digital Levels In Magnetic Memories

After several months spent reviewing magnetic principles, we're ready to apply some of them to the design of a **simple magnetic memory for digital information.**

Of course, computers and micro-

processors use the same two levels of signal as do the digital-logic circuits explained in my industrial electronics series. The higher of the two voltages often is called "logic 1" or simply a "high." The near-zero voltage is called "logic 0" or a "low."

Any device capable of attaining and holding two levels of operation can function as a memory. An on/off switch has only two levels of operation, the handle position is the readout, and it remains in the last state until forced to change again. Many other devices have some type of memory.

Last month, we observed how a square-loop magnetic material will retain considerable magnetism, even after the magnetizing force has been removed. From that begin-

ning, we'll show step by step how to store and retrieve digital signals.

Storing logic in magnetic cores

Figure 1A shows the polarity of magnetism needed to store a logic 0, while Figure 1B illustrates the opposite polarity required for storage of a logic 1. Additional components are necessary before the flux can be changed and the state identified.

Proper flow of electron current in a winding around the magnetic material can produce the polarity of magnetism needed for a logic 0 (Figure 1C) and for a logic 1 (Figure 1D).

A constant coil current is not required. The current can be turned on only long enough to produce the required flux, then it can be turned

continued on page 48

Your comments or questions are welcome. Please give us permission to quote from your letters. Write to Sam at:

J. A. "Sam" Wilson
c/o Electronic Servicing
P.O. Box 12901
Overland Park, Kansas 66212

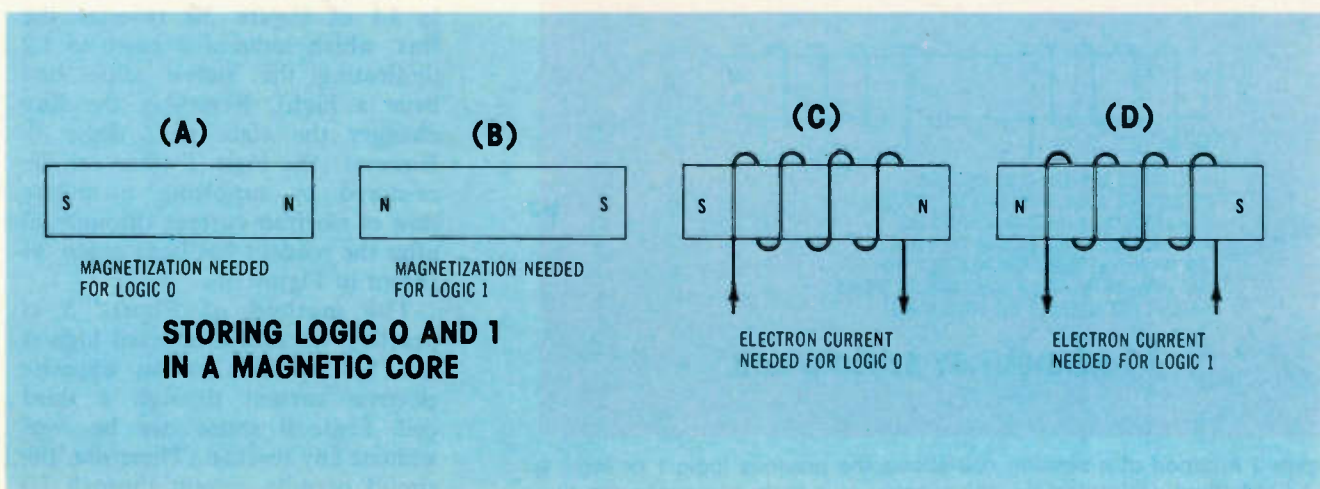

Figure 1 This is one method of storing logic 1 and logic 0 in magnetic cores, according to the polarity of the flux.

Technical Notebook

continued from page 47

off. Pulses of DC current are one practical source of magnetization. Of course, another pulse of the opposite DC current can reverse the magnetization, producing the other logic level.

Storage alone is not useful. The digital state of the magnetic material must be identified, and the

method of determining the state must not change or erase the state. Other components are needed.

Retrieving the information

Identification of the original flux state can be done with the addition of another coil to the coil/magnetic-material assembly previously de-

scribed. This added winding is called a "sensing coil."

Figure 2A shows the magnetic material in the low state, with nothing connected to the two coils. Electron current (of the same polarity as the current that magnetized it originally) is applied to L1. The magnetic flux does not change polarity. Therefore, a meter connected to L2 (as shown in Figure 2B) would NOT show a pulse of voltage. This is proof that the material previously was in the logic 0 state. The sensing current in L1 did not change the state of the flux. So, no further action is needed.

Flux for the high state is shown in Figure 2C. When the same electron current as used in Figure 2B flows through L1, the original high flux is reversed to a low. The changing flux induces a voltage in the sensing coil, L2, thus proving that the original state had been a high. In other words, the method identified the high digital state, but reversed it in the process.

Notice that the magnetic material is in the low state after one readout, regardless of the original state. Obviously, the method has limited usefulness.

A solution

This undesired reversal of high states (lows are not affected) during identification tests can be corrected later by signal current in a third coil.

In Figure 3A, the core is shown in the high state. Readout current in L1 of Figure 3B reverses the flux, which induces a pulse in L2 (indicating the stored state had been a high). Reversing the flux changes the state to a logic 0. However, the logic 1 state can be re-stored by supplying a reverse flow of electron current through L3 after the readout has been made, as shown in Figure 3C.

The method of Figure 3 is practical because a reversed logic 1 can be replaced by an opposite electron current through a third coil. Logic 0 states can be read without any reversal. Therefore, the circuit permits current through L3 only after a high has been read.

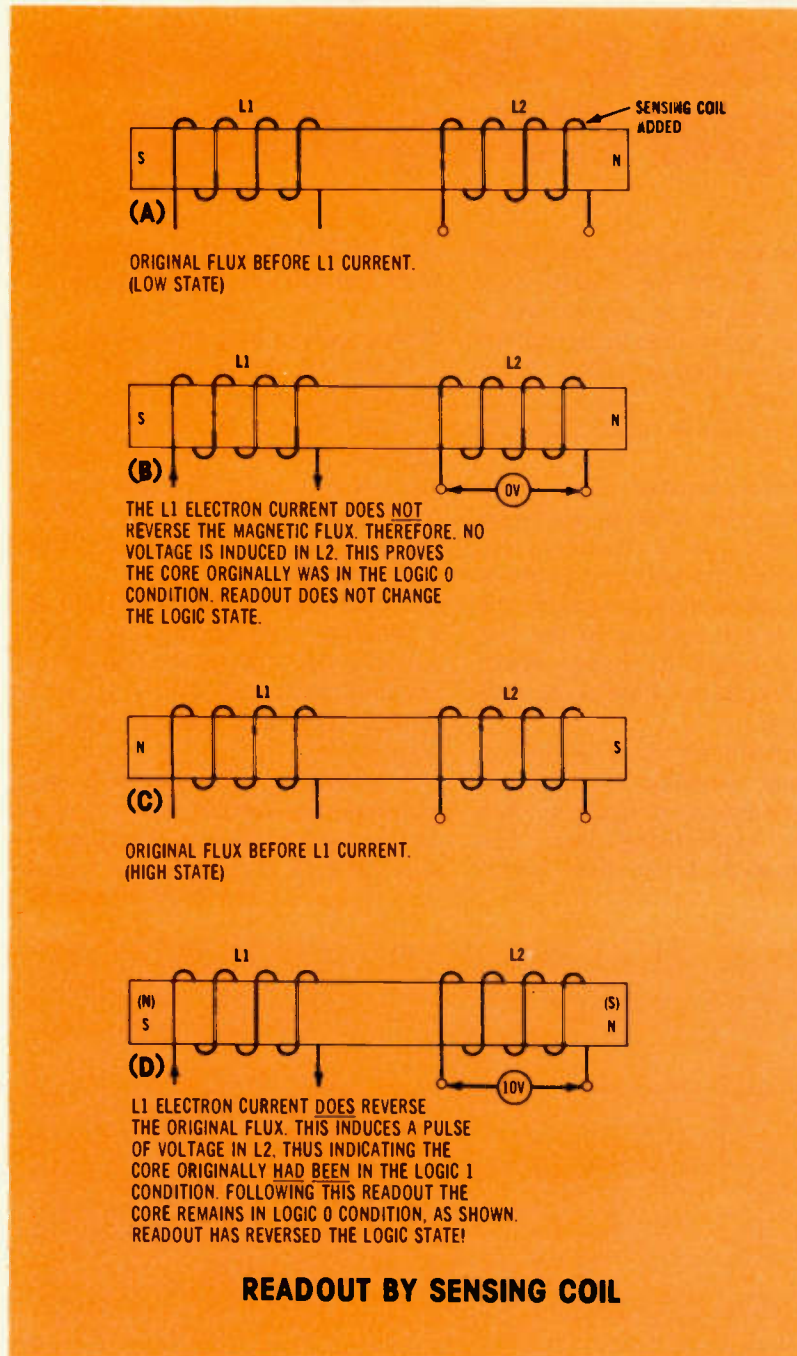

Figure 2 Addition of a sensing coil allows the previous logic 1 or logic 0 to be identified. Unfortunately, the sensing of a logic 1 reverses the flux to the logic 0 condition.

Circular cores

Less flux leakage and decreased pickup of hum and extraneous noise are obtained when the rectangular core of magnetic material is arranged into a toroid (Figure 4). The theory of operation remains the same.

More information about memories will be presented later.

Definitions???

Here are some electronic definitions sent to me by Mr. C. Jur of Los Angeles Valley College:

Negative Charge—you pay them

Positive Charge—they pay you

Forbidden Gap—scene of a horse opera

Junction—a fork in the road

P/N Junction—a roadside rest area

Energy Band—musicians who lift weights

Semiconductor—a truck driver

Degenerate Semiconductor—truck driver who likes "tea"

Recombination—meeting the same people for the first time

Dope—someone you know

Heavily Doped—someone you wish you didn't know

Stored Charge—a wine cellar

Silicon—a foolish prisoner

Base—the low man of a quartette

Collector—a person who collects something

Common Collector—a person who collects from everyone

Emitter—an exit

Common Emitter—the only door in the room

Emitter Capacity—total number of people who can squeeze through a door at the same time

Emitter Breakdown—the door collapsed

Current Density—present stupidity

Atom—part of the slang expression "up and atom"

Delay Time—the time before an employee begins working after arriving at the shop

Rise Time—the time after the alarm goes off before a person gets up

Storage Time—accrued sick leave

Fall Time—September to November

DCTL—Don't Complain if the Transistor's Lousy

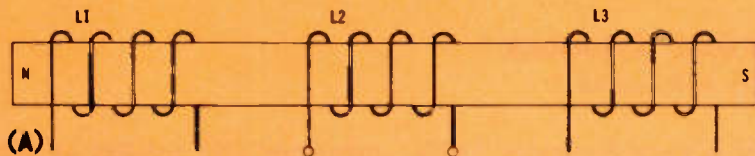

(A) CORE IS IN HIGH STATE AND READY FOR READOUT.

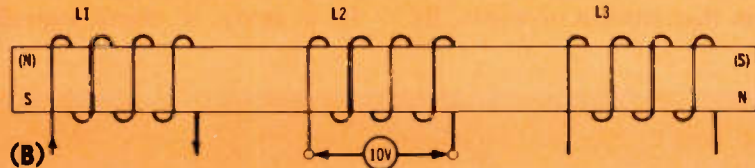

(B) READOUT CURRENT IN L1 REVERSES THE FLUX, AND INDUCES A PULSE IN L2 TO INDICATE A HIGH HAD BEEN STORED. THE L1 CURRENT ALSO CHANGES THE FLUX TO LOGIC 0.

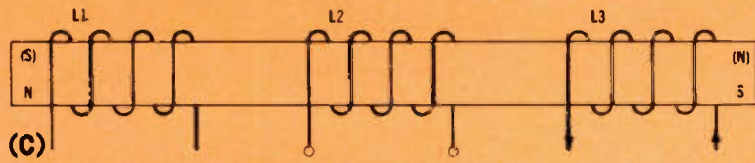

(C) A REVERSE ELECTRON CURRENT IN L3 REVERSES THE FLUX AGAIN, THUS RESTORING THE CORE TO ORIGINAL STORED HIGH CONDITION.

THIRD-WINDING CURRENT RE-STORES CANCELLED HIGH

Figure 3 Addition of a third coil permits a high to be re-stored after it is reversed by the readout current. No current is allowed in the re-storing coil, except following the readout of a high. (Readout of a low does not change the state of the core.)

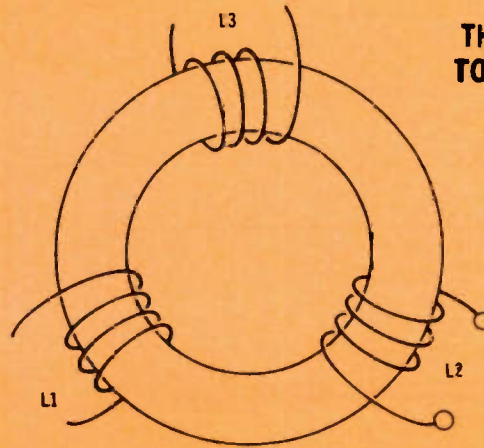

THREE WINDINGS ON A TOROID HAS LESS LOSS

Figure 4 Practical magnetic cores have a toroidal shape that minimizes signal leakage and core loss.

Switching Transistors—exchanging one transistor for another

Holes—the presence of nothing

Hole Density—a concentrated amount of nothing in a small space

Germanium—should have been a flower, but someone misspelled it.

This short course should have equipped you to talk electronic slang with anyone.

Faster Than A Speeding Bullet...

An old news release tells of a circuit developed by the Bell Laboratory that could transmit one billion bits of information per second over a laser beam. That's one gigabit per second!

If ever used in a continuous and practical application, the laser system could transmit 50,000 volumes

continued on page 10

Technical Notebook

continued from page 49

of books in about 8 minutes. That's about 200 complete books transmitted every second.

Of course, the system would just transmit that amount of words. By

comparison, the **printing** of actual books is a slow process.

Printing invention needed
In a study of electronographic

printing, I learned several years ago that the limitation of being able to print at high speeds is the near impossibility of moving the paper through the machinery fast enough.

Paper is an insulator, and the friction of passing through the press generates a tremendous amount of static electricity. These high voltages interfere with the printing process, in addition to the bother of miniature lightning strokes playing around the press.

One of the most-needed inventions is a method of reducing static electricity charges during the high-speed movement of paper. I'm passing this "pressing" need along to you, so you can become rich. Now, I've always wanted to know someone who's rich. And, I presume when you receive great wealth from your invention, that you'll remember where you learned of the opportunity.

To prevent you from wasting too much time, here are some of the ideas that have been tried before. One technique was to subject the paper to radiation produced by an atomic material. Another was to bombard the paper with ultra-violet light (or other rays) to neutralize the charges.

Of course, the paper could be made from a conductor rather than an insulator. But that's cheating, since it's not ordinary paper.

For relatively slow-moving paper, some presses have tinfoil strips attached to the press frame where they can contact the paper, and thus ground the static before it builds up to dangerous potentials.

After you develop and patent your solution to the static electricity problem, send me the details, and I'll print them in Technical Notebook.

Charge Coupling

Charge-coupled devices are mentioned frequently in news about electronic products. They have several important advantages over MOSFET and CMOS devices, and are certain to become very popular in the near future.

The model shown in Figure 5 consists of a semiconductor material with an insulating layer. Over the

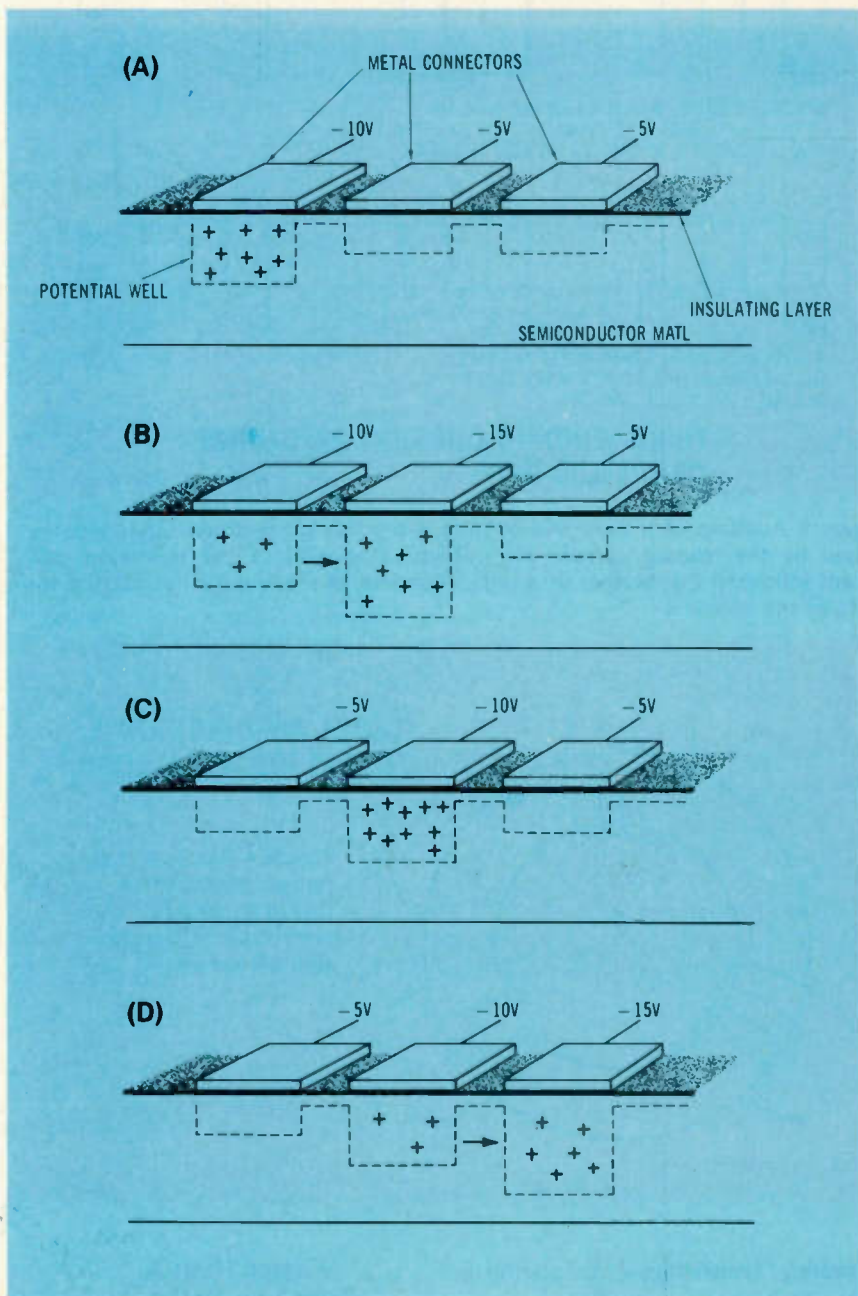

FIGURE 5 (A) The highest negative voltage at the first metal tab attracts positive charges in the semiconductor material under the tab. (B) When the DC voltages are changed as shown, the higher negative voltage at the second tab attracts charges from the first tab (a process that requires some time). (C) After all of the charges are moved over under the second tab, the DC voltages are changed to a quiescent condition, with the highest negative voltage at the second tab (to hold the charges there). (D) Applying the highest negative voltage to the third tab causes the charges to move over under the tab. After the charges are all under the third tab, the voltages are changed to a quiescent condition with -5V at the first and second tabs, and -10V at the third. The charges remain under the third tab until the voltages are changed again.

insulating layer are three metal tabs.

In Figure 5A, tab #1 (at the left) has a voltage of -10V, and the other two tabs each have -5V. The high negative charge applied to the first tab causes an accumulation of positive charges immediately beneath it. The potential barrier, which results from the negative charges of the tabs, is illustrated by the dotted line.

When the voltages are changed to -10V, -15V, and -5V, as shown in Figure 5B, the increased negative charge at the second tab forces the charges to move from left to right (as shown by the arrow).

In Figure 5C, all of the charge carriers are presumed to have moved under the center tab, and the voltages are returned to quiescent values (the tab holding the charge has double the negative voltage).

Notice that the potential well now is beneath the center tab. Motion of the charges from beneath one tab to the next was accomplished by changing the DC voltages, without any external current flow.

When the third tab voltage is changed to -15V, with -5V on the first and -10V at the second (see Figure 5D), the charges under tab two begin to move over to the right beneath tab three.

After all of the charges have moved to tab three, the voltages are returned to a quiescent condition, with -5V at the first two tabs and -10V at the third. (The higher voltage holds the charges there, until they are moved by a change of the voltages.)

Of course, the process can be continued with more tabs at the right of these three, thus moving the charge carriers as far as the material and tabs extend.

Notice that charges have been moved from one area of a semiconductor material to another by a simple change of voltage at the tabs. External current, such as necessary with the collector or drain of transistors, does not flow. Obviously, current can be moved in charge-coupled devices by the use of less power than in other types.

A MOS device requires about

100 microwatts for each bit (a logic 1), while a charge-coupled device needs only about 5 microwatts per bit.

CCD devices can be operated at frequencies of about twice that possible with MOS devices.

Charge-coupled devices require only one-third to one-fourth as much area for each bit handled.

Also, the physical construction of CCDs is much more simple than for either bipolar or CMOS devices.

In summary, charge-coupled devices surpass MOS ones in four areas: lower power; wider bandwidth; smaller size; and simpler construction.

Three phase

The term "three phase" sometimes is associated with charge-coupled devices. Think about that as you examine the operation of Figure 5 again. Imagine that the signal at each of the tabs is a varying voltage which is out of phase with the other two by 120 degrees. This is the phase between the three voltages of a 3-phase network. So, applying a 3-phase voltage to a series of tabs forces the charges to move along the material.

Applications

One of the first CCD applications was in a "bucket brigade," which moves bits of logic 1 and logic 0 information through a device in a series of tiny steps. In Figure 5, the tab with the accumulation of charges could represent a logic 1, while a tab without any charges might represent a logic 0.

Bucket brigades are used as delay devices, because each step takes a definite amount of time, and many steps can be furnished in an IC.

Another application for bucket brigades is in IC memories. Of course, memories store logic 1 or logic 0 levels, and the tabs of Figure 5 can hold a voltage almost indefinitely. The efficiency can be very high, since no external current is required either for programming or reading-out such memories.

We anticipate that charge-coupled devices will become very popular in the near future.



endeco
soldering &
desoldering
equipment

SOLDERING IRONS

Pencil style. Safety light. Two heats — 20w and 40w. 6 tips. Unbreakable handle. 2 and 3 wire neoprene cords.

DESOLDERING IRONS

Pencil style. Safety light. Some operate at 40w, idle at 20w. 8 tip sizes. 2 and 3 wire neoprene cords.



SOLDERING & DESOLDERING KITS

Everything needed to solder or desolder or both. All in a handy lifetime metal box with hasp.

See your distributor or write...

Enterprise Development Corp.

5127 E. 65th St. • Indianapolis IN 46220
PHONE (317) 251-1231

Circle (17) on Reply Card

SERIOUS ABOUT YOUR FUTURE IN HOME ELECTRONIC SERVICE?



The Sign of
Professional
Service

...a not for profit association championing independents' right to compete, and delivering valuable benefits continuously since 1950.

NATESA offers low cost group insurance, discounts on everything from eyeglasses to motor vehicles, individual consultation on particular problems, representation to government and industry at all levels and a place to unite to protect each individual member with the strength of all.

Send this ad with your card or letterhead to:

NATESA, Dept. ES
5908 S. Troy St.
Chicago, Il. 60629

- Membership. \$60.00 enclosed. As our member premium, please send free . . .
- Practical Business Manual - OR -
- Service Contract Manual

Relay-Protected VOM

The VIZ model WV-520B is a general-purpose multimeter with both a fuse and a relay to protect against overloads. A taut-band meter with color-coded scales provides 100,000-ohms-per-volt sensitivity for DC voltage measurements and 10,000-ohms-per-volt for AC voltages.

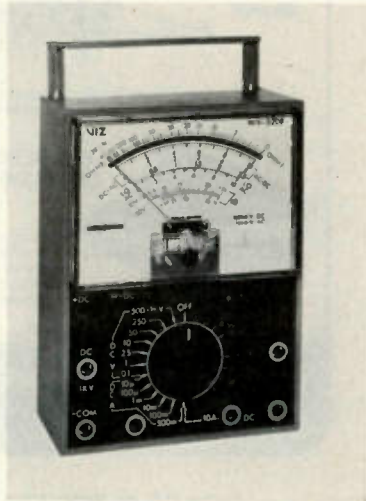

Eight DC voltage ranges cover from 0.1 volt full-scale to 1,000 volts, five AC voltage ranges cover from 10 volts to 1,000 volts, resistance readings are between 0.5 ohm and 20 megohms in four ranges, DC current from 10 microamperes full scale to 10 amperes, and two ranges of decibels. A polarity-reversing switch for DC readings, and an overload reset button are supplied on the panel.

With test leads, spare fuse, and operating manual, model WV-520B sells for \$68.

Circle (30) on Reply Card

Portable Dual-Trace Scope

Motorola Communications Division now offers model A-1004A dual-trace 5-inch portable scope. Vertical bandwidth is 15-MHz, and the



maximum vertical gain of each channel is 0.005 volt (5 millivolts), and the horizontal sweep has times from 0.2 microsecond-per-centimeter

to 0.5 second per division, plus an X5 magnifier.

In addition to the usual triggered-scope refinements, model A-1004A has three pre-set horizontal-sweep times for TV vertical, TV horizontal, and VITS. Automatic triggering provides a horizontal line even when there is no vertical input.

Front panel controls have been simplified, and high-stability circuits are used to minimize the need for internal adjustments or calibration.

Circle (31) on Reply Card

Portable Digital Multimeter

Model 272 digital multimeter is assembled and calibrated by EICO, and it sells for \$69.95. Four ranges of five functions allow measurements of DC up to 1000 volts, AC to 600 volts, AC and DC current to 1000 milliamperes, and resistances up to 1 megohm on the 0.3-inch LED 3-digit display.



Four penlight cells power the meter, which also features automatic zero, automatic polarity for DC readings, overload protection, and 10-megohms input impedance for voltage readings. Accuracy is rated at 0.5% for DC volts and 1.0% for other functions.

Circle (32) on Reply Card

1-GHz Frequency Counter

A direct-reading 4-range frequency counter that is pushbutton controlled between 10 Hz and 1 GHz is offered by Sencore. Model FC51 counter is rated at an accuracy of 0.5 parts-per-million (PPM). Push-buttons select the four frequency ranges and two reading rates. There are three inputs, also selected by pushbuttons.

The 50-ohm input has an average sensitivity of 100 millivolts from 10 MHz to 1 GHz, and it can be used

with an external cable, an untuned pickup loop (included), or the adjustable antenna that's included. In addition, the model WBA52 wide-band amplifier can be plugged into the 59-ohm input to increase the sensitivity to 5 millivolts. Model WBA52 is an optional accessory.

Crystals can be checked for



frequency by plugging each one into the "crystal check" socket and pushing the "crystal" button.

The 1-megohm input (with its own sensitivity control) has 10 millivolt sensitivity over most of the range between 10 Hz and 100 MHz.

FC51 counter can be powered either by 120 volts AC or by 12 VDC from any cigarette lighter in vehicles. It is priced at \$975 with leads and antenna.

Circle (33) on Reply Card

Pushbutton CB Generator

Pushbutton selection of all 40 CB channels is one feature of the phase-locked-loop (PLL) model 266 RF generator offered by Hickok.

The RF attenuator is double-shielded and metered to provide signals down to 0.3 microvolt. Level of the IF frequency is adjustable. In addition to the usual 455-kHz frequency, a front-panel socket accepts crystals (1-MHz to 20-MHz) for other IF frequencies.



Model 266 CB Signal Generator with bright LED channel readout sells for less than \$500.

Circle (34) on Reply Card

Digital Multimeter

Data Precision offers model 258, which has 4-1/2 digits of low-drain Liquid-Crystal Display (LCD) readout. Another unusual feature is the measurement of AC volts by a



“true-RMS” method. Model 258 measures AC and DC volts down to 10 microvolts, AC and DC current, and resistances to 20 megohms. All DC voltage ranges are rated at +0.05%. A calculating-converter LSI module allows true-RMS operation of AC voltage measurements.

Low-drain circuits and the LCD display together reduce the current to a low value, permitting up to 40 hours operation from NiCad batteries between recharges. A blinking decimal point warns that only 10 minutes of operation remains before recharging is needed.

The “TriPhasic” conversion system provides zero setting 2½ times per second just before each conversion. This is said to eliminate tracking discrepancies.

Model 258 sells for \$295, including carrying case, battery pack, test leads, battery charger, and instruction manual. Optional accessories are available.

Circle (35) on Reply Card

Power Supplies With Digital Readout

Model DG-4 “Voltage-Control Center” developed by PTS Electronics has four variable regulated voltage sources that can be measured by the internal digital voltmeter. Either positive or negative voltages can be selected by switches.



The BIAS supply is adjustable from zero to 15 volts; the SWITCHING supply from zero to 20 volts; the main SUPPLY from zero to 30 volts; and the TUNING supply covers from zero to 30 volts.

A 4-position switch and the 3-digit

readout allows very accurate monitoring of the output from any of the four supplies.

Model DG-4 has a vinyl cabinet that's available in walnut, black, or blue, and it sells to dealers for \$178.50 net.

Circle (36) on Reply Card

Thin IC-Test Clip

Pomona Electronics has developed a thinner test clip for 14-pin and 16-pin in-line ICs. This permits tests where space is limited. The DIP

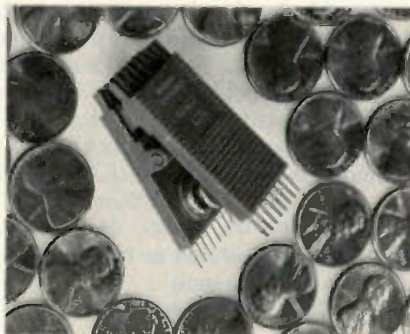

CLIP model 4236 has a molder barrier between each contact to prevent accidental shorts when technicians connect meters or scopes.

Price of model 4236 is \$5.75.

Circle (37) on Reply Card

True-RMS Digital Multimeter

Model RMS-350 Volksmeter digital multimeter from Non Linear Systems features true-RMS measurements of AC voltage and current.



The Liquid-Crystal Display (LCD) has 3½ digits, and the meter has automatic polarity on DC, overload indication, overload protection, and 10 megohms impedance for voltage readings.

Four ranges (five resistance ranges) allow DC readings from 1 millivolt to 1000 volts, AC readings from 1 millivolt to 750 volts RMS, AC and DC current from 1 micro-ampere to 1 ampere, and resistance from 1 ohm to 10 megohms.

Model RMS-350 Volksmeter sells for \$189.

Circle (38) on Reply Card

Features of these products were supplied by the manufacturers, and are listed at no charge to them. If you want factory bulletins, circle the corresponding number on the Reply Card, affix a stamp, list the required information, and mail the card.

A Public Service of This Magazine
& The Advertising Council



Your Business can be one too.

Red Cross needs individual volunteers, and donors of blood and money, by the millions.

But we need even more help. We need the solid support of American Business. And we never needed it more.

If your business is already helping, by organizing blood drives, and by supporting payroll deductions—either directly for the Red Cross, or through the local combined fund drive—the whole community owes you thanks. And we thank you, too.

Last year, with help from our friends, we offered major aid at over 30,000 disasters—from typhoons, to local (but just as devastating) house fires.

We were able to help the elderly with practical programs, we helped veterans by the hundreds of thousands, we taught people by the millions to swim or swim better. And that's just the tip of the iceberg.

Think of America without The American Red Cross.

And you'll know why we need your business as a Red Cross Volunteer. In your community. And all across America. Contact your local Red Cross Chapter to see how your company can become a volunteer.

Red Cross is counting on you.

Tool Cases

According to **Platt Luggage**, conventional tool-case pallets seldom last for two years. Therefore, the pockets on a Platt pallet are molded without seams, stitches, or rivets.



Also, the case is made of strong ABS Thermoplastic in a rugged one-piece construction. Both case and pallets have a 5-year warranty.

600T tool case sells for \$56.50.

Circle (39) on Reply Card

CRT Setup Chart

A 28-page, hardcover, ringbound book by **Leader Instruments** gives heater voltage, G1 voltage, and socket connections for almost 2000 TV picture tubes.

Although the book was developed for use with the Leader model LCT-910 CRT tester/rejuvenator (\$179.95), it also is available with the latest adaptors (needed for popular imported sets) for \$17.90 plus postage. The setup chart book can be obtained for \$6.95.

Circle (40) on Reply Card

Japanese Hardware

Hard-to-find hardware of the I.S.O. Japanese standard sizes is available in the **ORA Electronics** "Find-It-Fast—Japanese Hardware Pack."

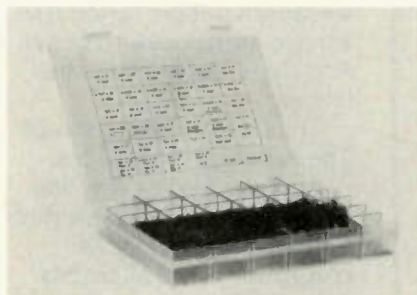

The pack contains screws, nuts, "E" rings, washers, and other hardware packed in a partitioned box.

List price of the assortment is \$24.95.

Circle (41) on Reply Card

Solder/Desoldering-Wick System

Chemtronics' SD5 modular system is designed to place both solder and desoldering wick at the technician's fingertips. The system consists of a pound spool of MIL-spec solder with the D5 desoldering wick dispenser tool inserted into the core of the spool. The unit can be refilled.

The D5 desoldering tool snaps in or out of the solder spool, as needed. The tool fits all pound and half-pound spools. It has a 2½-inch heat-resistant Teflon probe, permitting pinpoint wick application.

Solder is available in 16, 18, and 21 gauge in these alloys: 63/37 (eutectic), 60/40, 50/50, and 40/60. The wick is available in two gauges: .06-inch and .10-inch.

Circle (42) on Reply Card

IC Remover

Pomona Electronics offers a model 4386 remover for 14-pin and 16-pin Dual In-line Package (DIP) ICs. The

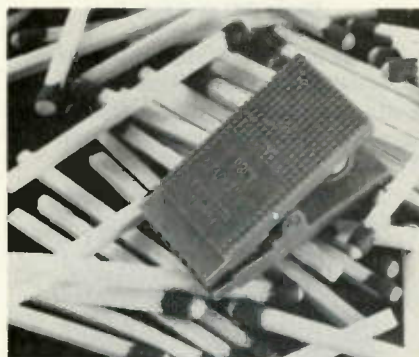

remover is made of glass-filled nylon material, and should minimize the bending of IC contacts.

Circle (43) on Reply Card

Module Extension Cables

Sylvania "Chek-A-Board" extension cable kits enable TV technicians to service modules in color-TV receivers without removing the chassis from the cabinet.



These Chek-A-Board kits are available for RCA and Zenith TV receivers, and each cable has a female connector at one end and a

mating male connector at the other end. Each side of the cable has a different color to help determine the orientation. The two-foot length enables the module to be removed a considerable distance from the chassis.

Circle (44) on Reply Card

Solderless Breadboard

Continental Specialties recommends model PB-6 "Proto-Board" kit for beginners at this kind of experimental wiring.

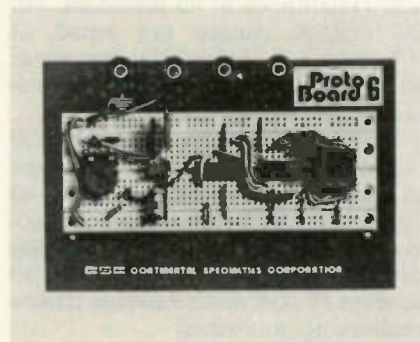

PB-6 kit has a preassembled socket, two preassembled solderless bus strips, four five-way binding posts, a metal ground base plate, mounting feet and hardware. Assembly time is said to be less than ten minutes.

The 630 tie points permit easy wiring of as many as six 14-pin DIP ICs.

Model PB-6 Proto-Board kit sells for \$15.95.

Circle (45) on Reply Card

Flameproof Resistors

A broad line of flame-proof resistors has been added to the **Sylvania** ECG line of components. The metallic resistance element is sandwiched between a noncombustible inner core and a flameproof outer coating. These resistors are said to be capable of enduring severe overloads without shorting or developing a flame.

Sylvania flameproof resistors of ¼-watt, ½-watt, 1-watt, and 2-watt sizes are available in blister-packed packages.

Circle (46) on Reply Card

Features of these products were supplied by the manufacturers, and are listed at no charge to them. If you want factory bulletins, circle the corresponding number on the Reply Card, affix a stamp, list the required information, and mail the card.

audio systems report

Cassette Tapes

Audiocassette tapes with an improved high-energy formulation of ferric oxides are available from **Memorex** in "MRX₃ Oxide" cassettes. Advantages are said to be lower distortion, higher level output, and better signal-to-noise ratio.

Cassettes are offered in 30-minute through 120-minute lengths.

Circle (47) on Reply Card

Conference Microphone

Astatic's new "Spectrum" conference microphone doesn't have the usual mike appearance, for it has a vertically-oriented dynamic cardioid omnidirectional mike in a low profile enclosure.

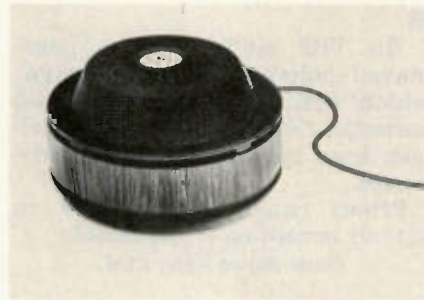

Most low-frequency noises coming from a table during group discussions are minimized by an internal shock-mounting system and a gradual rolloff of response below 200 Hz. Treble response is said to be effective to above 12,000 Hz at 60° to the axis, or to 15,000 Hz on axis. The low position of the mike rejects most sound reflections from the table.

Circle (48) on Reply Card

Portable Sound System

Model S-220 from **Perma Power** weighs only ten pounds for easy carrying, but is said to provide adequate coverage for as many as 150 persons.

This "Announcer" unit is self contained, with microphone, amplifier, speaker, and power source in one cabinet. Operating power either is from internal rechargeable transistor-radio batteries or from 120 VAC.

Suggested user price is \$154.

Circle (49) on Reply Card

Dual Folded Horns

Cobreflex III is the latest version of the **University Sound** old-favorite

folded horn with two air columns operating from a single driver speaker. Horns provide more efficiency over the voice range than any other basic type of baffle.

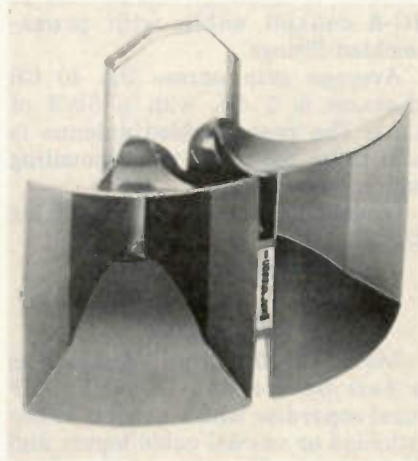

Features of the Cobreflex III include: a double-flair design for improved response down to the 250 Hz cutoff frequency; full weather-proofing; and a bracket that allows easy stacking.

Circle (50) on Reply Card

Auto Clock

A new electronic/quartz auto digital clock that shows the time of day, elapsed time, and the date has been introduced by **Sparkomatic**.

Model LED 2 has digital numbers for the three functions. Advanced solid-state circuitry is said to provide accuracy and dependability. A



flashing indicator shows when the clock is operating. LED 2 can be mounted on-dash, under-dash, or in-dash of cars, campers, vans, pickups, boats, or other vehicles.

Circle (51) on Reply Card

Features of these products were supplied by the manufacturers, and are listed at no charge to them. If you want factory bulletins, circle the corresponding number on the Reply Card, affix a stamp, list the required information, and mail the card.

The quick charge iron with 16 different quick change tips.



ISOTIP

QUICK CHARGE
Cordless Soldering Iron completely recharges in 3½-4 hours. Low voltage, battery powered, ground free isolated tip design. 16 snap-in tips to fit any job plus a PC Drill.

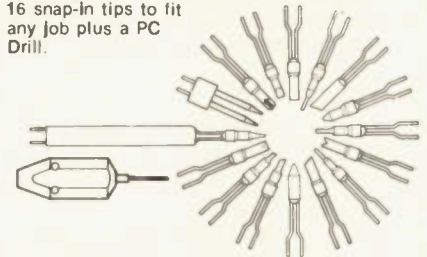

WAHL CLIPPER CORPORATION

ORIGINATORS OF PRACTICAL CORDLESS SOLDERING
• Sterling, Illinois 61081 • (815) 625-6525
"Manufacturing Excellence Since 1919"

Circle (14) on Reply Card

You Are Not ALONE!



If you think that being in business makes you **INDEPENDENT**, think again! Consumerists and government agencies are your silent - but greedy - partners; **AND THEIR SHARE COMES FIRST**; even if you don't make a profit.

WELL, YOU DON'T HAVE TO FACE THEM BY YOURSELF

JOIN NESDA

AND YOUR LOCAL & STATE ASSOCIATIONS

Send for more information to:

NESDA, 1715 Expo Lane
Indianapolis, IN 46224



Solution to:

VOLTS and NUTS

1 cores	14 lodestone
2 thermic	15 pretravel
3 kinescope	16 microvolt
4 operational	17 universal
5 experiments	18 diathermy
6 antijamming	19 expansion
7 tristimulus	20 condenser
8 statcoulomb	21 magnitude
9 multiplexer	22 insulated
10 polystyrene	23 centering
11 milliamper	24 circuit
12 calorimeter	25 brown
13 thoriated	

Start with 100 points and deduct 4 points for any part you may not have answered correctly.

Your rating:

60 - 64	Pretty good.
68 - 72	Very good.
76 - 84	Very good plus.
88 - 96	Excellent.
100	PERFECT! Stop in any time for a pat on the back and bring along a keg of beer.

Electronic Servicing

Advertising Sales Offices

KANSAS CITY, MISSOURI

Home office, P.O. Box 12901,
Overland Park, KS 66212;
Phone: (913) 888-4664

NEW YORK, NEW YORK

Chuck Horner, P.O. Box 175,
Greenlawn, NY 11740;
Phone: (516) 757-7863

CHICAGO, ILLINOIS

Helen Hull, P.O. Box 12901,
Overland Park, KS 66212;
Phone: (913) 888-4664

MOUNTAIN VIEW, CALIFORNIA

John MacKay, 2680 Bayshore Frontage
Road, Room 102, Mountain View, CA 94043;
Phone: (415) 961-0378

LONDON, ENGLAND

John Ashcraft & Co., 12 Bear St.,
Leicester Square, London W.C.2, England;
Phone: 930-0525

AMSTERDAM, HOLLAND

John Ashcraft & Co., John J. Lucassen,
Sloterweg 303, 1171 VC-Badhoevedorp,
Holland;
Phone: 2968-6226

TOKYO, JAPAN

International Media Representatives, Ltd.,
2-29, Toranomon 1-chome, Minato-ku,
Tokyo 105, Japan;
Phone: 502-0656

antenna systems report

CB Base Antenna And Mount

Model 5051 "Golden Hawk Tripod Kit" from Channel Master includes a model 5050 Golden Hawk CB base-station antenna, a gold EPC-coated 3-foot tripod mount, two 5-foot sections of masting, and 50 feet of RG-8 coaxial cable with preassembled fittings.

Average gain across the 40 CB channels is 5 dB, with a SWR of 1.3:1. The preassembled antenna is said to be ready for mast mounting within 60 seconds.

Model 5051 antenna kit retails for \$79.95.

Circle (52) on Reply Card

Band Splitter

Model CS-3010 from Winegard is a new back-of-the-TV VHF/UHF band separator which accepts either twinlead or coaxial cable inputs and has outputs for both 75-ohm VHF and 300-ohm UHF TV terminals.



The optional 300-ohm input is the no-strip screw type. A short length of coax with an "F" connector is the VHF output cable. An F-59 connector and ferrule are supplied.

CS-3010 was designed to match TVs which have 75-ohm VHF inputs and 300-ohm UHF terminals.

List price of each CS-3010 is \$8.74.

Circle (53) on Reply Card

"F" Connector Tool

Two new connectors and a hex crimping tool have been introduced by RMS Electronics. Number 1224 for 59U and number 1225 for 6U cable are the improved connectors, and the crimping tool is CR-596 (which lists for \$24.99).

Circle (54) on Reply Card

TV Antennas

Two lines of JFD Electronics SuperNova TV antennas have been introduced this summer. The first line of six antennas provides both

VHF and UHF receptions from local to fringe. Extra UHF gain is a feature of the SuperNova-C second line of six models that have a corner-reflector/bowtie for UHF.

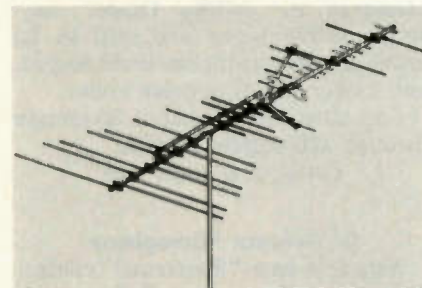

Although the UHF elements are tuned for best reception from channels 14 through 65, the antenna can be adjusted in the field for improved reception above channel 65.

The VHF section has an interleaved-colinear element design, which eliminates insulators and parasitics. Straight and solid aluminum bars replace the feeder harnesses.

Prices range from \$22.24 to \$117.91 according to the model.

Circle (55) on Reply Card

CB Antenna

The Sylvania "Auto-Match" antenna system measures the transmitted CB frequency at the feed point and then tunes the antenna for minimum VSWR. Thus, the antenna is retuned when channels are changed, and as the whip becomes wet or sways excessively.



The Auto-Match system operates from the same power source as the CB transceiver, and is designed for trunk mounting.

Circle (56) on Reply Card

Features of these products were supplied by the manufacturers, and are listed at no charge to them. If you want factory bulletins, circle the corresponding number on the Reply Card, affix a stamp, list the required information, and mail the card.

60. Norcom Electronics—"Back Talk" CB antenna tuners are described in this catalog. The isolated-circuit antenna tuner is said to tune as many as four mobile antennas or a CB base-station antenna to a flat SWR curve, even for 40 channels.

79. TRW/UTC Transformers—A 28-page technical product guide entitled "What You Should Know About TRW/UTC" has been published. The guide, which serves as a basic reference for purchasing magnetic products, includes information on the company's audio transformers, power transformers and inductors, low-power pulse transformers, high Q inductors, and electric wave filters.

80. Tucker—Reconditioned Hewlett-Packard, Tektronix and General Radio instruments and systems are listed in this updated catalog. Instruments include scope main-frames and plug-ins, signal generators, wave analyzers, recorders, meters, spectrum analyzers, and frequency counters.

82. Acoustic Research—"Truth in Listening," a 14-page catalog, defines the characteristics of accurate sound reproduction and describes the expanded AR hi-fi speaker line. Complete specifications, including DIN measurements, are provided for all seven speakers.

83. Electronic Devices—A miniature catalog shows the line of silicon-rectifier bridges, diodes, high-voltage rectifiers, TV high-voltage diodes.

86. Litton—The complete line of Kester standard solders, flux core solders, soldering fluxes, and vapor degreasing solvents are covered in a new 12-page catalog. Descriptions of more than 50 solders and related items are included.

88. Heathkit—Nearly 400 electronic products in kit form are listed in the latest catalog. Among new products featured in the catalog are a three-band UHF/VHF scanner, a matching stereo tuner and amplifier, a five-function aircraft clock timer, and a programmable home-heating control for saving on home-heating expenses. The catalog also describes automotive and marine accessories, amateur radio equipment, test in-

struments, learn-at-home electronics courses, stereo equipment, and color TVs.

89. TRW Semiconductors—Included in the revised RF Transistors and Hybrids Product Selection Guide is the complete line of RF transistors and hybrids. The 16-page booklet (Number 503) contains complete data for TRW's microwave, VHF, UHF, linear and mobile-radio product lines. It also has package design diagrams and a frequency index for all devices.

90. AP Products—Limited quantities of number 7701 Applications Notes are available. It is a reprint of the article "A 555 Tester" which appeared in two electronic publications.

91. Hewlett-Packard—A new technical note describes how to use a frequency counter. Written for the technician, this eight-page note discusses how to get the signal into the counter, how to interpret the answer, and how to keep from destroying the counter. It also includes examples, two conversion charts and a list of references.

92. GTE Sylvania—The replacement market division published a guide which cross references more than 5000 industry part numbers to the ECG line of semiconductor replacement devices for CB equipment. The 28-page guide lists replacements for diodes, integrated circuits, modules, rectifiers, and transistors.

93. Klein Tools—The proper use and care of hand tools is covered in a new 88-page, two-color booklet. The booklet contains hundreds of illustrations which show how to select the proper tool for various jobs, the care and maintenance of tools, and, many of the hazards which can result from misuse of tools. Cartoon characters are frequently used to emphasize the text.

94. Mallory—A 148-page cross-reference and product guide lists the firm's semiconductor products. Number 9-710D describes the lines of transistors, complementary-pair transistors, zener diodes, diodes, high-voltage components, color crystals, integrated circuits, and field-effect transistors.

95. GC Electronics—Nearly 200 products are pictured and illustrated in a new 24-page CB Accessories Catalog. Featured in the catalog are microphones, connectors, audio system accessories, antennas and exact replacement parts, auto alarms, mounts, cables, interference suppressors, maintenance items, and performance indicators. All accessories are for 23- or 40-channel CB radios.

96. Mountain West Alarm—The burglar and fire alarm catalog features the complete product line, and alarm-application information on system design, installation procedures, and connection diagrams.

97. Norcom Electronics—"The Ultimate in Antenna Tuning Systems," describes isolated-circuit antenna tuners for CB mobile and base radio operation. The brochure illustrates and describes the features and operation of the firm's "Iso-Tune", "Back Talk", and "Ultra-Tune" antenna tuners.

98. Raytheon—An interchangeability guide to 22 replacement semiconductors for the home-entertainment service market is available, along with a guide to the nearly 300 other types in the "RE" line.

100. Sprague—Catalog C-651 contains 28 pages of information about pre-packaged electronic components, ranging from capacitors (including trimmers) to carbon-film and vitreous-enamel resistors, silicon and germanium transistors, rectifiers, diodes, integrated circuits, quartz crystals, optoelectronic devices, switches, wiring components, pulse transformers, and CB noise filters.

NEW TUNERS

NOT universal or customized. NOT seconds, culls, dogs, or oddballs. Only \$24.95 for ANY new tuner. Over 5,000 in stock including Philco TT192.

CALL TOLL FREE 1-800-433-7124

TEXAS TUNER SUPPLY
4210 N.E. 28th St., Ft. Worth, TX 76117

Circle (19) on Reply Card

IT'S NO PUZZLE
TO ORDER

OELRICH SERVICE FORMS

FOR TV RADIO & 2 WAY RADIO SERVICE LEGAL FORMS FOR CALIF. FLA. UTAH NOW AT YOUR PARTS JOBBER OR WRITE FOR CATALOG B64
OELRICH PUBLICATIONS
4040 N. NASHVILLE AVE. CHICAGO, ILLINOIS 60634

Circle (20) on Reply Card

Advertising rates in the Classified Section are 35 cents per word, each insertion, and must be accompanied by cash to insure publication.

Each initial or abbreviation counts a full word. Minimum classified charge \$3.00.

For ads on which replies are sent to us for forwarding (blind ads), there is an additional charge of \$3.00 per insertion to cover department number, processing of replies, and mailing costs. Classified columns are not open to advertising of any products regularly produced by manufacturers unless used and no longer owned by the manufacturer or a distributor.

For Sale

REPLACEMENT COLOR YOKES-DEALERS ONLY. Zenith 95-2501-2532-2638-2667-S-89633 etc. 16.95, Magnavox 361380-1 18.95, Sylvania, GE etc. 14.95 to 19.95. Request for price list on your Letter-head. David Sims Enterprises, Inc., 665 Jericho Turnpike, Huntington Station, N.Y. 11746. 12-76-tf

TV & RADIO TUBES 36c EA!! Free color catalog. Cornell, 4221 University, San Diego, California 92105. 8-76-tf

ELECTRONIC SURPLUS, CLOSEOUTS, LIQUIDATIONS! Parts, equipment stereo, industrial, educational. Amazing values! Fascinating items unavailable in stores or catalogs anywhere. Unusual FREE catalog. ETCO-011, Box 762, Plattsburgh, N.Y. 12901. 6-78-tf

TUBES-RECEIVING. Industrial and Semiconductors Factory Boxed. Free price sheet including TV, Radio and audio parts list. Low, low prices. Transletronic, Inc., 1365 39th St., Brooklyn, New York 11218. Telephone: (212) 633-2800. Toll free: 800-221-5802. 5-78-12t

SEEKING ORIGINAL JAPANESE TRANSISTORS, IC'S, FET AND DIODES FOR CB, TV AND STEREO REPAIR? See our full page ad in this issue for listing of parts and prices. Write or call TOLL FREE for our complete list and compare prices. FUJI-SVEA ENTERPRISE, Dept. ES, P.O. Box 40325, Cincinnati, OH 45240. Nationwide: (800) 543-1607. Ohio: (800) 582-1630. 8-78-4t

R.C.A. T.V. & STEREO Sales & Service. Well established 70K Gross & Growing Northern California Retirement Community. Electronic Servicing, Dept. 518, P.O. Box 12901, Overland Park, KS 66212. 8-78-3t

"ELECTRONIC MAGAZINES" available from 1968-1978. Call: 1-305-457-9075 8-78-1t

NORTHERN CALIF. TV SALES & Service business. 12 years, top reputation. No real estate incl. Annual Sales \$40,000. Main lines Zenith, RCA, Pioneer, Hitachi. Price includes lease, van, equip., etc. No other shops within 35 miles. Will consider percentage with option for full time work. No window shoppers, please. Dick Murray, Box 816, Hayfork, CA 96041. 5-78-4t

SELLING RIDER'S MANUALS; early Sams' Photofacts. Beltman, Box 46, Highland Park, IL 60035. 8-78-1t

OBsolete, HARD-TO-FIND TV and Radio Tubes. We have several thousand, most in original cartons. If it is available, we have it. Send stamp for complete list. Same day service. Garrett's P.O. Box 2055 San Diego, Calif. 92112 8-78-2t

SENCORE CB-42 CB Analyzer (\$1095 list) for only \$795 plus \$5 shipping. Brand new, never used. Call 303-366-3980 after 6 p.m. MDT, no collect calls. Bob Begun, 1056 Fraser, Aurora, Colo. 80011. 8-78-1t

TELEVISION SERVICING can be a cinch! Tame tough-dogs easily with unique general tracer you build. Plans \$4.00. Salvador Tarin, 294 Limonite, El Paso, Texas 79932 8-78-1t

For Sale (Cont.)

TUNER SUB, \$19.95, wired, tested, complete with batteries and ready to use on tube or transistor sets. Tunes all VHF channels. This unit is without knobs or cabinet but very compact with no wires or controls dangling. Easy to use, simply connect set's coax to sub and view picture (instructions provided). Only \$19.95 and we pay shipping or will ship C.O.D. (\$1.85 C.O.D. charge). Phone Toll Free 1-800-433-7124. This is not a gimmick. If not completely satisfied, return within 10 days for full refund. **TEXAS TUNER SUPPLY,** 4210 N.E. 28th Street, Fort Worth, Texas 76117. 6-78-3t

TV SALES & SERVICE—15-year growing business, GE Dealership with room to expand, \$30,000 1977 gross. Write to: Donald Lewis, Route 1, Central City, Neb. 68826. 7-78-2t

SURBURBAN T-V REPAIR SHOP. AIR CONDITIONED. 25 YEARS EXCELLENT REPUTATION, 60,000 ANNUAL SHOPPING CENTER, 60,000 + RESIDENTIAL AREA. QUASAR SALES AND WARRANTY SERVICE. FORD VAN, SAMS, TEST EQUIP. FLOOR STOCK, OFFICE EQUIPMENT, 30K COMPLETE BUSINESS, 5026 TRAIL LAKE DRIVE, FORTH WORTH, TEXAS 76133. 817-292-1274. 8-78-1t

TV, CB, STEREO SHOP. Test equipment, manuals, parts. Gross 77,000. Will sell complete or individually. No real estate. Write: Electronic Specialists 8135 Market St. Youngstown, Ohio 44512. 8-78-1t

SAMS PHOTOFACTS—complete set through number 1172. Best offer. Shuttercraft, 4523 Grace Pl., Jamesville, N.Y. 13078 8-78-1t

B&K 40 CHANNEL CB TEST EQUIPMENT. Service Master-Model 1040 \$184.00, Frequency Counter-Model 1801 \$130.00, Signal Generator-Model 2040 \$377.50, Power Supply-Model 1640 \$50.00, & Oscilloscope-Model 1403A. \$155.20. 11 Utility plugs—never used all manuals included. Earl N. Helwig 611 W. Ellsworth Midland, MI 48640. Phone (517) 835-8144 8-78-1t

EXCESS TEST EQUIPMENT Tektronix 1S1, "Z," 533A; H-P 412A, 425A, 410B, 608A, 612A; Fluke 800; much more. List free. CLE, 3518 Riverside, Columbus, Ohio 43221 8-78-1t

GOING OUT OF BUSINESS. Sams photofacts #1 through #1200 in the cabinets for only \$900. You pay shipping. (201) 877-0750. 8-78-1t

Help Wanted

ELECTRONIC TECHNICIANS—MOTOROLA, leader in two-way radio communication, presently has openings throughout the U.S. for technicians and supervisors experienced in the installation and maintenance of communications systems (two-way, paging, microwave and CCTV). If interested in good salary and excellent fringe benefits send your resume and geographical preference to: BOB CLENDENIN, MOTOROLA, COMMUNICATIONS & ELECTRONICS, INC., 1821 N. Office Square, Room 200C, Schaumburg, IL 60196. Equal employment opportunity/affirmative action employer. 7-78-3t

Education-Instruction

REPAIR TV TUNERS—High Earnings. Complete Course Details, 12 Repair Tricks, Many Plans, Two Lessons, all for \$2. Refundable. Frank Bocek, Box 3236 Enterprise, Redding, Calif. 96001. 8-76-tf

Professionals Accredited

PROFESSIONAL BACHELOR DEGREE...earned with 4 or more years of Electronic Business Management, Sales, or Servicing Experience. For FREE information write: EBERT PROFESSIONALS INSTITUTE, Box 1651, Dept. R., Columbia, Missouri 62501. 5-78-6t

Business Opportunity

TV TECHNICIAN! Increase your income up to \$60,000 yearly. Rent-lease-sell TVs new-used, even from comfort of your home. Basic Preliminary \$4.00. Perry's TV Leasing, Box 1407, Santa Maria, CA 93456. 4-78-6t

SOUTHERN CALIFORNIA TV SHOP located in booming Orange County. Prime business location. Ten years in Garden Grove. Large inventory. Price negotiable. Contact Bill Ault, 9110 Garden Grove Blvd. 92641. 714-534-0450. 8-78-1t

ELECTRONIC TECHNICIAN SPECIAL, Homer, Alaska business Sales & Service in Marine, Mobile, and Home Entertainment. Franchises, Test Equipment, inventory Xtra. Aprills' Realty (907) 235-8759 8-78-2t

GET OUT OF THE TV RUT. Start making money now with Paltronix portable security systems. No technical hassles to keep up with. Full training provided. Good margins to work with. Plus your chance to diversify your services. For full details contact Don Musil, 48 West Golden Lake Rd., Circle Pines, Minn. 55014. (612) 786-4244. 6-78-3t

ESTABLISHED TV SALES & SERVICE Business for sale in growth oriented city. Central Ohio. Business includes: attractive store room, current inventory. Also exclusive TV Rental business. This is a substantial quality operation. Owner may assist in purchase for right party. For more information call or write Mr. Bruce Massa, P.O. Box 121, Reynoldsburg, OH 43068. Phone: (614) 864-4363. 6-78-3t

MECHANICALLY INCLINED INDIVIDUALS—BUILD ELECTRONIC DEVICES IN YOUR HOME. GET STARTED IN YOUR SPARE TIME. \$300 TO \$600/WK POSSIBLE. EXPERIENCE NOT NECESSARY. WRITE FOR FREE LITERATURE. ELECTRONIC DEVELOPMENT LAB., BOX 1535A, PINELLAS PARK, FLA., 33565.

8-78-1t

advertisers'index

B & K Precision, Dynascan Corp.	33
The Cooper Group	9
Dielectric Communications	12
Dynascan Corp., B & K Precision	33
EICO	46
Electron Tubes Int'l.	35
Enterprise Development Corp.	53
John Fluke Mfg. Co., Inc.	2
Gamit Enterprises, Inc.	46
General Electric Co., Television Business Div.	7
General Electric Co., Tube Products	3, Inside Back Cover
NATESA	53
NESDA	57
Oelrich Publications	59
PTS Electronics, Inc. Inside Front Cover-1	
Platt Luggage	11
RCA Distributor & Special Products	13
Sencore, Inc.	21
GTE Sylvania Consumer Renewal	5, 15
Texas Tuner Supply	59
Thorjanson Meissner, Inc.	11
Wahl Clipper Corp.	57
Winegard	30-31
Zenith Radio Corp.	Back Cover

Tibor Komoroczy,
Service Manager
Howard Roach TV & Appliance
300 East Valley Blvd.
San Gabriel, CA 91776

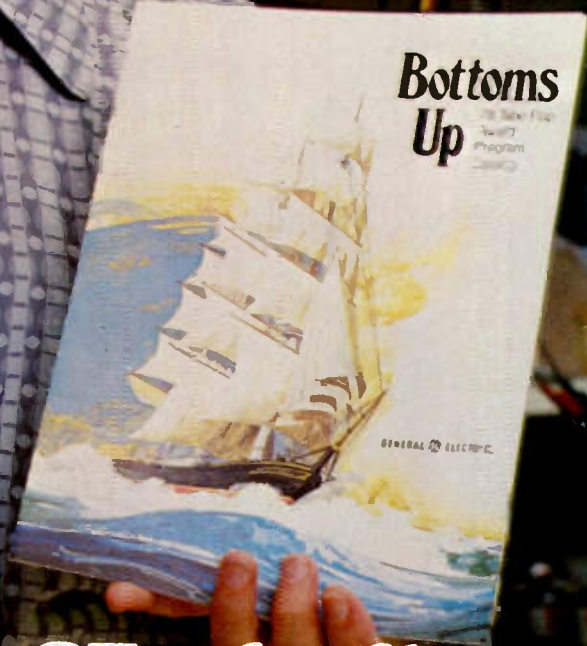

**“Don't throw away that GE tube flap
and lose award points. Get your
Bottoms Up Catalog and win!”**

Your reputation is our reputation
Tube Products Department - Owensboro, Kentucky 42301

GENERAL  ELECTRIC

Zenith's full line of antennas, featuring

CHROMATENNA II

with 18 ways you can count on for optimum picture quality!



Transmission Line Termination bleeds off static charges thru antenna system ground. Terminal stub improves front to back ratio on lower channels.



Aluminum Construction of all key metal parts works to eliminate rusting—provides long life. **Golden-Color Alodine Finish** is conductive—helps improve electrical performance!



High-Impact Plastic Insulators double-lock each element to the boom for extra bracing and durability.

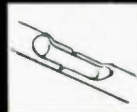

FM Block reduces FM gain up to 12dB. Remove to receive full FM gain.



Corner Reflector Bracket improved with larger tabs. (Combination models only.)



Zenith Dipole on UHF. (Combination models only.)



VHF Colinear Directors provide extra signal boost on both low and high band VHF.



Loading Straps—metal plates close to first VHF element insulators provide compensation for Lo and High band by tuning the first driven element with extra capacity.



Rugged 1" Square Boom provides extra strength compared to many round-type booms.

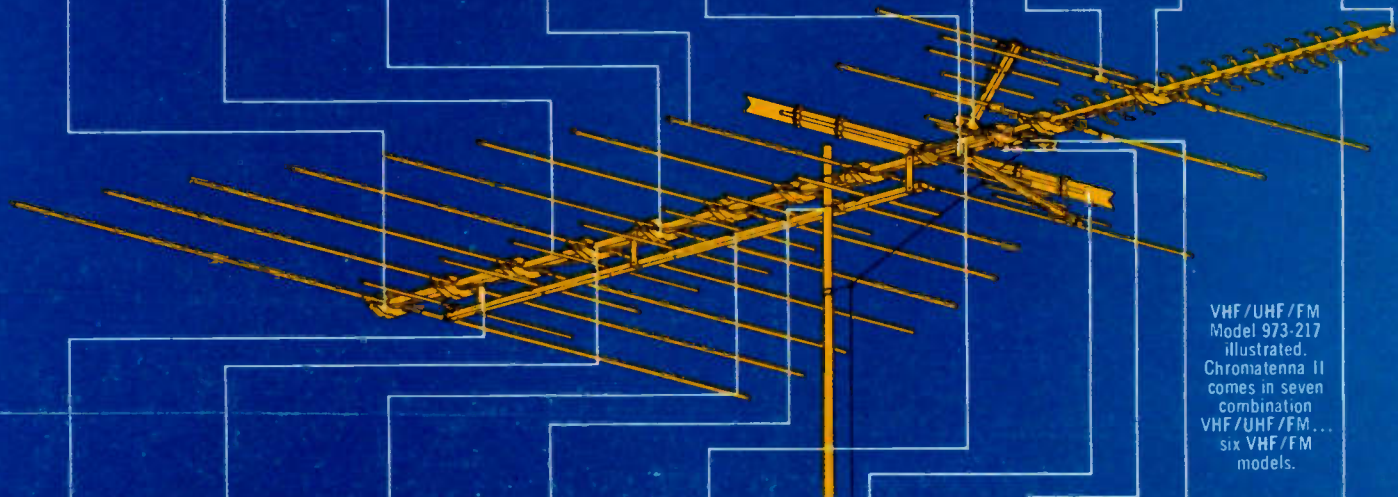

VHF/UHF/FM Model 973-217 illustrated. Chromatenna II comes in seven combination VHF/UHF/FM... six VHF/FM models.



Wide-Spaced, Heavy-Duty Feed Lines help prevent shorting from heavy build-ups of snow or ice.



Sleeved Elements of heavy-duty construction afford extra bracing and protection.



Hi-Bracket with angled ends for added strength.



U-Bolt Mounting provides a larger clamping area; larger locking nut with teeth an integral part assures a more rugged U-BOLT arrangement.



Dual Isolator Bars insure no loss of UHF to VHF signal transfer. (Combination models only.)



Proximity Spaced Signal Balancer (Z elements) provides automatic taper control of periodic driver, improves impedance matching and signal leveling on both Lo and High band channels. Improves Channel 7 pattern.



Electrically Matched Terminals With Stainless Steel Screws eliminate mismatch... protect against rusting, and provide positive electrical contact with improved no-strip stainless steel serrated washers for the take off terminals.



Strain Relief Insulator accommodates either 300-OHM twin-lead, Foam lead or Coax downlead.



Optional Break-away UHF Wing Directors provide maximum gain of standard UHF channels with optional coverage of Hi UHF channels and translator frequencies when broken off. (Combination models only.)

Zenith has quality do-it-yourself antenna kits—UHF only, VHF YAGI and Stereo FM antennas as well as a complete line of reception aid equipment.



The quality goes in before the name goes on®

Zenith Radio Corporation / Service, Parts & Accessories Division / 11000 Seymour Avenue / Franklin Park, Illinois 60131

Circle (18) on Reply Card