

# Electronic Servicing



A HOWARD W. SAMS PUBLICATION

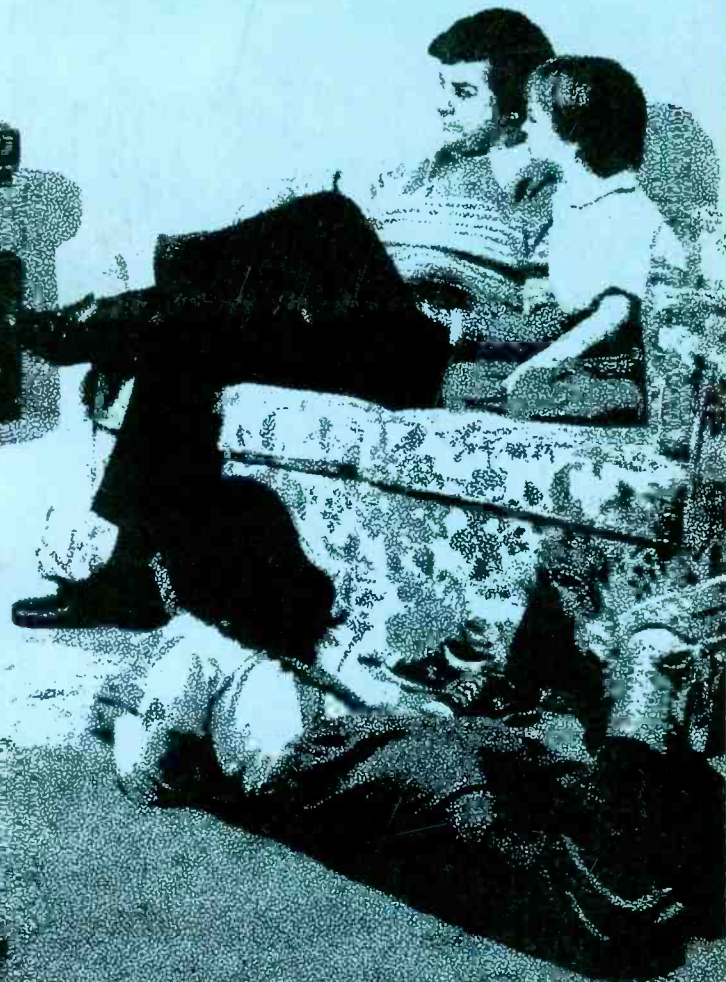
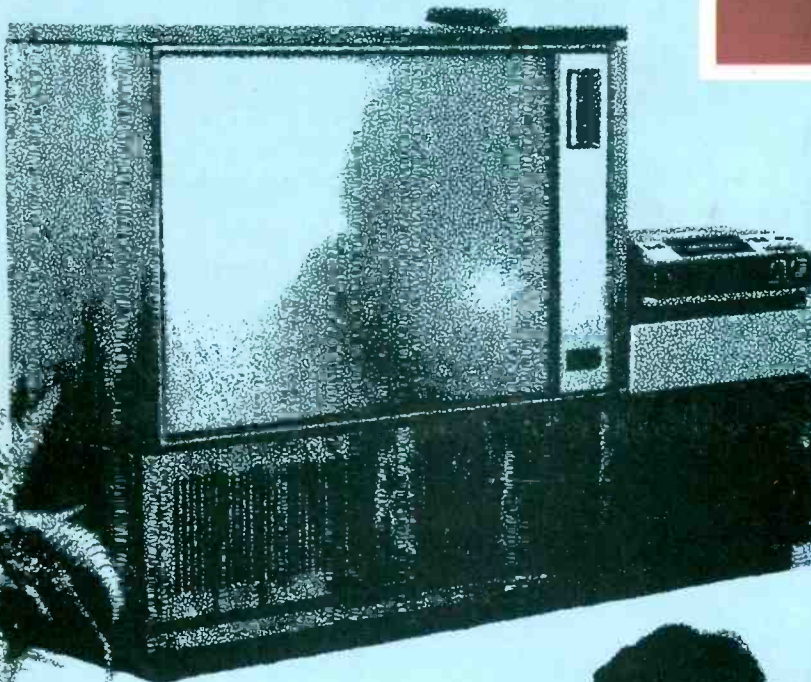
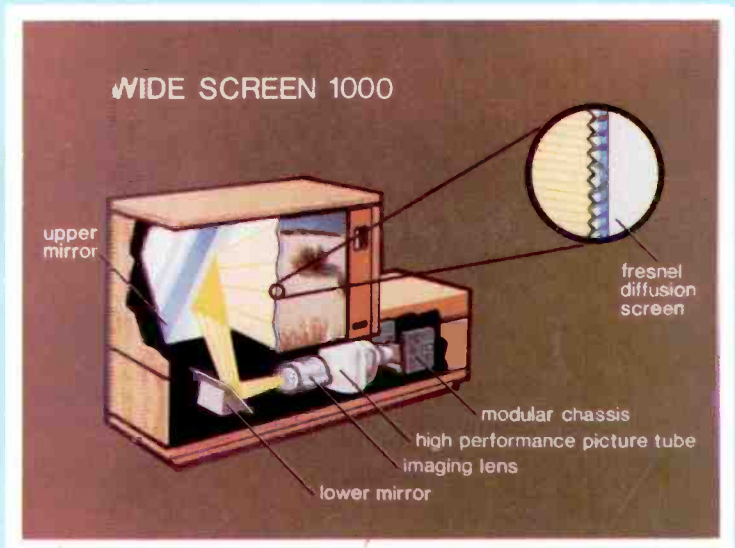
Sylvania Video

D-Latch Logic

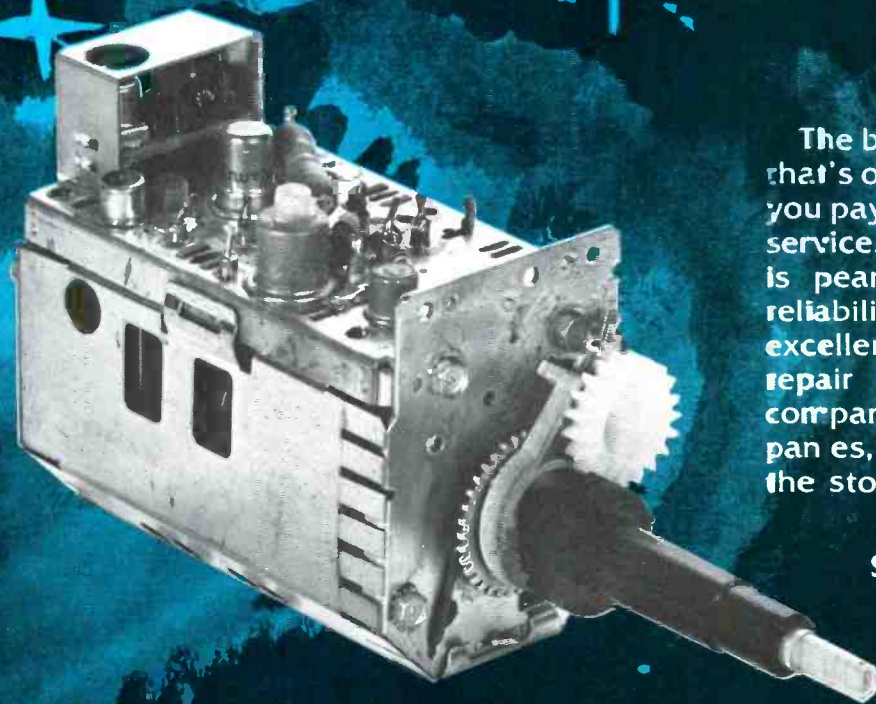
Formulas For Pricing

Betamax B&W Recording

## PREVIEW: GE Projection TV



# The Best of Everything Has It's Price... Even Tuner Service!



The best tuner repair service . . . that's our goal. You get only what you pay for even with tuner repair service. The price you pay at PTS is peanuts when you consider reliability and the standards of excellence we apply to every repair order. When you are comparing tuner service companies, price alone doesn't tell the story.

**SAME DAY SERVICE**  
**ORIGINAL OR**  
**SUPERIOR PARTS**  
**ONE YEAR**  
**LIMITED WARRANTY**

We Repair Them All . . . Any Make  
Or Model . . . Color, Black & White/  
Tube, Transistor or  
Electronic/Varactor!



**PTS ELECTRONICS, INC.**

THERE'S A PTS SERVICENTER IN MOST MAJOR METROPOLITAN AREAS.  
CHECK THE LIST AT THE RIGHT FOR THE ONE NEAREST YOU!

Circle (1) on Reply Card

# PTS SERVICENTER GUIDE

## MIDWEST

Home Office  
**BLOOMINGTON, IN 47401**  
5233 S. Hwy. 37, P.O. 272  
812-824-9331

**CLEVELAND, OH 44134**  
5682 State Road  
216-845-4480

**KANSAS CITY, KS 66106**  
3119A Merriam Lane, P.O. 6149  
913-831-1222

**MINNEAPOLIS, MN 55408**  
815-W. Lake St., P.O. 8458  
612-824-2333

**ST. LOUIS, MO 63130**  
8456 Page Blvd., P.O. 24256  
314-428-1299

**DETROIT, MI 48235**  
13707 W. 8-Mile Rd.  
313-862-1783

**GRAND RAPIDS, MI 49501**  
1134 Walker Northwest  
P.O. 1435

**CINCINNATI, OH 45216**  
8172 Vine St., P.O. 16057  
513-821-2298

**MILWAUKEE, WI 53218**  
7211 Fond du Lac  
414-464-0789

**COLUMBUS, OH 43227**  
4005A E. Livingston  
614-237-3820

**INDIANAPOLIS, IN 46202**  
28 E. 14th St.  
317-631-1551

**DAVENPORT, IA 52803**  
2024 E. River Dr.  
319-323-3975

**OMAHA, NE 68132**  
5008 Dodge Street  
402-558-1800

**CHICAGO, IL 60659**  
5744 N. Western Ave.  
312-728-1800

## SOUTH

**ATLANTA, GA 30318**  
1240 Techwood Drive N.W.  
P.O. 93887  
404-873-1787

**JACKSONVILLE, FL 32210**  
1918 Blanding Blvd., P.O. 7923  
904-389-9952

**WASHINGTON DC**  
Silver Spring, MD 20910  
8880 Brookville Rd.  
301-565-0025

**CHARLOTTE, NC 28225**  
726 Seigle Ave., P.O. 5512  
704-332-8007

**BIRMINGHAM, AL 35201**  
210 N. 9th St., P.O. 1801  
205-323-2657

**MEMPHIS, TN 38118**  
3614 Lamar Ave., P.O. 18053  
901-365-1918

**NORFOLK, VA 23504**  
3118 E. Princess Anne Rd.  
804-625-2030

**NEW ORLEANS**  
Metairie, LA 70004  
3920A Airline Hwy., P.O. 303  
504-837-7569

**TAMPA, FL 33690**  
2703 S. Macdill, P.O. 14301  
813-839-5521

**NASHVILLE, TN 37214**  
2426 A Lebanon Rd.  
615-885-0688

## NORTHEAST

**SPRINGFIELD, MA 01103**  
191 Chestnut, P.O. 3189  
413-734-2737

**PHILADELPHIA**  
Upper Darby, PA 19082  
1742-44 State Rd., P.O. 207  
215-352-6609

**PITTSBURGH, PA 15202**  
257 Riverview Ave., W. P.O. 4130  
412-761-7648

**E. PATERSON, NJ 07407**  
158 Market St., P.O. 421  
201-791-6380

**BUFFALO, NY 14212**  
993 Sycamore St., P.O. 1241  
716-891-4935

## BOSTON

Arlington, MA 02174  
1167 Massachusetts Ave., P.O. 371  
617-648-7110

**BALTIMORE, MD 21215**  
5505 Reisterstown Rd.  
301-358-1186

## PACIFIC

**SACRAMENTO, CA 95841**  
4351D Auburn Blvd., P.O. 41354  
916-482-6220

**SAN DIEGO, CA 92105**  
1111 University Ave., P.O. 5794  
714-280-7070

**LOS ANGELES, CA 90023**  
4184 Pacific Way  
213-266-3728

**PORTLAND, OR 97213**  
5220 N.E. Sandy Blvd.  
P.O. 13096  
503-282-9636

**SEATTLE, WA 98188**  
988 Industry Dr. (Bldg. 28)  
P.O. 88831 - Tukwila Branch  
206-575-3060

**SAN JOSE, CA 95112**  
466 Reynolds Circle  
408-289-1117

## MOUNTAIN

### DENVER

Arvada, CO 80001  
4958 Allison St., P.O. 672  
303-423-7080

**SALT LAKE CITY, UT 84106**  
1233 Wilmington Ave.  
P.O. 6218  
801-484-1451

**PHOENIX, AZ 85009**  
2916 West McDowell Rd.  
602-278-1218

## SOUTHWEST

**LONGVIEW, TX 75601**  
110 Mopac Rd., P.O. 7332  
214-753-4334

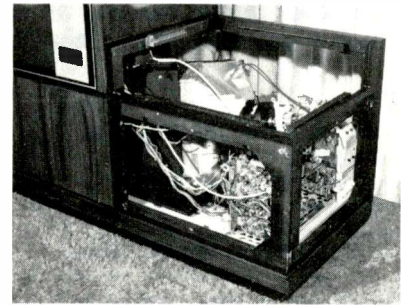
**OKLAHOMA CITY, OK 73106**  
3007 N. Moy, P.O. 60566  
405-947-2013

**HOUSTON, TX 77207**  
4326 Telephone Rd., P.O. 26616  
713-644-6793

# Electronic Servicing<sup>®</sup>

## Contents

- 14 1979 Color-TV Previews: GE "Widescreen 1000"**—A rear-projection flat screen of 1003 square inches is just one feature of this top-of-the-line General Electric color receiver—*Carl Babcoke.*



page 14

- 18 Service Management Seminar, Part 6**—Calculate accurate labor rates by these four simple steps—*Dick Glass.*

- 24 The Basics Of Industrial Electronics, Part 12**—NAND latches can operate as Schmitt triggers. Digital experiments and troubleshooting questions are included—*J. A. "Sam" Wilson.*

- 32 Servicing Betamax Videotape Recorders, Part 2B**—Details are given for the Betamax recording and playing of monochrome video. Also included are problems with "time-base errors," and B&W troubleshooting—*Harry Kybett.*

- 38 Technical Notebook**—In preparation for magnetic memories, Sam describes methods of measuring magnetic field strength—*J. A. "Sam" Wilson.*

- 41 Servicing Sylvania Color TV, Part 5**—Variable DC voltages control many video functions, such as ABL, peaking, contrast, and DC restoration. Many waveforms are included for easier troubleshooting—*Gill Grieshaber.*

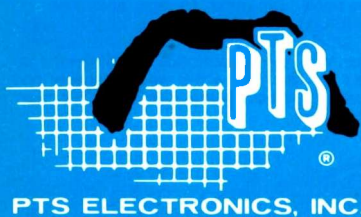
**About the Cover**—Some of the GE "Widescreen 1000" details are shown by the drawing, along with a typical home scene. Pictures are by the courtesy of General Electric.

## DEPARTMENTS

- |                                |                              |
|--------------------------------|------------------------------|
| <b>4 Electronic Scanner</b>    | <b>50 Audio Systems</b>      |
| <b>6 Reader's Exchange</b>     | <b>51 Test Equipment</b>     |
| <b>12 Symcure</b>              | <b>52 The Marketplace</b>    |
| <b>13 Troubleshooting Tips</b> | <b>52 Advertisers' Index</b> |
| <b>37 Photofact Bulletin</b>   |                              |

Second class postage paid at Shawnee Mission, Kansas and additional mailing offices. Published monthly at 9221 Quivira Road, Overland Park, Kansas 66212 by Intertec Publishing Corp., 9221 Quivira Road, Overland Park, Kansas 66212. Send Form 3579 to 9221 Quivira Road, P.O. Box 12901, Overland Park, Kansas 66212.

©Copyright, 1978, Howard W. Sams & Co., Inc. All rights reserved. Material may not be reproduced or photocopied in any form without written permission of publisher



# You can be sure

more times in more circuits in more places  
than with any other multimeters on the market today

Each Sencore DVM is backed with 15 Megohm input impedance for one third less circuit loading on every measurement. That means 50% higher accuracy than other DVMs.

## DVM38 \$395

3½ DIGIT .1% DCV ACCURACY  
AUTO-RANGING DVM

A "prime" standard at your fingertips for measurements you can trust. Auto-ranging for extended low-level range and ease of operation. 15 Megohm input impedance assures .1% reading accuracy is maintained in solid state circuits. Highly sensitive, yet fully protected to 2000 VDC overloads. Hi-Lo Power Ohms circuit simplifies in-circuit resistance measurements.

## DVM37 New \$268

3½ DIGIT .1% DCV ACCURACY  
PORTABLE DVM

Prime standard .1% accuracy on the bench or in the field for less than \$250. The DVM37 is the most accurate portable DVM you can buy, with 15 Megohm input impedance for 50% more accuracy. Includes automatic features—Auto Zero, Polarity, Decimal, Overrange. Fully protected inside to over 2000V on all functions, including Ohms, and protected outside with super-rugged case. Full ranges for every test. Fingertip "Push-On" switch in probe saves batteries as power is applied only when needed.



New DVM37



DVM32

## DVM32 \$225

3½ DIGIT .5% DCV ACCURACY  
PORTABLE DIGITAL MULTIMETER

Bench and field master for digital accuracy measurements anywhere. 0.5% DCV accuracy, backed with 15 Megohm input impedance. Exclusive battery-saving Auto-Display turns the display on automatically when you make a measurement. 2000V input protection on all functions and ranges—including Ohms.

## DVM36 \$158

3½ DIGIT .5% DCV ACCURACY  
POCKET PORTABLE DVM

Pocket portable lab accurate performance that fits every budget with highest performance-to-price benefits of any meter. .5% DCV accuracy, backed with 15 Megohm input impedance for lowest circuit loading. Full protection to 1000 V on all functions and ranges—including ohms. Drop-proof case. Battery-saving "Push On" button in probe.

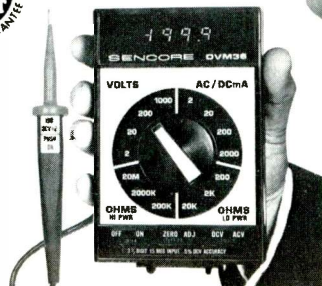
## DVM35 \$134

3 DIGIT 1% DCV ACCURACY  
POCKET PORTABLE DVM

Fast, direct reading digital accuracy for the man on the go. Same features as DVM36, except 3-digit, 1% DCV accuracy, backed by 15 Megohm input impedance that is ten times more accurate than analog meters.



DVM38



DVM36

**SENCORE**  
DIGITAL MULTIMETER SPECIALISTS  
3200 Sencore Dr., Sioux Falls, SD 57107 (605) 339-0100

In stock at your favorite local  
Sencore Full Line Distributor.

Circle (4) on Reply Card

## Electronic Servicing

Editorial, advertising and circulation correspondence should be addressed to: 9221 Quivira Road, P.O. Box 12901, Overland Park, Kansas 66212 (a suburb of Kansas City, Missouri). (913) 888-4664.

### EDITORIAL

RONALD N. MERRELL, Director  
CARL H. BABCOKE, Editor  
MICHAEL SCHEIBACH, Managing Editor  
DUDLEY ROSE, Art Director  
HILLARY MANES, Editorial Assistant  
MARY CHRISTOPH, Graphic Designer

### EDITORIAL ADVISORY BOARD

LES NELSON, Chairman  
Howard W. Sams & Co., Indianapolis  
JOE A. GROVES, Technical Consultant  
Howard W. Sams & Co., Indianapolis

### CIRCULATION

EVELYN ROGERS, Manager



Member, American Business Press  
Member, Audit Bureau of Circulations

### ADMINISTRATION

GEORGE H. SEFEROVICH, President  
MIKE KREITER, Publisher

### ADVERTISING SALES

Overland Park, Kansas 66212  
(a suburb of Kansas City, Missouri)  
Phone: (913) 888-4664

MARILYN CARROLL, Production  
Regional and Advertising Sales Offices  
with Advertising Index

**ELECTRONIC SERVICING** (with which is combined PF Reporter) is published monthly by Intertec Publishing Corp., 9221 Quivira Road, Overland Park, KS 66212.

**ELECTRONIC SERVICING** is edited for technicians who repair home-entertainment electronic equipment (such as TV, radio, tape, stereo, and record player) and for industrial technicians who repair defective production-line merchandise, test equipment, or industrial controls in factories.

**Subscription prices** to qualified subscribers: 1 year—\$8.00, 2 years—\$13.00, in the USA and its possessions. All other foreign countries: 1 year—\$11.00, 2 years—\$19.00. Subscription prices to all others: 1 year—\$25.00, 2 years—\$50.00, in the USA and its possessions. All other foreign countries: 1 year—\$34.00, 2 years—\$68.00. Single copy price \$2.25; back copies \$3.00. Adjustment necessitated by subscription termination to single copy rate. Allow 6-8 weeks delivery for change of address. Allow 6-8 weeks for new subscriptions.



INTERTEC PUBLISHING CORP.  
Subsidiary of HOWARD W. SAMS & CO., INC.

ELECTRONIC SERVICING



# electronicscanner

news of the industry

---

**A revised quick-turnover (QT) parts program** was initiated recently by the RCA Distributor and Special Products Division. The new QT program includes a single package of 150 of the most-needed TV parts, as determined by computer analysis. New features include Direction Information Service (by subscription) for dealers, and drop-shipping of parts. Color modules are available in separate kits. For further information, contact an RCA parts distributor.

**Interference-free communications around the high voltage of a power sub-station** will be provided by a fiber-optic telephone system to be built for Minnesota Power and Light by ITT Telecommunications. The contract calls for installation of the fiber-optic system between the company's Arrowhead sub-station near Duluth and the Square Butte DC station. The system will carry control and voice information.

**The Electronic Industries Association (EIA) honored Betty Ford** recently by naming her "CB Radio's First Mama." Mrs. Ford was praised for encouraging the proper use of CBs, and for focusing national attention on the practical as well as social aspects of CB radio. During the 1976 Presidential campaign, Mrs. Ford frequently used her CB to talk to Americans while traveling from city to city by car.

**The Digital Voice Protection System (DVP) from Motorola** is a new-technology voice-scrambling system intended especially for police, fire, and security forces. Over conventional radios, the signal appears to be noise only, without any hint of voice sounds. Regular speech first is converted to a digital signal, which is scrambled through a combiner algorithm. Special two-way radios can be coded in seconds from a huge number of codes, and the code can be changed at any time.

**TV receivers using microprocessors for remote channel selections** have been introduced by Sanyo Electric in Japan. As reported in *Retailing Home Furnishings*, a four-bit MPU permits users to select channels directly. For remote operation, an infrared system is used. Sanyo is said to be undecided about introducing these TVs in America.

**Polaroid has a new system for automatic focusing of cameras** that operates according to the arrival time of a transmitted ultrasonic echo, according to an item in *Electronics*. This is similar to the radar principle, although the unit is small enough to be included in the new SX-70 Land camera. An electrostatic transducer is used for transmitting and receiving the 50-KHz, 53-KHz, 57-KHz, and 60-KHz bursts of signal. These "chirps" are sent out during the first millisecond of operation. Four were chosen to minimize reflections from objects having different absorptions. The electronic circuits include a digital clock and four bipolar ICs. Coupled to the camera lens is a lens-count wheel which moves the lens to any of 128 positions of focus. A solenoid stops the lens at the proper focus position. After each picture is taken, the focusing motor returns the lens to the park position at infinity focus. Other companies have developed automatic focusing systems based on the electronic comparison of two images, and on the increase of picture contrast when it's in focus.

---



**Carl Meyer**  
President, A to Z TV Service  
Clinton & Harlem Streets  
Buffalo, New York 14224

**“I buy from the source—GE.  
They’re the world’s largest supplier  
of receiving tubes.”**

Your reputation is our reputation  
Tube Products Department · Owensboro, Kentucky 42301

**GENERAL  ELECTRIC**

# reader's exchange

There is no charge for listing in *Reader's Exchange*, but we reserve the right to edit all copy. If you can help with a request, write direct to the reader, not to *Electronic Servicing*.

**Needed:** Schematics for Elmac PMR-6A receiver and power supplies PSR-12 and PSR-116. Charles Anderson, 5914 Wood Lake Drive West, Tacoma, Washington 98466.

**For Sale:** EICO signal tracer model 147A, \$38; EICO flyback and yoke tester, model 944A, \$38; RCA/CRT tester and rejuvenator, type WT509A, \$75; and Simpson VTVM model 311, \$65. All cables, probes, and service manuals are included. William D. Shevtchuk, One Lois Avenue, Clifton, New Jersey 07014.

**Needed:** Any jukebox manuals, Blonder-Tongue Audio Baton, ARC-5 550 KHz-1500 KHz radio receiver, and a Pilot 3-inch TV. Jim Farago, c/o Young's TV, P.O. Box 335, South St. Paul, Minnesota 55075.

**For Sale:** Rider's radio manuals volumes 1 and 2, \$25 each; volumes 4-16 and 22, \$15 each; and volumes 7-10, \$10 each. All prices plus postage. Many obsolete tubes; list your needs. Jim Farago, c/o Young's TV, P.O. Box 335, South Saint Paul, Minnesota 55075.

**For Sale:** These tubes for antique radios: 33 UX301A; 9 UX200; 16 201A; 11 12A; 9 FM1000; 4 299; 1 UX199; 1 GC5; 3 864; 1 373 Spartan; 1 445; and 3 UX120. Goodman Radio Shop, Odd Fellows Nursing Home, T. Jurstrom, 12th Avenue, Mattoon, Illinois 61938.


**For Sale:** B&K-Precision 1077B TV Analyst, 465 CRT tester, and 607 tube tester; Heath IG57A marker/sweep generator, and IG37 FM-stereo generator; Sylvania CK3000 test jig; and other smaller items of TV test equipment. All in perfect condition, with manual and accessories. Also, one tube caddy. No reasonable offer refused. Bob Reib, 424 Law, Aberdeen, Maryland 21001.

**For Sale or Trade:** EICO 435 wideband scope, \$120; Heath IT-18 deluxe transistor tester, \$17. Both in excellent condition and half-cost. F. David Cummings, Ridge Road, RD4, Cazenovia, New York 13035.


**For Sale:** EICO 369/TV-FM sweep and post-injection marker generator, with cables, manual, 4.5-MHz crystal, plus several extra crystals, in excellent condition, \$120. Phil N. Booth, 9212 Coachman, Whittier, California 90605.

**Needed:** Calibration procedure and schematic for Barker & Williamson model 210FA audio oscillator. Will copy, or purchase the manual. Also, diagram (with voltages included) and alignment instructions for Hallicrafter model 5R10. H. Adams, 209 West Shadywood Drive, Midwest City, Oklahoma 73110.


continued on page 8



## AUTOMATIC STAPLE GUNS




No. T-18  
Fits wires  
up to 3/16"  
in dia.




No. T-25  
Fits wires  
up to 1/4"  
in dia.


**key  
TO  
CUTTING  
WIRE/CABLE  
INSTALLATION  
TIME  
&  
COSTS!**



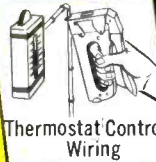
No. T-37  
Fits wires  
up to 5/16"  
in dia.



No. T-75  
Fits wires  
& cables  
up to 1/2"  
in dia.




Remote Control  
Wiring




Thermostat Control  
Wiring

**4  
MODELS  
Fit A  
WIDE  
RANGE  
of  
WIRE &  
CABLE  
DIAMETERS**

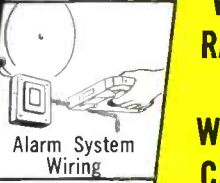
**For SAFE, FAST  
fastening in  
TELEPHONE  
ELECTRONICS  
COMMUNICATIONS  
ALARM SYSTEMS  
CATV Etc.**




Telephone Wiring



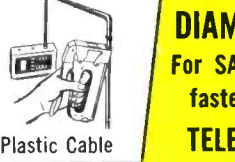
Intercom Wiring



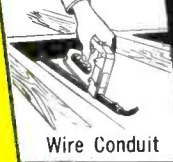
Alarm System  
Wiring




Radio & TV  
Assembly Wiring



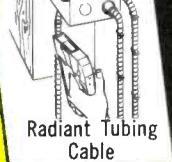
Plastic Cable



Wire Conduit




Cable TV



Radiant Tubing  
Cable

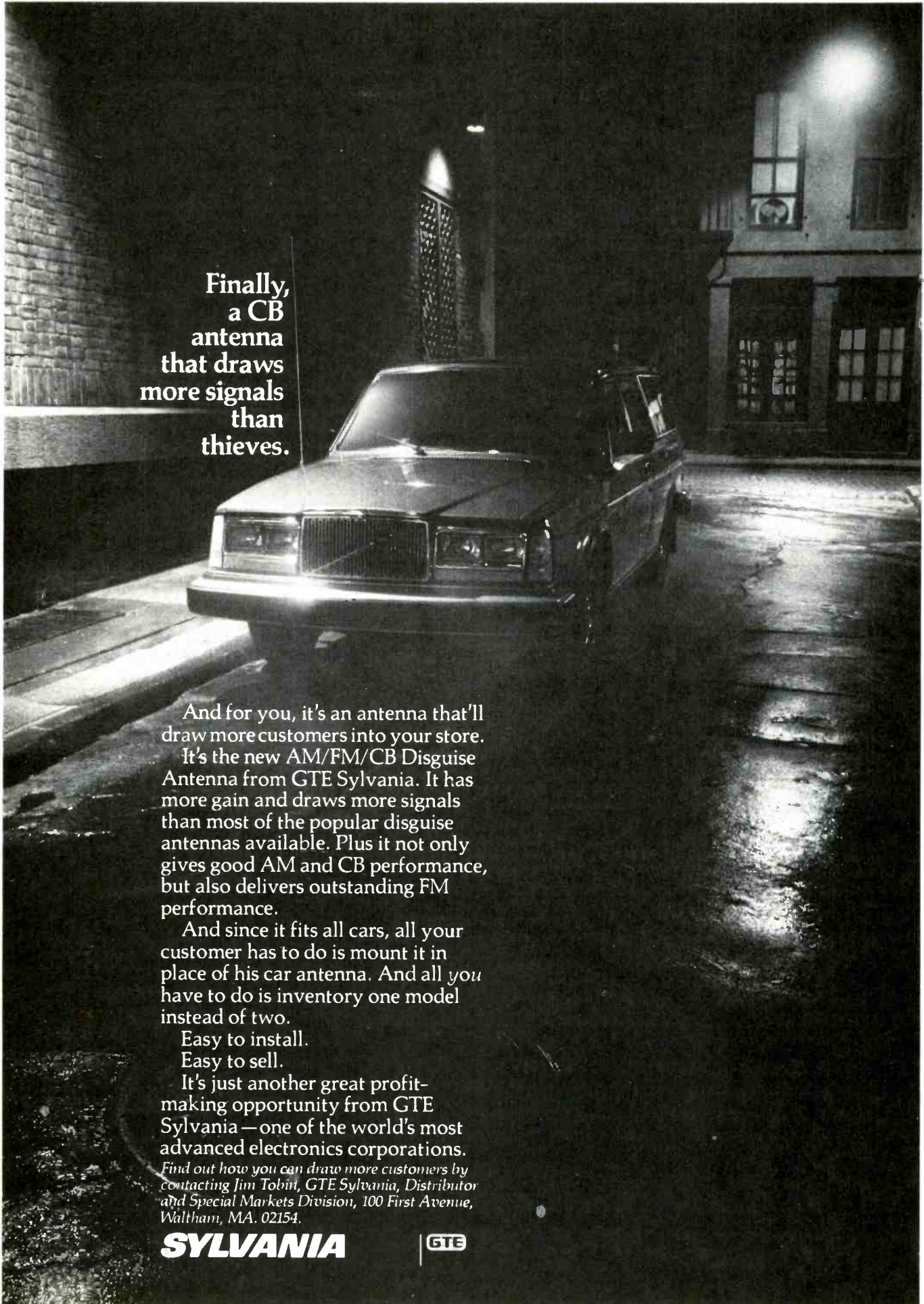
These four basic models, using a total of 12 different staple sizes — speedily and inexpensively meet the needs of wire and cable installers for safe, neat, snug-fit stapling in virtually every field. Arrow Staple Guns are built of all-steel for rugged durability with Patented Jam-proof Mechanisms for continuous, trouble-free performance.

SEND FOR CATALOG AND PRICES TODAY.



271 Mayhill Street, Saddle Brook, N. J. 07662





Finally,  
a CB  
antenna  
that draws  
more signals  
than  
thieves.

And for you, it's an antenna that'll draw more customers into your store.

It's the new AM/FM/CB Disguise Antenna from GTE Sylvania. It has more gain and draws more signals than most of the popular disguise antennas available. Plus it not only gives good AM and CB performance, but also delivers outstanding FM performance.

And since it fits all cars, all your customer has to do is mount it in place of his car antenna. And all *you* have to do is inventory one model instead of two.

Easy to install.

Easy to sell.

It's just another great profit-making opportunity from GTE Sylvania — one of the world's most advanced electronics corporations.

*Find out how you can draw more customers by contacting Jim Tobin, GTE Sylvania, Distributor and Special Markets Division, 100 First Avenue, Waltham, MA. 02154.*

**SYLVANIA**

**GTE**

# reader's exchange

continued from page 6



## LOWEST PRICE/WATT + these other exclusives:

- 1) Variable dc output. 2) Full 10-amp rating over 0-12 v range. 3) Super filtering over entire output.
- 4) Dual range. 5) Heavy overload capacity. 6) Fully enclosed steel cabinet. 7) Large, easy-to-read meters.
- 8) Full year warranty.

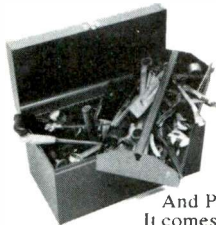
21 Stock Models from 6 to 125 vdc. See Your Distributor. Custom OEM Power Supplies Engineered to Your Requirements.

Send for FREE BULLETINS • See EEM and Gold Book for Data on Full Line  
EPSCO, Inc. 920-A Westwood, Addison, IL 60101  
312 543-0410



Performance-Proved Power Supplies Since 1936  
Circle (9) on Reply Card

## Where's the screwdriver?



In a tool box, tools and parts are everywhere. They're hard to find. They get lost. (And they get dirty.)

With a Platt tool case, that wouldn't happen. It's designed so you'll know where everything is. Smaller tools are in individual pockets in our patented one-piece pallet. Larger tools and parts are in compartments. And papers and order book are in lid pockets. (Everything is neat and clean.)

And Platt's tool case helps you look more professional. It comes in handsome, lightweight, durable ABS Thermoplastic. Or rich looking vinyl reinforced by ABS Thermoplastic.

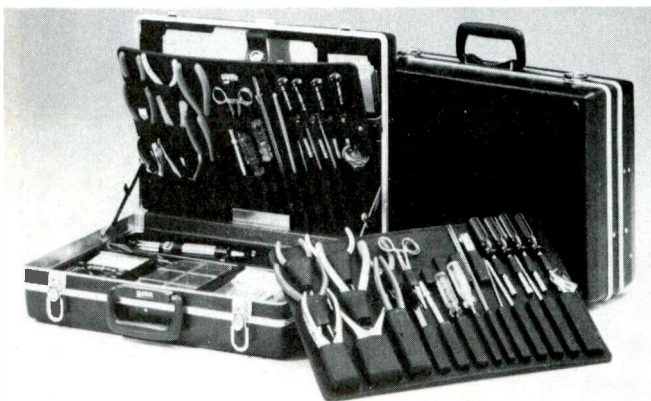
What's more, it also has a 5 year guarantee. Contact us for complete information on Platt's full line of tool cases and your nearest distributor.

Pat. No. 3,880,285

# platt

Cases for business and industry.

2301 S. Prairie Ave., Chicago, Ill. 60616 (312) 225-6670



Circle (10) on Reply Card

**Needed:** A B&K-Precision model 1077B television Analyst with cables, manual, slides. Must be in good operating condition, and reasonably priced. Phil N. Booth, 9212 Coachman, Whittier, California 90605.

**Needed:** Microwave-leakage detector probe; any model that is certified by HEW for checking microwave ovens. Clarence Kuschel, Aniwa Hardware, Box 4, Aniwa, Wisconsin 54408.

**Needed:** Any information for Mercury Electronics model 300 tube tester; Jackson Electronics Instruments test oscillator model 640; and Midwest Instruments cathode beam model CB54. Will buy photo copies. Vernon Lawver, RR1, Rockton, Illinois 61072.

**Needed:** Schematic and complete alignment data for an old battery-operated Philco signal generator, model 177 (uses 1F5 and 1H4 tubes). Also, need one 1F5 tube. Jethro F. Perry, Box 488, Lewisporte, Newfoundland, Canada AOG 3A0.

**Needed:** Volume R-17 of "Most Often Needed Radio Diagrams of 1957" by M. N. Beitman. Ronald S. Lettieri, 433 East Drinker, Dunmore, Pennsylvania 18512.

**Needed:** A UHF converter or UHF tuner 94E-200-12 and UHF tuner 94E-204-1 for admiral chassis 16UB9B. R. E. Becraft, 35 Hollywood Drive, Whitesboro, New York 13492.

**Needed:** A diagram and tube layout for a Type 6-D antique Kolster radio manufactured by Federal Telegraph. Will pay, or copy and return. Willie Tyson, Tyson TV, 239 Deluxe Circle, N.E., Thomaston, Georgia 30286.

**Needed:** Rider's manuals, or other similar service data, and back issues of **Electronic Servicing**. Send asking price. Bill Hopkins, OL-K 2187CG, APO New York 09221.

**Needed:** Correspondence with individual who has completed the Bell & Howell school home study digital-industrial electronics program. Stu Glenn, Lapeer County Vocational Technical Center, 690 Lake Pleasant Road, Attica, Michigan 48412.

**Needed:** Heathkit IM-102 3 1/2 digit multimeter. Will buy, or trade other equipment. Kenneth Miller, 10027 Calvin, Pittsburgh, Pennsylvania 15235.

**For Sale:** PF Reporter / **Electronic Servicing** from January 1959 through 1977. Also, 106 copies of Radio Electronics in the sixties and seventies, 27 copies of Electronic Technician in the sixties. John G. Cash, Natural Bridge Station, Virginia 24579.

**Needed:** A B&W 21ZP4C picture tube for old Philco television set. Must be new and not rebuilt. State price. B. G. Brandt Appliance Service, 241 Retama Place, San Antonio, Texas 78209.

# reader's exchange

**For Sale:** RCA WR-69A TV/FM sweep generator, \$45; RCA WR-70A marker adder, \$40; and EICO model 460 4.5-MHz scope, \$75. All are in good working order, and sales are final. Joe Toy, 621 East Belgrade, Philadelphia, Pennsylvania 19125.

**Needed:** NRI CB specialist training manual (or photocopy). State price. A. Kelsick, 6 West 123rd Street, New York, New York 10027.

**Needed:** The following twist-loc electrolytic capacitors: Philco no. 30-2590-12 (or Sprague no. TVL-3807-5); Philco no. 30-2590-13 (or Sprague no. TVL-4661.6); and Philco no. 30-2590-17 (or Sprague no. TVL-2224). Charles D. Prater, Edna, Kentucky 41419.

**Needed:** Used tube tester (preferably Accurate Instrument model 257) for color and B&W picture tubes and all receiving tubes. Ponce L. Smith, 2978 Holcomb, Detroit, Michigan 48214.

**Needed:** Instruction manual for RCA WR69A sweep generator. Will buy, or copy and return. B. San Juan, 4312 Cynthia, Bellaise, Texas 77401.

**Needed:** Construction manual for a 1957-58 Allied Radio Knight kit CB-22 transceiver (mobile version). Will buy, or copy and return. Ed Broznowski, 265 Dewey, Northlake, Illinois 60164.

**For Sale or Trade:** EICO 435 scope in excellent condition, \$115 with manuals. F. David Cummings, Ridge Road, RD4, Cazenovia, New York 13035.

**For Sale:** One Sencore sweep marker generator SM152, still in box, \$299 with extra cables; Sencore bias supplies Be156, \$24; Be 113, \$12; color test jig 19-inch for \$150; a Ballantine AC meter model 310A; and miscellaneous other parts and equipment, package price available. Edward O. Leduc, Eddie's Radio-Television, 361 Elm Street, Manchester, New Hampshire 03101.

**Needed:** Open reel tape recorder, operational, tube-type. Seven-inch reel size can be single track. To be used for dubbing. Must be reasonably priced, as I am retired on fixed income. Elmer L. Mosley, 720 Poplar Street, Kenova, West Virginia 25530.

**Needed:** Black & white picture tubes 14EP4 and 19GAP4; used or new; state price. Joe Mehalko, 324 4th, Blakely, Pennsylvania 18447.

**Needed:** IF transformer no. 1620-439 for a Philips transistor radio model L4d 91T, WA 15 268. James Gregorich, 117-2nd Street, North, Virginia, Minnesota 55792.

**Needed:** RCA record player, model VGP59E. Miller's TV, 13615 Elton Street, S.W., Navarre, Ohio 44662.

**For Sale:** Test equipment manuals for many popular brands (RCA, Sencore, Hickok, B&K-Precision, Heath, H-P, Tektronix, etc.). Send SASE with your needs. Ron Jordan, 5277 Larchwood Drive, San Jose, California 95118. □

## Another reason to join RCA's QT Parts Program! You get four free information packages every year.



**RCA's QT-150 Parts Program is better than ever!**

Registered dealers receive four free information mailings per year through RCA's Direct Information Service program.

Quarterly mailings include:

- Complete Dealer Price Book — RCA Consumer Parts
- Latest Price Supplement
- RCA Drawing Number to Stock Number Cross Reference
- Color TV Module Cross Reference
- B&W TV Module Cross Reference
- Dealer QT Inventory Control Form; and many other useful publications.

**To join, contact your RCA Distributor** and register as a QT Dealer. You will receive your package of 150 of the most-needed, fastest-moving parts to repair older TV sets. You will also receive your first quarterly information package. Every information mailing will include the latest price publication, plus additional information about RCA Parts required in your servicing business.

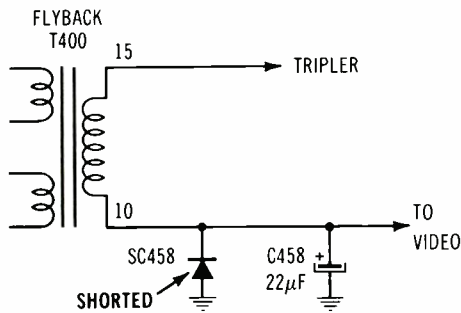
**Don't forget,** your QT Parts inventory program has automated annual drop-ship updating for your convenience. A special QT Parts Rack is also available to save time and space.

Call your RCA Distributor or write to RCA Distributor and Special Products Division, Deptford, N.J. 08096.

# RCA QT Parts

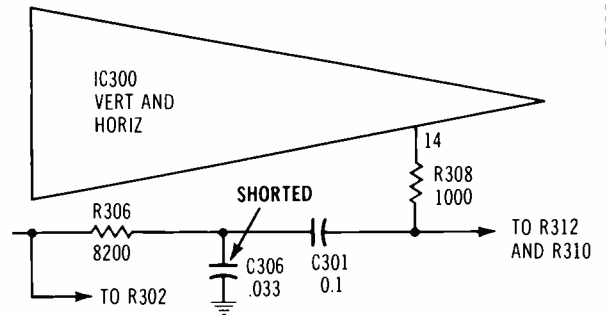
Circle (11) on Reply Card

**Chassis—Sylvania E44**  
**PHOTOFACT—1731-2**



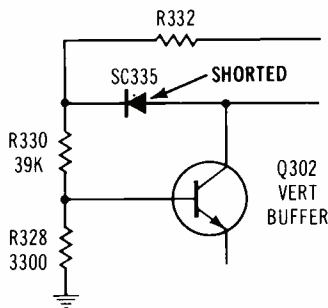
**Symptom**—No raster; HV okay  
**Cure**—Check diode SC458 and replace it if shorted

**Chassis—Sylvania E44**  
**PHOTOFACT—1731-2**



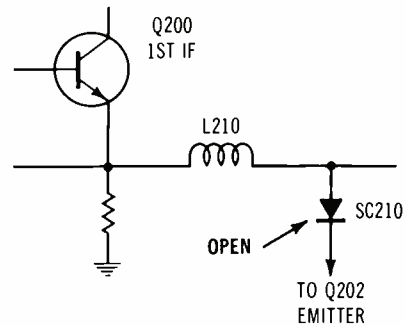
**Symptom**—Intermittent vertical roll  
**Cure**—Check capacitor C306, and replace it if shorted

**Chassis—Sylvania E44**  
**PHOTOFACT—1731-2**



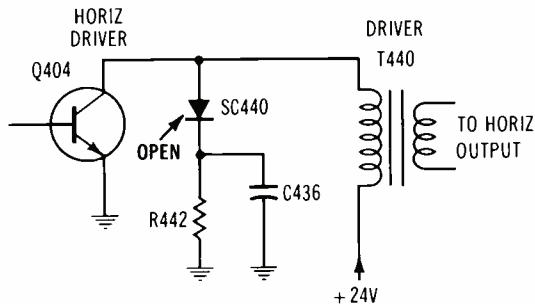
**Symptom**—Small, non-linear height at top, and none at the bottom  
**Cure**—Check diode SC335, and replace it if shorted

**Chassis—Sylvania E44**  
**PHOTOFACT—1731-2**



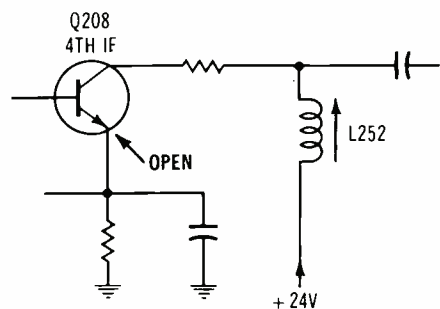
**Symptom**—Low contrast; no snow off channel  
**Cure**—Check SC210, and replace it if open

**Chassis—Sylvania E44**  
**PHOTOFACT—1731-2**



**Symptom**—Delayed failures of Q406, horiz output  
**Cure**—Check diode SC440, and replace it if open

**Chassis—Sylvania E44**  
**PHOTOFACT—1731-2**



**Symptom**—Good sound, but no picture and no snow  
**Cure**—Check Q208 4th IF, and replace it if open

# troubleshootingtips

## Double troubles Sears Silvertone chassis 562.10390 (Photofact 1003-2)

When she brought in the portable B&W TV receiver, the customer said the picture would try to fill the screen at first, then the height would decrease until the picture was about 3-inches high. Also, later the picture would leave entirely, leaving a dark screen.

Obviously, there was a height problem, and I checked the DC voltages around the vertical-output tube. They were normal, and I next tested the 6GH8 multivibrator (oscillator) stage. The normal -60 volts at the grid checked low (about -20 volts), and the +38-volt plate voltage was too high.

This suggested a defect in the positive-feedback loop between the output plate and the 6GH8 grid. Ohmmeter tests found a 1000-ohm

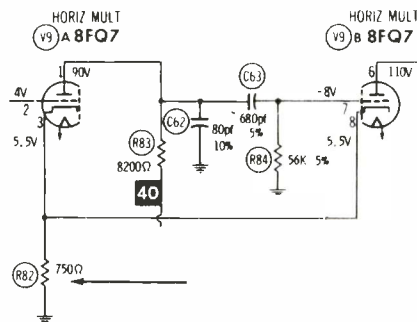
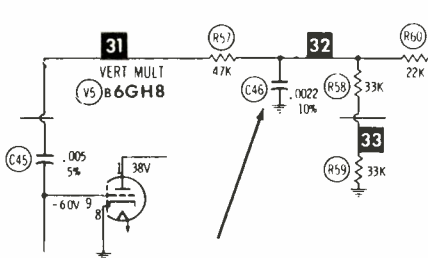
leakage in C46 (0.0022). Replacement of C46, and a touchup of the height adjustment, gave a steady picture of full height.

Forgetting the intermittent raster, I thought the repair was finished. However, I always operate the sets for a time after any repairs. During the heat test, the raster disappeared.

I carefully sprayed canned coolant on each component of the horizontal oscillator. When I came to R82 (750-ohm cathode resistor), the raster and picture popped on the screen. This time, after I replaced R82, the TV ran for hours without any more problems.

Cases like these prove that we always should listen carefully to the customer's description of the difficulty.

Charlie Jackson  
Buckner, Illinois



## Blanking bar at the center Sears 562.10110 B&W (Photofact 792-3)

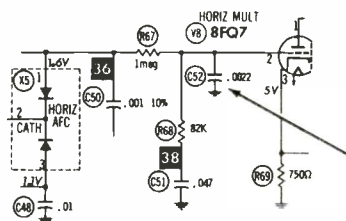
Although the horizontal locking was fairly tight, the horizontal-blanking bar was near the center of the screen.

Such symptoms usually indicate a defect in the horizontal phase detector, or a wrong waveform applied to the AFC detector. Sever-

al resistors around the X5 duodiode were slightly out of tolerance. However, new ones didn't change the problem.

Finally, I paralleled C52, and the locking became normal. Evidently, C52 was open, and the operation was okay after it was replaced.

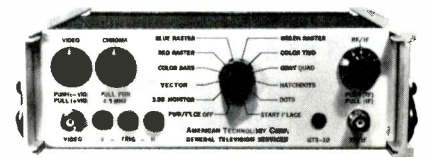
Arnold E. Kading  
Hackensack, Minnesota



# It's a fact, the GTS-10 is . . . "A SERVICE SIMPLIFIER"

**FACT I** - The GTS-10 does most of the work you're now doing using a color bar pattern generator, a substitute tuner, and an analyzer . . . and it does some special things these other instruments can't do. It comes in a small package so it's easy to carry into the home and when you're working on those tough dogs it takes only a small space on your bench. One instrument to carry and work with instead of 3 . . . that's not only simpler, but it's also less expensive.

**FACT II** - These special GTS-10 features (patents pending on many) are all designed to streamline and simplify your servicing.



- 4.5 MHz SOUND CARRIER to assist in tuning and sound trap adjustments.
- 3.58 MONITOR PATTERN to check the color oscillator frequency without even taking the back off the set.
- 6th BAR MARKER so you always know which is the 6th bar, even on severely over-scanned sets.
- CALIBRATED FULL RANGE RF/IF ATTENUATOR for instant check of tuner performance and AGC. (Faster and more accurate than a substitute tuner.)
- RED BLUE AND GREEN RASTER PATTERNS for purity check with no need to short gun grids or disturb screen controls.
- COLOR TRIO PATTERN for checking color balance saturation of the demodulators, matrix and electron guns.
- HATCHDOTS PATTERN for faster convergence, centering, and pincushion checks and adjustments.
- GRAY QUAD PATTERN for gray scale tracking check & adjustments, yoke polarity tests, and checking 60 Hz video response.
- VECTOR PATTERN uniquely free of double leading to eliminate confusion and provide an in-home check of 3.56 MHz receiver response
- VIDEO OUTPUT; multi-purpose with selectable polarity and variable output to simplify your work.
- QUICKIE REMINDER CARD on top panel to quickly guide you in using the GTS-10 to simplify all TV servicing.
- 2 VOLUME SERVICE MANUAL; comprehensive information on hook-up procedures, signal injection procedures, convergence and set up, etc

**FACT III** - It all boils down to one thing . . . servicing with a GTS-10 is simpler. And, when you stop to analyze it, that means more profit . . . and more profit means a happier you, a wife who quits nagging, and a banker that treats you like a real friend. Where else can you buy all that for only \$350.00.

Write for comprehensive 6-page full color brochure that describes these and many more features.

Telephone orders on VISA and MASTERCHARGE accepted for same day shipment. (303) 275-8991. 2 year factory warranty against all failures in normal use.

30 day money back guarantee.

ES06



AMERICAN TECHNOLOGY CORP.  
225 Main Street, Dept. 6A  
Canon City, Colorado 81212

Circle (12) on Reply Card

---

## 1979 Color-TV Previews

---

# General Electric Widescreen 1000

By Carl Babcoke, Editor



**Figure 1** In addition to the large-screen picture, the General Electric "Widescreen 1000" Home-Television Theater has all of the top-of-the-line features. The space above the TV chassis can be used for a videotape recorder (as shown), or as a shelf for flowers or books. (Photos and drawings courtesy of General Electric)

---

*The "Widescreen 1000" rear-projection color TV probably is the most unique instrument of the 1979 General Electric line. As the name implies, the rectangular, flat screen is slightly larger than 1,000 square inches. This article covers rear-projection basics and examines the General Electric features.*

---

### The Big TV Picture

At first sight, the General Electric "Widescreen 1000" Home-Television Theater appears to be only a large traditional color TV. There are some differences, such as the flat rectangular screen, and the extra width of the cabinet near the bottom (see Figure 1). But, few external signs point to the unique things inside.

This resemblance to a conventional console TV (in all but size) probably was not accidental, for the GE representatives emphasize that the machine is intended for home use, and it can be installed without any adjustments or special placement. However, the instrument is unusual. It is a **rear-projection color TV** with a 45.7-inch (diagonal) screen.

Early in May, a group representing the electronic press gathered

near the GE facility in Portsmouth, Virginia to view the 1979 GE line and to learn about the Widescreen 1000. I'm sure many of the group wondered just how GE had solved the basic problems of rear projection (low brightness and excessive setup adjustments). After all, B&W rear projection was tried in the 1950s, but without success. Most of the solutions to those problems will be explained here.

### Features

From the customer's viewpoint, these are the important features of the GE "Widescreen 1000":

- 1003 square inches of picture are contained in a cabinet 50 inches high, 70 inches wide, and only 24 inches deep.
- The brightness is satisfactory, in rooms with moderate light intensity.
- Infrared remote control or panel

keyboard gives random-access channel selections from a phase-locked loop that controls the varactor tuners.

- In addition to the usual color controls, the TV has VIR Broadcast-Controlled Color (see **Electronic Servicing** for March, April, and May of 1977).

- Twin speakers and improved circuitry provide better audio tone quality and volume, to match the large picture size.

- The cabinet is sealed to keep out any dust or dirt that might degrade the performance of the lens or mirrors.

- Most of the modules and electronic components are the same as used in the GE YM chassis.

### How It Works

All projection TVs require some kind of a lens system, because a

small picture must be enlarged. This is similar to the projection of a small color slide. Light coming through the slide is formed by a lens into a beam of light that spreads somewhat. The beam enlarges on the way to the screen. So, the distance from lens to screen determines the size on screen. Many of these principles are used in the "Widescreen 1000."

#### Picture tube

The original TV picture is formed on the screen of a 13-inch in-line picture tube. This is a special tube that can withstand the higher currents and voltages while retaining sharp focus. Otherwise, it is a conventional CRT. In fact, if you look inside the picture-tube tunnel when the TV is operating, you'll see a very bright picture on the CRT screen.

#### Chassis

The YP projection chassis is almost identical to the 25-inch YM chassis. Seven of the eight modules are the same. Only the convergence module, yoke, flyback, focus divider, and the picture tube are different for the YP chassis. Figure 2 shows the chassis, complete with radiation shields and the tunnel which supports the lens system. Notice that the CRT is mounted at

an angle in two directions (required by the folded beam path in the cabinet).

#### Lens, mirrors, and screen

Light from the 13VAWP22 picture tube goes through a F1.6 3-element coated plastic lens assembly (Figure 3). The lens assembly can be moved nearer the picture tube (or away from it) as needed to focus the picture optically. Notice that the picture tube has the usual electrical focus.

After traveling through the lens, the light beam is bounced from the smaller of two front-silvered mirrors, as shown in Figure 4. Front-silvered mirrors reflect more light (less loss), and they have a sharper picture, because the ghost reflection of rear-silvering is eliminated.

From the smaller mirror, mounted at the bottom of the cabinet, the enlarged light beam is bounced to the huge top mirror that's mounted at an angle, so it reflects light to the rear of the front screen.

This screen has three functions. The rear side of the screen has a circular pattern molded into it to form a fresnel lens. A fresnel lens concentrates the light straight ahead, rather than allowing it to scatter in all directions.

Figure 5 shows how the concentric ridges of a flat fresnel lens can

do the work of a thicker conventional convex glass lens.

Next, the light strikes a diffused surface inside the screen, and the picture is formed there. That's the second function. The front side of the screen minimizes the contrast-reducing effect of room lighting. In addition, the outside surface is made strong enough to withstand most accidental blows without damage, and it's processed to improve the resistance to abrasions or scratches.

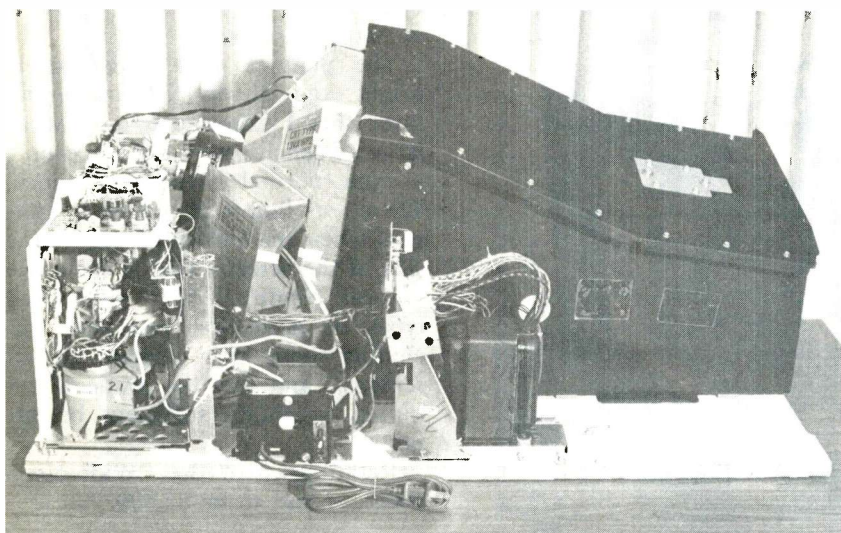
#### Servicing the "Widescreen 1000"

No maintenance adjustments should be required for the lens or mirrors; therefore, servicing this projection color TV should be confined to the usual chassis and picture-tube repairs and tests. Except for a different way of reaching the chassis, the service methods for the YP are the same as those for the more familiar YM GE chassis.

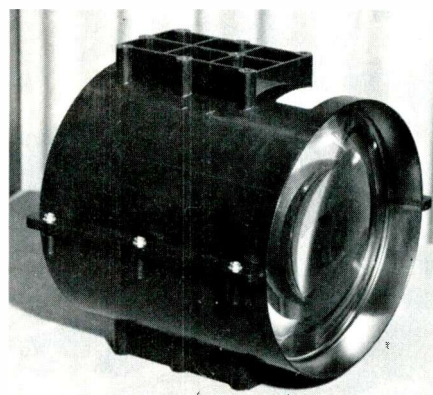
As shown in Figure 6, four of the six cabinet sides around the chassis can be removed without difficulty. This makes the chassis, modules, and power components accessible. Probably, it's easier to work on this projection version than on the direct-view types.

In addition, the board (with the chassis, picture tube, and CRT

*continued on page 16*



**Figure 2** All of the chassis and picture-tube components (except the tuner assembly) are fastened to a mounting board. The board and components can be removed together for servicing. Notice the extensive radiation and high-voltage shielding.



**Figure 3** This is the large F1.6 lens assembly.

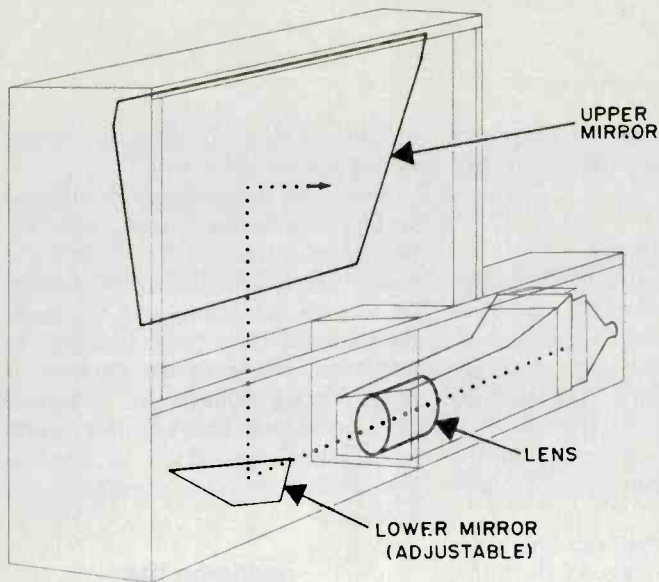


Figure 4 Locations of the picture tube, lens, and two mirrors are shown by this drawing.

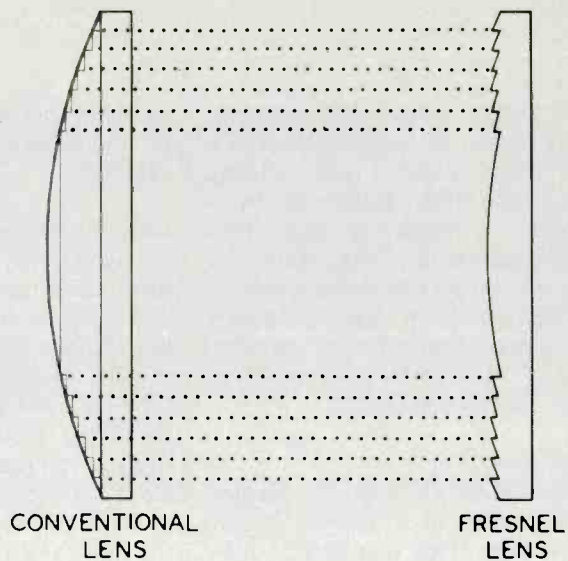


Figure 5 The drawing shows how a conventional lens can be approximated by individual lens segments that make up a fresnel lens.

## Widescreen

continued from page 15

tunnel with lens) comes out as a unit (Figure 2). The entire assembly can be taken to the shop, if necessary.

For troubleshooting outside the cabinet, you could set up a mirror in front of the CRT tunnel and

watch the picture that way. Or, the face of the picture tube could be positioned 70.56 inches (the length of the optical path) from a white wall or a movie screen to show a full-sized picture.

### Personal Comments

At the General Electric technical meeting, the "Widescreen 1000"

projection color TV was demonstrated under typical home-lighting conditions. The room lights (used for other presentations) were left on. All of the local TV stations were tuned in, and several short programs were shown from a General Electric VHS-type videotape recorder.

Each square foot of the screen was not as bright as the same area of a direct view CRT screen. However, the visual effect was better than the luminance figures predicted. For one thing, a *large* picture does not require so much brightness for the eye to regard it as natural.

The pictures were satisfactorily bright and sharp. The scanning lines (that I expected to appear as large as pencils) were not noticeable at the normal viewing distance. There was falloff of picture brightness when the viewer moved to the side of the screen. This is the same natural condition that affects all types of projection machines (including those with separate curved screens), and it's the tradeoff required to obtain sufficient brightness.

Retail price of the "Widescreen 1000" is said to be \$2,800.

### Next Month

In upcoming issues, the 1979 features of lines from other manufacturers will be discussed. □

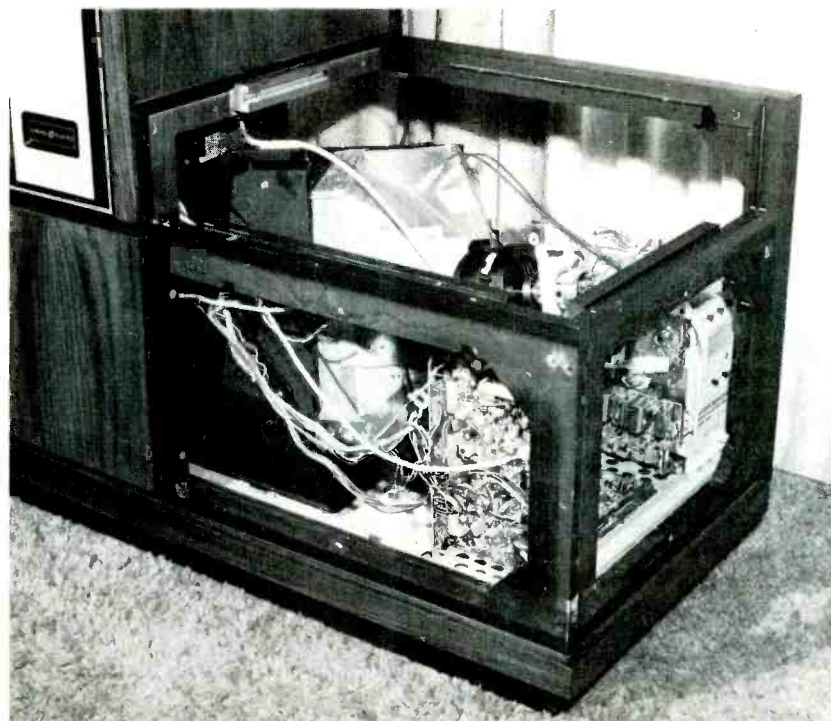


Figure 6 Four sides of the chassis compartment can be removed for troubleshooting or servicing the YP General Electric chassis.



# Call off the search.

Bussmann's new Small Dimension Fuse Catalog makes it easier to select. And protect.

The Bussmann Small Dimension Fuse Catalog puts a world of component and circuit protection at your fingertips.

This new edition is the most complete listing of small dimension fuses,

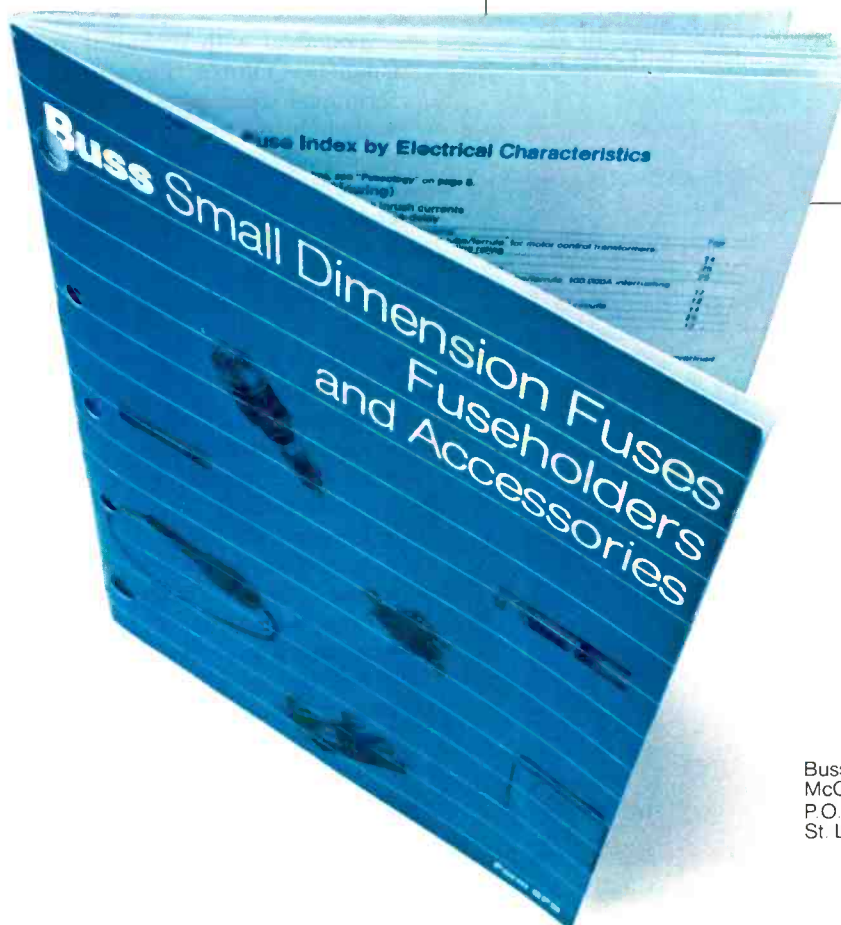
indicating devices, and accessories in the industry. And it makes selecting the right type of protection easier than ever.

Everything's conveniently indexed by electrical characteristics.

A selection of time current characteristic curves tells you how the products you choose will perform.

There's even an index of literature on Buss products and various fusing techniques.

Everything you need to take the guesswork out of circuit and component protection is in our new Small Dimension Fuse Catalog. So call off the search. Just call your Bussmann representative today and ask for Form SFB.



**McGraw-Edison**

**Bussmann.  
The Protection  
Experts.**

Bussmann Manufacturing Division  
McGraw-Edison Company  
P.O. Box 14460  
St. Louis, Missouri 63178



# Service Management Seminar, Part 6

By Dick Glass, CET

*These four simple steps of the Sterling formula allow you to calculate accurate labor rates.*

COST FACTORS	EXAMPLE OF THE PER-HOUR AMOUNT
DIRECT LABOR cost per hour	\$7.00
OVERHEAD expenses	\$5.00
RETURN ON INVESTMENT	\$ .50
Business PROFIT	\$1.00
Total income needed for every hour	\$13.50

Multiply needed income by the PRODUCTIVITY FACTOR to obtain the income for each chargeable hour

If your productivity is 0.50, the rate is: **\$27.00** per hour worked

**Table 1** Direct labor, overhead expenses, return on investment, business profit, and the productivity factor together determine the rate per chargeable hour of labor. (These figures are only for illustration.)

SERVICE CHARGES (fictitious)	FLAT RATE
Radio Repair—over the counter	\$16.00
TV Repair—over the counter, minor	\$20.00
TV Repair—over the counter, major	\$60.00
Auto Antenna Installation	\$10.00

**Table 2** If you use flat-rate pricing, your list might be similar to these imaginary service charges.

REASONING USED TO DETERMINE THE AMOUNT OF DEFICIENCY:		
DEFICIENCY	COST	DEFICIENCY
you paid the overhead	\$10,000	0
you paid for test equipment	\$ 1,000	0
you paid your taxes	\$ 3,000	0
you paid yourself	\$10,000	\$6,640
TOTAL DEFICIENCY		\$6,640

**Table 3** Use your own figures, and this kind of reasoning, to determine how much your income was deficient last year.

## Setting Service Rates Scientifically

This is the second half of the subject "Establishing Service Rates," that was started last month. The Sterling system of pricing will be described. From it, you can predict your future profits, with reasonable accuracy.

### A basic problem

You deal with technical subjects (such as Ohm's Law and other formulas) that are accurate and well defined, so it's logical for you to expect equal precision in cost accounting. Not so! There are few absolute standards or formulas with cost accounting.

For example, these are some of the factors relating to business costs:

- direct costs;
- indirect costs;
- overhead costs;
- engineered costs;
- allocated costs;
- variable costs;
- fixed costs;
- controlled costs;
- non-controlled costs;
- breakeven costs; and
- marginal costs.

Because of all these terms, and more, that are commonly used for determining cost figures for huge, well-staffed corporations, it's not surprising to find most TV-electronic servicers "guessing" about costs, and about the prices they charge for various repairs.

*continued on page 20*



## THE FASTEST WAY TO ORDER GENERAL ELECTRIC TV PARTS IS FREE.

General Electric has the magic number. A toll-free hotline connecting you directly with the GE Parts Center in most all areas. And the simple key to using it is charging your order to VISA, Master Charge or an approved GE Open Credit Account.

That's one way we're making your business easier. But it's not the only way. We're continuing to increase stocks throughout our national computer-linked parts distribution system. And striving to fill orders faster than ever before.

To make GE Performance Television even easier to service, we're packing a new Mini Manual into the back of every color set. It gives

you the right schematic diagram, parts list, symptom repair information and safety features for the set you're working on. Which makes your job a lot easier.

For our list of toll-free numbers and everything you need to order GE TV parts fast fill out and send in the coupon below. **It's our business to make your business easier.**

"DUTCH" MEYER  
GENERAL ELECTRIC TELEVISION  
ONE COLLEGE BOULEVARD  
PORTSMOUTH, VIRGINIA 23705

ES-78

Please send the following:

- Brochure covering GE toll-free ordering numbers.
- Listing of Parts Distributors.
- Master Charge and VISA information.
- GE Open Credit Account information.

Name \_\_\_\_\_

Service Company \_\_\_\_\_

Address \_\_\_\_\_

City \_\_\_\_\_ State \_\_\_\_\_ Zip \_\_\_\_\_

GENERAL  ELECTRIC

# Service Management

continued from page 18

REPAIR FUNCTION	OLD RATE	DEFICIENCY	NEW RATE
Radio repair	\$16.00	X 1.23(12.3%)	= \$19.68
TV repair-minor	\$20.00	X 1.23	= \$24.60
TV repair-major	\$60.00	X 1.23	= \$73.80
Auto antenna install.	\$10.00	X 1.23	= \$12.30

**Table 4** To obtain your new labor rates, multiply your present repair rate by your deficiency ratio plus 1.

In fact, most servicers have no pricing formula at all, but rather set their rates according to: a competitor's prices; some manufacturer's warranty list; or their customers' ideas of what is too high.

In other words, they have no real system, but depend on others.

### Factors affecting service charges

Last month, we dissected the service charge of a typical one-man shop, and showed the five components that determine the actual rate per hour. Table 1 shows a similar listing.

Unless you include all five of these factors in your charges, you are cheating yourself.

### Understanding the five factors

Before we show you a quicker and more simple method of adjusting your rates (either up or down), we want to stress the importance of understanding thoroughly (and approving) the five ingredients that determine your rates.

Almost everyone else would like for you to charge less. Some will try for a discount, or ask for free service. Others expect you to charge for only the actual time spent in

repairs (neglecting the necessary non-productive hours). Some advocate the discount store philosophy; that if you charge less you can obtain more work.

However, you **MUST** understand that each technician can produce only a limited amount of labor. Then, by knowing the other shop costs, you can deal with any pressure to reduce your rates.

Therefore, make sure you agree with all the reasons for your prices, and that you have calculated your rates as shown last month. It's essential to your success plan that you have confidence in the decisions you must make.

### Your Present Service Rates

The "Sterling" system of service pricing (to be described next) does not begin at zero base and build up to your final per-hour charge. Instead, it starts with your **PRES-ENT** service rates and adjusts them as needed.

Right now, you're charging some rates that were previously established. For example, Table 2 shows some imaginary rates for flat-rate pricing. Or, you might be using a Sperry or Tech-Spray system of

increment pricing at a per-hour charge of \$28.00.

### Step One

**Determine the income deficiency of your shop last year.** This is the hardest part of the method! Now, it's not difficult because the facts are questionable; it's hard because we human beings would rather avoid the issue.

We're all ready to complain that we didn't make enough money last year. But few technicians or shop owners will say **EXACTLY** how much more income should have been made! Did you make \$100 less than you felt was fair? Was your income \$2,000 less than others made in comparable jobs? Or, was your business income \$10,000 short of your goal last year? Only you can answer these questions.

The key to effective use of this system is to be honest with yourself and with your business. **You must establish a reasonable amount which you can justify as the deficiency suffered by your shop last year.**

If you are a one-man shop, perhaps you could use the reasoning shown in Table 3 (for your figures, use those from your tax report).

We determined that the income shortage was \$6,640 by using this reasoning:

- The owner is recognized as a journeyman technician.
- If the owner were to become incapacitated by accident or illness, the business would be forced to hire another person of his general capabilities.
- The wages and benefits paid to such a qualified person in this area are about \$8.00 per hour.

OLD RATE	DEFICIENCY FACTOR	NEW RATE	INFLATION FACTOR	FINAL NEW RATE
\$28.00 (hourly)	X 1.23	= \$34.44	X 1.10 (10%)	= \$37.88
\$16.00 (radio)	X 1.23	= \$19.68	X 1.10	= \$21.65
\$20.00 (TV-min.)	X 1.23	= \$24.60	X 1.10	= \$27.06
\$60.00 (TV-maj.)	X 1.23	= \$73.80	X 1.10	= \$81.18
\$10.00 (auto ant.)	X 1.23	= \$12.30	X 1.10	= \$13.53

(Of course, most shops would round off their flat-rates to the nearest dollar.)

**Table 5** Correction for both deficiency and anticipated inflation should be done in this way.

- \$8.00 per hour times 2080 hours (40 hours for 52 weeks) equals \$16,640.
- \$16,640 deserved salary less \$10,000 actual salary equals a deficiency of \$6,640.

### Step Two

**Find out how much labor you produced last year.** You can obtain the figure from your tax report, or your annual P&L statement. Don't include any income from parts or product sales; only your own labor.

For our example, we'll select a rate of \$28.00 per hour (for hours actually worked) and a productivity of 50% (1040 hours worked in the year) which figures the total labor income at \$29,120. (Of course, that's high for a one-man shop. But it's only an example.)

### Step Three

**Change your deficiency to a percentage of total labor.** In the previous example, the owner was \$6,640 short last year. To find what percentage of the total labor this is, we divide the deficiency (\$6,640) by the total labor (\$29,120) and obtain 0.23 or 23%.

So, last year your service charges brought in 23% too little money. Or, to say it another way, your last year's service charges should have brought in 23% more, to erase the \$6,640 deficiency.

### Step Four

**Adjust your rates by the deficiency percentage.** Multiply your present hourly rate by the deficiency percentage plus 100%, to obtain the new rate of \$34.44 per hour. (Your present rate is 100%, so 23% more will total 123%. This also can be expressed as the decimal 1.23.)

Assuming that your shop does the same volume of business this year, and that inflation does not increase your costs, you should receive the extra \$6,640 you need.

### Adjusting Flat Rates

It's just as easy to readjust your present flat-rate charges. Merely **multiply each separate flat-rate price by the same deficiency percentage**, as shown in Table 4.

Any other flat-rates used by your business should be adjusted in the

same way. Notice that you must multiply by 123% to increase the rate by 23%.

### Adjust For Inflation

Even after you have adjusted your hourly or flat-rate prices, you might find inflation ruining your needed profit. For 1978, it's predicted that inflation will be between 8% and 10%.

Therefore, you should take inflation into account **BEFORE** you establish your rates. Not *after* inflation has taken its toll.

Table 5 shows how your original flat-rate prices could be adjusted for both deficiency and inflation.

### A More-Realistic Deficiency

Table 6 shows other deficiency items of this 5-man shop. Notice that his wife had been working part time without salary.

Before you adopt the total deficiency figure as being unchangeable, you should find all possible ways of reducing costs. Otherwise, the false belief that your prices can be raised to *any* figure can cause complacency, which leads to reduced efficiency and poor productivity. Although most prices are far below that point now, it is possible to price yourself out of the business. Therefore, adjust the deficiency for all needed improvements.

For example, one owner saved \$3,000 by proper pricing of parts, made productivity improvements of \$2,000, and reduced overhead costs by \$1,000. This is a total of \$6,000, which is subtracted from the original \$20,000 to leave a net deficiency of \$14,000.

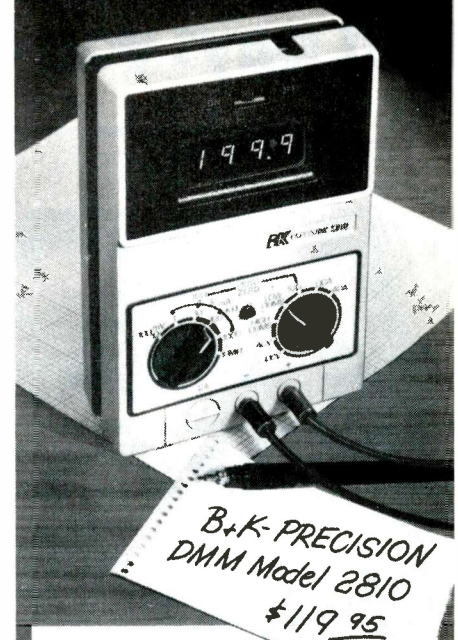
Next, we need to know the total labor produced by the shop during 1977. From the year-end P&L, we find it was \$75,000.

The \$75,000 is divided into the deficiency of \$14,000 to give the deficiency percentage of 18.6% (rounded off to 19%).

To obtain the new rate per hour, we multiply the present labor rate of \$28.00 by the deficiency 1.19 (119%) to give \$33.32. In turn, the \$33.32 is multiplied by the inflation rate of 1.08 (108%, or 8% increase), giving a final new labor rate of \$35.98, which is rounded off to \$36.

*continued on page 22*

# Measure resistance to .01Ω...



at a price that has no resistance at all.

- 3½ digit bright LED display
- 100μ V, .01Ω resolution
- 0.5% accuracy typical
- Autozeroing
- Completely overload protected on all 29 ranges
- RF shielded for use in RF fields
- 100% overrange reading
- Selectable high-/low-power ohms
- Full range of optional accessories available

At \$119.95, the 2810 is a "best buy" among DMM's currently available. Its 10 ohms range allows you to check the low contact resistance of switches, relays, breaker points or connectors. Poor solder connections can also be spotted. Place your order now...contact your local distributor for immediate delivery.

**B.K. PRECISION**  
**DYNASCAN CORPORATION**

6460 West Cortland Avenue  
Chicago, Illinois 60635 • 312/889-9087

In Canada: Atlas Electronics, Ontario  
Int'l. Sis. Empire Exp., 270 Newtown Rd.  
Plainview, LI, NY 11803

# RCA pays you to win!

Enter our fabulous **RCA SK Rebate/Contest** that pays you cash for every time you enter.



- Win one of ten RCA SelectaVision Video Cassette Recorders.
- Get cash rebates from RCA for 20, or more, RCA SK bags.

## WIN!



Expiration date extended to July 31, 1978.

## Service Management

*continued from page 21*

Of course, you should use your own figures and the estimated rate of inflation, when you calculate your labor rate.

### Questions?

Probably the first question asked by a dealer (after he has figured the

labor rate he *should* have) is, "Gosh, my customers won't pay such a high rate, will they?"

Well, if they really won't pay your fair rate, you should consider one of these alternatives:

- Perhaps you should change to a job where you will be paid what you are worth.
- Find all possible ways of reducing your costs (overhead, trans-

portation, parts bills, utilities, phone, etc.).

Any other action, or lack of action, means you are playing Santa Claus to your customers.

However, this month we are discussing how to determine proper rates. Next month, we'll take up the "Philosophy Of Pricing."

Perhaps your question is, "How can I raise my service rates arbitrarily without knowing whether low efficiency or low productivity are my problems?" Of course, you *must* find out how your rate compared to similar businesses. If your productivity is only 20%, but your competitor averages 80%, it's obvious that productivity is a serious problem with you. My experience shows that one-to-five-man shops seldom can be as much as 50% productive. So, pricing is the problem, in most cases.

### Examine three areas

Before you decide on an exact deficiency figure, you should examine these three problem areas:

ITEM	LAST YEAR	DEFICIENCY ESTIMATE
Owner drew for himself	\$15,000	\$ 5,000
Technician wages paid	\$48,000	\$10,000
Wife/sec drew for herself	0	\$ 3,000
Shop refurbishing and truck repairing	0	\$ 1,000
Test equipment	0	\$ 1,000
DEFICIENCY LAST YEAR		\$20,000

**Table 6** For larger shops, deficiencies other than the owner's salary should be included in the calculation.



### Here's a contest where you can't lose!

Because you earn generous cash rebates for RCA SK bags, and you can enter every time you send in at least 20 RCA SK bags. Your entry can win one of *ten* RCA SelectaVisions we are awarding. All you have to do is complete this statement, in 25 words or less: "I prefer RCA SK's because . . ." *It's that easy!*



### You can win an unsurpassed home video recording system.

RCA SelectaVision gives you 4 full hours of record/playback in a

single cassette. A built-in digital timer. A remote pause for chair-side editing. Record one channel while you watch another, or record while you're asleep or away. You and your family will love it.

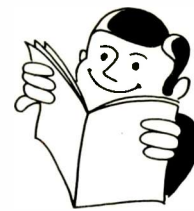


### You get generous cash rebates.

Save your RCA SK plastic bags for cash rebates, as follows:

- \$2 rebate for 20 bags
- \$5 rebate for 45 bags
- \$10 rebate for 80 bags
- \$15 rebate for 115 bags
- 13¢ rebate for each bag over 115

With each purchase of RCA SKs from your RCA Distributor you get an official entry blank. All entries will be judged by a panel of independent judges. Prizes will be awarded on the basis of dealer's expression of demonstrated and proven usefulness of RCA SKs.



### See your RCA Distributor for full information.

He will have all the details on RCA's complete line of replacement semiconductors and RCA SK Rebate/Contest rules. Or write to: RCA Distributor and Special Products Division, PO Box 250, Deptford, NJ 08096.

This contest is open to all electronic service technicians except RCA employees or members of their immediate families, RCA's affiliates or subsidiaries, its advertising agencies, and the judging organization. Void where prohibited or restricted by law. This contest subject to all federal, state and local laws. All prizes will be awarded.

# RCA

## SK Replacement Solid State

- Determine if your parts profits are sufficient. Don't attempt to compensate for inadequate parts profits by raising the labor rates. Place any blame where it belongs.
- Carefully check your overhead, to see if any money is being wasted. Every business should keep such costs at a minimum.
- Make sure the productivity is as high as possible. Don't set high rates to permit you or your techs to goof off. Improve the shop layout, update the test equipment, increase technical training, reduce or refuse unprofitable work, and reduce paperwork.

#### One flat-rate out of line?

Many servicers worry about whether their bench repair price is correct compared to that of service calls, as one example. If they are not in balance (according to time studies over a month's figures), then adjust them. However, the Sterling system is NOT affected by that fault, and it should give the profit you need even with such a

discrepancy. Usually, these relative prices are only minor problems. Of course, shops that price by an increment system have the most exact pricing.

#### New Rates Too High?

What if your calculations show rates that you believe are too high, and will not be competitive? Well, if that is your concern, then remember it's YOUR decision. No one else can tell you what to do.

Most shop managers make only a partial increase, and check the customer's reactions. But, whether you increase immediately to the calculated prices, whether you make a partial increase, or even if you make no change at all, **the important advantage is that you have made the calculation.** Now you know accurately what you should be charging to make the amount of money that's proper for you, your employees, and your business.

After you are armed by the facts, you can make intelligent decisions, as a manager should.

#### Summary

The Sterling formula is an excellent method of determining your labor pricing. These are the four basic steps:

- (1) Determine your deficiency for last year.
- (2) Figure the total labor income your business produced.
- (3) Find out what percentage of your total labor is represented by this deficiency.
- (4) Adjust your hourly (or flat-rate) prices by the deficiency percentage, and by the inflation percentage. □

#### Correction In May Issue

In the text on page 57 under the heading "Is Smith's TV Healthy," the ratio referred to should have been between CURRENT assets versus CURRENT liabilities. Therefore, the figures should be changed to \$14,000 and \$7,000, for a ratio of 2:1.

# The Basics of Industrial Electronics, Part 12

By J. A. "Sam" Wilson, CET

*Sam shows how Schmitt triggers can be obtained from NAND latches. Disallowed conditions of flip flops are explained, also experiments and troubleshooting questions are presented.*

## TTL IC Pinouts

The experiments of this article require TTL NAND gates. We will specify the IC number; however, the pinout numbering won't be listed.

As shown in Figure 1, many different pinouts have been used for the 7401 NAND-gate ICs, with the actual pinout identified by a letter or two after the IC number. We can't know which version you have. Therefore, you must consult a TTL manual for the correct pinout diagram.

All TTL logic devices require a regulated 5-volt power-supply source, so be certain your supply voltage does not drift more than a few tenths of a volt.

## More Uses For TTL Latches

NAND and NOR latches, such as the ones described last month, can be wired to operate as Schmitt triggers, and other useful circuits. For Schmitt triggers, a D-type flip flop can be used.

## D-Type Flip Flops

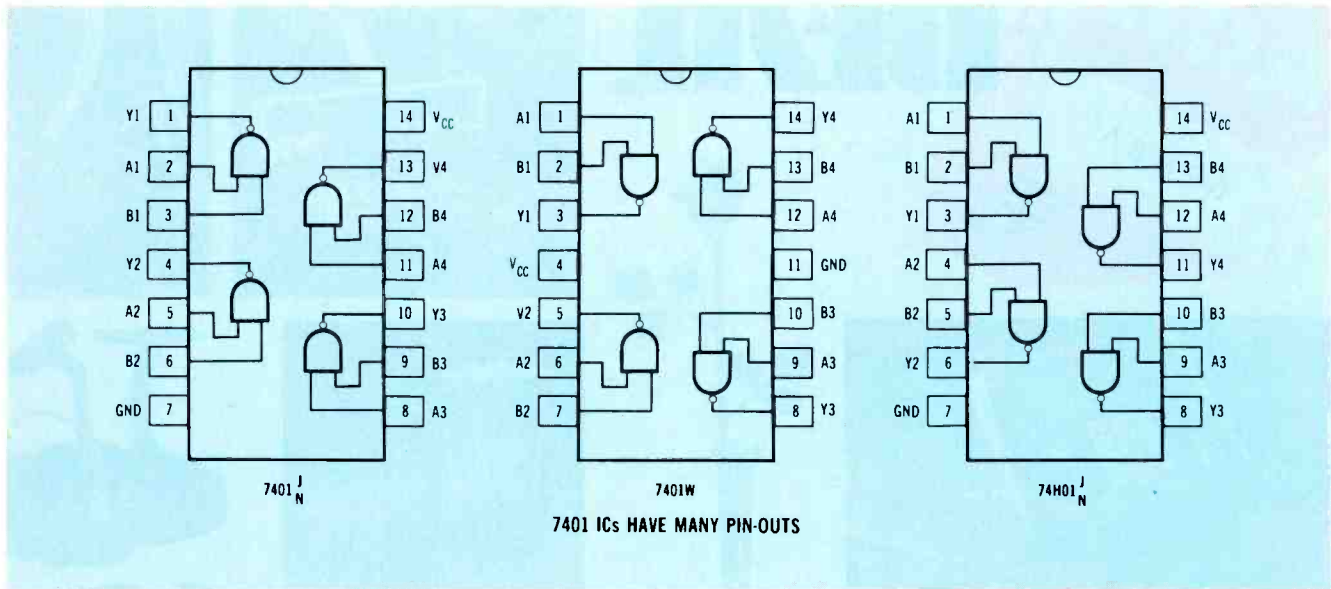
NAND and NOR latches are called "R-S flip flops." When such latches are wired with a new D input which feeds one input directly and the other through a NOT gate, the total circuit (Figure 2) is called a **D flip flop**.

Last month, we pointed out that R-S flip flops never should have the same logic level at both inputs. Identical inputs produce either a quiescent (inactive) or a disallowed output state. (Disallowed inputs

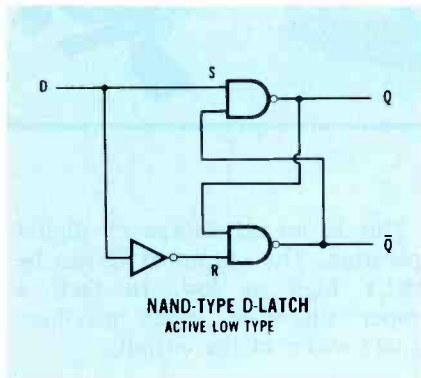
*continued on page 26*



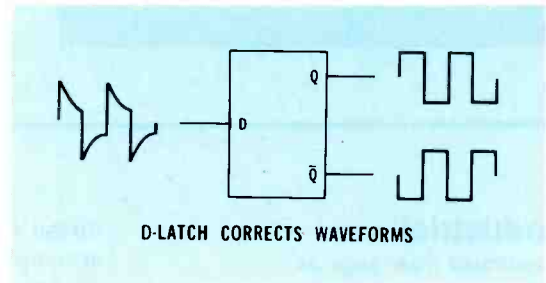




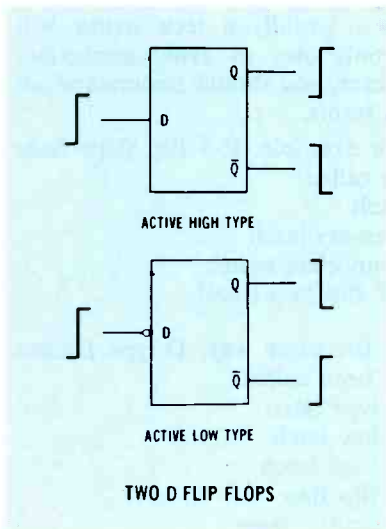
**Figure 1** ICs with several gates often have more than one pin-out diagram, as shown here for the 4-gate NAND IC. Therefore, the pin numbers won't be given for later experiments.



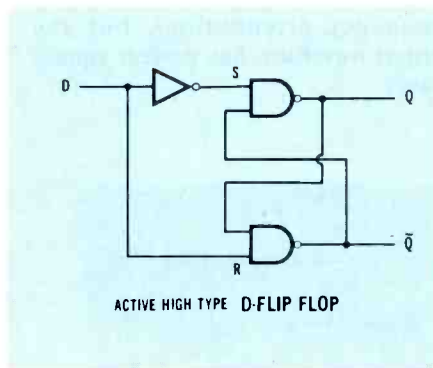
**Figure 2** Adding a NOT to the R input of a NAND latch changes the circuit to a type-D latch, that operates with pulses or square waves from a *single* source.



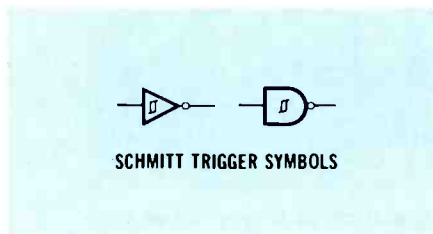
**Figure 3** One advantage of D-latches is the ability to correct distorted digital waveforms.



**Figure 4** D-latches are available in either active high types or active low types. The one in Figure 2 is an active low type.



**Figure 5** This is one possible way of constructing an active high type of D-latch (flip flop).



**Figure 6** The turn-on voltage of a Schmitt trigger is different than the turn-off voltage. Therefore, the hysteresis symbol is used.



# TOP DEAL



## Industrial

continued from page 24

cause an output that can't be determined with certainty.)

**Inversion of one input (by a NOT) prevents both quiescent and disallowed conditions.**

A square wave at the D input of Figure 2 will result in a square wave at the output. Now, that

doesn't seem like much of an accomplishment, but it also can produce good output square waves even when the input waveform is badly distorted.

For example, in Figure 3 the input signal has tilted square waves with overshoot (because of low-frequency attenuation), but the output waveform has perfect square waves.

This is an advantage of digital operation. The output at Q can be ONLY high or low. In fact, a proper sine-wave input produces square waves at the output.

### Duplication Of Terms

Digital gates often have many names. Usually a tech writer will use only one, to avoid confusion. However, you should understand all such terms.

For example, R-S flip flops have been called:

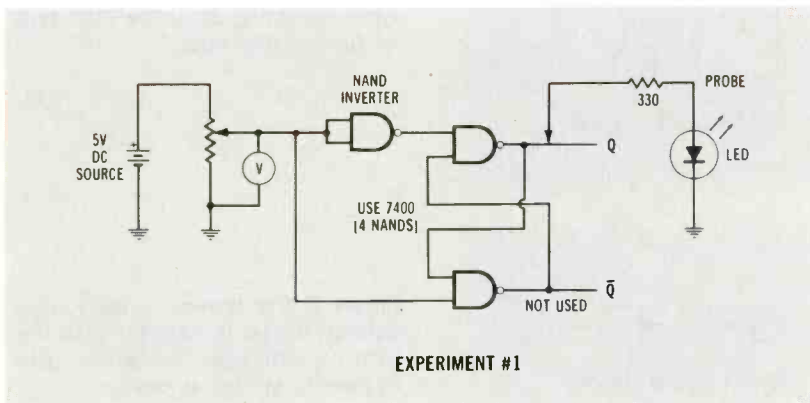
- latch
- memory latch
- bounceless switch
- SR flip flop (rare).

In the same way, D-type latches have been called:

- D-type latch
- D low latch
- D high latch
- D flip flop
- Schmitt trigger.

### High And Low D Latches

Figure 4 shows the symbol for a D "high" latch (the output goes



**Figure 7** Construct this circuit to test the operation of D-type active high latches. Use your simple probe to determine the output state.

# Here's a TOP DEAL for you!

## Buy RCA Entertainment Receiving Tubes, save the carton tops and earn valuable awards\*

RCA's got the TOP DEAL of 1978 for service dealers . . . a completely new collection of great merchandise awards, in exchange for RCA entertainment receiving tube carton tops. You choose from a wide selection of gifts for yourself, your family, and your home.

When you buy RCA receiving tubes, save the carton tops that bear the letters RCA and the tube type number. They are redeemable in required quantities for gifts of your



choice. Just a few are shown here.

Pick up your copy of the RCA TOP DEAL Prize book, saver envelope and award order form at your participating RCA Distributor. Save the proper number of carton tops for the prize you want, and mail with your award order form to: RCA Top Deal Headquarters, Box 154, Dayton, Ohio 45401. The award you select will be mailed to you promptly. Your order must be postmarked no later than



November 30, 1978 to take advantage of this great gift offer. Quality RCA Tubes mean a Top Deal for you. RCA Distributor and Special Products Division, Deptford, N.J. 08096.

\*Save the carton top that bears the letters RCA and the tube type number.

# RCA Receiving Tubes

high when the D input goes high), and another symbol for a D "low" latch (the output goes low when the D input goes high).

Notice the small circle at the D input of the D low latch. In digital schematics, such circles indicate inversion. Therefore, a D high latch can be changed to a D low latch by adding a NOT gate at the D input.

However, if you are constructing

a D latch from NANDs and NOTs, you can save one NOT gate by wiring the active high D flip flop as shown in Figure 5. Compare this to the active low D flip flop of Figure 2. **The difference is whether the S or the R input has the inverter.**

### Schmitt Trigger

Schmitt triggers are fast-acting digital switches that change output

state from low to high when the input signal rises above a certain voltage level. Therefore, the high D latch circuit of Figure 5 has the essential Schmitt trigger characteristics.

Schmitt triggers can be constructed by several different methods. Even NOT or NAND gates can operate as Schmitt triggers. However, most Schmitt triggers in ICs

*continued on page 28*

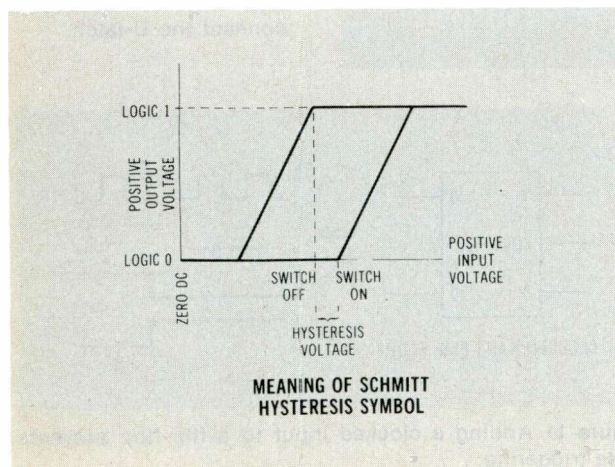


Figure 8 The Schmitt trigger symbol is a type of hysteresis graph, with the input and output levels shown together. When the DC input voltage is increased to the switch-on level, the output goes high (shown by the line sloping upward—it's sloping because time is required). At the top, the horizontal line extends to the right to show that further increases of input voltage do not change the output voltage. Next, the input voltage is decreased (shown by extending the line to the left) until the output goes low (line sloping down to zero). This switch-off input voltage is lower than the switch-on voltage. The difference between the two switching voltages is called the "hysteresis voltage."

have additional circuitry.

The symbol inside the NOT and NAND drawings of Figure 6 is the one most often used for Schmitt triggers, although it actually is the symbol for *hysteresis*. Hysteresis refers to any action that occurs at a different point according to whether an activating condition is increasing or decreasing.

In the case of Schmitt triggers, when the input voltage is increased gradually, the output suddenly will go high at one certain input voltage. Then, as the input voltage is decreased gradually, the output suddenly becomes low, but at a different input voltage than the one that caused the high. The next experiment demonstrates this hysteresis effect.

### Experiment #1

The circuit of Figure 7 allows you to measure the input voltage that causes a high output from this D latch, and the decreasing voltage that switches the D latch output to low. The voltage *difference* between these two trigger points is called the *hysteresis voltage*. A simple LED logic probe is used to determine

when the output is high (the LED is lighted).

#### Step 1

Starting at zero volts, slowly increase the input voltage by turning the potentiometer. Watch the voltmeter and the probe LED. Notice and write down the voltage that triggers a high at the output.

#### Step 2

Increase the input voltage to +5 volts, then gradually decrease it until the LED goes dark. Write down the voltage at turn-off.

#### Conclusion

The voltages you recorded at turn-on and turn-off should not be the same (if you measured accurately and carefully). Because these voltages are different, the hysteresis symbol is appropriate for the Schmitt trigger.

Figure 8 shows how the hysteresis symbol is developed.

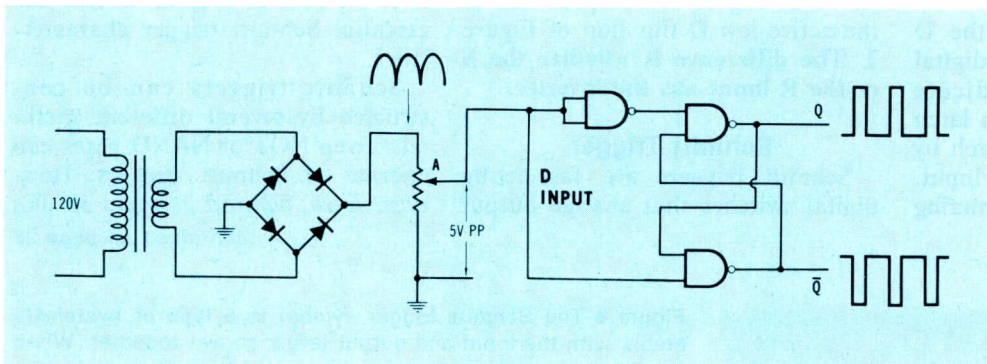
### Experiment #2

The waveshaping characteristic of Schmitt triggers is shown by this experiment.

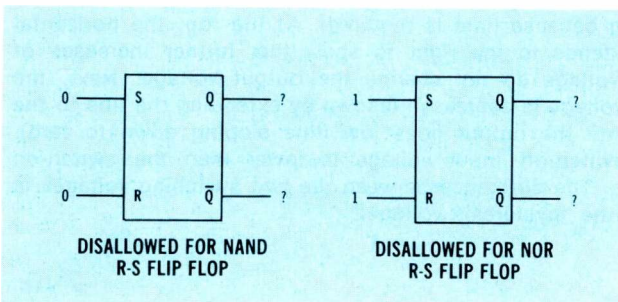
A 6.3-volt RMS heater transformer is used to supply a sinusoidal input voltage (Figure 9). 6.3 volts RMS is about 8.9 volts per peak. After rectification, each peak will measure 8.9 volts minus about 1.2 volts drop across the two diodes in series, or about 7.7 volts. This is too high for TTL gates, so you should begin with the voltage control turned down. Then, increase the signal voltage until it reads 5 volts peak-to-peak on a calibrated scope. If you don't have a calibrated scope, use a VOM or VTVM and adjust it for +3.6 volts DC (which will give about 5 volts PP for that waveform).

When the full-wave rectified voltage is applied to the D-type high flip flop, the output consists of square-tipped pulses, as shown in Figure 9. The output does not have square waves, because the input waveform is not symmetrical, and also the triggering point for turn-on and turn-off are not centered between zero and +5 volts.

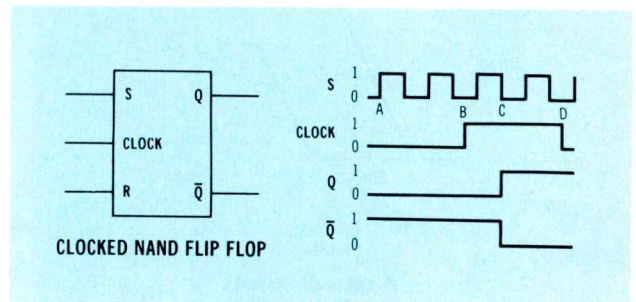
Use a triggered-sweep scope to measure the rise time and the decay time of the output pulses. (Remember that the rise and decay times



**Figure 9** Parabolic waveforms from unfiltered full-wave rectification can be used as an input signal to an active high D-latch, producing square-tipped pulses at the output. Use your scope to set the control for 5 volts peak-to-peak, *before* you connect the D-latch.



**Figure 10** These are the disallowed input conditions for NAND and NOR R-S flip flops.



**Figure 11** Adding a clocked input to a flip flop prevents false triggering.

are measured between the 10% and 90% points of the pulse or square wave total amplitude.)

Record the measured times here:

- rise time was \_\_\_\_ nanoseconds.
  - decay time was \_\_\_\_ nanoseconds.
- (Nano is exactly between pico and micro; so multiply microseconds by 1,000 to obtain nanoseconds.)

IC D-type flip flops typically have switching times of 20 to 30 nanoseconds. However, your D-type circuit might have slower switching (more nanoseconds) because of added stray capacitance.

### Clocked Flip Flops

One disadvantage of RS flip flops is that certain combinations of inputs are disallowed. In this case, "disallowed" doesn't mean it's impossible, but that it's not advisable. Different flip flops react in various ways to these wrong inputs. One might have a flurry of output highs and lows before settling down to a steady high or low output. But the output state is not predictable; it might be either high or low. Some flip flops draw extra current and destroy themselves. Regardless of the results, you should not deliberately cause a disallowed condition.

As shown in Figure 10, NAND R-S flip flops never should have lows at both inputs simultaneously, and NOR R-S flip flops should not have highs at both inputs.

NAND flip flops normally have highs (logic 1) at both inputs during the stable states, and the appropriate input is switched low momentarily to change the output condition. NOR flip flops are just the opposite; the inputs have lows, and one input is switched momentarily to high.

When R-S flip flops are stable in either a high or a low output condition, they remain steady until the proper input signal is delivered to the appropriate input terminal. However, a noise signal at the input, or an accidental input from some source that is not supposed to trigger the flip flop, can cause it to change condition. Any triggering at the wrong time is very undesirable.

To prevent accidental triggering, a clock input terminal can be added to a flip flop, as shown with a NAND in Figure 11. (NANDs are

triggered by a low at the proper input terminal.) At the beginning, the flip flop is in the low condition, with a 0 at Q output and a 1 at the  $\bar{Q}$  output. Before it can be triggered to a high condition, a high must be applied to the clock input and a low applied momentarily to the S input.

Digital square waves are at the S input, thus furnishing a series of highs and lows. But none of the lows can trigger the flip flop. That is, not until the clock input first is high. Only then can the next low at the S input trigger the flip flop to the high condition.

Between time point A and point B of the waveform, the flip flop is forced to remain in the original low condition, because the clock remains low. Then at point B, the clock signal goes high. However, the flip flop still can't change because the signal at the S input is low (remember NAND flip flops can change only when the input signal goes from 1 to 0). At point C, the S signal goes low, and the flip flop changes to high, with a high at Q and a low at  $\bar{Q}$ .

The clock signal returns to low at point D; however, the flip flop remains in the high condition. In fact, it will remain high until the R input is switched to low while the clock input is switched to high.

### Troubleshooting Question #1

The R-S flip flop of Figure 12 is in the high output condition. How should you flip the three switches to trigger a change to the low condition? Assume that the clock must be in a logic 1 (high) condition to allow the flip flop to change.

### Adding A Clock

Figure 13 shows one way of adding a clock input to a R-S flip flop. NANDs #3 and #4 are the two cross-coupled gates making up a R-S flip flop. Additional NANDs #1 and #2 are added to control the R and S inputs.

continued on page 30

# 3 electronic short cuts

## Wiss® SHEARS & SNIPS



On the bench or assembly line, in service kits or the hands of skilled technicians, experimenters, and hobbyists, you'll find these Wiss shears, scissors, and snips keeping company with the best electronic hand tools in the business. And no small wonder:

#### MODEL 1570 QUICK-CLIP® SPEED CUTTERS (above)

Fit palm of your hand. Spring-action, self-opening blades. Sturdy, lightweight, Delrin® frames. Replaceable stainless steel blades. Ideal for fine wires and filaments. 4¾" long. 1¼" cutting edge.

#### MODEL 175-E5 ELECTRICIAN'S SCISSORS

Hot, drop-forged, high carbon cutlery steel. Hardened, tempered, nickel-plated. Scraper/file on outer edge. Double stripping notch for 19 and 23 ga. wire. Cuts fine wire and filaments. 5" long. 1½" cutting edge.

#### MODEL 3765 CONTURA-LITE® SCISSORS

Slender, polished stainless steel blades. Needle-sharp points for intricate cutting of tapes, gaskets, foil, filaments, acetate, insulation, etc. Compact, see-thru case. 4¾" long. 1½" cutting edge.

At leading electronic  
and industrial distributors



### The Cooper Group Electronics Division

WELLER® · WISS® · XCELITE®

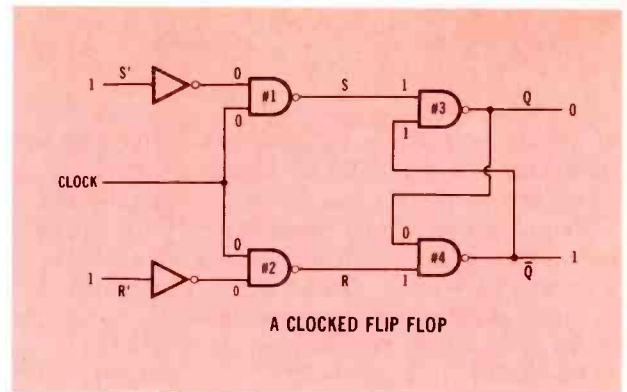
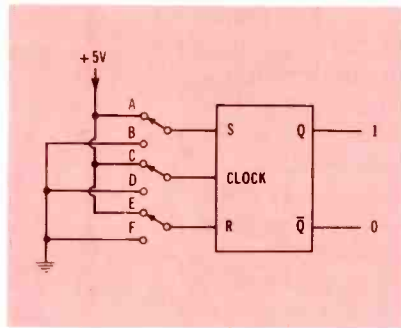
P.O. BOX 728, APEX, NORTH CAROLINA 27502, 919/362-7511

Circle (18) on Reply Card

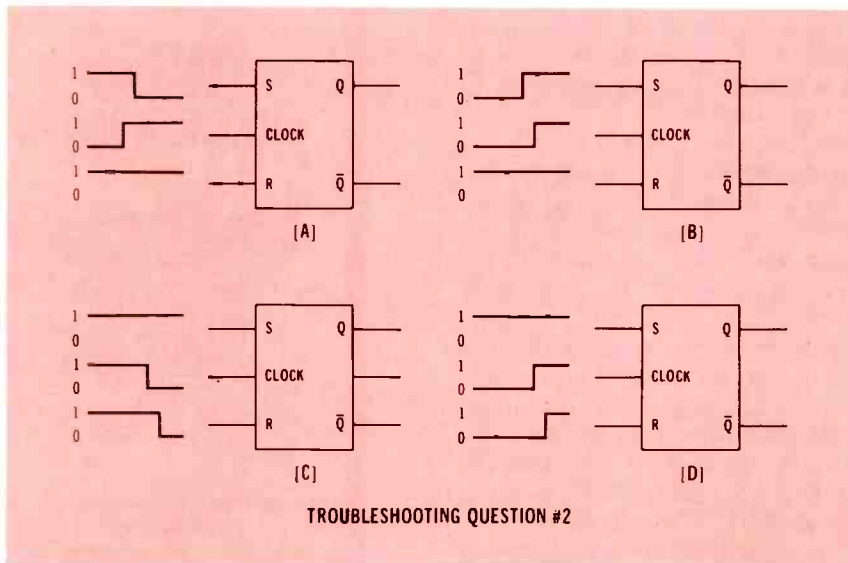
# Industrial

continued from page 29

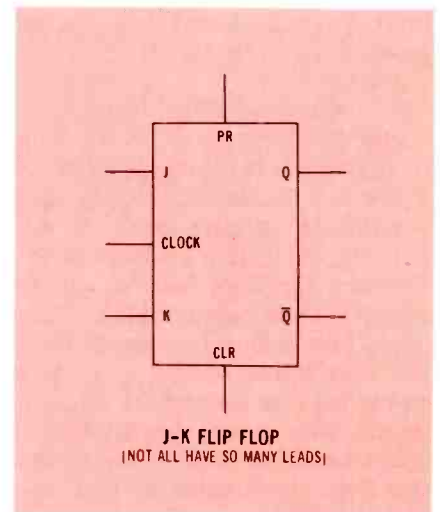
**Figure 12** Troubleshooting Question #1: Assuming that the clock input must be high for triggering to occur, how should you adjust the input switches to produce a low output from the clocked latch?



**Figure 13** This is one method of constructing a clocked flip flop, using NANDs.

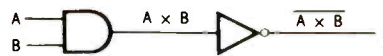


**Figure 14** Troubleshooting Question #2: Given these input conditions, what should be the output state of each clocked flip flop?



**Figure 15** J-K flip flops do not have any disallowed input states. Some versions have fewer pins.

Two schematics were reversed in Figure 2 of page 52 in the May issue of **Electronic Servicing**. The two figures are correctly reprinted here, in the original size. You can cut them out and paste them over the wrong ones, if you like.



**CIRCUIT AND TRUTH TABLE FOR  $\overline{A \times B}$**

A	B	A x B	$\overline{A \times B}$
0	0	0	1
0	1	0	1
1	0	0	1
1	1	1	0

**Figure 1** An AND gate followed by a NOT gate becomes a NAND. The math formula for AND gates is read, "A AND B = L." The NOT gate at the output negates that so it reads, "NOT A AND B = L." As shown in the drawing, the overbar should cover both letters and the expression which is in between. (It might be more clear written "NOT (A AND B) = L.")



**THIS IS A NOR CIRCUIT**

A	B	$\overline{A}$	$\overline{B}$	$\overline{A \times B}$
0	0	1	1	1
0	1	1	0	0
1	0	0	1	0
1	1	0	0	0

**Figure 2** Inverting both inputs of an AND gate does not produce a NAND gate (notice the differences in the truth tables). Instead, it is another way to construct a NOR gate. The formula is read, "NOT A AND NOT B = L." **Remember:** NOT A AND B = L isn't the same as NOT A AND NOT B = L.

Remember that a logical low (0) at *either or both* inputs of a NAND automatically produces a high (1) output. So, the outputs of NANDs #1 and #2 will be logic 1 so long as the clock input is maintained at a 0 input.

The true inputs to the circuit are at S' and R', and they are inverted by the NOT gates before reaching NANDs #1 and #2.

Except when the condition of the flip flop is being changed, the S' and R' inputs normally are maintained at logic 1. Therefore, both inputs of #1 and #2 are at logic 0.

The flip flop is in the low condition, as shown, so switching the clock to logic 1 places a 1 at both clock inputs of #1 and #2. If S' now is switched to 0, there will be two 1's at the input of NAND #1, therefore, the output will switch to 0.

NAND #3 now has a 0 input from NAND #1 and a 1 input from the  $\bar{Q}$  output terminal, causing a 1 output at Q. NAND #2 has not changed (a 0 and a 1 give a 1 output, just as the previous 0 and 0 did). NAND #4 has a 1 from the Q output and a 1 from the output of NAND #2, so the output changes to 0. The clocked flip flop now is in the high condition.

Telling all of these actions in sequence requires much time, but the switching time from the first input change to the stable high output requires about 20 nanoseconds (0.0000002 seconds) for TTL logic systems.

### Troubleshooting Question #2

What are the R-S flip flop outputs of Figure 14? The S R terminals are not marked with primes now, as they were in Figure 13, for they are considered to be the inputs to the clock flip flop. Assume that the flip flop is in a low condition when the switching signals arrive, and that a logic 1 must be at the clock terminal in order for the flip flop to change condition.

### The J-K Flip Flop

The most versatile of the IC flip flops is the J-K type. (The letters J and K have no special meaning.)

J-K flip flops do not have any disallowed input conditions. This improvement is possible by using one R-S flip flop to switch another. The schematic symbol of J-K flip flops is shown in Figure 15.

The two R-S flip flops in the J-K type are called the master and the slave, with the slave connected to the output terminals. Also, the preset (PR) and clear (CLR) terminals predominate. A logic 0 delivered to the PR terminal places the flip flop in the high condition, regardless of the logic levels at the other terminals.

We'll take up J-K flip flops in more detail next month, and also describe a simple counting circuit.

## Answers To Troubleshooting Questions

**Question #1** To change the flip flop to a low condition, the S switch of Figure 12 should be high (as shown), the clock switch should also be high (as shown), and the R switch momentarily should be switched to low (position F of the R switch). One reason for this specific sequence is to avoid disallowed conditions. For example, if S is low when R is switched to low, then both would be low simultaneously;

and that's a no-no. So, it's best to keep them both high *between* switchings.

**Question #2** The A flip flop of Figure 14 will switch to a high condition. The B flip flop will remain in a low condition. The C flip flop will stay in the low condition. The D flip flop will stay in a low condition.



**NEW EICO 480 TRIGGERED SWEEP 10 MHz SCOPE**

100% Solid State • Includes 10:1 Probe

More Professional scope performance for your money! DC to 10 MHz bandwidth, AC and DC coupling, 11 position calibrated attenuator, 10 mV/cm sensitivity, push-button operation. Outstanding features: Built-in TV Sync Separator; Digitally controlled trigger circuits; reference baseline display; calibrated 21 step sweep speed; Fully regulated power supply; Custom Bezel for standard camera mounting. **Assembled \$425.00**

**FREE '78 EICO CATALOG**  
Check reader service card or send 50¢ for first class mail. See your local EICO Dealer or call (516) 681-9300, 9:00 a.m.-5:00 p.m. EST. Major credit cards accepted.

**EICO—108 New South Rd. Hicksville, N.Y. 11801**

Circle (19) on Reply Card

## APPLIANCE REPAIR BOOKS



Thirteen Handbooks written in easy-to-understand language by experts in the service field with illustrations and diagrams! Acclaimed by instructors and professionals alike! How to diagnose and repair air conditioners, refrigerators, washers, dryers, ranges, microwave ovens, dishwashers, vacuum cleaners, electrostatic air cleaners, RV gas appliances, hair dryers, motors, water heaters, coffeemakers, can openers, floor polishers, steam irons, food mixers, lawn care appliances, electric knives, electric and digital clocks and many others. Also fundamentals of solid state, setting up a shop, using test instruments and more. **Only \$2.65 to \$4.90 ea.**

SEND FOR FREE PRICE LIST

Gamit, Dept. ES

5841 W. Montrose Avenue  
Chicago, Illinois 60634

Circle (20) on Reply Card

# PART 2

# Servicing Betamax Videotape Recorders

Second Half  
By Harry Kybett

The first half of Part 2 explained the general principles of recording monochrome video. Specific details of the Betamax monochrome recording and playback are discussed in this article.



### Betamax Recording System

A block diagram of the 2-hour dual-speed Betamax recording chain is shown in Figure 9. (Single-speed models are slightly less complex.) The circuit is similar to the general one given before, except for some additions and other details. Most of the circuitry is inside two ICs, and the signal continually enters and exits from each IC, at the pin numbers shown. (Actual component numbers are not listed, as they differ from model to model.)

The principal differences are the comb filter used to remove the chroma, the non-linear pre-emphasis during the 2-hour mode, the differentiated FM signal, the FM frequency shift, and the E-E path.

### Comb filter

A comb filter combines an amplifier, a delay line, and a resistive bridge. An inverted video signal is delayed for one horizontal line and added to the next line; thus, the chroma signal is cancelled at one side of the bridge and increased at the other. This operation is superior to the use of filters to separate video and chroma, because the comb filter does not restrict the bandwidth.

### Non-linear pre-emphasis

The non-linear pre-emphasis used during the 2-hour mode provides a steeper boosting curve than is usual, and it helps to improve the signal-to-noise ratio. Actually, the signal is pre-empha-

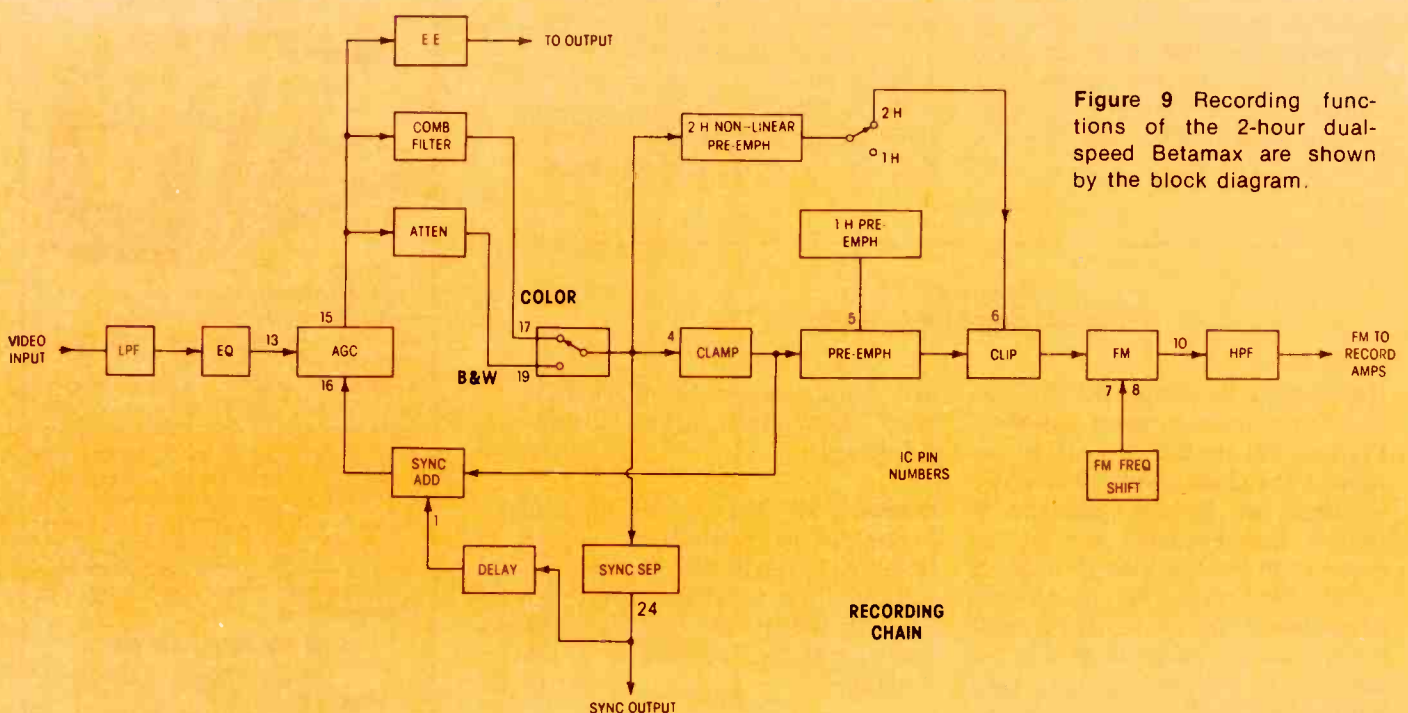
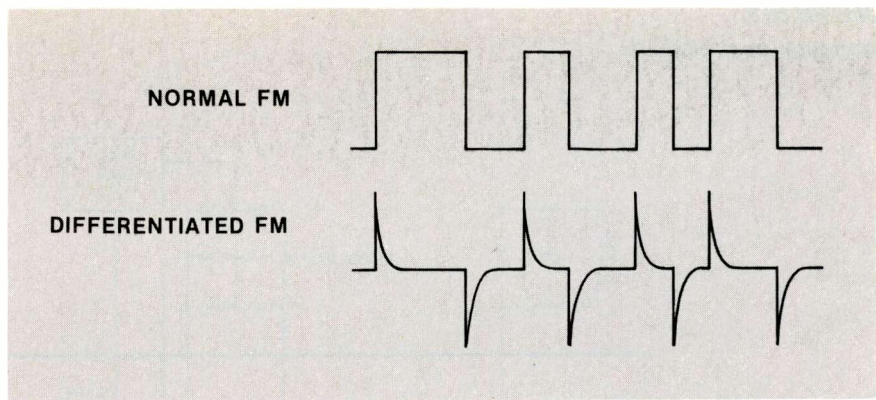


Figure 9 Recording functions of the 2-hour dual-speed Betamax are shown by the block diagram.





**Figure 10** This drawing shows how the clipped square waves of the FM recording carrier are differentiated into positive and negative pulses (which have the same zero crossings) before they are fed to the recording heads.

sized, compressed, pre-emphasized again, and compressed again.

Such a huge amount of pre-emphasis would overload the heads and the tape at times, except the square-wave signal is sent through a high-pass filter that differentiates it into positive-going and negative-going pulses, as shown in Figure 10. Less energy is required to record these pulses onto the tape, yet the new waveform retains the FM information, since the zero crossings are not altered. (The waveform, as viewed by a scope, at the output of the recording amplifier is shown in Figure 11. Remember, an FM waveform is locked at the left of the scope screen, but it moves sideways as the scope trace continues. So, it does not look the way you might imagine, or like the drawing.)

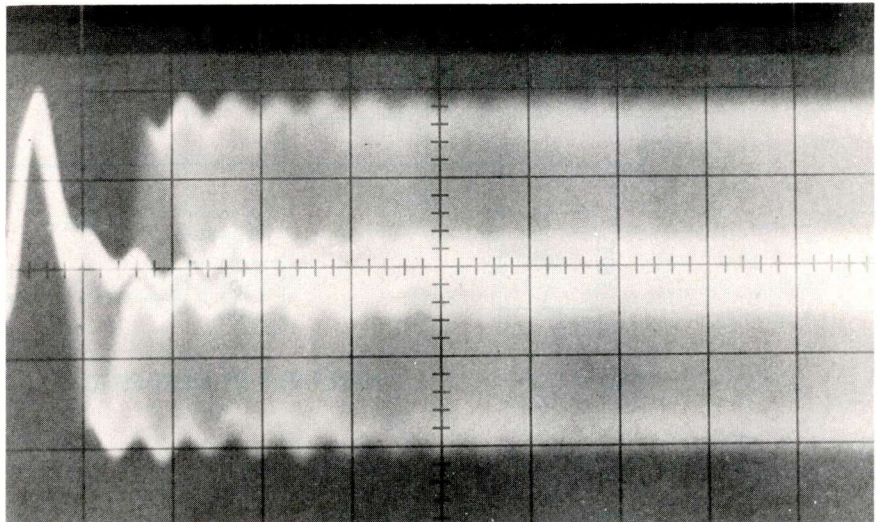
#### FM frequency shift

A frequency shift of the FM oscillator is required to eliminate the vertical interference line, which otherwise would appear about a quarter of the way from the right edge of the TV screen.

#### E-E operation

In the Betamax, the E-E path is different from the usual practice with VTRs. The video output from the AGC-controlled amplifier is diverted through a chroma trap and fed directly to the output of the machine, through the electronic switch in the IC. It is not a true E-E signal, since it has not been modulated and demodulated.

If the input is a weak or snowy color signal from a distant or weak TV station, the color circuits sense the low level of the chroma, and automatically kills the color. Rather than record an unsatisfactory color



**Figure 11** Because the recording signal is varying in frequency (FM), the actual scope photo is different from the drawing of Figure 10.

signal, the Betamax will record a reasonably good monochrome picture. Therefore, to prevent the viewer from seeing a color picture on the monitor while recording and a monochrome picture during playback, the chroma trap automatically is switched in as the color circuits are switched off. This filters out the 3.58-MHz chroma from the signal sent to the monitor output. Therefore, the TV monitor shows a monochrome picture when the Betamax is recording a monochrome picture.

It's advisable to remember this operation, for it can confuse and annoy any customers who do not understand the proper results.

#### Betamax Playback

The Betamax playback chain is very similar to the basic block diagram shown before, but it does contain a few differences. The pre-amplifiers, pre-amp switching, the

color/mono selector switching, limiters, and the DOC are all inside one IC, as shown in Figure 12. From the first IC, the signal enters the second IC where demodulation takes place. The de-emphasis for both speeds is a circuit external to the IC. The IC provides noise cancelling, and switching between playback and E-E signals. Output from the IC goes to the video-output amplifiers.

The 2-hour de-emphasis has a response curve opposite to the one used during recording. The actual circuit is complex, and it is not inside the ICs. It also contains a level-shifter, which helps to eliminate the interference caused by the horizontal sync-pulse crosstalk. Switching between this 2-hour de-emphasis and the one-hour mode de-emphasis is controlled by a signal from the speed-sense circuit in the capstan-servo system.

*continued on page 34*

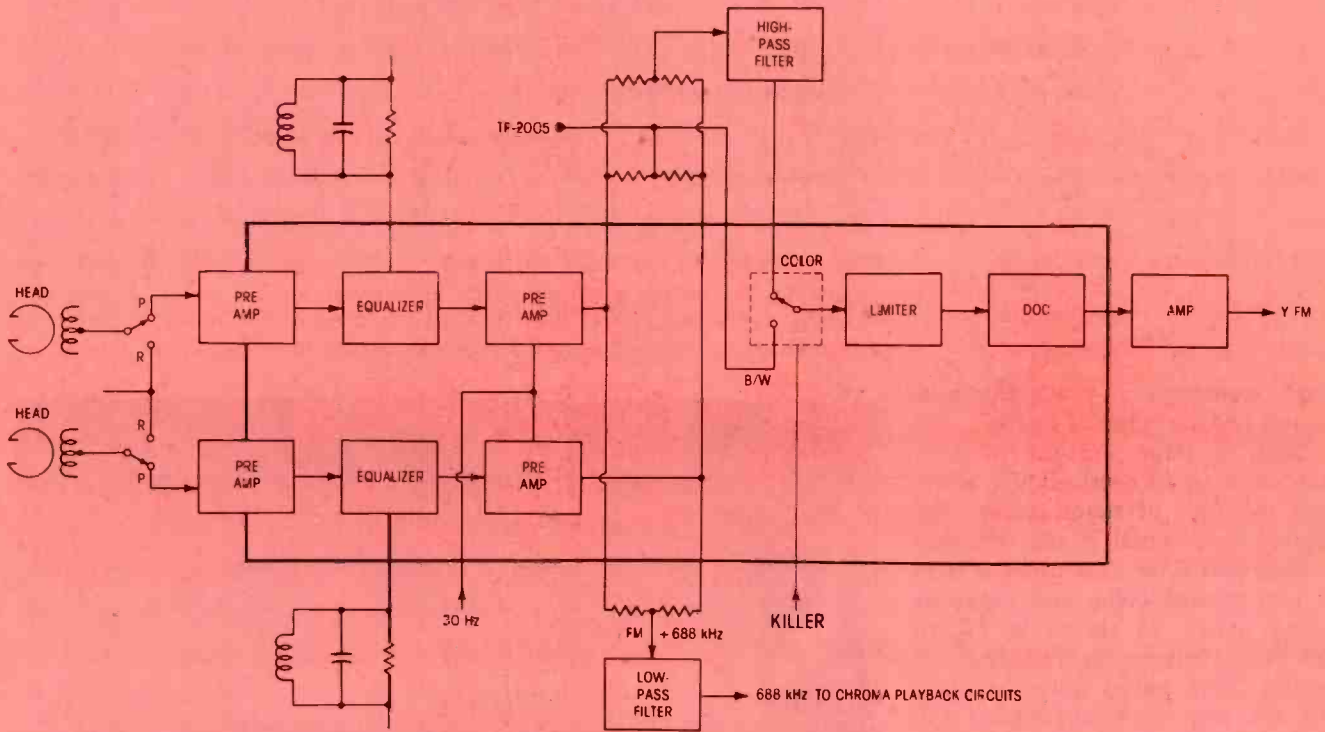


Figure 12A

**FUNCTIONS OF FIRST PB IC**

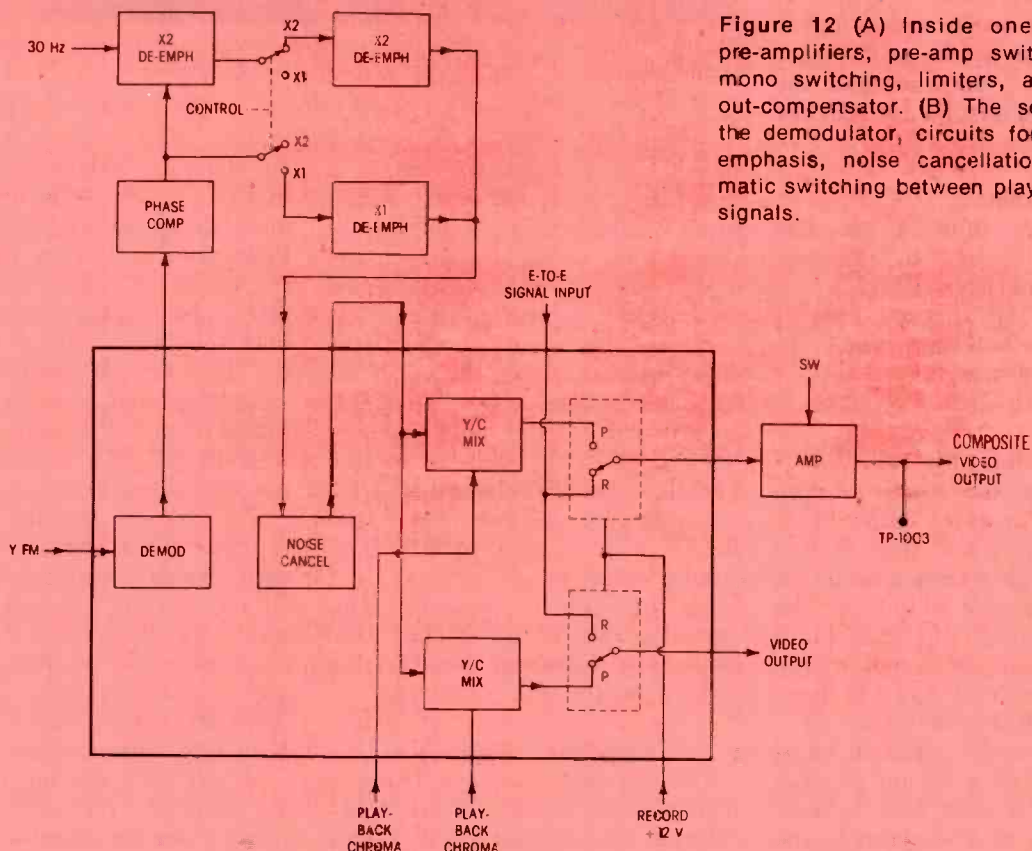
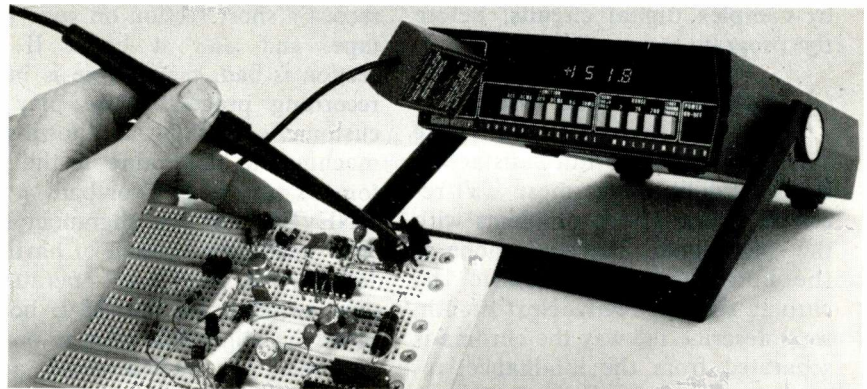


Figure 12B

**DEMODULATOR IC FUNCTIONS**

Figure 12 (A) Inside one IC are the pre-amplifiers, pre-amp switching, color/mono switching, limiters, and the drop-out-compensator. (B) The second IC has the demodulator, circuits for external de-emphasis, noise cancellation, and automatic switching between playback and E-E signals.

# Save design, troubleshooting and evaluation time with the Fluke Temperature Probe.



The 80T-150 Temperature Probe can be used with any voltmeter to quickly locate malfunctioning and overstressed components, or to confirm difficult thermal calculations.

## Playback Time-Base Errors

Most VTRs and HVCRs will playback an acceptable picture to the antenna terminals of a TV receiver. However, there are a few subtle or disguised problems which should be explained.

The sync signal is subject to very strict FCC requirements regarding the timing, the width of the pulses, and other parameters. These specifications are necessary to insure that the picture at the TV receiver will be stable, and that the signals transmitted by all TV stations can be received properly by all TV receivers. Problems in a station sync generator are evident by rolling, bending, or unstable pictures.

Difficulties with the rotating heads and the tape transport produced many mechanical problems with the early-model VTRs. Any slight deviation from perfect speed caused sync-timing errors to be recorded on the tape. Then, further errors were added during playback, resulting in unstable pictures. (Other timing errors occur from stretching of the tape.)

All such errors are included in the general term "time-base errors." Modern home-type VTRs usually produce an "apparently" stable picture, as the result of 20 years of development research. But this stability should not be taken lightly. It can result only from good design and manufacturing that allows a moderate amount of time-base error, coupled with some hiding of the errors by the TV receiver locking.

In other words, **some sync instability because of time-base errors is inevitable with any kind of HVCR machine, but TV receivers that have fast-operating frequency correction of the horizontal oscillator can mask the remaining instability.** Therefore, when the receiver horizontal frequency changes in perfect step with the varying horizontal sync of the VTR, the time-base errors are not noticed.

Unfortunately, not all American-built TV receivers have fast correction of the horizontal-scanning frequency. Those should be modified.

Incidentally, even those expensive broadcast-model VTRs have time-

*continued on page 36*

The Fluke 80T-150 Temperature Probe easily converts any DVM to a direct reading thermometer (1mV/degree). Range is  $-50^{\circ}\text{C}$  to  $+150^{\circ}\text{C}$  (or  $-58^{\circ}\text{F}$  to  $+302^{\circ}\text{F}$ ), and the probe can be used in surface, air or liquid

applications. Additionally, a 350V standoff allows measurement of live circuits. It is fast responding and battery powered. \$125.\*

Call today—800-426-0361 toll-free—and ask for Application Bulletin

AB-28 for information on other ways to make thermal measurements with the 80T-150. Or, write: John Fluke Manufacturing Co., Inc., P.O. Box 43210, Mountlake Terrace, WA 98043.

\*U.S. Price Only



For Literature Only Circle (2) On Reply Card  
For Demonstration Only Circle (21) On Reply Card

1806-7014

## Technicians— RCA Flameproof Film Resistors simplify your replacement problems.



More and more technicians are switching to RCA Flameproof Film Resistors. Here are 5 important reasons why:

- Many of today's circuits require flameproof resistors.
- Simplified inventory: RCA's 2% tolerance flameproof resistors replace many conventional types having 5% and 10% ratings.
- High quality service demands high quality replacement parts.
- They're available in the popular wattage ratings — 1/4, 1/2, 1 and 2 watts.
- Values run from 1.0 Ohm to 1.5 Megohms. Altogether there are 523 film resistors to choose from.

And, RCA's convenient, preloaded and prelabeled Flameproof Resistor Kit makes it easy to store and locate your resistors.

See your RCA Distributor for details or write to RCA Distributor and Special Products Division, 2000 Clements Bridge Road, Deptford, NJ 08096.

**RCA** Flameproof  
Film Resistors

Circle (22) on Reply Card

base errors. But, they are corrected by complex digital circuits, before the program is broadcast.

### Color Time-Base Errors

Time-base errors, even those small enough to permit satisfactory B&W stability with most TV receivers, cause severe problems with the color signal. Therefore, none of the home machines handle the chroma signal directly. Next month, we'll describe the way the chroma is separated from the luminance, recorded, played back, and then is recombined with the luminance to form the usual NTSC video.

### Troubleshooting Luminance Circuits

All of the luminance and chroma circuits are mounted on the YC-L and RS-L circuit boards. Their locations are shown in Figure 13.

With all problems, check first to determine if the trouble is evident during playback or record. Try your good test tape. If it does *not* play correctly, the machine has playback troubles.

If it does play correctly, then record a short section on your work tape, and play it back. If this section is bad, the trouble is in the recording process. Also, play the customer's tape on a known-good machine, to determine if the customer's tape is good or bad.

NEVER play the alignment tape on a machine suspected of having a defect. Also, don't hand-operate the slide switches on the RS-L board, when the alignment tape is on the machine. The switch could apply power to the erase oscillator, thus erasing the test tape.

After a machine is repaired, record something onto the work tape, and then play it back on that machine, as well as on a known-good machine. If it plays well on both, you have fixed the trouble.

The Betamax manuals show the adjustments which might be necessary during repairs, in addition to the component layout on the boards. We recommend that you obtain a manual before doing any more than the basic recording and playback tests.

## Common Problems

### No video or audio

A complete loss of both audio and video usually is caused by faults common to both circuits. Ordinarily, these symptoms occur for all modes; that is, neither recording or playing back produce anything, and the E-E picture can't be seen in the REW, FF, and STOP modes.

First, check to see if the tape is threaded, and if it is moving. If it's threaded, but not moving, then check the capstan belt. Look to see if the heads rotate (if not check the head belt and the AC motor). A tape that won't thread will be discussed later, with other mechanical problems.

If none of these obvious mechanical faults are found, the most likely trouble will be in the speed-detect and the muting sections of the capstan servo, which will be described later.

One quick and informative electronic test is to look for the playback CTL (control-track) pulses on the RS-L board at pin 2 of switch 501. If the switch is open, the pulses can't get to the capstan servo circuit, and the mute will remain active. The video can be unmuted quickly by grounding the base of Q7 on the YC-L board. This point has zero normally and about +5.7 volts when the muting is operating. If disabling the muting brings back the video, then the video circuit is okay, but the problem is in the muting circuit or the CTL pulses.

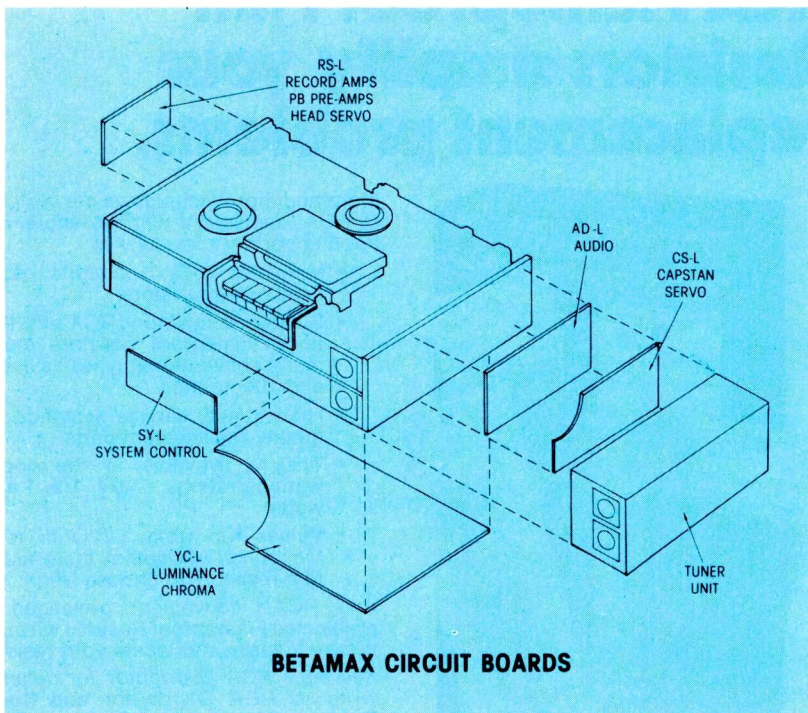
### Good Audio, But No Video

A loss of picture while the audio remains good occurs only rarely. Use a scope to trace where the video stops. A bad transistor, video IC, or the video-muting transistor are suspects.

Other troubleshooting tips will be given in future articles, along with symptoms from the TV screen for various defects or misadjustments.

### Next Month

Part 3 will discuss the treatment of the chroma signal during both recording and playback modes. □



**Figure 13** Locations of the major circuit boards are shown here. Incidentally, Sony does not accept complete boards under warranty. Repairs must be made to the boards in the field, and the individual defective parts are returned for warranty.

## ADMIRAL

Chassis T4N3, T5N3, T6N3 Series .....	1737-1
Chassis 9M45M-1A1/-1B/-1D1/-2A1/-2B/-2D1 .....	1732-1
Chassis 24M55M .....	1750-1

## BOHSEI

T-600 .....	1726-1
T-650 .....	1740-1

## CORONADO

TV29-1707A .....	1721-1
TV25-1117A .....	1722-1
TV25-1013A/B/C/D, TV25-1032A/B .....	1724-1
TV29-1727A .....	1725-1

## K-MART

SKC1952A .....	1727-1
----------------	--------

## PANASONIC

Chassis T801-A .....	1718-1
Chassis T205-10(A)/-20(A) .....	1723-1

## JC PENNEY

685-2904, 2904 (855-0295) .....	1719-1
685-1005 (855-0451) .....	1729-1
685-4002/-4004/-4006/-4937/-4944B/-4946 .....	1735-1
685-2019/-2033/-2029 (855-0428/-0303/-0311) .....	1737-2
Remote Control Receiver CTP23B, Transmitter CRK24F .....	1737-2-A
685-2011/-2011-00 (855-0402) .....	1750-2
Remote Control Receiver CR-212, Transmitter CT-213 (23120990) .....	1750-2-A
1016 (855-0436), 1019B (855-0030) .....	1739-1

## PHILCO

Chassis A19-7 .....	1725-2
Chassis E21-12/-13 .....	1741-2
Chassis E21-21/-23 .....	1752-1

## QUASAR

Chassis TS-958NL/NP .....	1719-2
Chassis 13TS-484 .....	1720-1
Chassis ACTS-/CTS-958 .....	1721-2
Remote Control .....	1721-2-A
Chassis 13TS-963, 15TS-963 .....	1738-1

## RCA

Chassis CTC74AP .....	1722-2
CRK22A, DAP-2A .....	1722-2-A
Chassis CTC89A/B/C/D .....	1724-2
Remote control receiver CTP23B, transmitter CRK24A .....	1724-2-A

## SANYO

21T70 .....	1751-1
-------------	--------

## SEARS

564.51370601 .....	1728-1
562.50262700 .....	1735-2

## SONY

Chassis SCC-100M-A, SCC-100N-A .....	1717-1
Chassis SCC-100R-A .....	1723-2
Chassis SCC-100Q-A, KV-1724 .....	1726-2
Chassis SCC-100D-A .....	1727-2

Chassis SCC-100S-A .....	1729-2
--------------------------	--------

## SYLVANIA

Chassis E44-3/-4 .....	1731-2
Chassis E46-1/-2 .....	1730-1

## TATUNG

19TDA .....	1730-2
-------------	--------

## TRUETONE

SCJ3807A-87 (24-3807-5) .....	1732-2
SCJ3812A-87 (24-3812-5) .....	1733-1
SCJ3819A-87, SCJ-3820A-87 (24-3819-0, 24-3820-8) .....	1736-1
SCJ4715B-87 .....	1717-2
ADM2896A-87 (24-2896-9F) .....	1728-2
Tuning System .....	1728-2-A

## ZENITH

Chassis 13JC10 .....	1733-2
Remote Control Receiver A-21, Transmitter 124-10 .....	1733-2-A
Chassis 17JC55 .....	1736-2
Chassis 19JC48 .....	1738-2
Chassis 19JC60Z .....	1740-2
Remote Control .....	1740-2-A
Chassis 19JC55Z .....	1739-2



## How To Protect Your Independence

Protect yourself from being swept away by O.E.M. service organizations. Help keep your independent status. You can... everytime you replace a flyback, yoke or voltage multiplier. How? Specify Thordarson — the leading independent supplier of flame retardant replacement flybacks, yokes and voltage multipliers for all brands.

Thordarson replacements fit exactly. They are designed and built better than the original being replaced. The replacement is fast and easy because Thordarson offers you accurate cross-reference data that is constantly updated.

To stay independent... buy replacements from your independent electronic parts distributor — where your best buy is Thordarson.

**THORDARSON**

Thordarson Meissner, Inc.  
Electronic Center  
Mt. Carmel, Illinois 62863  
In Canada—  
GTE Sylvania Canada Corporation

 Associate Member

Circle (23) on Reply Card



# Sam Wilson's Technical Notebook

By J. A. "Sam" Wilson, CET

Your comments or questions are welcome. Please give us permission to quote from your letters. Write to Sam at:

J. A. "Sam" Wilson  
c/o Electronic Servicing  
P.O. Box 12901  
Overland Park, Kansas 66212

## Applied Magnetics

A discussion of magnetics was started in a previous Technical Notebook, and it will be continued. My goal is to review the basics of magnetics first, and then to show how these basics lead to a better understanding of magnetic and electromagnetic devices.

This month, the center of discussion is measurements.

### Don't compare electricity and magnetism

A comparison of the similarities between magnetism and electricity has been done many times to help students understand magnetism. However, such comparisons often are more confusing than helpful. And wrong ideas are difficult to change, once they are learned thoroughly.

Therefore, I recommend only a listing of differences, not similarities, as shown in Table 1. (This table was included on page 52 of the April issue, but one section was garbled.)

## The magnetic field

A magnetic field consists of *flux lines*, which are nothing more than regions of equal magnetic intensity around a magnet.

A favorite school experiment is to place a piece of paper over a magnet and sprinkle iron filings on the paper. The filings concentrate over the magnet in curves showing the locations of the flux lines, as shown in Figure 1.

Unfortunately, a wrong impression often is given by the arrows that are usually placed on the flux lines. **The arrows really show the direction that a north pole would move**, if it were placed in the field. (The arrows do NOT show any movement of the flux lines. The flux lines are steady, and do not move.)

## Obtaining magnetomotive force

To produce flux lines in a material, such as a piece of soft iron, a source of magnetic flux is needed. This is called magnetomo-

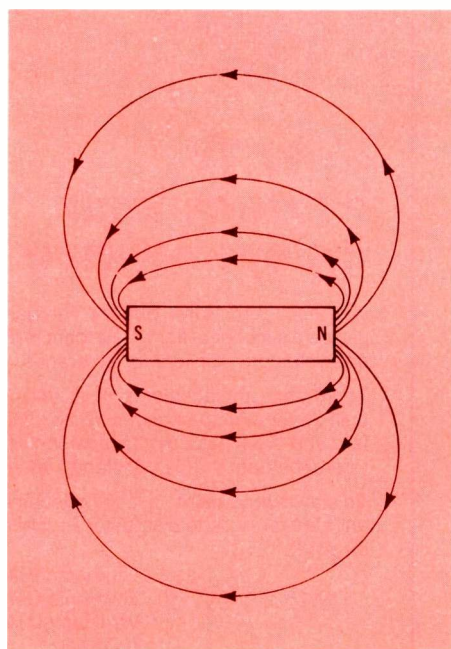


Figure 1 Magnetic flux lines

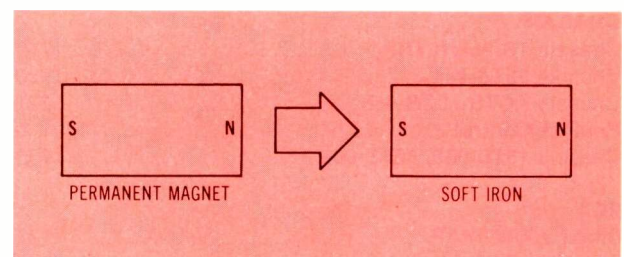


Figure 2 Magnetic induction

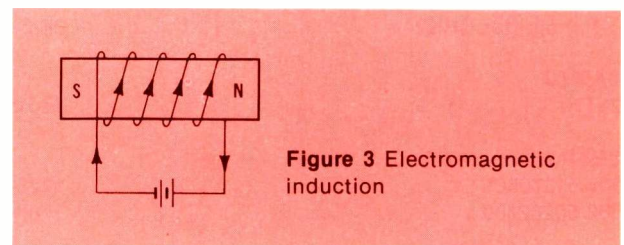


Figure 3 Electromagnetic induction

Table 1  
Differences Between Magnetic And Electronic Systems

Magnetic flux often is compared with current in an electric circuit, BUT...	...current flows through a circuit, while magnetic flux <b>does not move through a magnetic circuit</b> . Further, current is confined to the conducting path, but some flux can "leak" from a magnetic circuit.
Magnetomotive force (MMF) often is compared with electromotive force (EMF), BUT...	...neither MMF nor EMF is a force. Both are units of work.
Reluctance often is compared with resistance, BUT...	...resistance often is linear in electric circuits, while reluctance almost never is linear.
Current always has an accompanying magnetic field, BUT...	...a magnetic field is not always accompanied by an electric current.
Current through a wire produces heat, BUT...	...flux through an iron core does not produce heat.

tive force (MMF), and it causes flux lines to exist in a material.

Magnetomotive force can be obtained by two methods: by magnetic induction; and/or by electromagnetic induction.

The principle of magnetic induction is shown in Figure 2, where a permanent magnet serves as the source of flux lines. When the magnet is placed near the soft iron, flux lines are induced in the iron.

Figure 3 shows a second way of obtaining a magnetomotive force. A coil is placed over a soft-iron core, and current is forced through the coil. The coil's electromagnetic field serves as the source of MMF, and the method is called "electromagnetic induction."

#### Measuring MMF

After we have defined MMF as the source of flux, we need a way of measuring it.

One method is to use a standard magnet (one that is manufactured to certain rigid specifications). In a

laboratory setup, an unknown source of MMF can be compared with the MMF of the standard magnet.

Although the method of measurement by using a standard magnet can be very accurate, there are problems. Such magnets are expensive, and the procedure is complicated, as well as requiring mathematical computations.

An easier procedure is to produce

a known MMF by current in a coil, as illustrated in Figure 4. Measurements of voltage, current, and resistance are easy, so this method is cheaper and more convenient than the one using a standard magnet.

#### Magnetic intensity

Although it is true that MMF sets up the flux in a material, it's NOT a useful parameter when

*continued on page 40*

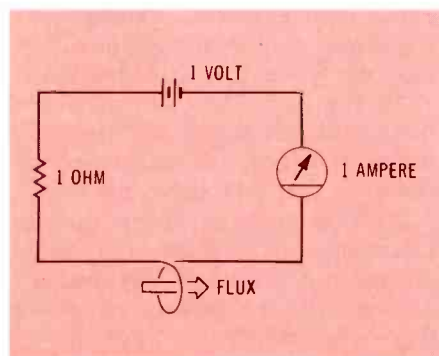


Figure 4 One ampere-turn of MMF

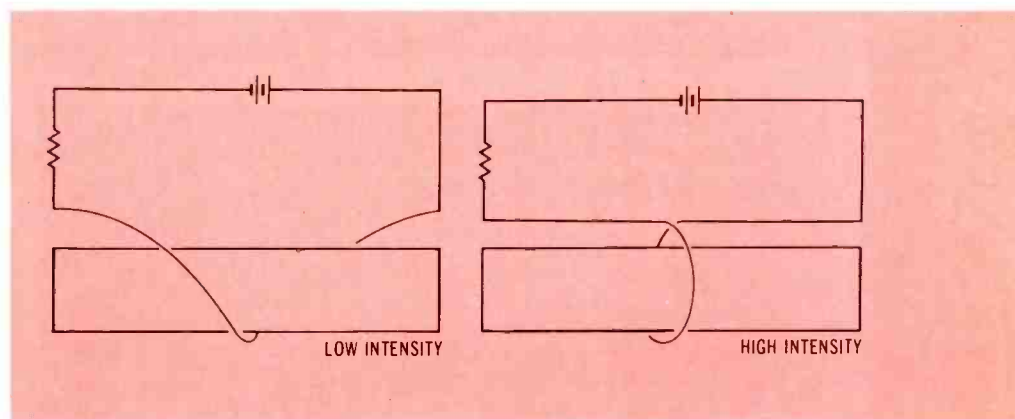


Figure 5 Turn spacing changes the intensity

taken by itself (see Figure 5). If the turn of wire is spaced closely, then all of the MMF ampere-turn is concentrated in a small region. If the same one turn is stretched out,

the MMF is stretched over a larger area.

Therefore, a magnetomotive force (MMF) can be concentrated in a short length, or it can be stretched

over a longer distance. That's why **the ampere-turn-per-unit-of-length is used as a unit of magnetic intensity** (rather than ampere-turns alone). In formulas, magnetic intensity is represented by a capital letter "B."

### Field strength

The amount of flux is one indication of the magnetic field strength. Obviously, more flux lines produce a stronger field. But, again there is a problem of how the flux lines are distributed.

Four flux lines spread over a large area, as shown in Figure 6, would not produce as much magnetic field strength as if those same four flux lines were concentrated within a smaller area.

Therefore, when we describe magnetic field strength, it isn't enough to specify how many flux lines there are. Instead, **the number of flux lines per unit area must be stated.** This is called the magnetic flux density, and it is represented by a capital letter "H."

### The B-H curve

The characteristic curve of a magnetic material is a hysteresis curve. In Figure 7, compare the characteristic curves of a silicon diode and a piece of soft iron.

The horizontal axis of the diode curve represents the applied voltage, which can be thought of as the moving force for the electrons. With the curve for soft iron, the horizontal axis represents magnetic intensity, which can be viewed as the force that establishes the flux.

With the diode curve, the vertical axis represents current—the result of applying a voltage. The vertical axis of the hysteresis curve is flux—the result of applying a magnetic force.

Both curves are non-linear, so Ohm's Law won't work with either situation. In addition, the magnetic curve shows hysteresis (different curves for increasing or decreasing magnetic intensity).

Next month, I'll finish the discussion about magnetic measurements, to be followed by applications of magnetism and electromagnetism. □

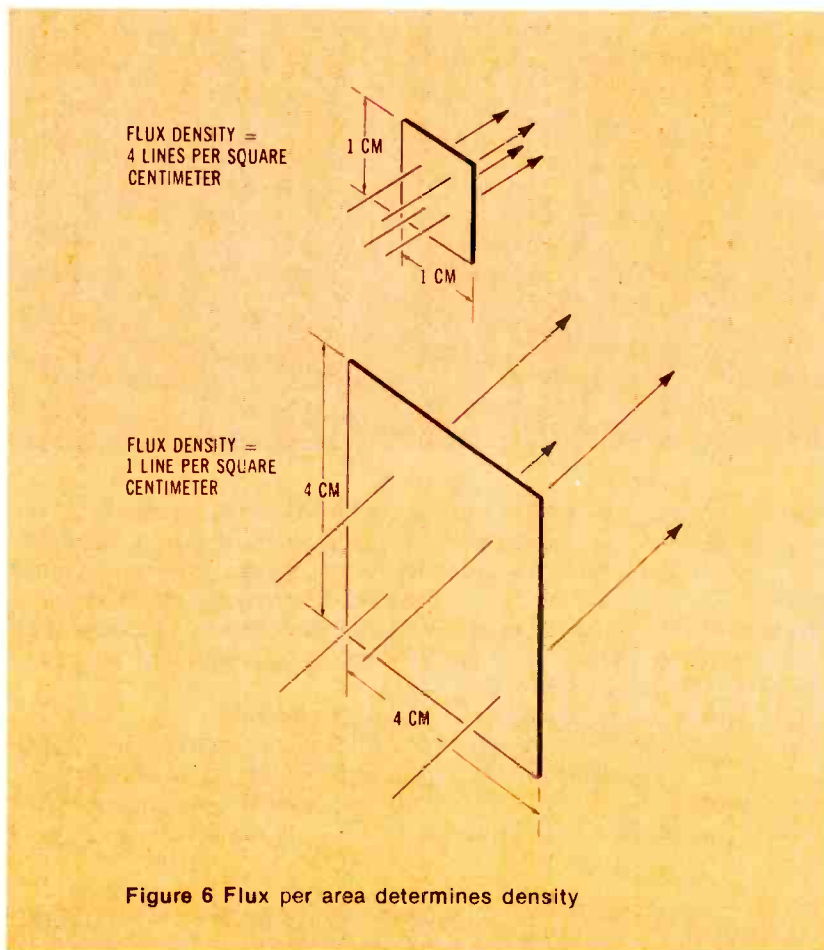


Figure 6 Flux per area determines density

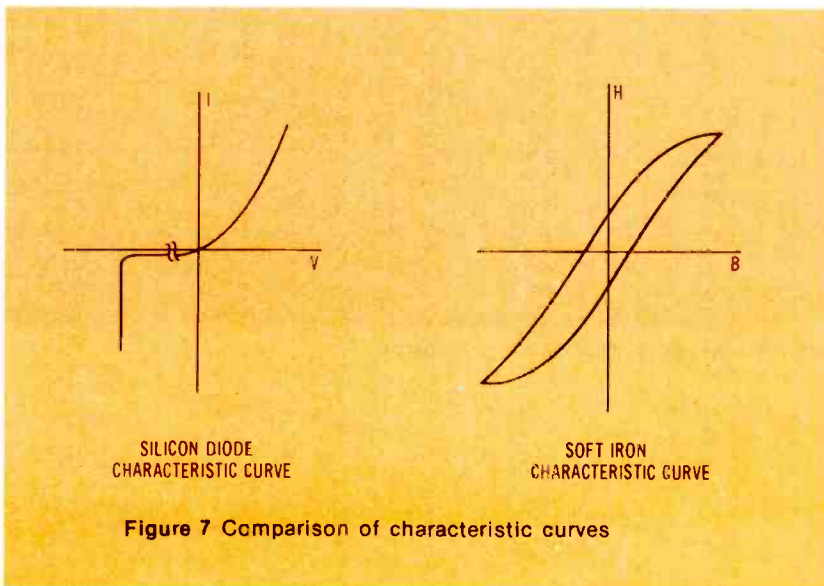


Figure 7 Comparison of characteristic curves





# Servicing Sylvania Color TV, Part 5

By Gill Grieshaber, CET

*Modern video systems are surprisingly complicated, because of ABL, blanking, light sensors, and extra automatic functions. This is true of the E44 Sylvania video circuits. DC voltages and waveforms are included with a thorough analysis of the video stages.*

## Vital Video Amplifiers

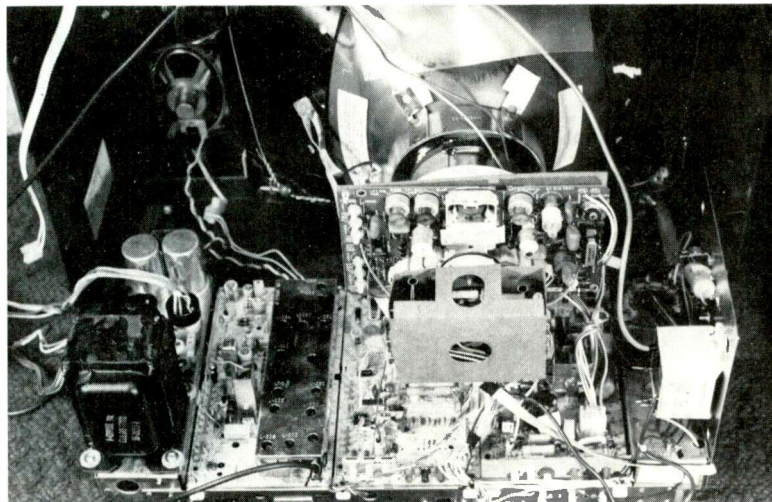
Six stages of video amplification are between the video detector of the Sylvania E44 and the picture tube. Many black-and-white TVs have simple video circuits with only one tube. Perhaps you wonder why so many stages of transistors and ICs are needed in these new color receivers. The answer is in two parts: the extra stages allow better

performance of the basic video functions (amplification and sufficient bandwidth); and, additional functions can be obtained.

## DC coupling

DC-coupled stages are more difficult to troubleshoot than are separate stages. But there are strong reasons for including DC coupling.

*continued on page 42*



**Figure 1** The Sylvania E44 chroma module is located near the center of the chassis. Three video drive and three screen-grid controls project from the rear of the module.

TV video should *always* have the tips of blanking pulses clamped to a definite DC-voltage level; otherwise, brightness changes apparently will occur when the scene contrast varies. Visually, this effect is similar to increasing the brightness during dark, moody scenes (thus making the black areas become gray), or to decreasing the brightness for pictures of white snow or light-colored sand (which darkens the bright areas too much).

Such shifting brightness levels are caused by two simultaneous conditions: when the video has no DC clamping; and, at the same

time, the contrast changes, or the widths of the video pulses vary. In other words, the lack of clamping allows the *average* video voltage to shift according to amplitude and waveshape.

The transmitted video has DC clamping. The direct output of the receiver video detector also has this same DC relationship. If the circuitry between detector and picture tube has direct coupling, the TV picture will have correct visual contrast and brightness.

However, a coupling capacitor eliminates this DC clamping, and allows the contrast/brightness ratio

to swing the wrong way. Of course, a DC-restoration circuit (usually involving a diode) can re-insert the DC level. Notice, as we analyze the circuit, that DC restoration is supplied at the base of Q904, following a coupling capacitor.

### Changing DC voltages

Because of direct coupling (or DC restoration), the DC voltage of video stages varies constantly as the scenes change. For example, the Sylvania CRT cathode voltage fluctuated between +145 and +170 during a three-minute period. So, accurate recording of video voltages

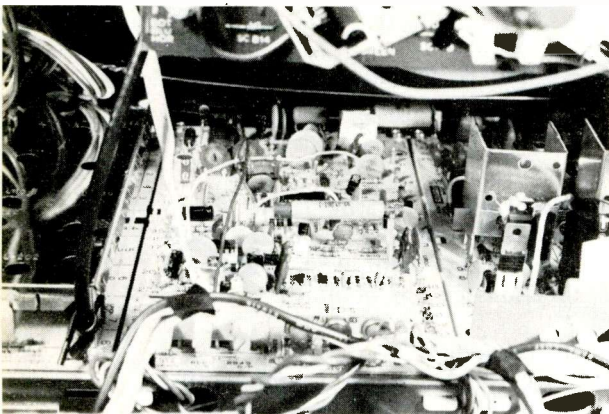


Figure 2 This picture shows the chroma module as it appears in the chassis.

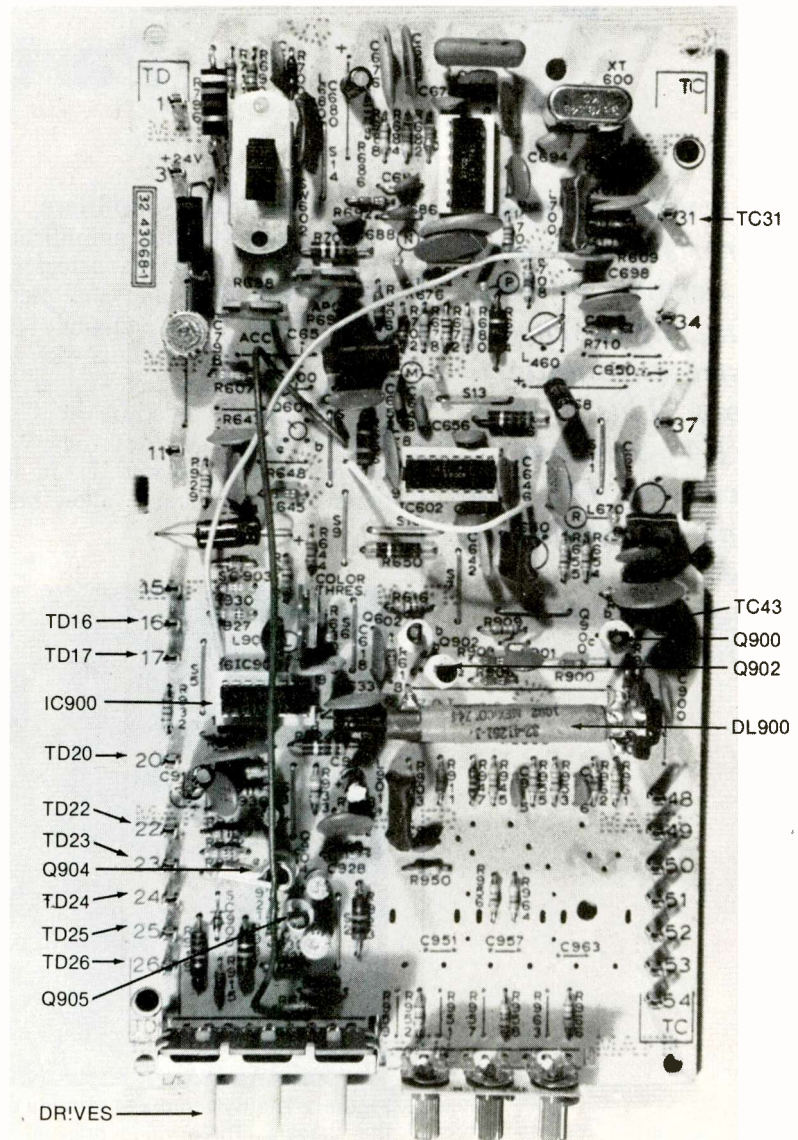


Figure 3 (at right) Locations of many of the video transistors and other components on the chroma module are pointed out by arrows.

from TV stations is almost impossible. That's why a steady generator signal was used during the measurement of most of the DC voltage and waveforms shown here.

#### Waveforms

A good chroma troubleshooting technique is to use the signal from a color-bar keyed-rainbow generator. However, a color-bar signal in the video circuits has smaller amplitude than the TV video or video generator waveforms have. That's why we show both a steady video pattern and a color-bar pattern at most of the checkpoints of the E44 video circuits.

#### Operation Of Video Circuits

Four transistors, one IC, and other necessary components of the video circuit are located on the chroma module, which is mounted near the center of the main horizontal chassis (see Figure 1).

The three power transistors that drive the picture-tube cathodes are mounted on the circuit-board/CRT socket (under the protective cover in Figure 1).

A closer view of the chroma module is shown in Figure 2. The horizontal round object near the center is the delay line, which is an important (and easy to find) test point. The arrows in Figure 3 show the locations of the important transistors and components, which we will discuss.

#### Chroma filter and delay line

Except for two items, Q900 is a conventional video amplifier stage for the signals that enter the chroma module at terminal TC43 (Figure 4).

One difference is the low gain. The positive-going signal at the collector only has about 10% more amplitude than the input negative-going signal at the base. The low gain is caused by the large unby-passed emitter resistor (750 ohms), and the low collector impedance (about 900 ohms).

Also, the chroma signal is eliminated here, although that is not readily apparent. The 3.58-MHz chroma is removed by the C900/

L900 tuned circuit at the cold end of the emitter resistor. This is proved by waveform W2 in Figure 5, which shows the color-bar pulses (without the sync and blanking pulses) at the tuned circuit. (Any signal developed between emitter and ground is subtracted from the base signal, thus reducing that part of the waveform in the collector signal.)

Of course, the chroma signal is picked off at the Q900 base (before the tuned circuit), so it is not affected by the trap.

From the Q900 collector, the video signal (without 3.58-MHz chroma) goes through the delay line (DL900) and a peaking coil (L901) to the base of Q902.

Remember that the resistive loads at BOTH ends of a delay line affect the ringing (which appears as multiple ghosts), and the frequency response. In this case, R906 (paralleled by Q902's B/E resistance) and R900 apply a load of about 1800 ohms to each end of DL900.

Q902 is a PNP type, so the base is less positive than the emitter, which returns to the +24-volt supply. Paralleling R908 (the emitter resistor) is the series-connected C901/R909 filter, which boosts the high-frequency end of the video response and causes some overshoot.

Instead of a gain, Q902 has a slight loss of about 15%, because of the large 1,000-ohm emitter resistor (R908) and the low-value 820-ohm collector resistor (R911).

From the Q902 collector, the video signal is applied to pin 12 of IC900. Also, a filtered sample is fed to IC900 pin 11.

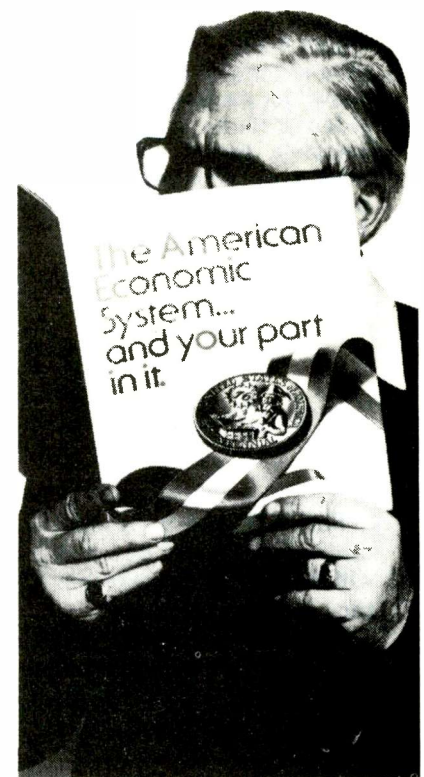
#### IC900 Functions

Not much is known about how IC900 functions. However, pins 11, 12, and 13 are concerned with the "aperture corrector," which is a type of video peaking to improve the picture sharpness. Pins 14, 15, and 16 handle the in/out vertical and horizontal blanking signals. The horizontal pulses also are used for chroma burst gating and AGC keying.

*continued on page 46*

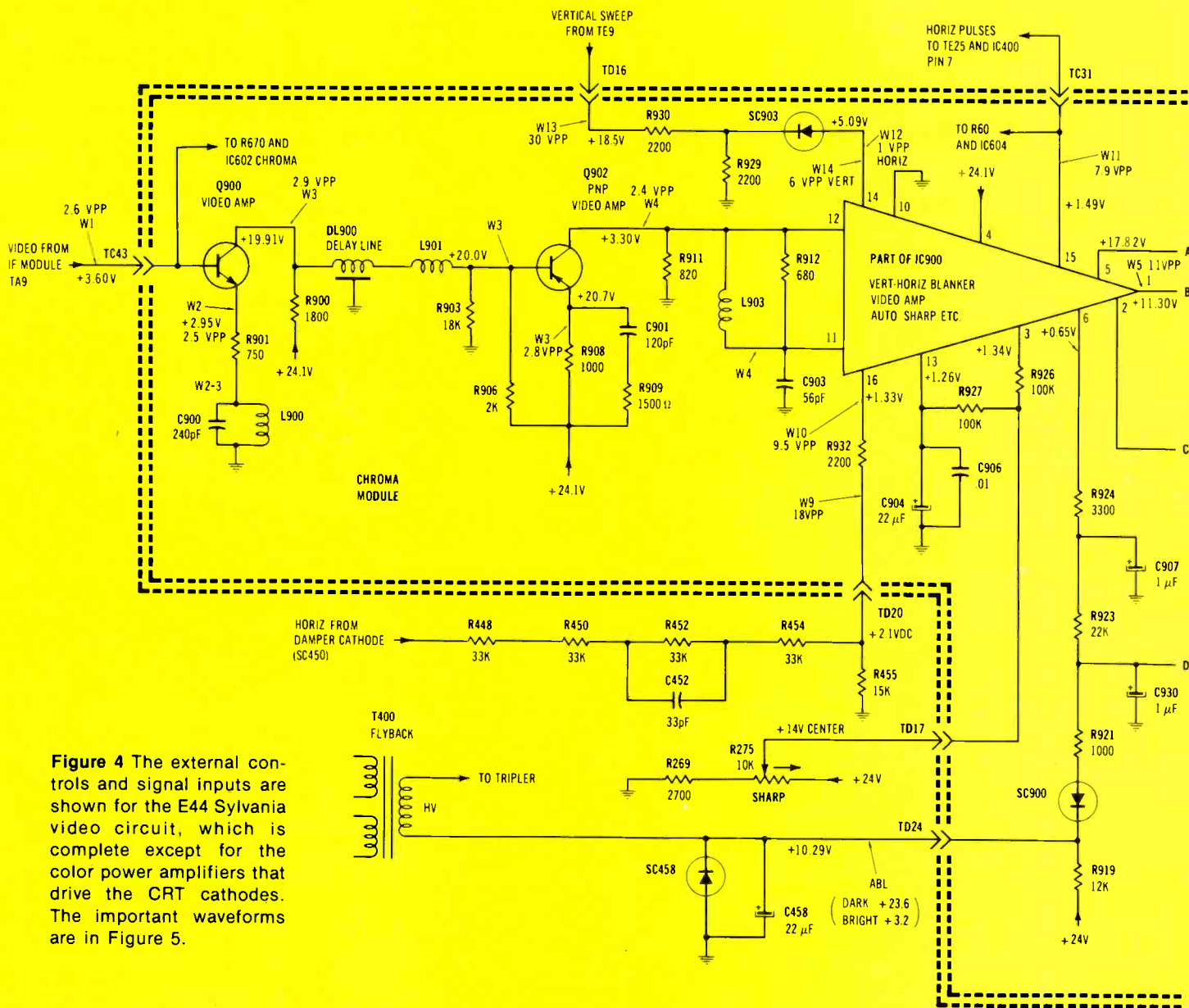
## How much change does our American Economic System need: A lot? A little? None?

The more we all know about our system and how it works, the better we can decide what to preserve, what to change in the years ahead. That's why this special booklet has been prepared. Every American ought to know what it says. For a free copy, write: "Booklets," P.O. Box 1887, New York, N.Y. 10001.



A public service of The Advertising Council & U.S. Department of Commerce presented by this Magazine





**Figure 4** The external controls and signal inputs are shown for the E44 Sylvania video circuit, which is complete except for the color power amplifiers that drive the CRT cathodes. The important waveforms are in Figure 5.

Pins 7, 8, and 9 are for the automatic color-level detector, which will be explained next month with the chroma operation.

The automatic black-level-control circuit uses internal IC900 connections and pins 1 and 2.

Apparently there are one or more video stages inside IC900, for the output at pin 5 is video of opposite polarity than the input at pin 12.

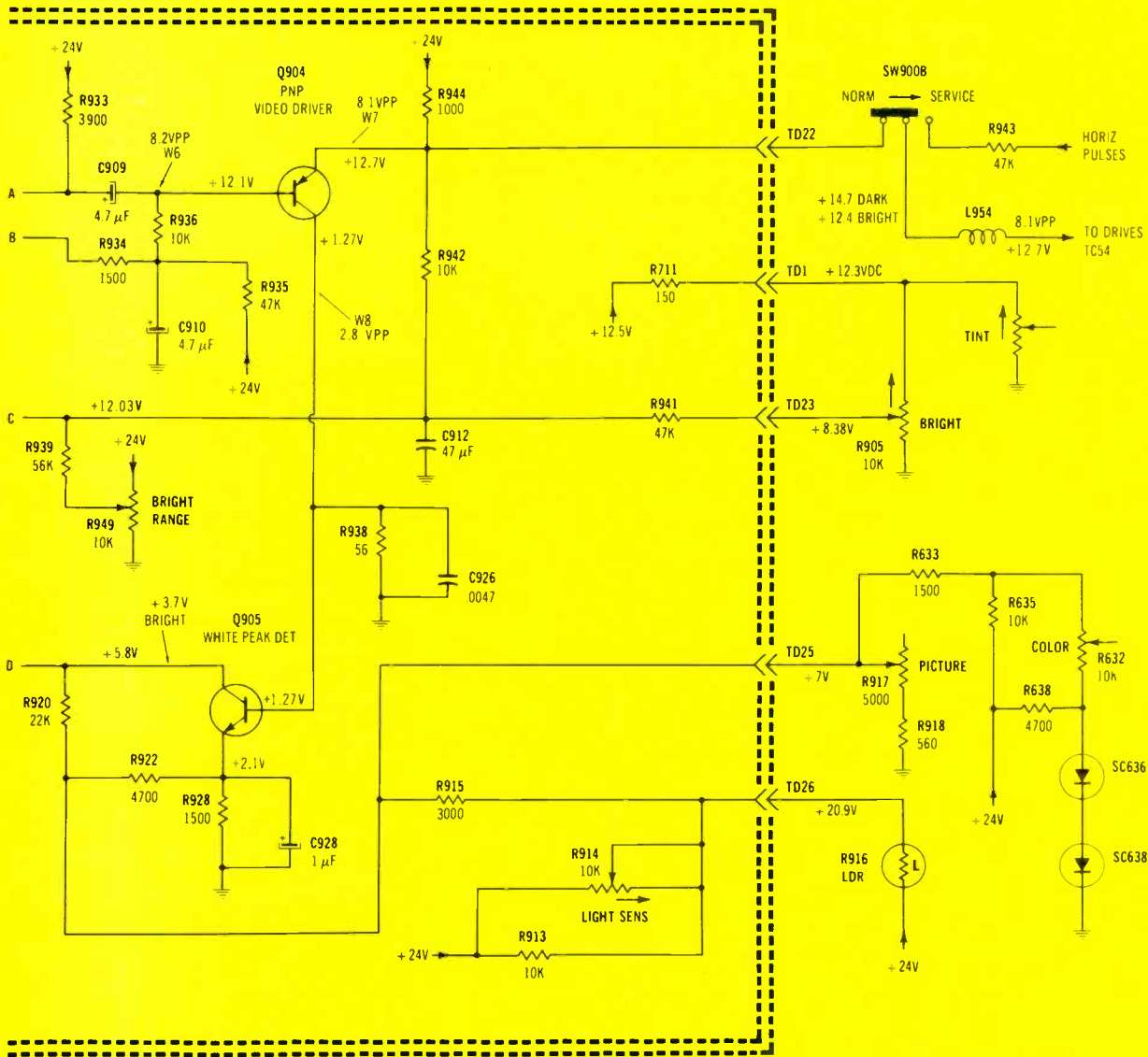
From pin 5, the video passes through coupling capacitor C909

and reaches the base of PNP-polarity Q904. Remember what was said about DC coupling or DC restoration? Well, the DC voltage from pin 1 is filtered by R934 and C910 before it is fed to the base of the same Q904. This DC voltage varies as necessary to maintain the correct black level. In other words, it is a type of DC restoration, with the AC signal coming through C909, and the DC voltage fed through R936. There is direct

coupling between the driver output (at the Q904 emitter) and the end of the circuit at the picture-tube cathodes. Those stages are the next part of the video path. However, before they are examined in detail, the IC900 control voltages and signal waveforms should be looked at.

### IC900 Control Voltages

As is customary with ICs, control of the color saturation, hue, con-



trast, brightness, and sharpness is accomplished by variations of the DC voltages that are applied to the various ICs.

For example, the DC voltage at pin 2 of IC900 determines the brightness. Connecting to this pin are DC voltages from the emitter of Q904, the brightness range control (R949), and the front panel brightness control. This combined DC voltage at pin 2 controls some internal circuitry, and the DC-

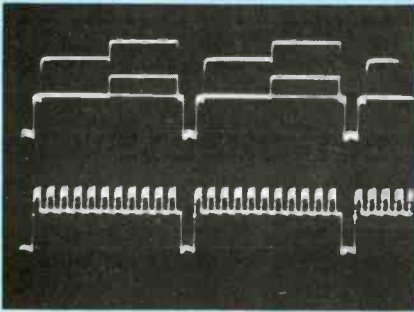
restoration voltage that's produced emerges at pin 1. The DC-restoration voltage is filtered and applied to the base of Q904, acting as bias.

A variable DC voltage from R275, the sharpness control, is applied to pin 13 and the internal peaking circuit, also to pin 3, and the auto-peak detector. At pin 13, the DC voltage varies from about +1.5 volts (for maximum sharpness) down to about +0.5 volt at minimum. The visual sharpness of

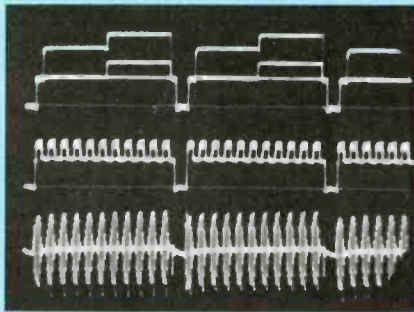
the picture changes a large amount during the adjustments.

Pin 6 of IC900 receives DC voltages from: (1) the ABL circuit; (2) the picture control (R917); (3) the collector of Q905 (the peak white detector); and (4) the Light-Dependent-Resistor (LDR) that's mounted on the front panel (to sense ambient room light levels). Operation of the light sensor and the picture control (which seems to

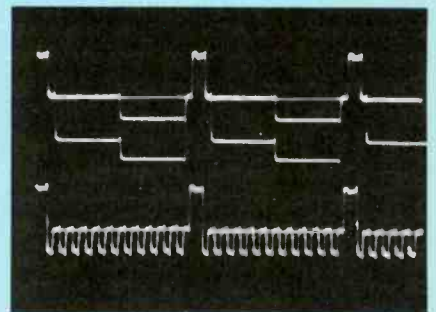
*continued on page 48*



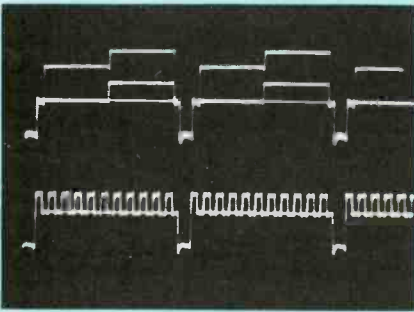
W1 Q900 BASE  
TOP 2.6 VPP B&W  
BOTTOM 1.8 VPP COLOR



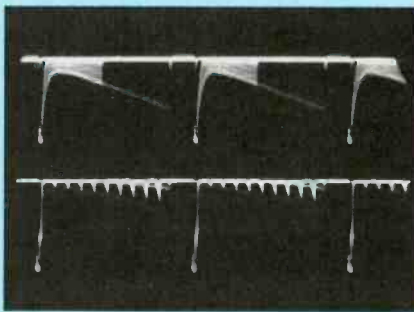
W2 Q900 EMITTER  
TOP 2.5 VPP B&W  
CENTER 1.7 VPP COLOR  
BOTTOM L900 0.2 VPP COLOR



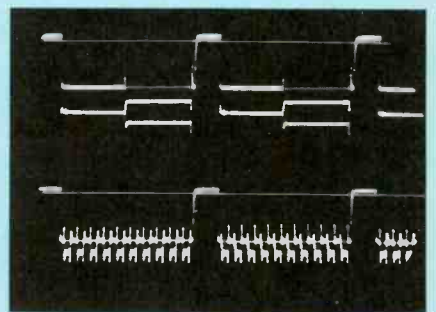
W3 (3 points)  
TOP 2.9 VPP B&W  
BOTTOM 2.5 VPP COLOR



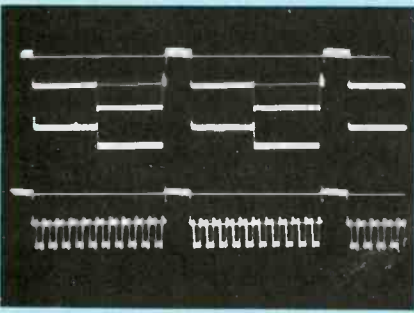
W4 Q902 COLL.  
TOP 2.4 VPP B&W  
BOTTOM 1.6 VPP COLOR



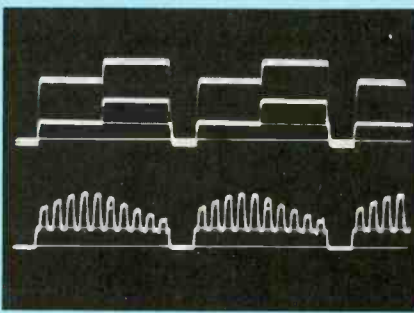
W5 IC900 #1  
TOP 11 VPP B&W  
BOTTOM 11 VPP COLOR



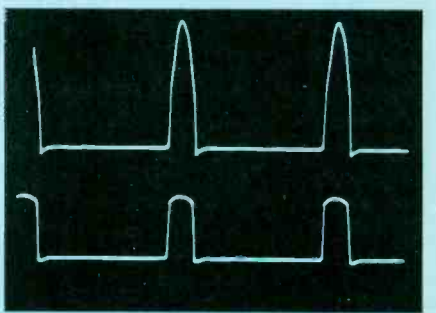
W6 IC900 #5 & Q904 BASE  
TOP 8.2 VPP B&W  
BOTTOM 7.8 VPP COLOR



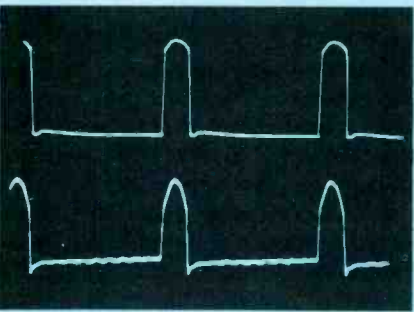
W7 Q904 EMITTER  
TOP 8.2 VPP B&W  
BOTTOM 7.8 VPP COLOR



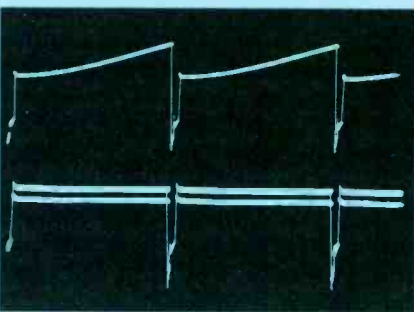
W8 Q904 COLL.  
TOP 2.8 VPP B&W  
BOTTOM 1.8 VPP COLOR



W9 TOP 18 VPP TD20  
W10 BOTTOM 9 VPP IC900 #16



W11 TOP 8VPP IC900 #15  
W12 BOTTOM 1 VPP IC900 #14



W13 TOP 30 VPP TD16  
(VERTICAL RATE)  
W14 BOTTOM 6 VPP IC900 #14  
(VERT)

**Figure 5** These are waveforms of the Figure 4 video circuitry. The W3 waveform is shown at three locations, because they have the same waveform and nearly the same amplitude. Waveforms from W1 through W8 have a video-generator signal in the top trace, and a color-bar waveform below. The W9 through W14 waveforms are *not* arranged in pairs. All waveforms are shown at the horizontal rate, except for W13 and W14 which are shown at the vertical-sweep rate. Notice that IC900 pin 14 has *both* horizontal and vertical signals together.

vary contrast, brightness, and color) is fairly straightforward. However, the ABL and the white peak detector need more explanation.

#### ABL

Many positive-voltage supplies have a "back door" that produces a negative voltage. That's true of the high-voltage rectification system in the E44. If the connection to module terminal TD24 were opened, and a resistor substituted for SC458 (wired from terminal 10 of the high-voltage transformer and ground), we would measure a negative voltage from that point to ground. Further, the negative voltage would vary according to the brightness of the picture, with a brighter picture causing more negative voltage.

Well, in the E44 circuit, flyback pin 10 is not grounded through a resistor. Instead, it returns to +24 volts via R919. Negative voltage from the HV bucks the B+ at SC458 cathode, varying it from about +23.5 volts (black raster) to about +3.2 volts at maximum brightness.

Because the cathode of SC900 is connected to the ABL positive voltage, it would seem that SC900 could not conduct. Of course, that's true, but only when the CRT HV current is not excessive. After all, ABL circuits should NOT interfere with normal brightness changes.

When the SC900 cathode becomes less positive than its anode (during times of excessive brightness), SC900 is forward biased, so it conducts to reduce the positive voltage at pin 6 of IC900. Anything that decreases the pin 6 voltage causes the brightness to decrease. This automatic action prevents the CRT current from exceeding the design maximum (which could cause severe blooming or component damage).

#### White-peak detector

Operation of the white-peak detector is more difficult to understand. A negative-going signal from the collector of Q904 is connected to the base of Q905. It's the only voltage at the base. Now, negative-

going signals usually aren't suitable for supplying forward bias to a NPN-type transistor. Further, Q905 has a *higher* DC emitter voltage, which is supplied by a voltage divider. In normal operation, it is reverse biased, and not conducting.

However, the "white" part of the video waveform IS positive-going, and if the video amplitude at Q905 base increases enough, the "white" areas will supply sufficient forward bias to force Q904 into conduction. When Q904 conducts, the current reduces the DC voltage at pin 6 of IC900. In turn, the lower voltage reduces the contrast, the brightness, and the video amplitude at pin 5 of IC900. One partial proof of this analysis is that removing Q905 (or grounding the base) does not change the picture in any way. It seems likely that an AGC problem would be one of the few things causing Q905 to conduct.

#### Blanking

Both vertical blanking and horizontal blanking are done inside IC900. A vertical-sweep waveform enters the chroma module at TD16. The signal is reduced in amplitude

and clipped (by R930, R929, and diode SC903) before it reaches pin 14 of IC900. This shaped signal is added to the video inside IC900.

Horizontal pulses taken from the damper diode are reduced by the voltage divider (R448, R450, R452, R454, and R455), and then are applied to pin 16 of IC900. Although these pulses are added to the video inside IC900, they also exit at pin 15 (and terminal TC31), and eventually go to the chroma IC for burst keying and to IC400 for the horizontal AFC.

#### Waveforms

Waveforms of the video circuits are shown in Figure 5. In most cases, the pictures show waveforms from both a video generator and a color-bar generator. They will provide typical waveforms for these two necessary signals.

#### Next Month

Details of the color power-amplifier stages and troubleshooting tips for the video circuits begin the Sylvania coverage. Also, circuits and servicing of the chroma stages will be started. □

**FIND COMPONENT PROBLEMS . . .**  
quickly and cheaply with

**SUPER FREEZE**

100% FREON 12<sup>®</sup>      The best chilling agent

- \* Locate Thermal Intermittents      \* Shrink parts from press fit
- \* Chill leads of transistors and phono cartridges to minimize solder heat damage
- \* Find Cracked P.C. boards      \* Safe - No residue

SPECIAL PRICE FOR DEALERS

\$2.00

18 oz. can with extension tube  
(\$3 min. order plus postage)



Reg. Dupont Trademark



PHONE ORDER SERVICE  
**1-800-558-9572**

PROJECTOR-RECORDER BELT CORP  
Box 176  
Whitewater, WI 53190

Circle (26) on Reply Card

IT'S NO PUZZLE

TO ORDER

OELRICH SERVICE FORMS

FOR TV-RADIO & 2 WAY RADIO SERVICE LEGAL FORMS FOR CALIF. FLA. UTAH NOW AT YOUR PARTS JOBBER OR WRITE FOR CATALOG B64

OELRICH PUBLICATIONS

4040 N. NASHVILLE AVE.      CHICAGO, ILLINOIS 60634

Circle (28) on Reply Card

NEW TUNERS

NOT universal or customized. NOT seconds, culls, dogs, or oddballs. Only \$24.95 for ANY new tuner. Over 5,000 in stock including Philco TT192.

CALL TOLL FREE 1-800-433-7124

TEXAS TUNER SUPPLY

4210 N.E. 28th St., Ft. Worth, TX 76117

Circle (29) on Reply Card

## 9 reasons why the real pros prefer Endeco desoldering irons



1. Operates at 120v, 40w. Idles at 20w for longer tip life
2. Flexible, burn resistant Neoprene cord set
3. Cool, unbreakable polycarbonate handle
4. Exclusive bracket insures alignment, prevents damage
5. Safety light in handle tells when it's on
6. Stainless steel construction
7. Temperature control. Low, high or off.
8. Eight tip sizes. Comes with .063 I.D.
9. Converts to soldering iron with 1/4" shank type tip

See your distributor or write . . .

### Enterprise Development Corp.

5127 E. 65th St. • Indianapolis IN 46220  
PHONE (317) 251-1231

Circle (24) on Reply Card

## SERIOUS ABOUT YOUR FUTURE IN HOME ELECTRONIC SERVICE?



The Sign of Professional Service

...a not for profit association championing independents' right to compete, and delivering valuable benefits continuously since 1950.

NATESA offers low cost group insurance, discounts on everything from eyeglasses to motor vehicles, individual consultation on particular problems, representation to government and industry at all levels and a place to unite to protect each individual member with the strength of all.

Send this ad with your card or letterhead to:

NATESA, Dept. ES  
5908 S. Troy St.  
Chicago, Il. 60629

Membership. \$60.00 enclosed. As our member premium, please send free . . .

Practical Business Manual - OR -

Service Contract Manual

50

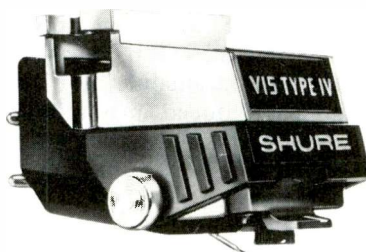
# audio systems report

## Super Phono Cartridge

Shure Brothers offers a new type IV version of the classic V15 stereo cartridge. Trackability has been improved by a new stylus assembly and a viscous-damped dynamic stabilizer.

Mass of the stylus is reduced by a telescoped shank and a lightweight, high-energy magnet. A two-function bearing system helps the tracking at both low and high frequencies. The hyper-elliptical diamond tip is said to provide as much as 25% decrease of distortion, compared to that from a conventional elliptical stylus tip.

The built-in dynamic stabilizer raises the arm-cartridge resonance and reduces the amplitude of the resonance. Also, the viscous-damping feature resists the effects of warped records. Attached to the dynamic stabilizer are more than 10,000 tiny electrically-conductive fibers which sweep dust from the grooves while they conduct the static charges safely to ground. This is said to remove one source of ticks and pops in the music.



V15 type IV is recommended for tone arms designed for low tracking forces. The suggested retail price of V15 type IV is \$150.

Circle (31) on Reply Card

## Car speaker

Any car can become a sound truck in just 45 seconds with the "Sound Cruiser" (model S-310), now offered by Perma Power Electronics.

Two weatherproof horn speakers are mounted on a cartop carrier, ready to clamp to an auto. They swivel and lock in any direction. The amplifier requires no adjustments other than volume. It mounts under the dash, and is powered by plugging into a cigarette lighter. Optional AC and battery power adapters also are available.

The suggested price is \$275.

Circle (32) on Reply Card

## Base Power Mikes

GC Electronic's Range Booster II is an amplified microphone having a maximum gain of 26 dB. It has separate push-to-talk and lock-to-talk levers and an adjustable gain control. The suggested resale price is \$53.10.

Range Booster III is similar except it has variable compression giving amplifier gain up to 56 dB. \$63.72 is the suggested resale price.



Each mike has a 6-wire cable, dynamic elements, and solid-state pre-amps. A standard 9-volt battery is required.

Circle (33) on Reply Card

## Wireless Intercom

A new two-channel, wireless, FM intercom system from GP Electronics is designed for three-station operation with two frequencies: channel A (200 KHz), channel B (260 KHz), and an A/B channel selector.



Circle (34) on Reply Card

Features of these products were supplied by the manufacturers, and are listed at no charge to them. If you want factory bulletins, circle the corresponding number on the Reply Card, affix a stamp, list the required information, and mail the card.



# test equipment report

## Automatic CB Analyzer

The CB49 Sencore CB analyzer is connected between the CB and the antenna for transmitting tests of RF watts; SWR; percent modulation; distortion; and percent of channel frequency error. Audio-power output and sensitivity are receiver tests done in the same way. Audio and RF dummy loads are built-in.

These test results can be read in exact figures from the analog meter. Or, untrained personnel can use the "good/bad" markings for preliminary go/no-go tests.

CB49 weighs 10 pounds, and operates from either AC power or battery for base-station or in-car mobile tests.



Another valuable feature is the built-in relative field strength meter which can prove to customers that their radios are radiating signals properly.

Circle (35) on Reply Card

## Frequency And Event Counter

Fluke model 1912A operates from 5 Hz to 520 MHz, giving period, period average, and totalize functions. In the totalizing mode, up to 9,999,999 events can be counted at rates up to 125 MHz.

An attenuator and a trigger-level control help minimize errors from signal noise. The input impedance is 1 megohm from 5 Hz to 125 MHz, and 50 ohms from 50 MHz to 520 MHz. Maximum sensitivity is 15 millivolts across most of the bandwidth.



June, 1978

The LED display has 7 digits, with annunciation and overflow capacity. Model 1912A sells to users for \$620.

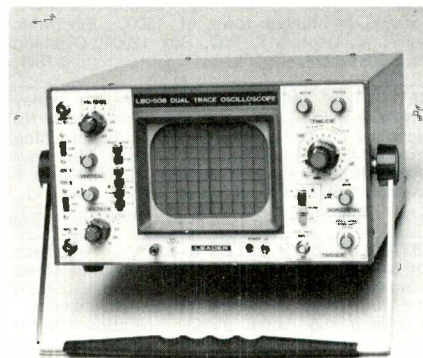
Circle (36) on Reply Card

## Dual-Trace Scope

Model LBO-508 scope from Leader has all of the usual triggered-sweep features, plus the ability to trigger automatically from either vertical channel.

Maximum vertical sensitivity of both channels is 10 millivolts, and the frequency response extends to 20 MHz, giving a rise time of 17.5 nanoseconds. The two vertical channels can be switched to add or subtract in a single trace. This is helpful for determining distortion, noise cancellation, or whether two pulses are simultaneous.

The horizontal triggered sweep has speeds from 200 milliseconds to 0.5 microseconds-per-CM, with a switchable magnification of X5. Selection of chop or alternate traces is done automatically.



Both vertical channels can be switched for a X-Y display, perhaps for vector measurements.

Price of the LBO-508 with probes is \$690.

Circle (37) on Reply Card

## Automatic Scope

Lectrotech's model TO-60 automatic dual-trace scope provides automatic triggering, automatic astigmatism, automatic horizontal sweep and automatic horizontal/vertical triggering.

Circle (38) on Reply Card

Features of these products were supplied by the manufacturers, and are listed at no charge to them. If you want factory bulletins, circle the corresponding number on the Reply Card, affix a stamp, list the required information, and mail the card.

# NEW & DAZZLING!!!

MS-15 Miniscope



With Rechargeable Batteries & Charger Unit **-\$289**

- 15-megahertz bandwidth.
- External & internal trigger.
- Auto or line sync modes.
- Power usage — < 15 W.
- Battery or line operation.
- 2.9" H x 6 4" W x 8.0" D.



**Non-Linear Systems, Inc.**

Originator of the digital voltmeter.  
Box N, Del Mar, California 92014  
Telephone (714) 755-1134 TWX 910-322-1132

Circle (25) on Reply Card



**WE'RE GROWING!**

to better represent

**YOU**

the successful service business operator.

- \*Over 2500 firms belong
- \*39 State Affiliates
- \*167 Local Associations

**YOU CAN JOIN!**

and learn how to make money and work less hours.

Write today for a membership application and more information.

1715 Expo Lane  
Indianapolis, Indiana 46224  
Phone (317) 241-8172

# themarketplace

Advertising rates in the Classified Section are 35 cents per word, each insertion, and must be accompanied by cash to insure publication.

Each initial or abbreviation counts a full word.

Minimum classified charge \$3.00.

For ads on which replies are sent to us for forwarding (blind ads), there is an additional charge of \$3.00 per insertion to cover department number, processing of replies, and mailing costs.

Classified columns are not open to advertising of any products regularly produced by manufacturers unless used and no longer owned by the manufacturer or a distributor.

## For Sale

**REPLACEMENT COLOR YOKES-DEALERS ONLY.** Zenith 95-2501-2532-2638-2667-S-89633 etc. 16.95, Magnavox 361380-1 18.95, Sylvania, GE etc. 14.95 to 19.95. Request for price list on your Letterhead. David Sims Enterprises, Inc., 665 Jericho Turnpike, Huntington Station, N.Y. 11746. 12-76-tf

**TV & RADIO TUBES** 36c EA!! Free color catalog. Cornell, 4221 University, San Diego, California 92105. 8-76-tf

**"NO MORE SLOW TIMES!"** IN SECOND PRINTING—WHAT YOUR SHOP COULDN'T FIND UNTIL NOW! PACKAGE PLAN, PORTIONS PRINTER-READY, SERVICE CONTRACTS, ANNUAL SCHEDULES, REPORT FORMS, AND MORE! DETAILS \$3, COMPLETE PACKAGE \$59.95. PECK'S PLAN, DEPT. "SMC," BOX 64, HILLSDALE, NY 12529. 4-78-3t

**TUBES-RECEIVING.** Industrial and Semiconductors Factory Boxed. Free price sheet including TV, Radio and audio parts list. Low, low prices. Transleteronic, Inc., 1365 39th St., Brooklyn, New York 11218. Telephone: (212) 633-2800. Toll free: 800-221-5802. 5-78-12t

**TV & APPLIANCE STORE** and TV repair in beautiful foothill town in the California Sierra Nevada mountains. Major brand franchises, great lease, fantastic opportunity. Call evenings (209) 736-4421. 5-78-2t

**COMPLETE COLOR B/W PICTURE TUBE** Rebuilding Equipment, never used. Phone (212) 387-2744. 616 Grand St., Brooklyn, N.Y. 11211. 6-78-2t

**SAMS PHOTOFACT** collection numbers 1 through 1000 complete. Bound. Best offer. Rittenhouse TV, 520 W. Howard St., Pontiac, Illinois 61764. (815) 842-1373. 6-78-1t

**TV BUSINESS** 18 yrs. same location. Grossing 90,000 +. Unlimited potential. Don Marble, CET. 305-989-5070. 6-78-2t

**ELECTRONIC SURPLUS, CLOSEOUTS, LIQUIDATIONS!** Parts, equipment stereo, industrial, educational. Amazing values! Fascinating items unavailable in stores or catalogs anywhere. Unusual FREE catalog. ETCO-011, Box 762, Plattsburgh, N.Y. 12901. 6-78-tf

**TUNER SUB, \$19.95,** wired, tested, complete with batteries and ready to use on tube or transistor sets. Tunes all VHF channels. This unit is without knobs or cabinet but very compact with no wires or controls dangling. Easy to use, simply connect set's coax to sub and view picture (instructions provided). Only \$19.95 and we pay shipping or will ship C.O.D. (\$1.85 C.O.D. charge). Phone Toll Free 1-800-433-7124. This is not a gimmick. If not completely satisfied, return within 10 days for full refund. **TEXAS TUNER SUPPLY,** 4210 N.E. 28th Street, Fort Worth, Texas 76117. 6-78-3t

**TV SERVICE/SALES SHOP IN MIAMI, FLORIDA.** Established 11 years, one owner. All necessary parts, tools, test equipment and van. One or two man shop, grosses over \$25,000.00. Take over with turn of key. Great opportunity. Write: South Dade Electronics, 6570 Bird Road, Miami, Fl. 33155. Or call: (303) 666-2874. 6-78-1t

**NORTHERN CALIF. TV SALES & Service** business. 12 years, top reputation. No real estate incl. Annual Sales \$40,000. Main lines Zenith, RCA, Pioneer, Hitachi. Price includes lease, van, equip., etc. No other shops within 35 miles. Will consider percentage with option for full time work. No window shoppers, please. Dick Murray, Box 816, Hayfork, CA 96041. 5-78-6t

**SEEKING ORIGINAL JAPANESE TRANSISTORS,** IC's, FET and diodes for CB, TV and stereo repair? See our full page ad in this issue for listing of parts and prices. Write or call TOLL FREE for our complete list and compare prices. **FUJI-SVEA ENTERPRISE,** Dept. ES, P.O. Box 30323, Cincinnati, OH 45240. Nationwide: (800) 543-1607. Ohio: (800) 582-1630. 4-78-4t

## Business Opportunity

**TV TECHNICIAN!** Increase your income up to \$60,000 yearly. Rent-lease-sell TVs new-used, even from comfort of your home. Basic Preliminaries \$4.00. Perry's TV Leasing, Box 1407, Santa Maria, CA 93456. 4-78-6t

**SAVE HUNDREDS!** dependable, quality Head-Ends, V/V, U/V Converters, Camera Modulators. Factory prices. Send \$5.00 (or business card). Box 809, Boyton Beach, Fla. 33435. 6-78-9t-EOM

**TV REPAIR BUSINESS**—Short lived. Over \$3600 invested in parts and test equipment. Call anytime: 814-473-3390. D. L. Hosey, Rimersburg, PA 16248. 6-78-11t

**TV TUNER TECHNICIAN** to take over T.S.C. Ft. Lauderdale. Salary 40% of gross sales. Temporary quarters available. Recent experience with one of major tuner services required. Call collect: (305) 566-4882. 6-78-11t

**TELEVISION SALES & SERVICE** 18 years same location. Grossing 200,000.00 per year. Good location, 2400 ft. building, Zenith franchise. Located in Illinois town of 15000. Electronic Servicing, Dept. 517, P.O. Box 12901, Overland Park, KS 66212. 6-78-11t

**GET OUT OF THE TV RUT.** Start making money now with Paltronix portable security systems. No technical hassles to keep up with. Full training provided. Good margins to work with. Plus your chance to diversify your services. For full details contact Don Musil, 48 West Golden Lake Rd., Circle Pines, Minn. 55014. (612) 786-4244. 6-78-3t

**ESTABLISHED TV SALES & SERVICE** Business for sale in growth oriented city. Central Ohio. Business includes: attractive store room, current inventory. Also exclusive TV Rental business. This is a substantial quality operation. Owner may assist in purchase for right party. For more information call or write Mr. Bruce Massa, P.O. Box 121, Reynoldsburg, OH 43068. Phone: (614) 864-4363. 6-78-3t

## Wanted

**START ELECTRONIC FACTORY IN YOUR HOME.** GET STARTED IN YOUR SPARE TIME. ONE MAN OPERATION. EXPECT BIG PROFITS. EXPERIENCE NOT NECESSARY. PRACTICALLY NO INVESTMENT. WRITE FOR FREE LITERATURE TELLING HOW. **ELECTRONIC DEVELOPMENT LAB,** DEPT. A, BOX 1535, PINELLAS PARK, FL 33565. 8-77-tf

**ELECTRONIC's TECHNICIAN** looking for bench position, west of Mississippi. Thomas D. Bowmaster, 124 "D" St., Lincoln, Nebraska 68502. (402) 432-8237. Resume upon request. 6-78-11t

**USED FM STEREO** transmitter 500 watts-1 kw and used AM transmitter 5 kw. No more than 10 years old. Radio MBC, Box 367, Port-au-Prince, HAITI. 6-78-11t

## Professionals Accredited

**PROFESSIONAL BACHELOR DEGREE**...earned with 4 or more years of Electronic Business Management, Sales, or Servicing Experience. For FREE information write: **EBERT PROFESSIONALS INSTITUTE,** Box 1651, Dept. R., Columbia, Missouri 62501. 5-78-6t

## Education-Instruction

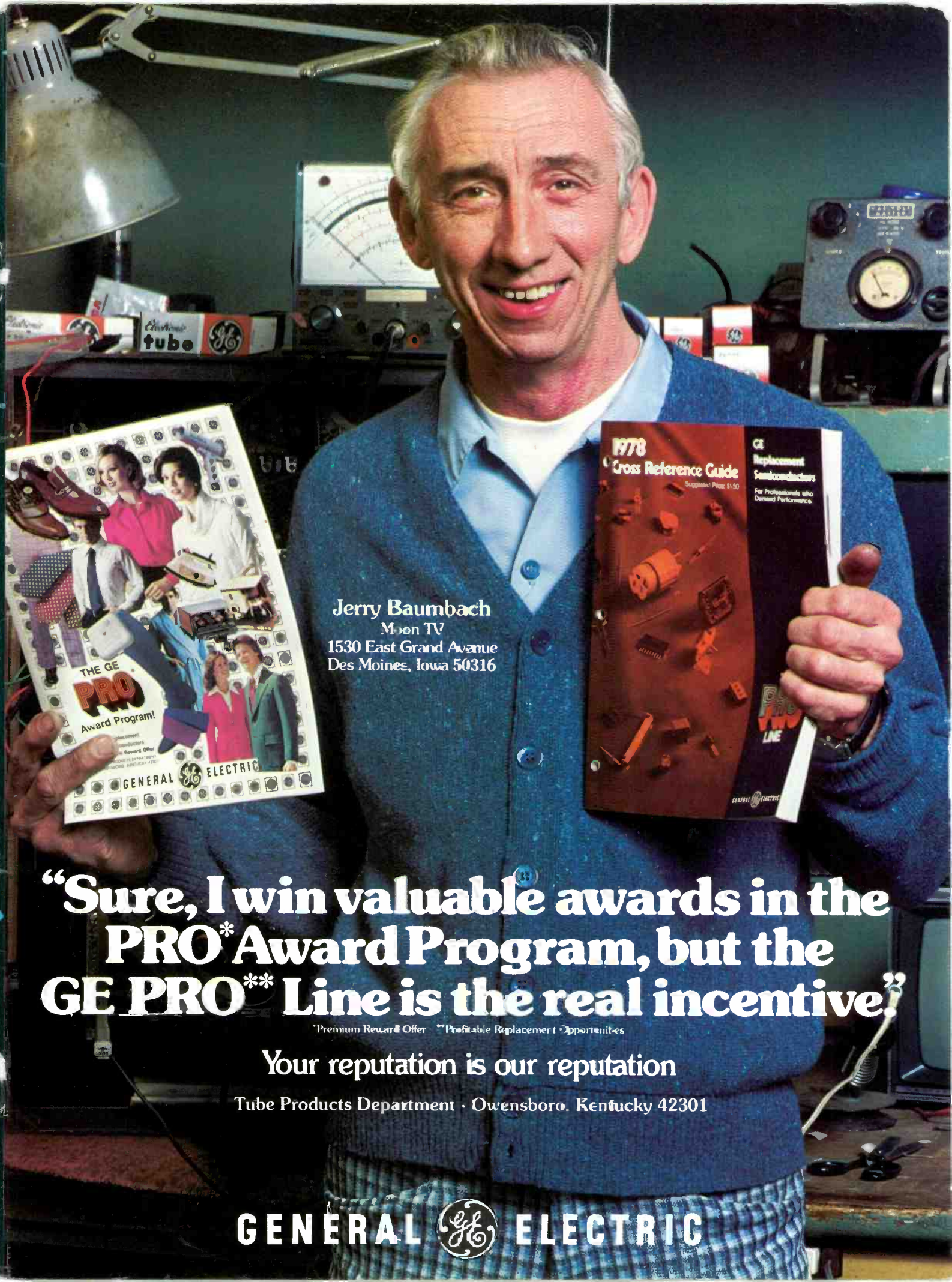
**REPAIR TV TUNERS**—High Earnings. Complete Course Details, 12 Repair Tricks, Many Plans, Two Lessons, all for \$2. Refundable. Frank Bocek, Box 3236 Enterprise, Redding, Calif. 96001. 8-76-tf

**IF YOU'RE A PROFESSIONAL,** you need a professional Service Invoice. Write for our Catalog of Service Forms, Pricing Guides and Invoices and see why they're better. Tech Spray, Box 949, Amarillo, Texas 79105. 4-78-3t

**INDUSTRIAL ELECTRONICS INSTRUCTOR**—Teach theory and laboratory work. B.S. degree in Electrical Engineering. Master's degree preferable. Current industrial experience required. Teaching experience desirable. Position available September 1978. John C. Vander Molen, Acting Department Head, Ferris State College, Big Rapids, MI 49307. An Equal Opportunity Affirmative Action Employer. 5-78-3t

## advertisers'index

American Technology Corp .....	13
Arrow Fastener .....	6
B & K Precision, Dynascan Corp ...	21
Bussman Mfg. Div., McGraw Edison Co. ....	17
The Cooper Group, Electronics Div. ....	29
Dynascan Corp., B & K Precision ...	21
EICO .....	31
Enterprise Development Corp .....	50
Epsco, Inc. ....	8
John Fluke Mfg. Co., Inc. ....	35
Fuji-Svea Enterprise .....	3
Gamit Enterprises, Inc .....	31
General Electric Co., Television Business Div .....	19
General Electric Co., Tube Div .....	5, Inside Back Cover
McGraw Edison Co., Bussman Mfg. Div .....	17
NATESA .....	50
NESDA .....	51
Non-Linear Systems, Inc .....	51
Oelrich Publications .....	49
PTS Electronics, Inc. ....	Inside Front Cover-1
Platt Luggage .....	8
Projector-Recorder Belt Corp. ....	49
RCA Distributor and Special Products .....	11, 22-23, 26-27, 35
Sencore, Inc .....	2
GTE Sylvania/EGC Consumer Renewal .....	7
Texas Tuner Supply .....	49
Thordarson Meissner, Inc. ....	37
Zenith Radio Corp .....	Back Cover



Jerry Baumbach  
Moon TV  
1530 East Grand Avenue  
Des Moines, Iowa 50316

**“Sure, I win valuable awards in the  
PRO\* Award Program, but the  
GE PRO\*\* Line is the real incentive.”**

\*Premium Reward Offer \*\*Profitable Replacement Opportunities

**Your reputation is our reputation**

Tube Products Department · Owensboro, Kentucky 42301

**GENERAL  ELECTRIC**

# Shape up your shop with Zenith's Instant Parts Program



It's the easiest, least expensive Zenith inventory control system ever devised for TV service technicians.

Organizes the most needed, most used TV replacement parts so they're where you want them, when you want them.

And ZIP (Zenith's Instant Parts Program) keeps these parts organized thru periodic checks by your Zenith distributor salesman who personally replaces slow-moving stock numbers with new, popular parts.

As a result, your original investment is protected and your supply of Zenith parts is always current.

Call your Zenith distributor now for all the details on the ZIP program that fits your needs.

*For your own reputation and in your customers' best interest, always specify Zenith exact replacement parts and accessories.*



The quality goes in before the name goes on®