

21061
GLEN BURNIE MD
BLVD-FERNDALE
25 BALTIMORE-ANNAPOLIS
E21-522 R #C 3511

November, 1975 □ 75 cents

Electronic Servicing



A HOWARD W. SAMS PUBLICATION



Goodbye, TV Ghosts!

Timing Short Circuits

Servicing RCA XL-100

Audio Systems

Let us solve your tuner problems

PTS will repair any tuner—no matter how old or new. Fastest Service—8 hour—in and out the same day. Overnight transit to one of our strategically located plants. Best Quality—you and your customers are satisfied.

PTS uses only ORIGINAL PARTS! No homemade or make-do, inferior merchandise (this is why we charge for major parts!). You get your tuner back in ORIGINAL EQUIPMENT condition.

PTS is recommended by more TV Manufacturers than any other tuner company and is overhauling more tuners than all other tuner services combined.

We're proud to announce the Grand Opening of our new Service Centers in Los Angeles, Columbus, Ohio, Phoenix, Boston, Norfolk & Indianapolis

Precision Tuner Service



ELECTRONICS, INC.

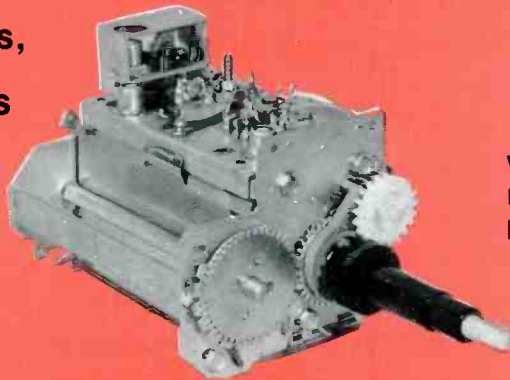

VHF, UHF \$10.95
 UV-COMBO 17.95
 IF-SUBCHASSIS .. 12.50

Major parts and shipping charged at cost.
 (Dealer net!)

Home Office	Bloomington, Indiana	47401	5233 S. Highway 37	812-824-9331
Alabama	Birmingham, Alabama	35222	524 32nd St. So.	205-323-2657
Arizona	Phoenix, Arizona	85061	2412 W. Indian School Rd.	602-279-8718
California	Los Angeles, Ca. Central	90023	4184 Pacific Way	213-266-3728
	Sacramento, Ca. No.	95841	4611 Auburn Blvd.	916-482-6220
	San Diego, Ca. So.	92105	5111 University Ave.	714-280-7070
Colorado	Arvada, Colorado	80001	4958 Allison St.	303-423-7080
Florida	Jacksonville, Fla. No.	32210	1918 Blanding Blvd.	904-389-9952
	Miami, Fla. So.	33168	12934 N.W. 7th Ave.	305-685-9811
Indiana	Bloomington, Ind.	47401	5233 S. Highway 37	812-824-9331
Kansas	Kansas City, Kansas	66106	3116 Merriam Lane	913-831-1222
Louisiana	Metairie, La.	70003	2914 Wytchwood Dr.	504-885-2349
Maryland	Silver Springs, Md.	20910	1105 Spring St.	301-565-0025
Massachusetts	Somerville, Mass.	02144	52 Holland St.	617-686-4770
	Springfield, Mass.	01103	191 Chestnut St.	413-734-2737
Michigan	Detroit, Mich.	48235	13709 W. 8 Mile Rd.	313-862-1783
Minnesota	Minneapolis, Minn.	55408	815 W. Lake St.	612-824-2333
Missouri	St. Louis, Mo.	63130	8456 Page Blvd.	314-428-1299
New Jersey	E. Paterson, N. Jersey	07407	158 Market St.	201-791-6380
New York	Buffalo, New York	14212	993 Sycamore St.	716-891-4935
North Carolina	Charlotte, N. Car.	28205	724 Seigle Ave.	704-332-8007
Ohio	Cinn., Ohio	45215	8180 Vine St.	513-821-2298
	Columbus, Ohio	43227	4003 E. Livingston Ave.	614-237-3820
	Parma, Ohio	44134	5682 State Rd.	216-845-4480
Oklahoma	Oklahoma City, Ok.	73106	3007 N. May	405-947-2013
Oregon	Portland, Oregon	97213	5220 NE Sandy Blvd.	503-282-9636
Pennsylvania	Pittsburgh, Pa.	15202	257 Riverview Ave. W.	412-761-7648
	Upper Darby, Pa.	19082	1742-44 State Rd.	215-352-6609
Tennessee	Memphis, Tenn.	38118	3614 Lamar Ave.	901-365-1918
Texas	Houston, Texas	77032	4324-26 Telephone Ave.	713-644-6793
	Longview, Texas	75601	Mopac Rd.	214-753-4334
Virginia	Norfolk, Va.	23504	3118 E. Princess Anne Rd.	804-625-2030
Washington	Seattle, Wash.	98108	432 Yale Ave.	206-623-2320
Wisconsin	Milwaukee, Wis.	53215	3509 W. National	414-643-8800

PTS

IS
 NUMBER ONE
 AND
 STILL
 TRYING
 HARDER

●

WE OFFER
 FINER
 FASTER
8 hr.
 SERVICE

●

1 YEAR
 GUARANTEE

●

NOT A
 FRANCHISE
 COMPANY

For More Details Circle (1) on Reply Card

Electronic Servicing

in this issue...

- 14 **Goodbye, TV Ghosts!**—Tests and theory indicate that TV ghosts can be reduced to almost zero, if both the transmitting and receiving antennas have circular polarization—*David A. Ferre*.
- 20 **Time Those Short Circuits**—This new method helps you locate the source of an overload that trips the circuit breaker—*Robert L. Goodman, CET*.
- 26 **Hi, Resistance!**—Test your electronic vocabulary by working this Just-Across-Word puzzle—*Edmund A. Braun*.
- 28 **Servicing Stereo Audio Systems, Part 3**—Mechanical and electronic audio distortions are defined and discussed—*J. A. "Sam" Wilson, CET*.
- 36 **Forest H. Belt's Eight-Track Workshop, Session 2**—Testing, adjustment, and diagnosis of problems with eight-track tape mechanisms are explained pictorially this month—*Dewey C. Couch*.
- 43 **Servicing RCA XL-100, Part 1**—The RCA CTC58 chassis is selected as an example of features and circuits of the XL-100 series—*Gilbert J. Grieshaber*.

DEPARTMENTS

Electronic Scanner	4
Symcure	8
Troubleshooting Tips	9
Reader's Exchange	11
Book Review	50
Product Report	51
Test Equipment	52
Catalogs and Literature	54
Advertiser's Index	56

ABOUT THE COVER

The ghostly test patterns at the left resulted from horizontal polarization of both the transmitting and receiving antennas, while the ones at the right are the improved patterns obtained when circular polarization was used for both transmitting and receiving. Correct orientations of receiving antennas in a poor-signal location were chosen for the pictures at the top. A less-ghostly location and 80° mis-orientations of both receiving antennas produced the lower pair of patterns. (Courtesy of Smith and Powstenko.)

Second class postage paid at Shawnee Mission, Kansas and additional mailing offices. Published monthly at 9221 Quivira Road, Shawnee Mission, Kansas 66215 by Intertec Publishing Corp., 1014 Wyandotte St., Kansas City, Mo. 64105. Send Form 3579 to 9221 Quivira Road, Shawnee Mission, Ks. 66215.

© Copyright, 1975, Howard W. Sams & Co., Inc. All rights reserved. Material may not be reproduced or photocopied in any form without written permission of publisher.

EDITORIAL
 RONALD N. MERRELL, Director
 CARL H. BABCOKE, Managing Editor
 SHARON ELWOOD, Editorial Assistant
 DUDLEY ROSE, Graphic Designer

ELECTRONIC SERVICING
 1014 Wyandotte Street
 Kansas City, Missouri 64105

TECHNICAL CONSULTANT
 JOE A. GROVES

EDITORIAL ADVISORY BOARD
 LES NELSON, Chairman
 Howard W. Sams & Co., Indianapolis

CIRCULATION
 EVELYN ROGERS, Manager

ADVERTISING SALES
 Kansas City, Missouri 64105
 Tele: 913/888-4664
MIKE KREITER, Director
 JOHN COX
 GREG GARRISON, Production

REGIONAL ADVERTISING SALES OFFICES

Indianapolis, Indiana 46280
 ROY HENRY
 2469 E. 98th St.
 Tele: 317/846-7026

New York, New York 10017
 STAN OSBORN
 Room 1227
 60 E. 42nd St.
 Tele: 212/687-7240

Mountain View, California 94043
 DENNIS TRIOLA
 2680 Bayshore Frontage Road, Room 102
 Tele: 415/961-0378

London W. C. 2, England
 JOHN ASHCRAFT & CO.
 12 Bear Street
 Leicester Square
 Tele: 930-0525

Amsterdam C. Holland
 JOHN ASHCRAFT & CO.
 W. J. M. Sanders, Mgr.
 for Benelux & Germany
 Herengracht 365
 Tele: 020-240908

Tokyo, Japan
 INTERNATIONAL MEDIA
 REPRESENTATIVES LTD.
 1, Shiba-Kotohiracho, Minatoku
 Tele: 502-0656



ELECTRONIC SERVICING (with which is combined PF Reporter) is published monthly by Intertec Publishing Corp., 1014 Wyandotte Street, Kansas City, Missouri 64105.

Subscription Prices: 1 year — \$6.00, 2 years — \$10.00, 3 years — \$13.00, in the U.S.A. and its possessions.

All other foreign countries: 1 year — \$7.00, 2 years — \$12.00, 3 years — \$16.00. Single copy 75c; back copies \$1. Adjustment necessitated by subscription termination to single copy rate.



Robert E. Hertel, Publisher
INTERTEC PUBLISHING CORP.
 Subsidiary of HOWARD W. SAMS & CO., INC.

New Mallory Ni-Cad Batteries. Rechargeable 1000 times.



Economical recharging —
Mallory BC-1 Charger draws only two watts.

Team these long-life nickel-cadmium cells with an automatic Mallory Charger, and you can recharge them 1000 times, or more.

You'll be sure of having fresh D, C, and AA batteries, while saving money, time and trouble. Mallory Rechargeable Nickel-Cadmium Batteries keep on coming back for more in electronic calculators, tape recorders, radios, cameras, toys, other battery-powered products.

Keep a spare set of Mallory Ni-Cads on hand,

and you'll never run out of battery power again. They recharge to full strength, two or four at a time. And unlike ordinary dry cells that lose voltage during discharge, Mallory Ni-Cads with a full charge maintain operating voltage during the entire work cycle. You get maximum power, continuously, for top product performance.

For the long run, Mallory Rechargeable Ni-Cads . . . the 1000-time batteries. Get them now at your Mallory Distributor.

MALLORY

MALLORY DISTRIBUTOR PRODUCTS COMPANY

a division of P. R. MALLORY & CO. INC.

Box 1284, Indianapolis, Indiana 46208; Telephone: 317-856-3731

Batteries • Capacitors • Controls • Security Products • DURATAPE® • Resistors • Semiconductors • SONALERT® • Switches • Fastening Devices

DURATAPE® and SONALERT® are registered trademarks of P. R. Mallory & Co. Inc.

For More Details Circle (6) on Reply Card

electronicscanner

news of the industry

Frederick W. Jones, a 33-year-old production supervisor for GTE Sylvania in Danvers, Massachusetts, has been awarded a **LaCroix Gold Medal** and \$2,500 for saving three persons trapped in a flaming automobile last December. The LaCroix awards are named for the late Morris Felton LaCroix, former Chairman of General Telephone Corp., now GTE. Although several Silver and Bronze Medals have been awarded under the program, Mr. Jones is the first person to be selected to receive the Gold Medal which is reserved for an "unusually meritorious act calling for extraordinary courage." Mr. Jones has received the Silver Medal of the Massachusetts Humane Society for "outstanding heroism" in connection with the same action.

Music can be sent between a stereo machine and a headphone, without the use of connecting wires, by equipment using infrared-light diodes. Demonstrations have been made at the International Radio And TV Exhibition Of 1975 in Berlin, Germany, according to **Home Furnishings Daily**. Audio from a stereo or TV modulates the infrared diode, radiating invisible light throughout the room. At the headphone, the light is picked up by another infrared diode, and amplified before driving the diaphragm.

During August, **RCA Distributing Corporation of Los Angeles** ran a rebate program offering customers \$1 back for each inch of screen size on the purchase of a 1976-model RCA color TV set.

Sales of projection TV receivers remain strong for home use, despite the high prices, states an article in **Home Furnishings Daily**. For example, one California dealer sold 32 \$3,695 Video Beam units in 10 weeks.

A new "ambience" headphone has been announced by **Matsushita**. It is reported that the sound is projected from outside the head, instead of directly into the ears, and this reduces listening fatigue. A circuit using **Bucket-Brigade-Devices (BBD)** to delay the sounds adds reverberation to simulate the echoes heard during live performances. Matsushita developed the headphone system to simulate stereo speaker sounds.

NARDA Trafficbuilders will offer three portable tape recorders and a portable AM/FM radio and recorder carrying the "Bigston" brand. **Home Furnishings Daily** reports that eventually NARDA expects to feature the entire medium-priced Bigston line.

(Continued on page 6)

TUNER SERVICE CORPORATION

SUBSTITUNER

JUST

\$44.95
U.S.A. ONLY

WITH CABLES



ONE YEAR
GUARANTEE

STILL ONLY

\$9.95
U.S.A. ONLY

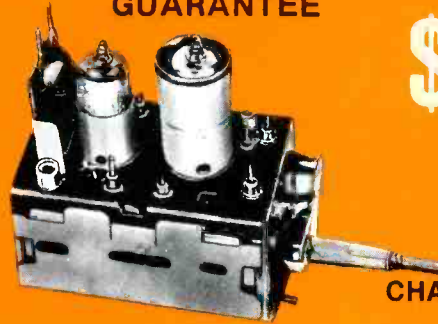

MAJOR PARTS
AND SHIPPING
CHARGED AT COST

FEATURES

- A UHF Tuner with 70 channels which are detented and indicated just like VHF channels.
- A VHF Hi Gain Solid State Tuner.
- AC Powered
- 90 Day Warranty

Demonstrate the **SUBSTITUNER** to your customers and show improved reception with their TV sets.

You may place your order through any of the Centers listed below.

PROVIDES YOU WITH A COMPLETE SERVICE FOR ALL YOUR TELEVISION TUNER REQUIREMENTS.

REPAIR

VHF OR UHF ANY TYPE (U.S.A. ONLY) \$ 9.95
UHF/VHF COMBINATION (U.S.A. ONLY) \$15.00

MAJOR PARTS AND SHIPPING
CHARGED AT COST

- Fast, efficient service at our conveniently located Service Centers.
- All tuners are ultrasonically cleaned, repaired, realigned, and air tested.

REPLACE

UNIVERSAL REPLACEMENT TUNER \$12.95 (U.S.A. only)

- This price buys you a complete new tuner built specifically by Sarkes Tarzian Inc. for this purpose.
- All shafts have a maximum length of 10 1/2" which can be cut to 1 1/2".
- Specify heater type parallel and series 450 mA. or 600 mA.

CUSTOMIZE

- Customized tuners are available at a cost of only \$15.95. With trade-in \$13.95. (U.S.A. only)
- Send in your original tuner for comparison purposes to any of the Centers listed below.



HEADQUARTERS	BLOOMINGTON, INDIANA 47401	537 South Walnut Street	Tel. 812-334-0411
ARIZONA	TUCSON, ARIZONA 85713	1528 S. 6th Ave.	Tel. 602-791-9243
CALIFORNIA	NORTH HOLLYWOOD, CALIF. 91601	10654 Magnolia Boulevard	Tel. 213-769-2720
	BURLINGAME, CALIF. 94010	1324 Marsten Road	Tel. 415-347-5728
	MODESTO, CALIF. 95351	123 Phoenix Avenue	Tel. 209-521-8051
FLORIDA	TAMPA, FLORIDA 33606	1505 Cypress Street	Tel. 813-253-0324
	FT. LAUDERDALE, FLORIDA 33315	104 S.W. 23rd St., Bay 18	Tel. 305-524-0914
GEORGIA	ATLANTA, GA. 30310	646 Evans St. S.W.	Tel. 404-758-2232
ILLINOIS	CHAMPAIGN, ILLINOIS 61820	405 East University Street	Tel. 217-356-6400
	SKOKIE, ILLINOIS 60076	5110 West Brown Street	Tel. 312-675-0230
INDIANA	INDIANAPOLIS, INDIANA 46204	112 West St. Clair Street	Tel. 317-632-3493
IOWA	WEST DES MOINES, IOWA 50265	822 Tenth Street	Tel. 515-277-0155
KENTUCKY	LOUISVILLE, KENTUCKY 40205	2244 Taylorsville Road	Tel. 502-452-1191
LOUISIANA	SHREVEPORT, LOUISIANA 71104	3025 Highland Avenue	Tel. 318-221-3027
MARYLAND	BALTIMORE, MARYLAND 21215	5505 Reisterstown Rd., Box 2624	Tel. 301-358-1186
MASSACHUSETTS	SPRINGFIELD, MASS. 01108	405 Dickinson St.	Tel. 413-788-8206
MISSOURI	ST. LOUIS, MISSOURI 63132	10530 Page Avenue	Tel. 314-429-0633
NEVADA	LAS VEGAS, NEVADA 89102	1412 Western Avenue No. 1	Tel. 702-384-4235
NEW JERSEY	TRENTON, NEW JERSEY 08638	901 North Olden Avenue	Tel. 609-393-0999
	JERSEY CITY, NEW JERSEY 07307	547-49 Tonelle Ave., Hwy. 1 & 9	Tel. 201-792-3730
N. CAROLINA	GREENSBORO, N.C. 27405	2914 E. Market Street	Tel. 919-273-6276
OHIO	CINCINNATI, OHIO 45216	7450 Vine Street	Tel. 513-821-5080
	CLEVELAND, OHIO 44109	4525 Pearl Road	Tel. 216-741-2314
OREGON	PORTLAND, OREGON 97210	1732 N.W. 25th Avenue	Tel. 503-222-9059
PENNSYLVANIA	PITTSBURGH, PA. 15209	503 1/2 Grant Avenue	Tel. 412-821-4004
TENNESSEE	MEMPHIS, TENNESSEE 38111	8158 Barron Avenue	Tel. 901-458-2355
TEXAS	DALLAS, TEXAS 75218	11540 Garland Road	Tel. 214-327-8413
VIRGINIA	NORFOLK, VIRGINIA 23513	3295 Santos Street	Tel. 804-855-2518
CANADA	ST. LAURENT, QUEBEC H4N-2L7	305 Decarie Boulevard	Tel. 514-748-8803
	CALGARY, ALBERTA T2H-0L1	448 42nd Avenue S.E.	Tel. 403-243-0971
		P.O. Box 5823, Stn. "A"	

WATCH US
GROW

IF YOU WANT TO BRANCH OUT INTO THE TV TUNER REPAIR BUSINESS,
WRITE TO THE BLOOMINGTON HEADQUARTERS ABOUT A FRANCHISE.

For More Details Circle (7) on Reply Card

(Continued from page 4)

Admiral has reported to the Consumer Product Safety Commission a possible defect in the line cord on some of its color TV sets. It is estimated that about 500 color TV sets distributed since 1973 might have been damaged during manufacturing to permit exposure of a bare wire. Admiral states that repairs necessary to correct the defect will be made at their expense.

A few video-disc players are being hand-assembled by RCA in Indianapolis. However, RCA says the machines are for tests by the company, and does not mean that a decision has been made to market the units.

Lester Fader, a University of Michigan professor, has been granted a patent for a system of three-dimensional color TV pictures. The picture tube would have a monochrome frontal face plate with a half-tone phosphor coating; the glass would have minute perforations so that electron beams could pass through; and inside would be a color TV face plate, according to **Home Furnishings Daily**.

Holiday Inns will begin distributing about 20,000 Zenith color television sets per year through its Products Division. The sets will be for newly-constructed Holiday Inns and refurbished inns. Zenith's nationwide network of some 40,000 service representatives and low power consumption were factors in the decision.

After 1975, General Electric will discontinue its portable phonograph and Show 'n-Tell products, and by mid-year will decide whether or not to continue in the compact stereo business. According to a report in **Home Furnishings Daily**, the decision will allow the company to concentrate on its radio and tape products lines.

Magnavox Corporation has established a separate division for manufacturing and selling a new line of hi-fi components called MX. The Magnavox name will not appear on the MX merchandise, and the marketing will be isolated from regular Magnavox channels.

The 1976 color TV line from Zenith Radio Corporation features two solid-state electronic tuning systems used in 70% of the line, and a new "zoom" circuit which enlarges by 50% the center of the picture for close-up viewing. One single-knob tuning system has 18 individual tuning positions (12 VHF and 6 UHF); the other system features 14 pre-tuned channels. According to **Home Furnishings Daily**, Zenith plans a 7% price increase from last year. □

HICKOK MODEL 217 SEMICONDUCTOR ANALYZER. NOTHING FASTER. NOTHING EASIER TO OPERATE.

The Hickok Model 217 gives you foolproof instant analysis with no manual switching. In less than a second, you know whether the device you're testing is BAD (open, shorted or very leaky) or GOOD.

Connect the leads without regard to basing. The fully automatic circuitry does the rest—even identifying the base. Your hands are free for intricate probing and troubleshooting. The Model 217 is the ideal instrument for all solid state equipment, as well as, computer, industrial and consumer servicing.

- Automatic, "hands-off" operation for fast, foolproof testing.
- Instant GOOD/BAD analysis of NPN's, PNP's, FET's, diodes, SCR's in or out of circuit.
- Versatility of line or battery power (rechargeable batteries optional).
- Meter for accurate leakage testing and Si/Ge identification.
- Completely portable in compact, rugged case with tilt stand/carrying handle and storage compartment for batteries, line cord and E-Z Hook® leads.



HICKOK
the value innovator

Available at these and other nearby Hickok distributors:

ALABAMA
WESTSIDE ELECTRONIC SUPPLY CO.
Tuscaloosa

ARIZONA
ELLIOT ELECTRONICS INC.
Tucson
DALIS ELECTRONIC SUPPLY
Phoenix

ARKANSAS
LAVENDAR DISTRIBUTING CO.
Texarkana
Little Rock
MIDSTATE SUPPLY CO.
Arkadelphia

CALIFORNIA
HURLEY ELECTRONICS INC.
Santa Anna
CASS ELECTRONICS
Oakland
AL LASHER'S ELECTRONICS
Berkeley
HAUER ELECTRONICS
San Francisco
MILLERS ELECTRONIC SUPPLY
San Jose
ZENITH DISTRIBUTING CORP.
San Francisco
Sacramento

MILLERS ELECTRONIC SUPPLY
Oakland
MARCUS & KLAUSNER INC.
Los Angeles
RADIO EQUIPMENT
Los Angeles
THE ELECTRONIC STORE
Costa Mesa

COLORADO
WALKER ELECTRONICS
Denver
L. B. WALKER RADIO
Pueblo
WALKER ELECTRONICS CO.
Greeley
WALKER ELECTRONICS, INC.
Colorado Springs

GEORGIA
GRAYBAR ELECTRONICS
Atlanta

HAWAII
ELECTRICAL EQUIPMENT
Honolulu

INDIANA
ELECTRONIC SUPPLY CO., INC.
Bedford

IDAHO
CENTRAL ELECTRONICS
Twin Falls
OAKLEY ELECTRONICS
Boise

ILLINOIS
MAINLINE SUPPLY CO., INC.
Joliet
UNION ELECTRONIC DISTRIBUTORS
Chicago
HOWARD ELECTRONIC SALES, INC.
Chicago
LURTZ ELECTRONICS CO.
Belleville
KLAUS RADIO & ELECTRONIC CO.
Peoria

IOWA
GIFFORD-BROWN INC.
Des Moines
IOWA RADIO SUPPLY
Cedar Rapids

LOUISIANA
WM. B. ALLEN SUPPLY CO., INC.
New Orleans
INDUSTRIAL ELECTRONIC SUPPLY
Shreveport
SOUTHERN ELECTRONICS
Shreveport

MAINE
RSL DISTRIBUTORS
Portland
Bangor

MASSACHUSETTS
NORTHEASTERN DISTRIBUTORS, INC.
Cambridge
MIL ELECTRONICS, INC.
Waltham
SYDLEE ELECTRONIC SUPPLY CORP.
Springfield
Greenfield
YOU-DO-IT ELECTRONICS
Needham
ELECTRONIC DISTRIBUTORS CORP.
Boston
PITTSFIELD RADIO
Pittsfield

MICHIGAN
ELECTRONIC PARTS CO.
Detroit

MINNESOTA
ELECTRONIC CENTER
Minneapolis
HARRY STARKS, INC.
Minneapolis
SM SUPPLY
Mankato

MISSOURI
DELTRONICS DISTRIBUTING CO.
St. Louis
BURSTEIN-APPLEBEE
Kansas City
MANHATTAN RADIO
Kansas City

NEW HAMPSHIRE
RSL DISTRIBUTORS
Manchester
NEW JERSEY
LEADER ELECTRONIC SUPPLY CORP.
Hillside

RESCO ELECTRONICS
Pennsauken
INTERSTATE ELECTRONICS
Keyport

NEW YORK
DALE ELECTRONICS
New York
STANDARD ELECTRONICS, INC.
Buffalo

Endicott
Syracuse
Niagara Falls
Rochester
Olean
FORDHAM RADIO CO., INC.
Bronx

RIM ELECTRONICS INC.
Bronx
GRIMMERS ELECTRONIC SUPPLY
Schenectady

NORTH DAKOTA
S & S ELECTRONICS, INC.
Fargo

OHIO
AKRON ELECTRONIC SUPPLY CO.
Akron
PATTISON SUPPLY
Cleveland
BECKER ELECTRONICS
Dayton

OREGON
AL SMITH CO.
Portland

PENNSYLVANIA
CUMBERLAND ELECTRONICS, INC.
Harrisburg
LINWOOD WHOLESALE
Linwood

RHODE ISLAND
ELECTRONIC SUPPLY CO.
Woonsocket

SOUTH CAROLINA
HORLACHER ELECTRONIC SUPPLY CO.
Columbia

SOUTH DAKOTA
BURGHARDT SUPPLY COMPANY
Watertown

TEXAS
INTERSTATE ELECTRONIC CO.
Dallas
ANGIE ELECTRONICS SUPPLY CO.
Houston

C & M ELECTRONICS INC.
Austin
HOUSTON RADIO SUPPLY CO.
Houston
RIO RADIO SUPPLY CO.
McAllen
SHERMAN ELECTRONICS
San Antonio
WICKS RADIO SUPPLY
Corpus Christi
KENT ELECTRONICS
Houston
R & R ELECTRONIC SUPPLY CO.
Abilene
Amarillo
Wichita Falls
Lubbock
Midland
Odessa

TENNESSEE
LAVENDAR DISTRIBUTING CO.
Memphis
WOODSON & BOZEMAN INC.
Memphis

UTAH
OSCAR E. CHYTRAUS CO.
Salt Lake City

VIRGINIA
CERTIFIED ELECTRONICS INC.
Alexandria

WASHINGTON
SEATTLE RADIO SUPPLY
Seattle
AMFAC SUPPLY CORPORATION
Spokane

WASHINGTON D.C.
COLLINS BROTHERS ELECTRONICS
Washington

WISCONSIN
Wisconsin Electronics Supply
Fond-du-Lac

WYOMING
HOUGE RADIO & SUPPLY CO.
Cheyenne
CHEYENNE WALKER ELECTRONICS
Cheyenne

ASK ABOUT A 10 DAY FREE TRIAL.

For More Details Circle (8) on Reply Card

Chassis—GTE-Sylvania D19
PHOTOFACT—1269-3

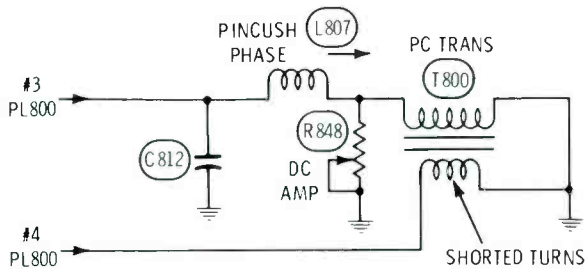

Symptom—Narrow picture, or no high voltage
Cure—Check by removing T800 and grounding pin #3 of PL800. Normal width and HV prove T800 has shorted turns.

Chassis—GTE-Sylvania D19
PHOTOFACT—1269-3

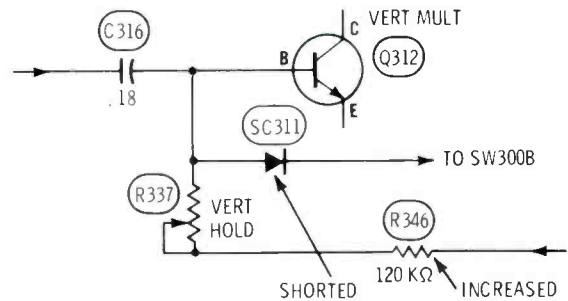

Symptom—Vertical hold locks at one end
Cure—Check R346, and replace if it has increased in value.

Chassis—GTE-Sylvania
PHOTOFACT—1269-3

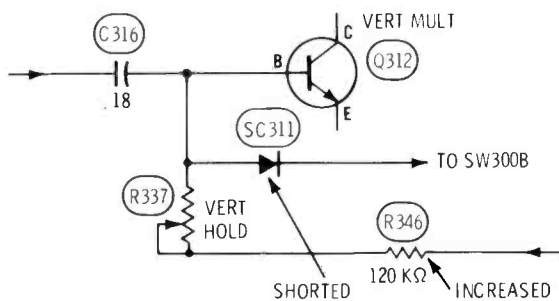

Symptom—No vertical sweep
Cure—Check SC311, and replace if it is leaky or shorted.

Chassis—GTE-Sylvania D16
PHOTOFACT—1325-2

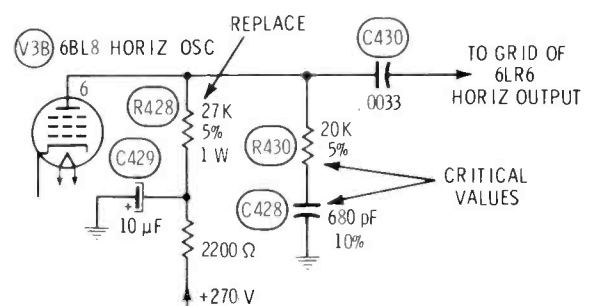

Symptom—Narrow at right, insufficient drive to 6LR6
Cure—Check R428, and replace if it is out of tolerance; also, the condition and values of R430 and C428 are critical.

Chassis—GTE-Sylvania E06
PHOTOFACT—1432-3

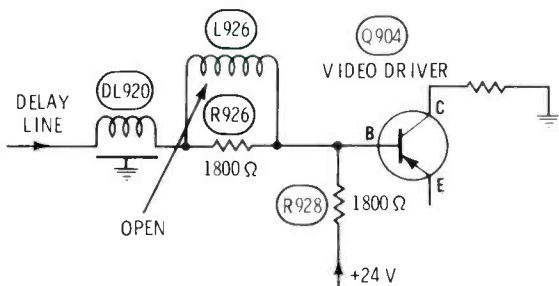

Symptom—Low-contrast, smeared picture
Cure—Check L926, and replace if it is open.

Chassis—GTE-Sylvania D12
PHOTOFACT—1143-1

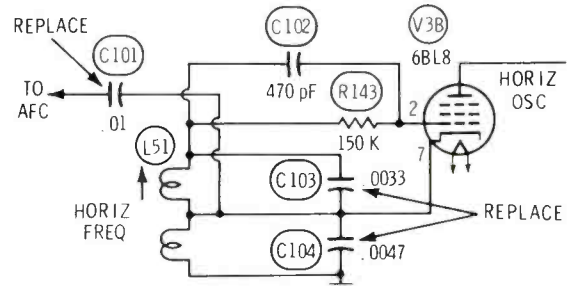

Symptom—Low high voltage, or drifting horizontal locking
Cure—Replace C101, C103, and C104 (these have critical specs).

troubleshootingtips

Horizontal drive missing Admiral H1-1A (b-w) (Photofact 894-1)

Horizontal locking or vertical problems

Zenith b-w 19EB12-B13 chassis (Photofact 1385-3)

We have found the cause of a number of horizontal locking or vertical problems (involving frequent replacement of transistors, module 9-94, or module 9-100) to be excessive heat from the dropping resistor, R236, which was located too near the modules.

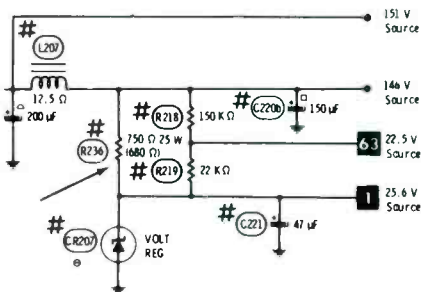

Be sure to dress this 25-watt resistor well away from any module.
Mac Kellman
Brooklyn, New York

First symptom was no raster, and a quick check proved there was no high voltage at the picture tube. Installation of new HV rectifier and horizontal output/damper tubes made no improvement.

Next, I scoped the grid (pin 9) of the horizontal-output tube, and found no drive signal there. The plate voltage of the oscillator was very low. Of course, this plate voltage comes from the +275 volts of B-boost, so it should be low when the output stage is dead.

My color-bar generator has a source of horizontal pulses for tests, and it connected it to pin 9 of the 33GY7, expecting to obtain higher boost. To my surprise, the screen lit up, showing the defect to be in the

oscillator or drive circuit. After more testing, I found that C49

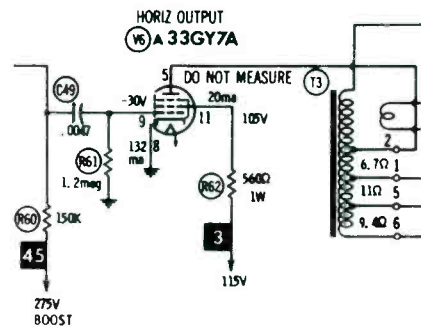

(.0047 coupling capacitor between the oscillator and the output grid) was open. Replacement of the capacitor cured the problem.

Nicholas Senker
Piscataway, New Jersey

Slipping idler wheels Most record changers

After much experimenting, we have found that application of a drop of Lux (liquid dishwashing

detergent) around the rubber tire of an idler wheel, then rubbed dry with a clean cloth, will restore the traction to like-new condition. Let

(Continued on page 10)

MINI-BAR[®] color generator

\$89.50

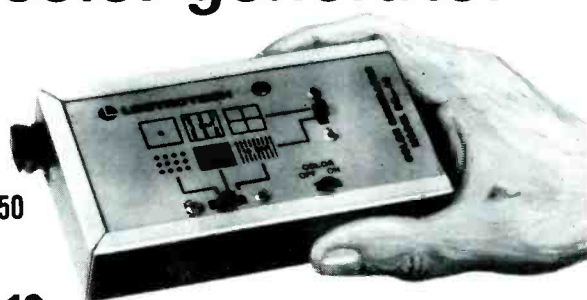

BG-10 battery-operated, fits in shirt pocket!

No AC plug in . . . automatic on & off with LED indicator . . . fast, easy hook-up with coaxial cable . . . all essential patterns . . . • Low power consumption for extended battery life (Uses inexpensive 9 volt batteries) • Shuts off when not in use • Enclosed RF cable compartment • Size: 5 1/2" x 3" x 1 1/8". Only 12 ounces • TV station type sync signals • CMOS LSI IC for all counting functions . . . no internal adjustments • RF output on Ch. 3, 4 or 5.

BG-10 (less battery) \$89.50
CC-1 Carrying Pouch \$ 2.95



See your distributor or write

LECTROTECH, INC.

5810 N. Western Ave.
Chicago, Illinois 60659
(312) 769-6262

For More Details Circle (9) on Reply Card

November, 1975



**You
can study
FM
two-way
radio
at
home!**

Thousands have increased their knowledge of FM two-way radio through the MTI home-study courses. Now, newly revised and better than ever!

Cut me in, send free information. (No salesman will call)

Name _____
Address _____
Code _____



Formerly

MOTOROLA TRAINING INSTITUTE
College Hill Road, Summerdale, Pennsylvania 17093

For More Details Circle (10) on Reply Card

FAST

COMPLETE SERVICE ON ALL MAKES OF TV TUNERS

Maximum Time In Shop 24 Hrs.

(WE SHIP C.O.D.)
YOU PAY SHIPPING
\$9.95

(Warranty: One Full Year)



Black & White or Color

VHF or UHF

UV Combo's \$16.50

Price includes all labor and parts except Tubes, Diodes & Transistors. If combo tuner needs only one unit repaired, disassemble and ship only defective unit. Otherwise there will be a charge for a combo tuner. When sending tuners for repair, remove mounting brackets, knobs, indicator dials, remote fine tuning arrangements and remote control drive units.

WE UNCONDITIONALLY GUARANTEE All Tuners FOR ONE FULL YEAR



All tuners are serviced by EXPERTLY TRAINED TECHNICIANS with years of experience in this specialized field. All tuners are ALIGNED TO MANUFACTURER'S SPECIFICATION on crystal controlled equipment and air checked on monitor before shipping to assure that tuner is operating properly.

GEM CITY TUNER SERVICE

Box 6G Dabel Station
1621 Mardon Drive
Dayton, Ohio 45420

Troubleshooting Tips

(Continued from page 9)

it set a few minutes before using the wheel. The Lux will not injure the rubber, yet it works very well.

G. Garvin
Osceola, Indiana

Intermittent convergence Philco-Ford 19FT60B (Photofact 1133-2)

After several minutes of normal operation, the center convergence changed quite a bit (causing mis-convergence over the entire screen).

In some cases, tapping or flexing the convergence board, which is

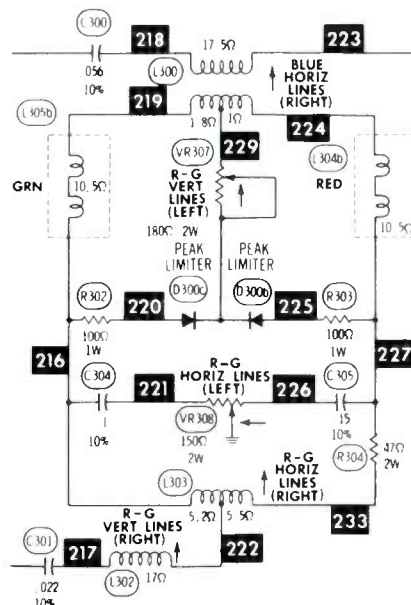

mounted around the neck of the picture tube) will restore the convergence. At other times, heating or cooling the convergence board triggers the problem, or stops it.

This trouble is very difficult to find by waveform, DC voltage, or resistance tests. I advise you to examine the soldering of the multiple-diode assembly (D300), and resolder or repair any breaks or poor soldering.

If the intermittent persists, replace the diode assembly, using Philco 34-8058-2, GE GECR-3, IR CD-07, or Sylvania ECG-120. In an emergency, four GE-504A, IR 8D4, or Sylvania ECG-116 diodes can be wired in individually.

Joseph Rotello, Jr.
Tucson, Arizona

Low brightness Zenith 19EC45 (Photofact 1377-3)

The symptoms seemed to indicate a weak picture tube. Brightness was low and the picture was milky. I checked the heater voltage with my trusty VTVM and obtained a reading of about 4.5 volts RMS. This seemed to be the reason for the weak CRT.

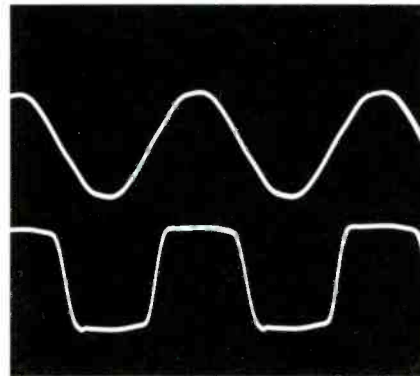

But before I wasted any time in tracing the reason for the low heater voltage, I remembered reading about this in the February 1975 issue of ELECTRONIC SERVICING (page 13). It seems the waveform of the CRT heater voltage is a kind of square wave when the power switch is on (bottom waveform), and it's a sine wave with the switch off (on those models with instant-on feature). The square wave was about 12.5 volts peak-to-peak, and the heater seemed to light up normally, so that proved the heater voltage was okay.

Further tests revealed an open peak/picture control, which is connected to the luminance module. At least I didn't waste any time following the false symptoms of weak CRT or low heater voltage.

Stan Simms, CET
Nutley, New Jersey

What would you like to read in ES? Send in your ideas.

reader's exchange

Needed: Schematic and any other service data for Instructomatic student 2-channel cassette recorder, Model 3015, and Instructomatic director's pedestal, Model 2020.

James E. Royalty
Director of Foreign Language Labs
University of Maryland
College Park, Maryland 20742

For Sale: Atwater Kent, TRF radio, type L chassis with type N speaker.

Art Ferguson
1340 Meadow Lane
Yellow Springs, Ohio 45378

Needed: Instruction manual and schematic for Jackson AM/FM universal signal generator, Model 641-A. Will buy, or copy and return.

B&L TV & Appliance
4140 East Madison
Des Moines, Iowa 50317

Needed: Will pay \$5.00 for a schematic of Bell TRW hi-fi receiver, Model 2445, manufactured by Thompson Ramo Wooldridge, Columbus, Ohio. Will pay \$10.00 if service manual included.

Massachusetts Specialty Company
444A Geneva Avenue
Dorchester, Massachusetts 02122

Needed: Working General Electric portable intercom, Model W-305A, or two non-working units.

Alfred J. Hruska
4110 Weaver Road
Lake Charles, Louisiana 70601

For Sale: Heathkit TV post-marker/sweep generator, Model 1G-57, recently overhauled, \$100.00.

Richard J. Dugo
P.O. Box 71
Dansville, New York 14437

For Sale: Three Tapetone regulated power supplies, Model PSR-150, 6.3 VAC one AMP output, 150 VDC, 70 milliamperes. One power supply is complete with tubes; two others are missing tubes. Best offer.

Ralph A. Deterling, III
43 Scotch Pine Road
Weston, Massachusetts 02193

For Sale: Rider's manuals Volumes 6-17. Need Volume 23 with index.

J. Allen Call W7KSG
1876 East 2990 South
Salt Lake City, Utah 84106

Speed TV repairs with the General Electric Symptom Repair Manual

The Symptom Repair Manual lists a variety of symptoms for individual General Electric television chassis and tells you what to check and in what order. These symptoms and repairs were developed from thousands of service technician invoices and represent the combined experience of hundreds of technicians.



The 70-page manual is 5½" by 8½" and fits neatly in your tool caddy.

Free to subscribers of GE Technical Data, the Symptom Repair Manual is offered to every non-subscribing technician for \$1.00 handling charge (four copies — \$3.00). Effective use of the manual saves time, money and aggravation and helps to build your reputation for fast, reliable service. Send the coupon to order yours today.

"DUTCH" MEYER
GENERAL ELECTRIC COMPANY
COLLEGE BOULEVARD
PORTSMOUTH, VA 23705

PLEASE CHECK ITEMS DESIRED:

- ONE SYMPTOM REPAIR MANUAL (\$1.00 ENCLOSED)
 FOUR SYMPTOM REPAIR MANUALS (\$3.00 ENCLOSED)
ENCLOSED IS () CHECK () CASH OR
() MONEY ORDER. (NO C.O.D. PLEASE).
 Please send details on GE Technical Data Subscription Plans
which include all updates of the Symptom Repair Manual

NAME _____

SERVICE COMPANY _____

ADDRESS _____

CITY _____ STATE _____ ZIP _____

We're making it our business
to make your business easier.

GENERAL  ELECTRIC

Everything we make has you in mind.

When you're looking for profitable electronic lines, look to RCA Distributor and Special Products Division:

TEST EQUIPMENT & ACCESSORIES

EXACT REPLACEMENT PARTS

SK REPLACEMENT SEMICONDUCTORS

FLAMEPROOF RESISTORS

COLOR & BLACK-AND-WHITE PICTURE TUBES

RECEIVING TUBES

INDOOR & OUTDOOR ANTENNAS

ANTENNA HARDWARE

ANTENNA ROTATORS

CAR RADIOS & TAPE PLAYERS

STEREO SPEAKER SYSTEMS

SCANNERS

BATTERIES

... AND MORE

See your RCA distributor. Or, for more information, contact RCA Distributor and Special Products Division, Bldg. 206-2 Cherry Hill Offices, Camden, New Jersey 08101.

RCA

Distributor and
Special Products Division

Needed: Radio books of '20s, '30s, and earlier for collection of Rider, Supreme, and factory service manuals.

Lawrence Beitman
409 East Chalmers
Room 610
Champaign, Illinois 61820

For Sale: Rider's Perpetual Trouble Shooter Manuals Volumes 2-14.

Best offer.
L. A. Cassinelli
167 Main Street
Milford, Massachusetts 01757

For Sale: Rider's TV Service Manuals Volumes 1-10, in good condition. Best offer.

G. Warren Ziegler
9 Sprague Drive
Valley Stream, New York 11580

For Sale or Trade: Motorola Training Institute course, will sell or swap for used TV correspondence course.

Robert G. Farricy
1017 Westmoreland Avenue
Syracuse, New York 13210

For Sale: Two Eico oscilloscopes, Model 460; one Heathkit digital multimeter, Model 1M-1202; two B&K TV analyzers, Model 1077.

All units 5 months old and working fine; send me your bid.
Billy Sudderth
Route 1, Box 216
Murphy, North Carolina 28906

Needed: Schematic or service information for Weston tube tester, Model 798, type 2.

Richard C. Schmick
909 Knepper Drive
Mechanicsburg, Pennsylvania 17055

Needed: Schematic diagram or service data for Falcon Mark IV CB radio; will pay.

Ray H. Rowland
Route 2, Box 120
Centre, Alabama 35960

Needed: Yoke Y1113 for Setchel Carlson color TV.

Model 3CM66-23.
Don's Radio & TV Shop
410 West Second Street
New Bremen, Ohio 45869

For Sale or Trade: Rider's TV manuals Volumes 1-5.
James Montesion
423 Beach 123rd Street
Far Rockaway, New York 11694

For Sale: Heathkit audio oscillator with manual, Model AO-1; needs work. Best offer.

Ralph A. Deterling, III
43 Scotch Pine Road
Weston, Massachusetts 02193

For Sale: 1939 Dumont TV with manual. Set has electrostatic deflection CRT.

Jim Farago
P.O. Box 335
South St. Paul, Minnesota 55075

Needed: Schematic and/or power transformer for Adonis XL1-240 AM/FM stereo 8-track tape player, manufactured by Sharp.

George O. Vincent
Summit Drive
Highland Mills, New York 10930

Needed: Schematic for Supreme audolyzer, Model 562.

A. Roy Fremstad
1328-15 Street NW
Calgary, Alberta T2N 2B6

Needed: Telechron 1 RPM motor, Model 2518, for old Sparton radio clock.

Jim Farago
P.O. Box 335
South St. Paul, Minnesota 55075

Needed: RCA Model TRK-5 or other pre-WWII TV. Also need 7JP4 picture tube.

George Gell
1516 Allen Drive
Westlake, Ohio 44145

Needed: Diagram for Model A1 Eauphnic intrusion alarm, built in Guaynabo, Puerto Rico.

John B. McCulloch
3421 Cass Avenue
Detroit, Michigan 48201

Needed: Operation manual and schematics for a Tektronix type 531 scope. Will buy, or copy and return.

Bill Yarborough
Presbyterian College Physics Dept.
Clinton, South Carolina 29325 □

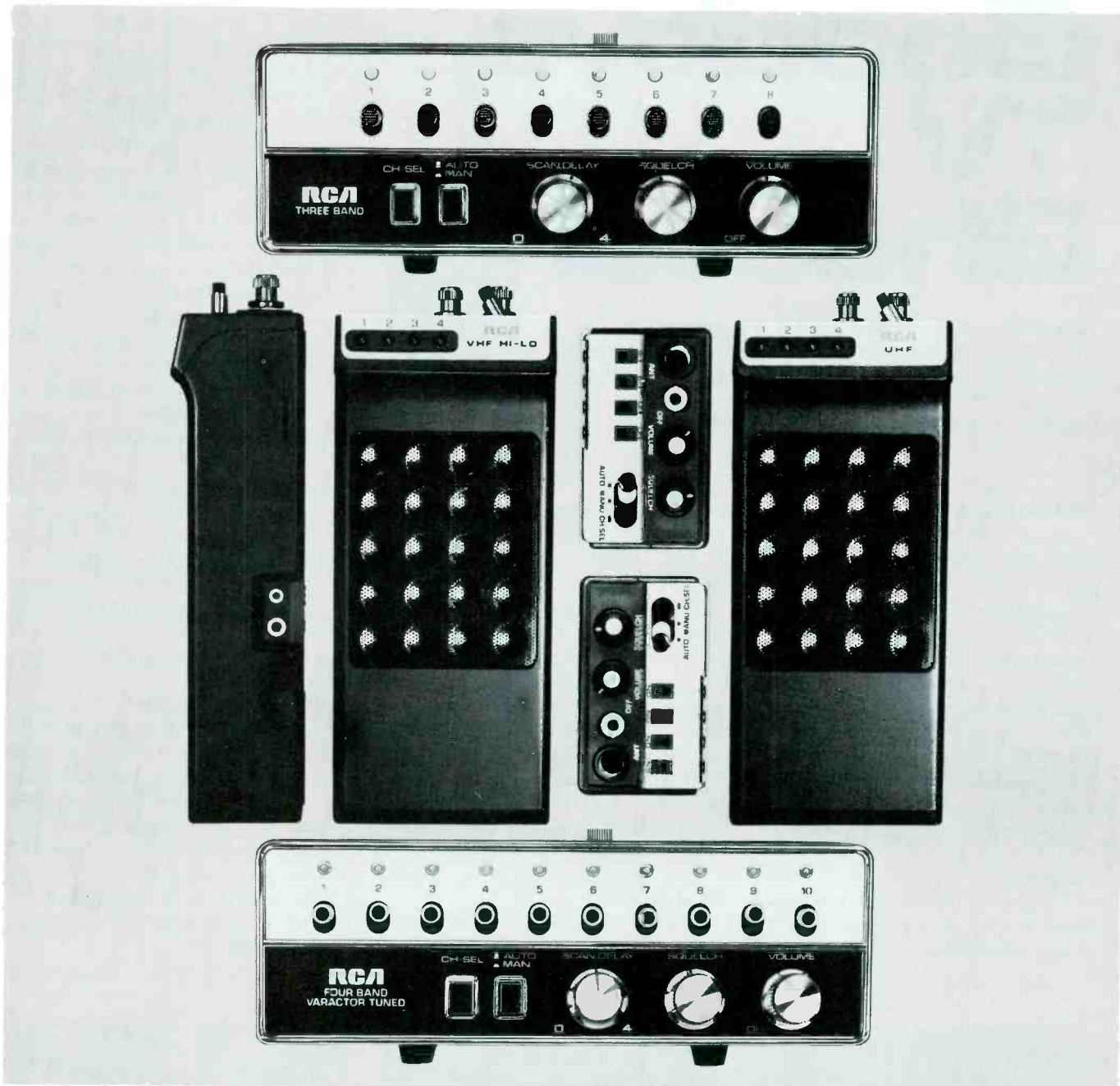

While your customers hear real life, you'll hear the sound of sales.

With RCA Scan-Aire Scanning Monitors.

One of the greatest names in consumer electronics now introduces a line with built-in excitement: Scan-Aire.

Four brand-new scanning monitors that let your customers hear the real life drama of police, fire, ambulance, marine, and other public service broadcasts.

Two home/mobile units — an 8-channel 3-band and a 10-channel 4-band, operable on 120-V AC or 12-V DC.

Two Pockette units — a Hi-Lo VHF and a UHF, operable on regular or rechargeable batteries (not furnished), car lighter socket or 120-V AC, with optional adapter.

And all Scan-Aire monitors come with the popular features that make RCA number one and make you money.

How does that scan?

For more information, contact your RCA distributor or RCA Distributor and Special Products Division, Bldg. 206-2, Cherry Hill Offices, Camden, N.J. 08101.

RCA Scan-Aire

Goodbye, TV Ghosts!

More than 90% of the visible TV ghosts can be eliminated by **circular polarization** of the antenna signals at both the broadcasting station and the receiver! This promises greatly-improved picture quality in the near future. By David A. Ferre'



Benefits Of Circular Polarization

Tests comparing conventional horizontal polarization (HP) to circular polarization (CP) of both transmitting and receiving signals have shown that CP offers these important benefits:

- virtual elimination of reflected signals (ghosts);
- less snow in the picture;
- reduced fading of the signals;
- less-critical orientation of the antenna; and
- stronger and clearer signals from "rabbit ears" and indoor loop antennas.

Except for the reduction of snow, these results were predicted by the theory of circular polarization.

Circular polarization has been used for years in FM broadcasting. It has helped prevent multi-path reception without the necessity of critical orientation of the receiving antenna.

Test Results

Two series of practical tests have been made of circular polarization for TV station antennas, one with a VHF station, and the other involving UHF. Full power and conventional operation were used in both cases, except for the CP.

CP at WLS-TV

Construction of the new Sears building, tallest in downtown Chi-

cago, caused strong ghosts. In efforts to eliminate the ghosts, two TV stations (including WLS-TV), moved their antennas to the top of the Sears building. Even this was not satisfactory with WLS-TV, which petitioned the FCC for permission to experiment with circular polarization. Two antennas were installed by WLS-TV. One was the usual horizontally-polarized type, and the other was an experimental CP type made by RCA.

Under the watchful eye of the FCC, the broadcasts were in CP one day, HP the next, and so on while reception conditions (such as ghosting, signal fading, snow, and co-channel interference) were investigated.

An extensive survey of signal strength and picture quality was conducted by the consulting firm of Smith and Powstenko, using a van equipped with monitors, measuring equipment, hydraulically-operated mast, CP antennas, and HP antennas. Our cover pictures came from that survey.

Circular-polarization operation consistently provided clearer pictures than did HP. In fact, only CP gave TASO Grade 1 (studio monitor quality) reception during the test period. At the location giving the poorest picture quality, the HP picture was only a blur, while the CP pictures showed slight ghosting. Figure 1 compares the reception from CP and HP.



Two TV stations moved to the top of the Sears building in Chicago (dark building at the center). The CP antenna is under a white cover. Other TV transmitters and antennas are on the Hancock building (dark tower at the upper right). Courtesy of Smith and Powstenko.

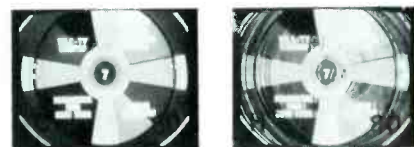

Circular

Horizontal

Fig. 1 Both CP and HP operation showed excellent reception with a minimum of ghosts at misorientation up to 40°. At 60° misorientation, CP was perfect and HP had noticeable ghosts. The most marked contrast occurred at 80°, where the HP picture was covered by ghosts, and CP had only a trace. Increased angles of misorientation showed poor picture with vertical roll for HP and nearly-perfect quality from CP. At only one point was CP inferior, and that was at 180°, where the lack of a rear lobe produced snow with CP. These pictures were made in a section of Chicago having average reception.

Courtesy of Smith and Powstenko.

Spiral antenna at KLOC-TV

An experimental spiral-type CP antenna manufactured and installed by Jampro Antenna Company is shown in Figure 2. It presently is being used for CP tests at KLOC-TV, Channel 19, in Modesto, California.

The first results from CP operation of KLOC-TV show the same improved reception as those of WLS-TV.

What Is Circular Polarization?

When an RF field radiates through space, varying in the **horizontal** direction, it is said to be "horizontally polarized". If the field varies in the **vertical** direction, it is said to be "vertically polarized".

Circular polarization can be created by mixing together a horizontal polarization and a vertical polarization which differ by 90° . As seen in Figure 3, the resultant is a **single** vector of constant length, that spirals its way into space.

Spiral antennas, such as the one at KLOC-TV, develop the circular polarization directly from the spirals of the antenna itself, so it is fed by a single signal, and not by two in quadrature. The "sense" of the polarization is determined by the right-hand or left-hand spirals. At this time, the standard is right-hand circular polarization.

CP also can be transmitted from a crossed dipole arrangement, with the vertical dipole fed by one transmitter and the horizontal dipole powered by a similar transmitter. The signals between the dipoles must have a 90° phase difference.

However, a single transmitter with two antenna feeds differing by 90° (see Figure 5) seems to be a more-practical solution.

Regardless of the type of transmitting antenna and transmitter feed used, the **total** power to a CP antenna must be doubled over that used with HP, in order to obtain the same signal strength at the receiver.

CP Ghosts Are Mirror Images

Figure 4 shows that a horizontally-polarized wave remains horizontally polarized after it is reflected. Therefore, any reflected signals are attenuated in amplitude and arrive later, because they have

traveled farther. Otherwise, they are unchanged. So, these reflected signals are accepted by both antenna and receiver, where they mix with the direct signal, appearing as "ghost" images to the right of the desired picture. This is the present HP system in action.

The "sense" of a CP signal is reversed by being reflected from a building, or other object. Look at it this way: your reflection in a mirror is reversed; right arm becomes left, and vice versa. So it is with the spiral CP signal. Right-hand CP becomes left-hand CP, and left-hand CP becomes right-hand CP.

Antennas for circular-polarization signals accept **only** right-hand or left-hand spiral signals. Therefore, direct signals are accepted, and reflected signals are rejected, thus reducing the intensity of any ghosts.

Ghosts are phased-out

Rejection of CP signals having the wrong "sense" (reverse spiral) is accomplished by phase cancellation. As shown in Figure 5, the transmitter signal is applied directly to the vertically-polarized section of the antenna, while the horizontal part of the antenna receives power through a device (such as an additional $\frac{1}{4}$ wavelength of cable) that delays the phase by 90° .

Thus separate signals of different polarization, and of 90° phase difference are broadcast.

Receiving antennas designed for horizontal polarization reject most of any signal broadcast by vertical polarization. And vertical polarization antennas have little output from signals that are horizontally polarized.

A direct signal at the receiving antenna (upper right corner of Figure 5) has the horizontal component passed through without phase change, while the vertical component has a phase delay of 90° . Both signals, following transmitting and receiving phase conditions, are in-phase at the output of the receiving antenna, so the amplitudes add.

Reflected (mirror image) signals have had the vertical and horizontal phases changed by 180° . Therefore, the 90° delay of the vertical signal makes the two signals opposite in phase (180°), producing amplitude cancellation.

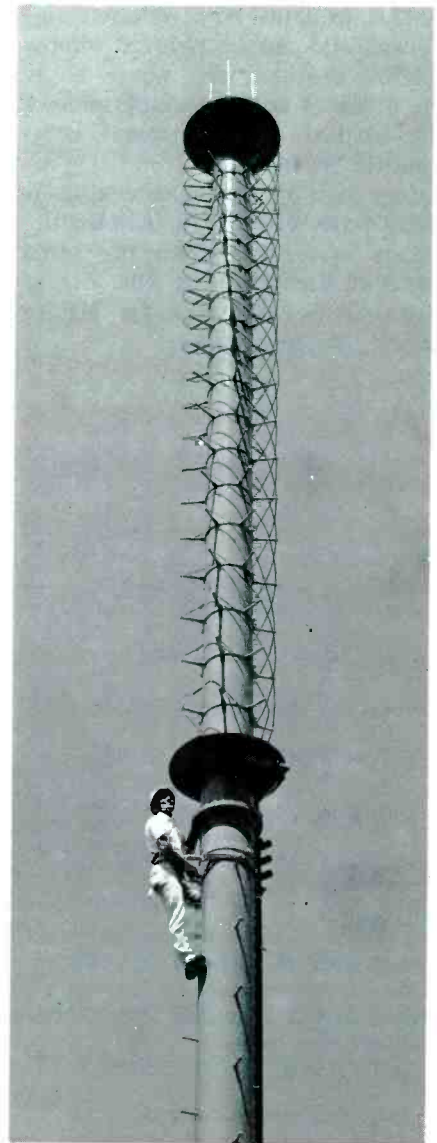

Fig. 2 This UHF antenna by Jampro achieves the CP mode by the spiral turns of the antenna. A single feed without phase changes is required. Courtesy of Jampro.

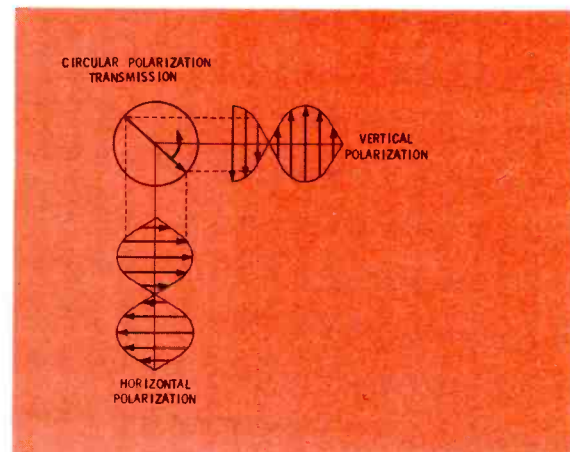

Fig. 3 Vector pattern shows how the vertical-polarization signal and the horizontal-polarization signal combine to create circular polarization with a rotating vector.

This explains how reflected signals (ghosts) can be reduced almost totally, provided the phase shifts are accurate and the amplitudes of the vertical and horizontal components are identical.

Rejection by phase cancellation is particularly effective in eliminating ghosts that arrive from the same general direction as the direct signal. It is impossible for HP to match this performance.

Receiving CP

If all the TV stations should convert to circular polarization, what changes would be necessary in the receiving antennas? First, it's not mandatory necessarily to make any changes involving the receiving antenna. Present-day conventional HP outdoor antennas will bring in the horizontal component of CP, without degradation of the quality. So, if your present reception is

satisfactory, no changes are necessary. That's compatibility.

However, in order to take full advantage of the ghost-eliminating potential of CP, your indoor or outdoor antenna must be replaced by a CP type.

Indoor Dipole Reception

When broadcasts are in CP, indoor reception with simple dipoles (rabbit ears) should produce better-quality pictures without critical orientation adjustments.

Of course, viewers who now use rabbit ears for HP are the ones most needing the benefits possible with CP. Ideally, rabbit ears should be replaced with specially-designed CP indoor antennas.

Outdoor CP Antennas

The usual problems of snow and signal fading, when HP antennas are oriented, are minimized with CP receiving antennas. The field patterns of Figure 6 reveal at least one reason. The forward lobe of the CP pattern is wider, making orientation less critical. An added bonus is the reduced rear lobe, which should minimize co-channel interference.

Spiral types also can be used; the problem is one of size. A spiral receiving antenna for VHF would be approximately 6-feet in diameter. However, for UHF the spiral might be only 8-inches in diameter; a very practical size.

One design approach is to have two nearly-identical antennas mounted together, with the elements of one pointing vertically, and the elements of the other horizontal. Then the electrical signals are joined in a wiring harness that also provides the proper phasing.

At this early date, the log-periodic design seems to hold promise, because of the natural 90° combining effect of the elements.

Some re-thinking of antenna installation procedures might be necessary, with broadband designs 15-foot long, and with elements pointing up and down as well as sideways.

If ghosts are not a problem, it's likely that a CP antenna will not be required in deep-fringe areas. A large high-gain broadband, HP antenna with a rotator probably would be adequate there, while CP single-channel antennas could be

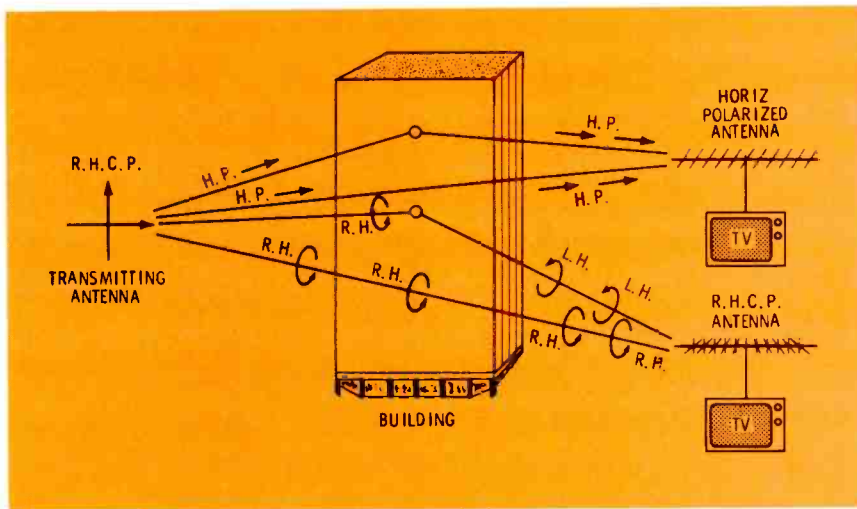

Fig. 4 Signals reflected from an object have the right and left sides reversed, as though seen in a mirror. HP has no rotary "sense", so is not changed when bounced, but the right-hand sense of a CP signal becomes left-hand after it is reflected. A CP receiving antenna designed for right-hand will reject any ghosts with left-hand sense.

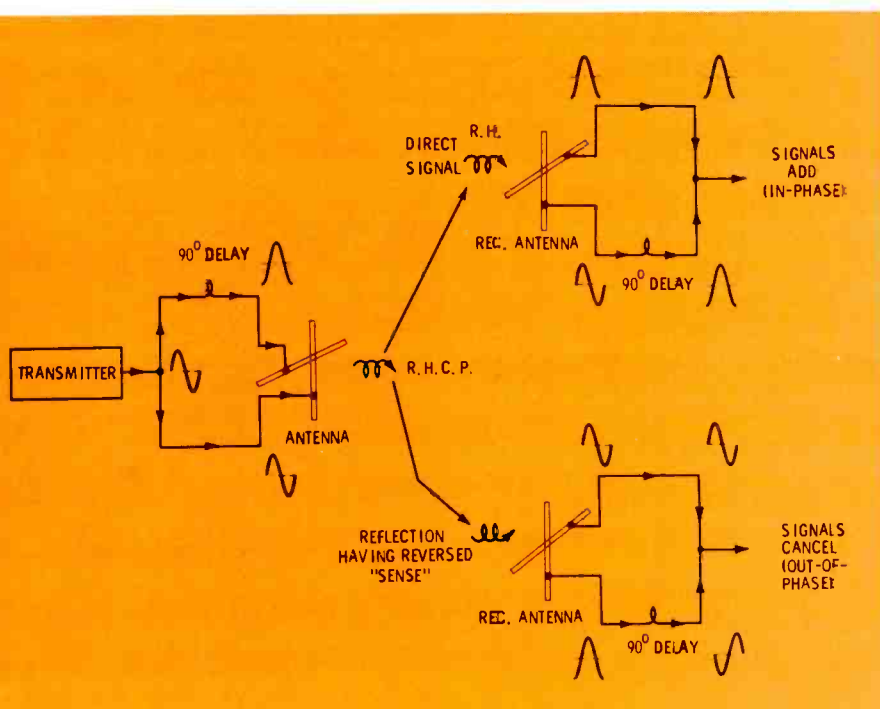

Fig. 5 These diagrams show how phase changes in the transmitting and receiving antennas operate to reinforce the direct signals and reject (by phasing-out) any reflected signals.

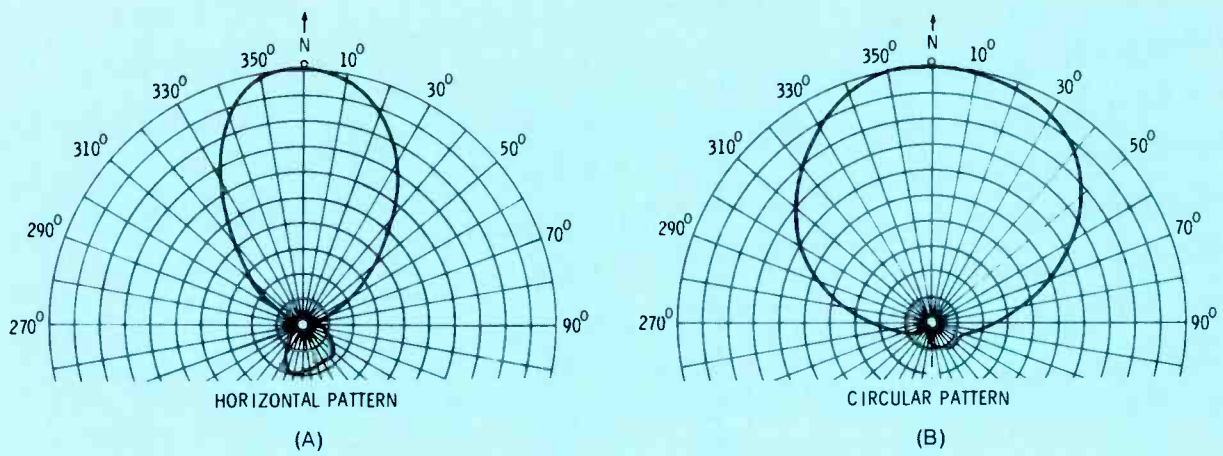

Fig. 6 Signal strength pattern (A) was recorded from a Channel 7 yagi HP antenna. It shows a sharp forward pickup and some rear pickup. A CP version of the same antenna shows a wider forward lobe (B), and a smaller rear lobe. Ghosts are not a problem with CP; therefore, the wider acceptance of the CP forward pickup is an advantage.

added to solve any unusual problems.

Radiation Contours Of CP Versus HP

During the tests of circular polarization, the contours of signal strength were of special interest to the Federal Communications Commission (FCC). CP required double the amount of power used for HP, although it was radiated in two different planes, and there was concern that the signal levels in fringe areas might be increased.

At first thought, it would seem advantageous to have a stronger signal. However, any increase of signal level could ruin the allocations of channels versus distances that have been worked out so carefully by the FCC. For example, reception midway between Channel 7 in Waterloo, Iowa and Channel 7 in Chicago would be degraded if the Channel 7 signal strength of

WLS-TV were increased while in the CP mode.

Analysis of the test results indicated that CP was **not** significantly stronger in fringe areas, so this should not be a problem.

The Future Of CP

Circular polarization has demonstrated dramatic improvements of picture quality, without any significant drawbacks, in the tests conducted so far. The next move is up to the FCC, which has not yet approved the use of CP on a permanent basis. Perhaps more tests in other localities will be required.

The manufacturers of TV transmitters and antennas seem to be ready whenever approval of CP becomes official. Some metropolitan TV stations probably will want to change to CP just as soon as possible.

Costs Of CP

For a TV station, the only deterrent against changing to CP is the cost. Not only is a special antenna required, but another duplicate final RF power amplifier must be added, or a new one of twice the power substituted. It's likely that hundreds of millions of dollars are involved in this decision.

And yet, many (perhaps most) of the TV stations will pay the price to obtain the improved picture quality.

When a station changes to CP, the cost for an individual set owner can range from nothing to moderate. He is **not forced** to make any change or purchase. Conventional HP antennas receive the HP component and give the same picture as if broadcast in HP. Only when he wants to benefit from ghost-free CP, will there be any extra cost.

As for myself, I say, "Goodbye, TV ghosts, and good riddance!" □

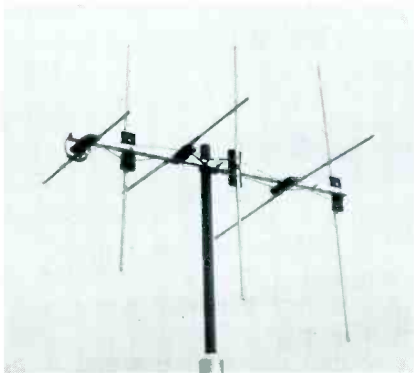

The JFD CP receiving antenna for VHF channels 7-13 has vertical and horizontal sections mounted together.

(Smith and Powstenko)

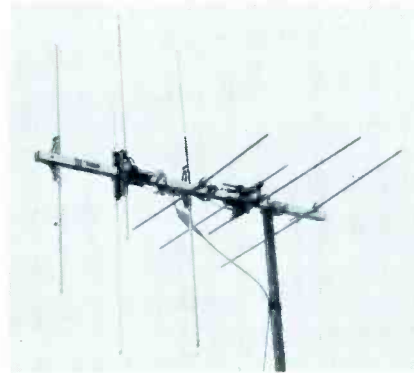

RCA arranged the vertical section of its cut-channel antenna for Channel 7 in front of the horizontal section.

(Smith and Powstenko)

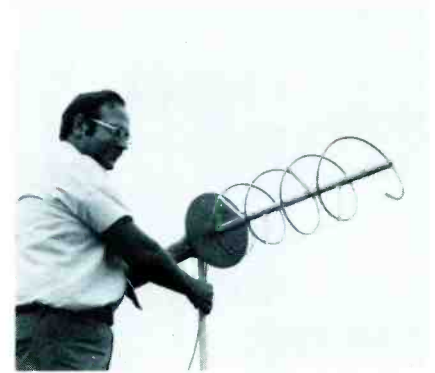

A spiral receiving antenna probably is the most simple, but size is a drawback except for UHF channels.

(Jampro)

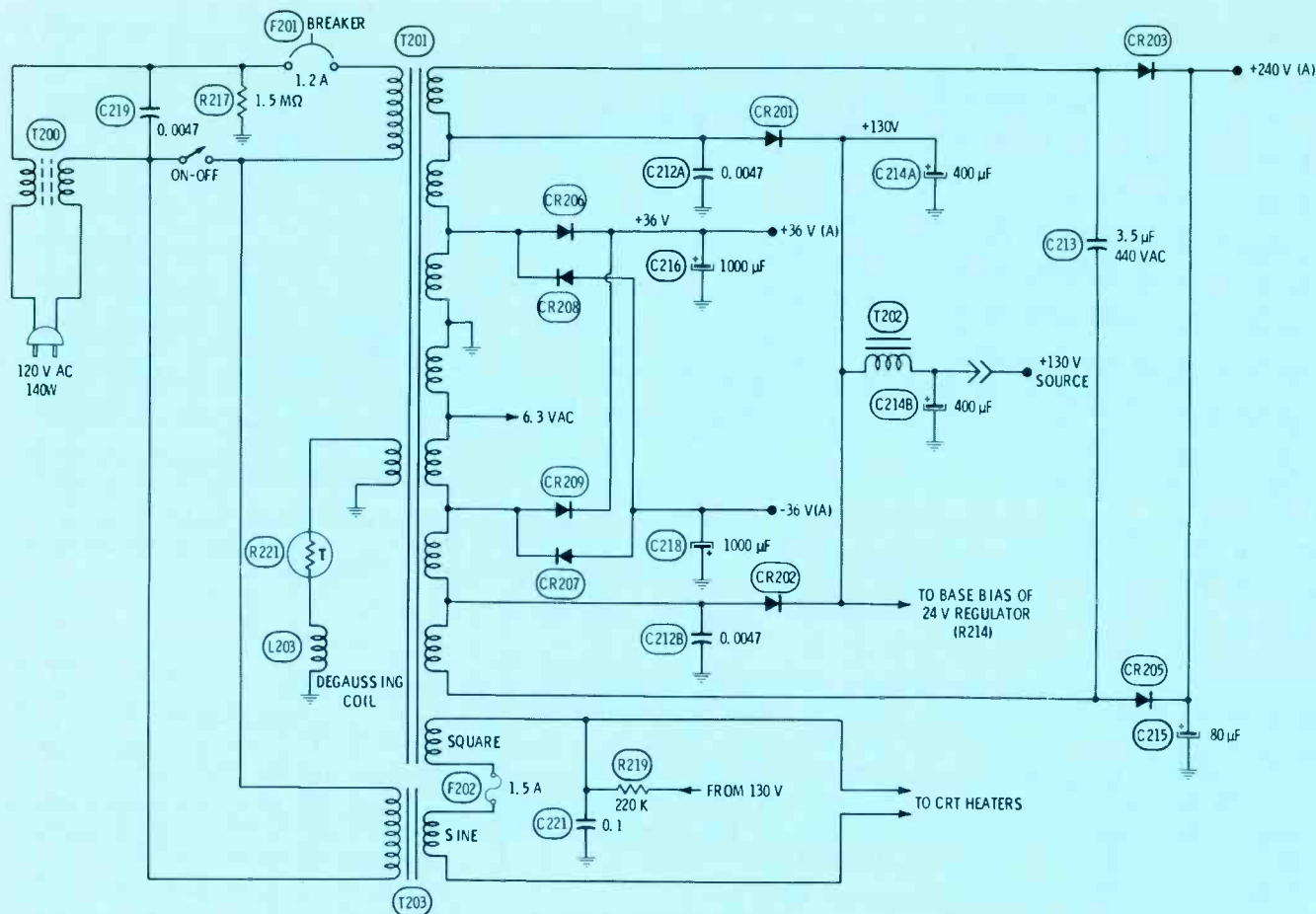

Fig. 1 The power transformer, T201 of Zenith chassis 19EC45 (Photofact 1377-3), regulates by supplying constant-amplitude square waves to all the secondary windings. C213 smooths the waveform, and increases the amplitude by resonant effect. In later models, the instant-on feature was eliminated by the omission of T203, and F202 was changed to a 4-ampere rating.

TIME THOSE SHORT CIRCUITS!

Here's a unique method of doing a preliminary analysis of TV power overloads by counting the number of seconds between turn-on and the tripping of the circuit breaker.

By Robert L. Goodman, CET



A fellow technician dropped by my shop to ask if I could suggest what defect might be causing a 19EC45 Zenith chassis to kick the circuit breaker.

"Does the breaker trip instantly, or does the power transformer growl for several seconds before the breaker trips?" "I really didn't notice", he replied. "Is the time important?" "Yes, often the number of seconds from turn-on until the breaker trips will indicate which circuit has a short."

Next day he called me and reported it required about 7 or 8 seconds for the breaker to trip. "Okay," I said. "probably the horizontal output transistor is shorted." He tested the transistor, found that it was shorted, replaced the transistor, and called me to report the success. "But, how did you know

the defect without even seeing the receiver?" I resisted the temptation to take more credit than I deserve, and merely told him it resulted from my extensive experience with the Zenith "E" and "F" series. Modesty aside, however, this method originated with my recognition of a pattern of the failure symptoms, added to my knowledge of these power supplies.

Voltage-Regulating Transformer

A vital part of my "timing-short-circuits" method is made possible by the current-limiting property of the special type of regulating power transformer used in many late-model Zenith color receivers (refer to articles starting on page 34 of September, 1973, and page 11 of February, 1975 issues of ELECTRONIC SERVICING.

Don't get burned

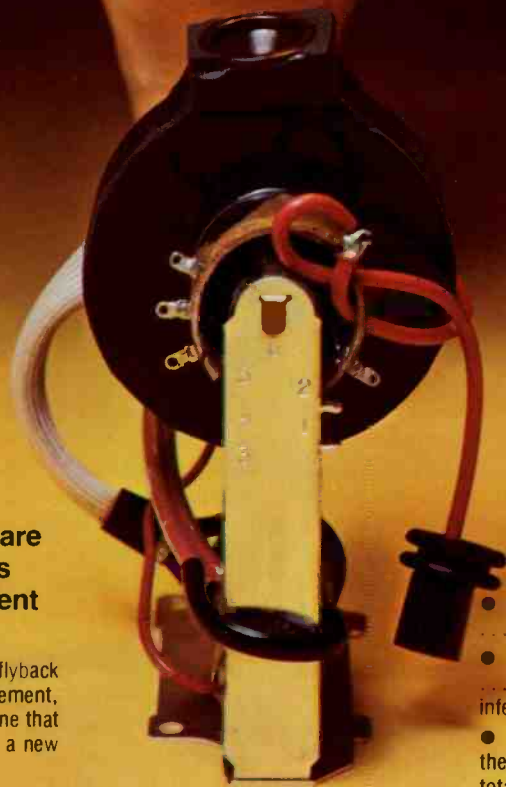

Only when you specify TM are you sure of getting flybacks that meet today's government safety standards.

It's true! If you specify the original OEM flyback instead of a THORDARSON exact replacement, you risk getting a part identical to the one that failed... a part that would be illegal in a new set built today.

Here's how THORDARSON MEISSNER makes sure you don't get burned:

- Every TM color flyback we make meets new set safety standards.
- 99% of THORDARSON replacements sold are exact replacements right down to the wiring color code... no hassles with re-wiring or confusing instructions.

THORDARSON
Established 1895
THORDARSON MEISSNER INC.
A subsidiary of Components Corp. of America
Electronic Center Mount Carmel IL 62863

- Every TM flyback is designed for reliability... not production line price specifications.

- Every TM part is quality made in the U.S. ...yet, almost always costs less than its often inferior OEM "equivalent."

- TM never undercuts your business. Since the inception of the industry, we've given our total support to America's independent parts distributors and service dealers.

- TM distributors stock in depth... and THORDARSON's unique Rush Order service for hard-to-get parts is available for fast factory-to-you shipments!

Ask your independent distributor (or write) for a free copy of the THORDARSON TV Replacement Guide.

Support your independent parts distributor... we do! NEDA  Associate Member

These transformers, sometimes called a ferro-resonant type, have loose coupling between primary and secondary, and a core that saturates around the secondary, but not around the primary winding. The secondary voltage rises only so high, then levels off, producing an approximate square-wave shape. A side effect of this action is that the primary current can increase only to about twice the usual value, even with a low-resistance short across the secondary. By comparison, a conventional-type transformer with a shorted secondary might show five to ten times the normal primary current.

Although a double amount of current **will** cause a circuit breaker to open (thus protecting the transformer) the lower current slows the operation of the breaker. And less severe shorts permit operation for several seconds before the breaker trips.

Heavy Overloads

Any of these major overloads will trip the breaker very rapidly:

- a shorted diode rectifier;
- a short in C213, the 3.5 microfarad capacitor (Figure 1) that tunes the secondary of the power transformer;
- a defective power transformer; or
- a shorted filter capacitor.

In addition, a serious short in the +130-volt supply rapidly trips the breaker. A fast test, to determine whether the short is in the supply itself, or in the circuits fed by it, is to unplug the yoke. A jumper in the plug disconnects all loads on the +130-volt circuit. Reset the breaker, and try the power again. If the breaker holds, the short probably is in the horizontal-sweep area; otherwise, it's in the supply circuit.

Usually, a short in the +24-volt supply will not trip the breaker, but will burn-up R214 (Figure 2), the resistor that feeds the regulator transistor. With power off, use an ohmmeter to test the 24-volt line while you remove modules until one is found that relieves the short.

The schematic in Figure 3 shows several components capable of causing serious overloads, and

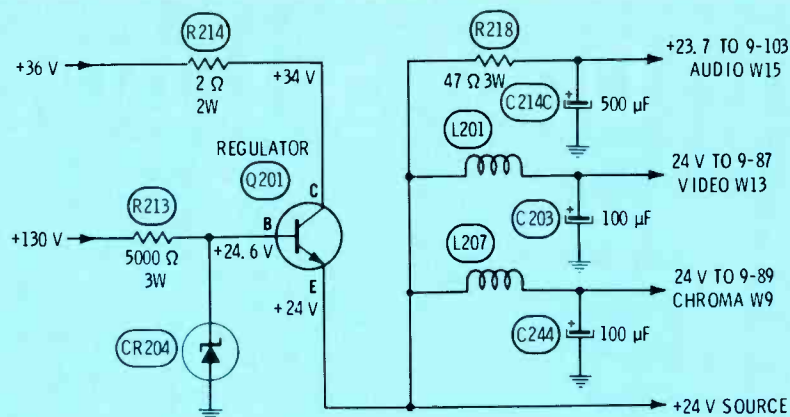

Fig. 2 Short circuits of the regulated +24-volt supply usually don't trip the breaker, but they might ruin Q201 and burn up R214. Test for shorts with power off as you remove one panel at a time.

others producing only moderate overloads when they fail. A dead short in CR211 (damper) diode, C229, C231, C237, C233, C234, C240 or C235 might trip the breaker within a couple of seconds. (You will remember from a previous article that several capacitors were used in parallel to minimize the chance of excessive high voltage should one open. If there were only one having the total capacitance of all, and it opened, the HV might increase 3KV. But with six, if any one opened, the HV could only increase about 500 volts. Later models incorporated a special 4-lead capacitor which opened either the collector or emitter circuit of the horizontal-output transistor if it became open. This eliminated all HV.)

Higher-resistance leakage in these components usually kills the HV, but the other symptoms vary with the amount of leakage. Moderate leakage might permit operation for 5 to 20 seconds before the breaker operates. Incidentally, a good test to determine which capacitor is leaking is to operate the receiver with power for a minute or so (in case the breaker does not trip), then turn off the power and feel the capacitors. The leaky one usually will be warmer than the others.

Also, some of the 4-lead capacitors have become intermittently open. To check for this possibility, just connect clip leads between wires A and B, or C and D. Normal operation proves the open was inside the capacitor (see Figure 4).

A shorted yoke kills the high

voltage, but doesn't usually overload the +130-volt supply enough to activate the breaker. Test for a bad yoke by unplugging the connector, jumpering chassis socket pins 12 and 15 (to defeat the B+ interlock), and operating the chassis with power. Partial amounts of high voltage and B-boost (Figure 3) without the yoke indicate that it has shorted turns.

If the CR212 boost rectifier shorts, the overload is not enough to trip the breaker. An open or shorted CR212 causes a dim picture, so measure the +700-volt supply when that symptom appears.

High-voltage tripler rectifiers activate the breaker when they short, but the time count is long, perhaps 15 seconds. Some triplers develop a warm spot on an area of the case, and others produce a dim, out-of-focus picture with streaks across it, because of internal arcs. Of course, an open tripler kills the high voltage, but doesn't cause any overload.

Horizontal-Output Transistor Failures

Any substantial overload in the horizontal-sweep circuit can ruin the output transistor (usually it tests shorted). Before installing a new one, test for overloads as shown in Figure 18 on page 34 of the March, 1975 issue of ELECTRONIC SERVICING. A serious overload can ruin a replacement transistor before you can pull the AC plug or turn off the power switch.

the only prime time test pattern.

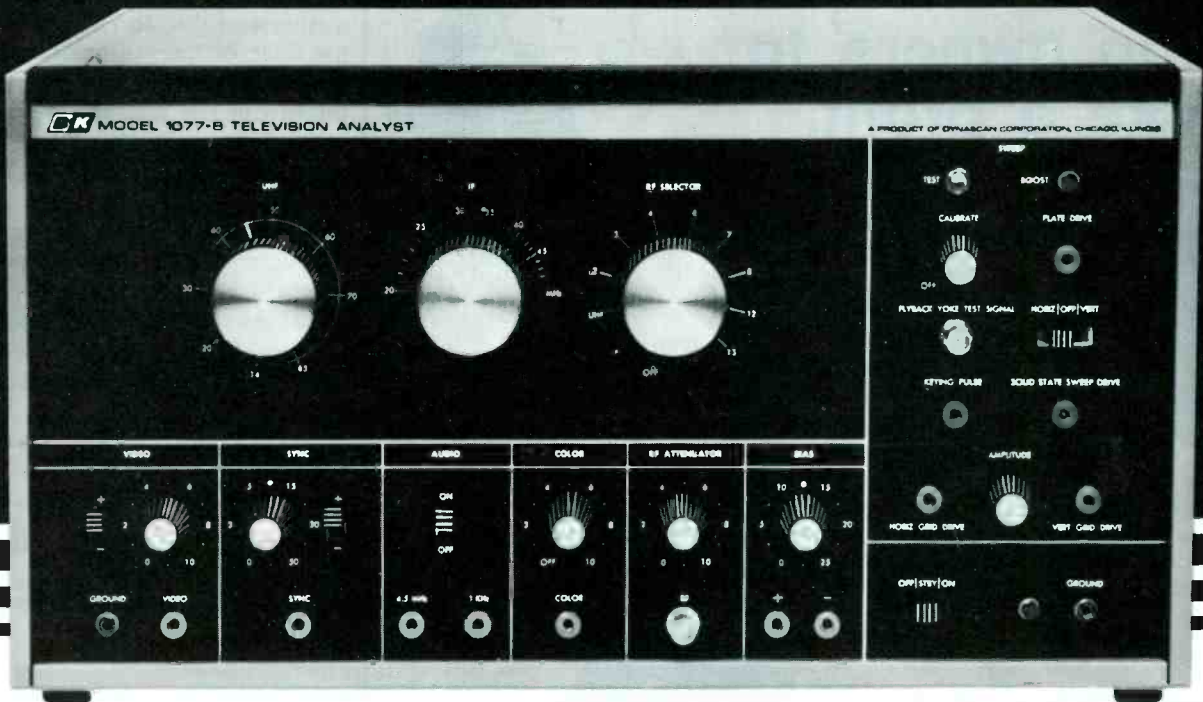

Model 1077B
\$454

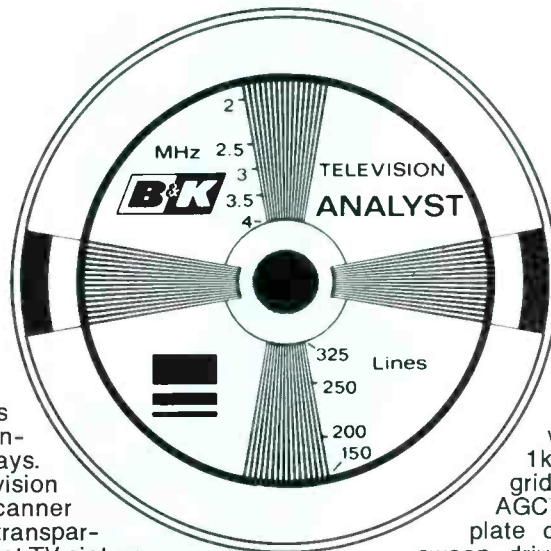

Remember the test pattern? Here's how to use that old standby to cut your troubleshooting time in half.

Broadcast test patterns are available only at very inconvenient times these days. So our Model 1077B Television Analyst has a flying-spot scanner that transforms any 3"x4" transparency into a broadcast-format TV picture. We even supply you with a test pattern slide.

A test pattern provides valuable information about picture size, linearity, focus, resolution, ringing (overshoot), low-frequency phase shift (smear) and frequency response. Unless the TV receiver isn't working, of course.

That's why the 1077B provides signal-substitution outputs to let you inject the test pattern anywhere in the chain from the flyback all the way back to the antenna terminals. You can pinpoint the problem in minutes instead of hours, check-

ing the quality of each stage as you go.

Outputs include: IF, 8 VHF channels, all UHF channels, video, sync, 4.5MHz sound subcarrier with 1kHz FM modulation, 1kHz audio, chroma, vertical grid drive, horizontal grid drive, AGC keying pulse, horizontal plate drive, horizontal solid-state sweep drive, vertical plate drive and vertical solid state sweep drive.

There's also a built-in dot/bar/crosshatch generator for color TV chroma and convergence adjustments. Plus positive or negative bias supply and B+ boost indication. All level controls are conveniently located on the front panel.

There's nothing else like it.

Ask your distributor for Model 1077B, the latest in over 20 years of television analysts—in stock now or write Dynascan.

B&K PRODUCTS OF
DYNASCAN

1801 W. Belle Plaine Ave. • Chicago, IL 60613 • Phone (312) 327-7270

Complete Line of Analog and Digital Multimeters, Oscilloscopes, Signal Generators, Semiconductor Testers, Power Supplies, Probes, Tube Testers and Substitution Boxes.

For More Details Circle (12) on Reply Card

Let me show you the pricing system that makes it easier for shop owners to make a profit.



tv & radio tech's guide to pricing

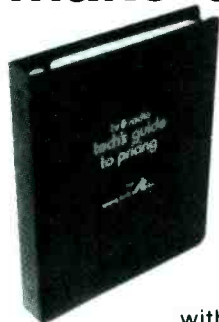

This system is proving itself in thousands of shops from coast to coast and Canada. It allows you to price your work profitably with conviction... A new dimension in pricing...

keeps a true and proper balance between cost and work performed with computer like accuracy. The original 6"x9" page size, hard cover, steel ring-bound issue for shop use remains available. It's the same system used in the Satellite described below. \$18.95 postage paid.

John C. Sperry John C. Sperry

Now, the system goes pocket-sized

The advantages of using the pocket-sized pricing guide is obvious (even fits a shirt pocket) fast-tab indexing to 19 major repair categories... your own print out and guide to reliable pricing. It's all you'll ever need for fast errorless pricing in the field, bench, or over the counter... you can bank on it... \$16.95 postage paid, instruction manual included.

And, parts pricing right out of the same pocket!

Hundreds of man hours are lost every year hunting down various parts prices during billing time that can be drastically recovered by the parts Satellite. Over 3500 fast moving parts are cataloged and up-dated periodically. In ordering a parts Satellite, all you do is fill out and send in the coupon below. We then send you a three-page work sheet on which you show us the mark-up you desire for different parts categories... a computer printout is then made with your retail parts prices tabulated. It is then reduced and bound into a compact parts catalog. The initial programming and set up charge is \$75.00 plus \$10.00 for each catalog.



But you're not necessarily home free if the replacement of the output transistor alone brings back a normal picture. First, make sure there's plenty of thermal compound on both sides of the insulating mica washer and that the insulator is not too thick or has two instead of one. These things can cause the transistor to run hot and fail later. Even more hidden is the effect of an open damper diode (CR211 in Figure 3), because there are no immediate symptoms. However, the output transistor probably will fail within a few days. (The collector/-base junction of the transistor rectifies the negative peak of the flyback pulse and permits operation, but the extra base current produces heat which eventually destroys the transistor.)

Recap Of Times Versus Defects

Here are some typical times in seconds from turn-on to tripping of the breaker for these component defects:

- Shorted power supply diodes or filter capacitors quickly trip the breaker, perhaps in one or two seconds. Before the breaker trips, a buzz can be heard in the speaker;
- If the power transformer or C213 is shorted, the breaker trips fast;
- When shorted, a CR211 damper diode gives a 2 or 3 second count;
- A shorted Q202 horizontal-output transistor often allows an 8-second count before the breaker operates;
- Shorted turns in T206 flyback transformer usually do not trip the breaker, but the windings might smoke or arc. The overload can ruin the output transistor, Q202;
- About 15 seconds to breaker tripping indicates a shorted CR214 HV tripler unit. Check for hot spots on the outside;
- Shorted turns in the horizontal coils of the yoke usually do not activate the breaker, although little or no HV will be produced. The two coils are in parallel, so there's no trapezoidal picture to provide a clue;
- Severe leakage in either the 4-lead

sperry tech inc. P.O. Box 5234 Lincoln, Nebraska 68505

- My check or money order enclosed for _____ copies of large (6"x9") pricing manual.
- My check or money order enclosed for _____ copies of the Labor Satellite.
- My check or money order enclosed for _____ copies of the Parts Pricing service.
- More information on all three.

Name _____

Company _____

Address _____

City _____ State _____ Zip _____

Ne. residents add City and State taxes U.S. Currency equivalent.

capacitor or any of the several capacitors that parallel the damper diode can cause tripping after 2 to 20 seconds, depending on the amount of leakage;

- Usually a shorted boost diode (CR212) doesn't trip the breaker, but the in-focus picture will be very dim. And,

- A short of the +130-volt supply trips the breaker rapidly, but overloads of the regulated 24-volt supply usually do not activate the breaker.

Comments

This information applies specifically to the Zenith "E", "F" and "G" line (19EC45, etc.) of solid-state color receivers. The amount of time before the breaker trips will be different for other brands and models. However, the basic premise is sound, and you can adapt the method to other receivers. For example, sets without this type of regulating transformer probably will trip the breaker more quickly for a comparable overload.

It isn't necessary to use a watch to time these tests. In photographic

darkroom work, the seconds can be measured accurately enough by saying or thinking: "Zero—one thousand—two thousand—three thousand, etc.". Adding the long extra word slows the count enough to keep you from speeding up. Practice a few times against a second hand of a clock, and you'll get it near enough. The main point is to be consistent.

Start noticing how long after turn-on before the breaker trips and you'll have another valid test for localizing defects that cause overloads. □

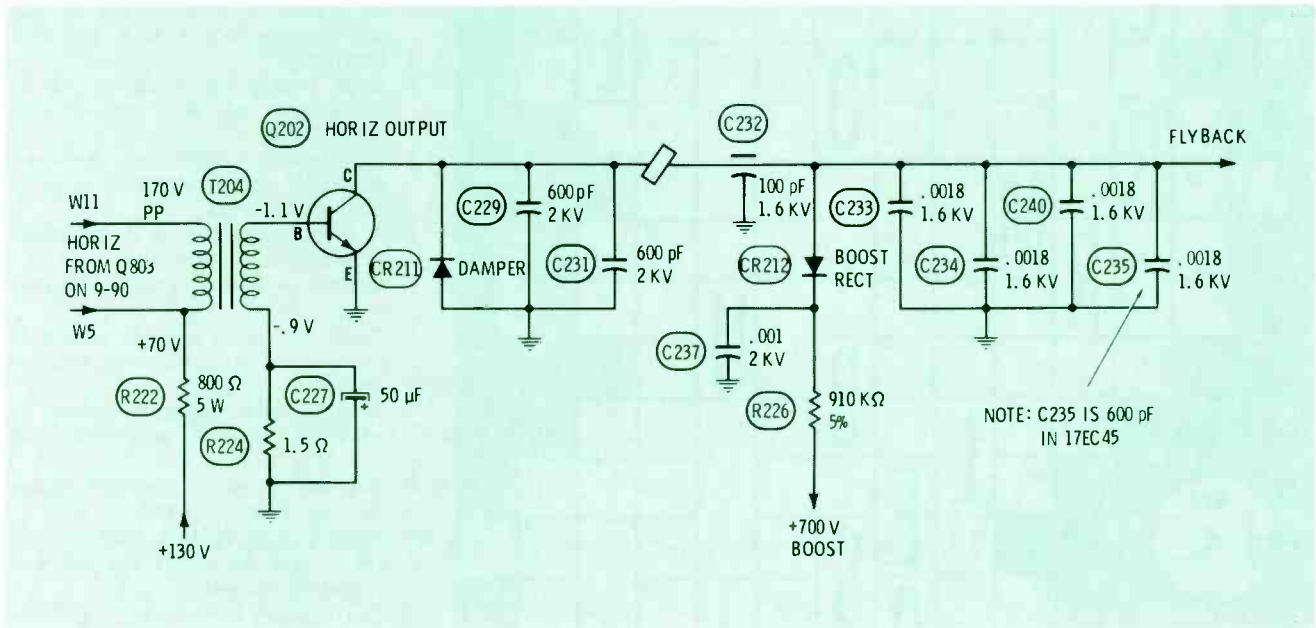

Fig. 3 This partial schematic of the horizontal-output stage shows some components that can trip the breaker if they short.

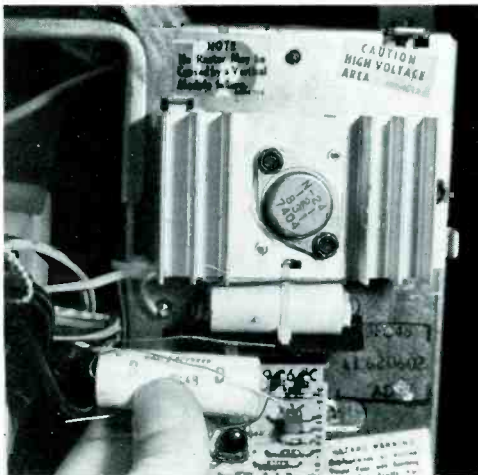

Fig. 4 One 4-lead safety capacitor now is used to replace most of the capacitors that parallel the damper (see Figure 3). If it opens, there is no deflection or high voltage; and if it leaks, it might run hot while eliminating the high voltage.

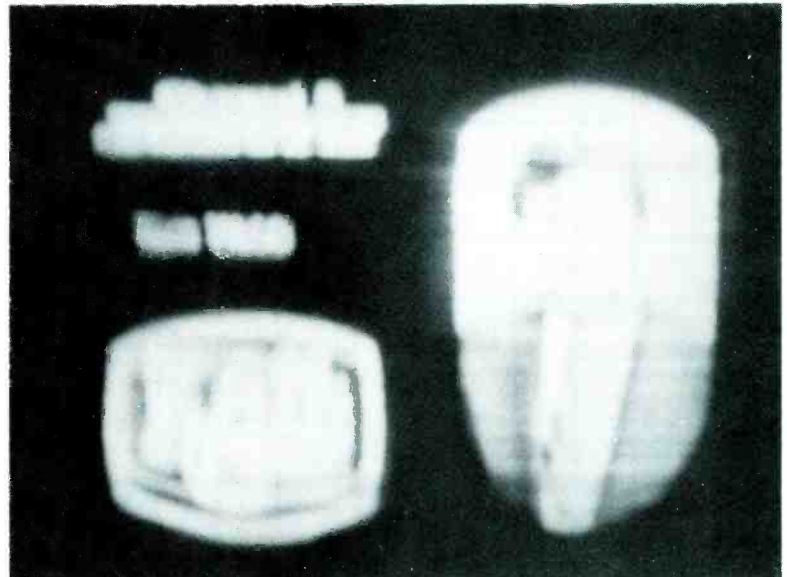
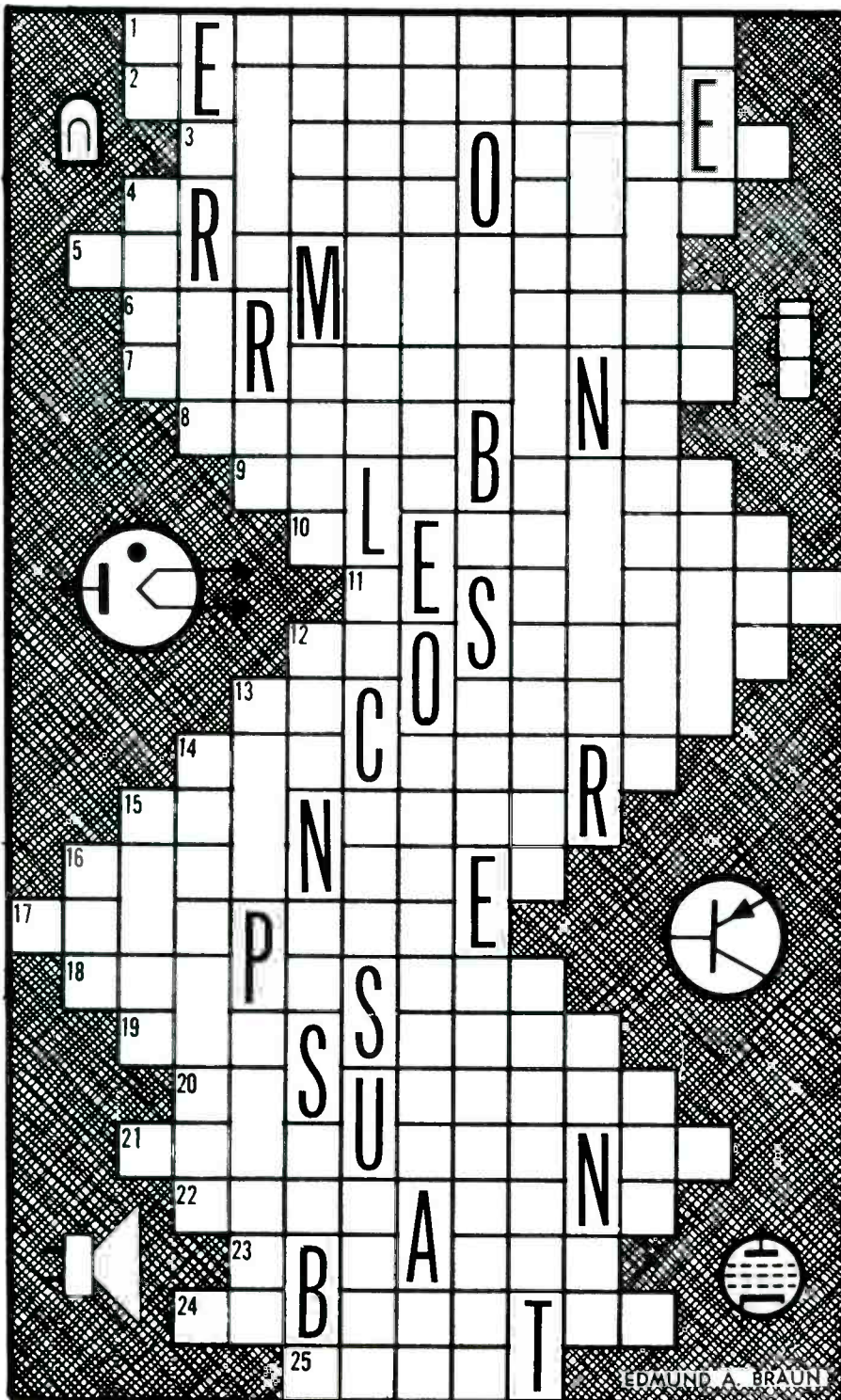

Fig. 5 Arcs inside the HV-tripler unit can cause streaks across an out-of-focus picture.

HI, RESISTANCE!

By Edmund A. Braun

Hi, there! Here's your chance to have fun solving this Just-Across-Word Puzzle based on electronics. Each word is connected to the word above and below by one or more letters although only one usually is shown as a clue. Each correct answer is worth 4 points; a perfect score is 100. It should prove quite easy, except perhaps for someone who thinks "beacon" is what the provider of the family is supposed to bring home; or that "rectifier" refers to a body and fender shop! Pencil sharp? Ready? Then, GO!



1. Ability of a material to remain magnetized after removal of magnetizing force.
2. A trademark for an imitation of animal skin.
3. RF transformer having the mutual inductance adjustable by coil rotation.
4. Fuse containing a spring which completes an auxiliary circuit when blown.
5. Colorimetric difference between any color and a reference color of equal luminance.
6. A load connected to a transmission line or other device.
7. Degree of effectiveness of operation.
8. Pertaining to an antenna usable at more than one frequency area or limit.
9. Antenna with broadside array of stacked dipoles with flat reflectors.
10. Shortest distance through space between two live parts.
11. Water-cooled tetrode tube.
12. Outermost region of the air surrounding the earth.
13. Instrument for measuring focal length of a lens or optical system.
14. Pertaining to the interconnections of components.
15. Three-terminal silicon semiconductor device.
16. Points of maximum displacement in a series of standing waves.
17. Method of determining azimuth and elevation angles simultaneously.
18. Subminiature constant-current tube containing two electrodes and filled with radioactive nitrogen.
19. High-resistance separator or support for conductors.
20. No current flows through this high-resistance device.
21. In DC circuits, the reciprocal of resistance.
22. Pertaining to a magnet that retains its attraction.
23. Centimeter-gram-second electromagnetic unit of capacitance.
24. A major, essential, functional part of an organized whole.
25. Movement of a station's signal from its original dial setting.

Will you please check our answers?
Solution is on Page 45.

Buss® Fuses Specialize Too!

in the protection of

C B

EQUIPMENT

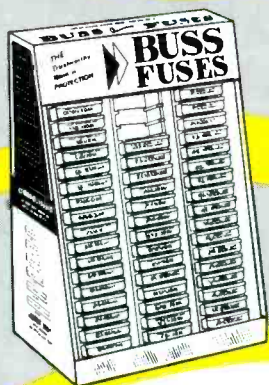
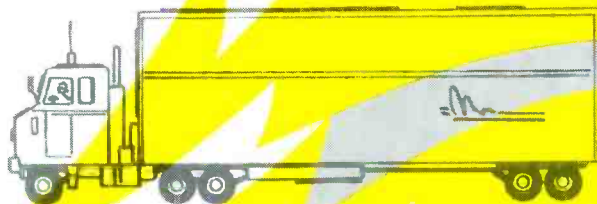

No. 240CB-3
Metal Display Stand



No. 80CB-1
Metal Display Stand

Now . . . four new BUSS fuse assortments exclusively designed with replacement fuses to service most Citizen Band Radios — offering a whole new area of opportunities for increased profits.

Two assortments contain 48 — 5 in metal boxes (240 fuses). BUSS No. 240CB-3 fuse assortment comes in a handy metal display stand. BUSS No. 240CB-4 fuse assortment is packed in a compact plastic display box.

In addition, there are two fuse assortments containing 16 — 5 in metal boxes (80 fuses). BUSS No. 80CB-1 fuse assortment packed in a metal display stand and BUSS No. 80CB-2 fuse assortment in a plastic display box.

Both BUSS fuse assortments contain a careful selection of the most popular fuses used in CB radios.

CB dealers can now have the fuses they need in a neat complete package to service all their customers fuse needs.

For full fuse assortment details, write for BUSS Bulletin CBA.

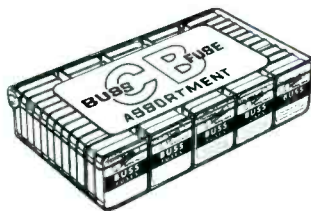

No. 240CB-4
Plastic Display Box

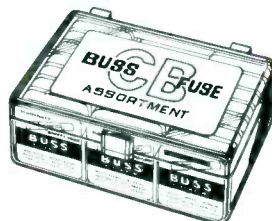

No. 80CB-2
Plastic Display Box



BUSSMANN MANUFACTURING
a McGraw-Edison Company Division
St. Louis, Missouri 63107



Servicing stereo audio systems



Part 3/By J. A. "Sam" Wilson, CET

Audio distortions, both mechanical and electronic, are the main subject this month. Much of the material in the series is based on questions most-often-missed by technicians taking the audio CET examination.

Record Player Distortion

Stylus problems

If the playback stylus does not fit in the groove of the record at the same angle as the cutting stylus did during recording, the reproduced sound will be distorted. Also, the wrong angle can cause excessive wear of the record, which in turn causes even more distortion.

Figure 1 shows examples of improper stylus position and angle.

The mounting of a stylus must have small mass, and therefore is susceptible to bending and damage from rough handling. Many styli have become bent when customers tried to clean off the dust and dirt that accumulated. After a new cartridge or stylus is installed, you should check to see that the stylus angle is correct. Remember that any time the stylus does not make proper contact with the record, the audio signal will be distorted.

Bent styli, styli out of the linkage, and worn tips of the styli probably account for most cases of poor tone quality coming from the cartridge. I have heard sound quality with distortion so severe that I thought the bias of the output tubes was missing, yet it was just a worn stylus. A worn stylus also causes excessive record wear.

Compliance

The term **compliance** refers to the ease with which a body can be

moved. A cartridge that allows easy tracking in the bends of a record groove is said to have "high compliance". If a cartridge has "low compliance", the stylus resists movement and tends to slice off the corners rather than follow the turns.

The compliance of a phono cartridge is not necessarily related to the distortion produced by the

cartridge. But low compliance causes unnecessary and excessive wear of the record, and the wear causes noise and distortion.

Tape Distortion

One important factor in obtaining the best possible sound reproduction from a magnetic-tape player is the alignment of the gap in the playback head.

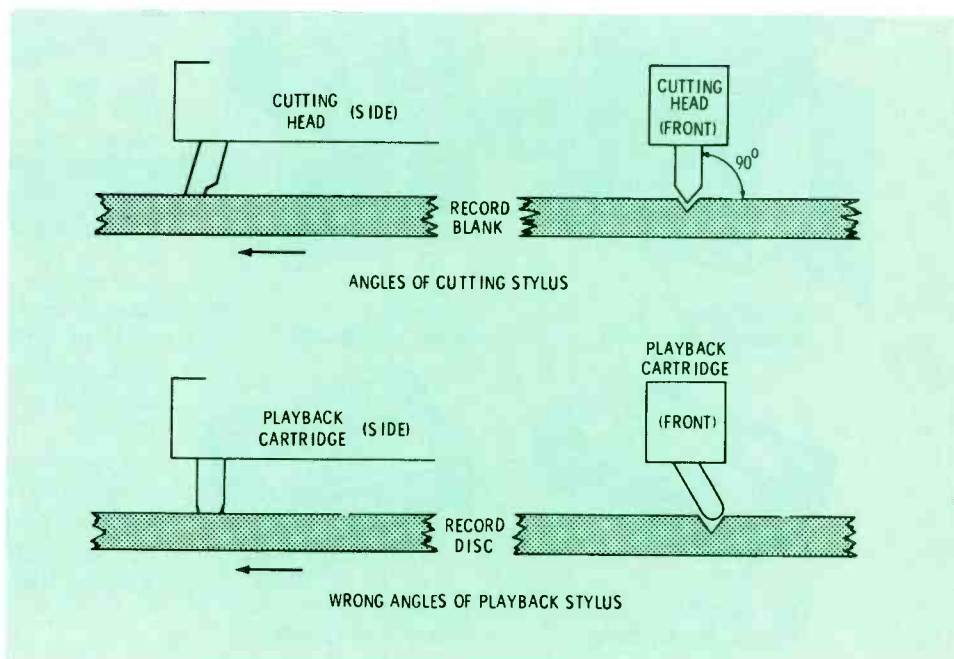

Fig. 1 If the playback stylus does not sit in the groove of a record at the same angle as the cutting stylus did, the music will be distorted. Two of the many possible wrong angles are shown.

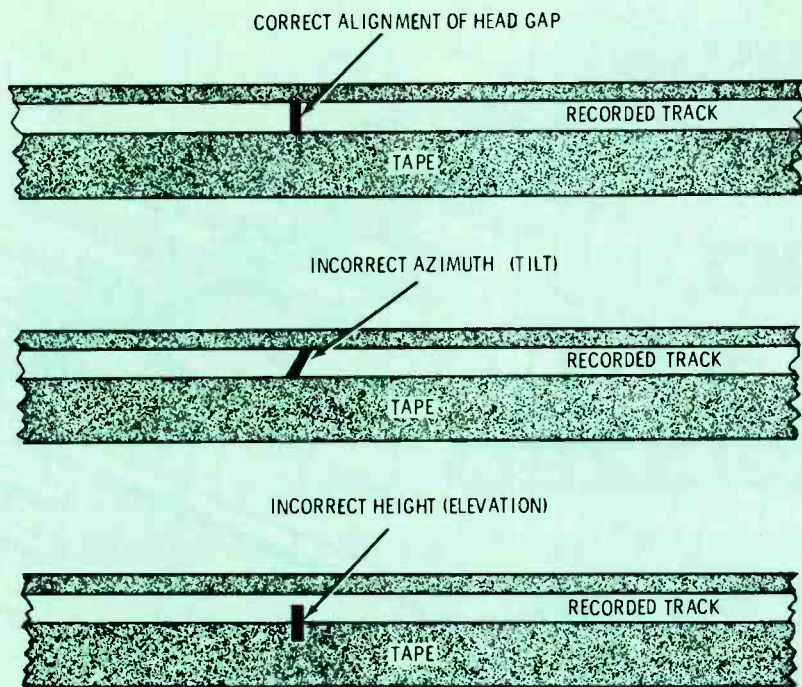

Fig. 2 An incorrect azimuth adjustment reduces the high-frequency response (center). A wrong elevation adjustment (bottom tape) does not affect the tone quality, but it reduces the volume, and could allow crosstalk from an adjacent track.

Two types of improper head alignment are shown in Figure 2. Azimuth (tilt) has the greatest effect at the higher audio frequencies. This is not some elusive, minor change. You can listen to music as you adjust the tilt, and the effect is similar to turning a treble tone control up and down.

When one range of audio frequencies is reproduced stronger or weaker than the others, it is called "frequency distortion". Although you can hear it, the effect is not so disturbing as harmonic or inter-

modulation distortion.

If the playback gap is above or below the recorded gap, the volume will be weaker than normal. Tape noise is decreased the same amount as is the audio level, and there is no change of harmonic distortion. Of course, the gap might cover a portion of the adjacent recorded track, causing a faint crosstalk to be heard.

Non-linear magnetism

The strength of magnetic fields is not in direct proportion to the

magnetizing current in a coil. This is a basic limitation in any attempt to record louder sounds by increasing the recording current. High-amplitude levels are compressed, causing harmonic distortion.

Nonlinearity problems become worse when the head becomes magnetized and retains a magnetic field when there is no current in the coil. As shown in Figure 3, a recording head that has a magnetized core produces a stronger magnetic field with one polarity of current than the other. Such a non-linear field results in audible distortion.

In addition, the residual magnetism changes the head during playback into a kind of weak permanent magnet that partially erases the track. Magnetized heads produce excessive tape noise during playback, also.

The switching of a combination record/playback head (between output and input of the amplifier) sometimes results in head magnetization, because the circuit is broken while a large current is flowing.

All tape heads should be demagnetized (degaussed) often, to minimize any distortion and noise from residual magnetism.

Distortion In Amplifiers

If it were possible to build an amplifier that had a perfectly-linear transfer characteristic, amplifier distortion would be nearly zero. However, all of the amplifying components (tubes, transistors, and FET's) have transfer curves with some nonlinearity. The best we can do is learn to recognize the types of distortion thus created, and how to minimize the amount of distortion.

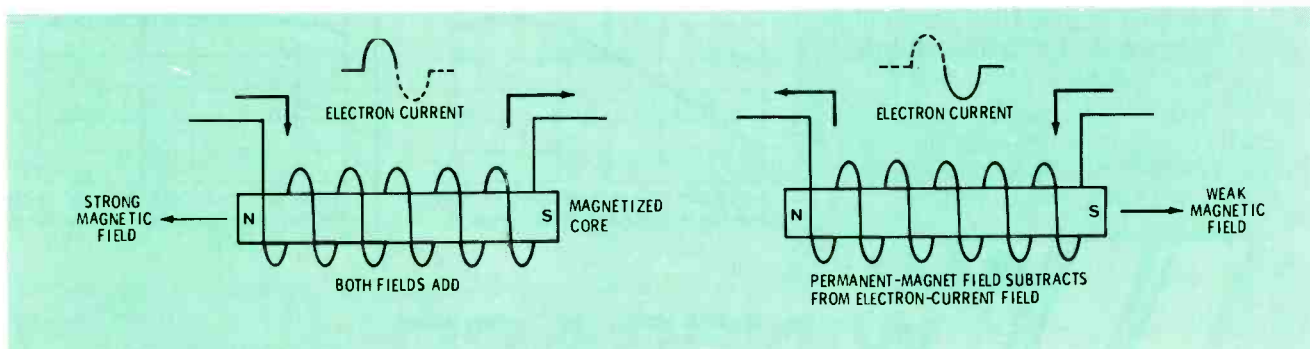
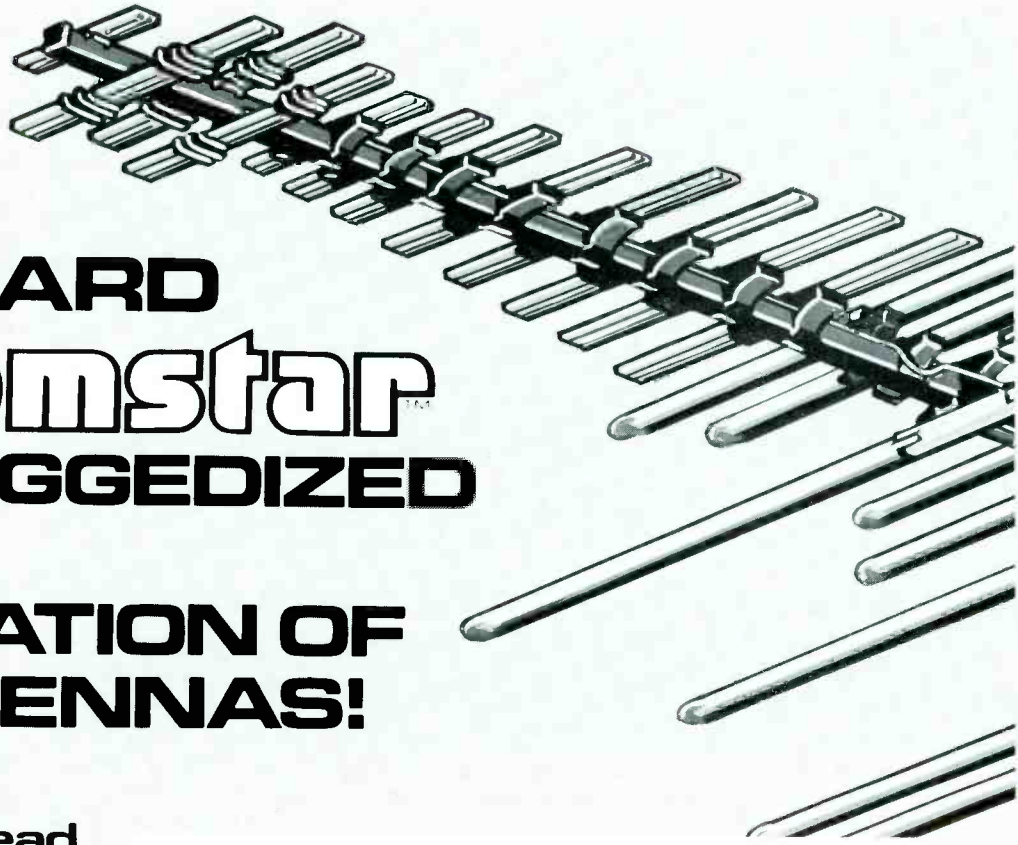

Fig. 3 Any permanent magnetization of the core in a tape head alternately aids and opposes the magnetic field produced by the winding current during recording, or picked up from the tape during playback. This causes distortion by making one peak larger than the other.



WINEGARD Chromstar™ THE RUGGEDIZED NEW GENERATION OF TV ANTENNAS!

**40 Models
With Far-Ahead
Features For
Finest Color
Reception Ever!**

**Ask your distributor
for complete information!**

- New Standard Of Excellence In Construction And Performance.
- Anodized and Ruggedized for Weather Protection and Long Life.
- Models To Solve Every Area Reception Problem.
- Most Powerful UHF and VHF Performance Ever.
- New Tri-Linear UHF Director System Extends UHF Reception Distance Up To 30 Miles Farther From Station in Many Areas.

PLUS... New Generation FM Antennas.
High Performance Ruggedized Yagis.
New Solid State Preamplifiers.



WINEGARD
TELEVISION SYSTEMS

3000 KIRKWOOD
BURLINGTON, IOWA 52601

NEW TRI-LINEAR UHF DIRECTOR SYSTEM*

Increases Gain up to 30%!

Provides broader signal capture area in a more compact configuration

ORDINARY UHF Director System.



5 1/4"

Uses half-wave directors approximately 5 1/4" long which respond primarily to the high end of the band, with very little gain on the low end.



55"

Boom length required for 12 directors

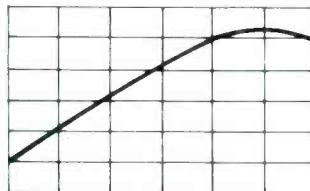

Typical gain curve with ordinary UHF directors. Note low response on low end of band.

WINEGARD High Gain Tri-Linear® Directors

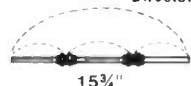

15 3/4"

Act as 3 half-wave directors on the high end of the band, and re-resonate as a loaded half-wave director on the low end of the band. This results in high linear gain on all UHF channels, giving the antenna sharper directivity and up to 30% more gain over other high gain UHF antennas.

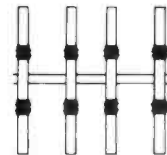

10"

Boom length required for 12 directors

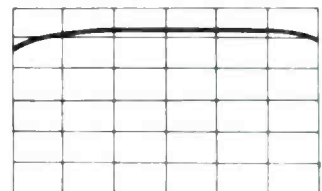

Typical gain curve with Winegard Tri-Linear directors. Note high uniform gain across entire band.

ANODIZED!

Exclusively Winegard! Elements are silver anodized, the boom blue anodized for the best possible protection for aluminum against corrosion and weather.

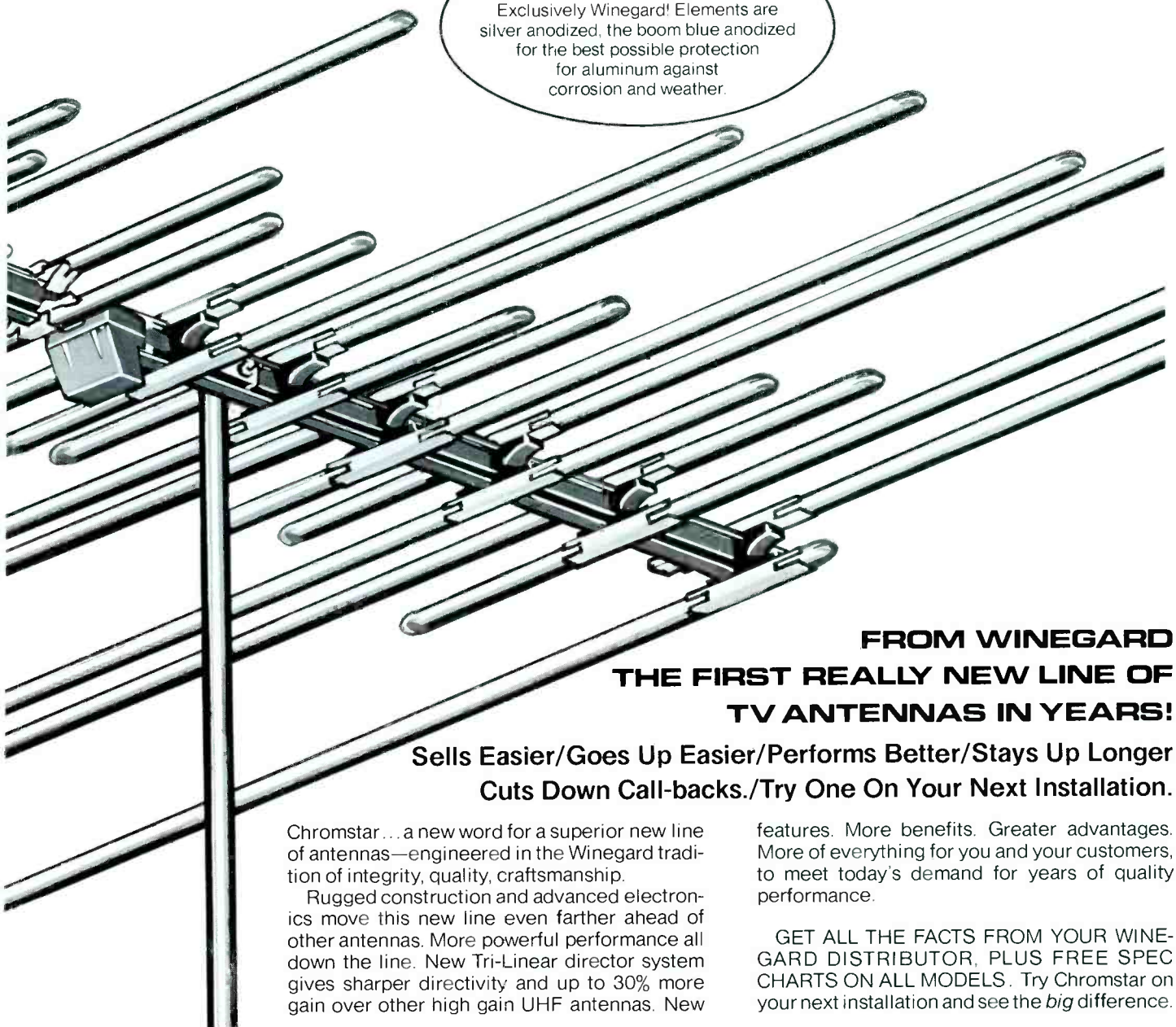

FROM WINEGARD THE FIRST REALLY NEW LINE OF TV ANTENNAS IN YEARS!

**Sells Easier/Goes Up Easier/Performs Better/Stays Up Longer
Cuts Down Call-backs./Try One On Your Next Installation.**

Chromstar... a new word for a superior new line of antennas—engineered in the Winegard tradition of integrity, quality, craftsmanship.

Rugged construction and advanced electronics move this new line even farther ahead of other antennas. More powerful performance all down the line. New Tri-Linear director system gives sharper directivity and up to 30% more gain over other high gain UHF antennas. New

features. More benefits. Greater advantages. More of everything for you and your customers, to meet today's demand for years of quality performance.

GET ALL THE FACTS FROM YOUR WINEGARD DISTRIBUTOR, PLUS FREE SPEC CHARTS ON ALL MODELS. Try Chromstar on your next installation and see the *big* difference.

RUGGEDIZED! Chromstar antennas are designed to defy weather and wear—are engineered for extra strength at all points of stress. You can actually see the difference in the rugged construction.

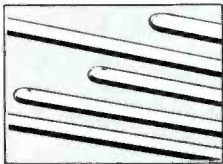

Exclusive 3/8" diameter aluminum tubing for 30% greater strength, better performance, longer life. Winegard is the first and only manufacturer to use this larger diameter.

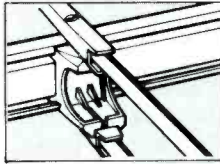

New truss-type phasing bars, top and bottom, with more conductive surface, give maximum transfer of signal. Truss-type "bridge" construction more than doubles boom strength.

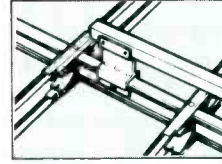

Double boom on longer flat line models for extra strength & rigidity.

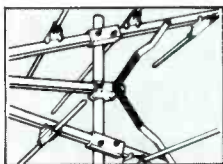

New scissors-type struts between upper and lower booms and center boom on wedge models, for extra support, easier installation.

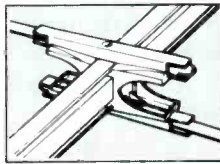

High-impact girder design support insulators are moulded of super-tough Noryl G-E plastic. Four positive locks give maximum support and permanent alignment.

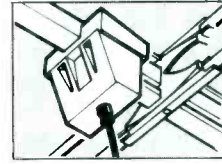

Critical-point weather protection! *New compact weatherproof cartridge housing for download, preamplifiers and filter modules. New printed circuit download module with both twin lead and 75 ohm coax connections. No separate matching transformer required.

TV ANTENNAS MORE PEOPLE LOOK UP TO

For More Details Circle (14) on Reply Card

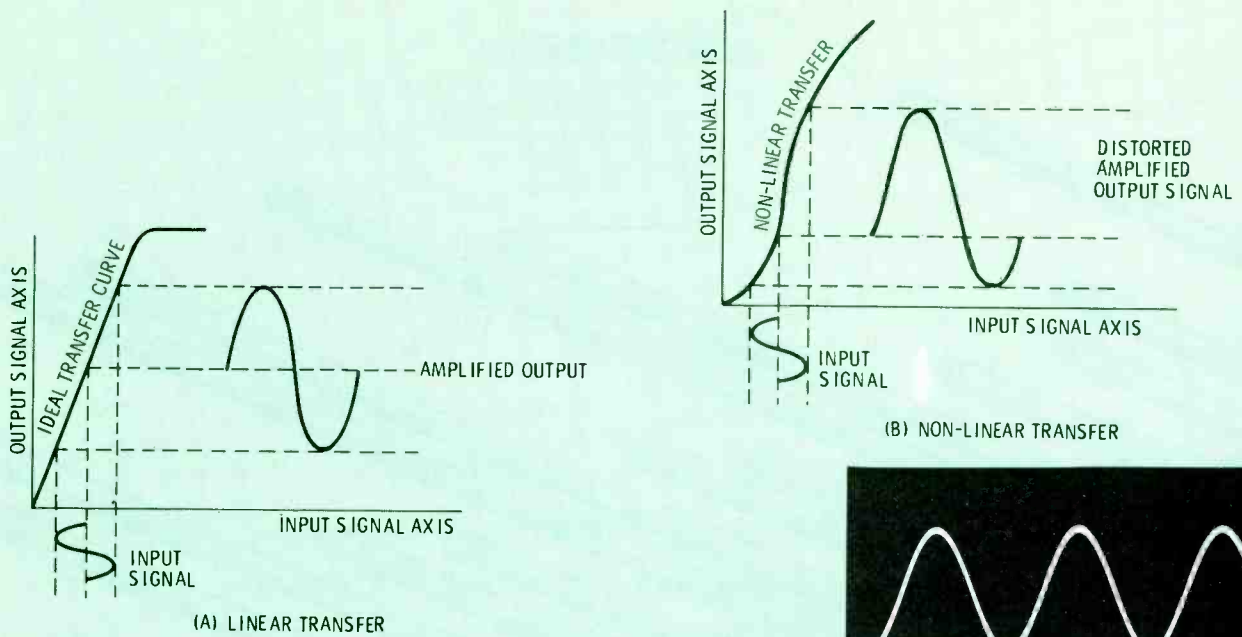

Fig. 4 An ideal transfer curve and a moderate input signal produces an amplified and non-distorted output signal (A). If the transfer curve is non-linear, the output signal (B) will be distorted. The top trace of (C) is a pure sine wave input, while the trace at bottom has rounded negative peaks caused by a non-linear transfer characteristic.

Amplitude (waveform) distortion

The graph of Figure 4 illustrates, in exaggerated form, how the transfer characteristics of an amplifier can create distortion. When the characteristic curve is linear, the output signal is undistorted (identical to the input, except for polarity and amplitude). Curvature of the transfer line causes the amplitude of the positive peak to be different from the amplitude of the negative peak. **This is a form of amplitude distortion**, although harmonic distortion also is generated, especially even harmonics.

All amplifying devices have some curvature of the transfer characteristics, although not so much as shown. Distortion can be reduced, but not eliminated, by operating over a narrow portion of the curve, and by operating at the most-linear section.

However, a transfer curve that is perfectly linear can contribute amplitude distortion. Either the top or bottom of the waveform can be clipped when the bias is wrong. Also, an excessive amplitude of input signal causes **both** peaks to have some clipping (Figure 5).

Because the linearity of the transfer-characteristic curve is af-

ected by the DC voltages applied to the amplifying device, it follows that making measurements of DC voltages is an important test for locating amplitude distortion. A defective amplifying component (tube, transistor, or FET) also can drastically distort the transfer curve.

Intermodulation distortion

When two or more frequencies pass through an amplifier that is nonlinear, the frequencies modulate each other, resulting in the addition of sum-and-difference frequencies to the original ones. **This is called intermodulation distortion (IM)**.

Suppose an amplifier has two input signals, 400 Hz and 1000 Hz (Figure 6). If the amplifier is linear, no intermodulation takes place, and the output has 400 Hz and 1000 Hz tones only. But nonlinearity produces other tones by adding 400 Hz and 1000 Hz to give 1400 Hz, and subtracting 400 Hz from 1000 Hz to generate 600 Hz. All four tones then appear at the output of the amplifier.

IM can't be eliminated completely, but it can be minimized by proper selection of the type of amplifying device, and the use of optimum bias and other operating

DC voltages. As with amplitude distortion, a good place to start looking for IM distortion is in those important DC voltages.

Harmonic distortion

A pure sine wave has no harmonic frequencies (multiples of the fundamental or lowest tone), and it has many important uses in measuring the performance of amplifiers. If you apply a pure sine wave to the input of an amplifier and get an output of a pure sine wave (no harmonics), the amplifier would be rated at 0% total harmonic distortion (THD).

Any modification or change of the original sine wave shape causes harmonics to be added. You can analyze and understand this by using **Fourier Analysis**. When I was in college, we called it "four-year analysis", because it seemed to take that long to complete a problem!

Any periodic waveform—regardless of how complex—can be considered by Fourier Analysis to be made up of a number of sine waves of the proper phase and amplitude.

Probably you know that a square wave is made up of a fundamental sine wave and a number of **odd**

harmonics, each decreasing in amplitude (100 Hz fundamental, 3rd harmonic 33%, 5th harmonic 20%, 7th harmonic 14%, etc.). Because of the special shape and frequency spectrum of square waves they often are used as a fast test of amplifier frequency response. Low-frequency attenuation causes a phase shift and a reduction of low-frequency amplitude which tilts the flat tops and bottoms, and a moderate amount of high-frequency attenuation rounds two corners.

Analysis of those changes in the shape of the square waves is a little tricky, demanding some study and experience for best results. But this much is easy: if the output square wave looks identical to the input square wave, you can be certain the amplifier has excellent frequency response.

If you apply a pure sine wave to an amplifier and obtain a non-sinusoidal waveform at the output, you can assume that the amplifier has added harmonic frequencies, and the output now has a fundamental and a number of harmonics. In fact, if the amplifier modifies the sine wave in any way, except amplitude and polarity, it produces **harmonic distortion**.

Crossover distortion

Amplifiers connected in Class-B push-pull arrangement (Figure 7) alternate the work load between the two output devices. One conducts and contributes power during the positive peak, then it has no current and the other device conducts during the negative peak. Ideally, there should be a smooth transition between these separate currents, resulting in a continuous, undistorted waveform. At least, that's the way it's supposed to work.

Seldom are tubes operated with a complete cutoff of current, but nearly all push-pull transistorized amplifiers are Class-B, in which each transistor has current only for **half** of each cycle. The problem arises when the input signal passes through the zero-voltage condition between the positive and negative peaks, because the non linearity is worst at that point.

If the transistor forward bias is insufficient there will be a time when **neither** transistor is drawing current. This is called **crossover dis-**

tortion, and it makes a little notch in each side of a sine wave, as shown in Figure 7B. The remedy is to apply just barely enough forward bias to wipe out the notch; or alternately, adjust the bias for minimum harmonic distortion at a low power output.

Another remote possibility is that the transformer is resonating with a capacitor in the output transformer circuit (Figure 7C).

Distortion In Speakers

I once saw in a customer's home an elaborate Hi-Fi system. The owner had insisted that the speaker out of his old (1940 or so) Golden Throat record player be used with the system. The speaker had a rip in the cone, and the paper of the cone was so dried it was brittle. A record, played through the speaker, had buzzes, rattles, and wheezes until I wanted to hold my ears. But the owner of the system loved it.

Now, the point is that regardless of the quality of the signal sources and the amplifying system, the sound can be no better than the speaker permits. Speaker distortion happens frequently.

Transient distortion

In a complete audio system, **transient distortion** is most likely to occur in the speaker. For example, the cone cannot move fast enough to follow a sudden sound such as certain kinds of drum raps.

Also, transient distortion happens when the speaker cone continues to vibrate after the electrical impulse is over. Sometimes this is called **hangover**.

Doppler distortion

Doppler shift is the apparent change of frequency when the relative speed between the signal source and the receiver is changing. It is used to determine the speed of stars. The classic example is a train whistle that sounds "flat" (lower frequency) as the train passes you and goes away. When the train is approaching, more cycles reach the ear per second, and when it moves away, fewer cycles reach the ear. Notice that the frequency at the source does not change, but there is a real difference of frequency at the receiver.

Suppose the cone of a speaker is moving forwards and backwards

More chances to be right



Thousands more cross references



Transistor kit for foreign sets

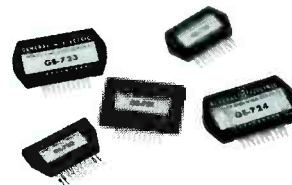

Replacement amplifier modules



All the help you need at your authorized distributor

Tube Products Department
General Electric Company
Owensboro, Kentucky 42301

GENERAL  ELECTRIC

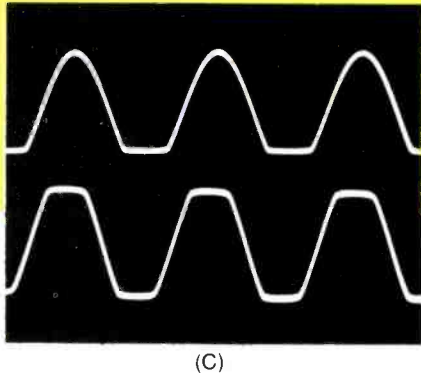
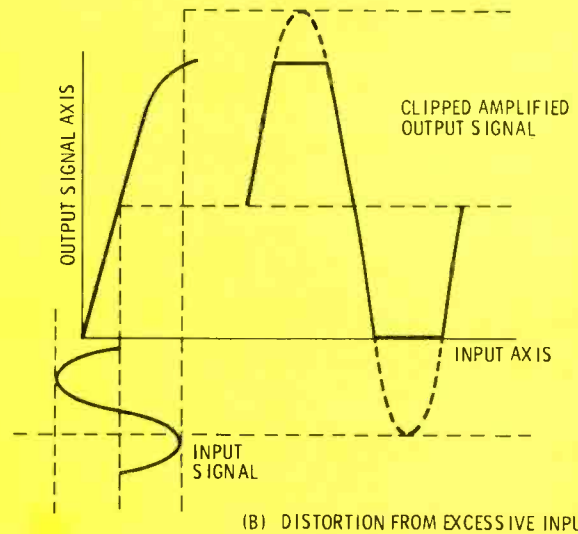
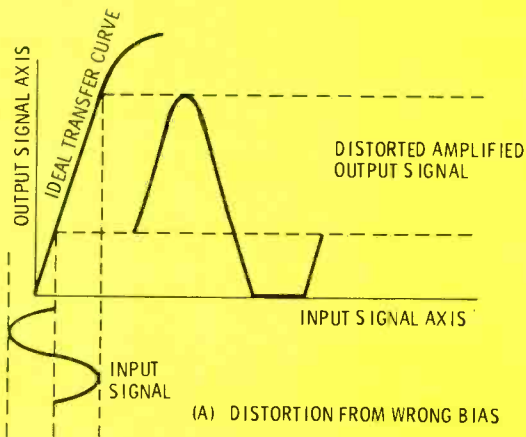

Fig. 5 Even an ideal and linear transfer curve can produce distorted output signals when (A) the bias of the amplifying device is wrong, and one peak is clipped; or (B) if the input signal is excessive, and both peaks are clipped. The waveforms of (C) show typical clipping of the negative peak, and the clipping of both peaks.

100 times a second (100 Hz) and at the same time is reproducing a 1000 Hz frequency. Will the slow movement of the cone towards and away from the listener change the frequency of the higher tone?

Editor's note: I have had some experience with this phenomena in electronic organs that have rotating speakers to give a type of vibrato [frequency shift at about 6 Hz]. Before a rotating speaker can provide a frequency swing wide enough to be pleasant to the ear, the speaker must travel around a horizontal circle that's several feet in

diameter. Compare that to a speaker cone which might travel $\frac{1}{4}$ inch, at most. Therefore, my opinion is that Doppler frequency shift does occur with speakers, but the amount is too slight to be heard as a separate effect. The use of several speakers, each one covering just a portion of the audio band, helps to reduce the already small amount of Doppler shift.

Whether Doppler-shift distortion exists or not, at least all audio experts seem to have heard about it.

Clipping

When more power is applied to a loudspeaker than it can handle, the cone moves to the limit of motion determined by the suspension and then stops, even though the signal to it calls for more movement. The result is a clipping of the peaks, in much the same way as during amplifier overload. Either the tops or bottoms (or both) of the waveforms might be clipped. Also, some speakers bottom-out when the cone moves in too far. When the voice-coil form strikes the magnet it causes a distressing sound, which sometimes appears to be noise or popping sounds.

The demand for reproduced music that exceeds the threshold of pain has brought specially-designed speakers capable of reproducing high wattages of audio, without burning out the voice coil or bottoming.

Nonlinear distortion

Nonlinear distortion by a speaker usually is the result of poor design of the speaker. Refer to the drawings in Figure 8. In the first example, the cone is at rest, and the voice-coil winding is centered in the magnetic field between the poles. When the cone moves outward, a part of the winding extends beyond the magnetic field, so that much of the winding is not effective. If it were possible for the winding to move completely beyond the field, then no increase of current could produce any more movement.

Any movement of the voice-coil winding outside of the field of the magnet produces a compression of movement, and results in distortion.

Another point to remember is that the voice-coil form and the winding must not touch the poles of the permanent magnet. A rattle, or a tinny sound, results from any such contact.

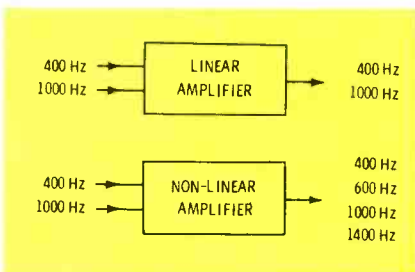

Fig. 6 A linear amplifier with an input of two frequencies has only those same two frequencies at the output. But if the amplifier is non-linear, the two frequencies will add and subtract from another because of intermodulation distortion, producing two more frequencies.

Usually, "rubbing" voice coils can be identified by removing the speaker from the cabinet and slowly moving the cone by hand as you hold the speaker near your ear. A scraping sound is proof of the defect.

Compliance

The word **compliance** sometimes is used in the rating of speakers. It is the measure of how well the cone "complies" with the commands of the signal from the amplifier, or how easily it moves with the music.

A high compliance rating is desirable for speakers, just as it is for cartridges. Low compliance produces audible distortion.

Damping Factor

A speaker has a low **damping factor** if it continues to vibrate after it is supposed to stop. Damping factor describes how quickly the

cone motion halts after the electrical signal stops. This damping is made up of many things, including the strength of the magnetic field, the weight of the cone, the kind of suspension, and even the stiffness of the air surrounding the rear of the cone inside the baffle.

Amplifier damping

A speaker that continues to have cone movement after the signal has ended becomes an inefficient generator, feeding voltage back toward the amplifier. Therefore, better damping of the speaker will result if the voice coil "sees" a low resistance when it feeds these spurious voltages back to the amplifier.

For example, suppose an 8-ohm speaker was connected to the 8-ohm tap of an amplifier, but the speaker acted as though it was fed from a 1-ohm source. (because of

amplifier negative feedback, primarily). The ratio between 8 and 1 is the damping factor. Some audiophiles say the damping factor should never be less than 15, but it's unlikely you would be able to hear any improvement from any damping factor over 20. Low damping factors encourage speaker **hang-over** (sounds after the signal stops).

Don't defeat the high damping, that has been carefully built into good amplifiers, by using connecting wire of small gauge, or by connecting unnecessary loss pads, or other gadgets, which add resistance between amplifier and speaker.

Next Month

Types of noise and distortion have been defined. The next step is to describe methods of measuring these characteristics, and reducing them to minimum. □

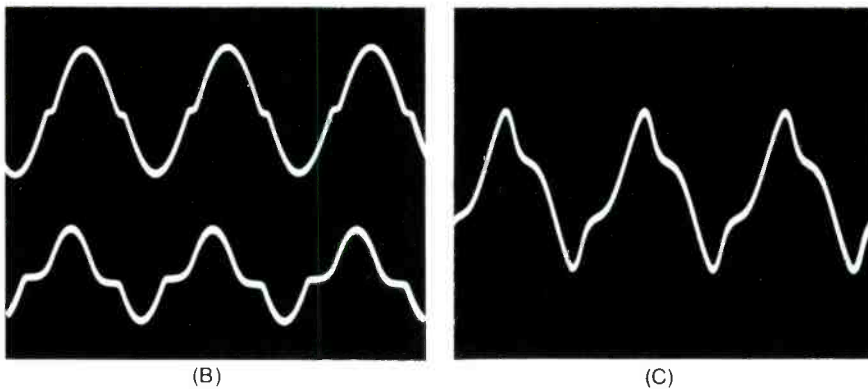
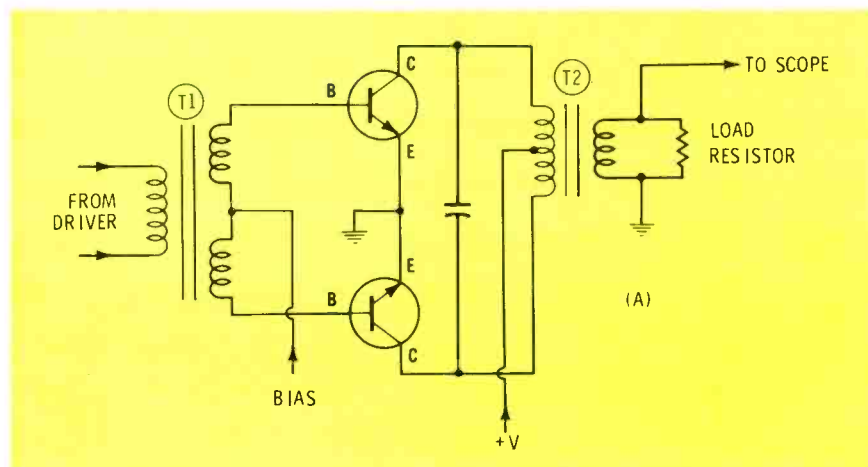

Fig. 7 This simplified schematic of a Class-B transistor output stage is typical of those with transformer coupled driver. To minimize crossover distortion, the forward bias is varied until the notch disappears, or the distortion is minimized. Contrary to most distortions, crossover distortion is worse at low volume levels, as shown in (B). The notch remains the same at both levels, but the *percentage* is worse when the amplitude of the signal is reduced (lower trace). Switching transients in the output transformer can cause ringing with any bypass capacitors in the output stage (C).

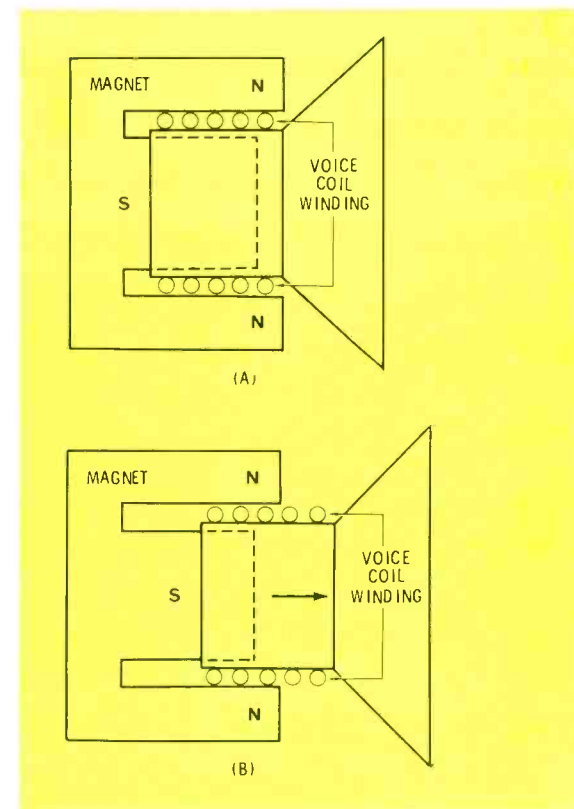

Fig. 8 Rounding of the peaks can occur in speakers if the movement of the cone forces the voice-coil winding outside of the magnetic field. Normal positioning is shown in the cut-away drawing of (A), while excessive cone travel (B) moves part of the winding to where it is ineffective because it is outside of the field. This is just one of many possible kinds of speaker distortion. □

Forest H. Belt's EIGHT-TRACK WORKSHOP

Session 2/Conducted by Dewey C. Couch

This Workshop series presents time-saving, systematic service procedures for eight-track tape mechanisms. Last month, we showed techniques for cleaning, lubrication, and visual inspection. Session 2 explains testing, adjustment, and diagnosis.



Both stereo and quadriphonic eight-track operation, plus an AM/FM-quadriplex radio, are features of the Model A295 Lear Jet under-dash auto-stereo unit. (Courtesy of Lear Jet)

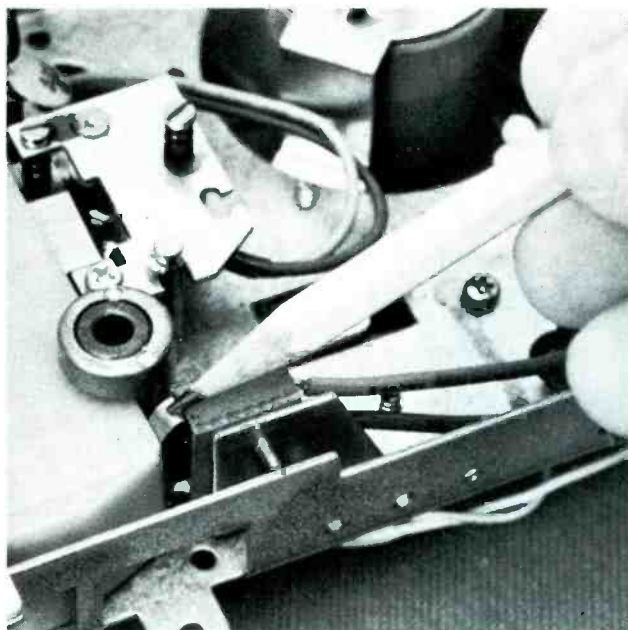

Step 1. After you've thoroughly cleaned and inspected the machine, check its various operations. You can learn a lot by watching the assemblies go through their various functions. First, let's examine those in the tape-drive section. Insert a cartridge and see if the motor starts. The cartridge should press against an actuator which closes a microswitch (a leaf switch in some machines) to power the motor. Make sure the actuator is not bent or binding.

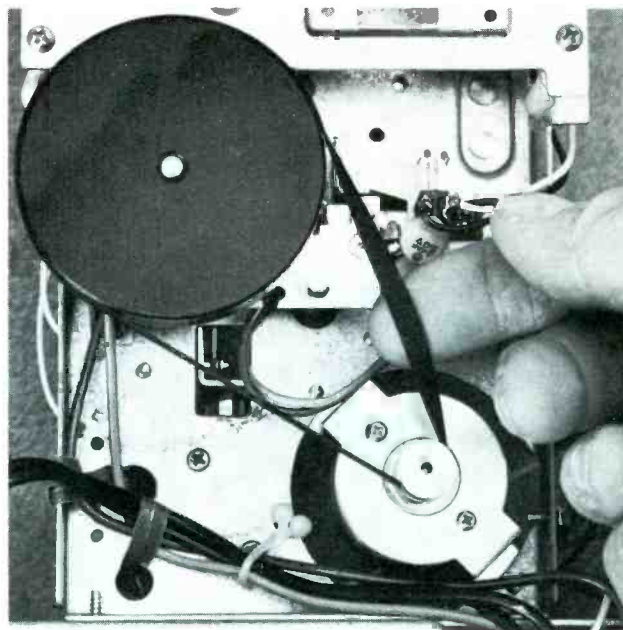

Step 2. The motor pulley, through a rubber belt, drives the flywheel. Check belt tension. A loose belt allows slippage, usually right there at the motor pulley, resulting in slow or erratic tape transport. Playback or recording speed can vary, delivering a "wow" on playback or a Donald-Duck sound at some spots in recordings. If the belt appears loose or sloppy, install a new one. Don't touch the new one with fingers. And be sure the pulley is clean, as you saw in Session 1.

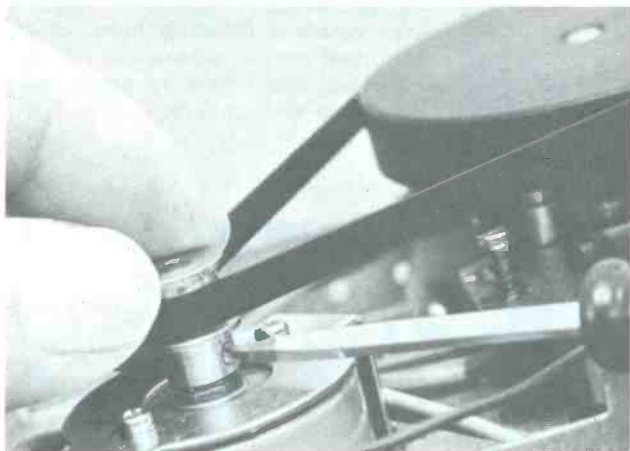

Step 3. Watch the belt travel around the flywheel. It should ride smoothly, with no up-and-down movement. If the belt rides too high or too low on the flywheel, the motor-mounting bracket (if the machine has one) probably is bent. Or, the motor pulley might be wrongly positioned on the motor shaft. Some pulleys are adjustable—you can slide the pulley to line it up with the flywheel. Just loosen the setscrew and position the pulley so the belt rides evenly on the flywheel. Don't forget to retighten the setscrew. And then reclean the pulley with a Q-Tip and alcohol, to remove finger-oil.

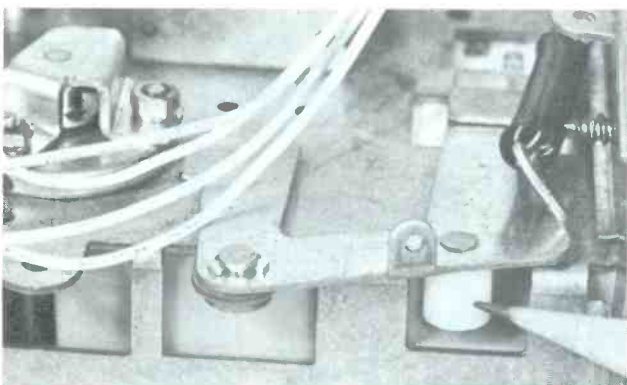

Step 4. Push in a cartridge to see if it seats properly. A detent roller should seat into a notch at the edge of the cartridge, forcing the cartridge fully into the playing slot. A pinch roller inside the cartridge presses the tape firmly against the capstan. Too-light pressure might let the capstan slip on the tape, then tape speed would be slow or erratic. Too much pressure between pinch roller and capstan digs the capstan into the rubber roller, causing excessive roller wear and possible tape breakage.



Step 5. You can use an inexpensive fish scale to check cartridge pressure. Fasten the ends of a strip of sturdy tape directly behind the pinch roller on top and bottom of the cartridge, forming a loop outside the cartridge. Insert the cartridge into the machine to be tested, and start the machine playing. Hook the scale into the loop. Pull on the scale until the output sound just starts to distort. Notice what the scale indicates. Three to five pounds is nominal. If cartridge pressure is not within this range, investigate three possible suspects: the pressure roller could be binding or frozen, the pressure lever might be bent or binding, or perhaps the tension spring is weak or bent.

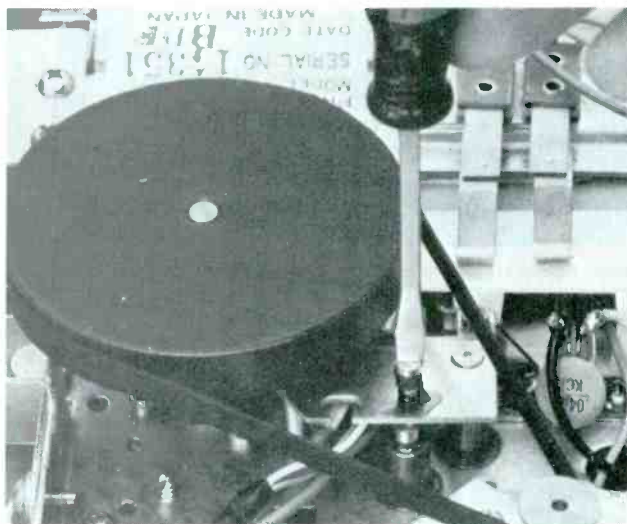

Step 6. Symptoms sometimes mislead. They might suggest an electronic malfunction, when they actually come from a mechanical irregularity. Low volume and distortion are examples. Play a familiar cartridge, one containing sustained high notes. Or, use a test cartridge. If sound is weak or distorted, suspect a dirty, defective, or maladjusted head. Most eight-track machines have two head adjustments: height and azimuth. The **height** adjustment lets you move the vertical position of the head gaps to conform precisely with the tracks on the tape. To adjust head height properly, play an alignment cartridge and rotate the height adjustment screw until right and left outputs are clear and equal, with minimum crosstalk from adjacent tracks. Your AC VTVM or DVM connected across speaker outputs, makes a satisfactory indicator. Instructions on or with the test tape point out which test segment to use.

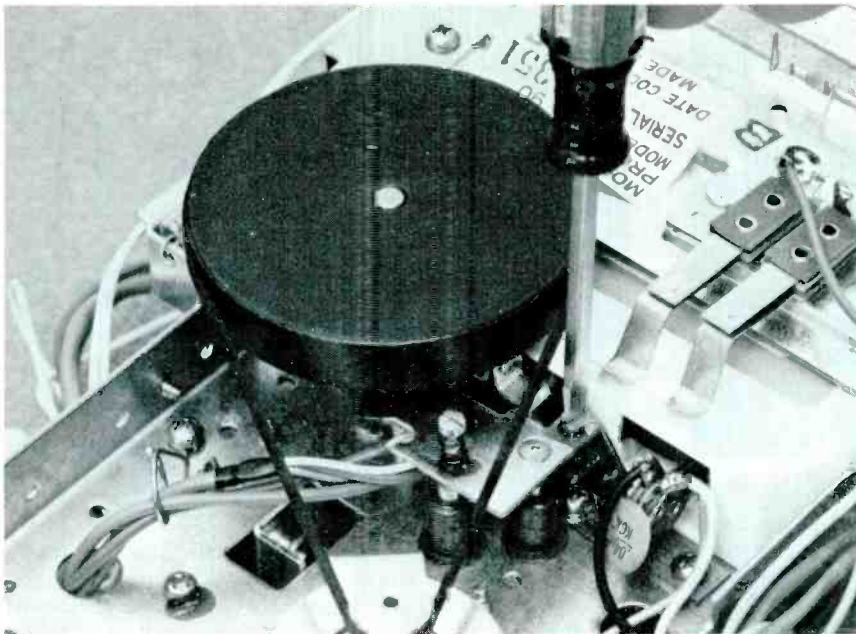

Step 7. The azimuth (tilt) adjustment lets you align the head gaps exactly perpendicular to the tracks on the tape. Any off-tilt reduces high-frequency response. Use the same cartridge as in Step 6. Play the high-frequency segment of the test tape, and adjust the azimuth-adjustment screw for maximum output on the indicator meter. Recheck the height adjustment; you could have altered it during azimuth alignment. Anytime you replace a defective head, or for any other reason remove and reinstall the head, you'll have to adjust both the height and azimuth.

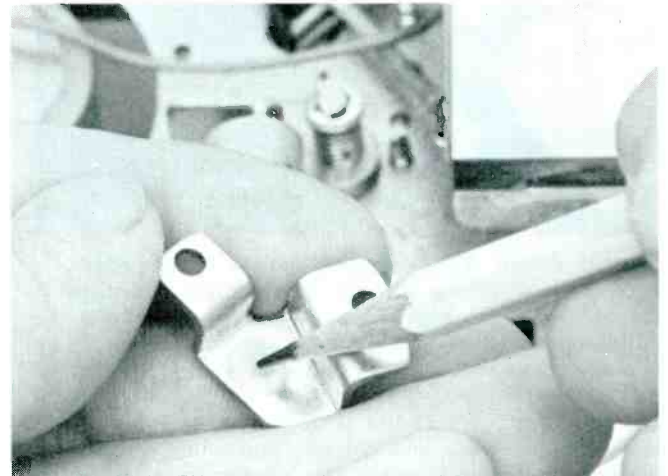
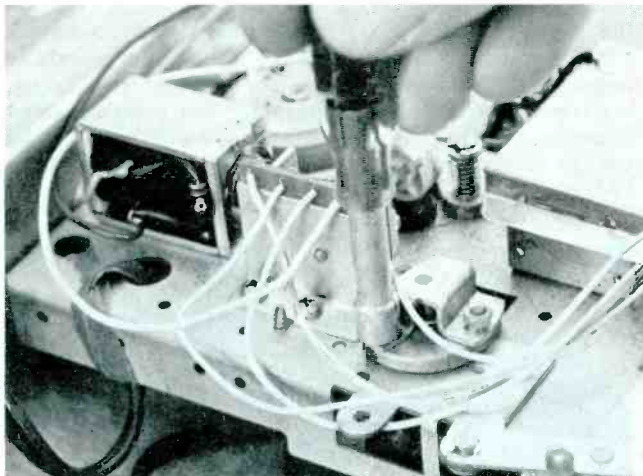

Step 8. Insert a blank cartridge, or actuate the motor-power switch without a cartridge in the slot. Listen for unusual sounds: squeaks, grinding, etc. The flywheel might rub some other part, or the flywheel thrust bearing (if the machine has one) could be worn or misaligned, allowing the flywheel to rub the chassis. You can remove the flywheel bearing bracket for closer inspection of the bearing, or to replace it.

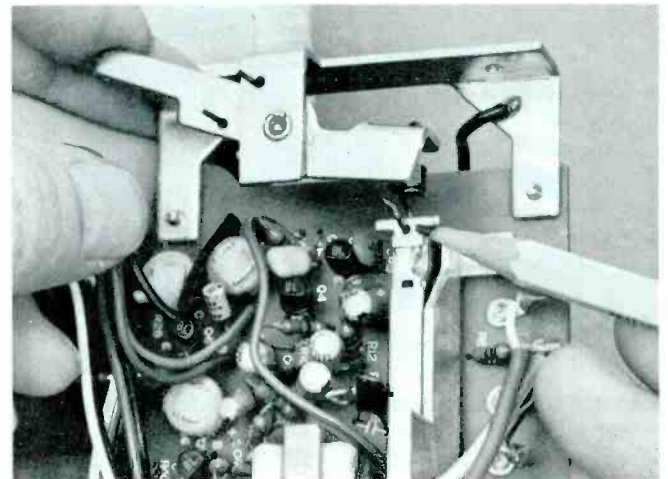
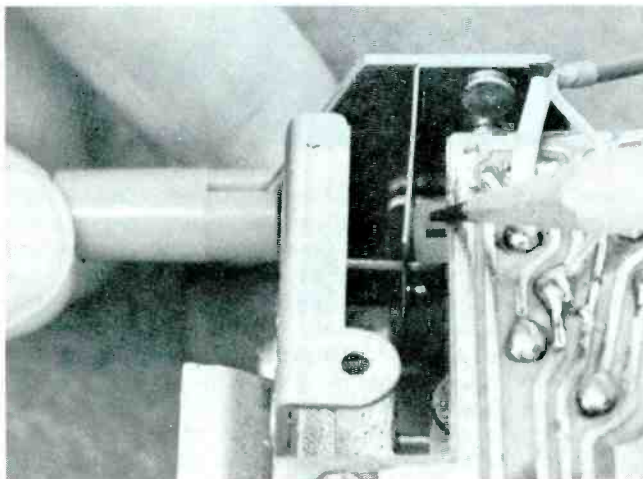

Step 9. Try recording, if the machine is a recorder. Push the Record button and watch the assemblies involved. The recording slide and its associated parts must move freely. Watch especially the spring on the recording slide that moves the record/play switch on the printed-circuit board. Leaf-type actuating springs sometimes become bent and fail to break or make as they should. Coil springs are prone to getting knocked loose or weakening. If either kind is damaged, install a new spring.

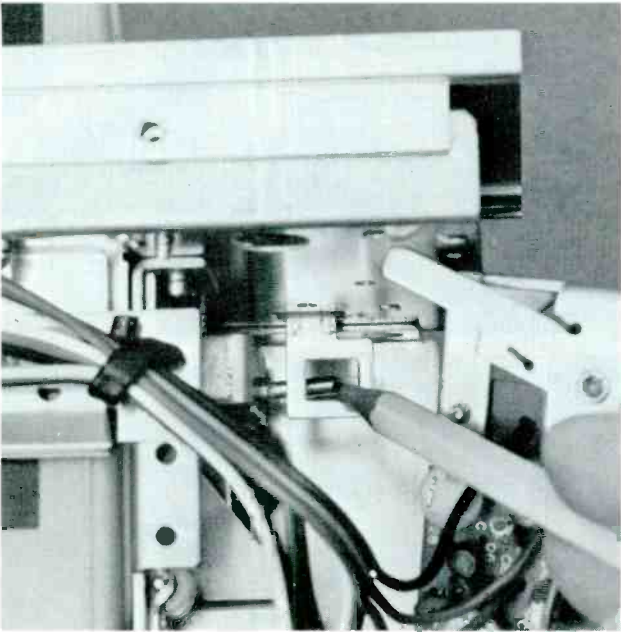
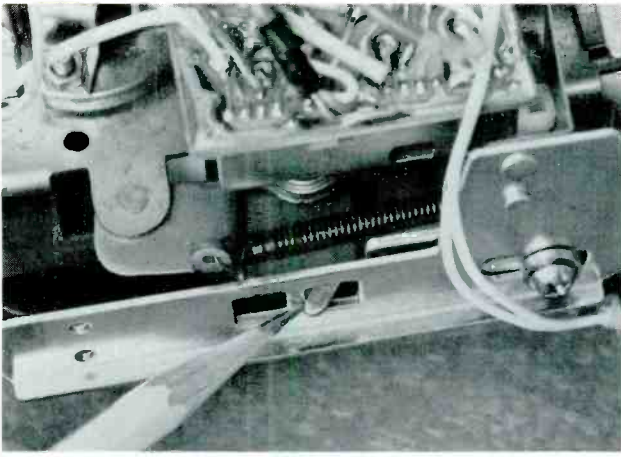

Step 10. Check the record-latch mechanism, which prevents accidental recording. Hold the Record button down and insert a cartridge. The cartridge should press a small plastic roller, mounted on a spring-loaded record-latch arm, and the pressure pivots the latch arm. A tab (or finger) on the arm engages a slot in the recording slide, holding the slide in the Record position. Be sure that no slides or levers are bent or binding.

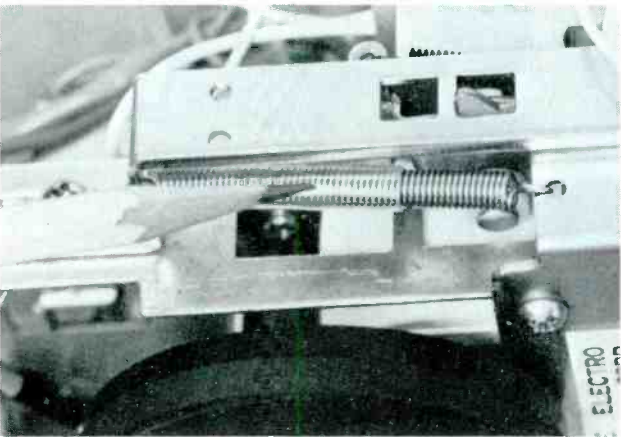

Step 11. Remove the cartridge and watch the recording slide return to its non-recording position. Be sure the spring is not stretched or loose. The switch must return to Play position, too.

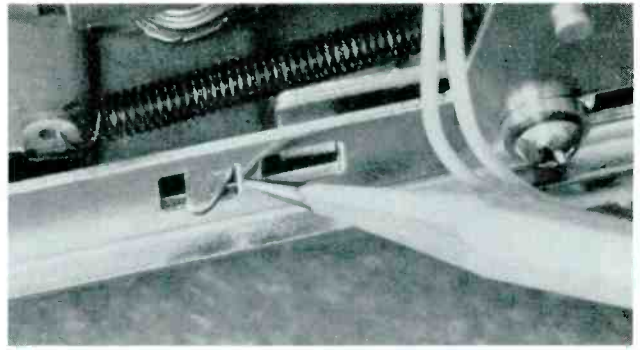

Step 12. Try pushing the Record button down (or in) after you have a cartridge inserted. A tab on the record-latch arm should engage another slot in the recording slide, holding it in the non-recording position. If you **can** push the button in with a cartridge already in place, the recording slide or latch arm is bent or worn, and should be replaced.

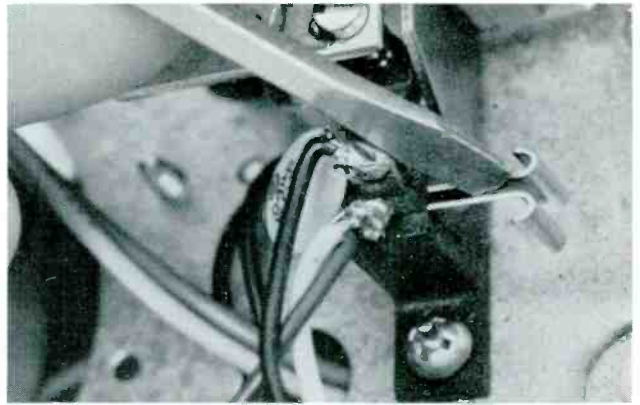

Step 13. Inspect the track-selector mechanism. Play a cartridge through the end of a program and watch how the assemblies move. Punch the program-selector button and again watch the result. If the solenoid plunger doesn't move, try shorting the contacts of the sensing switch with a screwdriver. That'll tell you whether the fault is at the sensing switch, or at the solenoid.

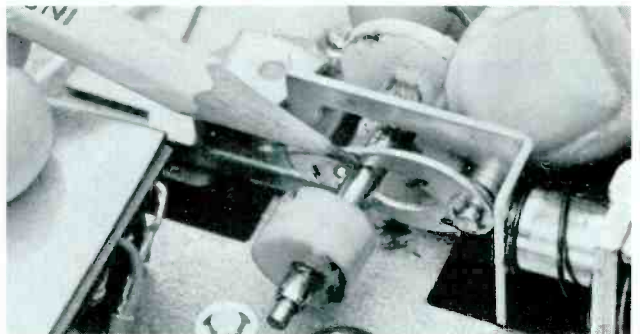

Step 14. Actuate the track-change solenoid by hand and see if the selector cam rotates. Cam and ratchet pawls must not be worn, and should be well lubricated. Rotate the cam yourself, one step at a time, and watch the head. It should drop freely from the level of one set of tracks (on the tape) to the next level. If the head doesn't move, the head tension spring might have been jarred loose. Try lifting the head-plate up and down by hand. You can feel if any shafts or bushings bind; in some cases, the head plate might be twisted. Check the head wiring. Wires must not interfere with movement of mechanical parts.

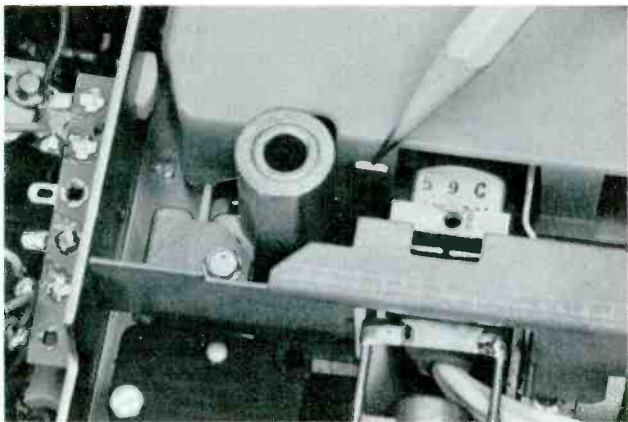

Step 15. Push the Pause button (if the machine has one). First of all, the cartridge moves away from the head and capstan, about 1/8 inch or so. A latch should hold the button down and keep the mechanism in the pause position. Motor and flywheel turn, but the tape should not move. On the machine illustrated here, a tab on the end of the eject lever pulls the cartridge back. Make sure the tab hasn't bent or broken off.

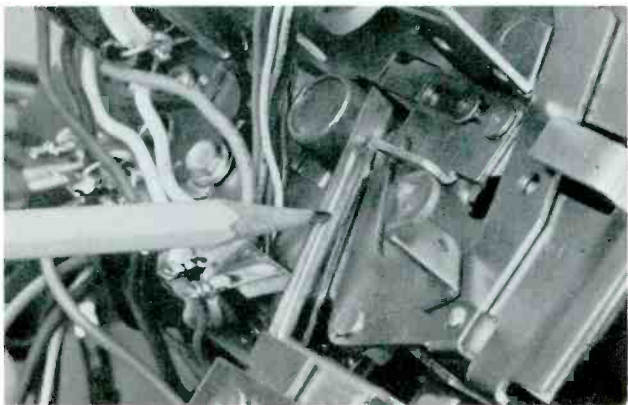

Step 16. Follow movement of the pause assembly as you push the button. The pause slide pivots a lever. A heavy leaf spring, mounted on the lever, pushes the eject lever back about 1/8 inch. Make certain the leaf spring is not weak or bent, and that all slides and levers move freely.

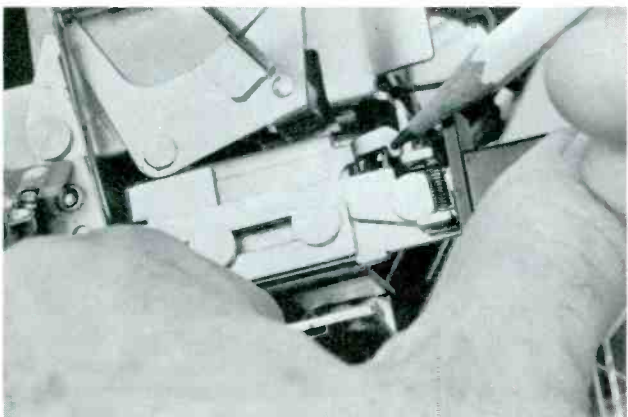

Step 17. Press the Pause button again. The pause mechanism should unlatch. A spring pulls the pause slide back to its original position, relieving pressure on the pivot lever. The cartridge returns to the playing position. The machine resumes operation (which may be play or record, depending on what it was doing when you pushed the Pause button).

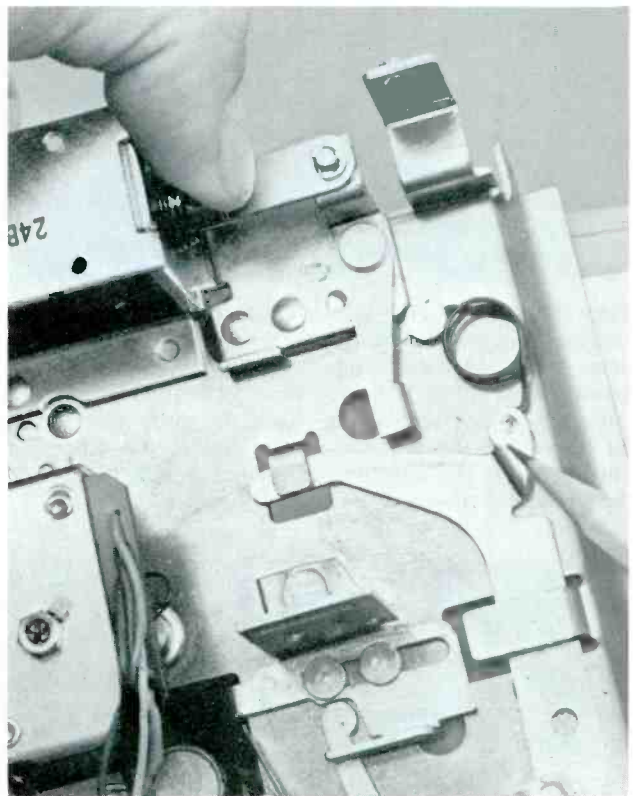
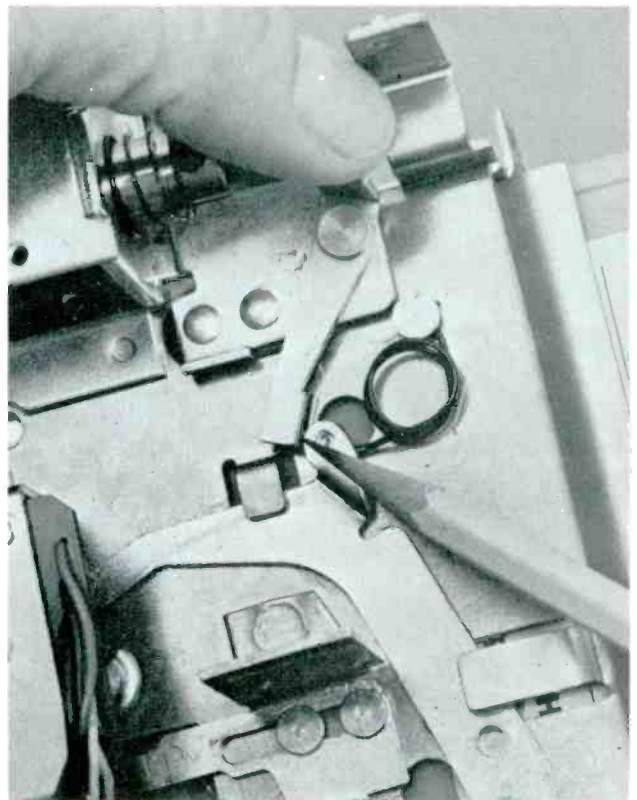

Step 18. Try the Eject button (if the machine is so equipped). In most eight-track machines, a solenoid powers the ejection mechanism. If the cartridge fails to eject, try moving the solenoid plunger by hand. Study the eject levers, slides, and springs. They can't move as they should if they're bent, weak, broken, or missing.

Our final session next month takes you step-by-step through a typical eight-track mechanism, including trouble symptoms and cures. □

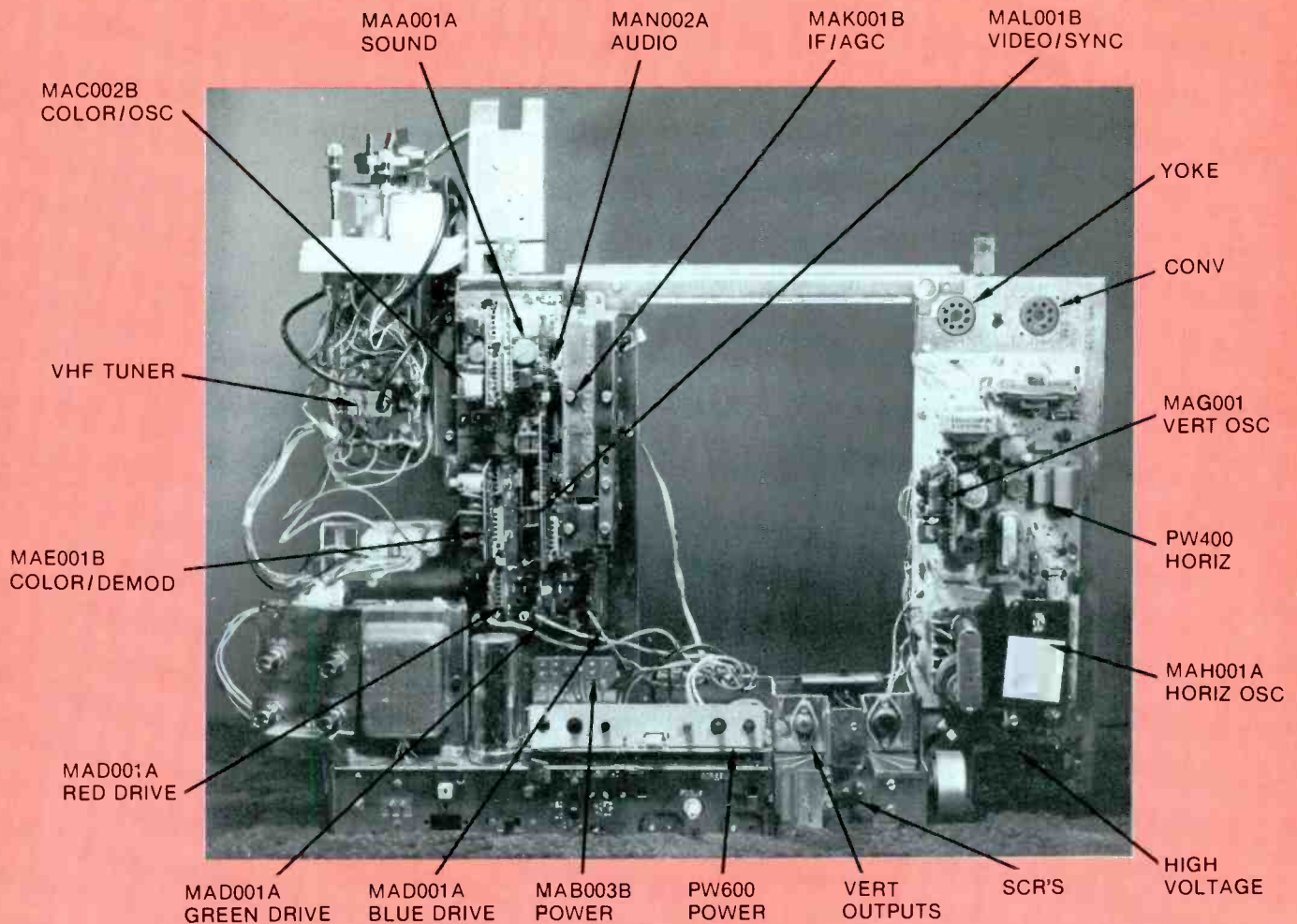

Fig. 1 Arrows point out the locations of the circuit boards and 12 modules of the RCA CTC58 XL-100 chassis. The tuners and front controls are shown in the service positions for testing outside the cabinet.

SERVICING RCA XL-100

Part 1/By Gilbert J. Grieshaber

Special features, power-supply circuits, and degaussing operation of the RCA CTC58 chassis are included in this opening article.



Special Features

Some important features of the RCA CTC58 chassis include:

- all-solid-state (except for picture tube);
- modular construction with 12 plug-in modules;
- transformerless vertical sweep, without a linearity control;
- matrixing of video and chroma before the color signals are applied to the three cathodes of the picture tube;

- delta-type picture tube with HV focusing and conventional convergence and pincushion correction circuits;
- horizontal sweep by controlled ringing using SCR's and diodes as switches;
- excessive high voltage activates a protection circuit, changing the horizontal oscillator frequency so it can't be locked by the hold control; and
- many IC's are used, and several functions (such as color, tint, and volume) are controlled by varying voltages that are applied to the IC's.

General Layout

Figure 1 shows the general layout of the CTC58 chassis, including the 12 modules. At the bottom is a metal chassis containing most of the power-supply components, including the power transformer, filter capacitors, and the PW600

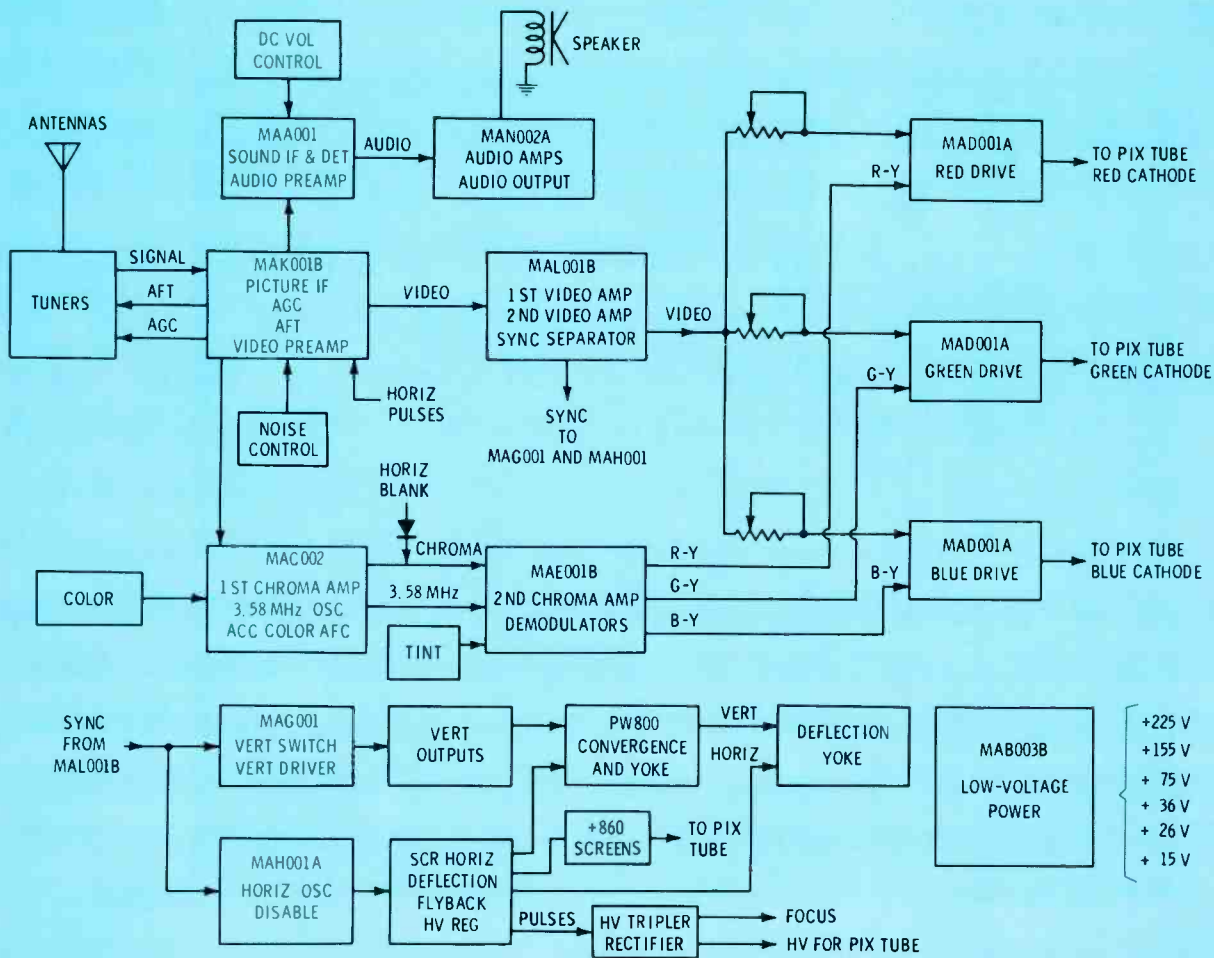

Fig. 2 Functions of the various modules and a flow chart of the signals are included in this block diagram, which is useful for troubleshooting.

circuit board. Power-supply module MAB003B plugs into PW600, and it has 9 rectifier diodes plus the degaussing components.

Miscellaneous small components and the sockets for the other 11 modules are mounted on the vertical part of the chassis.

A block diagram of the entire receiver, including the main functions of the modules, is given in Figure 2.

Power Supply Circuits

Of course, every TV receiver must have a power supply. Many models use well-known circuits, and we seldom give them a second glance. However, the RCA CTC58 has several variations that we should understand before any troubleshooting is started.

Let's look at the power-supply schematic in Figure 3. At first glance there doesn't seem to be anything very unusual; just a couple of bridge rectifiers and a

single diode. If the circuit is so simple, how can **four** basic DC voltages come from so few parts? Also, diode CR1 appears to have an output of +225 volts from an input of only 60-volts RMS. These circuits merit detailed study.

Combination bridge and full-wave

Four diodes (CR2, CR3, CR4, and CR5) operate in two different modes to give both +75 volts and +39 volts DC. If the actions of both DC supplies are analyzed simultaneously, the explanation becomes extremely complicated. It's easier to understand them separately. But first, there's some information about waveforms we need to know.

Unusual waveforms

I was amazed to find that all the secondary voltages from the power transformer have some of the positive and negative peaks clipped off. (Figure 4). Even the heater voltage

for the picture tube showed the same waveform, until the MAB003B module (including all 9 power-supply diodes) was unplugged. Then the AC voltages changed to the conventional sine waves. Apparently the total current drawn by the various rectifiers was so strong that it caused a voltage drop across the DC resistances of the power-transformer windings.

+75-Volt Supply

Starting with the easiest circuit, the +75 volts comes from a bridge (CR2, CR3, CR4 and CR5) with an AC input of 60-volts RMS. C103A makes the action peak-reading, and minimizes the ripple. The anodes of CR2 and CR3 are grounded as usual, but by way of a detour through interlocks in the yoke and convergence plugs, so if either connector is unplugged, the power supplies all have zero voltage, except for the +75-volt supply, which will have about +40. (CR4 and

CR5 then operate as a full-wave rectifier, with the load of the +36-volt supply acting as a ground for the centertap of the winding; see Figure 3.)

Testing a bridge circuit

Did you ever look at the waveforms and measure the DC voltages where the AC connects to the bridge? The peculiar waveforms in the CTC58 made me curious enough that I breadboarded a simple bridge circuit and measured the results, which are shown in Figure 5. The waveforms varied somewhat according to which way the AC plug was inserted in the outlet. Because the circuit floats, and is grounded only through the diode conductions, stray capacitances and unbalances play a large part in determining the exact waveform.

Even though the secondary of the transformer used for the test had a good sine waveform, the waveforms at both of the AC-input wires (to ground) was approximately a square wave. That's because the diodes connect each input point alternately to ground and to B+ during the cycle. So, when one diode conducts and connects an input to ground, that part of the waveform is zero volts. During the other half of the cycle, the other diode connects the same input to B+. (The same action also takes place at the other AC input, but reversed.)

Therefore, the top of each waveform (from AC input to ground) represents B+ voltage, and the bottom of the waveform is ground, or zero voltage. Because each AC input is connected to B+ for the same length of time that it is connected to ground, **the average DC voltage measured there is approximately 50% of the B+ at the output of the bridge.** Or, to look at it another way, the waveform at each AC-input point consists of positive-going square waves, so **the average DC voltage will be about one-half of the total peak voltage.**

Back to the +75-volt bridge

Measurements and waveform analysis of the +75-volt supply proved that it, too, followed the general conditions given for the breadboarded circuit, except for the clipped sine waves from the power

New Value For The Cost-Conscious Buyer \$1050 includes:



- 10 MHz at 10 mV/div •Dual Trace
- Compact Size (4" X 9" X 11") •Probes and Batteries

If your requirement dictates a portable oscilloscope with dual trace and 10 MHz at 10 mV/div sensitivity, but your budget demands frugality, then you should consider the new TELEQUIPMENT D32. It offers 10 mV/div to 5 V/div in 9 calibrated steps, automatic selection of chopped or alternate mode, depending on sweep speed setting, plus automatic selection of tv line or frame display. It also offers a choice of battery or ac line operation . . . with up to 4 hours continuous operation from 6 rechargeable, 'D' cell batteries. The batteries, two probes, and a molded front-panel protective cover are all included as **standard equipment.**

We feel the D32, at only 10 lbs., is

well suited as a servicing tool. Especially for industrial manufacturing, computer peripherals, and voice communication equipment. And it should be considered for servicing the rapidly increasing number of consumer electronic products.

If you agree and would like a demonstration at your convenience and in your environment, or simply additional information, contact your local Tektronix Field Office or write: Tektronix, Inc., P.O. Box 500, Beaverton, Oregon, 97077.

U.S. Sales Price FOB Beaverton, Oregon



TEKTRONIX®
committed to
technical excellence

For More Details Circle (23) on Reply Card

Solution to:

HI, RESISTANCE!

- | | | |
|----------------|---------------|-----------------|
| 1. retentivity | 10. clearance | 18. Curpistor |
| 2. Leatherette | 11. resnatron | 19. crossover |
| 3. varicoupler | 12. exosphere | 20. insulator |
| 4. grasshopper | 13. focometer | 21. conductance |
| 5. chrominance | 14. circuitry | 22. permanent |
| 6. termination | 15. trinistor | 23. abfarad |
| 7. performance | 16. antinodes | 24. subsystem |
| 8. multiband | 17. monopulse | 25. drift |
| 9. billboard | | |

Start with 100 points and deduct 4 points for any part you may not have answered correctly.

Your rating:

- 60-64 tch-tch.
- 68-72 Better.
- 76-84 Very good.
- 88-96 Excellent.
- 100 PERFECT!

Give yourself a pat on the back!

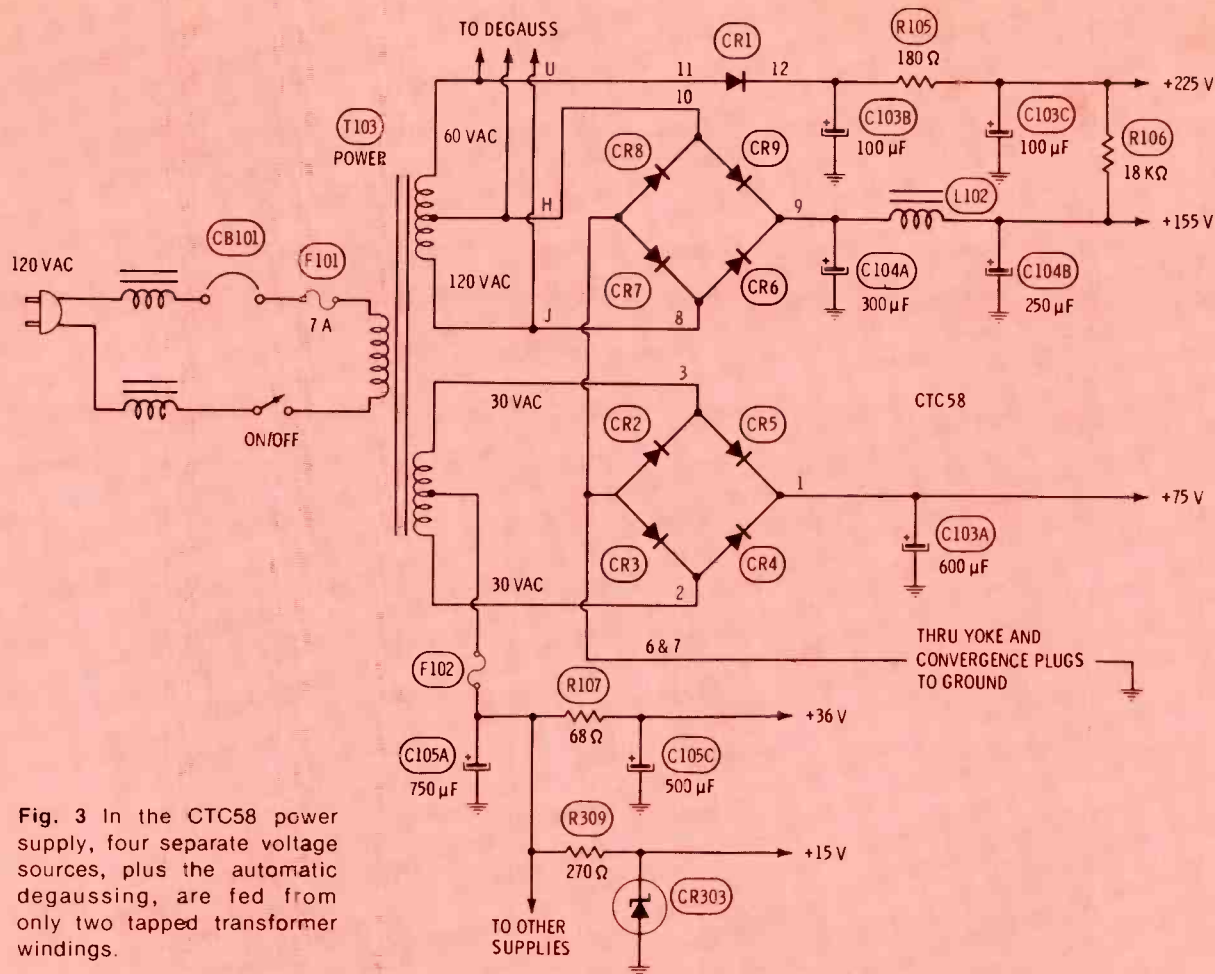

Fig. 3 In the CTC58 power supply, four separate voltage sources, plus the automatic degaussing, are fed from only two tapped transformer windings.

transformer, and the centertap of the winding. The waveforms are shown in Figure 6. They are opposite in polarity, but otherwise are identical. And the reason they have identical waveforms is because the centertap of the transformer is by-

passed to ground, thus giving the winding push-pull action.

Now, a bridge rectifier does **not** need a centertap of the transformer winding, although this one **has** a centertap. What's more, the centertap is the source of the +36-volt

supply! Question: what would happen if there were no centertap?

Bridge without centertap

As an experiment to determine how much the DC voltage, ripple, and other parameters would change

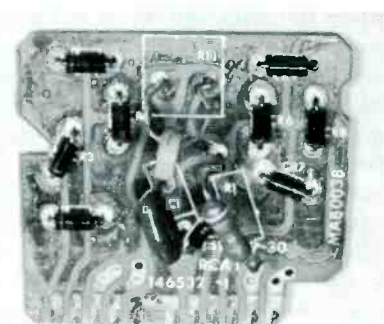
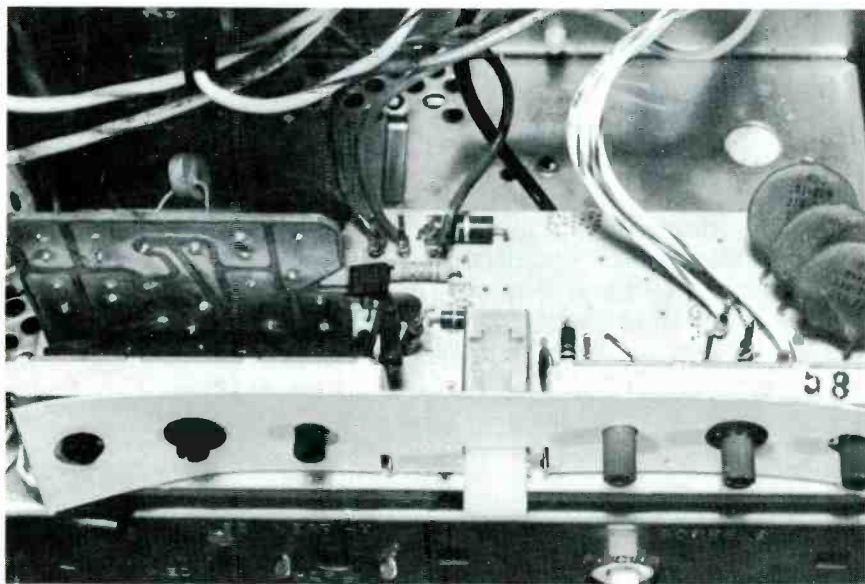

Power-supply board, PW600, has six controls, the service/normal switch, several power supply and other components, and the socket for the MAB003B power supply module. The MAB003B module has nine diodes, three degaussing components, and has copper wiring (that acts as a heat sink) on both sides.

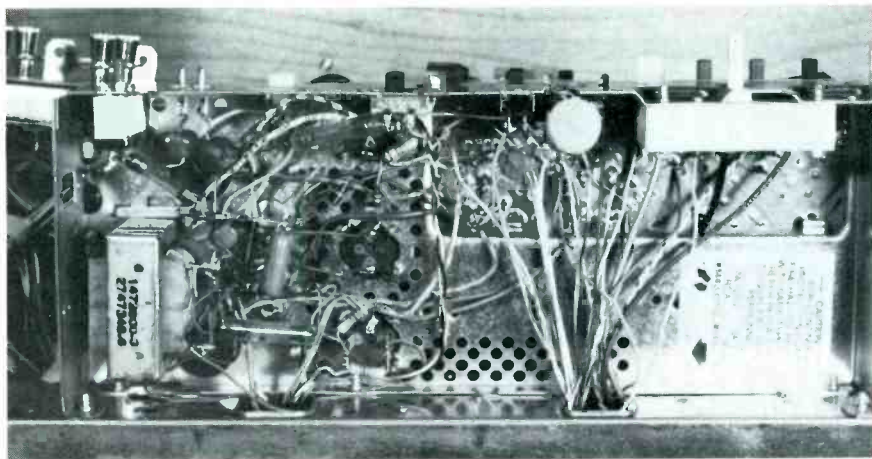

Underneath the chassis are the filter choke, two fuses, some power-supply wiring, and the lower side of PW600.

without the centertap circuit, F102 was disconnected. Of course, this eliminated the +36-volt supply and killed the TV, but the operation of the bridge was unchanged, except for the waveforms (Figure 7), and the slightly-higher DC voltage (because of lighter loading).

Apparently there are two reasons for the non-identical waveforms. The bridge now is floating, and subject to capacitive unbalance. Also, one diode is not matched to the other three.

Let's go on to the mystery of the +36-volt supply.

The +36-volt supply

Disable the +75-volt supply by unsoldering CR4 and CR5, and the remaining circuit becomes a full-wave supply operating from two diodes and a centertapped winding. (Figure 8 shows it is reversed from the usual wiring, but it works. Remember that rectified voltage coming from the cathode, even indirectly as here, is positive).

Each diode operates alternately, conducting whenever its anode is positive, so the ripple is 120 Hz, and the DC output voltage (peak reading) is slightly less than 1.4 times the RMS voltage of one side of the winding. The DC output is about +38 volts, which is reduced by R107 to +36 volts.

Another +36 volts

In the process of testing the various rectifier configurations, I wondered if there were a way to obtain a DC voltage equal to half the bridge output without using a centertapped winding.

Actually, two were discovered. Both involve using the DC voltages at the AC inputs to the bridge, and combining them so most of the ripple is cancelled. (Of course, it's possible merely to filter the AC/DC voltages, but that takes a lot of filtering.) The most practical way (Figure 9) is to connect one resistor to each of the AC inputs, connect together the other two ends, add a

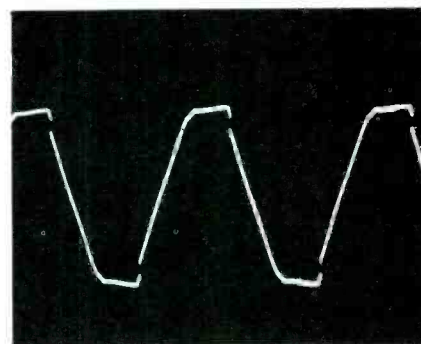

Fig. 4 This is the waveform obtained from all secondaries of the power transformer. When the MAB003B module is removed (disconnecting all the diodes), the waveform becomes a conventional sine wave.

filter capacitor, and it becomes a source of low-current +36-volts power. Because the AC components are out-of-phase, most of the two waveforms are eliminated, leaving a small amount of ripple and the entire DC voltage. Of course, the resistors must have a wattage rating sufficient to withstand both the AC and DC voltage drops.

The other way works, but it is not feasible economically. The AC/DC signals are brought through two in-phase windings of a transformer, and the other ends are tied together to form the +36-volt supply. Again, most of the AC components are phased-out, so little filtering will be required. This method is presented merely as a curiosity, since it has little value otherwise.

The 150-volt supply

A straight-forward bridge, consisting of CR6, CR7, CR8, and CR9, is the rectifying part of the +150-volt supply. This is the source of DC power for the horizontal

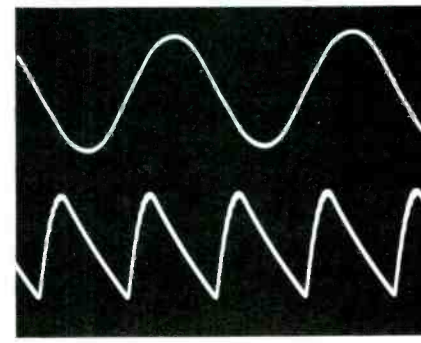
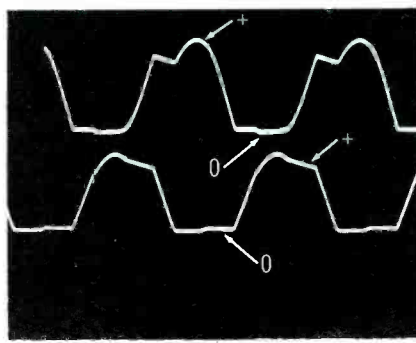
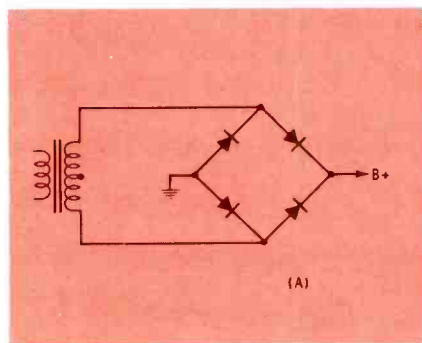

Fig. 5 A bridge circuit (A) was "breadboarded" to test the voltages and waveforms for comparison with those of the CTC58. In (B), a dual-trace scope showed these waveforms from the AC-input points to ground. Frequency doubling (120 Hz ripple) was proved by the double exposures in (C) of the input sine wave and the output ripple. The average DC at each AC-input point measured 1/2 of the B+ voltage at the output.

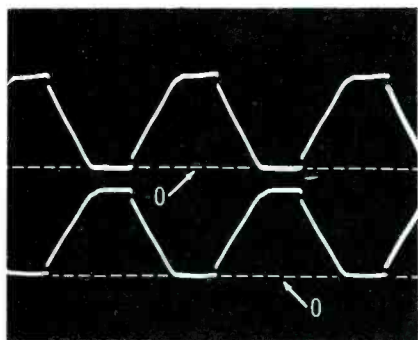

Fig. 6 These are the dual-trace waveforms at terminals 2 and 3 of the MAB003B module (see Figure 3). They are not typical of a true bridge because of the centertap, which makes them out-of-phase but otherwise identical. Each measured 80-volts PP and +38-volts DC.

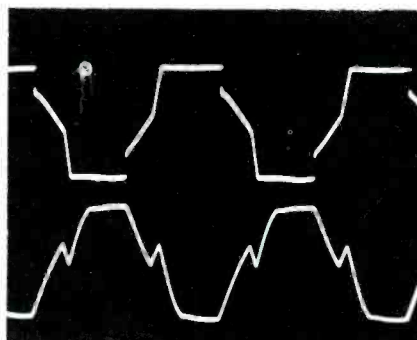

Fig. 7 When fuse F102 was disconnected for test, the +36-volt supply was zero, and these dual-trace waveforms were obtained at the AC-input points. Bridge operation of the +75-volts supply was normal, except the DC voltage was slightly high. Half B+ was at terminals 2 and 3.

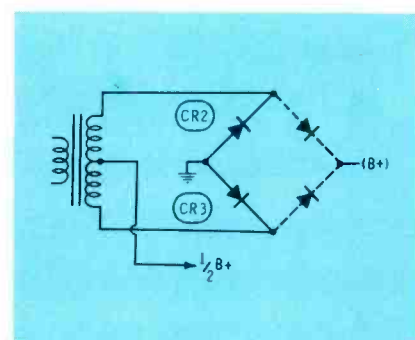

Fig. 8 This explains how +38 volts is obtained from the centertap of the winding. When CR4 and CR5 are disconnected for analysis, CR2 and CR3 become full-wave rectifiers of the centertapped winding. The circuit is reversed from the usual wiring, but it is valid.

sweep and high voltage circuits (using SCR's and diodes as switches), and it is required to furnish the most current of any DC supply in this chassis.

The windings of the power transformer at MAB003B terminals 8,

10, and 12 do triple duty, first for the bridge, second to power the degaussing circuit, and third as AC source for CR1 and the +225-volt supply. The bridge is conventional, so it requires no additional explanation.

One troubleshooting tip: if C104B (250 microfarad filter at the output of the +150-volt supply) develops reduced capacitance, excessive horizontal waveforms from the horizontal sweep circuit will cause an overload there, making the circuit breaker trip for no apparent reason.

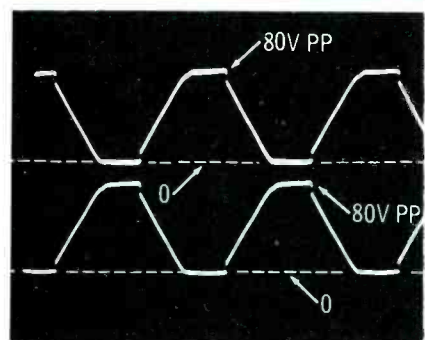
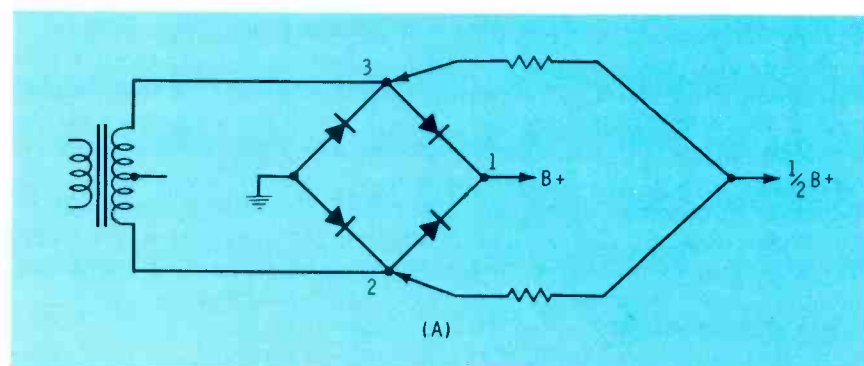

(B)

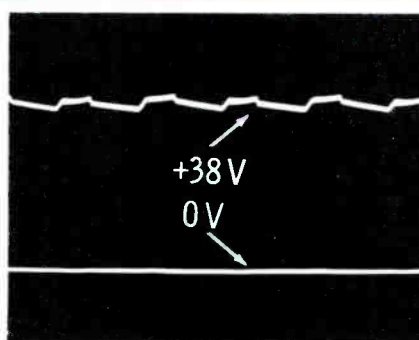

(C)

Fig. 9 There is a way of obtaining the half DC voltage from a bridge, without the centertap (diagram A). At terminals 2 and 3 are the waveforms of (B), measuring 80 volts PP and +38 volts DC. When they are combined by the two resistors, most of the AC is phased out, leaving a small ripple and +38 volts of DC. This is shown by the DC scope waveform in (C). The bottom line is zero volts, and the scope sensitivity is 10-volts-per-centimeter. Of course, such a method of obtaining the DC voltage is practical only for small currents, but it illustrates the truth that those points do have DC, and it is the same DC that is measured at those points when the centertap is used.

The 225-volt supply

Every rectifier circuit must have a return path (in this case the negative side of the circuit must return to ground). Yet there appears to be none for the CR1 wiring. Of course, we could oversimplify the situation and merely say that terminal 10 (the transformer winding return for CR1) is stacked on top of the bridge. And yet the bridge is not grounded, except through the conduction of CR7 and CR8.

This puzzle can be explained best by the use of waveforms from a DC-coupled scope, starting with the bridge.

Figure 10 shows the waveforms at terminal 10 (top trace) and terminal 8 (bottom). Those are strange, and can be partially explained by a power transformer that permits diode conduction to clip the peaks, a bridge that's floating except during the times of conduction, and an unbalance caused by the extra connection of CR1.

In both cases, the flat portions of the negative peaks are at zero voltage, so the entire waveforms are positive relative to ground.

Because the winding at terminal 10 has an AC voltage with a DC component (similar to that ex-

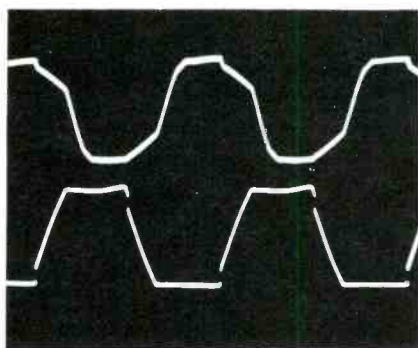
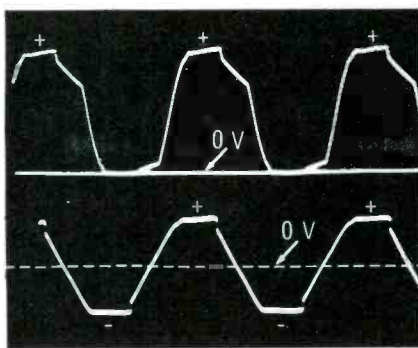
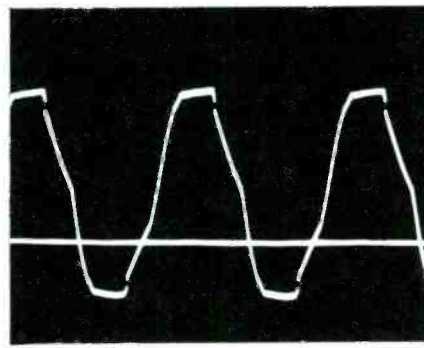

Fig. 10 At the AC inputs of the +155-volt bridge, the waveforms are not the same. The top trace is the waveform at terminal 10 of the MAB003B module, and below it is the terminal 8 waveform. Both measured 155-volts PP and +78-volts DC relative to ground.



(A)



(B)

Fig. 11 Top trace of picture (A) is the wavelshape at terminal 10. Notice the zero line at the tip of the negative peaks. Between 10 and 11 is the wavelshape of the lower trace, with the zero line in the center. The total voltage to the anode of CR1 (terminal 11) is the sum of those two waveforms, as shown in picture (B). Because one waveform was all positive, and only the top half of the other was positive, the result is a normal appearing waveform, except the zero line is about 78 volts from the negative peak and about 233 volts from the positive peak. CR1 rectifies the positive peak, producing 233 volts less the losses.

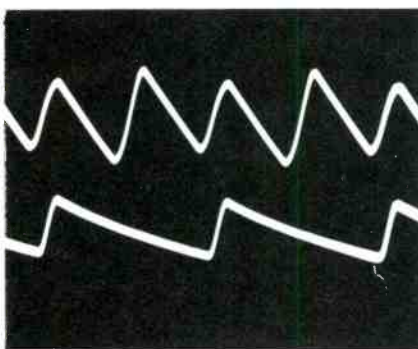

Fig. 12 Output of the +155-volt bridge at terminal 9 of MAB003B is shown by the top trace. It is 120 Hz, and the output of CR1 at terminal 12 is 60 Hz (bottom trace).

plained for the other bridge, but a higher voltage), and it is the return for the anode of CR1, it's certain that CR1 is supplied by much more voltage than the 60-volts RMS indicated by the schematic of Figure 3.

In fact, the voltage at terminal 10 is a positive-going near-square wave. Now, don't fall into the trap of taking the **average** voltage at terminal 10 and adding it to the DC rectified from the 60-volt RMS winding. The DC output by this error would be only about +160 volts; that's far short of the actual voltage.

Instead, the 150 volts peak-to-peak at terminal 10 is added to the half of the peak-to-peak voltage between terminals 10 and 11 (84 volts PP), making a total of 234 volts PP to be rectified. Peak-reading rectification would yield slightly less than that. The DC voltage actually measured +225 volts in this individual chassis.

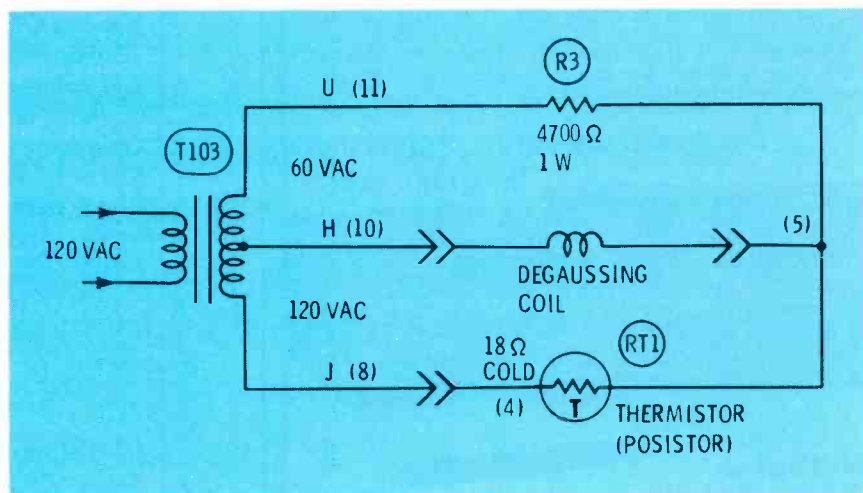

Fig. 13 A positive-temperature-coefficient thermistor rapidly decreases the current through the degaussing coil following turnon, and the small remaining current is cancelled by a fixed amount of out-of-phase power through R3. Degaussing occurs each time the AC power is applied when the TV is cold.

Perhaps a DC scope pattern will clarify it. The positive-going square waves at terminal 10 added to the near-sine waves between #10 and #11 form (at #11) a large waveform with the zero line 75 volts peak from the negative peak and 240 volts from the positive peak (see Figure 11).

CR1 has the right polarity to rectify the positive peak, so it operates on the 240 volts peak, while ignoring the negative peak. Such rectification should yield +240 volts less reductions for losses and ripple.

All of the DC supplies, except the +225-volt supply which is half wave and so has 60-Hz ripple, have 120-Hz ripple, as shown in Figure 12.

Automatic Degaussing Circuit

Each time the AC power is turned on from a cold start, a large AC current flows through the degaussing coils and RT1, a posistor type of thermistor (Figure 13). As the posistor heats, the resistance increases, until after a few seconds the current is very low, but not zero. Now an out-of-phase AC voltage comes from terminal "U" through R3 and it cancels the small remaining voltage, producing zero current through the degaussing coils.

Next Month

Details of the vertical sweep, and other circuits, of the RCA CTC58 will be presented in Part 2. □

Heath scopes give you more than you bargain for.

The single trace 4530... a professional service scope

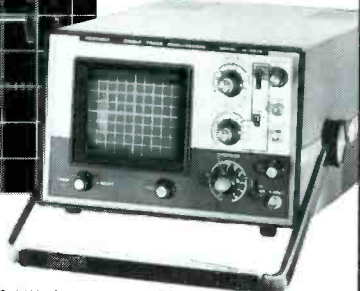
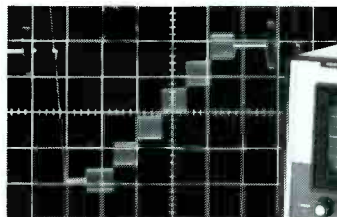

It's hard to find a better 10 MHz scope value than the Heath 4530. It features DC-10 MHz bandwidth, 10 mV sensitivity... trigger bandwidth guaranteed to 15 MHz, AC & DC coupled... TV coupling for service work... time bases from 200 ms/cm to 200 ns/cm... and true X-Y capability. The 4530 is easy to operate and offers a lot of performance for the money. Only \$425.00* for the factory assembled & calibrated S0-4530. Or order the easy-to-assemble Heathkit IO-4530, only \$299.95*

The dual trace 4510... a precision lab-grade scope

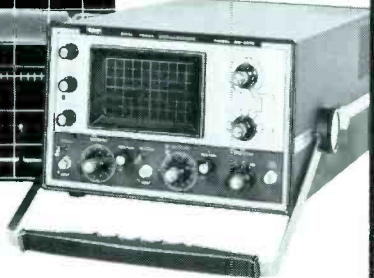
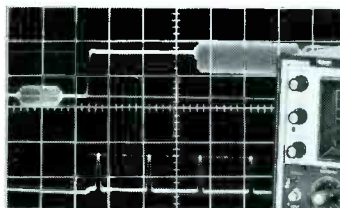

The 4510 is our best scope value — and it's easy to see why. With DC-15 MHz bandwidth... 1 mV/cm input sensitivity... 45 MHz typical triggering bandwidth, 30 MHz guaranteed... time base sweep 100 ns/cm... post-deflection accelerated CRT for high brightness... vertical delay lines for complete waveform display... X-Y capability... operates on any line voltage from 100 to 280 VAC. Assembled & calibrated S0-4510, only \$775.00*. Kit-form IO-4510, only \$569.95*.



For information on all the Heath scopes

... send for your free copies of our latest catalogs. The Heath/Schlumberger Assembled Instruments Catalog features a complete line of high performance, low cost instruments for service and design applications. Our new Heathkit Catalog describes the world's largest selection of electronic kits — including a full line of lab & service instruments.

HEATH COMPANY
Dept. 25-11

Benton Harbor, Michigan 49022

HEATH

Schlumberger

- Please send the latest Heath/Schlumberger Assembled Instruments Catalog.
 Please send the new Heathkit Catalog.

Name _____

Title _____

Company/Institution _____

Street _____

City _____

State _____

Zip _____

*MAIL ORDER PRICES; F.O.B. FACTORY.

PRICES AND SPECIFICATIONS SUBJECT TO CHANGE WITHOUT NOTICE.

EK-25-11

For More Details Circle (15) on Reply Card

bookreview

Light-Beam Communications

Author: Forrest M. Mims, III

Publisher: Howard W. Sams & Co., Inc., 4300 West 62nd Street, Indianapolis, Indiana 46268

Size: 160 pages, book number 21147

Price: \$4.95 paperback

Author Mims includes a detailed history of light-beam communications in this book. Principles of light-beam communications are covered, including modulation techniques and optical antennas. Various light sources such as different lamp-types and LEDs are discussed. Advantages and disadvantages of light detectors and the most important optical components and systems are described, including lenses, reflectors, and filters. The final chapter describes many experimental and commercial optical communicators.

Contents: Principles of Light-Beam Communications; Light Sources; Light Detectors; Optical Components and Systems; Optical Communications Systems.

1-2-3-4 Servicing Cassettes

Author: Forest H. Belt

Publisher: Howard W. Sams & Co., Inc., 4300 West 62nd Street, Indianapolis, Indiana 46268

Size: 240 pages, book number 20922

Price: \$5.25 paperback

Forest H. Belt's Easy-Read™ format of writing describes how the technician can combine speed and efficiency in servicing electronic equipment. The 1-2-3-4 method of finding trouble in radios, stereos, and TV sets is not new in principle. However, Belt's simplified procedure is said to help speed up everyday repair jobs for even experienced technicians. The thoroughness of the troubleshooting system catches even borderline faults that often are overlooked, resulting in reduced callbacks.

Contents: Fundamentals of 1-2-3-4 Servicing; 1-2-3-4 Servicing in Mechanical Equipment; Finding Your Way Around Transistor Circuits; The Cassette Tape Cartridge; The Cassette Tape System; The Electronics of Cassettes; Cassette Mechanisms; Applying 1-2-3-4 Servicing to Cassette Machines; Step One—Diagnose the Faulty Section; Step Two—Locate the Faulty Stage; Step Three—Isolate the Faulty Circuit; Step Four—Pinpoint the Faulty Part.

productreport

These features supplied by the manufacturers are listed at no-charge to them as a service to our readers. If you want factory bulletins, circle the corresponding number on the Reply Card and mail it to us.

Pocket Calculator

The HP-21 scientific calculator is the smallest and least expensive model in the **Hewlett-Packard** line. Priced at \$125.00, the HP-21 has all the trigonometric and logarithmic functions of the HP-35.

With this model the user can calculate in degrees or radians; convert from polar to rectangular coordinates and vice versa; format and round the display in either fixed or scientific notation; and perform register arithmetic with the contents of the single addressable memory.



Featuring the RPN logic system with a four-memory stack that holds intermediate answers and automatically brings them back when needed in calculation, the HP-21 uses two rechargeable batteries instead of three and gives up to five hours of continuous operation.

An owner's handbook, carrying case, and AC adapter/recharger are included.

For More Details Circle (25) on Reply Card

Phone Call Limiter

With the TPL 300 you can keep the line open to receive important calls. Easy-to-install, the device begins working the minute the receiver is lifted. Reminder beeps begin at time intervals that can be set anywhere from 30 seconds to every 3 minutes. After 10 minutes, an annoying tone is heard. The \$34.95 attachment from **Telco Products** works on all outgoing and incoming calls.

For More Details Circle (26) on Reply Card

Components Kits

Interkit, a series of 36 components kits offering electrolytic, tantalum, metalized-polyester-film and subminiature polyester-film capacitors, carbon-composition resistors, plus rectifier, zener and switching diodes, is available from **International Components Corporation**.

The kits come in compartmentalized plastic containers or drawer cabinets. One type of product is in each kit. Twelve design-engineer's kits sell for \$29.95 each. 12 servicemen's kits each retail for \$9.95, and hobbyists kits are priced at \$2.99 each.

For More Details Circle (27) on Reply Card

Multi-Purpose Bin Units

Bay Products offers a complete line of fully-assembled multi-purpose bin units. Features include shelves with continuous, full-width label holders, adjustable cross dividers, and shelf drawers with dividers that adjust on 1-inch centers.

Manufactured of heavy-gauge industrial steel, the units are available in any combination of shelves, sloping bins, dividers, and drawers, in 36½-inch width, 12-inch depth, and 39-inch or 75-inch heights with closed back, sides and base.

For More Details Circle (28) on Reply Card

AM/SSB Citizens Band Radios

Both new AM/SSB citizens-band radios from the **Cobra Communications Division of Dynascan Corporation**, offer maximum legal power on all channels in AM, upper-sideband and lower-sideband modes.



Model 138 mobile unit and Model 139 base station feature **Dynamike™** gain control, voice lock, separate noise-blanking and automatic-noise-limiting switches to minimize different types of noise, illuminated meters, public-address capability, detachable dynamic microphones, and Delta tuning. The Cobra 139 base unit also features separate meters for modulation percentage and signal strength.

Cobra 138 lists for \$320.00; Cobra 139 lists for \$395.00.

For More Details Circle (29) on Reply Card

(Continued on page 55)



the Versatile, Rugged AVO 8 Mark 5

WORKHORSE OF MULTIMETERS

The AVO 8/Mark 5 is no ordinary multimeter! It allows you to read AC or DC current to 10 Amperes, and AC or DC voltages up to 3000 Volts! You can also measure resistances to 20 megohms (200 megohms with external power supply), plus make Decibel readings on the AC Volt scale. Easy-to-read, clear, linear scales with anti-parallex mirror are used in all AVO 8 instruments plus unique overload protection. Safety-wise, every AVO 8 receives a 7 kV flash test before it leaves the factory.

Write or call for free literature today!



JAMES G. BIDDLE CO.
Plymouth Meeting, Pa. 19462

Phone: (215) 646-9200

500

For More Details Circle (17) on Reply Card

NEW FROM JERROLD!

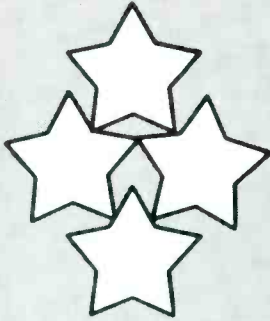

Levelite®

PATENTED

**EVERY TV-MATV
TECHNICIAN
NEEDS ONE!**



INSTANT GO, NO-GO TV SIGNAL INDICATOR

Levelite is not just a new product, it's a completely new type of test instrument . . . so different it has been granted a U.S. patent. About the size of a pocket calculator, it makes instant go, no-go tests for TV signals at antennas, preamplifiers, download, splitters and MATV outlets.

Just plug Levelite into an outlet, press the button and watch the green light. If the green light glows, you have TV signals. If not, there is insufficient signal.

Levelite is invaluable for troubleshooting TV and MATV signals. A handy range switch enables you to set the threshold signal level to -6 dBmV for weak signals or $+6$ dBmV for strong signals. The kit comes complete with adaptors for most types of 75-ohm and 300 ohm connectors, plus a padded holster-type carrying case that clips to any belt. Powered by 9-volt transistor battery (not supplied). One hand operation.



Ask your Jerrold distributor for a demonstration of the remarkable new Levelite.

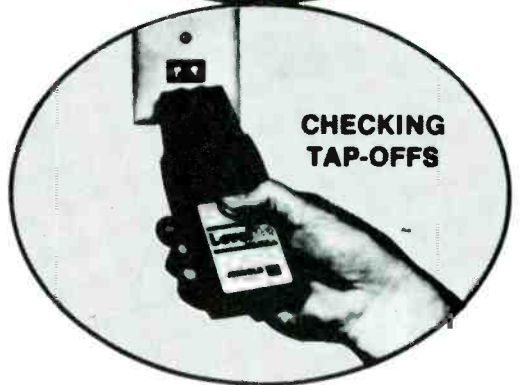

JERROLD



a GENERAL INSTRUMENT company

Distributor Sales Division

HEADQUARTERS & EASTERN OFFICE 200 Witmer Rd., Horsham, Penna. 19044, (215) 674-4800

SOUTHERN OFFICE 1 Perimeter Place, Suite 101, Atlanta, Georgia 30339, (404) 432-3102

WESTERN OFFICE 1255 Veterans Blvd., Redwood City, Calif. 94063, (415) 365-5050

MIDWESTERN OFFICE 1334 Atlantic Street, North Kansas City, Mo. 64116, (816) 474-0450

For More Details Circle (24) on Reply Card

test equipment report

These features supplied by the manufacturers are listed at no-charge to them as a service to our readers. If you want factory bulletins, circle the corresponding number on the Reply Card and mail it to us.

Triggered Scopes

The T900 line of scopes from Tektronix all have a 8X10CM CRT screen, beam finder, single-knob trigger control, delay line, automatic selection of TV line or frame for solid locking of video waveforms, and color-coded control panels.

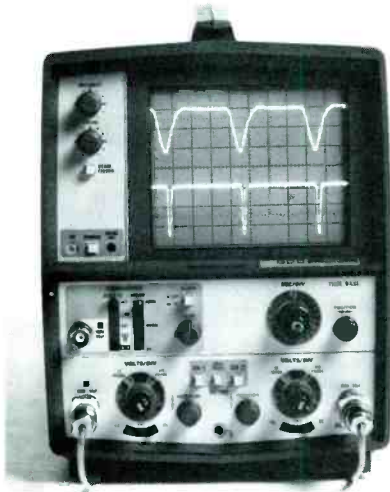

Of special interest for TV servicing are Model T921 single-trace and Model T922 dual-trace instruments. Both have vertical response from DC to 15 MHz at maximum sensitivity of 2 millivolts, sweep rate from .5 seconds to .2 microsecond (plus a 10X expander), regulated power supplies, and 12KV accelerating voltage for extra brightness.

T921 is priced at \$695, and T922 at \$850.

For More Details Circle (34) on Reply Card

Digital Multimeter

Model LM-3.5 digital multimeter (called Voltmeter Plus) from Non Linear Systems is a 3-1/2-digit, multi-range, palm-sized test meter.

Some features are: 4 ranges of DC and AC volts to 1000 volts DC or peak AC at 10-megohms input impedance, with 1 millivolt resolution on the 2-volt range; 5 resistance ranges from 2K to 20M full scale; AC and DC current, using external shunts that

are supplied; and automatic polarity on DC voltage ranges.



The LM-3.5 has three full digits plus 100% overrange, and the LED display numbers are .3-inch high. It sells to technicians for \$147, complete with test leads, NiCad batteries, external charger, and current shunts. Options include a leather carrying case that snaps to a belt or hangs from a shoulder by a strap, a desk stand, and a 30KV HV probe.

For More Details Circle (35) on Reply Card

Transistor Tester

Tokyo Electronics offers Model TT26EZ portable transistor tester. It gives a good-or-bad indication of diodes and PNP or NPN transistors, either in-circuit or out-of-circuit, and also indicates continuity. Connections are made by a 3-pin socket or by E-Z Hooks with leads.

Model TT26EZ uses a standard 9-volt battery, and sells for \$12.55 postpaid in kit form. Assembled testers are available at extra cost.

For More Details Circle (36) on Reply Card

Low-Distortion Audio Generator

Sharp square waves to test frequency and transient response, sine waves with .03% distortion between 500 Hz and 20 KHz, and burst signals with less than 2% leakage at 20 KHz are some of the features of the LAG-125 audio generator from Leader Instruments.



The compact LAG-125 has a tilt-up stand, output cable with clips, and it sells for \$499.95.

For More Details Circle (37) on Reply Card

NOW—CHOOSE FROM INVALUABLE ALL-IN-ONE COLOR TV & B & W TV SCHEMATIC/SERVICING MANUALS

Each Manual contains EVERYTHING you need to service all models of the brands covered! Here is complete service data, including full-size schematic diagrams, waveforms, setup and alignment instructions, field modification changes, trouble case histories, etc., for the most popular name-brand TV receivers, plus full-size schematic diagrams. Most manuals have parts lists included. All are 8 1/2 x 11", 196 or 228 pages, including schematic diagram foldout. Each \$4.95 unless otherwise marked.



COLOR TV MANUALS

SVCING. MODULAR COLOR TV RECVRS., Vol. 1 RCA CTC48, Motorola Quasar CTV7 & 8, Philco B-Line 3CS and 3CY(90 & 91) No. 662	
Vol. 2, MA & JA Magnavox 1979 Packard-Bell CTS-38 & 42, Zenith 25DC-57 & 58	No. 663
ADMIRAL Vol. 1, D11-12G13, K10	No. 545—\$5.95
ADMIRAL, Vol. 2, M20, K16, K20 & 930 ch	No. 641
AIRLINE (Mont. Ward), Covers 1972-1974	No. 741—\$5.95
EMERSON—See Admiral Vol. 2	
G.E., Vol. 1, CA to KE, incl. HB and HI Porta-Color	No. 536—\$5.95
G.E., Vol. 2, JA, H-2, H-4, N-1, N-2, KE-11, C-2, L-2, L-2	No. 609
JAPANESE, Vol. 1, Covers SONY, KV-1200U, KV-1220U, KV-7010UA, KV-9000U, SHARP, CN-32T, CN-62T, CT-51P, CU-50P, CY-61P, C2010, 2030, C6010, 8010, 9310, MIDLAND 15-214	No. 560
JAPANESE, Vol. 2, Covers PANASONIC CT-25, CT-65, CT-95, CT-97, CT-98, CT-99, HITACHI CFA 450, 460, GUN-870, 880, 890, CSU-690, DELMONICO 7208, 7300, 7408, 7438, 7500	No. 576
JAPANESE, Vol. 3, Covers HITACHI SWU-220, CTU-970, CU-100, CWU-220, CO Ch. CRX, CR-350, CORONADO 611, T5000, T5002, 9K 18, 10K 18, SANYO 31C35, 51C-51R, 91C57, 91C57R	No. 684
JAPANESE, Vol. 4, Years 1971-1973	No. 692—\$5.95
JAPANESE, Vol. 5, Years 1972-1974	No. 700—\$5.95
MAGNAVOX, Vol. 1, Ch. Series 37T940	No. 526
MAGNAVOX, Vol. 2, Covers Ch. 1950-T962	No. 589
MOTOROLA Vol. 1, Ch. TS-907—TS-924	No. 509
MOTOROLA, Vol. 2, Chassis TS-929—TS-938	No. 584—\$5.95
MAGNAVOX, Vol. 3, Chassis 1374 Hybrid, Solid-State 1979, T889, Solid-State Receivers T881, T892, T987, Modular Solid-State T995, and 11L-200 Odyssey Game Simulator	No. 572—\$5.95
PHILCO, Ch. 15M90-91—20GT87-90	No. 572—\$5.95
RCA, Vol. 1, Ch. CTC12-CTC40	No. 496—\$5.95
RCA, Vol. 2, Ch. CTC39X-CTC55	No. 578—\$5.95
RCA, Vol. 3, Ch. CTC48-CTC60	No. 720—\$5.95
RCA, Vol. 4, Ch. CTC55-CTC71	No. 721—\$5.95
RCA, Vol. 5, Chassis CTC64, 70, 72, 76, 68 and 71	No. 822—\$5.95
SEARS, Years 1970-1974	No. 740—\$5.95
SYLVANIA, Vol. 1, Chassis 576 solid-state E01	No. 539—\$5.95
SYLVANIA, Vol. 2, Chassis D14-D19, E02 and E01	No. 618
TOSHIBA, Vol. 1, Ch. C721, C924, C094, C335, C6A, C7A-C8A, C927, C812WD, C812, C501S, C802WR, C321, C912B	No. 760—\$5.95
ZENITH, Vol. 1, Ch. 14Z8C50-27KC20	No. 502—\$5.95
ZENITH, Vol. 2, Ch. 12A8C14-4825C19 & 408C50	No. 562—\$5.95
ZENITH, Vol. 3, 14DC14, 15, 15Z, 16, 16Z, 14CC14 (* & up), 18CC17, 23DC14, 29 & 30, 19DC11 & 25CC25, 12, 19DC19Z & 20, 20CC50 & 50Z, 50 & 55, 25CC56 & 57, 17-19EC45, & 25EC58	No. 668
ZENITH, Vol. 4, 17 chassis from 13GC10 thru 25GC45	No. 830—\$5.95

BLACK AND WHITE TV MANUALS

ADMIRAL, Covers ch. C to K	No. 569
GENERAL ELECTRIC, Ch. Series AA to V-2	No. 558
JAPANESE, Hitachi 1A-50TWU65, Panasonic TR-41B-TWU-65, Sharp, SO65P-89D	No. 602
MAGNAVOX Covers ch. Series 36 to T946	No. 572
MOTOROLA Covers ch. TS-454-TS-613	No. 594
PHILCO Covers ch. 15G20-20V35	No. 564
RCA Covers ch. KCS136-KCS178	No. 549
SYLVANIA Ch. A01-B14, Also 572-598	No. 599
ZENITH, Chassis, 13A12-14M23 & 1M-30T20-1Y22-B55	No. 552

SPECIAL SCHEMATIC/SERVICING MANUALS

HOW TO REPAIR SOLID-STATE IMPORTS. 100 schematics for Allied, Automatic Peerless, Telerad, Mercury, Lloyd's, Panasonic, Crown, Midland, Pencrest, Toshiba, & Matsushita. No. 532

TV TUNER SCHEMATIC/SERVICING MANUAL. Contains all info needed to adjust and repair ANY VHF or UHF TV tuner, from tube-type turret to modern varactor tuners, for Admiral, G.E. Magnavox, Motorola, Philco-Ford, RCA, Sony, Syl, Zen, 224p. No. 696—\$6.95

JAPANESE CONSUMER ELECTRONICS SCHEMATIC/SERVICING MANUAL. 89 models by 7 mfr's.—JVC, Jiyod's, Midland, Panasonic, Sanyo, Sharp, & Toshiba. Covers AM radios, clock radios, AM-FM receivers, FM stereo sets, multiband receivers, radio & tape player combos, cassette recorders, phonos & TV sets. No. 732—\$5.95

JAPANESE RADIO, RECORDER & TAPE PLAYER SERVICE MANUAL. Schematics, alignment data, service tips on record players, multiband radios, cassette tape players, and 8-track cartridge tape players. Craig Gambles, Hitachi, JVC, Lafayette, Midland, Montgomery Ward, Panasonic, Sharp, Masterwork, Realistic, etc. 228p. No. 642—\$6.95

SMALL-SCREEN TV SCHEMATIC/SERVICING MANUAL. ALL the service info needed to repair ANY small-screen TV, plus alignment/adjustment procedures for the 30 best-selling models made by Admiral, Broadmoor, Gambles, GE, Hitachi, JVC, Magnavox, Air-line, Panasonic, RCA, Sanyo, Sharp, Sony, & GTE-Sylvania. 100 case histories 240p. 7 x 10". No. 778—\$6.95

SERVICING ELECTRONIC ORGANS. Covers most popular instruments: Artisan, Baldwin, Conn, Gulbransen, Hammond, Lowrey, Magnavox, Rodgers, Thomas, etc. Provides step-by-step techniques for locating and correcting defects in any organ. Vinyl. No. 503—\$7.95

NO RISK COUPON—MAIL TODAY

TAB Books, Blue Ridge Summit, Pa. 17214

Please send me the Manuals below.

I enclose \$_____. Please send postpaid.

Send C.O.D. Invoice me on 10-day FREE Trial.

Name _____ Phone _____

Company _____

Address _____

City _____ State _____ Zip _____

Foreign, add 10% Pa. add 6% sales tax ES115

For More Details Circle (16) on Reply Card

**Some stores
sell test
equipment
at discount
prices.**

**At Fordham
we discount
their discount
prices.**

B&K, EICO, RCA, SENCORE
FLUKE, HICKOK, LEADER
and SIMPSON

Complete line of tubes,
tools and electronic supplies

**FREE CATALOG
FORDHAM**

RADIO SUPPLY CO., INC.

558 Morris Ave., Bronx, N.Y. 10451
Tel: (212) 585-0330

For More Details Circle (19) on Reply Card

FREE ALARM CATALOG

Huge selection of burglar & fire systems, supplies. Motion detectors, infrared beams; controls, door switches, bells, sirens. 500 items, 99 pp. packed with technical details, notes.

(Outside U.S., send \$1.00.)

mountain west alarm

4215 n. 16th st., phoenix, az. 85016



For More Details Circle (20) on Reply Card

APPLIANCE REPAIR BOOKS

Written in easy-to-understand language by experts with illustrations & diagrams. Acclaimed by instructors & professionals. How to diagnose & repair air conditioners, refrigerators, vacuum cleaners, ranges, washers, dryers, steam irons, portable kitchen appliances, water heaters; plus how to set up a shop, using test instruments and more. Only \$2.65 to \$4.90 each!

SEND FOR FREE DESCRIPTIVE PRICE LIST

C & N, DEPT. ES, 5841 MONTROSE, CHICAGO 60634

For More Details Circle (21) on Reply Card

**IT'S NO PUZZLE
TO ORDER**

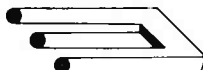

OELRICH SERVICE FORMS

FOR TV-RADIO & 2 WAY RADIO SERVICE LEGAL FORMS FOR CALIF. FLA. UTAH NOW AT YOUR PARTS JOBBER OR WRITE FOR CATALOG B64

OELRICH PUBLICATIONS

4040 N. NASHVILLE AVE. CHICAGO, ILLINOIS 60634

For More Details Circle (22) on Reply Card

catalogs literature

Circle appropriate number on
Reader Service Card.

101. Mouser Electronics—manual #803 lists low-cost components, production aids, and test accessories complete with specifications, illustrations, and pricing information. The products listed include: Sanwa precision multimeters, tantalum capacitors, ultra-miniature toggle switches, 1/8-watt carbon-film resistors, batteries, knobs, semiconductors, wide-view panel meters, variable and isolation transformers, PC drafting aids, electronic chemicals, tools, and hardware.

102. Heath—the Heathkit catalog describes over 350 kits for nearly every do-it-yourself interest ranging from TV, radio, stereo and 4-channel hi-fi, to fishing, marine, R/C models, home appliances, electronic organs, automotive, test instruments, and others.

103. Klein—presents an 80-page catalog of specialized professional hand tools. Organized for easy reference and indexed both alphabetically and by product number, the catalog includes a selection of pliers, wrenches, screwdrivers, saws, hammers, levels, measuring tapes and rules, and many specialized electrical and electronic work tools, plus belts, tool pouches, and pockets. Tools and safety equipment are illustrated with large photographs and drawings.

104. Brookstone Company—makes available a 68-page catalog featuring hundreds of products sold rarely by industrial distributors or found in stores. The collection of products includes hard-to-find hand tools and small power tools. A year's free subscription (six issues) is offered.

105. Precision Electric Company—offers a general catalog which describes their line of soldering equipment. Soldering irons, holders, tool and accessory kits, tips, aids, and pots are included. Size and heat specifications, and details of construction and materials are given.

Statement of Ownership, Management and Circulation, Act of August 12, 1970: Section 3685, Title 39, United States Code.

1. Title of Publication: Electronic Servicing
2. Date of Filing: September 30, 1974
3. Frequency of issue: Monthly
- 3A. Annual subscription price: \$6.00
4. Location of known office of publication (Street, city, county, state, zip code): 9221 Quivira Road, Shawnee Mission, Johnson County, Kansas 66215.
5. Location of the headquarters or general business offices of the publishers (not printers): 1014 Wyandotte St., Kansas City, Jackson County, Missouri 64105.
6. Names and addresses of publisher, editor, and managing editor: Publisher, Robert E. Hertel, 1014 Wyandotte St., Kansas City, Missouri 64105; Managing Editor, Carl Babecke, 1014 Wyandotte St., Kansas City, Missouri 64105.
7. Owner (if owned by a corporation, its name and address must be stated and also immediately thereunder the names and addresses of stockholders owning or holding 1 percent or more of total amount of stock. If not owned by a corporation, the names and addresses of the individual owners must be given. If owned by a partnership or other unincorporated firm, its name and address, as well as that of each individual must be given.) Howard W. Sams & Co., Inc.—a wholly owned subsidiary of International Telephone and Telegraph Corporation, 320 Park Ave., New York, New York 10022.
8. Known bondholders, mortgages, and other security holders owning or holding 1 percent or more of total amount of bonds, mortgages or other securities (If there are none, so state): None.
9. Paragraphs 7 and 8 include, in cases where the stockholders or security holder appears upon the books of the company as trustee or in any other fiduciary relation, the name of the person or corporation for whom such trustee is acting, also the statements in the two paragraphs show the affiant's full knowledge and belief as to the circumstances and conditions under which stockholders and security holders who do not appear upon the books of the company as trustees, hold stock and securities in a capacity other than that of a bona fide owner. Names and addresses of individuals who are stockholders of a corporation which itself is a stockholder or holder of bonds, mortgages or other securities of the publishing corporation have been included in paragraphs 7 and 8 when the interests of such individuals are equivalent to 1 percent or more of the total amount of the stock or securities of the publishing corporation.
10. This item must be completed for all publications except those which do not carry advertising other than the publisher's own and which are named in sections 132.231, 132.232, and 132.233, postal manual (Sections 4355a, 435b, and 4356 of Title 39, United States Code.)

	Average No. Copies Each Issue During Preceding 12 Months	Single Issue Nearest To Filing Date
A. Total No. Copies Printed (Net Press Run)	71,139	70,855
B. Paid Circulation		
1. Sales through dealers and carriers, street vendors and counter sales	3,781	4,502
2. Mail Subscriptions	63,481	62,806
C. Total Paid Circulation	67,262	67,108
D. Free Distribution (in- cluding samples) by Mail, Carrier or Other Means	1,300	521
E. Total Distribution (sum of C and D)	68,562	67,629
F. Office Use, Left-Over, Unaccounted, Spoiled after Printing	2,577	3,226
G. Total (sum of E and F— should equal net press run shown in A)	71,139	70,855

I certify that the statements made by me above are correct. (Signature of editor, publisher, business manager, or owner).

ROBERT E. HERTEL

Product Report

(Continued from page 51)

Snap-Mount Plastic Lites

The Littlelites line of neon snap-mount plastic lites has been expanded to include green neon lamps, available in rectangular, 5/16-inch diameter, and 1/2-inch diameter units from Littlefuse, Inc.

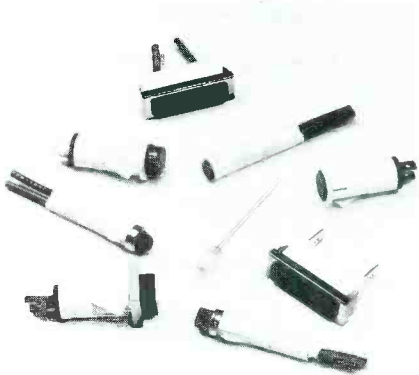

Standard neons emit light only in the orange, red, and yellow portions of the spectrum. The green neon lamp produces a highly visible green light when used with a green, white, or

colorless lens.

Featuring a built-in 33K resistor for operation at 125 volts and a 100K resistor for 250 volt applications, the units are rated at 1/3 watt and have a life expectancy of 10,000 hours. A wide choice of terminations, bezel finishes, and lens styles are offered.

For More Details Circle (30) on Reply Card

Resistance Test Unit

For circuit design, instrument repair and troubleshooting, the pocket-sized resistance substitution unit features an over 11-million step range in 1-ohm steps, to give 1 to 11,111,110 ohms.

Model 326-A from Phipps & Bird, Inc., is designed with 3 binding posts (one to ground case). The unit uses 1/2 watt resistors of 1% tolerance.

Model 236-A is available at a list price of \$58.00.

For More Details Circle (31) on Reply Card

Burn Spray

Recommended for every on-the-job first-aid station, G-63 pain killer helps reduce swelling and guards against secondary infection.

Distributed by General Scientific

Equipment Company, G-63 is available in 8-ounce spray cans.

For More Details Circle (32) on Reply Card

VHF/FM Marine Radiotelephone

The Carib VHF/FM marine radiotelephone unit covers every domestic frequency plus both U.S. and Canadian weather frequencies. Carib VHF is factory pretuned. According to the manufacturer, Pearce-Simpson, the phase lock loop circuit uses only 3 crystals and provides every frequency needed.



Carib VHF features 25 watt output, 1 watt capability, and an external speaker jack. The microphone, antenna, and power leads plug in. Chrome snap brackets firmly hold the radio onto the mounting bracket. □

For More Details Circle (33) on Reply Card

MEET OUR family

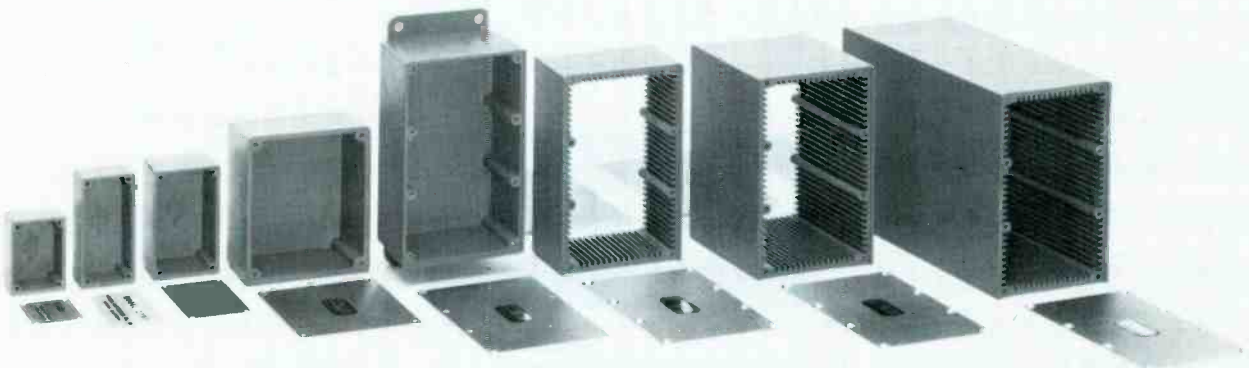

of shielded "black boxes"

Almost 10 years ago (1966 to be exact) we introduced our first two series of shielded electronic enclosures. They became an overnight success. Since then the demand for different sizes, shapes and applications has increased our family to eight series of models, each with a noise rejection greater than 70db.

Sizes range from 1.50" x 1.13" x 0.88" to 4.13" x 2.68" x 6.0"; in blank versions or with a complete choice of coaxial connectors; painted or unpainted; with or without printed circuit card guides; with mounting flanges or bottom mounting plates. All models supplied with aluminum covers and screws.



SOLD ONLY THROUGH ELECTRONIC DISTRIBUTORS

POMONA ELECTRONICS **ITT**

1500 East Ninth St., Pomona, California 91766 Tel: (714) 623-3463

The MARKETPLACE

This classified section is available to electronic technicians and owners or managers of service shops who have for sale surplus supplies and equipment or who are seeking employment or recruiting employees.

Advertising Rates

in the Classified Section are:

- 25 cents per word (minimum \$3.00)

- "Blind" ads \$2.00 additional

- All letters capitalized 35 cents per word

Each ad insertion must be accompanied by a check for the full cost of the ad.

Deadline for acceptance is 30 days prior to the date of the issue in which the ad is to be published.

This classified section is not open to the regular paid product advertising of manufacturers.

FOR SALE

RIDERS RADIO MANUALS, six to seventeen, antique tubes, resistors, by pass and filters. Goodwin Radio Shop, Rankin, Ill. 60960. 11-75-11

DON'T JUNK THAT T.V.—We have the most complete stock of T.V. picture tubes in U.S. B & W and color, old or new, over 1700 types at the lowest prices. ALLIED SALES, Pimento, Indiana 47866, 812-495-5555. 11-75-31

POWER SUPPLIES, adjustable 13.6 VDC 30 Amp continuous duty .005% ripple. These are computer power supplies 5 x 14 x 16, make beautiful test bench power supplies. Original cost 1900.00, now 200.00. LETT ELECTRONICS, 526 E. 4th, Hutchinson Ks. 67501, 316-663-1181. 11-75-11

TEST EQUIPMENT FOR SALE. Polarad Spectrum Analyser SA84WAB \$1250.00, Hewlett Packard 608B \$300.00, Hickok 680 \$50.00, Rubicon Inst. 1040A Wheatstone Bridge \$50.00, Lampkin 105B frequency Meter \$150.00. John Fleming, 2014 Delaware, Mishawaka, Ind. 46544, 219-259-8408. 11-75-11

ADVERTISING PACKAGE FOR TV service shops. Inexpensive eye catching ads contain personal message from you-build customer confidence. Keeps your name before the public weekly. **PROVEN RESULTS.** Thirty ads with instructions \$19.95. Sample \$1.00 refundable. TV TIPS, 430 South Jefferson, Lebanon, Mo. 65536. 11-75-81

PHOTOFACTS—Have most sets through No. 667. Will swap two for each one above No. 1175. List what you have and what you need. Cheek, 1730 Graham, Pittsburgh, Pa. 15235. 11-75-11

REJUVENATE TV PICTURE TUBES without expensive equipment. Use clip leads, power from set, and tube manual. No boosters required. \$5.00. Willie R. Collins, 4 Trans. BDE (PPD) APO NY, 09451. 11-75-11

NEW Canadian Magazine "Electronics Workshop". \$5.00 yearly. Sample \$1.00. Ethko, Box 741, Montreal "A" Canada. 10-75-121

FOR SALE (CONT.)

UNUSUAL SURPLUS AND PARTS Catalog. \$1. ETCO Electronics Dept. E.S., Box 741, Montreal "A" H3C 2V2. 12-74-121

CONVERT any transistorized T.V. tuner to a tuner substituter. Plans \$2.00. New accelerated Radio & T.V. course. RADIO TELEVISION TRAINING, Box 279, ES-105, Syracuse, N.Y. 13206. 8-75-1f

EDUCATION-INSTRUCTION

TV PROBLEMS?? Send symptoms with a copy of schematic and self-addressed stamped envelope and \$1.00 to Troubleshooter, Box 4553, Downey, Ca. 90241. Results Guaranteed. 9-75-1f

REPAIR TV TUNERS—High Earnings; Complete Course Details, 12 Repair Tricks, Many Plans, Two Lessons, all for \$2. Refundable. Frank Bocek, Box 3236 Enterprise, Redding, Calif. 96001. 10-75-6t

WANTED

TV PROBLEMS?? Send symptoms with a copy of schematic and self-addressed stamped envelope and \$2.00 to Troubleshooter, Box 4553, Downey, Ca. 90241. Results Guaranteed. 9-75-1f

REWARD—For schematic - Realistic 208 stereo Amp 1961-1963 model. Di Gloria, 1418 Catherine St., Key West, Florida 33040. 11-75-11

SIGNATURE—LOANS: \$100 - \$25,000, no collateral, (\$3.00) refundable. Tayo Paul, 980 Greene Ave., Brooklyn, N.Y. 11221. 11-75-31

BUSINESS OPPORTUNITY

EXPERT TV Technicians needed to repair and update master antenna systems with new patented method. No previous experience as I will train you the "right way" the first time. No competition, as you will be one of a select number directly under my technical assistance tied together with a Wats Telephone. Earning potential? Over \$200.00 per day. Send complete resume and credit references: Melvin Cohen, Television Broadcast Engineer, 1620 N. Federal Highway, Boynton Beach, Fla. 33435. Enclose 13 cent addressed envelope. 11-75-21

CAREER IN MARINE ELECTRONICS WANTED. Longtime Yachtsman with FCC 2nd. Job or possible purchase small shop. East Coast, Caribbean. P.O. Box 47, Larchmont, N.Y. 10538. 11-75-11

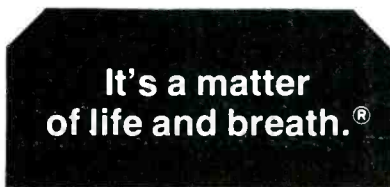

Space contributed by the publisher as a public service

advertisers' index

B & K Division, Dyanascan Corp.	23
James G. Biddle Co.	51
Bussmann Mfg. Div., McGraw-Edison	27
Castle TV Tuner Service, Inc.	Cover 4
Charous & Niebergall	54
Cleveland Institute of Electronics	39
John Fluke Mfg. Co.	Cover 3
Fordham Radio Supply Co., Inc. ...	54
Gem City Tuner	10
General Electric Co.	11, 33
Heath Company	50, 57
Hickok Electrical Instrument Company	7
Jerrold Electronics	52
Lectrotech Inc.	9
MTI	9
Mallory Distributor Products	3
Mountain West Alarm Supply Co.	54
Oelrich Publications	54
Pomona Electronics	55
Precision Tuner Service	Cover 2
RCA Distributor and Special Products	12, 13, 57
Sperry Tech, Inc.	24
GTE, Sylvania Consumer Renewal	1
Tab Books	53
Tektronix, Inc.	45
Thorderson Meissner, Inc.	21
Tuner Service Corporation	5
SGL Waber Electric Division	39
Winegard Company	30, 31

Electronic Servicing... ON-TARGET cards

YOUR DIRECT "HOTLINE" TO MANUFACTURERS/SUPPLIERS

•FILL IN THE CARD •PRINT CLEARLY •DROP IT IN THE MAIL

FREE! HEATH assembled instruments & over 400 electronic kits

Kit Our new Heathkit Catalog describes hundreds of easy-to-build kits...color TVs, stereo & four channel systems, fishing and marine instruments, amateur radio gear, automotive tune-up equipment, a complete line of precision instruments...all at do-it-yourself, kit-form savings.

Assembled

The latest Assembled Instruments Catalog features dozens of high performance, low cost instruments - frequency counters, oscilloscopes, multimeters, power supplies, strip chart recorders and more - all assembled and calibrated, at direct-to-you savings.



HEATH COMPANY, Benton Harbor, Michigan 49022

Please send my free Heath/Schlumberger and Heathkit catalogs.

NAME _____

TITLE _____

COMPANY/INSTITUTION _____

ADDRESS _____

CITY _____ STATE _____ ZIP _____

EK-259-11

When you think of profitable and easy servicing, think of RCA.

And now write for the full story. At no obligation.

Check the areas you'd like to hear more about:

- RCA Receiving Tubes
- Exact Replacement Parts in our computer-planned "QT" (Quick Turnover) Package
- RCA Outdoor Antennas, Rotators and Reception Aids including the new Mini-State Antenna System
- RCA Picture Tubes
- Test Equipment including RCA's new Industry Compatible Test Jig
- SK Replacement Semiconductors with 250 RCA types replacing 103,200 devices
- Batteries for all portable electrical needs

Name _____ Title _____

Firm _____

Address _____

City _____ State _____ Zip _____

RCA Distributor and Special Products Division

Subscription Offer

Enter my subscription to ELECTRONIC SERVICING

- 3 years \$13.00 2 Years \$10.00 1 Year \$6.00
- Bill Me Remittance Enclosed Extend Present Subscription

IMPORTANT! Please check your business classification.

Type of Business

Check One

- | | |
|---|--|
| A. <input type="checkbox"/> Independent Electronic Service Organization | F. <input type="checkbox"/> Wholesale, Jobber, Distributor |
| B. <input type="checkbox"/> Retailer with Electronic Service Department | G. <input type="checkbox"/> Other (Specify)..... |
| C. <input type="checkbox"/> Independent or Self-Employed Service Technician | Position |
| D. <input type="checkbox"/> Electronics, Radio, TV Manufacturer | H. <input type="checkbox"/> Owner, Manager |
| E. <input type="checkbox"/> Industrial Electronic Service | I. <input type="checkbox"/> Ser. Manager |
| | J. <input type="checkbox"/> Technician |
| | K. <input type="checkbox"/> Other |

Be sure you have checked one box in each column above!

Print plainly or write below:

Name _____

Firm _____

Firm Address _____

City _____ State _____ Zip _____

Did you receive this issue through Distributor Subscription

Electronic Servicing SUBSCRIPTION OFFER...

Use this handy card to subscribe or renew your subscription.

BUSINESS REPLY MAIL
No Postage Stamp Necessary If Mailed In United States

FIRST CLASS PERMIT
No. 395
Benton Harbor,
Michigan 49022

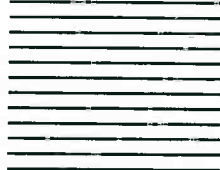

Postage will be paid by

HEATH COMPANY

Dept. 259-11

Benton Harbor, Michigan 49022

BUSINESS REPLY MAIL
No Postage Stamp Necessary if Mailed in the United States

FIRST CLASS
Permit No. 16
Camden, N.J.



Postage will be paid by

RCA Distributor and Special Products Division
Bldg. 206-2 Cherry Hill Offices
Camden, N.J. 08101

ATTN: Advertising Services

**Everything we make
has you in mind.**

RCA
Distributor and
Special Products Division

PLACE
FIRST CLASS
POSTAGE
HERE

Electronic Servicing.

1014 Wyandotte Street
Kansas City, Mo. 64105

Your VTVM is obsolete!

This may sound like a harsh claim, but it's true. Thousands of TV technicians are using instruments designed in the 1950's to trouble-shoot circuits designed in the 1970's.

And now, most color TV's have solid state circuits. So use of out-of-date test equipment just compounds the problem.

The generation gap has grown too big.

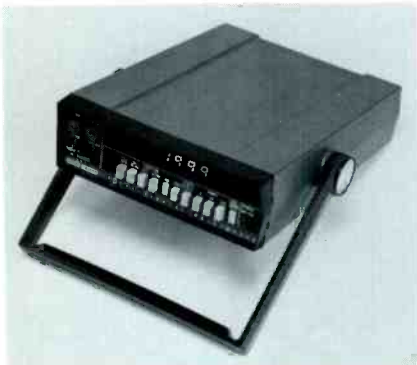

The Fluke 8000A 3 1/2 digit multimeter

Solid state calls for new performance standards.

Your "old fashioned" test equipment simply doesn't measure up to today's requirements. For example, the typical VTVM gives you 5% accuracy and 2% resolution. In the old days, that was good enough. Not so today.

Now you need an instrument to look at the voltages at each pin of an IC with sufficient accuracy and resolution to determine proper IC operation.

For example, a reading of "around 2.8 volts" is no longer sufficient. You must be able to distinguish between 2.80 and 2.82 volts.

You need a test instrument that gives you 0.1 ohm resolution so you can reliably measure resistance of switch contacts, circuit breakers, and low value resistors.

To do all this and more, you need the superior capabilities of the Fluke 8000A 3 1/2 digit multimeter.

An instrument designed specifically for testing solid state equipment.

The 8000A gives you up to 50 times the accuracy and 20 times the resolution of a VTVM, so you can measure the various voltage levels in a solid state chassis with absolute confidence.

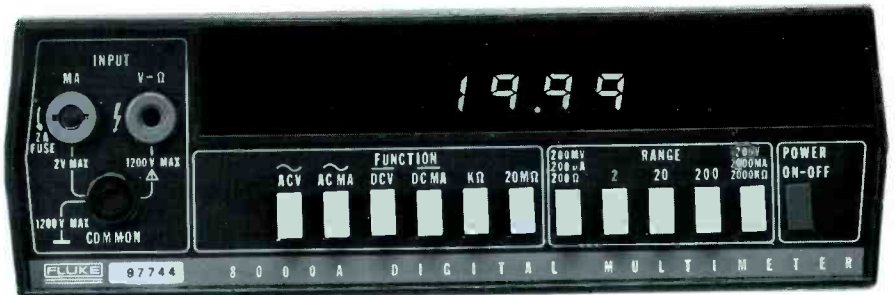

Resolution is 100 microvolts, 100 nanoamps and 100 milliohms

You get the sensitivity you need for low level dc measurements. The 200 millivolt range with 100 microvolt resolution tells you *exactly* what your values are.

The 8000A has an AC frequency response from 45 Hz to 20 KHz and, with accessory probes, to 500 megahertz. Resistance measuring capability ranges from 100 milliohms to 20 megohms. It offers a 15°C to 35°C accuracy temperature span. And a 1-year accuracy time span, meaning it seldom needs calibration.

Unlike other DMM's the 8000A has fast response time—3 readings a second. And the bright, digital readout means that no interpolation is necessary.

The 8000A measures high voltages, too.

Our 8000A is designed to answer *all* the needs of an electronic service technician.

One very important (and talked about!) safety requirement is that the picture tube anode voltage must not exceed the maximum specified by the manufacturer. Our 8000A has an optional high voltage probe that gives you guaranteed accuracy of 1% at 25,000 volts. The probe also extends the capability of the 8000A to 40,000 volts to measure the high voltage in the new 32,000 volt chassis.

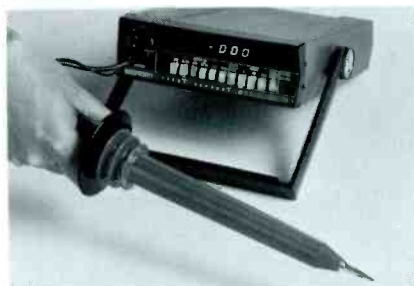

High voltage probe accessory gives you 1% accuracy at 25,000 volts

There's new high voltage protection on all ac/dc voltage ranges. The instrument will take transients up to 6 KV, 10 μseconds wide over a duty cycle of 60 per second.

Get the most up-to-date instrument available.

Don't be caught in the typical trap. Many electronic service shops don't really update their equipment when they decide to update. Switching to a TVM or a FET voltmeter doesn't really give you the accuracy and resolution you need today, or for that matter, tomorrow.

But with the 8000A on hand, you know you have a *true* solid state testing device.

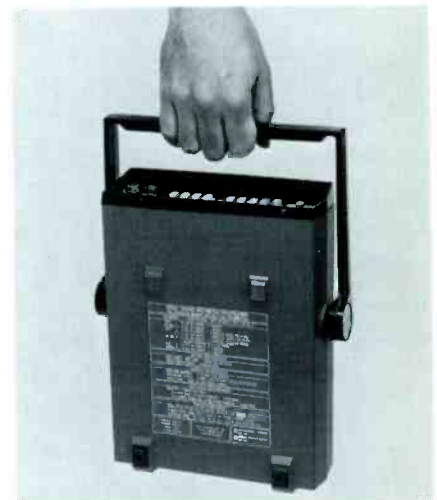

Carry it anywhere. Use it on line or with optional rechargeable battery power (\$50 extra). Note the conveniently mounted specs on the bottom decal.

It costs just \$299 (\$40 more with HV probe).* And it is far and away the largest selling, most rugged and reliable 3 1/2 digit multimeter in the world.

*Domestic only.

For data out today, dial our toll-free hotline, 800-426-0361



John Fluke Mfg. Co., Inc.
P. O. Box 43210, Mountlake Terrace, WA 98043

For More Details Circle (2) on Reply Card
For Demonstration only Circle (3) on Reply Card

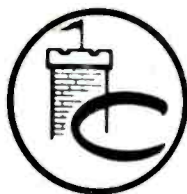

CASTLE Timesavers ... for the Professional

SUBBER® TV signal circuit analysts

Analyze the ENTIRE signal circuit system of any Color or Black & White Television receiver ... by signal substitution.

Outputs at video i.f., sound i.f., video and audio.

- Inbuilt monopole antenna • Inbuilt loudspeaker • Video carrier level meter • Battery indicator meter

Use on the bench or in the home ... anywhere.

Complete with 120vac wall plug-in transformer and matched test cables.



MASTER SUBBER® Analyst Mk V net \$169.95

*UHF-VHF
TV tuner and i-f
signal analyst
120 VAC + Battery*



**Mark IV-CUV
net \$64.95**

*TV tuner and i-f
signal analyst
120 VAC + Battery*



**Mark IV-C
net \$54.95**

MEZZER™ TV Field Strength Meters

Use for measurements of TV signals in:—

- Antenna installation • Antenna evaluation • CATV
- MATV • Output calibration of TV signal generators.

TV Service VHF Field Strength Meter

- Simple to operate
- Measures 300uV to 30,000uV.
- Uses ordinary 9v transistor batteries

**Model TVS
net \$69.95**



VHF Field Strength Meter

Range: 20 microvolts to 100 millivolts.
Attenuator: x 1, x 10, x 100.
Inputs: 75 & 300 ohms.
120vac & batteries

**Model FSM-V
net \$119.95**



UHF Field Strength Meter

Range: 20 microvolts to 10 millivolts.
Attenuator: x 1 and x 10.
Inputs: 75 & 300 ohms.
120vac & batteries

**Model FSM-U
net \$99.95**



Castle products — advanced technology — modern styling — and they work!

Ask your electronic distributor for them ... or write for more details.

CASTLE ELECTRONICS, INC. 5701 N. Western Ave., Chicago, Ill. 60645 • Ph. (312) 728-1800

For More Details Circle (4) on Reply Card