

EST-275 R 4C 1277 4
RICHARD B FONES JR
25 BALTIMORE-ANNAPOLIS
BLVD-FERNDALE
GLEN BURNIE MD 21061

April, 1975 □ 75 cents

Electronic Servicing®

PHILCO COLOR PROBLEMS



Pricing
Labor

Tuner
Tips

Modular-TV
Repairs

PTS ELECTRONICS

Precision Tuner Service

is proud to announce the **GRAND OPENING**
of our new Service Centers in



HOME OFFICE - INDIANA:
5233 S. HWY. 37
BLOOMINGTON, INDIANA 47401
TEL. 812. 824-9331

ALABAMA:
524 32ND ST. SOUTH
BIRMINGHAM, ALA. 35222
TEL. 205. 323-2647

ARIZONA:
2412 W. INDIAN SCHOOL RD.
PHOENIX, ARZ. 85061
TEL. 602. 279-8718

CALIFORNIA - NORTH:
4611 AUBURN BLVD.
SACRAMENTO, CALIF. 95841
TEL. 916. 482-6220

CALIFORNIA - SOUTH:
5111 UNIVERSITY AVE.
SAN DIEGO, CALIF. 92105
TEL. 714. 280-7070

COLORADO:
4958 ALLISON ST.
ARVADA, COLO. 80001
TEL. 303. 423-7080

FLORIDA - NORTH:
12934 N.W. 7TH AVE.
MIAMI, FLA. 33168
TEL. 305. 685-9811

FLORIDA - SOUTH:
1918 BLANDING BLVD.
JACKSONVILLE, FLA. 32210
TEL. 904. 389-9952

INDIANA:
5233 S. HWY. 37
BLOOMINGTON, IND. 47401
TEL. 812. 824-9331

KANSAS:
3116 MERRIAM LANE
KANSAS CITY, KANSAS 66100
TEL. 816. 891-4935

LOUISIANA:
2914 WYCHWOOD DRIVE
METAIRIE, LOUISIANA 70033
TEL. 504. 885-2349

MARYLAND:
1105 SPRING ST.
SILVER SPRING, MD. 20910
TEL. 301. 565-0025

MASSACHUSETTS:
191 CHESTNUT ST.
SPRINGFIELD, MASS. 01103
TEL. 413. 734-2737

MICHIGAN:
13709 W. EIGHT MILE RD.
DETROIT, MICH. 48235
TEL. 313. 862-1783

MINNESOTA:
815 W. LAKE ST.
MINNEAPOLIS, MINN. 55408
TEL. 612. 824-2333

MISSOURI:
8456 PAGE BLVD.
ST. LOUIS, MO. 63130

NEW YORK:
993 SYCAMORE ST.
BUFFALO, N.Y. 14212
TEL. 716. 891-4935

NEW YORK CITY - NEW JERSEY:
158 MARKET ST.
E. PATERSON, N.J. 07407
TEL. 201. 791-6380

NORTH CAROLINA:
724 SIEGLE AVE.
CHARLOTTE, N.C. 28205
TEL. 704. 332-8007

OHIO:
5682 STATE RD.
CLEVELAND, OHIO 44134
TEL. 216. 845-4480

OKLAHOMA:
3007 N. MAY
OKLAHOMA CITY, OKLA. 73106
TEL. 405. 947-2013

OREGON:
5220 N.E. SANDY BLVD.
PORTLAND, OREGON 97213
TEL. 503. 282-9636

PENNSYLVANIA - EAST:
1742 44 STATE RD.
UPPER DARBY, PA. 15202
TEL. 215. 352-6609

PENNSYLVANIA - WEST:
257 RIVERVIEW AVE. W.
PITTSBURGH, PA. 15202
TEL. 412. 761-7648

TENNESSEE:
3614 LAMAR AVE.
MEMPHIS, TENN. 38118
TEL. 901. 365-1918

TEXAS - NORTH:
MOPAC LANE
LONGVIEW, TEX. 75601
TEL. 214. 753-4334

TEXAS - EAST:
4324 26 TELEPHONE RD.
HOUSTON, TEX. 77032
TEL. 713. 644-6793

WISCONSIN:
3509 W. NATIONAL
MILWAUKEE, WI. 53215
TEL. 414. 643-8800

MILWAUKEE

PHOENIX

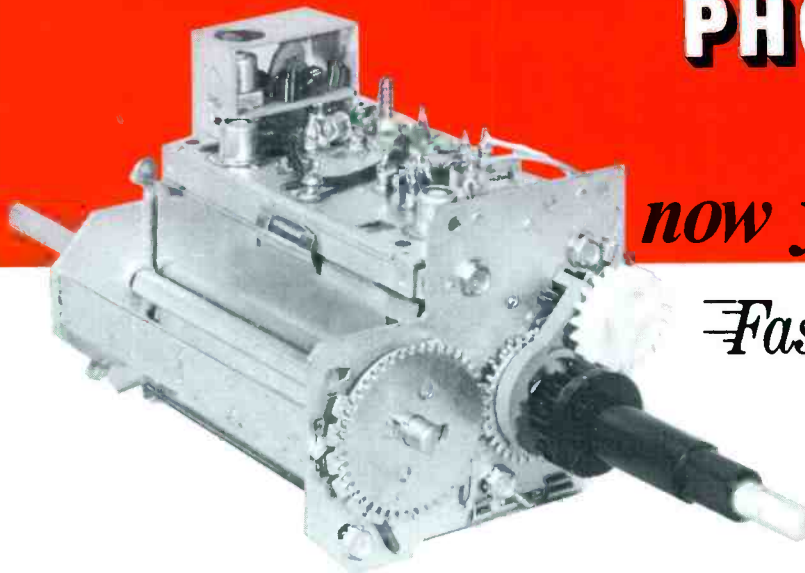

now you too get...

Fast **8** hr. Service!

\$ 10⁹⁵

1 YEAR GUARANTEE

ALL PTS BRANCHES are wholly owned subsidiaries of PTS ELECTRONICS, INC. (NO FRANCHISES!) and report directly to the Home Office in Bloomington, Indiana. Only this way can we guarantee the same quality - PRECISION TUNER SERVICE - that made PTS the leader in this field.

New 4th edition of our **TUNER REPLACEMENT PARTS CATALOG** now available (over 100 pages of tuner blow-ups, tuner - antenna coil - and shaft replacement guides 4th edition available for \$2.00)

**WE OFFER MORE.
SERVICE IS EVERYTHING
WITH US.**

**WE ARE DYNAMIC AND FAST.
TRUSTWORTHY.**

**YOU AND US - A
TRUE PARTNERSHIP.**

*PTS ELECTRONICS, INC. is recommended by more TV
manufacturers and overhauls more tuners than all
other tuner services combined!*

Color • Black & White • Transistor
• Tubes • Varactor • Detent UHF
All Makes

VHF, UHF	\$10.95
UV-COMBO	\$17.95
IF-SUBCHASSIS	12.50

Major parts and shipping
charged at cost.
(Dealer net!)

over 4000 exact tuner replace-
ments available for \$14.95 up
(new or rebuilt)

PTS-NUMBER ONE

AND STILL
TRYING
HARDER!

(NOT A FRANCHISE COMPANY)
For More Details Circle (1) on Reply Card

EDITORIAL
RONALD N. MERRELL, Director
CARL H. BABCOKE, Managing Editor
JOYCE PRUESSNER, Editorial Assistant
DUDLEY ROSE, Graphic Designer

Electronic Servicing.

ELECTRONIC SERVICING
1014 Wyandotte Street
Kansas City, Missouri 64105

TECHNICAL CONSULTANT
JOE A. GROVES

EDITORIAL ADVISORY BOARD
LES NELSON, Chairman
Howard W. Sams & Co., Indianapolis

CIRCULATION
EVELYN ROGERS, Manager

ADVERTISING SALES
Kansas City, Missouri 64105
Tele: 913/888-4664
E. P. LANGAN, Director
R. J. HANCOCK, Manager
JAKE STOCKWELL
DENNIS TRIOLA
CRIS BARNES, Production

REGIONAL ADVERTISING SALES OFFICES
Indianapolis, Indiana 46280
ROY HENRY
2469 E. 98th St.
Tele: 317/846-7026

New York, New York 10017
STAN OSBORN
Room 1227
60 E. 42nd St.
Tele. 212/687-7240

Mountain View, California 94043
MIKE KREITER
2680 Bayshore Frontage Road, Room 102
Tele: 415/961-0378

London W. C. 2, England
JOHN ASHCRAFT & CO.
12 Bear Street
Leicester Square
Tele: 930-0525

Amsterdam C. Holland
JOHN ASHCRAFT & CO.
W. J. M. Sanders, Mgr.
for Benelux & Germany
Herengracht 365
Tele: 020-240908

Tokyo, Japan
INTERNATIONAL MEDIA
REPRESENTATIVES LTD.
1, Shiba-Kotohiracho, Minatoku
Tele: 502-0656

in this issue...

- 12 **Troubleshooting Color Problems In Philco Hybrids, Part 1**—When you know the circuits, you can find many chroma defects without a scope—*John Simrell.*
- 22 **Pricing Versus Consumerism**—Service-pricing methods are under attack. The Sperry system of pricing is one answer—*Carl Babcoke.*
- 26 **How To Select Ladders For Value And Safety**—A ladder expert offers good advice about obtaining the ladder that's right for you, and gives valuable safety tips—*Norman Ackerman.*
- 34 **My Tuner Tips**—Probably the most common tuner problem is intermittent operation from loose or corroded switch contacts. Here's how to cure them—*Max Goodstein.*
- 37 **Servicing Modular Color, Part 3**—Continuing with the Zenith 19EC45 color chassis, the vertical-sweep circuit is featured, including loss of the horizontal line when the yoke current stops—*Charles D. Simmons.*

DEPARTMENTS

Electronic Scanner4	Book Review47
Symcure8	Product Report48
Troubleshooting Tips10	Audio Systems52
Reader's Exchange11	Catalogs and Literature53
Test Equipment46	Advertiser's Index54



ELECTRONIC SERVICING (with which is combined PF Reporter) is published monthly by Intertec Publishing Corp., 1014 Wyandotte Street, Kansas City, Missouri 64105.

Subscription Prices: 1 year — \$6.00, 2 years — \$10.00, 3 years — \$13.00, in the U.S.A. and its possessions.

All other foreign countries: 1 year — \$7.00, 2 years — \$12.00, 3 years — \$16.00. Single copy 75c; back copies \$1. Adjustment necessitated by subscription termination to single copy rate.

Second class postage paid at Shawnee Mission, Kansas and additional mailing offices. Published monthly at 9221 Quivira Road, Shawnee Mission, Kansas 66215 by Intertec Publishing Corp., 1014 Wyandotte St., Kansas City, Mo. 64105. Send Form 3579 to 9221 Quivira Road, Shawnee Mission, Ks. 66215.

© Copyright, 1975, Howard W. Sams & Co., Inc. All rights reserved. Material may not be reproduced or photocopied in any form without written permission of publisher.



Robert E. Hertel, Publisher

Intertec Publishing Corp.
Subsidiary of Howard W. Sams & Co., Inc.

Service back-up

Quasar's back-up programs are designed to help our thousands of authorized servicers keep their customers happy.

We design Quasar TV serviceability with you in mind. Our own service experts are, in fact, involved in design at the drawing board stage. Their contributions help you perform your job more professionally to help enhance your image with consumers. Such keen awareness of your needs helped lead to our pioneering in modular chassis concepts.

Our regular, practical training helps keep you up to date. Quasar's 83 distributors conduct thorough training seminars regularly to acquaint servicers with newly-introduced products and to pass along updated servicing techniques. Quasar even provides practical, valuable service literature regularly for a nominal subscription fee.

Our speedy PACE parts availability system helps you maintain customer good will. To help you satisfy most consumer problems promptly, yet help keep your shop inventory reasonable, Quasar offers its PACE program through distributors. Using this optional program, the distributor can stock 90% of all parts you'll ever need. Beyond that, we'll drop-ship through our distributors from the factory direct to you.



A new company with new solutions for today.

Quasar Electronics Corporation
A subsidiary of Matsushita Electric Corporation of America

electronicsscanner

news of the industry

Addressing dealers at NARDA's National School of Service Management, Dean Ridgely, a dealer from Green Bay, Wisconsin, charged that inadequate rates paid for appliance/TV in-warranty service often prompts some dealers to "cheat" on their warranty service invoices to producers. Ridgely claims that manufacturers make money on in-warranty service, reports **Home Furnishings Daily**.

Both the number of dealerships and the total number of electronics technicians servicing home electronics equipment decreased in 1974, according to a survey conducted by the National Electronic Service Dealers Association (NESDA). From January 1974 to January 1975, the number of firms engaged in consumer electronics service decreased from 77,230 to 72,165; service technicians decreased from 204,000 to 183,566; apprentices decreased from 12,250 to 6,500; but the number of students increased from 18,000 to 20,000. Dick Glass, executive vice-president of NESDA says previous state totals have reflected inaccuracies, and the 1975 figures are more accurate.

Television manufacturers estimate that Underwriters Laboratories' requirements on plastic-cabinet fire retardancy, effective in July, will add to the retail price of sets to be introduced in the spring. According to a report in **Home Furnishings Daily**, one manufacturer said the requirements are the most expensive cost factors involving product safety to be incurred by the industry. Manufacturers using polystyrene with fire-retardant additives have run into problems such as brittleness and light color fading of cabinets.

A new set of regulations issued by the Department of Consumer Affairs in New York city covering repairs of TV's, radios, and audio equipment became effective February 24, 1975. Technicians must guarantee their work for 30 days, reports **Radio & Television Weekly**, and replacement parts must be guaranteed for 90 days. The regulations forbid customers from signing statements absolving the technicians from liability connected with the service work. Before the actual repair work begins, a written estimate covering all repairs must be in the mail. Technicians say that increased administrative work and mailing costs will have to be borne by the customers.

Licenses issued by the Federal Communications Commission for Citizen's Band radios have reached 1 million for the first time, reports **Home Furnishings Daily**. Applications in 1974 were up 95% from 1973, according to figures from the Electronic Industries Association, and the market is expected to grow another 30% this year.

Instant Rebates from \$30 to \$50 in fair-trade states will be offered on five color TV sets from Panasonic. According to **Home Furnishings Daily**, the amount of savings will differ in other states. The program affects two 13-inch color sets, one 17-inch set, and two 19-inch models.

(Continued on page 6)

TUNER SERVICE CORPORATION

SUBSTITUNER



INTRODUCING
AT JUST

\$39.95
U.S.A. ONLY

WITH CABLES

ONE YEAR
GUARANTEE

STILL ONLY

\$9.95
U.S.A. ONLY



ALL PARTS
INCLUDED

EXCEPT TUBES
AND TRANSISTORS

FEATURES

- A UHF Tuner with 70 channels which are detented and indicated just like VHF channels.
- A VHF Hi Gain Solid State Tuner.
- AC Powered
- 90 Day Warranty

Demonstrate the **SUBSTITUNER** to your customers and show improved reception with their TV sets.

You may place your order through any of the Centers listed below.

PROVIDES YOU WITH A COMPLETE SERVICE FOR ALL YOUR TELEVISION TUNER REQUIREMENTS.

REPAIR

VHF OR UHF ANY TYPE (U.S.A. ONLY) \$ 9.95
UHF/VHF COMBINATION (U.S.A. ONLY) \$15.00

- IN THIS PRICE ALL PARTS ARE INCLUDED. Tubes, transistors, diodes, and nuvistors are charged extra. This price does not include mutilated tuners.
- Fast, efficient service at our conveniently located Service Centers.
- All tuners are ultrasonically cleaned, repaired, realigned, and air tested.

REPLACE

UNIVERSAL REPLACEMENT TUNER \$12.95 (U.S.A. only)

- This price buys you a complete new tuner built specifically by Sarkes Tarzian Inc. for this purpose.
- All shafts have a maximum length of 10½" which can be cut to 1½".
- Specify heater type parallel and series 450 mA. or 600 mA.

CUSTOMIZE

- Customized tuners are available at a cost of only \$15.95. With trade-in \$13.95. (U.S.A. only)
- Send in your original tuner for comparison purposes to any of the Centers listed below.



HEADQUARTERS	BLOOMINGTON, INDIANA 47401	537 South Walnut Street	Tel. 812-334-0411
ARIZONA	TUCSON, ARIZONA 85713	P.O. Box 4534, 1528 S. 6th Ave.	Tel. 602-791-9243
CALIFORNIA	NORTH HOLLYWOOD, CALIF. 91601	10654 Magnolia Boulevard	Tel. 213-769-2720
	BURLINGAME, CALIF. 94010	1324 Marsten Road	Tel. 415-347-5728
	MODESTO, CALIF. 95351	123 Phoenix Avenue	Tel. 209-521-8051
FLORIDA	TAMPA, FLORIDA 33606	1505 Cypress Street	Tel. 813-253-0324
	HIALEAH, FLORIDA 33013	906 East 25th Street	Tel. 305-836-7078
GEORGIA	ATLANTA, GEORGIA 30310	938 Gordon Street S.W.	Tel. 404-758-2232
ILLINOIS	CHAMPAIGN, ILLINOIS 61820	405 East University Street	Tel. 217-356-6400
	CHICAGO, ILLINOIS 60621	737 West 55th Street	Tel. 312-873-5556-7
	SKOKIE, ILLINOIS 60076	5110 West Brown Street	Tel. 312-675-0230
INDIANA	HAMMOND, INDIANA 46323	6833 Grand Avenue	Tel. 219-845-2676
	INDIANAPOLIS, INDIANA 46204	112 West St. Clair Street	Tel. 317-632-3493
KENTUCKY	LOUISVILLE, KENTUCKY 40208	2920 Taylor Boulevard	Tel. 502-634-3334
LOUISIANA	SHREVEPORT, LOUISIANA 71104	3025 Highland Avenue	Tel. 318-221-3027
MARYLAND	BALTIMORE, MARYLAND 21215	5505 Reisterstown Rd., Box 2624	Tel. 410-358-1186
MISSOURI	ST. LOUIS, MISSOURI 63132	10530 Page Avenue	Tel. 314-429-0633
NEVADA	LAS VEGAS, NEVADA 89102	1412 Western Avenue No. 1	Tel. 702-384-4235
NEW JERSEY	TRENTON, NEW JERSEY 08638	901 North Olden Avenue	Tel. 609-393-0999
	JERSEY CITY, NEW JERSEY 07307	547-49 Tonnele Ave., Hwy. 1 & 9	Tel. 201-792-3730
OHIO	CINCINNATI, OHIO 45216	7450 Vine Street	Tel. 513-821-5080
	CLEVELAND, OHIO 44109	4525 Pearl Road	Tel. 216-741-2314
OREGON	PORTLAND, OREGON 97210	1732 N.W. 25th Avenue	Tel. 503-222-9059
TENNESSEE	GREENEVILLE, TENNESSEE 37743	1215 Snapps Ferry Road	Tel. 615-639-8451
	MEMPHIS, TENNESSEE 38111	3158 Barron Avenue	Tel. 901-458-2355
TEXAS	DALLAS, TEXAS 75218	11540 Garland Road	Tel. 214-327-8413
VIRGINIA	NORFOLK, VIRGINIA 23513	3295 Santos Street	Tel. 804-855-2518
WISCONSIN	MILWAUKEE, WISCONSIN 53216	4722 W. Fond Du Lac Ave.	Tel. 414-871-7655
CANADA	ST. LAURENT, QUEBEC H4N-2L7	305 Decarie Boulevard	Tel. 514-748-8803
	CALGARY, ALBERTA T2H-0L1	448 42nd Avenue S.E.	Tel. 403-243-0971
		P.O. Box 5823, Stn. "A"	

WATCH US
GROW

April, 1975

IF YOU WANT TO BRANCH OUT INTO THE TV TUNER REPAIR BUSINESS,
WRITE TO THE BLOOMINGTON HEADQUARTERS ABOUT A FRANCHISE.

For More Details Circle (6) on Reply Card

(Continued from page 4)

According to a Home Furnishings Daily survey, only 10 high fidelity manufacturers account for almost half the industry's volume in this country. The manufacturers include U.S. Pioneer, Marantz, Fisher Radio, Teac Corporation of America, Kenwood, Sansui Electronics, JBL, United Audio, Shure Brothers, and JVC America.

RCA will introduce two commercial TV cameras featuring a new kind of electronic image sensor called the charge-coupled device. Although the silicon sensor is only the size of a postage stamp, it contains 163,840 electronic elements that can form an image pattern when exposed to light. Pictures similar to those produced by larger conventional vidicon tubes are created by scanning the sensor. **The Wall Street Journal** reports that RCA is making two "grades" of the sensor, varying in price from \$1,500 to \$2,300. Depending on which sensor is used, the cameras are priced at \$3,000 and \$3,800 each. For general use, one camera has a built-in lens with an automatic light-control system; the other takes interchangeable lenses and is intended for specialized industrial use.

Some dealers report that service work has increased up to 20% because consumers don't want to buy new products. To offset the declining sales profits, many dealers have raised the prices of service work. According to a report in **Home Furnishings Daily**, other profit-boosting methods in use include advertizing service departments, setting a minimum rate for repair jobs, and refusing unprofitable work.

Using a 43-year-old alloy developed by a Japanese university, the Victor Company of Japan has introduced a new tape-recorder head that reportedly matches the abrasion strength of ferrite heads and surpasses the frequency response of permalloy heads. Named Senalloy, the recording-playback head will be used in all JVC medium- and high-end cassette and open-reel tape recorders and decks introduced in April. **Home Furnishings Daily** reports Senalloy material consists of sendust chip and a permalloy core.

With the introduction of its 1976 color TV line in May, GTE Sylvania will shift to a 90-day labor warranty, **Home Furnishings Daily** reports. Changing from a one-year coverage, the new warranty will involve all Sylvania and Philco color sets. The one-year parts and two-year picture-tube warranty will be maintained.

The Climatic Corporation, Quasar distributor in South Carolina, recently offered rebates of \$40 on portables and \$100 on console color receivers, and **Home Furnishings Daily** reports that sales were boosted over previous slow weeks.

Zenith Radio Corporation will introduce a new warranty for its 1976 solid-state color-TV sets, beginning with the introduction of "G" line receivers in May. The plan will provide in-warranty service labor for the first 90 days of ownership, one-year coverage on replacement parts, and two years coverage on the color picture tube. □



The latest improvement in picture tubes.

Our labels.



If you can say what you want, you've got it. That's our simple new labeling system. The labels tell you what's inside, in simple, everyday language.

We've kept our standard color coding: red for all-new; blue for new screen and gun; green for new gun.

And inside, there's the same great tubes you've always had from Sylvania.

Trust Sylvania to make life easier. See your Sylvania distributor.

We're helping you make it.

GTE SYLVANIA

For More Details Circle (7) on Reply Card

www.americanradiohistory.com

Chassis—Philco-Ford 3CY90
PHOTOFACT—1344-1

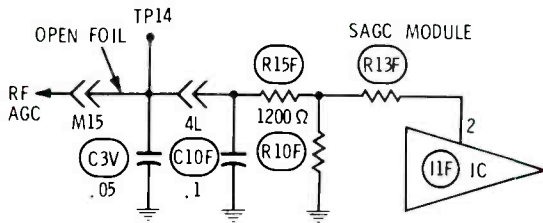

Symptom—Snow or blank raster, often intermittent
Cure—Check for an open foil between TP14 and M15 RF AGC terminal at the front of the chassis

Chassis—Philco-Ford 3CY90
PHOTOFACT—1344-1

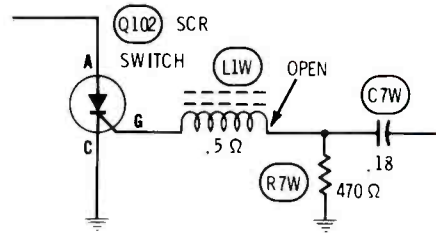

Symptom—Low high voltage, no raster
Cure—Check for an open RF choke L1W, and replace it if open

Chassis—Philco-Ford 2CY80
PHOTOFACT—1430-2

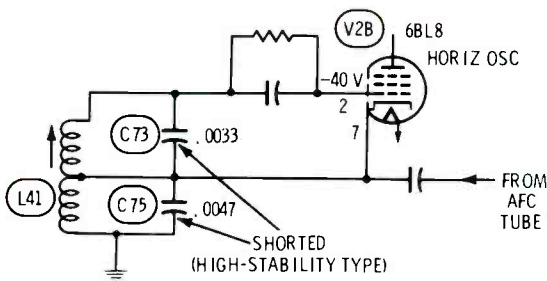

Symptom—No high voltage, plate of output tube is red
Cure—Check for a shorted C73 or C75, and replace it if open

Chassis—Philco-Ford 2CY80
PHOTOFACT—1430-2

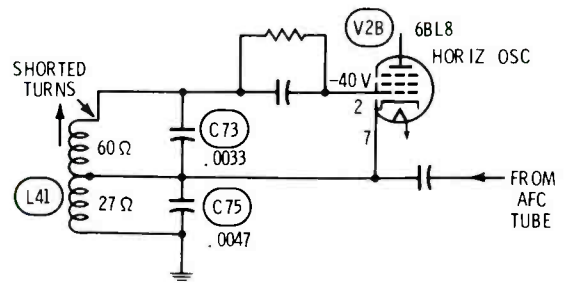

Symptom—Picture bends as brightness is varied
Cure—Check for shorted turns in L41 (60 ohms might be 35), and replace the coil if shorted

Chassis—Philco-Ford 2CY80
PHOTOFACT—1430-2

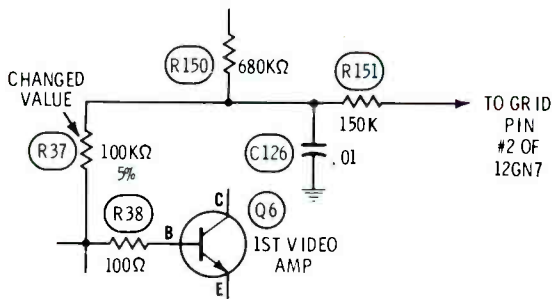

Symptom—Excessive or insufficient brightness
Cure—Check the resistance of R37, and replace it if out of tolerance

Chassis—Philco-Ford 2CY80
PHOTOFACT—1430-2

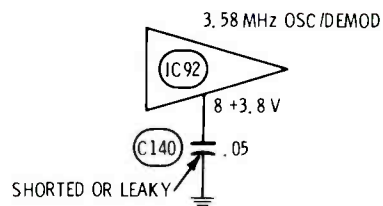

Symptom—Weak green is the only color
Cure—Check C140, and replace it if shorted or intermittently leaky

Type EV —
the space-saver 'lytic ◇◇◇◇◇◇◇◇◇◇◇◇◇◇◇◇

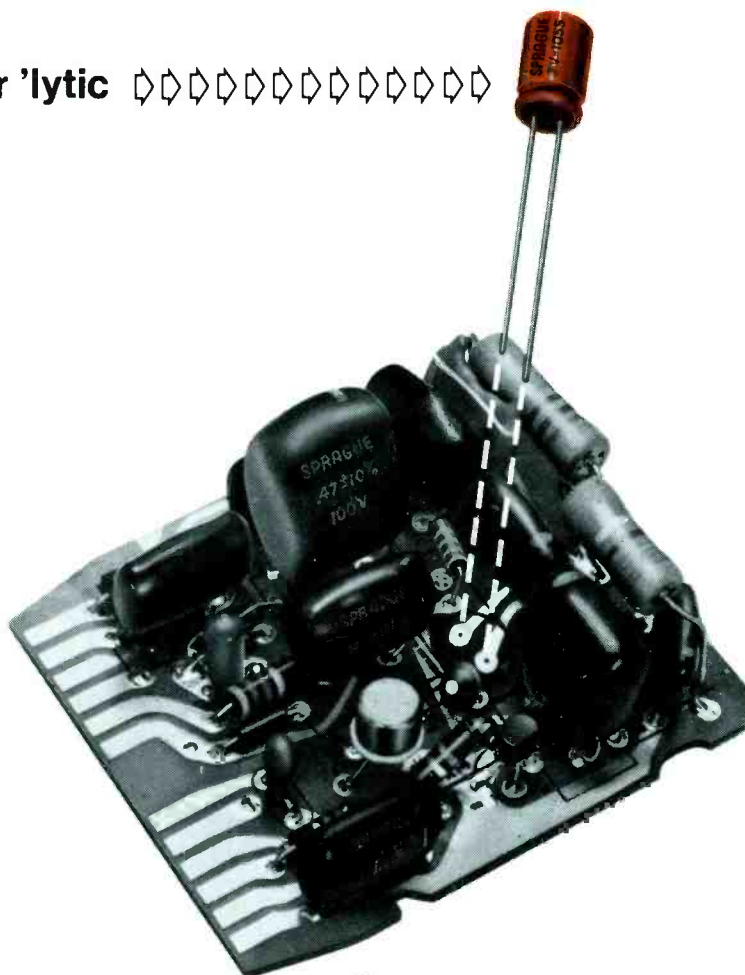

board room

For space-saving 'lytic capacitor replacements on crowded printed wiring boards found in most of today's foreign and domestic consumer entertainment products, Sprague Type EV Verti-Lytic® Capacitors have the widest range of values . . . in the smallest case sizes . . . of any single-ended capacitors available anywhere!



Get on Board with the KE-17 Assortment

This handy assortment of 61 Type EV Capacitors in the 27 most-popular ratings gives you an on-the-spot inventory of the replacement capacitors you need for most of the sets you'll encounter. Sturdy blue plastic cabinet has nine pre-labeled drawers for fast, easy selection. And you pay for capacitors only . . . the cabinet is yours at no extra cost!

See these "new era" capacitors at your Sprague distributor's. Or, get the full story by writing for Brochure M-951 to: Sprague Products Co., 105 Marshall Street, North Adams, Mass. 01247.



THE BROAD LINE PRODUCER OF ELECTRONIC PARTS

For More Details Circle (8) on Reply Card

FREE EICO CATALOG

346 Ways To Save On Instruments!

EICO's Test Instruments line is the industry's most comprehensive because each instrument serves a specific group of professional needs. You name the requirement—from a resistance box to a VTVM, from a signal tracer to a scope, from a tube tester to a color TV generator, etc., you can depend on EICO to give you the best professional value. Compare our latest solid state instruments at your local EICO Electronics Distributor, he knows your needs best—and serves your requirements with the best values!

"Build-it-Yourself" and save up to 50% with our famous electronic kits.

For latest EICO Catalog on Test Instruments, Automotive and Hobby Electronics, Eicocraft Project kits, Burglar-Fire Alarm Systems and name of nearest EICO Distributor, check reader service card or send 50¢ for fast first class mail service.

EICO—283 Malta Street,
Brooklyn, N.Y. 11207

30 years of service to the Professional
Serviceman.



10 For More Details Circle (9) on Reply Card

troubleshootingtips

Send in your helpful tips—we pay!

No picture, no sound
RCA CTC51 color chassis
(Photofact 1332-2)

The RCA with a CTC51 chassis had a raster only, but no picture or sound. I started taking voltage measurements around the first IF and the mixer in the tuner, and noticed clicks in the sound. I assumed this meant the circuits were okay from there to the picture tube, and I didn't bother to look for the noise flashes on the screen. That's where I made my mistake.

I assumed that the oscillator transistor in the tuner was bad, and then replaced it. Unfortunately, the trouble remained. Neither would a tuner substitute bring in any stations.

Next, I tried injecting the video signal of my color-bar generator to the various video stages. No results were obtained until the video was connected to the collector of Q7. I tested transistors Q5 and Q7, finding Q7 was defective. In talking

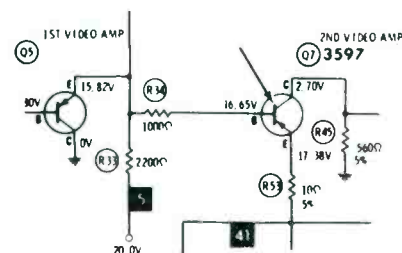

with other technicians, I have learned a failure of Q7 is quite common.

After the picture was restored, I had the mean job of squeezing the oscillator coils in the tuner to make the stations all tune in with the new (not needed) oscillator transistor. All this extra trouble could have been avoided, if I had stuck with my usual procedures.

Max Goodstein
Flushing, New York □

**Ideas for articles?
Send them to ES, now!**

ARROW AUTOMATIC STAPLE GUNS

CUT WIRE & CABLE INSTALLATION COSTS

... without cutting into insulation!

SAFE! Grooved Guide positions wire for proper staple envelopment! Grooved Driving Blade stops staple at right depth of penetration to prevent cutting into wire or cable insulation!

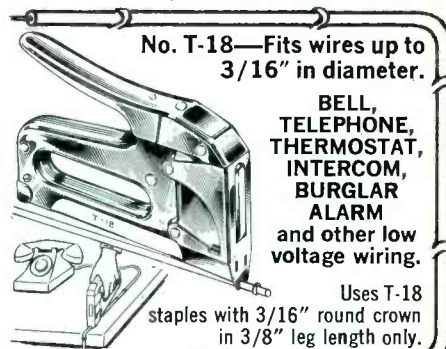

No. T-18—Fits wires up to
3/16" in diameter.

BELL,
TELEPHONE,
THERMOSTAT,
INTERCOM,
BURGLAR
ALARM
and other low
voltage wiring.

Uses T-18
staples with 3/16" round crown
in 3/8" leg length only.

No. T-25—Fits wires up to
1/4" in diameter.

Same basic construction
and fastens same
wires as No. T-18.

Also used for
RADIANT
HEAT WIRE

Uses T-25 staples
with 1/4" round crown in 9/32",
3/8", 7/16" and 9/16" leg lengths.

T-18 and T-25 staples also available in Monel and
with beige, brown and ivory finish at extra cost.

No. T-75—Fits wires and cables
up to 1/2" in diameter.

RADIANT HEAT
CABLE,
UF CABLE,
WIRE CONDUIT
COPPER TUBING
or any non-metallic
sheathed cable.

Also used as
DRIVE RINGS
in stringing wires.

Uses T-75 staples with 1/2"
flat crown in 9/16", 5/8" and
7/8" leg lengths.

Arrow Automatic Staple Guns save 70% in time
and effort on every type of wire or cable fasten-
ing job. Arrow staples are specially designed with
divergent-pointed legs for easier driving and
rosin-coated for greater holding power! All-steel
construction and high-carbon hardened steel
working parts are your assurance of maximum
long-life service and trouble-free performance.

Ask your Electrical Supply Dealer
or write for further details.

ARROW FASTENER COMPANY INC

Saddle Brook, New Jersey 07863

"Pioneers and Pacesetters
For Almost A Half Century"

For More Details Circle (10) on Reply Card

reader's exchange

Needed: Deflection yoke assembly RCA 906192-501, stock number 67115970, used in T-1 kit supplied by Sylvania Technical Schools.

M. C. Womack
Route 1, Box 173-X
Mathis, Texas 78368

Needed: Schematic for Philco radio Model 42-PT-7. Will buy.

Walter S. Opalach
982 Planetree Place
Sunnyvale, California 94086

Needed: Information about a method of removing the protective encapsulation on military circuit boards without destruction from chipping or heat.

Steven E. Collier
5610 Maxwell
Houston, Texas 77023

Wanted: Used Wintronix color rainbow generator Model 150 or 750, in working condition and with manual; reasonably priced.

Edward Schoener
P.O. Box 44
New Ringgold, Pennsylvania 17960



Patent 3,778,713

The Wayne Model WT2A

- makes YOU money
- saves much time
- makes trouble-shooting easier

A new concept in transistor testing based on proven methods of circuit analysis. A current limited AC voltage is applied to each semiconductor junction under test. The resulting DC voltage is monitored while the rectifying junction is passing normal rated current. Abnormalities are easily identified.

- Indicates PNP or NPN
- Measures relative gain
- Test leads applied without prior basing knowledge
- Locates base and collector during test
 - Indicates silicon or germanium
 - Indicates transistor non-linearity
- In-circuit tests with shunt impedance down to THREE ohms
- Performs all of above and more in less than ten seconds

WAYNE
ELECTRONICS
5412 Nordling St./Houston, Texas 77022

For More Details Circle (11) on Reply Card

the bright one

new phosphor picture tube
with twice the brightness

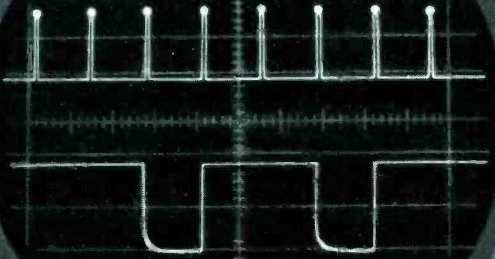

TO-60 automatic dual-trace triggered-sweep oscilloscope

P-31 phosphor CRT has double the brightness for bright displays even in high speed dual-trace modes. Bandwidth: DC to 15 mhz. Unique features for the industry's greatest value are: • Automatic Triggering • Automatic Astigmatism • Automatic Horizontal Sweep • Automatic Horiz/Vert. TV Triggering provides positive display on composite video signals. Vertical sensitivity: .01 volts/cm to 20 volts/cm in 1-2-5 step sequence. Horizontal Sweep Speeds: .2 sec/cm to .5μ sec/cm in 1-2-5 step sequence. Has 5X magnifier at all sweep speeds. External Horiz. Amp. Bandwidth: DC to .5 mhz; Sensitivity: .5 volts/cm. Calibrated Test Signal: 1 volt P-P square wave. Power: 105-125 volts, 60 cycles, 65 watts

Model TO-60 Less Probes. Net \$489.50

TO-55 automatic single-trace triggered sweep oscilloscope. Features same as TO-60 except Vert. Bandwidth is DC to 10 mhz.

Model TO-55 Less Probes. Net \$379.50

For the "bright one," see your distributor, or write:



LECTROTECH, INC.

5810 N. Western Avenue, Chicago, Illinois 60659
Area (312) 769-6262

For More Details Circle (12) on Reply Card

TROUBLESHOOTING COLOR PROBLEMS IN PHILCO HYBRIDS

Part 1/By John Simrell

Although this information is about the Philco-Ford hybrid color receivers, some of the general servicing principles can be applied to other sets that have diode-AFC and reactance-control circuits.

Many problems far removed from the chroma channel can simulate chroma defects. A poor antenna or lead-in sometimes weakens the color on one channel, giving critical fine tuning and degraded color quality. Poor purity of the raster can give the visual effect of no color, although test equipment will show it reached the picture tube. Even

such a simple thing as a mis-adjusted fine-tuning knob appears to be a serious color problem.

This article, for the most part, covers defects in the chroma circuits.

Actual chroma troubles can be grouped into these general categories:

●too much, or too little color;

- loose color locking;
- smearing color;
- wrong tints, and
- interference in the color.

It's not unusual to find various combinations of troubles happening at the same time. For example, weak color and intermittent color locking might be the twin symptoms.

Quite often, multiple symptoms make diagnosis easier, rather than more difficult.

The system of troubleshooting to be described requires only a meter, such as a VTVM, sensitive VOM, digital, or FET meter. Therefore, the tests can be performed during home service calls, as well as on the work bench.

No Color Or Weak Color

When the color is weak or missing entirely, but the b-w part of the picture appears to be normal, it seems logical to suspect the chroma circuits. But that's not necessarily correct. Defects in the tuner, IF amplifiers, and video amplifiers also can weaken the color.

Wrong alignment of the video IF's usually causes a larger change of chroma amplitude and quality than is possible by the same degree of chroma misalignment.

Luckily, there is a simple quick-and-dirty test for overall bandwidth that can be performed without equipment, but it's one providing reasonable accuracy.

Check the no-signal snow

Tune to a blank channel (if

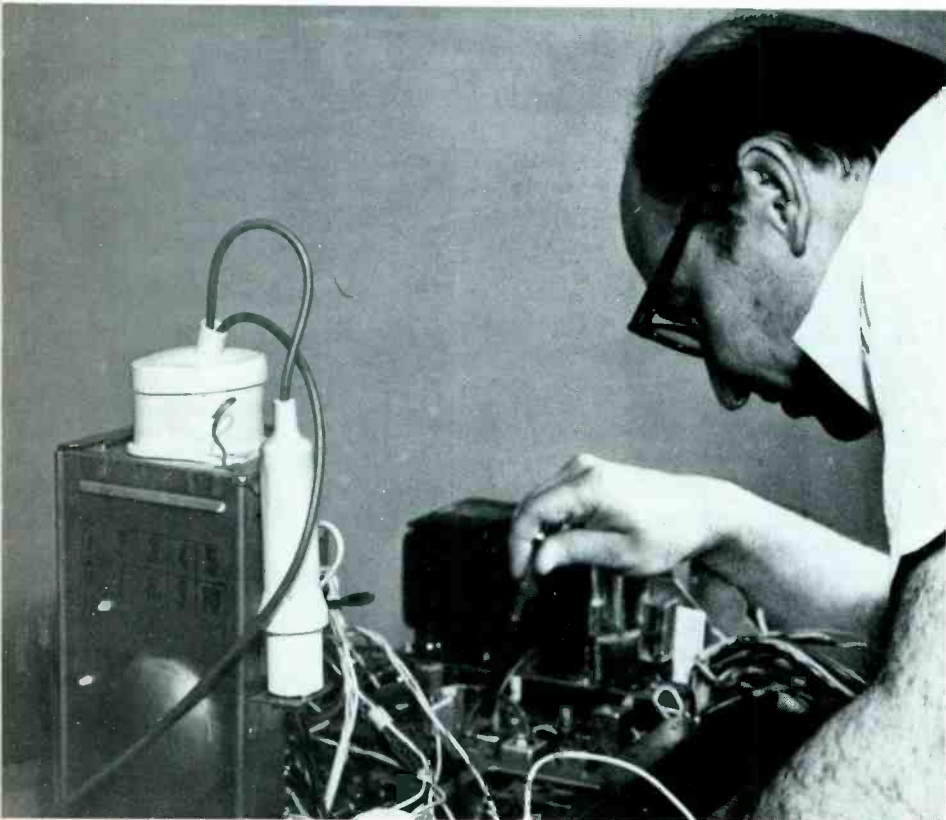

John Simrell pointed out to the photographer the locations of the major test points.

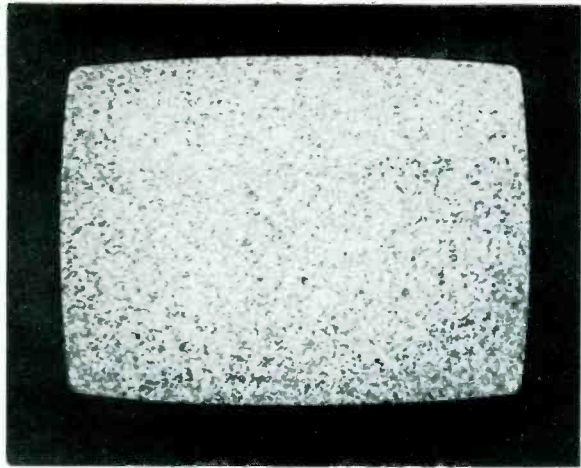

Fig. 1 Off-channel snow that appears hard, sharp, and grainy usually indicates the receiver is capable of passing the color signal through tuner, IF's, and video stages. Snow also can be used to simulate burst to test for approximate gain.

necessary, remove the antenna leads to eliminate any interference from another channel), and analyze the amount and quality of the snow visible on the screen. Make a practice of doing this on normal sets (Figure 1), and you will learn very quickly how much snow to expect.

In addition to having normal amplitude, the snow should appear

sharp and grainy, not blurred or in streaks. Snow is "white noise", theoretically consisting of all frequencies. Any TV with sharp, grainy snow usually is capable of passing the color through tuner, IF's, and video stages.

If the snow does not have enough amplitude or sharpness, make whatever repairs are necessary to restore the normal quality of the

snow. **Quite often, this also corrects the problem of the color.**

Defeat the color killer

The normal function of a color killer is to eliminate the color part of the picture when the program is in black-and-white. This prevents blotches of false color. However, a defective killer circuit might weaken or stop the color when the

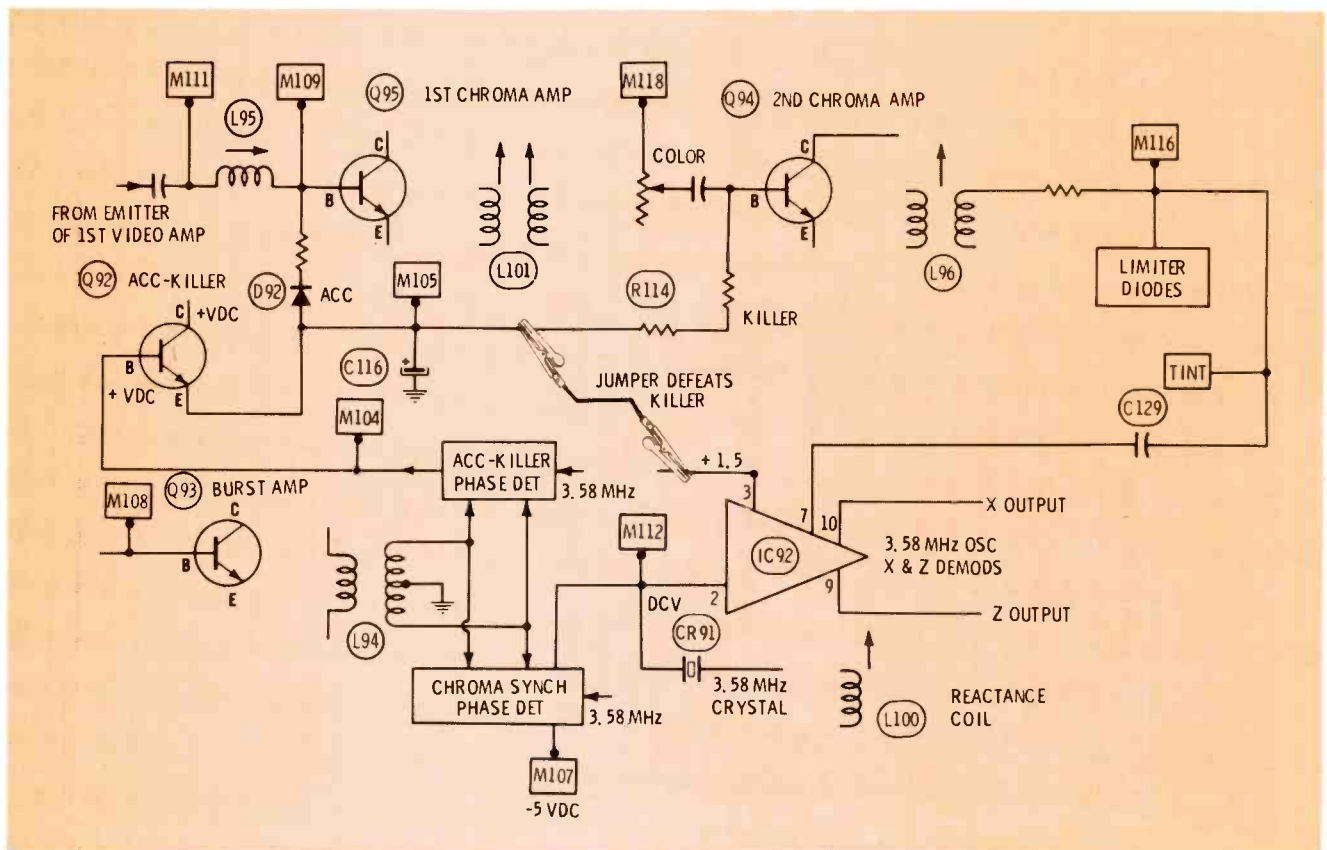

Fig. 2 This simplified schematic of the Philco 4CY80 chassis shows the major components and test points. Other similar chassis include 2CY80 and 3CP30.

picture is broadcast in color.

Often the killer action can be overridden by adjustment of the killer control (some Philco models don't have a variable control). Of course, that won't help if the defect involves the killer control. Most killer circuits have two points that can be shorted together, or a test point where a certain voltage should be applied, to defeat the action and give color gain at all times.

In these Philco receivers, both the ACC and killer voltages come from a common source, the emitter of Q92 (see Figure 2). Q95, the first chroma bandpass amplifier, has sufficient bias for normal operation without any DC voltage from Q92 (Figure 3). In fact, D92 blocks any additional voltage from reaching the base of Q95 until it exceeds the base voltage. When D92 conducts, the higher base voltage of Q95 reduces the gain. That's the ACC action.

On the other hand, the forward bias of Q94 (second chroma amplifier) is too low to allow gain until more voltage is furnished by Q92. Burst is compared in phase with the sample of 3.58-MHz signal and the resultant is rectified by D91 and D93 to generate a small positive voltage. This positive volt-

age forward biases the base of Q93 causing the transistor to conduct a positive voltage from the collector to the emitter and then on to the base of Q94, making the forward bias high enough that Q94 amplifies with normal gain. This is the killer action.

To defeat the killer action and make certain Q94 has sufficient forward bias for normal gain, apply +1.5 volts to the positive end of C116.

Bias from the IC

One easy way of obtaining the +1.5 volts (to make certain the killer is not interfering with the chroma gain) is to take the voltage from pin 3 of integrated circuit IC92. But there are two precautions to be observed first.

Check the voltage at C116 to make sure it is not already higher than +1.5 volts. If R116 is open or Q92 has a C/E short, the voltage there could be high enough to ruin IC92.

Also, be certain where pin 3 of the IC is, and check the voltage there. Don't use this point for a source of clamped killer voltage if the voltage is much above or below the usual +1.5 volts.

If these two voltages are not

abnormal, connect pin 3 of IC92 to the positive (ungrounded) end of C116 (Figure 4).

How is the color?

After the killer has been defeated, check the color. One of these conditions should be found:

- the color is normal in saturation, tint, locking, and sharpness (diagnosis: the defect is in the killer circuit);
- the color is in stripes (diagnosis: the color oscillator is operating too far out of frequency, or there is no locking to pull it in);
- color saturation remains weak (diagnosis: gain or alignment of either video IF's or chroma bandpass amplifier stages is abnormal);
- the color jumps out of lock making stripes when the tint control is adjusted or the programs change (diagnosis: there's trouble in the burst amplifier or phase detector circuits);
- there is no color; or
- tint is wrong, the color is smeared, or there are stripes of interference in the color.

As you can see, an overactive killer might obscure many symptoms. We will discuss many of these general defects as we proceed. But before we leave the subject of the killer, there is one more helpful diagnostic tool.

Color-tuning light

Examine the front panel of the receiver for a color light (Figure 5). Actually, the light does not necessarily prove the color is okay when the bulb is on; it means only that Q94 (second bandpass color amplifier transistor) is drawing sufficient collector current. In a normal chassis this happens when the killer is **not** eliminating the color gain.

If the killer is operating normally (not defeated) and the bulb lights when the fine tuning is near the sound bars, then goes out when the fine tuning is turned to a smeared picture, that's fairly good proof the color signal is reaching the top of the color control. (The color burst is taken from that point; the burst operates the phase detectors; one phase detector plus Q92 takes care of the killer action; and the killer action changes the collector current

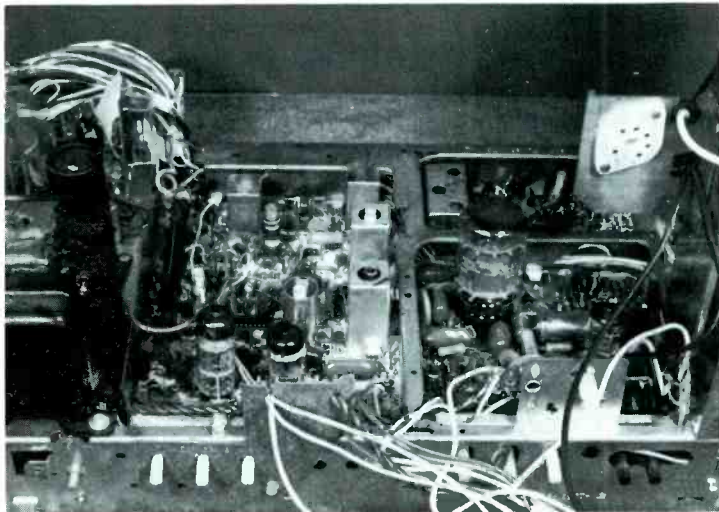

Chroma and sound circuits are on the circuit board to the left, deflection and IF boards are at the right.

of Q94, which controls the lighting of the lamp.)

At the other extreme, if the color-tuning lamp does not light at any time, even when the killer is jumpered, either Q94 is not drawing enough collector current, or the color-light circuit is defective.

Check DC voltages

When the color light doesn't operate, start testing by measuring the DC voltages at Q94. The collector should be around +18 volts, and the base should be about +.6 volt higher than the emitter.

Similarly, DC voltages at the light-control transistor (Q97) should be measured to prove or disprove any defect there. Because it is a PNP type, the base should be about .6 volt less positive than the emitter. And the collector should have enough voltage to light the bulb (4 volts or more for a 6-volt bulb, or 9 volts or more for a 12-volt bulb). Keep in mind that the forward bias for Q97 is developed by the collector current of Q94 flowing through R129. Both must be within tolerance for Q97 to have the proper bias. More Q94 current develops more forward bias for Q97, which in turn increases the Q97 collector current, lighting the bulb brighter.

No Color

In tube-powered color sets, chroma demodulation always was done in two separate stages; therefore, demodulator defects seldom would prevent all color. The use of IC's with a 3.58-MHz oscillator and both demodulators in one black box has taken that test from us. Now it's not too unusual for both demodulators to fail simultaneously.

If DC voltage tests of the IC are okay, or replacement of it doesn't bring back the color, it's necessary to find the stage where the color is lost.

Use snow as burst

One method is to use snow as a source of signal and measure the DC voltages that result.

Turn to a blank UHF channel. High frequencies of the video (snow) are amplified by Q95, the

first chroma bandpass, and the output signal goes both to the second chroma stage, and through C137 to the base of the burst amplifier (Q93 in Figure 6). When the positive-going horizontal pulses reach the base, Q93 amplifies the color burst, which is applied to the phase-detector diodes, D94 and D95, producing DC voltages by rectification. Those DC voltages will be in proportion to how much the snow has been amplified.

An average reading is -5 volts at the anode of D95 (point M107 in Figure 7). When the snow is heavy and sharp, but the voltage is less than -5, it's likely the lack of gain is in the Q95 first chroma stage.

If this reading is obtained, but there is no color, the defect might be in IC92 or the second chroma stage (Q94).

Diode limiters

The two diodes, D96 and D97 of Figure 5, can be used to determine how much chroma-IF signal is

being fed to pin 7 of the IC. They are provided to make certain excessive voltage does not reach that pin of the IC. This requirement probably includes excessive chroma signal, as well as minor arcs.

It would seem the diodes should eliminate all AC voltages, because they have opposite polarity; positive-going voltages would conduct through D97 and the negative-going ones through D96. However, silicon diodes below about .5 volt are open circuits, and they do not reach full conduction until the forward bias is about .8 volt. In power supplies, this bend of the curve is such a small percentage of the total voltage that it can be ignored. In this circuit, the chroma voltage is not clipped until it exceeds about 1.5 volts p-p.

Now, it's necessary only to disconnect **one** of the diodes, and the other becomes a half-wave rectifier. I usually lift the ground lead of D97. If both chroma-bandpass amplifier stages have normal gain,

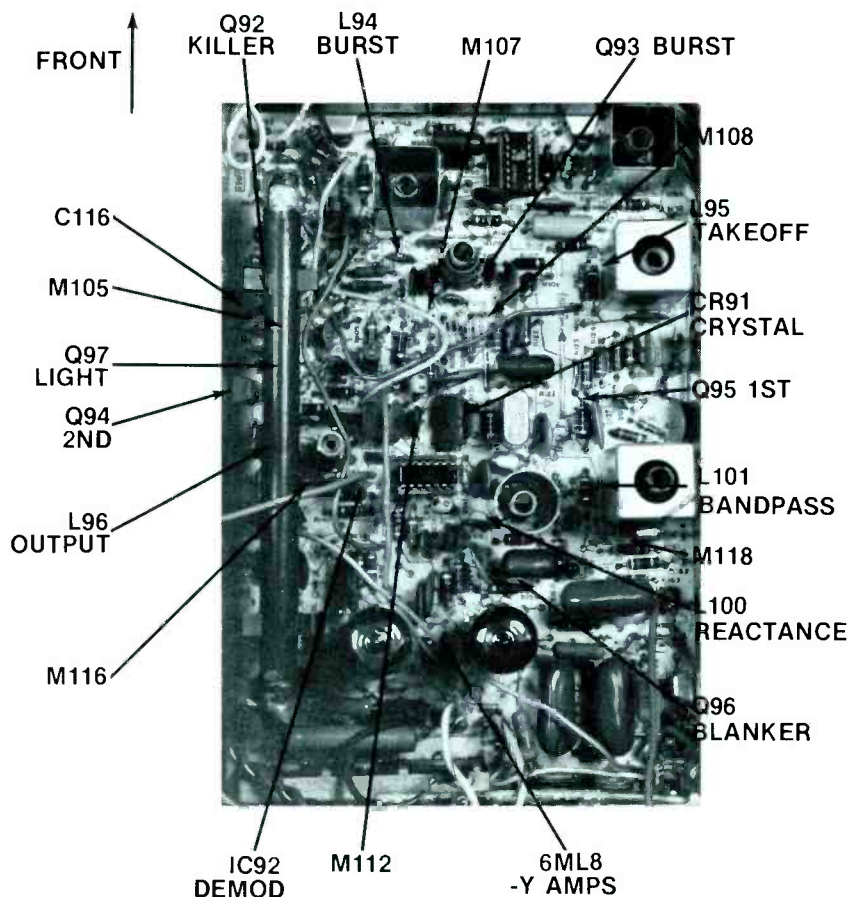

Arrows point to the major chroma components and test points.

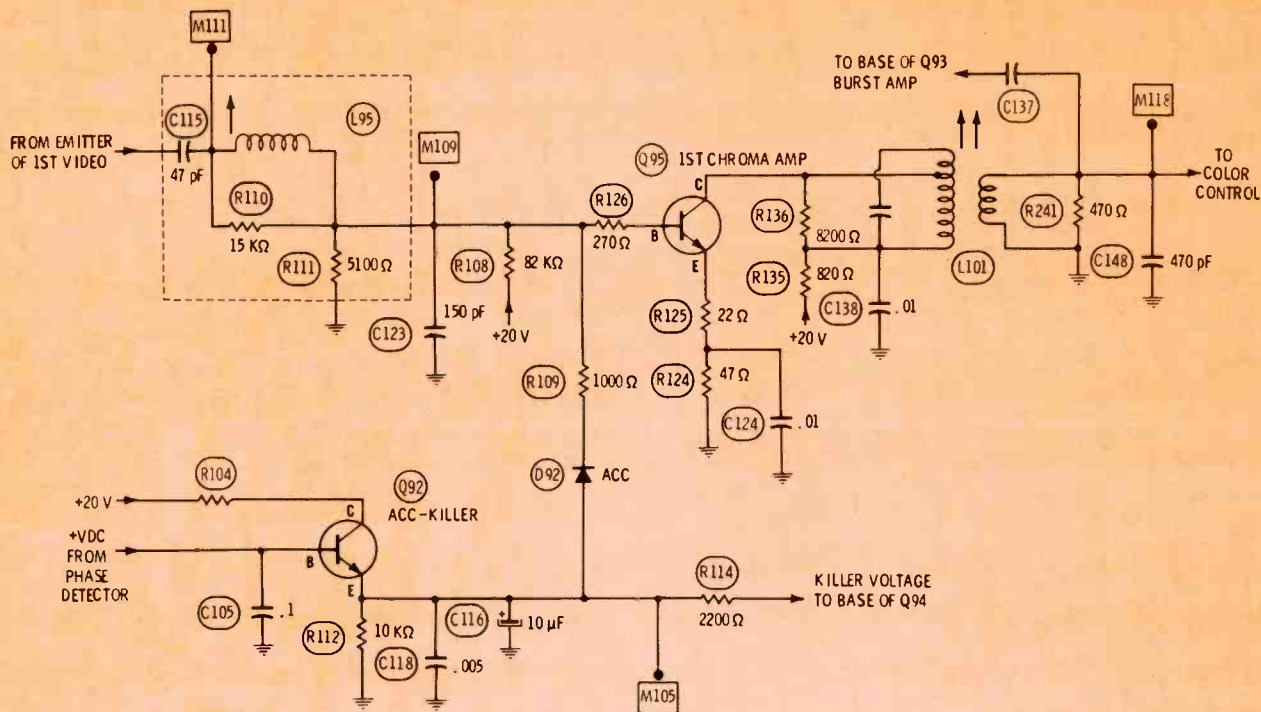

Fig. 3 R108 and R111 apply enough forward bias to Q95 to give normal gain. Excessive amplitude of burst at the ACC/killer phase detector causes Q92 to conduct and supply a positive voltage to D92, and D92 feeds the voltage to the base of Q95, reducing the gain. This is the ACC action. Burst is taken from the output of Q95.

a DC reading of about +.5 volts should appear at test point M116 (see Figure 8). Zero voltage means no signal is coming through L96. Of course, re-connect the diode after the test is completed.

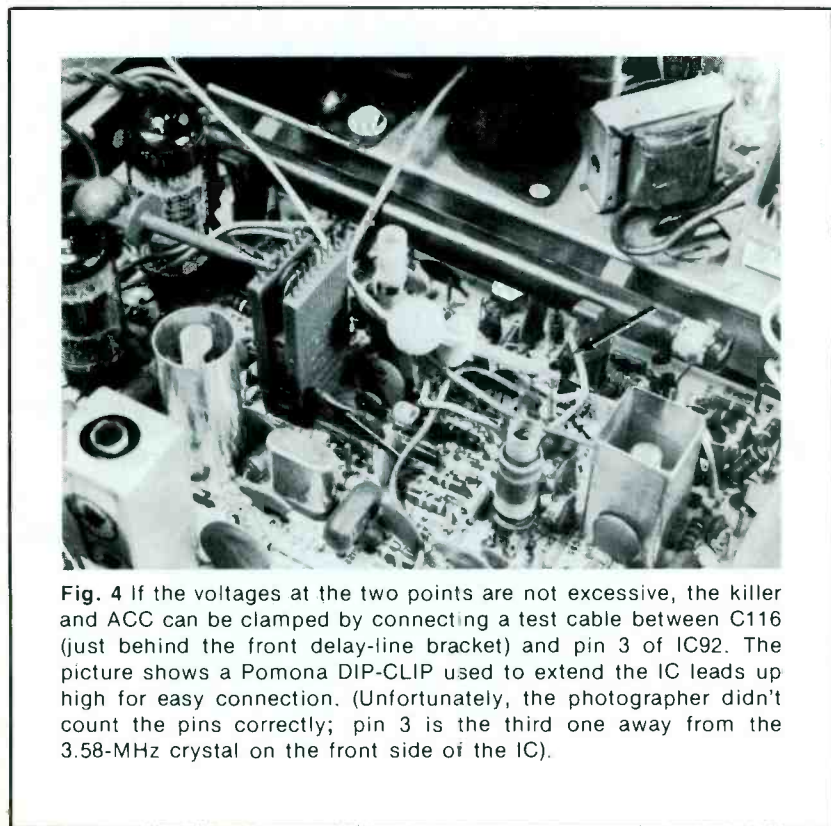

Fig. 4 If the voltages at the two points are not excessive, the killer and ACC can be clamped by connecting a test cable between C116 (just behind the front delay-line bracket) and pin 3 of IC92. The picture shows a Pomona DIP-CLIP used to extend the IC leads up high for easy connection. (Unfortunately, the photographer didn't count the pins correctly; pin 3 is the third one away from the 3.58-MHz crystal on the front side of the IC).

Some Case Histories

No color

Another technician brought to my shop a 2CY80 chassis that had no color. The snow on a vacant UHF channel was normal, indicating color should be available up to the chroma channel. Killer action was overridden by adjustment of the killer control; the color-indicator light came on proving Q94 was drawing collector current. With the color control at maximum, there was no color snow!

A voltmeter test at M107 showed -4.6, which is near enough to indicate the first chroma bandpass stage was amplifying. IC92 was replaced, with no change of symptoms.

These tests narrowed the field to the Q94 stage. DC voltages of the transistor were normal. D97 was unsoldered at the ground end, but there was no positive voltage at the cathode of D96 (M116).

Of course, D96 might be shorted, thus grounding the signal at M116. But an ohmmeter test proved the diode was good. The signal apparently was reaching Q94, which had correct voltages including for-

ward bias; however, there was no signal at the output of Q94.

I was beginning to appreciate why the tech had brought me this tough one!

One of my helpful ideas is to imagine every amplifier as having two currents flowing; one is a DC current, and the other is the AC (signal) current. In this case, what could kill the AC but leave the DC? Bypass capacitors and tuned circuits are two possibilities.

I paralleled C128 and C117 with new .01 capacitors, but that did not produce any signal at M116.

Only one tuned circuit remained in the Q94 stage: L96. Resistance of the secondary seemed okay, but the primary checked zero ohms. I removed L96 and looked at it carefully under a magnifying glass. The lead going to the top of the primary coil was shorted to the bottom end of the coil. Only a few minutes were required to relocate

the wire, reinstall the coil, and find **the color now was normal.**

Weak color

The color was so weak it barely could be seen on the picture from the 3CP30 chassis belonging to a retail customer. This model has no color killer, so I applied +1.5 volts to C116. It also has no color light, eliminating an easy test to determine conduction of Q94.

Off-channel snow was normal, but without any color flecks. At M107, a voltage test found -1.8 volts, which is much too low and indicated lack of gain in the first chroma stage.

DC voltages at Q95 showed base +1.2 volts and emitter zero. This is double the usual forward bias, but the zero emitter voltage proved a lack of conduction. Conclusion: base/emitter junction of Q95 was open. **Replacement of the transistor brought back the color.**

Low brightness

A Philco 2CY80 chassis came into the shop because of low brightness. Since that is a typical trouble (see Syncure this month), I easily found that R37 in the grid circuit of the video-output tube had decreased in value.

That solved the brightness problem, but the color would fall out of lock when the fine tuning was adjusted to remove the 920-KHz beat pattern. Also, I noticed the color saturation was barely enough with the color control at maximum.

Now, the receiver had a combination of symptoms. As stated before, sometimes this makes diagnosis easier. Because the burst signal is taken from the output of Q95, it seemed logical to assume that the defect was inside the first chroma stage.

Could D92, the ACC diode for this stage, be shorted? That would apply too much forward bias to the

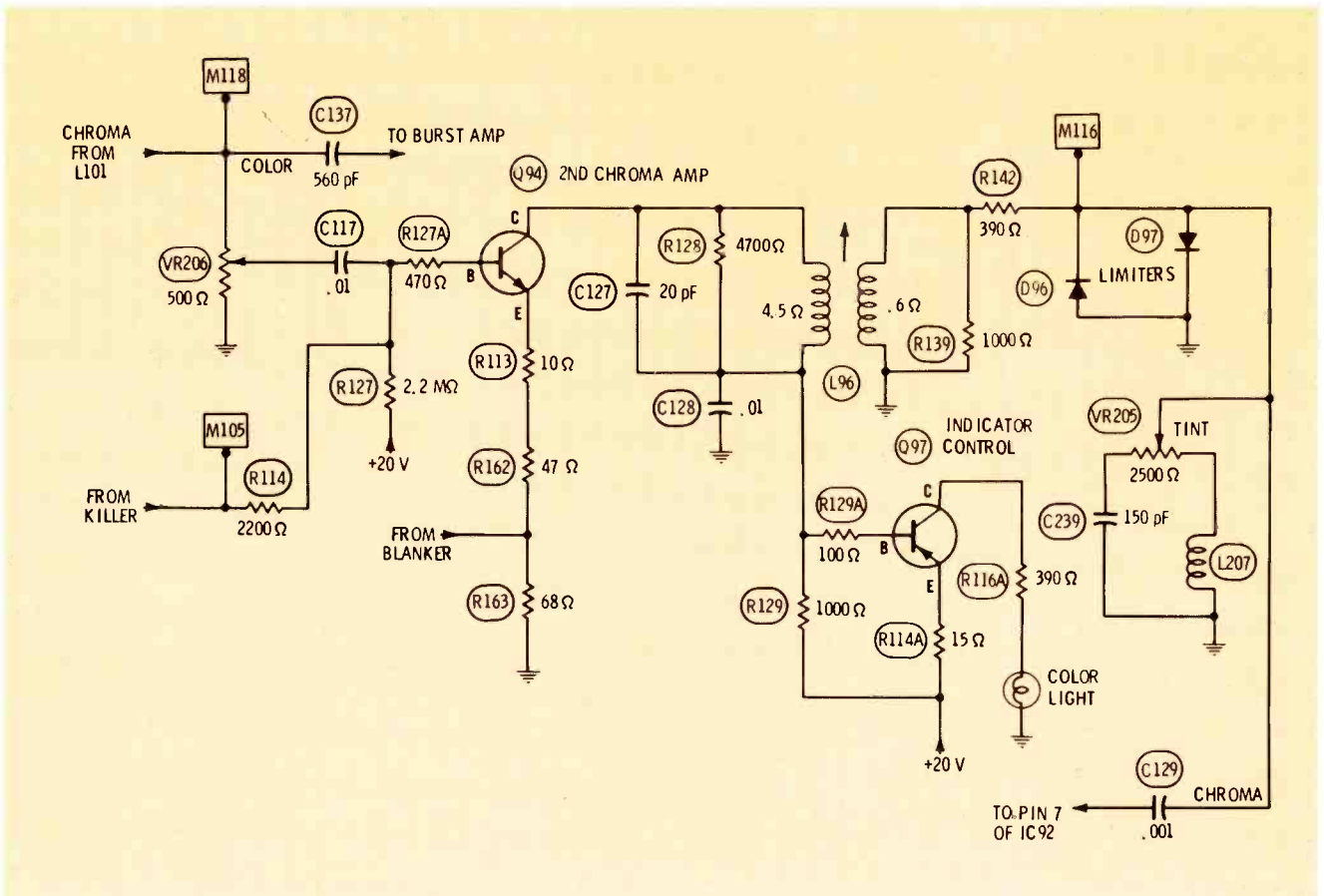

Fig. 5 Q94 does not have enough forward bias to give any gain until the killer transistor conducts. Forward bias to turn on Q97, the color light switch, is developed by the collector current of Q94 flowing through R129. One different feature is the limiter circuit (D96 and D97) used to prevent overload of IC92.

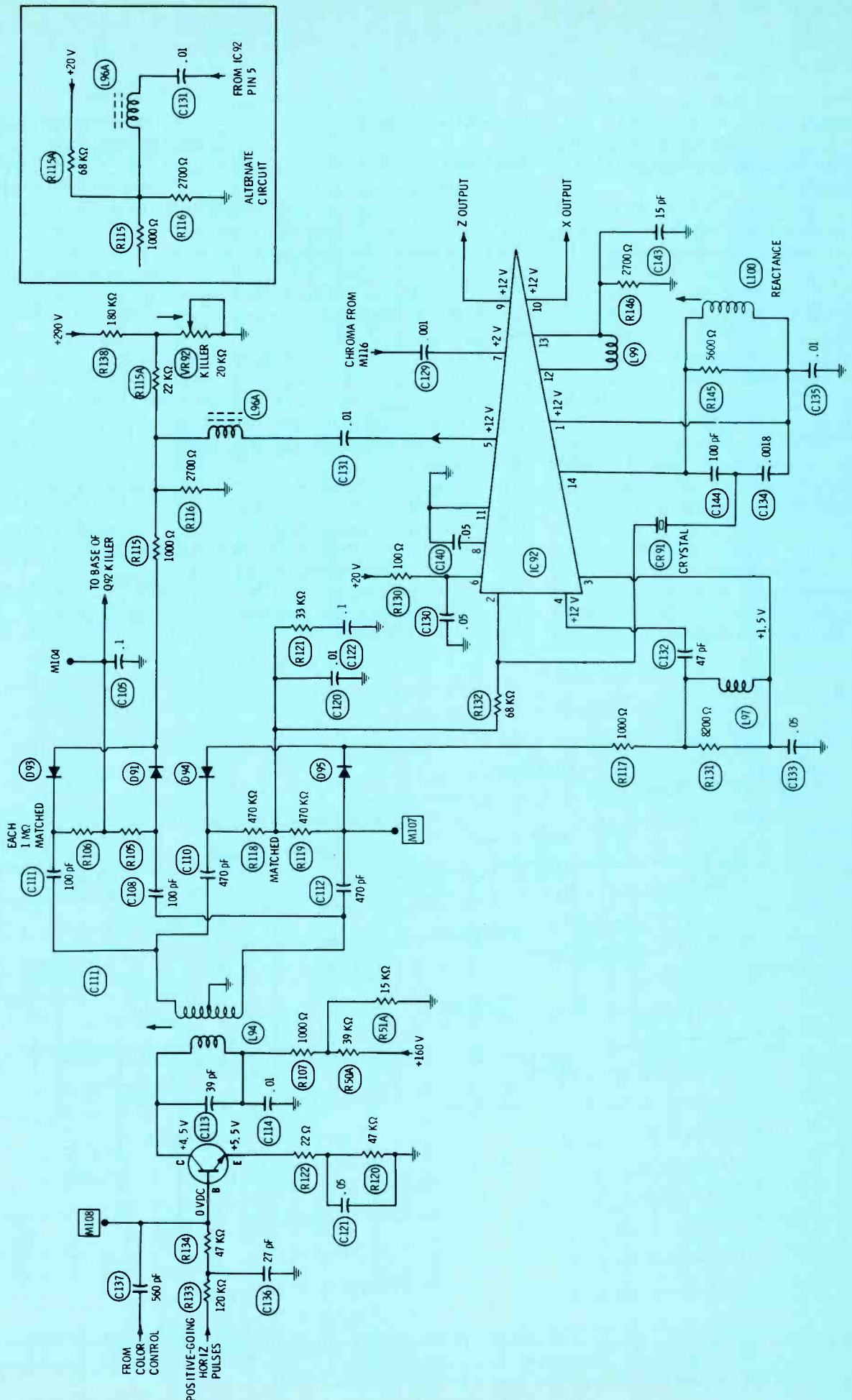

Fig. 6 This schematic shows the burst amplifier, both phase detectors, the IC (which combines reactance, 3.58-MHz oscillator, and both color demodulators), and alternate wiring for those chassis not having a variable killer control.

base of Q95, thus reducing its gain by the saturation effect. But D92 was not shorted, and the DC voltages at Q95 were normal.

With the set tuned to a blank UHF channel, the voltage at point M107 was only -3.5 volts, instead of the expected -5 volts. It was certain the problem was in the first chroma bandpass stage.

If this was not a DC problem, then perhaps it was an AC defect. C124 was paralleled with a test capacitor, but there was no change. When C138 was shunted, the color suddenly came in with strong saturation and good locking. Then I noticed a cold-solder joint at the ground end of C138, and a **quick resoldering job completed the repairs.**

With C138 open, R135 became a part of the AC collector load, so some of the signal appeared across R135, leaving less for L101.

Troubleshooting Color Locking

Tube-equipped color oscillator circuits with a reactance stage controlled by a diode-type phase detector were adjusted easily to frequency by merely grounding the output of the phase detector (simulating a correct zero control voltage) and then adjusting the reactance coil until the single color picture floated by upright. This was called "zero-beating" the oscillator, and it was a good method.

Although the Philco circuit is the solid-state equivalent of those tube circuits, there is one important difference: solid-state devices need forward bias. Pin 2 of IC92 has about +1.25 volts coming from inside the IC. Therefore, it is not recommended that you ground the output of the phase detector (M112) before adjusting the reactance coil.

Instead, ground the base of the burst amplifier (M108) to remove the burst from the phase detector. Then adjust L100 for zero beat of the color.

You also can use these steps to determine whether the loss of

locking is caused by weak burst or by wrong oscillator frequency. When M108 is grounded, notice the number of stripes of color in the picture. If there's less than two or three, the poor locking probably is due to a burst defect. However, many stripes of color indicate the oscillator is far out of frequency, either because of an oscillator trouble or because of a defect in the phase detector circuit (D94 and D95).

Comments

Of course, a scope can be used to locate many of the problems described here. I use one often. But, you don't always have a scope handy, and the voltmeter tests can help you to find most chroma troubles. In addition, voltage analysis of the circuits broadens our understanding about how they operate.

My next article deals with problems of interferences in color. □

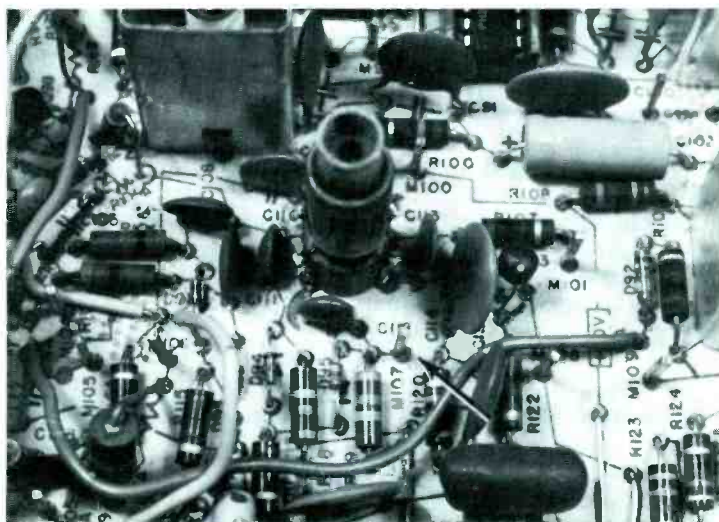

Fig. 7 Testpoint M107 is located slightly to the center and rear of the chassis from L94, the burst transformer. D95 and D4 are just to the left of M107.

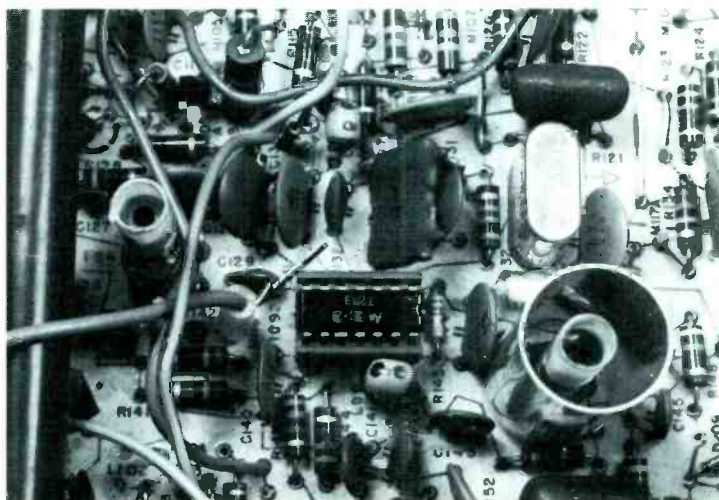

Fig. 8 Testpoint M116 is just to the left of IC92. A wire from there goes to the tint control on the front panel.

Electronics servicing is no mystery when

The 20 books offered on these two pages are representative of the vast amount of clear and authoritative electronic servicing help available from Sams. They can help you understand and efficiently service almost every electronic application. Look them over—and use the coupon to broaden your skills.

TELEVISION

Here are the first three of an all-new series of specialized service guides by Stan Prentiss.

Developed by the Audel® Division of Howard W. Sams & Co., Inc., they are comprehensive directories of detailed servicing data and information for all 1974-75 models of the leading home-entertainment manufacturers. Each covers troubleshooting, schematics, replacement parts lists, and service tips, and includes specific circuit write-ups and identification of all integrated circuits used.

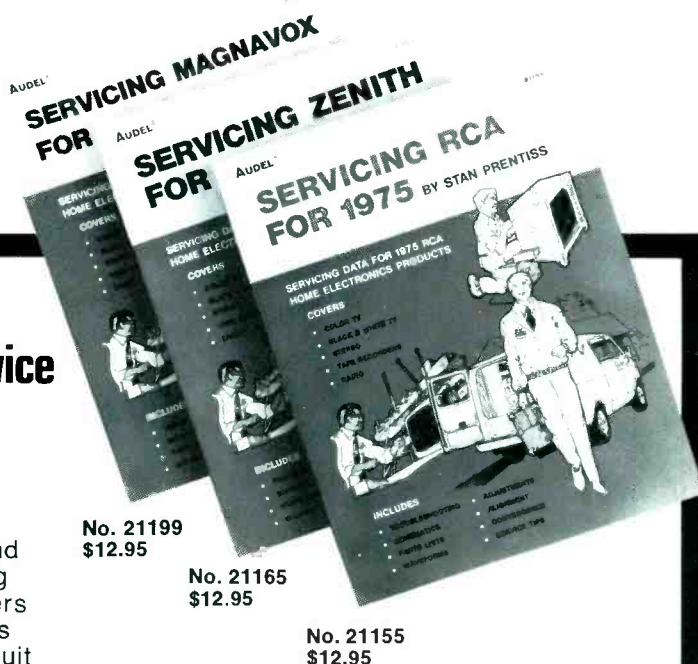

No. 21199
\$12.95

No. 21165
\$12.95

No. 21155
\$12.95

COLOR-TV SERVICING GUIDE (2nd Edition)

by Robert G. Middleton

This guide uses color photos to show symptoms of circuit defects as they appear on the picture-tube screen. If the serviceman follows these picture clues and uses proper troubleshooting methods, he can service sets correctly and in less time. Covers both tube and solid-state circuits. 112 pages, softbound.

No. 20990

\$5.50



TV SERVICING GUIDE Arranged by Trouble Symptoms

by Leslie D. Deane and Calvin C. Young, Jr.

An invaluable troubleshooting guide that can save much time and frustration. It enables the serviceman to diagnose troubles from picture and sound symptoms. It is organized by sections in the receiver and subdivided according to trouble symptoms encountered and their probable causes. 126 pages, softbound.

No. 20361

\$4.50

101 WAYS TO USE YOUR OSCILLOSCOPE

by Robert G. Middleton

This book is an eye-opener to television servicemen and electronics technicians who have gotten in the habit of using an oscilloscope on only a limited number of tasks. It describes potential oscilloscope uses, from basic to involved and complex; includes demonstration photos of waveforms, and discusses likely defects when the waveform is abnormal. 192 pages, softbound.

No. 20416

\$4.50

101 WAYS TO USE YOUR OSCILLOSCOPE



PHOTOFACT® GUIDE TO TV TROUBLES (2nd Edition)

by the Howard W. Sams Editorial Staff

Shows just what happens to the picture-tube display when any component in the receiver becomes defective. All of the Guide's many pictures are actual photos taken under simulated-defect conditions. By comparing them to the picture produced by a defective set, the components most likely to cause the trouble can be readily determined. 192 pages, softbound.

No. 20521

\$4.95

PHOTOFACT Guide to

SECOND EDITION

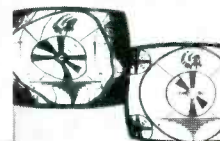

COLOR-TV Servicing Made Easy

Volume 3

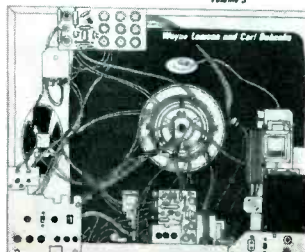

COLOR-TV SERVICING MADE EASY (Volume 3)

by Wayne Lemons and Carl Babcoke

This service guide is designed to help you service all makes and models of color tv. It covers general circuit descriptions; troubleshooting; high voltage regulators, including "fail-safe" circuits; atc circuits; and universal setup procedures; and has separate chapters devoted to specific manufacturers. 288 pages, softbound.

No. 20875

\$7.95

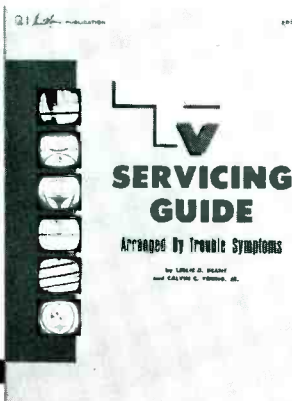

you follow these informative guides.

HI-FI, TAPE & AMPLIFIER

TAPE RECORDER SERVICING GUIDE — by Robert G. Middleton. Brings the technician up to date in servicing a fast-growing field of home and auto tape cartridges, tape cassettes, and stereo tape players. While the basic electronic circuitry may be familiar to the radio and television serviceman, this guide also explains and shows how to service such unique tape recorder features as magnetic circuits and bias oscillators. 96 pages, softbound. No. 20748 \$4.50

HI-FI STEREO HANDBOOK (4th Edition)—by William F. Boyce. A most valuable handbook on all kinds of sound equipment. It provides full coverage of the three major stages in hi-fi reproduction—the program-source equipment, the preamplifier and amplifier sections, and the speaker system. Completely updated with information on the latest equipment, circuits, systems, and technology. 400 pages, softbound. No. 20918 \$6.95

HI-FI STEREO SERVICING GUIDE (2nd Edition)—by Robert G. Middleton. Anyone servicing a-m tuners, fm tuners, stereo-multiplex units, and audio amplifiers can gain valuable service direction and assistance from this guide.

It also covers hi-fi speaker installations, system evaluation, troubleshooting, and methods of verifying test equipment performance. 104 pages, softbound. No. 21075 \$4.50

UNDERSTANDING IC OPERATIONAL AMPLIFIERS — by Roger Melen and Harry Garland. With the advent of semiconductor and microminiature electronics, complete op amps on a single tiny chip of silicon now have many applications. This book covers the IC op amp exclusively, explaining how it works, how it is fabricated, how practical circuits can be designed by using them, and how complete electronic circuits can be formed around op amp circuits. 128 pages, softbound. No. 20855 \$3.95

ELECTRIC GUITAR AMPLIFIER HANDBOOK (3rd Edition)—by Jack Darr. You no longer need hesitate to service an electric guitar amplifier. This informative guide relates the functions of all parts of the guitar to familiar electronic circuitry, and shows how to correct all electronic malfunctions. The latest types of amplifier schematics, solid-state amplifiers, replacement transistors, and integrated circuits are all covered. 240 pages, softbound. No. 20848 \$7.95



SOLID STATE

SOLID-STATE SERVICING—by William Sloat. Explains semiconductor theory as it applies to servicing solid-state electronics, and covers the function of circuits used in home-entertainment electronic products. By enabling the reader to think of circuits in terms of the functions they perform, it promotes the development of service techniques applicable to all solid-state electronic functions. 160 pages, softbound. No. 20888 \$5.50

TTL COOKBOOK — by Donald E. Lancaster. Transistor-Transistor Logic has opened up a fantastic number of applications for digital circuitry. It is not only better than traditional analog circuits, it is often cheaper. This timely book, by the author of the famous RTL Cookbook, explains what TTL is, how it works, and how to use it. 336 pages, softbound. No. 21035 \$8.95

RTL COOKBOOK — by Donald E. Lancaster. The family of digital-logic integrated circuits called Resistor-Transistor Logic, or RTL, is used in applications ranging from simple switching through digital measuring circuits. This book explains how RTL ICs are used, how they work, and how to adapt them for the complex electronic systems in use

today. 240 pages, softbound. No. 20715 \$5.50

LINEAR IC PRINCIPLES, EXPERIMENTS, AND PROJECTS—by Edward M. Noll. Introduces the principle of operation of the integrated circuit. Reviews semiconductor theory and practical devices, and discusses common internal circuit arrangements and basic external circuitry. Covers differential and operational amplifiers; multipurpose and digital ICs; and linear IC use in commercial, industrial, home, and test applications. 384 pages, softbound. No. 21019 \$8.95

TRANSISTOR-TRANSISTOR LOGIC —by George Flynn. An invaluable aid to understanding the function and circuit construction of logic devices. The book discusses the digital families of which TTL is a part, and covers the basic units—the gate, the various basic circuits, and the voltage and current requirements. Also covered are: flip-flops, decoders, multiplexers, shift registers, counters, TTL math, methods for determining information priority and storage, and how TTL, the dominant form of semiconductor logic, works with other types of circuits and logic families. 176 pages, softbound. No. 20967 \$5.50

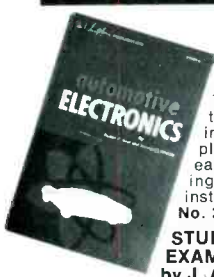

AUTOMOTIVE ELECTRONICS

by Rudolf F. Graf and George J. Whalen
This book divides the automobile electronic system into starting system, sensor instruments, and indicators. It then explains the operating characteristics of each system in great detail. Troubleshooting is covered in detail, along with the test instruments used. 320 pages, softbound. No. 20856 \$6.95

STUDY GUIDE FOR CET EXAMINATIONS

by J. A. Wilson, CET and Dick Glass, CET
You must pass a demanding 12-section test and have at least four years of experience in electronic servicing before you can become a Certified Electronics Technician (CET). This book presents a comprehensive review of the material covered by the CET examination, and also serves to help the reader pass a state or local licensing exam. 282 pages, softbound. No. 20834 \$5.95

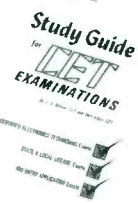

HOWARD W. SAMS & CO., INC. ES-045
4300 West 62nd Street, Indianapolis, Indiana 46206

Order from your Electronics Parts Distributor, or mail to Howard W. Sams & Co., Inc.

Send books checked at right. \$_____ enclosed. Please include sales tax where applicable. Canadian prices slightly higher.

Code:

<input type="checkbox"/> 21155	<input type="checkbox"/> 21075
<input type="checkbox"/> 21165	<input type="checkbox"/> 20855
<input type="checkbox"/> 21199	<input type="checkbox"/> 20848
<input type="checkbox"/> 20990	<input type="checkbox"/> 20888
<input type="checkbox"/> 20361	<input type="checkbox"/> 21035
<input type="checkbox"/> 20416	<input type="checkbox"/> 20715
<input type="checkbox"/> 20875	<input type="checkbox"/> 21019
<input type="checkbox"/> 20521	<input type="checkbox"/> 20967
<input type="checkbox"/> 20748	<input type="checkbox"/> 20856
<input type="checkbox"/> 20918	<input type="checkbox"/> 20834

Send FREE 1975 Sams Catalog.

Name _____

Address _____

City _____

State _____ Zip _____

For More Details Circle (13) on Reply Card

Pricing Versus Consumerism

By Carl Babcoke

Wild variations of labor pricing arouse suspicions of fraud. Before too many shops are legislated out of business by the consumerists, the service industry should adopt a pricing system based on actual times of repairs, rather than by a flat job rate.

Recently, both state and federal government bureaus have held "investigations" of the pricing methods and honesty of electronic technicians in several cities. It is not my purpose to comment on them in this article (although some of their mistakes leave them vulnerable to criticism), but to use those events as illustrations of the need to "put our own house in order."

One crucial area is the pricing of repairs. No, not uniform pricing by dollars, for that is illegal "price fixing," but more accurate pricing based on the repairs actually done.

Methods Of The Past

Many service shops use a simple method of pricing all repair labor jobs the same. There is a fixed price for service calls, and an additional fixed price for those sets pulled for the bench.

Granted, you can **average** out the time and costs of a hundred such jobs and arrive at a price allowing you to make a modest profit. If this is your method, undoubtedly you are satisfied with it. Bookkeeping is minimized, estimates are easier, and you rationalize that the customers feel secure knowing there is a ceiling on the charges. Sounds ideal, doesn't it?

But, it takes little logic or mathematics to show that some people are paying too much to balance the ones who pay too little. How much longer will the rabid consumerists allow you to operate this way? Suppose an investigator places a service call with you, and after the preliminary examination, you pull

the set for shop repairs. Perhaps you charge \$59 shop labor to replace one sync capacitor. How much sympathy do you expect when you explain that \$59 is your "flat rate" regardless of the time or difficulty?

Even worse, you are really caught red-handed if you charge \$20 for a 50-cent capacitor and make the shop labor only \$39! Yes, I know this type of billing sleight-of-hand has many precedents, originating perhaps in depression days of the 1930's when customers were even more unwilling to pay for labor than for parts. It will do you little good to protest that the **total** repair was priced reasonably.

Some of our critics might say that such over-simplified methods of repair pricing make no more sense than would a grocery store with **all** items priced at \$1.00.

Another factor forcing pricing changes is the fewer number of jobs where you can compensate for an insufficient labor charge by the unusual markup on tubes. Transistors don't have those inflated list prices, and the normal profit on parts is little more than enough to pay the parts expenses.

The Dilemma

There are several alternatives to the one-price method, although they have some drawbacks. Perhaps the best solution is to charge for **all** labor time (at a per-hour price based on actual costs), and to bill all parts at the normal percentage of markup.

Undoubtedly, this will bring resistance from those customers who receive higher billings. What's more, some of the consumer's bargains will be gone. After many of you, who have been working 10 to 14 hours per day for about 8-hours pay, figure your cost of doing business (and recover from the shock of finding how high it is),

you'll raise your prices to compensate.

Almost everything the authorities are demanding (in order to control the few "rotten apples" in the electronics barrel) is going to cost the consumer more. Certainly, the service shops can't absorb the extra costs of legally-binding written estimates which are sent through the mail, compulsory insurance, and the bills for additional printing and red tape. And the public in general must pay for the governmental agencies which will be required to police, investigate, and prosecute any suspected lawbreakers, should such legislation be passed.

However, as you can see, there is little choice; changes are being forced on the industry.

Now, suppose you decide you must change to pricing by the actual time used. How do you go about it? The thought of clocking every step of every repair is bad enough. Even worse is the problem of making estimates. Perhaps we can get ideas from other fields which also have had similar problems.

One Solution

One practical plan comes from the automotive industry, and the flat-rate **time** charts used for decades. Every servicing operation is broken down into minutes or tenths of hours. When the job is completed, the foreman totals the time and multiplies by the hourly labor rate.

A similar plan for repairing home-electronic equipment has been on the market since last year, and has been advertized in **Electronic Servicing**. It's called **Tech's Guide To Pricing** by John Sperry, and is (so far as we know) the only complete system of this kind on the market today.

How It Began

Years ago, John Sperry (Sperry TV of Lincoln, Nebraska) wanted to start pricing repairs by the amount of time required. There was no industry list of repair times, and none of the TV manufacturers could offer guidance. So, John started timing typical repairs. His technicians recall the many times they looked up from their work and noticed the boss with his stop watch.

Since then, John has used the



John Sperry of Lincoln, Nebraska originated the **Tech's Guide To Pricing**.

system in his own business to check out the times for accuracy.

At one stage of the planning, I consulted briefly with John, and I can testify to the agonizing decisions that are necessary to reduce the hundreds or thousands of possible repair times to a manageable few (without reaching the other extreme of the one-price-for-all sys-

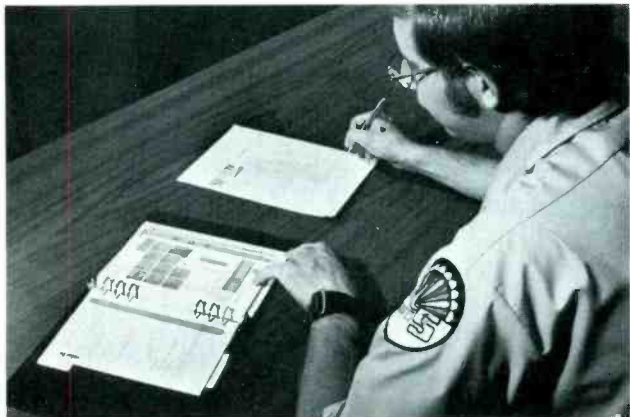

Michael Lukens, Sperry TV technician, is shown using the Tech's Guide To Pricing to bill the repair of a color TV.

tem). Therefore, if you try to develop your own system, lots of luck!

Does The System Work?

Of course, no shop manager wants to change to another pricing system that would reduce the income, require an excessive amount of paperwork, or be complicated to use. So, you need to know how the Sperry system works in practice. Although I have examined the book, and have priced a few imaginary jobs, I haven't had enough experience to answer the question. But John Sperry can give you the names of dozens of men who have used the system, and their comments about it.

The following description of the book should give you some ideas of the Sperry Pricing system.

Background and examples

The first 25 pages list much information about how to use Tech's Guide, how to estimate your hourly rate, and examples of typical pricing using this system.

Repair steps and times

Next are the listings of 19 different classes of products, such

ROHN[®] TOWERS



are
**BETTER
BUILT**

not cheaper

**LOOK
CLOSELY**
and
YOU'LL SEE
the

**BIG
DIFFERENCE**^{*}

*** 25 years manufacturing
gives 25 reasons why
they're BETTER!**

*Who else can make
that statement?*

**ROHN[®]
MANUFACTURING**

DIVISION OF 

P.O. BOX 2000 / PEORIA, ILL. 61601

For More Details Circle (14) on Reply Card

A PRECISION WAVEFORM GENERATOR AT A PRICE YOU CAN AFFORD.

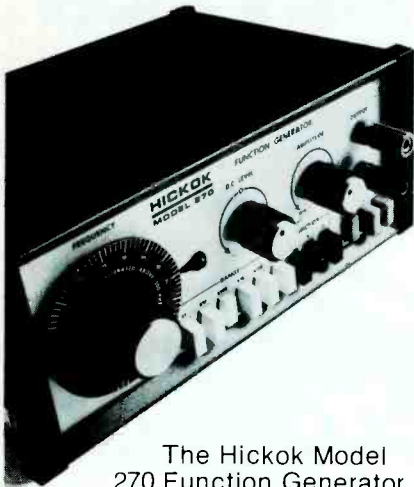

The Hickok Model 270 Function Generator gives you a lot more waveform generating capability than you'd expect for its price.

- Puts stable, calibrated, high quality sine, square and triangle waveforms from 1 Hz to 500 kHz at your fingertips.
- With external connections you can produce logic pulses, sweeps and ramps, AM and FM outputs, phase and frequency shift keying signals, tone bursts and more.
- Its an audio generator and much more.

Before you buy another function generator, check out the Hickok Model 270. Ask your Hickok distributor for full details or write us for our 4-page technical brochure.

\$166⁰⁰

HICKOK

the value innovator

INSTRUMENTATION & CONTROLS DIVISION
THE HICKOK ELECTRICAL INSTRUMENT CO.
10514 Dupont Avenue • Cleveland, Ohio 44108
(216) 541-8060 • TWX 810-421-8286

For More Details Circle (15) on Reply Card

as B&W TV, Color TV, Intercom Systems, etc, with the first page of each classification marked with a large index tab for fast location.

Each of the 19 product classifications occupy facing pages (to eliminate page turning while pricing) and is divided into 12 numbered sections (Preliminary Diagnosis, Adjustments, Alignment, etc.), which are the same for each product. Every section has sub-listings with either a time in minutes or a reference to a time chart on the same page (see Figure 1). In cases

of multiple defects, allowances are made giving reduced times for the second and subsequent repairs.

Calculator charts

At the back of the book are 30 pages of Time Calculator charts listing the time in minutes versus the price in dollars for times in 5-minute steps from 5 minutes to 340 minutes for one-man hourly rates from \$8.40 to \$36.00 in 60-cent steps. Each page also has 8 different rates per time listing for a two-man crew.

27

B&W TV

Color TV

9 / Bench Diagnosis		Tech's Guide Time	
a / first circuit or mechanical defect	30	35 40 45 50 55
b / 2nd & subsequent circuit or mechanical defect (ea.)	15	15 20 20 25 25
c / re-work or damaged areas		Time Price

Tuner UHF.....⑧ VHF.....⑧ Dials.....③ Gears.....④	Signal AGC.....⑧ I.F.....⑦ SYNC.....⑧ Video.....⑥	Audio Amplifiers.....⑥ Detection.....⑦ Output.....⑤ Sound I.F.....⑥ Speakers.....③	Control Motors Remotes.....⑧ Receiver.....⑦ Transmitter.....⑥
Power Filament.....④ Low Voltage Regulated.....⑦ Non-Regulated.....④ Battery Circuits.....③ AC Input.....③	Pix. Tube Grid Drives.....⑤ Input Circuitry.....⑤ Blanking.....⑥	Deflection Focus.....⑥ Deflection.....⑦ High Voltage.....⑦ Horiz. OSC/AFC.....⑧ Horiz. Output.....⑦ Vert. OSC.....⑦ Vert. Output.....⑦	
Clocks/Timers Standard.....④ Digital Mechanical.....⑤ Electronic.....⑧	Miscellaneous Cables.....④ Connectors.....⑤		

10 / Alignment		
a / A.F.C.	10
b / sound IF	20
c / video IF	25
d / remote control receiver functions (each)	10
e / tuner UHF	Exchange
f / tuner VHF	Exchange

11 / Component Removal & Replacement Time		
Item Replaced	NOTE: Accumulate time from left to right per part	
Individual Part or Assembly	Plug in Parts & Assemblies	Soldered Connections
Cabinet Parts	Dial Cords - Drives	Outside Ant. - MATV
Picture Tube	Regular Installation - 10 Irregular Installation - 20	

12 / Warranty Parts Tags		
		5 Each

Fig. 1 An example of the pricing coverage is the second page of the B&W TV listing. (Courtesy of Sperry Tech, Inc.)

Here's how to use the Calculator Charts:

- total the times listed for the individual repairs;
- turn to the page having your hourly rate;
- skim down the time column for your total time; and
- the labor price in dollars is just to the right. That's all.

Other Features

The pricing guide book is made in a 6-hole notebook format, with heavy plastic covers and thick plastic-coated pages for durability. I would guess that most smudges could be wiped from the pages.

Any or all of the pages can be removed and replaced at any time. However, I don't recommend that many unused ones be removed, they might be useful for review or to show a customer. And the system of locating tabs makes the task of finding the right section so easy that the extra pages are no bother.

One possible exception to this advice is to remove all of the Price Calculator pages except the one with your current per-hour rates. Store the extra pages in a safe place in case you change the rates at a later date.

Conclusion

Some surveys have shown repair prices for the same service in the same general area might differ by as much as 300%. There's not that much difference in technician's pay or the profit of the various shops. So, it is evident that much of the

variation is due either to guessing the prices or to unrealistic billing of all repairs the same.

When these conditions are given wide publicity in the news media, the general image of electronic shops again will plummet.

All service customers want to do business with companies they can respect and trust. A customer surely will be impressed favorably by watching you price his job with the same manual you used to price the neighbor's repairs.

One important value of a pricing system in book form is the strong psychological impact both on customers and on government bureaus. Partially, this is the power of "outside authority", and it gives the feeling that great effort has been expended in creating a system that's fair to both sides.

Industry-wide adoption of the Sperry Tech's Guide, or a similar system, would be a giant step toward improving the image of the electronic-repair industry. □

Get free luggage ...on the QT



Buy any RCA replacements parts QT package now* and we'll give you a bonus — free luggage. With our DP175 package of most needed "Quick Turnover" parts, for example, you'll get a piece of Biscayne soft luggage valued at \$42.50 manufacturer's suggested retail price. Free.

Chances are you'd order our QT package anyway. It puts the most frequently used parts right at your fingertips. And combined with the QT rack that's also available, you can streamline your inventory control. Cut re-ordering time. Give faster customer service. And eliminate inventory risk.

Get in touch with your nearest participating RCA Parts Distributor and he'll show you which free luggage goes with which QT package. Or contact RCA Parts and Accessories, P.O. Box 100, Deptford, N.J. 08096.

*Offer expires June 30, 1975



RCA Parts and Accessories



BUY AMP[®] TV ANTENNA TERMINALS BY MAIL!

Crimp unique one-piece "twin" terminal onto unprepared 300-ohm TV wire with pliers. Snap apart. Split wire. Reliable. Fast. Send \$1.00 for generous trial package 25 terminals. We'll include new AMP mail-order catalog free. Describes hundreds of electrical items for servicemen.

Order from:
Antenna, Dept. 4002,
AMP Special Industries,
Valley Forge, PA 19482.

AMP SPECIAL INDUSTRIES
Division of AMP Products Corporation Valley Forge, Pa.

Offer expires May 1, 1975.

For More Details Circle (29) on Reply Card
April, 1975

For More Details Circle (16) on Reply Card

How to select ladders for value and safety

By Norman Ackerman, Vice-President of Marketing, Perma Power Corporation

A ladder can save its cost over a period of time, if it has convenience features and the best specifications for the job, requires minimum maintenance, and has a long useful lifespan. A ladder expert offers valuable tips.

Although the subject of ladders is not likely to arouse any strong emotions, or even much interest, it is important to anyone who ever will be required to climb one. After all, it's **your** time you might waste in using an inferior ladder, and it's **your** injuries you might suffer because of an unsafe one.

What's more, it might surprise you to find out how much there is to know about ladders. Even if you are not using ladders just now, file this information for future use.

Selecting The Right Ladder

When selecting a ladder, you must choose the right type, size, strength, material, and features. Other important considerations include storage and maintenance requirements.

Types Of Ladders

There are three general types of ladders commonly used for repairing or installing antennas and MATV systems.

Most common is the self-standing stepladder, usually available in lengths from 5 feet to 10 feet. The next type is known by several names, such as: straight, single or wall type, and comes in various lengths from 12 feet to 24 feet.

The third type, a variation of the straight ladder, is the extension ladder (Figure 1). They are made

with two specialized kinds of straight sections nested together so the top section can be extended to various heights. Generally, extension ladders are available in four-foot multiples from 16 to 40 feet.

Each type has advantages and limitations. Stepladders are most useful where there are no walls near enough to support the other kinds. Also, stepladders can be placed at right angles to a wall, allowing you to work from ground level to the maximum height.

Extension ladders can do the same jobs as those required of simple straight ladders; in addition, they are adjustable in length, and usually have greater maximum lengths. However, they are heavier and more costly. You must decide on the type, based on your requirements.

What Size Is Needed?

When using a stepladder, you should not stand higher than on the third step from the top. This gives a place to brace the legs, or a steadying handhold. Maximum working height is the highest you can reach comfortably with arms extended, while standing on the third from the top step.

The base of a straight ladder should be moved out from the wall or eave (called the bearing point) to prevent any possibility of the ladder

and user tipping over backwards. Also, the ladder should **not** be spaced too far from the bearing point, to keep the base of the ladder from sliding away.

A handy rule-of-thumb is to set the base of the ladder about one-fourth of the distance from the ground to the bearing point. So, if the top of a 16-foot ladder is resting against a wall, the bottom should be about 4 feet away from the base of the wall. Similarly, if a 20-foot extension ladder is resting against an eave 16 feet off the ground, the bottom should be 4 feet farther out than the eave (Figure 2).

That basic necessity affects the selection of the proper length in two different ways. First, there's the theorem of the hypotenuse of a right triangle. Calculation for a 4/1 ratio of triangle gives a hypotenuse



Fig. 1 Typically, an extension ladder is used for installations of outside antennas.

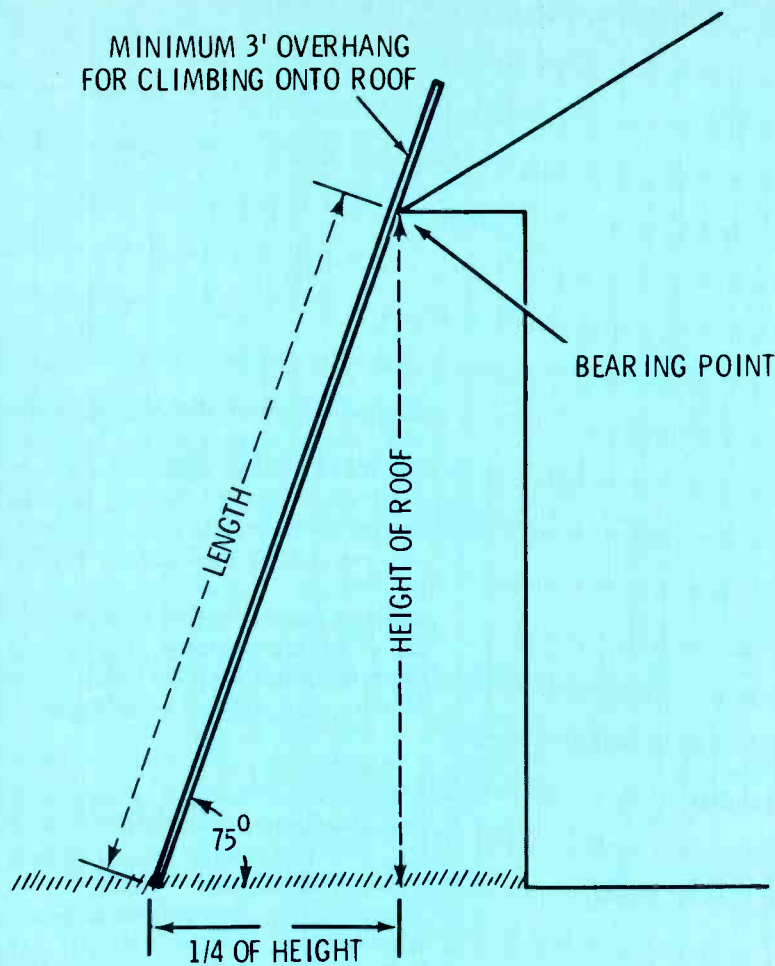

Fig. 2 When a ladder is leaning against an eave, the eave becomes the bearing point, and the ground directly below is the place from which to measure the horizontal distance to the foot of the ladder. Three feet, or more, of ladder must extend above the eaves, if you intend to climb onto the roof.

(ladder) length of almost 104% of the height. So, a 16-foot ladder would not reach an eave that's 16 feet from the ground. The next longer size must be selected.

Next is the question of the working height that is needed. Since a straight ladder is inclined toward the wall, a man on the ladder can't work against the wall until he reaches a certain height. Thus, the approximate minimum working height for a 16-foot straight ladder, with the top bearing against a wall, is 12.5 feet above the ground, and the maximum safe working height is reached by a man standing on the third rung from the top (Figure 3).

When a straight ladder is used by a man climbing onto a roof, the bearing point is where the ladder touches the eaves or gutters. The

top of the ladder should extend 36 inches (or more) above that bearing point. This is an OSHA requirement, providing the climber with a safe handhold on the top of the ladder as he swings around onto the roof.

The data of Table 1 should help you determine the size ladder to purchase for the various heights.

Extension-Ladder Sizes

The size of an extension ladder is the total length of the two sections. That is, a 20-foot extension ladder consists of two 10-foot sections. Of course, for strength, the two sections must be overlapped a minimum of three feet. That puts the maximum **useable** length of a 20-foot extension ladder at 17 feet.

Much useful information about extension ladders is given in Table 2. The minimum working height

range applies to the lowest point on a completely-closed extension ladder from which a man can reach the wall. For climbing onto the roof, the table allows for the minimum 36-inch overhang, plus the slight reduction of height brought about by the angle of the ladder against the wall. The maximum working height is for a man standing on the third rung from the top of the ladder when it is leaning against the wall. Thus, to climb onto a roof 17 feet from the ground, you need a 24-foot ladder.

As an aid in determining what ladder sizes to select, most manufacturers provide figures for typical houses. Although sizes can vary widely, the typical single-story dwelling has eaves that are approximately 11 feet from the ground, and the top of the roof about 17 feet from the ground; for this use a 24-foot ladder. A two-story dwelling has eaves approximately 19 feet from the ground, and the top of the roof is about 25 feet high; so use a 28-foot ladder.

Select the Right Duty Rating

After you've chosen the ladder size you need, look for a ladder of the right strength. The American National Standards Institute (ANSI) has established three duty ratings that are based on supporting the weight of a 200-pound man carrying various loads.

The Type I (Heavy-Duty) rating is based on a 250-pound load, or the equivalent of a man with a 50 pound load. Testing requirements, however, provide a four-times safety factor, so that a Type I duty rating is applied only when the ladder is tested to 1000 pounds.

In the near future, OSHA regulations are likely to be based on these ANSI standards. It then will become mandatory for electronic service industry personnel to use ladders with a Type I (heavy-duty) rating. A ladder for professional use also should have an Underwriters' Laboratories label.

Type II ladders are only appropriate for light-duty commercial requirements, as in infrequent

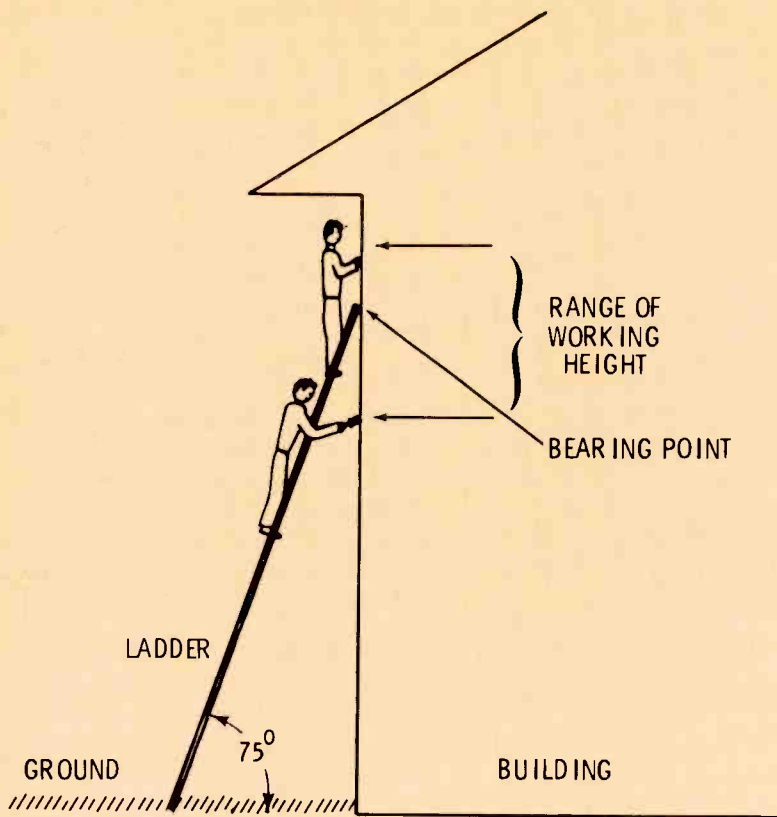

Fig. 3 Minimum working height is the lowest point on the ladder where you can reach the wall. Maximum working height is how high you can reach when standing on the third rung from the top; it's not safe to go higher.

maintenance use and in offices. Type III (Light-Duty) ladders are only appropriate for household use. Generally, hardware stores sell household and commercial ladders, Types II and III. Heavy-Duty Type I ladders can be found at industrial, maintenance, and some electrical supply outlets, as well as at some electronic distributors. For TV servicemen, the electronic distributor is an ideal source from the standpoint of convenience. Moreover, his stock will reflect those ladders particularly well-suited for your needs.

Ladder Materials

Portable, one-man ladders with a Type I rating are available in three materials: wood, fiberglass, and aluminum. Each material has its own advantages and shortcomings.

Wood

The greatest advantage of wood as a ladder material is its low cost. It is considered easy to care for and maintain. The main disadvantage of wood is that it becomes unreliable, especially as the ladder ages; also, it weakens under testing. In addition, wood's heaviness makes

the ladder more difficult to move and erect. Exposure to moisture can make a wood ladder electrically conductive, so it should not be trusted for electrical work. Moisture also can double the ladder's weight, as well as cause the wood to splinter, rot, and warp, in ways that are often undetectable. That's why there are more accidents with wood ladders than with all other types.

Fiberglass

Fiberglass-reinforced plastic is a desirable ladder material because of its excellent insulating qualities, light weight, and resistance to corrosion. Its primary disadvantages are that fiberglass ladders are expensive, and they deteriorate under prolonged exposure (about one year) to environmental elements, especially direct sunlight. There also exists the danger of skin and eye injuries from splinters, flakes, and fraying fibers.

Aluminum

Aluminum has the best combination of qualities of any ladder material. Besides being moderate in cost, aluminum also can be designed to specific load requirements. Aluminum's light weight permits the ladder to be moved and erected easily. Since it resists moisture and does not corrode, it stands up well to rugged use and environmental exposure. Most manufacturers, therefore, provide guarantees extending up to twelve years. Obviously, it's worth paying a little more for a ladder that's guaranteed to last, rather than buying one you'll have to replace in a year or so. The only limitation is that it should not be used for electrical work unless it is mounted in an insulated stand.

Features

Before any ladder purchase there

Your VTVM is obsolete!

This may sound like a harsh claim, but it's true. Thousands of TV technicians are using instruments designed in the 1950's to troubleshoot circuits designed in the 1970's.

And now, most color TV's have solid state circuits. So use of out-of-date test equipment just compounds the problem.

The generation gap has grown too big.



The Fluke 8000A 3 1/2 digit multimeter

Solid state calls for new performance standards.

Your "old fashioned" test equipment simply doesn't measure up to today's requirements. For example, the typical VTVM gives you 5% accuracy and 2% resolution. In the old days, that was good enough. Not so today.

Now you need an instrument to look at the voltages at each pin of an IC with sufficient accuracy and resolution to determine proper IC operation.

For example, a reading of "around 2.8 volts" is no longer sufficient. You must be able to distinguish between 2.80 and 2.82 volts.

You need a test instrument that gives you 0.1 ohm resolution so you can reliably measure resistance of switch contacts, circuit breakers, and low value resistors.

To do all this and more, you need the superior capabilities of the Fluke 8000A 3 1/2 digit multimeter.

An instrument designed specifically for testing solid state equipment.

The 8000A gives you up to 50 times the accuracy and 20 times the resolution of a VTVM, so you can measure the various voltage levels in a solid state chassis with absolute confidence.



Resolution is 100 microvolts, 100 nanoamps and 100 milliohms

You get the sensitivity you need for low level dc measurements. The 200 millivolt range with 100 microvolt resolution tells you *exactly* what your values are.

The 8000A has an AC frequency response from 45 Hz to 20 KHz and, with accessory probes, to 500 megahertz. Resistance measuring capability ranges from 100 milliohms to 20 megohms. It offers a 15°C to 35°C accuracy temperature span. And a 1-year accuracy time span, meaning it seldom needs calibration.

Unlike other DMM's the 8000A has fast response time—3 readings a second. And the bright, digital readout means that no interpolation is necessary.

The 8000A measures high voltages, too.

Our 8000A is designed to answer *all* the needs of an electronic service technician.

One very important (and talked about!) safety requirement is that the picture tube anode voltage must not exceed the maximum specified by the manufacturer. Our 8000A has an optional high voltage probe that gives you guaranteed accuracy of 1% at 25,000 volts. The probe also extends the capability of the 8000A to 40,000 volts to measure the high voltage in the new 32,000 volt chassis.

No other DMM's offer this feature.



High voltage probe accessory gives you 1% accuracy at 25,000 volts

Get the most up-to-date instrument available.

Don't be caught in the typical trap. Many electronic service shops don't really update their equipment when they decide to update. Switching to a TVM or a FET voltmeter doesn't really give you the accuracy and resolution you need today, or for that matter, tomorrow.

But with the 8000A on hand, you know you have a *true* solid state testing device... an instrument that can do the job the way it should be done.



Carry it anywhere. Use it on line or rechargeable battery power. Note the conveniently mounted specs on the bottom decal. They're always with you.

The 8000A comes from Fluke, one of the largest instrument companies in the U. S.

It costs just \$299 (\$40 more with HV probe). * And it is far and away the largest selling, most rugged and reliable 3 1/2 digit multimeter in the world.

*Domestic only.

For data out today, dial our toll-free hotline, 800-426-0361
John Fluke Mfg. Co., Inc., P. O. Box 7428, Seattle, WA 98133



For More Details Circle (30) on Reply Card
For Demonstration Only Circle (31) on Reply Card

**Table 1
Ratings for
straight ladders**

Ladder length	Max. height of bearing point	Horiz. distance at base	Range of working height
12'	11.6'	3'	8.5'—14.5'
16'	15.5'	4'	12.5'—18.5'
20'	19.4'	5'	16.5'—22.5'

are a number of things that should be checked. This will help to ensure a safe ladder that will provide years of dependable service.

Siderails

Look for metal ribbing—with an "I" or "Z" shape—to provide high strength with minimal weight (especially important with larger ladders).

Rungs

Make sure rungs will not twist in the siderails. They should be flat, preferably at least 3-1/2 inches across the flat and have non-skid treads that will provide positive footing at all levels. Rungs should be horizontal when the ladder is in working position.

Foot Assembly

The foot assembly should be wide and slip-resistant so it will not sink easily into soft ground. It should have provision for the use of ground spikes. High-quality ladders usually incorporate serrated ice cleats that are flipped into position.

Pull Rope and Pulley

The pulley assembly on an extension ladder should be of good quality, with the pull rope ample for the size of the ladder. Newer ladders use a polypropylene rope that will not deteriorate through environmental exposure.

Locking Assembly

One of the most important points to examine is the locking assembly that holds the extended section, to be sure it provides positive fool-proof engagement.

Maintaining Ladders

Good ladder maintenance begins with proper storage. Ladders should be stored away from harsh weather, excessive heat, and strong chemicals. They should be hung on three

or more supports equally along the length of the ladder so as to avoid any undue stress on any portion of the ladder.

Moving parts—extension locks, pulley, foot assemblies—should be lubricated occasionally. Avoid getting oil on the rungs. Regularly examine the siderails, rungs (for secureness and wear), and pull ropes. Metal ladders should not be twisted or distorted, and should be free from sharp edges and corrosion (especially the interiors of open and hollow rungs). Wood and fiberglass ladders should be examined for splinters and other evidence of deterioration.

Wooden ladders should not be painted, since this conceals possible defects. New wooden ladders can be coated with a clear preservative, such as varnish or lacquer, or brushed with linseed oil as recommended by some manufacturers.

Before each use, all nuts and bolts should be checked for tightness. The rungs should be clear of oil, grease, mud, or other contaminants.

Setting Up The Ladder

Before using a ladder, check that the ground surface is firm and level. On soft earth, use a wide, flat board to level the legs and prevent sinking. On ice or packed snow, use ice cleats or ground spikes and sand bags.

Other hazards also should be checked before setting up any ladder. **If doors can open toward the ladder, lock them or block them.** Secondly, check overhead for any electrical wires that present a potential hazard, (especially important when a metal ladder is being used). These precautions, incidentally, are specifically required by OSHA.

Whenever possible, have a second person help you erect an extension

ladder. Brace the bottom of the ladder against some stationary object, or have someone hold it down so that it does not slide. Lift the top part of the ladder, then walk under it and slowly raise the ladder, rung by rung, until it is vertical. Next, lean the ladder against the building. At this point, the feet of the ladder should be placed (as far as possible) in the position where the extended ladder will rest. When the top section is raised it will become increasingly difficult to move the entire ladder. As noted above, the feet of the ladder should be one-fourth of the length from the ground to the bearing point. The ladder should meet the ground at a 75° angle, and the rungs should be horizontal in this position.

Make sure the locking hooks for the top section are free, then raise the extension with the pull rope until the desired height is reached. Secure the extended section firmly by engaging the locking hooks. Use care, since from the ground a hook that is merely balanced on a rung can appear to be engaged.

There should be two feet (or more) of width at each bearing point, so minor shifts of position will not force the ladder to rest only on a single point.

Whenever possible, the top of the ladder should be tied to a stationary object, especially on windy days. When the ladder is used against the eaves of a house, a rope attached to the top of the ladder should be thrown over the roof and fastened securely to a stationary object on the other side.

Most ladder accidents result from the ladder slipping and falling, so the importance of properly erecting a ladder cannot be overemphasized.

Safe Ladder Usage

Before climbing a ladder, make

NEED A 1/4" x 1-1/4" TIME-DELAY FUSE OR QUICK-ACTING FUSE?

BUSS HAS IT!

Time-current characteristics of FUSETRON® dual-element time-delay fuses

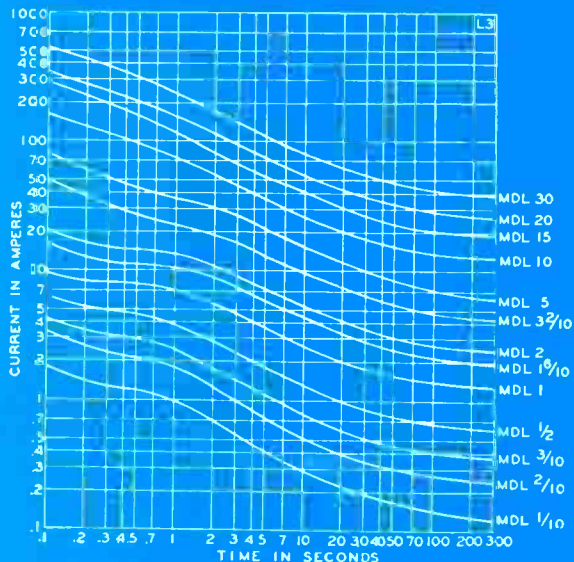

Time-current characteristics of BUSS® fast-acting fuses

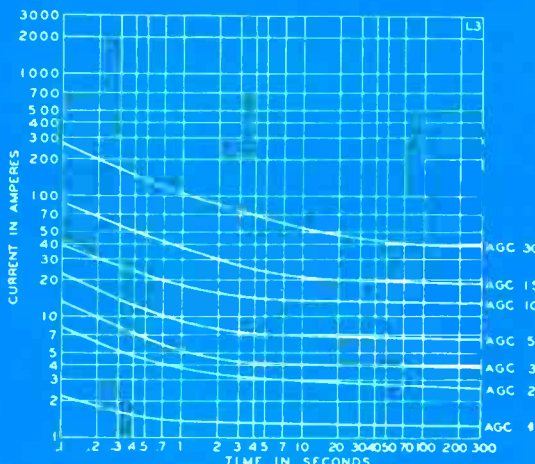

FUSETRON® dual-element fuses

Time-delay characteristics avoid nuisance openings from starting currents or surges—yet, give full protection from short-circuits or dangerous overloads.

Voltage	Symbol	Amperes
250 or less	MDL	1/100, 1/32, 1/16, 1/10, 1/8, 15/100, 175/1000, 3/16, 2/10, 1/4, 3/10, 3/8, 4/10, 1/2, 6/10, 7/10, 3/4, 8/10 or 1
250 or less	MDX	1-1/4, 1-1/2, 1-6/10, 1-8/10 or 2
125 or less	MDL	1-2/10, 1-1/4, 1-1/2, 1-6/10, 2, 2-1/2, or 2-8/10
125 or less	MDX	3, 3-2/10, 4, 5, 6-1/4 or 7
32 or less	MDL	3, 3-2/10, 4, 5, 6-1/4, 8, 10, 15, 20, 25 or 30



BUSS® fast-acting fuses

Fast-acting characteristics provide the instantaneous high speed opening necessary to protect sensitive instruments or delicate apparatus.

Voltage	Symbol	Amperes
250 or less	AGC	1/500, 1/200, 1/100, 1/32, 1/16, 1/10, 1/8, 15/100, 175/1000, 3/16, 2/10, 1/4, 3/10, 3/8, 45/100, 1/2, 6/10, 3/4, 1, 1-1/4, 1-1/2, 1-6/10, 2
250 or less	MGB	1/16 or 1/8
MBW & MBB fuses now called AGC.		
250 or less	AGC	2-1/2, 3
250 or less	MTH	4, 5 or 6
For 250 volt fuses above 6 amperes—See ABC fuses.		
125 or less	GLH	7, 8 or 10
32 or less	AGC	4, 5, 6, 7, 7-1/2, 8, 10, 15, 20, 25 or 30

For a complete selection of BUSS fuses and fuseholders ask for bulletin SFB.

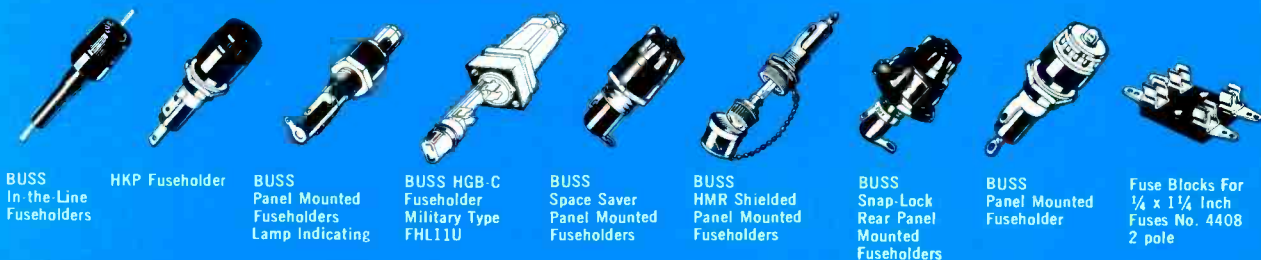

BUSS In-the-Line Fuseholders

HKP Fuseholder

BUSS Panel Mounted Fuseholders Lamp Indicating

BUSS HGB-C Fuseholder Military Type FHL11U

BUSS Space Saver Panel Mounted Fuseholders

BUSS HMR Shielded Panel Mounted Fuseholders

BUSS Snap-Lock Rear Panel Mounted Fuseholders

BUSS Panel Mounted Fuseholder

Fuse Blocks For 1/4 x 1 1/4 Inch Fuses No. 4408 2 pole



BUSSMANN MANUFACTURING
a McGraw-Edison Company Division
St. Louis, Missouri 63107



**Table 2
Ratings for
extension ladders**

Ladder length	Max. useable length	Max. height for climbing onto roof	Minimum working height	Maximum working height*
16'	13'	9.5'	5'	15'
20'	17'	13.5'	7'	19'
24'	21'	17.5'	9'	23'
28'	25'	21.5'	11'	27'
32'	29'	25'	13'	31'
36'	32'	29'	15'	35'
40'	36'	32'	17'	40'

*based on the climber standing on the third rung from the top of the fully-extended ladder

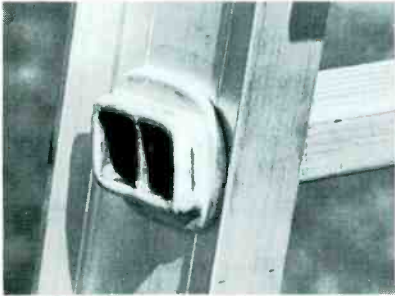

"I" beam construction of side rails gives strength with minimum weight. The flat rungs have center bracing, and are swaged to the side rails.

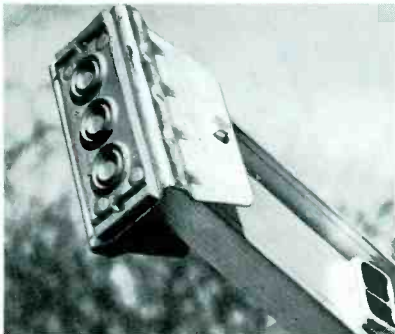

Safety shoes should be the large free-swinging type, with ice cleats and holes for spikes.



For long life, the pulley should be plastic, with a non-rotting pull rope. Strong brackets are required to prevent separation of the ladder sections.

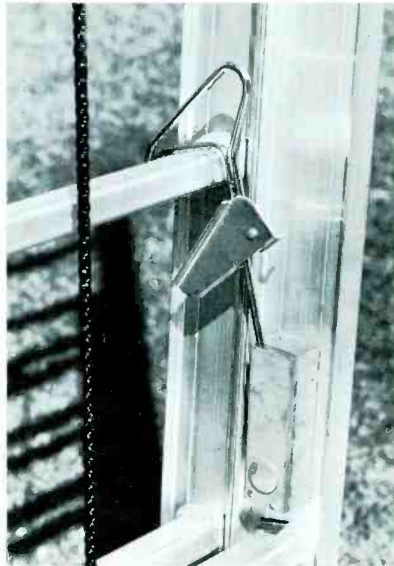

A dependable automatic-locking device is essential to prevent the top section from sliding down.

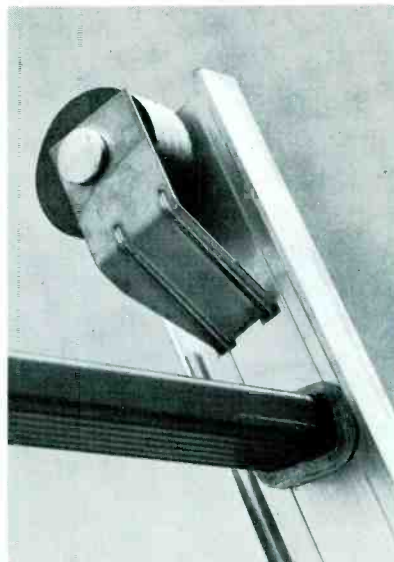

Large vinyl rollers allow the top section to be extended while against the wall, without damaging the house.

(Photos courtesy of Perma Power)

sure the soles of your shoes are free of mud, grease, or snow. **If you intend to work upon a roof, you should have shoes with non-slip soles.** When ascending and descending, always face the ladder and use both hands, preferably holding the side rails, not the rungs. Whenever possible, loads and tools should be hoisted by rope rather than carried. It's preferable for tools to be in a bucket rather than in a tool belt.

Never climb above the third rung from the top of a straight or extension ladder (the second top tread on a stepladder). **You always should have one hand on the ladder to maintain your balance.**

When working from a ladder, don't over-reach. The ladder should be positioned so you can comfortably reach your work at arm's length. It is recommended that you keep your belt buckle between the siderails. Otherwise your center of balance is away from the ladder. This results in an unstable weight distribution on the ladder that could cause it to slip and fall. If you can wrap one foot around a rung, you should do so.

Finally, **safe usage requires that you never leave an erected ladder unattended.** One danger is that a gust of wind can cause a ladder that is resting on a smooth bearing point to fall with considerable force. The resulting property damage can be expensive. Secondly, erected ladders are an attractive hazard to children, whose injury could well result in a lawsuit.

Like tools, ladders can be dangerous to yourself and others when precautions are not taken for their proper use. When properly selected, maintained, and used, however, they can provide many years of safe, dependable service. □

digital or analog

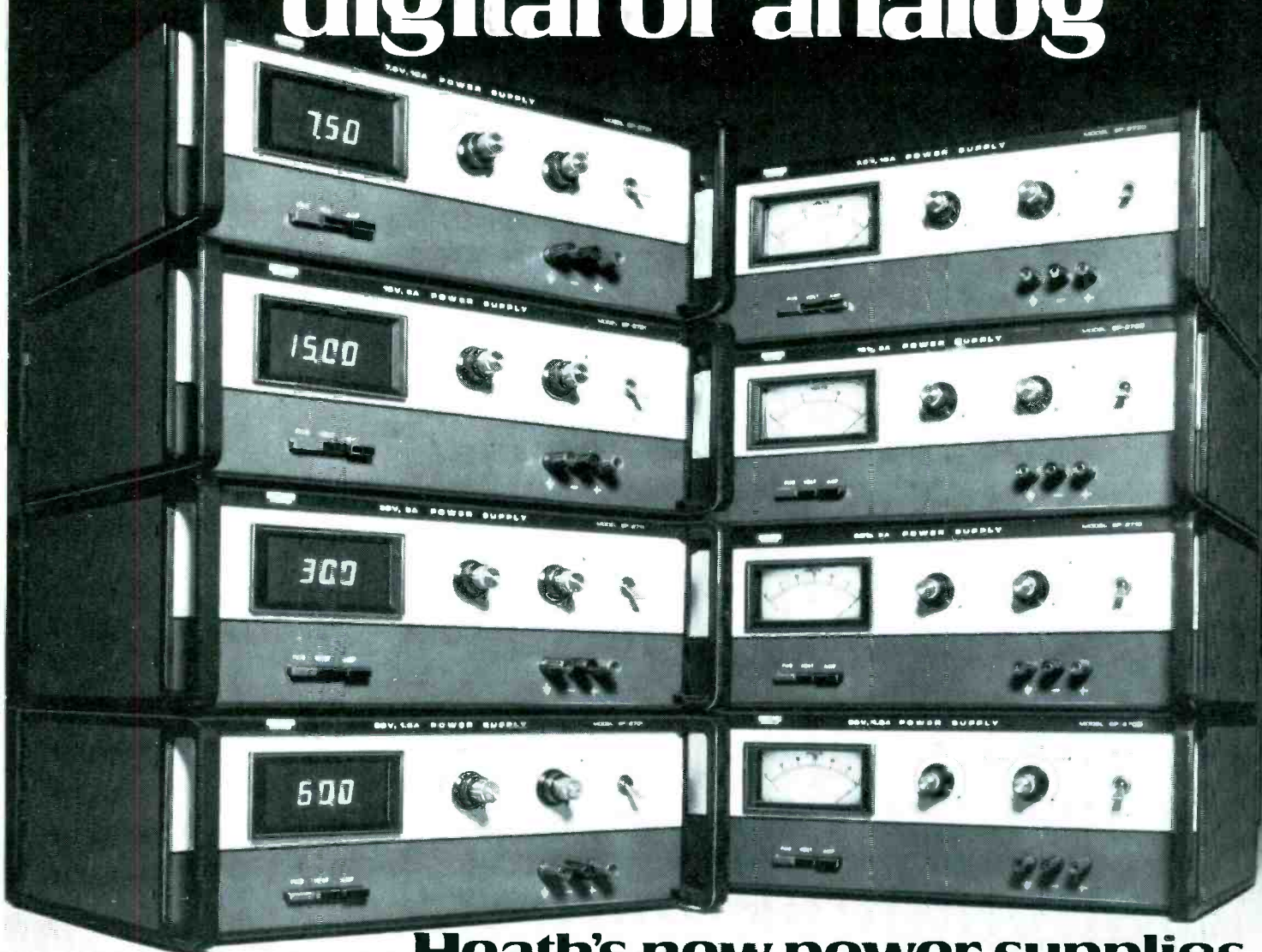

Heath's new power supplies set new performance standards

- Choice of four DC outputs: 0-7.5 V, 0-15 V, 0-30 V or 0-60 V
- 3½-digit or 3½" meter readout
- Constant voltage *and* constant current operation
- Remote voltage and current programming
- Precise load and line regulation — ±0.05% voltage, ±0.1% current
- Complete output protection
- Remote sensing automatically compensates for lead voltage drops
- Available factory assembled or in easy-to-build kit form

Heath's versatile new 2700-Series DC power supplies do much more than just provide the right voltage and current — they set new standards for precision and ease of operation.

Digital or analog readout. These power supplies are the first in their price range to offer a choice of readouts. The digital models have two-decade autoranging to provide high resolution for low voltage and current settings.

Constant current and constant voltage operation. And it's true constant current, not simple current limiting. Adjust two controls to get the voltage and current you need. And if one supply doesn't deliver exactly the output you require, just connect them in series or parallel — with no loss of regulation!

Remote programming and sensing. For systems use and remote applications, both voltage and current can be programmed. And all supplies provide remote sensing at the load to automatically compensate for voltage drops due to long leads and connectors.

Output protection. You don't have to worry about these power supplies. Short circuit operation or accidentally applied high voltages can't harm them.

All 2700-Series power supplies are available in easy-to-build kit form or completely factory assembled and calibrated. Either way you get a power supply that offers more performance per dollar than anything the competition can offer. Send for the latest Heath catalogs and get complete details.

Model	Readout	Maximum Rated Output		Price*
		Volts	Cur.	
IP/SP-2700	Analog	60 V	1.5 A	\$169.95 kit \$255.00 assem.
IP/SP-2701	Digital	60 V	1.5 A	\$219.95 kit \$340.00 assem.
IP/SP-2710	Analog	30 V	3.0 A	\$169.95 kit \$255.00 assem.
IP/SP-2711	Digital	30 V	3.0 A	\$219.95 kit \$340.00 assem.
IP/SP-2720	Analog	15 V	5.0 A	\$169.95 kit \$255.00 assem.
IP/SP-2721	Digital	15 V	5.0 A	\$219.95 kit \$340.00 assem.
IP/SP-2730	Analog	7.5 V	10.0 A	\$169.95 kit \$255.00 assem.
IP/SP-2731	Digital	7.5 V	10.0 A	\$219.95 kit \$340.00 assem.

HEATH COMPANY		HEATH	
Dept. 25-04		Schumberger	
Benton Harbor, Michigan 49022			
<input type="checkbox"/> Send my free '75 Heathkit Catalog. <input type="checkbox"/> Send my free Heath Assembled Instruments Catalog.			
Name _____			
Title _____			
Address _____			
City _____	State _____	Zip _____	TE-323
*MAIL ORDER PRICES; F.O.B. FACTORY.			
PRICES & SPECIFICATIONS SUBJECT TO CHANGE WITHOUT NOTICE.			

For More Details Circle (17) on Reply Card

www.americanradiohistory.com

MY TUNER TIPS



By Max Goodstein

Tuner repairs come in all degrees of complexity. However, intermittent switch contacts account for most problems. An "Old Timer" shares his tips and opinions.

Excluding tube replacements, about 90% of tuner repairs involve switch-contact problems. Most of the other 10% have neutralization troubles, or defective capacitors and resistors. Therefore, you shouldn't have much difficulty with tuner repairs, if you develop good methods of cleaning contacts, and then learn at what point to stop work and send the tuner to a repair station.

One of my theories is that the set users bring much of the contact troubles upon themselves by spinning the channel-selector knob too fast.

Also, I believe technicians should clean all contacts **before** attempting other repairs in tuners.

Symptoms Of Bad Contacts

It's usually possible to diagnose a case of poor switch contacts by operating the channel selector from the front of the receiver. Sometimes you must wiggle the knob to even receive a station. The slightest movement of fine tuning or channel knobs might kill the color, or bring in snow. Of course, the symptoms vary according to the particular contacts that are erratic.

These intermittents originate from two different conditions. Perhaps the circuit continuity is erratic because a contact spring has acquired a "set" from frequent pressure and doesn't hold the rotor contact tightly enough. Or the switch-contact surfaces have become covered with corrosion. Weak springs must be replaced or re-shaped, and corroded contacts should be cleaned.

Cleaning Contacts

Although no method of cleaning produces permanent results, most experts agree that longer-lasting benefits are obtained if you remove corrosion from switch-type tuners by use of a good degreaser (perhaps chlorethene or alcohol) on a soft-

bristled brush. Then apply a good lubricant direct to the switch contacts.

Turret (drum) tuners should have the coil-strip studs cleaned with a soft cloth moistened by degreaser (or by scrubbing with a short-bristled brush) before lubricant is applied to the stator contacts.

Cleaning pads

As a belt-and-suspenders precaution, I strongly recommend installation in turret tuners of a pad that cleans and lubricates the strip contacts with every revolution of the channel selector.

Here's the way to install a pad in a Zenith "Golden" tuner:

- Remove the shield cover;
- Strip off the protective backing from the pad, exposing the adhesive;
- Lay the pad on the drum (Figure 1) with the adhesive out (Caution: make sure none of the pad extends to the front far enough to interfere with the fine-tuning gears. If necessary, cut off some of the pad, so it is no longer than a channel strip);
- Re-install the cover, taking care not to move the pad. The pad now should adhere to the cover;
- Remove the cover, and squeeze the lubricant (usually furnished) along the length of the pad; and
- Re-install the cover. That's all.

Speaking of covers, **always** replace all covers and shields. Not only do the shields help keep out dust, but they often prevent large shifts of alignment caused by their removal. Perhaps the most noticeable result is when the fine tuning will not bring in the color until the cover is replaced. But remember that other circuits are misaligned just as much; the effect is not so noticeable.

Tightening Contacts

Spring-stator contacts that remain compressed when the pressure

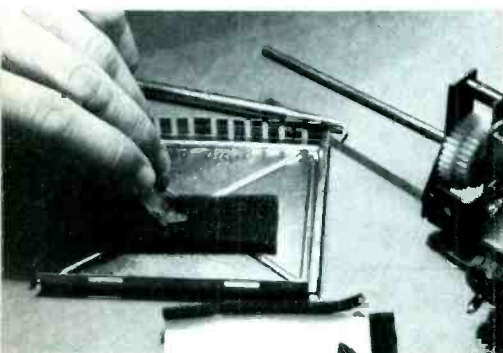
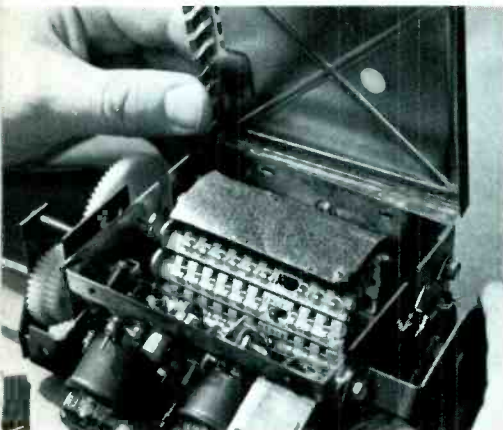

Fig. 1 To install a contact-cleaning pad in a Zenith Golden tuner, take off the shield, remove the protective backing from the pad, and lay the pad at the proper place on top of the turret (top photo), then install the shield so it adheres to the pad. Remove the shield and pad, and spread the lubricant on the pad (lower picture). Replace the shield.

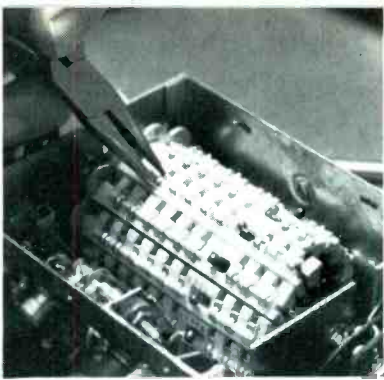

Fig. 2 Squeezing the contact studs of the Zenith turret makes them extend farther out from the turret. This is recommended rather than bending the stator springs to tighten intermittent contacts.

of the rotor is removed need more than cleaning.

Switch-type tuners have stationary contacts resembling a flattened "C" with the ends nearly touching. Then the flat blade of the rotor contact slides in between, spreading the "C" apart to apply pressure.

Turret tuners have flat stator springs shaped in an arch. When the rounded studs on the coil strips touch the arched springs, the springs are forced backwards by the pressure.

With either type of tuner, the "C" contacts or the arched springs should move when the rotor touches them. If not, the circuit might be open, or insufficient pressure might cause intermittents.

The correction you should do depends on the precise kind of tuner.

Zenith "Golden" Tuner

The arched, flat stator springs of the Zenith "Golden" tuner have given some problems. However, it's not so much the fault of the tuners, but from mutilated springs resulting from technicians using the wrong method of re-shaping the springs. Some have been found cracked near the rivets, and others have had excessive trouble with erratic contacts.

And the situation hasn't been helped by the drawing in the Zenith manual showing a hand with a modified paper clip used to re-arch a contact spring. Now, I'll grant you it's possible to do it that way. But it's also very easy to bend the spring too sharply, and that about ruins the spring.

Because of the difficulties of correctly shaping the stator springs, I recommend that you use small long-nose pliers (Figure 2) to **gently**

squeeze the contacts on the coil strips. This raises the level of the contacts, and increases the pressure against the springs, but without distorting the springs.

Magnavox And Sylvania Tuners

Before being concerned about repairs to Magnavox and Sylvania tuners, first try degreasing and lubrication, then install a lubricating pad on the tuner cover.

For loose contacts, some sources have suggested lifting each coil strip contact, using a small screwdriver. I urge caution, however, because lifting the contacts too far can cause the tuner to jam, or to break the strip contacts.

Before tightening and re-shaping any springs, check the elasticity of each stator spring by taking out 2 or 3 channel strips, and pressing each spring using a soldering-aid pick. If any spring is sluggish, then re-shaping that one will help very little. In that case, the only good solution is to snap off the defective spring close to the rivet, and install a new one by soldering it to the rivet before re-shaping it. I've had good success using Zenith springs #80-1503. In some tuners, it's necessary to narrow the springs with diagonal pliers to obtain the right width.

With the strips still removed, slowly spin the drum and notice if the stator springs have enough movement when the strip contacts touch them. Any springs without enough movement should be re-arched by placing a small screwdriver at the end of the spring (in line with the spring) and applying pressure towards the rivet. This should give a smooth arch, but don't overdo it.

RCA Tuners

The proper way of cleaning or repairing an RCA tuner is to dismantle it. In addition to the outer shield, there is an inner shield which must be removed before degreasing and lubrication.

However, if cleaning and lubrication doesn't help, and you suspect more serious contact troubles, you probably should send the tuner to a specialized tuner clinic. Often there is no open space where the "C" springs can be re-arched.

If it's the kind with a small turret for the front (oscillator) section, you can tighten those con-

tacts by cutting off the two rotor switch plates for the UHF position. This gives room to use the pick end of a soldering aid for bending the two ends of the "C" nearer together. Sanyo television tuners are built with these UHF contacts missing.

Zenith And Motorola Tuners

Zenith and Motorola tuners also have the antenna and RF sections built around rotary switches, while the oscillator section has a miniature drum or turret at the front. The photos of Figure 3 show how the UHF oscillator contacts can be cut off, thus giving room for shap-

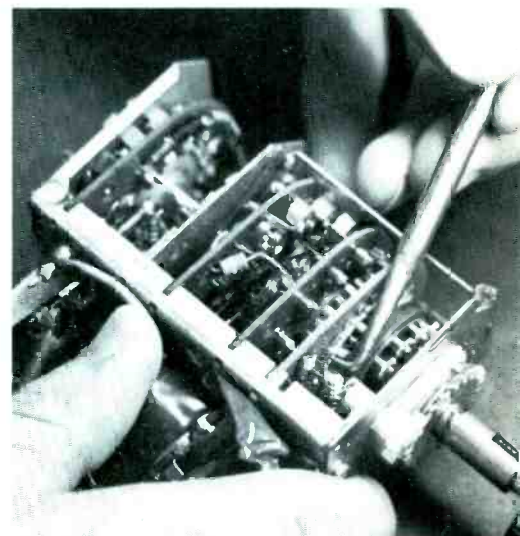
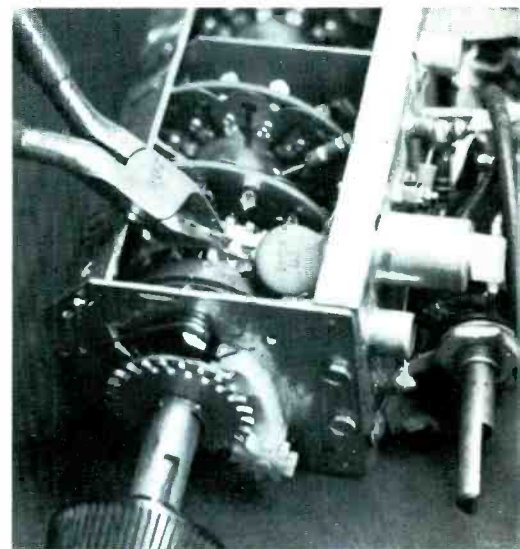

Fig. 3 With Motorola, Sylvania and some RCA tuners, to make room for re-shaping the "C"-shaped stator contacts, cut off the flat UHF contacts (upper photo), then tune to UHF position, and gently rebend the stator contacts (photo at bottom).

ing of the "C" section of the stator contact.

One recurrent problem with Zenith tuner numbers 175-701

through 175-749 is that the wafers of the RF and antenna switches strip so the shaft no longer can turn them. Either the defective wafer must be replaced, or it can be cemented to the shaft.

Admiral And General Electric Tuners

The Sarkes-Tarzian turret tuners used in Admiral and General Electric also occasionally exhibit problems with loose stator contact springs. These springs should rock back and forth as the channels are changed.

To tighten the contact of the stator springs, remove two channel strips and use a soldering-aid pick to bend out the springs, as shown in Figure 4. Degrease and lubricate the springs while the strips are removed.

Retuning Oscillators

Many turret tuners, after they age, cannot move the oscillator frequency enough by adjustments of fine tuning and the core of the oscillator coil to tune correctly into the color.

If the condition is not intermittent, remove the coil strip of that channel and change the inductance. With Sarkes-Tarzian types, use a pick (Figure 5) to spread the turns of the oscillator coil, the one nearest the front of the tuner.

Golden tuners by Zenith have the coil cemented in place. Therefore, it's necessary to break loose the cement, move the coil nearer the core gear and cement it again.

If you have available several brands of oscillator tubes, it's often

possible to find one individual tube that will produce correct fine tuning on all channels without any manipulation of the coil.

Miscellaneous Tips

One of the headaches of tuner repairs is the inaccessibility of parts and some contacts. Use care if you move wires or components in an effort to reach some certain area, because the physical position of many parts is part of the alignment. That peculiar-shaped piece of wire just might be a trimming inductance. Move or bend it and you have misalignment.

In a Magnavox service seminar, we were told to hand clean the MOSFET tuner (instead of spraying) to prevent possible damage to the MOSFET. Also, meter probes should not be connected to any MOSFET gate, to protect the device.

Use care not to confuse an intermittent connection with dirty contacts or loose stator springs. Probe gently with a plastic alignment tool to locate any bad joints.

Some RCA tuners (that have the turret oscillator section) develop poor connections at the rivets holding the "C" stator springs. The solution is to solder the rivets to the springs; but be **very careful** the solder doesn't run onto the spring.

Good tuner repairs demand small tools (including a tiny soldering iron), a bright source of light, a magnifying glass, and lots of patience. It's much better to go easy and take more time, than to break a part or bend a switch contact too far. □

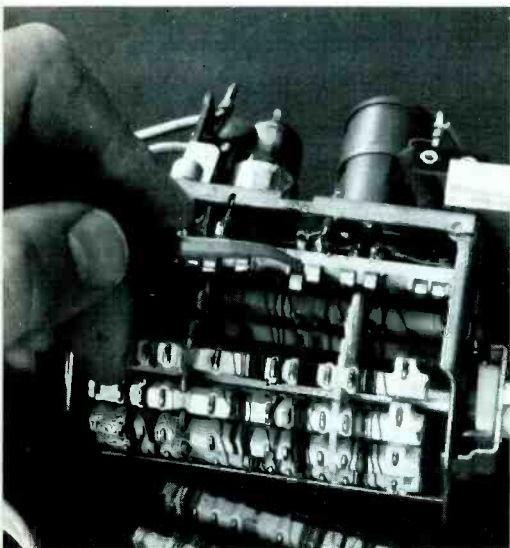

Fig. 4 Sarkes-Tarzian tuners can have the contacts tightened by removal of two coil strips, and then bending each spring, as shown.



Fig. 5 Correct fine-tuning action for color can be obtained with Sarkes-Tarzian tuners if the turns of the oscillator coil are moved (usually farther apart).

When you send in a tuner for repair

In many circumstances, it is wise to send a tuner to one of the specialized tuner repair stations. The following tips are suggested to help these repair stations do a better job for you.

- Include all identification about the receiver from which the tuner was taken—chassis, model and run numbers.
- Include the correct type of good tubes. Many similar tuners are made with parallel and series heaters, and other important differences. No tuner repair shop can possibly know all of this without information from you.
- Describe the trouble symptoms (or the defect) as clearly as possible. Nothing frustrates a conscientious technician so much as a "defective" tuner which appears to operate normally.
- If the tuner is from a color receiver, state this clearly so the tuner-repair technician will not adjust the mixer-plate IF coil. If this coil is misadjusted, you will need to align the IF circuit.
- Install all shields before you ship the tuner. Correct alignment or adjustment of the oscillator frequency is not possible without the shields.

SERVICING MODULAR COLOR



Part 3/By Charles D. Simmons

Lose vertical sweep and there's only one bright horizontal line on the picture tube. Right? Not if the color TV is a 19EC45 Zenith portable. With that series of chassis, a unique tie-in between vertical and video blanks out the raster if yoke current stops. That's just one different feature of the 19EC45 vertical sweep.

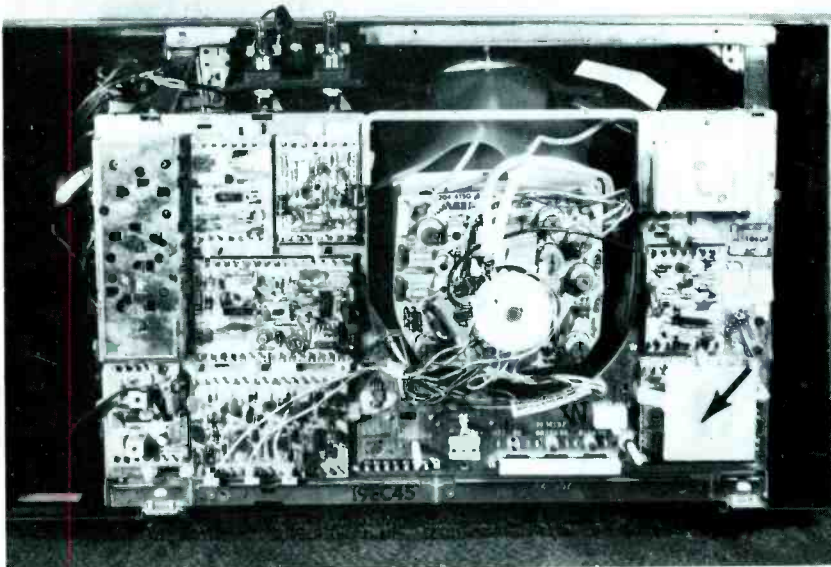

Fig. 1 All vertical-sweep components (except hold control, yoke and pincushion parts) of the Zenith 19EC45 chassis are mounted on the 9-92 vertical module, located at the lower right corner of the chassis.

All vertical-sweep components of the Zenith 19EC45 color chassis (except yoke and pincushion) are located on the 9-92 module (Figure 1). The three power transistors (driver and two outputs) are mounted on a heat sink that forms an "L"-shaped cover over the module (Figure 2).

Although the heat sink covers the module, preventing many live tests, it can be removed. Turn the plastic latches parallel to the edges of the module and gently pull top and bottom (alternately) of the module until the heat sink and module are freed from the terminals. Remove two mounting screws and carefully pull the transistor side of the heat sink away from the module. The transistor leads fit in socket pins, and can be removed and reinstalled without damage.

After the heat sink is removed, replace the module. Some tests with power on now are possible. The final three stages are direct coupled, and it's not practical to test much of their circuitry when the three power transistors are missing. However, the multivibrator oscillator and sawtooth-shaping stages can be tested thoroughly.

General Features

Many of the circuit features of the vertical sweep can be seen in Figure 3, the block diagram format eliminating some of the distracting details. **Notice that no sweep transformers are used.**

Two direct-coupled chains make up the total circuit. Two transistors, one PNP and one NPN, are used in a multivibrator 60-Hz oscillator, with direct coupling between Q701 and Q702. The output signal of Q701 also is direct coupled to transistor Q703, whose output is filtered to make sawteeth, before the signal is capacitance coupled to the amplifier stages.

DC voltage at the collector of Q703 determines the amplitude of the sawteeth there, and the voltage

is adjustable by the VERT SIZE control to vary the height of the picture. No vertical linearity control is provided, and none is needed. Because of feedback from the yoke current, **good linearity is maintained at full height, or with only partial sweep** (Figure 4).

Each of the complementary-symmetry output transistors is supplied by its own voltage source. Output signal is from the two emitters, which are at zero DC voltage. At least they are so long as both output transistors are good, and not open or shorted. There is no coupling capacitor to the yoke, so a dead short in either output transistor would apply nearly the full power supply voltage to the vertical yoke windings. Such a severe overload might burn up the yoke.

There has been some speculation that the hot yoke plus the heat of

the off-the-screen horizontal line might melt the glass of the picture tube. In any event, excessive power supply current flowing through the yoke certainly should be avoided.

That's the reason for the 600-milliamper fuse between the output transistors and the service switch. It is vitally important that **the fuse (F203) should never be jumpered or defeated** during tests, and that the replacement fuse should have the correct rating. There are good ways of testing while the original fuse is open; don't take chances.

Oscillator and Waveshaping Stages

The sweep circuit divides naturally into two halves, because of the way the stages are direct coupled. Understanding of the theory and troubleshooting techniques both are helped by keeping them separate.

A unique oscillator

Multivibrator oscillators are not unusual. Certainly, it's different, however, for one of the transistors to be a PNP type, and the other a NPN type. Both transistors draw current during the **same** part of the cycle, and not during opposite peaks as most multivibrators do. In addition, one feedback path is DC coupled, and the other is AC coupled.

Figure 5 shows the complete schematic of the oscillator and sawtooth-shaper stages. The large amount of parts, and the way some previous schematics were arranged, have made the circuit hard to understand. So, I have asked that the schematic be drawn to clarify the way each transistor's output feeds the other's input.

How it oscillates

Don't be too concerned because

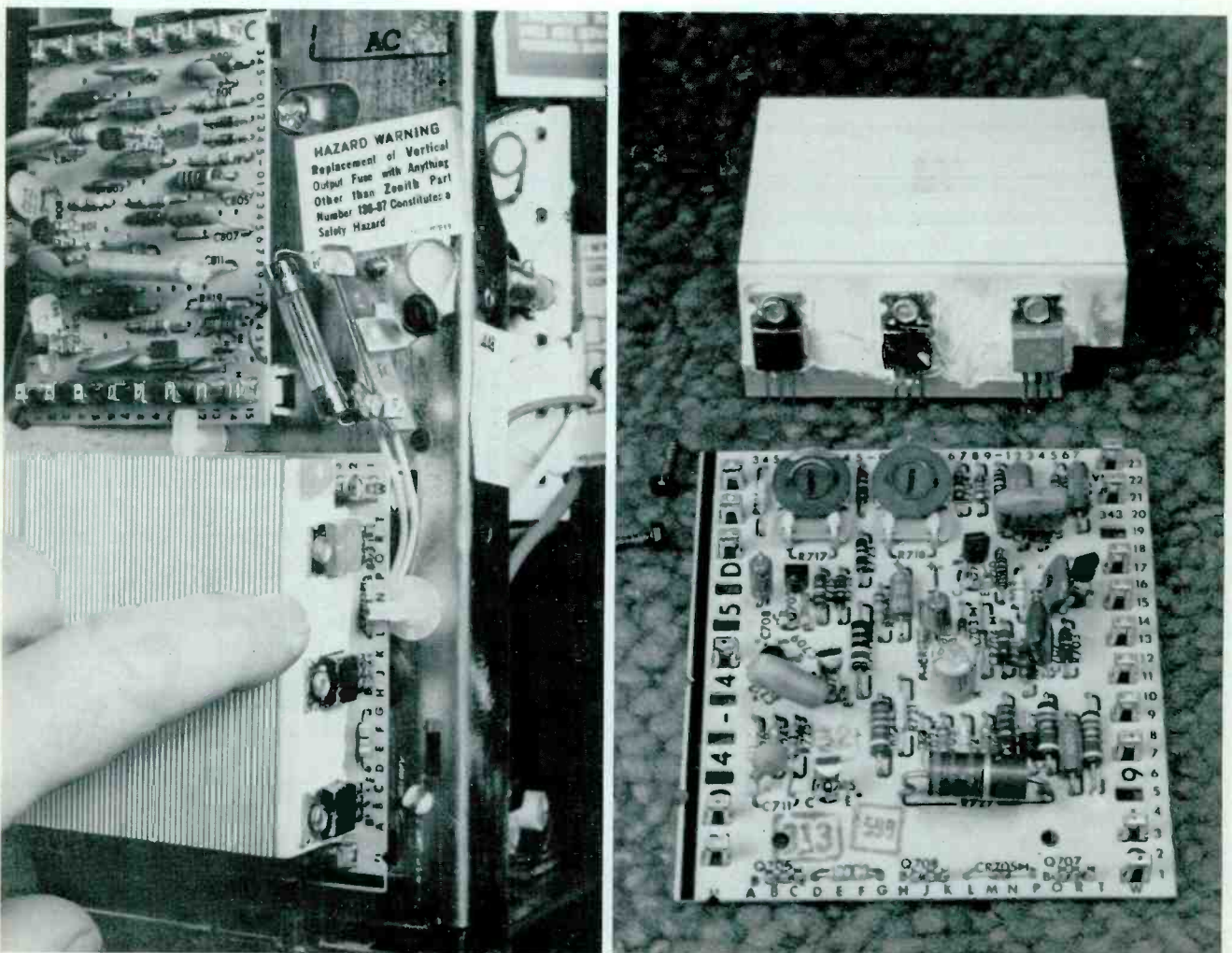

Fig. 2 Three power transistors (driver and 2 outputs) are mounted on a heat sink that covers the module. But the transistor leads fit into socket holes, and any transistor can be removed from the heat sink, or the heat sink with transistors can be dismantled from the module. The fuse shown is F203, which is in series with the yoke circuit.

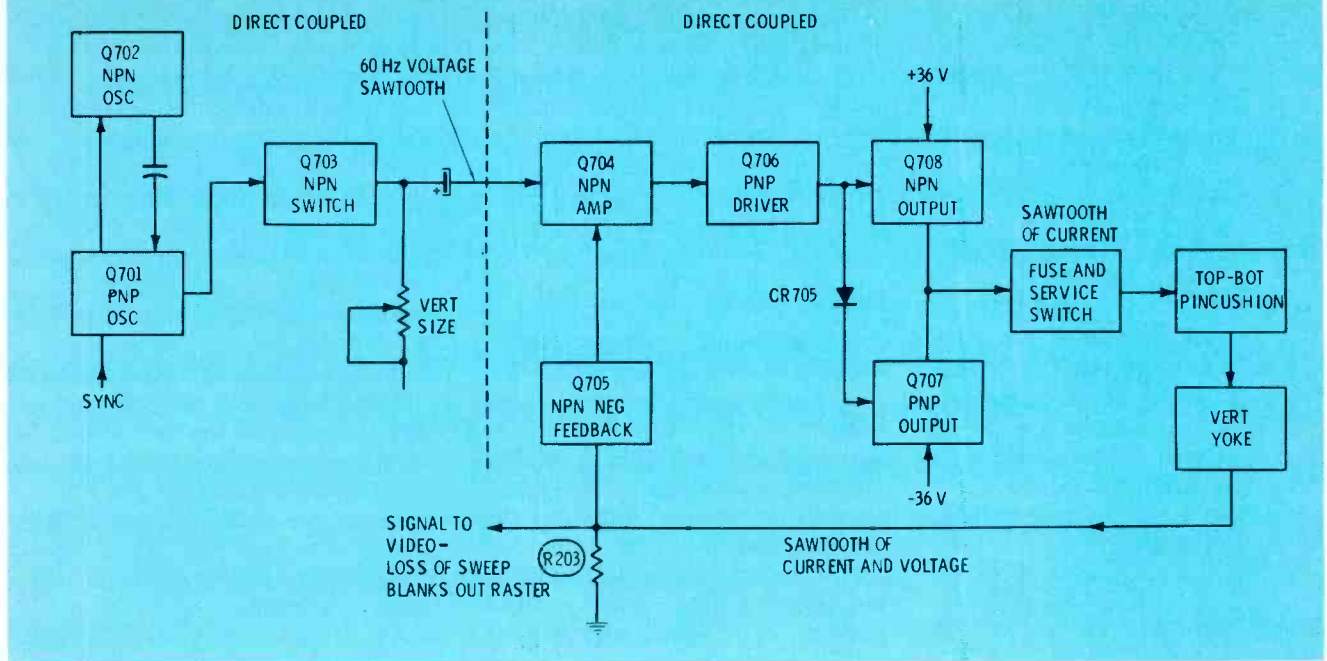

Fig. 3 This block diagram shows the complete vertical sweep system.

one oscillator transistor is a PNP, and the other a NPN. Naturally, this reverses the polarity of the forward bias necessary for maximum conduction. However, another fundamental remains unchanged: **an AC signal applied to a base emerges from the collector inverted in polarity, regardless of PNP or NPN.** Call the signals positive-going or negative-going and the circuit is far less confusing.

Let's assume the oscillator has been operating long enough to settle into its stable states. A pulse coming in through C704 to the base of Q701 causes base/emitter current (rectification) and charges C704 so the base of Q701 is more positive than its emitter. After the pulse is over, the base is biased to cutoff, so both base and emitter/collector currents cease.

There's no path for C704 to discharge through (CR702 and CR703 are reverse biased, thus are open) except through R704 and R256 (the hold control) to ground. Therefore, the time required for the base voltage to drop below the emitter voltage is determined mainly by the time constant of C704 and R704 plus R256.

Eventually, the base voltage of Q701 drops below its own emitter voltage (this is forward bias to the PNP) and collector current starts with a rush. Notice that Q701 is

supplied with B+ to the emitter through R701, R709 and CR704, and the collector is grounded through load resistors R713, R714, R711 and R712.

Previous to the conduction, the collector voltage was nearly zero (the path through the transistor was open). During conduction, the current caused the collector to go positive. This positive-going pulse goes to the base of Q703, and also through R711 and R712 to the base of Q702 (Figure 6), where it is forward bias for the NPN transistor. Q702 now draws collector current through R710, R731, R709, and R701. Some of this negative-going pulse (Figure 7) is applied to C704, where it causes base/emitter current

in Q701, and charges C704 with a DC voltage that reverse biases Q701 after the pulse has passed. The signal has gone full circle back to the beginning. All phases and amplitudes are correct, and oscillation takes place.

Vertical locking

Positive-going sync comes in through terminal W21 and is integrated by R706/R706 and R707/C707 networks (see Figure 8), then it is applied to the emitter of Q701. The positive-going sync pulse applied to the emitter acts the same as a negative-going one to the base: it is forward bias, which triggers Q701 slightly before the natural time.

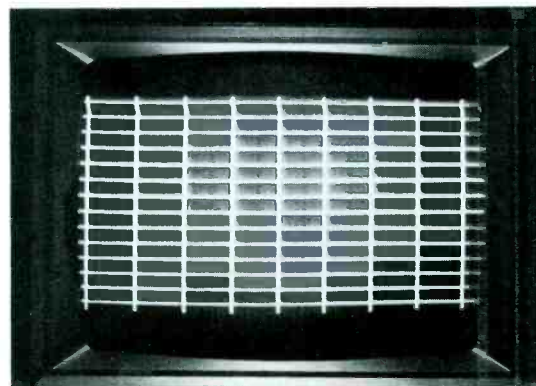

Fig. 4 There is no vertical-linearity control, but the linearity is very good, even when the height is reduced.

At first thought it seems CR701 would shunt the sync to the collector of Q702. After all, there are positive pulses at the anode of CR701, and negative pulses at the cathode. The explanation is that the two kinds of pulses are not there at precisely the same time. There is no pulse at the collector of Q702 (cathode of CR701) until the sync pulse has triggered Q701, and Q702 has been triggered in turn. By that time some of the Q702 pulses feed back through to the emitter of Q701. But that's too late to change the triggering. In fact, the extra pulses tend to turn off Q701 even more rapidly than would be possible without them.

Vertical blanking

Negative-going pulses (similar to those of Figure 7) come from the collector of Q702 through R703 to terminal W13 of the vertical mod-

ule, and then on to terminal W11 of the 9-88 video module.

In the video-amplifier circuit, the vertical pulses blank out the video during the vertical-retrace time, preventing the retrace lines that might appear as diagonal white lines during scenes having low contrast.

Forming sawteeth

Narrow positive-going pulses are formed at the collector of Q701 (Figure 6), and they are direct coupled to the base of Q703, the switch transistor. Q703 amplifies and inverts that signal; therefore, if the output of the transistor had only a collector resistor, the waveform would be negative-going pulses. But C708 is at the collector, and it, in conjunction with the collector resistor, forms a low-pass filter that makes linear sawteeth out of the pulses (Figure 9).

Amplitude of the sawteeth is

determined by the total resistance in the collector circuit, including the VERTICAL SIZE control. More sawteeth amplitude is required to drive the following amplifiers to produce increased height. In order to have a high-value resistance (for linearity), and yet have sufficient collector voltage, the voltage is obtained from the +130-volt source. Additional filtering is furnished by R202 and C202.

This completes the explanation of the oscillator and shaper circuits. All voltages and waveforms can be tested with power on (heat sink and power transistors removed).

Major components are located in Figure 10, and the board layout should help you to find the test-points you need.

Direct-Coupled Amplifiers

Second half of the vertical-sweep system consists of three direct-coupled stages (Figure 11).

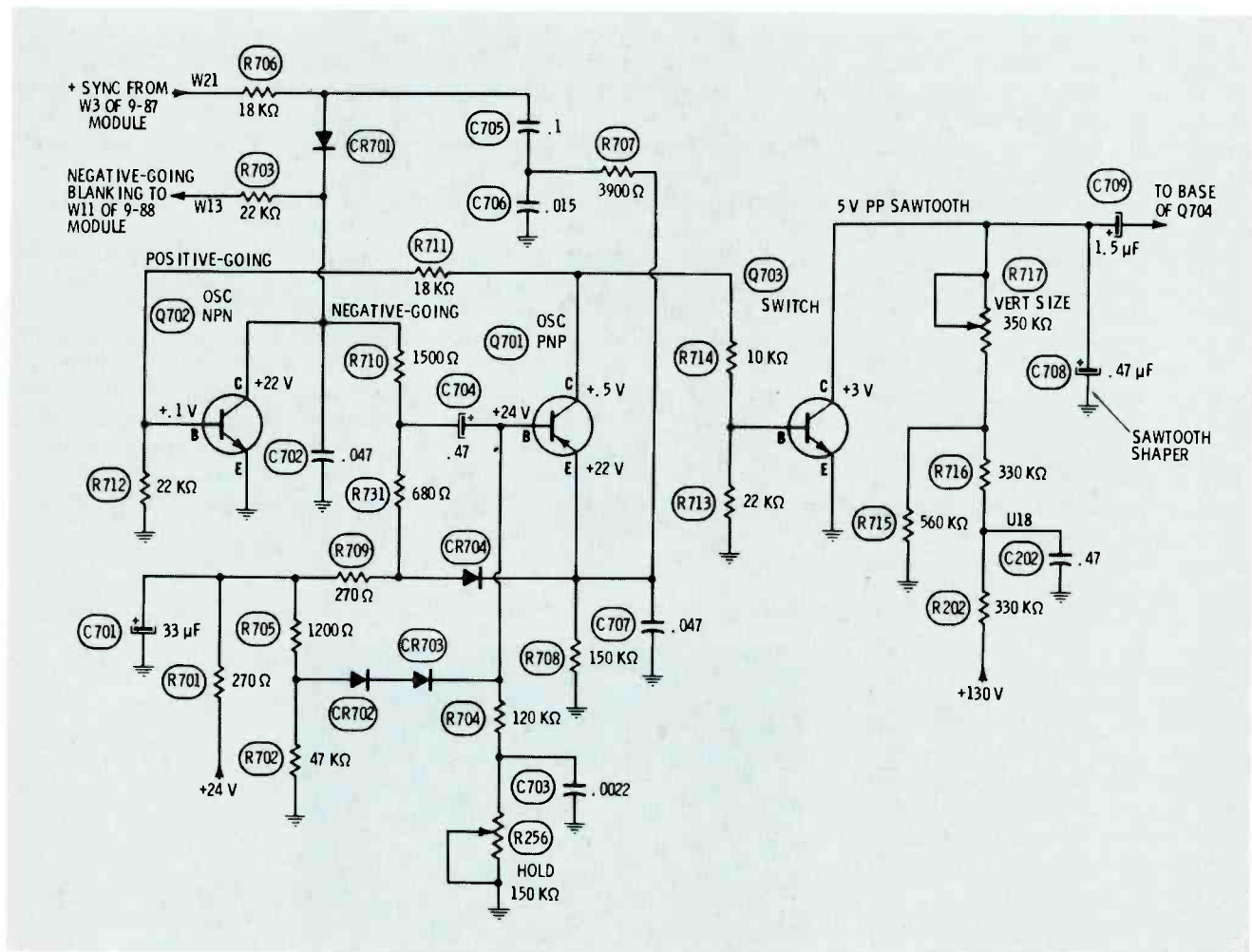

Fig. 5 Direct coupling is employed in two of the three signal paths of the vertical-oscillator and sawtooth shaper stages. One output signal is used for vertical blanking. The other (linear sawteeth) signal drives the 3 amplifier stages, and they power the yoke.

A unique first stage

Two things are unusual about the first stage. First, the bias is adjustable by the VERTICAL CENTERING control. This in turn changes the bias of the driver and the two outputs. Because one output is PNP, and the other NPN, the bias of one is increased and the other bias is decreased. Gain is not changed much, but the unbalanced transistor currents create a DC voltage at the output. Current from this voltage that's fed to the direct-coupled yoke moves the picture up or down (Figure 12).

The picture moves more than with any centering circuit I have ever seen before, but perhaps that is necessary to allow for accumulated component tolerances. There is a slight amount of linearity change and some misconvergence at the two extremes. However, it's unlikely so much correction ever would be required. The centering holds very well without drifting.

The other unique feature of the first stage is the use of two transistors in a differential circuit. Apparently, the reason is to provide a good path for negative current feedback. At the base of Q704 is the sawtooth signal from the oscillator/shaper stages, while the slower-retrace sawtooth from the yoke current is applied to the base of Q705 (Figure 13). Then the two emitters are tied together to mix the two signals. This mixing has the proper phases of signals to provide negative feedback that improves the linearity of the sawtooth of yoke current, and reduces the gain to minimize any drift.

In fact, the linearity correction is so good, that I could see no **expected** compression of sweep near the vertical center of the picture when I shorted out CR705 as a test!

Driver stage

The driver stage, with PNP Q706, appears to be a conventional one without complications. However, the waveforms there puzzled me for quite a time. I expected a sawtooth at the base and an inverted sawtooth at the collector. **Not so!** The actual waveforms are shown in Figure 14.

How can the waveforms at the base and the emitter of Q704 (Figure 13) ever produce the posi-

tive-going pulses (with just a hint of sawtooth between) at the collector? Well, remember base signals are inverted at the collector; emitter signals are not. Now, mentally add the waveforms with the top one inverted. The two sawteeth nearly cancel, leaving the **difference** between the two falling edges (negative-going pulses, see the top trace of Figure 14).

That accounts for the peculiar waveform, but it doesn't explain how pulses can produce sawteeth of deflection (without integration). Look at it this way: most of the pulse amplitude represents cutoff bias to Q706 (it's positive-going, and bias needs to be negative), so that part of the waveform does not

affect the collector current. A fairly-linear sawtooth results, but there is a notch in the center where the conduction of one output transistor ceases and the other one begins.

Output stage

Two medium-power transistors of identical characteristics, but of opposite polarity, are driven by direct coupling from the collector of Q706, a PNP medium-power type. CR705 diode is included to offset the bias of one transistor to minimize crossover distortion at the center of the signal. As I have said already, the negative feedback is so effective, no perceptible distortion was noted on the screen of the

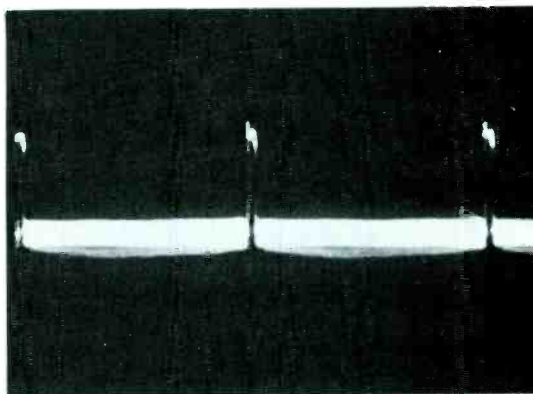

Fig. 6 Narrow positive-going pulses from the collector of Q701 go to the base of Q702 and the base of Q703.

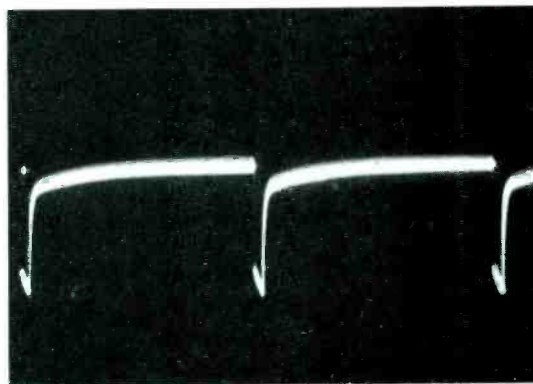

Fig. 7 Negative-going pulses from W13 (the collector of Q702 through R703) go to terminal W11 of the 9-88 luminance module to blank out the video during vertical-retrace time.

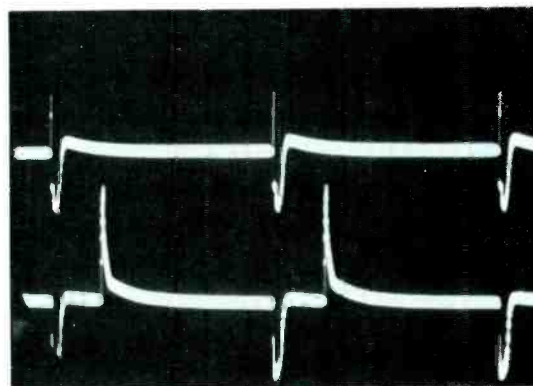

Fig. 8 Positive-going sync comes to the vertical module at W21. These waveforms show the sync and vertical-sweep pulses at the junction of CR701 and R706. The top trace is with the vertical locked, and the trace at bottom shows the two signals when the picture is drifting downward.

picture tube when I shorted across it as a test. Because of the opposite polarity of the transistors, the action is push-pull; one conducts more and the other less, and vice versa.

Q708 is a NPN type, with +36 volts applied to the collector. Q707 has -36 volts applied to the collector, because it is a PNP type. Both have 4.7-ohm emitter resistors that function as fuses if a transistor shorts, and the common point of the resistors is the output, going eventually to the yoke.

Because of the double power sources and the symmetrical design, the DC voltage at the output is almost zero. The exact voltage might be a volt or so of either polarity, depending on the setting of the CENTERING control. No output transformer or coupling capacitor is necessary.

First, the output signal goes to the protective fuse, F203, then to the setup switch (which opens the circuit to eliminate the sweep when the setup position is selected).

At the output of the setup switch, the signal goes three ways. A small amount goes to control the side-pincushioning correction, and some goes to the convergence circuit.

Most of the sweep power is used for the vertical yoke. The top-and-bottom pincushion correction is applied at the midpoint of the series connection of the two yoke coils, as shown in Figure 11.

Now, notice carefully that the low end of the yoke circuit does **NOT** go directly to ground, but through a 4.7-ohm resistor (R203) to ground.

If you want to obtain the voltage waveform of alternating current, just place a small value resistor in the current flow and connect a

scope across the resistor. So, the 4.7-ohm resistor between yoke and ground has across it the waveform of yoke current; in this case, a sawtooth.

One use for this sawtooth waveform is to provide an improvement of the linearity. Obviously it works; because there is no linearity control. Also, loss of this signal blanks out the raster.

Blanking The Raster

Two fail-safe circuits are supplied to protect the components from damage if certain kinds of vertical-sweep defects occur. One is the 600-milliamper fuse, F203. The main job of the fuse is to protect the power supply, the yoke, and other components in the event one of the output transistors shorts. Such a short would place an emitter resistor and the yoke components (a total of perhaps 20 ohms) across one of the 36-volt supplies. Probably about 1 ampere would flow (guessing a large drop of supply voltage because of the short). This would be more than 20 watts of heat, which could do considerable damage. In addition, the huge DC current would deflect the single horizontal line above or below the screen where it could not be seen or used as a symptom. Some people have speculated that the heat of the yoke added to heat from the electron beam striking the neck of the picture tube might melt it. So far as I know, this has not happened, but it **reminds us not to defeat the fuse or use a wrong size.**

The second protection is one that blanks out the raster if the vertical sweep is lost. When the sawtooth signal from R203 is sent to the video, special circuitry sets the picture tube cathodes to a certain voltage, and during setup, the brightness is tracked properly. Then if the waveform from R203 is lost, the protective circuit increases the CRT cathode voltages by about 50 volts, thus cutting off the raster.

Of course, loss of sweep power from the module, or an open circuit in the fuse, setup switch, yoke or pincushion circuits (or even any decrease in the resistance of R203) would cause a loss of the single horizontal line that indicates the loss of vertical sweep.

Therefore, the best sequence of tests when there is no raster is to

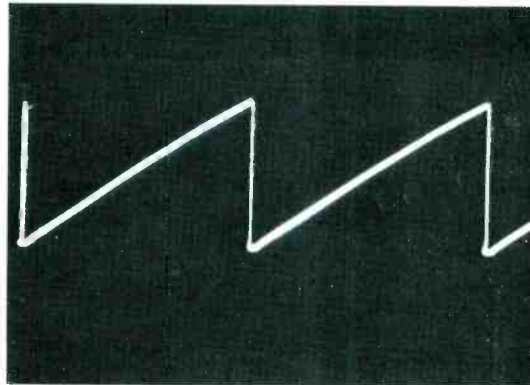

Fig. 9 Classic sawteeth, with very rapid fall times, are the correct waveform at shaping capacitor, C708. This is the signal used to drive the amplifier stages.

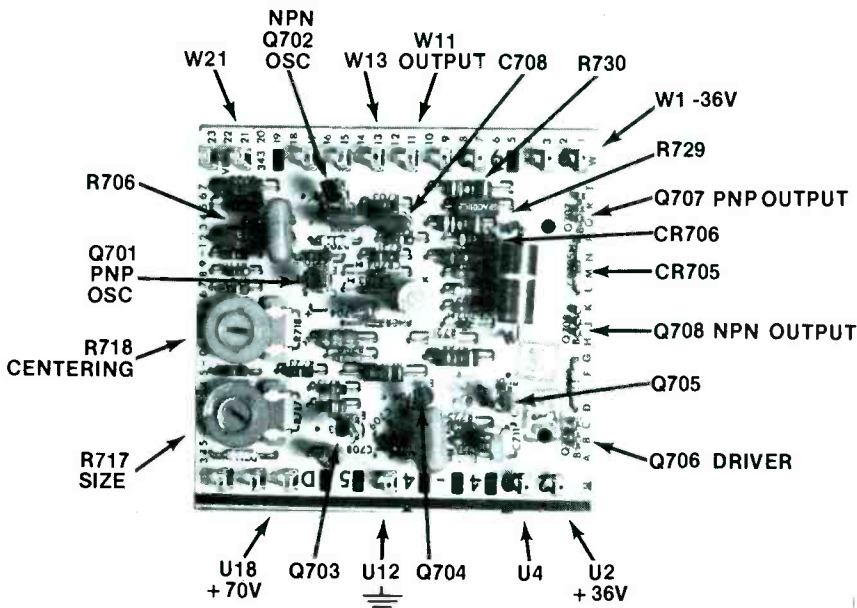

Fig. 10 Major components and test points are shown on the 9-92 module.

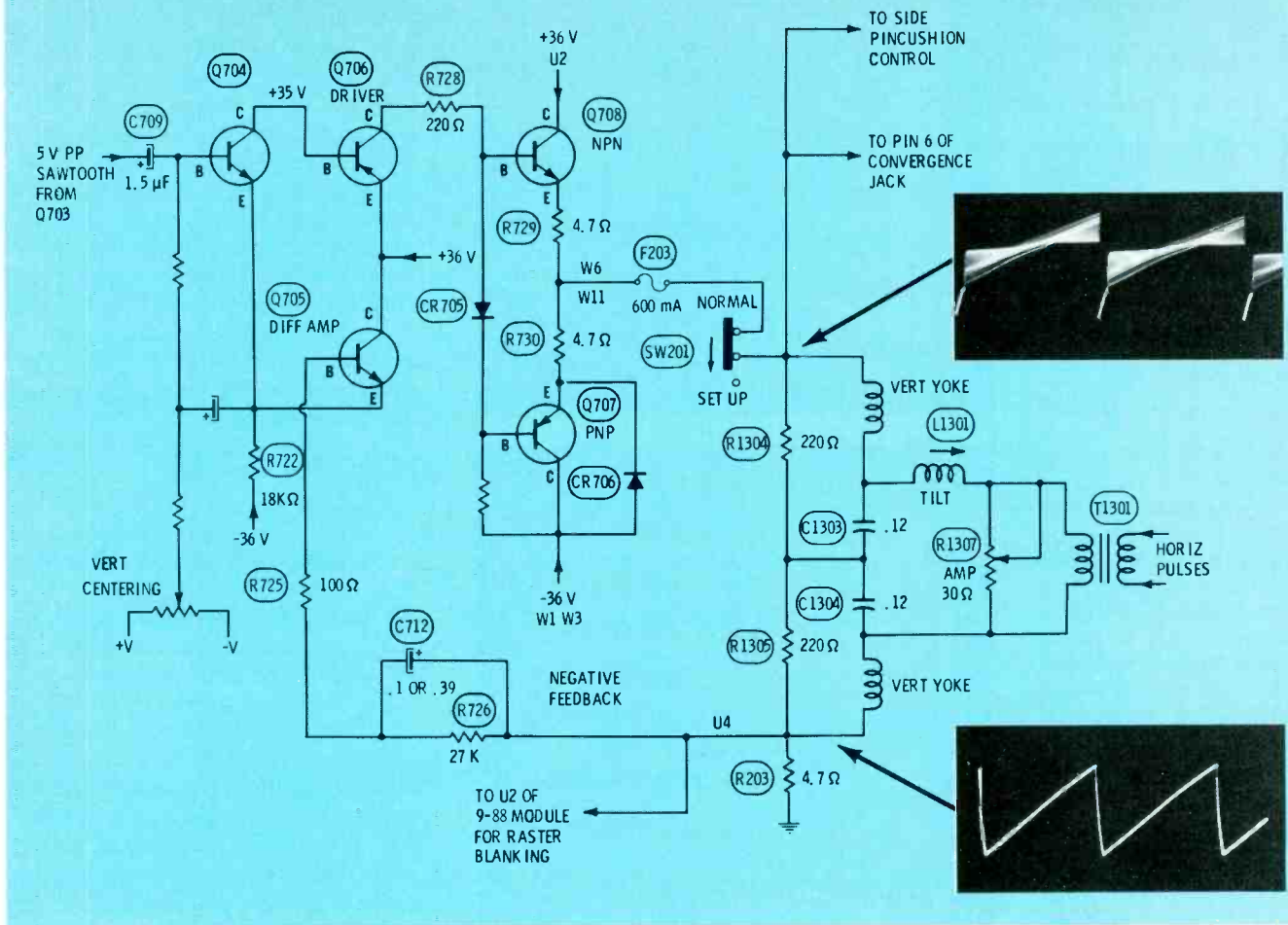

Fig. 11 Most of the components of the three amplifier stages, yoke, and pincushion-elimination circuits are shown in this schematic. Note especially that the low end of the yoke circuit goes through R203 before reaching ground. The waveform developed by the yoke current through R203 is used as feedback to improve the linearity, and as a signal whose loss blanks out the brightness of the raster.

test for high voltage and focus voltage; and if they are normal, to check the vertical sweep.

Waveforms And Troubleshooting

The output of the vertical-sweep circuit is connected to module terminals W6 and W11, also it's connected to the fuse, F203. This

fuse makes a fine testpoint. Not only is it one of the components that need checking, but it is conveniently located out in the clear just above the vertical module.

The trace at the top of Figure 15 is the correct waveshape of the 50 to 60 volts p-p signal at the fuse during normal operation. Incidentally, the same waveshape is found

at the bases of the output transistors, Q707 and Q708. That's because of the base/emitter conduction.

Before we analyze this somewhat-peculiar waveform, let's check out some of the facts behind it. As a test, I opened the fuse (to disconnect the yoke) and connected a 30-ohm noninductive 10-watt resis-

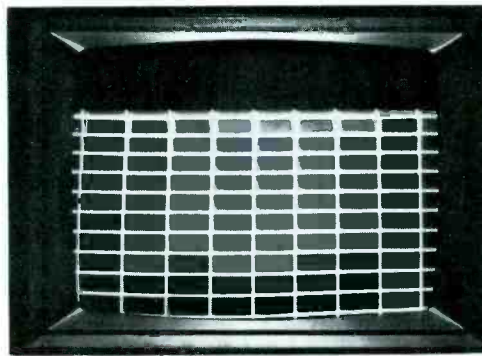
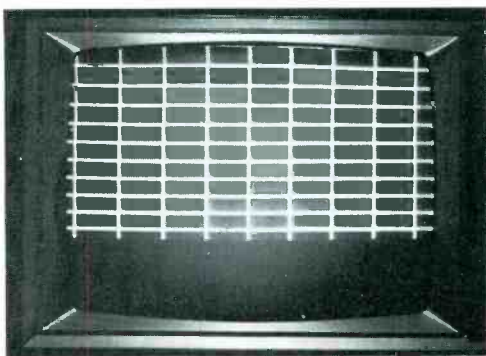

Fig. 12 The vertical-centering control moves the picture an unusual amount. Crosshatch patterns are shown at the extremes of the control adjustment.

Fig. 13 At the base of Q704 are the sawteeth with fast fall times (top trace), while the emitter has sawteeth showing slower fall times (trace at bottom). Would you expect the output at the collector to be sawteeth? The text explains.

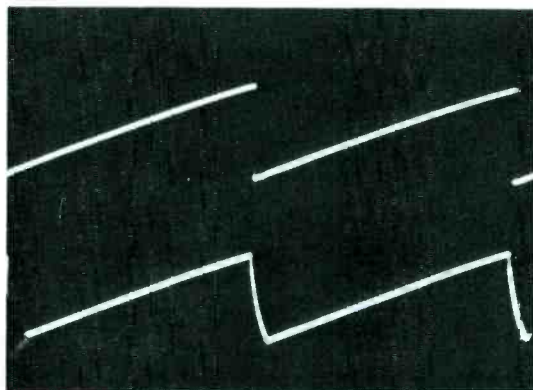

Fig. 14 The difference signal observed from base-to-emitter of Q704 is mainly negative-going spikes (top trace). At the collector of Q704 and the base of Q706 driver (relative to +36V) are positive-going pulses and weak sawteeth (trace at the center). Output of Q706 (as measured base-to-emitter of one output transistor, and shown by the bottom trace) has sawteeth, which have notches from the base conduction of the output transistors.

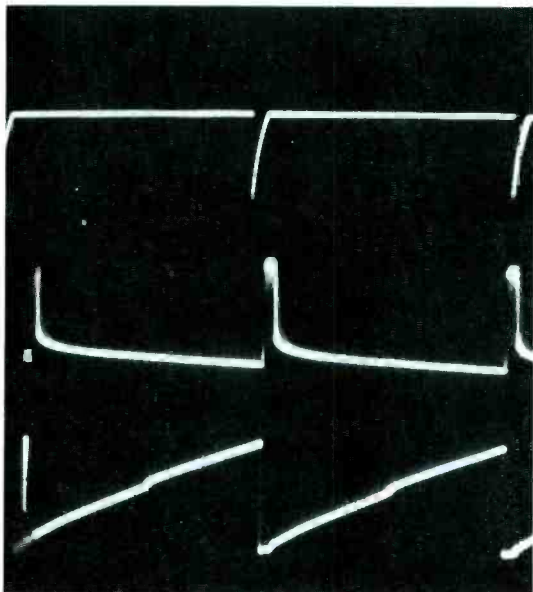

Fig. 15 Top scope trace shows the normal output waveform from the power transistors. When a resistor was substituted for the load of the yoke and pincushion circuits, the output signal consisted of plain sawteeth. (Pulses are added by the collapsing field of the yoke, and the "butterfly wings" are produced by the pincushion action.)

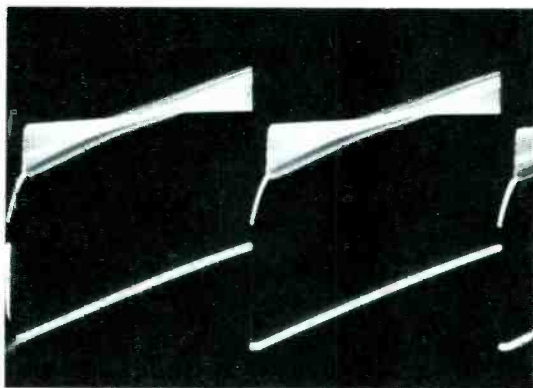
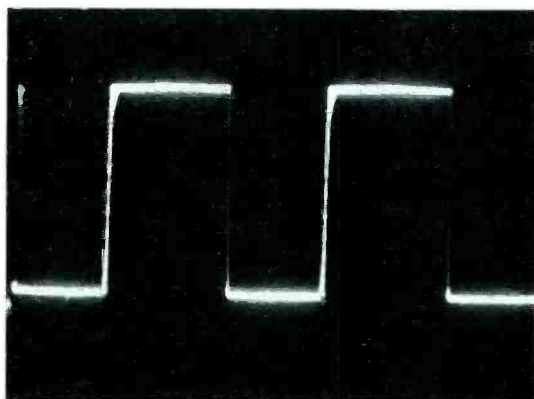

Fig. 16 An open in the yoke circuit, when the circuit is normal up to that point, causes the output waveform to be square waves.



tor between module terminals U4 and W6. This simulated the load of the yoke, but removed the inductive components. The sawteeth that resulted are shown at the bottom trace of Figure 15.

Now, add to that basic sawtooth a negative-going pulse at each falling edge (coming from the ringing of the yoke) plus the "butterfly wings" that are typical of pincushion-correction circuits, and the result is the waveform at the top of Figure 15.

Effects of an open load

That last test did not activate the protective circuit and blank out the horizontal line, because the load resistor returned to R203.

Other opens between F203 and R203 do cause loss of raster. In addition, there are other symptoms.

For example, assume a normally-operating vertical sweep, and that you opened the fuse circuit. At the module end of the fuse would appear large squarewaves (Figure 16). Why? Well, you would expect some increase of **sawtooth** amplitude (the pulses and butterfly wings would be eliminated, of course) because of the lighter load, but not so much change. The reason for the square waves is that the open circuit prevents any yoke current from flowing through R203. Without this waveform, there is no negative feedback to the differential amplifier. Loss of feedback allows the gain to increase, and the output transistors are overdriven until the output waveform is clipped and becomes square waves.

An open setup switch would give the same symptoms, except that the square waves would appear at both ends of the fuse.

Other opens in the yoke or pincushion-elimination circuit would produce different symptoms, depending on the location of the open.

For example, an open yoke coil will make the picture trapezoidal (taller on one side than the other). The anti-ring resistors, R1304 and R1305, would conduct enough current to give some deflection.

In the rare event of shorted turns in one of the vertical-yoke coils, the amplitude at the fuse would be reduced, and the current waveform at R203 would be greater than normal.

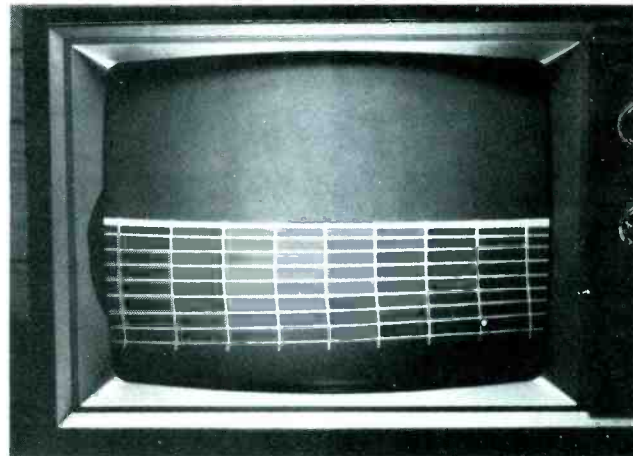
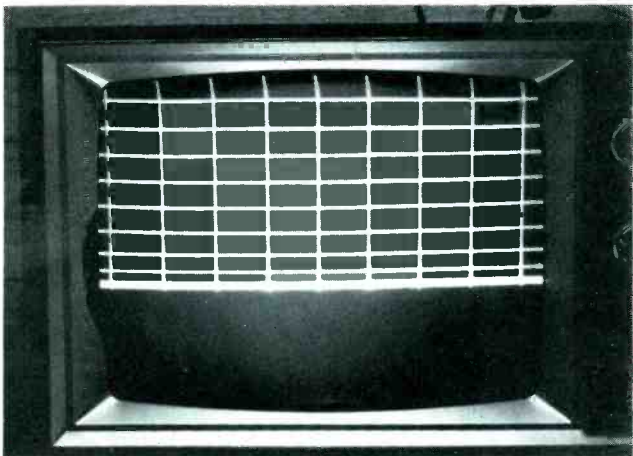
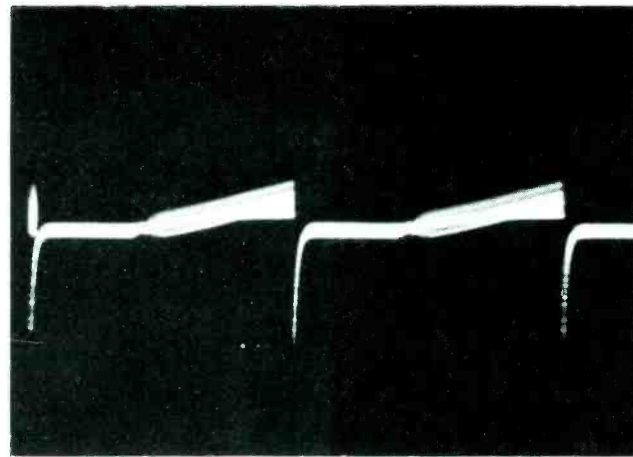
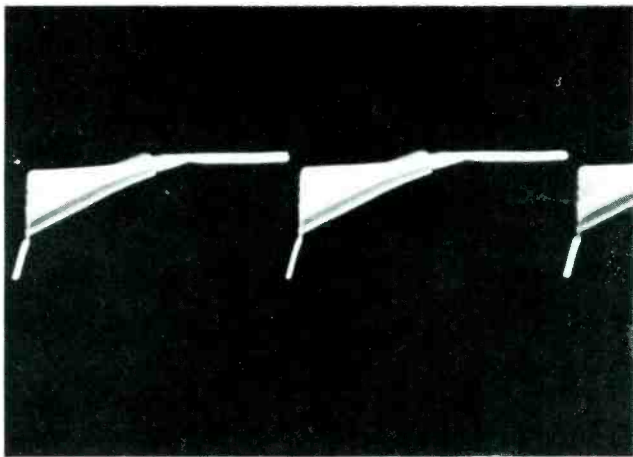

Fig. 17 When output transistor Q708 was open, the scope pattern of the output waveform and the crosshatch pattern on the raster both showed deflection only during the first half (top) of the sweep. In other words, Q707 supplies deflection for the top half of the picture. DC voltage at the fuse was -1.9 volts.

Fig. 18 An open Q707 permitted height only at the bottom, proving that Q708 gives deflection to the bottom half of the screen. Also, the clipped waveform at R203 confused the no-sweep protection circuit, and it blanked out the picture after a second or so. DC voltage at the fuse was +1.7 volts.

Open Output Transistors

Although far less likely to happen than shorted transistors, open output transistors (or open emitter resistors) can cause other strange symptoms.

Figure 17 shows both the scope waveform at the fuse and the resulting crosshatch pattern on the picture tube that result when Q708 is open. Both pictures prove that Q708 supplies the deflection for the top half of the picture.

The same things, in reverse, happen when Q707 is open (Figure 18). But there is one more symptom: the bottom half of the picture appears as usual when the AC power is applied. Then, it stays bright for a second or so before going black slowly enough that you can see it leave. The waveform fed back to the no-sweep protective circuit has fooled the circuit into

believing the sweep is insufficient, so it blanks out the raster.

Comments

As stated at the beginning, most of the vertical-sweep components are on the 9-92 module. However, the driver and output transistors, heat sink, hold control, yoke and pincushion components do not come with a replacement module.

Therefore, a certain minimum of testing should be done, even if you intend eventually to replace the whole module.

It's recommended you replace both emitter resistors (R729 and R730) if the output transistors have proven to be shorted. Resistors that have been overheated are often not dependable.

All three power transistors should be removed and tested out-of-

circuit. Of course, replacement of all three power transistors, the fuse, and the module is almost guaranteed to fix any trouble, if you can ignore the cost.

If a module is not available at the time, you can remove the heat sink, including the three power transistors, and check the oscillator and shaper circuits. These can be repaired quite easily.

Testing and repairing the final three direct-coupled stages is more difficult. Unless you're skilled in such diagnosis, it might be wiser to replace the module for problems in those three stages.

Next Month

The video stages of the Zenith 19EC45 chassis, with the no-sweep/raster-blanking and brightness-limiting circuits, will be the subject of discussion next month. □

VTVM ACCURACY IN YOUR POCKET.



The Hickok Model 350 Pocket FET Multimeter combines bench top accuracy in a pocket-sized portable package for troubleshooting sensitive solid state circuits.

- Full VTVM type ranges and 10 megohm input impedance
- Foolproof overload protection
- Simplified quick-reading meter; 3 scales plus db and battery condition

There's a lot more to the Model 350, including our unique 2-year warranty. Ask your Hickok distributor for full details or contact us.

\$119⁰⁰

HICKOK

the value innovator

INSTRUMENTATION & CONTROLS DIVISION
THE HICKOK ELECTRICAL INSTRUMENT CO.
10514 Dupont Avenue • Cleveland, Ohio 44108
(216) 541-8060 • TWX: 810-421-8286

For More Details Circle (18) on Reply Card

test equipment report

These features supplied by the manufacturers are listed at no-charge to them as a service to our readers. If you want factory bulletins, circle the corresponding number on the Reply Card and mail it to us.

Field-Strength Meter

Mezzer Model FSM-U measures the video-carrier and adjacent-channel signal levels of all UHF channels. The product of **Castle TV Tuner Service** features electronic tuning and attenuation, protective meter-driver amplifiers for the linear voltmeter, a transistor-regulated power supply, and an inbuilt battery-test circuit.

Tuner and amplifier micro-circuit modules are completely shielded to minimize stray pickup of signals. Inputs for both 75 ohms and 300 ohms are provided. No zero or balancing adjustments are required; all compensation is automatic. Weight is only 2.5 pounds, including batteries and transformer, and the price is \$99.95.

For More Details Circle (50) on Reply Card

Transistor Test Adapter

The **Eico Model 688 Quick Tester** connected to your oscilloscope dynamically tests the junctions of transistors and diodes. A switch selects the proper amount of current for in-circuit or out-of-circuit testing. Jacks and 5-way binding posts are mounted on the panel.



The adapter unit is available in kit form for \$14.95, or wired for \$22.95. A reference manual lists the test data.

For More Details Circle (51) on Reply Card

More chances to be right



Thousands more
cross references



Transistor kit
for foreign sets



Replacement
amplifier modules



All the help you need
at your authorized distributor

Tube Products Department
General Electric Company
Owensboro, Kentucky 42301

GENERAL  ELECTRIC

bookreview

Fix Your Small Appliances, Volume 1

Author: Jack Darr

Publisher: Howard W. Sams & Co., Inc. 4300 West 62nd Street, Indianapolis Indiana 46268

Size: 160 pages, book number 21051

Price: \$3.95 paperback

Dedicated to the handyman, this book covers the servicing of small electrical appliances with heating elements. Some of the topics discussed are diagnosis of trouble, repair techniques, tools, chemical aids, parts procurement, and a special chapter on modular appliances. With the servicing techniques, practical tips and shortcuts Darr has picked up over the years in his own electrical fix-it shop, the average handyman should be able to repair every small appliance in the home.

Contents: Diagnosis of Trouble; Heating Elements; Portable Table Ovens; Electrical Cooking Appliances; Electric Cookers and Coffee Makers; Electric Irons; Electric Toasters; Modular Appliances; Portable Electric Heaters; Electric Blankets and Heating Pads; Lighting and Controls; Miscellaneous Repair Techniques; Appliance Servicing.

Fix Your Small Appliances, Volume 2

Author: Jack Darr

Publisher: Howard W. Sams & Co., Inc. 4300 West 62nd Street, Indianapolis, Indiana 46268

Size: 160 pages, book number 21052

Price: \$3.95 paperback

Volume 2 covers the servicing of small electrical appliances with motors. Topics of discussion include diagnosis of trouble, testing techniques, small electric motors, and types of speed controls. Only time-tested, proven methods and tests are given.

Contents: Diagnosis of Trouble; Small Electric Motors; Electric Fans; Electric Carving Knives, Can Openers, Knife Sharpeners, Shoe Polishers, and Sewing Machines; Mixers, Blenders, and Grinders; Hair Dryers; Vacuum Cleaners; Electric Shavers; Electric Timers and Clocks; Electric Massage Machines and Scissors.

Your comments and ideas are welcome

Address your letters to:

Carl Babcoke, Editor Electronic Servicing
1014 Wyandotte Street Kansas City, Missouri
64105

All New PROBE IV

CHECK FOR—

- ★ Continuity
- ★ Digital Logic
- ★ Voltage
- ★ Polarity

Alligator
Clip
Adaptor
included.



Cat. No. 5104

Now you can check four functions with one instrument. And, PROBE IV is lightweight, pocket-size, and comes with its own protective, vinyl carrying pouch.

RE-TIPTM

Solder Cleaning Device

Cat. No.
9482- Base &
Cartridge

Cat. No.
9484-Cartridge



- Cleans tips (to 1/4") instantly to like-new condition. Simply insert hot iron into RE-TIP and withdraw. Prevents contaminated joints; prolongs tip life; tips solder faster. Ideal for shop and tool box.



GC ELECTRONICS

DIVISION OF HYDROMETALS, INC.
ROCKFORD, ILLINOIS 61101 U.S.A.



T & T VALUE SALE

RAYTHEON, I.C.C., RCA, SYLVANIA
FAMOUS MAKE NEW JOBBER BOXED TUBES
NOW WITH NEW 5-YEAR GUARANTEE
80% OFF LIST

★A 6GH8 Special 100 for \$69.00

- | | |
|--|---|
| <input type="checkbox"/> 1V2 5 for \$3.00 | <input type="checkbox"/> 6GJ7 5 for \$3.40 |
| <input type="checkbox"/> 2AV2 5 for \$3.75 | <input type="checkbox"/> 6GU7 5 for \$5.25 |
| <input type="checkbox"/> 3A3 5 for \$5.05 | <input type="checkbox"/> 6GY6 5 for \$4.35 |
| <input type="checkbox"/> 3CU3A 5 for \$6.15 | <input type="checkbox"/> 6HB7 5 for \$4.85 |
| <input type="checkbox"/> 3DB3/3CY3 5 for \$5.55 | <input type="checkbox"/> 6HM5/6HA5 5 for \$4.80 |
| <input type="checkbox"/> 3DJ3 5 for \$5.35 | <input type="checkbox"/> 6HQ5 5 for \$6.35 |
| <input type="checkbox"/> 3HM5/3HA5 5 for \$4.80 | <input type="checkbox"/> 6HV5 5 for \$11.80 |
| <input type="checkbox"/> 5GH8 5 for \$5.90 | <input type="checkbox"/> 6J56 5 for \$9.30 |
| <input type="checkbox"/> 5U4GB 5 for \$3.85 | <input type="checkbox"/> 6JU8A 5 for \$5.55 |
| <input type="checkbox"/> 6AQ5A 5 for \$4.25 | <input type="checkbox"/> 6KA8 5 for \$6.15 |
| <input type="checkbox"/> 6AW8 5 for \$5.65 | <input type="checkbox"/> 6KE8 5 for \$7.65 |
| <input type="checkbox"/> 6BA11 5 for \$6.15 | <input type="checkbox"/> 6KT8 5 for \$6.85 |
| <input type="checkbox"/> 6BK4 5 for \$9.35 | <input type="checkbox"/> 6KZ8 5 for \$5.15 |
| <input type="checkbox"/> 6BL8 5 for \$3.40 | <input type="checkbox"/> 6LB6 5 for \$10.75 |
| <input type="checkbox"/> 6BZ6 5 for \$3.90 | <input type="checkbox"/> 6LJ8 5 for \$5.55 |
| <input type="checkbox"/> 6CB6A 5 for \$4.10 | <input type="checkbox"/> 6LQ6/6JE6 5 for \$11.15 |
| <input type="checkbox"/> 6CG3/6CB3/6CD3 5 for \$4.95 | <input type="checkbox"/> 6Z10 5 for \$7.65 |
| <input type="checkbox"/> 6CJ3/6DW4/6CL3 5 for \$4.70 | <input type="checkbox"/> 8F07 5 for \$3.75 |
| <input type="checkbox"/> 6EA8 5 for \$4.95 | <input type="checkbox"/> 12A17/ECC81 5 for \$4.25 |
| <input type="checkbox"/> 6EH7 5 for \$4.95 | <input type="checkbox"/> 12AX7 5 for \$3.55 |
| <input type="checkbox"/> 6EJ7 5 for \$4.80 | <input type="checkbox"/> 12BY7 5 for \$4.50 |
| <input type="checkbox"/> 6EW6 5 for \$4.50 | <input type="checkbox"/> 12HG7/12GN7 5 for \$7.80 |
| <input type="checkbox"/> 6FQ7 5 for \$3.75 | <input type="checkbox"/> 17J28 5 for \$4.50 |
| <input type="checkbox"/> 6GF7 5 for \$6.65 | <input type="checkbox"/> 23Z9 5 for \$6.00 |
| <input type="checkbox"/> 6GH8 5 for \$3.95 | <input type="checkbox"/> 33GY7 5 for \$8.05 |
| | <input type="checkbox"/> 38HE7 5 for \$9.20 |

TRANSISTORS XACT. REPLACEMENT (BOXED) UP TO 90% OFF LIST

- | | |
|--|---|
| <input type="checkbox"/> SK3004 5 for \$1.90 | <input type="checkbox"/> SK3052 5 for \$3.90 |
| <input type="checkbox"/> SK3009 5 for \$3.90 | <input type="checkbox"/> SK3054 5 for \$4.50 |
| <input type="checkbox"/> SK3010 5 for \$2.10 | <input type="checkbox"/> SK3082 5 for \$3.90 |
| <input type="checkbox"/> SK3018 5 for \$2.25 | <input type="checkbox"/> SK3103 5 for \$3.00 |
| <input type="checkbox"/> SK3021 5 for \$3.15 | <input type="checkbox"/> SK3114 5 for \$2.40 |
| <input type="checkbox"/> SK3024 5 for \$3.30 | <input type="checkbox"/> SK3124 5 for \$2.10 |
| <input type="checkbox"/> SK3025 5 for \$4.50 | <input type="checkbox"/> SK3132 5 for \$2.60 |
| <input type="checkbox"/> SK3040 5 for \$3.75 | <input type="checkbox"/> ECC155 5 for \$4.90 |
| <input type="checkbox"/> SK3041 5 for \$4.20 | <input type="checkbox"/> ECC131 5 for \$3.90 |
| <input type="checkbox"/> SK3042 5 for \$6.60 | <input type="checkbox"/> HEP707 5 for \$15.00 |

DIODES and RECTIFIERS

- RCA Damper Diode Equiv. to:
 RCA 120818 \$1.95 RCA 135932 \$2.95
 ITT 6500 PIV Color Focus Rect. 10 for \$5.00
 2.5 amp 1000 IR170 100 for \$11.00

YOKES—TUNERS—FLYS

- Y94 Y105 Y107 Y109
 Y119 Y130 ea. \$7.95
 Any 4 for \$25.00
 Y132—DY101AC ea. \$12.95
 Y137—DY98AC ea. \$12.95
 Philco Color Fly H0652C 5 for \$5.00

RCA—ZENITH MODULES

- 132579 133455 134400 ea. \$3.49
 9-50 9-59 9-79 ea. \$3.95

AUDIO

- 60 Min. Cassette Irish 6 for \$2.50
 84 Min. 8 Track Irish Tape 3 for \$3.00
 Equiv. Shure 44 N75 N77 N91 ea. \$2.95
 Equiv. Pickering V15 ea. \$2.95
 BSR Cartridges—SX5M, SX1M, SC5M 4 for \$6.00
 15 Assorted Needles incl. diamond \$4.95
 Garrard Changer Mod. 5-300, incl. base, cover, cueing device \$32.95
 Cassette Head Cleaner 10 for \$5.00
 Emerson Mike w/RCA plug 12 for \$6.00
 Jap phono Arm incl. cart 10 for \$5.00
 Stereo Headset ea. \$4.95 2 for \$7.95
 Speaker Kit—incl. 2-4", 2-5", 2-4x6", 4-6" All 10 for \$12.00

ANTENNA

- 72 ohm-300 ohm Matching Transformer 5 for \$5.00
 300 ohm UHF/VHF Signal Splitter 5 for \$5.00
 59U-F Connectors 100 for \$10.00

GENERAL

- 19 & 25" 21" Color Boosters 3 for \$11.95
 SPECO 2 Station, 3-Transistor Intercom KE-20C ea. \$8.95
 SPECO 2 Station, 3 Transistor Intercom Security Model Ke20DR ea. \$8.95

Minimum Orders \$50.00 F.O.B. Brooklyn, N.Y.
 Catalogs \$1—Refundable upon your order.
 C.O.D.—Cash Only

T & T SALES CO.

4802 AVENUE K
 BROOKLYN, N. Y. 11234
 Phone (212) 241-5940

productreport

These features supplied by the manufacturers are listed at no-charge to them as a service to our readers. If you want factory bulletins, circle the corresponding number on the Reply Card and mail it to us

Two-Way Door Sign

An inexpensive, practical door sign from **General Electric** advises customers whether or not a store is open for business. A choice of two durable plastic signs is offered. The "clock" sign (ETRS 3826) informs the customer when the dealer will return; the "strip" sign (ETRS 7090) simply shows whether the store is open or closed.

For More Details Circle (52) on Reply Card

Heavy-Duty Ladders

Perma Power has announced a line of professional heavy-duty straight and extension aluminum ladders in sizes ranging from 12-feet to 40-feet. Designed for outdoor as well as indoor use, the ladders are rated at 250-pound load capacity, yet are light enough for easy one-man handling.

The ladders are unconditionally guaranteed for 12 years according to the manufacturer, and are moisture-resistant, non-sparking, and non-corrosive.

Safety features of the product include flat, extra-wide rungs with grip ridges that are center web-braced and swaged to the bar side rails to help prevent twisting; large free-swinging safety shoes with ice cleats and spike holes for greater stability; and an automatic locking device.

Prices range from \$47.95 to \$169.95.

For More Details Circle (53) on Reply Card

S.O.S. Light, Siren

A flashlight that functions also as a siren is now available from **Duola, Incorporated** for \$9.95. The metal body of the light is semi-water proof and shock proof. A red lens hood slips over the illuminator, which can be focused easily for wide-angle illumination. A sliding switch turns on the screeching alarm, said to be audible for one-half mile. Battery-operated, the light/alarm includes a leather wrist band for easy carrying.

For More Details Circle (54) on Reply Card

miniature soldering stations

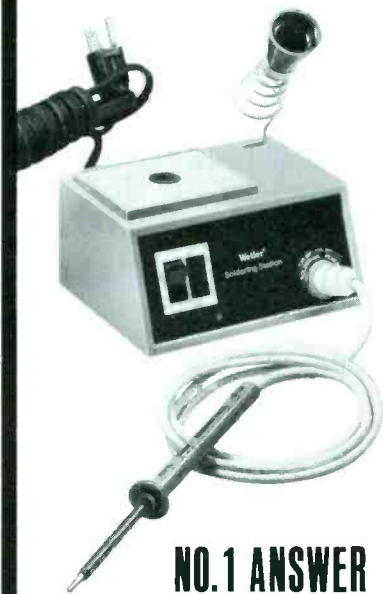

**NO. 1 ANSWER
FOR
PRINTED CIRCUITS**

BY Weller®

MP Series. Two models, 650°F or 750°F output, designed especially for today's printed circuit electronics. Famous closed loop control protects sensitive components from heat damage. Comfortable pencil-grip iron with non-burnable cord. Power unit operates from line-voltage with step-down transformer. ON/OFF switch and red indicator light. "Non-sinking" tool stand. Tip-cleaning sponge receptacle. Variety of available tips multiply usefulness of this versatile station.

Ask your local distributor or write...

**Weller-Xcelite
Electronics Division**



The Cooper Group

P. O. BOX 728,
 APEX, NORTH CAROLINA 27502

Audio, Radio Design Handbook

A limited quantity of F. Langford-Smith's text on audio and radio design, **The Radiotron Designer's Handbook**, is available from **RCA Electronic Components**.

Written in an easy-to-understand style, the book contains 1,500 pages of comprehensive vacuum-tube theory and practical information. Subjects covered include: audio frequency voltage and power amplifiers; speaker networks; recording characteristics; fidelity and distortion; tone compensation and tone control; radio frequency amplifiers; rectification; regulation and filtering; and AM/FM receiver design.

The \$15.00 text includes circuits, design aids, curves and nomographs, 2,500 references, and a comprehensive 50-page index containing over 7,000 cross-referenced headings.

For More Details Circle (55) on Reply Card

Small-Size Desoldering Tips

Enterprise Development Corporation has added to its line two small desoldering tips for use with Model 510 pencil-type iron when small components are to be removed from a circuit board.

The new tips, sizes .025 and .031,

are ironclad for longer life. The Endeco desoldering kits now include



tip sizes ranging from .025 to .090, with the .063 size as standard. A set of three in each size is blister packed.

For More Details Circle (56) on Reply Card

"Black Box" Adapters

Two "Black Box" adapters have been added to the variety of electronic test adapters offered by **Pomona Electronics**. The all-metal adapters are wired internally and provide the framework for in-line connectors.

Model 4057 adapter (two BNC jacks to BNC plug, wired in-line T) is designed for use where space limitations require cable to extend straight

out instead of at right angles.

Model 4050 adapter (binding posts to double banana plugs with BNC jack in-line T) permits interconnection of equipment such as signal generators with either double banana jacks or BNC plugs.

For More Details Circle (57) on Reply Card

Bench-Top Ultrasonic Cleaners

Tooltronics announces a line of stainless steel bench-top ultrasonic cleaners that feature compact design and rapid, thorough cleaning.



Ultra-Clean is pushbutton operated, with all-solid-state circuitry. Priced between \$98-\$317, the cleaners are available in 1½ to 8 quart units.

For More Details Circle (58) on Reply Card

Autoranging multi-function counter

\$349

1900A



- Traditional Fluke quality
- Autoranging in both frequency and period measurements
- 5 Hz to 80 MHz, high sensitivity — 25 mV
- Event counting to 10⁶ events, automatic overflow
- Six digit LED display with automatic annunciation
- Optional battery operation and data output
- Full 12-month guarantee
- Service centers coast to coast
- Available from stock

FLUKE
COUNTER DIVISION

John Fluke Mfg. Co., Ltd.
P.O. Box 1094, Station "D"
Buffalo, N.Y. 14210
Phone (716) 842-0311
TWX 610-492-3214

For More Details Circle (23) on Reply Card

WANT COMPLETE INFORMATION ON Oneida's BIG NEW LINE OF GLO-BARS[®]

a registered trademark of Carborundum

THERMISTOR'S and VDR'S

We've updated our inventory to include the most current numbers for replacing all popular makes.



Send me your latest catalog on GLO-BARS along with prices and name of Oneida Distributor.

Name
Company
Address
City State Zip

ONEIDA ELECTRONIC MFG., INC.

P.O. BOX 678 NORTH COTTAGE STREET
MEADVILLE, PA. 16335
PHONE 814/336-2125

For More Details Circle (24) on Reply Card

audio systems report

These features supplied by the manufacturers are listed at no-charge to them as a service to our readers. If you want factory bulletins, circle the corresponding number on the Reply Card and mail it to us.

"Music-on-Hold" System

Designed for new or existing key systems, Model TES-128 is a low-cost music-on-hold system that requires only a simple connection to the tip side of the line at the key telephone unit.

No modification of the telephone is necessary and no power is required for operation. Special features include: constant volume regardless of the number of lines on hold; a proprietary music-modulation circuit which helps to eliminate cross talk; and double-sided tape for easy installation without screws.

Music input can be obtained from any AM/FM radio, record player, or

tape machine. The compact system from Telephone Equipment Supply is priced at \$25.00.

For More Details Circle (59) on Reply Card

Four-Ohm Speakers

Quam-Nichols Company introduces two loudspeakers designed to be compatible with the latest model radios and tape decks. Both are air-suspension speakers with a voice coil impedance of 4 ohms.

Model 52C10FEXZ4 is a 5¼-inch speaker with a whizzer cone and orange foam edge and is priced at \$12.50.



Model 69C10FEXZ4 is a 6-inch by 9-inch oval speaker with the same features, and costs \$16.50.

For More Details Circle (60) on Reply Card

Telephone Amplifier and Monitor

Tele-Secretary, Model N70-150, is a battery-operated telephone device which can be used with any standard portable tape recorder. Connecting Tele-Secretary to the telephone and a tape recorder, permits automatic recording of all incoming and outgoing conversations.

Tele-Secretary is manufactured by Workman Electronic Products.

For More Details Circle (61) on Reply Card

Portable P.A. System

Eddcor's SS-22 is reportedly the only wireless, portable, dual-channel public-address system on the market. The 16-pound model allows greater freedom of movement, and maintains a 300-500 person volume indoors or outdoors.

Two microphones are available. One is a lavalier clip-on type; the other is hand-held. The transmitting range is 100-300 feet, using a crystal-control system to decrease frequency drift.

The SS-22 can function as a complete sound system, a wireless tuner for already-existing public systems, and an amplifier/speaker for tape or record players.

For More Details Circle (62) on Reply Card

// New generation // Flat rate pricing...

...truly outdates old methods ... prices your work realistically!

Still using the old single flat rate charge for house calls or bench work regardless of repair time required? You may say it all averages out. But, how strongly do your customers feel about consumerism and TV exposés? You could be leaving yourself wide open for trouble...big trouble!

This is where Tech's Guide to Pricing comes in ... the "New Generation" of flat rate pricing ... the system that breaks down each repair step or adjustment encountered. Keeps a true and proper balance between cost and work performed in the eyes of the consumer.

Tech's Guide is in a professional, hard-use cover, 6-ring steel binding, fast-tab design, 7½x9½ size fits in the tool box ... ready for immediate use. Calculator adjusts in seconds for any area in the U.S. ... it's the new industry standard. Relieves you of the stress and pressure of pricing responsibility! Simply fill out the coupon, include check or money order. All orders filled same day.



tv & radio
tech's guide
to pricing

\$18⁰⁰
per issue,
postpaid.

(Nebr. residents add city and state sales tax)

sperry tech  inc.
P.O. Box 5234
Lincoln, NE. 68505

More information please.
 My check or money order enclosed.

NAME _____
COMPANY _____
ADDRESS _____
CITY _____ STATE _____ ZIP _____

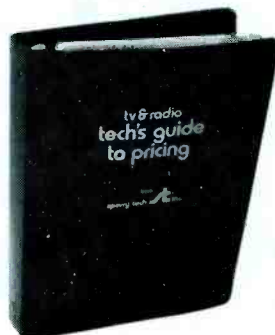

For More Details Circle (22) on Reply Card

catalogs literature

Circle appropriate number on Reader Service Card.

101. Electronic Tool Company—a catalog for the technician that describes 18 fully-equipped tool kits. Also featured are 13 tool cases that can be ordered custom-filled with a choice of tools, meters, parts containers, etc.

102. Pomona Electronics—introduces the Pomona line of electronic test accessories, and provides illustrations and complete engineering information including dimension drawings, schematics, specifications, features, and operating ranges. The 68-page catalog covers 500 products.

103. Motorola Training Institute—offers an 8-page pamphlet describing MTI's newly-revised home-study course. The pamphlet outlines the contents of 40 lessons and 13 reference texts included with the

course, which covers professional FM two-way radio from the technician's point-of-view.

104. GTE Sylvania—the catalog features 45 pages of information on Pathmaker wideband communications equipment. Included are sections on Series 2000 and 1000 trunk-amplifier stations, plug-in modules, power supplies, passives, and accessories. Product specifications and ordering information are given.

105. Marconi Instruments—the short-form catalog includes: FM/AM signal generators, FM deviation meters, HF spectrum analyzers, mobile-radio test gear, TV test equipment, intermodulation and baseband test gear, microwave instrumentation, bridges, Q-meters, and PCM/digital test equipment.

106. International Rectifier—the new edition of commercial products, lists four new product lines: Japanese "original equipment" transistors (for use in replacing Japanese TV and audio equipment parts); high-turnover electrolytic

capacitors with working voltages from 12 to 50 volts; four matched-pair transistors to expand replacement capability; and lighted rocker switches in SPDT and DPDT versions. Also listed are various types of rectifiers, semi-conductors, and diodes, as well as color TV components. The brochure gives complete specifications, line drawings, photographs, and prices.

107. Chemtronics—features application information, photos, descriptions, and specifications on chemicals used to speed electronic servicing and maintenance of electronic equipment. Included are tuner sprays, contact cleaners and lubricants, circuit coolers, insulating sprays, moisture removers, and heat sink compounds.

108. GC Electronics—offers a comprehensive assortment of CB and amateur radio replacement parts, and accessories such as power base and mobile unit microphones, dual power SWR meters, noise filters and suppressors, and a specially selected assortment of microphone and antenna plugs and connectors.

endeco Soldering and Desoldering KITS



Model 500K
12-piece
desoldering kit
\$21.55 NET

- Soldering kits • Desoldering kits
- Soldering-Desoldering kits

Everything needed to solder or desolder, or both. Featuring new Endeco soldering and desoldering irons with safety light . . . the irons professionals really appreciate. Tips, stand, desoldering head and cleaning tool included, as required, all in a metal box with hasp. \$21.55 to \$39.65.

To locate your nearest distributor
call toll-free 800-645-9200



5127 EAST 65TH ST.
INDIANAPOLIS,
INDIANA 46220
PHONE 317/251-1231

enterprise
development
corporation

For More Details Circle (25) on Reply Card

April, 1975

ACA

Chroma POWER

TV and FM ANTENNAS
AND ELECTRONICS

MR. DEALER — Return this ad with your letterhead for a FREE DEALER BONUS COUPON, CATALOG and the name of your nearest ACA distributor.

Mail to: P.O. Box 865, Burlington, IA 52601
Phone: 319-753-1625

Visit us at the Las Vegas Hilton
Hospitality Suites 2903 and 2904 • Booths G-43 and G-45

For More Details Circle (26) on Reply Card

IT'S NO PUZZLE
TO ORDER



OELRICH SERVICE FORMS
FOR TV-RADIO & 2 WAY RADIO SERVICE LEGAL FORMS FOR CALIF. FLA. UTAH NOW AT YOUR PARTS JOBBER OR WRITE FOR CATALOG B64
OELRICH PUBLICATIONS
4040 N. NASHVILLE AVE. CHICAGO, ILLINOIS 60634
For More Details Circle (27) on Reply Card

FREE ALARM CATALOG
Full line of professional burglar and fire alarm systems and supplies. 96 pages, 450 items. Off the shelf delivery, quantity prices.



mountain west alarm
4215 n. 16th st., phoenix, az. 85016
For More Details Circle (28) on Reply Card



"We would have brought our set into the shop only the doctor forbid us to go outdoors until we get over this blasted flu."

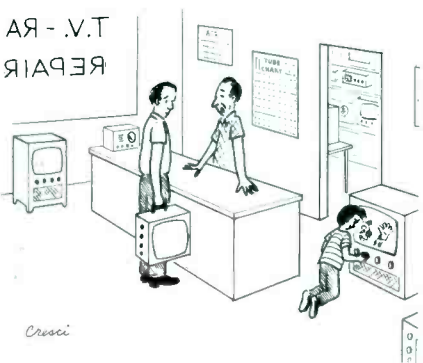

"He's in charge of quality control. If the set still works after he fools with it we know we did a good repair job."



"Well, look who just arrived! Oi 'work-with-the-power-on' Haggarty!"

The MARKETPLACE

This classified section is available to electronic technicians and owners or managers of service shops who have for sale surplus supplies and equipment or who are seeking employment or recruiting employees.

Advertising Rates
in the Classified Section are:

- 25 cents per word (minimum \$3.00)
- "Blind" ads \$2.00 additional
- All letters capitalized 35 cents per word

Each ad insertion must be accompanied by a check for the full cost of the ad.

Deadline for acceptance is 30 days prior to the date of the issue in which the ad is to be published.

This classified section is not open to the regular paid product advertising of manufacturers.

FOR SALE

NEW Canadian Magazine "Electronics Workshop". \$5.00 yearly. Sample \$1.00. Ethko, Box 741, Montreal "A" Canada. 10-74-121

UNUSUAL SURPLUS AND PARTS Catalog. \$1. ETCO Electronics Dept. E.S., Box 741, Montreal "A" H3C 2V2. 12-74-121

T.V. SERVICEMEN: 2.5A-1000V diodes; Hep-170, IR-170 4/\$1.00. Fantastic prices; test equipment, parts. 10 cents for list. F. & M. Electronic Dist. Box 236, DEPT. K Maspeth, N.Y. 11378. 1-75-41

LOW NOISE RESISTORS - 1/4W, 5%, carbon film from 10 - 3.3 Megohm for 3 1/2 cents. Fifty of one value for \$1.25. 1N4148 diodes for 6 cents. 75 cents postage. Free samples/specifications. Components Center-ES, Box 134, New York, N.Y. 10038 3-75-61

HARD-TO-FIND TV & Radio Parts, New & Used. Ask Anyway. CMC 4329-4 Woodman, Sherman Oaks, Calif. 91423 3-75-61

TRANSI-TEST. Tests transistors in/out circuit. Uses 9-volt battery. \$19.50 postpaid. P-G Electronics, P.O. Box 352, Beverly, MA. 01915. 4-75-11

JERROLD MATV Sweep Generators 900A \$350, 900C \$500, Jerrold 704B Field Strength Meter \$100, Tektronix 535A oscilloscope \$425, LaVoie LA-545 (Tektronix 545A copy) \$475, James Walter, 2697 Nickel, San Pablo, Ca. 94806. 4-75-11

WANTED

HALLICRAFTERS model T-54, early 7-inch TV receiver in metal cabinet with pushbutton tuning. Also manufacturer's service manual (not Photofact). Write: Carleton Sarver, 6011 N. River Rd., Waterville, Ohio 43566 3-75-21

WANTED (CONT.)

NEEDED: Picture Tube No. C6407 for Synphonic TV Model TPC-30. George Camacho, 1312 27st URB. Monte Carlo, Rio Piedras, PR 00924. 4-75-11

WANTED: Good used 2-way radio test equipment. Write: John Sepello, 6694 N. Manlius Rd., Kirkville, N.Y. 13082. 4-75-11

EDUCATION-INSTRUCTION

REPAIR TV TUNERS—High Earnings; Complete Course Details, 12 Repair Tricks, Many Plans, Two Lessons, all for \$2. Refundable. Frank Bocek, Box 3236 Enterprise, Redding, Calif. 96001. 12-74-61

PICTURE TUBE REBUILDING. Investigate and learn before you invest time and money. Qualified personnel to guide you. Write to: Engineered Electronic Services, 7127 Marshall Drive, Boulder, Colorado 80303. 4-75-21

BUSINESS OPPORTUNITY

TELEVISION BUSINESS SALES AND SERVICE. Exclusive Zenith and Magnavox Franchise, grossing over \$180,000.00 last year, concrete block building 25x100', 1,200 sq. ft. sales area, 450 sq. ft. repair shop and storage, 1,600 sq. ft. apartment, three bedrooms, two bathrooms, fireplace, carport and sundeck. Located in beautiful Central British Columbia, six miles from USA border. Ski, swim and fish. Down payment for stock and building \$45,000.00. For information write to Electronic Servicing, Dept. 505, 1014 Wyandotte, Kansas City, Mo. 64105. 4-75-21

advertisers' index

Amp Special Industries 25
 Antenna Corp. of America 53
 Arrow Fastener Co., Inc. 10
 Bussman Mfg. Div., McGraw-Edison 31
 Castle TV Tuner Service, Inc. Cover 4
 Eico-Electronic Instr. Co. 10
 Enterprise Development Corp. 53
 John Fluke Mfg. Co., Inc. 29
 Fluke Mfg. Co.-Counter Division . . . 51
 G C Electronics 47
 General Electric Company 46
 Heath Company 33
 Hickok Electrical Instrument Co. 24,46
 Jerrold Electronics Cover 3
 Lectrotech Inc. 11
 Mountain West Alarm Supply Co. . . 54
 Oelrich Publications 54
 Oneida Electronic Mfg., Inc. 51
 Precision Tuner Service Cover 2
 Quasar Electronics Corp. 3
 RCA Parts & Accessories 25
 Rohn Manufacturing 23
 Howard W. Sams & Co. 20-21
 Howard W. Sams & Co.-Photofact . . 1
 Sperry Tech, Inc. 52
 Sprague Products Co. 9
 GTE Sylvania/ECG Consumer Renewal 7
 T & T Sales Company 48
 Tuner Service Corp. 5
 Wayne Electronics 11
 Weller-Xcelite, Inc. 48

Jerrold's new Universal TV Remote Control



The Hottest New Product Since The Calculator...

■ **Makes every set on your floor a remote control model**

- Universal— Attaches to any set in minutes
- Changes channel instantly and fine tunes
- Turns set on/off

- Silent push-button varactor— diode tuning— 12 channels
- Amplifies signal and eliminates direct pick up ghosts
- For homes, apartments, bars, hotels/motels, schools, hospitals and nursing homes.



Packaged in a sturdy, colorful, self-selling carton

JERROLD



a GENERAL INSTRUMENT company

HEADQUARTERS & EASTERN OFFICE 200 Witmer Rd., Horsham, Penna. 19044, (215) 674-4800
 SOUTHERN OFFICE 1 Perimeter Place, Suite 101, Atlanta, Georgia 30339, (404) 432-3102
 WESTERN OFFICE 1255 Veterans Blvd., Redwood City, Calif. 94063, (415) 365-5050
 MIDWESTERN OFFICE 1334 Atlantic Street, North Kansas City, Mo. 64116, (816) 842-1555

For More Details Circle (2) on Reply Card

Proved in the lab! . . . approved in the field!

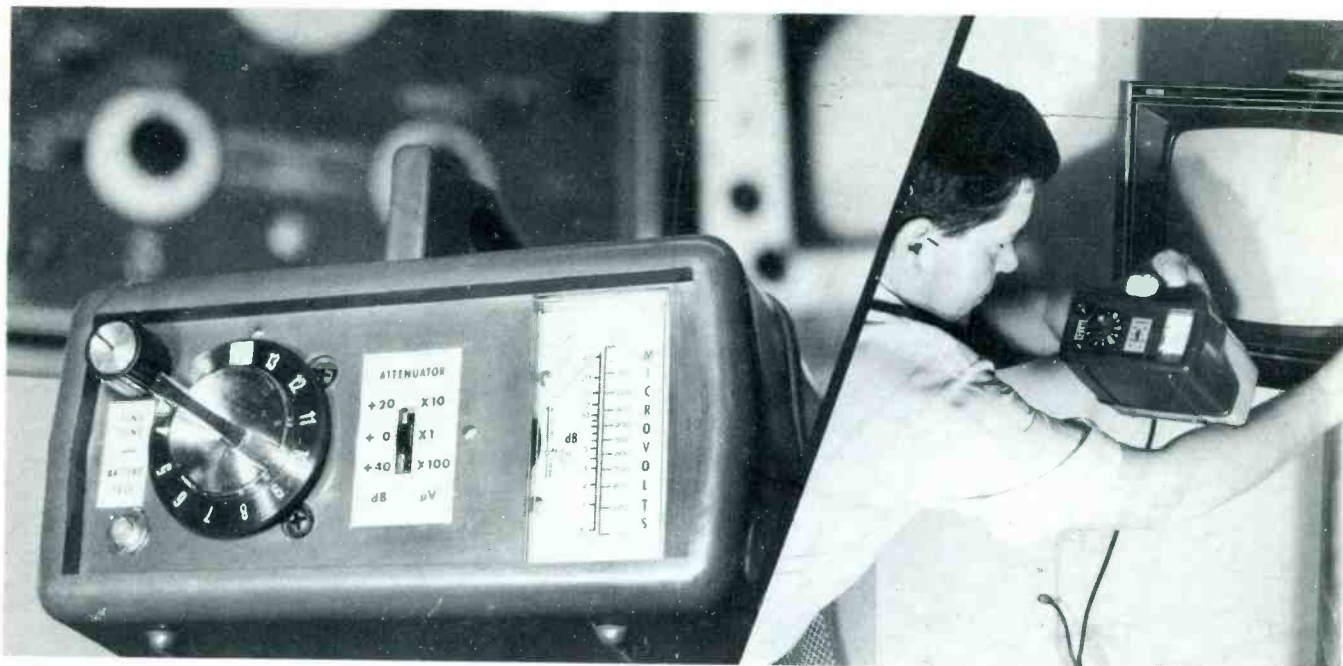

The NEW MEZZNER™

TELEVISION FIELD STRENGTH METERS

Invaluable for

- Antenna installation
- Antenna evaluation
- MATV
- CATV
- Output calibration of TV signal generators and similar signal sources

The instruments use two 9v alkaline transistor batteries for field use, plus inbuilt power supply with wall plug-in transformer for 120vac operation.

VHF Model FSM - V net \$119.95

Range: 20 microvolts to 100 millivolts
Meter: Scale calibrated in microvolts (linear) and dB (log.). Ref: 0dB = 1 millivolt. Full scale basic range 1 millivolt
Attenuator: X 1 (+ 0dB); X 10 (+ 20dB); X 100 (+ 40dB)
Tuning: All 12 VHF channels
Inputs: 75 ohms - "F" connector; 300 ohms - screw terminals
Accuracy: \pm 3dB typ.



UHF Model FSM - U net \$99.95

Range: 20 microvolts to 10 millivolts
Meter: Scale calibrated in microvolts (linear) and dB (log.)
Attenuator: X 1 (+ 0dB) and X 10 (+ 20dB)
Tuning: Full UHF band. Ch. 14 - 83
Inputs: 75 ohms - "F" connector; 300 ohms - screw terminals
Accuracy: \pm 3dB typ.



These instruments boast the extra features of all Castle products-advanced technology-modern styling-and they work!

Ask your electronic distributor for them . . . or write for more details.



CASTLE TV TUNER SERVICE, INC.

5701 N. Western Ave., Chicago, Ill. 60645 • Ph. 312-561-6354

In Canada: Len Finkler Ltd., Ontario

For More Details Circle (3) on Reply Card