

ES5-1173 R IA 576 6
TV SPECIALISTS
915 MAIN ST
CANON CITY COLO 81212

January, 1974 □ 75 cents

Electronic Servicing



A HOWARD W. SAMS PUBLICATION

Cures for
trapezoidal
pictures

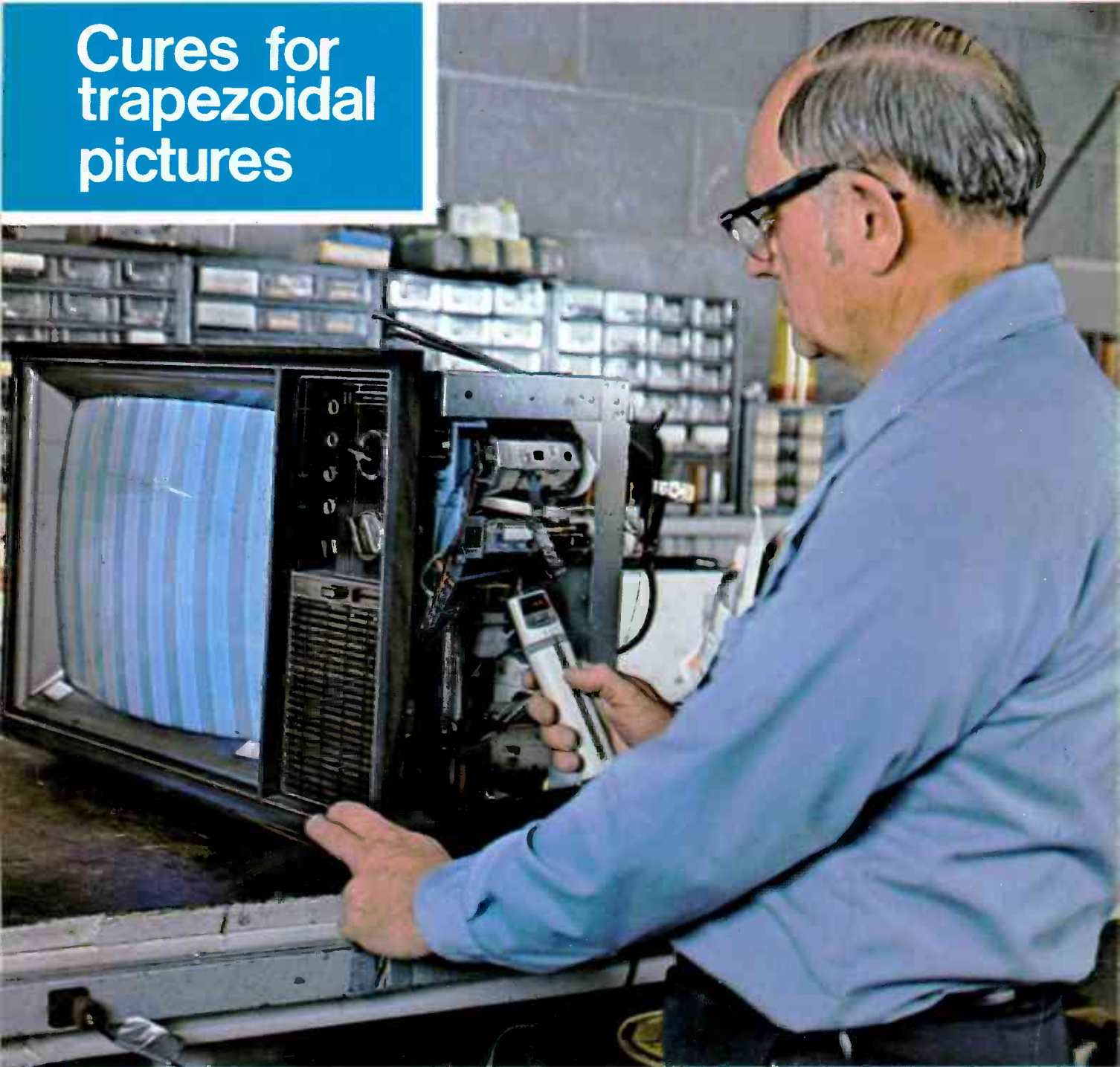

Index Of 1973 Articles

Golden Age Theme Doubles Sales

TV TUNER SERVICE



ELECTRONICS, INC. ALSO AVAILABLE IN . . .



**MINNEAPOLIS-ST. PAUL
WASHINGTON, D.C.
KANSAS CITY
NEW ORLEANS
PORTLAND, OR.
OKLAHOMA CITY
HOUSTON
BUFFALO, N.Y.**

now you too...
...get Fast 8 hr. Service!

\$995

1 YEAR GUARANTEE

All PTS BRANCHES are wholly owned subsidiaries of PTS ELECTRONICS, INC. (NO FRANCHISES!) and report directly to the Home Office in Bloomington, Indiana. Only this way can we guarantee the same quality—PRECISION TUNER SERVICE—that made PTS the leader in this field.

PTS is proud to be the only tuner service to publish a **TUNER REPLACEMENT PARTS CATALOG** (80 pages of tuner blow-ups, tuner-antenna coil-and shaft replacement guides available for \$1.00).

**WE OFFER MORE. SERVICE IS EVERYTHING WITH US.
WE ARE DYNAMIC AND FAST. TRUSTWORTHY.**

You and Us - A True Partnership.

PTS ELECTRONICS, INC. is recommended by more TV manufacturers and overhauls more tuners than all other tuner services combined!

**for finer, faster,
... Precision Tuner Service**

**Color • Black & White • Transistor
Tubes • Varactor • Detent UHF
All Makes**

**VHF, UHF or FM \$9.95
UV-COMBO 16.95
IF-SUBCHASSIS 12.50**

**Major parts and shipping
charged at cost.
(Dealer net!)**

over 4000 exact tuner replacements
available for \$14.95 up (new or
rebuilt)

Send faulty unit with tubes, shields and all broken parts to



- INDIANA—HOME OFFICE:**
PTS ELECTRONICS, INC.
P.O. BOX 372
BLOOMINGTON, IND. 47101
TEL. 812, 824-9331
- NORTHWEST CALIFORNIA:**
PTS ELECTRONICS, INC.
P.O. BOX 41354
SACRAMENTO, CALIF. 95841
TEL. 916, 482-6220
- SOUTHERN CALIFORNIA:**
PTS ELECTRONICS, INC.
P.O. BOX 5794
SAN DIEGO, CALIF. 92105
TEL. 714, 280-7070
- COLORADO:**
PTS ELECTRONICS, INC.
P.O. BOX 612
ARVADA, COLO. 80001
TEL. 303, 423-7080
- FLORIDA:**
PTS ELECTRONICS, INC.
P.O. BOX 7923
JACKSONVILLE, FLA. 32210
TEL. 904, 389-9952
- INDIANA:**
PTS ELECTRONICS, INC.
P.O. BOX 372
BLOOMINGTON, IND. 47101
TEL. 812, 824-9331
- KANSAS:**
PTS ELECTRONICS, INC.
3116 MERRIAM LANE
KANSAS CITY, KANSAS 66106
TEL. 913, 831-1222
- LOUISIANA:**
PTS ELECTRONICS, INC.
2914 WYCKWOOD DR.
METAIRIE, LA. 70033
TEL. 504, 885-2349
- MARYLAND:**
PTS ELECTRONICS, INC.
1109 SPRING ST.
SILVER SPRING, MD. 20910
TEL. 301, 565-0025
- MASSACHUSETTS:**
PTS ELECTRONICS, INC.
P.O. BOX 2189
SPRINGFIELD, MASS. 01103
TEL. 413, 734-2737
- MINNESOTA:**
PTS ELECTRONICS, INC.
815 W. LAKE ST.
MINNEAPOLIS, MINN. 55408
TEL. 612, 824-2333
- MISSOURI:**
PTS ELECTRONICS, INC.
3116 MERRIAM LANE
KANSAS CITY, KANSAS 66106
TEL. 913, 831-1222
- NEW YORK:**
PTS ELECTRONICS, INC.
993 SYCAMORE ST
BUFFALO, N.Y. 14212
TEL. 716, 891-4935
- NEW JERSEY - N. Y. CITY:**
PTS ELECTRONICS, INC.
150 MARKET ST.
E. PATERSON, N.J. 07407
TEL. 201, 791-6380
- OHIO:**
PTS ELECTRONICS, INC.
5682 STATE RD.
CLEVELAND, OHIO 44134
TEL. 216, 845-4480
- OKLAHOMA:**
PTS ELECTRONICS, INC.
P.O. BOX 80586
OKLAHOMA CITY, OKLA. 73106
TEL. 405, 947-7013
- OREGON:**
PTS ELECTRONICS, INC.
P.O. BOX 13096
PORTLAND, OREGON 97213
TEL. 503, 282-9636
- PENNSYLVANIA:**
PTS ELECTRONICS, INC.
P.O. BOX 18858
PHILADELPHIA, PA. 19142
TEL. 215, 724-0999
- TEXAS:**
PTS ELECTRONICS, INC.
P.O. BOX 7332
LONGVIEW, TEX. 75601
TEL. 214, 763-4334
- HOUSTON:**
PTS ELECTRONICS, INC.
P.O. BOX 26616
HOUSTON, TEX. 77032
TEL. 713, 644-6793
- WASHINGTON, D.C.:**
PTS ELECTRONICS, INC.
1105 SPRING ST.
SILVER SPRING, MD. 20910
TEL. 301, 565-0025

For More Details Circle (1) on Reply Card

www.americanradiohistory.com

Winegard challenges the competition

with the new, low cost

DA-825B...

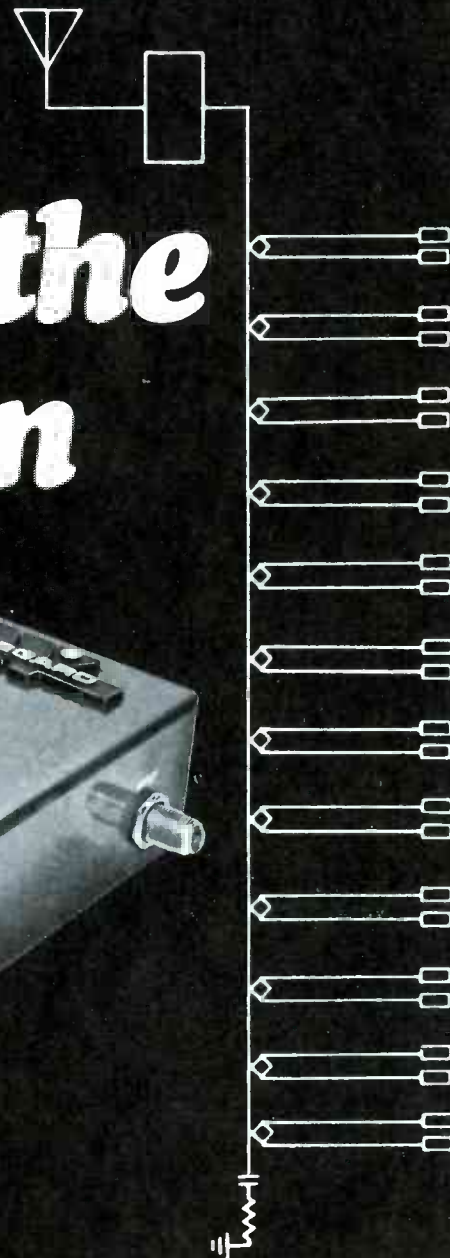

a cost breakthrough in distribution amplifier design!

Winegard's engineers have done themselves proud with this one — an amplifier that does the job at $\frac{2}{3}$ the cost of competition* — and more importantly, without sacrificing all these important features:

HIGH OUTPUT LEVEL: 46 dbmv (200,000 microvolts) on each of 7 VHF channels at 0.5% cross modulation; 45 dbmv (178,000 microvolts) on each of 5 UHF channels at 0.5% cross modulation ... enough to handle up to 48 taps without additional line amps.

HIGH INPUT LEVEL: Allows use in strong signal areas. 20 dbmv (10,000 uv) on each of 8 VHF channels, 22 dbmv (12,000 uv) on each of 5 UHF channels, both at 0.5% cross modulation.

HIGH GAIN: 26 db on VHF, 23 db on UHF for use in most reception areas.

LOW NOISE FIGURE: 3.6 db VHF, 6.0 db UHF for perfect color fidelity.

PASSES MID & SUPER BANDS (108-174 & 216-300 MHZ) — compatible with any CATV system.

LINE AMPLIFIER VOLTAGE to operate model L-213B or L-483B line amplifiers.

PLUS BUILT-IN FM TRAP, REGULATED POWER SUPPLY, LIGHTNING PROTECTION and more!

*Ask your distributor for full specs and prices, or write direct.



WINEGARD
TELEVISION SYSTEMS

Winegard Company
3000 Kirkwood Street
Burlington, Iowa 52601

For More Details Circle (3) on Reply Card

January, 1974/ELECTRONIC SERVICING 1

Electronic Servicing

in this issue...

- 16 **Golden Age Theme Doubles Sales**—A happy combination of unusual decor, good service and effective advertising brought success—*John Stapp*.
- 20 **Horizontal Sweep Revisited, part 2**—How to ring the flyback circuit using signal from the horizontal oscillator—*Bruce Anderson*.
- 26 **Causes And Cures Of Trapezoidal Pictures**—Yes, bad yokes cause trapezoidal rasters; but so do other defects—*Carl Babcoke, CET*.
- 31 **Signature Patterns**—In-circuit transistor curves of the Magnavox T979 chassis—*Jud Williams, CET*.
- 35 **Index of 1973 Articles**—The yearly index of articles, Troubleshooting Tips and Sycmures you have requested—*Electronic Servicing Staff*.
- 40 **Record Changer Workshop, part 3**—Pictures show record dropping, indexing and shut-off functions of an automatic changer—*Forest H. Belt, CET*.

DEPARTMENTS

Electronic Scanner4	Product Report47
Symcure8	Catalogs and Literature49
Troubleshooting Tips9	Photofact Bulletin50
Reader's Exchange12	Book Review51
Test Equipment45	Service Associations52
Advertiser's Index54	

Second class postage paid at Shawnee Mission, Kansas and additional mailing offices. Published monthly by INTERTEC PUBLISHING CORP., 1014 Wyandotte St., Kansas City, Mo. 64105. Vol. 24, No. 1. Subscription rate \$6 per year in U.S., its possessions and Canada; other countries \$7 per year. Send Form 3579 to 9221 Quivira Road, Shawnee Mission, Ks. 66215.

Copyright, 1974, Howard W. Sams & Co., Inc. All Rights Reserved: Material may not be reproduced or photocopied in any form without written permission of publisher.

EDITORIAL
RONALD N. MERRELL, Director
CARL H. BABCOKE, Managing Editor
LESLIE ANDERSON, Editorial Assistant
WEBB G. STREIT, Graphic Designer

CONTRIBUTING AUTHORS
Bruce Anderson
Joseph J. Carr
Wayne Lemons
Robert G. Amick

TECHNICAL CONSULTANT
JOE A. GROVES

EDITORIAL ADVISORY BOARD
LES NELSON, Chairman
Howard W. Sams & Co., Indianapolis

CIRCULATION
EVELYN ROGERS, Manager

ADVERTISING SALES
Kansas City, Missouri 64105
Tele: 913/888-4664
E. P. LANGAN, Director
R. J. HANCOCK, Manager
JAKE STOCKWELL
RON ROBINETTE
GREG GARRISON, Production

REGIONAL ADVERTISING SALES OFFICES
Indianapolis, Indiana 46280
ROY HENRY
2469 E. 98th St.
Tele: 317/846-7026

New York, New York 10017
STAN OSBORN
Room 1227
60 E. 42nd St.
Tele: 212/687-7240

Los Angeles, California 90005
MIKE KREITER
3600 Wilshire Blvd., Suite 1510
Tele: 213/383-1552

London W. C. 2, England
JOHN ASHCRAFT & CO.
12 Bear Street
Leicester Square
Tele: 930-0525

Amsterdam C. Holland
JOHN ASHCRAFT & CO.
W. J. M. Sanders, Mgr.
for Benelux & Germany
Herengracht 365
Tele: 020-240908

Tokyo, Japan
INTERNATIONAL MEDIA
REPRESENTATIVES LTD.
1, Shiba-Kotohiracho, Minatoku
Tele: 502-0656



ELECTRONIC SERVICING (with which is combined PF Reporter) is published monthly by Intertec Publishing Corp., 1014 Wyandotte Street, Kansas City, Missouri 64105.

Subscription Prices: 1 year — \$6.00, 2 years — \$10.00, 3 years — \$13.00, in the U.S.A. its possessions and Canada.

All other foreign countries: 1 year — \$7.00, 2 years — \$12.00, 3 years — \$16.00. Single copy 75c; back copies \$1. Adjustment necessitated by subscription termination at single copy rate.



Robert E. Hertel, Publisher

Intertec Publishing Corp.
Subsidiary of Howard W. Sams & Co., Inc.

This 10 MHz Triggered Scope is 1/3 the size of comparably performing scopes.



MODEL 1431 \$399.95

It's a lightweight 13 pounds in your hand and a heavyweight performance wideband scope with a 35 nanosecond rise time on your bench or jobsite. Whether you're servicing or designing industrial equipment or TV, there's the right sweep speed and sync for easiest operation. If you know our Model 1460, the leader in wideband 5" CRT scopes, you know our new 3" Model 1431 which gives you the same high performance in one third the size. (Only 4 $\frac{3}{4}$ "Hx7 $\frac{7}{8}$ "Wx12 $\frac{7}{8}$ "L)

Servicing, production, inspection, quality control and lab applications are all easier with this versatile all solid-state instrument. Triggering is accomplished with only 0.5V peak-to-peak. Ten millivolts per division sensitivity, 0.5 usec/cm to 0.5 sec/cm automatic and triggered sweep in 19 calibrated ranges, and external trigger input are just a few of the reasons you'll like it.

If you have been waiting to buy a portable scope until you could get all the features you'll ever need at a price you want to pay, you've been waiting for Model 1431. Contact your distributor or write Dynascan Corporation.



Shown with optional carrying cover and probe pouch.

B&K PRODUCTS OF
DYNASCAN
1801 W. Belle Plaine Ave.
Chicago, IL 60613 • (312) 327-7270

For More Details Circle (4) on Reply Card

January, 1974/ELECTRONIC SERVICING 3

electronic scanner

news of the industry

Dealers have failed in an attempt to have technicians included in a proposed licensing bill now before the City Council of New York City, according to **Home Furnishings Daily**. As it stands, the bill calls for a \$100 license fee for each store or shop, requires each shop to have a service manager who must pay a \$15 permit fee, directs that a hearing panel be established by the Department of Consumer Affairs to arbitrate complaints, and that the city set up a testing lab to judge technical aspects of complaints. Dealers were not opposed to licensing, but wanted licensing also of technicians. They did not want to be solely responsible for the actions of their employees. The committee turned down licensing of technicians on the grounds that it is difficult to find a satisfactory qualification test, and implementation costs might be prohibitive.

Many people in the service industry are up in arms about the possibility that Consumer Service—the servicing division of Westinghouse—intends to start servicing all brands of appliances. It's inevitable that this operation will be compared to RCA's ill-fated Service America, and some differences were noted in **Home Furnishings Daily**. Dealers who refer customers to Consumer Service will receive a 10% or 15% commission. When Westinghouse facilities become saturated, they will give other service departments the opportunity of buying into the deal. In that case, the technicians will become Consumer Service employees, either on a part- or full-time basis. Each technician will be assigned a truck with parts, tools, and a 2-way radio so he need not return to the branch until out of supplies, or to transport chassis.

Sansui Electronics Corporation has announced what a spokesman terms a "major breakthrough" in 4-channel matrixing technology. Circuitry of the Sansui QS vario-matrix decoder has been reduced to three IC chips. Sansui now is giving samples, information and technical assistance to audio manufacturers, with the intention of licensing them for commercial production of the decoders. This is the first decoder capable of handling more than one system of matrixing. In the QS mode, separation of 20 dB is claimed, plus good separation on all SQ records. Two-channel stereo has not been slighted, for the QS decoder is said to give a "surround" effect with fixed positions for the various instruments.

Jukeboxes might feature 4-channel sound this year. Wurlitzer, a leading manufacturer of jukeboxes, now has become a SQ licensee, according to **Home Furnishings Daily**. Wurlitzer's first quad-disc coin-operated jukebox was shown in November to members of the Music Operators of America Convention in Chicago. The machine is called the Americana 3800, with Wurlitzer Four-Star Quad Sound.

(Continued on page 6)



\$9.95

ALL PARTS INCLUDED
EXCEPT TUBES & TRANSISTORS

ONE YEAR GUARANTEE

TUNER SERVICE CORPORATION

PROVIDES YOU WITH A COMPLETE SERVICE FOR ALL YOUR TELEVISION TUNER REQUIREMENTS.

REPAIR

VHF Or UHF Any Type \$9.95.
UHF/VHF Combo \$15.00.

In this price all parts are included, tubes, transistors, diodes, and nuvistors are charged extra. This price does not cover mutilated tuners.

Fast efficient service at our conveniently located service centers.

All tuners ultrasonically cleaned, repaired, realigned and air tested.

REPLACE

Universal Replacement Tuner \$9.95

This price buys you a complete new tuner built specifically by **SARKES TARZIAN INC.** for this purpose.

All shafts have a maximum length of 10½" which can be cut to 1½".

Specify heater type parallel and series 450mA or 600mA.

CUSTOMIZE

Customized tuners are available at a cost of only \$15.95; (with trade-in \$13.95)

Send in your original tuner for comparison purposes.



WATCH US GROW

HEADQUARTERS	BLOOMINGTON, INDIANA 47401	537 S. Walnut Street	Tel. 812-334-0411
ARIZONA	TUCSON, ARIZONA 85713	1528 So. 6th Street, P.O. Box 4534	Tel. 602-791-9243
CALIFORNIA	NORTH HOLLYWOOD, CALIF. 91601	10654 Magnolla Boulevard	Tel. 213-769-2720
	BURLINGAME, CALIF. 94010	1324 Marsten Road	Tel. 415-347-5728
	MODESTO, CALIF. 95351	123 Phoenix Avenue	Tel. 209-521-8051
FLORIDA	TAMPA, FLORIDA 33606	1505 Cypress Street	Tel. 813-253-0324
GEORGIA	ATLANTA, GEORGIA 30310	938 Gordon Street S.W.	Tel. 404-758-2232
ILLINOIS	CHICAGO, ILLINOIS 60621	741 West 55th Street	Tel. 312-873-5555-6-7
	SKOKIE, ILLINOIS 60076	5110 West Brown Street	Tel. 312-675-0230
INDIANA	HAMMOND, INDIANA 46323	6833 Grand Avenue	Tel. 219-845-2676
	INDIANAPOLIS, INDIANA 46204	817 North Pennsylvania St.	Tel. 317-632-3493
KENTUCKY	LOUISVILLE, KENTUCKY 40208	2920 Taylor Boulevard	Tel. 502-634-3334
MARYLAND	BALTIMORE, MD. 21215	5505 Reisterstown Rd., P.O. Box 2624 ..	Tel. 301-358-1186
MISSOURI	ST. LOUIS, MISSOURI 63132	10530 Page Avenue	Tel. 314-429-0633
NEVADA	LAS VEGAS, NEVADA 89102	1412 Western Ave. No. 1	Tel. 702-384-4235
NEW JERSEY	JERSEY CITY, NEW JERSEY 07307	547-49 Tonnele Avenue HWY 1&9	Tel. 201-792-3730
	TRENTON, NEW JERSEY 08638	901 N. Olden Ave.	Tel. 609-393-0999
OHIO	CINCINNATI, OHIO 45216	7450 Vine Street	Tel. 513-821-5080
	CLEVELAND, OHIO 44109	4597 Pearl Road	Tel. 216-741-2314
	TOLEDO, OHIO 43624	119 North Erie Street	Tel. 419-243-6733
OREGON	PORTLAND, OREGON 97210	1732 N.W. 25th Avenue	Tel. 503-222-9059
TENNESSEE	GREENEVILLE, TENNESSEE 37743	1215 Snapps Ferry Road	Tel. 615-639-8451
	MEMPHIS, TENNESSEE 38111	3158 Barron Ave.	Tel. 901-458-2355
TEXAS	DALLAS, TEXAS 75218	11540 Garland Road	Tel. 214-327-8413
VIRGINIA	NORFOLK, VIRGINIA 23502	4538 East Princess Anne Rd.	Tel. 703-855-9955

FOR INFORMATION ON FRANCHISE, CONTACT HEADQUARTERS

For More Details Circle (5) on Reply Card

January, 1974/ELECTRONIC SERVICING 5

GTE-Sylvania has announced acquisition of four schools of the RCA Institutes, Inc. These units, with about 10,000 students, will become a part of GTE-Sylvania Technical Schools. Not included in the transaction is the RCA Resident School in New York City.

A new check-guarantee service for merchants has been initiated by The Bank of California, with Safeway Stores as the first major participant. Each check-guarantee card has a color photograph of its holder, his name, signature, card number and drivers-license number. Risk to merchants cashing cardholder's checks for \$100 or less is completely eliminated, if the check is pre-printed with the customer's name and address, is signed by the customer in the merchant's presence, and a valid card number and expiration date (taken from the back of the holder's check-guarantee card) are written on the back of the check.

RCA Corporation has developed an all-electronic private automatic-branch telephone exchange (PABX) using large-scale integrated circuits (LSI) so small that 64 switching cross-points could fit into a pencil-point-size area. Extensive use of LSI chips reduces the size of the new 600-line system to about one-tenth that of conventional electro-mechanical switches. Model 600 marks the entry of RCA into this field.

Sound systems that save lives were the topic of instruction at a fall seminar held in Harvard, Illinois by Darome, Inc., a designer and manufacturer of modular sound systems. Stressed was the pressing need in high-rise buildings for life-support sound systems and paging equipment. Recently, Darome introduced a desk-styled page turret that is a compact control center for selective-area paging and background music. The turret has an automatic emergency-page function providing a highest-priority channel for the entire sound system. If the power fails, the unit switches automatically to batteries. To minimize deaths and tragedies from fires in tall buildings, local building laws should specify some type of emergency-paging system.

Growing consumer demand and better profit margins compared to that of TV receivers are bringing more dealers into car-stereo retailing, according to a recent article in **Home Furnishings Daily**. In-dash units with higher price tags are increasingly popular for after-market installations. □

If you had to name the top electronics service company who would it be?

That's a tough question, because when it comes to service, it's hard to compare apples to apples. Some companies offer you many services—others very few. So before you make up your mind, we'd like to tell you about some of the services Panasonic has developed. Services that can make both our jobs a lot easier.

Like offering complete technical back-up information and assistance. We make available detailed service manuals on every product we've ever sold—over 11,000 since 1953. And if

you need more information, call the regional office in your area. And if you still want assistance, we'll send out one of our traveling field service specialists as your personal problem solver. And there's more. We hold annual training seminars to acquaint you with our products, inside and out. And at industry conventions, you'll find a Panasonic representative to explain our latest service advances.

At the core of it all are our products. All designed with a high level of serviceability—meaning

less time and effort for you. For instance, our Quatecolor TV sets scored 94.3 in the NEA serviceability tests of January 1973. And we're continually looking for new improvements. The fact is that Panasonic pays as much attention to service as it pays to sales. And everybody is profiting—consumers, dealers and service technicians. So before you consider who to name as the top electronics service company, run through the facts. The more you know about Panasonic, the better it is for everybody.



Panasonic

just slightly ahead of our time

For More Details Circle (22) on Reply Card

Chassis—Magnavox T958
PHOTOFACT—1273-2

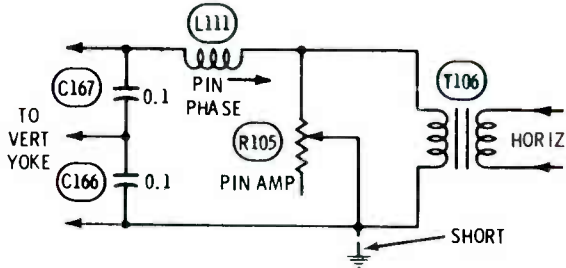

Symptom—Failure of 5-amp fuse
Cure—Test for a short inside R105 from element to case

Chassis—Magnavox T936
PHOTOFACT—1119-1

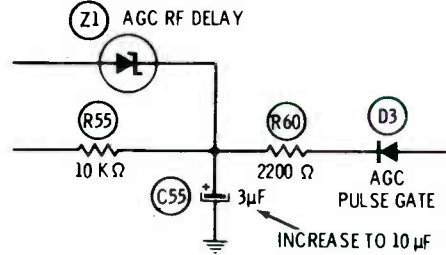

Symptom—Weak locking on some channels
Cure—Increase the value of C55 to 10 mfd

Chassis—Sylvania D17
PHOTOFACT—1288-3

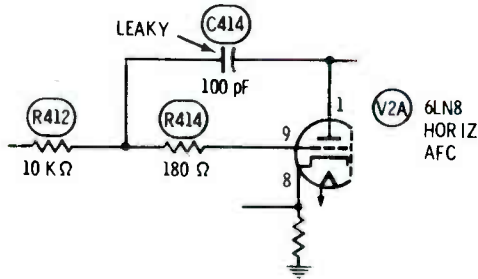

Symptom—Poor horizontal locking
Cure—Check C414, and replace if it is leaking

Chassis—Sylvania EO2
PHOTOFACT—1324-3

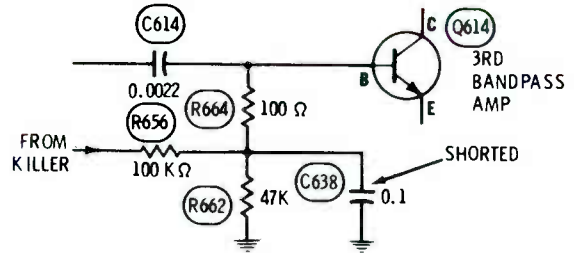

Symptom—Intermittent or no color
Cure—Check C638, and replace if it is shorted

Chassis—Sylvania EO2
PHOTOFACT—1324-3

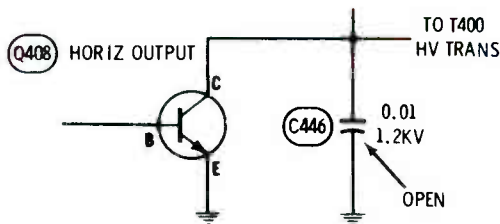

Symptom—Excessive high voltage
Cure—Check C446, and replace if it is open

Chassis—Sylvania D17
PHOTOFACT—1288-3

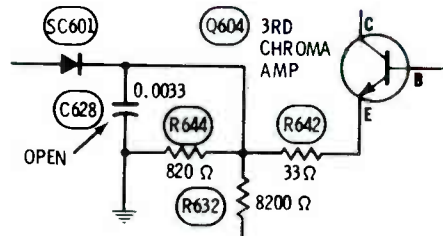

Symptom—Weak color
Cure—Check C628, and replace if it is open

troubleshooting tips

Send in your helpful tips—we pay!

Purple screen and noise in color RCA CTC53 color TV chassis (Photofact 1201-1)

With the color control turned down, the picture was purple, and there were streaks of colored noise when the color was turned up.

The purple screen indicated a loss of green from the raster, so I checked the DC voltages at the grids of the picture tube. Sure enough, the green grid was about 40 volts lower than red and blue.

Scope waveforms at the picture-tube grids showed normal small

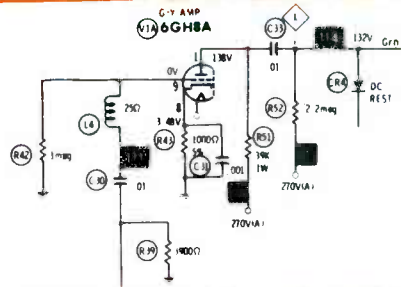

amounts of pulses at the red and blue, but the green grid had positive-going pulses of about 100-volts p-p. Evidently they came from the G-Y amplifier, because the grid had negative-going pulses.

When I grounded the grid of the G-Y amplifier, the screen color became normal and the colored noise was gone. This proved the problem originated in the grid circuit of the G-Y amplifier tube.

Ohmmeter tests in the grid circuit soon uncovered an open resistor, R739, which should have measured 3.9K. When the resistor opened, the grid bias was upset because of the connections back to

SYSTEMS SCOPE

have...
...all the you need!

A wide range of quality 'Scopes at a price that satisfies

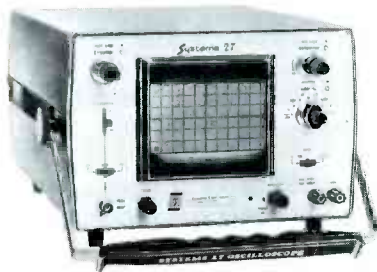

\$280.00

SYSTEMS 27 SOLID STATE DC-2.5 MHz SERVICE SCOPE

FEATURES: • 13 cm (5") CRT • Solid state circuitry • High sensitivity • TV line and field synchronization • Elegant finish • Easy-grip handle-cum-tilt stand • Compact size • Optimum cost.

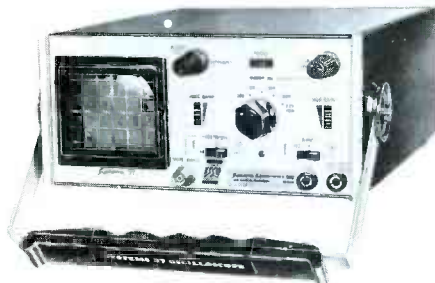

\$165.00

SYSTEMS 37 5 Hz-2.5 MHz MINI SCOPE

FEATURES: • 7 cm (3") CRT • High sensitivity • Elegant finish • Attractive metallic brush-finish anodized front panel • Truly portable • Low cost • Easy-grip handle-cum-tilt stand.



\$275.00

SYSTEMS 57 PORTABLE DC-3 MHz TRIGGERED SCOPE

FEATURES: • 7 cm (3") CRT • High sensitivity • Portability • Low cost • Elegant finish • Easy-grip handle-cum-tilt stand.

It's time a Lab or Service Tech owned one!



Systems Electronics Inc.
OF CALIFORNIA
makers of fine oscilloscopes

9727, South Inglewood Avenue, Inglewood, California 90301.

Tel: (213) 671-8231 • Telex: 67-7459
Cable: 'Rectusa'

For More Details Circle (6) on Reply Card

January, 1974/ELECTRONIC SERVICING 9

INVEST 5 MINUTES READING. (ADD \$150 OR MORE TO YOUR EARNINGS PER WEEK.)

Chemtronics chemicals can do that for you.

Starting with Tun-O-Wash. Our exclusive premium degreaser can help make a lot of jobs faster, better and less expensive.

Got a really dirty tuner? Tun-O-Wash degunks it like an ultrasonic bath—removing dirt, oxide and caked-on lubricant. Without drift. Without harming plastics. Without causing intermittents. And no need to pay another guy to do the job.

But Tun-O-Wash's powerful spray is good for lots of other things. Like cleaning tube pins and sockets, to restore proper operation. Degreasing of those encrusted switches you find on hi-fi components and appliances.

For removing grease from practically anything, the premium electronic solvent in Tun-O-Wash just can't be beat. Cleans tape heads, motor drives, brushes, linkages, cams and gears. Has dozens of other applications.

When you're finished cleaning, you can re-lubricate just as easily, with Chemtronics premium cleaner lubricants. Like Tun-O-Foam, Tun-O-Brite, Tun-O-Lube or Color Lube.

Why not get the full story on Chemtronics time-saving, money-making chemical problem-solvers. See them at your distributor's, or write for our brochure.



CHEMTRONICS
INCORPORATED
1260 RALPH AVE., BROOKLYN, N.Y. 11236
Our business is improving yours.

For More Details Circle (24) on Reply Card

the plates of the B-Y and R-Y amplifiers. This made the screen purple. Also, it upset the signal voltage-divider so the G-Y stage had too much input signal, causing the colored noise.

Roger D. Redden
Beaver, West Virginia

Editor's note: Exactly the same parts defect in a CTC52 was reported by Richard Castanie, CET, of Grand Rapids, Michigan.

Snowy picture Sharp CY61PC color chassis (Photofact 1163-2)

Channels 7 and 9 had normal sound, but very snowy pictures. Channels 2 and 4 were nearly normal.

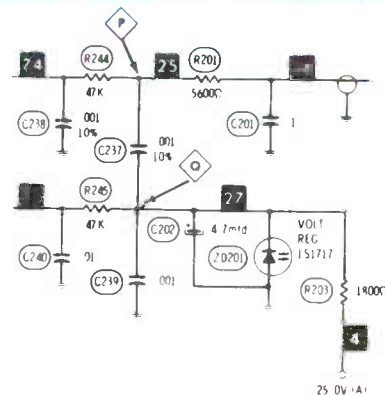

After some analysis, I decided it must be wrong tuning of the oscillator in the tuner. Voltage analysis soon revealed that the 6-volt AFT supply to the tuner was about 22 volts.

Zener diode ZD201 checked open. Performance on all channels was good after the zener was replaced.

Reliable TV Service
Mt. Clemens, Michigan

Intermittent hum bars Zenith 25DC56 color TV chassis (Photofact 1312-3)

Scope waveforms will tell you whether or not this is a power supply problem. But there is a shortcut in this case.

Monitor the DC voltage at the 24-volt line (emitter of Q212). If the voltage increases when the hum bars appear, replace CR211 zener diode, which is in the base circuit

of Q212.

Evidently, the zener changes re-

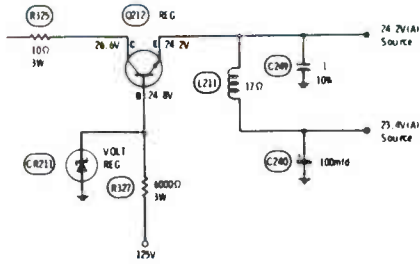

sistance intermittently causing a shift of the bias of Q212 and reducing the electronic filtering.

Stan Simms
Nutley, New Jersey

**Vertical non-linearity
RCA CTC50XP color TV chassis
(Photofact 1226-2)**

Vertical linearity was extremely poor at the top and bottom of the raster, and nearly normal at the center. It was a condition I had never seen before.

DC-voltage analysis of the entire vertical-sweep circuit revealed nothing really wrong. Height and linearity controls changed the raster about as they should except, of course, that the linearity never was right.

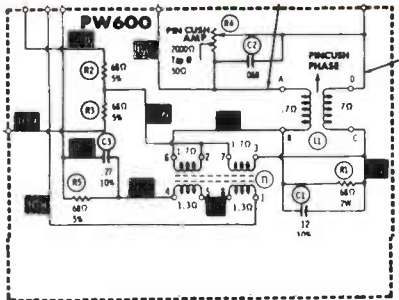

After wasting much time, I wondered if the pincushion-correction circuit might be responsible. After all, both horizontal and vertical sweep circuits are involved there.

To make a long story short, I found R5 in the pincushion circuit (PW600) to be open. I still don't understand exactly why this affected the vertical linearity, but a new resistor eliminated the problem.

C. E. Leukering
Metropolis, Illinois

(Continued on page 53)

UNTIL RECENTLY, THERE WERE OVER 22,500 TRANSISTOR PART NUMBERS TO WORRY ABOUT IN THE SERVICE BUSINESS.

Now, only 47 types
put an end to the nightmare.

Sprague's concise but complete line of 47 replacement transistors (24 small-signal, 18 power, and 5 field effect) is designed to do the work of over 22,500 O.E.M. transistors. But don't just take our word for it. The 'Fantastic 47' are on the self-service Semiconductor Q-Mart at your Sprague distributor's, ready to help you now.



And here's more good news! To help you keep the most-frequently-used transistors handy in your shop, we've got a new KS-10 Transistor Assortment. The Keen 18 . . . 10 small-signal transistors and 8 power transistors . . . give you a working inventory that replaces thousands of the most popular domestic and foreign O.E.M. part numbers. They come in an attractive, blue, durable plastic cabinet . . . you pay for transistors *only* . . . cabinet is yours at no additional cost!

See the KS-10 with a special introductory price at your distributor's. While you're there, pick up a free copy of the 48-page Sprague K-500 Semiconductor Replacement Manual. Or . . . write to Sprague Products Co., 105 Marshall St., North Adams, Mass. 01247.

NEW KS-10 TRANSISTOR ASSORTMENT . . . REGULARLY \$34.11



special
introductory
price . . .

\$24.99



THE BROAD-LINE PRODUCER OF ELECTRONIC PARTS

For More Details Circle (7) on Reply Card

readers'exchange

Needed: One power transformer No. TP-0040 for Muntz b/w TV.

Powers TV
327 Adams, S.W.
Camden, Arkansas 71701

Needed: A 24A type tube for an old Zenith radio.

Hicks Radio-TV Service
1325 North Mockingbird
Abilene, Texas 79603

Needed: Schematic and operating manual for a Model 650 Hickok universal video generator.

Oliver Neuse
422 Miller Avenue
Kingsville, Texas 78363

Needed: Tubes for General Motors 6-volt Autronic Eye. Delco numbers for tubes are 5943334, 5943335, and 5944545.

Schneider TV
Rt. 1 Mound Road
Jacksonville, Illinois 62650

Needed: Schematic and operating instructions for a Hickok oscilloscope model 195B.

Joseph A. Starenas
Cranbrook Drive
Holden, Massachusetts 01520

Needed: 400-uA amp 160-mV meter for a Precision Apparatus Company Series 920 Electronamic tube and set tester.

Claude H. Martin
3236 Radiance Rd.
Louisville, Ky. 40220

Needed: A schematic and a DC power cord for a Globe Star CB.

Neale Schmitt
P.O. Box 3002
Burlington, Vermont 05401

Needed: Schematic for Marquette radio model 249.

Peter Adams
Rt. 2, Box 187A
Onaway, Michigan 49765

TEST RIG FOR TUBE & SOLID STATE

THE COMBO RIG
MODEL CJ-175

\$89⁹⁵
less picture tube

- ELIMINATES HAULING CABINET & TUBE
- SPEEDS TROUBLE SHOOTING
- SERVICES TUBE & SOLID STATE

TELEMATIC TEST RIG CJ-175

CONSISTS OF:

- ★ Compact metal case
- ★ Universal Yoke
- ★ Convergence Yoke
- ★ Blue Lateral Magnet
- ★ Solid State Transverter
- ★ 4' Anode Extension
- ★ 4' 90 degree CRT Extension
- ★ 4' Yoke Extension
- ★ Convergence Load
- ★ 4 Yoke adaptors for Solid State



Telematic

Write us for free subscription of current cross-reference charts.
2245 Pitkin Avenue, Brooklyn, N.Y. 11207

For More Details Circle (8) on Reply Card

Needed: Tube chart for a B&K Dyna-Quik model 550 tube tester.

Douglas L. Ceclre
21114 Greenleaf Drive
Cupertino, Calif. 95014

Needed: Schematic or manual for Waterman "pocket-scope" model S-11-A.

Larry Muchka
770 Southern Parkway
Uniondale, N. Y. 11553

Needed: Schematics or any available data for Dukane transistor amplifier model 1A585 and Mobilpage transistor amp model 470-A. Also schematic and transformer layout for Olympic stereo model TG-8346.

William H. Eppley
988 Kingston Drive
Cherry Hill, New Jersey 08034

Needed: One model WR39C RCA marker generator. Wanted for parts, so is not required to operate, but must have crystals and not be a junker. Please quote price and FOB point.

B. C. Grant
6546 Murdoch Avenue
St. Louis, Missouri 63109

Needed: Head for Bell & Howell auto-reverse tape recorder model 2265, part 032225. Will buy good used head or new one if price is reasonable.

M. R. Davis
Davis Electronics
2655 West Park Drive
Baltimore, Maryland 21207

Needed: Schematic and operating instructions for a Precision signal generator, Series E-200-C. Will pay or copy and return.

Frank Fabbrizzi
130 Hartford
San Antonio, Texas 78223

Will Trade: Excess test equipment and old stock tubes (old types) for test equipment or service data.

Paulmer L. Williams
106 S. Jefferson St.
Lewisburg, W. Va. 24901

For Sale: A collection of PF Reporter and Electronic Servicing magazines dating from January, 1962. Excellent condition.

Everett V. Nussman
128 Lincoln
East Alton, Illinois 62024

5 ways to cut your cost of doing more business

Heathkit Transistor — FET Tester...49.95*

Tests transistors, diodes, FETs, SCRs, triacs, uni-junction transistors in or out of circuit. 5 current ranges measure leakage as low as 1 uA and collector currents as high as 1A. Gain (DC Beta), transconductance (GM), and leakage values read directly on large meter face. Special battery testing circuit gives meter indication of self-contained power supply. Kit IT-121, 6 lbs.



Heathkit Solid-State FET VOM...79.95*

This new dual FET portable multimeter has lab-grade accuracy, high (10 megohm) impedance input, and the ranges you really need...at a price you can easily afford. 9 DCV and ACV ranges from 0.1 to 1000 V. at $\pm 2\%$ accuracy. 6 DC and AC current ranges from 10 microamps to 1 amp. 7 resistance ranges, x1 (10 ohm center) to x1 Megohm. 9 dB ranges, -40 to +62. 1% precision metal-film dividers. 4 1/2", 100 uA ruggedized taut-band meter, diode and fuse protected. Battery check switch provided. Kit IM-104, less batteries, 4 lbs.



Heathkit 8-Digit 120 MHz Counter...299.95*

Measures 1 Hz to over 120 MHz. Over-range, gate, and two range indicators. Preassembled TCXO time base. 1 megohm FET input. Automatic triggering level. Sensitivity 125 mV or less to 120 MHz. ECL logic. Builds in 15 hours. Kit IB-1102, 12 lbs.



Heathkit 10 MHz Triggered Scope...229.95*

A 5" triggered sweep scope at a low kit price you can't afford to pass up. AC — 10 MHz response, calibrated attenuator, 50 ns sweep rate with magnification. AC-DC coupling, 50 mV sensitivity. One of the outstanding scope values on the market. Order one for your service bench today. Kit IO-103, 36 lbs.



Heathkit Digital Multimeter...229.95*

A digital multimeter that meets lab specs at a low, low kit price! 3 1/2 digits for 100 uV resolution on 200 mV range; 1V on 1000V; 1/3 DC ranges (100 uV — 1000V), either polarity; 5 AC ranges (100 uV — 500V); 10 current ranges (100 nA — 2A AC or DC); 6 resistance ranges (0.1 ohm — 20 megohms). DC calibrator supplied for 0.2% accuracy without external equipment. Can be lab calibrated to 0.1%. Kit IM-102, 9 lbs.

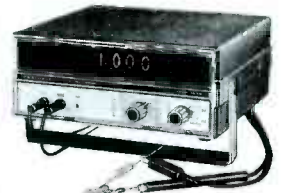

HEATH COMPANY, Dept. 25-1
Benton Harbor, Michigan 49022

Enclosed is \$ _____, plus shipping.

Please send model (s) _____

Please send FREE Heathkit Catalog.

Name _____

Address _____

City _____

State _____

Zip _____

TE-279

For More Details Circle (9) on Reply Card

A good number of reasons

3,000,000,000

That's a lot of receiving tubes, but when you've been in the business as long as we have you're bound to have produced billions. In fact, our "Receiving Tube Characteristics" brochure (ET-1350), right now, lists over 2000 different tube types. Pick up a copy at your local distributor and see what made us a leader.

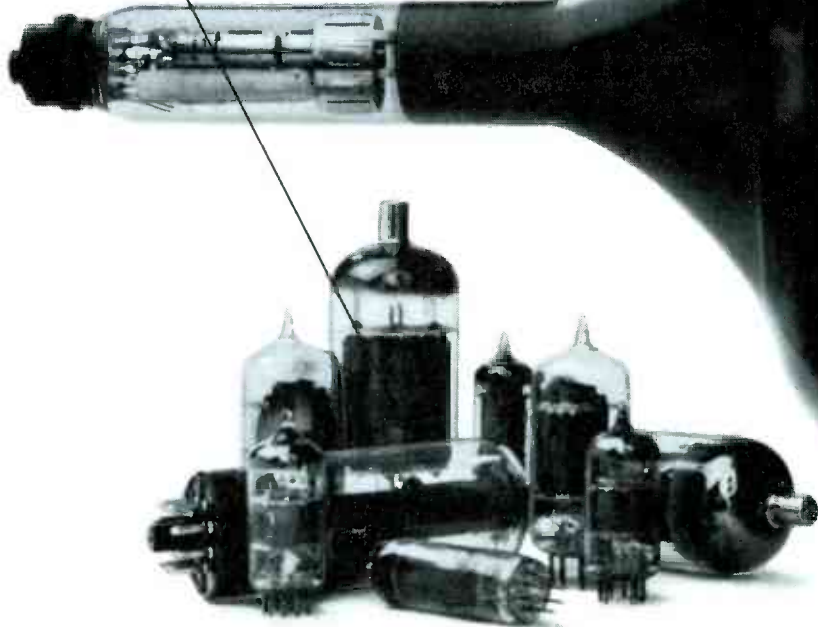

75,000

Who needs that many semiconductor replacement parts? You don't. Actually, what we have is an ECG Semiconductor Replacement Guide (ECG-212E) that will let you replace 75,000 parts with a total number in the low hundreds. That makes it easier for everybody to have a complete stock. And our Replacement Guide makes it easier to select the part you need right when you need it. Just pick up a copy of our Replacement Guide at your local distributor and you'll see why we're the leader.

why we're the leader.



55,000,000

That's how many cathode-ray tubes we've made. Both black-and-white and color. This year alone, we made more TV picture tubes than any other American manufacturer. And our Interchangeability Guide (ET-1496) lets you replace more tubes with fewer types. Get a copy of the Guide at your distributor. You'll see why we're the leader.

We've just given you 3,055,075,000 reasons why we're the leader. What more can you ask for?

Except Sylvania.

Sylvania Electronic Components, 100 First Avenue, Waltham, Mass. 02154

GTE SYLVANIA

For More Details Circle (10) on Reply Card

Bruce Tognazzini (left) and Mike Carr are two young San Francisco technician-merchants who have found that their unique Golden Age store atmosphere is a real business-builder.



GOLDEN AGE THEME

Gross income of this unusual sales-and-service store was doubled in just one year by a happy combination of unusual decor and efficient operation. Here are ideas for improving your own shop.

Walk into Carr's Golden Age Electronics, San Francisco, and you might think you're on the set of a TV Western. Along the "street" extending from front to rear of the store are what appear to be a livery stable, the U. S. Marshall's office, a freight office, and a gramophone store. On a cross-street, there's the Bucket o' Blood Saloon and the Jenny Lind Theatre.

The unusual decor is the brain-child of Mike Carr and Bruce Tognazzini, two young electronic technicians. In February, 1972, when they bought the 45-year-old store from Carr's father who was retiring, Carr's Electronics (as it

was then known) looked like many other neighborhood television sales and service stores. But young Carr and Tognazzini decided to make it dramatically different.

"My father always carried top-quality brown goods and featured service, and so do we," says Mike Carr. "Bruce and I decided that was the only way for a small store to go, considering all the competition from the mass merchandisers. But we needed something more if we were to reach the many new people who, we hoped, would become our customers.

"We decided that first of all we had to get away from the typical four-wall operation that looks like a TV warehouse, and so we discussed how we could remodel to make the store really different."

Attracts Customers
Tognazzini adds: "Our first

thought was to introduce a very advanced contemporary look. But when we finally hit on the idea of recreating scenes from the Golden Age of San Francisco, we believed we had something that would really attract attention and customers."

And so it has. The partners report that sales and service figures for their first year of operation will be just about double the figures for the previous year. It all started with remodeling but the young owners' program for growth included stepped-up advertising and shop improvements to provide "service while you watch."

The new look—or the old look of the late 19th century—brought compliments galore. Only one customer, out of hundreds visiting the remodeled store, said he liked the former look better.

"For a while, it seemed as if the store might become a hangout for



A Livery Stable houses the open-display service shop. The store entrance is at the extreme right in the picture.



Open-display service shop, in Livery Stable, is arranged for efficiency. The rotary carousel mounted on a post at the left was adapted from an idea they read about in *Electronic Servicing*.

DOUBLES SALES

By John Stapp

the kids," Tognazzini smiles. "But when they began coming back later with their parents, we found we had reached a whole new group of people who had never been in the store before although it's been here for many years."

Efficient, Too

The "Golden Age" look which intrigues visitors and customers alike is more than just decor—it's a highly efficient organization of the sales and service areas.

To your right as you enter is the Livery Stable which houses the open-display service shop. Next door is the U.S. Marshall's office where customers bring their sets for "service while you watch." The adjacent Bucket o' Blood Saloon, located just around the corner on a "cross-street," provides a second "service while you watch" station.

To the left of the entrance is the

Freight Office where the receptionist works, and down the "street" is the E. F. Akerman, Kinescope and Gramophone Store which serves as the business office. Between these two offices is a picket-fence-enclosed self-service nook displaying parts for do-it-yourselfers.

Along the cross-street at the rear is a Television Theatre. Some sets are displayed in a show window extending along the front of the TV Theatre. Inside, other sets are displayed on authentic hatch covers supported by heavy anchor chains. Ship lights provide a low level of illumination in this room, which is lined with planks to create the effect of the hold of an old sailing ship.

Stereo Room

Also along the rear wall is the Jenny Lind Theatre which, in

reality, is the stereo room. It is sound-insulated, eight-layers thick—(two layers of sheet rock, two of Celotex, two of egg cartons, a layer of velveteen cloth inside, and a brick facade over the studs on the outside).

"This is virtually a soundproof room," Tognazzini says. "For a number of years, I've installed such a room wherever I've lived, making it demountable for ease in moving. We're offering to build soundproof rooms such as this for customers at a cost of \$2,500, not including the stereo system."

A color organ is hooked up in the Jenny Lind Theatre and the partners find this is another sales plus for Golden Age Electronics.

Browsers Linger

Since the entire store area is only 1,000 square feet, Carr and Tognazzini had to do some close figur-



One of the two "service while you watch" stations is the Bucket O' Blood Saloon. Both carry-in stations are only a few steps away from, and are connected with, the main service shop.

ing to fit everything in and still not get an overcrowded look.

A mirrored wall next to the Jenny Lind Theatre helps create a sense of space. Fronting the mirror is a small fountain and real—not artificial—potted plants. Taped bird songs are heard in this "outside area"—a pleasant touch that has brought many appreciative comments from customers.

"With a separate stereo room and a television room, we find that people now stay and look over the merchandise much more than they did before we remodeled," Tognazzini observes. "They don't feel overwhelmed by all those sets we used to have out on the open floor.

"We've been very selective in what we carry and always explain to customers that every television set is checked as soon as it arrives. If necessary, we repair the set before putting it on display."

Carry-In Service

Featuring "service while you

watch" has played an important part in increasing service sales. Carry-in service now represents 75% of the service business.

A customer bringing in a set for service takes it to either the Bucket o' Blood Saloon or the U.S. Marshall's Office. Both of these carry-in service stations are just a few steps away from the Livery Stable which is the shop proper.

"We have to thank **Electronic Servicing** for giving us the idea for this type of service," Tognazzini says. "I read an article in the magazine on Jim Ballard's Serv-A-Set operation, and we adapted the idea of carry-in 'service while you watch' to our design format. We also picked up the carousel idea for our service shop from the same article and find it's given us good shop efficiency.

"Our experience is that carry-in service is growing in importance as the industry moves more and more to portable. We're selling more 17-inch than anything else.



U. S. Marshall's office serves as the other carry-in "service while you watch" station. Customer leaves the set in open doorway shown at the right. A tube tester can be seen through the barred window.



Across the "street" from the Livery Stable is the E. F. Akerman Kinescope And Gramophone Store which houses the business office. The name and store design were taken from a picture of an old San Francisco store. Note antiques in window.

“Our customers like ‘service while you watch’—it certainly lowers their fear of a rip-off. We fix anything that can be fixed in forty minutes for a fixed charge of \$17.95 plus the parts. This is profitable for us, and it’s a real business-builder.”

Advertising

An advertising program was developed by Carr and Tognazzini to build traffic for their newly-acquired business. A modest budget covers a 1/4-page ad in the yellow page (featuring “Service while you watch”); radio advertising; and direct mail.

For direct mail, the partners have acquired a Gestetner that produces 4-color pieces. Shortly after they bought the store, the first mailer went out to 1,000 customers to announce a big sale conducted by new management. Cost of the mailing was \$120. Sales of merchandise and service resulting from the promotion totaled \$6,000.

(Continued on page 53)



Partial view of the TV Theatre. Anchor chains support ship hatch covers on which the sets are displayed.



The Jenny Lind Theatre is a soundproofed room for stereo listening only.



Freight Office built with weather-worn boards, located to the left of the entrance, is a small office where the receptionist works. Leaded windows allow her to keep the store under observation and offer help to customers, when needed.

Horizontal sweep revisited part 2

By Bruce Anderson

In Part 1, details were given about substituting a load resistor for the flyback/yoke circuit, and then testing this half of the sweep by analyzing voltages and waveforms. A method is described this month of ringing the flyback/yoke circuit with pulses from the horizontal oscillator. Use of both these methods will be of immense help in rapidly locating defects in the horizontal output circuit.

Perhaps the most important single component in the horizontal-sweep circuit is the flyback transformer, which has two major func-

tions. It matches the plate impedance of the output tube to the much lower impedance of the coils in the yoke, and it steps up the retrace (flyback) pulses to a higher voltage that is rectified and used to supply the picture tube. A flyback/yoke circuit typical of those in color-TV receivers is shown in Figure 1.

Lesser functions of flyback transformers are to develop focus voltage, boosted-boost voltage, and various auxiliary pulses. These pulses key the AGC and burst amplifier, time the horizontal AFC, provide retrace blanking, drive convergence circuits, and power the

side-pincushion correction (where used). The high voltage can be killed just as easily by a short or excessive load in these extra circuits as by shorted turns in the flyback. Most such auxiliary loads can be unplugged or disconnected long enough for tests (see Figure 1).

Visual Tests

Because the horizontal-deflection and high-voltage system is a high-powered one, many malfunctions result in the destruction of the defective component. Thus, you should always make a careful visual inspection of the components before you proceed with other tests.

Fig. 1 A typical color flyback/yoke circuit showing connections for ringing tests and how to disconnect external loads.

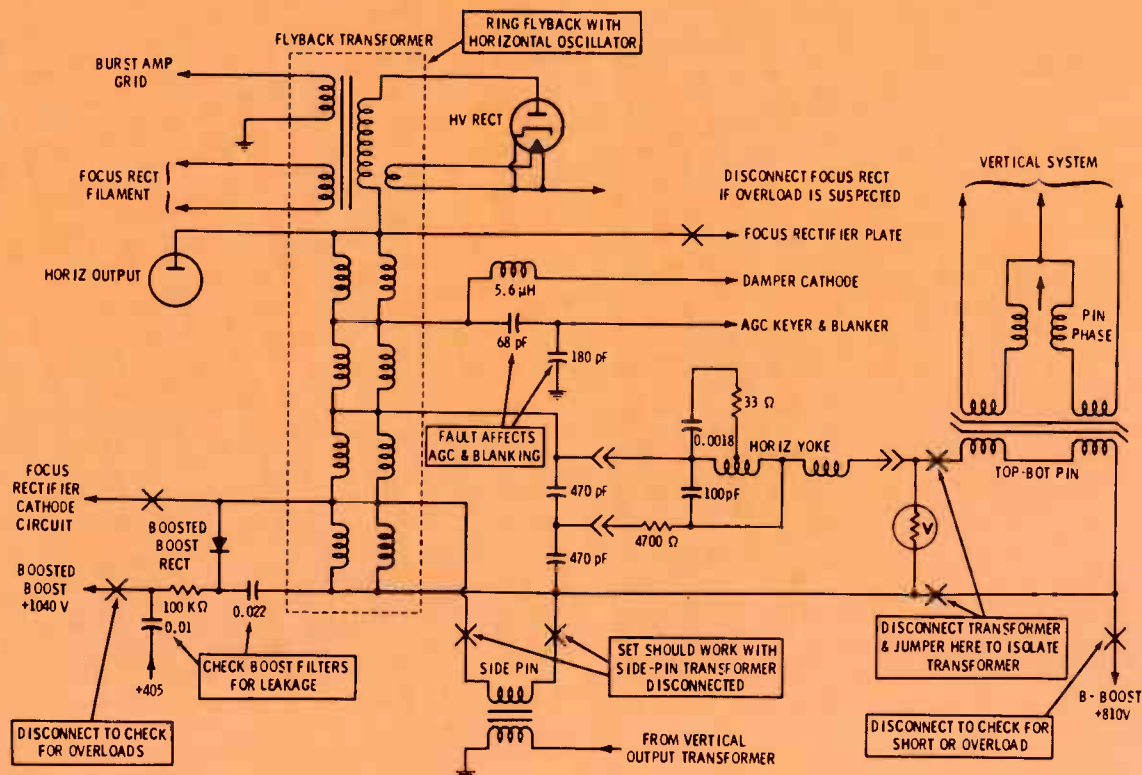

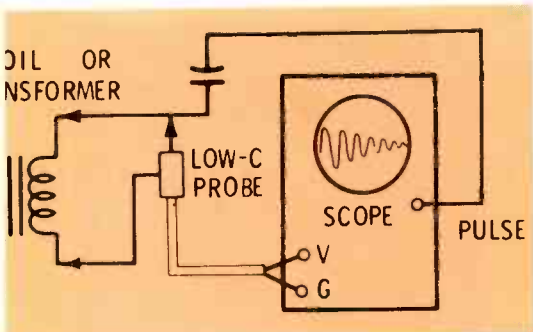

(A) Pulses from inside the scope are applied through a capacitor to the inductance. The scope observes the ringing waveform at the coil.

Fig. 2 Hookup for conventional ringing.

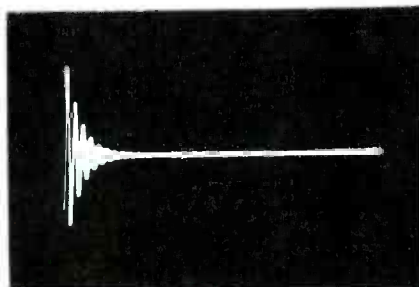

(B) Frequency-versus-inductance is important in obtaining a complete damped wavetrain. Here the pulse repetition rate is too slow.

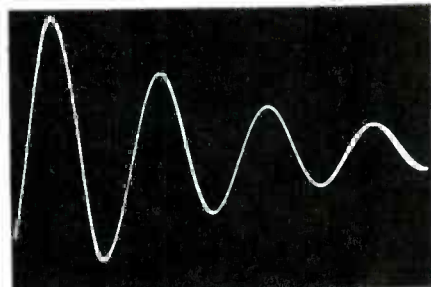

(C) Example of a pulse repetition rate that is too fast.

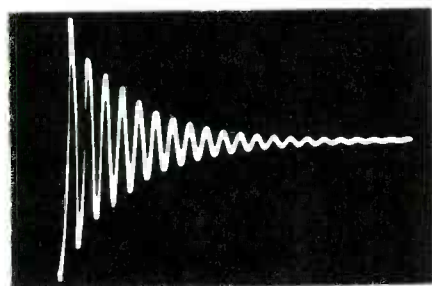

(D) Normal ringing for comparison.

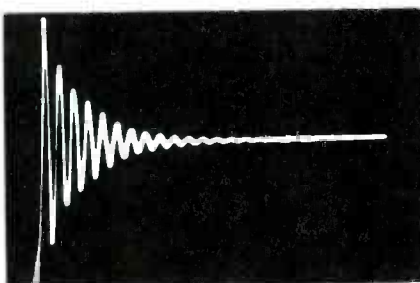

(E) Reduced ringing because of one shorted turn in the winding.

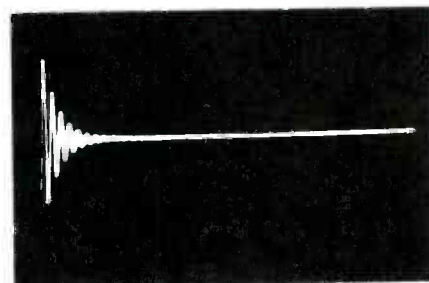

(F) Greatly-reduced ringing because of many shorted turns.

Look for burned flybacks, charred or discolored resistors, and swollen or ruptured capacitors. But don't arbitrarily replace a flyback merely because some wax has melted out of it. It's not unusual for a considerable amount of wax to gather under such transformers, and additional tests should be used to avoid making a wrong diagnosis. For example, a bulge or a charred spot on the windings indicates excessive heat in one small area, and this is a good sign of shorted turns. Or you could use ringing tests to determine if the flyback has been hot enough to cause insulation damage and shorted turns.

Resistance tests

Don't place too much faith in resistance measurements between terminals of the flyback transformer. Of course, such tests will show an open winding (if not paralleled by another component), but this is a rare event. The usual failure is a short between turns or layers of windings. Because a few shorted

turns have only a slight effect on the total resistance of a winding, the usual ohmmeter test is not likely to spot them. Yoke and pin-cushion transformers often are connected across portions of the flyback windings, and these must be disconnected before resistance checks are accurate.

Conventional Ringing Tests

Figure 2 shows the usual hook-up for testing a flyback transformer by ringing it. The pulses which are applied shock-excite the transformer into oscillation at a frequency determined by the value of the coupling capacitor, and by the inductance of the transformer and its distributed capacitance. If the transformer is good, losses in the winding will be small, allowing the ringing to continue for several cycles in the shape of a damped wave train. Even one shorted turn reduces the number of cycles of ringing.

These ringing tests usually are valid, but they suffer some draw-

backs. For one thing, all the external leads often require removal to prevent these auxiliary circuits from giving false indications. Frequency of the pulses is critical in order to obtain ringing of the proper duration for best analysis. In many cases, a different frequency must be used for each brand and type of transformer. Such rigid frequency control is very difficult to obtain when the pulses are taken from the sweep circuit of a scope.

Also, large amplitude of the exciting pulses is needed; otherwise the voltage developed in the windings might not be enough to trigger the type of short circuit that exists only when the transformer is driven strongly by the horizontal output tube. Finally, you might not have available a convenient source of pulses for ringing.

High-Level Ringing

For several years, I have used a simple variation of the ringing test and obtained fairly consistent results on various RCA hybrid receiv-

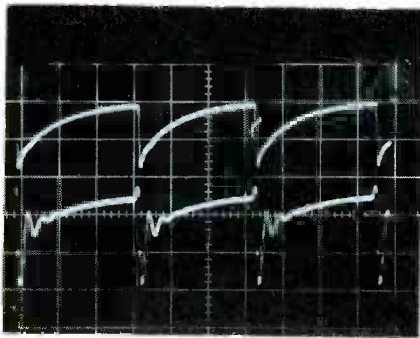

Fig. 3 Top waveform is the 180-volt P-P sawtooth at the grid of the horizontal output tube (100 volts/CM), and bottom waveform is the 540-volt signal at the grid of the horizontal oscillator (200 volts/CM and 20- μ S sweep).

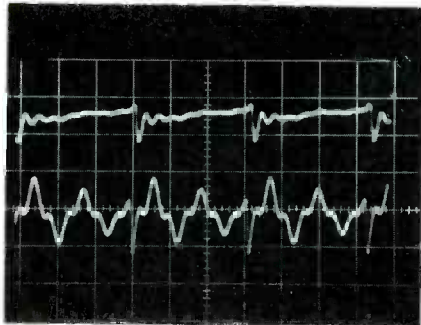

Fig. 4 Top waveform is the oscillator-grid signal, for reference (used to lock the scope). Bottom waveform is the ringing viewed at the output-plate terminal of the flyback (100 volts/CM). Ringing frequency is about three times horizontal.

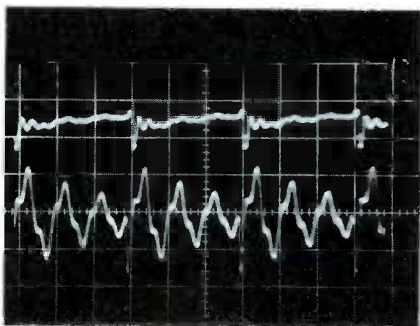

Fig. 5 Same as Figure 4, except horizontal-oscillator frequency was decreased to maximize ringing. Time base is about 27 μ S/CM.

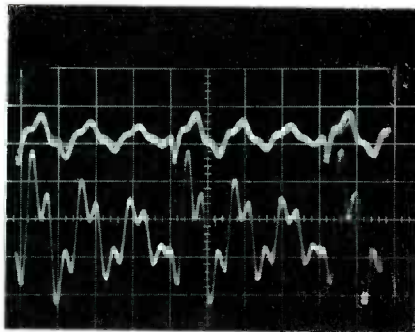

Fig. 6 Top waveform is the same as the lower one in Figure 5, but 200 volts/CM. Lower trace is the waveform at the high-voltage lead when it is disconnected from the picture tube. The HV-rectifier tube has no filament voltage and acts as a capacitive voltage divider (10 volts/CM).

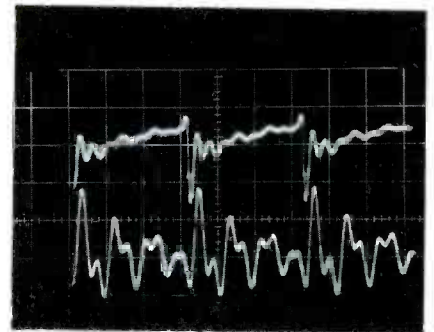

Fig. 7 Top trace is the oscillator grid waveform. Lower trace is the same as the lower trace of Figure 6, except the yoke has shorted turns. Notice that change is not sufficient to be useful.

ers. The method undoubtedly also works fine for other tube-powered sweep systems when allowances are made for minor differences of waveforms.

Instead of disconnecting all leads from the suspected flyback and ringing it with pulses from some item of test equipment, I leave all loads connected and ring the entire circuit by using the output signal from the horizontal oscillator of the receiver being tested.

In the CTC38 and CTC39 chassis, this ringing test can be done by removing the damper and horizontal output tubes, and then connecting a jumper wire from the control grid of the output tube to the cathode pin of the damper. The scope is connected to the plate cap of the output tube.

For the CTC41, CTC42 and CTC43, the hookup is the same, except for the output tube which can't be removed because of the series-heater string. Instead, unclip the solid-state damper, and disconnect both the plate cap and the cathode wire of the output tube. Then add a jumper from the grid of the output tube to the damper terminal of the flyback. Connect the scope probe to the plate cap of the output tube.

The CTC51, CTC52, CTC53, CTC55 and CTC63 chassis use tubes for both output and damper stages, and the heaters are series-connected. In those cases, disconnect the plate and cathode leads of

the output tube, and unsolder the flyback wire that goes to the cathode of the damper. Add a jumper from the output grid to the flyback wire formerly connected to the damper cathode, and observe the waveform at the plate cap of the output tube.

Incidentally, the cathode of the output tube should be disconnected to prevent possible damage to the output tube, and not because it has any effect on the tests.

These are the advantages of ringing the sweep circuit by this method:

- a stronger pulse amplitude is available;
- few wiring changes are required;
- it is not necessary to go scrounging for a source of pulses; and
- the frequency is sufficiently stable and accurate.

The only disadvantage I know of is that some of the waveforms are not exactly what I anticipated. However, they do make sense and they are repeatable. The waveforms which follow tell the story.

Scope Waveforms

To make comparisons easy, all waveforms were photographed from a dual-beam scope, and the triggered-sweep function made possible approximate measurements of the frequencies. However, a regular service-type scope is entirely adequate for your ringing tests, if you use external locking from the signal at the grid of the horizontal oscillator.

The two waveforms of Figure 3

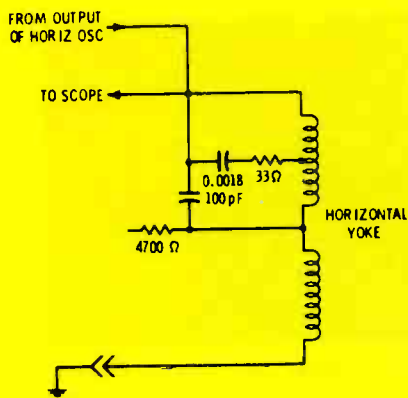

Fig. 8 Circuit for ringing the yoke alone from the horizontal oscillator.

are the normal ones for the CTC39 chassis. They should be examined in each case to be certain the horizontal oscillator is working okay. Any wrong operation such as abnormal waveforms, insufficient amplitude, or incorrect frequency should be repaired before you attempt to use the oscillator signal for ringing. Scope sweep was 20 microseconds - per - centimeter, and the normal 63 microsecond time of each cycle of the waveform proved the frequency to be correct.

In Figure 4, the top waveform is the signal at the grid of the oscillator, used for scope locking and shown for reference. And the lower waveform is the one found at the disconnected plate cap of the output tube. Frequency of the ringing is about three times the oscillator frequency. Each succeeding cycle of the ringing has less amplitude, but there is not enough time between pulses for a complete wavetrain to be displayed. Also, the ringing cycles are not smooth sine waves, as is the case with some other methods of ringing.

However, the results are repeatable and can be used in the diagnosis of the flyback condition, after we obtain some experience in the analysis of the waveforms. Notice on the upper trace that some of the ringing has traveled through the capacitance of the oscillator tube and appears as ripples in the grid waveform.

Conditions producing the wave-

forms of Figure 5 are the same as for Figure 4, except the oscillator frequency has been decreased to about 13,000 Hz to obtain a maximum amount of ringing, and the scope reset for better locking. This illustrates the amount of waveform change possible because of a wrong horizontal frequency.

An odd characteristic of the CTC39 horizontal circuit is that the oscillator frequency doesn't change smoothly as the hold control is varied. Instead it jumps from one frequency to another. This is not true of the portables, whose oscillator frequencies change smoothly. If the effect bothers you, merely disconnect the feedback loop between the oscillator output and the horizontal AFC diodes.

There is an interesting and time-saving way of examining the waveform at the plate of the high-voltage rectifier. Because the filament is cold, the tube does not rectify. Plate-to-filament capacitance inside the tube combined with the capacitance of the scope probe forms a capacitance voltage divider of about a 200-to-1 ratio. It's not necessary to open the HV cage; merely disconnect the high-voltage lead from the picture tube and connect it to the scope probe. Notice in Figure 6 that the ringing dies away more quickly at the high-voltage lead than at the plate of the output tube.

Waveforms From Defects

All waveforms shown before were photographed from a non-defective receiver, and are only of value when compared with those produced by component defects.

A shorted yoke coil made little change in the waveforms (Figure 7). Compare the lower waveforms of Figures 6 and 7 and you will agree that the differences are not sufficient to prove a defect.

Ringing the yoke

The circuit of Figure 8 can be used to ring the yoke alone. A good yoke rings very nicely (Figure 9). Unfortunately, so does one with shorted turns. Probably the reason is that the two yoke coils don't have much common magnetic coupling,

and the effect is the same as a good inductance in series with another having shorted turns. The shorted turns make a slight difference in the ringing, but not enough to be a foolproof symptom.

An open yoke in the flyback circuit gave the waveforms of Figure 10. However, this condition excessively loaded the oscillator and made necessary a change of wiring before the pictures were made. A 3900-ohm resistor was added in series with the jumper between the grid pin of the output tube and the flyback terminal that normally goes to the damper cathode. One effect of this addition was the smoother waveform at the grid of the oscillator (top waveform). Most significant was the decrease of flyback resonance to about twice the sweep frequency that occurred when the yoke was open.

Ringing a shorted flyback

Shorted turns of the flyback transformer drastically changed the ringing waveforms (Figure 11) so as to leave no doubt about a defect. No significant changes could be seen whether or not the yoke was connected.

Suggestion

Although most of my experience with this method of ringing by use of the horizontal-oscillator signal has been with RCA receivers, there is no reason why it will not work successfully with other makes and models.

One suggestion: Some specific circuits might ring better if the jumper between output grid and damper cathode is replaced with a capacitor. Try values between 100 pf and 470 pf. Use the smallest size that permits ringing with high amplitude; larger sizes tend to load the oscillator.

Conclusions

Non-defective horizontal-sweep circuits will ring very satisfactorily when excited by the output signals from their own horizontal oscillators. Shorted turns in the flyback, leakage in a capacitor shunting the flyback, or shorted turns in any auxiliary circuits such as focus or

FAST

COMPLETE SERVICE ON ALL MAKES OF TV TUNERS

Maximum Time In Shop 24 Hrs.

(WE SHIP C.O.D.)
YOU PAY SHIPPING
\$9.95

(Warranty: One Full Year)



Black &
White
or Color

VHF or
UHF

UV Combo's \$16.50

Price includes all labor and parts except Tubes, Diodes & Transistors. If combo tuner needs only one unit repaired, disassemble and ship only defective unit. Otherwise there will be a charge for a combo tuner. When sending tuners for repair, remove mounting brackets, knobs, indicator dials, remote fine tuning arrangements and remote control drive units.

WE UNCONDITIONALLY GUARANTEE All Tuners FOR ONE FULL YEAR



All tuners are serviced by EXPERTLY TRAINED TECHNICIANS with years of experience in this specialized field. All tuners are ALIGNED TO MANUFACTURER'S SPECIFICATION on crystal controlled equipment and air checked on monitor before shipping to assure that tuner is operating properly.

GEM CITY TUNER SERVICE

Box 6G Dabel Station
1621 Mardon Drive
Dayton, Ohio 45420

For More Details Circle (11) on Reply Card

pincushion transformers which parallel the flyback will change the ringing patterns enough for diagnosis to be definite.

Ringing tests of yokes are not conclusive, because shorted turns in the coils don't change the waveforms very much. An open yoke changes the flyback-circuit ringing from the normal 50 KHz to about 30 KHz, a very obvious difference. These same results also are obtained by the traditional method of ringing using square waves or pulses from scopes.

Three conclusions can be drawn from the tests described in this two-part series:

- Testing the horizontal-output tube in a temporary resistive-loaded configuration (described in Part 1) verifies good or bad operation of the oscillator, the output tube with its cathode and grid circuits, and the damper along with its efficiency coil;
- Ringing tests of the flyback circuit definitely will reveal any shorted turns in the flyback, whether or not the yoke is connected; and
- If the flyback circuit has been cleared as a source of the fault, only the yoke remains as a suspect. Plug in another yoke to see if the high voltage is restored. If it is, an intense spot of light will be seen at the center of the raster; don't operate the set more than a few seconds this way to avoid CRT damage. This test should be done before the old yoke is removed to prevent disturbing the purity and center-convergence adjustments.

After you become familiar with these simple procedures, you can perform all the tests in far less time than is required to change a good flyback because of a mistaken diagnosis. □



"Talk about 'the works being in a drawer.'"

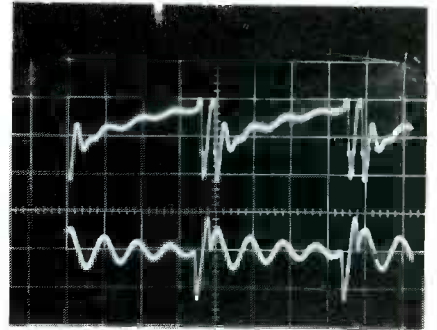

Fig. 9 Top waveform is the oscillator grid signal when the output was used to ring a non-defective yoke (lower trace). Nearly the same waveform was obtained when the yoke had shorted turns.

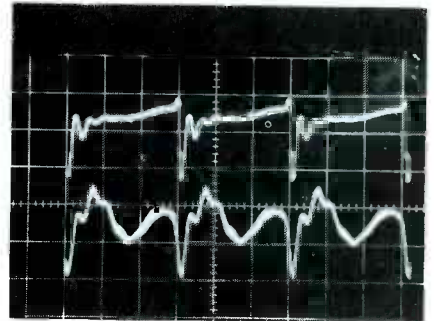

Fig. 10 Results of ringing the whole flyback circuit when the yoke was open. Excessive loading of the oscillator required a 3900-ohm resistor between the oscillator output and the flyback. The open yoke reduced the frequency of ringing (lower waveform).

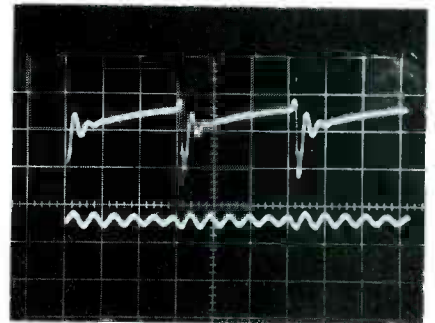
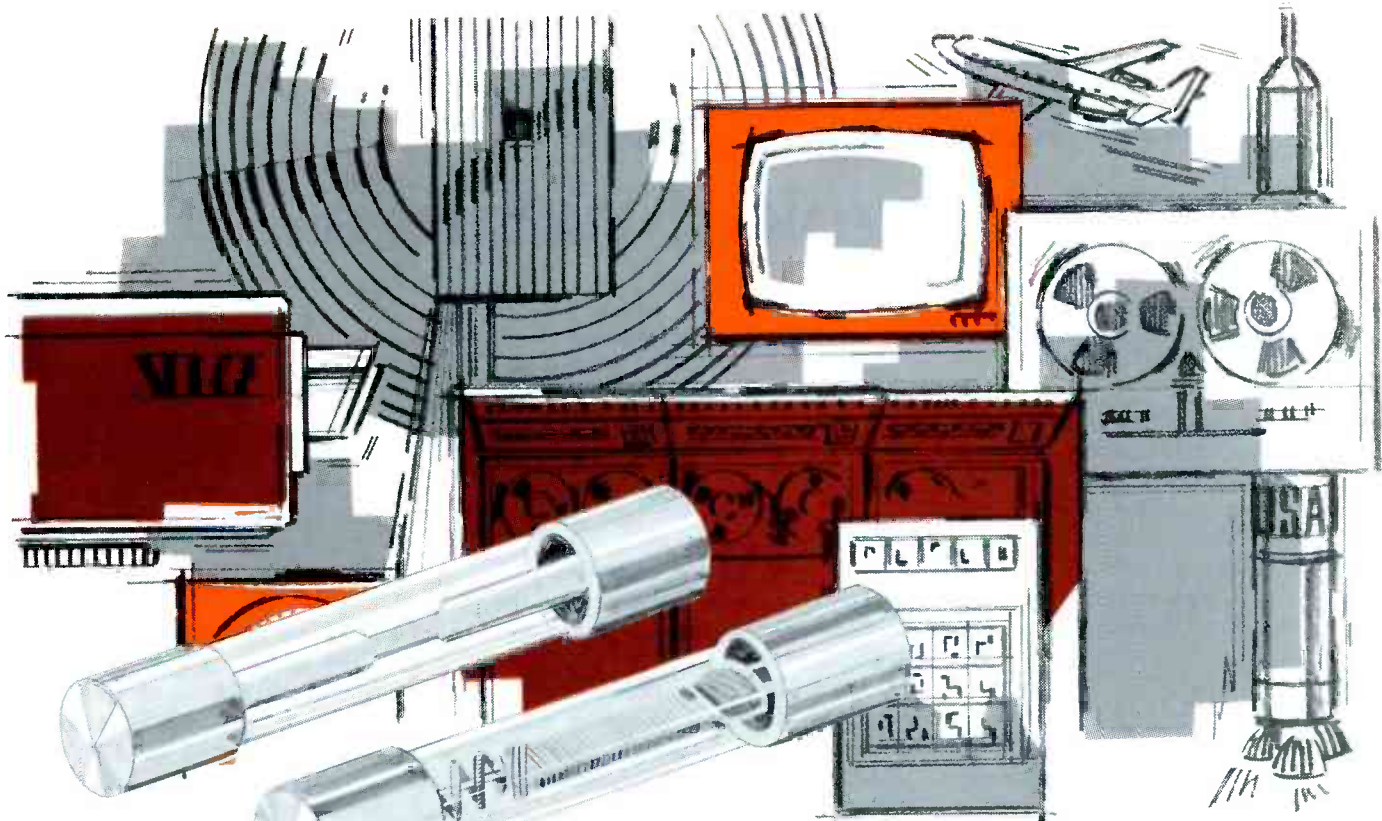

Fig. 11 Several shorted turns in the flyback winding produced the bottom waveform, (10 volts/CM) whether or not the yoke was connected.



¼ x 1¼ inch Normal Blowing Fuses AGC GLH MTH From 1/500 to 30 amps, for 32V, 125V, or 250V

¼ x 1¼ inch Time Delay Fuses — From 1/100 to 30 amps, MDL MDX for 32V, 125V, or 250V

For every electronic protection need BUSS® has a quality Fuse and Fuseholder



HWA Fuseholder for GMW Subminiature Fuses



Series HH and HI In-the-Line Fuseholder for ¼ x 1¼ Fuses



HTA Space-Saver Panel-Mounted Fuseholder for ¼ x 1¼ Fuses (solder terminals) also HTA-DD, 3/16" Quick-Connect Terminals and HTA-HH, ¼" Quick-Connect Terminals



HKL Lamp Indicating - Panel - mounted Fuseholder for ¼ x 1¼ Fuses

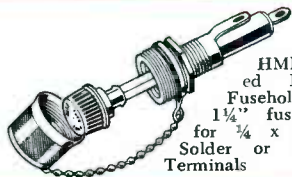

HMR RF-Shielded Panel-Mounted Fuseholder for ¼ x 1¼ fuses and HMS for ¼ x 1" fuses — Solder or Quick-Connect Terminals

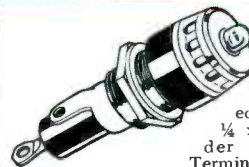

HLD Visual-Indicating Panel-Mounted Fuseholder — for ¼ x 1¼ Fuses — Solder or Quick-Connect Terminals



NEW: BUSS SNAP-LOCK rear panel mounted fuseholder for ¼ x 1¼ fuses — a "snap" to install Ask for BUSS Bulletin SFH-14

The BUSS line of fuseholders is as complete as the BUSS line of fuses, covering all applications.

If you've got a circuit to protect, BUSS has the fuseholder as well as the fuse to protect it.

For more information on the complete line of BUSS fuses, fuseholders, fuseblocks, and fuse clips, write for a free copy of BUSS Bulletin SFB.



BUSSMANN MANUFACTURING
a McGraw-Edison Company Division
St. Louis, Missouri 63107



Causes and cures of trapezoidal pictures

By Carl Babcoke, CET

Back in the "good old days" before rectangular color picture tubes, there was only one cause of a trapezoidal raster: a defective deflection yoke. Now there are more possible causes. Pincushion-correction components and high-voltage regulators also can cause trapezoids. Here are suggestions to speed your troubleshooting.

Symptoms of TV troubles often come in bunches. This time it was trapezoidal pictures, the kind that are taller on one side than the other, or wider at top or bottom. Although these symptoms usually don't happen too often, I encountered two within a period of a few days. Each receiver had a different defective part.

These repairs, plus reminders from editing I was doing on the Bruce Anderson article about ringing the yoke and flyback, convinced me it was time for an update about yokes, and the addition of some fresh new material. So we'll start with the fundamentals (some not well known) and work up to actual case histories.

Yoke Requirements

These are practical and important facts about yokes:

- Normal, desired deflection (both vertical and horizontal) is accomplished by **current** through the yoke coils;
- This current in the coils produces a magnetic field which moves the picture-tube electron beam (or beams);
- Magnetic deflection occurs at right angles to the coils; therefore, coils located **above** and **below** the electron stream are used for **horizontal** deflection;
- The coil above makes the picture wide at the top, and the one below makes the picture wide at the bottom of the raster;
- Two coils are used for vertical deflection, also. They are located on each side of the electron stream; one determines the height at the left and one the height at the right edge of the raster.
- Undesired deflection is possible if **voltage** through capacitive action is allowed to act on the same electron stream.

Although yokes have powdered-iron cores and thus might appear to be a type of transformer, the coupling between each pair of coils is

very loose. This is the reason that proper current applied to only one of the pair of coils gives full deflection at one edge of the raster and only partial deflection at the other. Shorted turns in one coil have little effect on the performance of the other (except as it changes the loading on the output stage).

To prevent a trapezoidal raster, it is essential that each coil of a pair generate exactly the same strength of magnetic field. In other words, both coils must have exactly the same number of turns (inductance) and the same current. Of course, the same-current requirement is satisfied by connection of the two coils in series (in tube-powered chassis).

Horizontal Yoke Circuits

The requirement for identical inductances of both coils would seem to dictate an identical circuit for each coil. And yet, many b-w TV schematics show a capacitor paralleling one horizontal-yoke coil and none across the other (Figure 1A). After a closer inspection, we find the capacitor is 100 pf, or smaller. This is much too tiny to affect the amount of deflection at this impedance. So why should a capacitor be provided there?

Fig. 1 Three basic horizontal-yoke circuits. (A) Black-and-white TV yoke wiring. The value of C1 is critical to eliminate ripples of the scanning lines on the left. (B) Circuit often used in color sets. Smaller values of C1 and C2 increase the high voltage, and vice versa. (C) Solid-state yokes have the coils paralleled, and no capacitor is necessary.

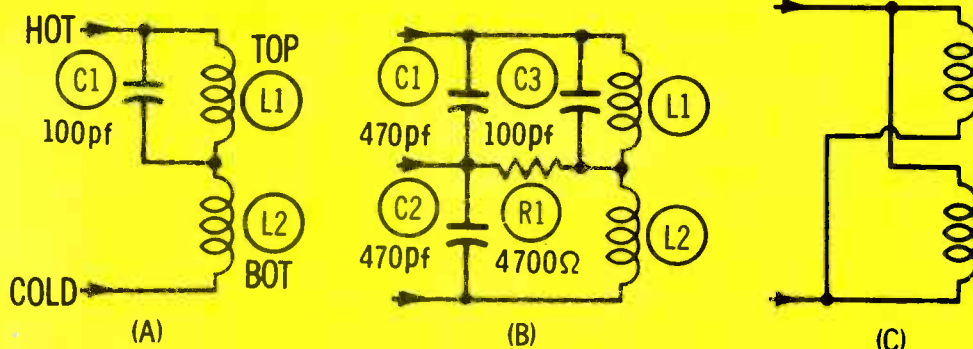

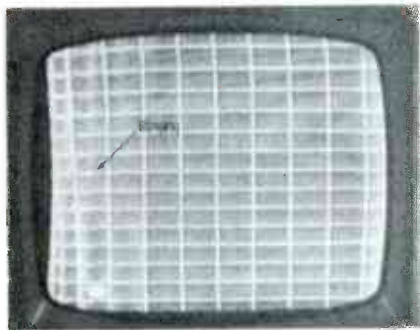

Fig. 2 Example of ripples in the scanning lines near the left edge of picture. They are caused by electrostatic deflection.



Fig. 3 Narrow picture at the bottom indicates L2 of Figure 1B has insufficient magnetic field.

To answer that question, let's think about the circuit of Figure 1A, and what happens if C1 is removed. The "hot" wire from the flyback transformer is connected to one end of L1. Because L1 is located above the neck of the picture tube and near it, some voltage from the huge horizontal signal (pulses) is transferred by capacitance action to the electron stream. The result is a small amount of deflection at the horizontal rate, but in a vertical direction. Remember that magnetic deflection occurs at right angles, and electrostatic deflection from voltage works straight on.

This stray capacitance is very small, so only the higher harmonics of the horizontal-voltage pulses give this vertical deflection. These higher harmonics are mainly ringing sine waves which decrease in inten-

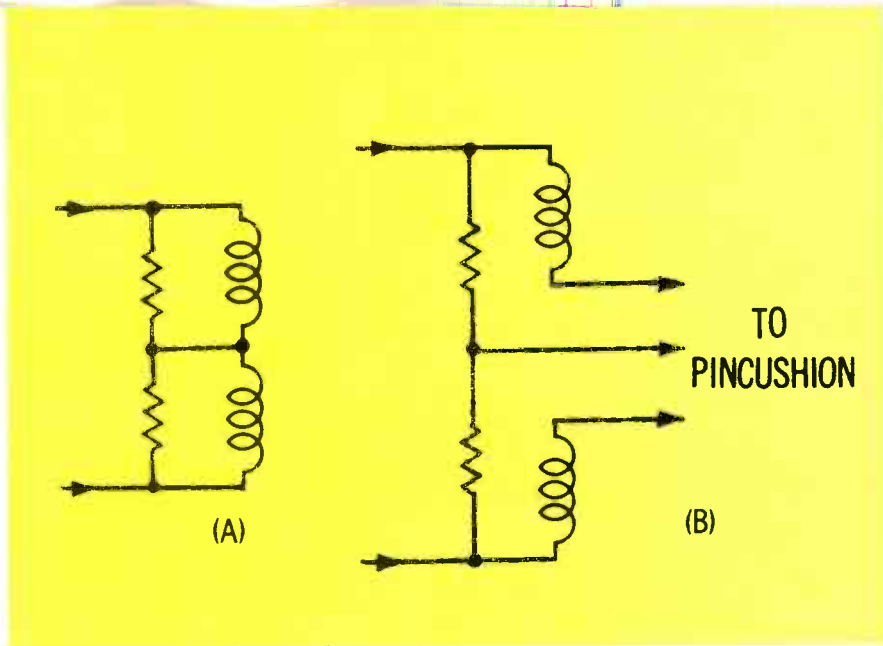

Fig. 4 Basic vertical-yoke circuits. (A) Circuit used in all sets except solid state and those having a pincushion-correction function. (B) Filtered horizontal pulses are added in series with the vertical yoke coils to reduce pincushion effect at top and bottom. Some of these added components also can produce trapezoidal pictures.

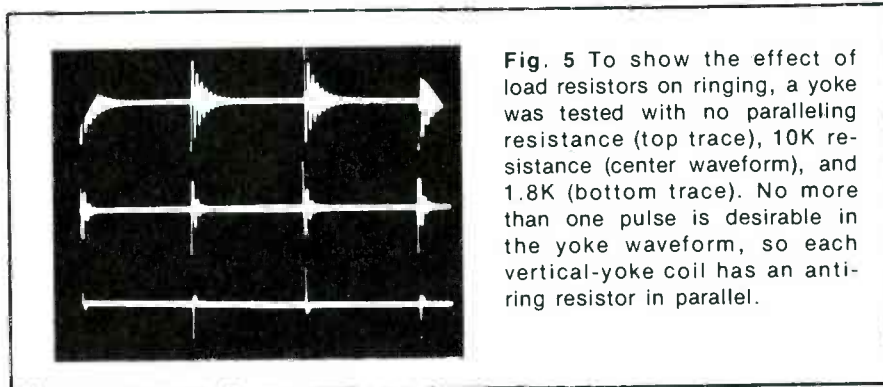

Fig. 5 To show the effect of load resistors on ringing, a yoke was tested with no paralleling resistance (top trace), 10K resistance (center waveform), and 1.8K (bottom trace). No more than one pulse is desirable in the yoke waveform, so each vertical-yoke coil has an anti-ringing resistor in parallel.

sity during the horizontal-sweep time. **Therefore, the visual effect is that of vertical undulations of the horizontal scanning lines, but only at the left side of the raster (Figure 2).**

Addition of C1 feeds the same higher harmonics to L2 as those supplied by the direct connection of L1. Therefore, vertical deflection from the ringing sine waves is cancelled because the same electrostatic signal is applied to both L1 and L2 (parallel signal), but the coils are on opposite sides of the electron stream (push-pull output). If the electrostatic deflection from the top coil tries to move the beam down, the bottom-coil deflection attempts to move the beam up the same amount. The result: no ringing.

Capacitance of C1 is critical in order to eliminate all the ringing

ripples from the scanning lines. Sometimes the correct size must be determined by trial and error when a new yoke or capacitor is installed.

Parts defects

Here are symptoms of parts defects in the yoke circuit of Figure 1A:

- Shorted turns in L1 causes a picture that is narrow at the top, and is blurred because of decreased high voltage;
- A shorted C1 also narrows the picture at the top;
- Shorted turns in L2 produce a narrowing of the picture at the bottom, plus a blurred picture and a tendency to bloom (Figure 3);
- An open in L1 or L2 kills the high voltage and blacks out the picture; and
- An open C1 causes vertical ripples in the scanning lines along the left



Fig. 6 At first glance, this might seem to be a case of insufficient height. However, the left edge is taller than the right, so it is a trapezoidal picture. One vertical-yoke coil was open, and a higher-than-usual load resistor supplied only a small amount of deflection.

edge of the raster.

More yoke parts

Figure 1B shows a typical color-TV yoke circuit with a resistor and two capacitors in addition to the parts previously described. C1 and C2 form a capacitive voltage divider which minimizes the vertical ripples at the left edge of the picture (capacitive voltage dividers have very wide bandwidth).

The capacitances of C1 and C2 are large enough to affect the width. Without them, the high voltage is increased and the width is narrower.

C1, C2, L1 and L2 form a kind of bridge circuit which balances well enough that little voltage is developed between the junctions of C1/C2 and L1/L2. R1 is connected between these two points, possibly to reduce the ringing even more.

Notice that practically no voltage appears across R1 in normal operation, and it runs cool. But any major change of the voltage drop across C1, C2, L1 or L2 upsets the bridge balance and causes a large voltage across the resistor. Then R1 usually burns up.

C3 is included for the same purpose as was C1 in the first schematic: to reduce ripples of the scanning lines.

One peculiarity of this circuit that's important to troubleshooting is that one parts failure can lead to another. Let's say C1 shorts. Balance of the bridge is upset and R1 runs very hot, perhaps hot enough to burn the insulation from wires of the nearest coil and ruin it.

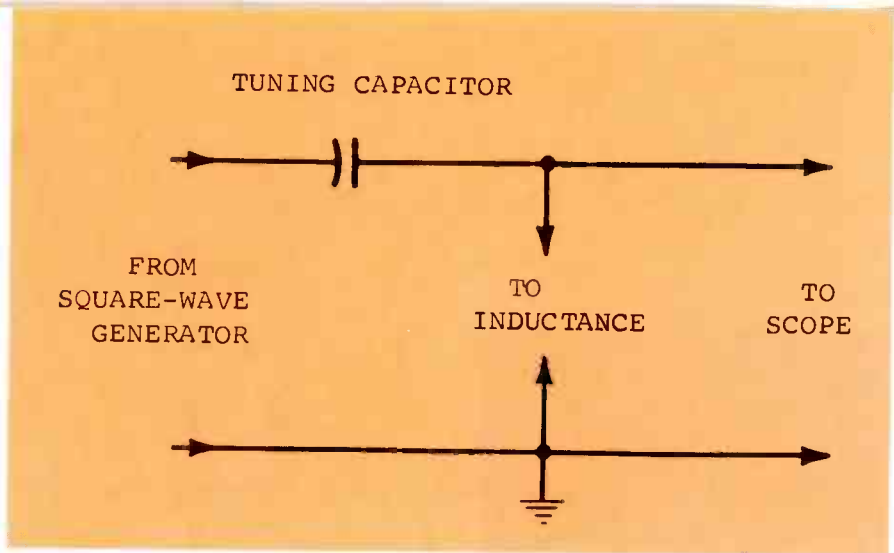

Fig. 7 Circuit to ring inductances by use of square waves requires a generator, scope, a tuning/coupling capacitor and several test leads.

Or the shorted capacitor increases the voltage applied to C2, which in turn might short out.

Color-TV yokes are so difficult to remove and reinstall (usually requiring a complete convergence job) that it's worthwhile to attempt yoke repairs...at least, if only replacement of capacitors or the resistor will be required. Just remember to check **all** those parts

Solid-state yokes

Although the basic principles of solid-state yokes are the same as those for tube sets, the coils are wired in parallel (see Figure 1C) to provide a lower impedance which better matches the transistors. No capacitors are required across the coils when they are paralleled. However, some of the symptoms are reversed when defects occur. Shorted turns are almost certain to kill the high voltage. An open coil produces a trapezoidal picture.

Vertical Yoke Circuits

The schematic of a typical b-w vertical yoke circuit is shown in Figure 4A. Across each yoke coil is a low-value resistor, usually about 470 ohms. Purpose of these resistors is to shorten the ringing time of the vertical-yoke and vertical-output-transformer circuit. Some sets have a capacitor paralleling the output from the vertical-sweep circuit. This is to eliminate any horizontal pulses from the yoke from entering the vertical circuit and possibly causing vertical jitter. Others have a capacitor from the vertical-output plate to ground or

B+. Or there might be a capacitive path to ground in the positive-feedback loop. There is a tendency for these capacitances and the combined transformer/yoke inductances to ring.

Vertical ringing changes the speed of the vertical deflection, so it might show in the picture as one or more horizontal rounded-edge bars at the extreme top of the picture where the scanning lines would be spread apart or compressed.

Such ringing is minimized by the resistors paralleling the yoke coils. A simulated example of how ringing is affected by resistors is shown in Figure 5.

Vertical trapezoids

These anti-ring resistors can cause one unexpected change of symptoms. If one of the yoke coils opens, we would assume a total loss of sweep, since they are in series. But the resistor that is across the open coil furnishes some deflection current to the normal coil. The result is a vertical trapezoid with one side of the picture taller than the other (Figure 6).

Rectangular-tube color receivers usually have additional circuits which multiply the chances of having a trapezoidal picture.

Pincushion-correction circuits

Correction of top and bottom pincushioning is accomplished by filtering part of the horizontal signal and adding it in series with the vertical yoke coils, as shown in Figure 4B. Notice that the anti-ring resistors parallel not only the yoke

coils but part of the pincushion circuit as well.

Open circuits in one side of the tilt coil or a winding of the pincushion transformer also can produce a trapezoidal raster.

Luckily, a positive test for such a possibility can be made easily and quickly. Just use a test lead to clip together the two yoke leads that go to the pincushion circuit. Usually they go to the PC-amplitude control where it's easy to short them together. **Restoration of a full raster proves the open is in the pincushioning circuit and not an open yoke coil.** Then ohmmeter tests can be used to find the open.

Yoke Tests By Ringing

Testing for shorted turns in a coil

or inductance by ringing it with a sharp-edged waveform is not at all new. But there are many variations, each with advantages and limitations. The basic principle is the same: Shock excite a tuned circuit with a pulse, or other sharp-edged waveform, and notice on a scope the length of time the circuit oscillates (or rings). There is a formula for determining "Q" by counting the number of cycles before the amplitude drops to a certain level. But that's too precise for our purposes.

One much-used method is to bring a pulse sample of the horizontal sweep out of the scope. It's not necessary to lock the scope (you get only one waveform no matter what you do), and no extra equip-

ment is needed. But the biggest disadvantage is that the scope's horizontal-sweep frequency is not very stable, and it is extremely difficult to know the frequency. Unless you can reset the frequency quite accurately and use the same coupling capacitor for each test, you will never achieve any reliable results. In that case, you are reduced to comparison tests between a good coil and the suspected one. Unfortunately, you might not have a standard coil, and be compelled to guess again.

And there are some precautions. I'll never forget the scope I modified many years ago by adding an internal capacitor and bringing the pulses out to a binding post on the front panel. Unfortunately, I made two mistakes. First, I did not provide for different sizes of coupling capacitance. I should have used about a .02 internally, because this is about the largest size ever needed (even for audio or vertical-sweep transformers and coils), then any needed value could have been provided externally as needed.

Second, I placed the binding post right beside the input connector for the vertical signal. Nearness of the scopes horizontal-sweep pulses to the input signal resulted in distorted waveforms at the higher scanning frequencies when the scope was used for normal purposes. Moral: Keep all wiring and binding posts far from the vertical input, attenuator, and control circuits.

Other possible problems are the lack of control over amplitude of the pulses, and that the impedance might be too high where the pulses are obtained. Under the worst combination of conditions, the ringing feeds back into the scopes sweep, causing a distorted waveform.

Use square waves

My favorite method of ringing is to use a sine/square generator (having low-impedance output and an attenuator) as a source of square waves. Most audio-service generators are okay for such use.

The circuit (Figure 7) is simplicity itself. A coupling (tuning) capacitor feeds the signal to the inductance, and the scopes input probe parallels the inductance.

Ground rules

The square waves are dif-

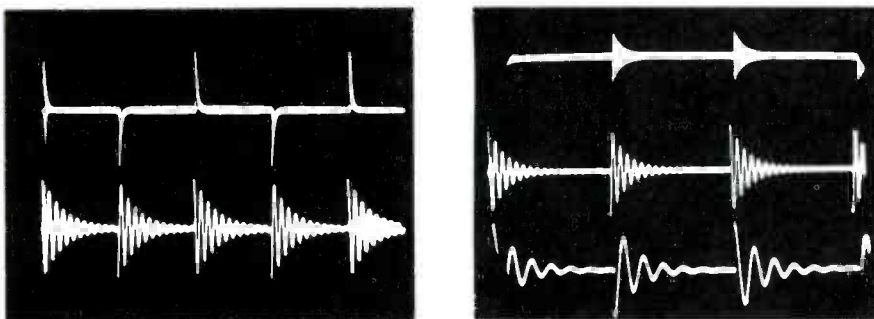

Fig. 8 Waveforms illustrate right and wrong ringing conditions. **(A)** Square waves are differentiated by the capacitance and inductance into pulses (at left), one positive-going and one negative-going for each cycle (top trace). Both ring the circuit, but the start of ringing is up in one case, and down in the other (bottom trace). **(B)** When the inductance does not have external capacitors attached, frequency of the ringing depends largely on the value of the coupling capacitor (picture at right). The horizontal-yoke coils shown in the top trace were rung through a 100 pf capacitor, through a .0025 (center trace), and with a .02 mfd in the bottom waveform. For this yoke, the .0025 gave best amplitude and ringing.

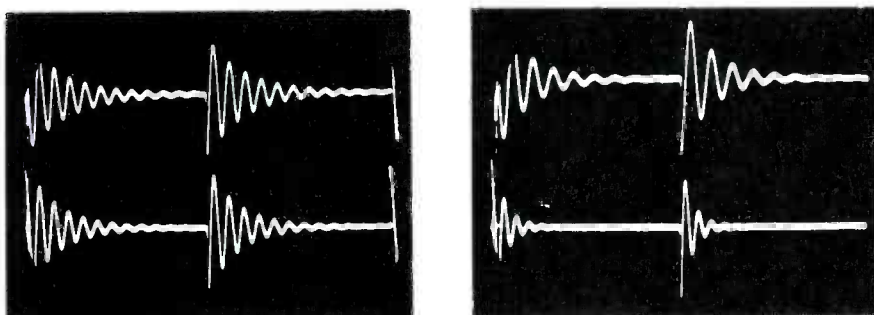

Fig. 9 Examples of ringing a color-TV yoke. **(A)** Proof that each coil is nearly independent (loose coupling) is shown by waveforms at left. Top trace is ringing of one horizontal coil when other coil has no load. Bottom trace is the same, but the other coil is shorted with a test lead. There is no significant difference. **(B)** Both coils of the yoke can be rung together, but there is no standard. Top trace in picture on right shows ringing of both normal coils. Bottom trace is the reduced ringing at a higher frequency when one coil had a dead short.

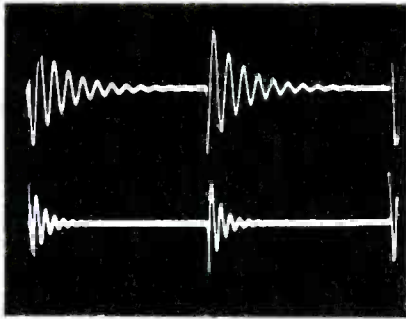

Fig. 10 Because yokes seldom have shorted turns in both coils, it's possible to ring each coil separately, and one then acts as the standard. Top trace shows ringing of the non-defective coil; and ringing of a defective coil that has about one-third of the turns shorted is shown in the bottom trace.

ferentiated into positive- and negative-going pulses by filtering action of the coupling capacitor and the AC impedance of the inductance. Therefore, there are two ringing (damped wavetrains) waveforms for each cycle of the square waves, and the generator should be set for one-half the frequency used with pulses or sawteeth.

Figure 8A shows the relationship between the pulses from the square waves and the ringing waveforms. Notice that the initiating pulses can be seen as the first line of each damped wavetrain. This causes one to start upward, and the next one downward. At first glance the wavetrains seem to be unequal in height because of the way they are started. Usually two or more wavetrains are displayed at once because of the blur seen when both slightly-different waveforms are overlapped.

Actually, there is an advantage in viewing several wavetrains at once. You can easily see the exact starting point and know that none of the waveform is missing (as is the case often when pulses are used for ringing).

Next, the value of the coupling capacitor is fairly critical for best ringing (see Figure 8B). Although it's true each real-world inductance

has stray capacity with which it can self-resonate in the parallel-tuned mode if there are no other capacitances present, in the ringing tests of out-of-circuit components, the coupling capacitor is dominant, which changes it to a series-resonant circuit. I favor using a capacitance value that gives nearly maximum amplitude of ringing when the frequency is adjusted to barely permit the ringing to die away between cycles. It's very easy to find this best value, if you use a component-substitution box.

Ringing yokes

One built-in advantage of ringing yokes is the two identical coils; one is the suspect and the other is the standard. But first we must prove such a test to be valid.

Earlier I made the statement that coupling between the two horizontal or the two vertical-yoke coils was very loose. The waveforms of Figure 9A show the ringing of one horizontal coil of an old color-TV yoke when the other coil was not connected and when it was shorted with a test lead. Practically no change occurred when the coil was shorted. This is proof of the lack of coupling between the coils.

In Figure 9B, the ringing is applied to both coils in series, then one coil is shorted out with a test lead. The results showed lower "Q" (amplitude) at a higher ringing frequency when the coil was shorted. But, unless you have a standard yoke for instant comparison, ringing both coils in series tells very little about the condition.

Lastly, ringing was applied to the good coil and then immediately transferred to the suspected coil (that for the test had about one-third of the winding shorted out). Ringing of the shorted coil (Figure 10) showed lower amplitude at a higher frequency and more damping. No question whether or not the coil had shorted turns.

Ringing can be used to check the vertical coils, too. However, the damping resistors must be removed first.

Case Histories

Case #1

Symptoms: No raster, no high voltage on an old b-w TV with a yoke circuit similar to that in Figure 1A.

Repairs: Disconnecting yoke produced a B-boost voltage about 50% above normal, indicating a defective yoke. Discovered C1 shorted and visibly burned so part of yoke cover had been carbonized. Replaced the capacitor, and exchanged yoke cover with one from a junker.

Notes: Not all sets will lose high voltage when the capacitor shorts, or when there are shorted turns in one horizontal-yoke coil. When raster is visible, it will be trapezoidal, and the high voltage will be found to be low because the entire sweep circuit is tuned to a too-high frequency.

Case #2

Symptoms: Color TV with circuit of Figure 1B had burned smell, no raster and no high voltage. Ringing tests of horizontal sweep both with and without the yoke connected showed the yoke had nearly a dead short. (Very unusual, because shorted turns usually occur in only one of the two coils.)

Repairs: C1, C2 and R1 were burned to a crisp. When they were disconnected, ringing tests showed the yoke coils to be okay. Replaced the parts and the spaghetti for one of the internal wires. It had been melted by the heat. My guess is that one capacitor shorted, burning up the resistor; that overloaded the remaining capacitor with excessive voltage so it shorted, also.

Case #3

Symptoms: Picture very narrow at the top, bloomed easily and was out of focus. Yoke circuit similar to Figure 1B.

Repairs: The yoke had shorted turns in the coil at top, and a new yoke plus purity and convergence was necessary.

Notes: One quickie test, that works best with b-w yokes where there is no disadvantage to moving the yoke is to operate the receiver for a few minutes, then turn it off and feel the yoke coils using your fingers. A hot spot in just one area usually indicates shorted turns.

Case #4









Symptoms: A color receiver having the vertical circuit of Figure 4B intermittently showed a picture of

(Continued on page 53)

SIGNATURE PATTERNS

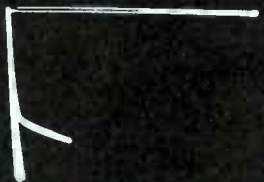
Made On Jud Williams Model A Curve Tracer

MAGNAVOX CHASSIS T979

MANUFACTURER MAGNAVOX		MODEL OR CHASSIS T979	
TRANSISTOR IDENTIFICATION & CURVE TRACER SETTINGS		SIGNATURE PATTERNS	
Q1 1ST IF A BD			
POLARITY	NPN		
SWEEP VOLTAGE	30V		
BASE CURRENT	500uA		
Q2 2ND IF A BD			
POLARITY	NPN		
SWEEP VOLTAGE	30V		
BASE CURRENT	50uA		
Q3 3RD IF A BD			
POLARITY	NPN		
SWEEP VOLTAGE	30V		
BASE CURRENT	200uA		
Q4 VIDEO DRIVER A BD			
POLARITY	PNP		
SWEEP VOLTAGE	30V		
BASE CURRENT	50uA		
Q5 AUX IF A BD			
POLARITY	NPN		
SWEEP VOLTAGE	30V		
BASE CURRENT	500uA		
Q6 AFT AMP A BD			
POLARITY	NPN		
SWEEP VOLTAGE	30V		
BASE CURRENT	10uA		
Q1 3.58 OUT B BD			
POLARITY	NPN		
SWEEP VOLTAGE	30V		
BASE CURRENT	100uA		
Q2 R-Y DRIVER B BD			
POLARITY	NPN		
SWEEP VOLTAGE	30V		
BASE CURRENT	10uA		
Q3 B-Y DRIVER B BD			
POLARITY	NPN		
SWEEP VOLTAGE	30V		
BASE CURRENT	20uA		
Q4 B-Y OUT B BD			
POLARITY	NPN		
SWEEP VOLTAGE	30V		
BASE CURRENT	50uA		

MANUFACTURER MAGNAVOX	MODEL OR CHASSIS T979
TRANSISTOR IDENTIFICATION & CURVE TRACER SETTINGS	SIGNATURE PATTERNS

MANUFACTURER MAGNAVOX	MODEL OR CHASSIS T979
TRANSISTOR IDENTIFICATION & CURVE TRACER SETTINGS	SIGNATURE PATTERNS

Q5 G-Y DRIVER B BD	
POLARITY NPN	
SWEEP VOLTAGE 30V	
BASE CURRENT 20uA	

Q11 NOISE CANC B BD	
POLARITY PNP	
SWEEP VOLTAGE 30V	
BASE CURRENT 50uA	

Q6 R-Y OUT B BD	
POLARITY NPN	
SWEEP VOLTAGE 30V	
BASE CURRENT 50uA	

Q1 CHROMA AMP C BD	
POLARITY NPN	
SWEEP VOLTAGE 30V	
BASE CURRENT 100uA	

Q7 G-Y OUT B BD	
POLARITY NPN	
SWEEP VOLTAGE 30V	
BASE CURRENT 50uA	

Q2 BANDPASS C BD	
POLARITY NPN	
SWEEP VOLTAGE 30V	
BASE CURRENT 100uA	

Q8 IF AGC B BD	
POLARITY NPN	
SWEEP VOLTAGE 30V	
BASE CURRENT 20uA	

Q3 CHROMA OUT C BD	
POLARITY NPN	
SWEEP VOLTAGE 30V	
BASE CURRENT 200uA	

Q9 RF AGC INV B BD	
POLARITY NPN	
SWEEP VOLTAGE 30V	
BASE CURRENT 20uA	

Q4 COLOR KILLER C BD	
POLARITY NPN	
SWEEP VOLTAGE 30V	
BASE CURRENT 10uA	

Q10 AGC KEYER B BD	
POLARITY PNP	
SWEEP VOLTAGE 30V	
BASE CURRENT 10uA	

Q5 ACC DRIVER C BD	
POLARITY NPN	
SWEEP VOLTAGE 30V	
BASE CURRENT 200uA	

MANUFACTURER MAGNAVOX	MODEL OR CHASSIS T979
TRANSISTOR IDENTIFICATION & CURVE TRACER SETTINGS	SIGNATURE PATTERNS

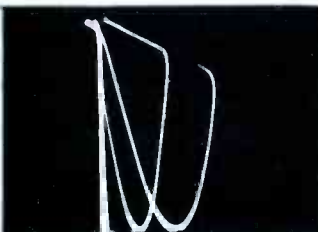
Q6 KILLER ACC C BD	
POLARITY NPN	
SWEEP VOLTAGE 30V	
BASE CURRENT 10uA	

Q7 BURST AMP C BD	
POLARITY NPN	
SWEEP VOLTAGE 30V	
BASE CURRENT 50uA	

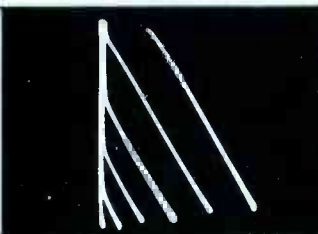
Q8 3.58 OSC C BD	
POLARITY NPN	
SWEEP VOLTAGE 30V	
BASE CURRENT 50uA	

Q9 3.58 AMP C BD	
POLARITY PNP	
SWEEP VOLTAGE 30V	
BASE CURRENT 100uA	

Q10 PHASE SPLITTER C BD	
POLARITY NPN	
SWEEP VOLTAGE 30V	
BASE CURRENT 50uA	

Q11 3.58 DRIVER C BD	
POLARITY NPN	
SWEEP VOLTAGE 30V	
BASE CURRENT 50uA	

MANUFACTURER MAGNAVOX	MODEL OR CHASSIS T979
TRANSISTOR IDENTIFICATION & CURVE TRACER SETTINGS	SIGNATURE PATTERNS

Q1 VIDEOMATIC MODULE H BD	
POLARITY PNP	
SWEEP VOLTAGE 30V	
BASE CURRENT 50uA	

Q1-Q2-Q3 D BD	NO SIGNATURE PATTERN: UNPLUG TO TEST.
POLARITY	
SWEEP VOLTAGE	
BASE CURRENT	

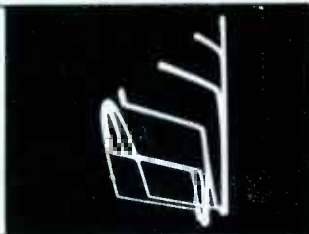
Q4 SYNC SEP D BD	
POLARITY PNP	
SWEEP VOLTAGE 30V	
BASE CURRENT 10uA	

Q5 SYNC PHASE SPLITTER D BD	
POLARITY NPN	
SWEEP VOLTAGE 30V	
BASE CURRENT 50uA	

Q6 SYNC KEYS D BD	USED IN SEARCH VERSIONS ONLY. NOT INCORPORATED INTO SAMPLE CHASSIS.
POLARITY	
SWEEP VOLTAGE	
BASE CURRENT	

Q7 REACT CONTROL D BD	
POLARITY NPN	
SWEEP VOLTAGE 30V	
BASE CURRENT 10uA	

MANUFACTURER MAGNAVOX	MODEL OR CHASSIS T979
TRANSISTOR IDENTIFICATION & CURVE TRACER SETTINGS	SIGNATURE PATTERNS

MANUFACTURER MAGNAVOX	MODEL OR CHASSIS T979
TRANSISTOR IDENTIFICATION & CURVE TRACER SETTINGS	SIGNATURE PATTERNS

Q8 HORIZ OSC D BD	
POLARITY NPN	
SWEEP VOLTAGE 30V	
BASE CURRENT 10uA	

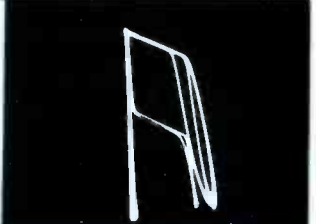
Q5 BLANKER E BD	
POLARITY NPN	
SWEEP VOLTAGE 30V	
BASE CURRENT 50uA	

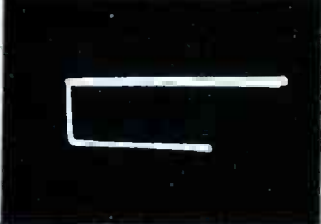
Q9 HORIZ DRIVER D BD	
POLARITY NPN	
SWEEP VOLTAGE 30V	
BASE CURRENT 500uA	

Q6 BEAM LIMITER E BD	
POLARITY PNP	
SWEEP VOLTAGE 30V	
BASE CURRENT 1000uA	

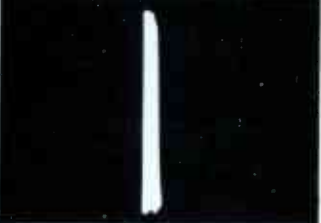
Q1 1ST LUM AMP E BD	
POLARITY NPN	
SWEEP VOLTAGE 30V	
BASE CURRENT 50uA	

Q1 REGULATOR DRIVER F BD	
POLARITY NPN	
SWEEP VOLTAGE 30V	
BASE CURRENT 20uA	

Q2 2ND LUM AMP E BD	
POLARITY PNP	
SWEEP VOLTAGE 30V	
BASE CURRENT 100uA	

Q201 REGULATOR	
POLARITY NPN	
SWEEP VOLTAGE 80V	
BASE CURRENT 1000uA	

Q3 LUM DRIVER E BD	
POLARITY NPN	
SWEEP VOLTAGE 30V	
BASE CURRENT 200uA	

Q301 VERT OUTPUT	
POLARITY NPN	
SWEEP VOLTAGE 40V	
BASE CURRENT 500uA	

Q4 LUM OUTPUT E BD	
POLARITY NPN	
SWEEP VOLTAGE 50V	
BASE CURRENT 200uA	

Q302 HORIZ OUTPUT	
POLARITY NPN	
SWEEP VOLTAGE 40V	
BASE CURRENT 1000uA	

Index of 1973 articles

ANTENNA AND CABLE SYSTEMS

Can't be anything wrong, MATV system is new Sep. 39
Details of new RCA cable receivers Oct. 18
Is it the cable...or the TV? Oct. 24
Living with snow from cable Mar. 38
Make money beating the sports blackout Apr. 14

AUTO ELECTRONICS

First look at Delco radio/tape combo Jan. 32
Working with car radio tuners Oct. 40
How to start auto-sound business Nov. 38

BUSINESS

Advertise now to boost business May 22
Better to push service or sales? Mar. 14
Business-tax calendar Jun. 34
Customer security Dec. 35
Ease the pain of taxes Mar. 22
Good reading for better business Jul. 20
How to start auto-sound business Nov. 38
How to meet competition Sep. 22
Improve your cash management Oct. 30
Inventory control for small shop Jan. 16
Learning to use "thumbnails" Jun. 44
Practical inventory-control system Feb. 28
Retention and protection of records Aug. 56
Your employees...major factor in success Apr. 34

COLOR TV

Brightness changed the height Mar. 24
Details of new RCA cable receivers Oct. 18
Finding source of noise spots and lines Mar. 28
Horizontal sweep revisited, part 1 Dec. 14
Is it cable...or TV? Oct. 24
Living with snow from cable Mar. 38
New from Zenith...voltage-regulating transformer Sep. 34
New ways of servicing video Feb. 44
Servicing SCR deflection, part 1 Jun. 38
Servicing SCR deflection, part 2 Jul. 22
Servicing SCR deflection, part 3 Aug. 24
Servicing solid-state AGC Aug. 42
Servicing two HV regulators Feb. 32
Solving elusive color problems Nov. 45
Strange case of vertical roll Jan. 20
Taming color rainbows, part 2 Jan. 24
Troubleshooting RCA CTC38 chassis Mar. 44
Ups and downs of vertical deflection Apr. 30
Understanding foreign color systems Sep. 40
Understanding signal-seeking UHF tuner Jan. 28
Universal color-TV setup procedures, part 1 May 44
Universal color-TV setup procedures, part 2 Jun. 22
Where did the convergence go? May 28

HORIZONTAL AND HIGH VOLTAGE

Horizontal sweep revisited, part 1 Dec. 14
Finding source of noise and lines Mar. 28

Servicing SCR deflection, part 1 Jun. 38
Servicing SCR deflection, part 2 Jul. 22
Servicing two high-voltage regulators Feb. 32

DIGITAL LOGIC

Basics of digital logic May 14
Digital logic, part 2 Jun. 28
Digital logic, part 3 Jul. 32
VHF scanners...a new challenge Dec. 38

MISCELLANEOUS

Advanced servicing of CB radio, part 1 Jun. 14
Advanced servicing of CB radio, part 2 Jul. 40
Advanced servicing of CB radio, part 3 Aug. 30
"Close-ups sharp, but backgrounds blurred" Jan. 36
Index of 1972 articles Jul. 28
News from CES show Sep. 26
Record-changer workshop, part 1 Nov. 14
Record-changer workshop, part 2 Dec. 24
VHF scanners, a new challenge Dec. 38

SECURITY SYSTEMS

Electronics of security Mar. 18
Installing and servicing security systems Aug. 18
Introduction to security systems Jan. 13
Misbehaving microwave May 36
Tips for selling security systems Sep. 18

SOLID STATE

Is the transistor oscillating? Dec. 32
New look at transistor substitution Feb. 39
New way of servicing video Feb. 44
Practical "quicktesting" of transistors Nov. 31
Test transistors by bias-shifting Mar. 34
Radio repairs can be frustrating May 34
Tips for servicing low-level audio Jul. 14
Troubleshooting solid-state AGC circuits Aug. 42
Understanding solid-state ignition Aug. 38
Using "Signature Patterns" for solid state Apr. 38

TEST EQUIPMENT

Are triggered scopes better? Feb. 14
Curve tracers revisited Apr. 44
Faster way of aligning FM receivers Apr. 22
1973 scope roundup Feb. 22
Using dual-trace scope for troubleshooting Dec. 18

VERTICAL CIRCUIT

Ups and downs of vertical deflection Apr. 30
Strange case of vertical roll Jan. 20

SIGNATURE PATTERNS

Admiral 2K20 chassis Aug. 53
General Electric 25MA chassis Nov. 26
Motorola CA29D and BA15 panels Jul. 37
RCA CTC48 chassis Oct. 34

Sylvania D18 and D19 chassis	May 40
Wells Gardner (Coronado, Penney, Bradford and Catalina) chassis T-7000	Dec. 36
Zenith 25DC56 chassis	Jun. 42

SYMCURE

ADMIRAL

K10-2A insufficient height; hold control at one end	Jan. 8
K19 burned volume control	Dec. 8
K20 failure of audio IC	Dec. 8
1K10-1A intermittently-weak picture and sound	Jan. 8
1K10-1A excessive brightness; weak and distorted video	Jan. 8
3H10 color cannot be locked	Jan. 8

CORONADO

TV2 6618A low HV and insufficient drive from horiz oscillator	Feb. 8
---	--------

GENERAL ELECTRIC

C-1 intermittent or no color	Feb. 8
C-2/L-2 weak or no horiz locking	Mar. 8
C-2/L-2 insufficient height or poor linearity following 16LUB replacement	Mar. 8

PACKARD BELL

98C19 Q4 video amplifier transistor runs hot	Apr. 8
98C19 intermittent high voltage	Apr. 8
98C19 no color, or intermittent color	Apr. 8

PHILCO

all hybrid color-picture negative or has white compression	May 12
all hybrid color-left edge or raster tinted, and smeared color	May 12
all hybrid color-colors are mainly magenta	May 12
all hybrid color-color slow to come on, or out of lock	May 12
all hybrid color-soft vertical locking or shimmy	May 12
all hybrid color-vertical b-w bars	May 12
most hybrids-picture 3 inches to the right	Dec. 8
19QT87 horiz pulling, perhaps intermittently	Sep. 12
19QT87 picture displaced 3 inches to the right	Sep. 12

RCA

CTC38 varying brightness and horiz locking	Mar. 8
CTC38X excessive brightness with retrace lines	Dec. 8
CTC39 excessive brightness, little control	Jun. 8
CTC39 no color	Nov. 10
CTC40 poor locking, sync bending	Jun. 8
CTC44 intermittently-blurred picture	Oct. 12
CTC44 vertical retrace lines, brightness control operates backward	Oct. 12
CTC44 colored hum bar moves upward	Jun. 8
CTC44 "pie-crusting" that varies with brightness	Dec. 8
CTC44 breaker opens following SCR replacements	Dec. 8
CTC46 intermittent color when control bin is tilted	Jun. 8
CTC46 insufficient height	Mar. 8
CTC46 and CTC48 excessive brightness with retrace lines	Nov. 10
CTC46 and CTC48 herringbone interference pattern	Nov. 10
CTC46 and CTC48 excessive brightness	Nov. 10
CTC46 and CTC54 excessive failure of SCR101	Nov. 10
CTC51 insufficient height or intermittent height	Jun. 8
CTC52 insufficient height or intermittent height	Jun. 8
CTC53 insufficient height or intermittent height	Jun. 8
CTC54 colored hum bar moves upward	Jun. 8
CTC54 circuit breaker opens at turn on	Nov. 10

CTC55 insufficient height or intermittent height	Jun. 8
--	--------

SILVERTONE

528.4347 excessive color and reddish tint	Feb. 8
528.4347 several horiz bars in picture	Feb. 8

SYLVANIA

D12 poor color, might appear as bad alignment	Oct. 8
D12 insufficient AGC	Oct. 8
D12 weak color, intermittent color locking	Oct. 8
D16 critical horiz locking	Oct. 8
D16 no high voltage, output tube hot	Oct. 8
D16 no raster, high voltage okay	Apr. 8
D16 horiz bending, poor AGC action	Apr. 8
D16-07 ringing in picture, no snow off-channel	Oct. 8
D19 insufficient height	Apr. 8
E01 at low brightness level, the picture flickers	Mar. 8
E01 excessive brightness, and control has no effect	Mar. 8

WARDS

GEN-11960A no vertical or horiz locking	Jan. 8
GEN-11960A picture bending and horiz instability	Jan. 8

ZENITH

4B25C19 failure of IC2 in early-production sets	Aug. 10
14DC15 and 14DC16 a good 21LF6 won't work but 26LX6 will	Aug. 10
14DC15 and 14DC16 hook at top and picture bends	Jul. 12
14Z33 vertical won't adjust to 60 Hz	Sep. 12
16Z7C19Z poor quality and intermittent color	Feb. 8
19CC19 failure of IC2 in early-production sets	Aug. 10
19DC12 buzz in the sound on UHF	Aug. 10
20Y1C38 soft locking, hook at top of picture	Sep. 12
23XC38 weak color	Feb. 8
25CC55 and 25DC57 loses HV during channel changes	Jul. 12
25DC56 vertical jitter on cable signals	Jul. 12
25DC56 double bend moves up the picture	Jul. 12
25DC56 (solid state) no high voltage, horiz driver transistor hot	Jul. 12
25DC56 one vertical line in center (no horiz deflection)	Jul. 12
25DC56 horizontal-output transistor hot, fails in few minutes	Aug. 10
25DC56 vertical jitter and poor interlace	Aug. 10
25DC56 picture is too far to the left	Aug. 10

TROUBLESHOOTING TIPS

ADMIRAL

H-10 narrow picture	Sep. 8
K19 poor horiz locking	May 8
K19 dark picture, or retrace lines	May 8
6H10 drifting bar of color	Oct. 10
12K20 dark picture without locking	Jun. 12

CURTIS MATHES

C40 weak horiz locking	Oct. 11
------------------------------	---------

EMERSON

30M20 horiz oscillator dead	Apr. 12
-----------------------------------	---------

GENERAL ELECTRIC

C-2/L-2 no high voltage, output tube runs red	Aug. 8
C4506F distorted audio, then no sound	Apr. 12
GB-21 excessive tube and flyback failures	Nov. 8
KD no b-w video	Aug. 8
MA flashes of color	July 8
U-1 horiz output transistor fails repeatedly	Nov. 8

JVC (CATALINA)

7408 intermittent vertical jitter Mar. 12

MAGNAVOXT924 no reds in color picture Apr. 26
T933 picture bending, or loss of sync Dec. 11
T939 linearity stretched at top Jun. 12
T952 smear of one color Jun. 12**PACKARD BELL**1C620 intermittent horiz oscillator Oct. 10
2M321 poor linearity Sep. 10**PANASONIC**CT25 poor vertical convergence following breakage
of 25HX5 tube Mar. 12
CT92 weak blue Oct. 10
N93A b-w vertical foldover Oct. 10**PENNCREST**

2631-48A audio distortion and poor AGC Aug. 8

RCACTC16 vertical retrace lines May 8
CTC16XL low gain, reduced contrast Aug. 8
CTC22AD intermittent blooming Nov. 9
CTC38 intermittent locking and contrast Jul. 8
CTC38 yellow picture on right Sep. 10
CTC48 narrow raster, excessive high voltage causing
HV-disable circuit to eliminate horiz locking Mar. 12
CTC52 no color May 8
KCS169B left side of picture blanked out Jun. 12**SILVERTONE**564.40050100 negative picture and weak
vertical sync Sep. 8**SYLVANIA**

D15 sudden change of vertical convergence Nov. 8

ZENITH12A10C15 intermittent raster Apr. 12
12B14C50 burned smell Jun. 12
14B38Z decreasing contrast Jul. 7
14B38Z vertical roll Jul. 7
14CC16 two complete pictures Jul. 7
14Z33 decreasing contrast Jul. 7
14Z34 decreasing contrast Jul. 7
14Z43 decreasing contrast Jul. 7
17EC45 no vertical sweep Dec. 10
20CC50 horiz pulsations Dec. 10
23DC14 intermittent vertical collapse to a
4-inch picture Mar. 12
25DC56 picture tube appears weak Dec. 10
25MC36 horiz wobble Dec. 10**MISCELLANEOUS**All "hot-chassis" sets—safety precaution Jul. 8
Malfunctioning defrost light—1973 Ford with
two-way business radio Sep. 8
Any television receiver—HV arcs, or flashing
in CRT May 8
B-W TV receivers—no high voltage Apr. 26
Any FM receiver using uA703 IC—defective IC Mar. 12
All brands and models—troubleshooting tip Dec. 11
Any tube-type horiz circuit—simplified
ringing test Apr. 12

the new automatics . . .

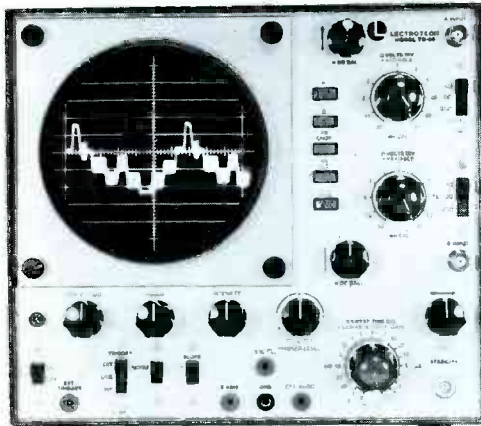

Made in U.S.A.

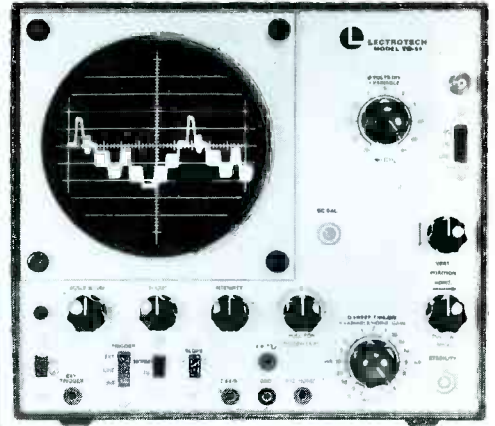
TO-60 automatic dual-trace triggered sweep oscilloscopeBandwidth: DC 15 MHz
10 mV sensitivity **\$459.50****TO-55 automatic single-trace triggered sweep oscilloscope**Bandwidth: DC 10 MHz
10 mV sensitivity **\$349.50**

Made in U.S.A.

Two outstanding new five inch oscilloscopes with exceptional stability, featuring:

- Automatic Triggering • Automatic Astigmatism • Automatic Horizontal Sweep • Automatic TV Trigger Selection • All Switching 1-2-5 Sequence • Vertical Amplifier Sensitivity: .01 volts/div. • Horizontal Sweep Speed .2 Sec.—.5 μ Sec./div. • 5x Magnifier • All Solid State • TO-60 Dual Trace Capability: Channel "A", Channel "B", A-B Chopped, A-B Alternate, Sum of A & B.



See your distributor or write:

LECTROTECH, INC.

5810 N. Western Avenue, Chicago, Illinois 60659 (312) 769-6262

Available in Canada
from
Superior Electronics
Inc.

For More Details Circle (23) on Reply Card

January, 1974/ELECTRONIC SERVICING 39

Record changer workshop ^{part 3}

By Forest H. Belt, CET

Record changers usually cost less than high-fidelity turntables and you'd expect they might be simpler. Not necessarily so. Often you'll find just the opposite; a turntable can be deceptively simple. Only the troubles they develop seem complicated.

Operating principles are nearly the same for both kinds of machine. Certain basic functions must take place in either one. These consist of tripping (initiating

the cycle), driving the cycling mechanism, lifting the arm, swinging it, dropping the record, swinging back the arm and lowering it in the right place (indexing). Most also shut off automatically.

Of course, there are some variations of design. But learn how these basic operations are performed, and you know the secrets of any machine. In this session, you see the functions of an ordinary record changer. Next month, a hi-fi turntable is the subject.

Step 1 Let's start with tripping. The key part is the trip tab, a little metal piece on the cycling cam. You can see it here, as it appears when tripped. Normally, it's back out of sight.



Step 2 The tab, when pushed out toward the spindle as shown, catches on this projection as the hub of the platter turns. The hub hits the tab, pulling the cycling gear into mesh with the hub gears.

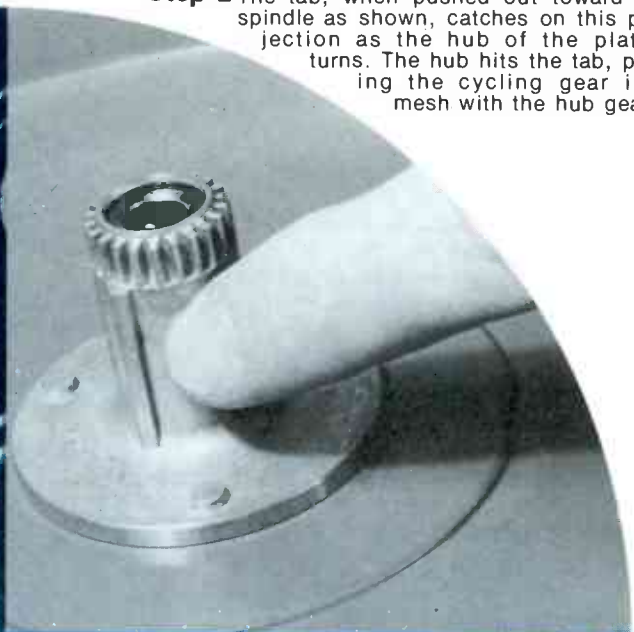

Step 3 The cycle can be initiated manually, by twisting the Reject knob. Underneath, that pulls a rod which nudges the trip tab out into the path of the hub projection.

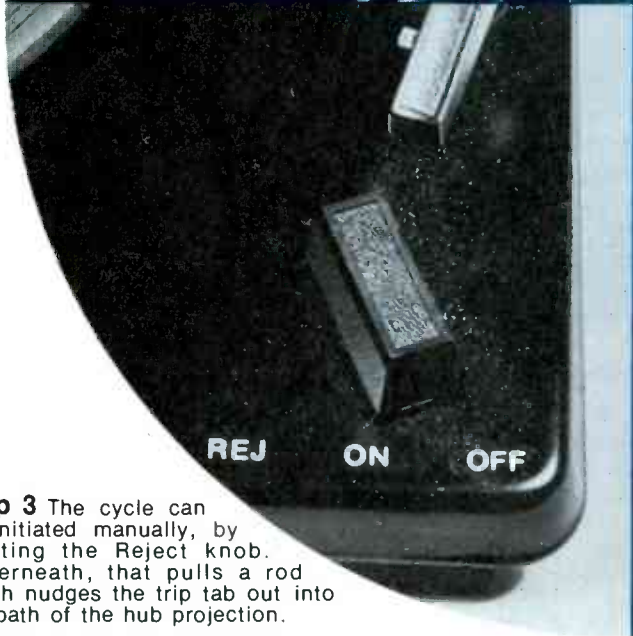

Step 4 Tripping occurs automatically when the tone arm reaches the leadout groove of the record. The tone arm assembly pulls the slide and nudges the trip tab.

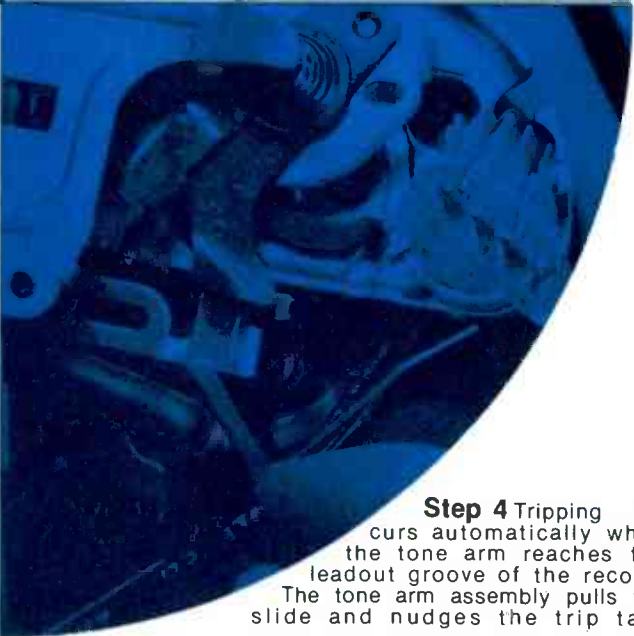

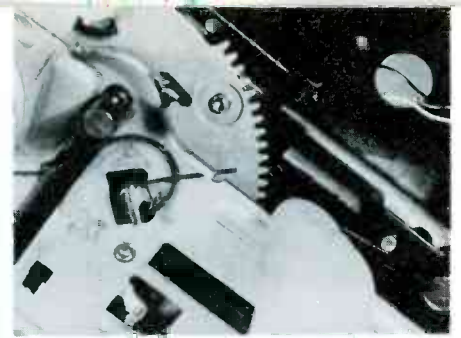
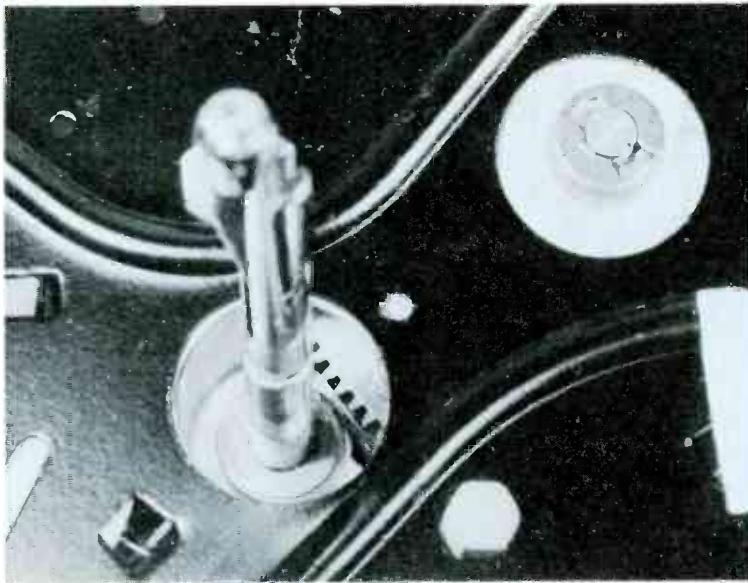

Step 5 In the top view, you can see the teeth of the cycling gear after the tab has pulled it into mesh with the hub (platter removed for this photo). View of the bottom of the changer shows the gear from the underside, with the Teflon detent pawl visible coming out from behind the cycling slide. The gap you see in the teeth is the same one as in Step 1.

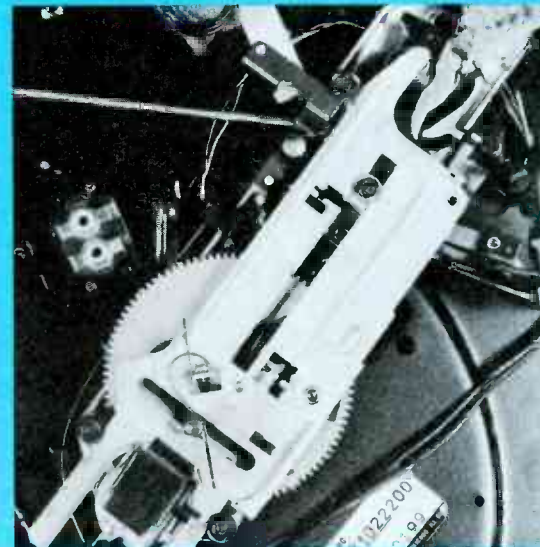
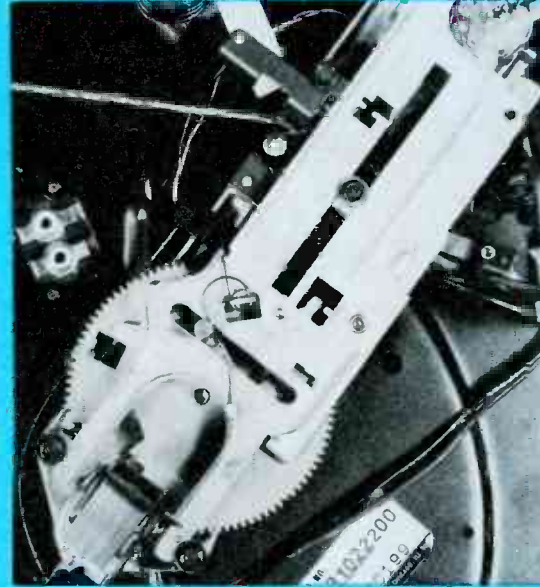
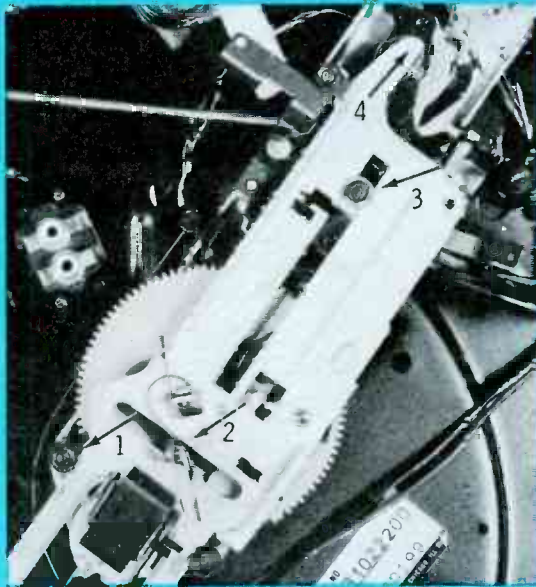

Step 6 The white rectangular-shaped part is the cycling slide, and the round part with the teeth is the cycling gear. Revolutions of the cycling cam gear drive the cycling slide sideways by means of a post mounted off-center on the cycling cam (arrow #2). It is visible in the cross-slot of the slide. As the cam gear turns, the post moves the slide (to the right and up in the photo). To prevent movement of the slide towards or away from the base, it is held in three places, the screw at #1, plus another at the opposite side of the slide, and one at #3. Movement of the slide is clear when compared to these three points. As the slide moves fully to the right and back, it initiates the record drop (parts near the left end of the slide), arm lift (ramp portion near #4), arm swing and backswing (parts between the slide and the baseplate), and arm lowering (ramp at #4). Notice the position of the post and slide in each photo in turn.

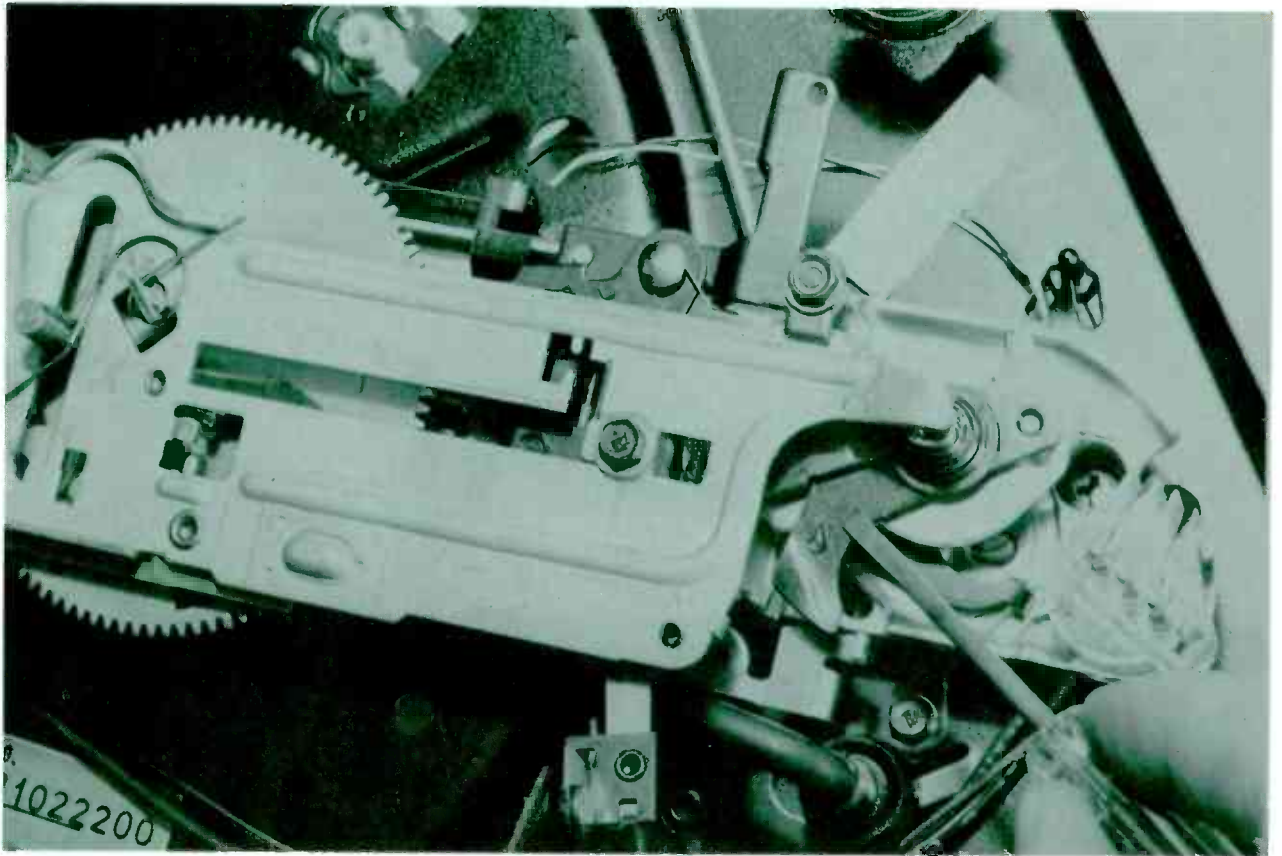

Step 7 This photo shows the arm that fastens to the bottom of the tone-arm lateral-pivot spindle. It has two jobs. It operates the trip slide (already explained) as the tone arm travels in the lead-out groove. And, during the cycle, the cycling slide catches the other end (opposite the screwdriver) and swings the tone arm laterally. It's sometimes called the lateral arm.



Step 8 These photos show the mechanics of the tone-arm lift. In the below-deck view, the ramp part of the cycling slide is raising the lift rod. In the top view, the upper end of the lift rod (arm moved out of the way for photo) is shown at the top of its travel.



Step 9 The spindle in most record changers can't easily be removed as it can from automatic turntables, for it has more to do with record dropping. The cycling slide, as it reaches almost the half-cycle position, encounters a rocker-type pawl. That lifts the center rod of the spindle, operating the pushoff tab and dropping the record.

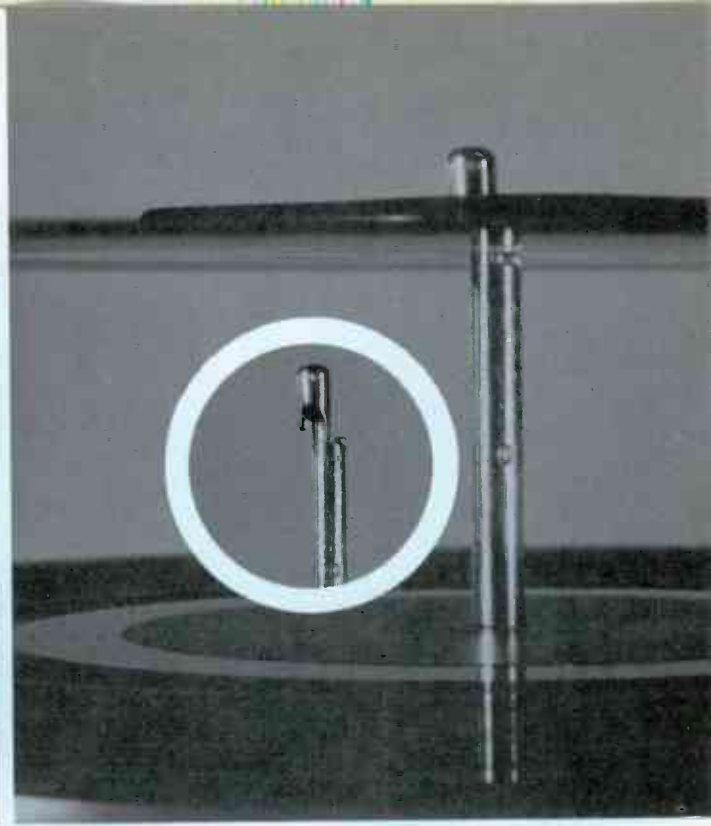
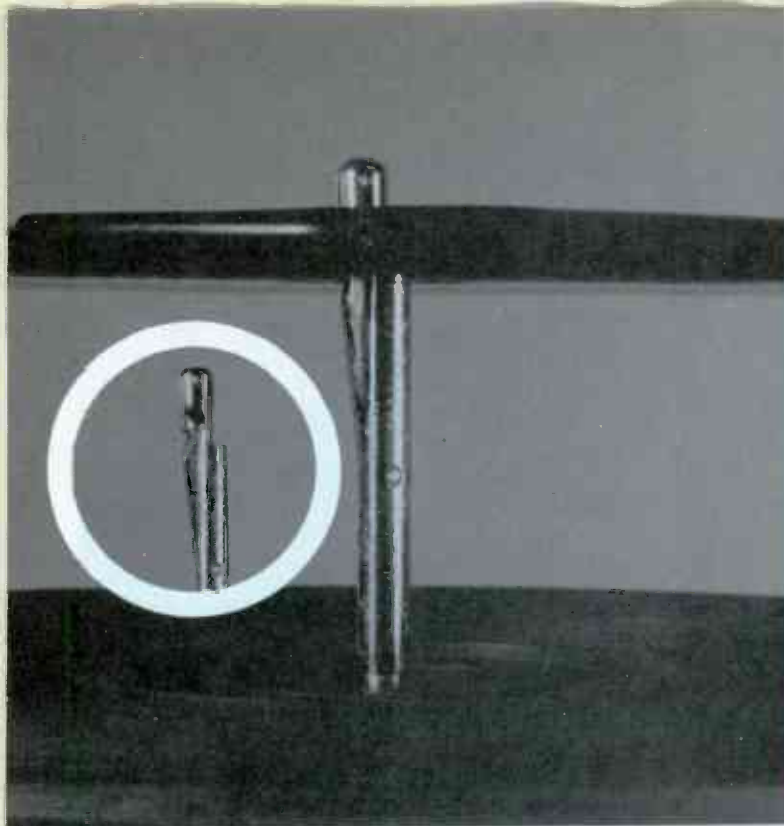

Step 10 Sequence of record dropping by the spindle is as follows: the records are placed on the spindle (inset of photo one shows how the pushoff tab does not permit the record to move sideways and fall down accidentally). The stabilizer arm is brought into position over the records to keep them level; now the action of the cycling slide moves the pushoff tab sideways inside the spindle, pushing off the lower record (photo two) which falls to the platter for

playing; the next record settles to the offset notch of the spindle while the pushoff tab is still over; then the pushoff tab is returned to its normal exposed position. Notice the small sliding part at the top of the spindle. Its only function is to move upward out of the way when the records are removed. But if it sticks at the top of its travel, records often drop at the wrong time.

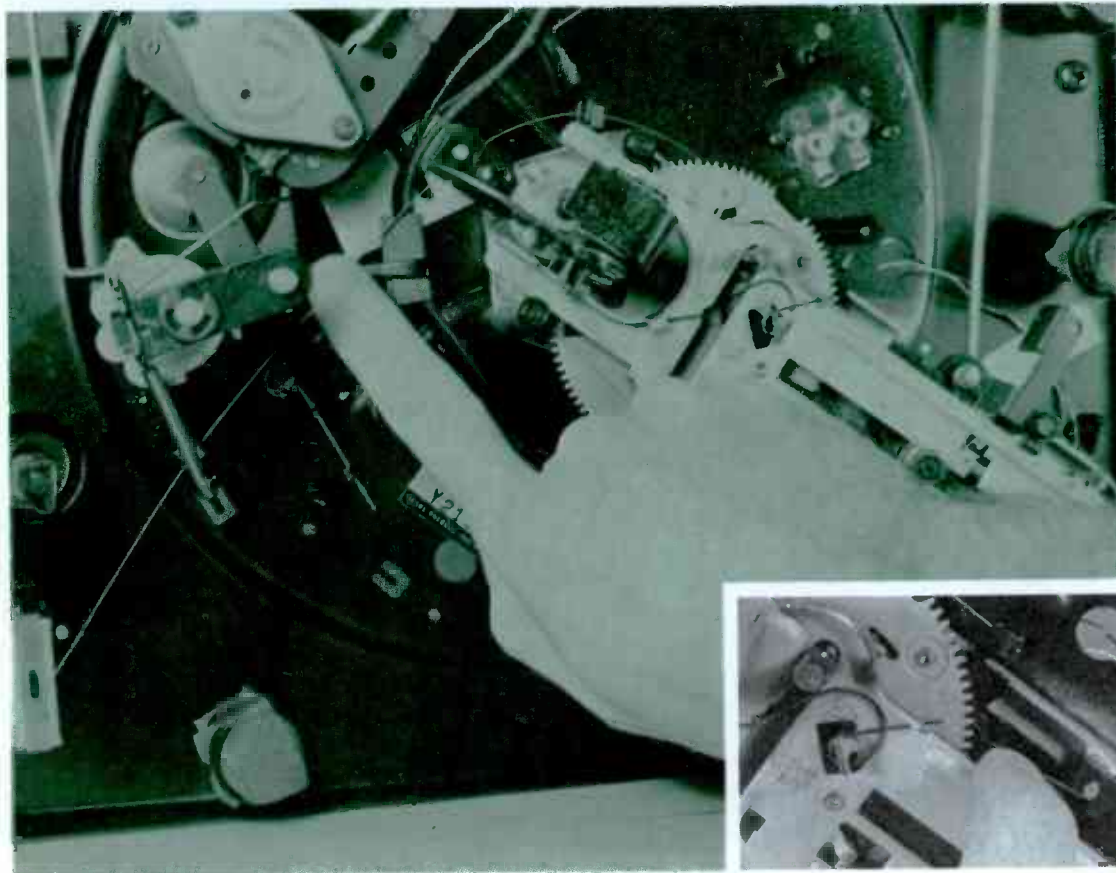

Step 11 Record-size indexing in this model changer is set by movement of a top-of-the-plate knob (near left hand). In turn, the wire (near right-hand index finger) moves the indexing latch bar (other photo) so the tone arm assembly is stopped in its swing-back movement by one of a series of "stair-steps".

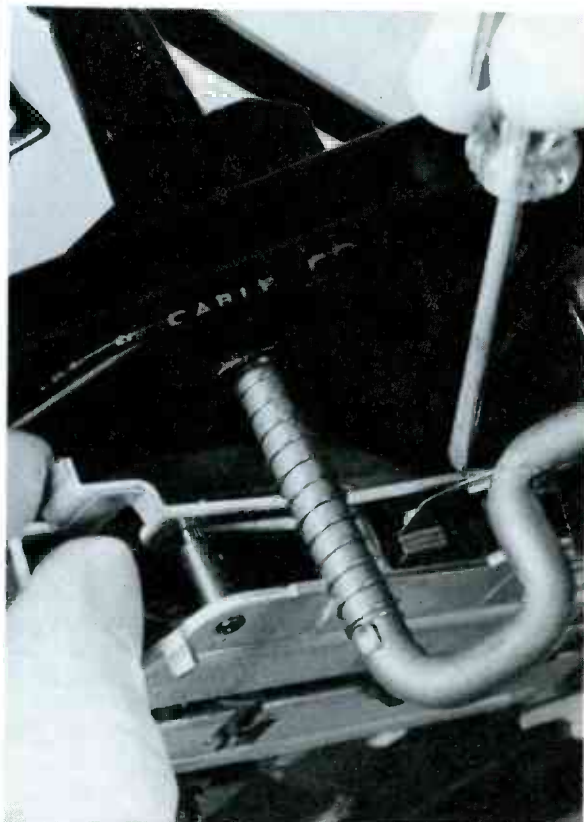
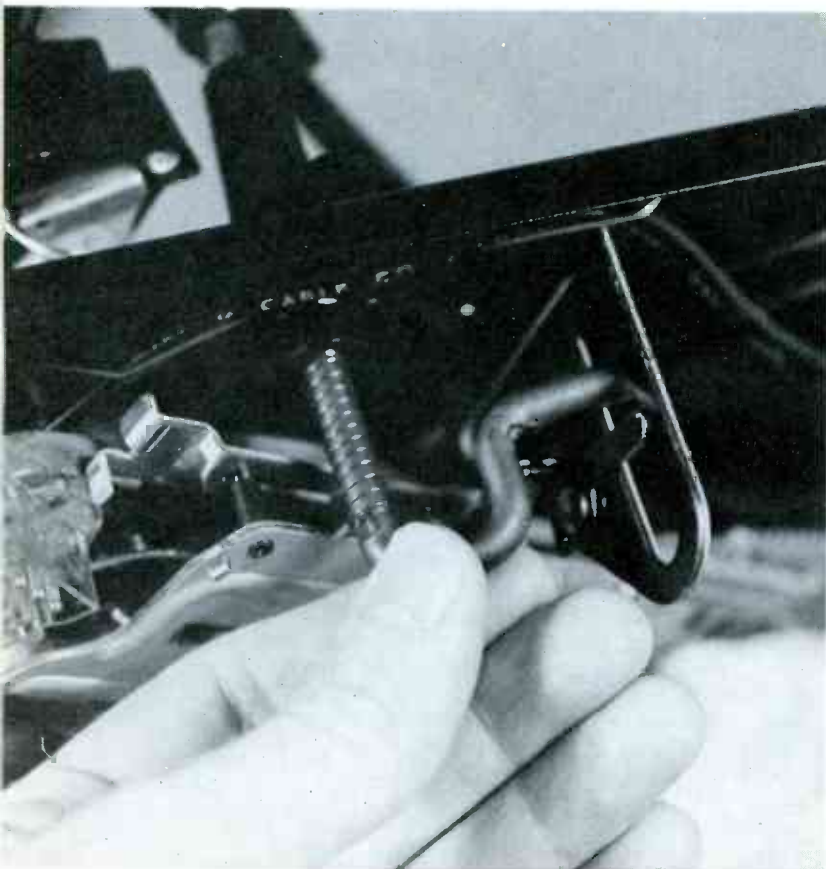

Step 12 Automatic shutoff usually is triggered by the vertical position of the shaft of the stabilizer arm, the one placed on top of the records to steady them. When the last record has dropped, the stabilizer shaft drops well below the normal operating level. Underneath, the shaft tilts a lever which intercepts the lateral movement of the arm so it cannot reach the record. The same lever also initiates a movement that shuts off the on-off switch after the arm sets down on the rest post.

There you have the main working mechanisms of a typical record changer. The motor and platter drive have been omitted because they are easy to figure out. Besides, you saw them in earlier sessions when I described cleaning and adjusting. Armed with this general understanding of record-changing mechanisms, you should have little difficulty working out how any particular brand or model works.

In the next session, the last of a series of four, I'll show and explain the insides of an automatic turntable. □

test equipment report

These features supplied by the manufacturers are listed at no-charge to them as a service to our readers.

If you want factory bulletins, circle the corresponding number on the Reply Card and mail it to us.

Substitution Box

A rapid means of providing the most-often-needed resistor and capacitor values has been made available with the Model LSB-41 RC substitution box now offered by **Leader Instruments Corp.**

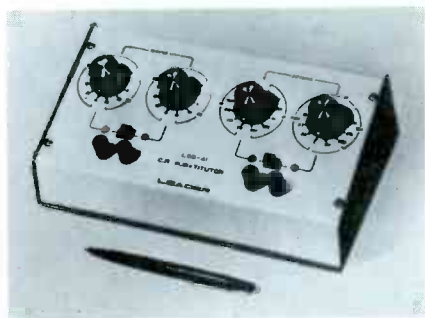

The unit features switch selection of high or low resistance values, and has the substitution capacity of 24 EIA, standard, 10%, 1W resistors from 10 ohms to 10 megohms. Also, the instrument selects any of 22 standard capacitors from 100 pf to 1000 uf.

Model LSB-14 weighs 3.5 pounds and measures 3-1/2 X 9-1/2 X 6-3/4 inches. It sells for \$59.95.

For More Details Circle (30) on Reply Card

Communications Counter

A new 512-MHz frequency counter Model 6252, designed for monitoring and measuring frequency carriers in the mobile communications bands, has been introduced by **Systron Donner.**

This field portable counter, designed to FCC requirements, features a level meter coupled to the input for indication of signal level, an overload relay circuit to prevent damage to the input when overloads occur, a frequency multiplier with a phase-locked local oscillator for making direct reading measurements of tone and LF inputs, and a choice of 5 optional oscillators offering stability from ± 3 parts in 10^7 /month to ± 5 parts in 10^{10} /day.

Input sensitivity of the Model 6252 is 25 mV rms to 50 MHz and 50 mV rms for inputs above 50 MHz. The

measurement is displayed by a solid state 8-digit readout which includes leading-zero suppression for error-free readings.

This new counter can be powered by AC as well as by two optional DC sources (an external DC power supply or a built-in rechargeable battery). The instrument can thus be used by communications checkout personnel directly at on-site transmitter locations.

Model 6252 sells for \$1095.00.

For More Details Circle (31) on Reply Card

Color Generator

Sencore has introduced the first portable, battery-operated digital color generator using CMOS Integrated Circuits. The CG25 "Little Huey" produces all RCA-licensed patterns with push button operation.



Stability is guaranteed with the digital counting circuits displaying patterns that cannot jitter. Low power drain is an improvement giving way to a long life, battery powered generator, backed up with an automatic shutoff. Less reaction to temperature allows operation from 120°F to -20°F. The extremely small size leaves room inside for added features including adjustable RF output to cover low channels 2-6, color level control from 0 - 200% and adjustable dot size, all easily accessible screw-driver adjustments on the bottom of the unit.

The unit is packaged in an unbreakable, acrylic case, the size of two 5U4 tubes, with a handy lead storage compartment in the back. It sells for \$99.00.

For More Details Circle (32) on Reply Card

Electronic Frequency Counter

Regency Electronics, Inc. announces the production of a six-digit electronic frequency counter.



The EC-175 is designed to enable the operator to measure crystal frequencies without mathematical computation. The counter reads out frequencies ranging from 5 Hz to 175 MHz. Five-position range switch with gate times of 1 μ s, 10 μ s, 100 μ s, 1 second and 10 seconds allows direct measurements of any in-range frequencies to within .1 Hz.

Six-digit LED display features automatic blanking, automatic decimal-point positioning and leading-zero suppression. The counter has a built-in 100-KHz harmonic generator for direct calibration to WWV. A 10.7 MHz crystal oscillator for AFC locking and IF alignment work is also a built-in feature.

EC-175 weighs 4-1/2 pounds and measures 6-1/2 X 2-5/8 X 9-1/2 inches. A converting bench stand/carrying handle permits portability. The unit is priced at \$449.00.

For More Details Circle (33) on Reply Card

Reference Chart

Telematic announces the new printing of "Test Jig Adapter Reference Chart." This reference chart crosses all brands of television (by chassis numbers) to Telematic Test Jig Adapter models in an easy direct listing.

Telematic adapters and convergence loads can be used with all makes of test jigs. Any brand of test jig can be adapted for solid-state television servicing with the use of the Telematic Transverter.

A special offer of the Transverter with a set of four solid-state adapters is now available as MAP3500 from

test equipment report

(Continued from previous page)
local distributors.

For More Details Circle (34) on Reply Card

Sweep Generator

A new, low cost HF sweep generator developed by Philips for use in radio-TV service and in production and laboratory work is now available from **Test & Measuring Instruments Inc.**

The PM5334 covers the frequency range from 3 MHz to 860 MHz in eight panel-selected sweep ranges. Setting accuracy anywhere in the eight ranges is better than 1%, which makes the instrument valuable for many applications in production and development work as well as in service and repair. The eight ranges of the PM5334 were chosen for convenience in operation in both general categories of application; typical applications include tests of TV sets (IF., chroma, and sound), tests of

wideband cable TV amplifiers, FM receiver work and work in TV bands I, III, IV and V and in FM band II.



Sweep width is continuously adjustable and the sweep can be made to cover any of the eight bands or any fraction of any band. Sweep frequency is continuously adjustable from 8 to 50 Hz on any band.

The PM5334 offers fixed frequency markers at 5.5, 10.7 and 38.9 MHz, each with 0.1% stability. A variable frequency marker is also available and can be set anywhere in the instrument's frequency range, with or without the fixed frequency markers.

Other features include a 0 to 30 V floating bias output voltage that eliminates the need for a separate power supply for radio and TV alignment work. For such applications, only the PM5334 and a dual trace oscilloscope are required.

The PM5334 costs \$575.00.

For More Details Circle (35) on Reply Card

RC Substitution Unit

Sencore announces an updated RC substitution unit that is easy to carry in the serviceman's tube caddy. The unit is called the "Parts Pak" because it has a full range of resistors, capacitors, and electrolytics needed to substitute on the spot.

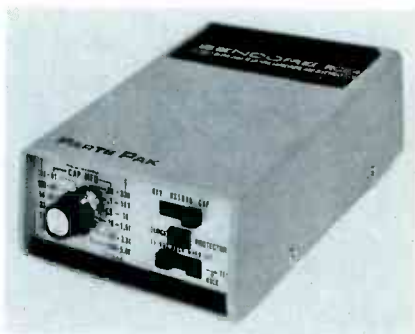

New features include electrolytics up to 1000 MFD for substitution in solid-state receivers. Surge protection guards the circuit electrolytic from being healed.

A second protective device is the surge-protector light that glows if excessive voltage is about to be applied to the lower-voltage (75 volts) electrolytic. The new Parts Pak Model RC24 has 36 most-often-used parts and comes packaged in a light-weight, acrylic case. A handy lead compartment enables technicians to tuck away the leads after each call so they don't get tangled with parts in the caddy.

The Parts Pak sells for \$38.00.

For More Details Circle (36) on Reply Card

RENEW YOUR SUBSCRIPTION NOW!



**GET THE NEW
1974**

TV TECH AID

COLOR and B&W

- 12 monthly issues, chock full of very helpful hints on circuit changes, trouble spots, "dogs" and modifications.
- Helps you find the symptoms and causes of recurring troubles in all types of situations.
- Saves you time and money.
- Back issues...Special reduced rates! (see below)

RENEW NOW RENEW NOW RENEW NOW

PLEASE SEND: 1969 12 issues \$3.95 1970 Book Form \$3.95
 1971 B&W Book \$3.95 1971 12 issues \$4.95
 1972 12 issues \$6.95 1973 12 issues \$7.95
 1974 All New 12 issues \$7.95

**MAIL CHECK OR
MONEY ORDER TO:**

**TV TECH AID
P.O. BOX 603
Kings Park, N.Y. 11754**

Name
 Address
 City
 State Zip

ES-1

For More Details Circle (12) on Reply Card

**We
need
you.**

If you can spend some time, even a few hours, with someone who needs a hand, not a handout, call your local Voluntary Action Center. Or write to "Volunteer," Washington, D.C. 20013.
 The National Center for Voluntary Action.



productreport

These features supplied by the manufacturers are listed at no-charge to them as a service to our readers. If you want factory bulletins, circle the corresponding number on the Reply Card and mail it to us.

Telephone Answering System

The DuoFone automatic telephone answering system answers up to twenty incoming calls, delivers a 15-second pre-recorded message and tapes the caller's 30-second reply on the built-in recorder. The outgoing message may be changed quickly and easily through the unit's built-in Message Maker control center.

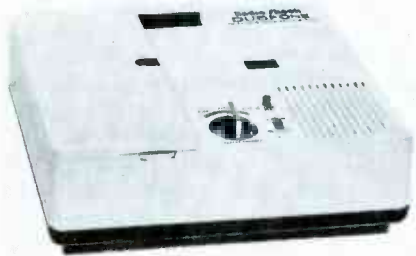

Installation requires no rewiring. The DuoFone connects easily to any telephone through a standard telephone wall jack, and is powered by three D cell batteries. A single knob controls all functions, and a fast forward button helps locate any message for playback.

The DuoFone automatic telephone answering system from Radio Shack comes with batteries, cord and plug. It is priced at \$79.95.

For More Details Circle (37) on Reply Card

TV Service Table

RCA Parts and Accessories Division now makes available to the TV service industry a labor-saving roll-around utility TV table that makes it easy to move heavy chassis and tools.

The RCA TV Service Table, Model 10J107, is designed for use by TV service technicians to move heavy equipment around their work area.

The table is constructed of strength-to-weight ratio tubular red enameled aluminum and 3/4" stained, non-splintering flakeboard. To help prevent damage from heavy items or sharp edges the top shelf, 24" X 24", has been heavily lacquered. For additional storage of tools and equipment there is a 23" X 23" shelf built into the table. This table is 36" tall, to coincide with average workbench height. Large 3" wheels permit smooth roll-around, even over cords or wires.

Locking device on one wheel keeps table from moving out of desired position.

For More Details Circle (38) on Reply Card

Mini Console

A customized mini console has been developed by Vicon Industries, Inc.



This console permits the user to utilize only the components he requires, from a single unit covering a small area to a multipole unit with a maximum capability of switching up to 20 cameras, controlling 6 pan and tilts, 6 motorized lenses, 6 scanners, and providing a video/alarm intrusion surveillance protecting 20 areas.

The mini console will accept single 9-inch or dual 9-inch or triple 5-inch monitors. They can also be cascaded side by side.

For More Details Circle (39) on Reply Card

Receiving Tube Manual

A new edition of the RCA Receiving Tube Manual was announced by RCA Electronic Components.

This new 752-page edition, RC-29, contains ratings and characteristics data on over 1400 receiving tubes including industrial types. The easy-to-read text explains the basic principles of operation, significant electrical characteristics, circuit applications and testing of various types of electron tubes.

For more convenient referencing of the latest types, the Technical Data for Receiving Tubes - Entertainment and Industrial Types section has been restricted to coverage of approximately 500 active entertainment and industrial types. Characteristics curves are presented for many types. Family types are conveniently cross-referenced for efficient data retrieval. Foreign types are also cross-referenced to their domestic equivalents.

FREE...

1974 Heath/Schlumberger Electronic Instruments Catalog

One-stop shopping for virtually all your test equipment needs:

80 MHz frequency counters from \$295* ... 200 MHz counters from \$495* ... 600 MHz counter only \$795* ... 600 MHz scaler just \$365* ... programmable timer only \$395* ... dual trace 15 MHz scope, \$595* ... sine, square, triangle wave generator, \$245* ... high and low voltage power supplies from \$34* ... multimeters from \$65* ... DVMs from \$285.*

The new 74 Heath/Schlumberger catalog describes all these and many more... all factory assembled and aligned... all specification-guaranteed for one full year... and all available at low mail-order prices. Use the coupon below and send for your FREE copy now.



FREE...
1974
Heath/
Schlumberger
Electronic
Instruments Catalog.
Send coupon now.

Heath/Schlumberger Instruments
Dept. 196-1
Benton Harbor, Michigan 49022

Please send 1974 Electronic Instruments Catalog.

Name _____

Address _____

City _____ State _____ Zip _____

Prices & specifications subject to change without notice.
*Mail order prices; F.O.B. factory.

HEATH
Schlumberger

EK-409

For More Details Circle (13) on Reply Card

January, 1974/ELECTRONIC SERVICING 47

productreport

(Continued from previous page)

The Picture Tube Characteristics Chart section contains concise data for over 170 black-and-white and color picture tubes. Keys to color and black-and-white tube type designation systems are also included.

Also contained in the manual is a Circuits section featuring 35 tube circuits of interest to hobbyists,

students, technicians, and engineers. Each circuit is accompanied by a parts list and circuit description.

The manual sells for \$2.50.

For More Details Circle (40) on Reply Card

Storage Bins

Manufactured by **Kole Enterprises, Inc.**, KOLE BINS are constructed of heavy duty corrugated fiberboard in 32 sizes. The bins are designed to withstand the maximum of use. Having a special cut-down front design enables the user to see in and insert or remove contents without taking the bin off the shelf.

For More Details Circle (41) on Reply Card

Nut Drivers

Ten new nut drivers in metric hex sizes from 4MM to 11MM have just been introduced by **Vaco Products Company**.

The drivers feature solid shaft, chrome molybdenum steel blades, and break-proof, shock-proof comformod handles. All handles are a bright blue in color to designate them as metric sizes. Metric sizes are marked on both handle and shaft.



The complete set of drivers is available in a metal stand for easy access and storage and is designated as No. 70200. The list price is \$13.75.

For More Details Circle (42) on Reply Card

Miniature Alarm Contacts

An easily installed and concealed miniature magnetic contact is available from **Mountain West Alarm**.

The Model S7 should be of particular interest to alarm installers and industrial security users. This contact has been especially designed to allow all wiring associated with an intruder alarm system to be "invisible", thus preventing shorting to disable the contact. Both the Alnico V magnet and the switch element are 1/4" in diameter, permitting installation with

any hand or electric drill.

The S7 is especially useful on aluminum doors and windows where conventional contacts are too large, hard to install, and unattractive.

These hermetically sealed contacts are designed for use in closed circuit systems; the circuit closes when the magnet is close (within 5/16"). For open circuit alarm systems the magnet may be offset so that the magnet passes the contact due to intrusion and momentarily closes the switch. The elements may be positioned end-to-end, parallel, or at right angles to each other.

S7 magnetic contacts sell for \$2.00 each with substantial quantity discounts.

For More Details Circle (43) on Reply Card

Cordless Soldering Iron

Portability and a built-in spotlight for working in dark areas are features of a new battery-powered soldering iron produced by the **Wall-Lenk Manufacturing Company**.

This Lenk cordless electronic soldering iron, just 8 inches long with tip and weighing only 6 ounces, fits easily in a tool box. It operates on a rechargeable nickel-cadmium battery and heats in about 5 seconds. A UL listed recharger is included with the unit, which can be recharged overnight.

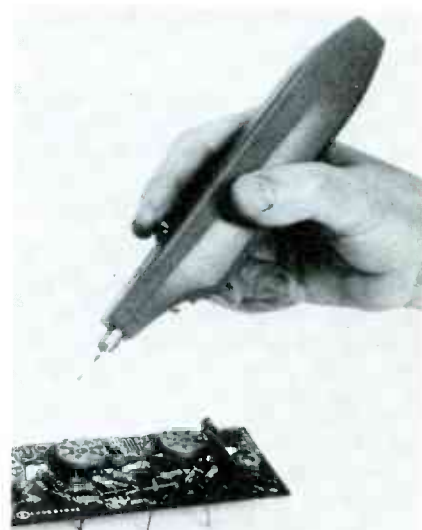

Tip temperature is over 700° F. Approximately 100 joints can be soldered from each charge, depending on the wire size, and the iron can be used while recharging.

An off-on button provides fingertouch control and the small tip permits pin-point work. Extra tips are available. □

For More Details Circle (44) on Reply Card

FREE ALARM CATALOG

Full line of professional burglar and fire alarm systems and supplies. 80 pages, 400 items. Off-the shelf delivery, quantity prices.

mountain west alarm
4215 n. 16th st., phoenix, az. 85016

For More Details Circle (14) on Reply Card

OWN YOUR OWN PICTURE TUBE REBUILDING BUSINESS

With Lakeside Industries rebuilding equipment you can rebuild any picture tube!

For complete details send name, address, zip code to

LAKESIDE INDUSTRIES
3520 W. Fullerton Ave.
Chicago, Ill. 60647
Phone: 312-342-3399

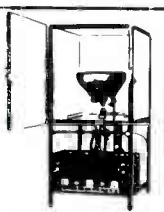

For More Details Circle (15) on Reply Card

need belts?



We've thousands in stock

Ready for immediate shipment! Belts for over 1800 makes and models of tape recorders, projectors, dictating machines, video recorders . . . and our simplified cross reference system makes it easy for you to order. Drive tires, wheels, phono idlers also listed. On most items we can ship the same day. Call or write today for your free catalog/cross reference chart.

PROJECTOR-RECORDER BELT CORP.

304 Whitewater St., Whitewater,
Wisconsin 53190 414/473-2151

For More Details Circle (16) on Reply Card

catalogs literature

Circle appropriate
number on Reader
Service Card.

102. Amphenol Sales Division—has published a full-color pocket-sized catalog which describes connector and socket devices designed specifically for use in hobbyist equipment. The catalog provides details on Amphenol's microphone, hexagonal, and RF connector families, and on its chassis socket, dual-in-line, and T. O. can socket lines.

103. The Antenna Specialists Co.—offers an 8-page brochure entitled "Why CB Antennas?" Illustrated with diagrams, patterns, and sketches, the brochure explains the technical side of CB antennas and a gain-to-effective power chart.

104. Bell Industries, J. W. Miller Division—offers a comprehensive 100-page radio and TV coil-replacement guide with a cross-reference directory. The guide lists 30,000 replacement coils for 375 manufacturers' names.

105. Centralab—presents a 36-page catalog describing Centralab's line of standard capacitors and ceramic substrates. Products listed in the catalog include disc, monolithic and special-application ceramic capacitors, aluminum electrolytic capacitors, polystyrene-film capacitors and a new line of 95% alumina-ceramic substrates.

106. Fordham Radio Supply Co.—has published a 32-page catalog of replacement parts and service supplies. The catalog lists features and specifications for products which include service kits, antennas, microphones, speakers, phono cartridges, and transistor testers.

107. Metropolitan Supply Company—has a directory of electronic tubes which lists some 5,000 industrial, entertainment and military tube types in alphanumerical order with quantity discount prices. Copies are available free when requested on company letterhead.

108. Motorola, Inc.—has released a full-line catalog on "Motorola Test Equipment" covering products ranging from service monitors to tone generators and wattmeters. The 36-page, color catalog includes photographs and complete listings of features, specifications and model nomenclatures for available test equipment.

109. Mountain West Alarm Supply Co.—has available M-73, an 80-page catalog which describes over 400 intrusion and fire alarm products, many of them UL listed. The alarm equipment offered ranges from relatively simple kits with instructions to the latest ultrasonic, radar, and infrared intrusion detectors.

110. Rohde & Schwarz—have a new addition to the 1973 Rohde & Schwarz Instrument Catalog containing a selection of new test and measuring instruments. Those covered include; mobile RF meter and test set, RF-DC millivoltmeter, directional-power meter, frequency counter, service-test set, VHF-UHF monitoring system, radio-monitoring/recording system, TV-relay receiver, and TV-monitoring receiver.

111. Stackpole Carbon Company—presents a comprehensive guide to performance characteristics and application criteria for fixed composition resistors. Bulletin No. 80-101 features selection and dimension data for 1/4, 1/2, 1, and 2 watt sizes, construction features, dimensions for various types of cut and formed leads, packaging options, and performance and testing curves.

112. TDK Electronics Corp.—has a 48-page booklet, "The TDK Guide to Cassettes", which contains useful information on home recording methods and equipment. The booklet offers facts and tips for those who want to learn more about tape-recording techniques and how to get more rewarding results. It contains a short course in tape-recording terminology and technology for the layman, including an explanation of the various types of tape formats, their merits and applications.

113. Triplett Corp.—has released the 59-T, a 16-page test-instrument catalog featuring a tester-selection guide that allows direct comparison of performance characteristics of each model now available from Triplett Corporation. The 59-T lists VOM's and accessories, including general purpose, special feature, laboratory accuracy, digital, FET, portables, leakage adaptors, cases, shunts, probes and tester stands. □

Think of what
just one company
can do to stop
pollution.
We have.



People start pollution.
People can stop it.

Please send me a free copy of your guide.

Name _____

Street _____

City _____

State _____ Zip _____



A Public Service of
The Magazine &
The Advertising Council

Keep America Beautiful
99 Park Avenue New York 10016

4 Money-saving reasons to buy EICO's Solid State Test Equipment.



EICO 242 FET-TVOM. Peak-to-peak measurements of AC volts and milliamps. 6½" meter. 7 non-skip ranges. High input impedance. Low 1 volt scale. DC/AC Multi-Probe. AC or battery operated. Kit \$84.95, Wired \$119.95

EICO 379 Sine/Square Wave Generator. Simultaneous sine and square wave outputs. Covers 20 Hz to MHz in five ranges. Low distortion sultzer feedback circuit. Square wave rise time better than 0.1 microseconds. Kit \$79.95, Wired \$119.95

EICO 330 RF Signal Generator. 5 bands cover a range from 100 kHz to 54 MHz. Calibrated modulation adjustment control. 400 Hz audio output. Provision for modulating RF with internal or external signal source. Kit \$69.95, Wired \$109.95

EICO TR-410 Triggered Sweep Scope. 100% solid state. DC to 10MHz bandwidth. Sweep synchronized gate output. Z-Axis input. Use as vectorscope for color TV servicing. One probe for direct and 10:1 measurements. Wired \$429.95.

FREE 32 PAGE EICO CATALOG

For latest catalog on Eico Solid State Test Equipment, Automotive and Hobby Electronics, Burglar-Fire Alarm Systems, Stereo, and name of nearest EICO Distributor, check reader service card or send 25¢ for fast first class mail service.

EICO, 283 Malta Street, Brooklyn, N.Y. 11207



For More Details Circle (17) on Reply Card

Take it to the moon or mountaintop. It's the new Fluke go anywhere telecommunications counter.



Model 1980A with rechargeable battery pack and carrying case.

- 5 Hz to 515 MHz
- 6 digit LED display
- Units annunciation
- Optional snap-on battery pack for up to 5 hours off-line operation
- 50 millivolt sensitivity over entire range
- Superb Fluke quality and reliability
- TCXO for instant-on full time accuracy
- World-wide network of factory service centers



John Fluke Mfg. Co., Inc., P.O. Box 7428, Seattle, WA 98133

For data out today, dial our toll-free hotline, 800-426-0361

For More Details Circle (18) on Reply Card

photofactbulletin

PHOTOFACT BULLETIN lists new PHOTOFACT coverage issued during the last month for new TV chassis.

BRADFORD 1142D23, 1142E23, 1142F23	1367-1
EMERSON Chassis T15K10-1B, T32K10-1A/-1B	1364-1
GENERAL ELECTRIC BA1202VY (Ch. 5BA)	1368-1
J.C. PENNEY 2868, 2888	1370-1
JVC 7810, 7820	1369-1
MIDLAND 1S-226	1368-2
OLYMPIC CT519	1368-3
PHILCO-FORD Chassis 3CR40, 3CR41	1366-1
RCA Chassis CTC58A, CTC58H	1365-1
SEARS 528.40910200 thru /0205, 528.41110200/0201/0202, 528.41682200 thru /2210/2211 thru /2220, 528.43270200 thru /0214/0215, 528.43280200 thru /0214/0215, 528.43570200 thru /0205, 528.43580200 thru /0205, 525.43590200 thru /0205	1364-2
SEARS 528.43300108 thru 528.43300117	1367-2
SEARS 562.40960200/1200/1201, 562.41910200/1200/1201	1366-2
SEARS SILVERTONE 528.41681914 thru 528.41681943	1369-2
SHARP C-1517, C-1723, C-1724 Remote Control Receiver XRCV-224, Transmitter XCMD-226	1365-2 1365-2-A
SONY TV-750	1364-3
SONY TV-950 (Serial 13001 and later)	1366-3
TRUETONE GEC3412A-47 (2DC3412), GEC3415A-47 (2DC3415)	1367-3
ZENITH Chassis 25EC58 Remote control receiver S-94892X, Transmitter S-94463	1370-2 1370-2A

bookreview

Introduction to Medical Electronics—for Electronics and Medical Personnel (No. 6301)

Author: Burton Klein

Publisher: Tab Books

Size: 5-1/2 X 8-1/2 inches, 272 pages

Price: \$6.95 paperback

This book ties together two highly technical fields (medicine and electronics) in a way that can be understood by members of both professions. For non-medical personnel, the human body is described in depth, in a chapter on anatomy and physiology. There is a continuing tie-in of physiological activities of the body with the equipment that is designed to detect, amplify, and present data signals concerning the body. Another section of the book is devoted to electronics for non-electronic personnel. The discussion covers basic principles of physics and electricity in a simple fashion, giving only sufficient background so that medical personnel will be aware of power, voltage, current, grounding interrelationships as they relate to safety for the patient and accurate use of the electromedical equipment. Many types of equipment are covered, from transducers (pick-ups), to building blocks such as amplifiers, to data readout, such as galvanometers and oscilloscopes. Maintenance, fault sensing, fault reporting, equipment management and follow-up for preventive maintenance, servicing, all are covered in depth.

1-2-3-4 Servicing Automobile Stereo, Second Edition (20975)

Author: Forest H. Belt

Publisher: Howard W. Sams & Co., Inc.

Size: 5-1/2 X 8-1/2 inches, 240 pages.

Price: \$4.95 softbound.

A modern stereo system, with both mechanical and electronic sections, can be repaired quickly and easily by the 1-2-3-4 Servicing method. This book applies the same simple procedure to automobile stereos. The author first explains the fundamentals of 1-2-3-4 Servicing, then shows how it is applied to a record changer, a unit that is principally mechanical. Chapters 3 through 7 explain electronic and mechanical principles of automobile stereo four-channel systems, FM multiplex, and tape cartridge systems. The remaining chapters are devoted to applying the 1-2-3-4 Servicing method to auto stereo and four-channel systems. Diagnosing the faulty section, locating the faulty stage, isolating the faulty circuit, and pinpointing the faulty part are covered fully. Numerous illustrations, charts, and schematic diagrams are provided, and the text is written in an easy-to-read style. This book will be helpful to both beginners and veteran service technicians. □

Telephone 212-881-9600

LARAN ELECTRONICS, Inc.

Auto Radio Specialists
STEREO 8

3768 BOSTON ROAD
Bronx, N. Y. 10469

Near
Baychester Avenue

Now — A One Stop Shopping Center for all your Auto Radio Electronic Parts

We Have Everything At Factory Discount Prices!

We are authorized Factory Parts Distributors

AC SPEEDOMETER	COMM SPEAKERS & GRILLS	LE 80 CASES	PEERLESS
AGFA FILMS	CRAIG	LLOYDS	PHILCO/FORD
AIWA	DELCO	LEAR JET	PHILLIPS AUTO RADIOS
AMPEREX SPEAKERS	DYNASONIC INLAND	MALLORY BATTERIES	QUAM SPEAKERS
ANPEX	DEWEKO	MEMOREX TAPES	QUICK MOUNT ANTENNAS
ARKAY SPEAKERS	E & H ALARMS	MIGA	RECOTON
AUDIOVOX	ELECTRO POWER SUPPLIES	METRA	ROBINS
AUTOMATIC RADIO	EV GAME PHONE NEEDLES	MILOVAC	ROLECOR EQUIPMENT
BECKER	EXCELITE TOOLS	MONROE TIMER ALARMS	SAMS PHOTOFACT BOOKS
BELLEWOOD RADIO & TAPE PLAYERS	GENERAL MOTORS RADIOS & STEREOS	MOTOROLA	SANYO
BEL AIR	HEP	MURA MICROPHONES	SPARKOMATIC SPEAKERS
BENDIX	HITACHI	NEW TRONICS ANTENNAS	TAPALINE
BLAUPUNKT	INLAND DYNOTRONICS	NUSONIC	TENNA
BOMAN ASTROSONIX	KRACO	DAKTRON SPEAKERS	TOYO
BORG WARNER	KUSTOM KREATIONS	ON GUARD ALARMS	TRUSONIC SPEAKERS
CHAPMAN CAR LOCKS	PANASONIC	P.O. ALARMS	UTAH SPEAKERS
			VERITAS

IMMEDIATE SERVICE Try Us for Hard to Get Parts. Call 212-881-9600 and ask for Aaron or send Part Number or Model Number and Description of Part. Feel Free to ask for any parts you may need

For More Details Circle (19) on Reply Card

"The Country Boys" Have It!

Make Your Own DRIVE BELTS & "O" RINGS



George Dalton



PRODUCE
INSTANT
DRIVE BELTS &
"O" RINGS

Three Kits do it all! Your kits eliminate need for stocking large replacement inventory. This is all you need to make easy repairs on . . . 8 tracks, cassettes (both imports and domestic) whether drive belt is round, flat or square. Kits come complete with ample rubber stock, Instant-Weld Adhesive, jig for controlling cuts, razor blade and special cleaning compound.

- ORK-1 Round Rubber Drive Belt Kit
- ORK-2 Flat & Square Rubber Drive Belt Kit
- ORK-3 "O" Ring Kit

No "down time" . . . no specials . . .
no molds . . . no vulcanizing.



Write for our complete catalog and discount prices.
ONEIDA ELECTRONIC MFG. INC.
MEADVILLE, PA. 16335

ELECTRONIC
MFG. INC.
Oneida

For More Details Circle (20) on Reply Card

January, 1974/ELECTRONIC SERVICING 51

SERVICE ASSOCIATIONS

Is Your Blood Pressure HIGH?

Most cases of high blood pressure, leading cause of heart attack and stroke, can now be controlled.

Protect yourself two ways: visit your doctor, and support your Heart Association's lifesaving program of research education and community service.

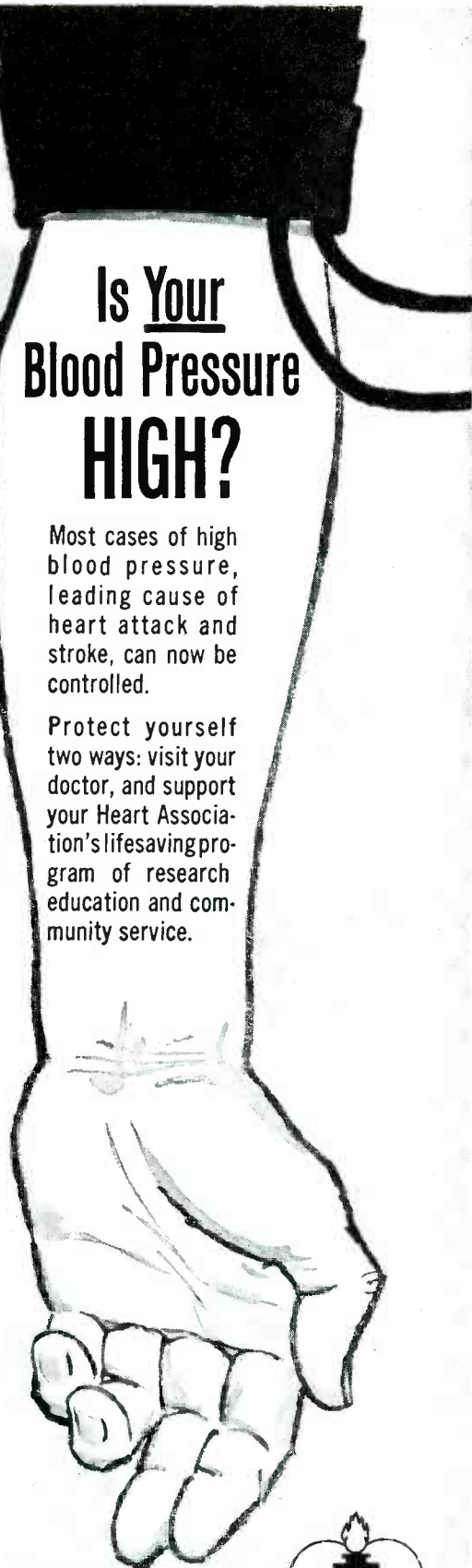

GIVE...
so more will live
HEART FUND



Contributed by the Publisher

BUSINESS PROBLEMS?

The NATESA Scope asks NATESA members if they have business problems for which they have no solution. Because of NATESA's quarter century of experience, good relations with government, industry, educational and consumer-information sources, the organization frequently has found workable answers for others. NATESA members should contact the national office in Chicago.

GOVERNMENT DATE PLAN OPPOSED

Opposition has been voiced by the executive committee of the National Appliance and Radio-TV Dealers Association (NARDA) to a government plan compelling TV manufacturers to mark each television receiver with the date of manufacturer, according to **Home Furnishings Daily**. NARDA urges dealers to write their disapproval to the FDA and their representatives in Congress. Reason for the opposition was given as the long time between manufacturing and possible sale to the consumer. For example, if a customer noticed a set dated 11 months before, he might reasonably assume it was an obsolete model which should be sold at a markdown.

LES NESVIK TO CONDUCT NESDA BUSINESS-MANAGEMENT SCHOOLS

National Electronic Service Dealers Association (NESDA) recently employed Mr. Les Nesvik, CET, as a full-time Co-ordinator of Education and Training. His main function will be to conduct business-management schools. Mr. Nesvik is well-qualified by formal education and by his 12 years as service manager of Wholesale TV Service, Indianapolis, Indiana, one of Indiana's largest service-only organizations. One full day or two consecutive evenings are required for each school. Contact NESDA if you want one of these schools in your area.

QUARTER MILLION DOLLARS FOR TRAINING

The Consumer Electronic Group of the Electronic Industries Association (EIA) has allocated a quarter of a million dollars for use in 1974 to expand its Service-Technicians Development Program. As reported in **Home Furnishings Daily**, the money was obtained from proceeds of the Consumer Electronics Show. Previously, between \$50,000 and \$100,000 had been budgeted each year. EIA circulates about 200 copies of a film entitled "Futures Unlimited", and is now the largest source of educational text books. Also, in 1974, EIA will sponsor 23 two-week Summer Seminars in 18 universities and colleges to upgrade the knowledge and teaching skills of instructors in the electronics departments of vocational and industrial-arts schools. □

The MARKETPLACE

This classified section is available to electronic technicians and owners or managers of service shops who have for sale surplus supplies and equipment or who are seeking employment or recruiting employees.

Advertising Rates in the Classified Section are:

- 25 cents per word (minimum \$3.00)
- "Blind" ads \$2.00 additional
- All letters capitalized 35 cents per word

Each ad insertion must be accompanied by a check for the full cost of the ad.

Deadline for acceptance is 30 days prior to the date of the issue in which the ad is to be published.

This classified section is not open to the regular paid product advertising of manufacturers.

FOR SALE

TV & RADIO TUBES 36c EA!! Free color catalog. Cornell, 4221 University, San Diego, California 92105 4-73-1f

AMAZING, Automatic, diagnostic, dial-a-fix is guaranteed to save you on your T.V. repairs. \$3. Paul Tayo 980, Greene Avenue, Brooklyn, N.Y. 11221. 11-73-3t

PHILCO AUTO RADIOS (1969-1974) audio network, 3L5-0002-01, \$1.75 each or 6 or \$10. BZ Enterprises, 6920 7th North St. Liverpool, N.Y. 13088. 11-73-3t

USE YOUR SCOPE (ANY MODEL, NO REWIRING) TO TEST TRANSISTOR IN/OUT CIRCUIT. SIMPLE INSTRUCTIONS \$1.00. SCHEK TECHNICAL SERVICES, 8101 SCHRIDER ST., SILVER SPRING, MARYLAND 20910. 10-73-12

UNUSUAL SURPLUS AND PARTS Catalog, \$1. ETCO Electronics Dept. E.S., Box 741, Montreal "A" H3C 2V2 12-73-12t

FOR SALE, TV repair business in Santa Fe, N.M., grossing approximately \$20,000. Asking cost of stock plus 2 months gross. Write P.O. Box 4132, Santa Fe, 87501. 12-73-2t

TELEVISION-RADIO Service material diagrams, manuals, 50-pound carton, only \$14.95, postpaid. BEITMAN, 409 EAST CHALMERS, CHAMPAIGN, ILL. 61820. 1-74-1t

SAMS PHOTOFACTS: Consecutive #787 to #965 plus 70 miscellaneous numbers and 4 drawer metal file cabinet. Best offer. Home TV, Box 495 Altus, Ok 73521 1-74-1t

EDUCATION INSTRUCTION

REPAIR TV TUNERS—High Earnings; Complete Course Details, 12 Repair Tricks, Many Plans, Two Lessons, all for \$1. Refundable. Frank Boeck, Box 3236 Enterprise, Redding, Calif. 96001. 9-73-7t

advertisers' index

B & K Div., Dynascan Corp.	3
Bussmann Mfg. Div., McGraw Edison	25
Castle TV Tuner Service	Cover 4
Chemtronics Incorporated	10
Eico Electronic Instrument Co.	50
The Finney Company	53
Fluke	50
Gem City Tuner	24
General Electric Company	Cover 3
Heath Company	13
Heath/Schlumberger Instruments	47
Jensen Tools and Alloys	53
Lakeside Industries	48
Laran Electronics, Inc.	51
Lectrotech, Inc.	39
Mountain West Alarm Supply Co. ...	48
Oneida Electronic Mfg., Inc.	51
Panasonic	7
Precision Tuner Service	Cover 2
Projector-Recorder Belt Co.	48
Sprague Products Company	11
GTE Sylvania - Consumer Renewal	14-15
Systems Electronics, Inc.	9
TV Tech Aid	46
Telematic	12
Tuner Service Corp.	5
Winegard Company	1

ELECTRONIC SERVICING

is your magazine!

If you would like to see an article about a particular subject directly related to servicing consumer or communications electronic products, send us your suggestion.

We value your comments and criticism.—Ed.



A Public Service of This Magazine & The Advertising Council

How would you like to sign the work you do?

Maybe it's a shame that most of us will never get to sign our work. Because as good as we are, it might make us better. And we can afford to be. No matter what kind of work we do, we'd have



more to show for it. More money, for one thing. Because we'd be giving each other our

money's worth for the products, the services and even the government we pay for.

For another thing, we'll be giving America better ammunition to slug it out with our foreign competitors. That should help bring the lopsided balance of payments back onto our side. And help make your dollars worth more.

Best of all, as we hit our stride we'll be protecting our jobs here at home. And we'll get more satisfaction out of the jobs we've got.

You don't have to sign your work to see all these things happen. And more.

Just do the kind of work you'd be proud to have carry your name.

America. It only works as well as we do.



The National Commission on Productivity, Washington, D. C.

We help him make it easier for you.

Your GE tube distributor is always there when you need him. With a complete line of GE entertainment receiving tubes, replacement semiconductors and ULTRACOLOR® or all-new Spectra-Brite® picture tubes.

Competitively priced. With fast delivery assured by his balanced inventory and the GE tube warehouse network. Along with all the technical information, business and technical aids you'll ever need. You can depend on him and GE tube products.

Tube Products Department,
General Electric Company,
Owensboro, Kentucky 42301

We're in this business together.

GENERAL  ELECTRIC



The Timesaver!



Latest, all solid state version of the sensational signal circuit analyzing timesaver originated by Castle.

Invaluable for locating the break in the tuner and i.f. signal chain or analyzing agc system defects in tube TV receivers . . . essential for speedy location of signal circuit defects in modular IC, solid state and hybrid TV receivers.

A NEW APPROACH to agc system analyzing!

Permits signal injection after the agc controlled stages to simplify testing for agc defects.

- Works with any 40MHz receiver . . . color or black and white . . . solid state, tube or hybrid.
- High level, low impedance output furnishes signal usable at input of final i.f. stage.
- Special output circuit works equally well into first i.f. input of late model, link coupled systems and older, low "C" bandpass coupled systems.
- Antenna input and i.f. output electrically isolated; no "hot" chassis hazards.
- No need to disconnect supply leads from suspected tuner being tested. Substitutes the VHF tuner and tests the UHF tuner.
- Tunes all 12 VHF channels, has preset (memory) fine tuning on all channels.
- Higher overall gain than previous models with wide range gain reduction control of 60db.
- Completely self contained and battery operated, uses popular batteries available everywhere. Simple battery replacement; battery compartment in rear of custom molded case.
- Reduced current consumption extends battery life to as much as double that of previous models. Bright LED indicator warns when unit is ON.
- Use on the bench or in the home . . . anywhere.
- Comes complete with extension cables, batteries and instructions.

TV TUNER SUBBER, Mark IV net \$45.95

Contact your distributor.

Specifications

Inputs:	300 ohm balanced VHF antenna terminals, electrically isolated. 75 ohm 40 MHz amplifier (Ch.#1) RCA phono Jack .
Sensitivity:	30 microvolts. Input signal handling capability: over 100,000 microvolts.
Output:	40 MHz TV i.f.: bandwidth 6 MHz. "Mastermatchcoupler" output circuit with matched cable to furnish usable signal for all input circuits. Termination is RCA phono Jack, electrically isolated.
Tuning Range:	All 12 VHF TV channels, plus Ch.#1 40 MHz amplifier position for testing UHF tuners. High stability of 40 MHz amplifier permits two Mk.IV Subbers to be cascaded for high level 40 MHz output signal from any VHF channel.
Tuning:	Preset (memory) fine tuning.
Gain Control:	Gain reduction 60 dB.
Power supply:	18 volts. Uses two 9v transistor batteries.
Size & Weight:	6.5"x 6.5"x 3.25" exclusive of control knobs and handle. 1.5lbs complete with batteries.
Accessories:	"Mastermatchcoupler" output cable with RCA phono jack termination. "Mastermatchcoupler" output cable with alligator clip terminations. UHF tuner test cable.



CASTLE TV TUNER SERVICE, INC.

5701 N. Western Ave., Chicago, Illinois 60645 • Phone: (312) - 561-6354

In Canada: Len Finkler Co., Ontario

For More Details Circle (2) on Reply Card