

# Electronic Servicing

Shop Talk this month:

## TESTING TRANSISTORS WITH A SCOPE

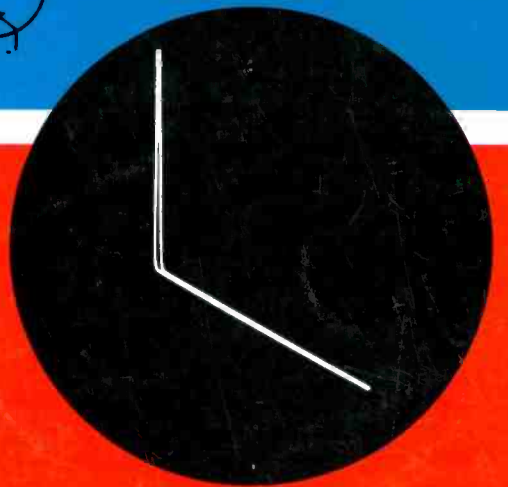
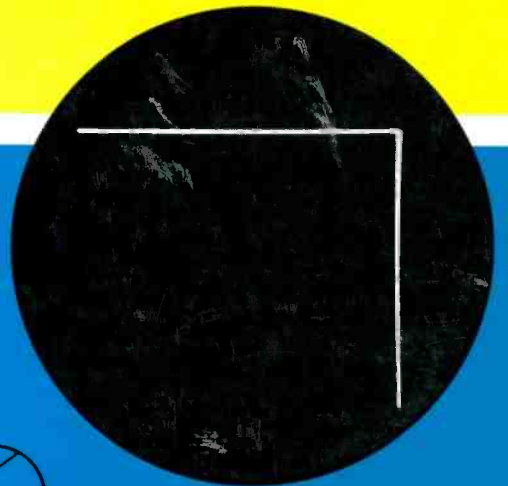
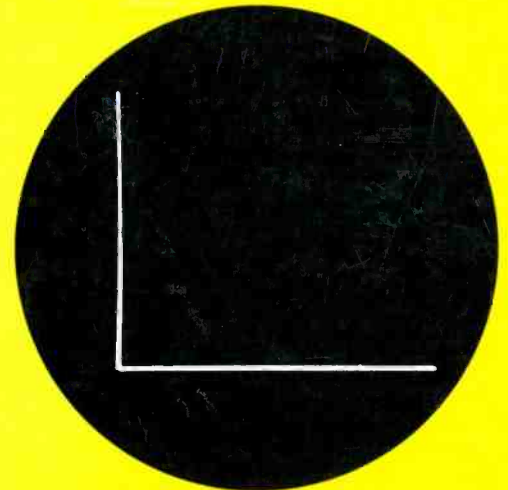
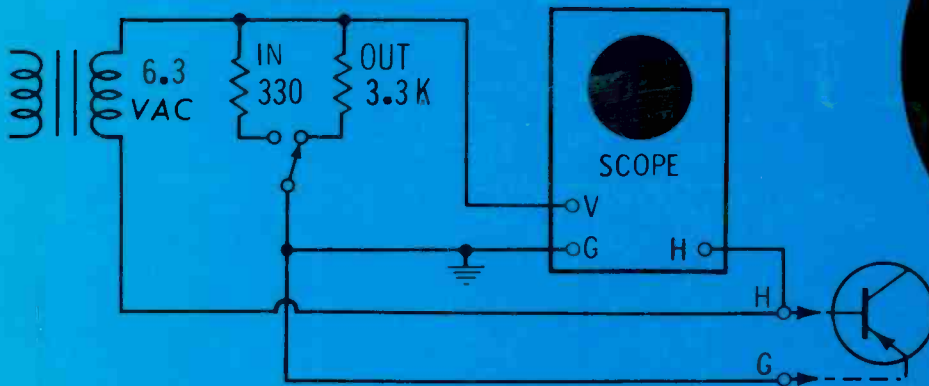

### COMMON CAUSES OF:

Intermittent Color, page 20

Poor Color Quality, page 14

Distortion In Auto Radio, page 44

# The first and only solid-state test equipment guaranteed for 5 years.

Now EICO, because of its emphasis on *reliability* in engineering and manufacture, offers the industry this breakthrough.

EICO's new line of solid-state test equipment comes with an unprecedented 5-year guarantee of performance and workmanship. (Send

for full details of this EICO 5-year GUARANTEE on factory-assembled instruments.)

Additional advanced features include: new functional design, new color-coordinated esthetics, new PC construction, new easier-to-build kit designs.

## New EICO Solid-State Test Equipment



### EICO 240 Solid-State FET-VOM \$59.95 kit, \$79.95 wired.

One all-purpose DC/AC OHMS Uniprobe®. Reads 0.01V to 1 KV (to 30 KV with optional HVP probe). 7 non-skip ranges, in 10 dB steps. AC or battery operated. RMS & DCV: 0-1, 3, 10, 30, 100, 300, 1000V P-P ACV: 0-2.8, 8.5, 28, 85, 280, 850, 2800V. Input Z: DC, 11 M; AC, 1 MΩ. Response 25 Hz to 2 MHz (to 250 MHz with optional RF probe). Ohmmeter reads 0.2 to 1 MΩ in 7 ranges. 4½" 200 μA movement. HWD: 8½", 5¾", 5". 6 lbs.

### EICO 242 Solid-State FET-TVOM \$69.95 kit, \$94.50 wired.

All the versatility of the EICO 240 plus: AC/DC Milliammeter, 1 ma to 1000 ma in 7 non-skip ranges; single all-purpose DC/AC-Ohms — MA Uniprobe®; and large 6½" 200 μA meter movement.

### EICO 150 Solid-State Signal Tracer \$49.95 kit, \$69.95 wired.

Multi-purpose troubleshooter for TV/FM/AM & Audio Equipment. Independent RF Audio inputs. Speaker and meter output indicators. 400 mW continuous power output. Substitution amplifier, output transformer, speaker. Input for rated output: 1 mV RF, 63 mV audio.

Hum 60 dB below 400 mW, 105-132 VAC, 50/60 Hz, 5VA. HWD: 7½", 8½", 5". 6 lbs.

### EICO 330 Solid-State RF Signal Generator. \$59.95 kit, \$84.50 wired.

5 fundamental bands 100 kHz to 54 MHz. Vernier control 0-100%. Output 300,000 μV into 50-Ohm load. External signal modulation or internal 400 Hz, 0 to 100%. 105-132 VAC, 50/60 Hz, 1.7 VA. HWD: 7½", 8½", 5". 5 lbs.

### EICO 379 Solid-State Sine/Square Wave Generator. \$69.95 kit, \$94.50 wired.

5 sine wave and 4 square wave bands. Low distortion Sultzer feedback FET circuit. Sine: 20 Hz to 2 MHz; 0-7.5V rms into hi-Z, 0-6.5V into 600 ohms Max. distortion 0.25%. Square: 20 Hz to 200 kHz; 0-10V p-p into hi-Z, pos. direction, zero ground. Rise time at 20 kHz less than 0.1 μ sec. 105-132 VAC, 50/60 Hz, 10VA. HWD: 7½", 8½", 8½". 9 lbs.

## New EICO High Performance Instruments



- EICO 385 — Solid-State Portable Color Generator \$79.95 Kit, \$109.95 Wired.
- EICO 465 — Wideband Vectorscope/Oscilloscope \$179.95 Kit, \$249.95 Wired.
- EICO 1025 — Solid-State Power Supply \$79.95 Kit, \$119.95 Wired.
- EICO 443 — Semiconductor Curve Tracer \$69.95 Kit, \$99.95 Wired.
- EICO 633 — CRT Tester & Rejuvenator \$69.95 Kit, \$99.95 Wired.
- EICO 635 — Portable Tube Tester \$44.95 Kit, \$69.95 Wired.

## New EICO Probes for the Pros

**Hi-Voltage Probe HVP-5, Wired \$19.95.**  
Convenient built-in voltmeter. Barrier sections isolate HV tip from handle and meter. Measures up to 30 KV. Lightweight, compact.

**Solid-State Signal Injector Probe PSI-1, Kit \$5.95, Wired \$9.95.**  
Pen-size, 1-ounce, self-powered signal generator. Frequency range from 1kHz to 30MHz, with harmonics. Clip it to your pocket — ideal for signal tracing in the field.

**Solid-State Signal Tracer Probe PST-2, Kit \$19.95, Wired \$29.95.**  
Flashlight-size, 2.2oz, self-powered. Hi-gain amplifier. 50Hz to 200MHz with demod tip. Input Z: 3500Ω, 35KΩ, 350KΩ; Output: 0.3 p-p volts. Noise —45dB. Distortion <5%. Complete with earphone, all probe tips, AA battery, pocket clip.



### SEND FREE 1970 CATALOG

Name \_\_\_\_\_  
Address \_\_\_\_\_  
City \_\_\_\_\_ State \_\_\_\_\_ Zip \_\_\_\_\_



**EICO Electronic Instrument Co., Inc.**  
283 Malta Street, Brooklyn, N.Y. 11207  
**EICO Canada Ltd.**  
20 Millwick Drive, Weston, Ontario

Circle 1 on literature card

# Don't sell a color picture tube unless its been on a test ride.

Down at the bottom of the page, you have a major advance in space-age homeliness.

And a major advance in color tube testing as well.

That machine squatting down there is our beloved Iron Horse, the fully-automated, revolving carousel we use to test our color bright 85® tubes for emission, gas leakage, shorts, arcing and screen uniformity prior to shipment.

Now we don't intend to go into a song and dance on how total automation reduces testing error.

But we will tell you one thing.

Our Iron Horse test ride, combined with our life testing and 100% set testing, makes it almost impossible for you to get a defective color tube from us.

Which in turn makes it almost impossible for you to get chewed out by a customer.

Next time you need a color replacement tube, remember the great thing about the color bright 85. We don't send it to you till it's been around.

**SYLVANIA**  
GENERAL TELEPHONE & ELECTRONICS

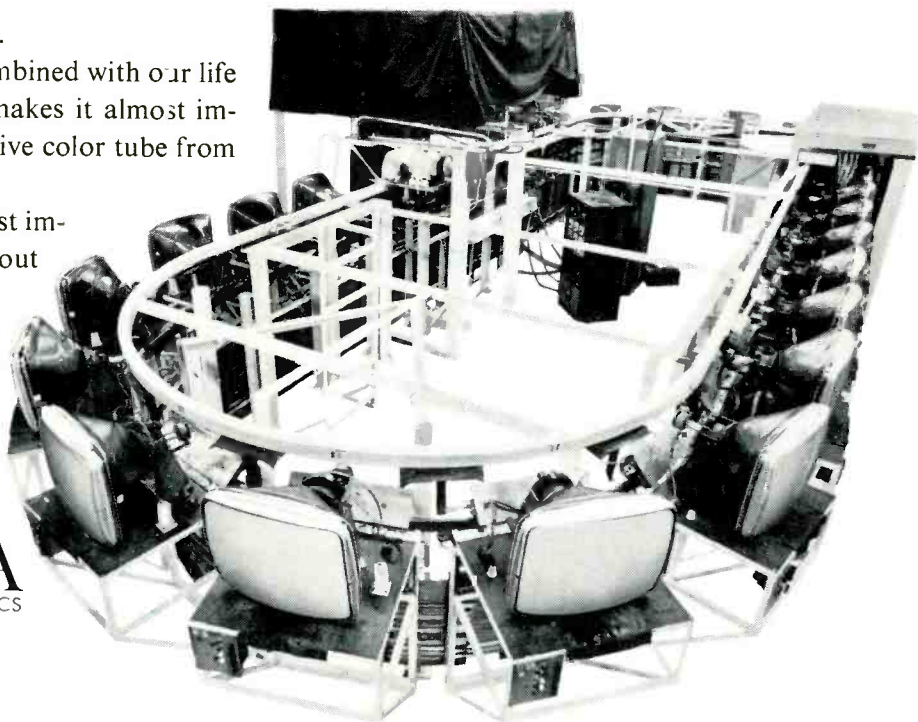

*Circle 3 on literature card*

# Electronic Servicing

Formerly PF Reporter

*in this issue...*

- 14 Common Causes of Poor Quality Color.** An in-depth review of the defects that most frequently cause such color-related problems as over or under saturation of colors, wrong tints, changing color, improper gray-scale, misconvergence, and shading resulting from raster impurity. **by Bruce Anderson.**
- 20 Frequent Causes of Intermittent Color.** Troubles that cause come-and-go color can and do originate in almost every section of a color chassis—and the tuner and antenna system. In this article the most common causes are listed in the order in which they normally should be checked. **by Wayne Lemons.**
- 26 Shop Talk—Quick Testing of Transistors.** Recently, ELECTRONIC SERVICING'S technical editor compared various "quick-tests" of transistors. After performing each of the tests and analyzing the results, he prepared this report which will acquaint you with the procedures, and will help you decide which test is the most efficient and accurate for you. **by Carl Babcoke.**
- 36 Dale's Service Bench—How to Cure a Sick Synthesizer.** A brief but comprehensive explanation of the operation of frequency synthesizers used in VHF and UHF transceivers, plus an easy method of determining which section of the frequency generating system is defective. **by Allan Dale.**
- 44 Common Sources of Distortion in Auto Radios.** Defects in audio and AGC circuits are the usual causes of distorted sound from auto radios. Typical defects found in late-model receivers, and how to isolate them quickly, are explained by a veteran servicer of auto radios. **by Joseph J. Carr.**
- 52 Adjustment and Minor Repair of Tape Recorder Input and Drive Systems.** How to inspect, service, adjust and/or replace record/playback heads, clutches and brake systems employed in modern tape recorders. **by Robert G. Middleton.**

## DEPARTMENTS

Electronic Scanner . . . . .	4	Book Review . . . . .	59
Letters to the Editor . . . . .	10	Test Equipment Report . . .	60
Symcure . . . . .	34	Advertisers' Index . . . . .	62
Troubleshooter . . . . .	42	Product Report . . . . .	62
Antenna Systems Report . .	43	Catalog and Literature . . . .	64
PHOTOFACT BULLETIN	51		

Second class postage paid at Kansas City, Mo. and additional mailing offices. Published monthly by INTERTEC PUBLISHING CORP., 1014 Wyandotte St., Kansas City, Mo. 64105. Vol. 20, No. 11. Subscription rates \$5 per year in U.S., its possessions and Canada; other countries \$6 per year.

Copyright, 1970, Howard W. Sams & Co., Inc. All rights Reserved. Material may not be reproduced or photocopied in any form without written permission of publisher.

**EDITORIAL**  
 GEO. H. SEFEROVICH, Director  
 J. W. PHIPPS, Managing Editor  
 CARL BABCOKE, Technical Editor  
 BARBARA L. SMITHSON, Editorial Assistant  
 DUDLEY ROSE, Art Director

**CONTRIBUTING AUTHORS**

Bruce Anderson  
 Joseph J. Carr  
 Allan Dale  
 Robert G. Middleton

**TECHNICAL CONSULTANT**

JOE A. GROVES

**EDITORIAL ADVISORY BOARD**

LES NELSON, Chairman  
 Howard W. Sams & Co., Indianapolis

**CIRCULATION**

EVELYN ROGERS, Manager

**ADVERTISING SALES**

Kansas City, Missouri 64103  
 Tele: 913/888-4664  
 E. P. LANGAN, Director  
 R. JACK HANCOCK, Manager  
 JAKE STOCKWELL  
 S. F. WILSON, Production

**REGIONAL ADVERTISING SALES OFFICES**

Indianapolis, Indiana 46200  
 ROY HENRY  
 2469 E. 98th St.  
 Tele: 317/846-7026

New York, New York 10010  
 CHARLES C. HORNER  
 3 W. 57th St.  
 Tele: 212/688-6350

Los Angeles, California 90005  
 JOHN D. GILLIES  
 3600 Wilshire Blvd., Suite 1510  
 Tele: 213/383-1552

London W. C. 2, England  
 JOHN ASHCRAFT & CO.  
 12 Bear Street  
 Leicester Square  
 Tele: 930-0525

Amsterdam C. Holland  
 JOHN ASHCRAFT & CO.  
 W.J.M. Sanders, Mgr.  
 for Benelux & Germany  
 Herengracht 365  
 Tele: 020-240908

Tokyo, Japan  
 INTERNATIONAL MEDIA  
 REPRESENTATIVES LTD.  
 1, Shiba-Kotohiracho, Minatoku  
 Tele: 502-0656



ELECTRONIC SERVICING (with which is combined PF Reporter) is published monthly by Intertec Publishing Corp., 1014 Wyandotte Street, Kansas City, Missouri 64105.

Subscription Prices: 1 year—\$5.00, 2 years—\$8.00, 3 years—\$10.00, in the U. S. A., its possessions and Canada.

All other foreign countries: 1 year—\$6.00, 2 years—\$10.00, 3 years—\$13.00. Single copy 75¢; back copies \$1.



Robert E. Hertel, Publisher  
 Intertec Publishing Corp.  
 Subsidiary of Howard W. Sams & Co., Inc.

## The big difference in TV Alignment instruments: **Ours Works.**

The B & K Model 415 Sweep/Marker Generator not only works, but it makes alignment jobs faster and more accurate.

Why? Because it eliminates the need for a separate marker generator, sweep generator, marker adder, and bias supply. You get it all in one compact instrument.

And it's so easy to use. The IF and chroma bandpasses are simulated on the front panel for constant reference. Lights tell you which of the crystal-controlled markers are in use and where they should be located. And the exclusive marker tilt feature lets you place the markers either horizontally or vertically, so you can always identify their exact positions.

Put the B & K Model 415 Sweep/Marker Generator to work for you.

Ask your distributor for complete details.



Product of  
DYNASCAN CORPORATION  
1801 W. Belle Plaine  
Chicago, Illinois 60613



Model 415:  
**\$399.95**

*Circle 4 on literature card*

## Shift to Service Will Continue

Employment during the next ten years will continue to shift toward the service industries, including both trade and government, according to projections by the Bureau of Labor Statistics, published in the April 1970 **Monthly Labor Review**.

An American economy with 100 million workers producing 60 percent more goods and services in 1980 than were produced in 1969 is profiled in the new projections, which cover productivity, gross national product, the labor force and employment.

Copies of the April 1970 **Monthly Labor Review** are available from the Editor-in-Chief, Room 2029, 441 G Street, N.W., Washington, D.C. 20212.

## Sylvania Names New Field Service Manager For Southeast

Richard Lamey has been appointed Field Service District Manager in Georgia, Alabama, and northern Florida for Sylvania Entertainment Products. He will make his headquarters at the company's Service and Parts Center, Forest Park, Ga.

Mr. Lamey will coordinate all service functions in the area with dealers and distributors of the company's television, stereo, radio, and tape recorder products. He succeeds Rush Hickman, who has resigned. Mr. Lamey joined Sylvania in 1967 as Field Service District Manager in western New York and western Pennsylvania.

## Packard Bell Changes Name

Packard Bell, television and stereo manufacturer, has changed both its name and logo. The company's new name is Teledyne Packard Bell.

The new name and logo are displayed on the service vehicle at the right in the accompanying picture.

Name changes are not novel to Teledyne Packard Bell. When Herbert Bell founded the company in 1926, to produce coin-operated radios for hotels, the firm was called Jackson-Bell Company; the company name included that of one of Bell's early partners, Edward

Jackson. Later the name was again changed to reflect a new partner, Leonard Packard, and the name became Packard Bell Company, and later, Packard Bell Electronics.

## RCA Continues Efforts to Find and Fix Sets Cited as Faulty

RCA is continuing its efforts to modify RCA color television sets which might pose a potential safety problem.

Since last January, the Company has been working through distributors, its RCA Service Company and independent dealers and service organizations to find, inspect and, if necessary, modify RCA sets which might constitute potential sources of smoke or fire. A majority of the sets inspected thus far have not required modification.

The Company is supplying its dealers as well as approximately 12,500 independent TV service agencies with technical information kits that will further assist them in locating the sets involved, according to Herbert T. Brunn, Vice President of Consumer Affairs for RCA. Costs of the program are being borne by RCA.

Mr. Brunn called the new activities "a logical next step" in a five-month-old campaign to search out and correct RCA sets cited as potentially hazardous by the National Commission on Product Safety, as well as models of similar chassis design.

As part of the intensified effort, the A. C. Nielsen Company, a national research organization which has carried out a number of survey programs for RCA in the past, has been retained to contact the dealers and service agencies to explain and help implement the program, he added.

A total of eight chassis designs are involved in the inspection-correction program, Mr. Brunn said. They are CTC15, CTC16, CTC16X, CTC17, CTC17X, CTC21, CTC24 and CTC40.

The number of RCA sets involved in fire or smoke incidences, as reported to the Commission in January, was less than 37 out of every million RCA sets in use annually over the 1965-69 period covered by the Commission study.

Mr. Brunn said RCA also has replaced parts in inventory which did not meet the Company's current safety standards.

"The number of sets that still could be characterized as a potential problem, while small in relation to the total in use, remains unacceptable to RCA and therefore we are continuing our program of corrective action," Mr. Brunn said.

The instances of fire or smoke reported in RCA sets have occurred principally in older models. Some involved components which had worn out after long periods of usage, Mr. Brunn said. He cited the fact that the components responsible for the incidents met or exceeded the applicable safety standards, including those of the Underwriters Laboratory, at the time of manufacture.

The consumer Affairs activity headed by Mr. Brunn was formed at the corporate level earlier this year to oversee the quality, reliability and safety of RCA products and services.

(Continued on page 6)



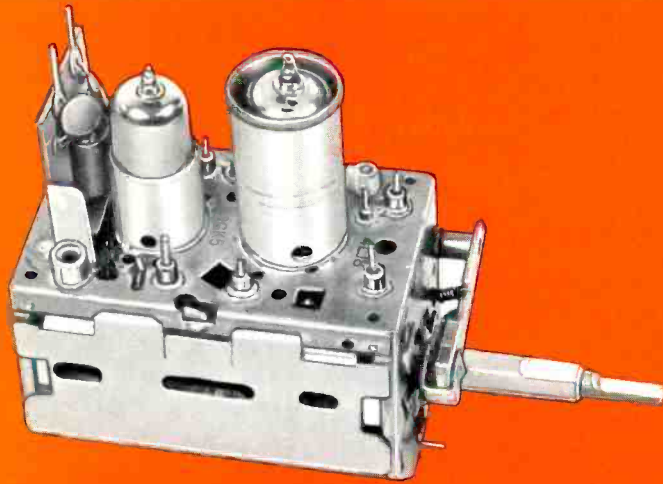

# \$9.75

## TUNER SERVICE CORPORATION

**PROVIDES YOU WITH A COMPLETE SERVICE FOR ALL YOUR TELEVISION TUNER REQUIREMENTS AT ONE PRICE.**

### TUNER REPAIR

VHF Or UHF Any Type \$9.75.  
UHF/VHF Combo \$15.00.

In this price all parts are included. Tubes, transistors, diodes, and nuvistors are charged at cost.

Fast efficient service at our 4 conveniently located service centers.

1 year guarantee backed up by the largest tuner manufacturer in the U.S.—SARKES TARZIAN INC.

All tuners are cleaned inside and out, repaired, realigned and air tested.

### TUNER REPLACEMENT

Replacement Tuner \$9.75.

This price buys you a complete new tuner built specifically by SARKES TARZIAN INC. for this purpose.

The price is the same for every type of universal replacement tuner.

#### Specify heater type

Parallel 6.3V  
Series 450 mA  
Series 600 mA

All shafts have the same length of 12".

Characteristics are:

Memory Fine Tuning  
UHF Plug In  
Universal Mounting  
Hi-Gain Lo-Noise

If you prefer we'll customize this tuner for you. The price will be \$18.25. Send in original tuner for comparison purposes to our office in INDIANAPOLIS, INDIANA.



## TUNER SERVICE CORPORATION

**FACTORY-SUPERVISED TUNER SERVICE**

**MIDWEST** . . . . . 817 N. PENNSYLVANIA ST., Indianapolis, Indiana . . . . . TEL: 317-632-3493  
(Home Office)  
**EAST** . . . . . 547-49 TONNELE AVE., Jersey City, New Jersey . . . . . TEL: 201-792-3730  
**SOUTH-EAST** . . . . . 938 GORDON ST., S. W., Atlanta, Georgia . . . . . TEL: 404-758-2232  
**WEST** . . . . . SARKES TARZIAN, Inc. TUNER SERVICE DIVISION  
10654 MAGNOLIA BLVD., North Hollywood, California . . . TEL: 213-769-2720  
*Circle 5 on literature card*

# BUSS QUALITY

## SMALL DIMENSION FUSES AND FUSEHOLDERS

For The Protection of All Types of Electronic and Electrical Circuits and Devices . . .



includes dual-element "slow-blowing", single-element "quick-acting" and signal or visual indicating types . . . in sizes from 1/500 amp. up.



HKA lamp-indicating, signal activating holder.



HMR RF shielded holder for 1/4 x 1 1/4 in. fuses.

HKP panel mounted holder for 1/4 x 1 1/4 in. fuses.



TRON Rectifier Fuses For the Safe Protection of Solid State Devices.

Provide extremely fast opening on overload and fault currents, with a high degree of restriction of let-thru current. Many types and sizes available. Ampere ratings from 1/2 to 1000 in voltage ratings up to 1500.



Circle 6 on literature card

### Motorola Recalls Digital Clock Radio To Prevent Possible Shock Hazard

Motorola has recalled one of their digital clock radios which, under certain conditions, could possess a shock hazard. About 1500 units are involved.

Consumers owning this digital clock radio, Motorola model number TC70GU, are urged by the company to disconnect it immediately and return it to the store from which it was purchased for inspection.

The consumer products division of Motorola Inc., said that no shock problems traceable to this radio model have been reported to the company by consumers or its distributors. However, the company's continuing quality control program discovered that under certain conditions, some units possessed potential shock hazards.

Motorola distributor service personnel will make the necessary modifications and safety-inspect the radio before returning it to the owner.

The company suggested that any consumer who might have moved from the city where the radio was purchased contact the nearest Motorola distributor, whose name and location is listed in the product guarantee. Consumers owning the TC70GU digital clock radio also can call, collect, (Area Code 312-451-1000, Ext. 3730) the Motorola director of consumer affairs, Garth J. Heisig, at divisional headquarters in Franklin Park, Illinois, for assistance in returning the radio for modifications and inspection.

The model number, TC70GU, can be located on

the bottom of the radio. When the radio is modified and safety-inspected, the letters "RC" will be added to the model number.

Edward P. Reavy, Jr., vice president and divisional general manager, said that the company has instituted a field program to trace all TC70GU radios, through distributors, retailers and consumers. The possible problem can be corrected through modification of the set.

### FCC Proposes 2-Way CATV

The Federal Communications Commission (FCC) has proposed technical standards for community antenna television (CATV) systems which require that they be designed to provide two-way communications for subscribers who desire it.

Such two-way cable communications in the future could include facsimile, mail delivery, videophone, credit payments, shopping, news and other types of in-home services.

The FCC in June invited comments on two-way CATV communications, as well as 20- and 40-channel CATV systems and individual community channels. Dean Burch, FCC chairman, said these and other rules proposed for CATV probably will become effective by about the middle of November, 1970.

Other CATV rules recently proposed include: 1) Permitting the importation of four distant signals by each CATV operator in the 100 largest markets. Commercials would have to be deleted from the imported signals and local advertising substituted. 2) Systems



with more than 500 subscribers would be required to originate some of their own programming after April 1, 1971.

The commission has proposed that cross ownership of CATV systems and TV stations not be permitted. Those who presently own both CATV systems and TV stations would be given 3 years in which to comply with the "no cross ownership" rule.

### Better Color Television Uniformity Expected as Result of EIA Testing

Improved, more uniform pictures on U.S. color TV sets are expected to result from nationwide tests that started September 1, the Electronic Industries Association (EIA) predicts.

The tests, which were arranged by the EIA Engineering Department Broadcast Television Systems Committee, with the help and cooperation of the major TV networks, are expected to last for three months. Should they prove the utility of the new test signal and be adopted for use, home television receivers will require less adjustment of color and hue (tint) controls when program changes occur.

During the tests, transmission of selected network programs will include a new vertical interval color reference (VIR) signal. Transmitter engineers at individual stations will use the VIR calibration signal to adjust their equipment so that the color TV picture each station broadcasts will correspond more closely to the picture originally sent from the TV studio.

No sudden improvement of home color TV reception is anticipated, however, during the period the tests are in progress. It might take some time for the station engineers to learn how to make best use of the VIR signal, according to Eric M. Leyton, chairman of the Field Test Subcommittee of the EIA Broadcast Television Systems Committee.

The VIR signal, which provides references, or calibration marks, for the picture's contrast, tint, and color, is transmitted during the interval when no video information is being broadcast, and should not be visible to the home viewer.

During the field testing, the VIR signal will be limited to selected programs on all three of the major commercial networks. The VIR signal is being restricted to these programs primarily because of a lack of necessary equipment and because full time VIR operating procedures have not been worked out for the system.

The new complex VIR signal was developed over the past 18 months by the EIA committee, made up of representatives of broadcasters, receiving and transmitting equipment manufacturers, telephone company, and private consultants. The VIR signal testing is being done with the full approval of the Federal Communications Commission.

A detailed, 24-page description of the VIR signal testing, titled "Exploratory Field Testing of the BTS Color Reference Signal for TV", can be obtained free of charge from the EIA Engineering Department, 2001 Eye Street, N.W., Washington, D.C. 20006.



**FNA FUSETRON**  
Fuse 13/32 x 1 1/2 in. slow-blowing, Visual-Indicating, Alarm-Activating. (Also useful for protection of small motors, solenoids, transformers in machine tool industry.)



**BUSS MIC-13/32 x 1 1/2 in.** Visual-Indicating, Alarm-Activating.

**BUSS MIN-13/32 x 1 1/2 in.** Visual-Indicating.



**BUSS GLD-1/4 x 1 1/4 in.** Visual-Indicating, Alarm-Activating.

**BUSS GBA-1/4 x 1 1/4 in.** Visual-Indicating.

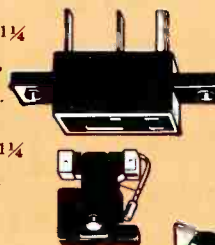

**BUSS GMT and HLT holder,** Visual-Indicating, Alarm-Activating.



**BUSS Grasshopper Fuse,** Visual-Indicating, Alarm-Activating.



**BUSS ACH Aircraft Limiter,** Visual-Indicating.

### The Complete Line of Signal-Indicating Alarm-Activating Fuses

For use on computers, microwave units, communication equipment, all electronic circuitry.

## SUB-MINIATURE FUSES

Ideal for space tight applications, light weight, vibration and shock resistant. For use as part of miniaturized integrated circuit, large multi-circuit electronic systems, computers, printed circuit boards, all electronic circuitry.



## TRON Sub-Miniature Pigtail

Fuses—Body size only .145 x .300 inch. Glass tube construction permits visual inspection of element. Hermetically sealed. Twenty-three ampere sizes from 1/100 thru 15.



## BUSS Sub-Miniature GMW

Fuse and HWA Fuseholder  
Fuse size only .270 x .250 inch. Fuse has window for visual inspection of element. Fuse may be used with or without holder. 1/200 to 5 amp. Fuses and holders meet Military Specifications.

BUSSMANN MFG. DIVISION,  
McGraw-Edison Co., St. Louis, Mo. 63107

For fuses and fuseholders of unquestioned high quality for every protection need . . .

Circle 7 on literature card

SUPPLIED THE ECONOMICAL WAY  
THRU DISTRIBUTORS

# BUSS QUALITY

FUSES



**A good tip...  
on how to  
save up to  
1/2 hour on  
every delivery.**

**FREE**

Fill in,  
clip out,  
and  
mail.

Please send me informative brochure on YEATS labor savers — no obligation

Name .....

Firm .....

Address .....

City .....

State ..... Zip .....

**YEATS**

**APPLIANCE DOLLY SALES COMPANY**  
1307 W. Fond du Lac Avenue • Milwaukee, Wis. 53205  
*Circle 8 on literature card*

**FREE CATALOG**



**RT COLOR CHAMPION**

**TV PICTURE TUBE REBUILDING EQUIPMENT**

**C.R.T. Equipment Company, Inc.**  
2740 Old Lebanon Road  
Nashville, Tennessee 37214

Telephone (615) 883-0215

**Mail Coupon Today**

(Please Print)

Name .....

Firm Name .....

Address .....

City ..... State ..... Zip .....

**Clip Me Out**

*Circle 9 on literature card*

**Takes the Watching Out of TV**

The sound portions of programs broadcast over TV channels 2 through 13 can be received by a new three-band portable radio developed by Topp Electronics and marketed by Juliette.

The new radio also receives conventional FM and AM radio broadcasts.

Company sales executives of the marketer reportedly believes that the vast majority of TV broadcasts lose very little when only heard and not seen, and the content of many programs, such as soap operas, interviews, music shows and news broadcasts, are primarily "hearing" programs anyway.

**Total U.S. Sales of TV, Radio and Phonos For First Six Months of 1970 Lag Behind Same Period For 1969**

Unit sales of black-and-white and color television, radio and phonographs during the first six months of 1970 were substantially lower than corresponding sales during the first six months of 1969, while tape recorders and players showed increases, according to statistics recently released by the Marketing Service Department of the Electronic Industries Association (EIA).

Total U.S. color TV sales during the first half of 1970 were 27.2 percent behind the sales in the same period in 1969. Monochrome TV total U.S. sales were off 10.2 percent.

Total U.S. sales of magnetic tape recorders, reportedly consumer electronics' fastest growing category, increased 26.7 percent over the same period of last year.

Product	Total U.S. Sales, 1970	Total U.S. Sales, 1969*
<b>TELEVISION</b>		
Monochrome	2,965,131	3,302,365
Color	2,146,079	2,946,384
Total	5,111,210	6,251,749
<b>HOME RADIO</b>		
AM	7,040,854	8,903,779
FM/AM or FM	8,968,219	8,293,974
Total	16,009,073	17,197,753
<b>AUTO RADIO</b>		
AM	4,844,298	5,193,403
FM/AM or FM	806,734	789,804
Total	5,651,032	5,983,207
Total Home & Auto	21,660,105	23,180,960
<b>TAPE PLAYERS</b>		
Automobile	* *	—
Others	1,415,557	—
Total	1,415,557	—
<b>PHONOGRAPHS</b>		
	2,147,618	2,687,550
<b>TAPE RECORDERS</b>		
	3,486,463	2,752,520

\*Source: EIA Marketing Services Department  
\*\*Data Not Published Because of Security Requirements  
—Data Not Available

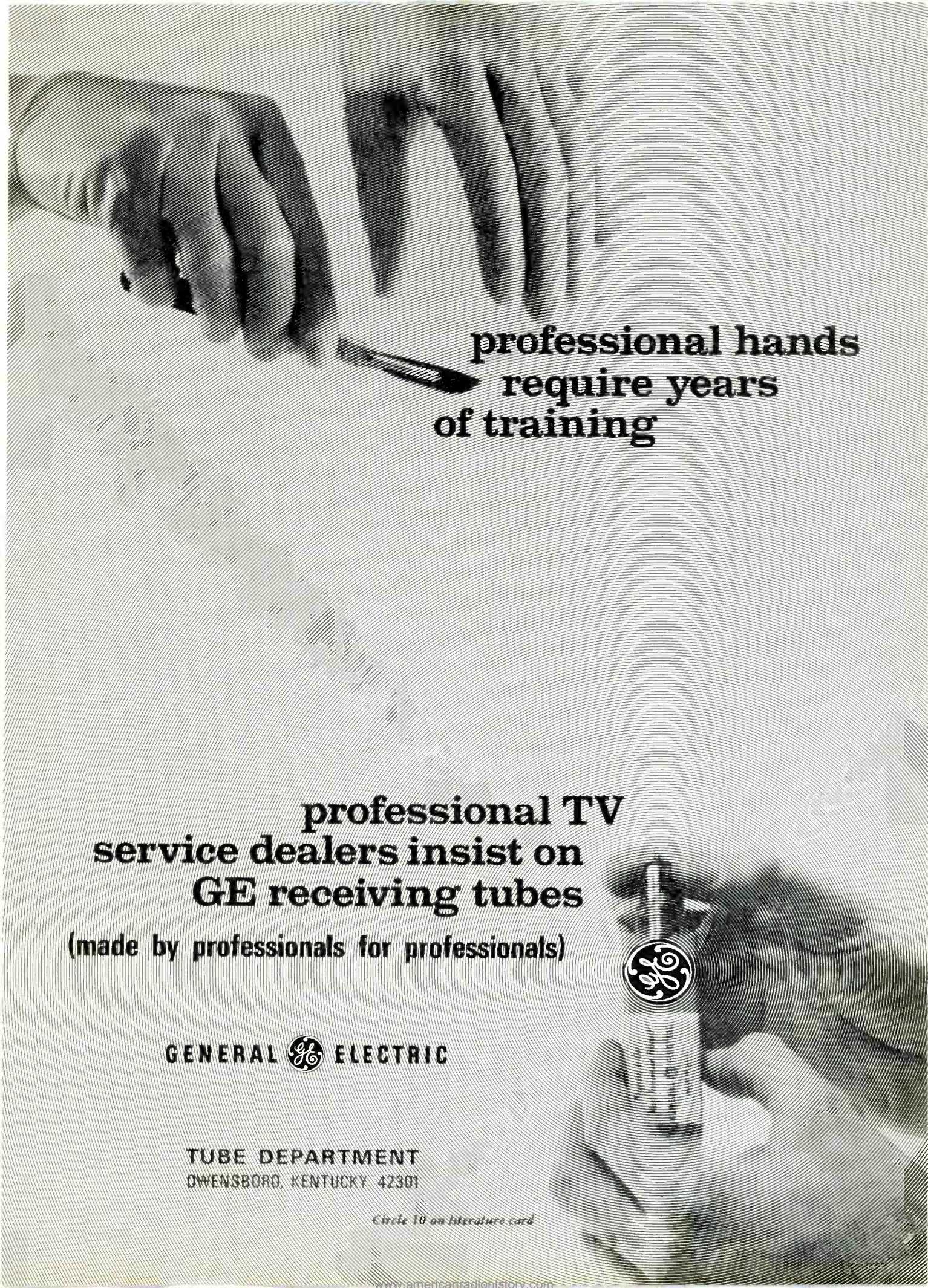

**professional hands  
require years  
of training**

**professional TV  
service dealers insist on  
GE receiving tubes**  
(made by professionals for professionals)

**GENERAL  ELECTRIC**

**TUBE DEPARTMENT  
OWENSBORO, KENTUCKY 42301**

*Circle 10 on literature card*

## **Servicing of Only Newer Sets Reduces Parts Availability Problems**

Enclosed is a copy of a letter I sent to Jack R. Fink, whose letter concerning parts availability appeared in the July issue of *ELECTRONIC SERVICING*.

"I have been servicing radio and television since 1929. In this time, I have learned that people will hold onto something forever, as long as it can be fixed. For example, I recently refused to repair a portable radio which I estimate was at least 15 years old. We also recently refused to service two black-and-white sets which the customers stated were 15 years old, or older.

"Your problem, Mr. Fink, may be that you have too many 'friends', in and out of the servicing business, who are sending you old sets. Take a look at the automobile industry—their own dealers cannot get parts for cars older than 5 years. You will find the majority of manufacturers reluctant to supply parts for sets older than 3 years. If you are fortunate enough to obtain parts for sets in excess of 5 years, they generally will be parts which are common to several manufacturers' products.

"Sometimes a distributor's service department will turn up parts that the parts department does not have. This generally happens when you talk to someone who understands what you want; usually the parts personnel do not know what you want.

"Remember that while you are repairing 'old dogs', your competition is repairing newer equipment, for which parts and information are readily available. I have had no problem obtaining parts since I started sending prospective customers with 'old dogs' to my competition."

Thomas A. McTiernan  
Wickenburg, Arizona

## **Hints on Color Temperature Adjustment**

I would like to add a few hints to Forest Bell's article on color temperature adjustment, which appeared on page 12 of the July issue of *ELECTRONIC SERVICING* magazine.

On Admiral sets, background controls are used to set low lights, as in the old RCA CTC5 chassis. Admiral drive adjustment, for setting high light tint, is done by moving a cathode lead to a pin with the proper drive level. Their (Admiral's) latest recommendations is to put a normal black-and-white picture on the screen, then increase master screen voltage to just short of washing out the blacks in the picture.

I prefer to ask someone in the customer's family how he likes the general background (gray scale) of the set with the color turned off. Usually the wife is the most "choosy". Do this with the same lighting which the family usually has in the room for TV viewing. When you let the customer decide, he can't very well ask for a callback merely because the gray scale is not agreeable.

On the other hand, if you are making the judgment on the tracking adjustment, rest your eyes from the tube before making final judgment. In daytime, look out the window at nature's color temperature. At night, sit down and converse with your customer a minute. This lets your eyes adjust to natural color.

I have seen no studies on how partial color blindness might affect the ability of a TV serviceman to do gray scale tracking. I was unable to see "enough" green and red back in the '30's to pass the Air Corps eye test for flying cadets. I can easily distinguish between a green and a red traffic light, but fail color blindness test charts. If a technician does not know whether he is partially color-blind, perhaps it would be worthwhile to have his eyes tested for that condition.

Some makes of sets sometimes give a different tinted raster on a black-and-white broadcast than on a color broadcast with the color turned off. This might be due to slight misalignment of the color circuits, for which the customer may not be willing to pay to have corrected. When I find this condition, I do tracking on a black-and-white broadcast, on an unused channel, with black-and-white color bars from the generator, or fine tune a color broadcast to the point where the color burst is not present to "turn on" the color circuits. This insures a neutral, or gray, background for black-and-white reception.

James O. Woodward  
New Castle, Ind.

## **Thanks to ES Readers**

In the Letters to the Editor department of the July issue of *ELECTRONIC SERVICING* I asked for help with my Jackson TVG2 Model sweep and marker generator. The response was overwhelming. As a result, I have all the information I need.

I especially would like to thank Dick's TV in New London, Ohio, and Fix Electronics, Richmond, Ind.

Ray's TV  
Jackson, Mich.

## **PF REPORTER's and PHOTOFACT's For Sale**

I have copies of PF REPORTER from 1961 to the present for sale. Also, I would like to sell my Sam's PHOTOFACT folders below No. 500, and some assorted schematics. No reasonable offer will be refused.

George Epstein  
200-27 46th Avenue  
Bayside, N.Y. 11361

## **More on GE's MXT Chassis**

Regarding the circuit change in the General Electric MXT chassis, I have found a solution easier than inserting the 470-ohm, ½-watt resistor in series with the control grid of the 6AF11.

I am the service manager of a hotel in New York City, where we have 400 to 500 GE sets of this type. After 5 to 6 years of operation, failure of the video detector began to occur.

We have been changing the 6AF11 video amplifier and the video detector using a 1N64 diode and a new

Model 5410  
30db Gain  
VHF Amplifier

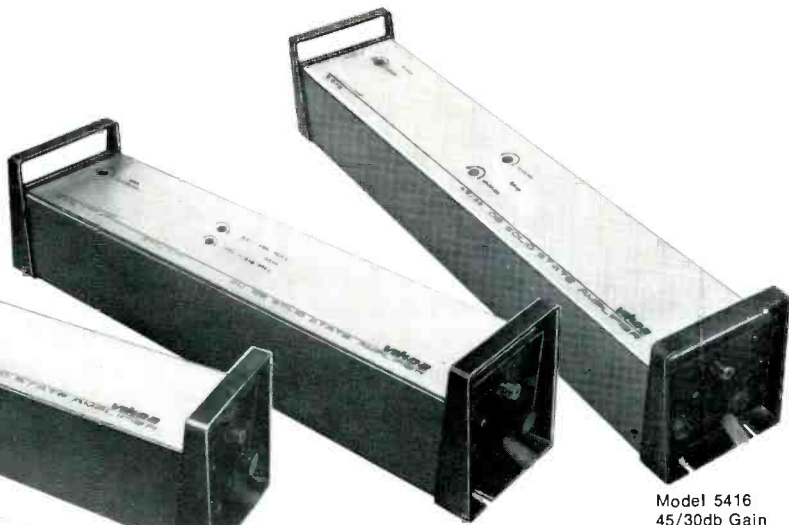

Model 5415  
30db Gain  
UHF/VHF Amplifier

Model 5416  
45/30db Gain  
UHF/VHF Amplifier

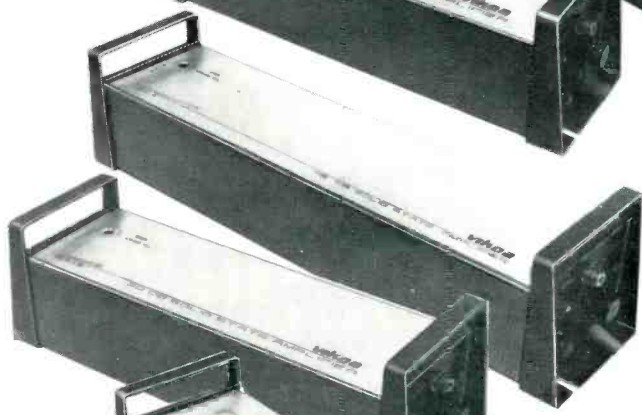

Model 5414  
45db Gain  
UHF Amplifier

Model 5411  
45db Gain  
VHF Amplifier

Model 5413  
30db Gain  
UHF Amplifier

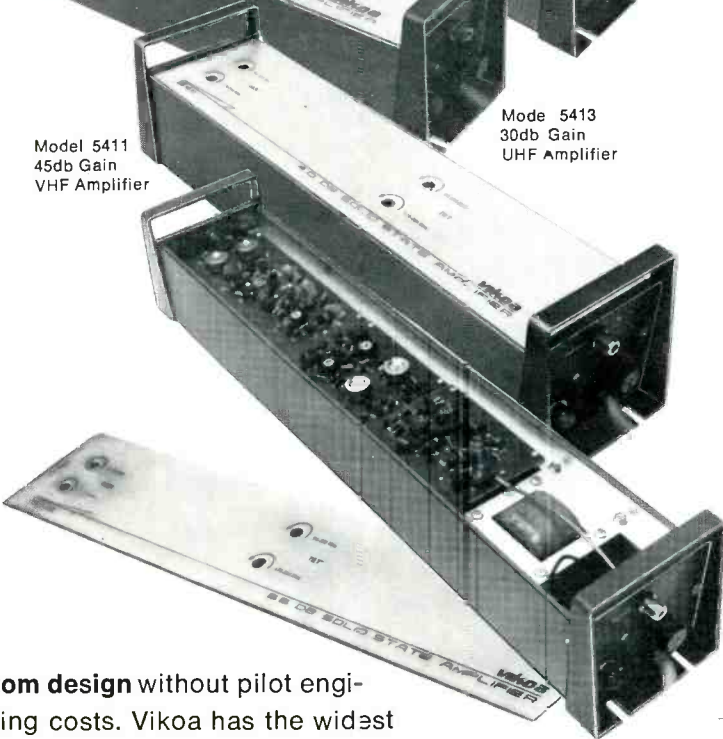

Model 5412  
55db Gain  
1 Volt  
VHF Amplifier

# **viko** CUSTOMIZED MATV POWER

**Custom design** without pilot engineering costs. Viko has the widest range of options available in the industry, fit the amplifier to your system, rather than fitting your system to an amplifier. 30 to 55db gain available, VHF and/or UHF, and

+47dbmv to +60dbmv (one full volt) output capability. These completely modular amplifiers feature low noise figure, flat response, and the dependability of silicon solid-state devices

mounted on military grade glass substrates. With attractive aluminum housing and cast end bells for rail type mounting, these low profile units can be mounted in the most inaccessible locations. For your next project get the best.

**viko**  
technically the one.



COMMUNICATIONS DIVISION: New York, N. Y. (212) 943-5793 • Hoboken, N. J. (201) 656-2020 • San Francisco, Calif. (415) 342-5239 • Dallas, Tex. (214) 276-1181 • Viko of Canada, Limited (514) 341-7440

Circle 11 on literature card

6AF11. This saves a lot of time and we have had no running failures.

I hope this helps some of those technicians who are having this problem.

Bob Rosenkrantz  
New York, N.Y.

### Service Labor Pricing

Here in Suffolk County, Long Island, there are approximately 23 service shops, some of which advertise "no charge for service labor". These shops are supported by factory service work.

Our service call rate is \$6.95 for b-w and \$9.95 for color TV sets. I feel we should get higher rates, but the public is unwilling to pay more because of the low cost of a new set. Here is an example: A customer needs a new flyback transformer in a \$100 b-w set. The total charge should be \$24 for service labor plus \$17 for the flyback for a total of \$41. However, we find that if we quote over \$24 for the entire repair of a \$100 set, the customer will take his business elsewhere.

Charging and getting higher rates is one thing, if you want to lose a lot of business. However, we have found that lower prices can help us stay in business. We have tried higher pricing and grossed \$6000 that year. We lowered our prices, did more work and were able to draw \$8200.

Martin Fischer  
N. Babylon, L. I., N.Y.

### TV Technicians Underpaid, but . . .

Each month your magazine relates how we television technicians are underpricing ourselves in comparison to other service fields.

You are right, but our field has a unique situation, for which we can thank the manufacturers, who are not as interested in serviceability as in replacement. The technician also can thank our government, which refuses to limit the amount of imports to the point where we are not yearning to see anything made in the U.S.A. And how many of our American companies have put their labels on Japanese or Hong Kong products?

The TV serviceman is put in an aggravating position when he has to tell a customer that his picture tube is fading. The customer many times simply refuses to replace it because of the unrealistic pricing of the replacement tube in relation to the initial price of the set.

If the construction industry had a problem with coolie labor—as the servicing industry does with imported sets—bricklayers, carpenters and many other trades would have the same problems of keeping their labor prices up.

The manufacturers who put their names on imported sets eventually find out that this system backfires. Many people shy away from imports altogether, and get disappointed when the brand name they have confidence in does not live up to their standards. Those who buy the imports for price don't, as a rule, buy brand names.

Max Goodstein  
Flushing, N.Y.

I would like to sell my color television servicing equipment, parts and service literature. Most of these items are less than one year old. If anyone is interested, please write me for a list.

David R. Camp  
P. O. Box 173  
Vestal, N.Y. 13850

I need a schematic and shop manual for a:

Sony Radio Receiver  
Model CRR-4A  
No. 5528  
Sony Corp.  
Tokyo, Japan

Sony Corp. of America, in Long Island City, told me this set does not exist.

John Yack  
97 Coldenham Rd.  
Walden, New York

I have a number of used test instruments with instruction manuals, and also a large quantity of obsolete tubes. I would like to trade for a late-model scope or will sell or trade.

Williams Radio & TV Service  
116 W. Washington St.  
Lewisburg, W. Va. 24901

I noticed a letter in a past issue looking for a spring for an old wind-up phonograph; I am in need of a spring, also. Another item which I could use is a complete set of Sam's Auto Radio Manuals, or, if not a complete set, at least a set which could be updated.

Edward J. Lee  
88 Rhode Island Rd.  
Lakeville, Mass.  
02346

I am in need of the manual and schematic for a Solar, Model "CE" (Serial No. E-5899) capacitor analyzer and a manual and schematic for an ATR, rectifier power supply, Type 120-C, Model EL 10.

Perhaps one of your readers could help me find this material.

L. Migliaccio  
5421 Quentin St.  
Philadelphia, Pa.  
19128

Would you please advise where I might obtain the following service schematics?

Schaub - Lorenz - Radio - Phonospur Stereo 10 type 38050. Made in Germany.

Stewart-Warner-Radio-Model R176 Serial No. 71488 made by Stewart-Warner, Alemite Corp. of Canada.

This set was made in the 1930's. Stewart-Warner in Canada suggested that I try down here because they have no data on equipment this old.

George Sarginson  
Box 126  
360 Eddy Street  
Scotia, California  
95565

**NEW!**

**TUN-O-BRITE**  
the  
heavy duty  
tuner spray  
with  
built-in  
polishing  
action!



BT-8 8 oz. \$2.39

BT-16 16 oz. \$3.49

**SEE THE DIFFERENCE**

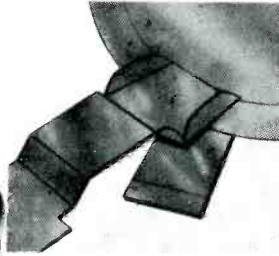

This tuner contact has been sprayed with an ordinary tuner cleaner. It looks clean, but close examination would reveal minute areas with corrosion and dirt.

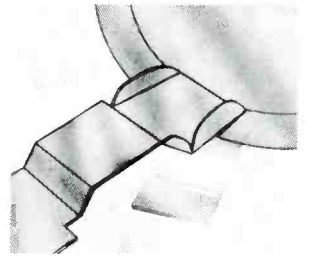

This tuner contact has been sprayed with new TUN-O-BRITE, with its built-in brighteners. It is not only clean, it has been polished shiny. There is absolutely no dirt or corrosion left to spread. What's more, the contact is protected by a film of ultra-long-lasting lubricant.

**FEEL THE DIFFERENCE**

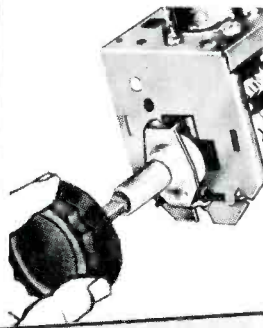

The extra heavy duty lubricant used in TUN-O-BRITE makes any tuner slide from channel to channel smoothly. Your customer will feel the difference immediately. When he sees bright, clear pictures on every channel and feels how smoothly the channels change, he'll know you've done something almost miraculous to his tuner.

**SAVE \$4<sup>78</sup>**  
**WHEN YOU BUY THIS 6-PACK!**

AVAILABLE FROM YOUR CHEMTRONICS DISTRIBUTOR



**CHEMTRONICS** INC. 1260 RALPH AVENUE BROOKLYN, N. Y. 11236

Circle 12 on literature card

# Common causes of *poor quality color*

by Bruce Anderson

Now that color television has been a reality for fifteen years, the state of the art has progressed to the point where any present-day receiver is inherently capable of producing a high-quality picture.

Nevertheless, many color receivers in daily use fall far short of this possibility.

This article will discuss present

causes of poor quality color and suggest the solutions to many of these problems.

## Customer Problems

It seems surprising, but there are still people who simply don't know how to adjust their color receivers for the best picture.

Perhaps you might feel a bit self-conscious explaining how to adjust color, tint, brightness and contrast; after all, it does seem simple to you. But from the customer's point of

view, you might be the "nice man who took time to show me how to get such a good picture."

Incidentally, don't preface your little demonstration with a test—no one likes to admit a lack of knowledge. Start with a gambit such as this: "Have you ever noticed how harsh the picture looks when the color control is set too high and the contrast set too low?" Or, "With these new picture tubes, it is no longer necessary to turn the brightness all the way up."

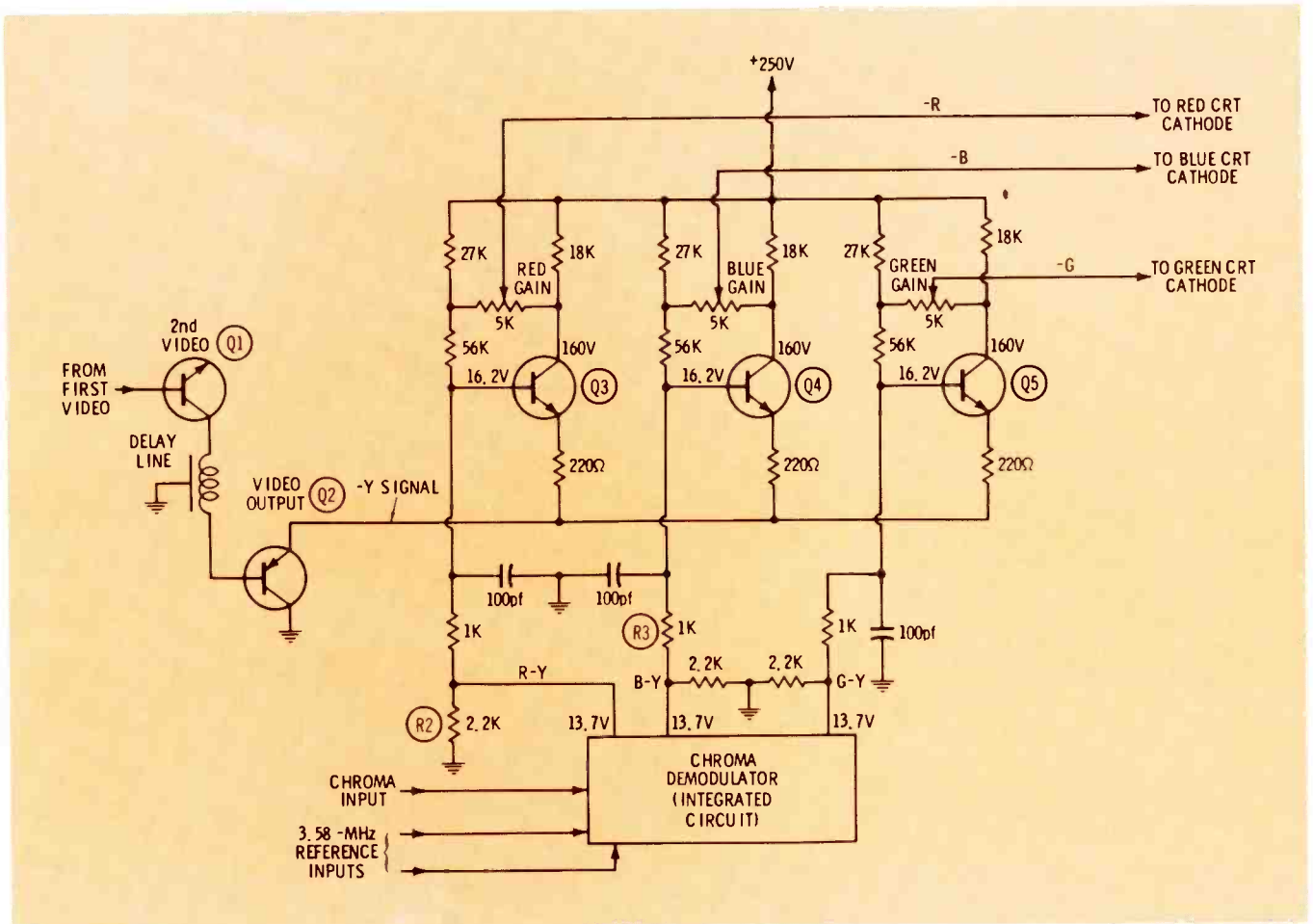

Fig. 1 Pre-CRT matrixing circuit of the Zenith 12A12C52 chassis.



## Picture Tube Defects

Of course, this article is more concerned with failures of the receiver than with customer relations.

One obvious source of poor color quality is the picture tube itself. Loss of color purity is one of the ways in which a picture tube can fail. A warped shadow mask, or distortion of the bulb, will make it impossible to adjust the purity magnet and the yoke position for a pure screen. On the other hand, don't give up until you have checked these other possibilities.

The automatic degaussing circuit might have failed, allowing the shadow mask to become magnetized. Also, it is possible that some current always is passing through the degaussing coil. In some instruments, an open rectifier in the power supply will cause the degaussing circuit to magnetize the picture tube. If you doubt the automatic degaussing circuit, disconnect the built-in degaussing coil, degauss with your own coil, and then check the performance.

Another possibility, when lack of purity is the problem, is that the chassis has become magnetized. In most cases, the internal degaussing coil will not de-magnetize the chassis. Again, your own coil should be used before going any further.

Allow the receiver to become thoroughly hot before making purity adjustments. If this is impractical, remember to approach the final yoke position from the bulb of the picture tube if it is cold, and from the socket if it is hot. This way, the glass expansion will work for you, rather than against you.

Convergence and purity adjustments should be made on color portables with the picture tube facing north or south. This will minimize purity changes when the set is moved.

If the emission of the picture tube guns is unbalanced, it will be impossible to get acceptable gray-scale tracking. Of course, a new picture tube is the ultimate solution to this problem, but if the customer cannot afford this, there are ways to improve the picture quality of the faulty tube. A brightener often will

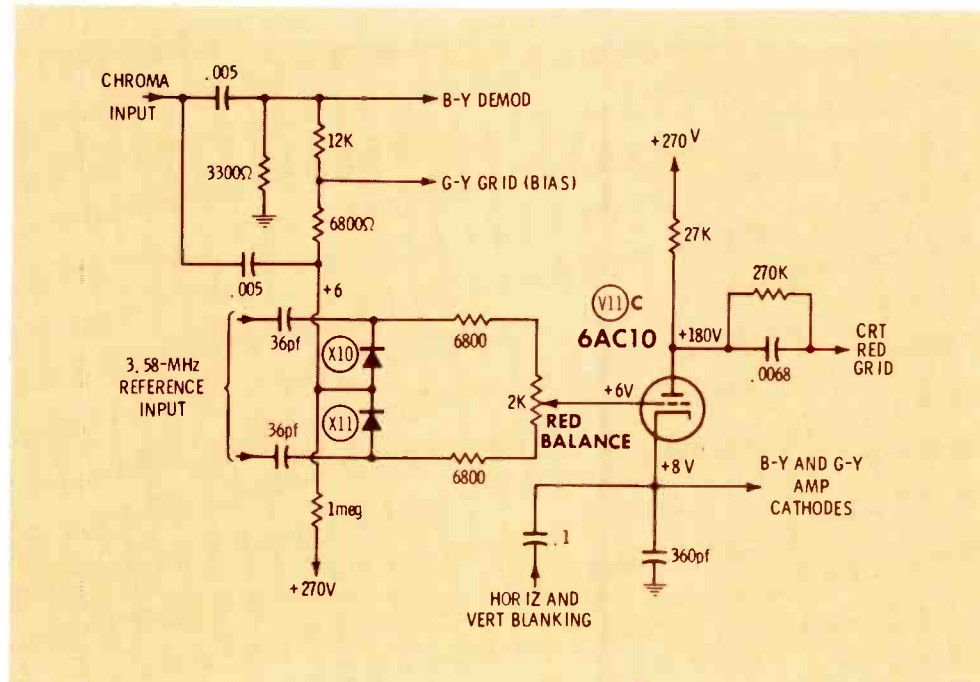

Fig. 2 R-Y demodulator and amplifier of the General Electric HC chassis.

improve performance drastically.

A rejuvenator sometimes will perform wonders on the emission of a weak gun, but there are some important points to remember. First, the results might be very temporary. Because of this, it is a good idea to let the instrument sit, turned off, for about a day after rejuvenation and then check it again before delivery. Also rejuvenation often increases the grid aperture, and hence the electron beam diameter. This might make it impossible to obtain good focus or purity. Use the rejuvenator sparingly.

A new trouble has cropped up with the new color CRT's that have smaller dots and the surrounding black screen. The symptom is best described as a moire effect; small colored circles or spirals appear to be moving on the raster, particularly near the corners.

The reasons for this effect are rather complicated; but it seems to be related to the spacing of the scanning lines and the dot triads. The effect may best be observed if the blue and red guns are extinguished. To remove the symptom, simply adjust the height control

slightly. In some instances, very slight rotation of the yoke also is necessary.

## High Voltage and Regulation

Reduced high voltage normally leads to picture blooming, loss of detail and lack of focus. Troubleshooting the high-voltage system is beyond our present interest, but the symptoms of a large reduction in high voltage are so common that nearly everyone recognizes them.

Intermittent conditions might cause the focus voltage to change. A loose or cracked core in the focus coil can be a real headache, unless one happens to be lucky enough to remember this possibility at the same time the trouble is encountered.

Whenever focus or blooming problems exist and the solution is not obvious, it is good technique to check the voltages at the connections to the picture tube. Measure these while the receiver is tuned to an actual colorcast, and observe the voltage variations which occur as the scene content changes. If the high voltage decreases 10 percent, for example, and the focus voltage

decreases 20 percent (or not at all), you might be on the track of the trouble because both voltages should rise and fall the same percentage. While you are measuring, don't forget the screen voltages. These, too, might be varying abnormally, causing intermittent gray-scale tracking and color balance problems.

### CRT Matrixing

For many years, chroma signals were applied to the grids of the color picture tube, and the video (or Y) signal was coupled to the cathodes of the CRT. Thus, matrixing was accomplished by electron coupling inside the picture tube.

While adding to the number of circuits to be tested, this matrixing system helped the troubleshooter because it provided two separate channels whose signal strength and picture quality could be compared. If the b-w picture showed full contrast, high brightness, good sharp-

ness and focus, the picture tube had to be normal, even though the color might be weak or blurred. Conversely, strong, bright color indicated a good CRT, despite the lack of contrast that might have been one symptom of a weak CRT.

### Pre-CRT Matrixing

In modern color receivers, such as the Motorola Quasar, the Sony KV120U with the Trinitron picture tube and the new Zenith 12A-12C52 chassis, the color and video signals are matrixed before they are applied to the CRT cathodes.

Fig. 1 shows a simplified schematic of the Zenith system. Note that direct-coupling is used throughout the entire circuit. R-Y is supplied to the base of Q3, B-Y to Q4 and G-Y to Q5, while the same -Y (video) signal is furnished to the three emitters of Q3, Q4 and Q5. Intensity of the red, blue and green signals obtained at the collectors is

adjusted with the three gain controls, and the signals are applied to the CRT cathodes.

Pre-CRT matrixing eliminates the video output stage, and therefore might become more popular with designers as solid-state components proliferate.

### Screen Color Changes

Most component defects which adversely affect gain or color quality also change the DC voltages. These, in turn, change the screen color and gray-scale tracking. If you are the first technician to service the receiver, changed screen color might be the only obvious symptom. Resist the temptation to correct it by adjusting the gray-scale; finding and repairing the basic trouble often will correct the wrong screen color, while retracking with the gray-scale controls alone will still result in a poor picture.

Fig. 2 is a partial schematic of the General Electric HC chassis which shows the diode-equipped R-Y demodulator and the R-Y amplifier stages. Direct coupling is employed from the demodulator diodes to the CRT grids; therefore, any change in the +6 volts that is applied to the grid of the tube through the demodulator, any change in the balance of the demodulator, or a change in the plate current of V11C will shift the screen color away from blue-gray. Leakage, shorts or opens in diodes X10 or X11 will cause poor quality of color, but the most noticeable change will be the difference in screen color on b-w programs.

Other examples of component failures that produce a change in screen color as the main symptom are shown in Fig. 3: The diode grid-clamps for the CRT of the RCA CTC27 (and other chassis). The .01-mfd coupling capacitors between the -Y amplifier plates and the CRT grids prevent DC voltage variations in the -Y amplifier stages from affecting the bias on the CRT grids, which would change the screen color. Nonsymmetrical chroma waveforms at the CRT grids will cause the CRT bias to vary abnormally, unless direct coupling or clamp-

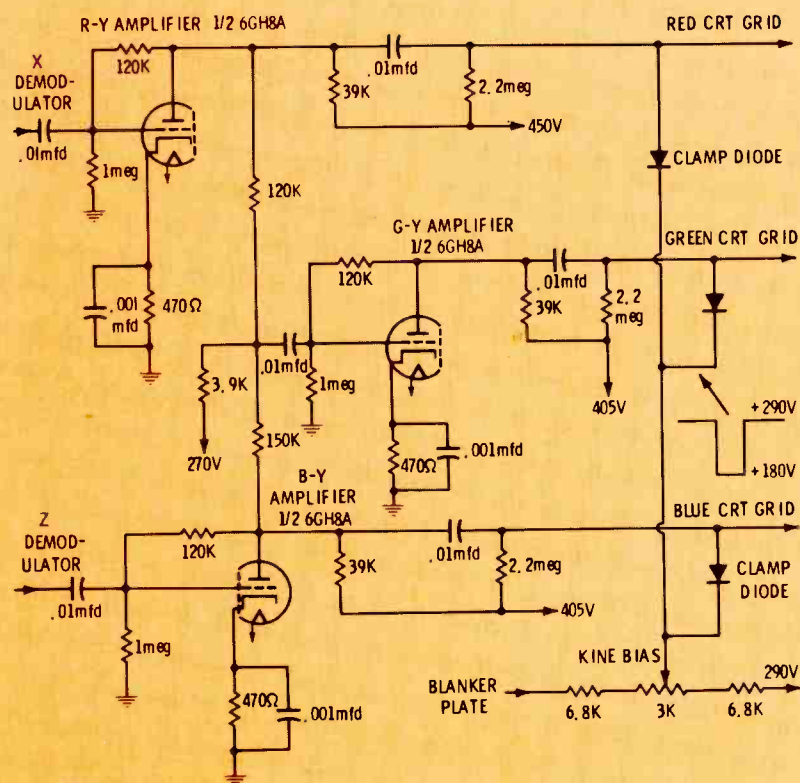
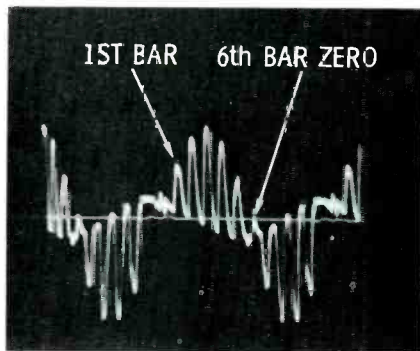
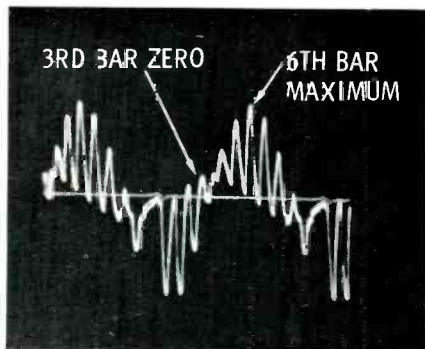

Fig. 3 Diodes are used as CRT grid voltage clamps in the RCA CTC27 chassis.



(A) At CRT red grid



(B) At CRT blue grid

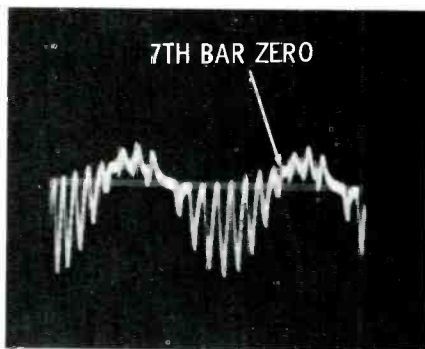

(C) At CRT green grid

Fig. 4 Waveforms at the grids of a color receiver when a keyed-rainbow generator is used for a signal.

ing is used. In the circuit in Fig. 3, a negative-going blanking pulse is applied to the cathodes of the three clamp diodes. When the individual CRT grid is more positive than the tip of the blanking pulse, the diode is forward biased, and charges the .01-mfd capacitor to the voltage of the tip of the pulse. Between pulses, the voltage on the CRT grid and .01-mfd capacitor increases slightly because of the 2.2-megohm resistor connected to B+. Then the next

pulse arrives and lowers the grid voltage again.

The most likely failure in this circuit is one or more of the three diodes. A shorted diode weakens and blurs the associated color, but, even more noticeable, it produces a major change in screen color. The affected grid is permanently shorted to the "kine bias" control, to which is applied a DC potential of approximately +300 volts. An open diode permits no pulse to pass through, so the capacitor gradually charges toward +405 volts (when the grid becomes more positive than the CRT cathode, grid current halts the voltage at that point). Completely turning down the screen control usually will not allow good gray-scale tracking, and the color also will be very poor. Just remember that an open or shorted diode will cause the associated color to be too bright. Play it smart—use a meter, to be sure of the defect.

#### Color Balance

The balance between R-Y, B-Y and G-Y chroma signals is very important. Most color hues are not pure red, blue or green, but mixtures of all three. Magenta is about 50 percent R-Y and 50 percent B-Y; the various shades of yellow and orange are a mixture of red and green. Even more important is human skin color, which is composed of gray (R-B-G) and orange (R and a small amount of green). Increase the amount of green, and the TV people become bilious (greenish) and sick-appearing. Increase the amount of blue, and the faces become purple or blue. Reduce the intensity of the R-Y signal and satisfactory skin color cannot be obtained at any setting of the hue control.

The relative voltages normally will have a ratio of about 10B:8.5R:2.5G. Thus, if the B-Y voltage measures 140 volts p-p, R-Y should be about 120 volts p-p and G-Y 35 volts p-p. This ratio might vary slightly, depending on the relative efficiencies of the CRT phosphors. Usually, these -Y voltages should be measured at the grids of the CRT (exceptions previously

noted). If horizontal blanking pulses also are present on the grids, the measurements should be made with a calibrated scope.

One rough check (usually sufficient for service calls) of the three color-difference signals is to observe the order in which the color bars from a keyed-rainbow generator are extinguished on the CRT screen as the brightness is lowered. In a receiver that has good gray-scale tracking and is working correctly, the green bars will be the first ones to go black and invisible, next will be the red bars, and the blue bars will be the last to be extinguished.

#### Demodulator Phasing

Either the 3.58-MHz carrier or the chroma sideband signal must have the phase changed before it is applied to the second demodulator. Theory, and practice as carried out in the older receivers, gives this phase difference as 90 degrees. However, most of the manufacturers, for practical reasons, now have selected a phase of about 105 degrees as giving the best visible color. This means we should tune in a keyed-rainbow color-bar signal, attach the low-capacitance scope probe to the red CRT grid and adjust the hue (tint) control so that bar 6 is nulled at the zero center line (see Fig. 4A). Then, without adjusting the hue control, change the scope probe to the blue CRT grid and check for the crossover point where the nearest bar is nulled. By the new standard, it should be half-way between bars 3 and 4; by theory it should be nulled at bar 3 (Fig. 4B). Actually, the phase difference between demodulators is not very critical; accuracy within one-half bar is considered adequate.

Errors in demodulator phasing caused by defective or off-tolerance components will change the color rendition of all composite colors, and a defect should be suspected if the phasing is more than one color bar (30 degrees) different from the specifications for that model.

#### Hue Control Servicing

Some confusion of terminology

exists; one manufacturer might call a control that changes the b-w screen color a "tint" control and a control that varies the phase of a signal applied to the demodulators, a "hue" control. Another manufacturer has no control to change the screen color and calls the control that changes the phase of the color burst a "tint" control. To avoid misunderstandings, the term "hue" control will be used here to indicate one which changes **phase**.

To accomplish hue changes, various manufacturers change the phase of the color burst, phase of the 3.58-MHz subcarrier, or phase of the chrominance sidebands by filtering or tuning. Regardless of the method, skin color on the screen should be adjustable from greenish-yellow to magenta (deep purplish red).

If the hue control does not have sufficient range, it is advisable to analyze the source of the problem by observing a color-bar pattern while the hue control is varied. Al-

though theory says the third bar from the left should be maximum red, in practice the hue control should move the brightest red bar from bar 2 position to bar 4. And it is even better if the red bar can be adjusted from bar 1 to bar 4, according to the way many network programs are received.

In circuits where resonance is used to change the phase, a lack of sufficient bar movement with use of the hue control often indicates the adjustable coil has been turned too far previously.

Ideally, good skin color should be obtained with the hue control at about mid-range. Practically, you might have to be content if a hue adjustment gives good skin color **anywhere** in its range.

#### Alignment

Color picture quality is greatly affected by receiver alignment. ELECTRONIC SERVICING has presented in recent issues articles on alignment in general, RCA specific

alignment, alignment using the B & K Model 415, and alignment methods featuring the Sencore SM152 generator. Each gave a fast method of checking alignment to determine if the receiver in question needed complete alignment. We recommend you become an expert at one of these systems of alignment. Fig. 5 shows the equipment set-up to check overall chroma alignment.

#### Summary

The quality of a color picture is the total of many things:

- A good b-w picture, including purity, gray-scale tracking, focus and convergence.
- Customer's ability to properly adjust the receiver.
- Sufficient CRT emission to give good brightness.
- Correct balance of R-Y, B-Y and G-Y signals.
- Correct demodulator phasing and hue control action.
- Normal alignment and bandwidth. ▲

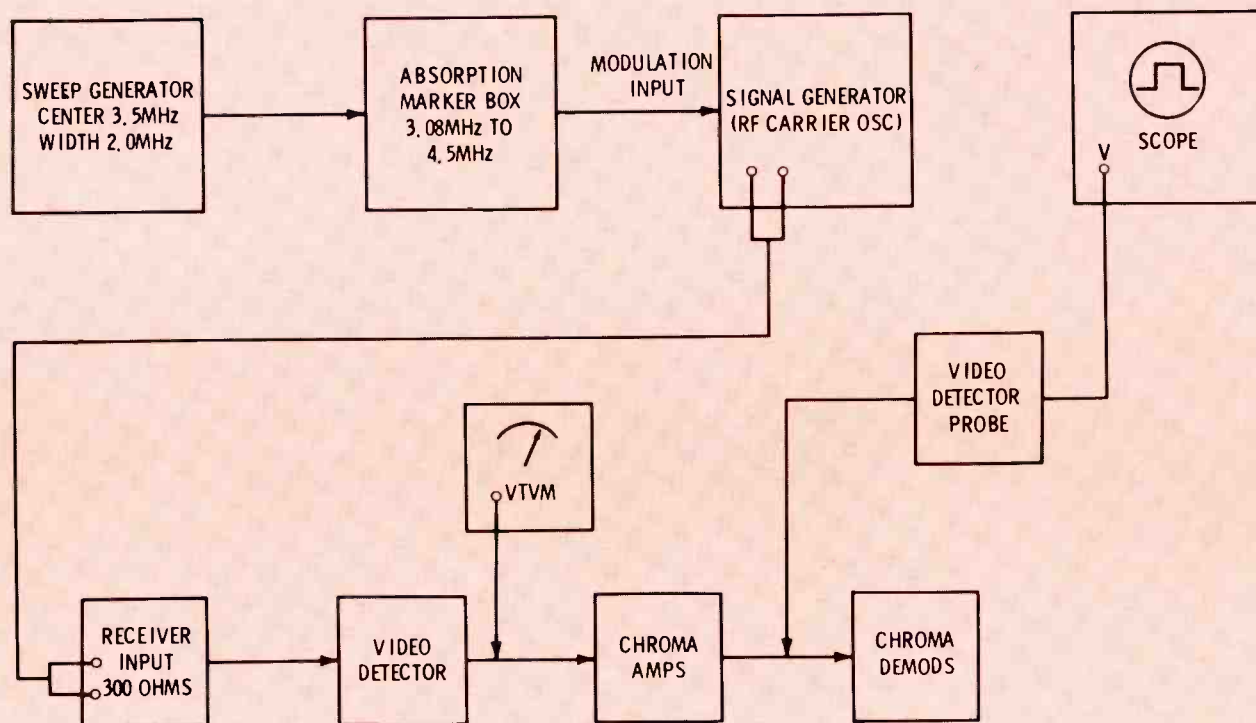

Fig. 5 Equipment setup for checking overall chroma bandwidth. Be certain the fine tuning is set correctly.

# NOW you can measure resistors accurately

# IN CIRCUIT!

## in solid state devices



**FE20 HI-LO**  
with hi-voltage probe and large  
six-inch meter **\$129.50**



**FE21 HI-LO**  
with 4 1/2-inch  
meter **\$99.50**

## WITH THE NEW HI-LO FIELD EFFECT MULTIMETERS

**USES ONLY .08 VOLTS TO POWER OHMMETER TO PREVENT TRANSISTORS FROM CONDUCTING AND UPSETTING READINGS**

Look at these extra features to see why the Hi-Lo meter belongs on your want list:

- Unbelievable specifications of 15 megohm input impedance on DC and 12 megohms on AC
- Laboratory accuracy of 1.5 percent on DC and 3 percent on AC
- 9 DC voltage ranges from as low as .1 volts full scale to 1000 volts
- 3 hi-voltage ranges of 3 KV, 10 KV and 30 KV
- 9 DC zero center ranges from .05 volts to 500 volts . . . a must for delicate transistor bias measurements
- 7 resistance ranges from 1000 ohms full scale to 1000 megohms
- 9 DC current ranges from 100 microamps to 1 amp
- Automatic built-in battery test . . . never a worry about rundown batteries, just push the switches under the meter and read.
- Standard .6 amp fuse to protect the ohms and milliamps scales if voltage or overload is accidentally applied. No more need to return the meter to factory for repair . . . just replace the fuse.
- Special probe with 100K isolation resistor in probe to prevent AC pickup or to prevent loading oscillator circuits. Leave in normal position for most tests.

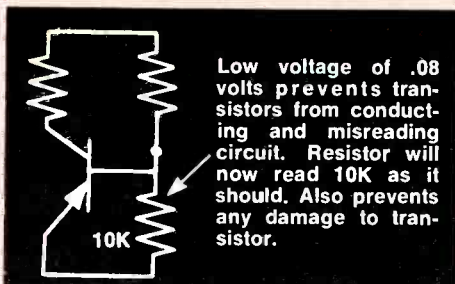

**Here is why you should have both Hi and Lo battery voltages for correct in-circuit resistance measurements in solid state circuits:**

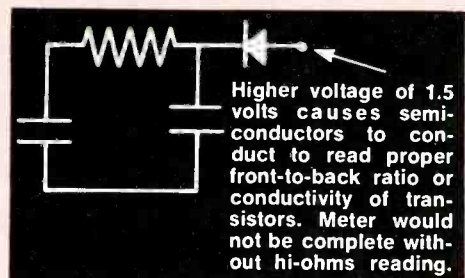

**SENCORE** INC. 3200 Sencore Drive • Sioux Falls, South Dakota 57107

Circle 15 on literature card

# Frequent Causes of Intermittent Color

by Wayne Lemons

A brief review of the most common troubles that produce come-and-go color.

Intermittent color symptoms often send technicians unwarily slashing into the innards of a chassis only to find that the actual problem is a minor trouble masquerading as a major fault.

## Misadjusted Controls

For example, borderline adjustment of the color killer control can be the cause of intermittent color, as can a misadjusted AGC control. And in some chassis, especially older ones, the horizontal hold adjustment might have to be centered correctly to get color, even though the black-and-white picture appears perfect.

## Tuner Trouble

One of the things found most often by technicians who go to a

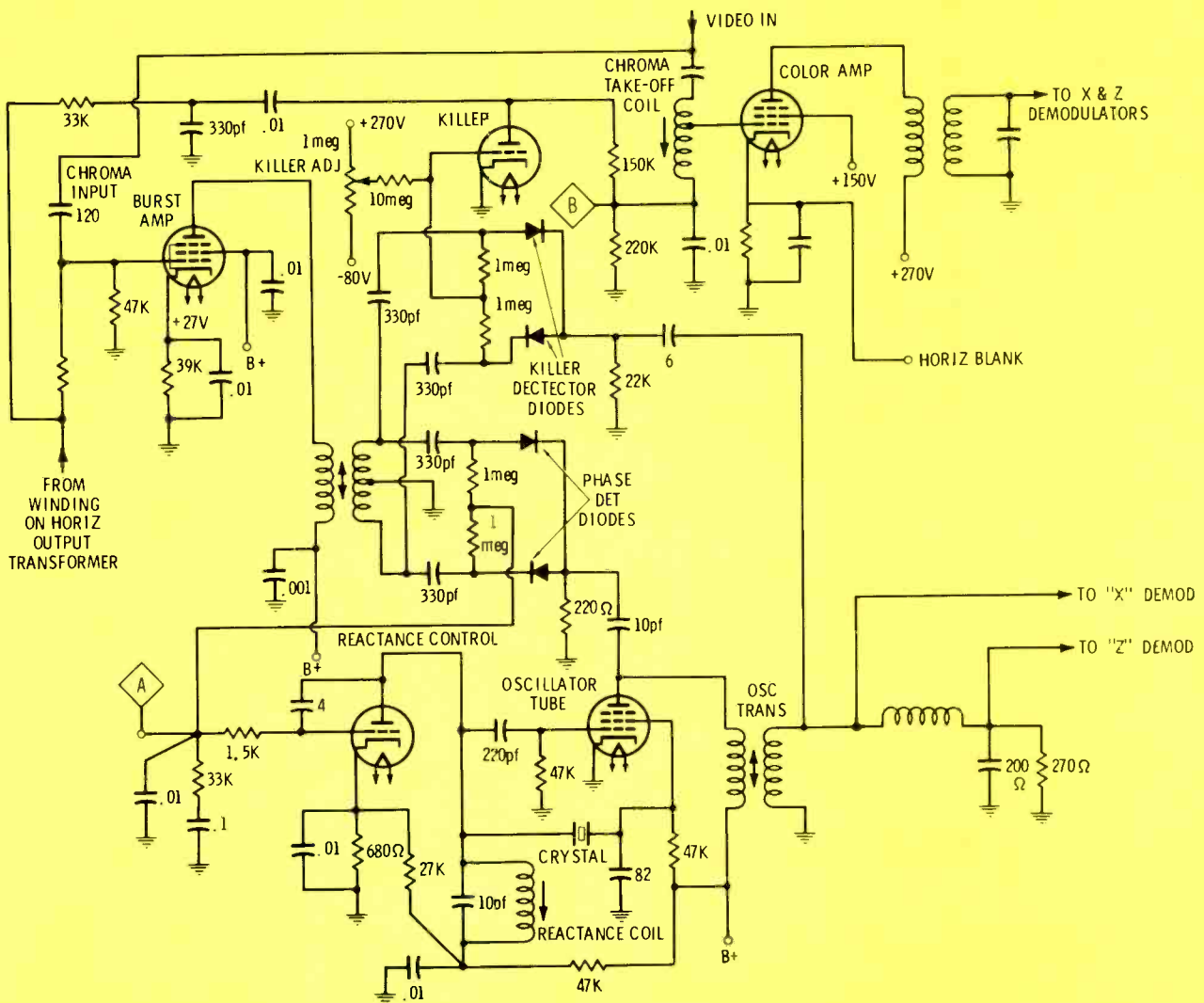

**Fig. 1** The color circuitry shown here, representative of that employed in most older receivers and many newer ones, is a source of many of the troubles that commonly cause intermittent color.

home on a "no or intermittent-color" complaint is that the customer doesn't have the fine tuning set correctly. In such cases, the technician should question the customer to determine if frequent resetting of the fine tuning is required, especially on high channels. If it is, tuner repair might be required. Try replacing the oscillator tube, and use a good tuner contact cleaner if the tuner contacts appear to be dirty—be sure to rotate the tuner through all channels in both directions several times while using the cleaner.

### Antenna Troubles

Another common "external" cause of intermittent color loss is a defective antenna or antenna lead-in. Lead-in that has an intermittent break can cause loss of color, even though there is little effect on the b-w picture. Usually, a broken lead-in will have more effect on one channel than on another. This is because voltage and current nodes appearing along the lead-in occur at different spots for different frequencies (channels). A break at a voltage node might have little effect on the **strength** of the black-and-white signal, but might cause a **phase** discontinuity that will "drop out" or seriously weaken the color signal. The main point is: If you have intermittent color on one channel, do not forget to include the antenna system in your diagnosis.

### Loss of Color Sync

If the intermittent color symptom does not respond to external adjustments or is definitely not caused by the antenna system, the next step is to find out from the customer, if possible, whether the trouble is loss of color sync, which causes color stripes, or "barber poling", or whether the color fades away gradually or is lost suddenly. In some chassis, loss of color sync will cause an immediate and complete loss of noticeable color, especially if the color oscillator has shifted far from its normal frequency. Let's talk about loss of color sync first.

Fig. 1 is representative of the circuitry used in most older color sets and in many new ones. It uses a color oscillator controlled by the DC output of a color phase detector, and a color killer controlled by the DC output of the two color killer detector diodes. The color killer op-

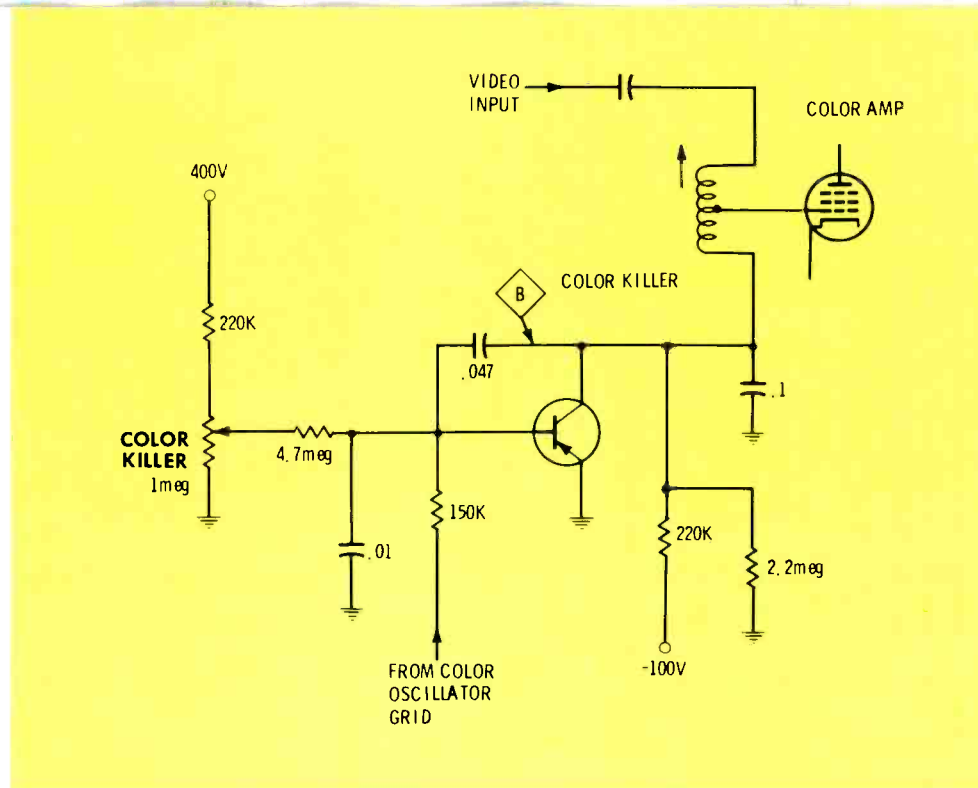

Fig. 2 Unlike a tube-type color killer, the solid-state counterpart shown here conducts when a color program is received; consequently, it can cause loss or intermittent loss of color.

erates by biasing the color, or band-pass, amplifier to cutoff when no color signals are being received, which eliminates the possibility of colored snow on black-and-white pictures.

### Color Subcarrier Oscillator

To produce solid color sync in the absence of the burst signal, the color oscillator should operate at close to the required frequency of 3.58 MHz. If it does, it will be controlled easily by the broadcast burst signal. However, if the color oscillator is out of adjustment and is operating beyond the "correction range" of the burst phase detector, the phase detector might lose control of the oscillator during periods of interference or during switching operations at the station. Once lost, control of the oscillator might be lost completely, or might not be regained until some internal or external disturbance is created; for example, the set might regain color lock if the tuner is quickly switched off channel and back on.

To set the color subcarrier oscillator, ground test point A. Connect a color-bar generator to the antenna terminals of the set. Adjust the reactance coil until the color bars are vertical—they won't stand still but they should be standing straight up. Remove the ground from test point

A and the bars should lock in solidly.

If about one turn or so of the reactance coil slug is required to get the oscillator back to "zero-beat", it indicates that the likely cause of the intermittent color problem was loss of color sync. But don't be too sure. Allow the set to operate at least an hour, and again ground test point A. The oscillator still should be very near zero beat. (Color bars vertical but moving when test point A is grounded; bars stationary when ground removed from test point A). If it has changed so that a major adjustment is needed, the problem is oscillator drift, which should be corrected. The tube can be causing the trouble or some part of the circuit. One likely suspect in the circuit is a burned resistor which has changed value. Also, be alert for a leaky coupling capacitor, such as the 220-pf unit between the reactance control tube and the oscillator tube. It also is possible for the crystal itself to cause this problem, as well as the reactance coil and capacitor, but these generally are the last things to check.

### Reactance Control Circuitry

If the oscillator appears to be comparatively stable but lock-in is critical, or there is a complete change in color sync when the

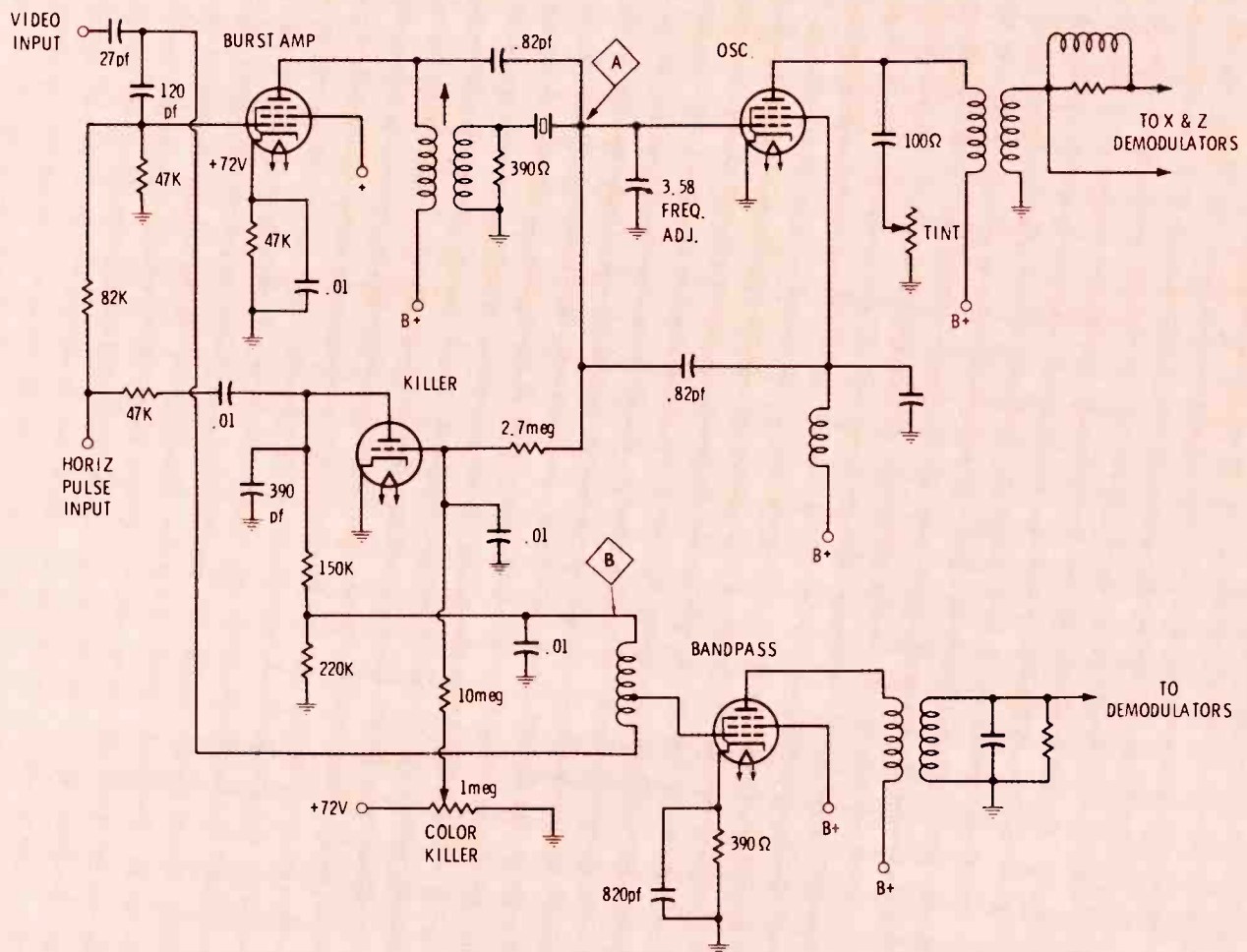

**Fig. 3** A "brute force" type of color locking system. The burst signal is applied directly to the crystal instead of indirectly through a phase detector. Always use exact replacement crystals in this type of circuit.

ground at test point A is removed, the trouble probably is in the grid circuit of the reactance control tube—check the .01- and .1-mfd capacitors for leakage or opens—or in the phase detector. Check the detector diodes and resistors for good balance—the voltage at test point A should be near zero. A leaky 10-pf coupling capacitor between the oscillator plate and the detector also can cause unbalance. Or the burst amplifier circuit might be defective.

If the burst amplifier does not receive a keying pulse from the flyback transformer, there will be no burst signal at its output. On the other hand, if the burst amplifier is not properly biased near cutoff, except during the horizontal pulse, it will amplify both the burst signal and the video signal as well. For example, one case of intermittent color, in which the colors changed with changes in scenes before finally being lost, was caused by a leaky cathode bypass capacitor in the

burst amplifier. An open cathode bypass also can cause such trouble, and in both cases the cathode voltage on the burst amplifier will be lower than normal if the flyback pulse is not reaching the grid. In the circuit in Fig. 1, the cathode voltage will drop to about 6 volts.

#### Color Killer

The other common source of intermittent loss of color is either improper adjustment or improper operation of the color killer circuit. With so many programs now in color, it seems to have become common practice to "open the killer up"; that is, not to worry about a little color snow during b-w reception, in preference to possible loss of color caused by too critical a setting of the color killer control. Because of this, and the other reasons, several manufacturers no longer provide adjustment of the color killer.

Because the color killer controls the bias on the color amplifier, it

easily can cause loss of color.

During a black-and-white program, the grid of the color killer in Fig. 1 operates near zero volts and the killer tube conducts, producing a rather high negative voltage, which is applied to the color amplifier grid. When a color signal is received, the killer grid goes negative, cutting off the killer tube and reducing the color amplifier grid voltage to near zero.

To check the color killer to see whether it might be faulty, you need only ground test point B, or, for a temporary check, you can use a test socket adaptor under the killer tube and ground the plate terminal. Still another way is to use a dummy tube with the cathode pin of the killer tube clipped off. Once you have determined that the trouble is in the killer circuit, the actual problem usually can be isolated with a VTVM.

A transistor color killer is shown in Fig. 2. The collector of the tran-





# Panasonic parts for Panasonic products. It makes sense.

Any other part means less than Panasonic quality. And we couldn't have that. Because we couldn't let our Panasonic family down.

A family made of Panasonic people. Standing behind every Panasonic part we make. Specialists at what they do. Designers. Engineers. Technicians. Testers. Inspectors. All concerned with doing their job the best way, and the most advanced way. Even the kind of package design and proper packing is carefully considered. Ensuring the best possible care in handling.

And our quality control and inspection doesn't end when a part is made. Products from the production line are tested. And re-tested. And tested again before they're put on shelves. And

sometimes even after they've been on the shelves for a while. It's a job that's continual. The only way we know how to do it. Because quality is our "thing" at Panasonic. We owe this allegiance to our family. To you who sell and service our products. And to our customers. So they'll be happy they bought Panasonic. And so they'll continue to buy Panasonic.

That's why we have Factory Servicenters, five Regional Parts Depots and a Central Parts Depot. To stock over 20,000 kinds of parts. There to back up each and every Panasonic sale.

Think about it, Panasonic parts for Panasonic products does make sense.

*Circle 16 on literature card*

**PANASONIC<sup>®</sup>**  
just slightly ahead of our time.

Matsushita Electric Corporation of America  
National Headquarters, Service and Parts Division  
10-16 44th Drive, Long Island City, N. Y. 11101

YOU'RE  
WHISTLING  
IN THE  
DARK ...



if you think that  
heart disease and stroke  
hit only the other  
fellow's family.

GIVE...  
so more will live  
**HEART  
FUND**

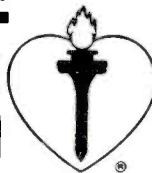

sistor can be temporarily grounded to determine whether or not the intermittent color symptom is caused by the killer circuit.

Fig. 3 shows a "brute force" type of color oscillator locking system. The burst signal directly "drives" the crystal to oscillate at the correct frequency, rather than indirectly through a phase detector. In systems that use a phase detector, the screen might still have a color tint should the oscillator fail, but in the brute force system an oscillator failure generally causes a **complete** loss of color. This difference of symptoms is not related directly to the type of oscillator control, but, instead, to the types of demodulators employed with each. Intermittent loss of color in brute force systems can be caused by trouble in the burst amplifier, in the color oscillator, the color killer, or the bandpass amplifier. Check voltages with a VTVM. The color oscillator grid voltage should be about -3 volts when no color signal is being received, and should increase several volts when a burst signal arrives. This increase in voltage is what triggers the operation of the color killer. Again, you can ground test point B or the plate of the killer tube to determine whether the killer is the probable cause of intermittent color loss.

#### Other Common Causes

Other common, but less frequent, causes of color loss, especially in certain chassis are: loose plugs and jacks connecting color controls to the main chassis; intermittently shorted or open coaxial cables, which sometimes are used between the chassis and the controls; and in at least one chassis, loss of color accompanied by a reasonably good black-and-white picture (and sometimes poor or buzzy sound) can be traced to a defective coaxial cable between the tuner and IF amplifier, or an improper type of coax.

Oscillation in either the tuner or the IF circuits can cause intermittent loss of color. This sort of trouble is usually accompanied by the need for extremely critical adjustment of the fine tuning, to obtain any color at all. In tuners using triode RF amplifiers, poor neutralization might be the problem. In IF amplifiers, it can be caused by poor grounds, lost shields, or by someone putting in the wrong tube. ▲

# FINCO 70 SERIES

COLOR TV ANTENNAS

NO VHF

VHF STRONG

VHF MODERATE

VHF WEAK

VHF VERY WEAK

All Prices Subject to Change



CS-U1  
\$12.05

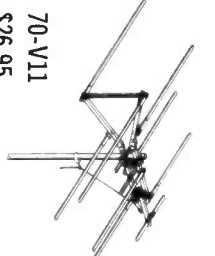

70-V11  
\$26.95

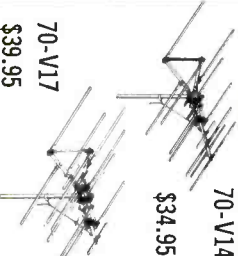

70-V14  
\$34.95

70-V17  
\$39.95



70-V20  
\$49.95

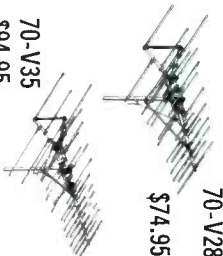

70-V28  
\$74.95

70-V35  
\$94.95

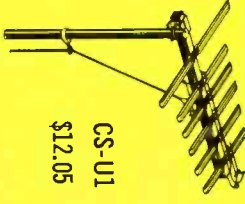

CS-U1  
\$12.05

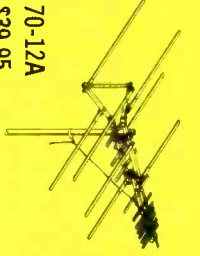

70-12A  
\$39.95

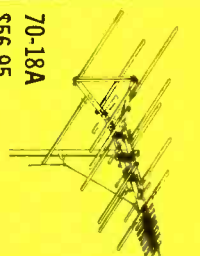

70-18A  
\$56.95

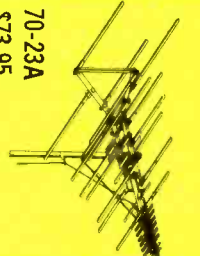

70-23A  
\$73.95

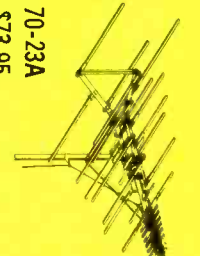

70-23A  
\$73.95

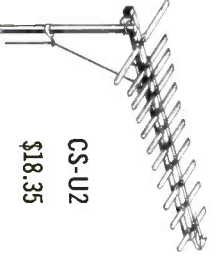

CS-U2  
\$18.35

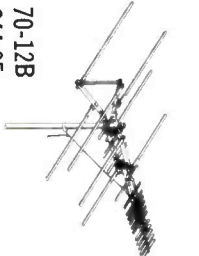

70-12B  
\$44.95

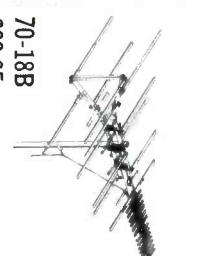

70-18B  
\$62.95

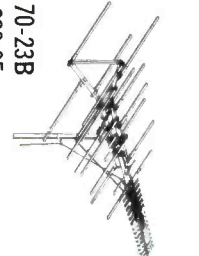

70-23B  
\$80.95

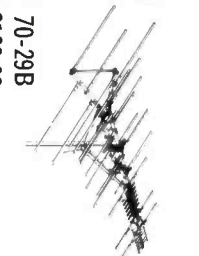

70-29B  
\$100.00

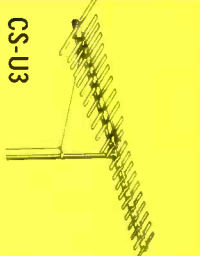

CS-U3  
\$26.40



70-18B  
\$62.95



70-18B  
\$62.95

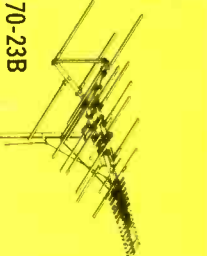

70-23B  
\$80.95

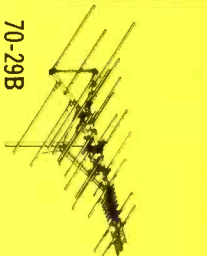

70-29B  
\$100.00

NOTE: Each model above is also available with 75 ohm coaxial cable downlead and compact behind-the-set balun-splitter to match antenna system to proper set terminals.

Select the antenna for your area from this chart

The set choice is yours...  
the antenna choice is **FINCO**

Send for free Catalog 20-556

NAME \_\_\_\_\_

ADDRESS \_\_\_\_\_

CITY \_\_\_\_\_ STATE \_\_\_\_\_ ZIP \_\_\_\_\_



**THE FINNEY COMPANY**

34 West Interstate St., Dept. ES-11  
Bedford, Ohio 44146

Circle 18 on literature card

# Quick Testing of Transistors

## shop talk

With Carl Babcoke  
ES Technical Editor



Most transistor failures are of the catastrophic type, such as open or short circuits, and can be found without guesswork by use of the simple tests described in the following paragraphs, each of which has been tried and proven in ELEC-TRONIC SERVICING'S lab.

### Use Your Scope to Check Transistors

One method of using an oscilloscope as a read-out device to test transistors is shown in Fig. 1.

All base-emitter or base-collector junctions of a transistor exhibit

diode characteristics. That is, when the element made of "P" material is positive relative to the other element made of "N" material, electrical resistance of the junction is at minimum. Conversely, negative voltage applied to the "P" element

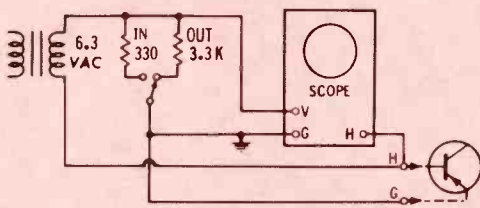

**Fig. 1** Schematic of a transistor testing adapter for use with almost any oscilloscope. Both vertical and horizontal deflection voltages are supplied by the adapter, and no locking of the scope is needed. Two values of resistors are shown: 330 ohms for in-circuit, and 3.3K ohms for out-of-circuit transistor or diode tests.

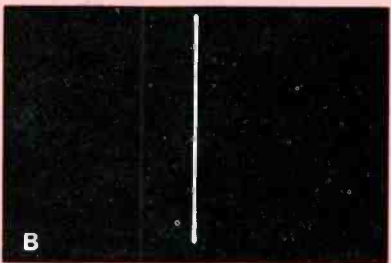
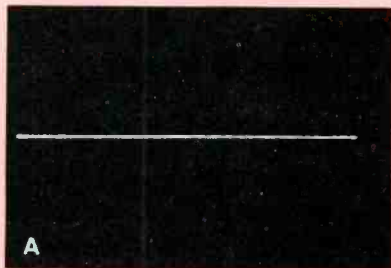

**Fig. 2** Single straight lines produced by open or shorted transistors (following the simple preadjusting explained in the text).

(A) A horizontal line indicates an open across the test leads.

(B) A vertical line indicates a short across the test leads.

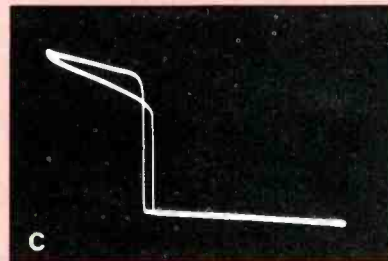
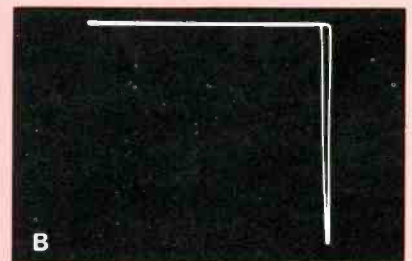
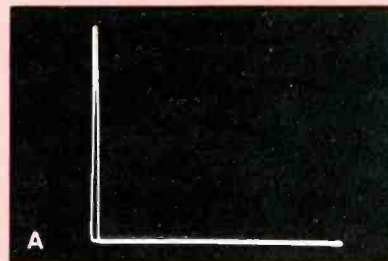

**Fig. 3** Waveforms typical of most normal germanium transistors.

(A) PNP polarity transistor with base connected to "H" and emitter (or collector) to "G". A diode with the cathode connected to "H" and the anode to "G" will produce the same waveform.

(B) The same PNP transistor with the base connected to "G" and the emitter (or collector) connected to

"H". A diode with cathode connected to "G" and anode to "H" produces the same waveform.

(C) A PNP transistor with the emitter connected to "H" and the collector to "G". Rectification is inefficient, and scope gain must be increased to obtain a large waveform.

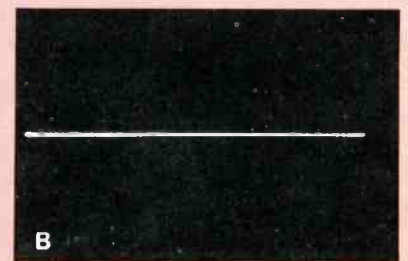
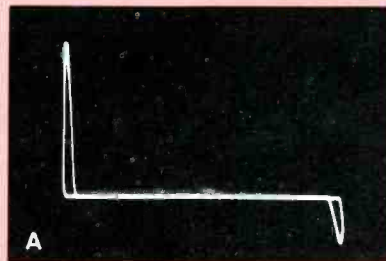

**Fig. 4** Silicon transistors present further problems.

(A) One type of NPN-polarity silicon transistor with the base connected to "G" and emitter to "H". The negative-going tip on the right is caused by Zener effect (actually, zener diodes produce a longer tip)—it is not scope overload, nor does it appear in the base-collector waveform.

(B) Collector-emitter tests indicate an open circuit when the transistor is a silicon type.

# CUT TV ALIGNMENT TIME

## IN HALF!



with the all new  
SENCORE SM158

## SPEED ALIGNER

and at \$120.00 less  
than competition!  
only \$275.00

*Here are 7 Reasons why we call the SM158 the Speed Aligner*

**AUTOMATIC ALL CRYSTAL CONTROLLED MARKERS:** You will never spend any more time looking up marker frequencies or interpreting them when you own an SM158; they are automatic. For example, want the chroma carrier on any RF curve, IF curve, or chroma curve, simply push the chroma carrier marker button. Want the sound, video, adjacent carrier markers or any other marker on any curve, just push the button as directed on the panel. The SM158 is fast and saves you time . . . that's why we call it the speed aligner.

**UNLIMITED MARKER AMPLITUDE:** The marker height control is like a powerhouse; crank it up as far as you want, even to the point where the markers are larger than the scope screen, without upsetting the response curve. Each marker is crystal controlled on fundamental frequencies and post-injected so that you may place all markers on the curve at unbelievable heights without affecting the curve in the least. That's why we call the SM158 the speed aligner.

**EASY TO CONNECT:** Just four connecting cables clearly marked TO TV and TO SCOPE. It takes just seconds to connect . . . that's why we call the SM158 the speed aligner.

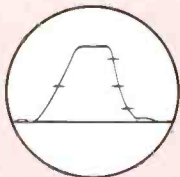
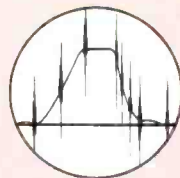

**TWO EXTRA VHF CHANNELS:** Competition has only two VHF channels; the SM158 has an extra high channel and an extra low frequency channel to prevent any co-channel interference. The SM158 is interference-free . . . that's why we call it the speed aligner.

**PLENTY OF SWEEP WIDTH:** A full 15 megahertz sweep signal, constant on all IF, chroma and RF curves, provides adequate sweep width to cover new solid state IF amplifiers. Competition covers only 12 megahertz. The SM158 gives you the full picture the first time . . . that's why we call it the speed aligner.

**GENERATES A ZERO REFERENCE BASE LINE:** You know where zero is with the SM158. All alignment instructions show a base line, yet some competitors do not generate a base line. You can follow TV manufacturers' instructions to the "T", easier and faster with the SM158 . . . that's why we call it the speed aligner.

**SWITCHABLE HORIZONTAL OR VERTICAL MARKERS:** want to tilt markers 90 degrees so you can view markers better in traps or for leveling? Merely pull the MARKER HEIGHT control out and markers appear horizontally — a real plus feature.

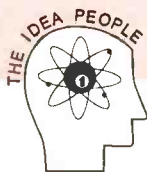

# SENCORE

3200 Sencore Drive  
Sioux Falls, South Dakota 57107

Circle 19 on literature card

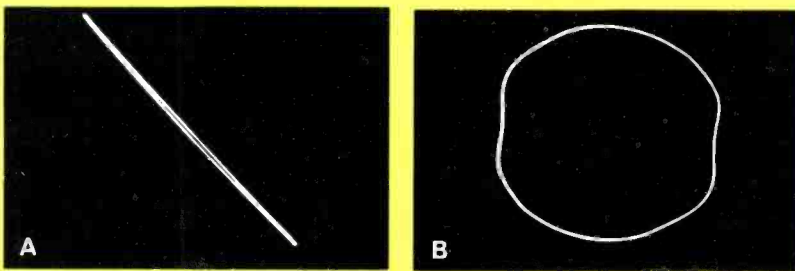

**Fig. 5** Waveforms produced by resistance, capacitance or inductance alone, without a transistor.

(A) A 3.3K-ohm resistor across the test leads produces this tilted waveform.  
 (B) A .47-mfd capacitor or a filter choke across the test leads produces a near-circle.

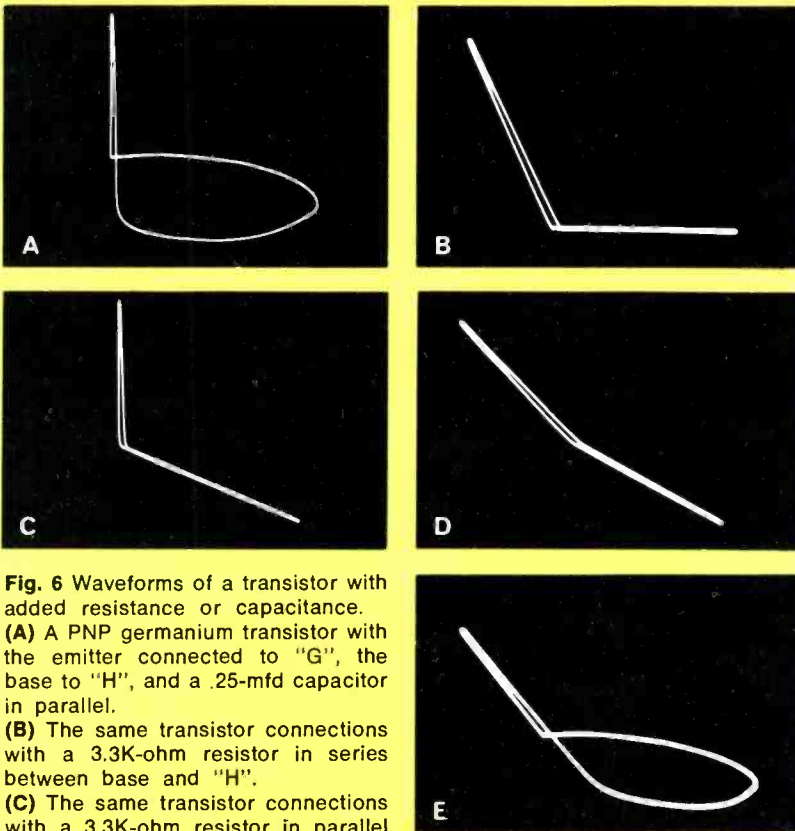

**Fig. 6** Waveforms of a transistor with added resistance or capacitance.

(A) A PNP germanium transistor with the emitter connected to "G", the base to "H", and a .25-mfd capacitor in parallel.

(B) The same transistor connections with a 3.3K-ohm resistor in series between base and "H".

(C) The same transistor connections with a 3.3K-ohm resistor in parallel between base and emitter.

(D) A PNP germanium transistor with the emitter connected to "G", the base to "H" through a 6.8K-ohm resistor, and a 6.8K-ohm resistor in parallel with the base and emitter. The waveform approaches that of a pure resistance, but the "diode" corner is still visible.

(E) The same transistor in (D) but with emitter connected to "G", the base to "H" through a 6.8K-ohm resistor, and a .068-mfd capacitor in parallel with base and emitter.

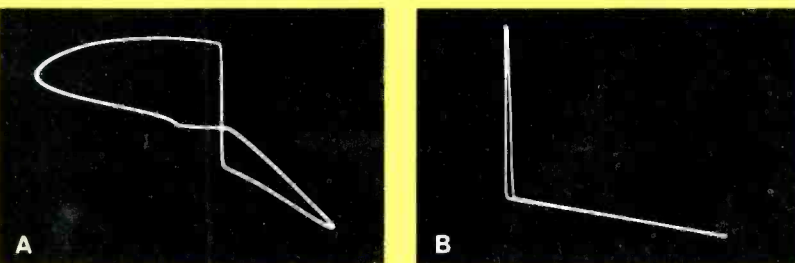

**Fig. 7** In-circuit waveforms.

(A) Emitter-to-collector waveform produced by a PNP germanium transistor connected to an unloaded audio-output transformer.

(B) Emitter-to-base waveform produced by the same transistor, including bias resistors and electrolytic coupling capacitor.

and positive voltage applied to the "N" element will cause a near-open circuit between the two elements.

These junctions also will rectify. The emitter-collector path involves a series connection of two dissimilar and opposite-polarity "diodes"; because of this, emitter-to-collector rectification is very inefficient, and related test results indefinite.

Interpretation of the scope waveform is the only difficult part of this test; photographs of typical waveforms are shown here to guide you. Signals supplied to both the vertical and horizontal amplifiers in the scope are changed by the condition of the transistor junction.

A horizontal line, as shown in Fig. 2A, indicates an open circuit; a vertical line (Fig. 2B) indicates a short across the test leads. (In fact, the scope is pre-set by shorting and opening the transistor test leads before the test is started. The "H" input on the scope in Fig. 1 is the external horizontal sweep input, and the sweep selector must be set to the "EXT" position. With nothing connected across the test leads, adjust the horizontal gain control for a horizontal line of about one-half the width of the scope screen. Short the test leads together and adjust the vertical gain control and range switch for a vertical line of about the same height as the length of the horizontal line in the previous step. Focus and beam intensity of the scope should be adjusted normally.)

Typical waveforms for a good germanium transistor tested out of circuit are shown in Fig. 3. As shown, connection of a specific test lead to a specific transistor element produces a definite and individual pattern; this characteristic enables you to identify the polarity of diodes or transistors. Otherwise, it is not necessary to observe polarity in connecting the test leads; the right-angle waveform will face the opposite direction if the leads are reversed or if a transistor having opposite polarity is tested.

In the base-emitter and base-collector tests, silicon transistors produce the same waveforms as germanium types (except for the Zener effect shown in Fig. 4A, which has been evident in all the base-emitter

ter tests of silicon I have made so far), but emitter-collector tests of silicon (Fig. 4B) indicate an open circuit.

Sharp corners on the scope waveforms are the hallmark of a good diode or a good transistor junction. This also is true during in-circuit tests. If there is a doubt, remove the transistor for a more definite test.

Waveforms produced by resistance, capacitance or inductance alone, without a transistor or diode, are shown in Fig. 5. Comparable waveforms produced by these characteristics and transistor junctions, as might happen in-circuit, are shown in Fig. 6. Two actual in-circuit waveforms are shown in Fig. 7 (the 3.3K-ohm out-of-circuit resistor was used to intensify the obscuring effect of the circuit components). Be certain the power is turned off to any circuits being tested.

Some of the advantages of this method of testing transistors as though they are rectifying diodes are as follows:

- Extreme speed. Just attach the test leads in sequence to the base-emitter, base-collector and emitter-collector. A short or open "result" indicates a defective transistor.

- No charts or scales. Just select the value of resistor for in-circuit or out-of-circuit tests; that's all.

Disadvantages of this test method are as follows:

- There is no indication of moderate leakage.

- The emitter-collector path of silicon transistors always tests open; consequently, this test is limited to shorts.

- No numerical ratings for reference can be found.

#### Using A Curve-Tracer To Test Transistors

More sophisticated tests of transistors can be made with curve tracers. We presently are conducting evaluation tests on curve tracers manufactured by Eico and Jud Williams, and hope to have our report

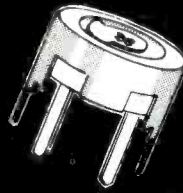

# COLOR TV CONTROLS

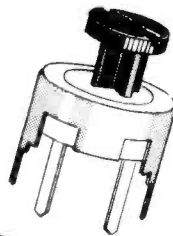
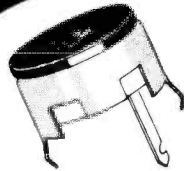

- Audio Controls
- Convergence Controls
- A.G.C. Delay Controls
- Vertical Linearity Controls
- Horizontal Linearity Controls

EXACT REPLACEMENTS FOR

RCA • SILVERTONE  
ADMIRAL • ZENITH  
GENERAL ELECTRIC

COLOR CODED KNOBS SAME AS  
MANUFACTURER'S SPECS.

AVAILABLE FROM  
YOUR FAVORITE  
DISTRIBUTOR

**WORKMAN** *Electronic*  
PRODUCTS, INC.  
P.O. BOX 3828 SARASOTA, FLORIDA 33578

Circle 20 on literature card

# TV TECHNICIANS

If you are a qualified, experienced electronic technician who can repair television sets...if you have the desire to make maximum use of your working time and earn an annual net income in excess of \$20,000...if you want the respect your profession deserves...then we're prepared to offer you a unique opportunity.

Our totally new Full Service Franchise gives you corporate benefits and services, plus the pride and profits of owning your own business.

We're building the largest, finest, and most reliable television repair network in Southern California. We hope you will look into joining us. Initial cash requirement \$4,500 (partial financing available), for a complete and ready-to-go Mobile TV MAN franchise.

For information contact Ronnie Simon, C.E.T., Vice President of Technical Services, Mobile TV MAN, 2040 Cotner Ave., Los Angeles 90025.

# (213) 477-3057

Circle 21 on literature card

# Who Needs a Tuner Wash?

Use

## QUIETROLE Mark II Spray Pack

The product that cleans and lubricates better than any product you can buy and has been used for more years than any product of its kind.

The Choice of "Better Servicemen" Everywhere



Circle 22 on literature card

### IF YOU ARE A TV REPAIR MAN YOU NEED TV TECH AID!

TV TECH AID is the best trouble shooting guide available today. It takes all the guesswork out of TV repair and is designed to help you solve your problems quickly and economically.

Each month you receive updated information on up to 40 different trouble-shooting cases. This important information is supplied to us by technicians, field reps and all the leading TV manufacturers. You will find every symptom pictured with a clearly marked schematic of the particular faulty stage. The faulty components and corrections will also be listed to aid in repair. You go right to the source of the trouble without guesswork. In addition you get valuable information on current models as well as older models along with circuit changes and modifications as they occur.

TV TECH AID is the best investment you can make in your own business. The cost to you is only \$7.95 for a full years subscription.

Send for it now . . . You'll be glad you did!

TV TECH AID  
P.O. BOX 603  
KINGS PARK, L. I.  
NEW YORK 11754

ENCLOSED IS A CHECK OR M.O. FOR \$7.95. PLEASE SEND 12 ISSUES OF TV TECH AID

TO:  
NAME .....  
ADDRESS .....  
CITY .....  
STATE ..... ZIP .....

Circle 23 on literature card

ready for the December issue of ELECTRONIC SERVICING.

#### Transistor Beta Testers

No shop should be without a transistor beta and leakage tester. In addition to the accuracy of the reading, the equipment makes a favorable impression on your customers who see you use one.

DC beta is the ratio of collector current versus base current. Most commercially built transistor testers vary the base current until a predetermined amount of collector current is read on the meter, then the meter is switched to read the base current. The meter scale is calibrated as DC beta.

To avoid interpreting wrongly the DC beta reading a tester might accurately give us, we should have some understanding about the significance of such tests. Because so many transistor types have been manufactured, a transistor testing manual which would give the control settings of the tester for each transistor, to permit the use of a good-bad scale, is not practical. Also, the beta reading varies with the collector current used during the test. We, the technicians, must decide the limits that are acceptable in beta readings—often without sufficient information on which to base this judgement.

A transistor with a DC beta of

#### Ohmmeter and Beta Tests of Three Power Transistors\*

**2N408 germanium PNP—low power/low voltage output transistor; DC beta 150—all leakages normal on transistor tester**

Test	negative lead to:	positive lead to:	meter scale:	reading in ohms:
forward	base	emitter	X10	31
forward	base	collector	X10	29
leakage	emitter	base	X10K	1meg
leakage	collector	base	X10K	700K
C/E forward	collector	emitter	X100	6000
C/E leakage	emitter	collector	X1K	200K

**2N301A germanium PNP—high power/medium voltage transistor; DC beta 130—slight, normal ICEO leakage**

Test	negative lead to:	positive lead to:	meter scale:	reading in ohms:
forward	base	emitter	X10	16
forward	base	collector	X10	15
leakage	emitter	base	X1K	45K
leakage	collector	base	X1K	33K
C/E forward	collector	emitter	X100	70
C/E leakage	emitter	collector	X100	8K

**NPN silicon—medium power/high-voltage transistor; DC beta 70—all leakages normal on transistor tester**

Test	negative lead to:	positive lead to:	meter scale:	reading in ohms:
leakage	base	emitter	X1meg	500meg
leakage	base	collector	X1meg	200meg
forward	emitter	base	X10	110
forward	collector	base	X10	104
C/E leakage	collector	emitter	X1meg	21meg
C/E forward	emitter	collector	X1meg	180meg

\*Ohmmeter function of a VTVM used for measurements; battery 1.5 volts.



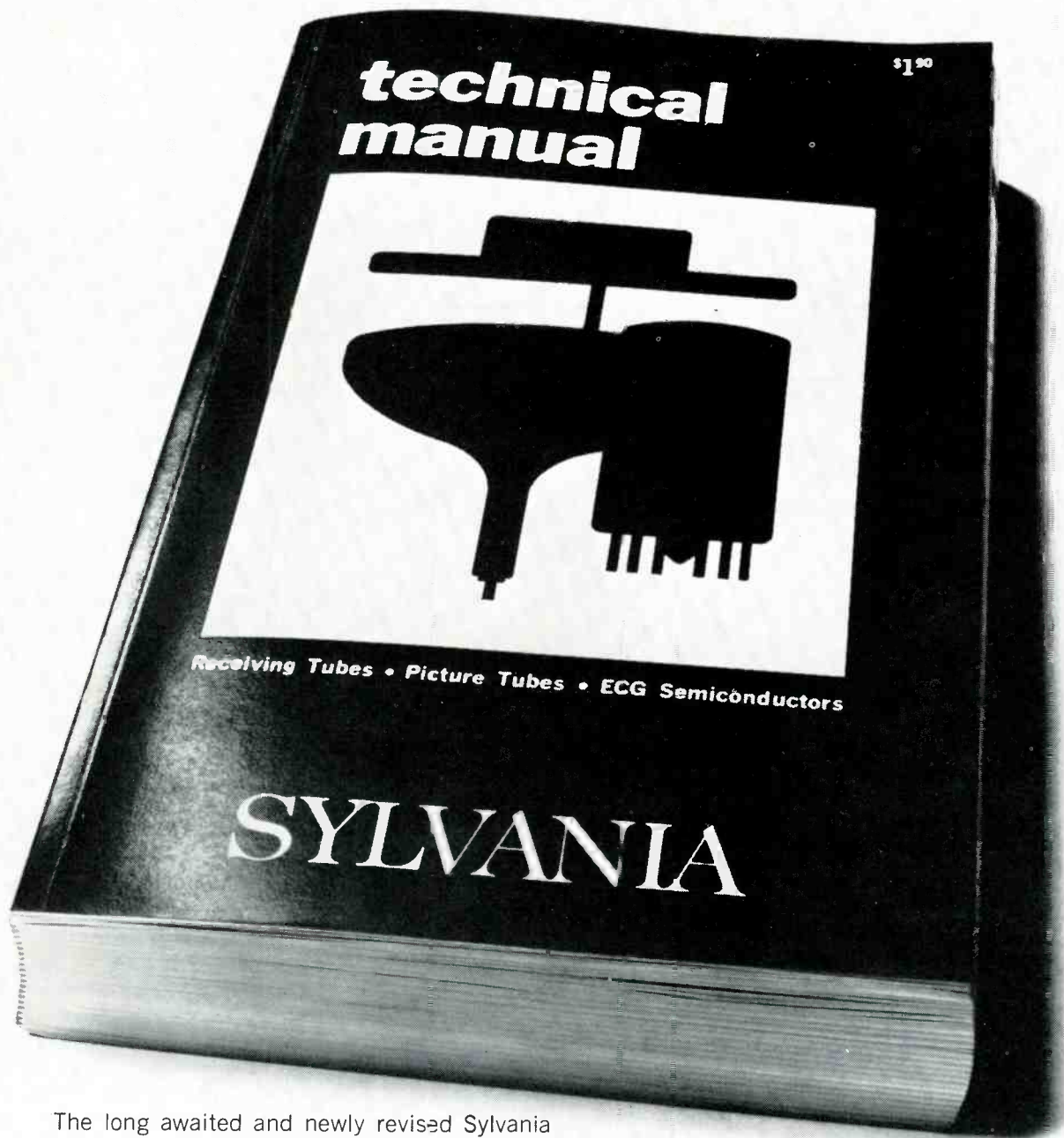

The long awaited and newly revised Sylvania Technical Manual is out. Complete and unexpurgated. The fantasy of every Independent Service Technician. Written anonymously by an agile team of Sylvania engineers. 32,000 components described in breathtaking detail. Including thousands of unretouched diagrams and illustrations. Discover the unspeakable thrill of new color TV Tubes, listed as never before. The ecstasy of 28,000 ECG Semicconductors.

From exotic Deflection Oscillators to a lurid account of Transistors and Rectifiers.

This book has what you want. Components for the man who knows what to do with them.

The 14th Edition of the Sylvania Technical Manual is not available in any bookstore. Your Sylvania Distributor is discreet. Speak to him.

**SYLVANIA**  
GENERAL TELEPHONE & ELECTRONICS

“Electrifying”

Circle 24 on literature card

November, 1970/ELECTRONIC SERVICING 31

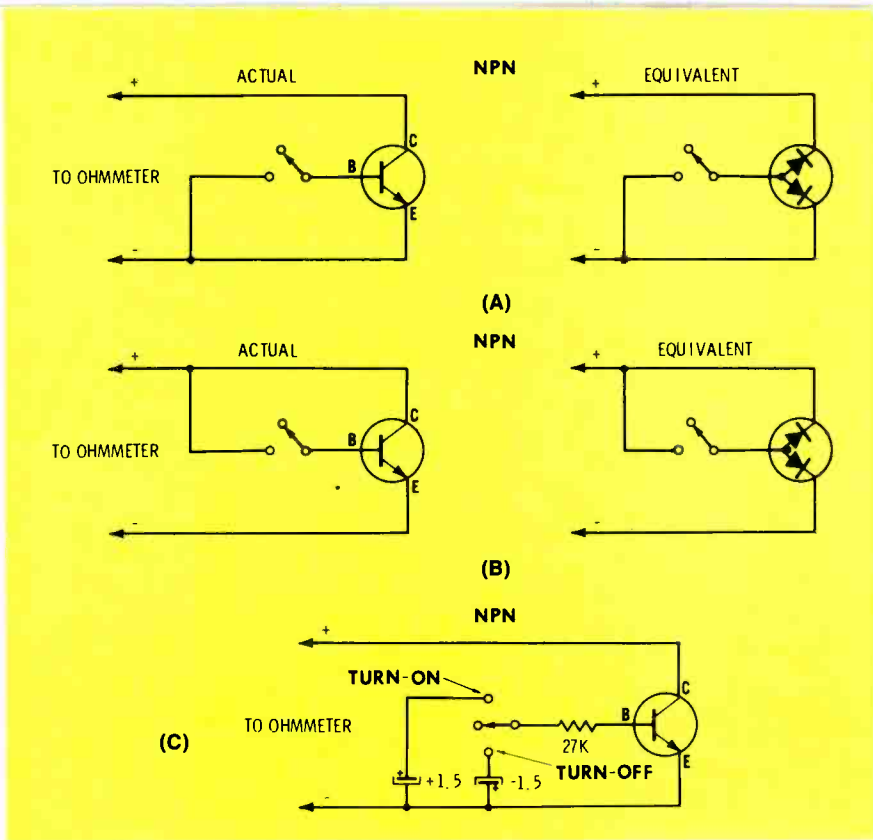

**Fig. 8** Simple turn-off and turn-on tests of transistors.  
**(A)** The collector-emitter resistance increases when the base is connected to the emitter—a fairly good test.  
**(B)** The collector-emitter resistance decreases when the base is connected to the collector—a false test of no value.  
**(C)** A switch, resistor and two batteries permit accurate turn-off, turn-on and ohmmeter tests—accurate indication of the transistor condition can be obtained, but leads must be changed during the test.

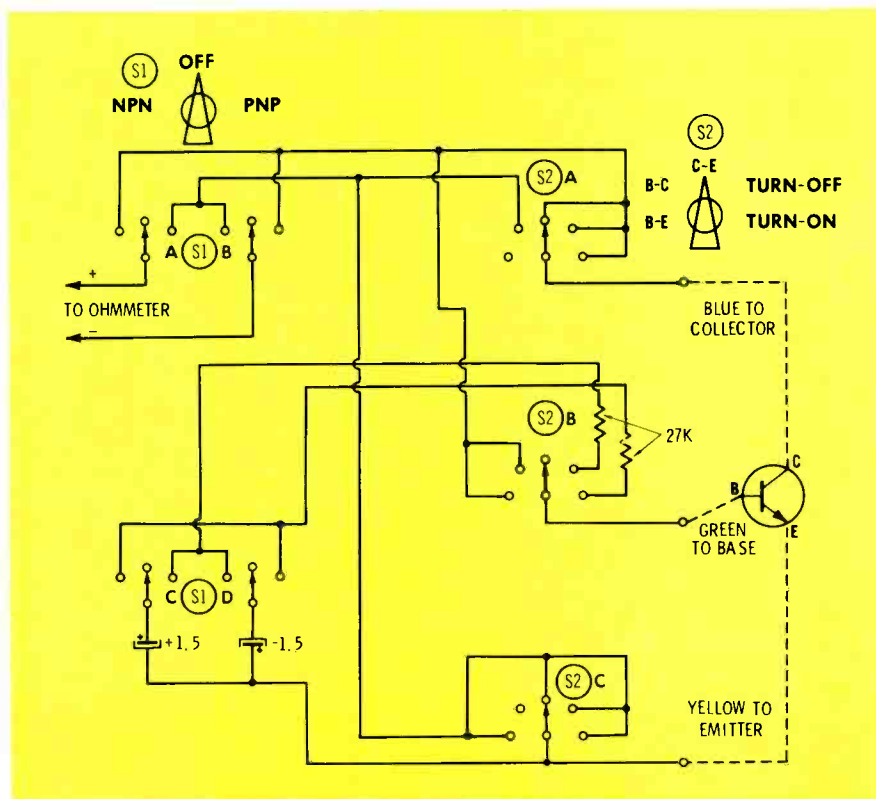

**Fig. 9** Complete schematic of an adapter you can build which permits quick and accurate turn-off, turn-on and ohmmeter tests without moving ohmmeter or transistor clip leads—a very good method.

150 does **not** automatically produce twice the AC gain of another transistor of the same type which, when tested, indicates a beta of 75. There are several reasons why this is true. The same circuits that stabilize against undesired changes caused by heat variations also partially stabilize against variations in average emitter current. Consequently, the more effective the heat stabilization of the circuit, the less AC gain variation will be observed when transistors of different DC beta are used. A transistor with a low DC beta might produce normal gain if the circuit can supply the added base current. However, the input resistance of the transistor will be lower, and this could have a noticeable effect on AC gain because of the change in impedance matching.

### Ohmmeter Tests

Ohmmeter tests of germanium type transistors and diodes are quite informative, but such tests are of questionable value for checking silicon devices, for which most ohmmeter readings normally indicate a nearly open circuit.

The accompanying table compares the ohmmeter readings of **individual** transistors and **not** those representing average conditions. Notice that only the forward bias readings of base-emitter and base-collector of the silicon transistor are low enough to have any significance in an ohmmeter test. Some of these ohmmeter readings will change from the heat of a person's fingers. Also, the table does not show the completely different readings obtained if another ohmmeter scale is used, or if a meter with a different value of ohmmeter battery voltage is substituted.

Despite all these limitations, nearly all germanium and many silicon transistor defects can be found with ohmmeter tests; because most failures are absolute, borderline or questionable results are seldom obtained.

### Turn-Off and Turn-On Tests

Ohmmeter readings combined with simple turn-off and turn-on tests provide an easy method of de-

# how to get a \$400 frequency counter for \$199<sup>95\*</sup>

termining the ability of the base to control collector-emitter current, plus adequate leakage checks.

The collector-emitter resistance (in the forward-bias polarity) increases when the base is connected to the emitter, as shown in Fig. 8A. This is true, but not complete, transistor action, because a small amount of voltage is developed between base and emitter when the base is floating, and this voltage acts as forward bias on the base, which reduces the collector-emitter resistance. Connecting the base to the emitter is the simplest type of turn-off test.

Logic indicates that the circuit of Fig. 8B should be a simple, but good, turn-on test. A low reading on the ohmmeter is produced when the base is connected to the collector. But examining the diode-equivalent schematic reveals that the positive ohmmeter lead now is connected to the base, which is forward biased relative to the emitter and, consequently, will be indicated as a low resistance. This is a false turn-on test, and is of no value.

True transistor action can be tested by the circuit shown in Fig. 8C, which keeps the collector isolated from the base as the base is supplied with forward bias, no external bias or reverse bias. Experience has proven the test results to be very good, but the operational drawback of changing leads increases the possibility of poor connections, not to mention loss of time.

A complete adapter that provides all connections for ohmmeter turn-off and turn-on tests is shown in Fig. 9. Neither the transistor nor the ohmmeter leads require reversing or changing, and a transistor can be identified as a PNP or a NPN by the readings obtained when those two positions of S1 are tried.

The same 2N408 used to obtain the readings in the accompanying table measured 200 ohms on the turn-on position of S2, 6K-ohms on the C-E position, and about 100 megohms on the turn-off position. No hair-splitting decisions are necessary to conclude that this transistor is normal. ▲



## ...build the new Heathkit® IB-101

- Accurate counting, 1 Hz to over 15 MHz
- Automatic trigger level for wide range input without adjustment
- Five digit readout with Hz/kHz ranges & overrange indicators give eight digit capability
- High Z input
- Computer-type integrated circuitry eliminates divider chain adjustment

The latest Heath breakthrough in low cost, high quality instrumentation. New IB-101 counts from 1 Hz to over 15 MHz; advanced integrated circuitry eliminates blinking readout & divider chain adjustment.

Overrange indicator & Hz/kHz switch give the IB-101 8-digit capability. Set the range switch to kHz & the display reads out to the nearest kHz... push the range switch to Hz and read down to the last Hz. Overrange & Hz/kHz indicators light up to give error-free measurement & correct range at all times. Automatic decimal locator eliminates interpolation & figuring.

Exclusive Heath-designed input circuit uses a dual-gate, diode-protected MOSFET... provides proper triggering without adjustment from less than 100 mV to over 200 V. Input Z is 1 megohm shunted by less than 20 pF to minimize circuit loading & error. Other features include sockets for all 26 IC's & 5 display tubes... 120/240 V AC operation & convenient handle/tilt stand.

Compare the new Heathkit IB-101... then order yours. **Kit IB-101, 7 lbs... \$199.95\***

**IB-101 SPECIFICATIONS:** Frequency Range: 1 Hz to greater than 15 MHz. Accuracy: ±1 count ±time base stability. Gate Times: 1 millisecond or 1 second with automatic reset. **INPUT CHARACTERISTICS** — Sensitivity: 1 Hz to 1 MHz, less than 100 mV rms, 1 MHz to 15 MHz, less than 250 mV rms, after 30 minutes warmup. Trigger Level: Automatic. Impedance: 1 Megohm shunted by less than 20 pF. Maximum Input: 200 V rms, DC — 1 kHz. Derate at 48 V per frequency decade. **TIME BASE:** Frequency: 1 MHz, crystal controlled. Aging Rate: Less than 1 PPM/month after 30 days. Temperature: Less than ±2 parts in 10<sup>7</sup>/degree C. 20 to 35 degrees C after 30 minutes warmup. ±.002% from 0 to 50 degrees C. **GENERAL:** Readout: 5 digits plus overrange. Temperature Range: Storage: —55 to 80 degrees C. Operating: 0 to 50 degrees C. Power Requirements: 105-125 or 210-250 V AC, 50/60 Hz, 8 watts. Cabinet Dimensions: 8¼" W x 3½" H x 9" D not including handle. Net Weight: 4½ lbs.

HEATH COMPANY, Dept. 25-11  
Benton Harbor, Michigan 49022



a Schlumberger company

Enclosed is \$ \_\_\_\_\_, plus shipping.

Please send model (s) \_\_\_\_\_

Please send FREE Heathkit Catalog.  Please send Credit Application.

Name \_\_\_\_\_

Address \_\_\_\_\_

City \_\_\_\_\_

State \_\_\_\_\_

Zip \_\_\_\_\_

\*Mail order prices; F.O.B. factory. Prices & specifications subject to change without notice. TE-232

Circle 25 on literature card

**Chassis—Admiral K10**  
**PHOTOFACT folder—1022-1**

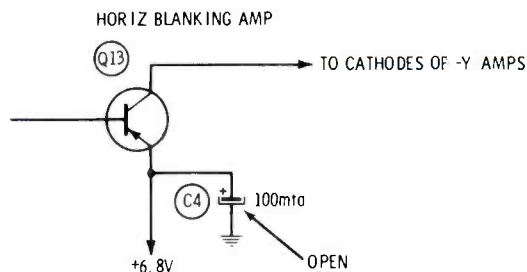

**Symptom**—left side of raster lighter than right  
**Cure**—check and replace open C4

**Chassis—Admiral K10**  
**PHOTOFACT folder—1022-1**

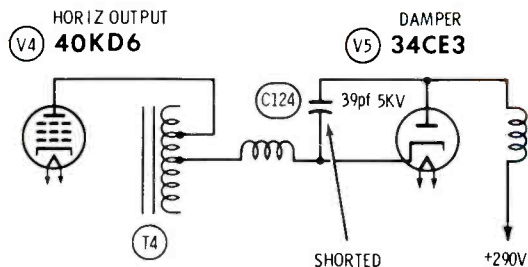

**Symptom**—no high voltage; boost voltage low  
**Cure**—check C124; replace if leaky or shorted

**Chassis—Admiral K10**  
**PHOTOFACT folder—1022-1**

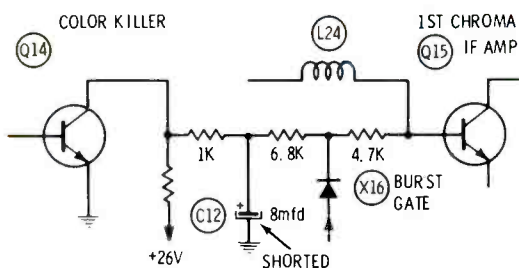

**Symptom**—no color; voltages low on Q14 collector and Q15 base  
**Cure**—replace shorted C12

**Chassis—General Electric KE**  
**PHOTOFACT folder—1028-1**

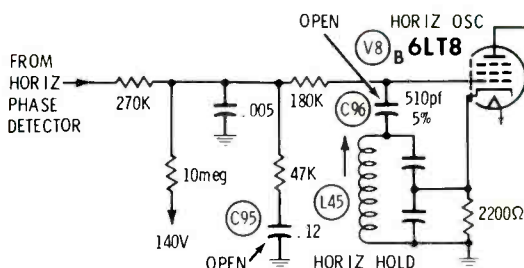

**Symptom**—no high voltage; horizontal frequency low; damper excessively hot  
**Cure**—replace intermittent or open C96

**Chassis—Admiral K10**  
**PHOTOFACT folder—1022-1**

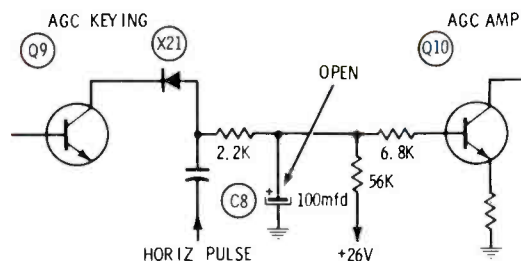

**Symptom**—AGC overload; negative voltage on base of Q10  
**Cure**—check and replace open C8

**Chassis—General Electric KE**  
**PHOTOFACT folder—1028-1**

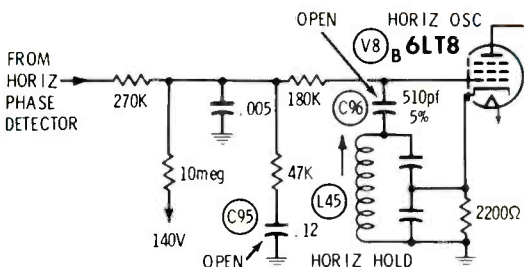

**Symptom**—horizontal pulling, or "pie crust"  
**Cure**—replace intermittent or open C95

Chassis—Philco 19QT87  
PHOTOFACT folder—1026-3

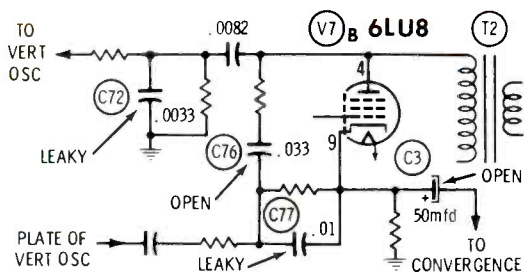

**Symptom**—raster shrinks vertically  
**Cure**—check for a leaky C72

Chassis—Philco 19QT87  
PHOTOFACT folder—1026-3

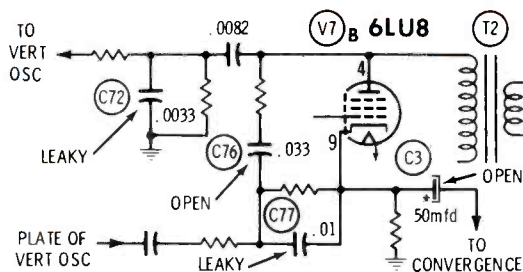

**Symptom**—lack of height, or foldover at the top of picture  
**Cure**—check C3; replace if defective

Chassis—Philco 19QT87  
PHOTOFACT folder—1026-3

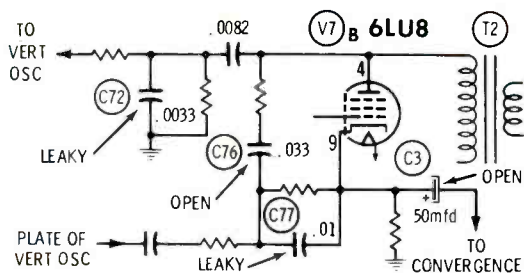

**Symptom**—retrace lines at top of raster  
**Cure**—check C76; replace if defective

Chassis—Philco 19QT87  
PHOTOFACT folder—1026-3

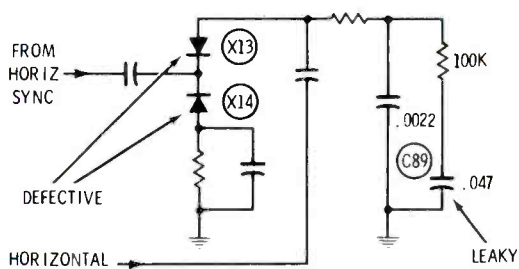

**Symptom**—poor horizontal hold  
**Cure**—check X13 and X14 phase detector diodes; replace if defective

Chassis—Philco 19QT87  
PHOTOFACT folder—1026-3

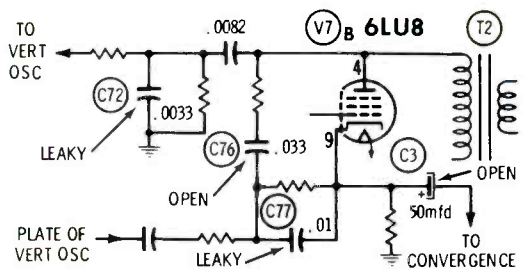

**Symptom**—foldover or jitter at bottom of picture  
**Cure**—check C77; replace if defective

Chassis—Philco 19QT87  
PHOTOFACT folder—1026-3

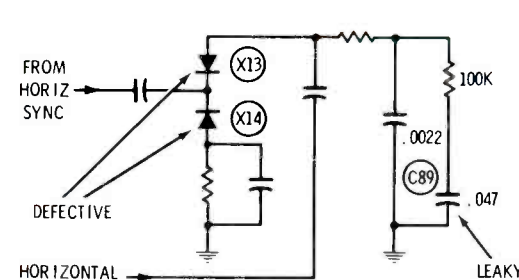

**Symptom**—poor horizontal hold  
**Cure**—check for leakage in C89; replace if defective

by Allan Dale

# How to Cure a Sick Synthesizer

It's odd that frequency synthesizers fool some technicians. Their principle is simple. Signals at certain frequencies beat together and produce signals at other frequencies. It's the old heterodyne principle.

Sometimes I think it's the math. Many practical techs avoid even the easiest arithmetic—and that's what's involved in frequency synthesizers. Plain addition and subtraction. In transceivers that operate at VHF or UHF frequencies, there's also some multiplication. The math of frequency synthesizers is not complicated. You'll see.

One more point. You don't **have** to figure out the math of a synthesizer to service one. But it helps. You can sometimes tell right away which crystal or oscillator is bad if you know how the frequencies are put together. But that's not mandatory; there are other ways.

## "Creating" Frequencies

First, let's review the fundamentals of heterodyning. You know when two signals mix in a non-linear stage, the output is four signals: the original two, plus a signal at a frequency which is the sum of the original two, and a signal at the difference frequency.

As an example, imagine two oscillators. One is at 20.0 MHz, the other at 25.5 MHz. Mixed, they produce four output frequencies: the difference, 5.5 MHz; the sum, 45.5 MHz; and the two original frequencies, 20.0 and 25.5 MHz.

If you want to use only one of those four, you insert a resonant circuit set for the frequency you want. A 5.5-MHz tuned circuit picks off 5.5 MHz and rejects the other three. A 45.5-MHz tuned circuit rejects all but 45.5 MHz.

In essence, that's what happens in a frequency synthesizer. Certain

sum-or-difference relationships are carefully calculated, and the desired signals picked off by tuned circuits.

For servicing, however, remember this: The calculations were already made by the designer. You need only understand the relationships. Then, if the synthesizer fails, you can tell which portion is at fault. Crystal frequencies and their relationships are usually listed in the service manual for the transceiver. You just sort out which crystal or crystals affect the portion that's faulty, and you're halfway home.

## Many From A Few

The place you're most likely to encounter frequency synthesis is in 23-channel Citizens Band (CB) transceivers. Crystals are expensive. To have 23 channels of transmit and 23 of receive, a CB unit seemingly needs 46 crystals. With synthesis, a mere dozen can do the same job.

The block diagram in Fig. 1 will help you understand how it's done. Three oscillators are used in this transmitter. Two of them, the 8-MHz and the 11-MHz, are in the main synthesizer. The third, the 7.5-MHz oscillator, is part of synthesis, but isn't considered inside the synthesizer itself.

Two decks of a channel switch in the transceiver choose the two appropriate synthesizer crystals for a particular channel. The charts included in Fig. 1 tell you which crystals are for which channels.

Suppose you turn the selector switch to channel 1. The two switch decks select the 8615-kHz and 10.85-MHz crystals. They beat together in the mixer stage. The result is four frequencies: 2235 kHz, 8615 kHz, 10.85 MHz, and 19.465 MHz. A 19-kHz broad-band tuned

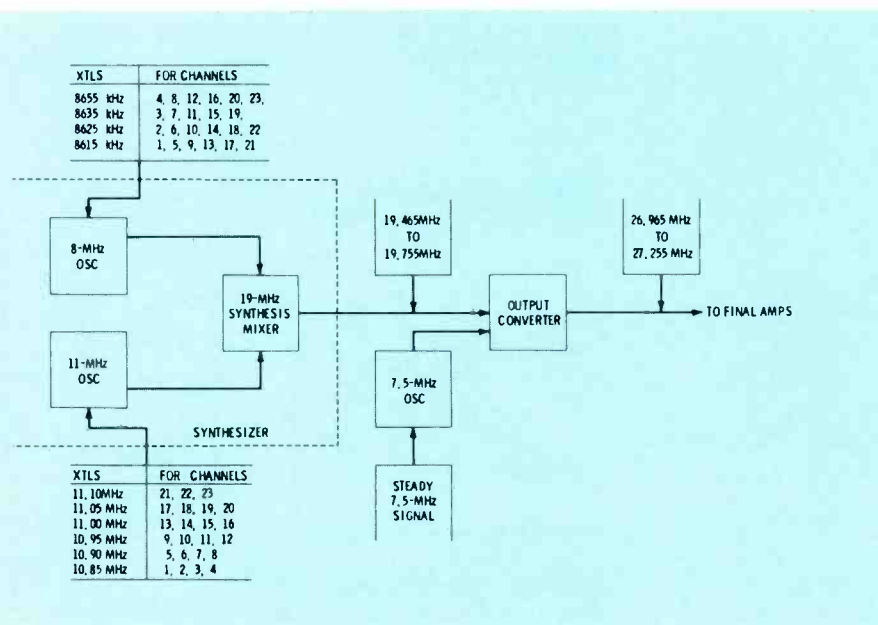

Fig. 1 Basic system in which synthesizer drives transmitter section. Transmitter output frequency is then synthesized in another converter.

circuit following the mixer eliminates the three lower ones. Only 19.465 MHz is fed to the output converter.

A 7.5-MHz signal from the third oscillator mixes with the 19.465-MHz signal in the output converter. The result, again, is four frequencies: 7.5, 11.965, 19.465, and 26.965 MHz. A broad-band 27-MHz tuned circuit eliminates the lower three, and the 26.965-MHz signal is fed to the final amplifiers of the transmitter.

You can calculate the synthesizer frequencies for any channel from Fig. 1. Take channel 9 as another example. The synthesizer crystals picked by the switch decks are 8615 kHz and 10.95 MHz. The synthesis mixer produces 19.565 MHz. The output converter produces 27.065 MHz. That's the frequency of channel 9 (see the chart in the accompanying table).

Channel 14: The 8625-kHz and 11.00-MHz crystals produce 19.625-MHz. That and the 7.5-MHz oscillator produce 27.125 MHz. So eleven crystals produce the entire 23 transmitter channels.

Now, what about reception? That is, in effect, another 23 channels to be produced, because the receiver is a superhet type. Fig. 2 should clarify how it's done in this transceiver.

The synthesizer works exactly the same as during transmit. The two switch decks pick the same crystals indicated in Fig. 1. So the receive frequency from the synthesizer is the same as for transmit. The big difference lies in the third-oscillator frequency (actually, a different oscillator is used).

Consider a channel . . . say, channel 1. The synthesizer produces 19.465 MHz. The channel-1 signal from the RF amplifier is at 26.965 MHz. The first receive converter

beats the two together. The four outputs: 46.430 (sum), 26.965 (original), 19.465 (original), and 7.5 MHz (difference). A sharply-tuned 7.5-MHz tuned circuit excludes all other frequencies at the output of the converter.

So only a 7.5-MHz signal goes on to the second receive converter. There, it's mixed with a steady 7.975-MHz signal from the receive oscillator. The sum and original frequencies are filtered out by 475-kHz tuned circuits. Thus, only the 475-kHz difference signal passes on to the IF amplifiers.

You can easily do the arithmetic for other channels. Fig. 1 gives you the synthesizer frequencies.

Channel 22, for example: The synthesizer selects the 11.10-MHz and 8625-kHz crystals, and produces 19.725 MHz. That mixes with incoming channel 22 at 27.225 MHz and produces 7.5 MHz. In the second converter, that mixes with 7.975 MHz to produce the 475-kHz IF.

#### A Different Version

Not all 23-channel CB transceivers are the same. The transmitter in Fig. 3 has a different setup. The crystal charts with each oscillator give you the information you need to figure out the synthesis. It's a one-step synthesis. Some examples should clarify it.

Channel 1 uses 11.310-MHz and 38.275-MHz crystals. Beat together in the mixer, they produce four frequencies: 11.310, 26.965, 38.275, and 49.585 MHz. A broad-band 27-MHz tuned circuit eliminates all but the 26.965-MHz signal. That's fed to the transmitter amplifiers.

Channel 9 uses 11.310 and 38.375 crystals. The difference frequency is 27.065 MHz. That's the transmitter output frequency.

This synthesis system uses 14 crystals to get the 23 transmitter frequencies. The 38-MHz crystals are third-overtone types, some of which are more expensive than lower-frequency crystals. Stability is okay if the oscillators are designed right and held within certain operation tolerances.

For reception, the same 38-MHz oscillator is used, and the same crystals are used for the same channels. Fig. 4 shows how the receiver functions. Only two other crystals are needed.

Consider channel 14, as an example. The 38-MHz oscillator generates a 38.385-MHz signal (get this from the chart in Fig. 3). The incoming channel-14 signal is at

TABLE

#### Citizens Radio Service Frequencies

Channel No.	Frequency (MHz)
1	26.965
2	26.975
3	26.985
4	27.005
5	27.015
6	27.025
7	27.035
8	27.055
9	27.065
10	27.075
11	27.085
12	27.105
13	27.115
14	27.125
15	27.135
16	27.155
17	27.165
18	27.175
19	27.185
20	27.205
21	27.215
22	27.225
23	27.255

27.125 MHz. The difference frequency, the only one wanted, is 11.260 MHz. A tank circuit broadly tuned near 11.3 MHz takes the signal from the first mixer and feeds it to the second. Part of the channel switch connects the 11.1750-MHz crystal to the receiver oscillator. That signal beats with the 11.260-MHz 1st IF signal and produces a 455-kHz 2nd IF. That's amplified by the IF amplifiers.

Another example is channel 20. Incoming frequency is 27.205 MHz. The channel switch selects the 38.515-MHz and 11.765-MHz crystals. The 27.205-MHz and 38.515-MHz signals beat together and produce 11.310 MHz, which beats with the 11.765-MHz signal in the 2nd mixer, producing 455 kHz.

You can figure out other channels.

### Troubleshooting Synthesizers

As you'll discover when you run across your first CB unit that has synthesizer trouble, servicing is not as complicated as you might think. Trouble falls into three categories: (1) One of the oscillators has quit. (2) One of the crystals has quit. (3) One of the crystals is off-frequency. That last trouble doesn't happen often.

I'll tell you about some cases I've encountered, and you try to figure out which trouble category each one falls into.

A transceiver like the one in Figs. 3 and 4 came in with transmit functioning okay, but only part of the channels receiving. First thing I did

was make a list of the channels that were dead. The manual didn't have a chart of which crystals are switched in for which channels; but I get this model in often, and I had long ago penciled my own charts into the service manual.

You already should have figured out that one of the crystals driving the receive oscillator was faulty. My list of channels not operating told me which one. Channels 1-4, 9-12, and 17-20, were the dead ones, so I knew, without testing a single thing, that the 11.765-MHz crystal wasn't functioning. As it turned out, it had jarred loose in its socket.

In case you missed the reasoning, here is how it went: All channels could transmit, so the 38-MHz oscillator had to be functioning on all crystals. Likewise, the 11-MHz os-

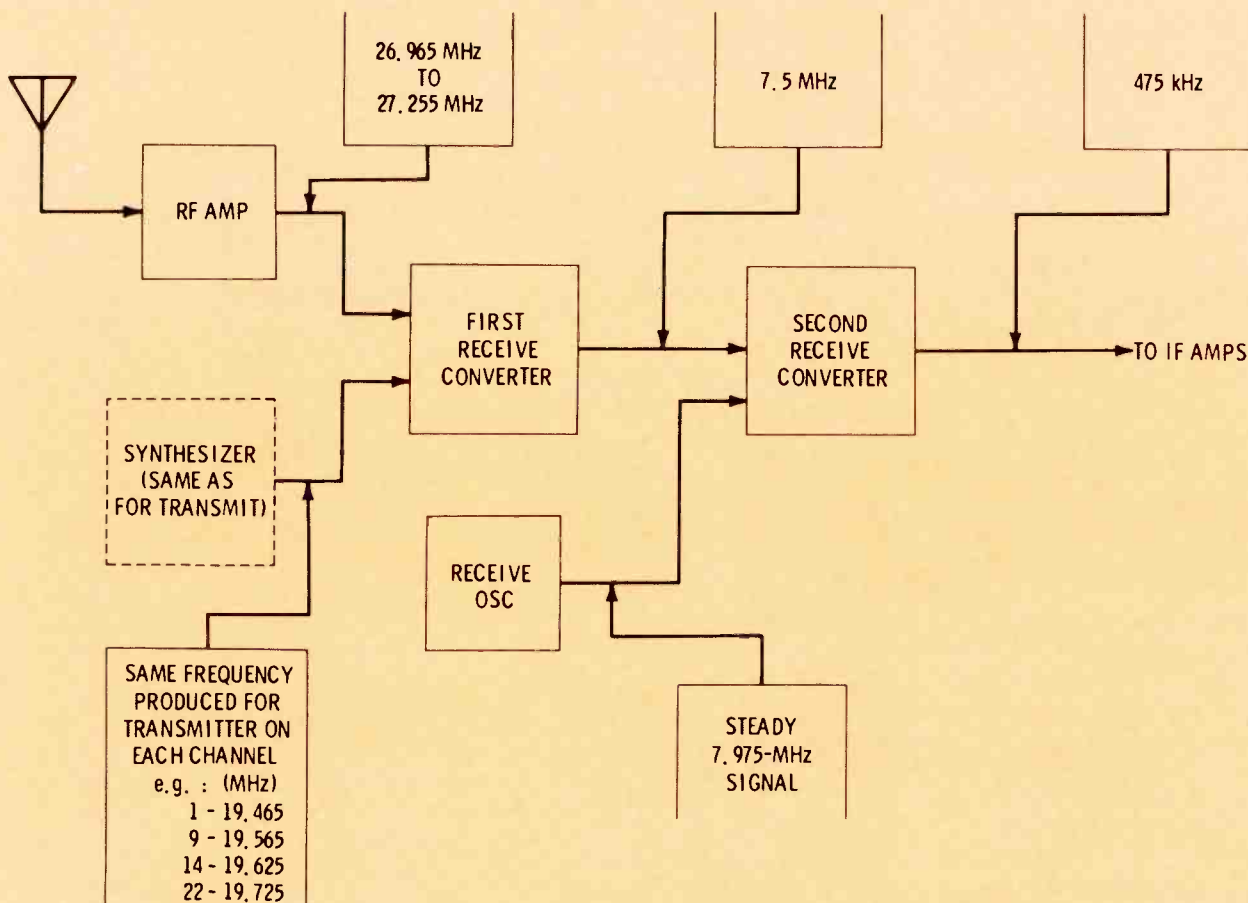
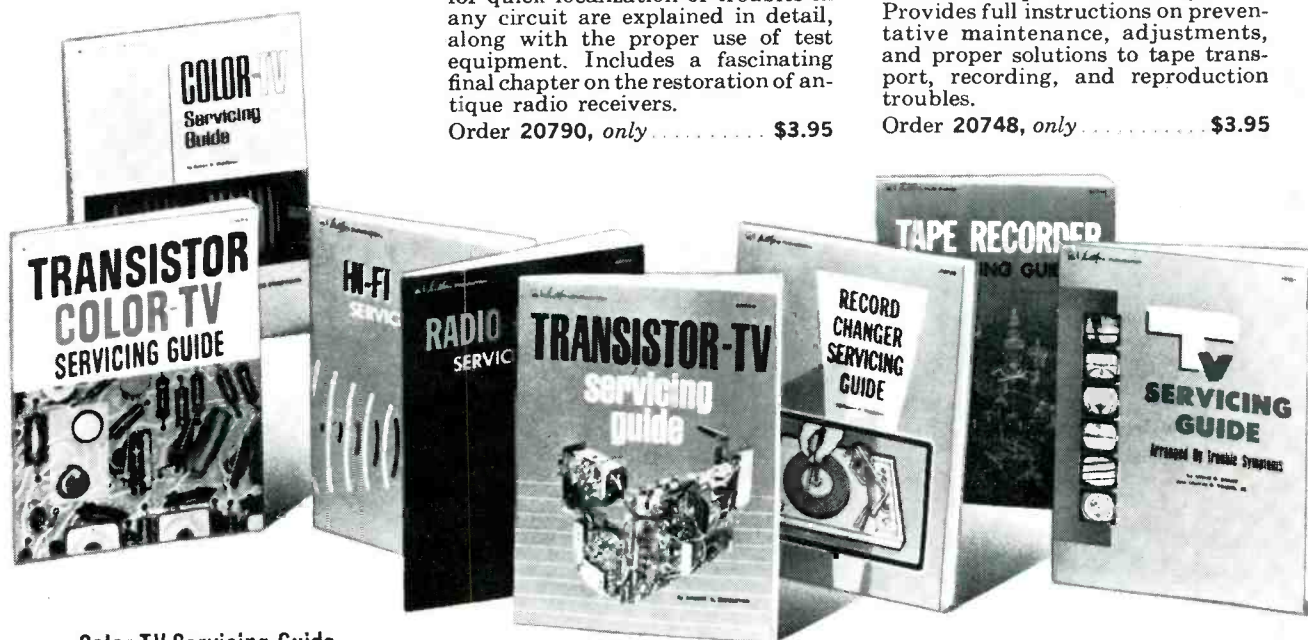

Fig. 2 Receive function employs same synthesizer used for transmit. Channel switch selects same crystal combinations.



# Sams Books

famous for  
Servicing  
Know-How



## Hi-Fi Stereo Servicing Guide

by ROBERT G. MIDDLETON. A complete guide to effective servicing of a-m tuners, fm tuners, stereo-multiplex units, and audio amplifiers (all components, except record players and tape recorders). Includes hi-fi speaker system installations, trouble localization, and overall system evaluation. Also gives testing methods for verifying performance.

Order 20785, only ..... \$3.95

## Radio Receiver Servicing Guide

by ROBERT G. MIDDLETON. Presents the professional technician's approach. Covers troubleshooting and repair of a-m radio receivers, both solid-state and tube type. Methods for quick localization of troubles in any circuit are explained in detail, along with the proper use of test equipment. Includes a fascinating final chapter on the restoration of antique radio receivers.

Order 20790, only ..... \$3.95

## Record Changer Servicing Guide

by ROBERT G. MIDDLETON. Presents the general principles of record changer design, followed by a detailed analysis of the working parts of changer mechanisms. Explains adjustment and lubrication procedures, diagnostic techniques for operating troubles, and the corrective measures required to remedy them. This is a thoroughly practical guide.

Order 20730, only ..... \$3.95

## Tape Recorder Servicing Guide

by ROBERT G. MIDDLETON. Tells how to repair tape recorders profitably. Thoroughly explains the principles and characteristics of magnetic recorder circuitry, describing the various components and systems. Provides full instructions on preventative maintenance, adjustments, and proper solutions to tape transport, recording, and reproduction troubles.

Order 20748, only ..... \$3.95

## Color TV Servicing Guide

by ROBERT G. MIDDLETON. Shows how to apply fast troubleshooting techniques to color-TV repair using the famous Middleton system based on analysis of trouble symptoms illustrated by actual full-color picture tube photos. Clearly-written text explains possible trouble causes and diagnostic procedures. Final chapter explains in detail how to use color-bar generator.

Order 20358, only ..... \$4.25

## Transistor Color-TV Servicing Guide

by ROBERT G. MIDDLETON. Clearly explains the basics of the various circuits used in transistor color-TV receivers, including the most recent developments. Shows how to apply proper troubleshooting procedures based on analysis of trouble symptoms. Includes a wealth of circuit diagrams, charts, and picture tube and waveform photographs.

Order 20693, only ..... \$4.50

## Transistor-TV Servicing Guide

by ROBERT G. MIDDLETON. Second edition. Updated to provide full information on latest circuitry and many additional new test procedures. Clearly explains general transistor circuitry and servicing techniques and then proceeds through the receiver, section by section, describing various picture and/or sound trouble symptoms and their remedies.

Order 20696, only ..... \$3.95

## TV Servicing Guide

by LESLIE D. DEANE and CALVIN C. YOUNG, JR. This is the famous guide used by more than 100,000 service technicians. Shows how to apply quick troubleshooting procedures based on analysis of trouble symptoms illustrated by picture tube photos. Fully explains possible causes for each trouble symptom and then details proper diagnostic and repair procedures.

Order 20361, only ..... \$3.25

### HOWARD W. SAMS & CO., INC.

Order from your Electronic Parts Distributor, or mail to Howard W. Sams & Co., Inc., Dept. ES-110  
4300 W. 62nd St., Indianapolis, Ind. 46268

Send books checked at right. \$\_\_\_\_\_ enclosed

Send FREE 1970 Sams Book Catalog

Name \_\_\_\_\_

Address \_\_\_\_\_

City \_\_\_\_\_ State \_\_\_\_\_ Zip \_\_\_\_\_

- 20785
- 20730
- 20790
- 20748
- 20358
- 20693
- 20696
- 20361

Circle 26 on literature card

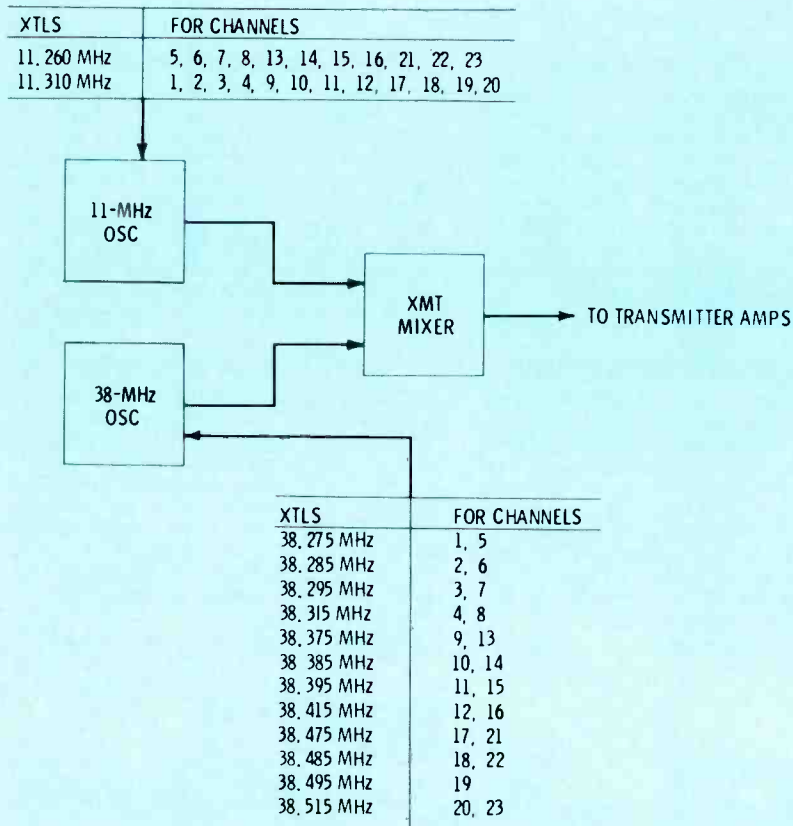

**Fig. 3** Simpler heterodyne system for synthesizing output frequency in one step. This is ordinary AM transmitter. Synthesizing for SSB is slightly more complicated.

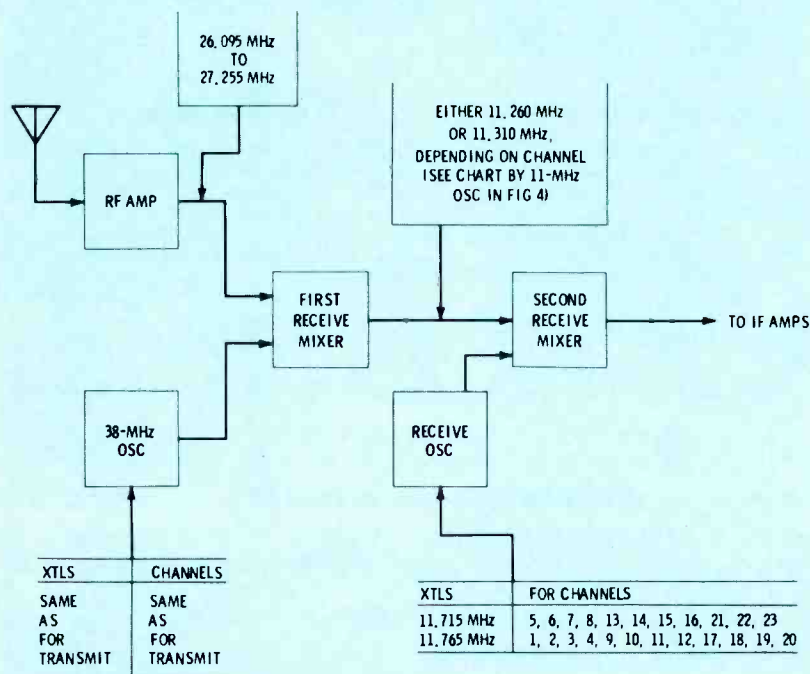

**Fig. 4** Receiver is double-superhet, employing same HF oscillator used for transmitting. This receiver matches up with transmitter in Fig. 3.

illator had to be operating on both crystals. The receive oscillator itself had to be okay, or **none** of the channels could have received. The list of dead channels coincided exactly with the list of channels operated by the 11.765-MHz crystal. So that had to be the fault. Testing was limited to a very small part of the chassis.

A case involving a transceiver somewhat similar to the one in Figs. 1 and 2 was no more difficult to "dope out". The customer said channel 9 was dead. Upon questioning him further, I learned that he only used that and channels 14 and 22. He could use both of the latter, but not channel 9.

On the bench, into a dummy load, the unit actually wouldn't transmit on 1, 5, 13, 17, or 21, either. Going down the chart in the service manual, I found one crystal in the 8-MHz oscillator common to all those. It had to be replaced, but diagnosing it was obviously simple.

### Dead Oscillators

You have to consider the design when you service a transceiver that uses frequency synthesis. In one that uses the system shown in Figs. 1 and 2, the 8-MHz oscillator was dead. As a result, the whole transceiver was dead. No transmit, no receive, on any channel. (With a transceiver system like that shown in Figs. 3 and 4, only the 38-MHz oscillator can kill both functions.)

The 7.5-MHz oscillator of the system in Fig. 1 could fail without bothering reception. Or, the 7.975-MHz oscillator in Fig. 2 could fail without affecting transmission. But failure of either oscillator in the synthesizer would kill both functions.

If you service CB units that have synthesizers, sit down and take the time to calculate the frequencies involved with the various crystals. Make charts like mine for each model and put them in the service manual, if the manual doesn't already have a chart. You'll save yourself lots of testing time when there's an oscillator fault.

Identifying a dead oscillator is easy with tubes. The grid bias volt-

age decreases drastically when the oscillator stops. You can inject a weak signal from a generator at the grid and see if the tube can amplify it. Just pick up a frequency near one of the oscillator's crystals; then rock the generator dial back and forth and you'll be able to tell if the tube is amplifying. If so, the feedback network is bad. If not, check tube supply lines and operating voltages.

With transistors, the base stays somewhat near the same voltage whether the stage is oscillating or not. You usually have to rely on symptoms to tell you if a transistor oscillator is working.

Test the transistor first. Then try signal injection at the base. If the signal goes through the transistor to its collector, check the feedback arrangement. You might have to substitute feedback components. Also try substituting more than one transistor — they are funny creatures about oscillating. They often do it too much when you don't want them to, and not enough when they're supposed to. If a weak injected signal doesn't come out much stronger at the collector, measure DC voltages and troubleshoot the stage as if it were an amplifier that wouldn't function.

#### Next Month

Sometimes we get hung up with how to service one particular kind of equipment. If we specialize, it's even easier to fall into sloppy servicing habits. Every now and then



"He's our ground wire specialist."

it's good to pause and examine our overall troubleshooting technique.

One of the most logical ways to approach troubleshooting in any kind of equipment is a technique called **1-2-3-4 Servicing**. It's originator, Forest H. Belt, is a former Editor for **ELECTRONIC SERVICING**. The technique has been expounded at length in two books

published by Howard W. Sams & Co., Inc.: **1-2-3-4 Servicing Automobile Stereo** and **1-2-3-4 Servicing Transistor Color TV**.

I've got permission to give you a capsule version of how it works, and how you can apply it to any kind of electronic servicing. Next month, that's what **Service Bench** is devoted to. ▲



## Don't shoot till you see the tenths of a volt.

The sure way to troubleshoot solid state TV is with a scope that measures DC.

Take Leader's five-inch LBO-53B:

It gives you a drift-free DC input, so you can see those tenths of a volt. It gives you a bandwidth to 10 MHz. And it gives you a sensitivity of 10 mv/cm or better.

Now for the shocker. You can have a Leader LBO-53B for just \$229, about half the price of any other scope with the same capabilities.

Since the proof is in the seeing, we direct you to your Leader distributor. Ask to see our color bar generators too; you haven't seen the finest until you've seen Leader's.

**Seeing is believing.**

#### Leader Instruments

37-27 27th Street, Long Island City, N. Y. 11101, (212) 729-7411

Circle 27 on literature card

## Periodic Collapse of Vertical Sweep

The raster of an Airline Model GEN12448B color TV periodically collapses to a white horizontal line, then comes back on, filling the entire screen except for an area at the top. This sequence is repeated over and over.

Adjusting the height and vertical linearity controls has no effect on the trouble symptom. I have checked these controls and all other capacitors and resistors in the vertical circuit, but all seem to be okay.

The voltage on the plate of the vertical output tube is normal, but all other voltages are not.

When I position the normal/service switch to "service", the raster goes black and the voltage on the grid of the vertical output tube shifts from a negative potential to a positive 140 volts. The voltage on the grid of the vertical oscillator varies also, but not as much, and it remains negative.

What could be causing this trouble symptom?

Leon Thomas  
Columbus, Texas

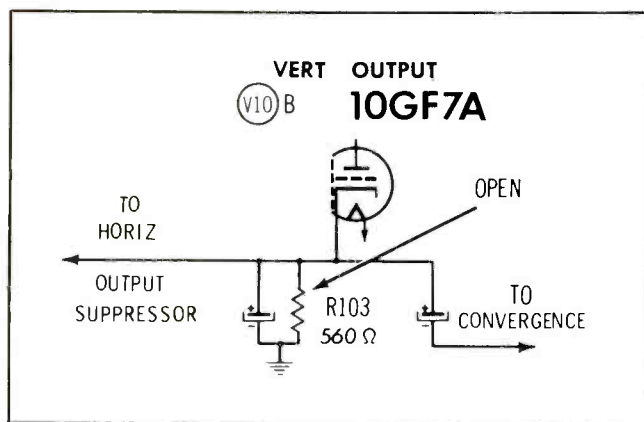

The trouble symptoms you have described are typical of those encountered when the cathode circuit of the vertical output stage is open.

This particular chassis employs a single cathode resistor, R103. Also, a small amount of current is taken from the cathode voltage and fed to the suppressor grid of the horizontal output tube, to suppress snivets.

If R103 is open, the output still conducts periodically to charge C14 and C15. When these two capacitors are completely charged, the cathode current stops, except for the small amount supplied to the suppressor grid of the horizontal output tube.

The vertical sweep functions only during the short period required to charge C14 and C15. The vertical sweep stops when the capacitors are charged. This action produces the intermittent vertical scan of the raster.

## High-Voltage Overload

Over the years, I have seen many CRT troubles, but this problem with a Toshiba color receiver is a new one to me. Even after the base socket is removed from the CRT, the high-voltage circuit is still overloaded, as indicated by the red glow of the plate in the horizontal output tube. However, if I disconnect the high-voltage lead from the CRT anode, the red fades from the plate of the horizontal output tube, and the high voltage returns to normal. What inside the CRT could cause this problem?

Chris Walsh  
South Portland, Maine

If the high voltage had returned when you removed the CRT socket, the defect probably would have been insufficient bias, which caused excessive CRT current.

Because the high voltage returned when the high-voltage lead was disconnected from the anode of the CRT, there are only two possibilities: The CRT might have an internal short, although such shorts are extremely rare. A much more likely defect is that the high-voltage rectifier is shorted or gassy and is allowing "raw" AC to reach the CRT. The picture tube capacitance filters and stores DC, but it is nearly a short to horizontal-frequency AC.

The mortality rate of rectifier tubes that have been transported extensively in tube caddies is often quite high; if other symptoms point toward a bad rectifier, try more than just one replacement until you are certain.

If the high voltage is AC, a DC meter will read nearly zero, even when a large arc can be drawn. Or attach the high-voltage lead to an external 500-pf, 25-kv capacitor whose other connection is grounded. Loss of high voltage and a red plate in the horizontal output tube indicate that the output is AC. ▲

## New Service Literature

**TV TECH AID**, Edward G. Gorman, Kings Park, L.I., New York 11754; printed monthly; yearly subscription \$7.95.

A monthly summary of actual color and b-w TV trouble symptoms, their possible causes and the cure for each. Where needed, a schematic of the circuitry involved is included.

The troubles and cures are grouped according to manufacturers, which, in turn, are listed alphabetically. The format of the publication is designed to facilitate filing the troubles and cures according to manufacturer and chassis number—a **definite aid to quicker servicing.**

**Statement of Ownership, Management and Circulation, Act of October 23, 1962; Section 4369, Title 39, United States Code).**

1. Date of Filing: September 30, 1970  
 2. Title of Publication: Electronic Servicing  
 3. Frequency of issue: Monthly  
 4. Location of known office of publication (Street, city, county, state, zip code): 1014 Wyandotte St., Kansas City, Jackson County, Missouri 64105.

5. Location of the headquarters or general business offices of the publishers (not printers): 1014 Wyandotte St., Kansas City, Jackson County, Missouri 64105.

6. Names and addresses of publisher, editor, and managing editor: Publisher, Robert E. Hertel, 1014 Wyandotte St., Kansas City, Missouri 64105; Editor, George H. Seferovich, 1014 Wyandotte St., Kansas City, Missouri 64105; Managing editor, J. W. Phipps, 1014 Wyandotte St., Kansas City, Missouri 64105.

7. Owner (if owned by a corporation, its name and address must be stated and also immediately thereunder the names and addresses of stockholders owning or holding 1 percent or more of total amount of stock. If not owned by a corporation, the names and addresses of the individual owners must be given. If owned by a partnership or other unincorporated firm, its name and address, as well as that of each individual must be given.) Howard W. Sams & Co., Inc.—a wholly owned subsidiary of International Telephone and Telegraph Corporation, 320 Park Ave., New York, New York 10022.

8. Known bondholders, mortgages, and other security holders owning or holding 1 percent or more of total amount of bonds, mortgages or other securities (If there are none, so state): None.

9. Paragraphs 7 and 8 include, in cases where the stockholders or security holder appears upon the books of the company as trustee or in any other fiduciary relation, the name of the person or corporation for whom such trustee is acting, also the statements in the two paragraphs show the affiant's full knowledge and belief as to the circumstances and conditions under which stockholders and security holders who do not appear upon the books of the company as trustees, hold stock and securities in a capacity other than that of a bona fide owner. Names and addresses of individuals who are stockholders of a corporation which itself is a stockholder or holder of bonds, mortgages or other securities of the publishing corporation have been included in paragraphs 7 and 8 when the interests of such individuals are equivalent to 1 percent or more of the total amount of the stock or securities of the publishing corporation.

10. This item must be completed for all publications except those which do not carry advertising other than the publisher's own and which are named in sections 132.231, 132.232, and 132.233, postal manual (Sections 4355a, 435b), and 4356 of Title 39, United States Code).

	Average No. Copies Each Issue During Preceding 12 Months	Single Issue Nearest To Filing Date
A. Total No. Copies Printed (Net Press Run) .....	63,713	60,566
B. Paid Circulation		
1. Sales through dealers and carriers, street vendors and counter sales..	6,638	6,256
2. Mail Subscriptions..	49,763	48,005
C. Total Paid Circulation..	56,401	54,261
D. Free Distribution (including samples) by Mail, Carrier or Other Means .....	1,623	856
E. Total Distribution (sum of C and D) .....	58,024	55,117
F. Office Use, Left-Over, Unaccounted, Spoiled after Printing .....	5,689	5,449
G. Total (sum of E & F—should equal net press run shown in A) .....	63,713	60,566

I certify that the statements made by me above are correct. (Signature of editor, publisher, business manager, or owner).

ROBERT E. HERTEL

# antenna systems report

## Packaged MATV System for TV Showrooms

A new packaged master antenna TV (MATV) system for TV showrooms has been made available by JFD Electronics Corp./Systems Division.

Model SL-9004 includes antenna matching transformers, an 82-channel headend amplifier, a two-way splitter, six dual-output tapoffs, 12 television set-matching transformers, two line terminators and all necessary cables and connectors.

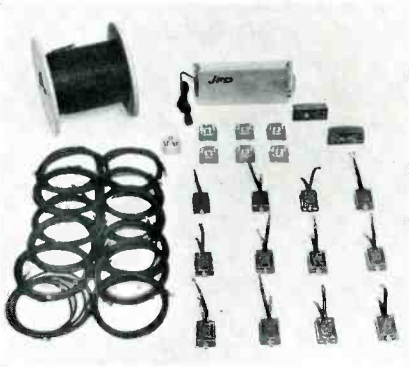

The system reportedly is capable of supplying top-quality antenna signals (UHF, VHF and FM) to every TV and FM set on the showroom floor. Designed to serve 12 sets, the SL-9004 can be expanded to handle 50 to 100 sets.

Installation is accomplished by mounting the individual components and then plugging them together with cables. An illustrated, step-by-step instruction manual is included.

Price is \$460.00 complete.

Circle 60 on literature card

## 82-Channel Wallplates

Three new 82-channel wallplates that accommodate FM signals are available from The Finney Company.

FINCO Models M-313 and M-314 82-channel wallplates are designed for use with 75-ohm RG-6/U cable in MATV systems.

Model M-313 has a 300-ohm tapoff for TV and FM. Model M-314 is equipped with a 75-ohm tapoff for TV and a 300-ohm tapoff for FM. Both are available with 10-, 15- or 20-dB isolation. FM isolation of these two models reportedly is 10 dB more than that specified for TV isolation, to reduce the chance of the FM signal interfering with the UHF/VHF signals.

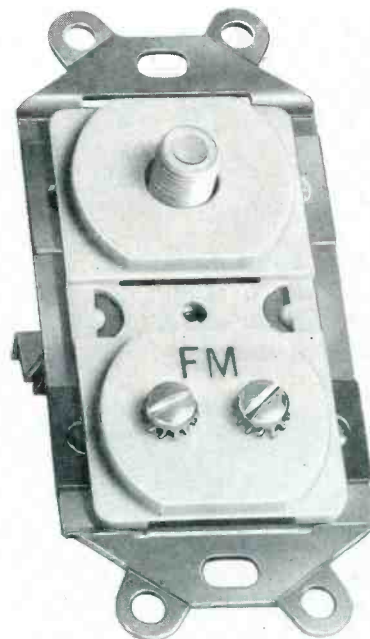

FINCO Model M-312 has both 300-ohm input and output, with no isolation available.

The three models are sold in quantities of 10, and are priced at \$7.00 for Model M-313, \$8.70 for Model M-314 and \$1.00 for Model M-312. ▲

Circle 61 on literature card

GIVE ... so more  
will live

# HEART FUND

# Common sources of distortion in auto radios

Tips about recurring defects, and how they can be isolated quickly.

by Joseph J. Carr

Distortion is one of the more common troubles encountered in auto radio servicing. The rigid requirements imposed on a car radio by its environment makes distortion both more frequent and more acute. Defects in the audio stages, the AGC circuit, or oscillation in any of the stages can lead to a "distortion" complaint. In the following paragraphs we will examine some of the common sources of distortion and a few specific defects found in some recent-model sets.

## Audio Distortion

The audio stages are a frequent source of distortion. The audio output stage of a typical (if

such exists) car radio is a direct-coupled, cascade circuit using two NPN driver transistors and a PNP power transistor. An example of such a circuit is shown in Fig. 1. This is the audio section of a recent-model Delco car radio. Delco has used this configuration, as well as close variations, in many General Motors cars. This type of circuit dates back to the late production 1963 radios. (A transformer-coupled circuit was used previously.) Circuits similar to this have been used by most car radio manufacturers at one time or another.

The DS-501 power transistor (Q3 in Fig. 1) derives its operating bias from the voltage drop across the 47-ohm resistor (R4) in the base circuit. This voltage drop is caused

by the flow of collector current in Q2 (NPN, DS-66). This means that the collector current of Q3 will increase as the collector current of Q2 increases. Q2, in turn, is biased by Q1 and the voltage drop across R2, the 3.3K-ohm resistor. This network functions similarly to a voltage divider, with Q1 acting as a variable resistor. The voltage appearing between the base of Q2 and ground will decrease as more current is drawn by the collector of Q1, because more of the available supply voltage will be dropped across R2. Since Q2 is an NPN transistor, this will tend to reduce the amount of current in its collector circuit, which, in turn, will reduce its gain.

The 600-ohm variable resistor in

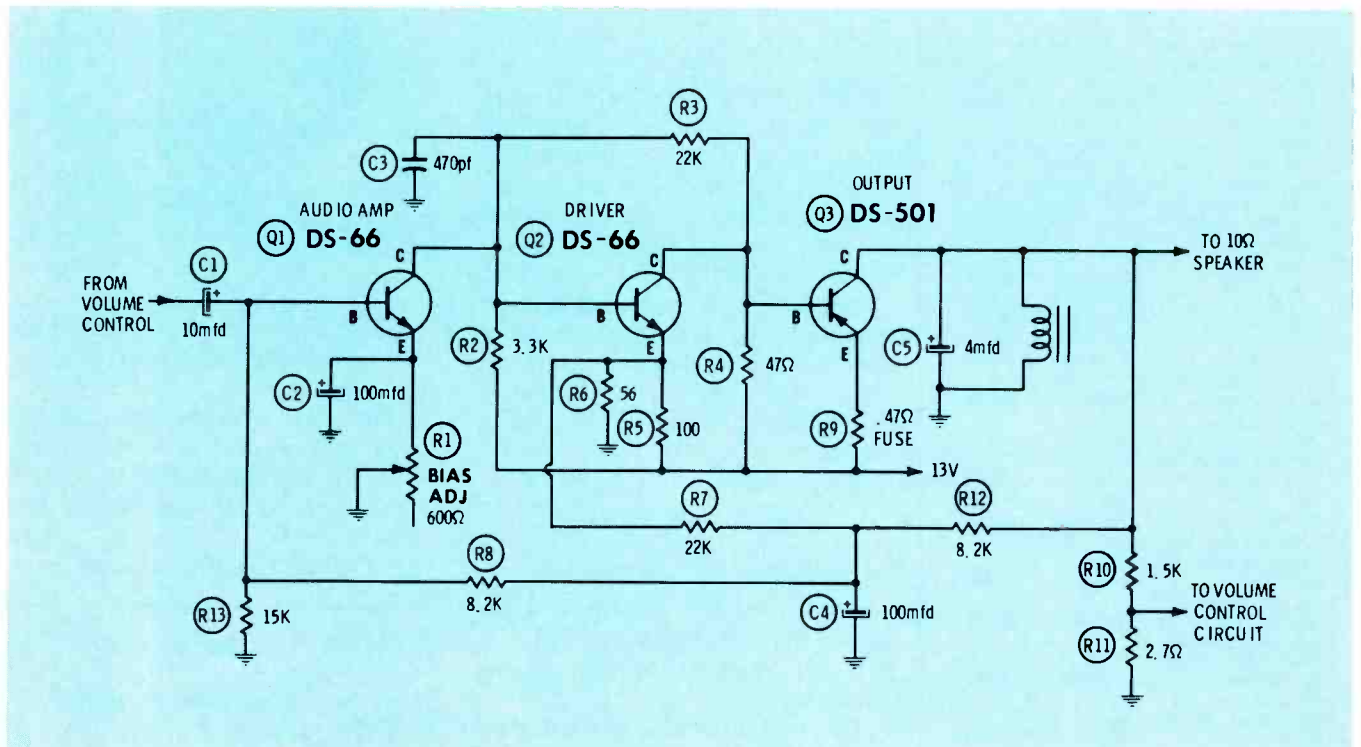
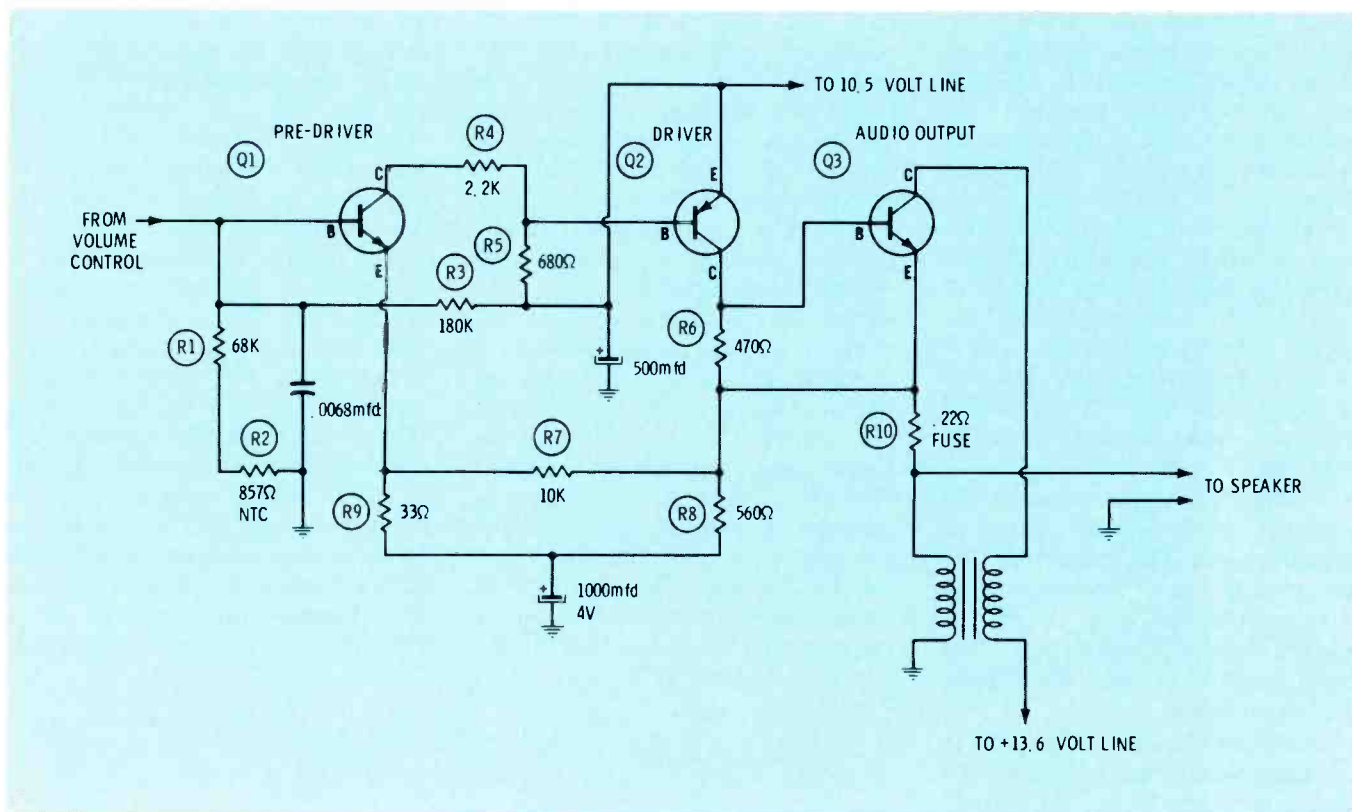

Fig. 1 Direct-coupled, cascade audio section typical of Delco model auto radios. Transistors and defective bias adjust pot are frequent sources of distortion.



**Fig. 2** Bendix auto radio employed in 1970 Fords uses NPN audio output stage and direct-coupled, cascade circuitry. Older-type output transistor with high failure rate, open output transistor, open emitter-bypass capacitor in driver stage and burned output transformer are common troubles in this receiver.

the emitter circuit of Q1 (R1 in Fig. 1) sets the operating conditions for all three audio stages by controlling the amount of current drawn by Q1. (Because one of the driver transistors tries to cut off as the other draws more current, the jargonists in the auto radio business have dubbed this circuit the "see-saw" amplifier.)

Transistor defects are a major source of trouble in this type of circuit. The output transistor, for instance, frequently becomes either leaky or shorted. This often causes the fuse resistor (R9) to blow. In such cases the customer might complain of weak and distorted output

from the radio. There are several symptoms that offer the servicer a diagnostic shortcut at this point.

First, he will notice little or no "thump" from the speaker when the set is turned on or off. Second, he might notice that the fuse resistor is either charred or completely burned. And third, he might notice that there is no collector voltage on Q3.

An alternate to the preceding three symptoms also might be found occasionally: Sometimes the output transistor will draw excessive current that is not yet high enough to pop the fuse resistor. The collector voltage will increase from its

normal range of under 2 volts to about 2.5 to 4 volts.

Troubleshooting these circuits can be time consuming unless the proper procedures are followed. Any one of the three transistors or any of the other parts in the entire audio chain can malfunction and cause distortion. It doesn't help matters any if you try to "over-isolate" too early in the game. These transistors all interact with each other. Because of this, the entire three-stage chain must be treated as a whole.

A small collection of miniature alligator clip leads is a real help in locating troubles that cause ex-

cessive current in the collector circuit of the output transistor. Use one clip lead to short together the base and emitter terminals of the output transistor. Use another to bridge across the fuse resistor if it is burned out. Watch the "A" lead ammeter as you briefly turn on the set. If the radio is still drawing excessive current, the trouble is a shorted output transistor. If it doesn't draw more than a few milliamps, you can assume that the base of the output transistor is still capable of controlling collector current. In such a case, look for trouble in one or both of the NPN driver stages.

The next test point will be the base of driver transistor Q2. Remove the alligator clip lead used to short the base-emitter junction of the output transistor and use it to short the base-emitter junction of Q2. If this cuts off the output transistor, you can be reasonably sure that Q2 is okay.

Voltage measurements must be made to determine the status of the audio amplifier transistor, Q1. Because of the "see-saw" effect mentioned earlier, you should not use the "cut-off" test on Q1. This could possibly increase the current drain even more.

A frequent source of trouble in the circuit of Q1 has been the 600-ohm bias adjust in the emitter circuit. This control tends to open intermittently. When this happens, the base voltage on Q2 increases drastically. The higher (more positive) base voltage on this NPN transistor causes it and the output transistor to draw excessive collector current. The customer who owns one of these sets is likely to complain of intermittent distortion or "cutting". Another clue to this trouble is a slightly charred ceramic case on the fuse resistor. If such symptoms are present, lightly tap the bias pot (through the access hole) with a pencil eraser or other small instrument and see if it has an effect on the distortion. This problem also can be the cause of one of those "no apparent reason" failures of the output transistor. Because this bias adjust has been such a problem in the past couple

of years, the author makes it standard procedure to check all 1968-69 Delco bias pots.

Another trouble spot in these sets, although not as frequent as the bias pot problem, has been the DS-66 audio amplifier transistor, Q1, especially in the AM/FM sets. In some receivers these transistors have been found with the emitter lead loose at the transistor's epoxy case. This will cause the same intermittent symptoms as does the bias pot.

Fig. 2 shows the audio output circuit used by Bendix in many of their 1968, 1969 and 1970 car radios. It uses an NPN output transistor and a two-stage driver amplifier that consists of one PNP and one NPN transistor. The three transistors are connected in a direct-coupled, cascade configuration.

There are two basic types of output transistors associated with this circuit. The older, and no longer used, type has a modified "diamond" base. Its appearance is different because it does not have the protective dome usually found on TO-3 cases. The transistor is molded inside a small, blue epoxy package that is spot-welded to the

diamond base. Because the failure rate of these older-type transistors is extremely high, it is good practice to update it with a newer type in any Bendix radio using it.

The newer transistor (see Fig. 3B) is packaged in a small, tab-mounted epoxy case. Extreme care must be exercised when handling this kind of case because they are easily damaged. The primary danger seems to be in bending the leads toward the sides of the transistor. The internal connections apparently will not tolerate such movement. This can lead to problems when installing replacement transistors in certain sets. See Fig. 3A for the allowable bends.

The output transistor in Fig. 2 is biased by the collector voltage of the PNP driver transistor, Q2. This transistor, in turn, is controlled by the NPN pre-driver, Q1. Resistors R4 and R5 form, with Q1, a voltage divider network that controls the conduction of Q2. An increase in the collector current flowing through Q1 will produce a larger voltage drop across R5. This action lowers the base voltage of Q2. Because this transistor is a PNP type, its collector current will

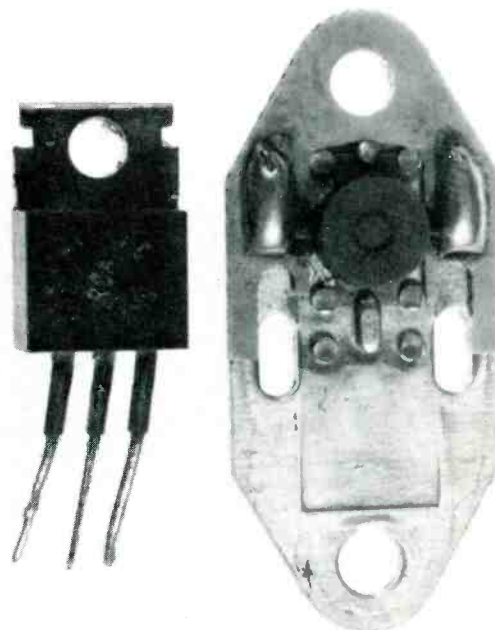
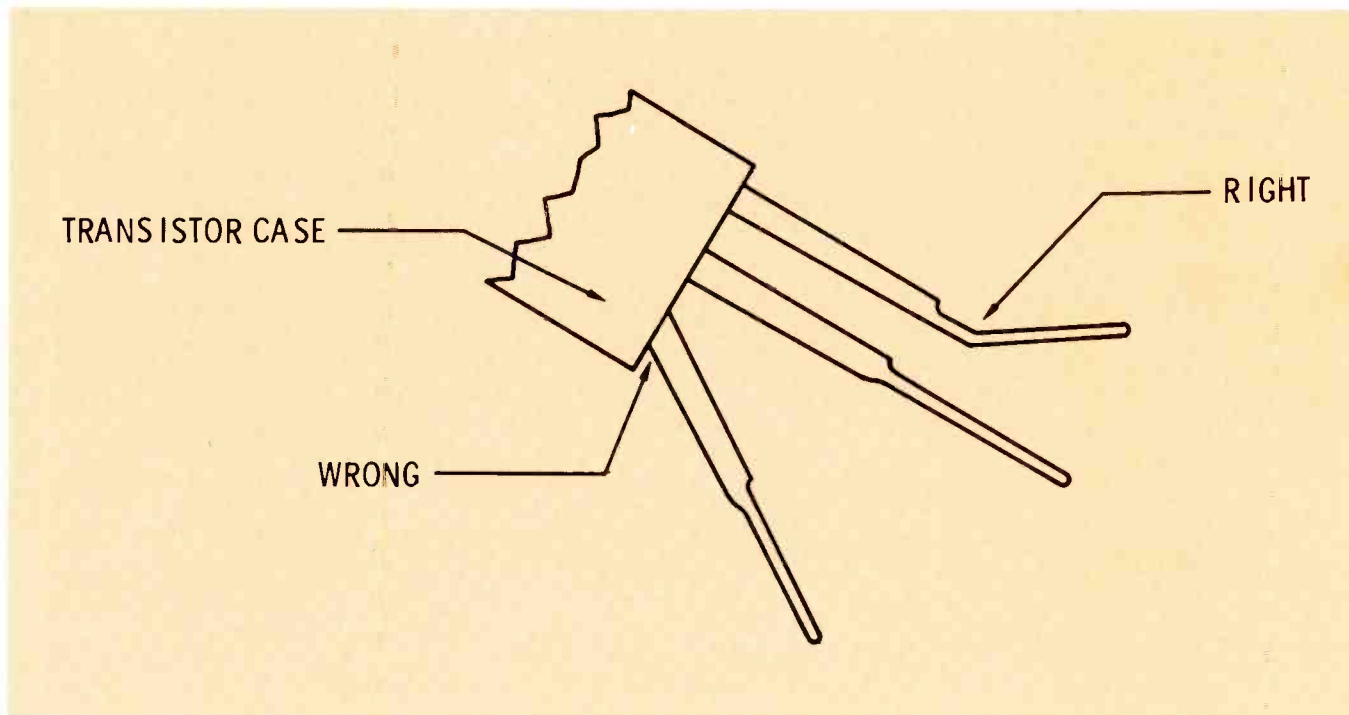

Fig. 3 (A) Older type of output transistor previously employed in 1968, 1969 and 1970 auto radios shown here on right has high failure rate and should be replaced with newer type shown on left.





(B) Newer type of transistor is easily damaged if leads are bent toward sides of case. Right and wrong methods of bending leads are shown here.

increase when the base voltage is lowered. This, of course, assumes that the emitter voltage remains constant. An audio signal from the detector is coupled into the base of the NPN pre-driver transistor. This signal's positive and negative excursions will cause a variation in the Q1 collector current. This variation is passed through the other stages, being amplified along the way, and appears at the speaker as audio output.

Besides the usual problems associated with direct-coupled audio circuits there are three main difficulties that can, and do, result in distortion. One of these is an open output transistor. While it is true that this kills the set at low volume, there is some distorted "leak-through" when the volume control is rotated to its maximum position; the customer complaint will be

"weak and distorted audio" rather than a "dead" radio.

These radios also have exhibited a certain habit that can be a bit annoying if it causes a callback: The output transistors develop an open circuit across the base-emitter junction. The resultant current registered on the "A" lead ammeter will be a few milliamps, which will cause just a slight flicker of the meter movement as the set is turned on. The real telling indication, however, is excessively high base voltage on Q3. This voltage is normally in the 2- to 3-volt range. When the transistor opens, this voltage shoots up almost as high as the collector voltage.

A second common cause of distortion in these sets is an open emitter bypass capacitor in the driver stage. This is the 1000-mfd, 4-volt DC unit shown in Fig. 2. It

will cause weak volume when it opens.

The third common cause of distortion is a burned output transformer. It will appear charred and will emit the characteristic odor of burned transformers. The cause of this problem usually is a short to ground of the wire between the transformer and the collector of the output transistor. Although this usually is the cause of burned transformers, it must be realized that a shorted output transistor also can be the cause.

The type of circuit shown in Fig. 4 has been used in the hi-fi field for several years. In car radios, however, it is something rather new. This configuration is used in the output stage of all AM/FM-multiplex and AM/FM-multiplex/8-track tape-equipped receivers manufactured by Phillips, Ltd., of

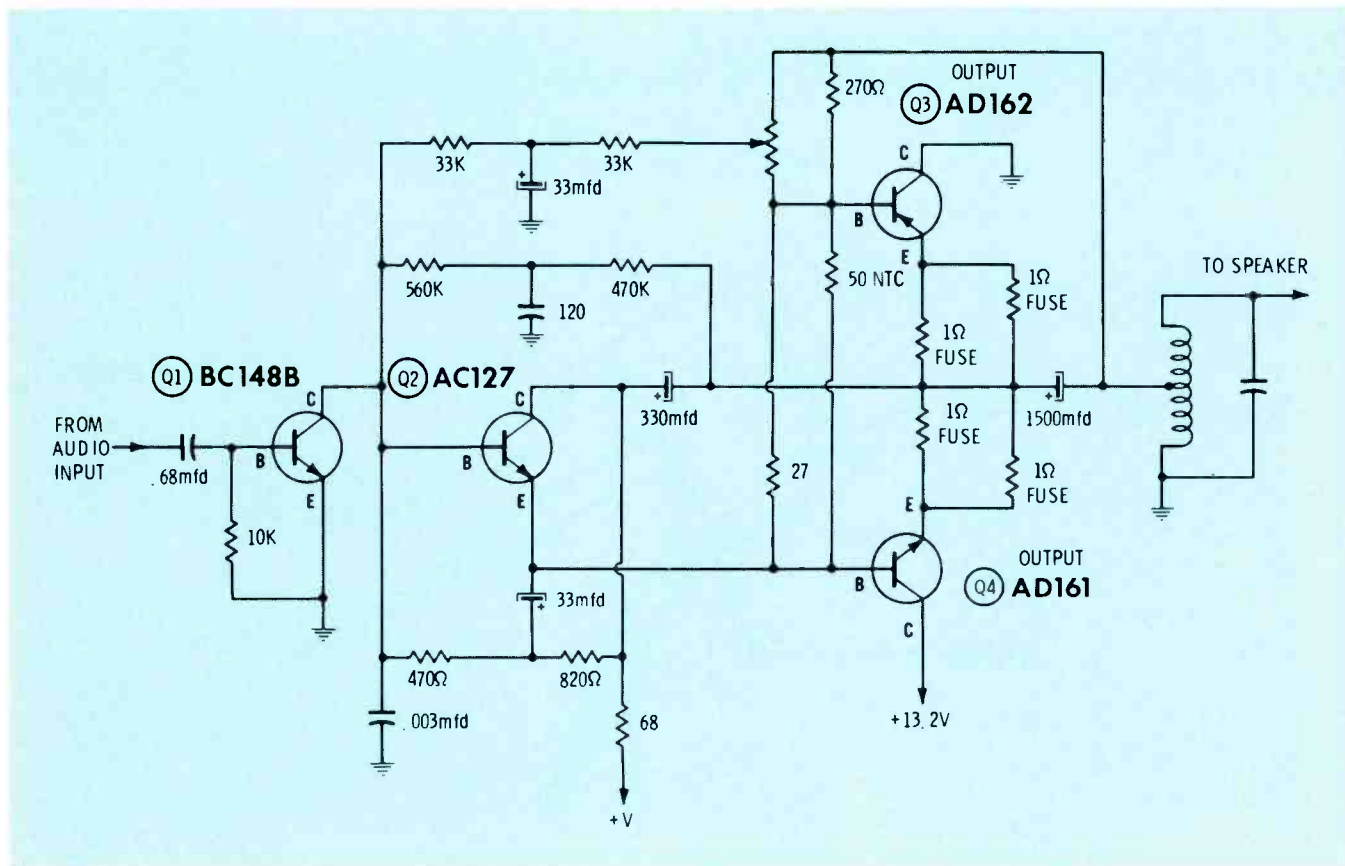

**Fig. 4** Complementary symmetry type circuit, used in output stage of some Phillips auto receivers, will produce slightly reduced, but distorted, audio when one of two dissimilar transistors is shorted. If one of 1-ohm fuse resistors in emitter circuit is burned, replace associated transistor, to avoid callback.

Canada. These sets are used as original equipment in some Chrysler products.

The type of output circuit employed in Fig. 4 is known as a "complementary symmetry" configuration. It gets its name from the two push-pull transistors that feed the speaker: one is PNP and the other is its NPN complement (same basic characteristics, but NPN instead of PNP).

One reason for using such a configuration is elimination of both the interstage and output transformers. Phase splitting, normally required in a push-pull circuit, is accomplished automatically by the inherent polarity differences between PNP and NPN transistors. The bases of the two transistors, therefore, can be fed in parallel by the AC127 emitter-follower stage. The audio signal is fed to the speaker

via a tapped choke and a 1500-mfd electrolytic capacitor.

This complementary type circuit can produce an interesting distortion problem if just one of the transistors shorts out. When this happens, it often does not kill the radio because the other transistor continues to function. The output will be reduced slightly and will be highly distorted. Such a situation, good volume and distortion, might lead you to believe that the trouble is in one of the driver stages. Quite often it will be found that one pair of 1-ohm fuse resistors is burned out, yet the transistors that they feed seem alright. In this case it is wise to replace the associated output transistors. If only the resistors are replaced, you probably will have to make a callback. If the AC127 transistor shorts from base to emitter, and they do pull this

trick occasionally, an unusual situation is created: The bias of the output transistor will be abnormal while the AD162 bias will be nearly normal. The result will be bad distortion.

#### AGC Distortion

The car radio's automatic gain control (AGC) circuitry is another frequent source of distortion. This type of distortion often is confused with AF distortion, until proper checks are made in the audio amplifiers. There are, however, some peculiarities that are common to AGC distortion but not to the audio variety.

One of these peculiar symptoms is distortion of the stronger stations but not the weaker ones. This occurs because a strong signal, under such conditions, is capable of overloading the front end of the

radio. Because the AGC circuit reduces the gain of the RF amplifier when stronger signals are received, overloading usually does not occur. If there is a defect in the AGC circuit, however, reduction of the gain does not occur. Consequently, as a general rule, look at the AGC circuit if only high-level signals are distorted. There is an exception to this rule, which we will discuss later.

Fig. 5 shows a typical car radio single-diode AGC circuit. It and its close relatives have been in use for a number of years. This particular circuit is found in many of the Automatic brand car radios. The AGC diode receives a sampling of the IF amplifier signal via the 180-pf capacitor. The amplitude of this signal controls the current flowing from the 10.2-volt line to the base of the RF amplifier transistor.

There are numerous defects that can cause this circuit to distort the radio. Open or shorted AGC diodes are a major cause. These usually can be successfully checked with an ohmmeter. Simply read both the forward and reverse resistances; they should have a ratio of 10:1. If the diode checks good, do not overlook the possibility that the AGC filter capacitor (the 25-mfd

electrolytic) might be either open or leaky.

The RF amplifier transistor is capable of causing distortion that is very similar to that caused by AGC trouble. This is the inevitable exception-to-the-rule mentioned previously. It is often difficult to determine immediately whether a particular case of distortion is caused by the RF amplifier or by the AGC system. There is one symptom, though, that does occur more frequently with AGC distortion than it does with RF distortion. This symptom is oscillation on or near the station frequencies. Usually, if the AGC is at fault, there will be some highly noticeable squealing as you tune across the sidebands of a station signal. On some occasions, the squeal might even be present when the receiver is tuned to the center of the signal. Because it is possible for this symptom to appear when the RF amplifier is defective, do not accept this as an absolute rule. The best procedure seems to be a quick ohmmeter check of the AGC diode. If this fails to reveal the trouble, next check the filter. If after the AGC has been certified free of trouble, and the difficulty persists, check the RF transistor.

Another common auto radio AGC circuit is shown in Fig. 6. This is a Delco circuit that has been in use since the early '60's. It uses two DS-27 diodes. Except for the extra diode, this circuit is similar to the circuit in Fig. 5. One thing, though, must be said about this Delco version: Replace the DS-27 diodes with either Delco original replacement parts or two equivalent units of the same brand. Never replace just one, unless the replacement part is another Delco DS-27. The author has tried to get away with replacing just one diode with a universal replacement. Occasionally it works fine. In too many cases, however, I succeeded only in blowing the remaining DS-27.

Should a DS-27 be shorted, causing low voltage on the B+ line, look for a shorted 180-pf capacitor before turning the set on. This isn't a common trouble, but is encountered occasionally.

### Oscillation

A frequently overlooked cause of distortion is oscillation of one type or another. If the oscillation is audible, of course, it probably will be eliminated before the source of distortion is confirmed, although it usually is the cause of the distortion. Not so easy to recognize, however, is the case where the oscillation is above the range of human hearing. If any of the bypass or decoupling filter capacitors are open, a feedback path will exist which can lead to oscillation or related forms of amplifier instability. Should the circuit constants be proper for oscillation in either the ultrasonic or RF ranges, distortion might well be the only outward symptom. The usual checks utilizing a sine/square-wave audio generator and an oscilloscope will usually isolate the trouble.

### Watch Out for Shop-Made Distortion

The author recently encountered distortion in a Lincoln Continental radio (Model 9FBL). This set had been on the bench of a younger

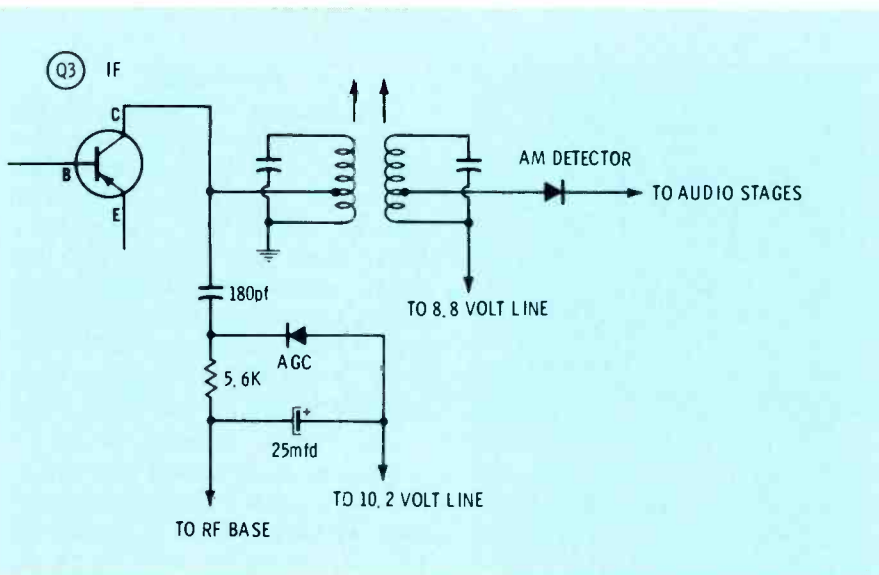

Fig. 5 Typical car radio single-diode AGC circuit. Open or shorted AGC diodes in this circuit can cause distortion.

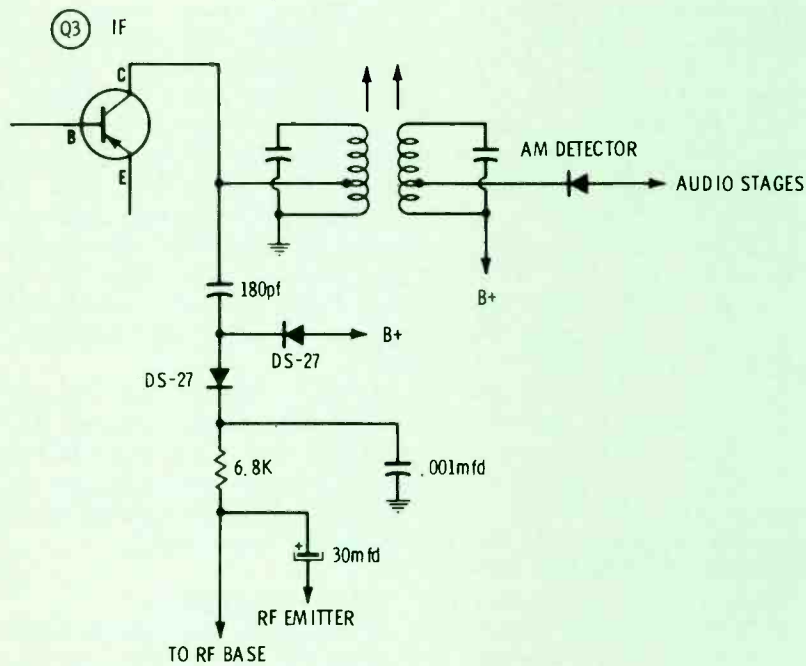

Fig. 6 AGC circuit shown here, employed in Delco model auto radios since early '60's. is similar to circuit in Fig. 5, except for extra diode. If only one diode is defective, replace it with unit that is identical to original.

apprentice technician. The original complaint was the familiar "dead set" problem. The set was, by then, very much alive, but highly distorted. It also exhibited a high-pitched oscillation that would change frequency as either the volume or tone controls were rotated. This was one of those mind-bending cases where everything **looked** normal. By all indications, the set should have been operating normally.

After a bit of questioning, it was learned that our apprentice had changed the dual NPN output transistors and a fuse (see Fig. 7). He had failed to make a diagram of the wire placement on the printed-circuit board where these transistors are mounted. When installing the new parts, he interchanged the base wires. This little foul-up switched the feedback connection to the opposite phase side of the push-pull amplifier, or from negative to positive. Oscillation and distortion was the result. Our apprentice technician is now slightly wiser for the experience.

### Conclusion

Distortion in car radios basically is little different from distortion found in other types of solid-state electronics equipment. The man who is armed with a few basic facts about car radios, and the usual technician's savvy about both solid-state and distortion in general, should experience little difficulty in profitably bringing these gremlins to bay.

Car radios, especially distorted car radios, have offered many technicians a quickie course in solid-state servicing. This is knowledge that can be highly valuable to the technician who must update to solid state or lose a big share of this business. ▲

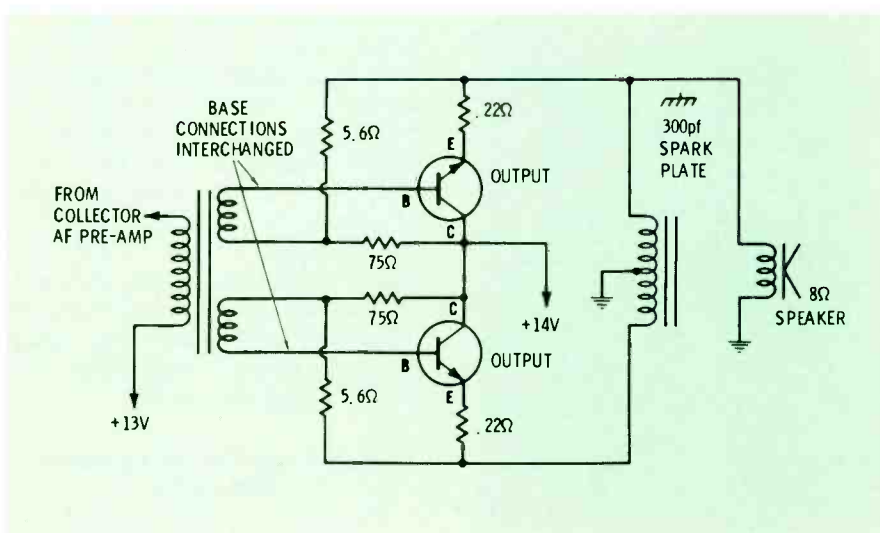

Fig. 7 Bendix push-pull audio output circuit used in 1969 Lincoln Continentals. Accidentally interchanged base leads caused oscillation and associated distortion.

PHOTOFACT BULLETIN lists new PHOTOFACT coverage issued during the past two months for new TV chassis. This is another way ELECTRONIC SERVICING brings you the very latest facts you need to keep fully informed between regular issues of PHOTOFACT Index Supplements issued in March, June and September. PHOTOFACT folders are available through your local parts distributor.

## ADMIRAL

Chassis TK10-2A, 3K10-1A 1125-1  
Chassis 9C2B, 9C2C ..... 1130-4

## AIRCASTLE

757 ..... 1126-5  
TRC-600F ..... 1129-3

## CORONADO

RA70-5506A ..... 1132-4  
RA60-5507A ..... 1133-3  
PH20-6022A/29A,  
PH20-6222A/24A/25A . 1134-4

## CURTIS MATHES

40M770, 40M780,  
70M260 (Ch. 40-1) .... 1134-5

## EMERSON

31L65/66, 31T57/60/61 .. 1136-4

## HITACHI

CWA-200 ..... 1129-1  
K-712H, KC-742H,  
KC-752H, KC-753H .... 1129-4  
CFA-450 ..... 1131-1

## MAGNAVOX

Chassis T949-01-AA ..... 1128-1  
Chassis T948-01-AA ..... 1136-1

## MOTOROLA

Chassis C19TS-/C21TS-/  
D21TS-599 ..... 1134-1

## MUNTZ

2181, 2381 (Ch. AS-9021-8) 1134-2

## NIVICO

2410, 2420 ..... 1125-2  
7438 ..... 1133-1  
7408 ..... 1135-1

## PANASONIC

CT-64P/PC, CT-65D/DC 1127-1  
TR-449B, TR-449BC ..... 1128-2  
AN-112T/TC, AN509,  
AN509D/DC ..... 1132-1

## PENNCREST

4910 ..... 1127-6  
2895, 2896 ..... 1128-3  
4707, 4708 ..... 1128-5  
2885 ..... 1130-2

## PHILCO-FORD

Chassis 20QT90 ..... 1126-2  
C3051TWA (Ch. 19FT60B) 1133-2

## PILOT

Chassis 123006 ..... 1125-4

## RCA

Chassis CTC39XA/XP/XAA/  
XAD/XAE/XAF/XAH 1126-3  
Remote Receiver CTP11H,  
Transmitter CRK9A ... 1126-3A  
Remote Receiver CTC12G,  
Transmitter CRK10C .. 1126-3B  
Chassis KCS176D/E .... 1127-2

## REALTONE

3308 ..... 1134-6  
3315, 3415 ..... 1126-6

## SHARP

TU-69P ..... 1136-2

## SONY

8FC-59W/WA ..... 1128-6  
STA-88W ..... 1131-5  
TVC-111U ..... 1132-3  
STA-38A ..... 1132-5

## SYLVANIA

Chassis Q27-2/-3/-4,  
S38-1/-3 ..... 1136-5

## SYMPHONIC

6200WA (Ch. R-820) .... 1125-5  
6202WA, 6207MA, 6208PC,  
6400WA (Ch. R-823) .. 1130-5

## TRUETONE

SYR6085A-07 (4DC6085) 1130-6  
ELI5055B-07,  
ELI5059B-07 ..... 1133-4  
WEG5069A-17/5069B-07/  
5167A-17/5989A-17 .... 1135-4

## WARDS AIRLINE

GCI-2420A/30A/50A,  
GCI-2530A/40A ..... 1133-5  
GEN-979A ..... 1135-5  
GCI-15540A/540B/820A/  
820B/840A/840B/850A/  
850B, GCI-17420B/440B/  
450B/620B/620C/640B  
640C/650B/650C, GHJ-  
17420A/430A/440A/  
450A/620A/640A/640A 1136-3  
GEN-1709A/1720A/  
1940D/1950A ..... 1136-6

## ZENITH

Chassis 12A8C14 ..... 1125-3  
A279W, A289W (Ch.  
8ZT56, 8ZT57) ..... 1131-6  
6AT24, 29AT24 ..... 1132-6

## PRODUCTION CHANGE BULLETIN

## MAGNAVOX

Chassis T927-01-BB-CB,  
T927-02-AA, T927-03-AA,  
T927-04-AA, T927-05-AA,  
T927-08-BB/-CB/-DB/-EB  
T927-06-BB/-CB/-DB/-EB 1127-4



# Adjustment and minor repair of tape recorder input and drive systems

by Robert G. Middleton

Even after record and playback heads have been cleaned, aligned, and demagnetized, they often fail to operate normally for several reasons. If the transport appears to be operating properly, the head should be inspected for excessive wear or damage. This inspection requires partial disassembly of the recorder. The required procedure can be determined by "sizing-up" the mechanical design.

In some designs, you must remove protective covers from above the heads and tape guides. However, many transistor recorders are constructed so that the protective cover is an integral part of the case; the chassis must be removed to gain access to the heads. Chassis

removal is usually a simple procedure; in a typical situation, you need only to remove four Phillip's-head screws and then lift the chassis out of the case.

Fig. 1 illustrates the placement of a typical record/playback head. This example has two mounting screws, one of which secures the head to a boss, and the other provides azimuth adjustment. (No adjustment is provided for head height in this example.) To remove the head, take out the mounting screws and unsolder the connecting wires to the head terminal.

An example of the side-mounted arrangement is shown in Fig. 2; both azimuth and height adjustments are provided.

You also will encounter rear-mounted heads similar to that shown in Fig. 3. No height adjustment is used in this design. However, if the technician needs to adjust the height, shim stock can be placed between the mounting bracket and the boss. Brass shim stock is generally available in 0.001- and 0.002-inch thicknesses.

You also will find bottom-mounted heads in some recorders, as illustrated in Fig. 4. Occasionally you will encounter the "no-mount" type of head in Fig. 5, which is mounted in a bracket under spring tension.

## Inspection for Head Wear

A head cannot be properly inspected unless it is clean. If oxide and/or tape lubricant are deposited on the face of the head, they can be removed with a suitable solvent and swab. Since we are concerned with minute defects, an optical aid is required to evaluate head wear or damage effectively. A magnifying device, such as illustrated in Fig. 6, is desirable. A good magnifying glass will make the more prominent head defects visible, and has the advantage that the head does not



Fig. 1 Arrow points to record/playback head.

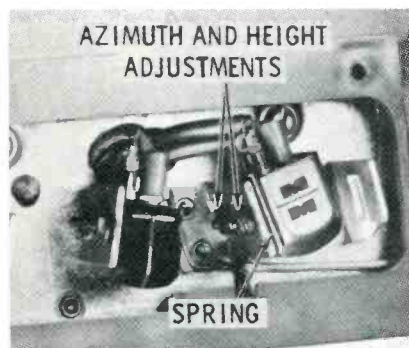

Fig. 2 A typical side-mounted head assembly.



Fig. 3 Example of rear-mounted playback head.

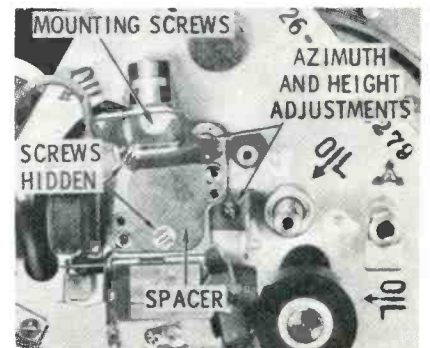

Fig. 4 Typical bottom-mounted tape head.

- Inspection and replacement of record/playback heads
- Servicing of belt-type clutches
- Servicing of disc-type clutches
- Friction-brake maintenance
- Magnetic-brake maintenance

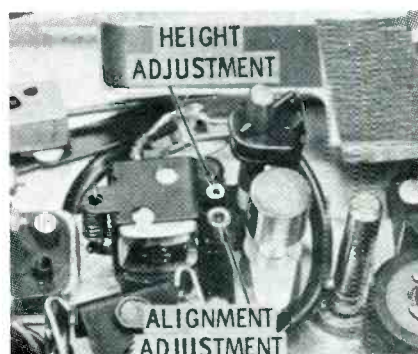
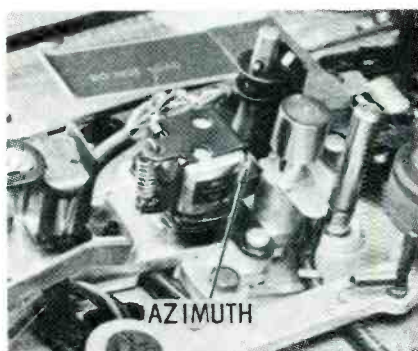

Fig. 5 A "no-mount" record/playback head in its bracket.

have to be removed from the chassis for inspection. However, evaluation of details such as small pits, grooves, and estimation of gap width cannot be made unless higher magnification is used. A watchmaker's loupe is the most practical optical device for this job. Analysis of tape surfaces, however, should be made under a low-power microscope.

Before a head is removed from a chassis, it is good practice to make a note of the color coding of the terminal leads. Operation might be impaired if the leads are inadvertently reversed. This is because the turns and layers of wire in the head winding have considerable distributed capacitance. If the "hot" lead is connected to the outer layer, this distributed capacitance has a greater bypassing effect than otherwise. As a result, the high-frequency response of the head is impaired. Do not drop heads on the bench or lay a head down on its polished face. Again, note that a head can be inspected to some useful extent

under a magnifying glass, as illustrated in Fig. 7, revealing grosser defects such as serious pitting, grooving, or surface roughening.

Inspection under a higher-power magnification device necessitates removal of the head from the chassis. Sometimes, apparent head defects are actually caused by loose mounting screws. Two of the mounting screws in the example of Fig. 7 are located beneath the head, and can be viewed with a dental inspection mirror, as shown in Fig. 8. Note that the mirror image can be magnified, if desired, as illustrated in Fig. 9. If a mounting screw has worked loose, or is missing, the head in Fig. 8 must be removed. Its face then can be inspected under considerably greater magnification, and the gap width can be checked. The gap width increases rapidly as a head nears the end of its useful life. You should also inspect the gap for uniformity, and check to see whether the gap is wider at one end than at the other.



Fig. 6 Single- and double-lens loupes, magnifying glass, and low-power microscope.

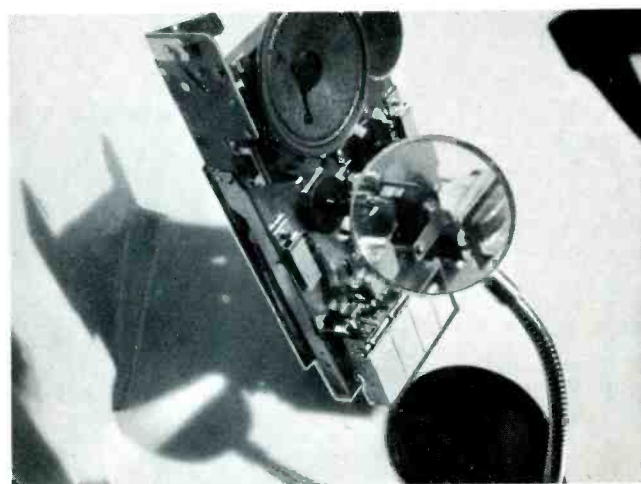
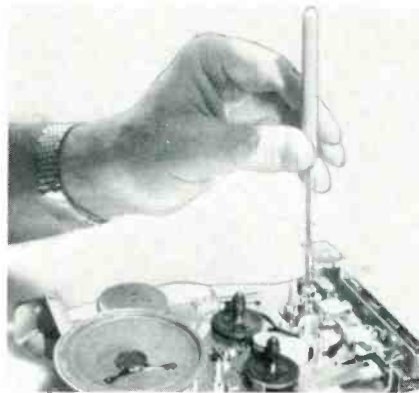

Fig. 7 A head can be inspected under a magnifying glass.

A head should be rejected if the gap width has become excessive. Although an optical comparator can be used to measure the gap width accurately, this is basically an engineering instrument. In a service shop, comparison tests are preferred. That is, inspect the worn head under the same magnification as a new head, to determine whether the gap width has increased appreciably. Experience is the best guide in deciding whether a head is approaching the end of its useful life. Various head designs employ gap depths from 0.010 to 0.006 inch. As would be expected, a shallow gap design has a shorter life expectancy, other things being equal. If the pressure pads are in good condition and exert normal pressure, and if the head and tape are kept clean, popular types of heads have a life expectancy of several thousand hours.

A head also can be inspected to good advantage under a loupe, as illustrated in Fig. 10. Both single- and double-lens loupes are available, and they also are designed for various working distances. A loupe is constructed in a plastic mount, and usually has 1-inch diameter lens. If desired, it can be fitted with a lightweight spring steel headband. However, most technicians prefer to



**Fig. 8** Use of a dental mirror to inspect underneath a head.

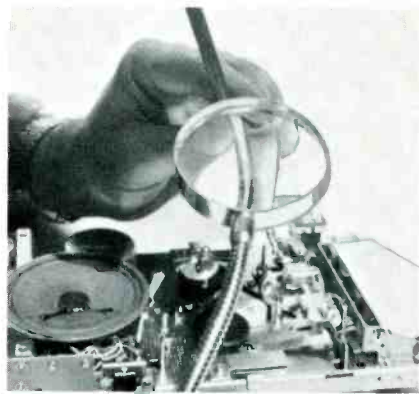

**Fig. 9** Magnification of an image in a dental mirror.

simply hold it between the eyebrow and cheekbone, in the manner of a monocle. Standard single-lens loupes have working distances in the ranges from 2 to 4 inches. A 2-inch loupe has a magnification of 2½ times.

Note that illumination must be increased as the magnification is increased. Thus, lighting that is

adequate for the method shown in Fig. 7 might be quite inadequate for that shown in Fig. 11 (stylus inspection microscope). A small high intensity lamp will be found useful and convenient when making observations under high magnification.

An ideal head is perfectly smooth with a highly polished surface, and the core gap has a uniform width of specified value. Under a magnification of 50 times, even a new head will appear substantially grooved and pitted, although the gap will appear quite uniform in width. Evaluation of surface defects must be made on the basis of experience. If you will carefully inspect a number of worn and discarded heads, and compare them with new heads under high magnification, you will soon become familiar with what is normal and what is not.

#### Preventive Maintenance

The construction of a laminated mu-metal head is shown in Fig. 12A. Mu metal is commonly employed because it has high permeability at low magnetizing force, and is not as expensive as other ferromagnetic substances, which are slightly advantageous from certain technical viewpoints. Although mu metal is comparatively soft, nevertheless it provides longer head life than various other harder substances.

Head wear is minimized by using lubricated magnetic tape. Although the iron-oxide coating on a tape is much harder than the mu metal in the head lamination, this difference in hardnesses contributes to ex-



**Fig. 10** Inspection of a head face under a loupe.

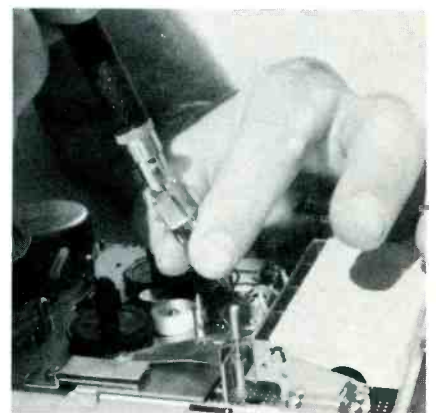

**Fig. 11** Inspection of a head face under a stylus microscope.



tended head life. The different surface textures of the tape and the head reduce abrasion, because their relief contours do not match. This is the same technical principle that is exploited in fitting a steel shaft with a babbitt bearing.

Dust, grime, and dirt are the chief enemies of head surfaces, and these contaminants abrade and scour the face much more rapidly than the iron-oxide coating of the tape.

A pressure pad usually is employed to maintain normal contact of the tape with the head, as shown in Fig. 12B. A pad pressure of  $\frac{1}{2}$  ounce might be specified for the record/play head, and  $\frac{3}{8}$  ounce for the erase head. Pressure measurements are made by using a spring scale to determine the point at which the pressure is just removed from the tape head.

Heads with a hyperbolic contour are designed to operate properly without pressure pads.

If a pressure pad is badly worn or completely missing, head life will be seriously impaired. When a pad is replaced, check the pressure that is exerted, to insure normal operation and head life. In the more elaborate recorders, the pad assembly can be repositioned for this purpose. However, in simplified recorders, the tension spring must be replaced if the pressure value is incorrect.

## Clutches

### Belt-Type Clutch

The belt-type clutch is used in

many recorders. It employs a pulley driven by a slipping belt. Its chief advantages are simplicity and low manufacturing cost. Fig. 13 shows a belt-type clutch which employs a grooved pulley with a rubber belt, and provides a constant torque. This type of clutch has no adjustment, and its operation depends upon the condition of the belt and pulley. In most cases, subnormal torque is traced to a defective belt. After extensive service or excessive aging, a rubber belt tends to lose its tension, and stretches. A glazed and hardened surface will result from subnormal torque, even if the belt tension is normal. The belt should be replaced routinely, when take-up torque problems are encountered. Belt replacement might require minor disassembly, as illustrated in Fig. 14.

When the take-up torque is subnormal, the tape is not reeled in as fast as it is reeled out by the capstan assembly. Also, the customer complains that the tape "piles up" between the take-up guide and reel, or that the tape is pulled out of a cassette.

A new belt will not cure the trouble unless the pulley grooves are clean and free from oil or grease. The value of a thorough inspection and cleaning procedure cannot be over-emphasized.

The technician can be misled by confusing clutch trouble with what is really a cassette defect. It is good practice to lay the original cassette aside, and to make the preliminary

evaluation of trouble symptoms using a know-good cassette.

Fig. 15 illustrates the meaning of torque, or twisting force. Torque values are measured in ounce-inches, ounce-centimeters, gram-inches or gram-centimeters. Conventional procedures usually specify ounce-inch measurements. For example, if the radius of the hub in Fig. 15 is one inch, the value of force  $F$  in ounces is also the value of the torque in ounce-inches. Torque measurements are usually specified at a certain speed setting, such as  $1\frac{7}{8}$  in/s. There are 28.35 grams in an ounce; this is the factor used to convert grams to ounces. Although take-up torque specifications vary, values from  $\frac{1}{2}$  to 1 ounce-inch are quite common. Some inexpensive recorders do not have specified take-up torque values.

The procedure for torque measurement is as follows:

1. With reference to Fig. 16, a standard plastic reel (or a measuring hub) can be employed. If the hub diameter is exactly 2 inches, the spring scale will read directly in ounce-inches of torque. Reels with smaller hubs can be brought up to 2 inches diameter by winding on sufficient tape. However, if a diameter other than 2 inches is utilized, multiply the spring scale by the hub radius to find the torque value in ounce-inches.

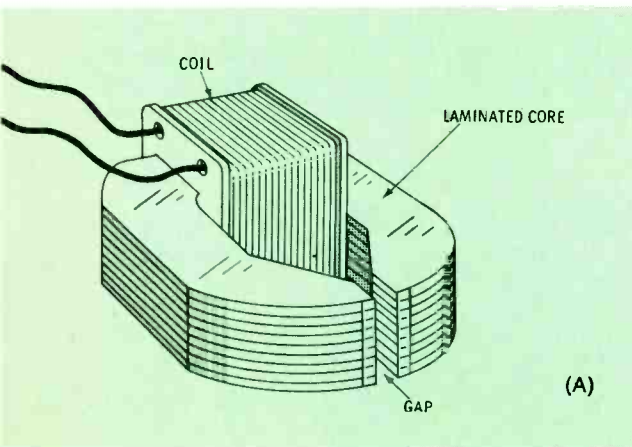
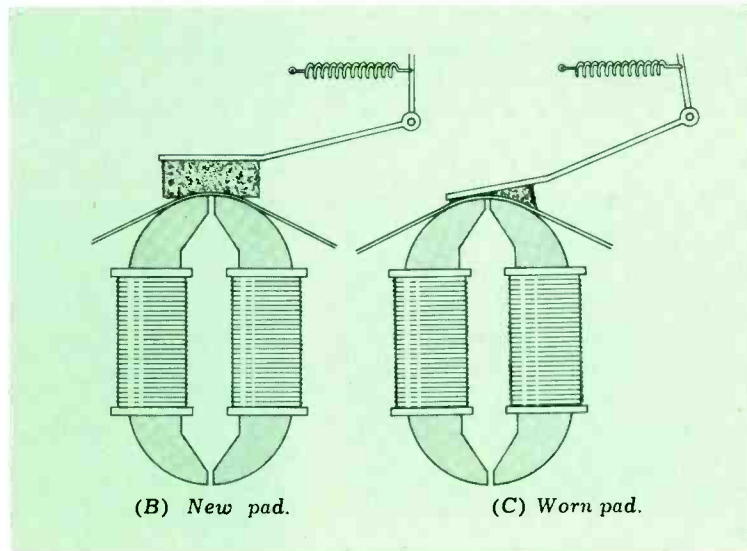

Fig. 12 Tape head and pressure pad.



2. A piece of string 30 inches long is used. A loop is tied in one end for securing the hook on the spring scale.
3. Take-up torque is measured on the driven reel; hold-back (drag) is measured on the supply reel.
4. To measure take-up torque, wind a few turns of string around the hub, and hook the spring scale into the loop at the end of the string. Start the recorder and observe the scale reading.
5. To measure hold back (drag), wind the hub of the supply reel with almost the full length of the string and attach the spring scale. Do not start the recorder; instead, pull the scale back so that the string unwinds slowly, and read the scale.

As would be expected, values specified for rewind and fast-forward torques are several times as great as for take-up torque. These increased torques are commonly obtained by throwing a planetary drive-disc arrangement into contact between the flywheel and the reel turntables. The torque are determined by spring tension, and an adjusting screw might be provided. Otherwise, the torque spring must be replaced when its tension becomes incorrect. A planetary train will fail to provide normal torque, even if the spring tension is correct, if the tires are worn, glazed, or contaminated with lubricant. Clean or replace, if necessary.

#### Servicing of Disc-Type Clutch

The disc-type clutch also is employed in many recorders. This type of clutch employs a rotating disc

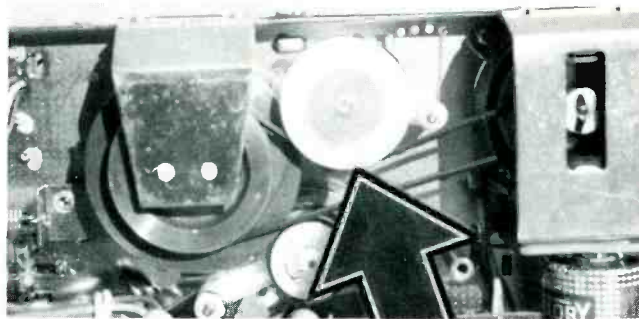

Fig. 13 A belt-type clutch.



Fig. 14 Bearing bracket removed to permit belt replacement.

that is driven at constant speed. In most recorders, the clutch is driven by the same motor that turns the capstan. The clutch disc may be fabricated either from metal or from plastic. A felt surface is placed on a second disc, which provides frictional torque between the two discs. The amount of torque might be adjustable by means of a spring assembly, or the torque might be "fixed" in simpler recorders. When the torque value is not adjustable, normal operation depends upon the condition of the felt surface in the clutch assembly.

With reference to Fig. 17, the take-up torque in the playing mode is developed by the disc clutch comprising clutch spring (82), reel disc felt (80), clutch disc (81), take-up

spindle (56), and spindle cap (34). In this example, the take-up torque has a nominal value of 1/2 ounce-inch, and is not adjustable. If the torque value is incorrect, look for a worn felt, or contamination with lubricant. If the trouble persists, the clutch spring should be replaced. In rare cases, a defective bearing develops opposing torque and causes erratic operation.

Next, note in Fig. 17 that the supply reel drag is provided by spring (51) and felt pad (35). This is a pad-type clutch that operates in the same basic manner as a disc clutch. In this example, the supply reel drag torque has a nominal value of 1/4 ounce-inch. The torque value is determined by the condition of the felt, and by the tension

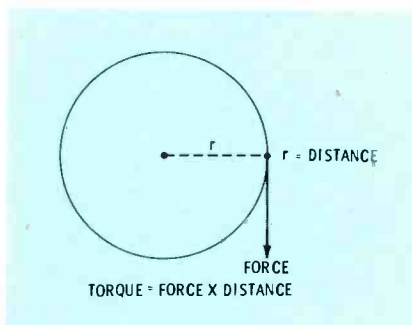

Fig. 15 Illustration of torque.

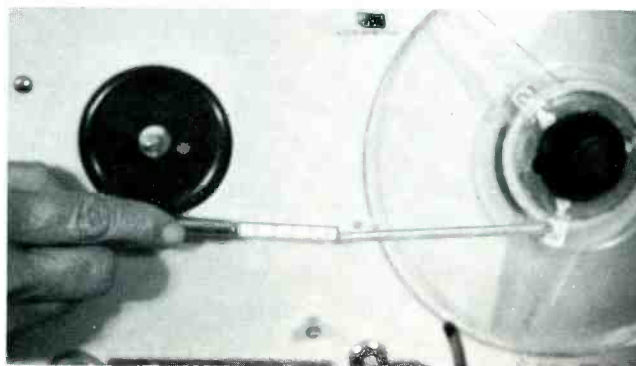

Fig. 16 Torque measurement.

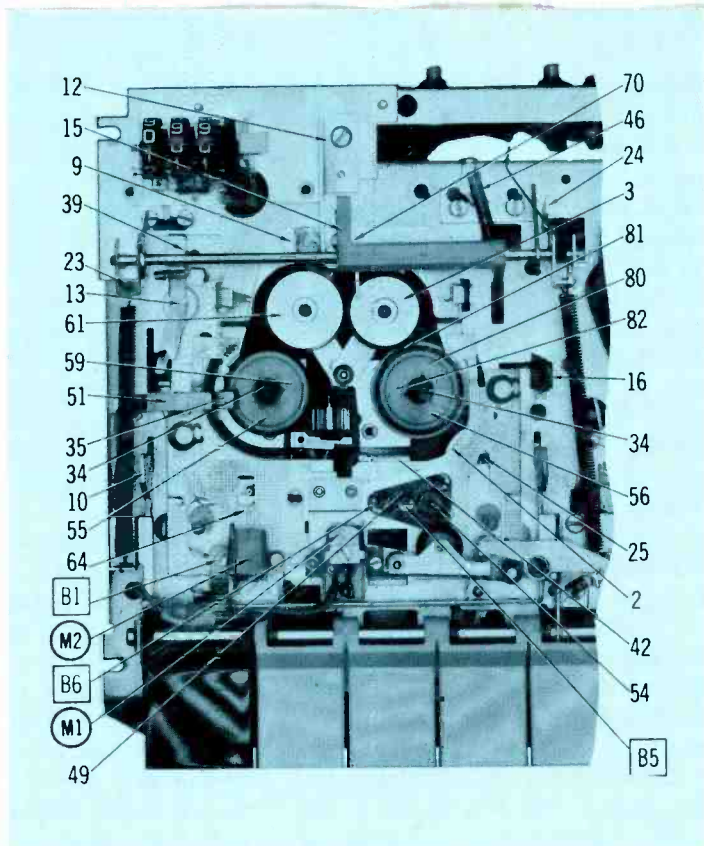

Fig. 17 Recorder with disc-type clutches.

of the spring. Although no adjustment is provided for spring tension, you can bend the spring as required to change its tension. The take-up reel drag in this example depends entirely on the cassette drag.

When the supply-reel drag becomes incorrect in this type of transport, the condition of the felt pad should be checked first. If it is contaminated, the pad can be cleaned by washing it in alcohol. The counter drive pulley (59) in Fig. 17 also should be cleaned be-

fore replacing the clutch pad and spring. If the felt is worn, it should be replaced, because its remaining life will be short. When a clutch felt is permitted to wear away completely, it is likely that the counter drive pulley will be damaged by friction against the metal spring. In such case, the pulley also must be replaced.

Preventive maintenance procedures normally include inspection of clutch components, as well as functional checks.

### Magnetic Clutch

In professional recorders, take-up torque might be provided by a magnetic clutch. This is accomplished basically by an induction motor operated in its stalled mode.

An induction motor develops its rated torque only at or near its normal rotational speed. When the motor is started up, it develops starting torque only, and this starting torque is only a small fraction of its rated operation torque. If an induction motor is forced to rotate at a low speed, it develops starting torque only, and is said to be operating in its "stalled" mode.

Although a magnetic clutch is much more expensive than a disc or a belt-type clutch, there is a characteristic of the magnetic clutch that is desirable in this application. Let us consider the torque requirement in somewhat greater detail.

In the case of disc-type and belt-type clutches, the torque applied to the take-up reel is practically constant. However, constant torque is not optimum torque in this case. When the reel is nearly empty, the tension on the tape is high, conversely, when the reel is nearly full, the tension on the tape is low. Although the capstan is supposed to maintain a constant tape speed, it operates under difficulties when the tape tension varies over a wide range. If the capstan pressure happens to be subnormal, the tape speed will vary substantially as the

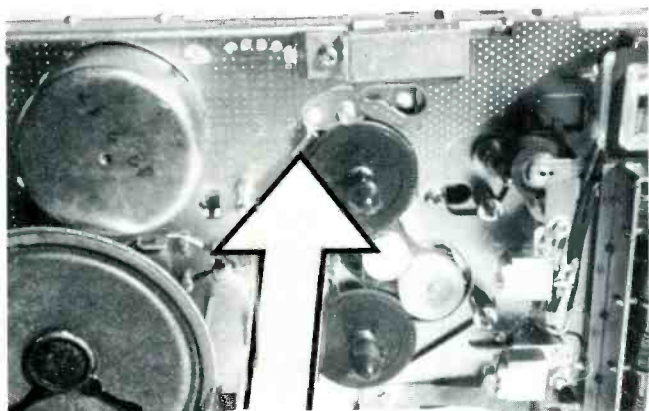

Fig. 18 Arrow points to brake shoe.

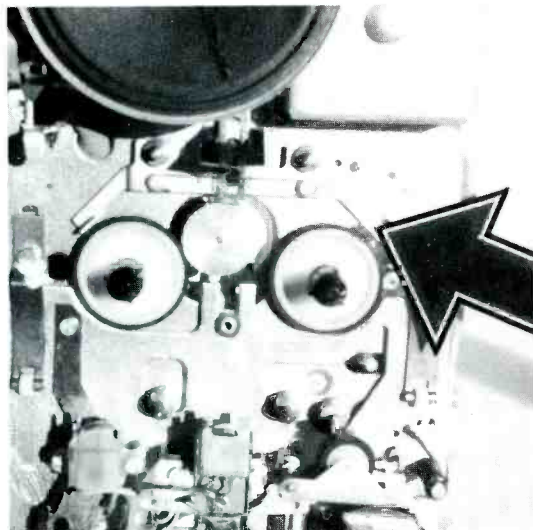

Fig. 19 Another example of a brake assembly.

tension changes. The possibility of this trouble is avoided by a properly designed magnetic clutch, which provides constant tape tension, rather than constant torque.

Another advantage of the magnetic clutch is that its operation is independent of temperature and humidity, and it is not affected by careless lubrication. Consequently, a magnetic clutch is much less likely to cause trouble symptoms than a disc- or belt-type clutch. In case a magnetic clutch does develop a defect, the troubleshooting procedure is the same as for induction motors: Disassemble the unit and clean and lubricate and/or replace the bearings, etc.

### Friction Brake Maintenance

When a recorder is set to the "stop" position, the reels must brake as rapidly as possible without damaging the tape. The same requirement applies to the pause operation.

A widely used type of friction brake employs a metal brake shoe that is brought into contact with the spindle rim, as shown in Fig. 18. More braking torque is normally applied to the supply spindle than to the take-up spindle. This ensures that the transport will stop without pulling tape from the cassette. Typical braking-torque values are 1¼ ounce-inches and ¾ ounce-inch for the supply and take-up spindles, respectively. Although mechanical details might vary (Fig. 19), the end result is the same.

In some recorders, a metallic spindle rim is employed with a padded brake shoe. When a metal shoe is utilized, it presses against a rubber or plastic spindle surface.

Braking force is determined by spring tension, which is adjustable in the more elaborate types of recorders. In an economy-type recorder, the brake spring must be replaced if the braking force is incorrect. This is somewhat of a critical requirement, because faulty brake action can cause tape spillage, tape stretching, or tape breakage. A broken or missing brake spring results in no braking action, and the transport then coasts to a stop, often with tape spillage.

Brake shoes and drums should be systematically cleaned during preventive maintenance procedures. As in the case of clutch assemblies, oil, grime, or other foreign matter can seriously impair brake action. Worn pads should be replaced, because the life expectancy of the brake is short. If pads are permitted to wear away completely before replacement, the brake drums might become badly scored or pitted, and require replacement. Lubrication neglect also can lead to brake trouble symptoms. If the spindle bearing wears excessively and "wobbles," braking action becomes erratic. Alternatively, a dry bearing can seize and jam the mechanism.

In certain types of professional recorders, magnetic braking is employed in combination with friction braking. This design is advantageous because it provides very rapid brake action without damage to the tape. Magnetic braking also is called dynamic braking. Single-phase induction motors, utilized in many machines, provide starting torque by use of shading coils, such as is illustrated in Fig. 20. To employ

magnetic or dynamic braking, the AC voltage is removed from the stator coils, and DC current is switched into the shading coils. Eddy currents in the rotor develop braking torque. As the armature slows down, the braking torque decreases but does not become zero until the rotor stops completely.

As was noted previously, the starting torque is less than the running torque at rated load for an induction motor. The dynamic braking torque is specified in terms of starting torque. To obtain a braking torque equal to 25 percent of the starting torque, a DC current equal to 250 percent of the full-load current must be applied to the motor.

Maintenance of the magnetic braking system involves attention to the switch and switching circuit. In some cases, the rectifier in the DC power supply might need replacement. A motor defect also is a possibility.

The preceding article has been adapted from a new Howard W. Sams book titled "Tape Recorder Servicing Guide" (Catalog No. 20748), by Robert G. Middleton; copyright 1970, Howard W. Sams & Co., Inc., 4300 W. 62nd St., Indianapolis, Indiana.

The introduction of tape cartridges, tape cassettes and stereo players for both home and auto has drastically increased consumer demand for tape-recorder servicing.

To help technicians meet this demand and earn even more profits from this source through increased proficiency, Bob Middleton, one of the most-read and highly respected technician/authors in the electronics field, has written this detailed but concise text which tells how the mechanics and electronics of tape recorders function, and how professional technicians can troubleshoot, service and adjust both in a minimum of time. Like all Sams electronics books, including the many authored by Mr. Middleton, this one is thorough without laboring each point, yet highly practical.

General principles of the characteristics of magnetic circuits, AC bias systems, heads, erasure and drive systems and basic recorder circuitry are explained in Chapter 1.

Preventive maintenance and evaluation of recorder performance are the subjects of Chapter 2. Adjustments and minor repairs, the subject of the preceding article, are outlined in Chapter 3.

Chapter 4 through 6 analyze causes of and troubleshooting techniques for isolating tape transport, recording and reproduction troubles, respectively.

The final chapter tells how to evaluate and service test equipment required for servicing tape recorders. ▲

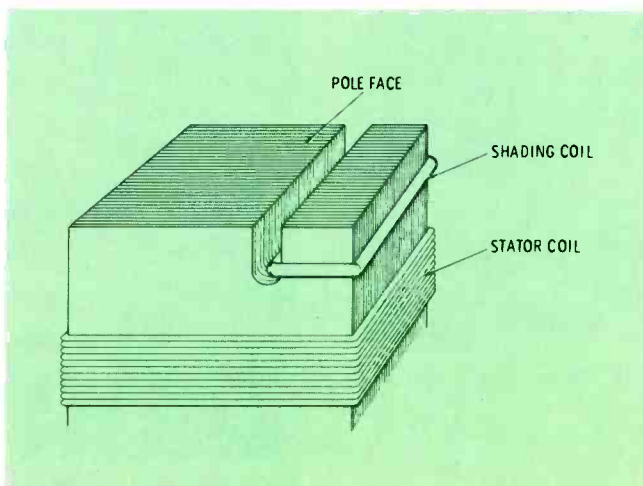

Fig. 20 Position of shading coil in pole face of shaded-pole motor.

## bookreview

### Transistor Specification Manual:

Howard W. Sams Engineering Staff, Howard W. Sams & Co., Inc., Indianapolis, Indiana 46206, Catalog No. 20788, 1970; 192 pages; 6 inches X 9 inches; softcover, \$4.50

An up-to-date guide containing complete electrical and physical specifications for over 10,000 types of transistors.

Specifications of each bipolar transistor listed include: Polarity, maximum applied voltages, power dissipation, collector current, operating frequency, collector cutoff current and DC current gain.

A new separate listing of RF power transistors includes design frequency, power output, power gain and collector efficiency.

All EIA-registered TO outlines (base diagrams and related physical specifications for semiconductor devices that have more than two terminals) are included.

Physical data about transistors for which no TO outline is available are included in a separate section.

A special "Lead and Terminal Identification" section enables technicians to quickly determine the identity of element leads. Every transistor listed is assigned a "lead identification number" that corresponds to the associated diagram in the special section.

Where positively known, obsolete transistors are indicated, and the last known manufacturer's name is provided.

### Home-Call TV Repair Guide:

Jay Shane, TAB Books, Blue Ridge Summit, Pa. 17214, 1970; 141 pages, 5½ inches X 8½ inches; hardbound, \$6.95; paperback, \$2.95.

A text about troubles, cures and troubleshooting tech-

niques, with quick-reference charts of the most-frequent causes of common trouble symptoms arranged in logical order.

### Collected Basic Circuits:

D.I.P. Stretton and A. W. Hartley, Howard W. Sams & Co., Inc., Indianapolis, 1970, Catalog No. 20748; 176 pages, 5¾ inches X 8½ inches; softbound, \$4.95.

A one-source reference for circuit diagrams and the most-important operating characteristics of over 250 tube and solid-state circuits. Waveforms are included for many circuits.

The circuits have been grouped into 14 categories, each group being the subject of a chapter. Forty-nine amplifiers and various types of coupling circuits are presented in Chapter 1, followed by clippers, limiters and clampers in Chapter 2.

Astable, monostable and triggered oscillators are described in Chapter 3. Various types of multivibrator—free-running, monostable, bistable and Eccles-Jordan—and pulse generators are analyzed in Chapter 4.

Trigger-forming circuits, common logic and gate circuits and sweep generators are covered in the next three chapters, respectively.

Foster-Seeley, Round-Travis, locked-oscillator and other types of detectors, comparators and discriminators are the subjects of Chapter 9.

The final five chapters describe regulators, stabilizers and converters; modulators; choppers and switches; power supplies, including full-and half-wave types and voltage doublers and quadruplers; and miscellaneous circuits—integrators, adders, time-delay circuits, light relays, etc.

A detailed index is provided at the end of the text, for quick reference. ▲

**SOLID STATE**  
**ONE GUN BOOSTER**  
**FOR COLOR TV**

EXTENDS COLOR GUN LIFE

RESTORES RED, BLUE OR GREEN BRILLIANCE

EASY TO INSTALL  
(INSTRUCTIONS ON BACK)

WORKMAN Electronic PRODUCTS, INC.  
SARASOTA, FLORIDA

WEAK SERVICE LINE BEFORE

BOOSTED SERVICE LINE AFTER

installation of  
**ONE GUN BOOSTER**  
Boosts the one weak color needed for a BALANCED color picture.

MANUFACTURED BY  
**WORKMAN Electronic PRODUCTS, INC.**  
SARASOTA, FLORIDA

Circle 28 on literature card

The sure way to  
**ELIMINATE CALLBACKS**

**Injectorall**  
**BLUE LUBE**  
TUNER CLEANER  
Permanent  
Foam Spray

Only Injectorall's new **BLUE LUBE** foam spray contains Oxident — an anti-oxidation chemical that cleans contacts, keeps them permanently clean and prevents callbacks. Eliminates picture streaking and intermittents with one application.

**Injectorall**  
**ELECTRONICS CORPORATION**  
Great Neck, N.Y. 11024  
In Canada:  
CANADIAN GENERAL ELECTRIC LTD.  
Ontario

Circle 29 on literature card

# test equipment report

## Solid-State Audio Generator

A solid-state audio generator, featuring FET circuitry, has been introduced by Leader Instruments Corp.

Model LAG-54 generates sine and square waves over a frequency range of 20 Hz to 200 KHz. The



sine waves are produced by a Wein-bridge oscillator and the square waves are produced by a Schmitt trigger.

The sine-wave output is 3 volts rms with an impedance of 600 ohms. Distortion reportedly is less than 0.5 percent at mid range and amplitude is flat to within  $\pm 0.5$  dB referred to 1 KHz. The square-wave output is 5 volts p-p from 20 Hz to 20 KHz. Power is 105-125 volts, 50/60 Hz.

The unit measures 6 inches X 10 inches X 6 inches and weighs 5.5 lbs.

Model LAG-54 is priced at \$84.50.

*Circle 50 on literature card*

## Hi-Lo Multimeter

Sencore has announced the development of a multimeter that incorporates an ohmmeter section powered by both 1.5 volts and a lower voltage of .08 volt, which allows resistors to be measured in-circuit in solid-state devices.

The lower voltage reportedly does not cause conduction of the semiconductor, which would cause mis-reading of the resistance value. The

higher voltage of 1.5 volts is necessary in cases where conduction is required, such as reading the front-to-back ratio of a diode.

Features of Model FE21 include: a 4½-inch meter; ten DC voltage ranges, from .1 volt to 3,000 volts; ten DC zero center-scale ranges,



with full calibration from .05 volt to 1,500 volts; seven resistance ranges, from zero ohms to 1000 megohms; nine DC current ranges, from 100  $\mu$ a to 1 amp; and fused multiplier resistors.

Price is \$99.50.

*Circle 51 on literature card*

## RF Wattmeter

The THRULINE® Model 43 RF wattmeter, manufactured by Bird Electronic Corp., is a flexible, directional power monitor for continuous indication of forward or reflected CW power under normal operating conditions.

This meter covers a full-scale power range from 1 watt to 10,000 watts and from 0.45 MHz to 2.3 GHz, depending on the plug-in element selected. DC currents proportional to the RF power level in the main line are displayed on a meter calibrated in watts. Forward or reflected power measurement is se-

lected by rotation of the plug-in element. No batteries or AC power is required, and full-scale accuracy is maintained at  $\pm 5$  percent.

Equipped with the patented CQ



(quick-change) Connector feature, any common RF cable connectors reportedly can be used with the instrument without the use of adapters.

Price of the wattmeter is \$100.00, and most plug-in elements sell for \$30.00.

*Circle 52 on literature card*

## Dual-Beam Oscilloscope

The newest and reportedly lowest-cost dual-beam oscilloscope designed and manufactured by its English subsidiary is announced by Tektronix, Inc.

Features of Telequipment Model D51 are: DC-to-6 MHz bandwidth for Channel 1, DC-to-3 MHz bandwidth for Channel 2, deflection factors from 100 mv/cm to 50 v/cm for both channels (X10 gain for 10 mv/cm to 5 v/cm at DC-to-2 MHz on Channel 1), sweep rates from 1

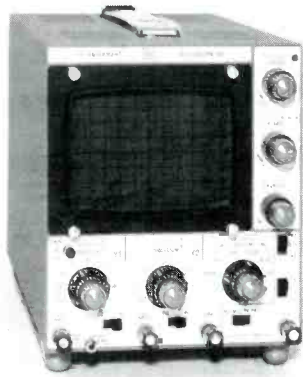

$\mu$ s/cm to 100 ms/cm in 6 steps, measurement accuracy within 5%, selectable sweep triggering including TV field, 6- X 10-cm CRT. Dimensions of the unit are 9 inches X 7 inches X 18 inches. Weight is 20 lbs. Price is \$345.00.

Circle 53 on literature card

### Solid-State VOM

A new portable, battery-operated solid-state VOM, has been developed by Triplett Corporation.

Model 602 features an auto polarity circuit, actuated by pushbutton switches, which eliminates the need for checking current and voltage polarity when measuring, saving time for the user. It also eliminates the need for switching test leads.

The new test instrument reportedly has a sensitivity and input resistance of 0.3 volts full-scale AC and DC, at a constant 11 megohms on DC and 10 megohms on AC. Two voltage scales are used for all 24 AC, DC current and voltage ranges.

The new VOM has been engineered so that the same amplifier is used for all functions—AC and DC volts, current and resistance measurements. The stable amplifier reportedly incorporates a high degree of feedback, which produces linear AC and DC meter tracking scales down to 1% of scale. Because of this feedback, any changes in the meter moving coil resistance caused by temperature are automatically compensated, permitting the Model 602 to be used in a wide temperature range of 32° to 120° F without loss of accuracy. Also, any component changes due to age of environmental conditions will not affect the accuracy of the tester, according to the manufacturer.

The unique auto polarity feature reportedly is easy to use. To determine what polarity is being measured, the plus or minus pushbutton switches on the left front of the tester are operated. When a positive voltage is applied to the input, the meter will give an "up" scale reading. If the positive marked pushbutton is depressed, the reading remains the same. If the negative marked pushbutton is depressed, the indication falls to below zero. The reverse is true if a negative-polarity potential is applied to the input.

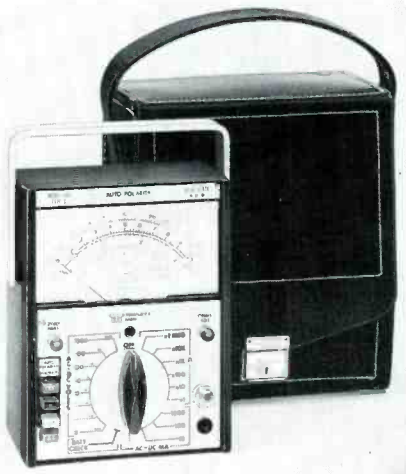

Unlike more conventional VOM's, in which the test leads have to be reversed to change polarity, Model 602 reverses the battery when reverse polarity is needed. When in auto polarity, the tester's indicator is not adjusted for zero, as in conventional units. Instead, Model 602 is adjusted for zero null, permitting the user to make a zero adjust from an angle, and parallax of the pointer can be neglected.

The DC volts ranges of the Model 602 are: 0.3, 1, 3, 10, 30, 100, 300 and 1000. Accuracy is 3%, and input resistance is 11 megohms.

The AC volts ranges are: 0.3, 1, 3, 10, 30, 100, 300, and 1000. Accuracy is 3% and input resistance is 10 megohms. Frequency range is 50 Hz to 50 KHz, with frequency compensation on all ranges except 300 to 1000 volts.

The ohmmeter ranges are: RX1, RX10, RX100, RX10K and RX1 megohm. Accuracy is 3% of DVC arc. Measurement range is 0.2 ohms to 1000 megohms.

The Model 602 VOM comes in a case constructed of black, molded, high-impact plastic. A rigid carrying handle, made of extruded aluminum, also doubles as a stand to place the test instrument on a 25-degree angle for easy viewing. Outside dimensions of the unit are 3-3/16 inches x 5 1/8 inches x 6 1/2 inches.

The tester uses two types of "readily available" batteries, a "D" cell for resistance measurements and two 9-volt batteries for the amplifier circuit. The condition of the 9 volt batteries is given when the user positions the tester's range switch to "Batt Test". For easy access to the internal circuitry and batteries of the unit, the user simply removes one large, slotted thumb screw on the back of the case.

The price of Model 602 is \$100.00. Accessories supplied with the tester include a probe assembly, one ground lead, two alligator clips, three batteries and an easy-to-follow instruction manual. A leather carrying case also is available for 15.40. ▲

Circle 54 on literature card

## REBUILD YOUR OWN PICTURE TUBES?

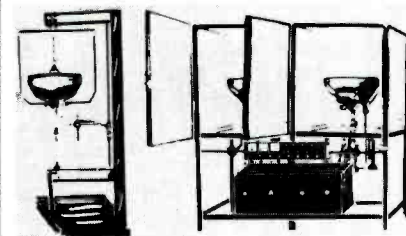

With Lakeside Industries precision equipment, you can rebuild any picture tube!

### EASY TO OPERATE!

Requires only 4x8 ft. of space.  
Your cost to rebuild black and white—  
\$1.50

Your cost to rebuild Color—\$5.80

For complete details, mail coupon.

<b>Lakeside Industries</b> 5234 N. Clark St. Chicago, Ill. 60640 Phone: 312-271-3399	
<input type="checkbox"/> Free demonstration appointment <input type="checkbox"/> Send me more information	
Name .....	
Address .....	
City .....	State .....

Circle 30 on literature card

## WANTED

Experienced TV or Appliance Technician to relocate in the rocky mountain trade area. Stable employment and excellent fringe benefits. Write E. L. Peters P.O. Box 5208 Denver, Colorado 80217. Describe previous experience and salary requirements.

## advertisers' index

B & K Manufacturing Co.....	3
Bussmann Mfg. Div. McGraw-Edison Co. ....	6-7
C.R.T. Equipment Co., Inc. ....	8
Chemtronics, Inc. ....	13
EICO Electronic Instrument Co., Inc. ....	Cover 2
The Finney Company ....	25
General Electric Co. Receiving Tube Dept. ....	9
Heath Company ....	33
Injectorall Electronics Inc. ....	59
Lakeside Industries ....	61
Leader Instruments Corp. ....	41
Littelfuse, Inc. ....	Cover 4
Mobile TV ....	29
Panasonic ....	23
Quietrol Company ....	30
RCA Electronic Components ....	Cover 3
RMS Electronics, Inc. ....	63
Howard W. Sams & Co., Inc. ....	39
Sencore, Inc. ....	19, 27
Sylvania Electric Products Inc. ....	1, 31
TV Tech Aid ....	30
Tuner Service Corporation ....	5
Vikoa Inc. ....	11
Workman Electronic Products, Inc. ....	29, 59
Yeats Appliance Dolly Sales Co. ....	8

## productreport

for further information on any of the following items, circle the associated number on the reader service card.

### Contact Cleaner

A new contact cleaner that reportedly penetrates, degreases and lifts solids from electrical contacts, yet evaporates completely, leaving no residue, has been announced by CRC Chemicals.



CO Contact Cleaner No. 2016 comes in aerosol form, is nonflammable, nonstaining and noncorrosive, and has no damaging effect on plastics, according to the manufacturer. Content is trichloro-trifluoroethane with fluorinated propellant. Price is \$32.00 per dozen cans.

Circle 40 on literature card

### Sonar Battery Adapter

Sonar has introduced a mobile adapter with charger and audio booster, Model CH 2913.

The unit combines a nickel cadmium battery charger and a 5-watt audio amplifier as a single unit. It

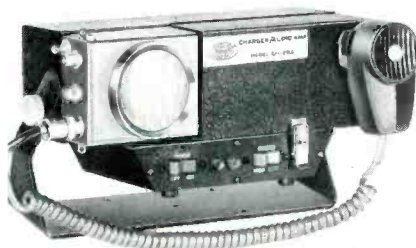

reportedly can be used in any vehicle having a 12-volt DC, negative-ground electrical system.

The CH 2913 has two charging rates, high and low, plus provisions for connecting an external trumpet speaker. The unit reportedly can recharge a completely depleted battery in 12-14 hours.

The CH 2913 is priced at \$135.00, less mike.

Circle 41 on literature card

### Variable AC Voltage Transformers

A new line of plug-in variable AC voltage transformers is available from General Electric Co.

Available in 120- or 240-volt models, the Volt-Pac® plug-in units reportedly are suitable for heat control, motor speed control, appliance testing, lamp intensity control and other applications requiring adjustable AC voltage.

The 120-volt unit adjusts from 0- to 140-volts output and is available in six sizes, from 2.5 to 18 amps. The 240-volt model adjusts from 0



to 280 volts and is available in three sizes, from 4 to 8.5 amps.

A gold-plated brush track facilitates low-loss voltage take-off through grain-oriented solid carbon brushes. The brushes are held in place by precision springs for uniform conductivity. Coil windings are epoxy bonded to assure rigid construction, and coil conductors are coated with high-temperature insulation.

Available for either bench or wall mounting, Volt-Pac units range in price from \$16.70 to \$73.00.

Circle 42 on literature card

### Circuit Chiller

RCA Deluxe Circuit Chiller (stock number SC102) is intended for use on faulty components such as capacitors, resistors, semiconductors and oxidized junctions, which reportedly can be located easily with the chiller. This instant cool-





ing spray aids in troubleshooting by helping to track down intermittents and hard-to-locate troubles.

The price of a 16-oz. spray can is \$1.90.

Circle 43 on literature card

### Gun Brightener

Telematic has introduced a new plug-in single-gun brightener, Colorite.

Colorite reportedly brightens only the low-emitting gun of a color CRT, and is designed to plug in between the CRT and the CRT socket.

With Colorite, the manufacturer

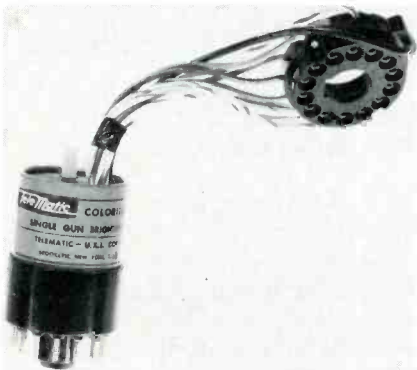

states, there is no need to locate and splice into the appropriate grid lead, thus saving time and eliminating accidents caused by errors.

Colorite is available for red, green and blue guns, in both 70° and 90° socket plug configurations. The cost is \$4.95. ▲

Circle 44 on literature card

**For more information on above products use reader service card**

**Tired of hand-me-down copies of ELECTRONIC SERVICING?**

Fourth page of a five-page article missing by the time you get to read ELECTRONIC SERVICING? Schematic diagram missing? Then you need a subscription of your own! Priced right and packed with profitable information each month! Use the convenient order form inside the back cover of this issue! P.S.—If that's missing, too, send us a note with your name and address—we'll contact you with full details!

## TOP PERFORMING UHF/VHF ANTENNAS FOR ALL AREAS!...

Color engineered for best reception on UHF/VHF Channels 2 to 83! Exclusively features Reynolds Aluminum durable Colorweld Gold finish! Single down-lead for economical, simple installation! Durable all-aluminum weather proof construction for long installation life!

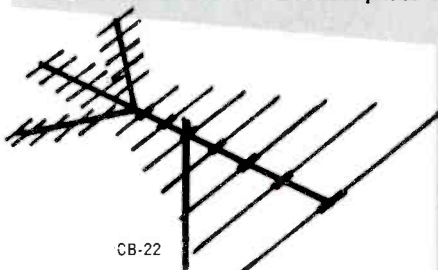

CB-22

### COLOR-BOOSTER SERIES

Model	Number of elements			Range of Reception	
	VHF	UHF	Total	VHF up to	UHF up to
CB-22	7	5	10	22 miles	35 miles
CB-28	11	7	10	28 miles	60 miles
CB-34	15	9	10	34 miles	80 miles

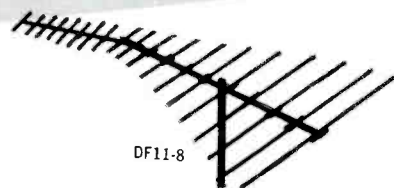

DF11-8

### DIRECTION-FINDER SERIES

Model	Number of elements			Range of Reception	
	VHF	UHF	Total	VHF up to	UHF up to
DF3-3	3	3	6	30 miles	20 miles
DF5-4	5	4	9	45 miles	40 miles
DF7-8	7	8	15	50 miles	75 miles
DF7-11	7	11	18	50 miles	100 miles
DF11-8	11	8	19	75 miles	75 miles
DF11-11	11	11	22	75 miles	100 miles
DF15-8	15	8	23	100 miles	75 miles
DF15-11	15	11	26	100 miles	100 miles
DF19-8	19	8	27	125 miles	75 miles
DF19-11	19	11	30	125 miles	100 miles

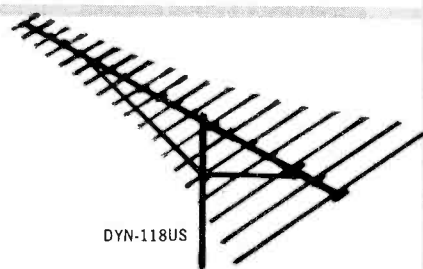

DYN-118US

### DYNERGY SERIES

Model	Number of elements			Range of Reception	
	VHF	UHF	Total	VHF up to	UHF up to
DYN-33US	3	3	6	35 miles	20 miles
DYN-54US	5	4	9	60 miles	30 miles
DYN-66US	6	6	12	65 miles	50 miles
DYN-88US	8	8	16	125 miles	75 miles
DYN-118US	11	8	19	125 miles	75 miles
DYN-158US	15	8	23	150 miles	75 miles

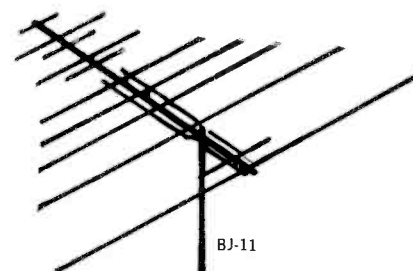

BJ-11

### BIG SHOT JR. SERIES

Model	Number of elements	Area Used
BJ-11	11	Metropolitan and Suburban
BJ-12	12	Semi-Fringe

For complete specs and Profit picture—Write:

**RMS ELECTRONICS, INC.**

50 Antin Place, Bronx, N.Y. 10462 • Tel. (212) 892-6700

Circle 31 on literature card

## ANTENNAS

100. *Jerrold Electronics Corp.*—Catalog S, titled "Systems and Products for TV Distribution," lists specifications of this manufacturer's complete line of antenna distribution system products, including antennas and accessories, head-end equipment, distribution equipment and components, and installation aids.
101. *Vikoa, Inc.*—is making available a 64-page, illustrated catalog covering their line of wire and cables and IDS/MATV equipment. Hardware, accessories, connectors and fittings and an index also are included.\*

## AUDIO

102. *Jensen Manufacturing Div.*—has issued an 8-page, catalog, No. 1090-E, which describes application of 167 individual speaker models. Special automotive, communications, intercom and weathermaster speakers, plus a complete line of electronic musical instrument loudspeakers are featured.

## COMMUNICATIONS

103. *Sonar Radio Corp.*—Catalog titled "Sonar Business Radio, FM Monitor Receivers and CB Equipment" lists specifications and prices of this manufacturer's line of transceivers, receivers and communications accessories.

## COMPONENTS

104. *Loral Distributor Products*—has made available a 24-page electrolytic capacitor replacement guide. The catalog features replacement products by the original manufacturers part number.
105. *Sylvania Electric Products Inc.*—a 73-page guide which provides replacement

considerations, specifications, and drawings of Sylvania components plus a listing of over 35,000 JEDEC types and manufacturers' parts numbers. Copies are \$1.00.

106. *Semitronics Corp.*—has a new, revised "Transistor, Rectifier, and Diode Interchangeability Guide" containing a list of over 100 basic types of semiconductors that can be used as substitutes for over 12,000 types. Include 25 cents to cover handling and postage.
107. *Stancor Products*—pocket-size 108-page "Stancor Color and Monochrome Television Parts Replacement Guide" provides the TV technician with transformer and deflection component part-to-part cross reference replacement data for over 14,000 original parts.
108. *General Electric*—a 12-page, 4-color, illustrated "Picture Tube Guidebook", brochure No. ETRO-5372, provides a reference source for information about GE color picture tube replacements and tube interchangeability.\*

## SERVICE AIDS

109. *Chemtronics Inc.*—is releasing the 8-page 1970 edition of "Electronic Chemical Products Made Exclusively for the Industry", Catalog No. 7071, which covers Chemtronics' complete line of aerosol and bottled chemicals used to speed servicing.\*

## TECHNICAL PUBLICATIONS

110. *Howard W. Sams & Co., Inc.*—literature describes popular and informative publications on radio and television servicing, communication, audio, hi-fi and industrial electronics, including their 1970 catalog of technical books on every phase of electronics.\*
111. *Sylvania Electric Products Inc., Sylvania Electronic Components Div.*—has pub-

lished the 14th edition of its technical manual, which includes mechanical and electrical ratings for receiving tubes, television picture tubes and solid-state devices. The price of this manual is \$1.90.\*

## TEST EQUIPMENT

112. *B & K Mfg. Div., Dynascan Corp.*—is making available an illustrated, 24-page, 2-color Catalog BK-71, featuring B&K test equipment, with charts, patterns and full descriptive details and specifications included.\*
113. *Mercury Electronics Corp.*—14-page catalog provides technical specifications and prices of this manufacturer's line of Mercury and Jackson test equipment, self-service tube testers, testers, test equipment kits and indoor TV antennas.
114. *Sencore, Inc.*—has issued its 12-page 1970 catalog, Form No. 517, which describes the company's complete line of test instruments, and features 5 new instruments, with performance data and prices included.\*
115. *Triplett Corp.*—Bulletin No. 51570, a two-page technical bulletin which provides the specifications and price of Triplett's new Model 602 VOM.

## TOOLS

116. *Diamond Tool*—Catalog W28 details this manufacturer's complete line of special-use electronic tools, including holding-wire cutters, wrenches, pliers and metal cutting snips.
117. *General Electric*—has issued 2-page brochure No. GEA-8927, describing the features of GE's new soldering iron.\*
118. *Xcelite Inc.*—Bulletin N770 describes this company's three new socket wrench and ratchet screwdriver sets.

\*Check "Index to Advertisers" for additional information. ▲

# READER SERVICE CARD Electronic Servicing

Use the handy postage-free card below to obtain free catalogs and literature...and to subscribe or renew your subscription.

Read instructions carefully.

As a service to its readers, ELECTRONIC SERVICING makes the postpaid card below available for your convenience in obtaining current manufacturers' literature.

To use the card, simply:

- Circle the numbers corresponding to the numbers of the items about which you would like to receive additional information.
- Print your name and address and check your occupation.
- Include ZIP code—requests may not be filled without it.
- Tear out lower half of this insert and place in mailbox.

Note the deadline date—Requests received after this cannot be filled.

▼ Free catalogs & literature

Subscribe or renew your present subscription to the nation's favorite electronic servicing magazine... ELECTRONIC SERVICING (formerly PF REPORTER).

Now with expanded editorial coverage of the entire electronic servicing business, ELECTRONIC SERVICING is more valuable to you than ever! Monthly it brings you the latest solutions to service problems on home entertainment electronics, including concise, timely coverage of new testing methods, product reports and practical service procedures!

Start ELECTRONIC SERVICING coming by sending in this postage paid order form... TODAY!

▼ Subscription offer

NOVEMBER, 1970  
OFFER EXPIRES FEBRUARY 1, 1971

Please indicate number of items you have circled →

1 2 3 4 5 6 7 8 9 10 11 12 13 14 15 16 17 18  
19 20 21 22 23 24 25 26 27 28 29 30 31 32 33 34 35 36  
37 38 39 40 41 42 43 44 45 46 47 48 49 50 51 52 53 54  
55 56 57 58 59 60 61 62 63 64 65 66 67 68 69 70 71 72  
73 74 75 76 77 78 79 80 81 82 83 84 85 86 87 88 89 90  
91 92 93 94 95 96 97 98 99 100 101 102 103 104 105 106 107 108  
109 110 111 112 113 114 115 116 117 118 119 120 121 122 123 124 125 126  
127 128 129 130 131 132 133 134 135 136 137 138 139 140 141 142 143 144  
145 146 147 148 149 150 151 152 153 154 155 156 157 158 159 160 161 162  
163 164 165 166 167 168 169 170 171 172 173 174 175 176

Print plainly or type below:

Name

Firm

Firm Address

City  State  Zip

Did you receive this issue through  Distributor  Subscription

## Subscription Offer

Enter my subscription to ELECTRONIC SERVICING

- 3 Years \$10.00     2 Years \$8.00     1 Year \$5.00  
 Bill Me     Remittance Enclosed     Extend Present Subscription

IMPORTANT! Please check your business classification.

Type of Business

Position

Check One

Check One

- |   |  |
|---|--|
| A. <input type="checkbox"/> Independent Electronic Service Organization     | H. <input type="checkbox"/> Owner, Manager |
| B. <input type="checkbox"/> Retailer with Electronic Service Department     | I. <input type="checkbox"/> Ser. Manager   |
| C. <input type="checkbox"/> Independent or Self-Employed Service Technician | J. <input type="checkbox"/> Technician     |
| D. <input type="checkbox"/> Electronics, Radio, TV Manufacturer             | K. <input type="checkbox"/> Other          |
| E. <input type="checkbox"/> Industrial Electronic Service                   |  |
| F. <input type="checkbox"/> Wholesale, Jobber, Distributor                  |  |
| G. <input type="checkbox"/> Other (Specify) .....                           |  |

Be sure you have checked one box in each column above!

# WRITING TO Electronic Servicing?

Help us prevent delay

If your comment or question is about . . .

## YOUR SUBSCRIPTION

Changes of address or any questions about your subscription should be sent to the address at right. Please advise us of a change of address at least 4-6 weeks in advance of your move, if possible.



Evelyn Rogers, Circulation Manager  
ELECTRONIC SERVICING  
1014 Wyandotte St.  
Kansas City, Mo. 64105

## ANY OTHER SUBJECT

If you have a comment or question about an article, condition in the industry, a service tip or problem, need a part or schematic, or would like to pass along information about an industry oriented event, etc., write to:



J. W. Phipps, Managing Editor  
ELECTRONIC SERVICING  
1014 Wyandotte St.  
Kansas City, Mo. 64105

**BUSINESS REPLY MAIL**

No Postage Stamp Necessary if Mailed in the United States

Postage Will be paid by

# Electronic Servicing

P.O. Box 2609

Clinton, Iowa 52732

FIRST CLASS  
PERMIT NO. 217  
CLINTON, IOWA



# 10 million reasons why it pays to promote matrix, the brightest, sharpest color picture tube in RCA history!

Reasons 1 to 10,000,000. Large-screen MATRIX can upgrade the performance of at least 10 million color TV sets now in use. The RCA 25BCP22 is a direct replacement for the 25XP22, 25AP22A, 25BGP22, 25BAP22 (Chromacolor), and 20 other industry types! Giant-screen sales potential for the RCA MATRIX—practically unlimited!

More RCA Color Picture Tubes are stocked and

sold by distributors than any other color picture tubes in the industry. So, MATRIX is more readily available to you no matter where you are, to give your customers faster service and ring up more profitable sales.

MATRIX is the brightest and sharpest color picture tube in RCA history!

Here's why:



#### The RCA jet-black matrix\*

It soaks up room-light normally reflected back at the viewer from the face of the tube. Result: brighter pictures because now there's no need to "filter out" brightness to maintain contrast under strong room-light conditions.

#### The RCA MATRIX phosphor-dot process\*

First, we developed brilliant new phosphors and a unique screening process incorporating a jet-black matrix. Then we deposited the 1,200,000 red, green, and blue high-intensity phosphor dots precisely within the black matrix. Result: brightness doubled with dramatic improvement in contrast and clarity.

#### The RCA MATRIX picture\*\*

Spectacular! In operation, a new, unique high-resolution gun "shoots" the phosphors with more energy than any other gun previously available. Result: black matrix + phosphors + high-resolution gun = maximum sharpness over the entire brightness range, truer colors under all viewing conditions.



New 4-color consumer flyer on MATRIX is available from your RCA Distributor.  
RCA | Electronic Components | Harrison, N. J. 07029

\*Magnified drawing \*\*Simulated



# THE SAFEST SETS YOU'LL EVER SERVICE HAVE LITTELFUSE CIRCUIT BREAKERS.



Littelfuse TV set circuit breakers are the safe, reliable, money saving short-circuit-problem-solvers . . . 17 available models—exact replacements—cover the entire range of domestic television sets.

Littelfuse circuit breakers are available from your distributor—singly or in bulk.

Super-simple in operation—the sensitive breaker flips open under current overloads protecting the circuitry. Reset by merely pressing the red reset plunger. A built-in “trip free” feature of Littelfuse breakers prevents forced closing when dangerous overload currents are present.

Standard Catalog Part No.	Hold Rating (Amps.)	Standard Catalog Part No.	Hold Rating (Amps.)
815.650	.490	8152.75	1.92
815.800	.600	815003	2.1
815001	.650	8153.25	2.2
8151.25	.930	815004	2.5
81501.5	1	81504.5	3
8151.75	1.2	815005	3.25
815002	1.4	815006	3.9
8152.25	1.5	815007	4.14
81502.5	1.65		

Nothing's more reliable than a Littelfuse circuit breaker. Thermal-responsive Littelfuse breakers are dual operated bi-metallic devices providing temperature compensation over a wide range of ambient temperature variation. Molded phenolic construction eliminates warping and distortion of the base, maintaining exact factory set calibrations. The unit is completely enclosed to protect critical moving parts from dirt and other foreign matter.

Any TV set you're likely to service will take Littelfuse circuit breakers.

They'll flip for safety.

You'll flip for satisfaction.

# LITTELFUSE

DES PLAINES, ILLINOIS 60016

SUBSIDIARY OF TRACOR, INC.  
Circle 2 on literature card

5911 BREIDEL NIA 1071 4  
BREIDEL RADIO-TV SVC  
1316 S 13TH ST  
A CROSSE WIS