

PF Reporter®

PHOTOFACT

the magazine of electronic servicing

**Elusive Sync is
Solved Quicker with
the Scope, page 4**

OTHER FEATURES IN THIS ISSUE:

Routine Servicing of
Auto Radio

Stage-by-Stage Gain Testing In
Solid-State TV

Transistors: State of the Art
Report—Part 3

This Thing Called Stereo



**REMEMBER TO ASK—
“WHAT ELSE NEEDS FIXING?”**

18791 01803
BOX 144
FRAMPTON RADIO SERV.
R. A. FRAMPTON
IA 7J 117 570
ELDRED, PA. 16731

The name of the game was hide and seek.

The good color picture hides. The viewer looks for it. And sometimes it takes quite

a while to find. The good sound drifts, and between rotor

and tuning dial the search for a perfect stereo balance begins again.

Well now all that time-wasting and bother is over. Because CDE invented the Autorotor™ system. It's more than an ordinary rotor. Buttons are easily set for clear, bright, perfect color pictures. And pure stereo sound. There are five and they allow you to pre-set 10 to 15 channels. Leave one channel and whenever you choose to return to it, just press the button again.

CDE's famous heavy-

duty Bell Rotor gives you high repeatability and no antenna drift. It's an all-solid-state, silent operation. The Autorotor system's precision is within 1° and combining it with pushbutton electronic control, not mechanical control, makes it today's most advanced rotor.

CDE took another step forward in the Autorotor control design. They had William Snaith, of Loewy-Snaith, world famous designers, create the Autorotor console. He made it attractive. Made it so you can place it on a table top or shelf without it being an eyesore.

This is the story you can tell your customers to sell the top-of-the-line in rotors. The latest advance from the quality house of rotors — Cornell-Dubilier.

For complete information on new Autorotor write:

CDE **CORNELL-DUBILIER**

50 Paris Street, Newark, New Jersey 07101
"Remember to ask what else needs fixing"



Circle 1 on literature card

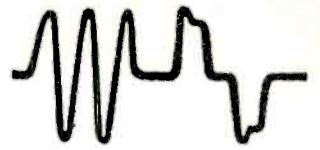

Do-it-yourself stereo clutch controls

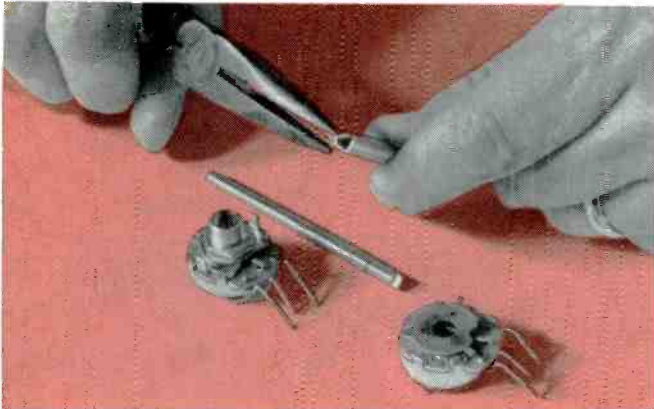

First, squeeze the end tines of the outer shaft together (the tines on the end of the shaft that go into the control) with a pair of pliers, until the tines just touch. Then insert the outer shaft into the front control section.

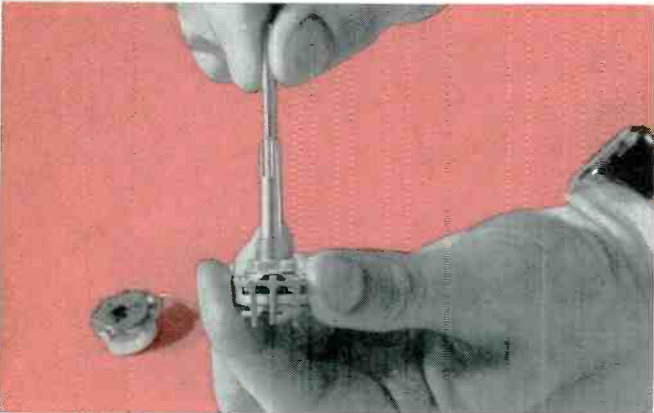

Next, insert the inner control shaft through the outer shaft from the front. You'll have to apply some pressure to force the inner shaft through the squeezed tines of the outer shaft. As you do this, the outer shaft will lock in place in the front control section.



Now push the inner shaft through the front control far enough so you can slide the rear control section in place on the shaft. Finally, attach the rear control section and snap it into place.

Many stereo sets use a dual volume control which lets you adjust volume of both channels either together or separately. As in most dual controls, there's an inner and outer shaft linked to the front and rear control sections. By means of separate knobs, you can adjust each channel simply by holding one knob and rotating the other . . . and this is how you adjust right and left balance. These controls have an extra feature: there's a friction clutch that ties the two shafts together. So once you set the balance the way you want it, you can turn just one knob and raise or lower both channels together.

When you need to replace one of these clutch controls, you may find that an exact replacement may be tough to locate. Rather than go to the delay and cost of ordering from the manufacturer, you can get the job done quickly and economically by one visit to your Mallory distributor. He'll have the parts you need in his Sta-Loc® Control cabinet. They're all standard Sta-Loc parts. It's what you do to them that's special.

And what have you got? A friction clutch dual control, tailor-made for stereo. Friction between inner and outer shafts will make both controls move when either knob is turned—or either knob can be turned separately while you hold the other.

This is just one of the many time-saving tricks you can do with the Sta-Loc Controls components immediately available from your Mallory Distributor. See him for all your replacement parts requirements. Or write Mallory Distributor Products Company, a division of P. R. Mallory & Co. Inc., Indianapolis, Indiana 46206.

DON'T FORGET TO ASK 'EM *"What else needs fixing?"*

Circle 2 on literature card

GEO. H. SEFEROVICH, Director
J. W. PHIPPS, Managing Editor
ELLSWORTH LADYMAN, Technical Editor
B. J. MILLER, Editorial Assistant
DUDLEY ROSE, Art Director
LEILA JOHNSON, Assistant Artist

PF Reporter

PHOTOFACT

the magazine of electronic servicing

TECHNICAL CONSULTANTS

JOE A. GROVES
C. P. OLIPHANT

EDITORIAL ADVISORY BOARD

LES NELSON, Chairman
Howard W. Sams & Co., Indianapolis

CIRCULATION

R. VINCENT WARD, Director
PAT OSBORNE, Manager

ADVERTISING

E. P. LANGAN, Director
R. JACK HANCOCK, Manager
S. F. WILSON, Production
LEE MILLER, Promotion

REGIONAL ADVERTISING SALES OFFICES

Indianapolis, Indiana 46206
ROY HENRY
HOWARD W. SAMS & CO., INC.
4300 West 62nd St.
Tele: 317/291-3100

New York, New York 10019
ALFRED A. MENEGUS
3 W. 57th St.
Tele: 212/Murray Hill 8-6350

Los Angeles, California
THE MAURICE A. KIMBALL CO., INC.
2008 Carson St., Suites 203-204
Torrance, California 90501

San Francisco, California 94104
THE MAURICE A. KIMBALL CO., INC.
580 Market Street, Room 400
Tele: 415/392-3365

London W. C. 2, England
JOHN ASHCRAFT & CO.
12 Bear Street
Leicester Square
Tele: Whitehall 0525

Amsterdam C. Holland
JOHN ASHCRAFT & CO.
W.J.M. Sanders, Mgr.
Herengracht 365
for Benelux & Germany
Tele: 24.09.08

Paris 5, France
9 Rue Lagrange
ODEon 20.87

Tokyo, Japan
INTERNATIONAL MEDIA
REPRESENTATIVES, LTD.
3, Nakanocho, Akasaka, Minato-ku
Tele: 582-5881

in this issue...

4 Sync Is Simple . . . Almost. A case history that points up the value of waveform analysis in solving sync problems.

14 This Thing Called Stereo. A fresh approach to the how's and why's of in-depth sound.

18 Transistors: State of the Art Report—Part 3. A discussion on test methods and test equipment required to service solid-state designs.

26 Stage-by-Stage Gain Testing in Solid-State TV. An "old" troubleshooting method applied to today's transistor circuitry.

34 Routine Servicing of Auto Radio. In-auto and bench-servicing procedures that pinpoint defects in minimum time.

ABOUT THE COVER

The service technician on this month's cover is using the proper technique for solving sync problems—the scope and waveform analysis.

DEPARTMENTS

Tube Substitution Supplement	a
The Electronic Scanner	11
Notes on Test Equipment	40
Symfact	47
The Troubleshooter	53
Photofact Bulletin	56
Product Report	57
Book Review	67
Advertisers' Index	67
Free Catalog and Literature	68

Second-Class Postage Paid at Indianapolis, Ind. Published monthly by INTERTEC PUBLISHING CORP., 1014 Wyandotte St., Kansas City, Mo. 64105.

Copyright, 1968, Howard W. Sams Co., Inc. All Rights Reserved: Material may not be reproduced or photocopied in any form without written permission of publisher.



PF REPORTER is published monthly by Intertec Publishing Corp., 1014 Wyandotte Street, Kansas City, Missouri 64105.

Subscription Prices: 1 year—\$5.00, 2 years—\$8.00, 3 years—\$10.00, in the U. S. A., its possessions and Canada.

All other foreign countries: 1 year—\$6.00, 2 years—\$10.00, 3 years—\$13.00. Single copy 75¢; back copies \$1.



Robert E. Hertel, Publisher

Intertec Publishing Corp.
Subsidiary of Howard W. Sams & Co., Inc.

YOU DON'T NEED TO MAKE MORE SERVICE CALLS TO DO MORE BUSINESS

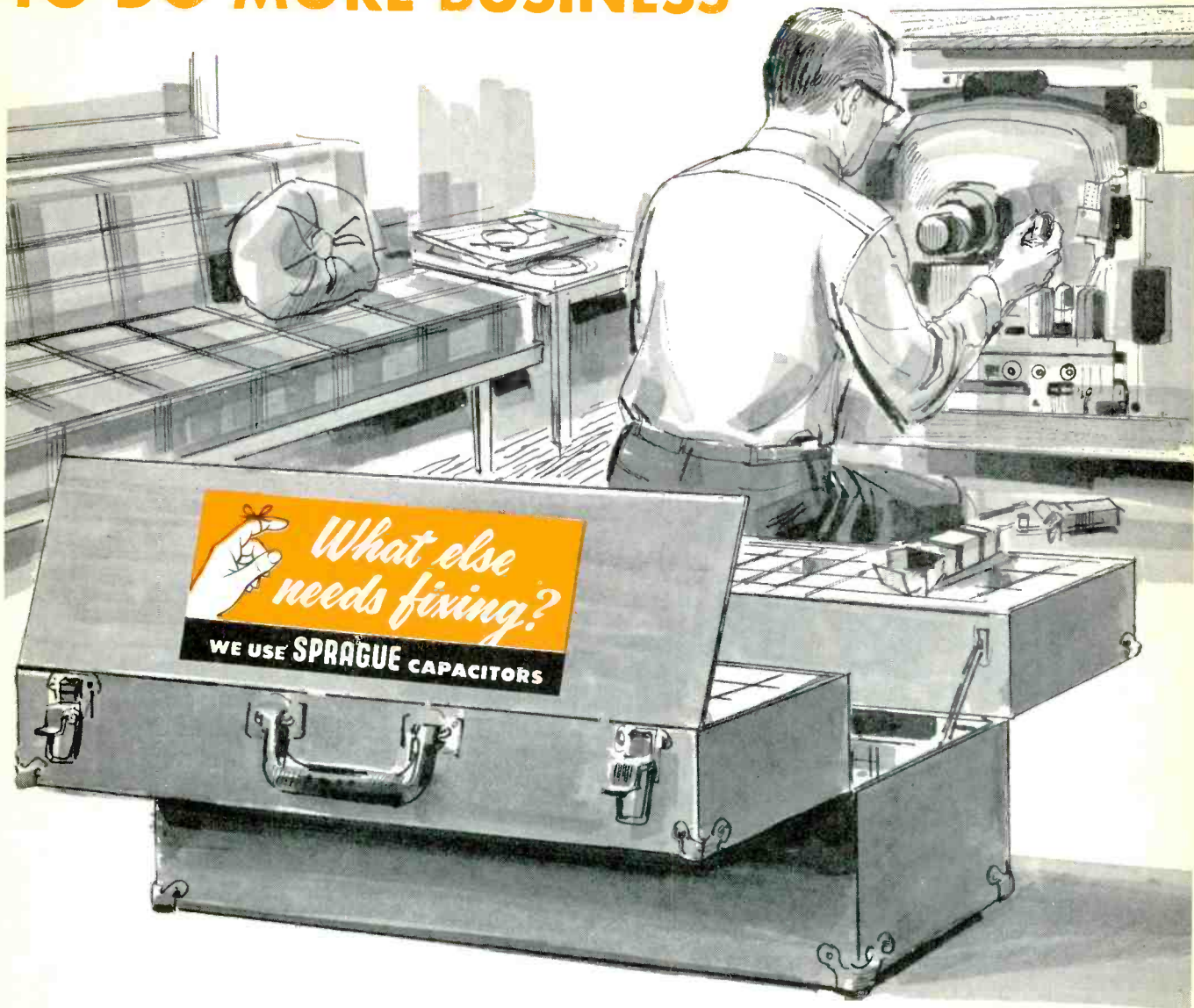

JUST ASK, "WHAT ELSE NEEDS FIXING?" ON EVERY SERVICE CALL YOU MAKE

A test program initiated by the Electronic Industries Association in a large mid-west area proved the point. Participating service dealers enjoyed a 7½% bounce in business. There's magic in asking!

You can do it too! Put the question to your customers visually as well as verbally. Apply "What else needs fixing?" stickers on your caddy and in your store. Request sticker D-200 from your Sprague distributor, or write: Sprague Products Co., 105 Marshall St., North Adams, Mass. 01247.

SPRAGUE®
THE MARK OF RELIABILITY

WORLD'S LARGEST MANUFACTURER OF CAPACITORS
Circle 3 on literature card

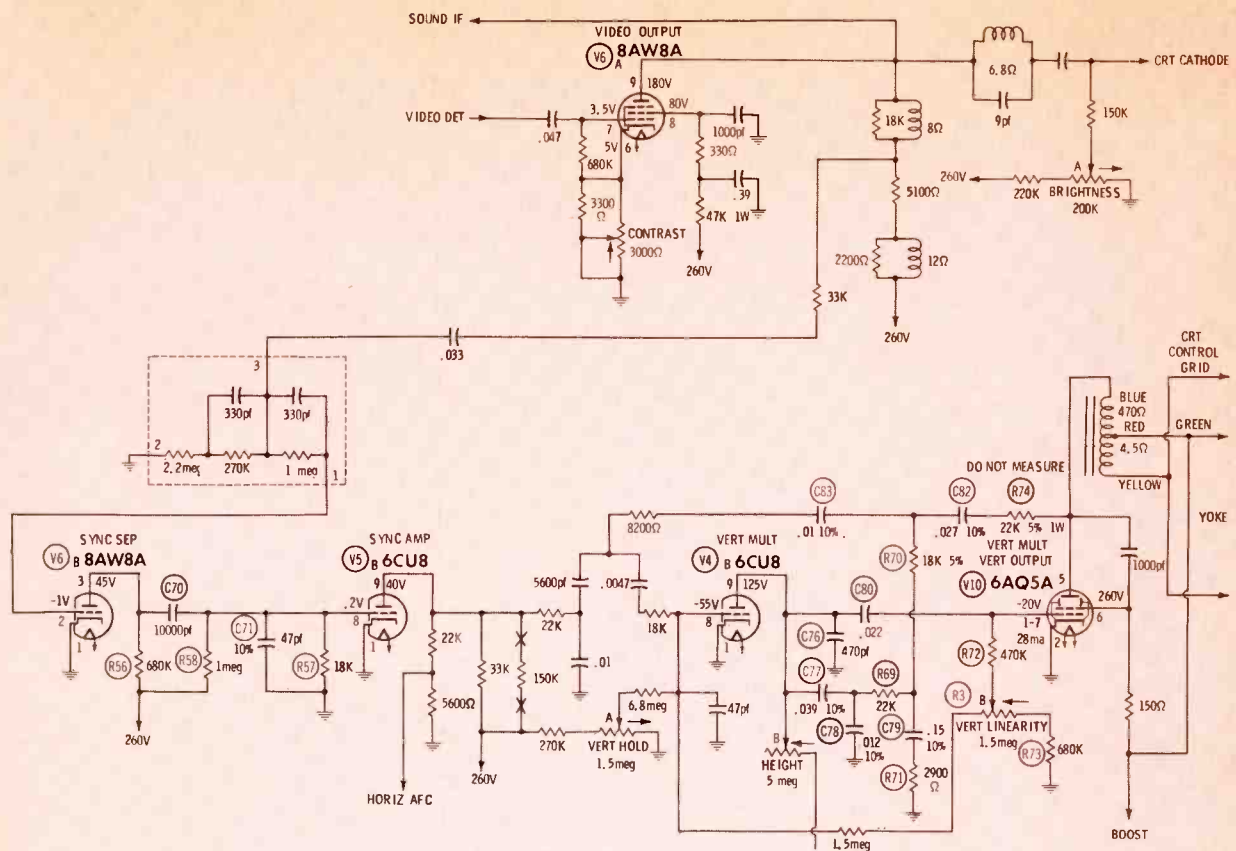

Fig. 2. Schematic of circuitry under discussion.

Sync is simple... almost

An analysis of waveforms pinpoints the cause of a sync problem.

by Stan Prentiss

When broadcast sync pulses and the output of the receiver sync oscillators fail to mesh there is always trouble.

Here is an example. An older receiver, an RCA 17PD8094, had a shorted RF amplifier that burned a 270-ohm current limiting resistor connected to B+. In addition, a misplaced audio tube (a 4AU6 can be substituted for a 4DT6) produced buzzing sounds. After these troubles were eliminated we were ready to tackle the sync problem: intermit-

tent vertical roll accompanied by intermittent shrinkage of the raster.

This receiver is one of the first printed-circuit portables with a combination video and sync chassis separate from the remaining circuitry. The video-sync chassis is securely fastened at right angles to the hand-wired horizontal output and high- and low-voltage supplies that are attached to an upright metal plate which is parallel to the CRT. Screws secure the perpendicular video-sync chassis. There are also numerous solder points hidden beneath a bolted and soldered shield plate that covers the entire bottom. Therefore, investigations or repairs from the underside of these circuits can be difficult.

The best approach to both tubes and components was from the top. The chassis and the CRT had to be pulled from the cabinet. After attaching an isolation transformer (the set has one side of its AC power input connected to the chassis), B+ was measured and found adequate, as was B+ boost. With

these two voltage sources eliminated as possible causes of the trouble, the next problem was getting at the tubes to make voltage and waveform measurements. This was accomplished with 7- and 9-pin tube mounts that fitted in the several tube shields housing the video amplifier, the sync separator and the vertical oscillator-output stages. All mounts were secured so there was no excess wiring capacitance.

The next step was to apply the oscilloscope, which employed a set of DC and AC amplifiers with a triggered sweep time base calibrated to within 5 percent. With the centimeter values shown for each waveform, the AC peak-to-peak value for each signal and its DC operating voltage level could be quickly determined. This also gave an accurate time base reference. Triggered sweep held each waveform steady throughout the entire voltage and frequency investigation. Since $T=1/f$ and $F=1/t$, the use of the time base allowed seconds to be conveniently converted

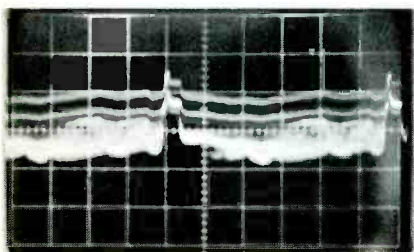

Fig. 1. Signal at plate of video amplifier.

OVERHAUL

\$975

GUARANTEED for 1 Year



OVERHAUL \$9.75 • REPLACEMENT TUNERS...\$10.45

Nine-seventy-five buys you a complete tuner overhaul—including parts (except tubes or transistors)—and *absolutely no hidden charges*. All makes, color or black and white. UV combos only \$15.

Guaranteed means a full 12-month warranty against defective workmanship and parts failure due to normal usage. That's 9 months to a year better than others. And it's backed up by the only tuner repair service authorized and supervised by the world's largest tuner manufacturer—Sarkes Tarzian, Inc.

Four conveniently located service centers assure speedy in-and-out service. All tuners thoroughly cleaned, inside and out... needed repairs made... all channels aligned to factory specs, then rushed back to you. They look—and perform—like new.

SEND ORDERS FOR UNIVERSAL AND CUSTOMIZED REPLACEMENT TUNERS TO OUR OFFICE IN INDIANAPOLIS.

Prefer a universal replacement? Sarkes Tarzian will give you a universal replacement for only \$10.45. This price is the same for all models. The tuner is a new tuner designed and built specifically by Sarkes Tarzian for this purpose. It has memory fine tuning—UHF plug-in for 82 channel sets—universal mounting—hi-gain—lo-noise.

ORDER TUNERS BY PART NUMBER, AS FOLLOWS:

Part #	Intermediate Frequency	AF Amp Tube	Osc. Mixer Tube	Heater
MFT-1	41.25 mc Sound 45.75 mc Video	6GK5	6LJ8	Parallel 6.3V
MFT-2	41.25 mc Sound 45.75 mc Video	3GK5	5LJ8	Series 450 MA
MFT-3	41.25 mc Sound 45.75 mc Video	2GK5	5CG8	Series 600 MA

Prefer a customized replacement tuner? The price will be \$18.25. Send us the original tuner for comparison purposes, also TV make, chassis and model numbers.



TUNER SERVICE CORPORATION FACTORY-SUPERVISED TUNER SERVICE

MIDWEST	817 N. PENNSYLVANIA ST., Indianapolis, Indiana (Home Office)	TEL: 317-632-3493
EAST	547-49 TONNELE AVE., Jersey City, New Jersey	TEL: 201-792-3730
SOUTH-EAST	938 GORDON ST., S. W., Atlanta, Georgia	TEL: 404-758-2232
WEST	SARKES TARZIAN, Inc. TUNER SERVICE DIVISION 10654 MAGNOLIA BLVD., North Hollywood, California	TEL: 213-769-2720

WATCH FOR NEW CENTERS UNDER DEVELOPMENT

Circle 4 on literature card

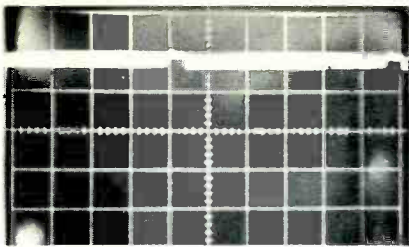

Fig. 3. AC voltage measured with the vertical amplifiers of scope on DC.

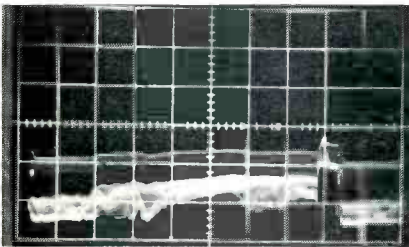

Fig. 4. Waveform with negative tip was obtained at grid of sync separator.

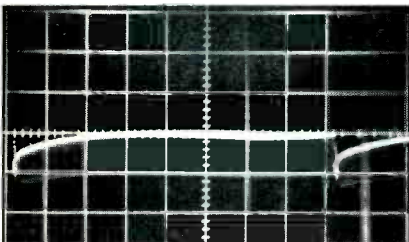

Fig. 5. Amplified signal at plate of sync separator appeared inverted.

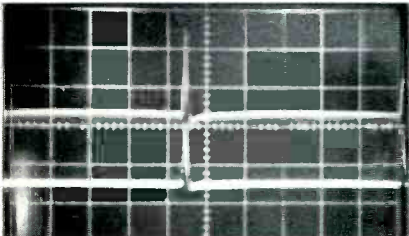

Fig. 6. Plate waveform of sync amplifier at p-p value of 40 volts.

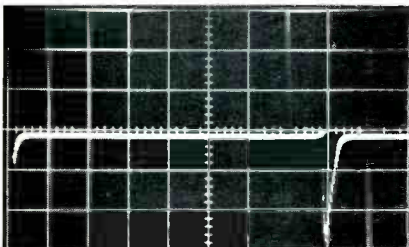

Fig. 7. Waveform at grid of vertical oscillator with plate shorted to ground.

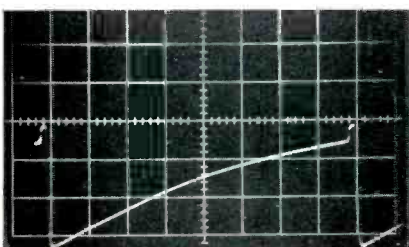

Fig. 8. Waveform less than 200 volts p-p.

to cycles per second, milliseconds to kilohertz and microseconds to megahertz. In estimating the repetition rate of a 3.5-MHz sync signal in a color set, timing a 19-KHz sine wave in a stereo receiver, or doing industrial digital or analog work, this extra facility is almost a necessity. This timing will be demonstrated later.

Investigating the associated waveform showed obvious defects that helped pinpoint the cause of the trouble. The signal shown in Fig. 1 was obtained at the plate of the video amplifier (V6A, Fig. 2) that supplies both the CRT and the sync section. With the contrast control set at mid range, the video measured about 40 volts p-p. In the waveform in Fig. 3, this same AC voltage was measured with the vertical amplifiers on DC and was shown riding at about 170 volts DC. Checking the schematic showed both levels within tolerance and, even with the sync plateau a little higher than the remainder of the waveform, it passed as a satisfactory AC and DC voltage.

Connecting the scope probe to the grid of the sync separator (V6B, Fig. 2) produced the waveform shown in Fig. 4. It was noticed that the waveform's tip was negative one or two volts and its amplitude varied between 10 and 20 volts, depending on the incoming signal from the video amplifier. The video at this point was stripped from the sync signal by a combination of grid biasing and low plate voltage. The amplified signal appeared inverted at the plate of the sync separator, as shown in Fig. 5. The amplitude was 22 volts and was hanging at a DC level of 60 volts. This waveform must swing to considerably more than the 45 volts DC illustrated on the schematic, and the signal amplitude should be at least 35 volts to correspond to that at the grid of the sync amplifier, V5B. This was the first defect to be investigated.

Keeping Fig. 5 in mind, the remainder of the sync and vertical circuits were checked. Fig. 6 showed the plate waveform of the sync amplifier at a peak-to-peak value of 40 volts (plus 40 volts more for the vertical spike) and riding at a DC level of 35 volts. This did not seem unusual considering the signal input and voltage tolerances.

In Fig. 7 the plate of the vertical oscillator had been shorted. The 6-volt negative spike of voltage at its grid was a couple of volts off and may have been significant.

The waveform in Fig. 8, however, had two noteworthy peculiarities: It was less than 200 volts p-p and its sync tips were not quite at the zero reference level. This, then, was the next probable fault. The plate of the vertical oscillator (V4B, Fig. 2) was riding high at 180 volts, but the shape of the waveform (Fig. 9) was normal, and the plate voltage could be adjusted by the height control, R4B. Following the path to the vertical output stage, the grid waveform, Fig. 10, looked acceptable and the DC level was at just about—25 volts, within tolerance.

Returning to the plate of the sync separator, R56, R58 and C70 were investigated. R56 measured 1.2 megohms instead of 680K ohms, and R58 measured between 30K ohms and 40K ohms instead of 1 megohm. The sync separator tube was pulled and the 260-volt line grounded to make sure the 1.2-megohm reading for R56 was accurate. (Current through a resistance is the IR drop, which is how an ohmmeter makes its measurement.) C70 and C71 might have retained a charge. To check R58, the junction at that point was grounded with a shorting clip to remove any charge. The measurement across R58 was now 30K ohms, and this looked suspicious. As another check, the 260-volt bus to the chassis was grounded and the junction of C70-C71 was checked to see if R57 was actually 18K ohms. This was also a check to see if C71 was leaking badly. The measurement indicated that C71 was okay. But what should be the DC reading at the junction of R58 and R57? Since this is a series filament string set, pull any tube and the DC bus should immediately rise from 260 to 350 volts.

$$E_o = \frac{E_{in} \times R_1}{R_1 + R_2} = \frac{350 \times 18K}{350 \times .18 \times 10^6 + 18K} = \frac{6.3 \times 10^6}{1.02 \times 10^6} = 6.2 \text{ volts.}$$

This voltage divider measured 7 volts and was working correctly. The reason the 1-megohm resistor could not be measured in-circuit was that the small current in the

REVOLUTIONARY

NEW

FIRST

FROM

KAY-TOWNES

The **COLOR-TUNED**
Family of
Antennas

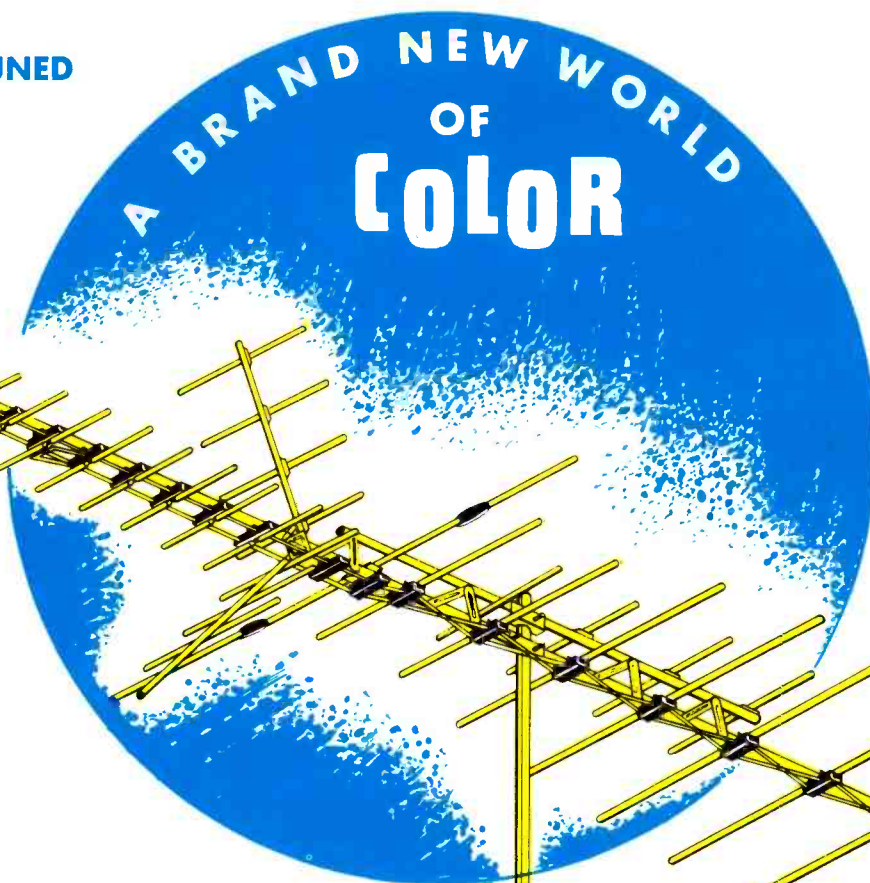

CT-34G
UHF-VHF

IT'S **COLOR-TUNED**

AN ENTIRELY NEW CONCEPT IN ANTENNA DESIGN!

Most conventional UHF-VHF combination antennas use the "pass through" coupling system. The VHF signals pass through the UHF antenna, acting as a section of the transmission line. The presence of the UHF elements attached to this transmission line results in a line mismatch at various VHF frequencies with the standing waves being detrimental to color reception.

**NOW — RECEIVE TRUE COLOR
AS IT IS TRANSMITTED!**

Kay-Townes new "Color-Tuned" concept obsoletes the old "pass through" system. The high gain, nine driven element UHF antenna is coupled to the VHF portion in a manner that actually tunes the VHF section. The antenna features a double stub UHF trap to assure 100% isolation, resulting in a no-loss coupling of the two systems to a single transmission line. A corner reflector doubles as a high gain UHF reflector and a broad, high band, high gain director on VHF channels 7-13 and reduces the space loop losses in both bands.

KAY-TOWNES

ANTENNA COMPANY
Box 593 Rome, Ga. 30162

Circle 5 on literature card

September, 1968/PF REPORTER 7

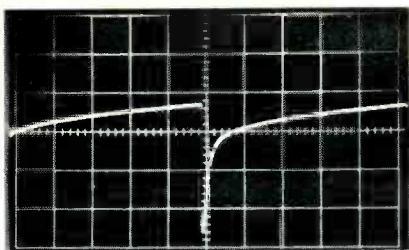

Fig. 9. Waveform at plate of vertical oscillator was normal, but reference level of 180 volts was high.

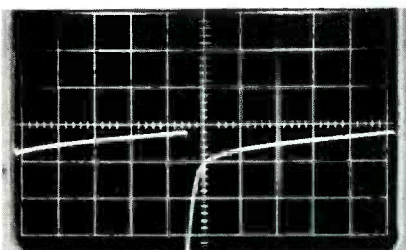

Fig. 10. Normal waveform at grid of vertical output stage.

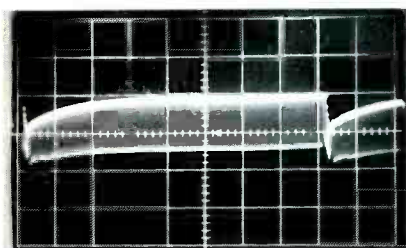

Fig. 11. Waveform with DC level almost 80 volts and AC amplitude 35 volts.

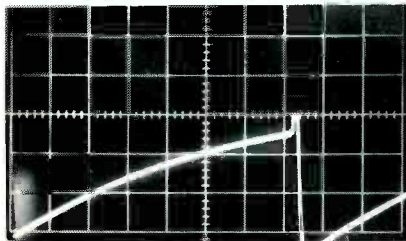

Fig. 12. Amplitude of waveform at grid of vertical oscillator about 200 volts p-p.

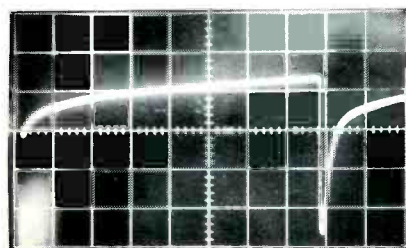

Fig. 13. Waveform with 200-volt DC level at plate of vertical oscillator.

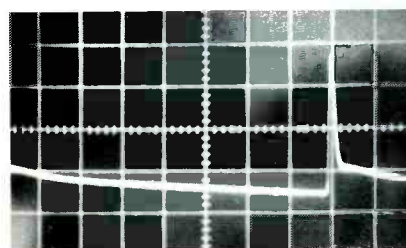

Fig. 14. Waveform at junction of R70, C82 and C83 in feedback network.

voltmeter divides through R57 and R58, or back into the power supply, and there was no positive reading. Without making a single disconnection, a little probing and reasoning established that R56 was defective.

To check C70, the 350-volt bus was jumpered to pin three of empty tube mount V6B and a check then made to see if there were more than 7 volts DC on the other side. The reading (DC level) remained at 6.2 volts, which was correct. More voltage at this point would have indicated that C70 was leaking. R56 was replaced by dexteriously positioning the little shielded chassis, first on one end and then on the other. The appearance of the waveform in Fig. 5 then more closely resembled that shown in Fig. 11. It was hanging at a DC level of almost 80 volts and its amplitude was just about 35 volts, exactly where it should be. So the first fault was corrected and a more usable sync signal was then available to the vertical and horizontal oscillators.

The waveform in Fig. 12 showed that the amplitude of the waveform at the grid of the vertical oscillator was then about 200 volts p-p and the sync tip had reached a -20 to 0 volts—a solid conduction level for this particular oscillator. The biggest change was at the plate of the vertical oscillator, where the waveform also measured 200 volts p-p and was riding at about 200 volts DC, as shown in Fig. 13. A bar generator indicated that the vertical scan was linear and the vertical hold seemed to be normal with one exception: It was near the end of its range. Vertical linearity and height adjustments, however, soon cleared this. But the schematic indicated that the DC level at the plate of this oscillator should be approximately 125 volts.

The AC and DC voltages at the grid of the vertical output tube were still correct, as they were in the beginning. The linear vertical scan showed black at the top and bottom of the picture immediately following the overflight of an aircraft. To see if the flutter caused by signal change was the result of defects within the sync circuits, the capacitors in these circuits were checked.

First the circuit was examined. From the schematic it was apparent the vertical oscillator was being

driven very hard with considerable plate voltage in order to operate satisfactorily. This plate supply is coupled through the height control from the 570-volt boost source, which is generated in the flyback transformer and damper circuits. The plate supply measured normal and the height control correctly increased and decreased this voltage. The linearity control (the grid return for the vertical multivibrator) rotated through its range without skips, so it, too, was satisfactory. The output of the oscillator was shaped by C80, R72, R3 and R73 and then fed to the grid of the vertical output stages. Since there seemed to be no problem with either the DC voltage at the grid of V10 nor the waveshape, these components were assumed to be functioning properly. Once more, the receiver was turned off for a few minutes, turned on again, and the height and linearity controls adjusted for a symmetrical picture. The vertical hold control was in the center of its range, as it should have been.

To solve the shrinkage problem the defective capacitor had to be isolated. Before printed circuit boards, one could unsolder a half dozen of the plate and dielectric capacitors associated with such circuits and test them individually for leakage. However, in a chassis such as this there was no room to get into the board to do this, or time for a protracted job of troubleshooting.

The capacitors in the feedback and lower plate-circuit network (C78, C79, C82 and C83) were heated while monitoring the waveform developed at the junction of R70, C82 and C83 in the feedback network (Fig. 14). A positive spike of 300 volts AC was showing; however, this waveform was riding on 150 volts of DC. Tracing the waveshaping circuit through R70, C79, R69, C77, etc., it was discovered that this was a closed AC circuit and there should be absolutely no DC in it. The voltage on one side of R69 was about the same as that on the other side. Either C77 or C82 was leaking. Shorting either capacitor caused the picture to fold severely from the bottom and elongate from the top. Shorting C82, however, had less effect than shorting C77, so C82 was checked first.

Since this 0.027-mfd unit was a vertical tubular capacitor and rather difficult to reach, the end of R74 was raised and the entire capacitor was bypassed by a new one to the junction of C83 and R70. The DC level of the waveform then returned to zero (Fig. 15). The DC level of the waveform at the plate of the vertical oscillator (Fig. 16) increased to 125 volts—exactly what it should be. Thus, the receiver was returned to normal operation after replacing only one capacitor and one resistor.

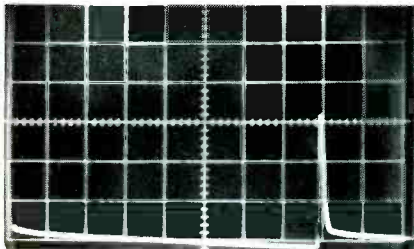

Fig. 15. DC level returned to zero.

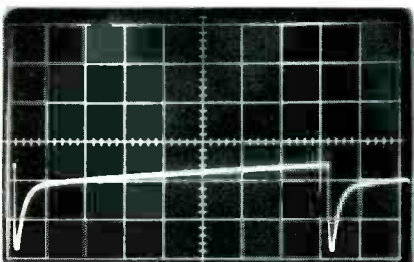

Fig. 16. DC level of waveform at plate of vertical oscillator increased to 125 volts.

Determining Frequency

In checking the repetition rate or frequency, look at the waveform in Fig. 8. The calibrated oscilloscope interval is 2 milliseconds per division. This takes almost exactly 8.2 divisions. Therefore,

$$F = \frac{1}{8.2 \times 2 \times 10^{-3}} = \frac{1}{0.061 \times 10^3} \text{ or } 61 \text{ Hz.}$$

It is within 2 percent of the 60 cycles per second scanned in each complete picture waveform. Figs. 2 and 3 were also taken at 2 milliseconds per centimeter. The divisions occupied by each cycle is roughly 5.8. Use the same equation:

$$F = \frac{1}{5.8 \times 2 \times 10^{-3}} = \frac{1}{11.6 \times 10^{-3}} = 86 \text{ Hz.}$$

The different findings could be the result of an uncalibrated scope. ▲

**FAR
SUPERIOR
TO
ANY
VTVM
OR
VOM**

**--and
for
less
money**



NEW FIELD EFFECT MULTIMETER

Here is the revolutionary new approach to circuit testing, the solid state Sencore FIELD EFFECT METER. This FE14 combines the advantages of a VTVM and the portability and versatility of a VOM into a single low-cost instrument. This is all made possible by the use of the new space age field effect transistor that is instant in action but operates like a vacuum tube in loading characteristics. Compare the features of the FIELD EFFECT METER to your VTVM or VOM.

Minimum circuit loading — 15 megohm input impedance on DC is better than a VTVM and up to 750 times better than a 20,000 ohm per volt VOM — 10 megohm input impedance on AC is 20 times better than a standard VTVM. The FIELD EFFECT METER is constant on all ranges, not like a VOM that changes loading with each range.

Seven AC peak-to-peak ranges with frequency response to 10MHz. Seven zero center scales down to 0.5 volt. Five ohm ranges to 1000 megohms. DC current measurements to 1 ampere. Full meter and circuit protection. Mirrored scale. Low current drain on batteries — less than 2 milliamps. Built-in battery check. Unbreakable all-steel vinyl clad case. Optional Hi-Voltage probe adds 3KV, 10KV and 30KV ranges with minimum circuit loading for greatest accuracy in the industry... \$9.95.

**Only Sencore offers the FIELD EFFECT METER.
Ask for it by name at your distributor.**

only \$69.95 (less batteries)



SENCORE

NO. 1 MANUFACTURER OF ELECTRONIC MAINTENANCE EQUIPMENT

426 SOUTH WESTGATE DRIVE, ADDISON, ILLINOIS 60101

Circle 6 on literature card



7 VOLTS OUTPUT! 54 db GAIN!

Signal test point (-20db) where output of amplifier may be monitored while system is in operation.

Output jack suitable for RG-59/U or RG-11/U cable. Maximum signal output 7 volts on Model DA-1000.

Three-position tilt control switch provides correction for the nonlinear attenuation characteristics of coaxial cable.

Pre-amplifier voltage switch connects AC voltage to input jack to power Super Color-tion Cartridge Pre-amplifiers.

VHF input jack. Suitable for RG-59/U or RG-11/U cable.

Fuse holder on front panel for easy access.

Power transistors in sockets with heat sinks for stable operation and easy maintenance.

Gain control with 10db range designed so it will not affect noise figure or amplifier.

Fixed input pad controls input signals up to -20db. Uses PD type pads available in 8 values from 0 to -20db.

FM trap switch attenuates FM band, -30db when on.

DA-1000 \$225.00

3 MODELS FOR VHF-FM MATV

WINEGARD SOLID-STATE AMPLIFIERS!

When it comes to selecting distribution amplifiers for MATV systems, some folks tend to overlook many factors that are just as important as amplifier gain. What about voltage output? What about the noise figure? What about circuit reliability? What about the features that allow you to equalize and control signal levels? Winegard engineers took these—and

many other factors—into consideration in designing this new series of transistorized, printed circuit amplifiers. These VHF-FM amplifiers have just about everything you could ask for. Including, of course, reliable performance to give your clients the best possible color fidelity and complete reception satisfaction. No matter what size the system.

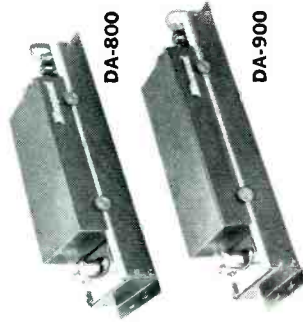

For full specifications and sample system layouts on the DA-1000 (54 db), DA-900 (40 db) and the DA-800 (28 db), write for Winegard Fact-Finder #253. We promise you'll be impressed.



Winegard
ANTENNA SYSTEMS
© Copyright, 1968, Winegard Co., Burlington, Iowa

WINEGARD COMPANY • 3000 KIRKWOOD STREET • BURLINGTON, IOWA 52601

Circle 7 on literature card

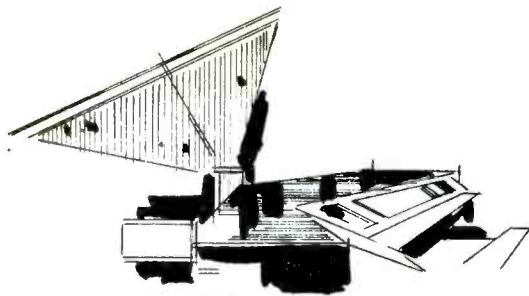

THE ELECTRONIC SCANNER

Mechanical Switching Eliminated in New Tuner

The industry's first fully solid-state television tuner substitutes varactor diodes for mechanical switching and tuning mechanisms. Production designs of the new solid-state tuner for VHF channels 2 through 13 have been completed at Standard Components Division of Standard Kollsman. Production engineering on a companion varactor tuner for UHF channels 14 through 83 will be completed in the near future. Both tuners are reportedly readily adaptable to the use of integrated circuitry.

The varactor diodes in the new tuner use voltage-variable capacitance to tune RF amplifiers, oscillators and mixers to resonance. Other diodes, under forward biasing, short out part of the tank coil for bandswitching. The only mechanical switches in the system control direct current voltage, not signal.

Varactors are distant relatives of the transistor and of the "galena and cat's whisker" remembered by those who tuned in their first radio program more than 50 years ago. When voltage passes through a varactor diode from one direction, it acts like a conventional variable-capacitor tuner—from the opposite direction, it acts like a shorting switch.

Present-day VHF tuners, which succeeded the ganged-capacitor tuners of early television, are essentially electromechanical switches containing as many as 157 electrical contacts.

The new tuner replaces this electromechanical switching with solid-state varactors. Nothing moves inside varactors but electrons. In addition to its solid-state dependability, the patented varactor tuner is smaller than present-day devices.

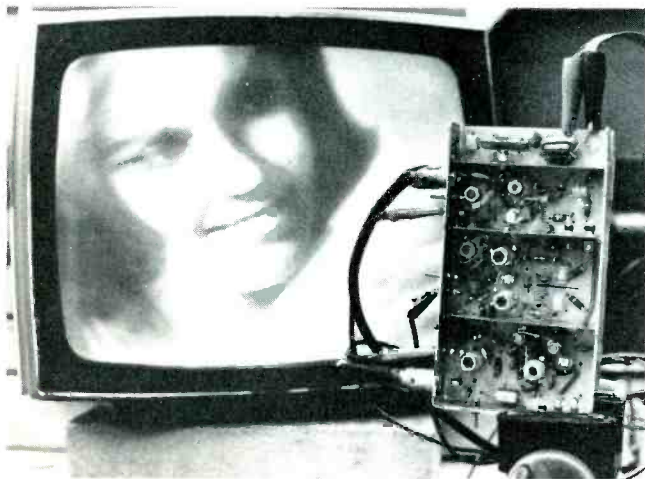

Keep abreast of modern Electronics Technology

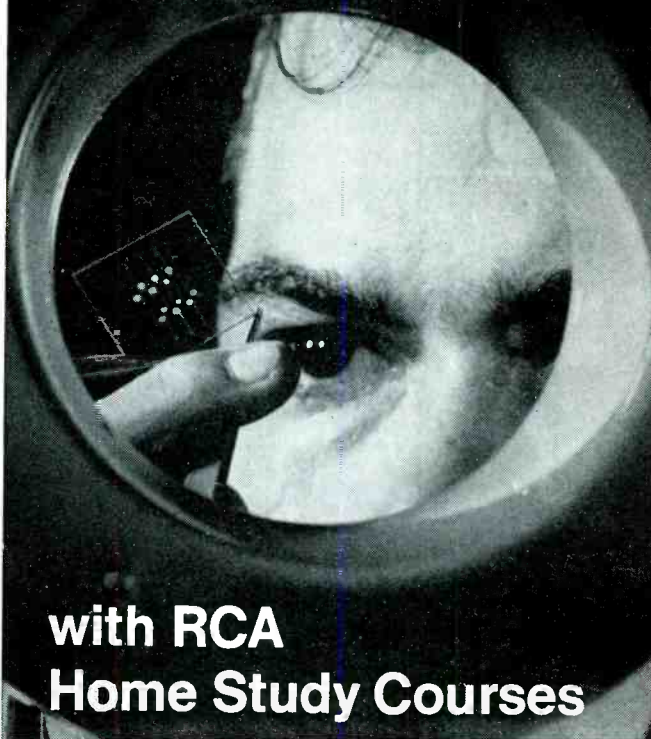

with RCA Home Study Courses

This very tiny thin-film transistor is an important new semiconductor development.

4 WAYS TO INCREASE YOUR INCOME . . . RCA Institutes, Inc., offers these four comprehensive home study courses especially designed to help build your income immediately!

- **COLOR TV** Add profitable color TV to your skills with this home training course, newly revised to include information on the latest techniques, receiver circuitry and equipment.
- **TRANSISTORS** Get the necessary background for semiconductor technology including characteristics of tunnel diodes, rectifiers and other solid state devices. Transistor TV receiver kits also available.
- **AUTOMATION ELECTRONICS** Trains you for its many applications: Photoelectronics, Digital Computer Techniques, Synchros and Servomechanisms, Automatic Control Systems, many more!
- **MOBILE COMMUNICATIONS** Trains you to service 2-way radio communications on land, sea, and air. FCC License Preparation Course also available.

Take advantage of RCA's Liberal Tuition Plan. You only pay for the lessons you order; no long-term obligations. Licensed by New York State Education Department. Approved for Veterans. Accredited Member National Home Study Council.

RCA

RCA INSTITUTES, INC. Dept PF-98
320 West 31st Street, New York, N.Y. 10001

Please send me your **FREE** Home Study Catalog. No salesman will visit you. I am also interested in Resident School

Name _____

Home Address _____

City _____ State _____ Zip _____

SUB-MINIATURE FUSES

Ideal for space tight applications, light weight, vibration and shock resistant. For use as part of miniaturized integrated circuit, large multi-circuit electronic systems, computers, printed circuit boards, all electronic circuitry.

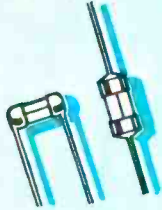

TRON Sub-miniature Pigtail

Fuses — Body size only .145 X .300 inches. Glass tube construction permits visual inspection of element. Hermetically sealed. Twenty-three ampere sizes from 1/100 thru 15.



BUSS Sub-miniature GMW Fuse and HWA Fuseholder

Fuse size only .270 X .250 inches. Fuse has window for visual inspection of element. Fuse may be used with or without holder. 1/200 to 5 amp. Fuses and holders meet Military Specifications.

Write for BUSS Form SFB

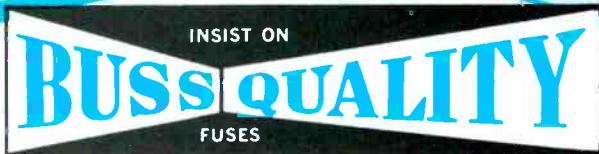

BUSSMANN MFG. DIVISION, McGraw-Edison Co. St. Louis, Mo. 63107

THE COMPLETE LINE OF *Small Dimension* FUSES

For The Protection of All Types of Electronic and Electrical Circuits and Devices . . .

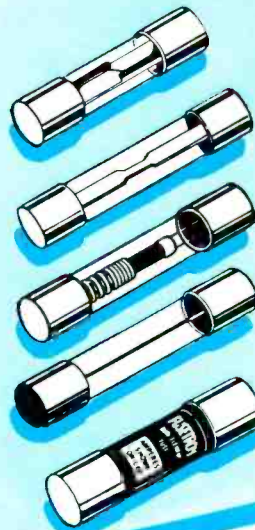

. . . includes dual-element "slow-blowing", single-element "quick-acting" and signal or visual indicating types . . . in sizes from 1/500 amp. up.

For special fuses, clips, blocks or holders, our staff of fuse engineers is at your service to help in selecting or designing the fuse or fuse mounting best suited to your requirements.

Write for BUSS Form SFB



BUSSMANN MFG. DIVISION, McGraw-Edison Co. St. Louis, Mo. 63107

BUSS: The Complete Line of Fuses and . . .

Because it is electronic, varactor tuning can simplify remote control and automatic frequency control circuitry and permit additional options in the method of channel selection.

TEA Salary and Pricing Survey

The hourly pay of electronic service technicians ranges from a low of \$1.75 for an outside technician to a high of \$4.50 paid to top inside technicians. The foregoing figures were compiled from information submitted by 84 association members who responded to a recent survey by the Texas Electronics Association (TEA). According to the survey, the median salary of an outside technician is \$3.00, while the top scale is \$4.00. Inside technicians are reportedly better paid, with a low salary of \$2.25 and a median of \$3.25. Trainee pay was also a subject of the TEA survey, with the following results: top, \$2.00; low, \$.85; and a median of \$1.50. Of the shop owners who responded, 67 percent employed two or less technicians, and 24 percent indicated they did not want trainees.

Service pricing information compiled from the TEA survey revealed that a wide range of pricing still exists. B-w home-call charges ranged from a low of \$4.00 to a high of \$9.95. Color TV home service calls were only slightly higher with a range of \$5.00, low; to \$10.95, high. An even greater variation in pricing was evident in the minimum charges for b-w in-shop repairs—low only \$2.50 and high, \$12.50. Another interesting fact revealed by the survey was that the median minimum charge for under-chassis work was

\$12.50 for both b-w and color TV, while the high for such charges varied by \$10.75—\$29.50 for color TV and \$18.75 for b-w. The maximum price charged by any shop for setting up color TV was \$25.00, as opposed to a low of \$7.50—again, a considerable spread. Of the shop owners who responded, 445 said they charged extra for additional home time, while only 15 percent charged extra for installing tubes during a house call. Asked if they would raise prices in 1968, 56 percent replied yes; 32 percent, no; and 12 percent were undecided at the time of the survey.

—Merchandising Week

Electrohome to Supply TV for Olympics

Electrohome Limited has announced that it has been awarded a \$250,000 contract to supply 1,000 TV sets to Mexico for the 1968 Olympic games in the fall.

The sets will be installed in the auditoriums of about 40 high schools in and around Mexico City so that persons who do not own a set or cannot afford a ticket for the games will be able to see the international spectacle.

The sets, which are b-w special educational models, were sold to a Mexican "Organizational Games Committee." Following the conclusion of the games, the sets will be retained in the schools for continued educational use.

Markets Selected for "Discover Color TV" Push

Fifteen basic metropolitan markets nationally have been selected for local action programs during the na-

tionwide "Discover Color TV" promotion this fall sponsored by the Consumer Products Division of the Electronic Industries Association (EIA).

According to Jack Wayman, EIA staff vice president of the division, they represent 28 percent of the country's retail sales volume.

The 15 key markets are: Boston, Chicago, Dallas, Denver, Houston, Jacksonville, Los Angeles, Minneapolis/St. Paul, Philadelphia, Phoenix, Pittsburgh, Providence, San Francisco/Oakland, Seattle and Washington, D.C.

"Discover Color TV" is the first industry-wide promotion for consumer electronic products. It is mobilizing all elements of the industry for impact on the general public starting mid-September, 1968. Timing is keyed to the heightened interest in color TV, generated both by the season's programming as well as by manufacturer innovations in product lines.

"Discover Color TV" is the first in a year-round program of special promotions planned by the division. It will be followed in the spring of 1969 by a campaign built around portable televisions, radios, phonographs and tape equipment.

All-Electronic Remote

Remote operation of a variable control, such as volume, in past and present television remote control systems involved the use of a small DC motor mechanically coupled to the control. The motor rotated the control in response to a transmitted signal.

Motorola has recently announced the development

of a new all-electronic system to replace the previously described electromechanical method of remote "variable adjustment." The heart of the new system is a memory module. A neon bulb acts as an electronic switch, isolating the critical capacitor timing circuit from the external charging circuitry when the function switches are closed. When either of the function switches is closed, the neon bulb conducts, allowing the capacitor charge to be varied up or down in response to the direction of control desired. The resultant DC control voltage is then used to control, or bias, a variable-gain amplifier in the audio section of the receiver.

The capacitor is a special low-leakage unit designed to minimize stray leakage resistance. The semiconductor device is an insulated gate field-effect transistor (IG FET) designed for maximum input resistance.

All devices employed in the memory module are carefully selected for high-resistance, low-leakage characteristics. The high resistance is maintained by encapsulation in a special Motorola compound material. Ultra-sonic cleaning of the assembly prior to encapsulation, plus vacuum wax impregnation after encapsulation protects the entire unit from the adverse effects of environment. The preceding manufacturing process is necessary since the ability of the device to "remember" voltage is dependent upon the capacitor retaining the desired charge over a long period of time. (Laboratory tests indicate that the unit is capable of retaining a high voltage level with less than a 5 percent change over a period of 1000 hours.) ▲

Fuseholders of Unquestioned High Quality

The Complete Line of Signal-Indicating Alarm-Activating Fuses

For use on computers, microwave units, communication equipment, all electronic circuitry.



BUSS GLD- $\frac{1}{4}$ x 1 $\frac{1}{2}$ in. Visual-Indicating, Alarm-Activating.



BUSS Grasshopper Fuse, Visual-Indicating, Alarm-Activating.

BUSS GBA- $\frac{1}{4}$ x 1 $\frac{1}{2}$ in. Visual-Indicating.



BUSS MIC-13/32 x 1 $\frac{1}{2}$ in. Visual-Indicating, Alarm-Activating.



BUSS AGH Aircraft Limiter, Visual-Indicating.

BUSS MIN-13/32 x 1 $\frac{1}{2}$ in. Visual-Indicating.



FNA FUSETRON Fuse 13/32 x 1 $\frac{1}{2}$ in. slow-blowing, Visual-Indicating, Alarm-Activating. (Also useful for small motors, solenoids, transformers in machine tool industry.)



BUSS GMT and HLT holder, Visual-Indicating, Alarm-Activating.

Write for BUSS Form SFB

INSIST ON

BUSS QUALITY

FUSES

The Complete Line of Fuseholders For All Applications

Panel mounted, in-the-line, lamp indication, signal-activating, visual indicating . . . with solder terminals, quick connect terminals. Also holders to meet Military Specifications under MIL-F-19207B.

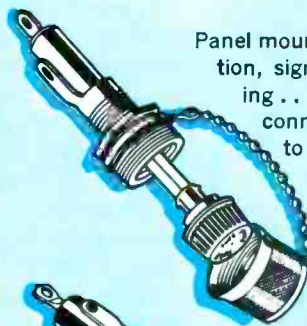

HMR RF shielded holder for $\frac{1}{4}$ x 1 $\frac{1}{2}$ in. fuses.



HPC Panel mounted holder for 13/32 x 1 $\frac{1}{2}$ in. fuses. Rated 30 amperes for any voltage up to 600.



HKA lamp-indicating, signal activating holder.

HKA lamp-indicating, signal activating holder.

Write for BUSS Form SFB

INSIST ON

BUSS QUALITY

FUSES

This thing called STEREO

A proper perspective of this form of audio reproduction will help you educate the layman.

by Norman H. Crowhurst

The people who at one time boasted a Hi-Fi now boast a Stereo. The real enthusiasts in audio reproduction see a fundamental difference between the two and for those to whom possessing a Stereo is mainly a matter of prestige, 'mono' is passé. From the technician's viewpoint, however, stereo is the latest form of what was formerly known as high fidelity.

The high-brow, component-type enthusiast is more concerned with what is in the system than the man who buys a stereo just for listening. However, both are seeking the same thing: realism in audio reproduction. All the changes over the years—improved speaker systems; improved recording techniques, such as microgroove; better pickup designs and improvements in the electronics—are steps toward this end: a sound that comes nearer the real thing.

The perfectionist defines his objective as being the re-creation of the original. If a recording was made in Carnegie Hall, he visualizes the perfect system as creating the illusion of being in Carnegie Hall listening to the original program. Much has been written about

how this might be accomplished.

No system can transport the listener into the original environment where a recording was made or a live program originated. The best that can be achieved is a good illusion. Most of this article is oriented toward one or another's idea of how it can be done.

Why Stereo?

Some can remember back in the '20's when enthusiasts listened to radio on headphones and swore it sounded as if the performers were there in-the-room, and the old acoustic phonograph was accepted as a real marvel of realism. Some dismiss this memory as being a response prompted by imagination, because in those days **any** reproduction was a miracle.

As one listener who yet remembers those days, I don't believe that explanation is correct. Although frequency response and many other things that were lacking in those earlier efforts have improved, they did possess a realism of impression that has not always been present in some later efforts.

In early radio and records there was little, if any, bass. It may not have been missed as it wasn't heard, but what was heard sounded realistic. With the advent of moving coil

speakers, particularly woofers, and electrical recording, which used a microphone instead of an acoustic trumpet, bass came into its own. Now the drums and the string bass were heard, which before had been inaudible.

As an A-B demonstration, the difference was impressive. The change definitely brought it in. What was often neglected was that the things already heard had lost something. The bass brought intermodulation troubles.

The notes from the bass instruments themselves were clear and stood out, but they produced a jarring effect in the sound from other instruments. Sometimes the sound became quite gargly.

The next dramatic improvement was not quite as dramatic as the claims promised. Adding the higher frequencies, by means of tweeters and supertweeters, did not make anything more audible than it was before unless it was the edginess of the wire brush used by the drummer or a particular realism about the cymbal. But again, the change needed to get these extra frequencies through was apt to present other problems.

Another kind of intermodulation, this time among the higher frequen-

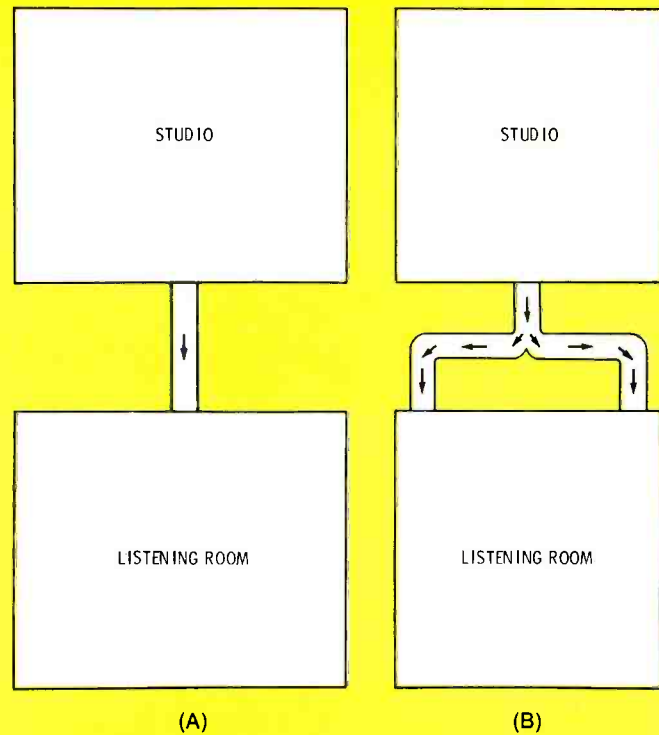

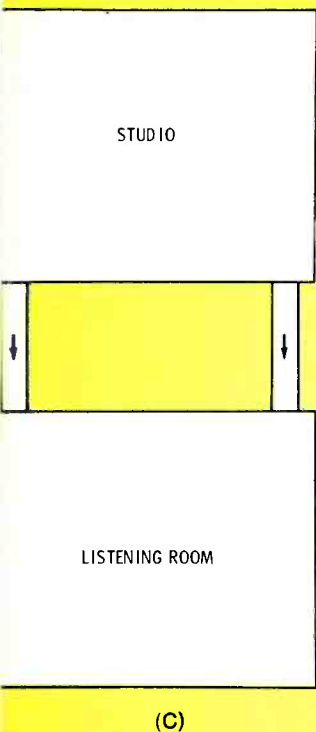

Fig. 1. Equivalent differences in listening conditions: (A) the old "mono" hi-fi, with a single speaker system, is like a single hole in the wall, through which you listen: (B) adding a speaker to a 'mono' system is like using a branching hole: still there is only one hole 'at the other end'; (C) stereo provides the equivalent of two holes, spaced apart, and increasing the communication capabilities tremendously.

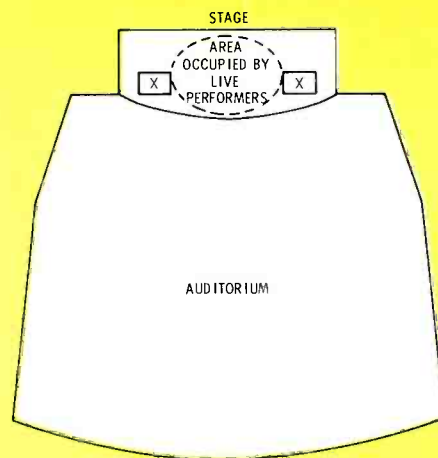

Fig. 2. A method of presenting stereo in an auditorium, such as Carnegie Hall: If an orchestra playing live is located in the dashed-line ellipse, and the same program reproduced is presented over the stereo speakers, marked 'X', an A-B test between them shows how good such a system can be.

cies themselves, produced spurious frequencies that were lower and more audible. At its worst, this intermod sounded like a buzz, particularly noticeable when two high notes were played together. Far less definite was a general sense of muddiness, or indistinctness, that the effect caused. The clarity that once made the listener feel the performer was in the room had slipped a little farther away.

This distortion can be aided by amplifiers, but all other parts, such as phonograph pickups (even the recording heads which put it on the record), tape heads and radio transmission links, can destroy that in-the-room realism.

By this time the advocates of stereo had noted that a reason for unrealistic sound was the limitation produced by crowding all the sound through one small loudspeaker. Adding tweeters did not help much because the main opening was not any bigger. Extra speakers were placed around the room, but this just became multi-hole listening.

Visualize the sound as being in another room (the recording studio or theater) to which the listener is connected by a hole in the wall (the loudspeaker); making two holes helps. But adding a speaker was

not really like making a second hole, in this sense, because the sound was a duplicate of the sound from the first speaker, like a branching hole (Fig. 1).

To get a sense of the magnitude of the sound sources, orchestra, organ, combo, etc., you needed something to duplicate what our human hearing does: Listen with two ears. Thus the idea of stereo was born.

But was it worth all the extra to get a second channel? Even if you got all the program into one groove or on one piece of tape, which advancing technology has made possible, you still needed two amplifiers, speakers, etc., which was apt to cost twice as much. Some argued that stereo would not be worth the extra cost. For like the advent of bass and ultra-treble, stereo brought its own problems. Merely using two channels of sound did not automatically make things sound better.

The advocates of stereo did not help matters in the early days. They had a definite idea of what stereo was supposed to do. You had to hear separation. People listened for separation, so there just had to be separation.

Music was arranged for stereo, so one group of instruments would

come over one speaker, and another group would answer over the other. People who really enjoy music and wanted better reproduction were reluctant to buy the ping-pong effect.

But spatial separation isn't the most important contribution stereo has to offer as an advantage over mono: separation, yes; but not necessarily spatial. We like to hear an orchestra as an assemblage of instruments all playing their parts in unison. We don't pay close attention to where they are located in the orchestra pit, but we like to hear the different groups come in to play their parts.

This was what our widening hi-fi had somewhat obscured unless we used a truly high-fidelity system which achieved very low distortion in all components from the microphone through the recording, playback amplifier to the speakers and into our own listening room. A few very good systems could give the impression of a real live orchestra, with realism in all respects. But the cost of such systems was beyond the average person's reach.

The advent of stereo provided separate channels over which different parts of the program came in varying proportions, to represent

left, right, and in-betweens across the center. This gave a sense of separation or clarity not as easily possible by sheer purity of reproduction over only one channel. This was the place under the sun that the new stereo eventually occupied.

Once this was understood, stereo systems or packages could be made in the same price range as the older hi-fi packages had been. In the same price bracket, stereo can sound better than mono. But to do so, the system must be used properly, knowing what the objective is.

In the British Science Museum is a tremendous, correctly developed exponential horn, giving good response to quite a low frequency. Thirty years ago, listening to this gave one a strong feeling that the actual program source was actually

concealed in the depths of that thing.

Horns are undoubtedly the most efficient means of converting electrical signals corresponding to sound into actual sound waves. But few modern living or recreation rooms can find room for such a monster horn, much less two of them. Even if an enthusiast should build one or two so it or they give out into the room, the room isn't suited to receive such big sound waves.

We have to create our illusions with smaller speakers, more or less of the bookshelf variety, designed so they reproduce all the relevant frequencies, if somewhat less efficiently. If we didn't accept this compromise, the majority would decide they couldn't afford to rebuild their houses just so they could enjoy hi-fi or stereo.

Room Acoustics

Which brings us to some rather fundamental differences in stereo, in relation to the size of the listening room. If you have a large listening room, where sounds are propagated strictly according to textbook, such as an auditorium like Carnegie Hall, then you can take two horn-type, multi-way speaker units and do a terrific job (Fig. 2).

Mr. Briggs, of the Wharfedale Loudspeaker Company in England, has done just this, two or three times, in Carnegie Hall and other auditoriums around the world, to show that reproduced music can be almost indistinguishable from the original. He A-B's between live and reproduced and sometimes it's difficult to know which is which. But not many people have a Carnegie Hall for a living room.

Unfortunately, you can't make that kind of A-B test in your living room, because there is no way of getting the Carnegie Hall stage, complete with orchestra, into the living room for direct comparison. You can only compare one reproduction with another reproduction in the somewhat limited environment of your living room.

Different rooms have different acoustic properties apart from their size differences. The way to get stereo in a living room, furnished with wall-to-wall carpet, plush furniture and heavy drapes, differs considerably from the method needed in a recreation room with tiled floor, panelled or bare walls,

and wrought iron furniture.

Any good, conventional speaker system, properly separated, will sound well in the acoustically damped room with all the furnishings. Put the same system in the highly reflective recreation room, and the result is audio confusion. A cheap imported transistor radio will probably sound just as good, for not much more than one hundredth the cost.

Good stereo can be obtained in this kind of room, however, by having the acoustics work for you. A stereo package unit with the speakers in the ends will do well by bouncing the sound off the walls (Fig. 3). Another useful trick is using the open-back speakers that work like dipole radiators. These should be placed differently from conventional, closed-back speakers (Fig. 4).

In fact, this kind of system installed in a recreation room can give more uniform stereo effect throughout the room than the more conventional system, for which only a central position in the room gives a really good illusion.

Stereo does something that mono never succeeded in doing. The mono system was responsible for the drive for ever larger powered systems but, to the enthusiast, more power was never enough to give realism. No matter how much power the system put out, it never sounded big. Using multiple speakers helped, but it still sounded 'limited'.

Stereo fills the space with separated sound thus giving the illusion of bigness even when played relatively quietly. Switching from mono to stereo (where a system provides this facility) will increase the apparent power, even though just as much is being delivered when switched to mono.

So the motivation to play excessively loud is gone though some have formed the habit, which may die hard. This may be partly because their hearing has been impaired by previous loud-playing. But the trend for more power has gone. It is no longer necessary to annoy the neighbors before it's loud enough to suit yourself.

Having put stereo into some perspective, we will discuss troubleshooting techniques for this fascinating medium in an article next month. ▲

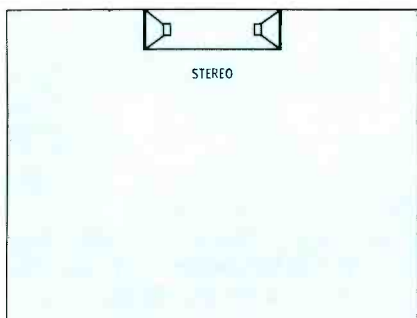

Fig. 3. One method of attacking the problem of the over-reverberant room: a package-type system where the speakers are mounted in the ends; this works because you utilize the sound reflections, rather than trying to avoid them.

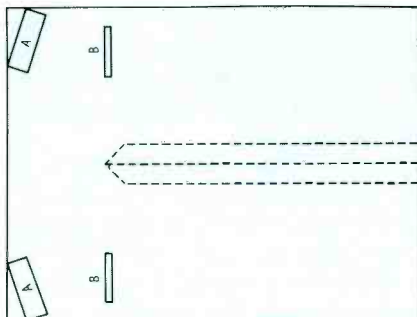

Fig. 4. Comparison of speaker placements: AA are conventional, close-back speakers; BB and an alternative (not to be used with AA) pair of open-back speakers. The closed-back type gives really good separation only down the center line represented by the heavy dashed line, and good stereo within the light, dashed-line enclosure. The open-back types cover virtually the whole room. However, closed-back speakers are better for acoustically well-damped (furnished) rooms.

breakthrough

Breakthrough



B&K Model 1450 first and only service-designed oscilloscope with “intermittent analyzer” and “electronic memory”

That elusive intermittent . . . how many hours have you spent trying to locate the source of the problem—how much time was wasted testing each circuit when you could have been doing more productive work? Now, B&K know-how and engineering genius have come through for you.

Result . . . the intermittent analyzer in the Model 1450 Diagnostic Oscilloscope. It will tell you *if* and *where* an intermittent occurs—even without your being there! The electronic memory will keep the intermittent indicator “on” until you return. Think of the time and money it saves.

The easiest to use 'scope ever built, its unique screen gives error-free direct readings of peak-to-peak voltages—it syncs automatically at any signal level—easily displays color reference signal. Convenient for use as a vectorscope too, all inputs and controls are on the front panel.

Deluxe in every respect, the 1450 is another B&K innovation that will make your time more profitable in solid state and color TV service. Years-ahead planning for present and future use . . . the best-value all-around 'scope you can buy. With probe. Net, \$279.95

INTERMITTENT MONITOR. Designed to supplement the indicators on the 1450, this plug-in monitor can be placed anywhere in your shop. It flashes and buzzes when an intermittent occurs . . . and projects a professional image to your customer. Net, \$24.95



B&K Division of Dynascan Corporation
1801 W. Belle Plaine Avenue • Chicago, Illinois 60613



Where Electronic Innovation Is A Way Of Life
Circle 10 on literature card

TRANSISTORS:

State of the art report

The final installment in this series discusses test equipment requirements and servicing techniques demanded by solid-state circuitry.

by Jack Darr

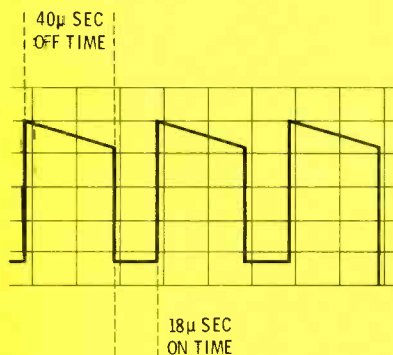

Fig. 17. Horizontal drive waveform of RCA KCS-153 showing ratio of on to off time.

The appearance of the first transistorized equipment caused varied reactions among the service technicians. There was opposition to them, at first, and there still is. Printed circuits caused the same reaction when first introduced but have since been accepted. Transistor circuits will also be accepted.

A radical change had to be made in service thinking with the combination of PC construction and transistors. The successful technician must now be able to think his way through the circuit and locate the trouble with much more certainty, and efficiency.

Transistor circuitry is not difficult to correct, though the successful technician will have to make

some minor changes in his service methods. He will not have to replace all of this equipment, but will have to learn a different way of using it to get the information he must have.

Equipment Needed

The main problem is the small size. PC board construction is almost universal, and most boards are badly crowded. This presents three major problems: location of parts, identification of parts, and testing.

In the first two problems detailed schematic diagrams, photographic illustrations, and complete service data are essential. Sams PHOTOFACT photographic illustrations of the chassis, with callouts showing the location of each resistor, capacitor,

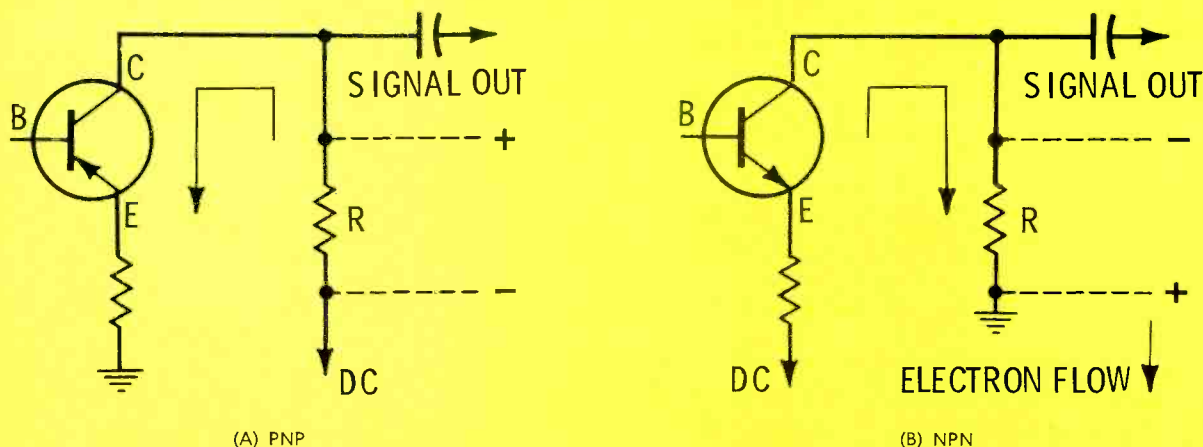

Fig. 18. Collector voltage developed by current through load resistor.

etc., are invaluable for this work. The schematic plus the symptoms generally disclose in what stage or group of stages the trouble is located.

Tests are needed to locate the cause of the trouble. Only one item, a transistor tester, will be needed as a new piece of test equipment.

For many years voltage measurements have been relied on to pinpoint the cause of the trouble. Because of the inherent advantages of this method, it will still be the quickest. There are no circuit disconnections needed, and a test probe can always supply the information. While the transistor has been advertised as a current amplifier, there is no need to read currents directly, i.e., break the circuit and insert an ammeter. Voltage measurements can still be used—the voltage-drop developed across a known resistor will be directly proportional to the current flowing through it.

Long and involved calculations of this current are not needed, as the voltage readings will be given on the schematic. As long as these voltages are within tolerance, there is current.

Signal Tracing

A signal tracer is a set of tuned AC vacuum-tube voltmeters providing RF, IF, and audio circuits, as well as some of the first DC

VTVM'S. It can read very small signals through any radio or audio amplifier and, with only a minor modification, can be used on some TV circuits.

In signal tracing, a stage or group of stages can be gone through to find where the signal stops. Then, voltage measurements, and sometimes even part-substitution, will give the answer in the least possible time. There are several different units that can be used for this kind of work, aside from the signal tracers: the scope, with a signal-generator; a good VTVM with appropriate probes; or anything that will give an indication of the signal level at the input of a stage.

Audio Signal Tracing

This is the simplest of tests. A test signal is fed in from an audio signal generator, a test record or tape, or an off-the-air signal. Then it is followed through the audio circuits until the stage which has input but no output is found. A number of the later amplifiers have stage gains shown on the schematic, however, this is not absolutely essential. After practice, it is possible to follow signals through any audio stage to find the trouble. In some cases there will be stages which have very low gain. This can be normal with transistor work. Some stages have very low load impedances so they can show small voltage gains but

still have normal current gain. For a definite check, read the DC voltages around the stage to see if they are within tolerance. In most cases, the signal will not be low, but missing, thus making the location of the trouble obvious. Shorted transistors, open resistors, shorted capacitors, etc., will stop the signal entirely.

The Scope In Signal Tracing

The scope indicates whether there is a signal present in any kind of circuit. There is no need to lock the sweep to the signal to determine its amplitude as compared to the signal amplitude at the input of the stage. A higher blur at the output than is present at the input is no problem; this stage is amplifying the signal. Signal generators, test records, off-air signals or anything that will give an indication, can be used.

For signal tracing in RF and IF circuits, the scope works well. A crystal-demodulator probe will report the envelope (modulation) of the signal.

For tracing sync circuits the scope is the only reliable instrument. Even the simplest scope will show vertical and horizontal sync pulses, sawtooth waveforms, and video signals. In transistor circuits, where the drive frequencies are the same but the waveform is different, the scope is needed since the waveform of transistor drive signals is important.

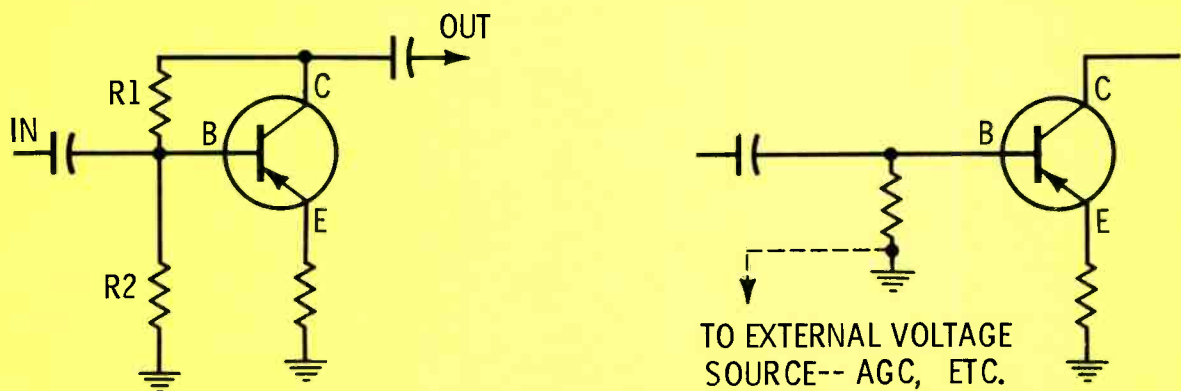

(A) Voltage divider.

(B) External source.

Fig. 19. Base voltage taken from voltage divider or from external source.

Transistor horizontal-output circuits are driven by a flat-topped pulse, almost a square wave. The on-off ratios of these pulses are important, as shown in Fig. 17. These determine the efficiency of the stage, and they must be set correctly. This is done by adjusting the horizontal oscillator coils. The off time is twice the on time. This measurement can be made quite accurately by comparing the percentages. The off time covers two squares on the scope graticule, and the on time one. The horizontal oscillator must be locked to a TV signal when this is done, to use it as a standard.

Voltmeters and Ohmmeters

A late model VOM that measures 20,000 ohms per volt works well. The VTVM is highly useful, especially in sensitive circuits where there must be the least possible circuit loading: tuned circuits, high-impedance circuits (though these are less common), etc. The FET voltmeter is the ideal instrument for this work, since it has no connection to the AC line. Besides being more portable, this eliminates accidental damage to a transistor from induced voltages on the case, etc. However, the AC-operated VTVM can be used on most transistor circuitry.

The Transistor Tester

The one new instrument needed to service solid-state circuitry is a transistor tester. There are several on the market from all major test-equipment manufacturers. Those we

have checked have done a fine job. Tests of transistors in-circuit show that these testers detect malfunctioning transistors in everything from an audio amplifier to a MATV line amplifier. Even with very low-resistance shunts in the circuit, they read the beta of a transistor with accuracy.

Most transistor testers can detect transistor leakage down to 1.0 microampere. This is invaluable especially in such circuits as AGC and sync separators. Collector-to-base leakage, (I_{cbo}) is the most bothersome, since it upsets the bias. This test must be made out of circuit since there are always resistors in shunt across these elements. Germanium transistors have a small amount of natural leakage. Silicon transistors have none, and even a leakage as low as 10-15 microamperes is enough to cause trouble. The major symptom of this would be low gain or no gain and usually a severe voltage upset. Beta often checks close to normal. However, the voltages and/or currents give a clue. For example, a vertical-output transistor may show excessive collector current and low output, and the bias controls have practically no effect on this current since the transistor itself is leaky.

Safety note: When checking any transistor in a set with an AC power supply, be sure that the set's AC power cord is out of the socket. This eliminates any chance of some kind of odd circuit forming between the set and tester chassis. Although this may be rare, making transistor tests with both the set and tester plugged into the AC line, even with the set switched off, can result in a blown transistor or even a blown tester.

Hand Tools and Others

There are only a few additional tools needed. One is a good sharp pointed pick. A needle point test prod with no wire should suffice. A pair of small long-nosed and diagonals, or tweezers, and a couple of nylon sticks (alignment tools, etc., for punching and probing around in transistor circuits without the danger of a short) are needed.

A solder-sucker type of soldering iron is almost a necessity for PC board work, especially for removing parts with more than one terminal, like IC's, IF transformers,

filter capacitors, etc. The soldering iron and air hose method to blow the melted solder away is often used, but this is messy.

There are other tools that are not necessary but useful. A short test lead with needle-point test prod on each end is used to bridge PC board conductors suspected of having hair-line breaks, etc. If this completed the circuit, take the fine-pointed soldering iron and run a thin coat of solder all the way down this conductor. This will bridge all hairline breaks, including the ones not seen.

Needle point test prods on VOM or VTVM and ohmmeter penetrate PC boards coated with moisture-resistant varnish. Blunt test prods will not penetrate such a coating to detect resistance or voltage, and, thus, will give a false open-circuit reading. Stout alligator clips on the common leads of the voltmeters, etc., must have a strong grip to make a tight, low-resistance ground connection.

Short test leads with miniature alligator clips on each end are used for making temporary connections of parts or even transistors for testing. If all the solder joints are rounded off so the clips will not hold, tack short (1/4" or so) pieces of solid wire on each. Bend a little hook on the end and the clips will hold. If need be, these can be left in place if they will not cause a short. Small scraps or wire clipped off resistors and capacitors are ideal.

A small, powerful, pen-light flashlight is used for spotting parts or solder joints on the other side of a PC board. Hold the light on the end of the resistor wanted; its solder terminal will then show up in the center of a spot of light on the underside of the board.

Voltage Measurements: Why and How

In the typical transistor stage, there will be a voltage on the collector, either from an external power supply source or developed by current flow through a resistor. Fig. 18 shows these two types of voltage source. (The only difference between the methods shown is the polarity of the voltage. The electron flow enters negative ends of the load resistor, as shown.)

If the transistor is working, collector current is flowing. If collector current is flowing, there will be a

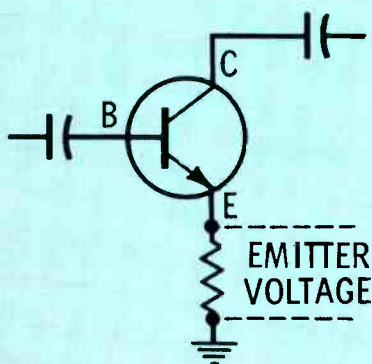

Fig. 20. Emitter voltage provides a simple test of transistor's operational status.

Know why RCA's color chassis are so easy to service?



Because service men like you helped us design them.

First we got their advice, then we designed the whole assembly for easy servicing. For example, the chassis give you easy access. You don't have to pull out the chassis to get at the high-line voltage connection. Circuits and components on the circuit board are clearly marked so you can easily service them. The tuner assemblies are simplified for your convenience. And, we set up more test points. They're the kind of chassis we think you'd design yourself. Fact is, all our chassis designs are reviewed by a representative group of servicemen. And we appreciate their advice. We think you will, too—every time you service sets by RCA.

RCA

Circle 11 on literature card

September, 1968/PF REPORTER 21

voltage drop across the load resistor. This will be shown in the form of a positive or negative voltage to ground; read the voltage at the collector.

There is also a voltage on the base. This can come from a voltage divider, an external voltage source (AGC, etc.) or the base current flowing through a resistor to ground, as in Fig. 19. In all cases, if this voltage is different from what the schematic calls for, investigate.

Watch for test conditions also. In practically all cases the DC voltages found on the schematic are taken with no signal input to the receiver. In many stages, such as AGC, IF's sync separators and even in some audio stages, the voltages with signal present will be different from the no-signal voltages.

The emitter voltage, as shown in Fig. 20, is used by many transistor technicians as an indication that the transistor is operating — current flowing through the emitter resistor, which in this case is identical to the cathode resistor used in tube circuits. If there is no voltage drop across this resistor, no current is flowing, and the transistor is not operating. In the frequently used

common emitter stages, the emitter voltage of each transistor can be checked in stages such as the video IF. When no voltage is found, the trouble has been located. The opposite reaction is useful, too. If the emitter voltage reads higher than it is rated, there is a defect in the circuit. Bias voltage is always read between the emitter and the base, which is the same as reading bias between the cathode and grid of a tube.

Following is a description of what happens when the bias changes:

PNP: Base goes more negative for higher collector current.

NPN: Base goes more positive for higher collector current. In tube circuits, if the grid becomes more positive, a higher plate current is drawn and vice versa. Due to the different types of transistors used, there can be a higher collector current for either polarity, depending on what type of transistor is in the circuit (NPN or PNP).

Another important point: a tube at zero-bias will draw a high current. If a transistor is at zero bias (zero voltage difference between base and emitter), it will cease to function. No collector current will

flow, no emitter current will flow, so the voltage-drops across the respective resistors will be incorrect. As a good test, read the voltage between emitter and base on a low scale on the meter—as low as 0.2 volt, or lower. The schematic will state what the normal voltage difference should be. Subtract one from the other to get the bias, e.g., with 5.2 volts on the emitter and 5.6 volts on the base, the bias is 0.4 volts. This can be either positive or negative, depending on the type of transistor. The actual bias also depends on the type of semiconductor used. Silicon transistors will average about 0.6 volt; germanium about 0.2 volt.

Circumstances alter cases. The preceding figures are for a typical amplifier operating Class A. For instance, a transistor with zero bias should be checked to see if it is being used as a sync-separator, etc. If so, zero bias is normal since the transistor should be cut off to prevent the video signal from getting through. Only the sync-tips drive it into conduction, thus clipping the sync, which is the correct action.

Hints for Transistor Testing

To check collector currents in big power transistors, remove one of the two screws holding the collector (case) to the socket (Fig. 21.) Be sure that all wiring connections are made to this screw. Now that the collector circuit is broken, connect the milliammeter between the two terminal lugs as shown, and you will directly read the collector current. The remaining screw makes contact to the collector.

When removing a transistor TV from the cabinet, be sure to connect at least two jumper leads between the chassis and the CRT mounting. When such sets are turned on, the high voltage comes on instantly. There is always the chance of an arc to the chassis, and the resulting spike or transient can cause damage to the output or other transistors.

Check the settings of the vertical size, linearity and hold controls. If these have been turned far from their normal settings, they can cause the vertical-output stage to draw a high current—often enough to trip the circuit breaker. (Since there are actually no defective parts or shorts, this trouble symptom can be time

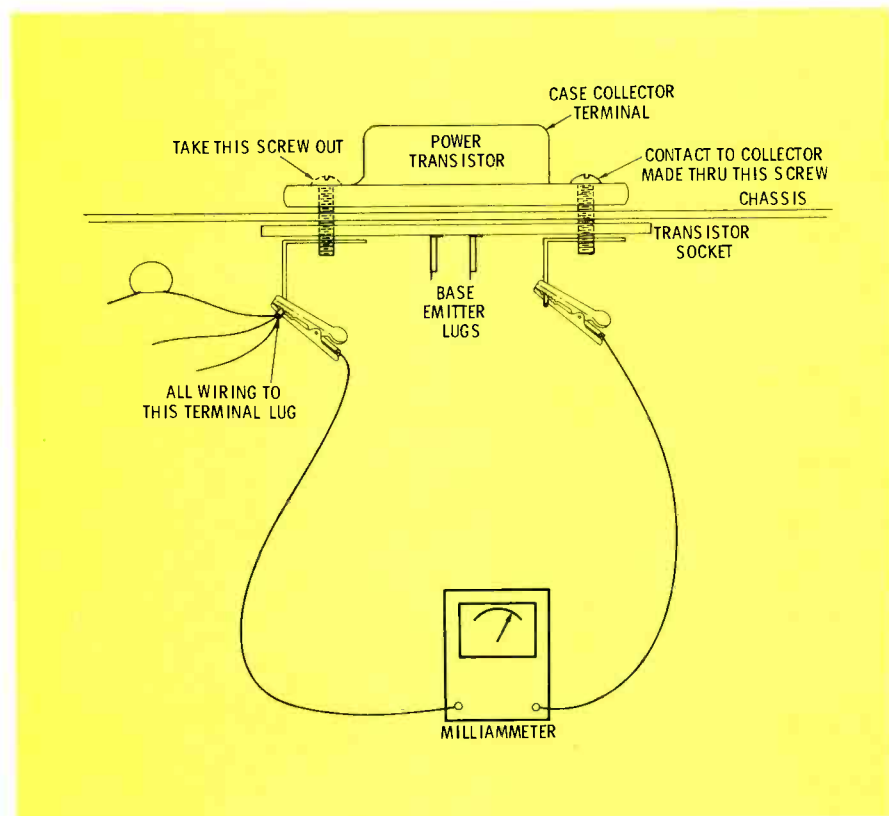
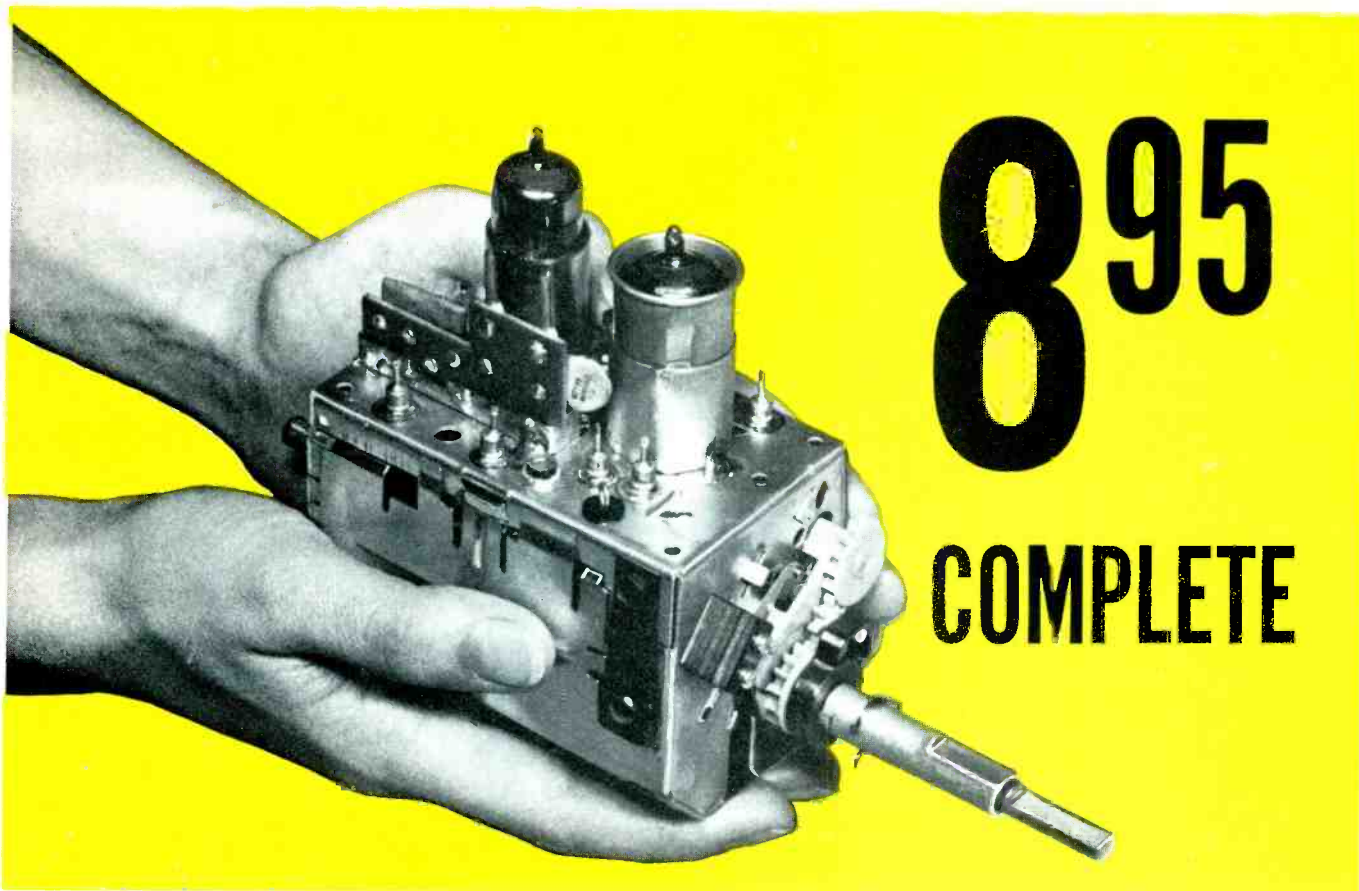

Fig. 21. Removing screw at end of socket where wiring is attached and connecting milliammeter across to other screw provides quick test of collector current.



895 COMPLETE

Castle, the pioneer of television tuner overhauling, offers the following services to solve ALL your television tuner problems.

● **OVERHAUL SERVICE** — All makes and models.

- VHF or UHF tuner \$9.95
- UHF-VHF combination (one piece chassis) \$9.95
- TRANSISTOR tuner \$9.95
- COLOR tuner \$9.95
(Guaranteed color alignment . . . no additional charge)

Overhaul includes parts, except tubes and transistors.

Simply send us the defective tuner complete; include tubes, shield cover and any damaged parts with model number and complaint. Your tuner will be expertly overhauled and returned promptly, performance restored, aligned to original standards and warranted for 90 days.

UV combination tuner must be single chassis type; dismantle tandem UHF and VHF tuners and send in the defective unit only.

And remember—for over a decade Castle has been the leader in this specialized field . . . your assurance of the best in TV tuner overhauling.

● **CUSTOM REPLACEMENTS**

Exact replacements are available for tuners that our inspection reveals are unfit for overhaul. As low as \$12.95 exchange. (Replacements are new or rebuilt.)

● **UNIVERSAL REPLACEMENTS**

Prefer to do it yourself?

Castle universal replacement tuners are available with the following specifications.

STOCK No.	HEATERS	SHAFT		I.F. OUTPUT		PRICE
		Min.*	Max.*	Snd.	Pic.	
CR6P	Parallel 6.3v	1¾"	3"	41.25	45.75	8.95
CR7S	Series 600mA	1¾"	3"	41.25	45.75	9.50
CR9S	Series 450mA	1¾"	3"	41.25	45.75	9.50
CR6XL	Parallel 6.3v	2½"	12"	41.25	45.75	10.45
CR7XL	Series 600mA	2½"	12"	41.25	45.75	11.00
CR9XL	Series 450mA	2½"	12"	41.25	45.75	11.00

*Selector shaft length measured from tuner front apron to extreme tip of shaft.

These Castle replacement tuners are all equipped with memory fine tuning, UHF position with plug input for UHF tuner, rear shaft extension and switch for remote control motor drive . . . they come complete with hardware and component kit to adapt for use in thousands of popular TV receivers.

Order universal replacements out of Main Plant (Chicago) only.



CASTLE TV TUNER SERVICE, INC.

MAIN PLANT: 5701 N. Western Ave., Chicago, Illinois 60645
EAST: 41-90 Vernon Blvd., Long Island City, N.Y. 11101

Circle 25 on literature card

consuming). As a quick check of the vertical oscillator: connect the scope to the vertical circuit and set the scope to AC line sweep (60 Hz). If there is only one waveform, the circuit is all right. If there is more than one cycle, or only a half-cycle, etc., the vertical oscillator is off frequency.

When testing stereo amplifiers, tie the two inputs together and feed in an audio signal. Next, go through each stage of the circuit, comparing signal levels at the input and output

of each stage in the two channels. This cross-checking simplifies stereo testing. If there are no signals in either channel, there is probably a lack of power.

The IC should not be suspected until all other possibilities have been exhausted. Check signals and voltages through the whole circuit, as the trouble could be in a bad transformer, resistor, voltage supply, or something external.

The typical TV set now uses a great many diodes. Even in tube-

type receivers there may be as many as 17. They can leak, short or open, just like a transistor. The transistor tester can check a great many of these in-circuit. For a definite leakage test, one end of the diode must be lifted, as with the transistor, to get away from the shunting resistance which is always present.

General Replacement Transistors

As stated in the beginning, there will be a great many cases where general replacement transistors will work well. The best test is to just try them, and if there is any meaningful loss of gain, power, etc., it will be noticed. In TV circuits any change can be seen.

When replacing unknown transistors, find out as much as possible about the circuit. A schematic will show the type, NPN or PNP. From this, or by checking the battery used, the maximum voltage is known. Then, from the application (RF, IF, audio, etc.), a similar transistor may be found in the general-replacement catalogues.

An example would be the IF transistor in a broadcast radio. RCA's catalog shows that SK-3005, 3006, 3007 and 3008 are PNP germanium types, rated 12-15 volts. General Electric's catalog shows the GE-1 (PNP) and the GE-5, GE-6 and GE-7 (NPN's), also rated at 12-15 volts. If the set uses a 9-volt battery, a substitute transistor of the proper type can be used. A test transistor can be attached temporarily to the proper connections on the bottom of the board.

Conclusion

The need now is for the really skilled technician in electronics maintenance. It is necessary to know the circuitry, its function, why and how. Learn to look for the function that isn't there—horizontal sweep, high voltage, vertical sweep, signal, etc. This should isolate the area of the trouble, and from here stage by stage tests will pinpoint the difficulty. Circuits used with transistors are no more complex than the ones used in tube sets. The only major difference is the voltage level and polarity such as -4 instead of 400.

Those who are willing to learn the circuits and apply this knowledge will have a definite advantage over those who are not. ▲

DISHONEST

“ You might think so when you see Mercury's unbelievable values. You get all the equipment you need for fast, accurate, profitable Color TV servicing at low, low prices. We tell it like it is. ”

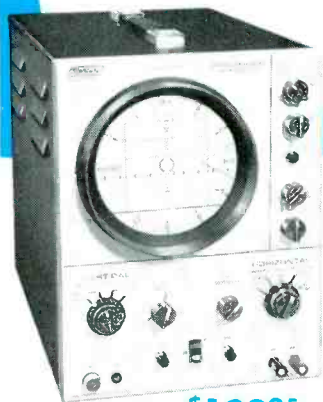

Kit—\$10995
Wired—\$15995

Model 3000—5" High Sensitivity 5 Mc OSCILLOSCOPE-VECTORSCOPE
Precision engineered to fill all your requirements for waveform observation—Color and B/W. Top quality construction and circuitry make model 3000 ideal for TV technicians, electronic experimenters, development engineers as well as for applications in Technical Schools and Industry. Includes Vectorscope calibrations on the calibrated Graticule, permitting vectorscope analysis through access to the deflection plates at rear of unit. A significant analysis tool in Color TV servicing. VERTICAL AMPLIFIER: Sensitivity—10 Mv RMS/Cm • Frequency Response—10 Hz to 5 Mc \pm 3 Db • Rise Time—0.08 Microsecond. HORIZONTAL AMPLIFIER: Frequency Response—5 Hz to 500 KHz \pm 3 Db • Sweep Range—5 Hz to 500 KHz, continuously adjustable.



Model 1901—Solid State, Battery Operated COLOR GENERATOR

Offers every essential feature needed to install and service Color TV. Pre-tested rock solid pattern stability under extremes of heat and cold. Exclusive: Line Width and Dot Size Adjustment • Crystal Controlled • Gun Killers.

\$8495 (Available in AC operated model—\$9995)

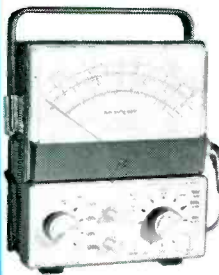

Model 4000—FIELD EFFECT VOLT-OHM-MILLIAMMETER—6" METER

High impedance, Solid State unit assures instant operation and permanent operating stability. Combines advantages of standard VTVM and FET circuitry. DC current ranges up to 1 Amp. Operates on both AC and Battery.

\$6995

ALL MERCURY TEST EQUIPMENT GUARANTEED FOR ONE FULL YEAR!
UPDATED TUBE TEST DATA AVAILABLE ON ALL UNITS.



MERCURY ELECTRONICS CORPORATION
315 ROSLYN ROAD, MINEOLA, N. Y. 11501 • (516) 742-5400
CANADA: WILLIAM COHEN CORP., 8900 PARK AVE., MONTREAL 11
EXPORT: SINGER PRODUCTS CO., INC., 95 BROAD ST., N. Y. C. 10004, U. S. A.

Circle 13 on literature card

ANNOUNCING NEW

CHANNEL MASTER

COLOR VECTOR
ANTENNAS

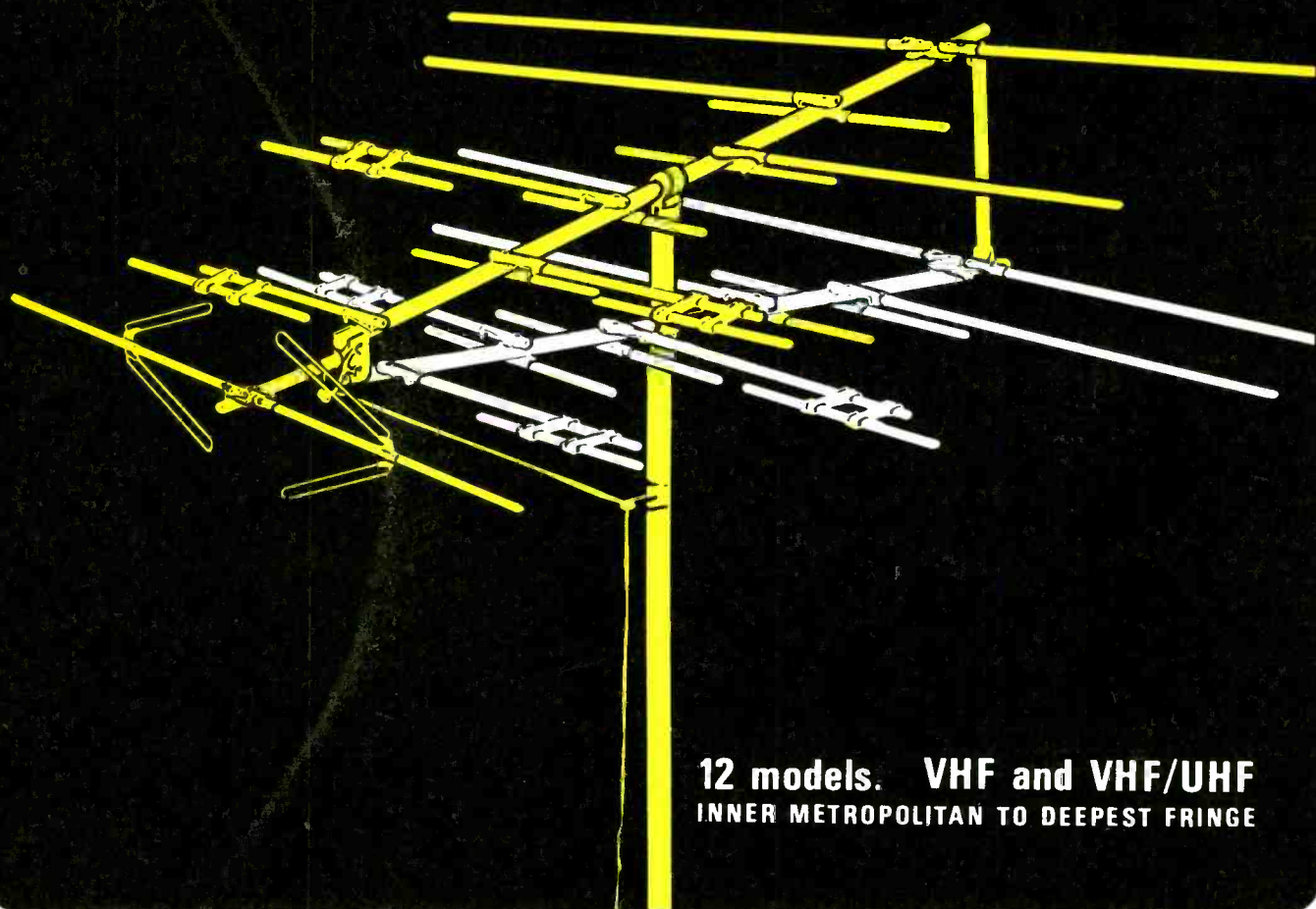

12 models. VHF and VHF/UHF
INNER METROPOLITAN TO DEEPEST FRINGE

Antennas as revolutionary in performance as they are in appearance. And, to introduce them, your Channel Master Distributor has an unprecedented promotion and profit program. Call him today.

CHANNEL MASTER
DIVISION OF AVNET, INC. Ellenville, N.Y.

© 1968 Channel Master, Div. of Avnet, Inc.

Circle 14 on literature card

September, 1968/PF REPORTER 25

Stage-by-stage gain testing

A method for quicker localization of trouble in transistorized circuitry

Technological advances are wonderful, but sometimes they cause a lot of new problems while they are solving old ones. Transistors and printed-circuit (PC) boards did just that for the harassed electronics technicians. They are hard to fix. I have diagnosed and repaired thousands of tube radios in less than 10 minutes; I would like to see someone do that consistently with a transistor radio.

However, printed circuits are here and we can't lick 'em, so we must join 'em. We must work out a practical method of diagnosing and repairing trouble in this equipment if we are going to remain competitive in the service business.

Learn From The Past

History often shows us the answer to a "modern" problem. Away back in the late 1930's, we used a service method that was fast and reliable—signal tracing. This servicing technique has a fine, logical basis. Electronic equipment is inherently logical; therefore, service methods are based on logic.

Every type of electronic equipment handles a signal of some type. The signal goes in at the front and comes out at the other end, usually much larger—the signal-path is always a series circuit. When there is a fault, the signal-path is broken, we have input, but no output. In order to effectively repair, we must locate the break in the signal-path—find out where the signal stops—in the shortest possible time. Once we locate this point, we make voltage tests, component checks, etc., until we find the defective part.

In audio amplifiers, we have an AF signal. In radios, RF/IF and audio. In TV sets, RF/IF, video, sync, color, sweep, etc., but all this is just more of the same. Each circuit has its own specific signal-path. This fact can be used to lead us to

the source of the trouble in the least possible time—if we use the proper test instruments.

A Two-Way Process

There are two types of test methods that use a signal. The original, called signal tracing, used a test signal applied to the input. This signal was followed through the circuits with special indicating instruments—tuned RF voltmeters, AF voltmeters, etc. The main path of such tests is from "front to back", starting at the input and working stage by stage toward the output.

(There were several special "signal-tracers" built for use on radios: the old Hickok 155 "Traceometer" with three tuned VTVM's—RF/IF, oscillator, and AF; the Meissner "Analyst"; and the Rider "Channelyst", which used magic-eye tubes, etc. A lot of this old equipment has been reclaimed and returned to service. Several test instrument manufacturers are designing new versions.)

There is another servicing technique that uses a signal; it is called "signal substitution" and is possibly a little simpler than "signal-tracing", requiring less equipment. Basically, you start at the back (output) and work toward the front. You can use the set's own "output indicator" (picture tube, speaker, etc.) or a meter or oscilloscope. All that is needed for signal substitution is the right test-signal: AF for audio stages and video stages, modulated RF for RF and IF, a color-bar pattern for color circuits, etc. The signal is fed to the input of the last stage, and the output noted. Then, the signal is moved to the input of the preceding stage, and the amount of increase in output noted. This is followed all the way back to the input, reducing the level of the test signal each time, as required.

With an identifiable test signal,

this method will show you exactly where the signal stops or has a loss in gain. All you need to do is look for an increase in output each time the probe of the indicating device is moved to the output of the succeeding stage.

Stage-By-Stage Gain Figures

To use this method, we need some data. Experience will soon tell us about how much gain should be expected through a given stage. However, if the stage-by-stage gain data is given on the schematic, it will be a big help. For instance, in the video amplifier of Fig. 1., you can see that there is 0.9-volt p-p on the base of Q4, the 1st video amplifier, and 0.8-volt on the base of Q5, the video-output transistor. The output on Q5's collector is 50 volt p-p.

There appears to be little or no gain through the 1st video amplifier, in fact, a slight loss. That's right. No voltage gain, but the normal input and output signal levels, and that's all you need. The input stage and output stage are direct-coupled, and there is a current gain; however, there is no resistor to develop a voltage drop across.

The video-output stage employed in the same chassis has voltage gain in large quantities; a 0.8-volt p-p input comes out as a 50-volt p-p output—a gain of roughly 60.

You will run into the same situation in audio circuits, particularly direct-coupled stages. However, using a signal-substitution, and starting with a known signal value such as the output signal to the speaker, excellent results can be obtained. As we go along, we will give you some values that will be close to normal for most circuits.

For instance, the General Electric T-25 transistor amplifier has five transistors per channel. Fig. 2 shows one channel. The voltage values as given in the General Elec-

in solid-state TV by Jack Darr

by Jack Darr

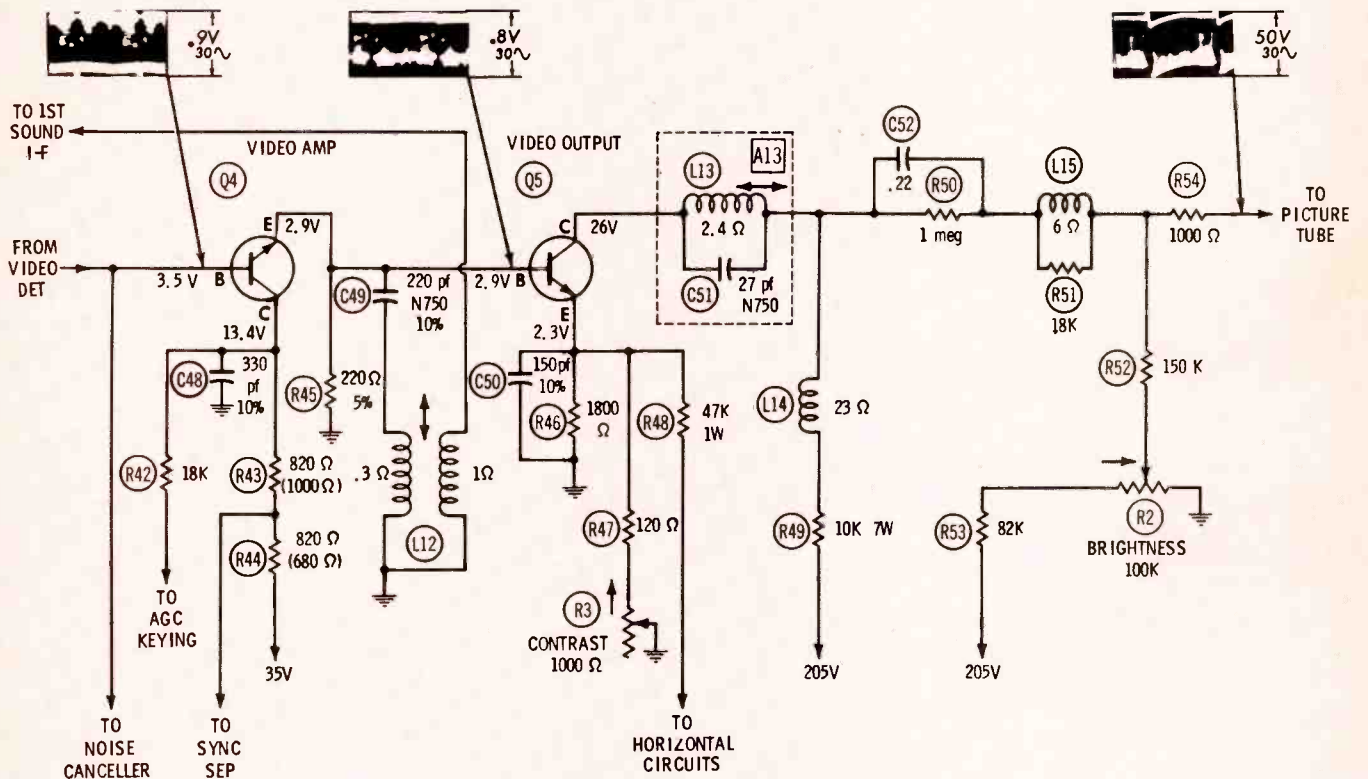

Fig. 1. First video amplifier indicates voltage loss.

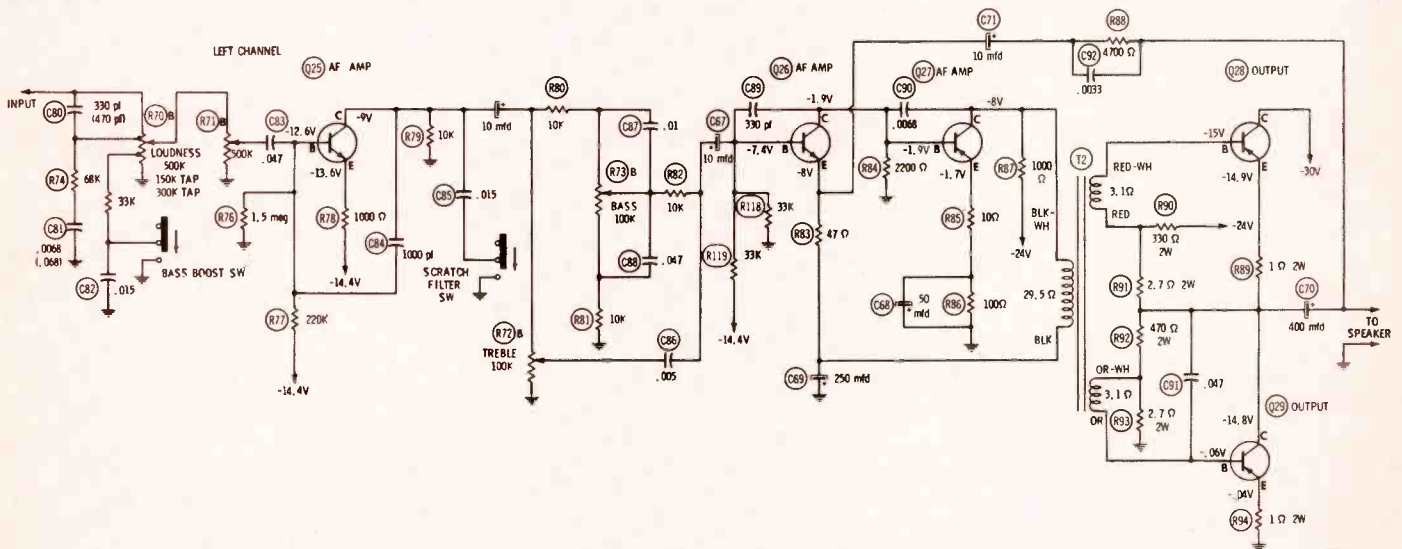

Fig. 2. Five-transistor amplifier delivers 8.5 volts to speaker with 50-mv input.

tric service manual, are shown in Table 1:

Table 1

Across the speaker	8.5v.
Q28/Q29 bases	2.0v.
Q27 collector	6.0v.
Q27 base, Q26 collector	40 mv.
Q26 base	40 mv.
Q25 collector	250 mv.
Q25 base (input)	50 mv.

All of these voltages are rms, although it makes no difference which one you use, rms or p-p. What we are looking for in this type of test procedure is the ratio between input and output signal.

Notice that here, too, we have an apparent "no gain" situation in Q26—40 mv on base and collector. However, this stage has unity gain or "one" and we should get the same levels at the input and the output. The collector is direct-coupled to the base of Q27, so the voltage gain is small, but the current gain is normal.

Also, note the loss as the signal proceeds through the tone-control circuits: 250 mv on the collector of Q25, and only 40 mv on the base of the following stage (Q26). This is normal in many transistorized tone-control circuits, because of the low impedances. However, the pre-amplifier stage, Q25, has a voltage gain of 5, with a 50-mv input and 250-mv output.

Test Voltage Levels

At this time, it would be a good idea to go over some actual test-voltage levels. There is no universally accepted standard for this, although a lot of manufacturers seem to use 50-mv input, as you can see from the figures above. However, this is pretty small, especially for accurate reading with service-type equipment.

We do not want to use a very high signal level at the input; excessive signal will cause overloading of the

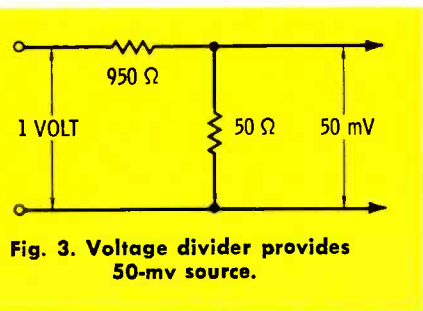

Fig. 3. Voltage divider provides 50-mv source.

transistors in the output, etc. During actual tests of assorted mono and stereo cartridges, we obtained the following output signal-levels using a 1,000-Hz tone from a test record as a source: FET voltmeter—15-megohms input impedance, 0.7 volts rms; tube VTVM—11-megohm input, 0.6 volts rms; scope, direct probe—1.8 volts p-p. These readings were taken with the cartridge output disconnected from the amplifier. With the cartridge connected to a low-impedance input, the readings would have been lower.

You will be safe in using a more readable level of voltage for testing—something like 0.5 volt rms fed to the input. Use the smallest "readable deflection" possible to be on the safe side. If you prefer a 50-mv signal, you can get one quite easily. Construct a voltage divider using a 950- and 50-ohm resistor in series, and apply one volt of audio across the circuit. You will have a low-impedance source of 50-mv developed across the 50-ohm resistor (See Fig. 3). You can use any value of resistors you want, as long as you keep the 950-50 ratio.

No Weak Stages

There is one thing about transistor circuitry: weak stages are rare. If a transistor is defective, it usually either shorts or opens. Even with a high leakage condition (I_{CEO} , I_{CBO}), the resultant upset of the bias will usually kill the gain because the base can no longer control the collector current. Therefore, we hunt for a stage with normal input, but distorted or reduced output.

AM Radio Checking

AM radios can be signal-traced in much the same manner as that discussed previously. For example, in one such circuit (Fig. 4), we find the values shown in Table 2.

TABLE 2

Detector output (Audio, 1-kHz)	30 mv.
2nd IF transistor base (455-kHz, 30% modulated)	1500 μ v.
1st IF transistor base	50 μ v.
Converter base	6.0 μ v.
Antenna input (1,000-kHz, 30% modulated)	90 μ v.

Here again, we do not have to have an absolutely accurate RF signal. We can use the voltage-gain

ratios of each stage as we check back through the IF and RF stages (we are assuming that the audio stage has been checked out as previously described). For example, the 1st IF stage has a voltage gain of 1500/50, or 30 times; from the converter base to 1st IF base, 50/6, or 8 times, etc. Even if your RF signal generator does not have a well-calibrated output attenuator, you will soon learn what amplitude of RF voltages is "normal" for each stage.

FM Radios

In a typical FM radio, we find values similar to those in Table 3.

Table 3

Limiter base (10.7-MHz, AM)	80,000 μ v.
3rd IF base	8,000 μ v.
2nd IF base	800 μ v.
1st IF base	55 μ v.
Mixer base	60 μ v.
RF amplifier base (98.0 MHz, AM)	5 μ v.

Very few of us have "microvolters" or an RF generator with an accurately calibrated output. So, we must find a way to do without such instruments. Actually, as we said before, all that is needed is the voltage gain ratio between the input and output of a given stage. To obtain an indication of this ratio, connect an output indicator (scope, FET-VM, VTVM, or VOM) to point A in Fig. 4, which is the schematic of the FM receiver from which were taken the gain figures in Table 3. Connect the RF signal generator to the base of the limiter (X8) through a DC-blocking capacitor. Set the signal generator to 10.7 MHz, (0% modulation) and adjust the RF output to show any readable deflection on the meter—1.0 volt, 0.5 volt, 0.1 volt or whatever is "comfortable" for you. Note the attenuator setting of the signal generator. This may not be 80,000 μ v, but that is what we are going to use it for. It is our "standard."

Next, move the signal generator output back to the base of the 3rd IF stage. The meter reading should increase appreciably. In fact, if the 3rd IF stage has normal gain (80,000/8,000=10) you should have to turn the step attenuator of the signal generator from X100 back to X10 (divide output by 10) to get approximately the same meter reading you had originally. That is all

Marketing axiom number 1:

SELL WHERE YOU BUY.



Chances are you or somebody in your company uses the Yellow Pages regularly to buy supplies or services you need to do business. A study of just manufacturing firms alone proved 9 out of 10 buyers do. That's why the Yellow Pages is such a good place to reach business prospects with *your own* advertising. Sell where you buy. It's good business.

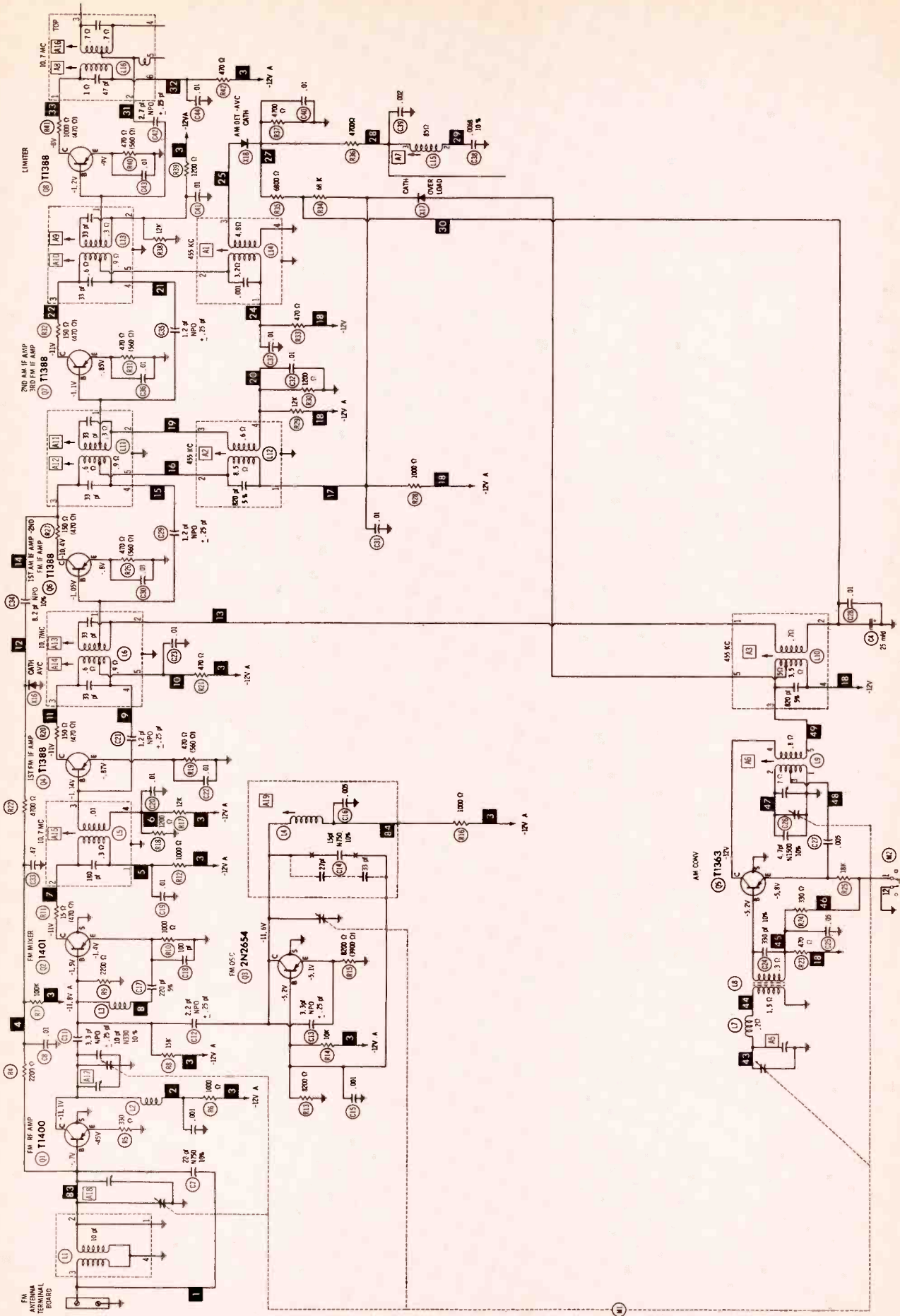

Fig. 4. Transistor radio employs the same transistors for AM or FM IF amplification.

there is to it; proceed through the rest of the stages, following the same procedure. To make the meter indication easier to read, you can adjust the signal generator output when you determine the "comfortable" output for that stage. All of the tests discussed in this article can be made "one stage at a time," so we can adjust the instruments to read the gain of only a single stage.

The average shop-type RF signal generator probably will not produce a signal level low enough to give an accurate 30- to 40-mv level; this is because of leakage around the output attenuator, stray capacitance, etc. However, if you require a weaker signal, loosen the coupling and, instead of making a direct connection to the input of a stage, clip the signal-generator output to something near (proximity coupling) the input.

This procedure is particularly helpful for checking RF stages; if you cannot direct-couple a 90-MHz RF signal to the RF transistor base, you can obtain ample signal by simply laying the end of the RF output cable on the bench near the antenna (loop). Just make sure that it is clipped to something solid (and insulated, of course) so that it cannot change position, which changes the coupling and, consequently, the level of the input signal.

Notice that in both the AM and FM RF/IF circuits we do get a voltage gain through each stage—which makes things a lot easier. Troubles in these circuits are usually caused by open IF transformers, leaking capacitors, bad resistors, or leaky transistors. Also, AGC trouble will affect the overall gain of all controlled IF stages. However, the AGC circuit can be clamped in the same manner as in TV AGC circuits. Check the normal bias voltage shown in the schematic with no signal input; this is the maximum gain condition for IF amplifier stages.

The actual test procedure requires less time than it takes to read about it. After connecting the test equipment and locating the proper test points, you can proceed through the circuits very quickly and isolate the defective stage in a minimum amount of time. As in TV IF testing, we can shortcut the test procedure by injecting a very weak signal into the input of the IF stages and listen-

ing for a strong "beep" from the audio output. If you get nothing through the IF at all, begin the stage gain tests.

Gain Checking in Transistor TV

A transistor TV set is no more difficult to signal trace than any other type of solid-state equipment—there are more signals, not different ones. They are all "signals," no matter how you define them.

The fastest way of servicing transistor TV is by "function," which is

the same method you have been using for years; you look at the defective unit and find out what is not working—picture, sound, sync, etc. Then, through the process of elimination, you go direct to the stage(s) that relates to that function.

The Scope

Because we do have separate signals now, (sound, video, sync, etc.) we have to use a test instrument that will tell us the shape of the signal, as well as how much there is of it. The only instrument capable of

Now—Compare CRT Color Guns AUTOMATICALLY!

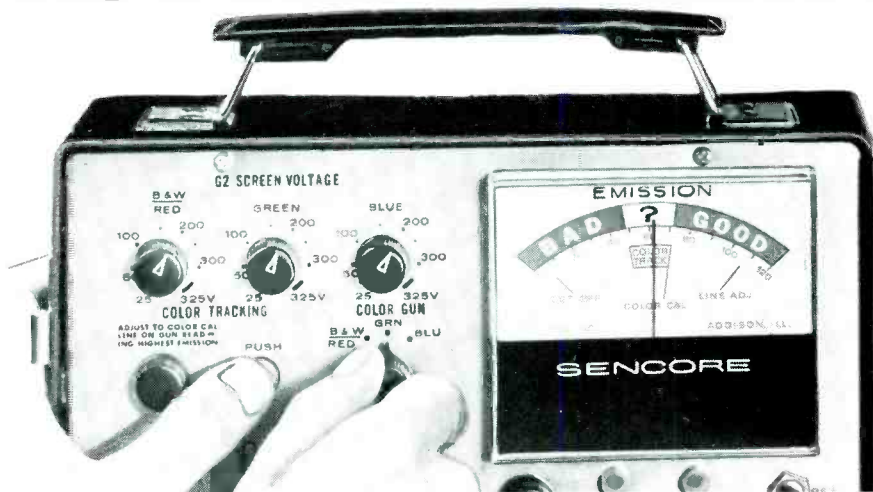

- Simplifies Color CRT Tracking Test
- Tests Each Gun in Color or B&W CRT's Completely

Now, for the first time, you can test CRT color guns for color tracking automatically; and exactly according to industry standards. No more time-consuming logging of each color gun reading at every setting of the G2 control like other testers.

Only the Sencore CRT CHAMPION has three separate G2 screen grid controls just like the color TV itself. A color tracking scale right on the meter makes the all-important tracking test easy, fast, and accurate. This is most important when claiming credit for a defective color CRT.

The CHAMPION also makes all the standard color and black and white CRT tests—short, emission, and life tests. Line Adjust control assures exceptional accuracy. An exclusive three step Automatic Rejuvenation Circuit lets you save many a faulty black and white tube or equalize gun currents in color tubes. Plug-in sockets are provided for fast testing and easy updating. Rugged vinyl-clad steel case has spacious lead compartment.

CRT manufacturers, set manufacturers, distributors, technicians all recommend the CR143 CRT tester as the only tester that does a complete job. Why not check with them before you buy.

Sencore CR143—CRT CHAMPION ...\$99.50



SENCORE

NO. 1 MANUFACTURER OF ELECTRONIC MAINTENANCE EQUIPMENT

426 SOUTH WESTGATE DRIVE, ADDISON, ILLINOIS 60101

Circle 15 on literature card

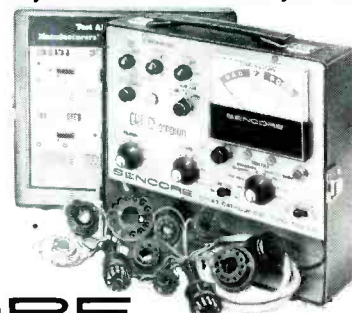

this is the scope. Even a very accurate peak-to-peak VTVM can tell us only that we have a certain amplitude at a specific test point, it cannot tell us the shape of the waveform. It could be video, audio, or even hum. Only the scope can tell us whether we are actually measuring the correct signal.

Because the scope is basically a "comparison" instrument, you can make very rapid gain checks with it. Touch the scope probe to the input and output of a stage, and you have your information. If the input shows

a 0.25" (vertical) pattern, and the output a 2.5" pattern, the stage has a gain of 10.

The scope is an ideal "output indicator"; use it as the VTVM was used in the radio tests discussed previously. Connect it to the output of the circuit—CRT cathode for example. Next, adjust the scope controls for a "usable" pattern. You can then check the preceding stage for gain by simple moving the scope probe to the input of the preceding stage, and noting the decrease in pattern height. Assume

the circuit under discussion is a video amplifier with a normal voltage gain of 50, as in the example previously given. The difference between the input and the output patterns should be representative of 50 times, the output being 50 times greater than the input (approximately).

We do not have to make absolute gain measurements with the scope. (Or with any of the previously mentioned indicators, for that matter.) What we are looking for during the initial tests is a stage that has no gain at all, or one with a distorted pattern or greatly decreased gain. Connect the probe of the scope to the input and output of the stage, and look for an unusually large difference in pattern height. When testing a multi-stage circuit, you need to touch the probe to only two points per stage—signal input and output. This will tell you what you must know, or, at what point the signal disappeared.

Service Data: Location of Parts and Stages

Last, but definitely not least, is the most important thing of all—service data. For the most efficient service, you must have complete, accurate service data; not only a schematic diagram, but also a phantom-view and photographs of the actual chassis. Without this, you are greatly handicapped in the performance of any servicing technique. That is, as far as making any money is concerned. As an experiment, I tried to "cold turkey" a little import auto radio without a schematic, photo or any data at all; the results—almost 4 hours of bench time. (Approximately twice the value of the whole radio.) The same thing happened on other "experiments" with portables, etc. Out of several units, the only one that was fixed in anything like a reasonable time was a small three-transistor phono amplifier that had a shorted rectifier.

Summary

If you are going to be able to profitably service transistorized equipment, you must develop and use a practical servicing method that will permit you to find faults and repair them in the *shortest* possible time. The method described in this article is one that works for me, and I think it will work for you. ▲

TEST WITH THE BEST

POCKET-SIZE CIRCUIT TESTER U-50b



- Meter movement of 35 microamperes, safeguarded by a protection circuit.
- Reading error eliminated by battery sheaths.
- Shunt adapter separately available.

MEASUREMENT RANGES

DC voltage : 0.1V 0.5V 5V 50V 250V 1000V (20k Ω/V)
 AC voltage : 2.5V 10V 50V 250V 1000V (8k Ω/V)
 DC current : 50μA 0.5mA 5mA 50mA 250mA
 Resistance : Range - RX1 RX10 RX100 RX1K
 Midscale - 50Ω 500Ω 5kΩ 50kΩ
 Maximum - 5kΩ 50kΩ 500kΩ 5MΩ
 Volume level : -20~+62dB

Allowance. ±3% for DC and ohm ranges
 ±4% for AC ranges

Batteries. Two 1.5V dry cells (UM-3 or equivalent)

Size and weight. 131×89×41mm & 425 gr

Accessories available. Shunt adapter High voltage probe
 Clip adapter Carrying case

VERSATILE MULTITESTER 501-ZTRb

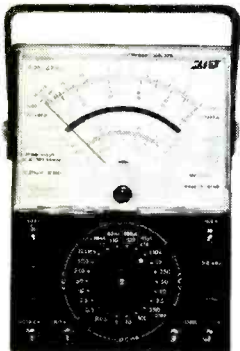

- Meter movement safeguarded by a silicon-diode protection circuit.
- Standard HV probe.
- Polarity reversing switch.
- Germanium diode rectifier.
- Extended coverage of frequency response (100 kHz).

MEASUREMENT RANGES

DC voltage : 0.25V 0.5V 2.5V 10V 50V 250V 500V 1kV 5kV
 25kV (with probe) · 20k Ω/V
 AC voltage : 2.5V 10V 50V 250V 1kV · 4k Ω/V
 DC current : 50μA 1mA 10mA 100mA 250mA 10A · 250mV
 Resistance : Range - ×1 ×10 ×100 ×1K ×10K
 Midscale - 34Ω 340Ω 3.4kΩ 34kΩ 340kΩ
 Maximum - 5kΩ 50kΩ 500kΩ 5MΩ 50MΩ
 LI : Maximum - 85mA 8.5mA 850μA 85μA ...
 LV : Maximum - 3V 3V 3V 3V (25V)
 Volume level : -10~+22dB +36~+50~+62dB

Allowance. ±2% for DC and ohm ranges
 ±3% for AC ranges

Batteries. Two 1.5V (UM-2, or equivalent) and one 22.5V (BL-015) dry cells.

Size and weight. 195×152×85mm & 1100 gr

For detailed information, write today.

Universal Enterprises, Inc.

P.O. Box 25392 · Portland, Oregon 97225
 Cable Address : Universal Portland, Oregon

Test with the Best—Test with a Sanwa

SANWA SANWA ELECTRIC
 INSTRUMENT CO., LTD.

Dempa Bldg., 2-chome, Sotokanda, Chiyoda-ku, Tokyo, Japan. Cable: "SANWAMETER TOKYO"

Circle 16 on literature card



Join "THE TROUBLESHOOTERS"

who get paid top salaries for keeping today's electronic world running

Suddenly the whole world is going electronic! And behind the microwave towers, push-button phones, computers, mobile radio, television equipment, guided missiles, etc., stand THE TROUBLESHOOTERS—the men urgently needed to inspect, install, and service these modern miracles. They enjoy their work, and get well paid for it. Here's how you can join their privileged ranks—without having to quit your job or go to college to get the necessary training.

JUST THINK how much in demand you would be if you could prevent a TV station from going off the air by repairing a transmitter... keep a whole assembly line moving by fixing automated production controls... prevent a bank, an airline, or your government from making serious mistakes by servicing a computer.

Today, whole industries depend on electronics. When breakdowns or emergencies occur, someone has got to move in, take over, and keep things running. That calls for one of a new breed of technicians—The Troubleshooters.

Because they prevent expensive mistakes or delays, they get top pay—and a title to match. At Xerox and Philco, they're called Technical Representatives. At IBM they're Customer Engineers. In radio or TV, they're the Broadcast Engineers.

What do you need to break into the ranks of The Troubleshooters? You might think you need a college degree, but you don't. What you need is know-how—the kind a good TV service technician has—only lots more.

Think With Your Head, Not Your Hands

As one of The Troubleshooters, you'll have to be ready to tackle a wide variety of electronic problems. You may not be able to dismantle what you're working on—you must be able to take it apart "in your head." You'll have to know enough electronics to understand the engineering specs, read the wiring diagrams, and calculate how the circuits should test at any given point.

Learning all this can be much simpler than you think. In fact, you can master it without setting foot in a classroom... and without giving up your job!

For over 30 years, the Cleveland Institute of Electronics has specialized in teaching electronics at home. We've developed special techniques that make learning easy, even if you've had trouble studying before. Our AUTO-PROGRAMMED™ lessons build your knowledge as easily and solidly as you'd build a brick wall—one brick at a time. And our instruction is personal. Your teacher not only grades your work, he analyzes it to make sure you are thinking correctly. And

he returns it the same day received, while everything is fresh in your mind.

Always Up-To-Date

To keep up with the latest developments, our courses are constantly being revised. This year CIE students are getting new lessons in Laser Theory and Application, Microminiaturization, Single Sideband Techniques, Pulse Theory and Application, and Boolean Algebra.

In addition, there is complete material on the latest troubleshooting techniques including Tandem System, Localizing through Bracketing, Equal Likelihood and Half-Split Division, and In-circuit Transistor Checking. There are special lessons on servicing two-way mobile radio equipment, a lucrative field in which many of our students have set up their own businesses.

Your FCC License—or Your Money Back!

Two-way mobile work and many other types of troubleshooting call for a Government FCC License, and our training is designed to get it for you. But even if your work doesn't require a license, it's a good idea to get one. Your FCC License will be accepted anywhere as proof of good electronics training.

And no wonder. The licensing exam is so tough that two out of three non-CIE men who take it fail. But our training is so effective that 9 out of 10 CIE graduates pass. That's why we can offer this famous warranty with confidence: If you complete a license preparation course, you get your FCC License—or your money back.

Mail Coupon for 2 Free Books

Want to know more? Send for our 40-page catalog describing our courses and the latest opportunities in electronics. We'll also send a special book on how to get a Government FCC License. Both are free—just mail coupon below.

ENROLL UNDER NEW G.I. BILL

All CIE courses are available under the new G.I. Bill. If you served on active duty since January 31, 1955, or are in service now, check box in coupon for G.I. Bill information.

CIE Cleveland Institute of Electronics
1776 E. 17th St., Dept. PF-51 Cleveland, Ohio 44114

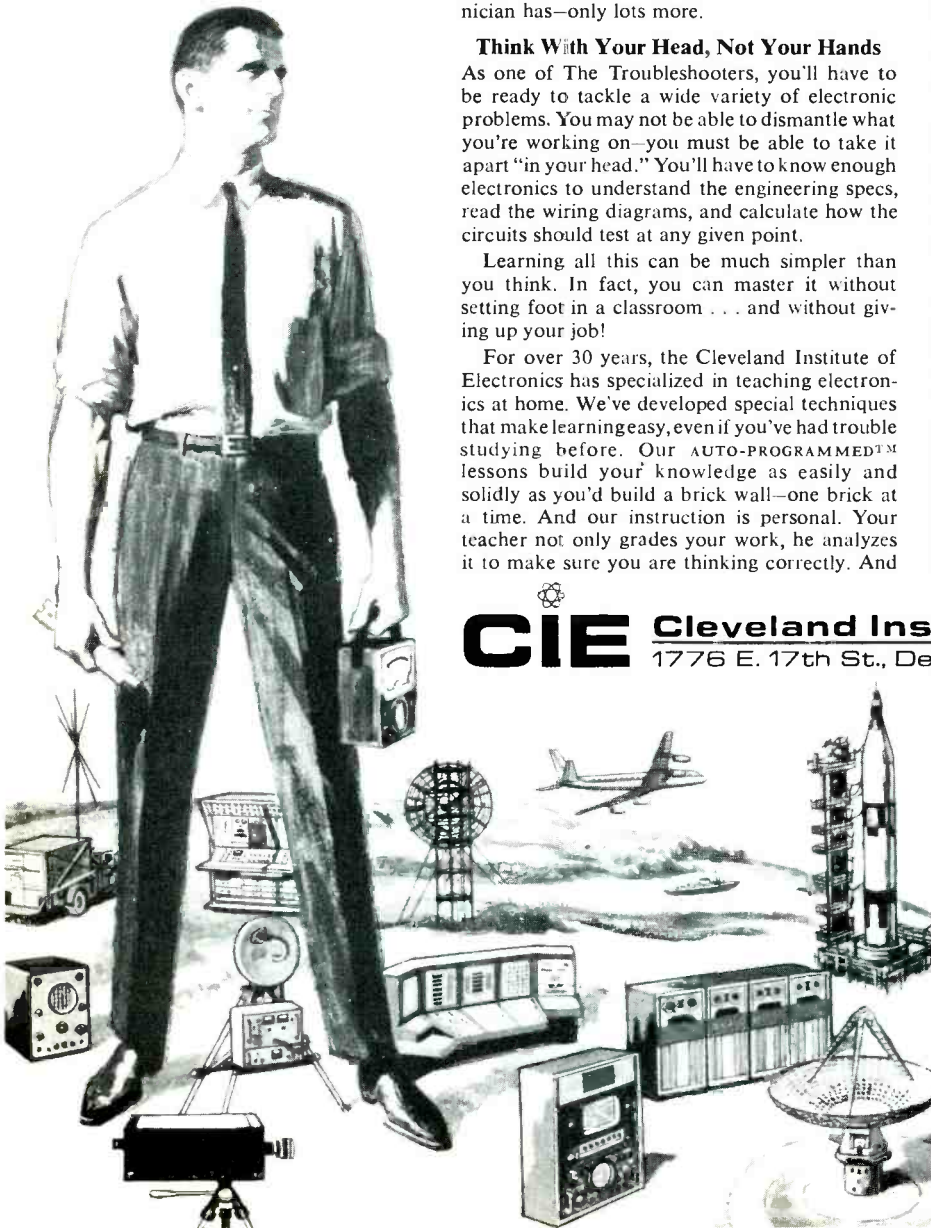

Cleveland Institute of Electronics
1776 E. 17th St., Cleveland, Ohio 44114

Please send me without cost or obligation:

1. Your 40-page book "How To Succeed In Electronics" describing the job opportunities in electronics today, and how your courses can prepare me for them.
2. Your book on "How To Get A Commercial FCC License."

Name _____ (Please Print)

Address _____

City _____

State _____ Zip _____

Occupation _____ Age _____

Check here for G.I. Bill information
Accredited Member National Home Study Council
PF-51

Circle 17 on literature card

Routine servicing of **AUTO RADIO**

A logical testing sequence speeds troubleshooting. by Homer L. Davidson

Quick servicing of any consumer electronic device demands a routine, logical troubleshooting procedure. Auto radio is no exception—even though it is relatively simpler to service than a b-w or color TV receiver. To diagnose and repair the greatest number of receivers within a given period and thus realize the greatest profit, the technician must employ a servicing routine that will quickly pinpoint the trouble with a minimum amount of testing. Such a routine begins with an accurate analysis of the trouble symptom(s), proceeds with a logical troubleshooting technique and concludes with correct replacement or lasting repair of the defective part or component.

The following paragraphs discuss the general servicing procedures and test equipment required for repairing auto radios. Although a logical, step-by-step analysis of the subject is intended, in some cases it has been necessary to deviate from this course in order to dwell on the more probable causes of a specific trouble symptom.

Test Equipment Requirements

Although there are some hybrid



Fig. 1. Pencil-type noise generator.

designs still in use, the majority of auto radios are of solid-state design. Thus, if you are now servicing other solid-state consumer electronic products, most of the test equipment required for auto radio servicing is probably already on your service bench. Specific equipment includes: a well-filtered variable DC power supply producing from 0 to 15 volts; a VTVM or FET-type VOM; a transistor tester, preferably an in-circuit beta tester; and an RF or noise signal generator. A pencil-type noise generator, such as the one shown in Fig. 1, is suitable.

In-Auto Checks

Before removing the radio from the auto, determine exactly what trouble symptoms are displayed either from the owner or, preferably, from your own first-hand evaluation. Typically, the owners description of the trouble is "It doesn't play" or "It just went dead." Such descriptions, although basically true, don't provide any specific clues to the source of the trouble. Usually the owners description is helpful only in the cases of intermittent operation, fading sound, or distortion. Consequently, you'll probably save a lot of diagnosis time by evaluating the operation of the radio yourself.

First, turn the on-off switch on. If a thump is heard from the speaker, you can eliminate the audio output and speaker as the source of the trouble. If no thump is heard, check the speaker for continuity with an ohmmeter. The speaker should click as the ohmmeter leads are applied.

With the volume control fully advanced, slowly tune across the band, listening for even a faint signal. If none is heard, connect a spare antenna to the antenna jack on the receiver. The receiver should now pick up a local station if the original

antenna or lead-in was defective. If the receiver operates normally with the spare antenna and lead-in attached, troubleshoot and repair the original antenna system, looking for broken or corroded connections or an open lead-in or antenna. If the trouble symptom was intermittent operation, thump the antenna, tighten connections, or bend the lead-in in an attempt to determine if the antenna system is the source of the trouble.

If you have not uncovered and repaired the source of the trouble at this point, you have learned all there is to learn about the trouble with the receiver in the car and must now remove it for bench checking.

Bench Checking

After connecting the receiver to the DC power source and the shop antenna and speaker, perform another quick evaluation of the trouble symptom: Turn the volume to maximum and slowly tune across the band. In some cases, the receiver will suddenly come to life, indicating that you have overlooked a bad antenna system or speaker during your in-auto check. However, it is more probable that the original trouble will still be present.

Dead Radio

Many technicians consider this symptom the easiest to solve since it involves a go/no-go situation. The best approach to finding the source of the trouble is a logical process of elimination commonly referred to as signal substitution.

First, localize the trouble to either the RF-IF or audio sections of the receiver. This is accomplished by injecting an audio or noise signal at the detector side of the volume control (point 1, Fig. 2). If the signal is not heard in the speaker, the audio section is probably the

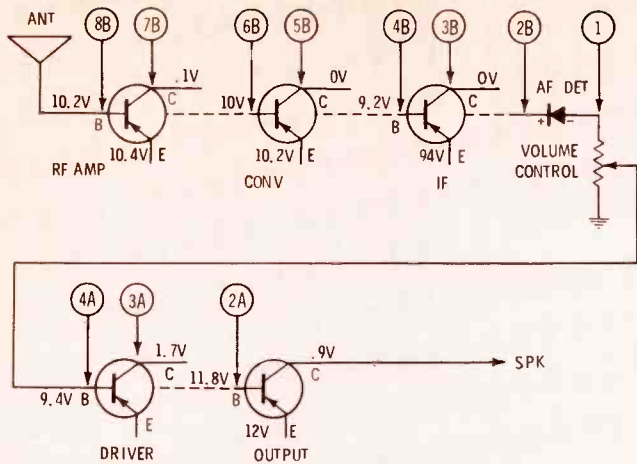

Fig. 2. Block diagram of auto radio showing signal injection points.

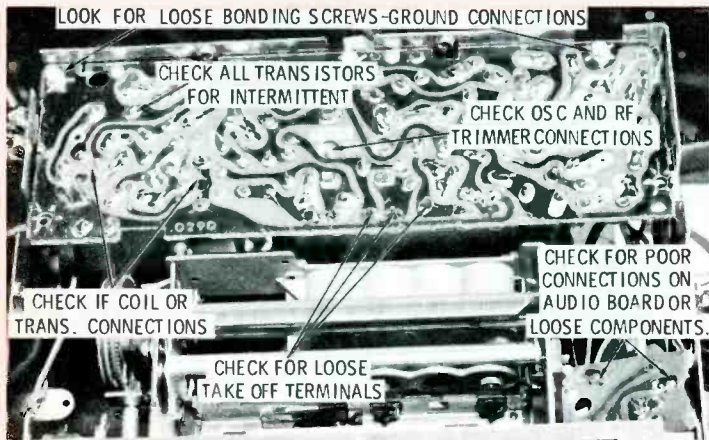

Fig. 3. Possible sources of trouble causing intermittent symptom.

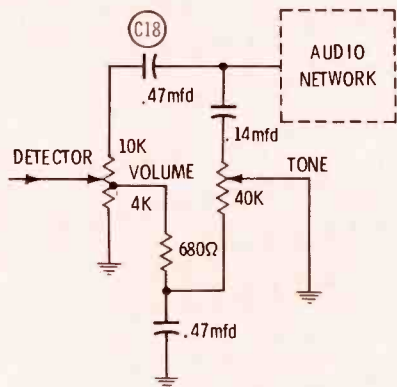

Fig. 4. Circuitry involved in intermittent symptom displayed by Ford Model 8TPO.

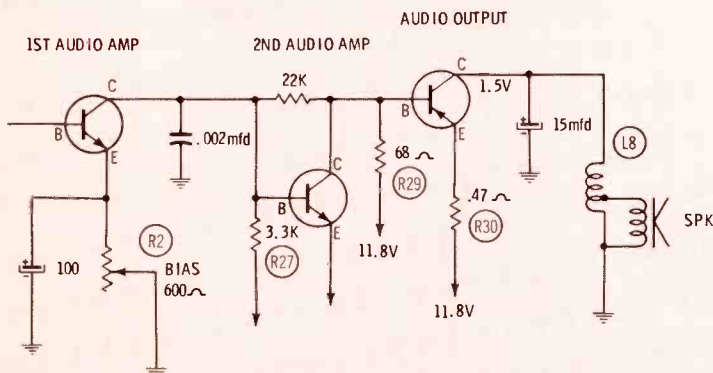

Fig. 5. Open bias control caused weak reception in Delco Model 7303311.

source of the trouble. Apply the audio or noise signal to point 2A in Fig. 2. If no sound is heard in the speakers, check the output transistor with a transistor tester. If the transistor checks good, perform voltage and resistance measurements in the output circuitry. (When making resistance checks in transistor circuits, remove the transistor for more accurate measurements. In many instances the internal resistance of the transistor can produce misleading readings.) If the power supply is the cause of the "dead radio" symptom, voltage measurements will now reveal it. Typical voltages found in an auto radio are shown in Fig. 2.

If a signal is heard in the speaker when the test signal is injected at point 2A, proceed to test points 3A and 4A, respectively, until the defective stage is located. Perform voltage and resistance checks to isolate the defective component(s) as previously described.

If the initial test at test point 1 indicates the trouble is toward the front of the receiver, proceed toward the antenna coil with tests at 2B through 8B, respectively.

When the noise signal generator is placed on the opposite end of the detector (test point 3B, Fig. 2), there is substantial loss in audio signal. Because of this, the noise generator is not effective in the converter and RF stages. An RF signal generator is required for signal tracing in these stages.

Set the RF generator to 262 KHz to match the IF frequency of the receiver. Start at the base of the second IF stage, then move to the collector of the first IF stage as indicated in Fig. 2. Next, start at the base of the converter stage and keep turning down the gain control of the RF signal generator. To signal trace the RF stage, set the RF signal generator frequency to 1600 KHz with the radio dial at 1600.

The FM section of an AM-FM radio is serviced in the same manner as the AM section. If the AM section is working and the FM receiver is not, check the FM-RF and converter stages. Since the first FM-IF stage is common to the AM section, the trouble must lie ahead

of the IF transformer. The components in the FM section are compact and should be replaced in the exact location as the originals. Follow the alignment procedure outlined by the manufacturer's service literature or PHOTOFACT Folder.

Intermittent Conditions

Intermittent trouble symptoms in an auto radio are difficult to locate and repair. Sometimes they occur only while the receiver is in the automobile. In most cases the trouble causing the intermittent will be found to be a defective transistor, a cracked PC board, a rosen joint, coupling capacitor or IF transformers as indicated in Fig. 3.

In cold weather if the radio refuses to play until the auto is warmed up, the trouble is probably an intermittent transistor. Remove the radio from the car and connect it to the bench power supply. Lower the supply voltage to 9 volts (auto radios will perform at this low supply voltage). If the radio cuts out, replace the convertor transistor. (This also applies to a radio that will not play on either end of the broadcast band.)

To locate the intermittent transistor, first try the noise signal generator. Always inject the signal to the collector terminal of the transistor. Then apply the signal to the base terminal. If the radio suddenly begins playing the transistor is probably intermittent.

Remove the suspected intermittent transistor from the PC board and connect it to the beta transistor tester. If the results of the test are good, leave the transistor connected and apply cold mist. Generally this will cause it to open. If not, leave the transistor connected to the tester



Fig. 7. Applying silicone grease to power output transistor.

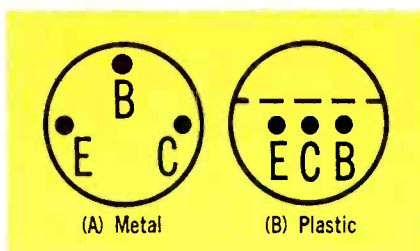

Fig. 6. Metal and plastic-cased transistors have different lead layout.

and check it every half hour. Sometimes, carefully applying heat from a soldering gun near (but not touching) the transistor will cause it to open. A quick spray of cold mist sometimes helps after heat has been applied.

It is best not to apply the in-circuit transistor tester to a suspected intermittent transistor while it is soldered to the PC board. Applying the in-circuit tester will probably cause the intermittent transistor to snap on, and you will have to wait until the radio is dead again.

Transistors with plastic cases are prime suspects for an intermittent condition. Twist the body of the transistor with long nose pliers to determine if the connecting element wires inside the case are making connection only intermittently.

Another method to make the intermittent transistor react is to spray each transistor with cold mist while the radio is playing. Start at the RF amplifier and work toward the power output stage. Spray the transistors at least three times, letting each warm up before going to the next one. Warm the transistor by holding it between your fingers. For difficult intermittent conditions, lower the supply voltage to 9 volts and then again spray each transistor with the cold mist.

Check the PC board by gently twisting and prodding around on it. Sometimes it is quicker to resolder the complete PC wiring to eliminate an intermittent board. Repair the cracked board with regular hookup wire.

Probe around on the soldered terminals of the IF transformer to reveal a suspected intermittent condition. While the radio is playing, twist the IF can. Remove the suspected IF transformer from the metal case. Check to see if each coil winding is soldered to the terminal connections. Many of these terminals have the coil wire just wrapped around and not soldered.

An example of a typical intermittent trouble involved a Ford 8TPO model. The radio would quit operating and would only resume when the car dash was hit. At other times, if the car hit a bump in the road, the radio would cut out. When the receiver was pulled from the car, it resumed operating on the repair bench. By tapping the chassis, the music would become intermittent. With the radio in a non-playing condition, a noise generator traced the signal past the audio network. The signal was dead at the center tap on the volume control.

This meant the trouble lay between the volume control and the audio network. A look at the schematic revealed that the most probable source of the trouble would be C18, the .47-mfd coupling capacitor. With the noise signal generator probe on the top terminal of the volume control, C18 was twisted and the radio began to play. C18 was replaced and the intermittent condition disappeared.

Weak Reception

Defects causing weak reception can be uncovered using the signal substitution method described for a "dead radio symptom," except in this case the indication of a weak stage will be a drastically reduced output from the speaker instead of a signal or no-signal condition. Experience will acquaint you with the signal levels that are satisfactory for each test point in Fig. 2. However, simple voltage and resistance tests, together with a clear understanding of circuit action, will often provide an even quicker indication of the defective stage.

Following is a typical case history of a weak reception symptom. Only a whisper could be heard on all stations across the broadcast band of a Delco Model 7303311. When the on-off switch was turned on, no sound was heard from the speaker. The trouble was assumed to be in the output circuit.

The output transistor had recently been replaced, so the .47-ohm bias resistor was checked. This resistor had also recently been replaced, so both units were again checked. The emitter and base terminals indicated 12 volts. Zero voltage was indicated on the collector terminal. Both bias resistors and the audio output transformer checked normal.

COLOR GENERATORS

FOR EVERY NEED

**4 reasons why Sencore is your best buy
in professional test instruments**

1

LOBOY CG10

America's lowest priced professional quality standard color bar generator. All solid state. Battery powered for maximum portability.

\$89.95



2

LOBOY CG12

AC operated version of the CG10. Also has 4.5 MHz crystal controlled signal for fine tuning adjustment.

\$109.95



3

COLOR KING CG141

Absolute stability assured by exclusive "Temp Control" and new timer circuitry. All standard patterns, plus new movable single dot and single cross. Analyzing features too.

\$149.95

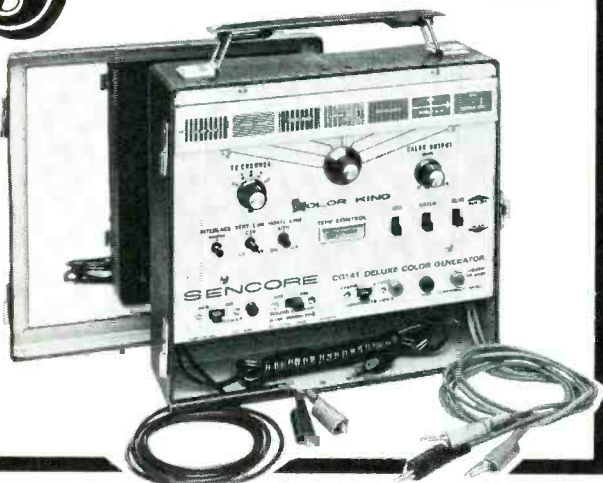

4

COLOR ANALYZER CA1223

The complete analyzer for color and B&W—far more than just a color generator. Has variable RF and IF outputs, composite video, chroma, and horizontal and vertical sync pulses.

\$187.50



Whatever the need, Sencore has the color generator that is just right for you. Each has the built-in quality you expect from Sencore. Each has standard RCA licensed color bar patterns.

Each is triple tested for guaranteed accuracy. Each is steel encased with chrome panel. See your distributor for more reasons why Sencore is your best buy, always.



SENCORE

NO. 1 MANUFACTURER OF ELECTRONIC MAINTENANCE EQUIPMENT
426 SOUTH WESTGATE DRIVE ADDISON ILLINOIS 60101

Circle 18 on literature card

Since the first and second audio amplifier transistors were directly coupled, each collector lead was removed and in-circuit transistor tests were made. Both transistors tested normal. Checking the schematic, we focused our attention on R2, which varies the voltage on the emitter of the first audio amplifier. The bias control was found to be open near the emitter terminal of the first audio amplifier. Replacing the bias control restored the radio to normal service.

Distorted Reception

Garbled or distorted sound usually results from a defect that affects the frequency response of the audio section. Bias resistors and coupling capacitors are the most likely suspects, although a damaged speaker should be the first suspect during the in-auto check. Substitution of suspected components is usually the only positive method of isolating and curing a distortion symptom.

Removing and Installing the Transistor

To prevent further damage, exercise care when removing a suspected transistor from the PC board. Use a bulb or other type desoldering attachment to remove excess solder. Also, use the tip of a pair of long nose pliers as a heat sink.

A small, pencil soldering iron will not provide enough heat to remove a transistor element lead from a double-sided PC board. Use a large soldering gun, being careful not to "pop" any PC wiring from the insulated board.

Always check to see where the collector terminal is located. Some transistors are marked with an arrow beside the metal transistor case or on the PC board. In some instances no terminals are marked on either the PC board or transistor. Most metal transistors can be mounted directly into the PC board holes; however, this does not hold true for some plastic transistors whose leads will not correspond to the position of the holes in the PC board (Fig. 6). After the transistor is installed, do not cut the terminal leads until you are sure the replacement has cured the trouble.

To remove the defective transistor from a double-sided PC board it is easier to cut the element leads close to the PC wiring. Cut the new transistor leads close to the correct length and form a curl, or loop, on each element wire and slip it over the cut lead on the PC board. Solder the two leads together with a pencil iron.

Before the transistor is replaced, all corresponding components should be checked. Determine if associated capacitors are leaky, and check for burned base and emitter resistors. If a small transistor runs warm, replace it; but do not become alarmed if the power output transistor feels warm; this is normal. However, an output transistor that will turn moisture to steam should be replaced.

When replacing the power transistor on the heat sink, use a clean piece of insulation material. Apply silicone grease to the transistor and one side of the insulation piece as shown in Fig. 7. All power transis-

tor base and emitter terminals are off center and should be lined up before being placed into position.

Checking Transistors

A quick method of checking the condition of a transistor is with a beta in-circuit transistor tester. Clip the small, insulated alligator clip leads to the correct transistor terminals. Double check to insure that all terminal clips are on the correct transistor elements. The transistor can be tested for open, leaky, shorted, or intermittent conditions while the transistor is still soldered to the PC board.

When a transistor is open there will be no reading on the beta scale of the tester. If the tester indicates an open transistor, check to see that all clips are firmly attached to the correct transistor terminal, and be sure the tester is set to the correct PNP or NPN position.

Generally, if the meter registers high on the beta scale the condition of the transistor is good. In auto radio circuits, the in-circuit leakage tests will usually read quite high. This does not necessarily mean the transistor is defective. However, when the in-circuit leakage test indicates a dead short, the transistor is definitely defective. To make a correct leakage test, unsolder the collector terminal from the PC board and take another reading.

Alignment

For complete RF and IF alignment of the auto radio, follow the general procedures outlined in Table 1. Although auto receivers very seldom need alignment, often a quick touch-up will improve the selectivity. Always touch up the RF-IF alignment after replacing an IF transformer or convertor transistor. When an RF or IF stage will not align properly, check for defective coils, IF transformers, and bypass capacitors.

Last Minute Adjustments

Before the covers are placed on the radio, be sure to check the condition of the pilot light. Clean all dust and dirt from the chassis and front dial assembly. Spray picture tube cleaner on the front dial and push button assemblies, brushing the solution around to get into the corners and between the push buttons; wipe dry. Adjust all push buttons to the favorite local stations. ▲

TABLE 1.

Signal Generator Frequency	Signal Generator Connection	Set Radio Dial	Meter and Connection	Adjust
Connect probe through a .1-mfd capacitor to base of convertor transistor ground shield.	262KHz with 400Hz modulation	above 1600KHz	Output meter across voice coil of speaker	Top & bottom slugs of both IF transformer for maximum reading on meter.
Connect probe through 47-pf capacitor to antenna input.	1600KHz	1600KHz	same	Adjust OSC, RF trimmer capacitors for maximum reading on meter.

Two New SK Devices Simplify Servicing of TV Deflection Circuits

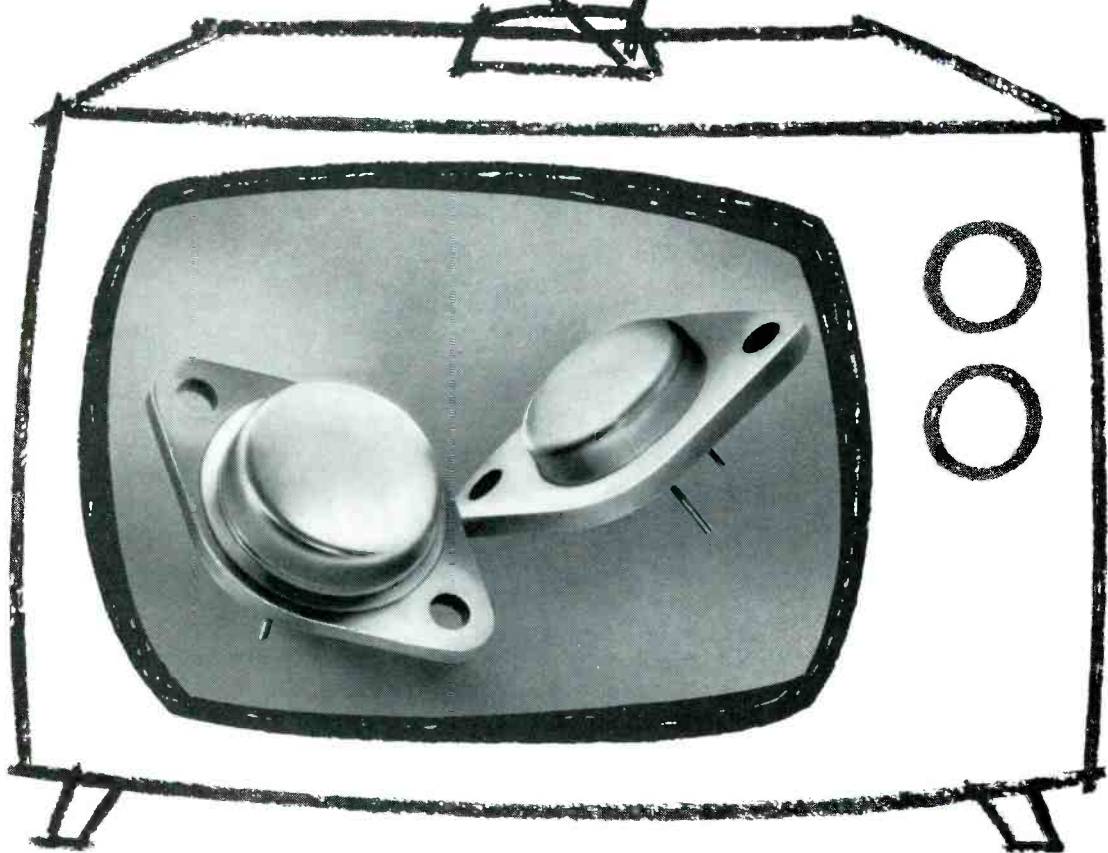

More than a dozen solid-state TV sets—RCA and others—can use these two new RCA SK-Series transistors—specifically designed for replacement use in deflection circuits.

The RCA SK3034 is for replacement use in horizontal driver and in vertical-deflection-output circuits; the SK3035 is for replacement use in horizontal-deflection-output circuits.

Both units are germanium p-n-p devices in hermetically-sealed TO-3 packages, and are for use in domestic and imported TV sets with anode voltages to 18 KV and with picture tubes having deflection angles up to 114°.

Add both to your stock of RCA "Top-Of-The-Line" SK-Series replacement transistors. See your RCA Distributor today about your supply of RCA SK-Series replacements . . . 33 individual units that can replace approximately 11,800 solid-state devices.

RCA Electronic Components, Harrison, N. J. 07029.

Circle 19 on literature card

Get This Set of Screwdrivers FREE with your SK-Series solid-state replacements.*

- 6 separate screwdrivers with graduated blade widths: 0.8 to 3.8 mm.
- Rust-proof, tempered, hardened tungsten-steel blades.
- Chrome-plated brass handles.
- Work with one hand—screwdriver pivots around the top.



*Ask your participating RCA Distributor for details.

RCA

*analysis of test instruments . . .
operation . . .
applications*

NOTES ON TEST EQUIPMENT

by ELLSWORTH LADYMAN

Solid-State Meters

Solid-state meters seem to be the answer to the service technician's prayer. These compact, small meters combine the attributes of both VTVM and VOM meters and, seem-

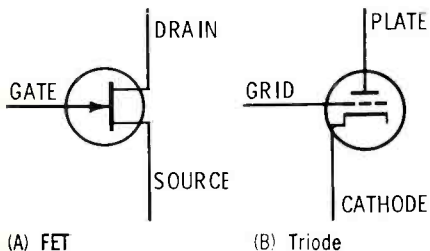

Fig. 1. Function of FET and Vacuum tube elements are uniquely similar.

ingly, have none of the inherent disadvantages of either instrument. Advantages include:

- a. Lightweight
- b. Compact design
- c. Battery operated
- d. High input impedance
- e. Versatile
- f. Extremely portable.

Current drain is not extreme, and with proper care battery life will be fairly long. Most solid-state meters use conventional batteries that are available anywhere, which lessens the possibility of losing the services of your meter due to a dead battery while on a service call.

FET Circuit Analysis

A brief discussion of field-effect transistor (FET) circuits, illustrating their relation to vacuum-tube operation, will help to show their adaptability to meter circuitry (see Figs. 1 and 2). A negative bias voltage is applied between the gate and the source elements of the FET. This voltage is analogous to the grid bias applied between the grid and the cathode of a vacuum tube. A positive voltage is applied between the drain and the source. This voltage compares to the plate voltage of the vacuum tube. When the gate voltage is increased (negatively) to a suffi-

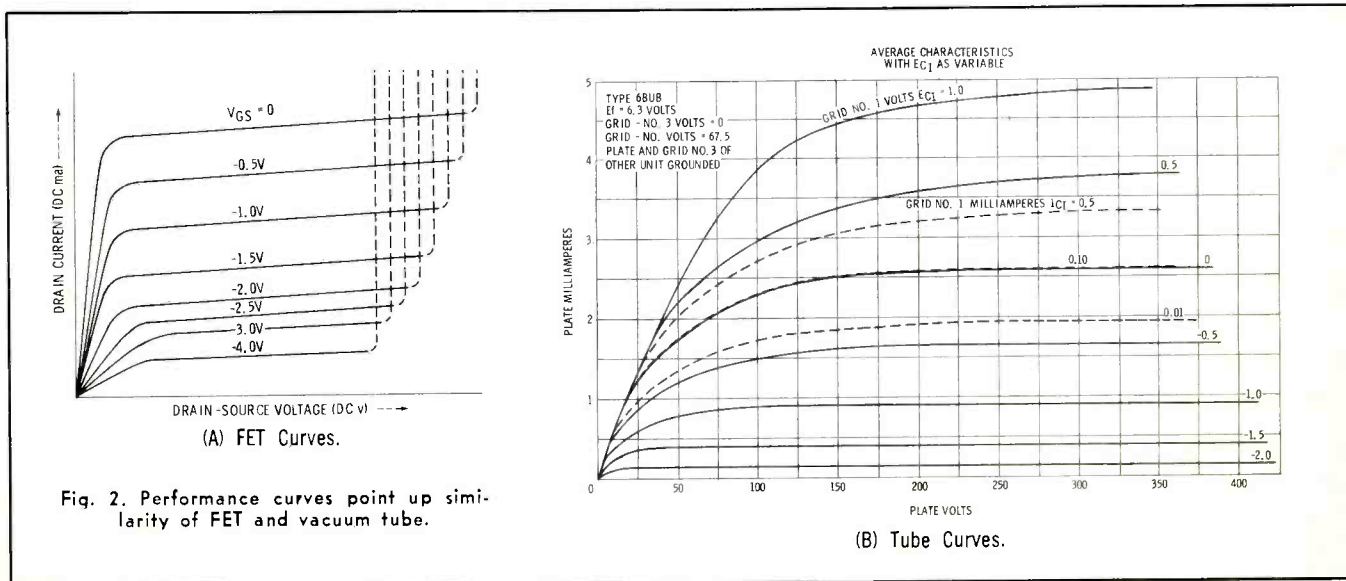

Fig. 2. Performance curves point up similarity of FET and vacuum tube.

cient value, "pinch-off" occurs and drain current flow ceases. This is the same as bias cutoff in the vacuum tube.

When the proper values of voltages are applied to the gate, source, and drain, a decrease in gate bias effects an increase in drain current and, conversely, an increase in gate bias effects a decrease in drain current. The reverse-biasing of the gate junction causes gate current flow to be at a minimum; therefore, the high input-impedance characteristic that is desired for meter application is attained.

Solid-State Meter Circuits

DC Voltmeter (Fig. 3)

For measuring DC voltages, an amplifier employing an FET at the input provides impedance conversion and drives the meter. Precision voltage dividers extend the range from the basic 100 mv sensitivity to 1000 volts. In the AC mode, an additional amplifier furnishes the required gain to provide 10 mv sensitivity. The DC voltage at the input is applied across a voltage divider to the amplifier. Basic attenuation is in decade steps; intermediate ranges are attained through a reduction in amplifier sensitivity.

Ohmmeter (Fig. 4)

Ohmmeter action is the same as for most meters. The unknown resistance, when connected across the input circuit, is placed in series with a portion of the voltage divider network and the battery. The voltage drop across the known and unknown resistance is proportional to their value since identical current flows through each. The voltage applied across the unknown resistance is applied to the amplifier; meter deflection is calibrated in terms of resistance, or ohms.

AC Voltmeter (Fig. 5)

Input AC voltages of less than one volt amplitude are applied directly to an impedance converter circuit. The output of the impedance converter is attenuated to provide a 10-mv input to the amplifier at full scale on all ranges. A compensated attenuator reduces input voltages ranging from 1 to 1000 volts, 50 db previous to impedance conversion.

The AC amplifier circuit is conventional. DC feedback provides for bias stability. Output detection is normally accomplished through the use of an average-responding detector between the input and the meter.

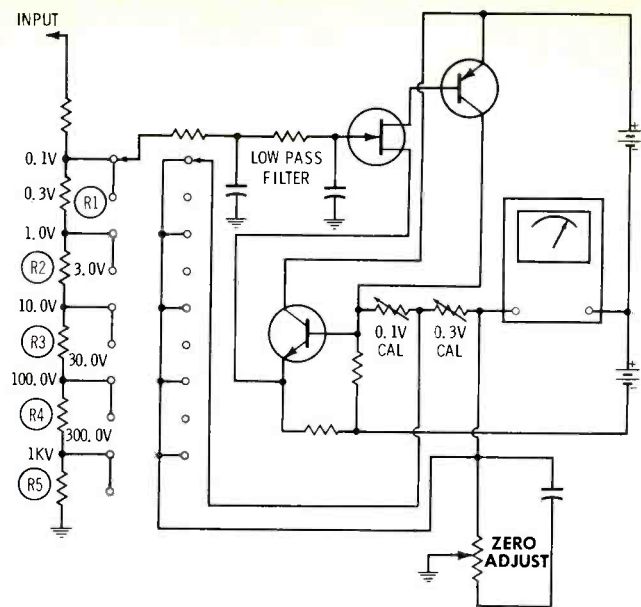

Fig. 3. Simplified schematic of FET DC voltmeter.

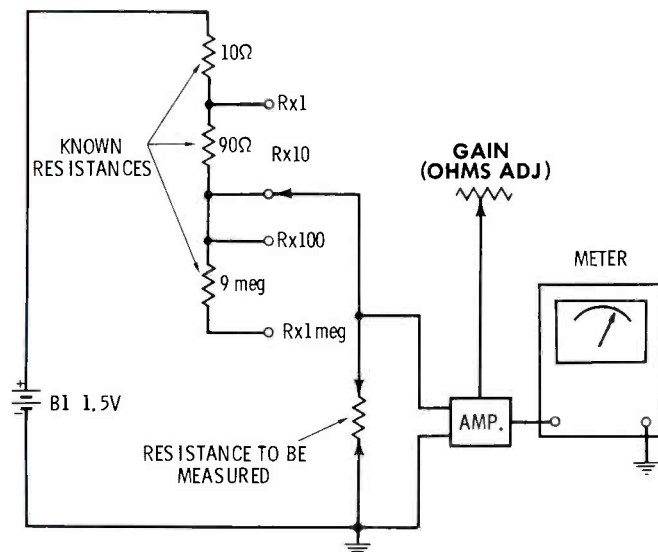

Fig. 4. FET meter ohmmeter circuit is similar to that employed in conventional VTVM.

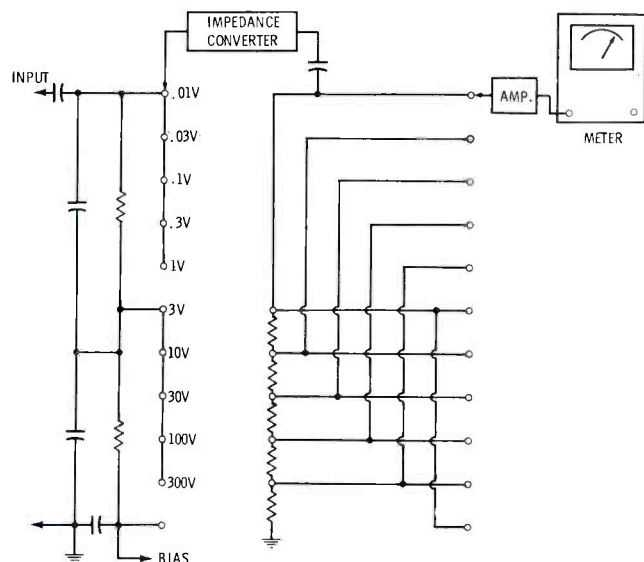

Fig. 5. Simplified schematic of FET AC voltmeter.

Triplet Model 601 is designed to provide a means of measuring practically every variable in the home entertainment field from ohms to dB. Push-button switching allows the service technician to quickly select either DC volts (+ and -), ohms, AC volts, or power ohms.

A unique feature of Model 601 is the Low Power Ohms range. This

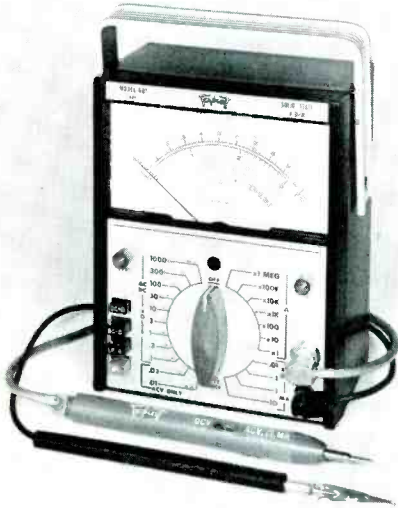

Fig. 6. Triplet Model 601 solid-state VOM.

allows the operator to make in-circuit resistance measurements of integrated circuits without damaging delicate electronic components. In-circuit resistance measurements are made without loading; 75 millivolts is applied to the device under test, with maximum applied power being 0.1 mw.

Hi-fi and stereo service technicians will like the dB scale range. The operator can make measurements in 10 dB steps from -40 to +60 dB. A single function selector provides control of all operations.

To counteract the high-sensitivity requirements for AC measurements, Model 601 utilizes a slender, shielded probe and insulated lead. The probe has a built-in slide switch with a resistor in series with the meter circuitry for DC voltage readings. This probe plus a "ground lead" comprises the probe requirements for all measurements.

The outside dimensions of the instrument are 3 3/16" x 5 1/8" x 6 1/2". The theory of operation of Model 601 was covered under the heading of "DC Voltmeter," "Ohmmeter," and "AC Voltmeter" earlier in this article.

Differential Amplifier Meter Circuit (Sencore Model FE14, Fig. 8)

Sencore uses a different approach, employing an all-FET circuit design in a differential amplifier type circuit (see Fig. 9). Circuit operation is as follows: Q1 and Q2 form the differential amplifier used for DC volts and ohms measurements. With zero volts applied to the input of Q1, the Zero Adjust control (R31) is adjusted in such a manner that voltages developed across the source resistor, R14 and R22, are equal. Therefore, no current can flow through the meter. The DC Balance control (R29) is an internal adjustment. Its function is the same as the Zero Adjust control, except



Fig. 7. Amphenol Model 870 VOM.

Triplet Model 601 (Fig. 6) Specifications

DC Volts	0 to 10, 100, 1000, 10,000 microampere at 100 mv.
Ranges:	
0 to 0.1, 0.3, 1.0, 3.0, 10, 30, 100, 300, 1000 @ 11 megohms.	
AC Volts	
Ranges:	
0 to 0.01, 0.03, 0.01, 0.3, 1.0, 3.0, 10, 30, 100, 300, 1000 @ 11 megohms.	
Ohms	
Ranges:	
0 to 1000, 10K, 100K, 1 meg, 10 meg, 100 meg, 1000 meg (standard 1.5V, 5.5).	
0 to 1000, 10K, 100K, 1 meg, 10 meg, 100 meg, 1000 meg (Low Power 0.1 mw, 75 mv).	
Center Scale value 10 ohms on x1 range.	
DC Current	
Ranges:	
	0 to 10, 100, 1000, 10,000 microampere at 100 mv.
AC Current	
Ranges:	
0 to 10, 100, 1000, 10,000 microampere at 100 mv.	
dB	
Ranges:	
-40 dB to +60 dB in 10 dB steps.	
Meter Size and Type:	4 1/2" suspension meter movement
Sensitivity:	10 mv on AC
Accuracy:	± 2% of full scale on DC ± 3% of full scale on AC
Input Impedance:	11 megohms on all ranges.
Frequency Response:	50 Hz to 50 KHz
Batteries:	Ten 1 1/2-volt "AA" cells, NEDA #15.

Amphenol Model 870 (Fig. 7) Specifications

DC Volts	0 to 0.1, 0.3, 1.0, 3.0, 10, 30, 100, 300, 1000
Ranges:	
0 to 0.1, 0.3, 1.0, 3.0, 10, 30, 100, 300, 1000	
AC Volts	
Ranges:	
0 to 0.01, 0.03, 0.1, 0.3, 1.0, 3.0, 10, 30, 100, 300	
dB	
Ranges:	
-40, -30, -20, -10, 0, +10, +20, +30, +40, +50 (-12 to +2 Scale)	
Accuracy:	± 3% of full scale on all ranges from 50 Hz to 50 KHz.
Input Impedance:	10 mv to 1V, 10 megohm shunted by 31 pf. 3V to 300V, 10 megohm shunted by 20 pf.
Weight:	5 lbs. (includes batteries) 4.5 lbs. (less batteries) 8.5 lbs. (shipping weight)

Zenith Tubes...

life-tested for greater dependability!



ZENITH TV PICTURE TUBES are rigorously tested at elevated line voltages for lengthy periods. Just one reason you can be sure of Zenith's great reliability and long life that better satisfies your customers. More than 200 Zenith quality tubes—for color TV, black-and-white TV, or special purposes—are in the complete line.

ZENITH "ROYAL CREST" CIRCUIT TUBES undergo over 1½ million hours of life-testing every month. Under actual operating conditions, they must meet the same quality standards as Zenith original parts—to perform with unrivaled dependability. Choose from a full line of more than 900 top-quality Zenith tubes.

Order all genuine Zenith replacement parts and accessories from your Zenith distributor

Exciting Surprises
for You—
and Your Family!
Fun for all!
Get the details
at your Zenith
Distributor's
Parts Department.

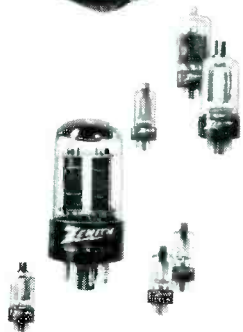

Zenith B&W replacement picture tubes are made only from new parts and materials except for the glass envelope in some tubes which, prior to reuse, is inspected and tested to the same high standard as a new envelope. Some color picture tubes contain used material which, prior to reuse, is carefully inspected to meet Zenith's high quality standards.

BEST YEAR YET TO SELL THE BEST



ZENITH

*The quality goes in
before the name goes on*

Circle 20 on literature card

NEW

HOME CARTRIDGE TAPE PLAYERS

now covered in the famous **PHOTOFACT®**
Specialized Service Data Series!

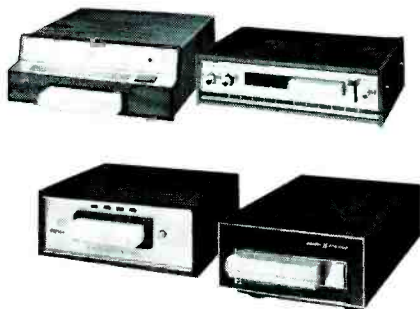
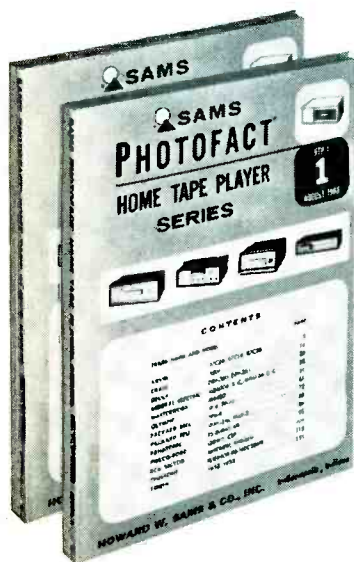

**Prepares you to cash in
on the servicing problems
connected with the fast-
growing sales of the new
Home Cartridge Tape Players**

Volumes in the Home Cartridge Tape Player PHOTOFACT Series will now be issued as required to cover the appearance of new models in all makes. Each volume includes incomparable PHOTOFACT service data for an average of 12 to 14 units. You get a wealth of complete, authoritative, exclusive information: Standard Notation® schematics, CircuiTrace®, chassis photos, troubleshooting clues, replacement parts lists—everything you need for time-saving, profitable repair work!

**Regular price per volume \$3.95—
only \$3.65 when purchased on a yearly
subscription—you save 30¢ per volume!**

See your local **SAMS Distributor** for a money-saving subscription to the HOME CARTRIDGE TAPE PLAYER Series (latest addition to the famous PHOTOFACT Specialized Service Data Series which now covers Tape Recorders, Auto Radios, CB Radios, and Transistor Radios). Get in on the profit potential of specialized equipment servicing!



HOWARD W. SAMS & CO., INC.

4300 W. 62nd St., Indianapolis, Ind. 46268

Circle 21 on literature card

NEW

TRANSISTOR FUNDAMENTALS SERIES

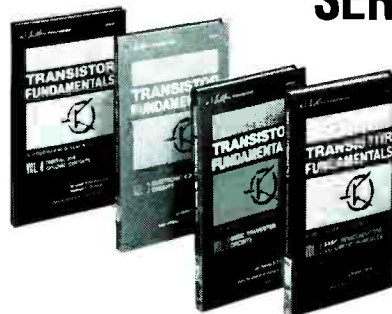

Here is the authoritative, complete 4-volume study and reference work on transistors. The text is brilliantly programmed for easy understanding. The series begins with a description of transistors and how they work; later volumes explain their applications in a wide variety of circuits. All volumes, 5 1/2 x 8 1/2".

Vol. 1 Basic Semiconductor & Circuit Principles

by *Robert J. Brite*. A carefully planned programmed introduction to semiconductors and the basic electrical circuits. Describes transistors; gives a detailed explanation of transistor principles. To provide a background for understanding, there are explanations of voltage, current, resistance, and Ohm's and Kirchhoff's Laws; sheds light also on the factors of inductance, capacitance, and resistance in ac circuits. 240 pages. Order **20641, only** **\$4.50**

Vol. 2. Basic Transistor Circuits

by *Charles A. Pike*. Describes how transistors are used in semiconductor circuits. Simple circuits illustrate the basic principles involved; the more complicated circuits, such as those used in amplifiers and oscillators, help to show how the basic operations are applied. Also presents recent semiconductor developments and devices. 208 pages. Order **20642, only** **\$4.50**

Vol. 3. Electronic Equipment Circuits

by *Martin Gersten*. Covers circuits used in audio, radio, and television equipment. Gives basic explanation of block and schematic diagrams, and operating principles of input and output devices. Covers the uses of basic test equipment; teaches how to recognize trouble symptoms in circuits, and how to track them down to specific stages or points. 192 pages. Order **20643, only** **\$4.50**

Vol. 4. Digital and Special Circuits

by *Reginald H. Peniston & Louis Schweitzer*. Explains how transistorized digital circuits operate. Describes the binary number system so that its application in digital circuits can be understood. Covers the basic principles of various digital circuits; once these circuits are understood, their application in computers, test equipment, and tracking and sensing devices, can be easily mastered. 208 pages. Order **20644, only** **\$4.50**

4-Volume Set in Slipcase.

Order 20645, only . . . \$15.95

These and over 300 other **SAMS Books** are available from your local **Electronics Parts Distributor.**

that it provides only a **coarse** zero adjustment, functioning to compensate for component aging and tolerances in manufacture. When a DC voltage is applied to the input of Q1, the balance existing between Q1 and Q2 is upset. The meter will indicate in proportion the amplitude of the applied voltage. Seven DC and AC ranges are supplied by the input voltage dividers, R1 through R8. Capacitors C2 through C8 provide compensation for the dividers for measuring AC voltages. The DC Calibrate control (R15) is, as the name implies, used to calibrate the meter on the DC scale. A known DC voltage is applied to the meter; the DC Calibrate control is then adjusted to read accordingly. When a voltage whose amplitude exceeds the setting of the range switch is applied to the gate of Q1, a neon bulb (NE2) conducts (fires), holding the applied voltage to a safe level and, thus, preventing damage to the FET.

Resistance

Resistance readings are accomplished by applying the battery voltage across a voltage divider consisting of the unknown resistance and a resistor of a known value (R9 the known resistance for X1 range,

R10 the known resistance for X10 range, etc.), then reading the voltage developed across the known resistance. Originally, with the unknown resistance having a value of zero (leads shorted together), the Ohms Adjust control (R23) is adjusted so the meter reads full scale (the total battery voltage supplied by B1 is applied across Q1). When an external, unknown resistance is placed between the leads, the meter will read proportionately lower, depending on the value of resistance. This is due to the voltage drop across the divider network. The voltage applied (battery voltage) divides across the known and unknown resistors according to the value of the unknown resistance.

AC Measurements

The input AC voltage is applied to Q1 through a voltage divider network consisting of R2 through R8, as was also true for operating in the DC volts mode. The output of Q1 is coupled to a peak-to-peak detector consisting of capacitors C10, C11, and diodes X1 and X2. The DC output of the peak-to-peak detector circuit is applied to Q2 through a coupling network composed of R25, R26, R27 and X6. The meter movement is connected to the source

circuit of Q2; therefore, the meter indication is proportional to the peak-to-peak AC voltage applied to Q1. Diodes X5 and X6 function to compensate for temperature changes, keeping the meter indication accurate over a temperature range from 32° to 122° F. Diodes protect the meter movement from excessive overloads of several amperes. Resistor R24 functions to protect diodes X3 and X4 and will open when the maximum current ratings of the diodes are exceeded.



Fig. 8. Sencore Model FE14 FET meter.

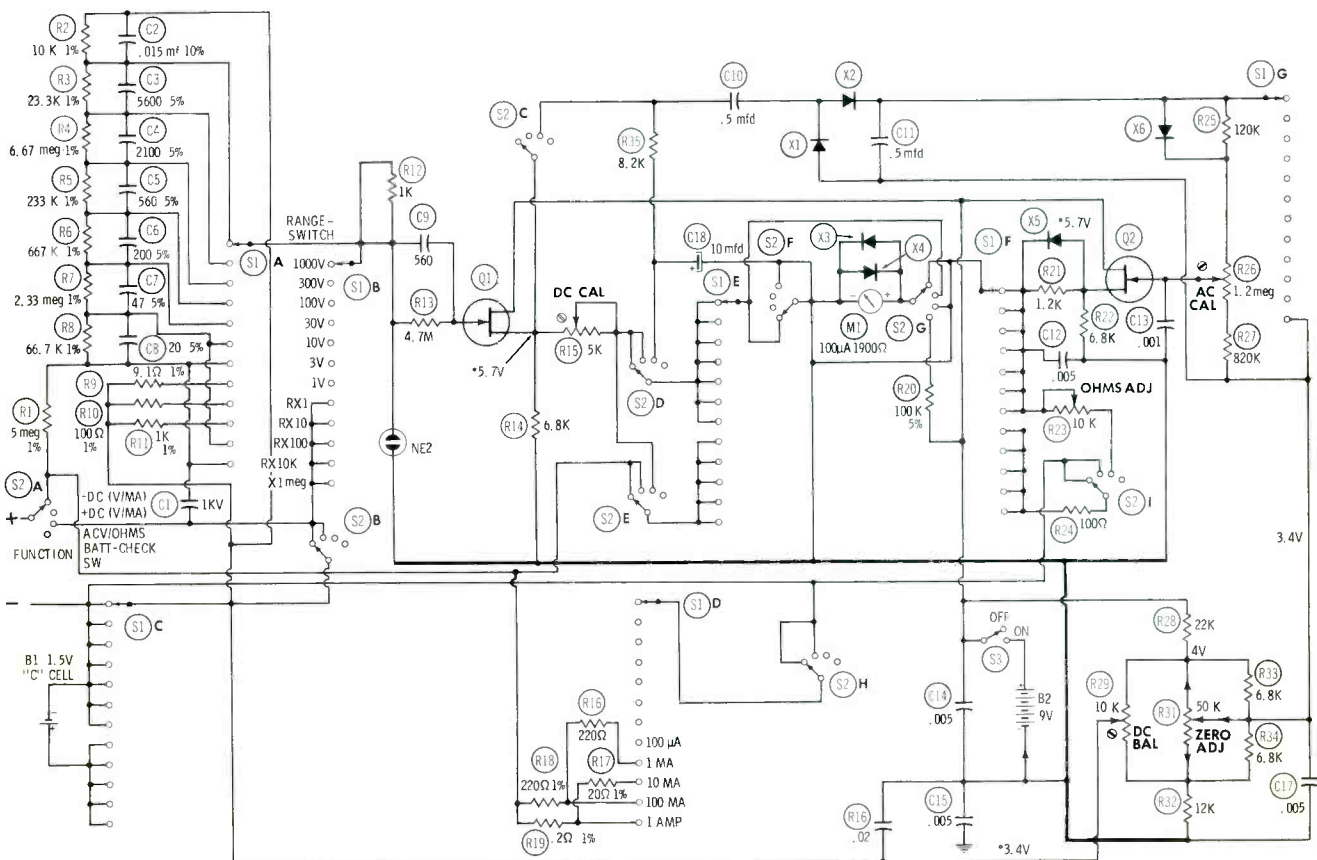
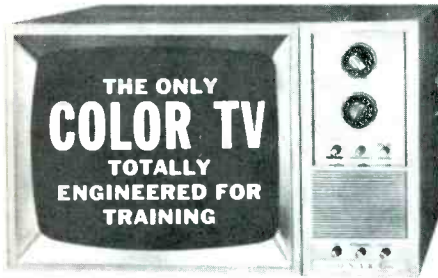

Fig. 9. Sencore Model FE14 employs all-FET differential amplifier design.

ALL NEW!

NRI learn-by-doing training in

ADVANCED COLOR TV



- Build your own custom color set in 5 training stages
- 50 designed-for-learning color circuit experiments
- Programmed with 18 "bite-size" lesson texts

A comprehensive training plan for the man who already has a knowledge of monochrome circuits and wants to quickly add Color TV servicing to his skills. DEFINITELY NOT FOR BEGINNERS. It picks up where most other courses leave off—giving you "hands on" experience as you build the only custom Color TV set engineered for training. You gain a professional understanding of all color circuits through logical demonstrations never before presented. The end product is your own quality receiver.

TRAIN WITH THE LEADER

This NRI course—like all NRI training—is an outgrowth of more than 50 years experience training men for Electronics. NRI has simplified, organized and dramatized home-study training to make it easy, practical, entertaining. You train with your hands as well as your head, acquiring the equivalent of months of on-the-job experience. Demand for Color TV Service Technicians is great and growing. Cash in on the color boom. Train with NRI—oldest and largest school of its kind. Mail coupon. No obligation. No salesman will call. NATIONAL RADIO INSTITUTE, Color Div., Wash., D.C. 20016.

MAIL FOR FREE CATALOG



NATIONAL RADIO INSTITUTE
Color TV Division
Washington, D.C. 20016 45-098

Send me complete information on NRI new Advanced Color TV Training. (No salesman will call)

Name _____ Age _____

Address _____

City _____ State _____ Zip _____

ACCREDITED MEMBER NATIONAL HOME STUDY COUNCIL



Circle 22 on literature card

Sencore Model FE16 (Fig. 10)

Sencore is shortly going to make available Model FE16, identical in size and specification to Model FE14 but with closer tolerances and geared for industrial electronic functions. Accuracy of the FE16 will be 1.5 percent on DC ranges and 3 percent for AC ranges.



Fig. 10. Sencore Model FE16 FET meter.

Sencore Model FE149 Senior (Fig. 11)

Another new model proposed by Sencore is a bench-type FET meter, Model FE149. It will feature push-button range and function selection, with a 15-megohm input impedance on both AC and DC ranges. Included in the specifications of this model are: true peak-to-peak on AC volts, AC and DC current ranges, calibrated zero center and a 6-ohm center-scale ohms range that will measure up to 6,000 megohms. Model FE149 also features a unique three-way power system. It can be operated either from an AC line, from a rechargeable battery system or while the batteries are recharging. A simple probe is used on all functions of Model FE149.

Sencore Model FE14 Specifications

DC Volts

Ranges:

0 to 1, 3, 10, 30, 100, 300 and 1000, full scale—.5 to .5, —1.5 to 1.5, —5 to 5, —15 to 15, —50 to 50, —150 to 150 and —500 to 500, zero center scale ranges.

Input resistance:

15 megohms shunted by 14 pf.

Accuracy:

+3% full scale from 32° F. to 122° F.

AC rejection:

30 to 300 times (30 to 50 dB).

AC Volts

Ranges (Rms):

0 to 1, 3, 30, 100, 300 and 1000 full scale, frequency compensated.

Ranges (peak-to-peak):

0 to 2.8, 8.4, 28, 84, 280, 840 and 2800, full scale, frequency compensated.

Input resistance:

10 megohms shunted by 29 pf.

Frequency response:

Flat from 25 Hz to 1 MHz.

Accuracy:

±5% full scale from 32° F. to 122° F.

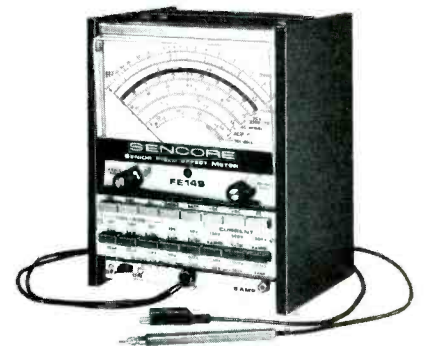
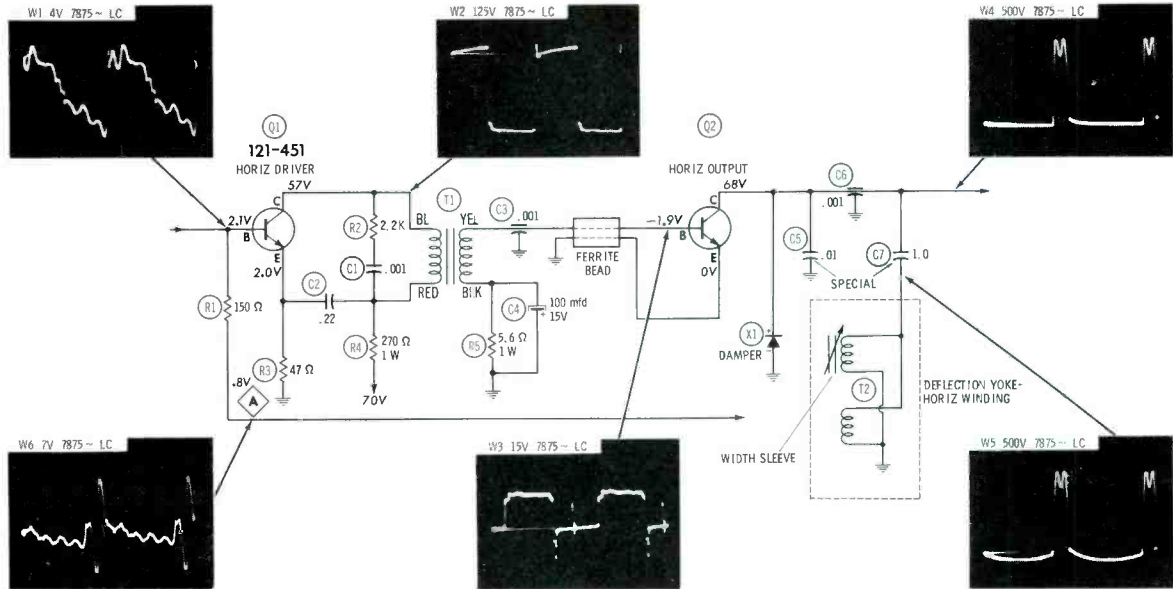

Fig. 11. Sencore Model FE149 FET meter.

Coming Next Month In PF Reporter...

- Troubleshooting A Multi-Trouble TV
- Proper Conduct During Home Calls
- Turntable Repairs

- Servicing Stereo
- And many more features packed with practical servicing info.



DC VOLTAGES taken with VTVM—no color signal input. *Indicates voltage taken with color-bar input—see "Operating Variations."

WAVEFORMS taken with wide-band scope; TV controls set to produce normal color-bar pattern. LC (low-cap) probe used to obtain all waveforms.

Normal Operation

Circuit shown (Zenith Ch. 1Y21B55) is typical horizontal driver/output stage used in both small- and large-screen, all-transistor TV receivers. Configurations may vary, but action is similar. Driver stage receives pulses at horizontal rate, shapes signal into square wave, and powers the output transistor. Both driver and output transistors operate as switches; driver conducts only on positive pulses from oscillator. Output transistor is cut off during negative portion of waveform present at base, but conducts heavily during positive-going portion. Zenith Ch. 1Y21B55 uses sine wave horizontal oscillations at collector (sine-wave pulse occurring at horizontal rate). Emitter is direct-coupled to base of Q1 (driver); oscillator collector pulses are shaped into a square wave (W1). Q1 (NPN) conducts on positive portion; collector output is square wave with positive portion starting simultaneously with occurrence of horizontal sync pulse. W2 is transformer-coupled (matches impedance of Q1 collector to Q2 base) to output stage. With transformer inversion of signal, first portion of W3 (negative going) drives Q2 into cutoff, second half cycle (positive going) saturates Q2. Output transistor (Q2) circuit action: During Q2 cutoff capacitor C7 discharges through yoke winding, deflecting CRT electron beam linearly. At center of trace Q2 becomes saturated by positive portion of W3 and conducts heavily, supplying power to yoke, sustaining remainder of trace. Combined action—Q2 cutoff/saturated—results in linear trace across CRT (W4, W5). At end of trace W3 drives Q2 into cutoff, causing overshoot pulse in flyback transformer. This pulse reverses yoke current, producing retrace. Capacitor C7 charges during Q2 conduction time.

Operating Variations

- Q1** Very slight DC variation with changing signal strength; drops approximately 0.1 volt only because B+ source drops approximately 0.1 volt. Adjustment of horizontal hold control to point where picture is out of sync effects a slight change in contour of wave shape; however, basic peaks remain the same.
- Q1E, Q1C** Little or no variation at these points in either voltage or waveshape. Neither signal strength nor adjustment of control produces a change in waveshape or amplitude.
- Q2B,C** Very slight change with signal variation, voltage difference caused by slight change in B+ source voltage. Contour and magnitude of waveforms remain fairly constant.
- Yoke-Input** Contour and magnitude of waveform remains fairly constant under change of signal strength. Slight variation in voltage although contour of waveshape does not change when brightness control is varied.
- Boost** Signal voltage composed of rectified output of Q2. This signal then filtered and used for focus action. Magnitude of signal voltage remains fairly constant under different signal strengths and control adjustments.
- High Voltage** High voltage varies 1.5K from minimum to maximum brightness control settings; 20KV at normal brightness, 19KV at maximum brightness and 20.5KV at minimum.

New Dual Purpose OSCILLOSCOPE / VECTORSCOPE



NOW — YOU CAN HAVE BOTH IN ONE INSTRUMENT:

- A CONVENTIONAL WIDE BAND OSCILLOSCOPE
- A PROFESSIONAL 5-INCH VECTORSCOPE

The PS148 wide band scope is identical in features and specifications to the PS127. In addition, it provides a vectroscope for complete simplified troubleshooting and alignment of color TV chroma circuits. Now, you can view the vector patterns as recommended by Zenith or display the standard "S" pattern as recommended by RCA. Both methods are at your fingertips with the PS148. Now, for only \$20.00 more than the PS127, you can view vectors and still own a deluxe wide band scope for all other work. Why pay many times more?

- Converts at the flick of a switch on rear panel from a professional wide band scope to a large 5-inch vectroscope. All vectroscope connections and controls are located on rear for ease of operation and to prevent color demodulator circuit loading.
- Simplified instructions for using the vectroscope in color TV chroma circuits and for troubleshooting and alignment are packed with each instrument.
- Comes with special vectorgraph screen which shows exact degree of chroma demodulation; also includes viewing hood.
- Use with any standard 10 bar color generator, such as all Sencore, RCA, etc. Use your present color generator and save money.
- Vectroscope connections on PS148 rear also speeds up other work where direct connections to the CRT deflection plates are required; such as, modulation checks and lissajous patterns for communications or lab work.

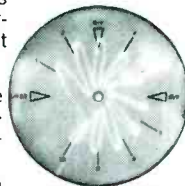

Typical Vector pattern

ONLY
\$219⁵⁰

NO. 1 MANUFACTURER OF ELECTRONIC MAINTENANCE EQUIPMENT
SENCORE
426 SOUTH WESTGATE DRIVE, ADDISON, ILLINOIS 60101
Circle 23 on literature card

SYMPTOM 1

Horizontal Foldover

Narrow Picture
R4 Increased in Value
(Q1 Collector—270 ohms, 1 watt)

Symptom Analysis

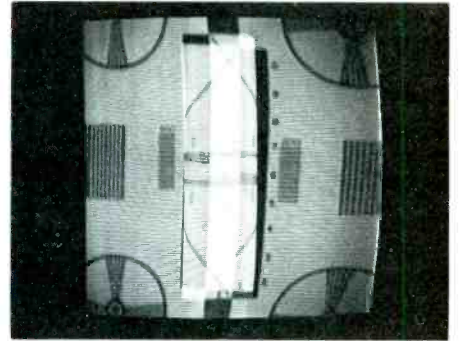

Raster shows 2" to 3" foldover in center of screen. Width is insufficient regardless of adjustment of width sleeve. Picture is dim and slightly out of focus. High-voltage measures 10KV but blooms slightly more than normal. Vertical sweep excessive; however, controls work normally.

Waveform Analysis

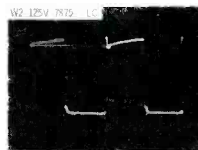
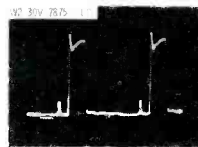
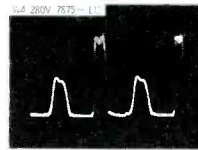

W4 is key: large pulse decreased to 280 volts p-p with an uncountable trailing pulse. W1 is decreased (3 volts p-p, normally 4 volts p-p), but sufficient basic content provides proper square-wave output at collector of Q1. W2, at Q1 output, indicates timing is off (Q1 not on long enough during each cycle). W2 is reduced (30 volts p-p, normally 125 volts). W3 supports findings of W2 (5 volts p-p, normally 15 volts). W6 could also be key: only 3 volts p-p compared to normal 7 volts.

Voltage and Component Analysis

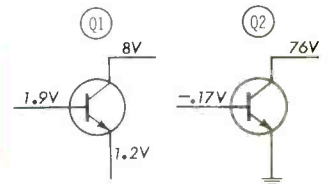

B+ on collector of Q2 measures higher than normal, indicating horizontal output stage not conducting. B+ source voltage is high (77 volts). Reading at Q2 base (-0.17V) indicates reduction in drive. Q1 collector measures only 8 volts—condition affects B+ and bias circuits. Symptom usually originates as compression in center of screen, critical horizontal sync or "Christmas tree" when brightness control advanced. Reduced amplitude of W2 is relevant, but important clue is change in "on-off" cycle of square wave. Shorter duration of "on" cycle, coupled with voltage inversion in T1, reduces cutoff time of Q2, distorting W4 and W5.

Best Bet: Scope, then VTVM.

SYMPTOM 2

Narrow Raster

Dim Picture
Q1 Leaky
(Horizontal Driver—NPN)

Symptom Analysis

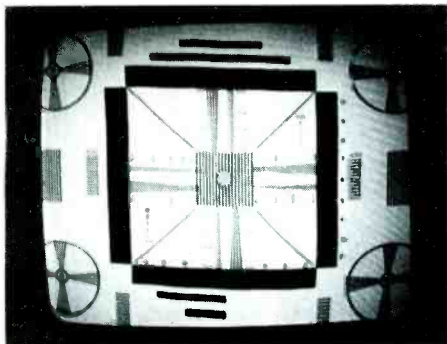

Right side of raster lost. Raster can be expanded by centering and adjusting width sleeve. Right side compressed, left side expanded. Raster blooms when brightness control is advanced; focus poor; second anode voltage low (10 to 12KV, normally about 20KV with normal brightness adjustment).

Waveform Analysis

W4 and W5 appear near normal in content but reduced in amplitude (W4 at 400 volts p-p, W5 at 420 volts p-p, normal is 500 volts). W3, only about 50% of normal amplitude, also shows distortion—not a linear square wave—positive-going portion (used to switch Q2 “on”) of shorter duration than negative portion. W2 weak in amplitude and distorted (positive-going portion much longer in duration than negative portion). W1 slightly increased in amplitude—proper polarity, but distortion is evident.

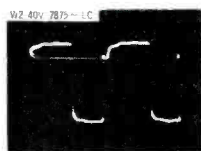
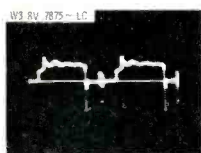
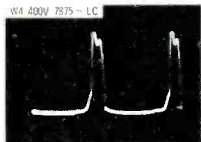

Voltage and Component Analysis

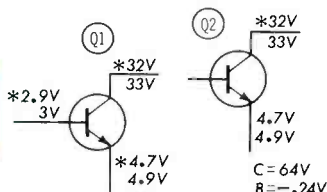

The clue is reduced Q1 collector voltage (32 volts, normally 57 volts). Q1 emitter voltage is above normal and Q1 is potentially cut off, producing change in switching time. Further increase in Q1 leakage will completely cut off Q1 and raster will disappear. VTVM readings indicate 470 ohms between collector and emitter of Q1. Right side of raster is affected since second half of trace and retrace is produced by conduction of Q2. Leakage of Q2 reduces drive signal at Q2 base, therefore limiting conduction of Q2. In this instance, Q2 conduction allows nearly normal high-voltage production and flyback action.

Best Bet: VTVM and component substitution.

Weller®
makes first class
soldering the easiest
part of any job



The original Dual Heat Soldering Guns

Preferred by technicians for their fast heating copper tips, exclusive trigger-controlled dual heat, and high soldering efficiency. Available in 3 watt-age sizes, each with spotlight.

100/140-watt Model 8200, 145/210-watt Model D-440, and 240/325-watt Model D-550. Also in complete kits:

Dependable MARKSMAN Irons in a size for every job



Ideal for deep chassis work and continuous-duty soldering, Marksman irons outperform others of comparable size and weight. All five feature long-reach stainless steel barrels and replaceable tips.

- 25-watt, 1¼-oz. Model SP-23 with 1/8" tip (In kit with extra tips, soldering aid, solder—Model SP-23K)
- 40-watt, 2-oz. Model SP-40 with 1/4" tip
- 80-watt, 4-oz. Model SP-80 with 3/8" tip
- 120-watt, 10-oz. Model SP-120 with 1/2" tip
- 175-watt, 16-oz. Model SP-175 with 5/8" tip

25-watt Technician's Iron for intricate circuit work



Industrial rated pencil iron weighs only 1¾ ounces, yet delivers tip temperatures to 860°F. Cool, impact-resistant handle. All parts readily replaceable. Model W-PS with 1/8-inch tapered tip.

Also available: A new Battery Operated Iron for use with 12 volt battery or 12-24 volt AC/DC source. Complete with 12 ft. cord and battery clips. Model TCP-12.

Complete Weller Line at your Electronic Parts Distributor.

WELLER ELECTRIC CORPORATION, Easton, Pa.

WORLD LEADER IN SOLDERING TOOLS

Circle 24 on literature card

Your next tuner cleaning job could cost somebody 15 bucks.

You.

You blow about 15 bucks every time you have a contact cleaning call back. Isn't it worth spending a few extra minutes to save that \$15 and your customer's good will? Then do the job right the first time with Contacare Kit III. Unlike sprays that simply push the "gunk" around to dry and harden, Contacare does a thorough cleaning and lubricating job. You just pour the special liquid cleaner on the lint-free cloth applicator and wipe away all film, dust and dirt. Then apply a little of our permanent lubricant to the contacts. The job's done—right. And you may have saved yourself \$15. Contacare is non-flammable, non-conductive, and provides trouble-free results for both black & white and color sets. Properly used, Contacare Kit III will provide you with over 100 cleanings. Available at parts distributors. Price \$1.98



HELPFUL TUNER SERVICE TIPS INSIDE EACH CARTON!

A valuable booklet on repair and servicing written by one of the world's largest tuner manufacturers is packed with each kit.

Standard Components

DIVISION OF STANDARD KOLLSMAN INDUSTRIES, INC.
2085 North Hawthorne Ave. • Melrose Park, Illinois 60160

Circle 25 on literature card

SYMPTOM 3

Center Drive Line

Christmas Tree Effect
R5 Increased in Value
(5.6 ohms, 1 watt)

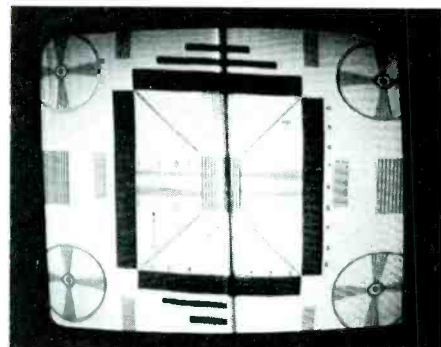

Drive line in exact center of screen. Raster narrow; can be adjusted with width sleeve. Raster has Christmas tree effect at higher brightness control settings. High-voltage decreased slightly (18KV) at normal brightness; drops to approximately 15KV at maximum.

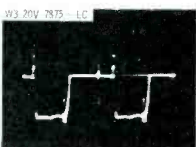
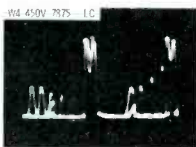

Waveform Analysis

First W4 amplitude near normal; however, spike halfway through trace causes compression of raster (drive line). Second W4, taken with brightness control advanced, contains series of spikes associated with Christmas tree effect which places increased load on output transformer. Amplitude of W3 increased 30 to 35% and slightly distorted (negative portion longer). W2 amplitude also increased (200 volts p-p, normally 125 volts), and distorted interval of negative-going portion should be shorter. W2 indicates defect probably in drive control circuit.

Voltage and Component Analysis

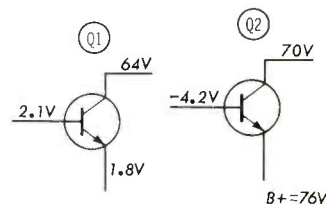

Relatively high bias voltage at base of Q2 is best clue (—4.2 volts, normally —1.9). Negative bias on NPN type transistor misleading, but bias set so that Q2 conducts only on positive-going portion of square wave, cut off on negative going portion. In this instance, incorrect bias upsets Q2 switch-action timing. Trouble compounded by interaction of stages. Example: horizontal oscillator emitter bias is through R1 to bottom of output secondary winding and a 100-ohm resistor to B—; thus, erroneous output signal is fed back to oscillator through driver output stage.

Best Bet: VTVM for voltage and resistance.

SYMPTOM 4

Narrow Raster

**Raster Compressed At Left Center
X1 Leaky
(Damper Diode)**



Symptom Analysis

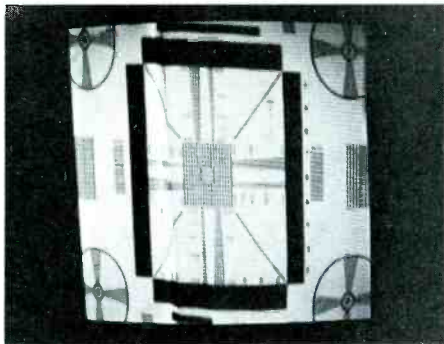

Raster quite narrow, drawn in from both sides with distinct horizontal drive line (compressed area) at the left center portion of the screen. Raster blooms when brightness control is advanced. Picture and sound information normal.

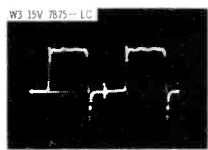
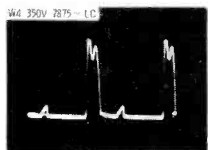

Waveform Analysis

Waveform at Q2 collector (W4) is low in amplitude (350 volts p-p, compared to a normal of 500 volts). Content distorted showing a positive going spike (same direction as retrace) about halfway through trace, thus indicating the compressed area of raster. Waveform W3 at base of Q2 is near normal in content and amplitude, a symmetrical square wave with negative going spikes, the first spike initiates Q2 cut-off, the second has no effect as Q2 is cut off at this time. W2 also near normal in content and amplitude. Waveform analysis isolates trouble to Q2 or Q2 output circuitry.

Voltage and Component Analysis

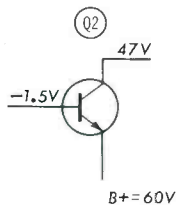

Q2 collector voltage decreased to 47 volts, 13 volts below B+. Collector supply circuit is through 10-ohm varistor and primary of output transformer, should be little drop in voltage. Horizontal output circuit is major portion of total load on B+ supply. Short causes severe B+ loading. Leaky capacitors C5, C6 or C7 could cause similar symptom, as could Q2. Damper diode serves same purpose as tube type, but if diode (damper) opens only linearity is affected since Q2 acts as damper. High voltage not lost as boost, not supported from damper circuit.

Best Bet: Scope, then VTVM.

**In-Circuit Transistor Testers
Used To Be Expensive...**



**The Heathkit® IT-18
Just Changed That... \$24.95**

- Tests transistors in or out of circuit for DC Beta
- Tests transistors out of circuit for I_{ceo} and I_{cbo} leakage
- Identifies unknown diode leads and NPN & PNP transistors
- Big 4 1/2", 200 uA meter reads DC Beta and leakage directly
- Two DC Beta ranges, 2-100 and 20-1000
- Expanded leakage current scale, 0-5000 uA, 1000 uA midscale, 5 uA first division
- 10-turn planetary ball type calibrate control
- Portable, battery powered from a single "D" cell
- Handy, attached 3' test leads

Heath engineers have done it again — a major price breakthrough in the cost of in-circuit transistor checkers. And this one has practically everything that the more expensive ones have and a few things that they don't, like a scale that reads DC Beta, not AC, from 2-1000, in or out of circuit. A big plus, because all manufacturers' specs are DC Beta. Measures emitter to collector and base to collector leakage current out of circuit, from 0-5000 uA, with 1000 uA center scale for extra readability. Matches transistors of the same or opposite types too. The ten-turn calibration control takes the frustration out of calibrating the IT-18 and you don't have to worry about circuit damage from improperly connecting it either. You'll like its small portable size, built-in test leads, front panel socket for low power devices, long "D" cell battery life and the ease of being able to check any bi-polar device. Order your IT-18 now, build in less than 2 hours, and congratulate yourself on knowing an extra value when you see it!

Kit IT-18, 4 lbs. . . . no money dn., \$5 mo. \$24.95

IT-18 SPECIFICATIONS — D. C. Beta: x 1 range — 2 to 100, x 10 range — 20 to 1000. **Out-of-Circuit Accuracy:** ±5%. **In-Circuit Accuracy:** Indicates good or bad (accuracy depends upon circuit being tested). **Leakage:** I_{ceo}, I_{cbo}, diodes forward or reverse (out-of-circuit only) 0-5000 uA. **Power:** One standard "D" cell (not supplied). **Dimensions:** 8 1/2" wide, 4 1/2" high, 7 1/2" deep (including handle). **Net Weight:** 2 1/2 lbs.

**FREE
1969
Heathkit
Catalog**

World's largest selection of electronic kits . . . over 300 to choose from . . . for school, home, and industry. Send for your free copy today.

HEATHKIT
HEATH COMPANY, Dept. 25-9
 Benton Harbor, Michigan 49022
 Rush my FREE Heathkit Catalog.
 Enclosed is \$ _____ including shipping.
 Please send model(s) _____
 Name _____
 Address _____
 City _____ State _____ Zip _____
 Prices & specifications subject to change without notice. **TE-188**

Circle 26 on literature card

SYMPTOM 5

Narrow Raster

**Linearity Near Normal
C5 Decreased in Value**
(Flyback Tuning Capacitor)

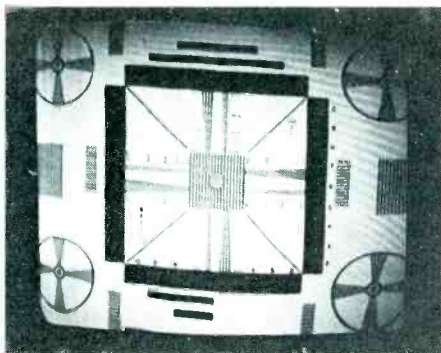
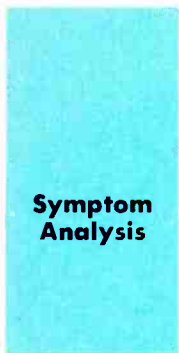

Raster narrow. Vertical sweep near normal; width sleeve adjustment helps, but corner shadows appear before attaining proper width. Horizontal linearity slightly off—compression at left, expansion at right. Brightness excessive. Second anode voltage 22KV at normal brightness (should be 20KV).

Waveform Analysis

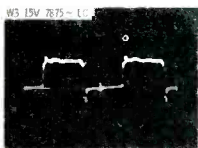
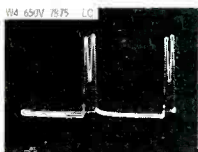

W4 has relatively linear baseline portion (nearly straight line), retrace portion is distorted—instead of one pulse with dip at peak, it is now two separate spikes, and amplitude is excessive (650 volts p-p, normally 500 volts). Increased amplitude of W4 results in incorrect control of CRT electron beam—trace completed before entire screen scanned. W3 near normal in content and amplitude, isolating defect to output stage. W5 shows results of change in capacitance of C5.

Voltage and Component Analysis

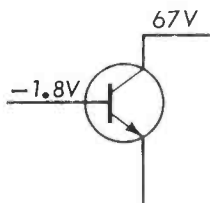

DC voltages measure well within tolerance and offer no clues to the source of trouble. Primary function of capacitor C5 (in conjunction with other components in circuit) is to resonate with flyback and yoke inductances at a frequency of 50KHz. C5 value is extremely critical and should be replaced only with capacitor having exact same specifications. A small change in either direction results in a noticeable change in raster width and the amplitude of high voltage.

Best Bet. Careful scope work; component substitution.

SYMPTOM 6

Excessive Width

**Vertical Sweep Normal
C7 Decreased in Value**
(Yoke Coupling—1 mfd)

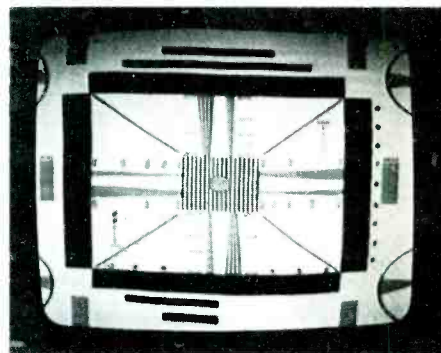

Raster far too wide. Vertical sweep appears near normal. Much of picture is lost at edges. Width sleeve adjustment narrows picture but in process causes non-linearity, compressed edges, and expanded center. High voltage is normal, but some blooming at maximum brightness.

Waveform Analysis

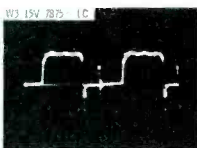

Waveform W5, at input to horizontal deflection coil, distorted, excessive in amplitude (600 volts p-p versus normal 500 volts), dropping to an exaggerated low in base line portion. Waveform W4 is normal in both content and amplitude. Waveform W3, at input of Q2, is also normal in content and amplitude. Due to the interaction of components in the output stage, waveform analysis is far more useful in isolating a defective stage than in attempting to isolate the specific defective component.

Voltage and Component Analysis

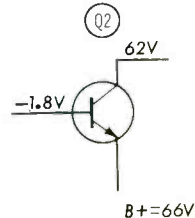

Q2 collector voltage lower than normal, but within tolerance. C7 is close-tolerance capacitor and should be replaced only by exact type. Functions of C7: block DC from deflection yoke, couple and shape yoke drive signal. C7 charged during Q2 conduction cycle. Q2 ceases conducting at end of trace, flyback ringing starts, large pulses reverse yoke current (retrace). X1 damps ringing pulses as C7 discharges through yoke, producing linear trace through first half of sweep.

Best Bet: Scope; component substitution.

THE TROUBLESHOOTER

Smear

There is a trouble symptom that has plagued me on several occasions. This symptom has not been covered, to my knowledge, in any of your books or in PF REPORTER. It is a symptom where the brightest reproductions of white cause a smear in the direction of the scanning. This is especially true if the white object parallels the scanning lines. In extreme cases the white smear extends horizontally across the entire picture. Small portions of the picture, or the lettering is surrounded by a small, round arc.

NORBERT SHRINEK

Hutchinson, Minn.

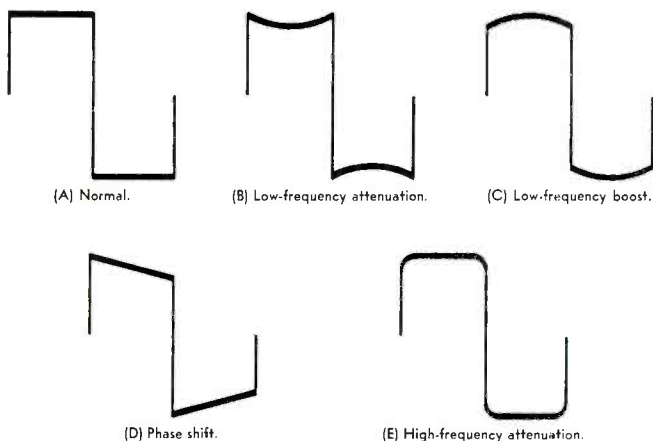

The symptoms are interesting but due to their infrequency we have not made them the subject of an article. Our plans for the next few issues do not include this subject; however, we will keep it in mind.

The causes of this symptom seem to fall into three categories: video amplifier malfunction, vertical deflection breakdown, or a defective CRT. The smear that follows the brightest reproductions of white on the CRT can be caused by a number of component failures in the video amplifier stage. A leaky coupling capacitor, an open cathode or screen bypass capacitor, change of value in resistors, or a defective peaking coil can give this indication.

A good method of isolating this trouble is through the use of a square-wave generator and scope to check the square-wave response at 30 Hz (for low-frequency response) and then at 200 KHz (for high-frequency

Why is a Vectorscope essential for Color TV servicing?

- 1 Check and align demodulators to any angle . . . 90°, 105°, 115° . . . accurately and quickly. No guesswork. New color sets no longer demodulate at 90°. Only with a Vectorscope can these odd angles be determined for those hard-to-get skin tones.
- 2 Check and align bandpass-amplifier circuits. Eliminate weak color and smeared color with proper alignment. No other equipment required. Only a V7 Vectorscope does this.
- 3 Pinpoint troubles to a specific color circuit. Each stage in a TV set contributes a definite characteristic to the vector pattern. An improper vector pattern localizes the trouble to the particular circuit affecting either vector amplitude, vector angle or vector shape. Only a V7 Vectorscope does this.



EXCLUSIVE FEATURES:

Color Vectorscope: Until now, available only in \$1500 testers designed for broadcast use. Accurately measures color demodulation to check R-Y and B-Y, for color phase and amplitude. A must for total color and those hard-to-get skin tones. **Self-Calibrating.** Adjust timing circuit without external test equipment. **Dial-A-Line.** Adjust horizontal line to any width from 1-4 lines. **Solid State Reliability** in timer and signal circuits. **Plus:** All Crosshatch, Dots, Vertical only, Horizontal only and Keyed Rainbow Patterns. RF at channels 3, 4 or 5. Video Output (Pos. and Neg. adjustable) for signal injection trouble-shooting. Red-Blue-Green Gun. Killer. All transistor and timer circuits are voltage-regulated to operate under wide line voltage ranges. Lightweight, compact—only 8¼x7½x12½". **NET 189.50**

ONE YEAR WARRANTY

V6-B New, improved complete color bar generator with all the features of the V7 except the Vectorscope. Only **99.50**



For the full story, see your distributor or write for literature. Dept. PF-9

LECTROTECH, INC.

1221 W. Devon Ave., Chicago, Ill. 60626

Circle 27 on literature card

response). A 200 KHz signal contains harmonics up to several megahertz. By observing the waveshape of the video output circuit you can determine the quality of reproduction and amplification of the video output stage.

Some of the basic distortions found in video amplifiers are shown here. Most video amplifiers will have some overshoot on the leading edge of the square wave. This is done to provide for extremely fast rise time. However, this overshoot should be less than 10 per cent to prevent undue distortion.

The compression or folding of the raster during vertical scan is sometimes caused by insufficient filtering in the power supply or in the vertical output stage. Leakage and/or loss of capacitance can allow spurious signals to feed into the vertical circuits. Bridging of the capacitors does not always correct this. The best method for isolating this defect is to use the scope to visually inspect the power supply output and the voltage on the control grid of the vertical output stage. A small spike on the linear portion of the sawtooth waveform is a classic indication of an unwanted signal feeding into the vertical section.

Multiple Symptoms

I have in for repair a Catalina Model 122-772B. The original complaint was a blurry picture. Operation then degenerated, producing the following symptoms: a decrease in vertical sweep, double image (at times) and an increase in brightness resulting in an increase in vertical sweep with blooming and loss of focus. All components related to the vertical section have been

replaced. The high-voltage rectifier, horizontal output, and horizontal oscillator have also been replaced. Are these symptoms related?

PAT N. KILLDORD

Taylor, Texas.

The trouble causing the symptoms you describe is not necessarily located in the vertical section. You made no mention of the boost voltage. I suggest you check that and the current through the horizontal output tube (V9). Also, check and adjust the high voltage applied to the anode of the CRT.

Intermittent Boost

I am working on an RCA CTC19D color chassis. The symptom is no picture; sound normal. Boost voltage is reduced by 50 percent. All source voltages are within tolerance. In checking the horizontal AFC, oscillator, and output stages I found the abnormal readings shown in Table 1.

Table 1

V10					
Pins	1	2	3	6	7
Voltage	15V	-0.5V	0.3V	235V	0.15V
V11					
Pins	1 and 7	2 and 6	8		
Voltage	15V	4.5V	50V		

I have checked all tubes including the CRT and they are okay. All resistance measurements (using the

Discriminate Between Desired Signal and Unwanted Noise

with the

FREE SPACE STANDING WAVE MAGNETIC ANTENNA UHF-VHF-FM-COLOR

Investigate now!

S&A Electronics Inc.

Manufacturers of the TARGET ANTENNA

Phone 419-693-0528

206 West Florence Street Toledo, Ohio 43605

Circle 28 on literature card

Got a Troubleshooting Tip?

If you've recently run across an unusual trouble symptom and have determined what caused it, why not pass the information on to the other readers of PF Reporter? You'll not only be saving other service technicians valuable troubleshooting time, you'll also be making a little extra change yourself. Send a thorough description of the trouble symptom and the solution along with a brief discussion of your troubleshooting technique to:

Troubleshooting Tip
PF REPORTER
1014 Wyandotte Street,
Kansas City, Mo. 64105

We defy competition

to top Oxford quality, variety, delivery, and prices!

Here are the speakers with the quality features demanded for today's critical sound requirements. Extra heavy ceramic magnets for wider range, with Oxford's exclusive "Floating Suspension Surround" the permanently flexible edge that extends the low frequency spectrum without undesirable hangover, assuring smoother mid-range, brilliant high frequency response.

Paging and Talk Back Speakers

Public Address Speakers

"TEMPO" Hi-Fi Speaker

All Weather Speakers

Replacement Speakers

Professional Musical Instrument Speaker

Match your needs from a full range of speakers for new highs in high fidelity performance. Best of all, they're available now from -

OXFORD,
of course.

MEMBER
ALMA

MEMBER
ELECTRONIC INDUSTRIES
ASSOCIATION

Write for complete information today!

**OXFORD TRANSDUCER
COMPANY**

A Division of Oxford Electric Corporation
3911 S. Michigan Ave., Chicago, Ill. 60653



Circle 30 on literature card

PHOTOFACT BULLETIN™

PHOTOFACT BULLETIN lists new PHOTOFACT coverage issued during the last month for new TV chassis. This is another way PF REPORTER brings you the very latest facts you need to keep fully informed between regular issues of PHOTOFACT Index Supplements issued in March, June and September. PHOTOFACT Folders can be obtained from your local parts distributor.

ADMIRAL	Chassis K1563-5, 12G1363-5 . . .	986-1
ARVIN	Chassis 1.31701/801/901, 1.37101	982-1
BRADFORD	CATV-59584/691/709, CWES-57018/133	986-2
CATALINA	Model 122-760A	980-1
PACKARD BELL	Chassis 98C11A	985-1
MAGNAVOX	Chassis T931-01-AA thru -19-AA, T391-23-AA/-25-AA/-26-AA . . .	984-1
	Remote Control Transmitter 704041-1, Receiver 704044-1 thru -10 . . .	984-1A
RCA	Chassis CTC27XAA	982-2
	Chassis CTC35C	979-1
	Chassis KCS169B	984-2
	Chassis KCS171B	981-1
	Chassis KCS173B/D/E/H . . .	980-2
	Remote Control Receiver KRS29B Transmitter KRT4B	980-2A
SETCHELL CARLSON	Chassis U806	978-2
	Chassis U807	979-2
	Chassis U808	980-3
SHARP	Model TU-30P	986-3
SYLVANIA	Chassis BO4-7, B04-8	983-1
TRUETONE	Models MEA3755B-76, MEA4857A-86	982-3
WESTINGHOUSE	Chassis V-2659-1/-2, V-2660-1/-2/-3	984-3
	Chassis V-2662-1	985-2
ZENITH	Chassis 13Y12	978-3
	Chassis 15Y6C15	983-2
	Chassis 20Y1C48, 20Y1C50 . . .	981-2
	Remote Control Receiver S-74626, S-75276, S-79636	981-2A
	Remote Control Receiver S-77536, Transmitter S-68936	981-2B
	Remote Control Receiver S-78304	981-2C

PRODUCT REPORT

for further information on any of the following items, circle the associated number on the Catalog & Literature Card.

Power Adapter (55)

An AC adapter for use with 12- and 14-volt mobile transceivers has been developed by the **Amphenol Corporation**.

The new universal power supply is the first AC adapter ever designed to provide instant DC power for almost all transistorized in-car shortwave radio transceivers. Known as the Amphenol Model 790 "Power Pedestal," the AC to DC adapter requires no special connectors, mounting straps, terminal lugs or alignment pins. Two magnetically impregnated rubber mounting strips hold the transceiver

in place. Electrically isolated from the supply circuit, they permit use with any mobile transceiver that has a flat metal base surface. Chassis isolation enables instant termination to both positive and negative ground communications sets. Electrical connections are made to two binding posts, clearly marked for polarity, at the rear of the power supply chassis.

A transistor capacitor/multiplier configuration serves to increase apparent circuit filtering capacity automatically as the load is varied. The unit exhibits five percent output regulation with only 0.05 percent ripple (low current ripple: 0.4

RMS BEST PERFORMING UHF CONVERTERS

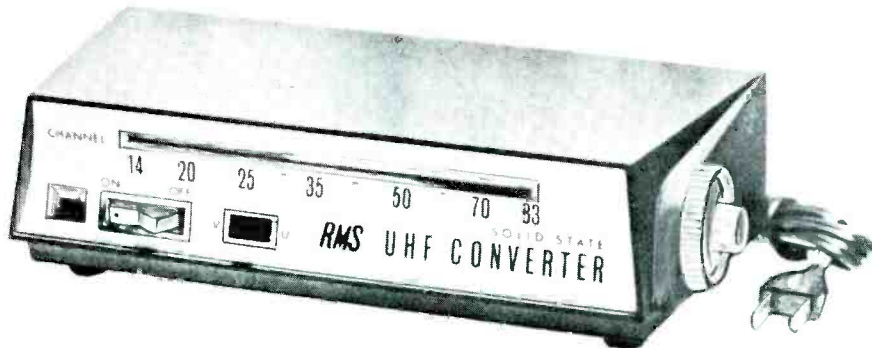

RMS SOLID-STATE TWO TRANSISTOR DELUXE UHF CONVERTER HAS BUILT-IN AMPLIFIER!

Updates any VHF TV Set to receive any of the 83 UHF/VHF Channels. Low noise, drift-free operation. Simple hook-up. Charcoal Gray Hi-Impact Plastic Housing has Silver-matte finish front panel. Features accurately calibrated UHF dial, UHF/VHF antenna switch, on/off switch, advanced pilot light indicator and tuning control. Model CR-300

List \$34.95

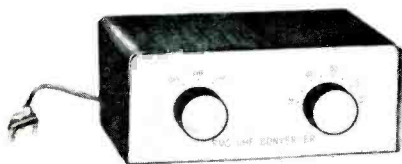

RMS SOLID-STATE ECONOMICAL UHF CONVERTER

Two transistor advanced circuitry. Durable metal housing has wood grain finish and Satin Gold front panel with Black knobs having Gold inserts. #CR-2TW List \$27.95

RMS UHF ANTENNAS...

Top performers for all areas! Brings clearest Color and Black and White Reception on all UHF Channels 14-83. Features Reynolds Aluminum COLORWELD!

Write for FREE Information on these and other Profit Building Products...

RMS ELECTRONICS, INC.

50 ANTIN PLACE, BRONX, N.Y. 10462 • Tel. (212) TY 2-6700

Circle 31 on literature card

FAST

COMPLETE OVERHAUL ON ALL MAKES OF TV TUNERS

Maximum Time In Shop 24 Hrs.
Price Change Effective August 1, 1968

(WE SHIP C.O.D.)

\$9.95



Black & White or Color

VHF or UHF

UV Combo's \$16.50

Price includes all labor and parts except Tubes, Diodes & Transistors. If combo tuner needs only one unit repaired, disassemble and ship only defective unit. Otherwise there will be a charge for a combo tuner. Ship tuners to us complete with Tubes, Tube Shields, Tuner Cover and all parts (including) any broken parts. State chassis, model number and complaint.

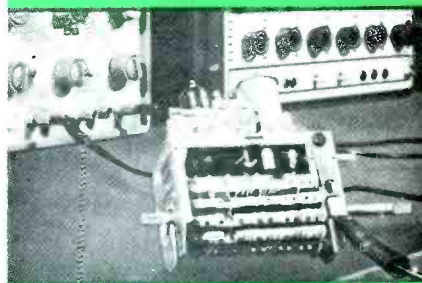

All tuners are serviced by **FACTORY TRAINED TECHNICIANS** with years of experience in this specialized field. All tuners are **ALIGNED TO MANUFACTURERS SPECIFICATION** on crystal controlled equipment and air checked on monitor before shipping to assure that tuner is operating properly.

GEM CITY TUNER REPAIR SERVICE

Box 6C Dabel Station
2631 Mardon Drive
Dayton, Ohio 45420

Circle 32 on literature card

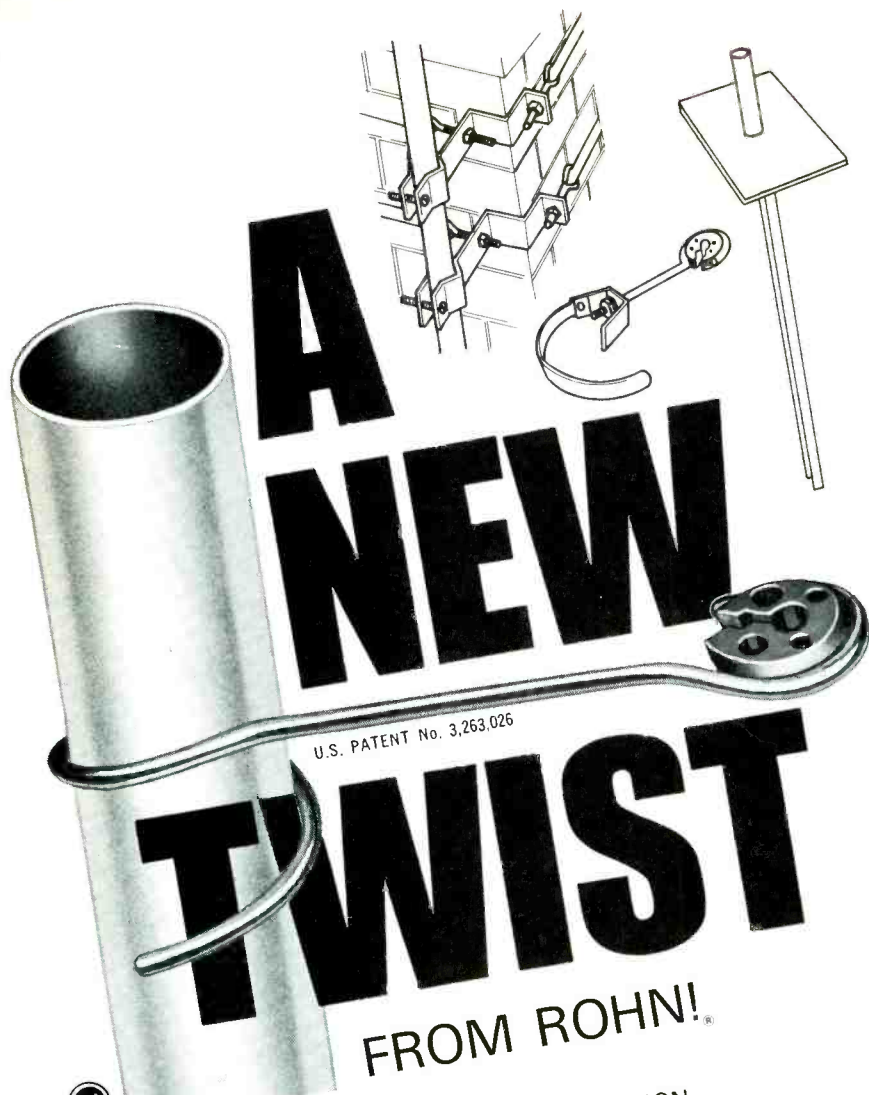

TWIST-ON STAND-OFF NEWEST ADDITION TO POPULAR LINE OF TV INSTALLATION HARDWARE AND ACCESSORIES

Rohn engineers have done it again! Now, with a simple twist of the wrist, the new Twist-On Stand-Off can be instantly installed on a TV or radio mast — and it can be removed the same way and used again. Simple but ingenious design prevents slipping — makes it stay where it's put. Ideal for both permanent and temporary use! The ingenuity that produced the new Twist-On Stand-Off has provided for you one of the most complete and outstanding lines of quality TV installation hardware and accessories — all available for instant delivery — all conforming to the rigid quality controls imposed by ROHN for all equipment bearing the ROHN name.

Write today for free copy of NEW ROHN TV INSTALLATION HARDWARE AND ACCESSORIES catalog.

ROHN®

ROHN MANUFACTURING CO.
Post Office Box 2000
Peoria, Illinois 61601

ROHN SOUTH
VULCAN TV MAST & TOWER CO., INC.
911 Thomason Ave., Post Office Box 6537
Tarrant, Birmingham, Alabama 35217

Circle 33 on literature card



mv AC ripple at 1 amp). Output voltage is 13.5 volts DC, nominal.

Model 790 is solid-state through-out, featuring dual rectifier diodes, 2N544 transistor capacitor/multiplier and ZA-14 zener diode voltage regulator.

Housed in an inclined silver and blue case, the unit weighs 4 lbs., measures 3" x 6" x 8", and is priced at \$29.95.

Tape Case (56)

The Winegard Company has announced the availability of the Tape-Case. The portable cabinet for home and auto has been designed to file and protect both 4- and 8-track tape cartridges. The case measures 11 $\frac{5}{8}$ " x 6" x 5 $\frac{3}{4}$ " and holds as many as nine cartridges.



The cabinet is molded of high impact polystyrene and rollback doors are polypropylene in off-white to coordinate with the walnut grain vinyl top and bottom.

The versatile case sits on side, end or bottom and is lightweight. Price is \$5.95.

Compressor-Preamplifier (57)

Caringella Electronics announces the new solid-state Model ACP-1 Compressor-Preamp. The unit is available as a kit or completely wired and tested.

The Compressor-Preamp can be used with any tape recorder for automatic control of recording level,



and with any P.A. system for maintaining a constant output level and eliminating annoying feedback. The unit is also a useful accessory for amateur radio and CB transmitters, providing added modulation "punch" and protection against overmodulation.

A low-noise, high-impedance FET input stage is utilized in the five-transistor one-diode circuit. The compression range is 30 dB. Frequency response extends from 20 to 20,000 Hz. Input and output signal levels are completely adjustable. The unit installs in the microphone line of any tape recorder, PA system, amateur radio or CB transmitter. Printed-circuit layout and easy-to-read instructions are included with the kit. Months of power are provided by an internal 9-volt battery. The unit is housed in a 2½" x 3" x 4¼" metal cabinet. Kit price is \$18.50. Wired and tested units are \$26.50.

Ultrasonic Annunciator (58)

The Euphonics Corporation has developed the first ultrasonic annunciator for use in offices, homes and stores. The Model AN-1 will cover an area rather than just a specific entrance. In addition, the unit can double as a short-range intrusion alarm when the premises are not occupied and the annunciator function is not needed.

Use of the ultrasonic principle eliminates the need for photocells, light sources, and installation wir-



ing. The AN-1 plugs into any standard 110-volt AC outlet and is aimed at the general area to be covered. A standard AC receptacle at the rear accepts a line cord from a chime, a bell, buzzer, lamp, or any combination that does not exceed 5 amps. Small motors also may be connected to this outlet if desired.

Upon detection of motion produced by a person coming into the protected area, or by a door opening, etc., the AN-1 triggers the device connected into its outlet, announcing their presence. After 15 seconds, the unit resets itself, and is ready for the next visitor.

A timer control switch is provided with two positions. In the "short" position, the device controlled will ring on sound for an instant, as an annunciator signal. In the "long" position, the device controlled will go on for 45 sec-

onds. The latter position is used to control a loud bell when it is desired to use the AN-1 as an intrusion alarm.

The range of the unit is adjustable from 4' to 15'. Power consumption is 3 watts. Universal mounting brackets are supplied, but a special swivel mount model, ANS-1, also is available at slightly higher cost.

The case is gray aluminum with black end panels. The size is 2" x 11" x 2½". The circuitry is all solid state. Price is \$64.95.

50,000

users can't be wrong!

TECHNICIANS EVERYWHERE RELY ON FAMOUS SENCORE MIGHTY MITES. HERE'S WHY.

- Grid Leakage Test with ultra-high sensitivity of 100 megohms
- Emission Test at full rated cathode current
- Shorts Test picks out interelement shorts of 180K ohms or less
- Mighty Mite accurately checks over 3,000 tubes, including foreign



NEW MIGHTY MITE V TC142

Now, Sencore's new Mighty Mite V gives you the same reliability and accuracy, plus new features that make the "V" the most up-to-date tester of all.

- NEW—Magnoval socket so you check many more tubes.
- NEW—Horizontal in-line switch layout saves setup time.
- NEW—Rugged vinyl-clad steel case stays new longer.
- NEW—Brushed chrome panel; detachable cover.

The new TC142 is truly Sencore's mightiest Mighty Mite and it's only

\$79.50

IN STOCK AT YOUR DISTRIBUTOR NOW.



SENCORE

NO. 1 MANUFACTURER OF ELECTRONIC MAINTENANCE EQUIPMENT

426 SOUTH WESTGATE DRIVE, ADDISON, ILLINOIS 60101

Circle 34 on literature card

WORKMAN
believes
 that they make
 the best circuit
 breakers in the
 industry and
 are willing to
 send you one
FREE
 to prove it.

WORKMAN *Electronic*
 P.O. BOX 3828 SARASOTA, FLORIDA 33578 PRODUCTS, INC.

MANUFACTURES A
 COMPLETE LINE OF

**FAIL
 SAFE**
 IN
 MOLDED
 BLACK
 PLASTIC
 CASE

**CIRCUIT
 BREAKERS**

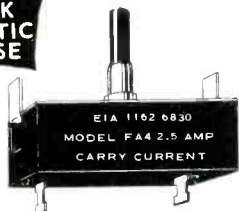

Model Numbers FA1.5 to FA7

When Red Button is depressed,
 contacts remain open, circuit is
 refused **ONLY** after Red Button
 is released.

RECOGNIZED UNDER THE
 COMPONENT PROGRAM OF

**UNDERWRITER'S
 LABORATORIES, INC.**

Circle 35 on literature card

**Bench Grinder
 (59)**

A new, multi-feature electric bench grinder has been introduced by **Wen Products, Inc.** It features dynamically balanced 6" grinding wheels ventilated for smooth, quiet, cool running using heavy duty precision ball-bearings and a 1/3 horsepower, 8.5-amp shaded pole motor delivering 3450 RPM, plus calibrated and adjustable tilting tool rests.

Also provided are two dynamically balanced Carborundum grinding wheels that are 3/4" thick with 1/2" arbor and have 36 grit coarse and 60 grit fine finishes.

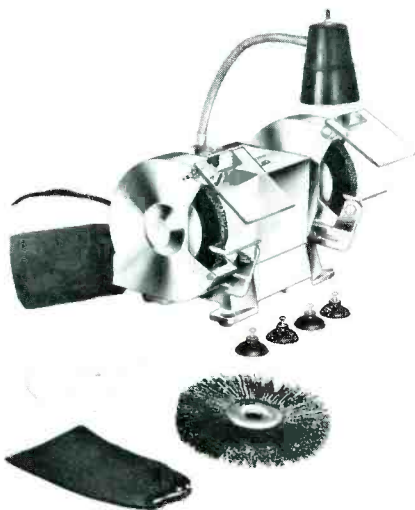

Other features include: adjustable see-through eye shields and spark arrestors; a sharpening groove in one of the tool rests to hold drill bits for proper sharpening angle; rear dust exhaust ports designed for dust collector bag attachment; combination rubber feet and mounting grommets that are predrilled for easy work-table mounting and quiet operation; enclosed steel wheel end-guards; and a heavy cast aluminum housing with a life-time Ball-Brite finish.

Model 1030 weighs approximately 16 lbs. Its overall dimensions are 9 1/2" x 5 3/4" x 15". The unit sells for \$49.95. An accessory kit, Model 1030-K9, consisting of two dust collector bags, one flexible auxiliary lamp assembly, a 6" wire scratch brush wheel, a 6" buffing wheel and four rubber feet with screw attachments for vacuum mounting is also available for \$11.34. The combined grinder and kit, Kit 1030-2, is priced at \$50.95.

NEW!

- TUBE TESTER
- GRID CIRCUIT TESTER



- ✓ CHECKS B & W PICTURE TUBES
- ✓ CHECKS COLOR PICTURE TUBES

**MODEL
 88A
 IN NEW
 MOLDED
 ROYALITE
 CASE**



Complete coverage of all popular receiving tubes including novars, nuvistor, newest 10-pin types, compactrons, decal and magnovals — PLUS a black and white CRT Adapter and two COLOR CRT ADAPTERS. Patented Grid Circuit Test makes up to 11 simultaneous checks for leaks, shorts and grid emission — plus Tube Merit and Filament Continuity Tests. For 115 VAC operation. Complete with speed indexed setup data. Mounted in durable NEW MOLDED ROYALITE CASE. Dimensions: 9 1/2" x 12 1/2" x 5". Shipping weight 6 lbs.

MODEL 88A Complete with Adapters \$ **89.50** NET
 Model 88A Less Adapters \$ **84.50** NET



**SECO ELECTRONICS
 CORPORATION**

1003 2nd St. So., Hopkins, Minn. 55343

Circle 36 on literature card

Rotator

(60)

A new type of rotator for home television antennas has been introduced by **Jerrold Electronics Corporation**. The Dyna-Rotor combines an all solid-state control unit with a light home TV antenna rotor. Powered by a dynamic spline drive, with fewer parts and improved reliability the unit develops high starting torque to overcome inertia, wind and ice loading. According to the manufacturer, the Dyna-Rotor is capable of aiming and holding the antenna precisely in the directions of selected transmitters and has no need for auxiliary or mechanical braking devices. The mast-mounted unit is permanently synchronized with the control unit at the TV set and automatically locks into any selected position.

Housed in a sturdy cast aluminum case, the rotor assembly is 5" high and 4 $\frac{3}{8}$ " in diameter at its base and weighs five lbs. The Dyna-Rotor rotates the largest antennas

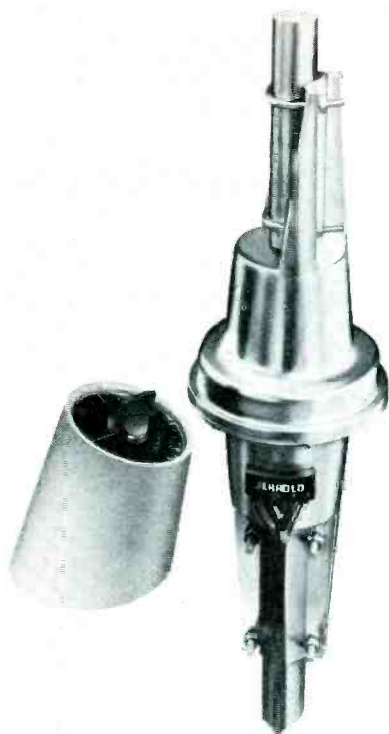

360° in less than 40 seconds. To operate the unit, a viewer turns the control knob to a marked position. There is no need to hold the knob in position. Price is \$54.95.

Dyna-flex*

the only practical probe for testing transistors in circuits.

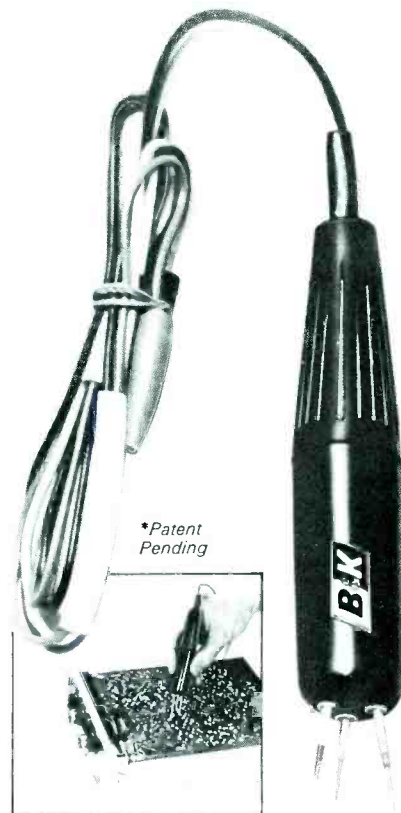

Throw away your alligator clips! Dyna-flex, the world's first and only 3-point probe, makes instant test connections to transistors in printed boards. Easy to use, the Dyna-flex probes are spring-mounted on ball joints. Allow you to adjust to any spacing 1/32" to 5/8", using only one hand. Dyna-flex eliminates costly unsoldering; can be used to make temporary component substitutions on printed wiring boards. Each point is color-coded for fast, easy identification. Dyna-flex—another engineering breakthrough from B&K.

Model FP-3, \$12.95 user net



B&K Division of Dynascan Corporation
1801 W. Belle Plaine Avenue / Chicago, Illinois 60613
Where Electronic Innovation Is A Way Of Life

Circle 38 on literature card

September, 1968/PF REPORTER 61

New Coil Catalog and Replacement Directory

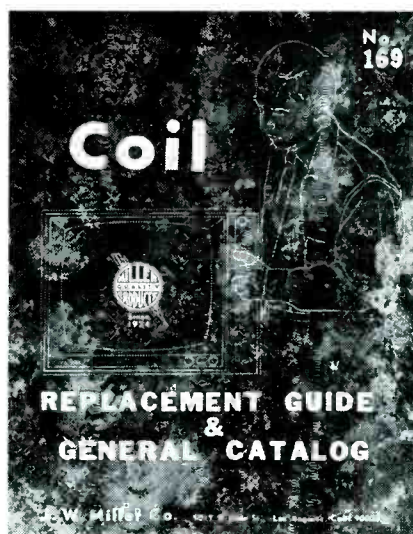

Catalog 169 gives prices, specifications and installation diagrams for the industry's most complete line of RF and IF coils. Replacement directory cross references exact replacement coils for all known color and black & white TV sets, home radios and car radios.



J.W. MILLER COMPANY

5917 South Main Street ■ Los Angeles, California 90003

SEE YOUR LOCAL DISTRIBUTOR FOR THE FULL LINE OF RF AND IF COILS, CHOKES, FILTERS AND TRANSFORMERS

Circle 37 on literature card

RATCHET-TYPE CHIMNEY MOUNT

With Stainless Steel
Strapping



Catalog No. 8008
Suggested Net \$4.28
(12' lengths)

Catalog No. 8008-L
Suggested Net \$5.10
(18' lengths)

New in design... tops in materials... first in service life. Here is the quality-constructed two-bracket chimney mount designed to give maximum service in high wind, seasonal storms, adverse weather conditions. Available with 12 or 18-foot lengths of stainless steel strapping to fit any chimney, a locking "U" bolt that accepts antenna masts up to 1 1/2" in diameter. This mount installs in minutes, requires only a single wrench to secure to chimney. Buy with confidence from the world's largest basic manufacturer of television hardware... you'll make your job easier, faster, and more profitable... more satisfying to your customer.

Always insist on **GC**...
you'll get more for your money, everytime!

GC ELECTRONICS
A DIVISION OF HYDROMETALS, INC.
MAIN PLANT ROCKFORD ILL. U.S.A.

Giant FREE Catalog...

Only GC gives you everything in electronics... has for almost 40 years. Match every part and service need from over 10,000 quality items. Write for your copy today!

Circle 39 on literature card

GC

has
everything
in
**TELEVISION
HARDWARE**

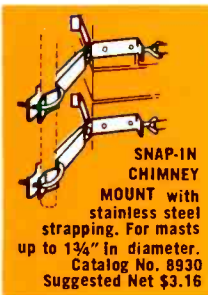

**SNAP-IN
CHIMNEY
MOUNT** with
stainless steel
strapping. For masts
up to 1 3/4" in diameter.
Catalog No. 8930
Suggested Net \$3.16

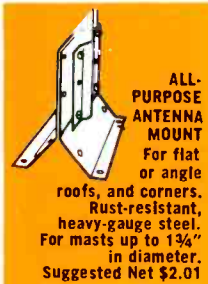

**ALL-
PURPOSE
ANTENNA
MOUNT**
For flat
or angle
roofs, and corners.
Rust-resistant,
heavy-gauge steel.
For masts up to 1 3/4"
in diameter.
Suggested Net \$2.01

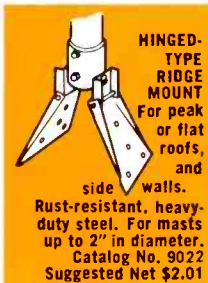

**HINGED-
TYPE
RIDGE
MOUNT**
For peak
or flat
roofs, and
side walls.
Rust-resistant, heavy-
duty steel. For masts
up to 2" in diameter.
Catalog No. 9022
Suggested Net \$2.01



Electronic Thermostester (61)

The Mura Corporation introduces Thermy, a patented device that electronically measures the temperature of any component from -60° to 400°F. (or from -50° to 200°C.). A sensitive thermal unit at the probe tip reacts instantly upon physical contact and reads

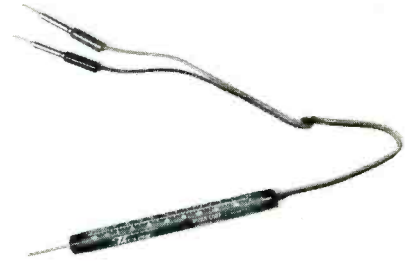

electronically when used in conjunction with a multimeter or ohmmeter. A simple conversion scale is provided to translate values from ohms to degrees. Packaged in an attractive, protective case, it comes equipped with banana pins and phone tip adapters. Price is \$12.50.

Multimeter (62)

Phillips Electronic Instruments, Division of PEPI, has introduced the solid state PM-2400 multimeter. This unit can sense, through the use of logic circuits, DC (either polarity) or AC inputs without the need for switching and always reads up-scale. It operates 1000 hours on one set of batteries, is self-calibrating and provides 42 direct reading ranges with long, high-resolution scales. The PM-2400 automatically measures current, AC and DC, from 1 full scale to 3 amps full scale; voltage, AC and DC, from 100 mv full scale to 1KV full scale and resis-

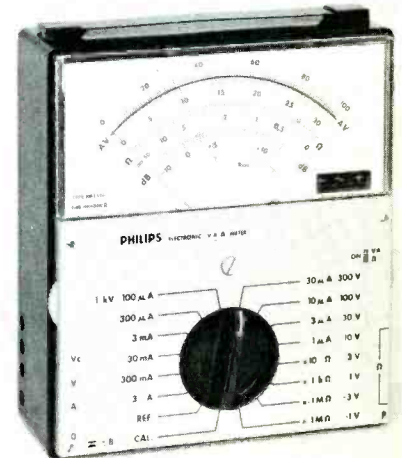

tance from 0.5 ohms to 50 megohms. The unit has all the advantages of an electronic multimeter without being power-time-bound. It floats as effectively as any passive VOM. Price is \$130.

**Screwdriver
(63)**

A screwdriver for those working with electrical systems is the Moody #50 Insulated Reversible Pocket Screwdriver manufactured by Moody Machine Products Co., Inc.



The hollow handle is made of nylon which insulates against shock. The handle also securely stores the blades, and the hex head provides a strong grip as well as preventing the screwdriver from rolling away from the work area. Price is \$1.50.

**Scope Dolly
(64)**

A new model scope dolly for laboratory and shop applications has been introduced by Metal Dynamics Corporation. The design of Model 61056 includes a 20° viewing angle which will accommodate



**15 CRYSTAL MARKERS
3 SWEEP RANGES
ONLY \$135**



**New Heathkit IG-57
Solid-State Color TV
Marker/Sweep Generator**

The IG-57 combines the features of both a post marker and a sweep generator for less than you'd expect to pay for just one of these functions.

- Three linear sweep ranges for TV tuned circuits in sound IF, color bandpass, video IF circuits and proper overall RF/IF response
- External attenuator provides 1, 3, 6, 10 and 20 dB steps up to 70 dB maximum
- Can also be used with external sweep or marker
- 15 crystal-controlled markers provided for color bandpass alignment; picture and sound carrier frequencies for channels 4 and 10; FM tuner, FM IF and discriminator alignment; TV sound IF adjustments
- All crystals included
- Completely isolated 1-15 VDC variable voltage supply for positive or negative bias
- Built-in 400 Hz modulation for trap adjustment and checking and adjusting FM tuners
- Phase Control and Trace Reverse Switch so markers will appear from left to right as in set manufacturer's instructions, regardless of 'scope used
- Blanking Switch eliminates return sweep and provides base line
- Circuit Board Construction — three circuit boards, 27 transistors, 3 silicon diodes, 2 crystal diodes and 2 Zener diodes combine to make assembly faster with less chance of error
- Bias and Scope Horiz. leads, Attenuator, Demod In, Scope Vert., RF and Demodulator cables included in kit.

Kit IG-57, 14 lbs., \$135.00; Assembled IGW-57..... \$199.00

IG-57 SPECIFICATIONS — Marker frequencies: 100 kHz; 3.08, 3.58, 40.8, 4.50 MHz, ± 0.01%. 10.7, 39.75, 41.25, 42.17, 42.50, 42.75, 45.00, 67.25, 193.25 MHz ± 0.05%. Modulation frequency: 400 Hz. Input impedances: External Marker, External Sweep, & Attenuator — 75 ohm. Demod In — 220 k ohm. Output impedances: Marker Out, Sweep Output & Attenuator — 75 ohm. Scope Vert — 22 k ohm. Bias voltage: Positive or negative 15 volts DC at 10 milliamperes. Type of marker: Birdie. Controls: Bias control with pull-on/push-off switch; Marker/Trace — dual concentric; Sweep Width/Sweep Center — dual concentric; Marker Out — concentric with Sweep Range switch; Phase. Switches: Rocker type — separate switch for each of the above listed frequencies; Blanking, On/Off; Trace Reverse; Modulation On/Off. Transistor — Diode Complement: (19)-2N3692 transistor. (7)-2N3393 transistors. (1)-2N3416 transistor. (3)-silicon diode rectifiers. (2)-crystal diodes. (1)-13.6 volt zener diode. (1)-20 volt zener diode. Sweep frequency ranges and output voltage: LO Band — 2.5 to 5.5 MHz ± 1 dB at 0.5 volts RMS fundamentals, and 10.7 MHz on harmonics. IF Band — 3B to 45 MHz ± 1 dB, at 0.5 volts RMS, fundamentals. RF Band — 64 to 72 MHz ± 1 dB at 0.5 volts RMS fundamentals, and 192 to 198 MHz on harmonics. Attenuator: Total of 70 dB of attenuation in seven steps — 1, 3, 6, 10, 20 and 20 db. Power requirements: 120 volts, 60 Hz AC at 20 watts. Dimensions: 13 3/8" W. x 5 1/2" H. x 12 1/8" D.

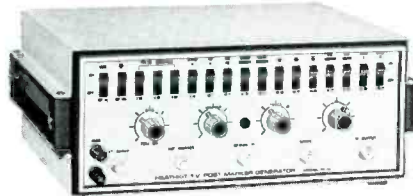

DON'T NEED THE SWEEP?
The IG-14 has the same features and specifications — without the sweep.

Kit IG-14
12 lbs. shpg. wt.
\$99.95



**Free 1969
Heathkit Catalog**

Describes these and over 300 other kits for test, stereo/hi-fi, color TV, SWL, Amateur Radio, CB, Marine, Educational, home and hobby. Save up to 50% the easy and enjoyable Heathkit way. Just mail coupon or write: Heath Company, Benton Harbor, Michigan 49022.

HEATH COMPANY, Dept. 25-9
Benton Harbor, Michigan 49022

Enclosed is \$ _____, plus shipping.
Please send model (s) _____
 Please send 1969 Heathkit Catalog.

Name _____ (please print)
Address _____
City _____ State _____ Zip _____
(Prices and specifications subject to change without notice) TE-182R

Circle 40 on literature card

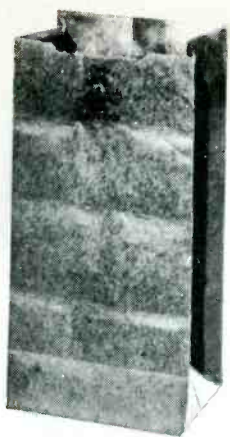

THEIR BULK PACK.



OURS!

 Pick up this handful of best-selling needles from your Electro-Voice distributor, and you get a handsome display carton free.

And if you want more, ask about our permanent phono needle/cartridge merchandiser, wall banners, literature, and the best cross-reference catalog in the industry.

We don't just make the most complete line of needles and cartridges, we also help you sell... help you profit. Insist on Electro-Voice. From the parts distributor with more than parts to offer!

ELECTRO-VOICE, INC., Dept. 98R
632 Cecil Street, Buchanan, Michigan 49107



Circle 41 on literature card

any popular type laboratory scope and a protective rubber gasket that prevents damage to the scope while installing or removing.

The unit features three convenient power outlets and one input; a storage area for spare preamplifiers, plus a storage pan for accessories, i.e., power cord, tools, manuals. Casters are 5" diameter, ball bearing, swivel-type with semi-hard rubber wheels. It is equipped with adjustable brackets that range from 6" to 12³/₄" wide, from 16¹/₂" to 22¹/₂" long. The unit is constructed of cold rolled steel with a gray, textured, baked, enamel finish. Price is \$59.95.

Riveter (65)

A professional-style riveting tool called the Vaco Pow'Riveter No. 175002 has been introduced by **Vaco Products Company**. Besides being designed to reach into confined places and deep openings, it has other features.

The tool has a two-position stroke adjustment that makes it easy to adapt to a single long stroke performance or an easy-pulling power stroke. It also has an outside jaw grip adjustment that is accom-

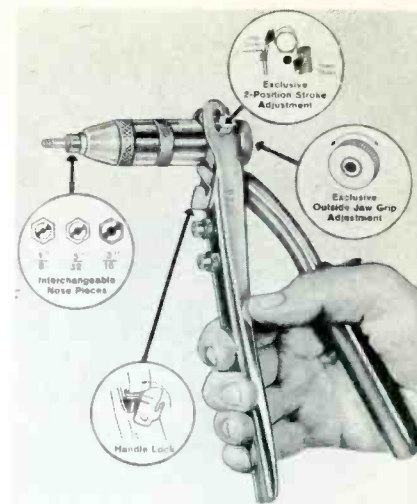

plished by turning a knob until the jaws grip the rivet mandrel.

The tool comes equipped with three interchangeable nose pieces to accommodate 1/8", 5/32" and 3/16" rivet mandrels. These pieces are stored on the handle of the tool which has a swivel keylock, and can be removed and attached to the Pow'Riveter by using a box wrench which is included for changing the stroke adjustment bolt.

Pow'Riveter No. 175002 is available in a heavy duty storage pouch, including a supply of Pow'Rivets and sells for \$22.95. Also available

THE BEST ANTENNA INSTALLATIONS START WITH . . .

South River QUALITY MOUNTING ACCESSORIES

THE MOST COMPLETE LINE IN THE INDUSTRY



South River HEAVY-DUTY / TUBULAR / TRI-POD
ROOF TOWERS

- Pre-assembled, individually boxed, opens like an umbrella.
- Gold baked enamel or Hot-Dip galvanized 1¹/₄" OD steel tubing.
- Exclusive adjustable slide permits tower feet to fasten directly to non-standard spaced rafters, on peaked or flat roofs.
- For masts up to 1¹/₂" OD.
- Roof sealing pitch patches, all hardware, 2" lag screws supplied.

AVAILABLE IN:
2 ft. 5 ft.
2¹/₂ ft. 7¹/₂ ft.*
3 ft. 10 ft.*

*Exclusive swing-lock feature permits mast to be placed in sockets from side of tower

SEND FOR CATALOG SHEET

AT SOUTH RIVER QUALITY IS OUR MOST IMPORTANT PRODUCT

SOLD THROUGH DISTRIBUTORS

SOUTH RIVER METAL PRODUCTS CO., INC. / SOUTH RIVER, N. J. 08882

Circle 42 on literature card

is an unbreakable, compartmented plastic box that measures 10" x 7½" x 1¾" and holds the tool plus a 55-unit assortment of four sizes of Vaco Pow'Rivets. The kit is priced at \$26.50.

UHF Converter and Amplifier (66)

A UHF Converter, Model CR-880, is the latest development of **RMS Electronics, Inc.** The solid-state converter features 3 transistors, 2 diodes, and a high-gain amplifier. Another unique feature is a Local/Distant Switch that enables the user to switch from local to long distance, thereby switching on the amplifier and boosting signal gain to a full 30 dB. The manufacturer claims the CR-880 also boosts signal strength and improves reception on all channels.

The unit updates any standard TV set to receive any of the 83 UHF and VHF channels. Screw terminals at the rear of the converter provide easy hook-up of antenna and set lead-ins. The TV set plugs directly into the AC receptacle at the rear of the converter.



There are three push button controls for switching on the converter and to select either UHF or VHF signals. A pilot light is illuminated when the converter is in UHF operation. Selection of UHF channels is made by a single tuning control and accurately calibrated dial panel. The converter features a char-

coal gray, high-impact plastic housing with a silver-matte front panel and tuning control. Rubber bumpers at the base of the converter provide safe placement on any fine furniture. Price is \$49.95.

UHF Antenna Add-On Kits (67)

Gavin Instruments, Inc. has introduced three UHF antenna Add-On Kits. According to the manufacturer they can be added on to any existing VHF installation. Each



for
action
and
profits,

check the "Silencer" . . . QUIETROLE

Check QUIETROLE . . . the "Silencer" for noisy radio, TV, (black and white, color too) and instrument controls, that protects your reputation, guards your profits.

QUIETROLE, the quality lubricant-cleaner for over 20 years, is harmless to plastics and metals, is non-conductive, non-corrosive, non-flammable . . . with zero effect on capacity and resistance.

For best results, specify QUIETROLE . . . Mark II for tuners Spray Pack for controls and switches Silitron for general use Available in Aerosol Can or Dropper Bottle

manufactured by
QUIETROLE COMPANY
Spartanburg, South Carolina
Circle 43 on literature card

Meet the Pro's Pro! CONTINENTAL II



MU150

World's Finest Tube Analyzer

Sophisticated Circuitry
Plus Advanced
Mechanical Design
For The Ultimate
In Performance

This is the MU150 Continental II—Sencore's new combination emission and mutual conductance tube tester. So precisely accurate you'll never have to guess again whether a tube is good or bad. See why we say it's the professional's professional tester.

NEW

Replaceable tube socket chassis
Simplified setup book
Sectioned and reinforced panel and case
Portable high-style attache case

- Checks over 3000 tubes—foreign and domestic.
- Mutual conductance test with 5000 Hz square wave truly analyzes the tube.
- Emission tests at near full rated cathode current on power tubes. Not available on other mutual conductance testers.
- 100 megohm grid leakage sensitivity check. A must to catch troublesome tubes with grid leakage or gas.
- 180K short sensitivity check. Compares each element in the tube against all others for possible shorts.
- Regulated for complete accuracy and assurance on marginal tubes.

If you want to go first class—go with the MU150 Continental II. Only **\$219⁵⁰**

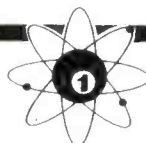

SENCORE

NO. 1 MANUFACTURER OF ELECTRONIC MAINTENANCE EQUIPMENT

426 SOUTH WESTGATE DRIVE, ADDISON, ILLINOIS 60101

Circle 44 on literature card

It costs you less to repair a tuner than to buy a new one. Right?

Wrong!

Figure it out. Repairing costs about \$9.75. New tubes cost around \$3.00. Now add your time and cost for packing and shipping to say nothing of the money you're out while waiting for it to be returned. (And who pays for your call back if another part of the tuner fails.) A brand new SC Super Arbor Preset Tuner with mounting brackets and tubes costs \$12.95. And you can pick it up in whatever time it takes you to get to the distributor—5, 10, 15 minutes. You get a new tuner warranty—1 year from date of purchase. The new tuner costs you less in time and money. Your customer gets a brand new tuner instead of a used one. Everybody's happy. Right? Right. Available at your parts distributors.

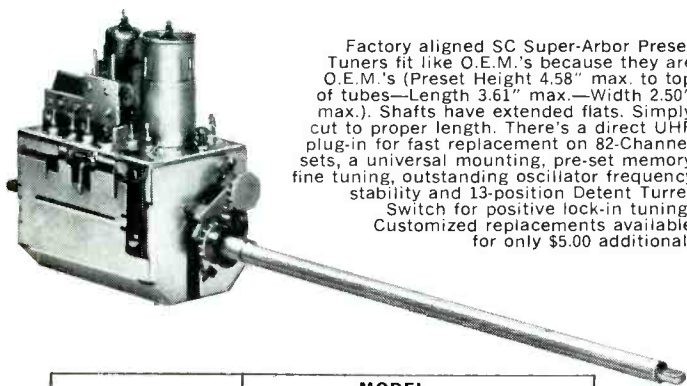

Factory aligned SC Super-Arbor Preset Tuners fit like O.E.M.'s because they are O.E.M.'s (Preset Height 4.58" max. to top of tubes—Length 3.61" max.—Width 2.50" max.). Shafts have extended flats. Simply cut to proper length. There's a direct UHF plug-in for fast replacement on 82-Channel sets, a universal mounting, pre-set memory fine tuning, outstanding oscillator frequency stability and 13-position Detent Turret Switch for positive lock-in tuning. Customized replacements available for only \$5.00 additional.

	MODEL		
	SBR-250	SBR-252	SBR4S-251
13 Position Switch			
Antenna Input	300 ohms balanced to ground		
Intermediate Frequency	41.25 mc sound 45.75 mc video		
RF Amplifier Tube	6HQ5	2HQ5	3HQ5
Oscillator-Mixer Tube	6GJ7	5HB7	5GJ7
Heater	6.3 volts	600 ma	450 ma
B Plus	125-145 volts dc.....		

sk *Standard Components*

DIVISION OF STANDARD KOLLSMAN INDUSTRIES, INC.
2085 North Hawthorne Ave. • Melrose Park, Illinois 60160

Circle 45 on literature card

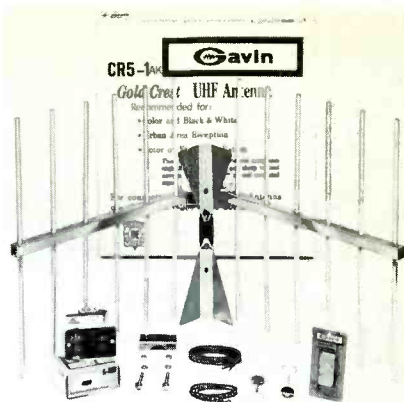

kit contains the following: a UHF antenna; a UHF/VHF antenna coupler to combine the two antennas into one existing download; two lengths of twinlead, cut to correct length with connectors attached; two snap-on, stand-off insulators; an indoor UHF/VHF/FM adaptor to provide separate twinleads for the UHF and VHF terminals of the TV set; and complete instructions.

Model CR-5AK uses a 13-element corner reflector antenna and sells for \$15.95; Model J-1AK uses a 7-element UHF Yagi and sells for \$15.50 and Model J-3AK uses a 20-element UHF Yagi and is priced at \$21.50. ▲

TEXAS CRYSTALS

is the line for you

CQC
means
CONTROLLED QUALITY CRYSTALS
for...

- Color TV
- Citizen Band
- Commercial and Industrial Radio

See Your Parts Distributor

CRYSTEK

TEXAS CRYSTALS

Division of Whitehall Electronics Corp.

1000 CRYSTAL DRIVE

FORT MYERS, FLORIDA 33901

Plants in Fort Myers and Los Angeles, Calif.

Circle 46 on literature card

Book Review

Measuring Methods and Devices in Electronics: A. C. J. Beerens, Hayden Book Co., Inc., New York, New York, 1968, 182 pages, 8 1/4" x 5 3/8", soft cover, \$4.25; cloth-bound, \$6.25.

Intended as a convenient reference to the methods and devices used in electronic measurements, this text covers the general testing procedures required by both the engineer and the technician.

Part 1 describes the operation and properties of the various types of measuring instruments — VTVM's, scopes, signal generators, impedance measuring bridges, frequency meters, regulated power supplies, etc.

Part 2 covers methods of measuring electronic quantities such as current voltage, power, frequency, resistance, capacitance, and inductance. Also included are techniques for making measurements on passive and active networks, and on tubes and transistors.

Part 3 provides guidance for determining the limits of accuracy of electronic measurements.

new Sams books

Transistor TV Training Course

by Robert G. Middleton. Provides a complete understanding of modern transistor television circuitry. Progresses functionally through a typical receiver from signal input or tuner stages, through video and audio i-f and detector stages, picture and sound amplifier stages, vertical and horizontal deflection and synchronizing systems; concludes with analysis of power supply circuits. Includes review questions. 128 pages. Order 20619, only \$3.95

Know Your Tube and Transistor Testers

by Robert G. Middleton. Explains principles and circuits used in tube and transistor testers. Includes schematics, specifications, and analysis of typical service and lab-type instruments. Packed with troubleshooting and repair data for various instruments. 144 pages. Order 20630, only \$3.50

North American Radio-TV Station Guide

by Vane A. Jones. NEW 5th EDITION. Completely updated, listing frequencies, call letters, locations, etc., for all a-m, f-m, and tv stations in the U.S. and possessions, Canada, Cuba, Mexico, and the West Indies. Includes over 5,000 a-m stations, over 2,200 f-m stations, and nearly 1,100 vhf and uhf tv stations. 144 pages. Order 20635, only \$2.95

FET Principles, Experiments & Projects

by Edward M. Noll. Explains in detail the theory and use of field-effect transistors. Black-box equivalent circuits are developed for the various modes of operation. Experiments involving the measurement of parameters and projects using FET's in practical circuits are included. 288 pages. Order 20594, only \$4.95

These and over 300 other SAMS Books are available from your local Electronics Parts Distributor . . .

HOWARD W. SAMS & CO., INC.
4300 WEST 62nd ST. INDIANAPOLIS, INDIANA 46268

Circle 47 on literature card

Advertisers' Index

September, 1968

American Telephone & Telegraph Co.	29
B & K Mfg. Co. Div. of Dynascan Corp.	17, 61
Bussmann Mfg. Div., McGraw-Edison Co.	12-13
Castle Television Tuner Service	23
Channel Master	25
Chemtronics, Inc.	67
Cleveland Institute of Electronics	33
Cornell-Dubilier	Cover 2
Electro-Voice, Inc.	64
GC Electronics, Div. of Hydrometals, Inc.	58
Gem City Tuner Repair Service	57
Heath Co.	51, 63
Injectorall Electronics Corp.	68
Kay Townes Antenna Corp.	7
Leader Electric Co., Ltd.	55
Lectrotech, Inc.	53
Littelfuse, Inc.	Cover 4
Mallory, P. R. & Co., Inc.	1
Mercury Electronics Corp.	24
J. W. Miller Co.	61
National Radio Institute	46
Oxford Transducer Co.	56
Quietrole Co.	65
RCA Institutes, Inc.	11
RCA Electronic Components & Devices (Picture Tubes)	Cover 3
RCA Electronic Components & Devices (Semi-Conductor Distributor Products)	39
RCA Sales Corp.	21
RMS Electronics, Inc.	57
Rohn	62
S & A Electronics, Inc.	54
Howard W. Sams & Co., Inc.	44, 67
Sanwa Electric Instrument Co., Ltd.	32
Seco Electronics	60
Sencore, Inc.	9, 31, 37, 48, 59, 65
South River Metal Products, Inc.	64
Sprague Products Co.	3
Standard Components, Div. of Standard Kollsman Industries, Inc.	50, 66
Texas Crystals	66
Tuner Service Corp.	5
Weller Electric Corp.	49
Winegard Co.	10
Workman Electronic Products, Inc.	60
Zenith Sales Corp.	43

**NOW YOU CAN
COMPLETELY
REMOVE ALL
GREASE, DIRT & OIL
THAT DETUNES
TV TUNERS**



325

DEALER NET

#2400

**A THOROUGH
DEGREASING
BATH IN SECONDS**
without
REMOVING THE TUNER
ONLY WITH THE NEWEST IN
ELECTRONIC CHEMICALS by



BROOKLYN

N. Y. 11236

Circle 48 on literature card

September, 1968/PF REPORTER 67

FREE CATALOG & LITERATURE SERVICE

ANTENNAS

100. *Antenna Specialists*—Professional and CB radio antenna catalogs, sectionalized and indexed. Professional catalog is loose leaf with plastic slip-on binder.
101. *Belden*—4-page catalog describes basic specifications and accessory information of company's Teflon-insulated products.
102. *JFD*—New 40-page dealer catalog of TV-FM antennas and accessories.

AUDIO

103. *Bogen*—Sound systems



“and not only that, but they took his **INJECTORALL SUPER 100 TUNER CLEANER** as well.”

Circle 49 on literature card

catalog #208 describes 23 amplifiers, 5 preamplifiers, 5 booster amplifiers, microphones, loudspeakers and accessories along with technical specifications.

104. *Craig*—4-page illustrated brochure describes videotape recording systems.
105. *Jensen*—Form PK features 5 decor-styled furniture Hi-Fi systems.
106. *Robins Industries*—35-page catalog describes its line of magnetic recording tape and accessories.
107. *Switchcraft*—Bulletin 171 describes 2 new audio connector adapters. Bulletin 175 features 3 new audio adapters. Bulletin 176 lists new multi-pin adapters and cable assemblies.

COMMUNICATIONS

108. *Hallicrafters*—4-page illustrated brochure describes line of monitor receivers. Also literature on 2-way radio equipment, folder for short wave receivers, catalog on line of “Ranger” and “Sea-Air” portable radios with direction finders.
109. *Mark*—Brochure about the “Mark Invader 23” AM CB transceiver.

COMPONENTS

110. *Bussmann*—Small TV fuse leaflet designed to fit pocket or tool kit, shows list prices of fuses most commonly used in TV sets. Ask for BUSS leaflet TVLP.*

SERVICE AIDS

111. *Alpha Wire*—A new guide provides basic wire and cable specification data that includes charts, diagrams and illustrations.
112. *Bay Products*—40-page catalog of shop and laboratory furniture and storage equipment.
113. *Blonder-Tongue*—New publication, “SOLUTION 1,” contains information for

servicemen about reception problems.

114. *Dazor*—Catalog No. 6300 is indexed and lists floating lighting fixtures.
115. *GC Electronics*—Catalog FR69, a 304-page listing for all product divisions.*
116. *Mid-State Tuner Service*—Flyer describes 24-hour tuner service.
117. *Precision Tuner Service*—Free mailing kit and tuner replacement list.

TECHNICAL PUBLICATIONS

118. *Hayden and Rider*—92-page catalog of up-to-date, illustrated guides and reference books dealing with electricity and electronics, audio and high fidelity, computers, radio operation, test equipment, etc.
119. *Sams, Howard W.*—Literature describing popular and informative publications on radio and TV servicing, communication, audio, hi-fi and industrial electronics, including special new 1968 catalog of technical books on every phase of electronics.*

TEST EQUIPMENT

120. *Motorola*—4-page brochure No. TIC-3316, describes wide-band, triggered, laboratory-quality oscilloscope.
121. *Triplet*—literature on new 3490-A transistor analyzer with complete specifications, descriptions and data.

TOOLS

122. *Diamond Tool and Horsehoe*—16-page, pocket-sized booklet W-68 about Diamond, Diamolloy and Copaloy wrenches, pliers, snips and electronic tools.
123. *Vaco*—Catalogs No. SD-66X and SD-66 list new special imprint tools.

*Check “Index to Advertisers” for additional information.

Here's something you'll want every one of your customers to read!

This important message on TV service, which originally appeared in TV GUIDE, is being made available in reprint form by RCA for your use. This message tells of the training, skills, and investment that enable the nation's TV technicians to perform a real service for their customers. It's really your story. So read it carefully and then get copies of it into the hands of your customers as far and wide as possible. They're available from your Authorized RCA Tube Distributor. RCA Electronic Components, Harrison, N. J.

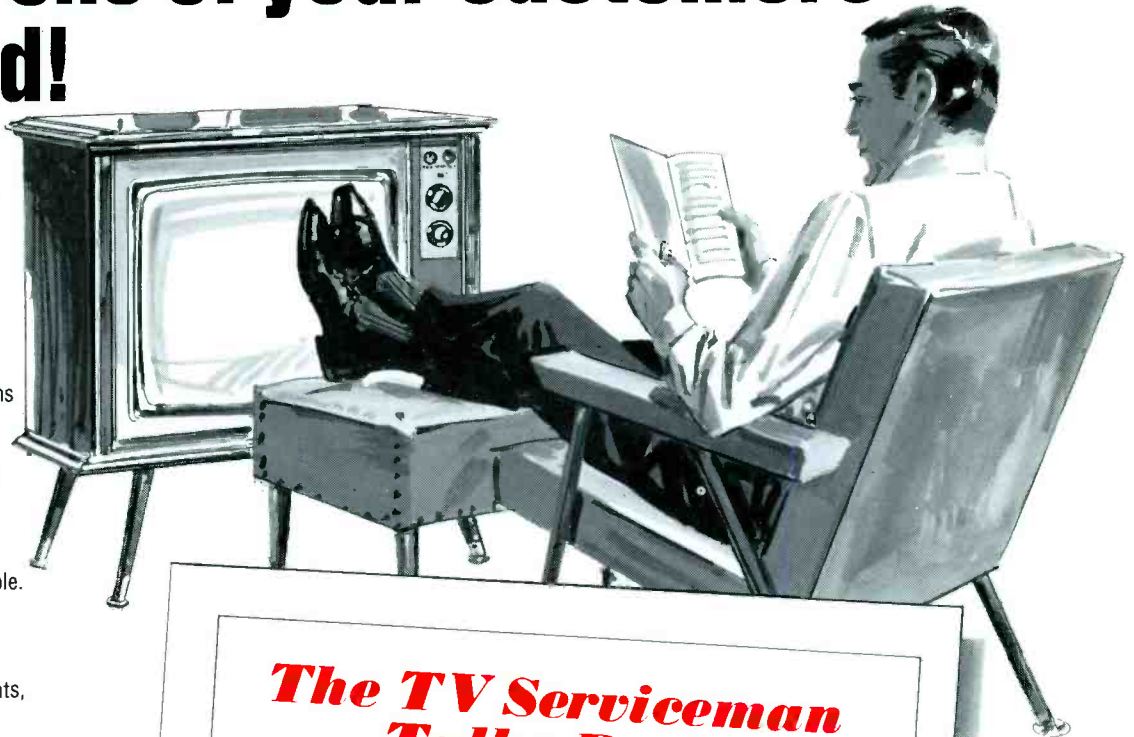

The TV Serviceman Talks Back

He details his reasons for feeling maligned, overworked and underpaid

By David Lachenbruch

Complaints about television service have received increasing publicity in recent months. But the man who fixes your set has a few complaints of his own. He feels he's misunderstood, maligned, distrusted, unappreciated, overworked and underpaid.

These complaints would appear to indicate a basic feeling of insecurity, except for the absence of one classic symptom. He doesn't feel the least bit unneeded. He *knows* he's needed. Everybody needs him, and they all need him yesterday.

This serviceman syndrome may be more a case for a public-relations man than a headshrinker. TV-repair technicians feel that they've taken more than their share of lumps lately, as the result of a wave of "exposés" which, they feel, make them look like a bunch of thieves — incompetent thieves, at that.

This malaise in the service industry comes at a trying time. It's accelerating the exit of many top-notch technicians into higher-paying, better-appreciated jobs—just when tens of thousands of new super-competent service dealers are urgently needed to doctor the ever-increasing number of complex color TV sets now moving into the Nation's homes.

TV-set manufacturers consider the technician shortage so serious that they've united in a five-year "Service Technician Development Program," whose total budget could run well above a million dollars, to attract and train young servicemen.

Richard Tinnell, a former Oklahoma State University electronics professor who coordinates this development program, rebuts the suggestion of widespread incompetence with circumstantial evidence: "There are 515 million electronic instruments in the hands of the American public—including TV sets, radios, phonographs and tape recorders—and 75 million are being added each year. All 515 million are in working order. If 65 percent of the service technicians were unethical or incompetent, this situation just couldn't exist."

He was referring to the kind of publicity which irks servicemen the most—the doctored-set caper. Two of these were summarized last fall in TV GUIDE ("Set Repair Frauds," Nov. 11), one in New York, one in Chicago. In the New York test, 20 service dealers were asked to repair sets in which one bad tube had been purposely inserted but which were otherwise in good shape. The test's sponsors esti-

RCA

Reproduced from TV Guide Magazine.
March 16, 1968 issue, with permission.
Copyright © 1968 by Triangle Publications, Inc.

**TV
GUIDE**

Give yourself a break you can depend on!



actual size
1 3/4" x 1 3/8" x 1/2"



#094077

CIRCUIT BREAKER CADDY

10 ratings, one each 2-1/4, 2-1/2, 2-3/4, 3, 3-1/4, 4, 4-1/2, 5, 6 and 7 amps.

SERVICE CADDY Breakers and Fuses

One service call is all—8 breakers—one rating each 2-1/4, 2-3/4, 3, 3-1/4, 4, 4-1/2, 5 and 7 amps and 30 fuses—five each type C3/10, C1/2, C3-1/2, N3/10, N7/10 and N1.



#094076

Designed for the protection of television receiver circuits, the Littelfuse Manual Reset Circuit Breaker is also ideally suited as a current overload protector for all types of electronic and electrical control wiring such as model railroads and power operated toy transformers, hair dryers, small household appliances, home workshop power tools, office machines and small fractional horsepower motors.

Available individually packaged one breaker per display card; or 5 breakers of same rating per unit pack or as complete, versatile assortments for shop use or replacements in the field.

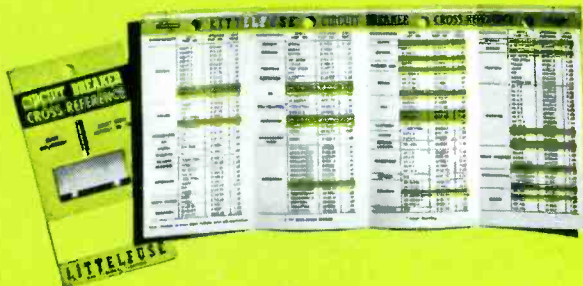

Included with each assortment:
Pocket size cross reference on color and black/white TV circuit breaker applications.
Form No. CBCRP-1266H

LITTELFUSE

DES PLAINES, ILLINOIS

Circle 51 on literature card

www.americanradiohistory.com