

# PF Reporter®

PHOTOFACT

*the magazine of electronic servicing*

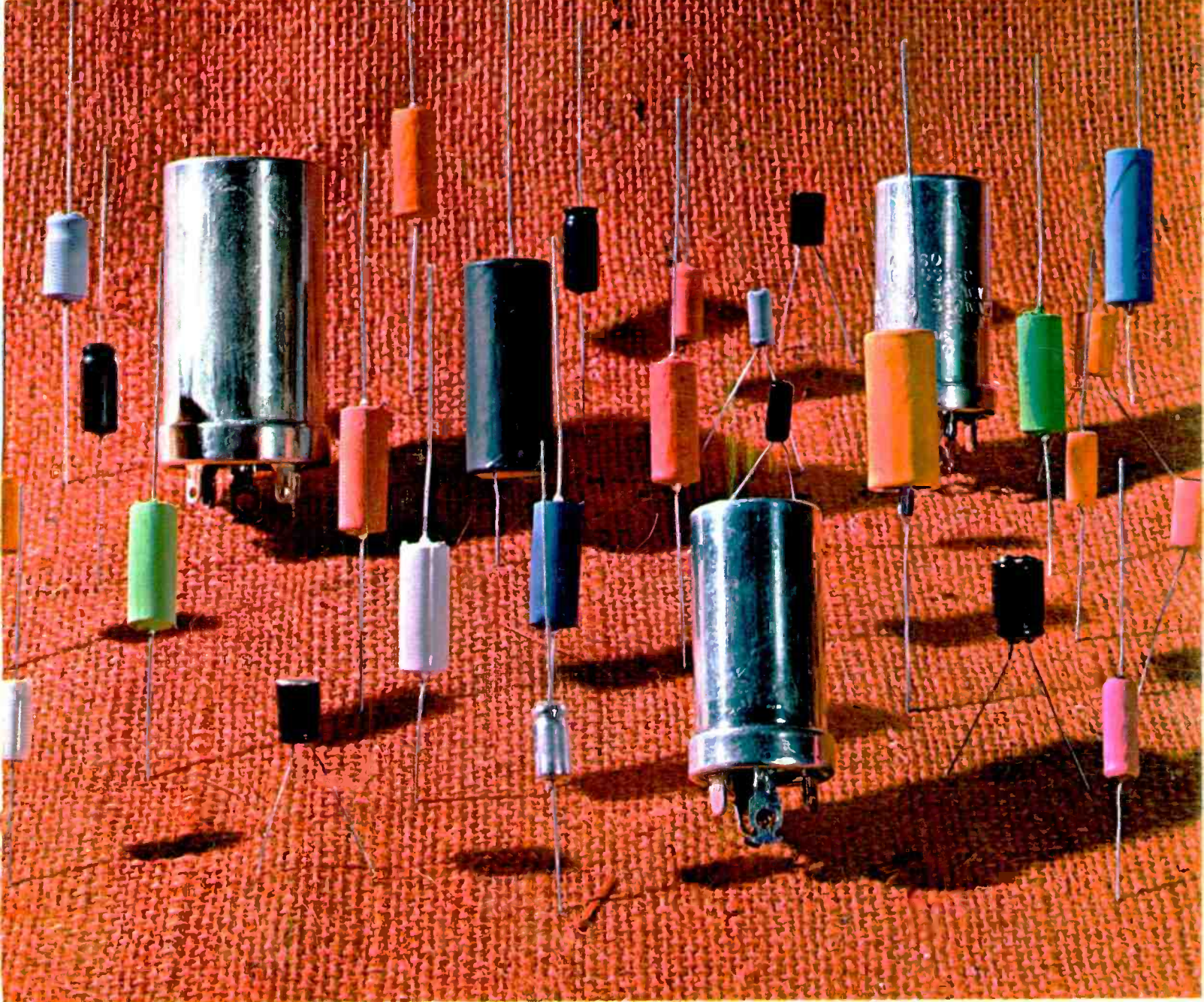

W. M. DAVIS  
 RADIO & TV SERVICE  
 118 RIVERSIDE AVE.  
 CANON CITY, COLO. 81212

- Great Blobs of Color
- Electrolytic Capacitors in TV
- Electronic Organ Servicing
- Previews of New Sets
- Video Speed Servicing



# Help stamp out blue people

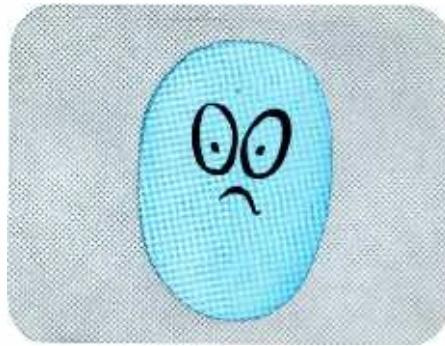

## Focus on Jerrold Paralog Plus™ Coloraxial Antennas for true color



Jerrold Paralog Plus Antennas show a definite improvement in the sharpness, fidelity and color stability of the image on any TV set. Sharp directivity, uniform response and perfect matching see to that! And the rugged construction insures that the quality stays

high—not for months—but for years. It's the high-gain Coloraxial antenna for people who insist on VHF and FM reception—without compromise. And there are seven models to choose from.

The Paralog Plus is one of a complete spectrum of problem-

solving Jerrold TV reception aids—Pathfinder, VUfinder and Colorpeak antennas... Powermate pre-amplifiers, amplified-couplers and splitters... Coloraxial cable, wall outlets and wall plates. See your Jerrold distributor today. Catalog available on request.

**JERROLD**®

Focusing on one thing—  
better reception

*Circle 1 on literature card*

Shown here is the Airline 23" model using either a 25AP22A or 25GP22A rectangular picture tube. This is one of the family of models which also includes models GHJ7527B(B), GHJ7547B(B), and GHJ7557B(B). These sets feature the bonded faceplate picture tube; however, a series of similar models using the 25BP22A require a separate safety glass. These are assigned model numbers without the (B) suffix.

This chassis is similar to the earlier 12-150-135 chassis, but some changes have been incorporated. The power supply has been changed to incorporate a bridge rectifier instead of the voltage doubler used previously, a "fast warm-up" is included, and a "color-tracking" circuit has been added.

The fast warm-up has an over-riding "vacation switch" which allows all voltage to be removed if the set is not to be used for an extended period. When the vacation switch is closed, line voltage is applied across the entire primary winding of the power transformer and reduced voltage is supplied to the tube filaments. The On-Off switch has three sections which (1) shunt a section of the power transformer primary, (2) energize the pilot light, and (3) connect the rectifier to the power transformer.

For ease in making purity adjustments, the Service-Normal switch has a third position labeled "purity". In this position, video is removed from the raster.

The contrast control located in the cathode circuit of the 3rd video amplifier also sets the base voltage of the transistor in the "color track" circuit. The cathode bias of the chroma bandpass amplifier is determined by the collector voltage of this transistor. Thus, chroma saturation "tracks" with the contrast control. The potentiometer labeled "color track" is a range control for this circuit.

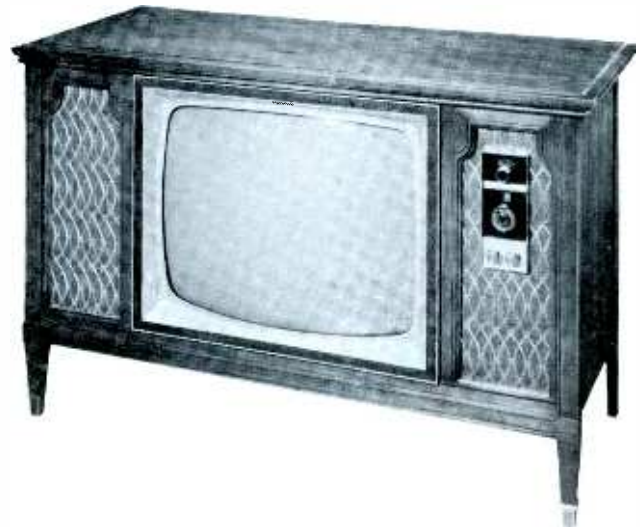

**Model GHJ7537B Chassis 913-179466**

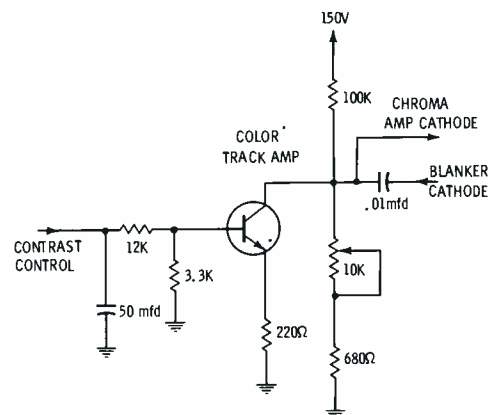
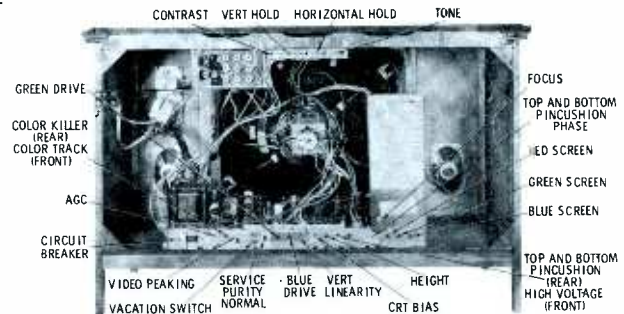

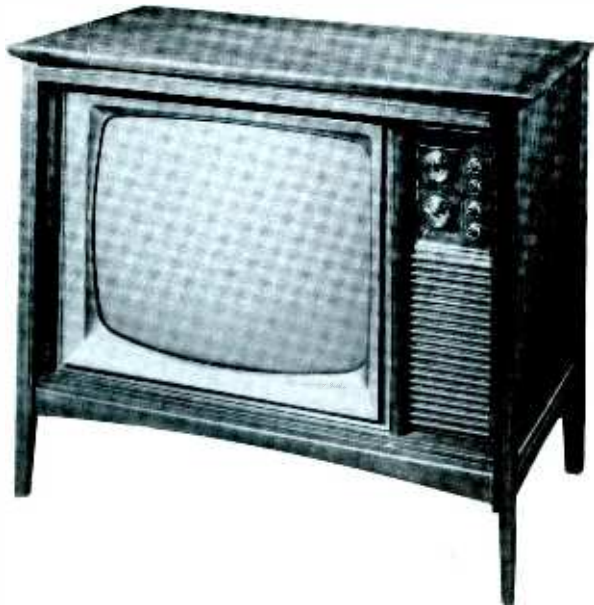

Model M980 CWD Model M980 CWD

The chassis used in the 23" color receiver shown here is basically similar to this manufacturer's CB chassis, introduced last year. Differences involve the tube complement, video amplifier, and pincushion circuits. Also, a tuning meter circuit has been added to the KC chassis.

Compactrons are used extensively in this chassis and include the following types: A 6BH11 double triode-pentode serving the horizontal reactance and oscillator circuits; a 6M11 double triode-pentode employed in the burst gate, sync separator, and sound IF; double pentode 6AL11 in the sound demodulator and audio output stages; a 6BW11 double pentode used in the chroma bandpass amplifier and chroma subcarrier amplifier; a double triode 6FM7 divided between the vertical oscillator and output stages; and a 6AG9 triode-pentode employed in the video output and keyed AGC circuits. Rounding out the compactron line-up are a 6JS6A pentode in the horizontal output circuit, a 6CG3 diode in the damper, a 6EF4 tetrode in the shunt regulator, and a triple triode 6AC10 used in the color difference amplifiers.

Two NPN transistors are employed in the 1st and 2nd video amplifier stages. A half-wave silicon rectifier in the emitter circuit of the 1st video amplifier stage provides bias for that stage. In addition, the bias developed by this rectifier is also applied across the brightness control circuit. A silicon rectifier in the base circuit of the 2nd video amplifier is used to rectify horizontal pulses from the damper cathode. The horizontal pulses are amplified by the 2nd video amplifier and video output stage and appear at the CRT cathodes, providing horizontal retrace blanking.

The side pincushion corrector circuit employed in the CB chassis has not been included in the KC chassis, which is designed with only a top and bottom pincushion corrector circuit.

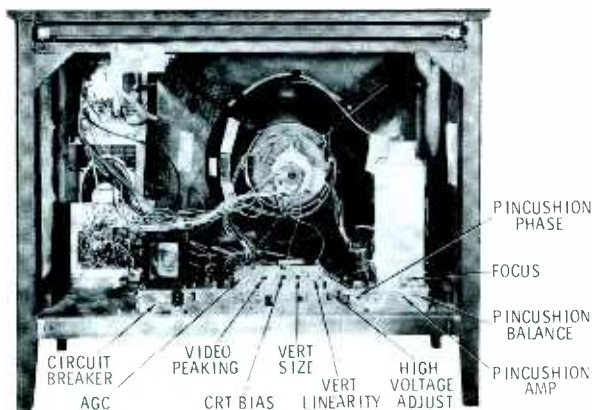
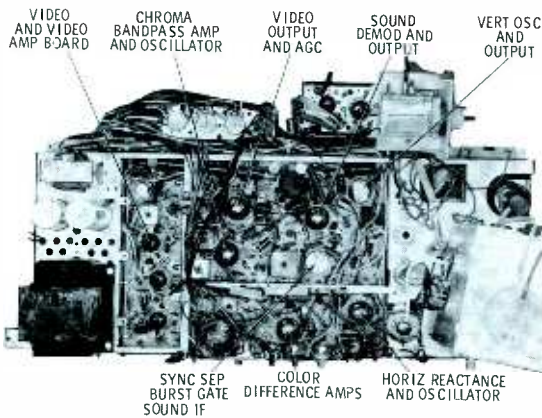



# PREVIEWS OF NEW SETS Pilot

The 18" Japanese-made color consolette pictured here is one of the first color sets introduced by this manufacturer. All circuitry, with the exception of the tuners and convergence board, is contained on a single hand-wired chassis that is horizontally mounted. The tube complement consists of 28 tubes, including the CRT and one 6JS6A compactron used in the horizontal output stage.



**Model C309**

There are a number of design differences which set this chassis apart from more conventional sets. The most notable of these is the chroma demodulators, shown here. The three separate R-Y, G-Y, and B-Y demodulators share half of a double triode 7247 with their respective difference amplifiers.

The brightness and linearity control circuits are also unusual. As shown here, both have "sub" controls. The sub-brightness control adjusts the effective range of the brightness control by regulating the amount of current through it. The sub-linearity control is part of a waveshaping network designed to alter the shape of the vertical output grid drive pulse at the plate of this stage.

Color gun controls employed in the CRT grid circuit connect each of the three grids to ground through a 100-K ohm resistor. Thus, all three colors can be killed, either separately or together.

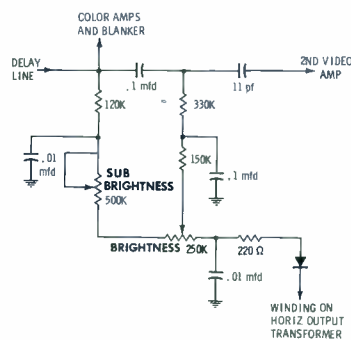
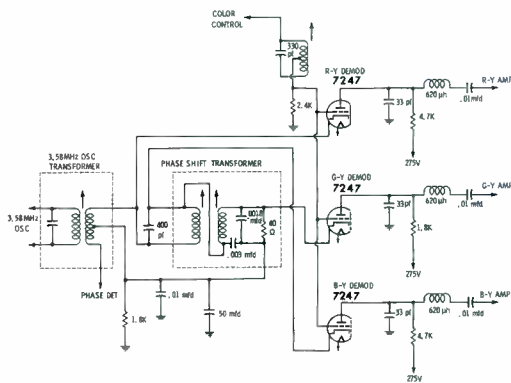
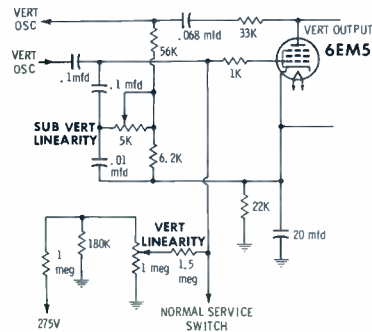
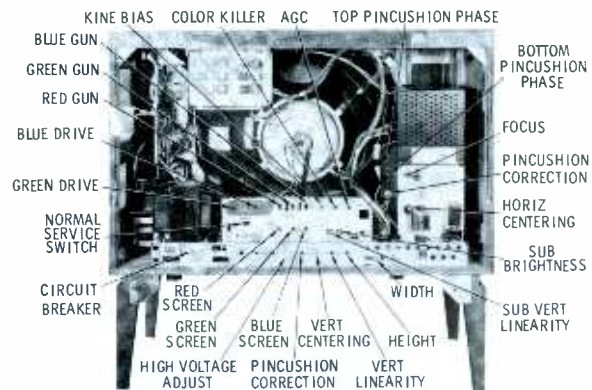



Model 19TC14-1 Chassis DO5-1

The chassis employed in this 18" color table model is changed a great deal from the DO3-2 chassis used previously in this manufacturer's 18" color sets. Major circuit changes involve the tube complement, chroma circuits, and video IF and amplifier sections.

The chroma demodulators have been changed completely. High-level R-Y and B-Y demodulators were used in the DO3 chassis, with the G-Y signal derived from the difference between the R-Y and B-Y signals. Thus, only the G-Y signal required a difference amplifier. This system has been discarded in the DO5 chassis and more conventional low-level "X" and "Z" demodulators employed in its place. A double pentode 12BV11 compactron serves the demodulators, while a triple triode 12MD8 performs in the difference amplifiers. Other chroma circuit changes include the use of semiconductor diodes in the phase detector, replacing the twin diode half of an 8AC9 used in the DO3. Also, an additional chroma amplifier (total of two) is designed into the DO5 chassis.

Another semiconductor addition to the DO 5 chassis is found in the 2nd video amplifier, which has been changed from the triode section of a 5MB8 to an SE1002 transistor configuration. Two other transistors are also used in the chassis, one in the grounded emitter noise gate circuit and one in the UHF oscillator. A third IF stage has been added to the video IF section. The tube complement of this section has also been changed and includes a 4BZ6 pentode in the 1st stage, a 5GM6 pentode in the 2nd stage, and a 5JK6 pentode in the final video stage.

Compactrons used in this chassis include a double pentode 12T10 employed in the quadrature sound detector and audio output stages, a 21LU8 triode-pentode serving the vertical oscillator and vertical output stage, and a 34CE3 diode in the damper.

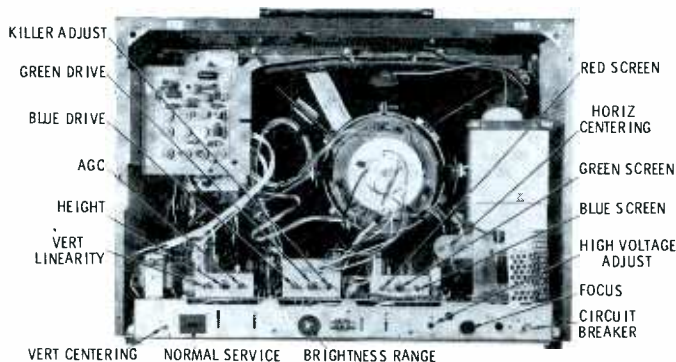

VERT CENTERING NORMAL SERVICE BRIGHTNESS RANGE

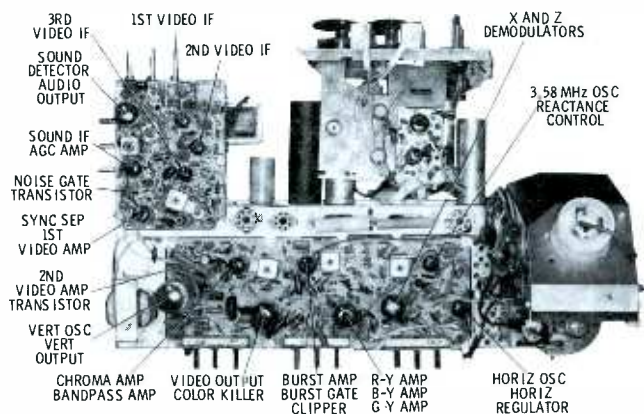





SEE PHOTOFACT Set 721, Folder 3

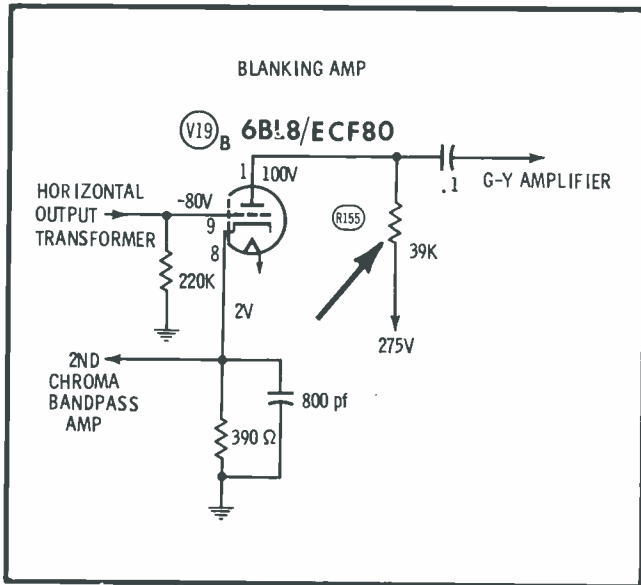

SEE PHOTOFACT Set 721, Folder 3

Mfr: Motorola

Chassis No: TS-908/A, B, YA, YB.

Card No: MO TS-908-10

Section Affected: Raster.

**Symptom:** Insufficient brightness. Customer brightness control does not have sufficient range to remove high voltage from the regulator, even when master G1 control is turned fully clockwise. Low voltage at plate (pin 1) of blanking amplifier.

**Cause:** Open plate load resistor in blanking amplifier circuit.

**What To Do:** Replace R155 (39K, 2W).

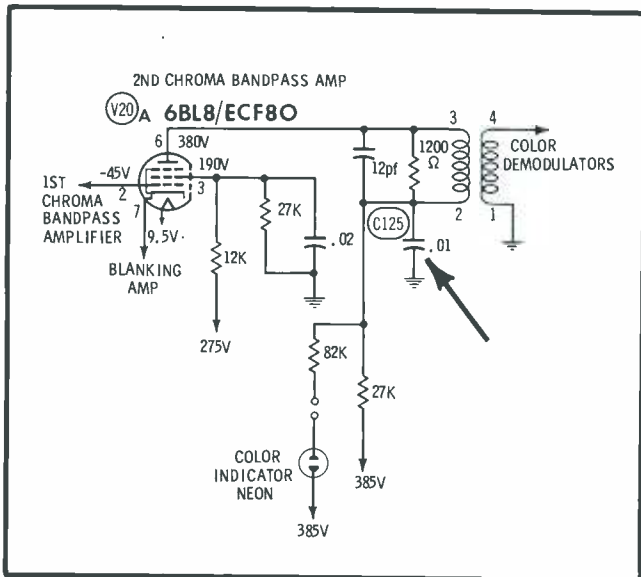

Mfr: Motorola

Chassis No: TS-908/A, B, YA, YB.

Card No: MO TS-908-11

Section Affected: Color pix.

**Symptom:** B-W pix normal. No color. Color indicator light is on at all times. Low B+ on plate (pin 6) of chroma bandpass amplifier.

**Cause:** Shorted filtered capacitor in plate circuit of 2nd chroma bandpass amplifier.

**What To Do:** Replace C125 (.01 mfd).

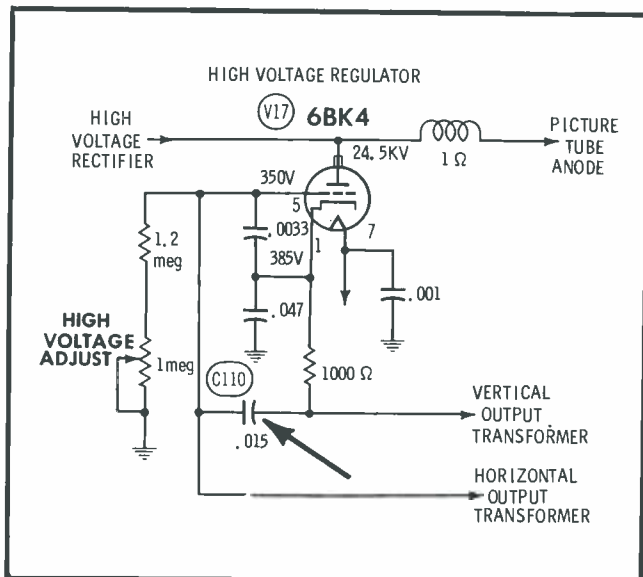

Mfr: Motorola

Chassis No: TS-908/A, B, YA, YB.

Card No: MO TS-908-12

Section Affected: Raster.

**Symptom:** Poor focus; brightness low; width reduced.

**Cause:** Shorted capacitor in grid circuit of high-voltage regulator.

**What To Do:** Replace C110 (.015 mfd).





SEE PHOTOFAC Set 731, Folder 2

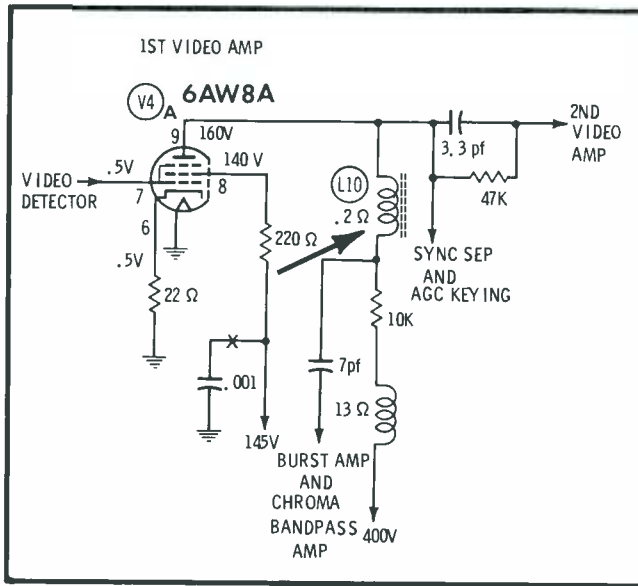

SEE PHOTOFAC Set 731, Folder 2

Mfr: Olympic

Chassis No: CTC-15/U

Card No: OL CTC-15-4

Section Affected: Pix.

Symptom: Pix smeared and out of focus.

Cause: Bad solder connections on RF choke in plate circuit of 1st video amplifier.

What To Do: Resolder leads on L10.

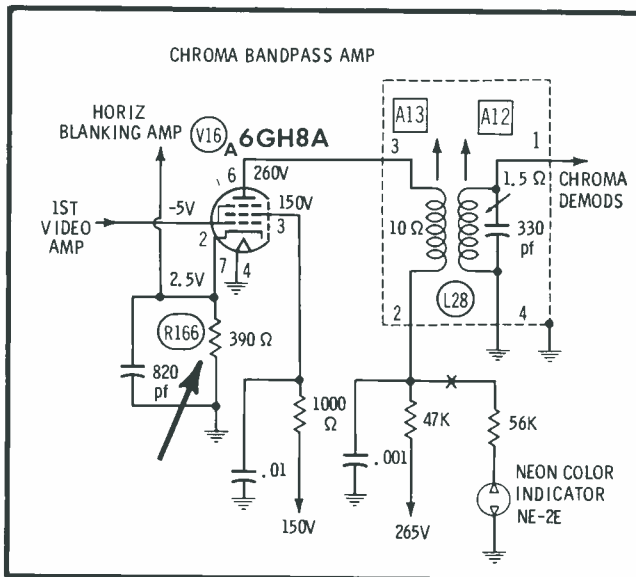

Mfr: Olympic

Chassis No: CTC-15/U

Card No: OL CTC-15-5

Section Affected: Color pix.

Symptom: B-W pix normal. Color disappears intermittently. Voltage fluctuates at cathode (pin 7) of chroma bandpass amplifier.

Cause: Cathode resistor overheats and changes value.

What To Do: Replace R166 (390 ohms), and check V16 (6GH8A).

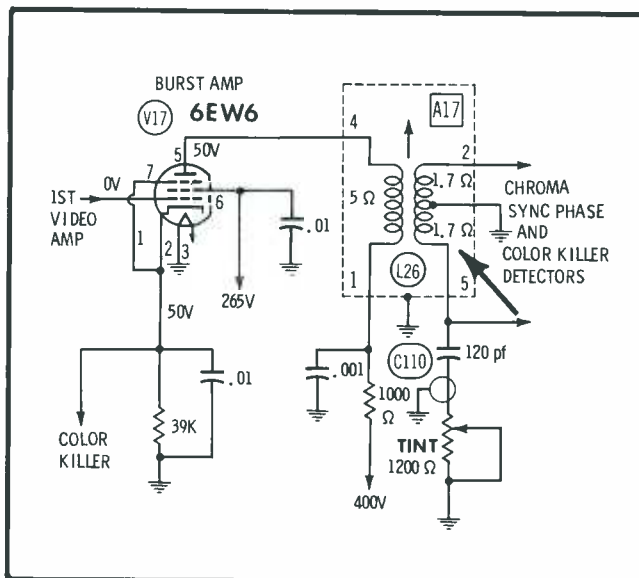

Mfr: Olympic

Chassis No: CTC-15/U

Card No: OL CTC-15-6

Section Affected: Color pix.

Symptom: Color hues unstable.

Cause: Bad solder connections at junction of C110 and terminal 5 of burst phase detector transformer.

What To Do: Resolder connections at junction of L26 (terminal 5) and C110 (120 pf).



# How to expand your service department without adding a man.

**You can help your present service technicians become more skilled...more professional. Talk with the service manager at your Motorola Distributor's. He offers a complete training program that will help accomplish this objective.**

Finding competent service technicians is a task that's far from easy . . . that's why more and more service organizations are putting increased effort into "growing their own." Motorola Distributors are responding to this new trend with new ideas for training.

Some have training facilities set up in their own places of business . . . so you can send your technicians in for "refresher courses."

Many hold periodic training meetings for large groups. Motorola Regional Service Managers are often in attendance at these meetings to provide detailed information about design and service features.

And in some cases, your Motorola Distributor can enroll your service men in Motorola's "Professional Technician Program." These new "P.T.P." sessions take place *in your place of business* and your technicians work on a man-to-man, face-to-face basis with one of our factory technicians.

The service manager from your Motorola Distributor can help you with almost any type of training activity. Contact him.

Good training can help you keep the service technicians you have. Good training can help you get the service technicians you need.



# PF Reporter®

PHOTOFACT

*the magazine of electronic servicing*

VOLUME 17, NO. 5

MAY, 1967

PUBLISHER  
HOWARD W. SAMS

GENERAL MANAGER  
DONALD W. BRADLEY

EDITOR  
WILLIAM E. BURKE

MANAGING EDITOR  
JAMES M. MOORE

ASSOCIATE EDITORS      CONSULTING EDITORS  
Thomas T. Jones          Joe A. Groves  
J. W. Phipps              C. P. Oliphant  
Carl F. Moeller          George B. Mann  
PRODUCTION MANAGER      RESEARCH LIBRARIAN  
Esther M. Rainey          Mrs. Bonny Howland

CIRCULATION MANAGER  
Pat Osborne

ART DIRECTORS  
Louis J. Bos, Jr. & Robert W. Reed

PHOTOGRAPHY  
Paul Cornelius, Jr.

ADVERTISING  
SALES MANAGER  
HUGH WALLACE

ADVERTISING SALES OFFICES

*central and midwestern*

ROY HENRY

Howard W. Sams & Co., Inc., 4300 W. 62nd St.  
Indianapolis, Ind., 46206 • 317-291-3100

*eastern*

ALFRED A. MENEGUS

Howard W. Sams & Co., Inc., 3 W. 57th St.  
New York, New York, 10019 • 212-688-6350

*southwestern*

MARTIN TAYLOR

P. O. Box 22025, Houston, Texas 77027  
.713-621-0000

*western/Los Angeles*

G. R. (JERRY) HOLTZ

The Maurice A. Kimball Co., Inc.  
2008 W. Carson St., Suites 203-204  
Torrance, Calif., 90501 • 213-320-2204

*western/San Francisco*

The Maurice A. Kimball Co., Inc.  
580 Market St., Room 400

San Francisco, Calif., 90501 • 415-392-3365

Address all correspondence to PF REPORTER  
4300 W. 62nd Street, Indianapolis, Indiana 46206



Copyright © 1967 by Howard W. Sams & Co., Inc. PF REPORTER is a trademark of Howard W. Sams & Co., Inc. No part of PF REPORTER may be reproduced without written permission. No patent liability is assumed with respect to use of information herein. Acceptance of advertising does not in any manner signify the products, policies and services so advertised have been approved, endorsed or recommended by this magazine.

Subscription Prices: 1 year—\$5.00, 2 years—\$8.00, 3 years—\$10.00, in the U. S. A., its possessions and Canada.

All other foreign countries: 1 year—\$6.00, 2 years—\$10.00, 3 years—\$13.00. Single copy 75¢; back copies \$1.

Indexed in Lectrodex. Printed by the Waldemar Press Div. of Howard W. Sams & Co., Inc.

## CONTENTS

<b>Tube Substitution Supplement</b>	<b>1</b>
<b>Previews of New Sets</b> <small>Airline Model GHJ75378, Chassis 913-179466; General Electric Model M980 CWD, Chassis KC; Pilot Model C309; Sylvania Model 19TC14-1, Chassis D05-1.</small>	<b>5</b>
<b>Video Speed Servicing</b> <small>Service hints on Motorola Chassis TS-908/A, B, YA, YB and Olympic Chassis CTC-15/U.</small>	<b>9</b>
<b>Letters to the Editor</b>	<b>18</b>
<b>The Electronic Scanner</b>	<b>19</b>
<b>Great Blobs of Color</b> <i>Jack Darr</i> <small>Loss of luminance doesn't always kill color.</small>	<b>22</b>
<b>Getting Started in Electronic Organ Servicing</b> <i>Monte J. Hasso</i> <small>A promising market for your services— even if you aren't musically inclined.</small>	<b>25</b>
<b>Electrolytic Capacitors in TV Receivers</b> <i>Allan Kinckiner</i> <small>An analysis of circuits, troubles, and scope techniques points the way to more effective troubleshooting.</small>	<b>27</b>
<b>Quicker Servicing</b>	<b>39</b>
<b>Symfact: Tuner AFC</b> <small>Operation and trouble analysis of the automatic fine tuning circuit used in RCA's CTC21C chassis.</small>	<b>41</b>
<b>Notes on Test Equipment</b> <i>T. T. Jones</i> <small>Circuit analysis of color generator countdown circuits that use unijunction transistors and lab report on Hickock Model GC660 Color Generator.</small>	<b>46</b>
<b>The Troubleshooter</b>	<b>57</b>
<b>Book Review</b>	<b>60</b>
<b>Photofact Bulletin</b>	<b>61</b>
<b>Product Report</b>	<b>62</b>
<b>Free Catalog and Literature Service</b>	<b>70</b>
<b>Monthly Index on Free Literature Card</b>	

## ABOUT THE COVER

A layman might interpret this month's cover photo as evidence of life on Mars. But the sharp-eyed electronics technician will quickly recognize that these celestial beings are nothing more than a wide variety of trouble-causing gremlins. Yes, behind that colorful camouflage exist the shorts, leaks, and opens that plague the earthbound serviceman. An article beginning on page 27 of this issue provides some valuable clues to the personality of these Martians.





For window-size blow-ups  
of this message, send 10¢ to  
Sprague Products Co.,  
105 Marshall St., North Adams,  
Mass., to cover handling  
and mailing costs.

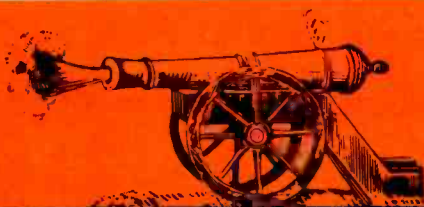

# EVERY DAY IS INDEPENDENCE DAY



FOR YOU AND YOUR  
★ **INDEPENDENT** ★ ★  
TV SERVICE DEALER



Your independent TV Service Dealer is in business for himself because he too wants to exercise his independence just as you do. You purchased your TV or radio set where you wanted to . . . when you wanted to . . . and at the price you decided was right.

Your TV service dealer is also an independent in the things he buys in his day-to-day work. He buys repair parts where he can get the highest quality and the best service. And, he trained himself in his own way, on his own time, at his own expense, to be able to do the very best for YOU.

He stands or falls on what you think of him and his work. He has to do good work to keep your business . . . and he knows it!

We're lucky in these United States that every day is Independence Day. Independent buying, selling, and servicing is the very lifeblood of American business. Let's keep it that way.

**THIS MESSAGE WAS PREPARED BY SPRAGUE PRODUCTS COMPANY,  
DISTRIBUTORS' SUPPLY SUBSIDIARY OF SPRAGUE ELECTRIC COMPANY, NORTH ADAMS, MASSACHUSETTS FOR . . .**

**YOUR INDEPENDENT TV-RADIO SERVICE DEALER**

# KWIKETTE\* Soldering Aids available these NEW ways...



Packet of 10  
for 29¢



Package of 100  
for \$2.79



With all Sprague pre-packaged wire-lead service-type capacitors at no extra cost to you!



## NOW...YOU CAN SAVE TIME, TROUBLE, AND \$\$\$\$ ON MORE SOLDERING JOBS

*This is it:* the revolutionary KWIKETTE that speeds component replacement . . . and practically lets you do "in-circuit" parts testing. This unique soldering aid is not just another wire spring connector. It features a Copperweld wire inner core, an intermediate layer of flux, and an outer jacket of solder . . . all you need is heat!

You can now buy KWIKETTES from your Sprague distributor in packages of 10 and 100. You'll also find them included with all Sprague pre-packaged wire-lead service-type capacitors . . . at no extra cost to you.

★Trademark

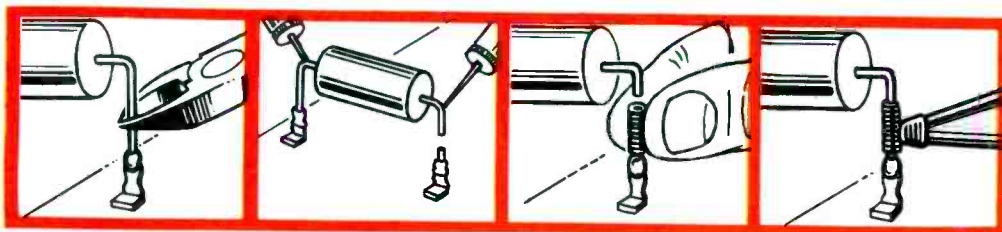

SNIP LEAD...

TEST...

SLIP ON KWIKETTE...

APPLY HEAT!

If you haven't tried KWIKETTES yet, do it now. They're the biggest boon to the service technician since the soldering gun!

**DON'T FORGET TO ASK YOUR CUSTOMERS  
"WHAT ELSE NEEDS FIXING?"**

65-7103 V2

Circle 4 on literature card





# successful service shop beats rising costs with B&K television analyst



*"As every serviceman knows, major TV repairs represent an increasingly large part of the service business and the average time per repair has increased"...*

says Willard Horne of Horne Radio and Television in Evanston, Illinois.

After more than 25 successful years in the service business, twenty of them in the same location, Mr. Horne can be considered an authority on how to keep a business profitable. Mr. Horne says, "In order to be successful, our 3-man shop has to be competitive on the large jobs as well as the small ones. With the increase in bench time that we were experiencing and the limitations on what we could charge, there was a reduction of profit that had to be stopped. Then we bought a B&K Model 1076 Television Analyst."

"Now our customers get the same extra-value service on the big repairs and the small ones," said Mr. Horne. "We use the Television Analyst for troubleshooting a wide variety of complaints, particularly for those that require touch-up align-

ment, location of IF overloads and color convergence. We are more competitive now that we use the B&K Television Analyst because we spend far less time on the jobs that used to be dogs, with benefits both to the shop and our customers."

B&K Model 1076 Television Analyst checks every stage in a black and white or color TV receiver. Nine VHF RF channels, 20 to 45 MC IF, audio, video, sync, bias voltage and AGC keying pulse are available. The model 1076 provides its own standard test pattern, white dot, white line crosshatch, and color bar pattern slide transparencies. It includes a blank slide which can be used for closed-circuit-TV display floor promotion. Its net price is \$329.95.

*Find out how you will increase your TV service profits with a B&K Model 1076. See your distributor or write for Catalog AP 22.*



**B & K MANUFACTURING CO.**  
DIVISION OF **DYNASCAN CORPORATION**  
1801 W. BELLE PLAINE AVE. • CHICAGO, ILL. 60613

Export: Empire Exporters, 123 Grand St., New York 13, U.S.A.

# The most experienced all-channel amplifiers keep getting better and better

Blonder-Tongue pioneered and developed the industry's first all-channel, all-transistor TV signal amplifier. That was more than two years ago. During that period this top-rated original design has brought superior all-channel and color reception to homes located in all areas.

Now, we are employing the better performing silicon transistor in these amplifiers. The result: 40% more gain in the lowband, 100% more in the highband, greater ability to handle strong signals without overloading and better signal to noise ratio. Color or black-and-white TV reception on any and all channels from 2 to 83 is better than ever.

Only Blonder-Tongue gives you a choice of all-channel, color-approved amplifiers:

**U/Vamp-2**—mast-mounted, deluxe 2-transistor UHF/VHF amplifier. Weatherproof housing. Remote power supply. AC operated. Separate UHF and VHF 300-ohm inputs and outputs. Ideal for separate UHF and VHF antennas.

**Coloramp-U/V**—same as the U/Vamp-2 except it has a single UHF/VHF input. Matches the new all-channel antennas.

**V/U-All-2** — deluxe 2-transistor indoor UHF/VHF amplifier. Can drive up to 4 TV sets. Has built-in 2-way splitter with excellent impedance match and isolation for interference and ghost-free reception.

These UHF/VHF amplifiers are just one more reason to go all-channel from antenna to TV set with color-approved Blonder-Tongue TV products. Of course, we also have a full line of top quality VHF, VHF/FM and UHF-only amplifiers. Write for free catalog #74.

Blonder-Tongue Laboratories, Inc., 9 Alling Street, Newark, N. J. *Blonder-Tongue, the name to remember, for TV reception you'll never forget*

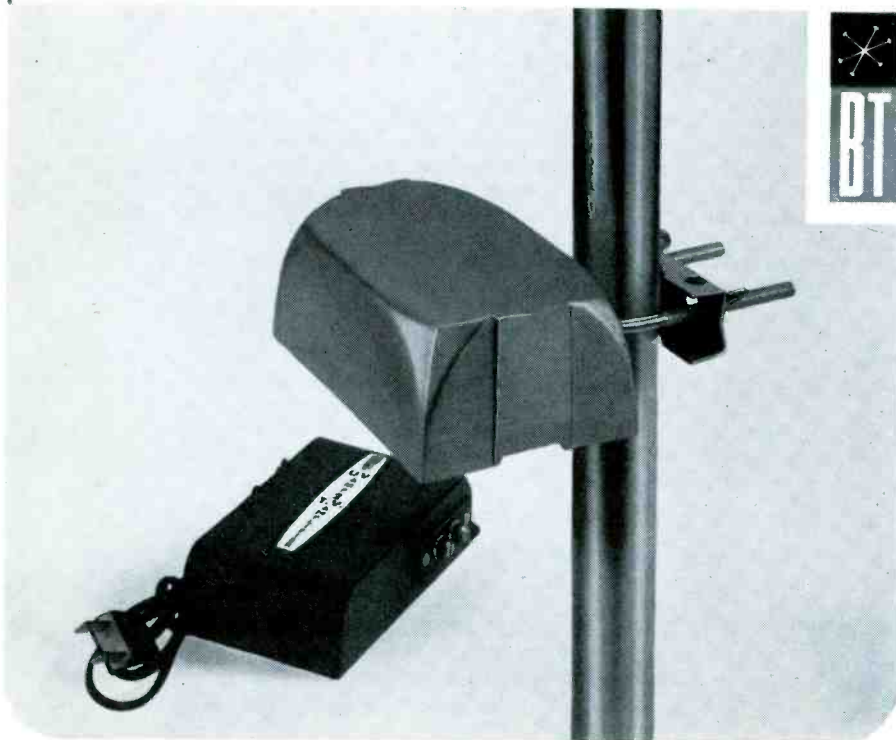

Circle 6 on literature card

## LETTERS TO the EDITOR

Dear Editor:

In "Short Cuts in Mathematics" you seem to have a friendly debate started (October, 1965; December, 1965; and December, 1966). This is all very good, but most shops will usually misplace the nomographs and more often than not, will not have a mathematics reference as part of the bench set up.

Here's one that can be set up as a formula but need not be. Suppose a resistor of 500 ohms is needed but is not in stock.

Let the needed resistor =  $R_t$  or 500 ohms.

Let the unknown resistors =  $R_1$  and  $R_2$ .

To find  $R_1$  multiply  $R_t$ , or 500 ohms, by any simple number such as 5. Then divide the answer, or  $R_1$ , by one less than first number used — in this case,  $5 - 1 = 4$ .

Then:

$$\begin{array}{r} 500 \times 5 = 2500 = R_1 \\ \hline 2500 \\ 4 \phantom{00} = 625 = R_2 \end{array}$$

As another example, let  $R_t$  equal 500 ohms again and use four as the multiplier.

$$\begin{array}{r} 500 \times 4 = 2000 = R_1 \\ \hline 2000 \\ 3 \phantom{00} = 666 = R_2 \end{array}$$

Using standard resistors of 2000 ohms and 680 ohms, the parallel resistance will be 507 ohms, or within 2% of desired value.

Suppose that  $R_t$  cannot be made up with two standard resistors or that one of these two is not in stock. The needed resistor is 60 ohms.

$$60 \times 7 = 420 = R_1$$

If  $R_2$  value is not in stock, the divisor may be factored into two parts. Divisor should be 6. This can be factored into 2 and 4.

$$\begin{array}{r} \frac{420}{4} = 105 = R_2 \\ \frac{420}{2} = 210 = R_3 \end{array}$$

With standard values of 430, 100, and 220, the parallel resistance is 59.3 ohms, or within 2% of desired value.

M. BARKER

*As several readers have pointed out, there is one "theoretical" case where the method will fail and that is when any one resistor has the value of zero.*

—Ed.





# THE ELECTRONIC SCANNER

*news of the servicing industry*

## New Red Phosphor

RCA announced development of a new red phosphor which makes possible the brightest color television picture tubes in the industry.

Samples of RCA color TV picture tubes employing the new phosphor were demonstrated publicly for the first time at the 1967 Institute of Electrical and Electronics Engineers (IEEE) Convention in the New York Coliseum.

"The new phosphor provides on the average a 40% increase in the red phosphor efficiency and a 38% increase in high-light brightness over the best competitive color tubes now on the market," according to John B. Farese, Vice President, RCA Electronic Components and Devices.

The new color tube red phosphor also provides television viewing with high picture contrast at high ambient-light levels, he added. This high brightness and high-picture contrast produce full, living color at high ambient-light levels.

"RCA's new red phosphor achieves unity current ratio which means that each of the tube's three electron guns have an equal beam current. This technical advance eliminates color fringing due to 'red blooming' in the highlights of both color and black-and-white programs," he said.

## Mergers & Expansions

William B. Humes, president of Bell & Howell's New Business Group, announced that DeVry Institute of Technology, a subsidiary of Bell & Howell Company, will establish a new resident training school in Phoenix.

DeVry Tech presently operates resident training schools in Chicago and Toronto for more than 3,000 students, with an additional 17,000 enrolled in home study courses throughout the United States and Canada.

# For a top job in Radio-TV ... get a FIRST CLASS FCC LICENSE ... or your money back!

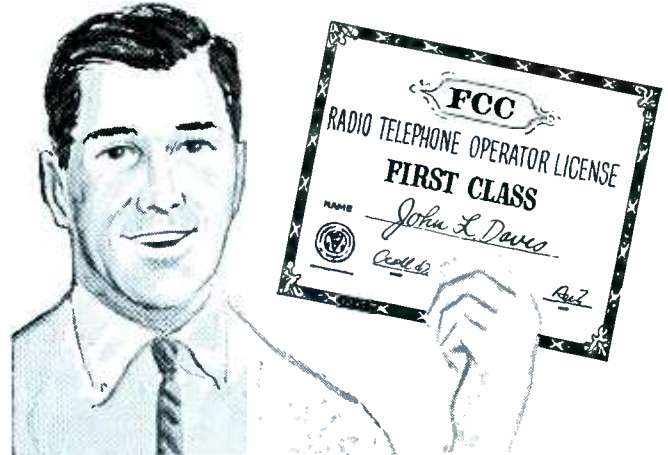

YOUR key to future success in electronics is a First-Class FCC License. It will permit you to operate and maintain transmitting equipment used in aviation, broadcasting, marine, microwave, mobile communications, or Citizens-Band. Cleveland Institute home study is the ideal way to get your FCC License. Here's why:

Our electronics course will *quickly* prepare you for a First-Class FCC License. Should you fail to pass the FCC examination after completing your course, you will get a *full refund* of all tuition payments. You get an FCC License . . . or your money back!

And only CIE offers you new, up-to-the-minute lessons in all these subjects: Logical Troubleshooting, Microminiaturization, Single Sideband Technique, Pulse Theory and Application, Boolean Algebra, and many more.

You owe it to yourself, your family, your future to get the complete details on our "proven effective" Cleveland Institute home study. Just send the coupon below for FREE book or write to Cleveland Institute of Electronics, 1776 E. 17th St., Dept. PF-35, Cleveland, Ohio 44114.

## ENROLL UNDER NEW G. I. BILL

All CIE courses are available under the new G.I. Bill. If you served on active duty since January 31, 1955, OR are in service now, check box in coupon for G.I. Bill information.

MAIL COUPON TODAY FOR FREE BOOK



**CIE** Cleveland Institute of Electronics  
1776 East 17th Street, Cleveland, Ohio 44114

Please send me your FREE book, "How To Get A Commercial FCC License."

Name \_\_\_\_\_  
(please print)

Address \_\_\_\_\_

City \_\_\_\_\_ State \_\_\_\_\_ Zip \_\_\_\_\_

Occupation \_\_\_\_\_ Age \_\_\_\_\_

Veterans check here for GI Bill information

Accredited Member National Home Study Council  
A Leader in Electronics Training . . . since 1934 PF-35

Circle 7 on literature card

May, 1967 / PF REPORTER 19

Get Trouble-Free Fuse Protection  
in Wet Locations with a

# TRON

IN-THE-LINE  
WATERPROOF  
Fuseholder



**FOR PROTECTION OF CIRCUITS  
OF 600 VOLTS OR LESS**

**FOR USE ON:**

- Electronic Components at Missile Sites
- Marine Equipment
- Mobile Power Supply Units
- Yard Lights
- Military Field Applications
- Communications Equipment
- Any circuit operating in exposed locations.

Watertight construction; resistance to damage by weather, water, salt spray or corrosive fumes permit use of TRON fuseholders in exposed locations where safety and long life are of vital importance.

TRON fuseholders are available to take two sizes of fuses,  $1\frac{3}{32}$ " x  $1\frac{1}{2}$ " and  $1\frac{3}{32}$ " x  $1\frac{3}{8}$ "; and take many sizes of solid or stranded wire.

Write for BUSS Bulletin SFH-11

**INSIST ON**  
**BUSS QUALITY**

BUSSMANN MFG. DIVISION, McGraw-Edison Co., ST. LOUIS, MO. 63107

Top officials of **Zenith** were on hand to officially open the new \$3,000,000 manufacturing facility operated by its wholly-owned subsidiary, the Wincharger Corporation. Joseph S. Wright, Zenith president, and Sam Kaplan, executive vice president and treasurer, were honored at the dedication luncheon in the new 220,000-square-foot plant in Sioux City, Iowa.

The new plant has been phasing in its operations since September. It permits Wincharger to increase production of Zenith radio receivers, provide additional facilities for manufacture of FM-AM receivers, and enable Wincharger to begin production of electronic components for a wide range of Zenith consumer products.

### Sales

Consolidated net earnings and sales for **Amphenol Corporation** and its subsidiaries reached record highs in 1966, according to Matthew L. Devine, chairman of the board. Per share earnings were \$1.98, an increase of 56% over earnings of \$1.27 per share for 1965. Sales totaled \$152,440,604, an increase of 37% over sales of \$111,233,322 for the previous year.

"The increased earnings were due primarily to higher sales volume, improved efficiencies, and generally good business conditions," Mr. Devine said. "The year-end backlog was also at a record high level which assures us of a good start for 1967," he added.

## BUSS: The Complete Line of Fuses and . . . . .

Work is nearing completion on a \$10 million plant expansion in Portsmouth, Va., designed to increase **General Electric's** production capacity for personal portable color television sets. The addition doubles the plant's size, and all of the new space will be devoted to production of PortaColor and personal color sets.

The original plant of GE's Personal Television Department was opened a little more than a year ago to produce TV sets—both color and monochrome—with sizes up to 16 inches (viewable diagonal).

**Oaktron Industries** has recently completed a major engineering expansion program. A completely new applied research, development, and testing facility has been added to provide one of the most modern speaker laboratories in the Industry. Taking over two years to complete, and with a 30% increase in staff, the new Center provides a total program—from basic design and materials analysis to prototype testing.

Production of electron guns, a vital component for color television picture tubes, has begun at the new multi-million-dollar plant of **RCA de Puerto Rico**, a wholly-owned subsidiary of the Radio Corporation of America. The 25,000-square-foot facility, located in Juncos, 30 miles South of San Juan, was dedicated at formal ceremonies attended by representatives of government, business, and the press.

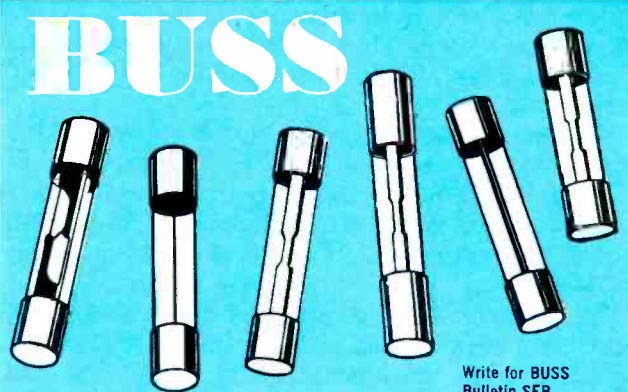

Write for BUSS  
Bulletin SFB.

## QUICK-ACTING FUSES

"Quick-Acting" fuses for protection of sensitive instruments or delicate apparatus;—or normal acting fuses for protection where circuit is not subject to current transients or surges.



BUSSMANN MFG. DIVISION, McGraw-Edison Co., St. Louis, Mo. 63107

Circle 8 on literature card



# FUSETRON

dual-element FUSES

*Slow Blowing*



"Slow blowing" fuses prevent needless outages by not opening on harmless overloads—yet provide safe, protection against short-circuits or dangerous overloads.

Write for BUSS Bulletin SFB

INSIST ON

## BUSS QUALITY

BUSSMANN MFG. DIVISION, McGraw Edison Co., St. Louis, Mo. 63107

and secondary school laboratories; Citizens Band communications products; and Telemotive radio remote control systems for overhead cranes.

President Jack D. Hughes reported that the 1966 sales and net earnings of Littelfuse surpassed all previous annual financial records.

Net sales were \$11,673,654, an increase of 19% over sales of \$9,823,053 in 1965. Net earnings for 1966, keeping pace with net sales, were \$398,469, rising to 19% above earnings of \$334,917 in the previous year.

Thomas M. Blake, board chairman, attributed the 1966 record financial increases to Littelfuse's greater product penetration in the television and home appliance markets. Business prospects for 1967 continue to improve. New products developed in 1966 for the consumer electronics field, such as the color television degaussing switch and bimetallic television circuit breakers, together with new types of low voltage fuses, are expected to help increase the company's profits.

Sprague Electric Company reported record high net sales and net profits for the year ended December 31.

Net sales totalled \$141,466,479 for the year, compared to \$107,077,249 in 1965, for an increase of 32%. Net earnings for the year reached \$8,831,334, an increase of 79% from \$4,935,541 the previous year. ▲

## .. Fuseholders of Unquestioned High Quality

Record sales and earnings for **Belden Manufacturing Company** in 1966 were reported by Robert W. Hawkinson, President.

Net sales for the Chicago-based manufacturer of insulated wire and cable were \$65,869,698, an increase of 23% from the previous year's record total of \$53,509,682.

Capital expenditures totaled an all-time high of \$5,473,259, an increase of 56% over the previous year's record outlay, Hawkinson noted. This included the opening of an electric cord plant at Franklin, North Carolina and the construction of an additional magnet wire plant at Pontotoc, Mississippi.

**Dynascan Corporation** sales topped \$5 million for the first time and earnings soared 54% in 1966, President Carl Korn announced in the company's annual report.

Sales in 1966 by the Chicago-based electronics company amounted to \$5,020,208, a 20% gain over 1965 sales of \$4,174,198. Net earnings for the year of \$225,505 were 54% higher than 1965 earnings of \$146,645.

Korn said the firm has signed a licensing agreement with Standard Telephone & Cables, Ltd., London, a subsidiary of ITT, to manufacture and distribute Dynascan "Telemotive" radio remote crane control systems abroad.

Dynascan makes B & K electronic test and service equipment for color and black-and-white television; Precision Apparatus instruments for industrial, college,

## Blocks for BUSS fuses



### TYPES AVAILABLE FOR ALL APPLICATIONS

Single pole, multiple pole, small base, full base, molded base, laminated base, porcelain base for fuses from  $\frac{1}{4}$  x  $\frac{1}{8}$  inches up. Also signal type fuse blocks and special blocks of all types.

Tell us what you need or . . .

Write for BUSS Bulletin SFB

INSIST ON

## BUSS QUALITY

BUSSMANN MFG. DIVISION, McGraw-Edison Co., ST. LOUIS, MO. 63107

Circle 8 on literature card



# Great BLOBS of COLOR

*You can have a good black-and-white without color, but you can't have good color without black-and-white. Confused? Well, its all colorfully spelled out here—in black-and-white.*

By JACK DARR

THE video amplifier stages of a color set have no business bothering the color. They just sit there along the top of the schematic and black-and-white pictures, while the color demods and all the other color stages sweat and strain down below, trying to keep up with vectors and things going in all directions. The video stages will bother the color, though—yes, indeed they will. Under certain circumstances, they can turn a nice picture into great blobs of color, streaks, stripes, and more odd things than you can shake a diddle-stick at. Now, let's find out Y. (Little obscure technical pun there.) (*A little too obscure, if you ask me—Ed.*)

Seriously speaking, the video amps are a nice straight-forward DC-coupled circuit. They build up the Y or video signal to the amplitude needed for color picture work, which is a good deal more than the 50 volts p-p or so found in B/W sets. The color signals generally are taken off back about the first video amplifier stage and go their separate ways. The two signals must rejoin at the picture tube, and at the

proper time, amplitude and polarity. If this is fouled up, we can get some very confusing troubles!

All colors we see on the screen are the sum of two components; the pure color itself, and the brightness or 'white' component. If the white isn't right we'll see just the color signal, and this will be distorted—usually oversaturated. The colors will also be pretty blurry, because of the narrow bandwidth of the color subcarrier.

There are a lot of color shows on the air now, especially in the daytime, and our natural tendency is to check a color set on a color show. If we see "color troubles," we may waste a good deal of time looking for them in the color circuits while the real trouble could be in the video circuitry. Therefore, it's a very good idea to make a quick check of the picture in B/W. Turn to a channel with a B/W show or simply turn the color control off. This will give you a much better idea of what's going on.

So, the main object of this discussion will be "color troubles that aren't color troubles." To clear up that





Fig. 2. Picture shows faint raster with a colored bar.



Fig. 3. Black raster, heavy, retrace lines due to H-K short.

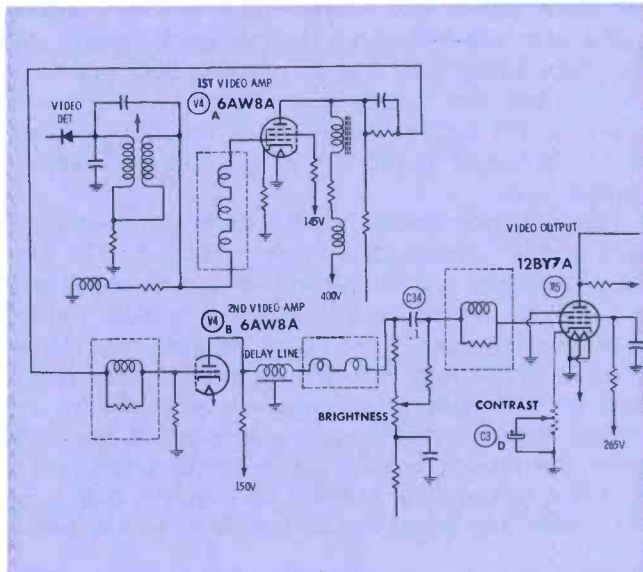

Fig. 1. Video amplifier circuits of the RCA CTC15.

lucid little statement, this means troubles which cause a poor color picture, but which are not due to defects in the color circuitry itself. The brightness or Y component will be missing, distorted, etc. To be quite frank about it, these are rare cases, from my experience. But when I ran into them they've been real buggers, for the reasons given!

Most video troubles can't be seen at all. Why? Because there won't be a raster for you to see them! The standard video amplifier circuitry in a color set is DC coupled all the way back to the video detector. The plate voltage on the video output tube sets the bias for the three cathodes of the color CRT. Anything that upsets the video circuits, even as far back as the 1st video amplifier, will cause the video-output plate voltage to shift—usually in the direction which causes the picture tube to cut off. The screen goes dark. This has caused a lot of unnecessary checking of high voltage, etc. Fig. 1 shows the video amplifier circuitry of an RCA CTC15, typical of those used in the majority of color sets up until the last year or so.

Here we have three stages, fed by a negative-going



Fig. 4. Same pix after bar crept up.

video signal from the detector. Everything is DC coupled; a change in the grid bias of the first stage changes the plate voltage of the last stage. For instance: measured voltages in an actual set; 12BY7 control grid, +1.0 volt, plate +240, screen grid +150, and +300 volts on each cathode of the CRT. This is for a picture of normal brightness, with signal.

The DC voltages are fed to these circuits from several places. The 12BY7 control grid actually gets its bias from two sources; one of which is the plate of the 2nd video amplifier tube. If the delay line should open, the control grid would lose a part of its normal supply. It will drop to a -1.5 volts, the plate rises to +360, the screen grid to +260, and the CRT cathodes jump up to +360 volts apiece. This is enough to cut the picture tube off, and the screen will turn black. So, if you can't get any raster, you should check the HV first, then take some readings at the base of the CRT. The great majority of troubles in the video circuit seem to have the above effect. Not all of them, though. Like any other circuit, we can have troubles that will cut off the signal while having no effect on



Fig. 5. Results of an open C3 on contrast control.



Fig. 6. Sylvania DO-5 with negative Y and positive color.

the DC voltage readings! And therein lies the source of our great blobs of color. Let's look at a few cases.

A simple one happened in a CTC15. The picture looked odd. It was almost black and white, though I knew the program was in color. Crawling up through the picture was a bar about two inches high; there was color in this bar, but nowhere else in the picture! (Fig. 2). This looked a lot like the old "light bar crawling up through the picture" trouble that we used to find in sets with insufficient filtering. Since there was only one bar, this had to be some kind of 60-Hz trouble, and I did think of filters first. However, this set has a voltage doubler, which makes 2 bars (120 Hz), so that was out. This being one of my better days, I thought of a heater-cathode short in one of the tubes. Up tube-check and at 'em. Going through the video amplifiers, IF's, etc., got nowhere. Hmm. . . . So, I went on.

When I got to the 6GU7 green amplifier, there it was; a good sized flicker of the short lamp. Oh, ho! But wait—green? This trouble wasn't in the green, it affected all colors, and it was blanking most of the color right out of the picture—BLANKING? That's

the secret word! Checking the schematic showed that the other half of that shorted tube was the blanker, and a new tube cleared up the trouble. Evidently, the short was killing the colors by affecting both the video circuits and the bandpass amplifier, which gets its bias from the blanker cathode. The brightness control had to be turned all the way up to get a good enough picture to see.

Heater-cathode shorts in other tubes can have some very distinct effects, too. Look at Fig. 3. The first time I saw this one, the screen was almost completely blacked out. There were very heavy vertical retrace lines showing, with three colors in each one. However, I stopped long enough to remember that retrace lines are always out of convergence, since they're out of step with the convergence waveforms. While I sat there idly musing like the guy with the raven on his shoulder, a bright bar crawled up from the bottom of the picture and things began to look more like home. (Fig. 4.)

Now it looked familiar. This was a good old 60-Hz hum bar! A bad one, since it was blanking the raster completely out in some places, but a hum bar just the same. In the place where you could see the picture, the colors were there, but very fuzzy and over-saturated. So, up tube-check again. This time I was lucky; I started with the last video amplifier tube, and this was it. (It's usually the one on the other end of the string from where you begin, as everyone knows!) The 12BY7 had a big fat H-K short. Since a lot of the important circuitry is in the cathode circuit of this tube, including the video peaking and the contrast control, the short was really playing hob with things. Once again, a new tube cured the trouble. Just for luck, I checked out the contrast control, electrolytic, and so on, in case there had been any damage. These were OK this time, but it never hurts to check.

While we're in this particular circuit (Fig. 1), let's see what effect some other possible troubles could have. If C34 opens, it will kill the Y signal, but won't affect the color signals. The picture will look something like the title illustration; the thing will be 'pale' and the colors will be pretty odd looking. An open

● Please turn to page 55

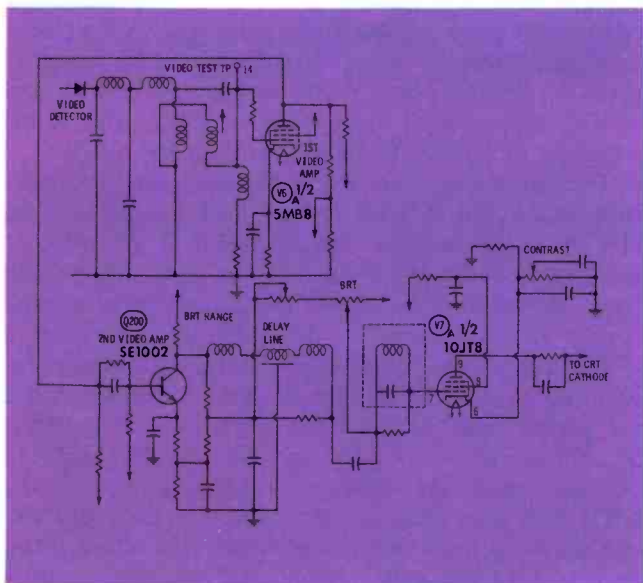

Fig. 7. Video amplifier circuit of Sylvania DO-5.





*You don't have to know middle C from F sharp, or be a Brahms or Bach—if you are a competent electronics technician, you can repair electronic organs.*

# Getting Started in

# ELECTRONIC ORGAN SERVICING

By MONTE J. HASSO

Electronic organs are a potential source of income for *any* competent technician. Then, why don't more TV men offer this service? Primarily because they have preconceived objections to organ servicing as a business or sideline. The most popular objections are:

1. I can't read music.
2. Organs are complicated, both mechanically and electrically.
3. There is not enough business to make it worth while.

Let's get these misconceptions out of the way right now. The truth of the matter is:

1. A large percentage of organ owners can't read music; even more significant, nearly all of the organ repairmen I have known couldn't either. Sure it helps, but it's not essential.
2. The electronic circuits found in organs are no more complicated than a color TV receiver, while the mechanical functions are much simpler than most record changers.

3. Before you make up your mind that there is no market for your services, ask an organ owner. In the larger towns, owners often have to wait several weeks for the repairman to get to them. Today, the organ serviceman is about as busy as a family physician. People in smaller towns have organs too, and because repair service is not available locally, they usually end up having a repairman from a nearby large city come out to do the job.

And by the way, organ servicing is an area where a competent technician can charge what he's worth and not have the customer raise an eyebrow.

Okay, so now the business doesn't seem so alien to a TV man. Let's take a closer look at electronic organs.

## Organs and Music, Briefly

The first thing we notice about the organ (Fig. 1.) is, of course, the *keys*. Note that these are laid out in a definite pattern—5 dark and 7 white keys—that is

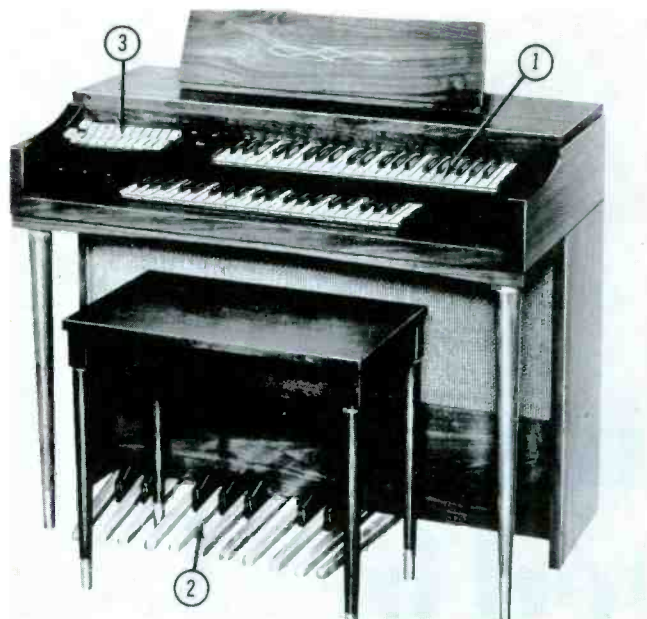
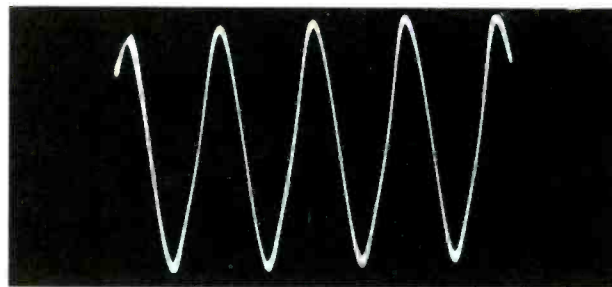

Fig. 1. The Thomas "Sernade" showing (1) keys, (2) pedals, and (3) stops.

repeated several times. To the service man, the only thing of importance about the keys is the letters and numbers assigned to them. Nearly all parts lists are made up so that the various components are listed by key letter and number. The numbers may be different from one organ to the next, but the letters are the same. However, regardless of model, the lowest number is always assigned to the lowest frequency key.

The second thing we notice about the organ is the *pedals*. Actually, these are keys also. Notice that they are laid out in the same pattern as the white and dark keys. The lowest pedal is nearly always assigned the number 1C1. (The highest key is often labeled 7C73, which means that the note is the 7th harmonic of the lowest C-note, developed in the 73rd tone generator).



(A) Flute note.

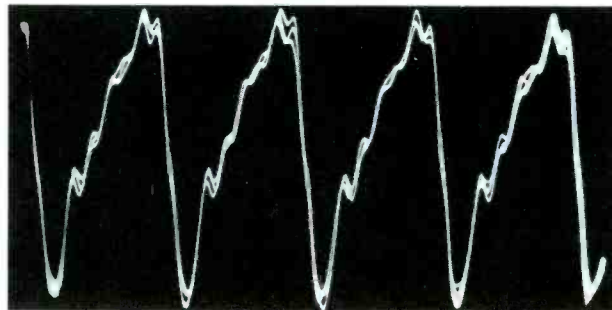

(B) Horn note.

Fig. 2. Waveforms of typical musical notes.

Near the keys will be found a number of switches called *stops*. These shape the waveform of the note so that it sounds like the instrument named on the stop. The simplest waveforms are produced by the *flute stops*, while more complex waveforms are produced by the *reeds* (horn). Fig. 2 illustrates these waveforms, which are shaped by adding components in an integrator. Other stops perform different functions, such as adding reverberation, changing the decay rate of a note, etc.

### Basic Organ Theory

The basic block diagram of a typical organ is shown in Fig. 3. Each note has its own tone generator, typi-

• Please turn to page 50

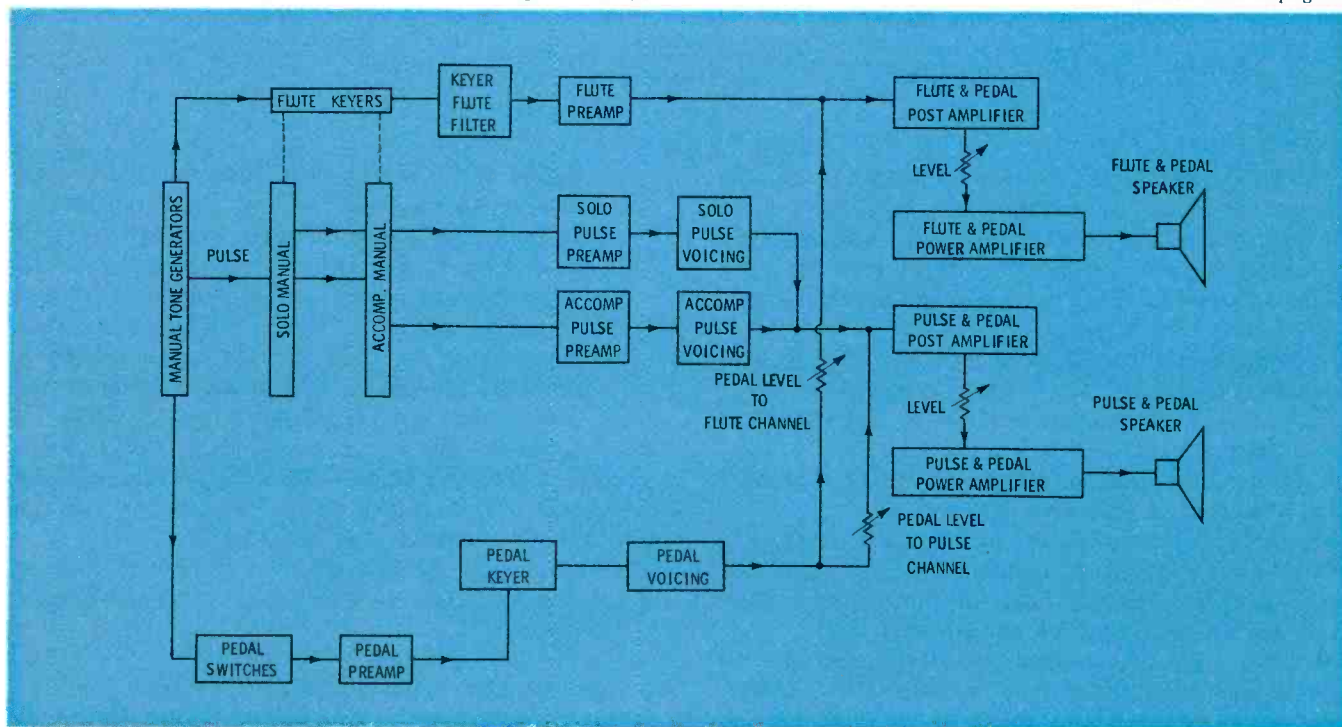
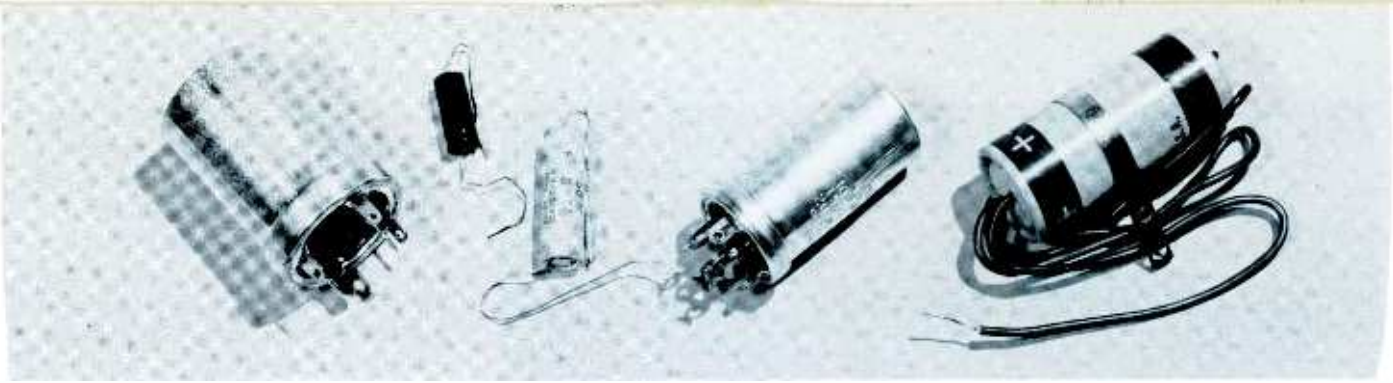

Fig. 3. Block diagram of a typical organ.





# Electrolytic Capacitors in TV Receivers

No model or make of TV receiver has been entirely immune from electrolytic capacitor failure. Depending upon the type of failure, a great many different trouble symptoms have resulted. While many of these troubles have symptoms readily identifiable with filter defects, a considerable portion do not; in fact it is often surprising to find that a tough-to-correct marginal trouble stems from a defect in an electrolytic filter capacitor. In many troubles of this kind appreciable troubleshooting and repair time can be saved by use of the oscilloscope.

### Capacitor Defects and Testing

A low resistance or dead short resulting from breakdown or puncturing of the dielectric is the easiest of all electrolytic capacitor failures to pinpoint. It invariably causes at least one section of the receiver to be totally inoperative (and in most instances the entire receiver). A shorted electrolytic capacitor always causes some component to overheat to a level where it is damaged or destroyed, unless a fuse or other protective device is included in the circuit. An ohmmeter will quickly trace down these problems.

A capacitor defect somewhat less common than the dead short is one in which the dielectric becomes leaky. In this defect the capacitor assumes a DC resistance much lower than normal and passes DC current much higher than normal. The resistance reads less than 10,000 ohms on the average ohmmeter. The resistance check is abnormal in another way; instead of the ohmmeter deflecting to zero and

By ALLAN KINCKINER  
*Failure of an electrolytic capacitor can lead to exasperating trouble symptoms. A review of the signals present in circuits employing electrolytics, together with an analysis of trouble symptoms and troubleshooting techniques saves time and temper.*

then dropping back to a high value, it settles immediately at the leakage value. While trouble symptoms are not as pronounced as those produced by a shorted capacitor, this defect does produce two definite side effects; the capacitor or the

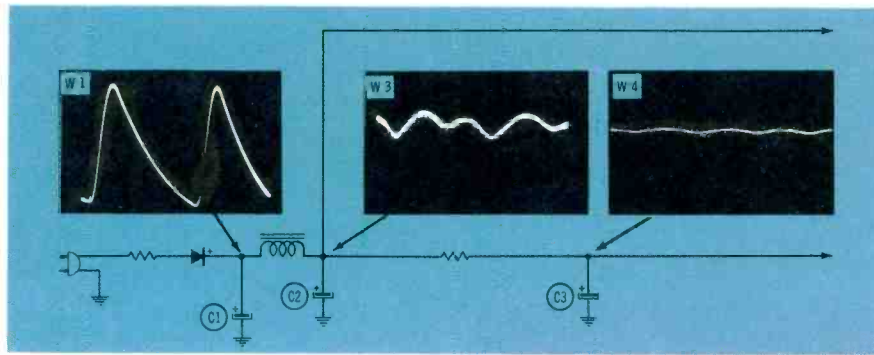

Fig. 1. Deterioration of paper casing.

can in which it is included will get quite warm after a short period of operation, and the capacitor's electrolyte will eventually boil out through a vent or ooze out at points where terminals are inserted. Receiver symptoms such as weak sound, decreased raster size, low brightness, or weak contrast are typical for this type of failure.

Loss of capacitance however, is the most common electrolytic capacitor failure. This condition prevents the capacitor from smoothing ripple, bypassing unwanted signals, or decoupling sections on the filtered line—the basic purposes of any electrolytic filter. Trouble symptoms vary infinitely from this condition—hum in sound, hum in picture, twist or other picture distortions, raster shading or shading bands, and poor sync are typical. Severity of the trouble is determined by the extent of capacitance loss. Mild loss introduces barely perceptible troubles, while considerable capacitance loss or a completely open filter produces extreme picture or sound troubles. In some instances capacitance loss assumes a frequency characteristic, affecting only high frequency bypassing or low frequency ripple smoothing. In the first noted condition, unwanted coupling between different stages takes place, the second condition (excessive low frequency ripple) will produce vertical instability, decreased vertical deflection, or picture twist. Examination of the filtered lines via scoping is the easiest and surest way to locate loss of capacity defects.

One of the least common electro-



A. Simple half-wave circuit.

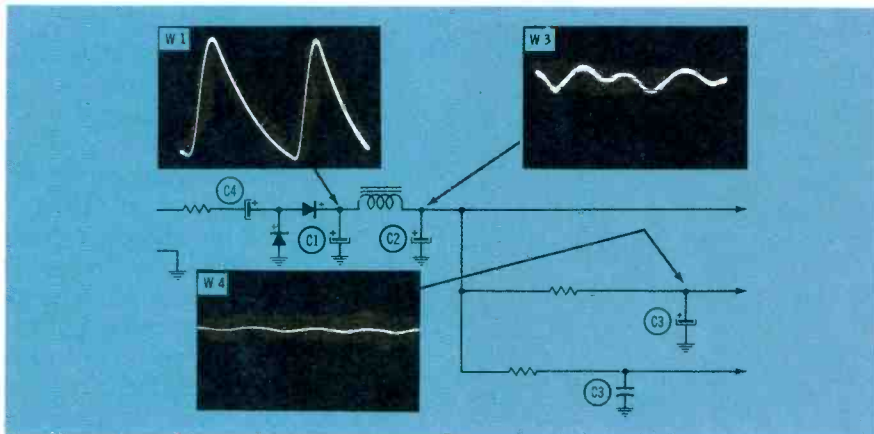

B. Simple half-wave doubler.

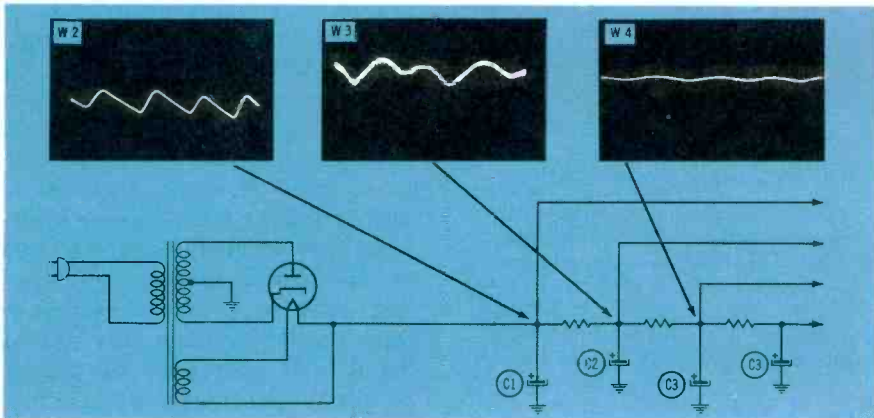

C. Full-wave tube circuit.

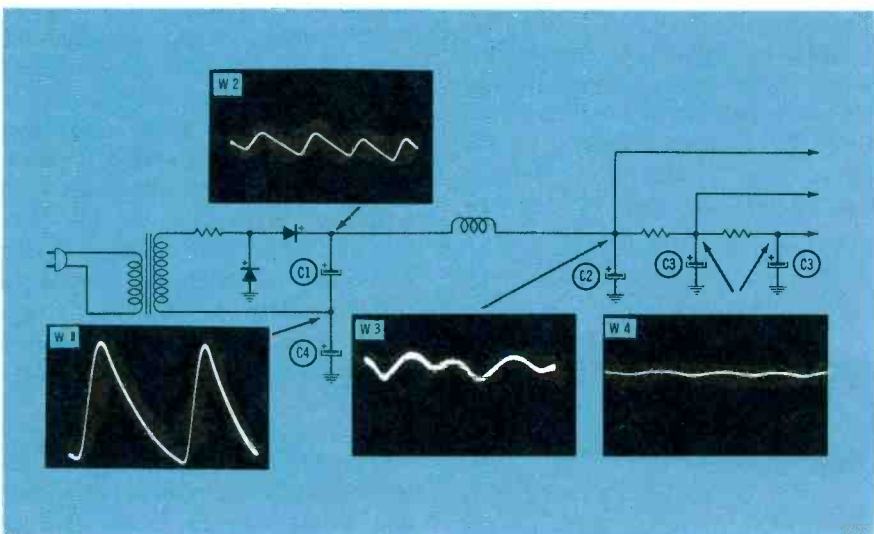

D. Full-wave doubler.

Fig. 2. Circuits representative of modern TV receivers.

lytic filter defects is AC leakage between sections in cans containing more than one capacitor. The product of this defect is the introduction of alien signals into certain receiver stages from other receiver stages. Several examples of this condition will be covered later in this article. Scoping is the only means by which this condition can be detected; the old trick of shunting suspected filters with external units will be non-productive even when the shunting units have several times the capacity of the defective units.

Current leakage through the casing of paper-encased electrolytics is another very rare defect. Fig. 1 shows a unit having this defect. The stained area indicates the current path through the casing to the capacitor mounting strap. In one such case we found, the only symptom was that the fuse would blow after about one hour of operation. In another case with this leakage defect, severe hum resulted.

Because the shorted or leaky capacitor defects are not difficult to locate or check they will not be discussed further in this article. The loss of capacity defects and the AC leakage between sections defects though, will be covered in depth, primarily because they produce many of the so-called 'Tough Dog' troubles. However, before digging into defective filter case histories, we shall study normal signals on filtered lines. It is quite helpful to examine the signals on these filters when they are normal.

### Primary Circuits

The group of circuits shown in Fig. 2 are typical and representative of B-plus supplies employed in virtually every TV receiver designed and manufactured in the past fifteen years. The filter capacitors and the choke or resistor preceding each capacitor are considered as primary filter circuits. A minimum of three filter capacitors are used in economy models such as shown in Fig. 2A, but in most monochrome receivers more than three are employed and in color receivers as many as nine electrolytic filter capacitors will be found.

Four basic functions are served by the capacitors in Fig. 2 (any



circuit). C1 refines the pulsating DC supplied by the rectifier into a steady DC voltage having ripple of not more than 10 per cent. C2 in each circuit (in conjunction with the choke or resistor preceding it) reduces the ripple, producing a smoother DC having a semi-sine wave ripple of about 2 percent. In addition, C2 bypasses signals from the various circuits fed by its line, preventing signals from one stage being coupled into other stages. C3 smoothes the DC further, provides increased decoupling between stages, and provides a ground return for all signals on the line.

C4 (in the voltage doubler circuits) functions quite differently, as it is not a filtering capacitor. Operating in conjunction with the first rectifier, C4 charges to the peak value of the applied AC voltage. Using this DC charge as a base, the second rectifier then produces a DC voltage approximately equal to the peak-to-peak value of the supplied AC voltage. Thus the DC obtained in Figs. 2B and 2D is approximately two times the RMS value of the supplied AC voltage.

Normal waveforms are included in the Fig. 2 circuits. W1 in Figs. 2A and 2B has a sawform ripple of 60 Hz, and as previously noted, has an amplitude of ten percent of the DC voltage. The ripple amplitude varies inversely with size of C1 and directly with the current drain requirements of the supplied circuits. W2 in the full-wave circuits Figs. 2C, 2D, and 2E has a frequency of 120 Hz. Except for this frequency difference W2 is identical to W1 in all respects. W3 in all the Fig. 2 circuits has a semi-sine wave shape with an amplitude of less than three volts. In the half-wave circuits its frequency is 60 Hz. and in the full wave circuits 120 Hz. W3 is reasonably steady when the vertical deflection is synced, but when vertical deflection is out of sync, W3 becomes slightly distorted and contains a small amount of bounce. W4 in all the Fig. 2 circuits should have an amplitude of less than 1 volt with a smooth waveshape as shown.

### Secondary Circuits

In addition to the primary filter

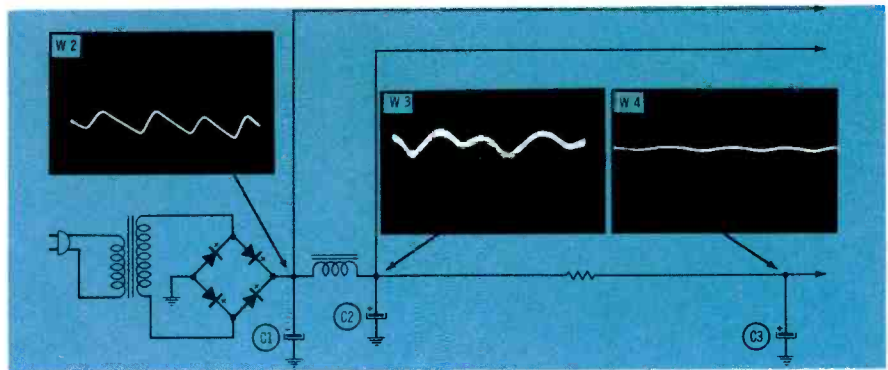

E. Bridge circuit.

Fig. 2. Circuits representative of modern TV receivers.

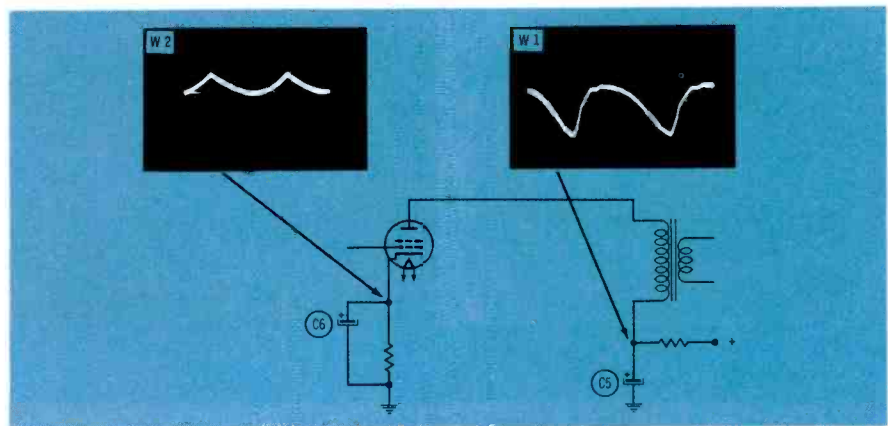

A. Audio or vertical output stage.

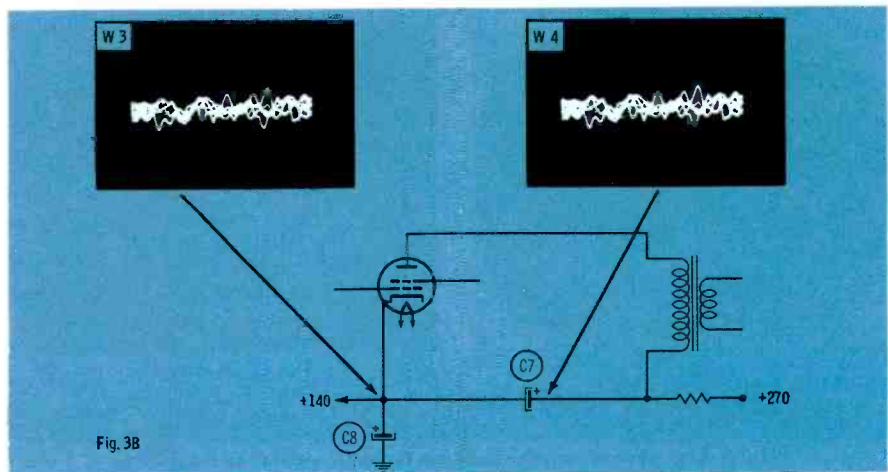
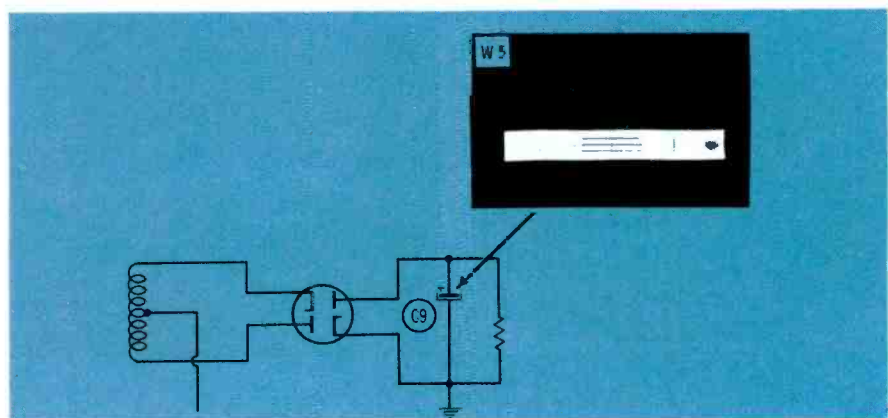

Fig. 3B

B. Stacked audio output stage.



C. Ratio detector.

Fig. 3. Secondary filtered circuits often employed.

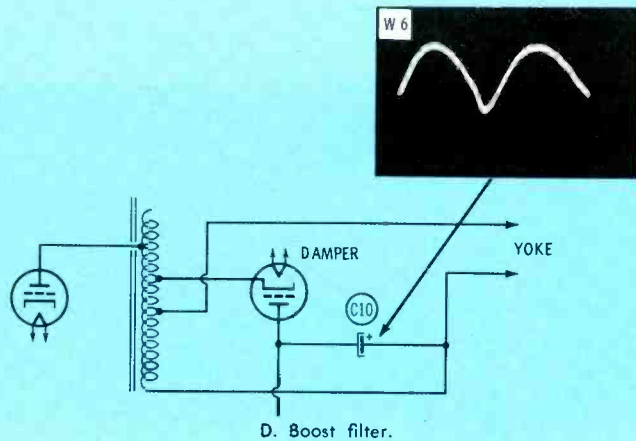

Fig. 3. Secondary filtered circuits often employed.

circuits, most TV receivers employ other electrolytic capacitors in circuits similar to those in Fig. 3. The average black-and-white TV set contains four or five capacitors in supply circuits and between one and three more in circuits similar to those in Fig. 3. Color receivers generally have nine to eleven electrolytic capacitors. Purposes and functions of the filtering in the Fig. 3 are discussed in explanations of the individual circuits.

Fig. 3A is typical of either an audio or vertical output stage. C5 is the plate supply filter and C6 is the bypass for the cathode-bias resistor. C5 further filters any ripple from the B+ supply, minimizes voltage variations resulting from varying current demands of the tube, and thus assures maximum output efficiency. C6 prevents cathode-bias degeneration and provides increased low-frequency efficiency. Considering Fig. 3A as a vertical output stage, the capacity of C5 is normally greater than 20 mfd and C6 is 20 to 100 mfd. As an audio output stage, C5 and C6 are usually about 10 to 20 mfd.

Fig. 3B is the familiar stacked B+ circuit using the audio output stage. C7 normally has a capacity greater than 40 mfd. It smooths B+ voltage fed to the tube and reduces voltage fluctuations at the B+ end of the transformer. These fluctuations result from varying current demands induced by audio signal levels. C8 (usually between 40 and 100 mfd) reduces cathode circuit degeneration at low frequencies and supplies a smooth supply voltage to circuits in the fed portion of the stacked arrangement.

Fig. 3C is a ratio detector used for sound detection in FM and TV receivers. C9 charges to the carrier amplitude and, because of the long time constant of this capacitor and the resistor paralleling it, retains the charge despite carrier amplitude variations. The diodes are thus biased and respond only to frequency variations of the signal. The circuit therefore detects only the frequency modulation of the signal while limiting or clipping amplitude modulation to very small levels. In most designs C9 has a capacitance between 2 mfd and 10 mfd.

A limited number of receiver



A. Screen symptoms.

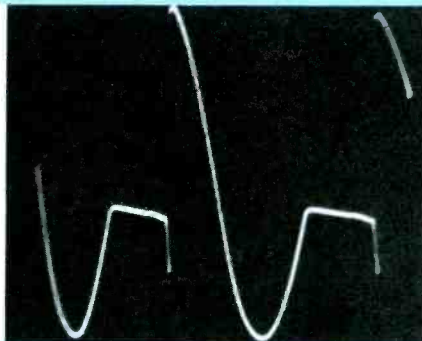

B. Ripple at C1.

Fig. 4. Example of severe twist.



A. Screen symptoms.

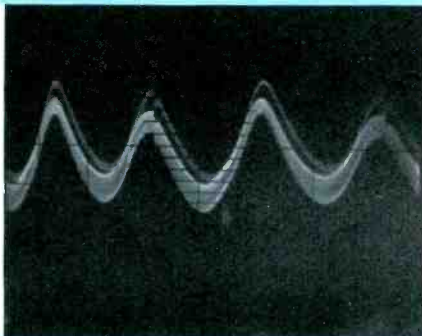

B. Ripple at C2.

Fig. 5. Less severe twist caused by secondary filter capacitance.



A. Screen symptoms.

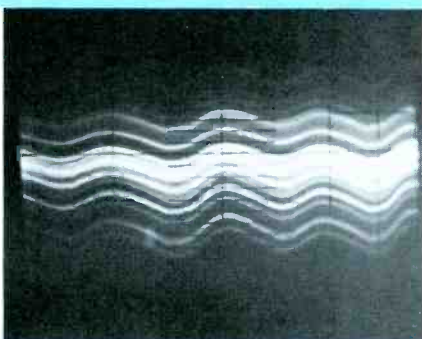

B. Waveform at C3.

Fig. 6. Mild twist normally associated with trouble in C3.



It's a sensational home system TV amplifier!

It's a great amplified 4-set coupler!

It's an amazing amplified splitter!

It's an ingenious line extender!

Operate up to 4 sets direct!

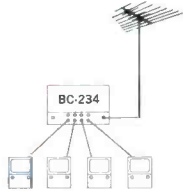

Run sets in series!

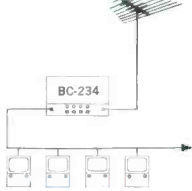

Power a pre-amp, too!

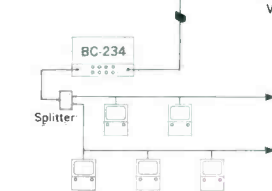

Cascade them for big systems! (up to 100 sets—with 30db gain)

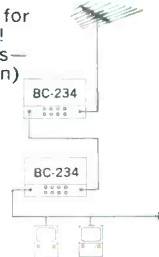

Use as a line extender!

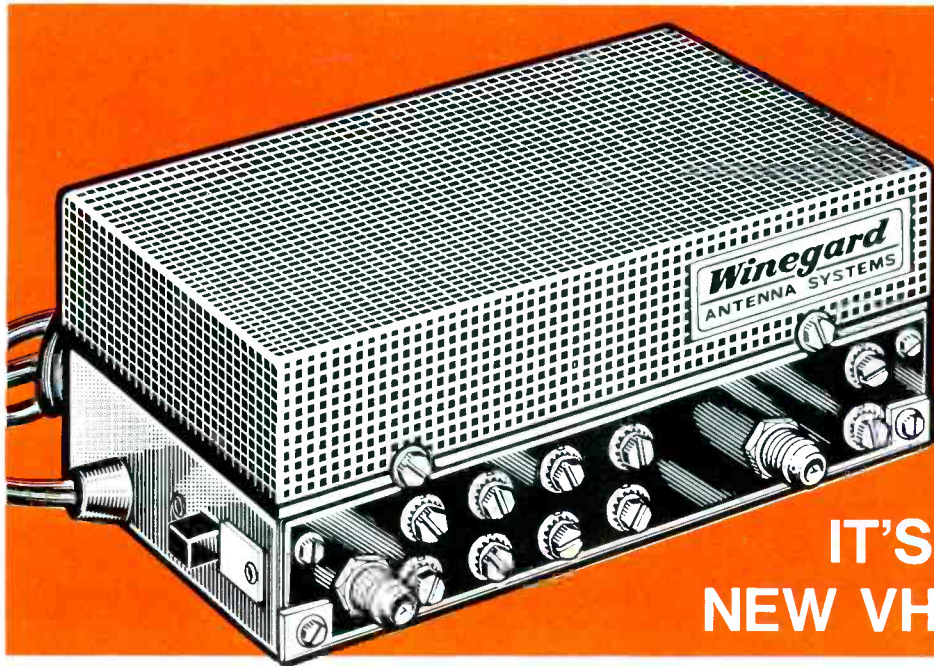
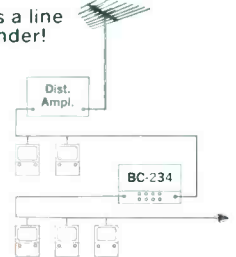

... the first solid state, high gain COLOR TV Booster/Coupler/Amplifier with complete flexibility and no overload problems!

## IT'S WINEGARD'S NEW VHF/FM BC-234

We say there's never been anything like the BC-234. But don't take our word for it. Just try to find another solid state Booster/Coupler/Amplifier capable of producing up to 3,000,000 (3-million) microvolts of signal output—and capable of operating more TV sets than any other home system amplifier on the market.

The sensational BC-234 does it all. And always with exceptionally high gain and *no* overload problems.

Check the features for yourself, including the rugged steel housing (not plastic) that's comparable to housings used on the most expensive commercial amplifiers.

- **Solid State Circuitry**—for long life and the highest gain on each of the four 300 ohm outputs.
- Both 75 ohm and 300 ohm inputs... no switches or transformers needed.
- **Overlay Silicon Transistors**—temperature tested from  $-60^{\circ}$  to  $200^{\circ}$  C. for positive temperature stability.
- All metal housing construction for positive electrical shielding.
- Four 300 ohm outputs and one 75 ohm output. Extremely high isolation—no interaction between sets—no need to terminate unused output terminals.
- Flat gain response: +15db on every channel—makes the BC-234 perfect for COLOR TV reception.
- Responds to the very weakest fringe area signals, yet can't overload.
- Can be used as an antenna booster to reduce snow in fringe areas.
- On-off switch enables power to be

sent up line to operate pre-amplifier for increasing number of sets and cutting snow.

- No-strip malco terminals for all 300 ohm connections.
- F-type jacks with connectors provided.
- Complete with mounting brackets and screws.

Now admit it. That's a lot of Booster/Coupler/Amplifier for any price. And especially for only \$34.95. In fact, there's nothing else like it—anywhere! Better call your Winegard distributor today, or write for Fact-Finder #250 for all the facts about the BC-234 and BC-274, plus complete information about Winegard's sensational new 82-Channel Booster Couplers.

### Model BC-274 VHF/FM

All 75 ohm Booster/Coupler/Amplifier with 4 coax outputs, 300 ohm and 75 ohm inputs. Connectors included. \$39.95



© Copyright 1967, Winegard Company, Burlington, Iowa

WINEGARD COMPANY • 3000 KIRKWOOD STREET • BURLINGTON, IOWA 52601

Circle 9 on literature card

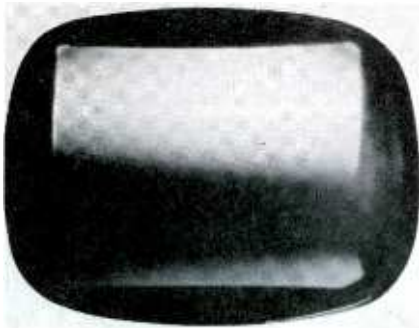

Fig. 7. Raster caused by open C4.

designs use an electrolytic capacitor from the boost source to the damper plate as shown in Fig. 3D. It usually has a capacitance of 10-20 mfd, and is sometimes a nonpolarized unit. The signal across it is normally less than 20 volts. This signal incidentally is scoped at  $\frac{1}{2}$  horizontal frequency; all other scopings in this article are done at  $\frac{1}{2}$  of vertical frequency.

Just as the circuits in Fig. 2 have normal shaped and sized waveforms so also have the Fig. 3 circuits. Considering the Fig. 3A circuit as a vertical stage, both W1 and W2 scope as shown, with an amplitude of less than twenty volts; actual amplitude of either is subject to capacitance of the electrolytics involved. In an audio output stage similar to Fig. 3A, W1 and W2 waveforms are more similar to those of Fig. 3B, with the audio content dominant.

W3 and W4 (Fig. 3B) are virtually identical in waveshap and amplitude. Amplitude value is limited to approximately seven volts and if it becomes greater, it invariably produces bounce in the picture corresponding with sound signal levels. Occasionally excessive levels in the W3 and W4 signals produce sound bars in the picture.

Signals across the electrolytic capacitors in the ratio detector cir-

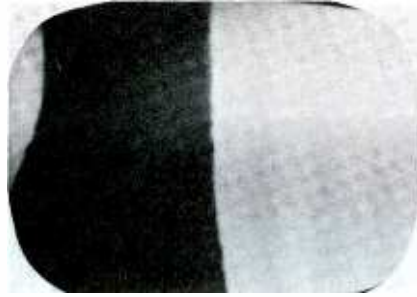

A. Screen symptoms.

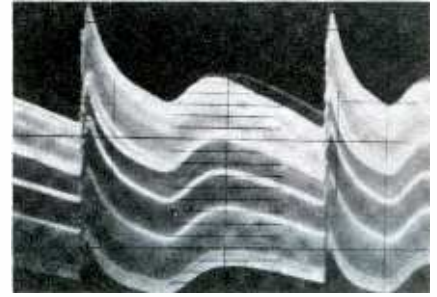

B. Waveform at any filter.

Fig. 8. Complete loss of filtering caused by open common negative lead.

cuits (W5 in Fig. 3C) have the shape shown and an amplitude of only a few tenths of a volt.

Normally the signal across C10 in the Fig. 3D circuit will have an amplitude of less than 15 volts with, as previously noted, a horizontal wave-shape similar to that shown.

### Scoping

Knowledge that all filter circuits in TV receivers have definite signal ripple amplitude limits can reduce troubleshooting time immeasurably. With a calibrated scope the filtering capability of any electrolytic capacitor can be determined as quickly as the scope probe can be applied. Therefore, all filtered circuits in any set can be checked in less than one minute. Not only can the ripple amplitude be measured but scoping will also quickly reveal the presence of hash or other unwanted signals.

### Filter Defects and Picture Troubles

The most common trouble symptoms associated with filter defects are shown in Figs. 4A to 6A. Because these bend, twist, and curvature conditions are common, they are readily associated with filter defects by experienced TV technicians. The extreme condition in

Fig. 4A has been found in numerous sets using voltage doubler circuits; when C1 in Fig. 2B or C4 in Fig. 2D suffer from considerable loss of capacitance, the waveform at the B+ supply source scopes as in Fig. 4B and has an amplitude of more than 100 volts. A less severe twist distortion (Fig. 5A) usually results from a fault in a filter corresponding to C2 in any of the Fig. 2 circuits. The odd waveshape (15 VP-P) shown in Fig. 5B will be present at C2 because the low frequency portions of the signal across the filter increase much more than do the higher frequency signals. The very mild twist and bend in Fig. 6A is often traceable to defects in filters corresponding to C3 in any of the Fig. 2 circuits. Generally a scope trace similar to Fig. 6B results, indicating that the higher frequency bypassing efficiency is affected most.

Small and/or partially blanked rasters as presented in Figs. 7-10 are also the products of defective filters. The picture in Fig. 7 stemmed from an open capacitor corresponding to C4 in a circuit similar to Fig. 2D.

When the common negative opened in a four-section containing filters corresponding to C1, C2 and two C3's in a circuit similar to Fig. 2E, the picture shown

● Please turn to page 36



Fig. 9. Open C1 in full-wave circuit produced this raster.



A. Screen symptoms.

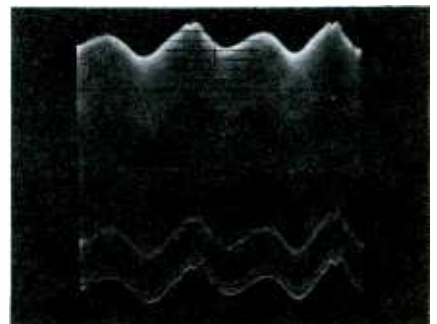

B. Waveform on the filter.

Fig. 10. Open filter on horizontal B+.



# Let's talk sense about color TV lead-in!

The common sense of the situation calls for two 82-channel lead-ins for color and UHF TV... one to give a stronger signal in uncongested fringe areas where interference usually is not a serious problem. The other to give a much cleaner signal in congested or close-in areas where serious interference problems are likely to exist. This is why Belden gives you a choice—the *Color Guard Twins*.

**8285** ▶

*Color Guard  
Twin—Belden  
Permohm\**

Use to get stronger signals in uncongested fringe areas, like this . . .



You get an excellent color image . . . because in a 100-foot run, Permohm delivers 38% to 200% more signal voltage than RG-59/U with matching transformers and 23% to 80% more signal voltage than "Low Loss Coax" with transformers.

Permohm obtains the highest efficiency of any available unshielded 300 ohm line when exposed to weathering and industrial atmospheres. Low loss cellular polyethylene insulation around the conductors provides the necessary protection.

You don't need expensive transformers and connectors.

L TV

◀ **8290**

*Color Guard  
Twin—Belden  
Shielded Permohm\**

Use to get cleaner signals in congested or close-in areas, like this . . .



Belden Shielded Permohm (8290) combines strong signal strength with the clean signal protection of shielded cable.

Shielded Permohm eliminates transmission line pickup of noise and ghost signals. You can install it easily anywhere . . . no need for standoffs, twisting, or inconvenient routing of lead-in. Tape it to a mast, route it through metal pipe, or bury it underground.

Beldfoil<sup>†</sup> shielding is used to shield against outside signal interference. The jacket is weatherproof polyethylene. The critical signal area is protected from rain, snow, salt, smog, fog and industrial contamination. No expensive transformers or connectors are needed.

Belden Trademarks Reg. U.S. Patent Office  
\*Patent No. 2,782,251 and Pat. Pending  
†Patent No. 3,032,604

Choose the Color Guard Twin that gives your customer the best 82-channel color TV reception. Get complete information on the Belden Color Guard Twins.

**CALL YOUR BELDEN ELECTRONIC DISTRIBUTOR.**

**Belden**

**BELDEN MANUFACTURING COMPANY • P. O. Box 5070-A • Chicago, Illinois 60680**

Circle 10 on literature card

May, 1967 / PF REPORTER 33

This *Remington* PREMIER PORTABLE TYPEWRITER

FREE



WHEN YOU BUY THIS RCA WR-64B  
COLOR BAR / DOT / CROSSHATCH  
GENERATOR...THE ESSENTIAL  
COLOR TV TEST INSTRUMENT

Here's a deal you can't afford to miss! A FREE Remington portable typewriter—yours when you purchase the most essential color-TV test instrument—the RCA WR-64B!

Just imagine how handy your new typewriter will be—in the shop or at home. You'll use it almost as much as you use the RCA WR-64B—standard of the color TV servicing industry.

Here's how to get your FREE Remington Typewriter. Mail in the warranty card plus the gold label from the shipping carton of your new RCA color bar generator to RCA Test Equipment Headquarters, Bldg. 17-2, Harrison, N.J. We will ship your new Remington portable typewriter to you direct, freight prepaid. But remember—this offer covers only equipment purchased between February 1, 1967 and July 15th, 1967. To allow for postal delay, we will honor cards postmarked up to July 31st.

Plan NOW to take advantage of this BIG offer—a FREE Remington portable typewriter with your purchase of an RCA WR-64B color bar/dot/crosshatch generator.



The standard of the Color-TV Servicing Industry. Generates all necessary test patterns—color bars, crosshatch, dots plus sound-carrier. Only \$189.50\*

\*Optional Distributor resale price. All prices subject to change without notice. Price may be slightly higher in Alaska, Hawaii, and the West.

Ask to see it at Your Authorized  
RCA Test Equipment Distributor

RCA Electronic Components and Devices, Harrison, N.J.



The Most Trusted Name in Electronics



AT LAST! THE PERFECT 82-CHANNEL  
(VHF-UHF-FM) HOME COLOR TV SYSTEM

# Winegard's New BC-782 82 Channel Booster Coupler Only \$44.95

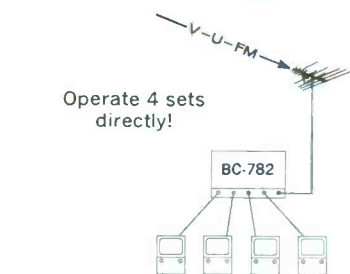
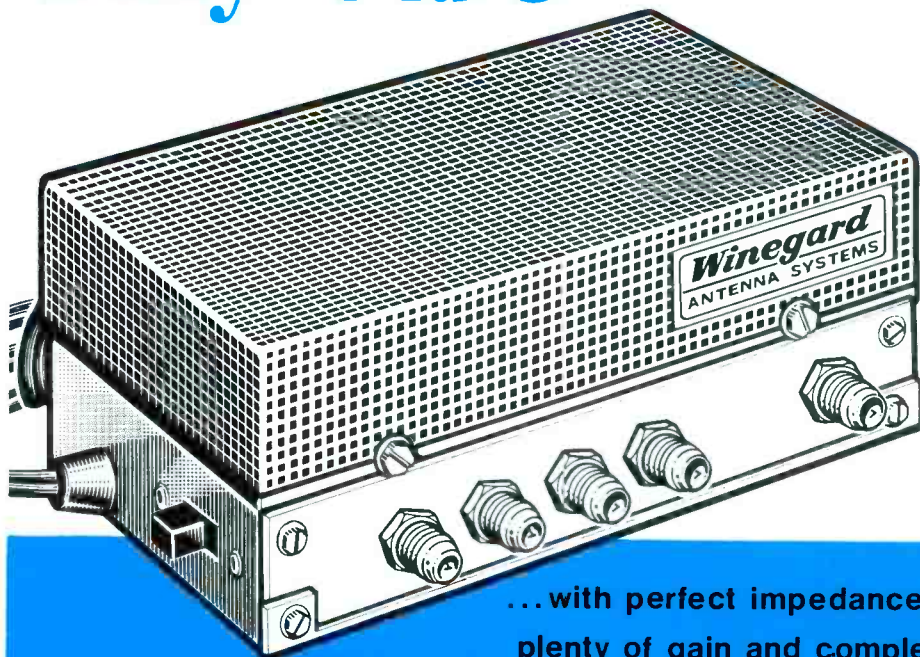

Operate 16 sets  
(4 off each output)  
with no interaction  
between sets!

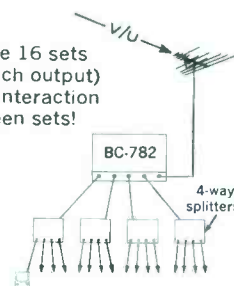

... with perfect impedance match on all 82-channels,  
plenty of gain and complete isolation between sets!

Here's the greatest thing ever to happen to your booster coupler business... Winegard's sensational 75 ohm BC-782.

What makes the BC-782 so great? First off, it's an 82-channel booster coupler, the only truly operational and efficient TV signal amplifier that delivers *uniform gain* on all 82 channels.

It has solid state circuitry, incorporating 3 of the newest overlay silicon type transistors (temperature tested from  $-60^{\circ}$  to  $200^{\circ}$  C.) for long life... low noise figures to cut snow... and *full gain* on all 82 channels.

The BC-782 has extra power, too—enough gain to operate 1, 2, 3 or 4 sets directly—or as many as 16 sets (4 off each output) with *no* interaction between sets.

Even the housing is something special—with steel construction throughout (not plastic) comparable to the most expensive commercial units, for positive electrical shielding.

And that's not all. The BC-782 has plenty of other

exclusive performance and construction features, including:

- Extremely high isolation between sets—no interaction—no need to terminate unused output terminals.
- Responds to the very weakest fringe area signals.
- Perfect for COLOR TV reception because of flat gain response on all channels 2 to 83, plus FM.
- Ultra-low noise figures effectively eliminate snow even in deep fringe areas.
- F-type 75 ohm jacks with connectors provided.
- On-off switch.
- Complete with mounting brackets and screws.

That's Winegard's new BC-782, the greatest thing ever to happen to your booster coupler sales. And with a great price to match—only \$44.95. Call your Winegard distributor today, or write for Fact-Finder #250 for all the facts, plus information about Winegard's new COLOR TV Booster/Coupler/Amplifiers.

#### Model BC-382

300 ohm twin lead Booster Coupler with same exclusive features as BC-782. \$39.95



**Winegard**  
ANTENNA SYSTEMS

© Copyright 1967, Winegard Company, Burlington, Iowa

WINEGARD COMPANY • 3000 KIRKWOOD STREET • BURLINGTON, IOWA 52601

## Electrolytic Capacitors

(Continued from page 32)

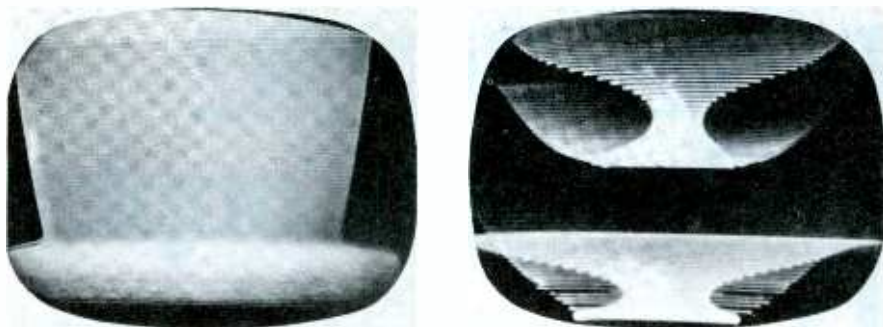

Fig. 11. Incomplete rasters produced by more than one open filter.

in Fig. 8A resulted. The waveform in Fig. 8B was scoped on all four terminals of this multisection filter. The condition shown in Fig. 9 has been seen in several receivers when the first section filter in a full wave rectifier circuit opens; amplitude of the ripple across this filter rises to several hundred volts P-P.

In an older Philco the unusual blanked raster in Fig. 10A resulted from an open filter on a separate B-supply line feeding the horizontal deflection circuit. The signal across this filter, Fig. 10B, attained an amplitude of over 100 volts and the filter choke preceding the ca-

pacitor overheated and charred.

Incomplete and odd shaped rasters are also symptomatic of electrolytic filters having lost capacitance. Invariably more than one filter is involved. Generally the first filter off the rectifier plus the filter on the horizontal deflection B-supply line cause the condition. Typical cases of this condition are shown in Figs. 11A and 11B.

### Conclusion

Some technicians will question the idea of scoping filters. "Why not just shunt suspected units?"

they'll ask. In addition to the fact that not all filter-caused troubles draw suspicions to filters, there are several other good reasons; 1. Shunting only individual sections when many sections are bad is invariably ineffective. 2. Shunting always presents the hazard of temporarily curing a bad filter by shocking. 3. Scoping definitely and absolutely indicates the condition of filters. 4. Scoping every filter in a set can be done in less time than it takes to shunt even a few of them.

The normal ripple and signal levels given in this article can be used to pinpoint defective capacitors. Analyzing these normals will reveal that sawform wave shapes are found at only one or two filters, and their maximum peak-to-peak value should be less than ten percent of the B voltage. Only two other filters will scope over ten volts signal; those at the vertical output tube's cathode, and at the vertical B voltage line. No capacitor should have hash or video signal greater than a few tenths of a volt. Knowing these normal conditions it becomes simple to determine a filter capacitor's efficiency. ▲

Designed and manufactured in U.S.A.

# NEVER A BURNOUT

IN 6 EMC DIODE-PROTECTED VOMS

NOBODY ELSE BUT EMC DESIGNS IN SO MUCH VALUE!  
 • Professional quality and versatility • Lifetime protection against electrical abuse • No meter burnout, needle damage, or fuse replacement

### VOLOMETER

**Model 109A** Factory Wired & Tested \$28.95  
**Model 109AK** Easy-to-Assemble Kit \$21.15  
 20,000  $\Omega/v$  DC sens. 10,000  $\Omega/v$  AC sens. 4½" 40 $\mu$ a meter. High impact bakelite case. 5 DC voltage ranges: 0-6-60-300-600-3000v. 5 AC voltage ranges: 0-12-120-600-1200-3000v. 3 DC current ranges: 0-6-60-600ma. 3 AC current ranges: 0-30-300ma; 0-3A. 3 resistance ranges: 0-20K, -200K, -20 megs. 5 db ranges: -4 to +67db. With carrying strap. 5¼" W x 6¾" H x 2⅞" D.

### VOLOMETER

**Model 103A** Factory Wired & Tested \$20.75  
**Model 103AK** Easy-to-Assemble Kit \$16.80  
 4½", 2% accurate, 800 $\mu$ a D'Arsonval type meter. One zero adjustment for both resistance ranges. High impact bakelite case. 5 AC voltage ranges: 0-12-120-600-1200-3000v. 5 DC voltage ranges: 0-6-60-300-600-3000v. 5 db ranges: -4 to +64db. 5 AC current ranges: 0-30-150-600ma. 4 DC current ranges: 0-6-30-120ma; 0-1.2A. 2 resistance ranges: 0-1K, 0-1 meg. 5¼" W x 6¾" H x 2⅞" D.

### POCKET SIZE VOLOMETER

**Model 102A**  
 Factory Wired & Tested \$16.95  
**Model 102AK** Easy-to-Assemble Kit \$14.40  
 3½", 2% accurate 800 $\mu$ a D'Arsonval type meter. One zero adj. for both res. ranges. High impact bakelite case. 5 AC voltage ranges: 0-12-120-600-1200-3000v. 5 DC voltage ranges: 0-6-60-300-600-3000v. 3 AC current ranges: 0-30-150-600ma. 4 DC current ranges: 0-6-30-130ma; 0-1.2A. Resistance: 0-1K, 0-1 meg. 3¾" W x 6¼" H x 2" D.

EMC, 625 Broadway, New York 12, N.Y.  
 Send me FREE catalog of the complete value-packed EMC line, and name of local distributor. PF-5

NAME \_\_\_\_\_  
 ADDRESS \_\_\_\_\_  
 CITY \_\_\_\_\_ ZONE \_\_\_\_\_ STATE \_\_\_\_\_

# EMC

ELECTRONIC MEASUREMENTS CORP.  
 625 Broadway, New York 12, New York  
 Export: Pan-Mar Corp., 1270 B'way, N.Y. 1

## Coming in June

- Sweep Alignment for TV
- Transistor TV Techniques
- Solid-State Stereo Revisited
- Scope or Meter—Which?
- Thermistors and VDR'S in TV
- and many more!



# The first major improvement in 75 ohm Coaxial Cable since the introduction of braided shielding

## COLOR-DUCT 82

ULTRA LOW LOSS UHF/VHF RG-59 TYPE COAXIAL CABLE

Model  
9537

- **LOWEST COST**  
**82 CHANNEL CABLE**
- **LOWEST LOSS**
- **100% SHIELDED**

100% SHIELDING literally creates a direct line to color.

Until now, total shielding has been used only on transmission cables in commercial and military communications, radar, and in professional audio and broadcasting installations. Here, where complete shielding from radiation and interference pick-up are critical, the solid tube type of shield has always proven most effective.

NOW, Channel Master has applied this proven 100% shielded construction... for the first time in TV history... to 75-ohm coaxial cable designed for MATV and home television installation. Yet, it has all the flexibility and handling ease of ordinary coax.



Channel Master's over-all shield is created by laminating aluminum foil to both sides of high tensile strength mylar.



This shield is then totally wrapped and over-lapped around the virgin polyethylene dielectric core containing the copper clad center conductor.



Before the black outer jacket is applied, four equally spaced, parallel wires are positioned around the circumference of the shield. In addition to providing extra strength to the cable, these wires maintain electrical conductivity even if a break should occur in the shielding.



In ordinary braided shielding, air spaces are formed between the wire strands, reducing both the conductivity and the shielding effect from 80 percent in the best qual-

ity coax to as low as 50 percent in lower grade cable where fewer strands have been used in the braid.

ORDINARY RG-59 TYPE CABLE

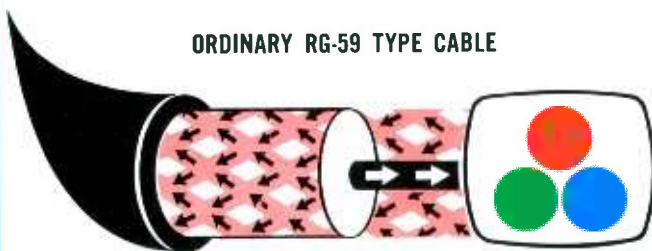

While current in the center conductor flows in a straight line with minimum resistance, to complete the circuit between set and antenna, return current must traverse individual braid strands in a "maze" pattern that creates a resistance loss. In lower grade standard coax with fewer strands, this loss is even greater.

NEW COLOR-DUCT 82 COAXIAL CABLE

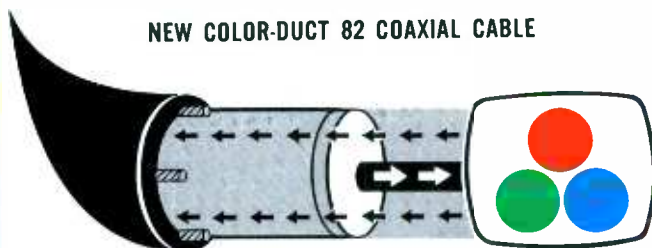

The over-all shield, plus four wires, conducts current through the same low resistance, straight-line path as the center conductor. The result is lower db loss per 100 feet at both VHF and UHF. In fact, at higher UHF frequencies in the average installation, use of Color-Duct 82 instead of ordinary coax is actually the equivalent of adding a 3 db amplifier to the installation! This is a tremendous advantage for UHF color as well as VHF fringe area coaxial installations.

Finally, new Color-Duct 82 is so economical you can now give the owner of any set... UHF, VHF, Color or Black and White... the luxury of a professional coax installation.

Pick up THE DIRECT LINE to UHF/VHF color. Call your Channel Master Distributor or write **The House of Color**

**CHANNEL MASTER**

ELLENVILLE, N.Y., 12428

From now on, the antenna is the only equipment you'll ever need change to make any MATV Installation 82-channel.

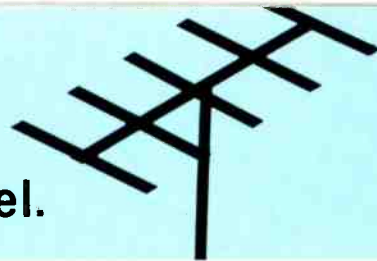

## **New Channel Master *CONTINUOUS* MATV Color Amplifiers bring in all 82 directly "on channel".**

They said it couldn't be done...continuous 82-channel, on-channel amplification in a single electronic circuit! But trust Channel Master...pioneer in coordinated MATV components...to find the answer. Now, with new Color Boosters, Color Tandem Amps, and Color Distribution Amplifiers, all 82 channels come in **directly** on frequency. Furthermore, continuous U-V coverage is obtained without com-

promising on any frequency or sacrificing gain to achieve bandwidth. When you install this new equipment any VHF MATV installation is automatically UHF-capable, too. The only thing you ever need change is the antenna.

So...if you're designing for VHF, use these amplifiers. If it's UHF, use these amplifiers. If it's UHF and VHF, use these amplifiers.



**15 DB COLOR BOOSTER (Model 7264).** Mast-mounted 75 ohm preamplifier with separate power supply. Also available in 300 ohm (Model 0062).



**15 DB COLOR DISTRIBUTION AMPLIFIER (Model 7263).** 75 ohm MATV distribution amplifier. Also available in 300 ohm (Model 7260).



**30 DB COLOR TANDEM AMP (Model 7261).** Separate 75 ohm preamplifier and amplifier. Also available in 300 ohm (Model 7262).

And, these new amplifiers are matched with a complete line of UHF/VHF coordinated equipment: Baluns, Splitters and Mixers, Attenuators, Wall Tap-offs, Line Drop Taps, and Matching Transformers. Add new Channel Master Color-Duct 82 Coax Cable (its loss is so much lower you can actually revise your cable calculations) and you're ready **now** to install the most efficient 82 channel MATV systems available anywhere.

**CHANNEL MASTER**  
ELLENVILLE, NEW YORK

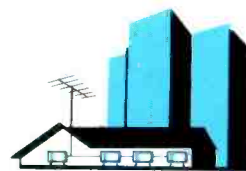





# QUICKER SERVICING

We have found many instances in which an extension cable could not be used with an octal plug and



Fig. 1.

socket combination because not all 8 holes were provided in the socket. We have also found a shortcut for this situation.

Obtain seven of the spring-type banana plugs with a wire-retaining screw in the side (Fig. 1). These



Fig. 2.

must be of the type having bent springs over a central rod. On each

remove the springs, the setscrew, and the insulating shell. File the central rod smaller until it fits snugly into one of the holes on the socket. The pins of an octal plug normally are between .090" and .096" in diameter. The central rod on the banana plug we used measured .115". There may be some plugs from various manufacturers with a central rod closer to .093".

Position one adapter on each of the male pins that needs to be extended and tighten the setscrew. Position the adapters so that adjacent setscrews do not short together.

When the plug is inserted into the socket, make sure that the correct pins are mated. The indexing key is too short to guide the plug correctly. ▲

**COMPLETE TUNER OVERHAUL**

**995**

**ALL LABOR AND PARTS**  
(EXCEPT TUBES & TRANSISTORS)

VHF

UHF

COLOR

UV

TRANSISTOR

**COLOR TUNERS**    GUARANTEED ALIGNMENT ADJUSTMENT    COLOR NO CHARGE

Simply send us the defective tuner complete; include tubes, shield cover and any damaged parts with model number and complaint. Your tuner will be expertly overhauled and returned promptly, performance restored, aligned to original standards and warranted for 90 days.

UV combination tuner must be single chassis type; dismantle tandem UHF and VHF tuners and send in the defective unit only.

Exact Replacements are available for tuners unfit for overhaul. As low as \$12.95 exchange. (Replacements are new or rebuilt.)

And remember—for over a decade Castle has been the leader in this specialized field... your assurance of the best in TV tuner overhauling.

**CASTLE**

**TV TUNER SERVICE, INC.**

5701 N. Western Ave., Chicago 45, Illinois  
41-90 Vernon Blvd., Long Island City 1, N. Y.

Pioneers of TV Tuner Overhauling

Circle 13 on literature card

# TEST ALL TUBES!



## New Deluxe 107C Tester

**Exclusive "eye" tube spots momentary shorts. Superior accuracy and stability from constant voltage transformer—no line adjust.**

Now a portable tube tester unmatched in speed, sensitivity and reliability for all modern TV, radio, hi-fi, industrial and foreign tubes. Tests more than 1000 different tubes without setup, more than 3000 in total. Patented Grid Circuit Test; Dynamic Mutual Conductance and Cathode Emission Tests; many others.

**\$198<sup>50</sup>**  
NET

**MODEL 98.** For comprehensive analysis of all modern TV and radio tubes. Includes patented Grid Circuit, Cathode Emission, Tube Merit, Heater Current tests for more than 2500 types of receiving and picture tubes.

**\$109<sup>50</sup>**  
NET



**MODEL 88.** Popular, low cost Grid Circuit and Tube Merit Tester. Complete coverage of all popular receiving tubes plus adaptor for more than 400 picture tubes. Includes speed indexed setup data.

**\$74<sup>50</sup>**  
NET



**ASK YOUR DISTRIBUTOR**  
or write for full details.

**SECO**  
**SECO ELECTRONICS CORP.**  
1001 Second St. So. • Hopkins, Minn. 55343

Circle 14 on literature card

# GOOF- PROOF

# VOM



Here's the most foolproof volt-ohm-milliammeter ever made. Protection approaches 100%. It's the VOM you will want to have on hand where inexperienced people are running tests . . . or will reach for yourself on those days when you're all thumbs. The 260-5P will save you all kinds of headaches from burned out meters and resistors, bent pointers, and inaccuracies caused by overheating.

#### Combined Protection You Won't Find In Any Other VOM

1. Reset button pops out to indicate overload.
2. You cannot reset circuits while overload is present.
3. Protective circuit does *not require* massive overloads which can cause hidden damage to the instrument.
4. All ranges are protected except those not feasible in a portable instrument—1000 and 5000 volts DC and AC; 10 amp DC.

## SIMPSON 260-5P

ONLY \$88.00

*Write for Bulletin 2076*

**Ranges**—The 260-5P has the same ranges and takes the same accessories as Simpson's famous 260-5 volt-ohm-milliammeter.

# Simpson

INSTRUMENTS THAT STAY ACCURATE

Representatives in Principal Cities  
...See Telephone Yellow Pages



#### SIMPSON ELECTRIC COMPANY

5209 W. Kinzie Street, Chicago, Ill. 60644 • Phone: (312) ESTebrook 9-1121  
Export Dept.: 400 W. Madison Street, Chicago, Ill. 60606 Cable, Amergaco  
In Canada: Bach-Simpson Ltd., London, Ontario  
In India: Ruttonsha-Simpson Private Ltd., International House,  
Bombay-Agra Road, Vikbrali, Bombay

WORLD'S LARGEST MANUFACTURER OF ELECTRONIC TEST EQUIPMENT

Circle 15 on literature card



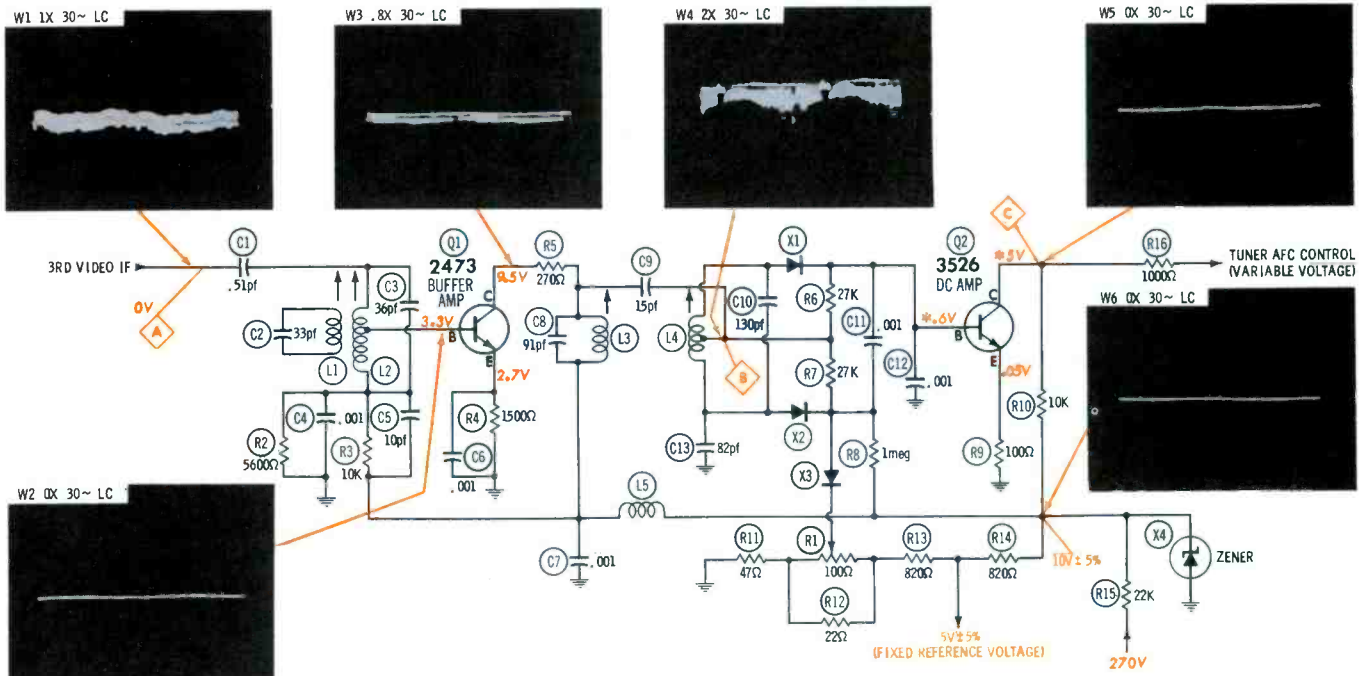

**DC VOLTAGES** taken with VTVM, on local station signal. \*Indicates voltage will vary according to fine tuning adjustment — see "Operating Variation."

**WAVEFORMS** taken with wideband scope; TV controls set to produce normal picture and sound. Low-cap (LC) probe used to obtain all waveforms.

**Normal Operation**

Purpose of tuner automatic frequency control (AFC) is to correct any frequency error in tuner local oscillators caused by either incorrect fine tuning adjustments or any "drift" that might occur in tuners. This is accomplished by monitoring IF picture carrier signal and developing a voltage to correct oscillator frequency. The oscillators are paralleled by "voltage-dependent-capacitance" circuits; circuit capacitance varies with changes in DC voltage and, in turn, controls oscillator frequency. Output of 3rd video IF is coupled to point A of circuit shown here (RCA CTC21C), then through L2 to Q1 base. Input and output tanks of buffer amplifier are tuned to 45.75-MHz picture carrier frequency, providing maximum transfer of this signal. Bandpass of stage is intentionally narrow to prevent discriminator from operating on wrong signal, such as adjacent channel sound, color, and co-channel sound. L1 and C2 form trap to limit high-frequency pull-in range of unit. Output of Q1 coupled through C9 to discriminator coil L4, tuned to exactly 45.75 MHz. Discriminator circuitry develops correction voltage whenever there is a difference between L4 frequency and incoming IF signal (positive if high, negative if low). Discriminator output connects directly to DC amplifier base and controls bias. This in turn varies collector voltage which is connected to one side of control component in tuner. Other side is connected to fixed reference voltage from junction of R13 and R14. Collector voltage rises above or drops below reference voltage (according to discriminator output). This varies bias of control component, which then changes capacitance.

**Operating Variations**

- Disc.** R1, (with R8) sets reference level for discriminator. Narrow pull-in range ( $\pm .75$  to 1.25 MHz either side of picture carrier) prevents "lock-in" on wrong carrier. R1 determines pull-in range above and below picture carrier—at one end of control pull-in is good, even if oscillator increases about 2 MHz, but will not correct decrease in frequency. Opposite is true with control at other end. At optimum setting, pull-in is equal with either high- or low-frequency error.
- Q2** Base bias determined by R6, R7, R8, and discriminator output. Voltage is about .6 volts with tuner oscillator on frequency—varies  $\pm .1$  volt with picture carrier frequency error. Emitter changes from 0 to .1 volt according to amount of transistor conduction. Collector voltage deviates from normal (oscillator on frequency) 5 volts to about .45 volts in one direction and 9.5 volts in other.
- Waveforms** Since p-p readings are extremely small, value of W1 is designated 1X and amplitude of other waveforms compared to it. Normal W1 is approximately .1 to .2 volts p-p. Even low-C probe detunes input to Q1 to extent that no waveform can be seen at base. Probe also affects W3—reading (.8X). W4 varies somewhat with signal strength from 2X to about 4X. Any AC present at point C or at B+ source (W5 and W6) indicates malfunction—normally only DC voltages present at this point.

## AFC Range Narrow

Fine Tuning Must Be Exact

### C4 Open

(Bypass capacitor — .001 mfd)

#### Symptom 1

#### Symptom Analysis



Most noticeable on color programs since fine tuning must be exact for proper color reception. Weak stations are worst—color “comes and goes”—no AFC action. Pull-in range is quite narrow—small oscillator drift or fine tuning error will cause loss of color.

#### Waveform Analysis

Highly peaked tuned circuits, along with very low amplitude signal in both input and output circuits of Q1, make signal tracing difficult, even with low-C probe. W1 appears normal with 1X. W3 (not shown) measures about .5X, versus normal .8X. Best place to obtain indication of Q1 stage gain is at point B. W4 shows only a trace of waveform (.1X, normally 2 to 4X). Best clue to trouble is presence of waveform at junction of L2 and C4—normally only DC present at this point.



#### Voltage and Component Analysis

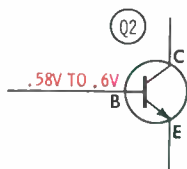

Normally, Q1 element voltages do not change between “signal” and “no signal” conditions; therefore, voltages measure normal with symptom present. Slight variation of Q2 base voltage—.02 volts, normally about .2 volts. Rotating fine tuning in both directions shows discriminator output is insufficient. C4 is RF ground to input signal. With C4 open, signal is dropped across R2 and R3, instead of Q1. Result: Q1 has little signal to amplify and discriminator circuitry has insufficient signal to operate properly.

Best Bet: Scope; VTVM; component substitution

## No AFC Action

Manual Fine Tuning Not Affected

### Q1 Leaky

(Buffer Amp — NPN Transistor)

#### Symptom 2

#### Symptom Analysis

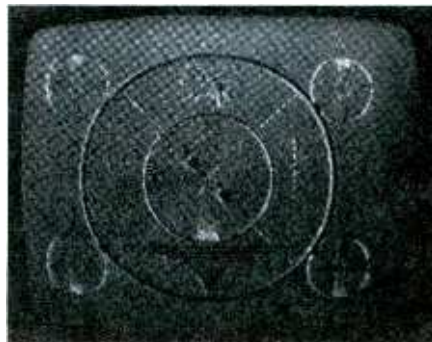

Fine tuning operates just like set that is not equipped with AFC or has AFC turned off. No pull-in action—mistune either direction, release fine tune knob, and picture stays same. Normally, AFC circuitry will correct tuner oscillator frequency error.

#### Waveform Analysis

W1 shows sufficient amplitude and content for proper AFC action. Since this waveform is from output of third video IF, amplitude is dependent upon RF amplification, fine tuning, AGC, and IF amplification. Also, vertical gain of scope is a factor. Maximum scope vertical amplifier setting necessary to get 1X reading at A (W1). W3, normally .8X, is almost nonexistent, as is W4, which should be at least 2X. Waveform analysis indicates input signal is lost in buffer amplifier stage.

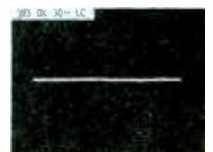

#### Voltage and Component Analysis

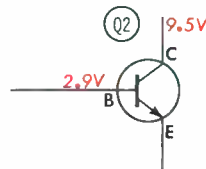

Best voltage clue is comparison of Q1 emitter and base voltages—although bias is correct polarity, only .1 volt difference between two elements (normally .6 volts difference). Emitter is .1 volt high, base .4 volts low. Shorted transistor is good suspect. Q1 and associated circuitry is essentially another IF amplifier stage, except bandwidth is very narrow so that signal transfer is limited to 45.75-MHz carrier. Any trouble that blocks input signal kills AFC action since discriminator has no reference signal.

Best Bet: Preliminary checks; VTVM



## Oscillator Frequency Incorrect With AFC on Normal With AFC Off X1 Open

(Discriminator Diode)

## AFC Detunes Oscillator

Frequency Low

X1 Shorted

(Discriminator Diode)

Symptom 3

Symptom 4

Symptom Analysis

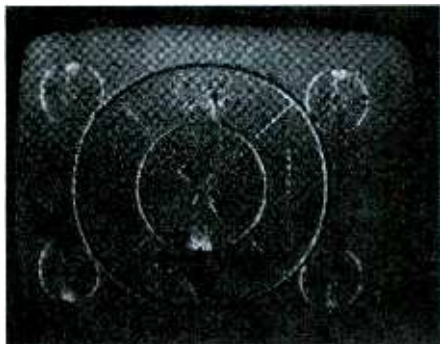

Symptom Analysis

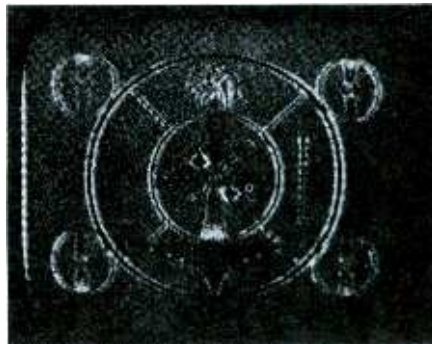

AFC is automatically made inoperative during fine tuning by shorting variable and reference voltages together. Adjusting fine tuning for best picture and sound, then releasing knob, results in badly mistuned picture—AFC adjusts oscillator to wrong frequency.

Symptom here is similar to that described in symptom No. 3—fine tune for good picture, then release knob, and picture is badly mistuned—sound in picture and poor sound. Normal picture possible with AFC on by mistuning, but pull-in action is not correct.

### Waveform Analysis

Tracing input signal through Q1 to point B shows operation is normal. W1 measures 1X. W3 (not shown) at Q1 collector is acceptable (.7X). W4 also has sufficient amplitude (2X) for good AFC action. Waveform at Q2 base indicates trouble in discriminator since only DC voltage is normally measured here. Although only IF picture carrier is fed to AFC circuitry, signal is rectified to some extent and looks similar to composite video waveform.

### Waveform Analysis

Waveform taken with AFC off so that good strong station signal is available. AFC switch in off position shorts variable and fixed reference voltage sources together so that no correction voltage is fed to control circuit of tuner. This does not affect AFC input or discriminator circuitry. W1 and W4 read 1X and 3X, respectively—show discriminator has good input. Presence of waveform at Q2 base again throws suspicion on discriminator.

### Voltage and Component Analysis

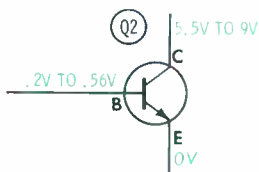

Collector and base voltages, with fine tuning set for good picture, are good clue—8 and .5 volts, respectively. Collector should read same reference voltage when fine tuning is correct. Normal “on frequency” reading at base is .6 volts, and .5 to .7 volts when varying fine tuning. Now base is .5 volts, and .2 to .56 volts—limiting collector to reference voltage or above. With X1 open, discriminator output always negative going (Q2 base wrong)—Q2 collector voltage causes tuner control circuit to vary oscillator.

Best Bet: VTVM will locate.

### Voltage and Component Analysis

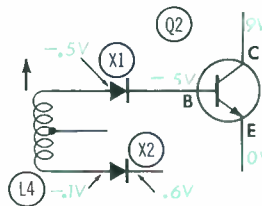

Voltage at Q2 base after fine tuning for good picture is  $-0.5$  volts—transistor is cut off, with near maximum voltage at collector. Variable and fixed reference voltages normally are near same potential when fine tuning is correct. Best clue is same voltage reading at both cathode (Q2 base) and anode X1. Shorted X1 sets off chain reaction: Q2 base bias is wrong; causes incorrect collector voltage; control circuit in tuner changes capacitance and produces incorrect local oscillator frequency.

Best Bet: Scope isolates; VTVM locates.

## AFC Detunes Oscillator

Error Slight

R14 Increased

(Voltage divider — 820 ohms)

Symptom 5

Symptom Analysis

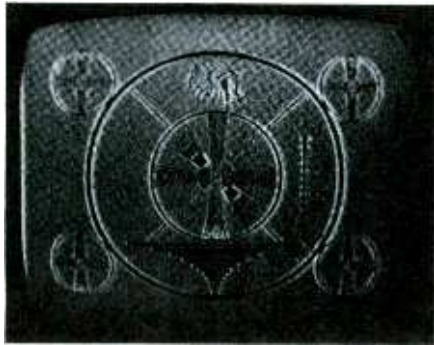

Good picture and sound can be received by adjusting fine tuning with AFC off. But when AFC is turned on, tuner local oscillator frequency is changed and sound and/or picture is affected. Normally, AFC would only “lock-in” on correct frequency—not change it.

### Waveform Analysis

Strong W4 (3 to 4X) clears input circuitry. Second and third waveforms are taken at top and bottom of L4 (junction of L4, X1 and L4, X2) and amplitude of each is approximately 1X. While input signal is rectified to some extent by circuit and looks similar to composite video, discriminator operates only on frequency error between IF video carrier (input signal) and tuned circuit L4. Waveform analysis indicates discriminator is receiving necessary signal.



Voltage and Component Analysis

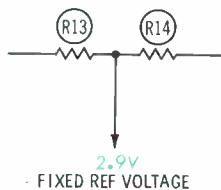

Q2 collector voltage (variable source) shows normal range of readings from 2 to 9 volts with different fine tuning settings. However, collector potential relative to ground not only consideration—its relation to fixed reference voltage ( $\pm 5$  volts) controls variable capacitance unit in tuner. If variable voltage rises above reference, oscillator frequency increases—if lower, frequency decreases. Incorrect reference voltage produces wrong correction voltage across tuner control circuit, causing local oscillator to shift.

Best Bet: Circuit analysis and VTVM.

## Detuned Picture With AFC On

Normal With AFC Off

Q2 Leaky

(DC Amplifier — NPN Transistor)

Symptom 6

Symptom Analysis

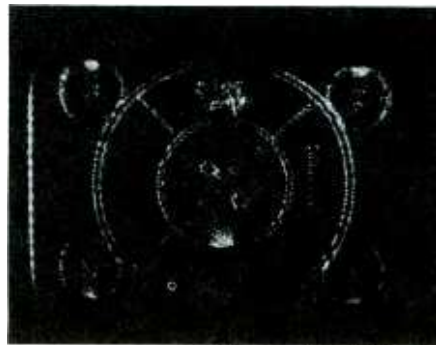

Receiver operates in normal manner with AFC off, but when on, picture is detuned after fine tuning knob is released. Good picture and sound can be received by mistuning in opposite direction from sound bars, but there is no AFC “lock-in” action.

### Waveform Analysis

First W1 waveform taken with symptom present (oscillator off frequency) shows slightly low amplitude (.7X, normally 1X) and content is mostly noise — snow on screen. Second W1, with AFC off, is normal in content and amplitude (1X). W4 shows good input signal to discriminator. Again, normal input waveforms can be observed with AFC switch off since switch only shorts variable and reference voltages together and does not affect input circuitry.

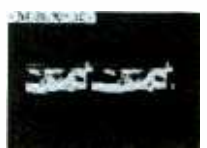

Voltage and Component Analysis

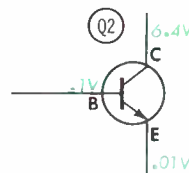

Most important clue is Q2 base voltage—remains at .1 volt through changes in fine tuning. Since base bias does not change, collector (variable voltage source to control circuit in tuner) remains at same level. Normally, base varies maximum of about .1 volt above or below .6 volts according to discriminator output and, in turn, sets collector voltage above or below fixed reference voltage. Leaky transistor (base to emitter) holds bias at constant level—doesn't allow discriminator output to control operation of stage.

Best Bet: VTVM for voltage and resistance checks.





# Thrifty-paks are back!



**Look for  
Big League Specials\* on  
General Electric Color Tubes.  
See Your GE Distributor Now.**

TUBE DEPARTMENT

**GENERAL  ELECTRIC**

288-06A

\*All specials available at the option of your GE distributor.

## analysis of test instruments ...operation...applications

by T. T. Jones

### The Unijunction Transistor

During the past few years many equipment manufacturers have introduced new color generators. The prices have steadily decreased, while the signal quality and reliability has increased. So we're getting a lot more for our test equipment dollar. One of the biggest reasons for this increased value is the use of solid-state components. We're all of course aware of the reduction in power requirements afforded by transistors, which allows us to use lighter and less expensive components.

To most of us however, a multivibrator is still a complex circuit, using two triodes (or transistors) and a lot of other components—something like the circuit in Fig. 1. This has been our old standby frequency divider—and a good one. It oscillates at its own frequency, triggered by pulses of another oscillator working at a higher frequency. In recent color generator designs, the tubes have been replaced by transistors.

About two years ago the unijunction transistor started appearing in color generators. The UJT multivibrator also oscillates at its own design frequency, triggered by higher

frequency pulses. And there the similarity ends. The circuit is so much different that it warrants a closer examination.

Fig. 2 shows the basic UJT multivibrator circuit. Note that the waveform on the emitter closely resembles the waveform on the grid of the tube circuit. (Disregard the number of pulses; the circuits are dividing at different rates). So this simple little circuit produces the same useful output with less than half as many components as the tube circuit—and with less expensive components.

The operation of a UJT is really quite simple. For those of you who like to draw analogies between solid-state devices and tubes, the UJT is roughly comparable to a gas thyratron.

However, it has some characteristics of its own, and does not have all the characteristics of the thyratron, so there is no exact counterpart in the tube world. Our discussion will omit the theory of holes, carriers, depletion layers and the like. (This information may be found in GE Application Note 90.10 5/65.)

The three elements of the UJT are called Emitter, Base 1, and Base 2 (Fig. 3). The emitter is the heart of the device. Signals are often taken from the emitter as well as inserted upon it.  $V_{BB}$  is the applied positive bias on the device. As long as the emitter voltage is kept below a critical point (determined by the parameters of the UJT in use) no current will flow in the emitter circuit. As the emitter voltage is raised past the critical point, current will flow between the emitter and Base 1.

The emitter characteristics are shown in Fig. 4. Note that as the emitter voltage reaches the critical point (called the peak point), the device displays a negative resistance characteristic. The current rises as the emitter voltage falls, until they parallel at the valley point. The regions of the curves to the right of the valley are saturated.

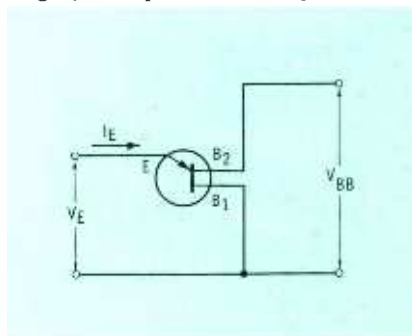

Fig. 3. Diagram shows important UJT nomenclature.

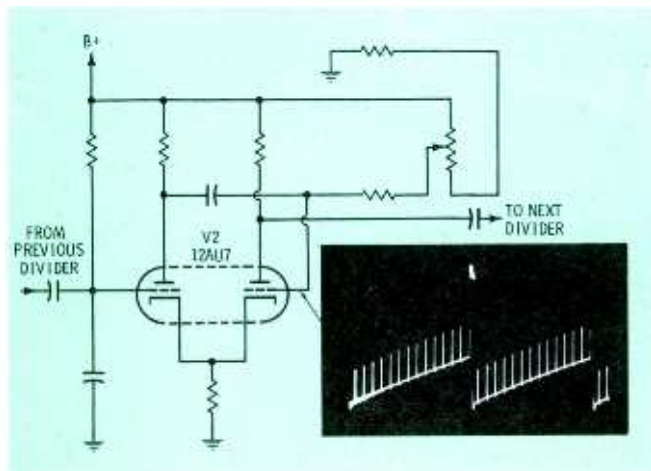

Fig. 1. Typical tube-type multivibrator.

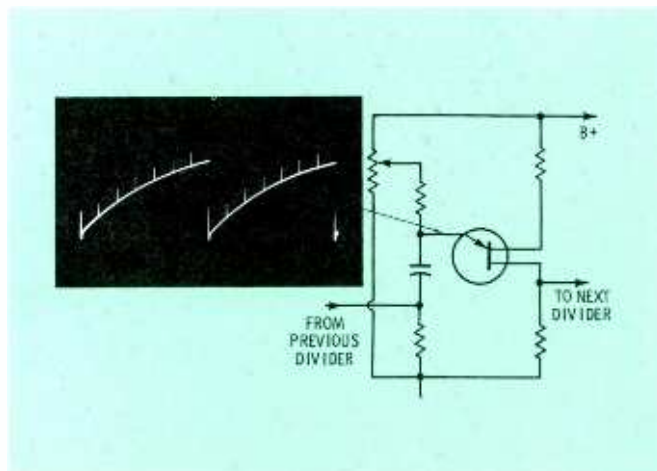

Fig. 2. The UJT multivibrator.



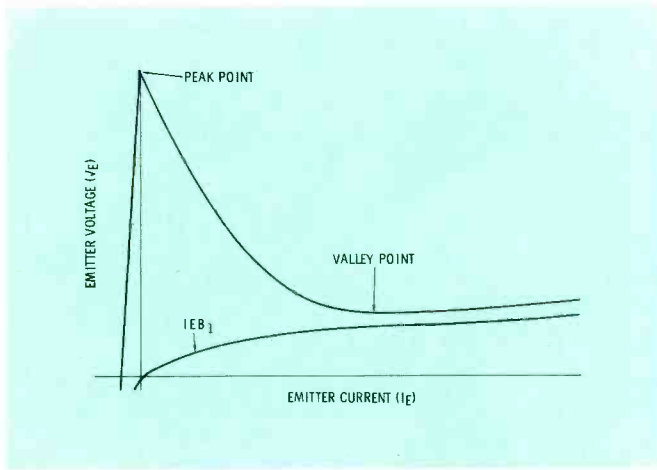

Fig. 4. Static emitter characteristic curve.

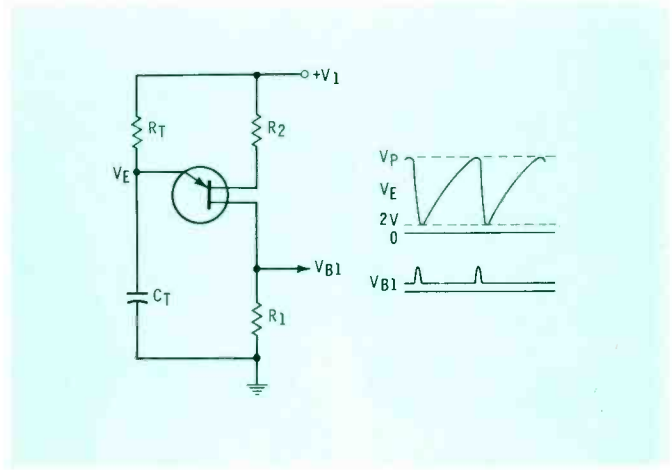

Fig. 5. Typical UJT relaxation oscillator.

Fig. 5 shows the UJT in a typical relaxation oscillator circuit. The voltage waveform on the emitter will be a sawtooth with a frequency determined by  $R_T$  and  $C_T$ . The output,

$V_{B1}$ , is a series of pulses corresponding to the discharge of the capacitor. The capacitor discharges at the peak point of the emitter curve. By adjusting biases of the elements it is

possible to synchronize the UJT relaxation oscillator to incoming pulses, as in Fig. 2. The circuit then becomes a multivibrator for our purpose, which is countdown circuits.

### New Color Generator

Hickok's new Model GC 660 color generator is pictured in Fig. 6. With the cover in place, the instrument bears a strong resemblance to the older Model 660. It's about the same size, and housed in the same style leatherette-covered wood case. As soon as you pick-up the GC 660, you'll realize that there's been some changes. The old 660 weighed 15 pounds; the GC 660 weighs but 6¼ pounds.

The outputs of the GC 660 are essentially the same as older model, with two very important differences. Now included is a set of gun killers.

These are controlled by a rotary switch which gives a choice of guns to be left "on"—Normal, R + G, R + B, G, B, or R.

The second important new feature is the color display. This is now a keyed-rainbow, rather than the unkeyed-rainbow of the 660.

A third feature which may be of interest is the fact that there is absolutely no similarity electrically between the two units. The GC 660 is solid-state and uses completely different circuits.

The block diagram is shown in Fig. 7. Note that the counting sequence starts at 378 kHz, has a number of buffers, and no stage divides by more than 7. These factors, and the use of unijunction transistors, insure that the GC 660 will maintain a high degree of stability under most any conditions.

The vertical and horizontal bars are developed by silicon switching transistors, which have inherently fast rise time. The lines and dots, therefore, are very narrow. ▲

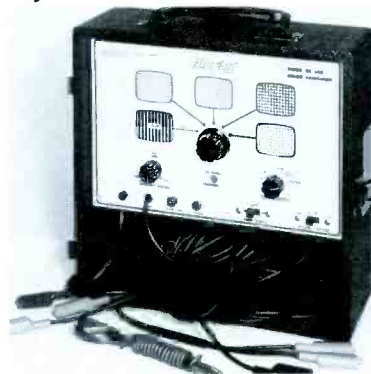

Fig. 6. New solid-state color generator.

For further information circle 48 of literature card

### Hickok Model GC 660 Specifications

#### Patterns:

- Vertical bars (18).
- Horizontal bars (18).
- Crosshatch (18 × 18).
- Dots (324).
- Keyed rainbow.

#### Outputs:

- Composite Sync, 2V P-P.
- Composite video, 2V P-P, + or -.
- RF carrier channels 3-5, adjustable from front panel.
- Sound carrier (4.5 MHz).

#### Power Requirements:

- 105-125 VAC, 50-60 Hz, 3 watts.

#### Size (HWD):

- 10¾" × 10¾" × 5".

#### Weight:

- 6¼ pounds.

#### Price:

- \$159.50.

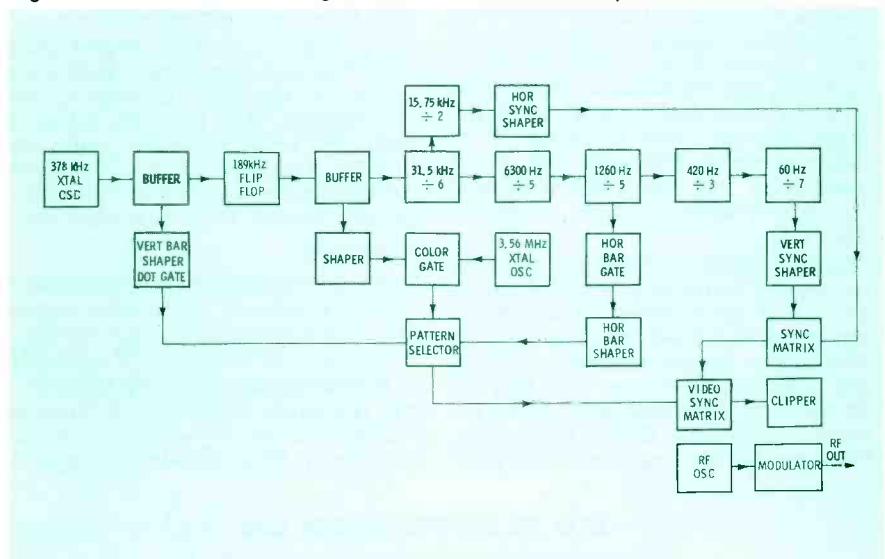
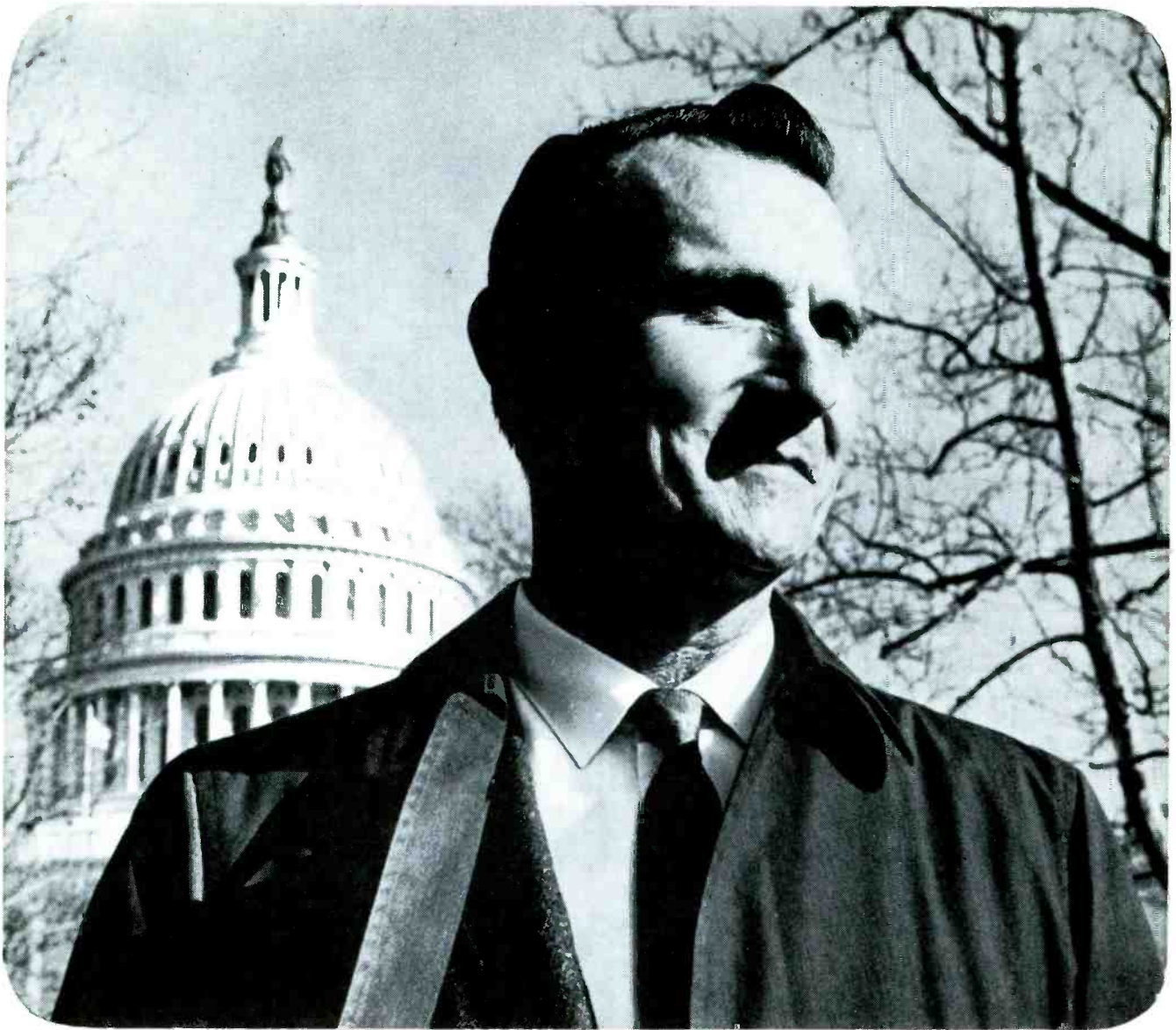

Fig. 7. Portions of GC 660 block diagram.



## "When you're commissioned to do antenna installations for the Capitol

... Blair House, the Pentagon, Washington National Airport, Department of Justice, Federal Trade Commission, Federal Communications Commission, and the National Space and Aeronautics Administration Buildings, you can't take chances. That's why we install JFD television antennas exclusively," says JERRY PEAKE, of Jerry Peake Co., Inc., Washington, D.C.

"As the biggest professional antenna installing company around these parts, we can't afford to be No. 2. We've got to deliver top picture—VHF and UHF—for the dealers, retailers and department stores who rely on us to keep their sets sold and customers satisfied. Color, especially, must be natural and ghost-free. Only

JFD LPV antennas come across with this kind of reception."

Jerry Peake Co., Inc., Washington, D.C., has installed over 185,000 antennas in the last 18 years in the Washington, D.C. area. He relies on both JFD LPV-CL Color Lasers and LPV-TV Log Periodics—like other professionals—to get performance people expect from a professional. Here's why:

- W-I-D-E BAND LPV LOG PERIODIC DESIGN** delivers *more gain, higher signal-to-noise ratios, pinpoint directivity that kills ghosts—VHF and UHF.*
- SHOWROOM QUALITY COLOR**—*flat response across each channel. No "suck-outs" or "roll-off." Out-performs any other antenna in color or*

black and white—*keeps customers sold.*

- CAPACITOR-COUPLED ELEMENTS** work on *both fundamental and harmonic modes. Entire antenna (not just part of it as in other antennas) responds to every channel.*
- RUGGED NEW "FLIP-LOK" ASSEMBLY** snaps out elements—*keeps them tight and right on target.*

# JFD<sup>®</sup>

# LPV<sup>®</sup>

**JFD ELECTRONICS CO.** 15. Avenue at 62 Street, Brooklyn, N.Y. 11219

JFD International, 64-14 Woodside Ave., Woodside, N.Y. 11377 JFD Canada, Ltd., Ontario, Canada  
JFD de Venezuela, S.A., Avenida Los Haticos 125-97, Maracaibo, Venezuela

Circle 17 on literature card





# Start here:

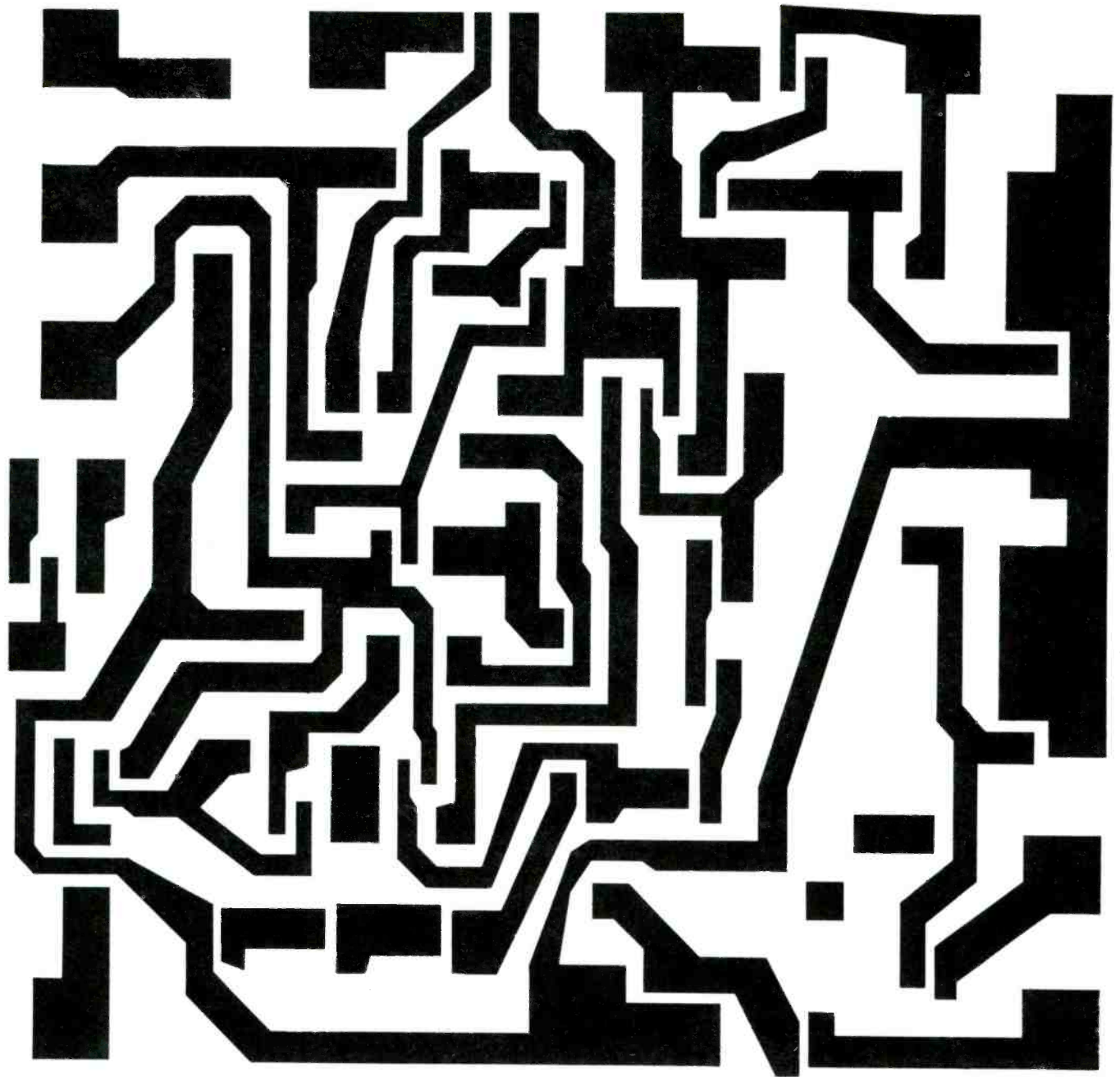

## and come out dollars ahead.

(It's an integrated circuit—and RCA Victor uses it now.)

Blown up to several thousand times its actual size, an RCA integrated circuit looks like no more than a maze. In actuality, it's no less than amazing. Just one of these silicon chips may incorporate 40 or 50 electrically interconnected components. Patterns that make up the mosaic are as narrow as two human hairs. Far more amazing than that, though, is their dollar-making potential. Integrated cir-

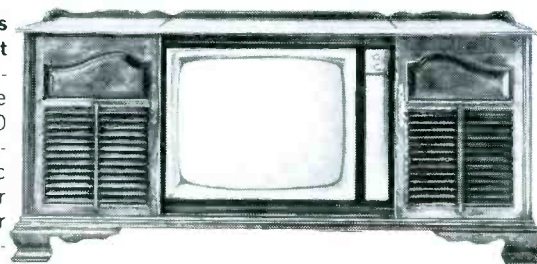

uits are designed to be the most reliable kind of circuitry ever made for a consumer product. Reliability is what prompted RCA Victor to use integrated circuits in the sound system of some of our newest color and black-and-white TV sets. When you start with an integrated circuit, there's just no telling where it can take you.



The Most Trusted Name  
in Electronics





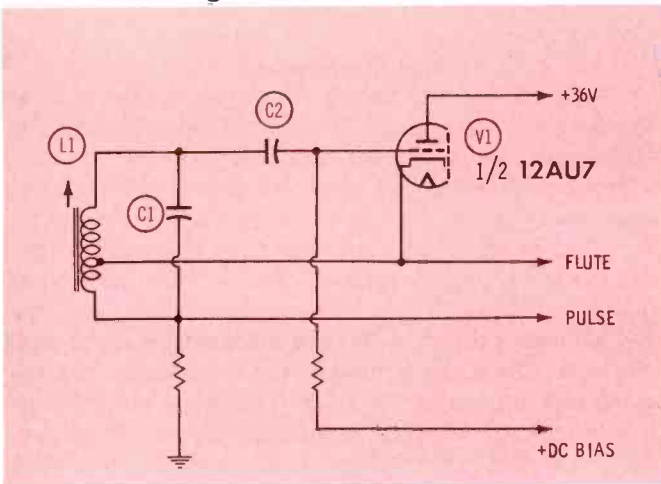

Fig. 4. Conn tone generator.

cally a Hartley oscillator, as in Fig. 4. The pulse output, which is richer in harmonics than the flute output, is used for the reed and string stops. When a key is depressed, its note is allowed to pass from the generator, on through the organ, to the speakers. Sometimes the note is switched directly through a set of contacts below the key. More often though, the note is switched by an electronic keyer.

A typical transistor keyer is shown in Fig. 5. The incoming signal is applied to the emitter of Q1, which is biased to cutoff by the blocking voltage applied through R24, R21, and R22. If the key for this note is depressed, a negative keying voltage is applied to the base of Q1 through R20 and R22. This negative voltage forward biases Q1, allowing it to conduct and pass

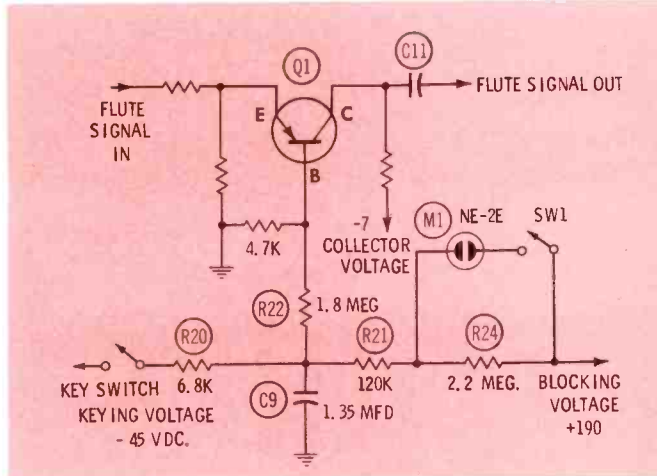

Fig. 5. Transistor keying switch.

the signal on to the preamplifier. The decay characteristics of the note are determined by C9 and the amount of blocking voltage. When the key switch is released, C9 starts to discharge through R22 and R23 and tends to maintain the forward bias on Q1 for a longer period of time, producing a gradual decay of the signal, rather than a sharp cutoff. The amount of blocking voltage, and therefore the length of the note, is selected by stops, such as SW1. There are other stops elsewhere in the circuitry.

A typical preamplifier and associated stops is shown in Fig. 6. This is a straightforward common base configuration and needs no discussion. However, the stops are interesting. Note that with all switches closed (stops off) the output of the amplifier is grounded

## NEW HEATHKIT®

### Solid-State High Impedance V-O-M

**Kit \$80      Wired \$115**

Never Before Has An Instrument With These Features and Performance Been Available At Less Than \$200

- 13 Silicon Transistors Plus 2 Field Effect Transistors
- 11 Megohm Input Impedance on DC
- 10 Megohm Input Impedance on AC
- 9 DC Voltage Ranges From 150 Millivolts Full Scale to 1500 Volts Full Scale ... Accuracy ±3% Full Scale
- 9 AC Voltage Ranges From 150 Millivolts Full Scale to 1500 Volts Full Scale ... Accuracy ±5% Full Scale
- 7 Resistance Ranges, 10 Ohms Center Scale x1, x10, x100, x1k, x10k, x100k, x1 meg ... Measures From One Ohm to 1000 Megohms
- 11 Current Ranges From 15 Microamps Full Scale to 1.5 Amps Full Scale ... Accuracy ±4% DC, ±5% AC
- AC Response to 100 kHz
- 6", 200 ua Meter With Zero Center Scales For Positive and Negative Voltage Measurements Without Switching
- 1% Precision Resistors
- Separate Switch For Each Function Eliminates Constant Changing
- Ten-Turn Thumbwheel Zero Adjustment For Precision Settings
- Built-In 120/240 VAC, 50-60 Hz Power Supply Plus In-Cabinet Holders For Battery Supply During Portable Operation
- Easy Circuit Board Assembly
- New Heath Instrument Styling With "Unitized" Construction and Low Profile Appearance; Color Styled in Handsome Beige and Black

The first of an exciting new line of Heathkit test instruments, the IM-25 Solid-State V-O-M does all the measurement jobs normally required in tube or transistor circuits with the no-loading high impedance of a VTVM, the convenience and versatility of a VOM, and the accuracy and sensitivity of separate lab instruments. Whether you choose the factory assembled model or the new, easier-than-ever kit version, we believe you will find the IM-25 a significant step forward in design and value.

Kit IM-25, 10 lbs. (Available May) ..... \$80.00  
 Assembled IMW-25, 10 lbs. (Available June) ..... \$115.00

**HEATH COMPANY, Dept. 25-5**  
 Benton Harbor, Michigan 49022

Enclosed is \$ \_\_\_\_\_, plus shipping.

Please send model (s) \_\_\_\_\_

Please send FREE Heathkit Catalog.

Name \_\_\_\_\_  
 (Please Print)

Address \_\_\_\_\_

City \_\_\_\_\_ State \_\_\_\_\_ Zip \_\_\_\_\_

Prices & specifications subject to change without notice.

TE-159

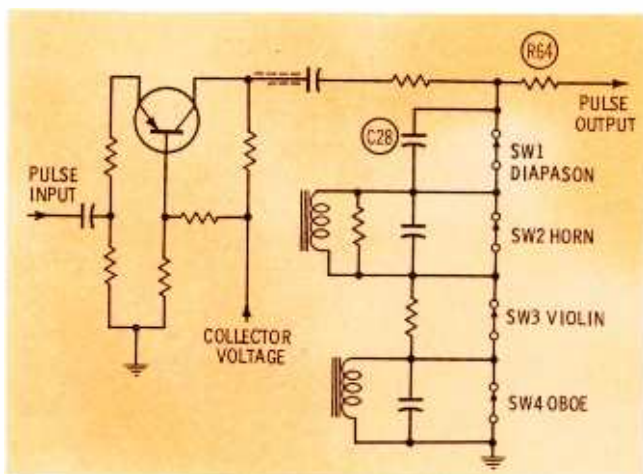

Fig. 6. Preamp with stops.

and no note will sound. Adding the diapason effectively makes a simple integrator circuit of R62 and C28. A large portion of the waveform is shaped and passed by this integrator. Adding other stops produces more complex wave shaping.

From the preamplifier on to the speakers, the organ may be treated as a typical Hi-Fi amplifier. There are often separate preamplifiers for pedal notes and the various stops, and these must be adjusted so that their relative gain is about equal. This is done to insure that one group of notes will not over-power the others. These adjustments will be found in the manufacturer's service information.

### Troubleshooting

The basic test instrument for organ repairing is a VOM or VTVM. About 90% of all troubles can be found with this instrument alone. A good AC VTVM with scales down to .03 volts will also prove valuable since many of the signals to be measured in organs are small in amplitude. Another must is an audio signal tracer. (Some models of AC VTVM have this built-in.) With a tracer you can make sure that the AC voltages you are measuring are actually signal and not hum. The tracer is used in much the same manner as an oscilloscope in TV work. The scope, by the way is seldom used in organ servicing. The waveforms are quite complex, and in many cases, so similar that they become meaningless. For this reason, the tracer and an experienced ear are used to determine what signal is present at any given point in the organ.

Since most manufacturers are changing to solid-state organs, it follows that a good in-circuit transistor tester will be helpful in organ repair. Though there may be several hundred transistors in the organ, only a few need be tested on any one job. There will be only a dozen or so in the direct line from key to speaker, and often it is easy to narrow the trouble down to one particular stage, even before removing the back from the organ.

A study of Fig. 3. will show how this is possible. The many different signals merge at different places along the line from keys to speakers. For instance, if

## Increase Your Profits!

Servicemen, the Teletone Company wants to franchise a selective group of service companies to handle its in and out of warranty repairs on portable phonographs sold in all leading national syndicated and chain store operations. Teletone makes these units under its own name and is one of the country's largest manufacturer of private label brands.

You can increase your earnings with this exclusive franchise by servicing this additional volume and by the special discounts for components and parts Teletone offers its service organizations.

All territories open—write today for full particulars.

**TELETONE COMPANY, Inc.**

Mt. Vernon, N.Y. 10550  
(914) OW 9-2100

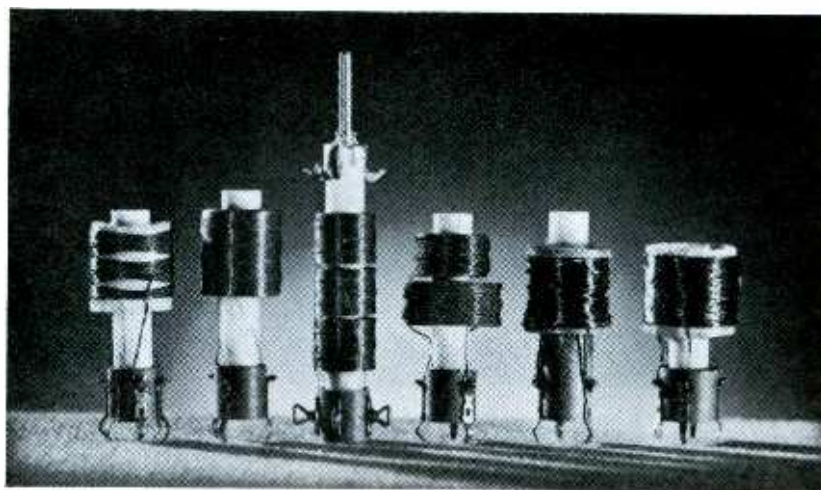

### Exact Replacement Sweep Circuit Coils for More than 25 Color TV Manufacturers

Color TV exact replacements for focus, convergence and sweep circuit coils are now available for sets made by manufacturers such as RCA • Philco • Westinghouse • Muntz • Motorola. Installation instructions and diagrams are included.



Write today for Color TV Coil Cross Reference Guide.

**J. W. MILLER COMPANY**

5917 SO. MAIN STREET • LOS ANGELES, CALIFORNIA 90003

SEE YOUR LOCAL DISTRIBUTOR FOR FULL LINE OF RF & IF COILS, CHOKES, FILTERS & TRANSFORMERS.

Circle 19 on literature card



both the pedals and flutes work, the serviceman need only listen at the pulse speaker to determine if the pulse is lost before, or after, the pulse post preamplifier. If the pedal note is present in the pulse speaker, the pulse post preamplifier and pulse power amplifier must be functioning normally. The principle is exactly the same as troubleshooting an AM-FM-MPX radio/phonograph combination.

The biggest difference in organ service work, compared to TV work, is that all repairs must be done in the home. The organ is a large instrument, with most sub-chassis dependent on each other. Because of this, you can't remove it to the shop as a whole unit, nor in pieces. However, as we have pointed out previously, little test equipment is needed, and furthermore, most organs are designed for easy "on-site" troubleshooting.

In spite of the fact that there are many, many components in an organ, the parts needed to repair any one manufacturer's line may be carried in a case no bigger than a tube caddy. This is because so many of the circuits are repeated over and over. The 73 tone generators in a Conn Organ all use the same tube type—a 12AU7. Although the frequency determining components are different, many are shared, so that the total required is nearly halved. Also, most parts are not critical and may be freely substituted, so the number of spare parts carried is further reduced. However, the tone generator parts (L1, C1, and C2 in Fig. 4) are critical. C1 and C2 are special temperature-compensated capacitors and should always be replaced with the manufacturer's parts. If exact replacements are not used, the note is almost sure to drift out of tune, resulting in a call-back. Also, for intermittent or drifting notes, it is advisable to replace all of these components at the same time. The component cost is small compared to the cost of a callback.

Once you have repaired a tone generator, the note must be tuned. The tuning adjustments vary widely from one make of organ to the next. Some use a potentiometer or trimmer capacitor, while some use a coil adjustment. The procedure for tuning one note is simple. Play the note one

octave below or above at the same time as the note to be tuned, and adjust for a zero beat. If the whole organ needs tuning, a standard must be used. This may be a tuning fork or a strobotuner. The instruction manual supplied with the strobotuner tells how to use this instrument. Instructions on the tuning fork method may be found in Howard W. Sams books ORG-1 (page 171) and EOA-1 (page 229). These books also contain a wealth of other information on organs, including specific service information on many models.

### How to Begin

If you are living in a smaller town, with only a few organs to take care of, make contacts with nearby organ dealers. In most cases, they will be happy to learn that you're willing to take care of the organs in your community. They will be able to furnish you with service manuals and parts, or at least refer you to the factory. The same holds true in the larger towns; in many cases, the dealers have a problem taking care of their customers and will welcome your assistance in sharing the load. ▲

## NO MORE GUESSWORK!

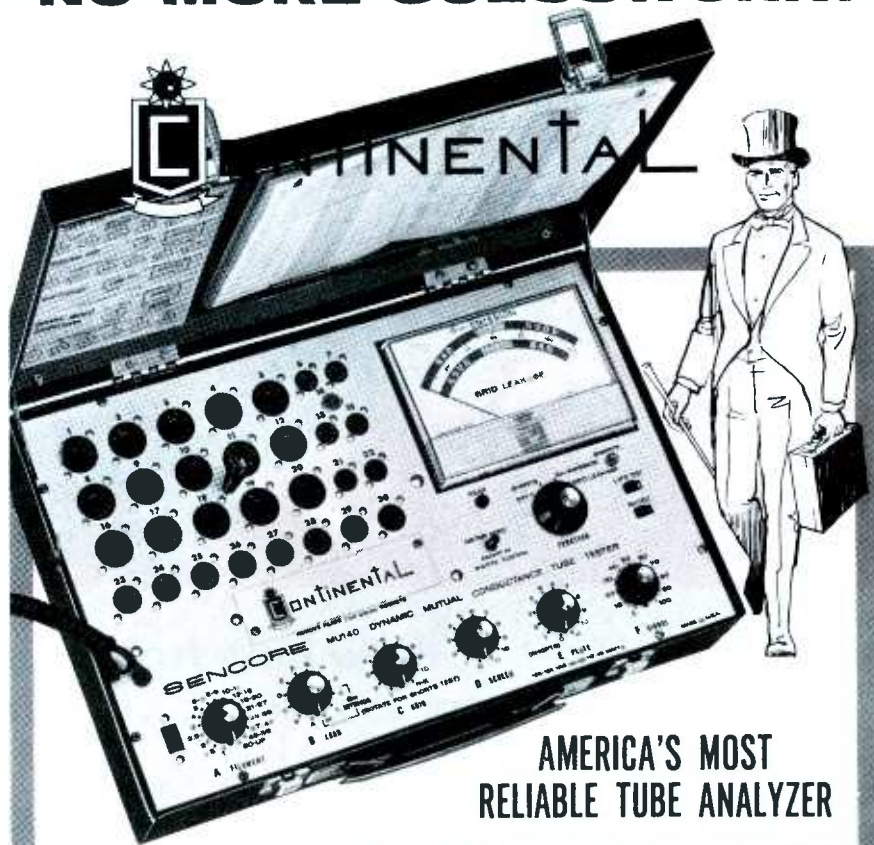

### AMERICA'S MOST RELIABLE TUBE ANALYZER

You don't need three guesses to tell if a tube is bad—or why. With the new Sencore MU140 Continental, you **know**. Right now. And you simply can't go wrong. Because it's a complete tube analyzer for 4-way testing—true mutual conductance (using exclusive 5000 hertz square wave), full cathode emission, 100 megohm grid leakage, and internal shorts. Tests all tubes, including foreign—over 3000 in all. Obsolescent-proof, too—with "new socket" panel, and controls so standard the switch numbers correspond to the pin numbers in any tube manual.

If it's reliability you want—for years to come—you need the Continental. It's the best way to be sure—

for only  
**\$179<sup>50</sup>**

See America's most complete line of professional test instruments—at your Distributor now.



## SENCORE

NO. 1 MANUFACTURER OF ELECTRONIC MAINTENANCE EQUIPMENT

426 SOUTH WESTGATE DRIVE, ADDISON, ILLINOIS 60101

Circle 21 on literature card

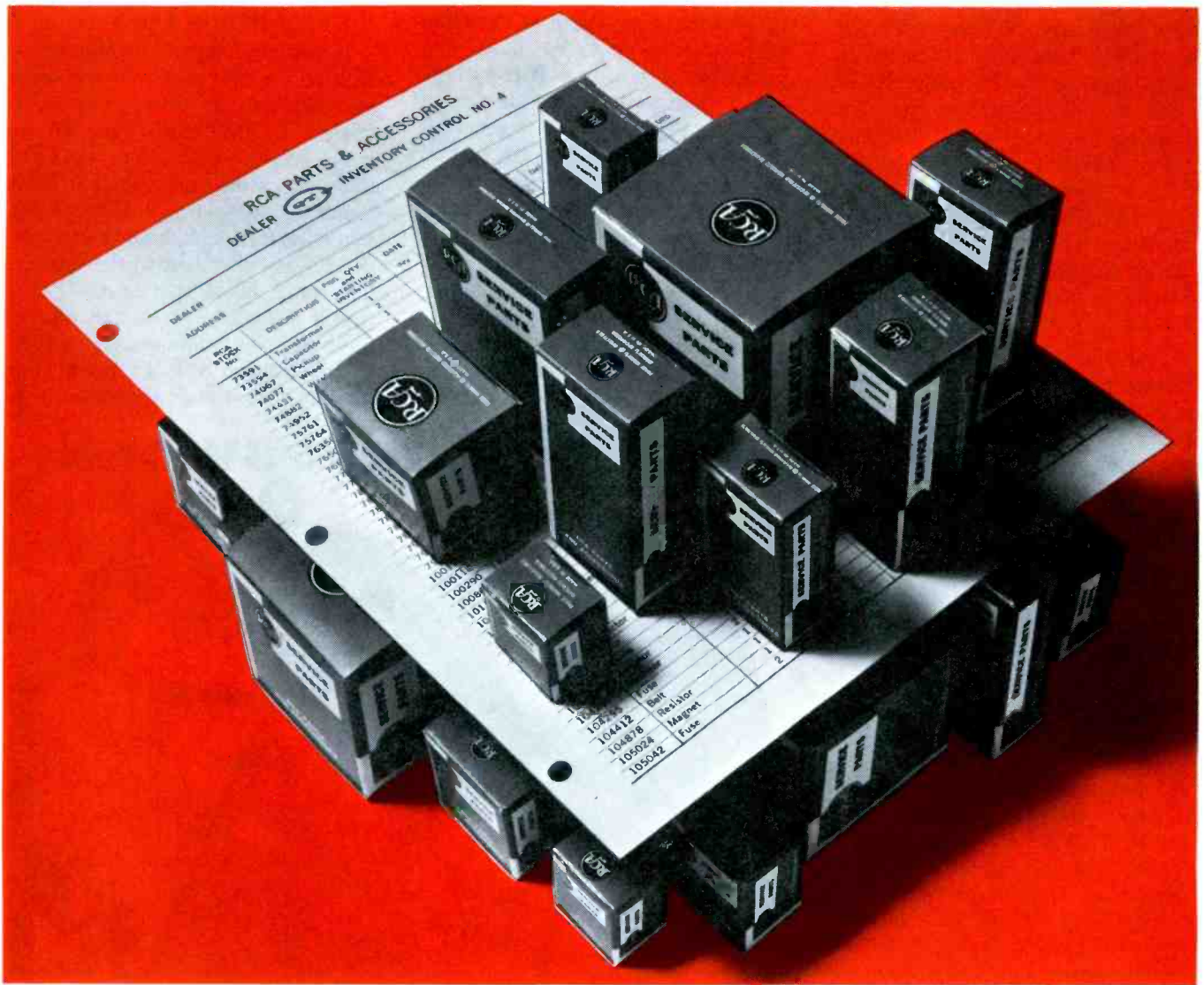

## New help from RCA to reduce your loss-time...increase your profits

**An RCA "QT" Inventory takes the guesswork out of stocking replacement parts... puts the most used RCA home instrument parts at your fingertips.**

Your RCA Replacement Parts Distributor has a computer planned inventory program that makes your job easier. It will help you improve efficiency, speed up customer service, reduce inventory liability, and increase profits.

RCA "QT" (Quick Turnover) Inventories are designed to suit various-size service operations, with varying quantities of the most used RCA Home Instruments Replacement Parts.

These inventories are reviewed and updated semi-annually in accordance with the most current usage data, based on an analysis by RCA Electronic Data Processing Equipment of national sales patterns.

Once you get the "QT" habit, you have what's needed to produce better service, satisfied customers and additional business.

There are so many advantages to the RCA "QT" Inventory Program that it will be worth your time to call your RCA Distributor and ask him about them. Call him *today*—and start enjoying the profitable benefits that can be yours.



RCA PARTS AND ACCESSORIES, Deptford, New Jersey

**The Most Trusted Name in Electronics**



## Great Blobs of Color

(Continued from page 24)

electrolytic in the contrast control circuitry will give you a picture that is similar but not identical. It will be very pale looking, and the colors will go reddish, as you can see in Fig. 5. This one is easy: The contrast control won't have any effect at all on the picture. (Incidentally, while I'm thinking of it, watch out for this control on some of the older sets, back around the CTC9 or so. If the contrast control in these is turned all the way up, you'll have more troubles than you can shake a stick at! Misconvergence, oversaturation of color, and on and on all due to too much contrast. The proper operating position for this control in these chassis is all the way off! Try it and see.)

For a set with an assortment of symptoms, and one that called for some really scratchy diagnoses, this one took the cake. This was a Sylvania DO-5 table model color set. The screen was a mess; colors in great blobs, unstable sync, and a few other odd things. Fig. 6 shows this better than I could ever describe it. While sitting there scratching my head, I tuned the set back and forth across several channels. I happened to go by a station with an old-fashioned, black-and-white picture. Luckily, I stopped long enough to look at it. It was black and white, all right, but the black was where the white ought to be! In other words, I had a very nice negative picture! Oh, ho! Now I began to see the light. Even I can figure out that color signals with the Y component reversed are going to look funny, and they does!

Well, only one thing causes this: a reversal of polarity. This set seems to have a two-stage video amplifier, like the DO-3; a 5MB8 on the video IF board, and a 10JT8 video output. Now, let's see. . . . whoa! Look at the schematic (Figure 7). Looky there! A little transistor amplifier in between the two tube amplifier stages. Well, well.

There's only one way to find out. "Up scope!" The video signal looks good on the 5MB8 grid. Sync going negative, just as it should. 5MB8 plate, sync going positive; still OK. Transistor base signal about what it should be. Going to the grid of the 10JT8 output tube, about the same.

Hmm. No gain. Hmm, no inversion either! Sync still going positive; this won't do. When we invert in the 10JT8 tube, we'll wind up with negative going sync, and a negative picture. Well, that's what we've got, isn't it?

So, I counted the number of signal inversions on my fingers, and then checked the polarity of the video detector crystal on the schematic, to make sure that the transistor wasn't connected as an emitter follower or something, which it wasn't. The transistor wasn't amplifying the sig-

nal, and it wasn't inverting it, either.

Well, everybody knows what causes this! A base-collector short in the transistor. So, I hooked up my new in-circuit transistor checker, pushed the red button and . . . Hmm. What d'you mean GOOD? Look, stupid, I can see that transistor's shorted! No inversion, no gain and look here—my ohmmeter says that there's a 120-ohm short directly across the thing from base to collector! And you sit there and beam your little red eye at me and say 'GOOD'? Well, all

# stability!



In one word, STABILITY is why you need a new Sencore CG141 Color King. With its exclusive thermostatically controlled heating element and its patent pending timer circuitry, the Color King maintains absolute stability from 20° below zero to 140° in the shade. Gives you the most reliable and rock solid patterns ever designed into a standard color bar generator.

**Now-generates seven patterns in all:** Standard RCA color bars, cross-hatch, individual vertical and horizontal lines, adjustable size dots plus two new patterns—single dot and cross that can be moved to any spot on the screen to speed up dynamic convergence. New snap tuning, channel 2 through 6; interlace control to form a perfectly round dot; and increased chroma and sync signals make the color king a complete color analyzer too.

Get yours now — the KING OF VALUE at **\$149<sup>95</sup>**



See America's most complete line of professional test instruments — at your Distributor now.

## SENCORE

NO. 1 MANUFACTURER OF ELECTRONIC MAINTENANCE EQUIPMENT

426 SOUTH WESTGATE DRIVE, ADDISON, ILLINOIS 60101

Circle 23 on literature card

May, 1967/PF REPORTER 55

right, you smart-alec transistor tester, we'll see. I'll take your word for it, and leave the transistor in there until the last thing. Now let's find that short.

There are only eight resistors, a wee capacitor, and one tiny peaking coil in the whole circuit. So, let's unhook 'em and see. I clipped the ohmmeter across the circuit from the transistor base to the delay-line output, and every time I pulled something loose, I checked the meter to see if that killed the short. Seven resistors and one peaking coil later, the short was still there. One resistor left. I disconnected it, and the short disappeared! Ah, ha! Rechecked the transistor; still good. Hmm. Now, I replaced the last resistor I unhooked. (All of these parts checked good, of course). Hmm. No short now. I put all the parts back, watching the ohmmeter. Oh goody! No short. Take the ohmmeter off and turn the set on and let's see. Fine! Perfect picture; nice color, plenty of contrast, everything you'd want.

Now, what's we do? We cleared the short, obviously, but where the heck was it to begin with? Well, you can sit there long enough and you begin to think, even if it does make your head hurt. When I disconnected the last resistor, I'd noticed this little lance through the PC board wobble just a bit. Evidently, there had been a solder blob somewhere on the other side that had been shorting to something else. When I melted the joint, the solder blob had retracted, and so had the color blobs. A close examination of the whole thing with a magnifying glass failed to show it up, but the short had been there, and I'd cleared it (more or less accidentally). Anyhow, I'd learned

one thing; the transistor checker worked.

We're going to run into more and more transistor circuitry. Zenith is using almost the same thing in the 23XC36 series chassis, and others. A small transistor amplifier between two tube amplifier stages. The arrangement is different, as the video detector delivers a positive going video signal, the 1st video stage is a cathode follower, the transistor stage is a common emitter type, and the last stage is the high-gain 12HL7 tube, with a positive-going-sync picture coming out on the cathodes of the color CRT at about 130 volts p-p.

In the Sylvania circuit, the color signals take off from the emitter of the transistor stage; so, it acts as an emitter-follower for color, and as a common-emitter for the video signals. As you can see from the picture in Fig. 6, the shorted stage upset the colors pretty badly, and at the same time it inverted the video signal polarity. In other transistor amplifier circuits you will probably find different symptoms, depending on just what kind of defect has developed. Here, as in any kind of transistor amplifier stage, we're going to have to watch out for those tiny bias voltages.

The scope is still the most effective weapon for testing Y circuits. It will show you the signal levels at input and output of the stage, and if these levels are within tolerance, the stage is pretty apt to be all right. When you find a stage with input and no output, then stop and hunt for troubles. Or, as you can see, if we find one with input right side up and output still right side up, when it ought to be upside down, then we've found the trouble. Voltage readings won't tell you anything about signal polarity, but the scope will. ▲

# Why not sell the best

## NEW ZENITH LOG-PERIODIC ANTENNAS built to the quality standards of Zenith original parts

Advanced designs . . . developed by the Antenna Research Laboratories of the University of Illinois. Model 973-49 (right) works like a powerful, multi-element Yagi. It offers superior Color or B&W reception on *all* channels. And it delivers better FM/Stereo FM performance in metropolitan areas.

Other Zenith quality periodic antennas are specially designed for UHF, VHF, FM and FM stereo, or planar helical UHF reception.

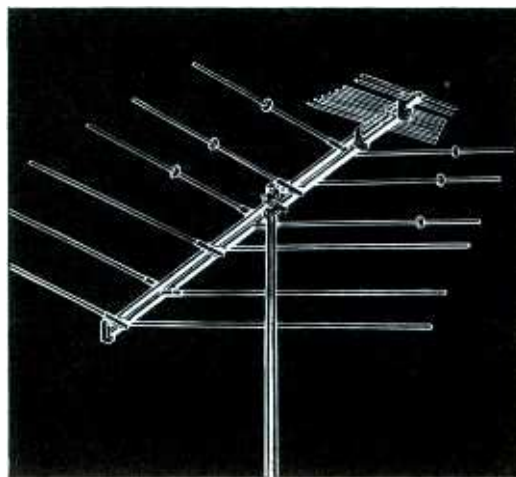

Order Zenith antennas and all genuine Zenith replacement parts and accessories from your Zenith distributor.

**ZENITH®**  
The quality goes in before the name goes on

Circle 24 on literature card



# THE TROUBLE-SHOOTER

answers your servicing problems

## Video Detector

We had a General Electric Chassis AY (PHOTOFACT Folder 725-2) with no video and poor sound. On examining the set, we discovered that the video detector diode had been brought from its original location to a bracket on the rear of the set. It was connected into the circuit with a section of 300-ohm lead-in. We replaced the diode, and the picture and sound returned to normal.

Three months later, the diode went bad again. All circuits around the diode check within tolerance. Any clues?

DONALD D. TEAGLE

Barberton, Ohio

*This looks like another good argument for keeping the shielding and lead dress intact. With the diode connected at the end of long leads, there is a good possibility that the leads are picking up energy radiated from the sweep circuits. This energy can be great enough to exceed the peak ratings of the diode and cause it to burn out.*

*When the diode was taken from its original location, the tuning of L7 may have been changed. After you put the diode back where it belongs, check to see if the detector circuit needs to be aligned. As "insurance" against more trouble, insert a 750-ohm resistor between the detector output and the video amplifier grid.*

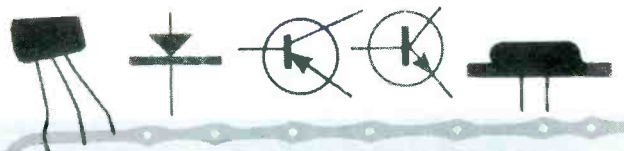
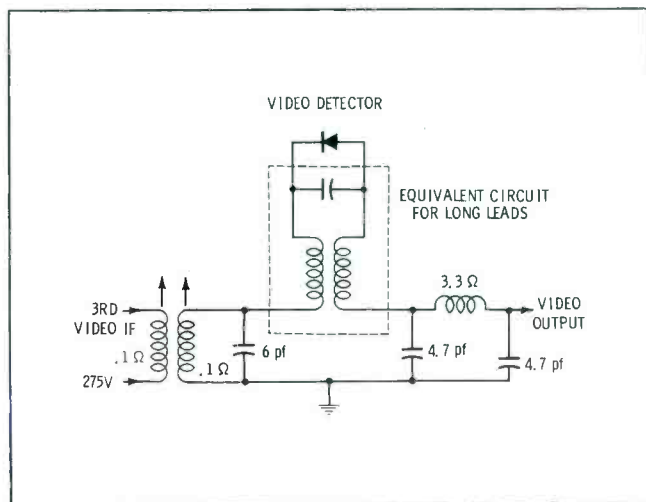

## TEST TRANSISTORS IN SECONDS in circuit

TR139  
89<sup>50</sup>



Also check all transistors, diodes, and rectifiers out of circuit for true AC beta and Icbo leakage.

### Your best answer for solid state servicing, production line testing, quality control and design.

Sencore has developed a new, dynamic in-circuit transistor tester that really works—the TR139—that lets you check any transistor or diode in-circuit without disconnecting a single lead. Nothing could be simpler, quicker or more accurate. Also checks all transistors, diodes and rectifiers out of circuit.

**BETA MEASUREMENTS**—Beta is the all-important gain factor of a transistor; compares to the gm of a tube. The Sencore TR139 actually measures the ratio of signal on the base to that on the collector. This ratio of signal in to signal out is true AC beta.

**ICBO MEASUREMENTS**—The TR139 also gives you the leakage current (Icbo) of any transistor in microamps directly on the meter.

**DIODE TESTS**—Checks both rectifiers and diodes either in or out of the circuit. Measures the actual front to back conduction in micro-amps.

**COMPLETE PROTECTION**—A special circuit protects even the most delicate transistors and diodes, even if the leads are accidentally hooked up to the wrong terminals.

**NO SET-UP BOOK**—Just hook up any unknown transistor to the TR139 and it will read true AC beta and Icbo leakage. Determines PNP or NPN types at the flick of a switch.

Compare to laboratory testers costing much more. . . \$89.50

See America's Most Complete Line of Professional Test Instruments — At Your Distributor Now.



NO. 1 MANUFACTURER OF ELECTRONIC MAINTENANCE EQUIPMENT

**SENCORE**

426 SOUTH WESTGATE DRIVE, ADDISON, ILLINOIS 60101

Circle 25 on literature card

May, 1967/PF REPORTER 57

Good medicine for tape recorder dealers and service centers!

# Nortronics OPERATION HEAD/START

acts like a miracle drug to create a brand-new profit source

## worn tape head replacements

Millions of tape recorders are victims of *deteriorated fidelity*, also called the mushy sound disease, often caused by a worn-out tape head. You can cure it by selling a Nortronics replacement.



Nortronics makes it easy, provides you a convenient, inexpensive package for handling over 750 different head replacements *on the spot*. Nortronics Head-Start Packages contain everything you need—your basic tape head inventory, all necessary hardware, complete easy instructions, point-of-purchase sales aids and promotional material.

*Your investment?* As low as \$35.37. *Your potential?* Fantastic . . . and all found money!

*Your Nortronics distributor?* Send the coupon; we'll send his name by return mail. He has your Head-Start package in stock.

### THE NORTRONICS COMPANY, INC.

8101 Tenth Avenue North  
Minneapolis, Minnesota 55427

Head-Start sounds like just what the doctor ordered! Who's my local distributor?

NAME \_\_\_\_\_

COMPANY \_\_\_\_\_

ADDRESS \_\_\_\_\_

CITY, STATE, ZIP \_\_\_\_\_

### No Vertical Output

I have an Admiral Chassis 21B1 (PHOTOFACT Folder 118-2) with intermittent vertical sweep. The sweep returns occasionally, sometimes with compression at top and bottom. Even when I have a full raster, the retrace lines are visible and the top few of them appear to "dance" and have white spots on them.

With no vertical sweep, the only unusual voltage reading is at the grid of the 6S4 vertical output tube. This voltage should be zero, and although the VTVM "hovers" around the zero mark, the needle jitters as though an alternating voltage were present.

All components in the vertical section have been changed, but still no sweep. I would appreciate any help you can offer. Incidentally, if this set is from another production run, perhaps some components have been added which I don't know about.

Thirteen days later — A new 6S4 socket was installed and the vertical sweep returned. I still had the retrace lines with the "dancing white spots," but replacing the vertical output transformer eliminated this problem. The voltage readings are now normal with no jitter at the grid of the vertical output tube.

H. HAVENER

Ardsley, N. Y.

*Your two letters seem to cover the subject adequately. It is so easy to ignore the passive components, and when one of them goes "sour," finding it can be a big problem. The use of a scope will often speed troubleshooting these "dogs."*

### Hum Before Raster

A Zenith 15L22 chassis (PHOTOFACT Folder 715-4) has a very loud hum until the raster appears, then it has a good picture with very little hum. At times it has a slight horizontal pull. All waveforms are normal. I have replaced all filters and rectifiers. Do you have any ideas on possible causes of hum associated with this receiver?

EUGENE N. SPETTER

Rossville, Kansas

*From all indications your set is operating normally. The choke-type filter*



## Commercial Sound Speaker Source...

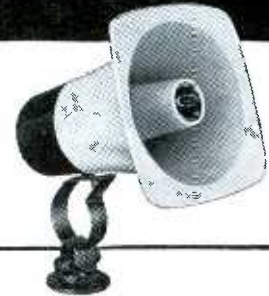

You never compromise with fidelity or quality when you specify Oxford on all your speaker needs.



That's because Oxford electronic and sound engineers know that specialized applications require specialized developments. Oxford doesn't produce just horn or cone types, Oxford studies the application and the problem, develops specific units or specific needs. You're never stuck with trying to pour a bushel basket into a pint measure. Paging and talk-back horns, outdoor hi-fi systems, P.A. systems and other commercial sound installations all find the perfect speaker for the system at Oxford.



Visit display room 509-A  
June 9th through 21st  
Conrad Hilton Hotel  
Chicago

Match your skills with the Oxford line of speakers that bring out the best in every sound installation. Write for the Oxford catalog of "speakers for every purpose" today!

**OXFORD TRANSDUCER  
COMPANY**  
A Division of  
Oxford Electric Corporation

3911 S. Michigan Ave.  
Chicago, Ill. 60653

Circle 26 on literature card



used in this chassis not fully effective until an appreciable amount of current is passing through it. Since this current is from the sweep circuits, a certain amount of hum is normal until the set develops a full raster. The horizontal pull indicates the set needs horizontal alignment, as outlined in the PHOTOFACT folder for this set.

### Open CRT Filament

I am having trouble with a Motorola Chassis 534D-13 (PHOTOFACT Folder 312-8) and I would appreciate any advice you can give. The original CRT was replaced with a type 21-

FLP4, but after a few months, the set was brought back with an open CRT filament.

Another new CRT was installed, and after two days, it also developed an open filament. The owner reported that he saw "flashes" before the raster disappeared. I have installed another new CRT and there is arcing in this tube.

I have taken the following measurements with a 20,000 ohms-per-volt meter with no signal applied: CRT filament, 6 volts AC; CRT cathode, 160 volts; CRT control grid, 540 volts;

video amplifier plate, 150 volts; and video amplifier screen grid, 125 volts.

STANLEY GENDELMAN

New Hyde Park, N. Y.

The reason for the repeated CRT filament burnouts is the high potential being applied to the CRT cathode and the video amplifier plate. This is causing arcing between the CRT cathode and filament. The CRT cathode potential is determined by the drop across R58 and R59, and you will probably find that one of these resistors has changed to a low value. ▲

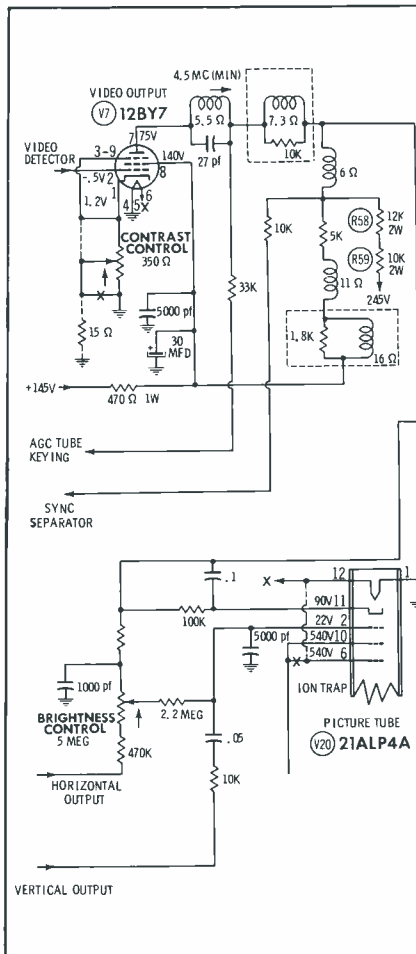

**MOVING?**  
Don't Lose  
Touch...

Receive PFR  
as usual at  
your new address  
(Include old and new address.)  
Write:

**PF REPORTER**  
Circulation Dept.  
4300 West 62nd St.  
Indianapolis, Ind. 46206

## 50,000 USERS CAN'T BE WRONG!



**DEPENDABLE!**  
**ACCURATE!**  
**UP-TO-DATE!**

### NEW MIGHTY MITE V

Technicians everywhere believe in the most dependable tube tester of all, the famous Sencore Mighty Mite. For in-home or shop use, 50,000 users rely on its proven accuracy. Here's why.

- **Grid Leakage Test** with ultra-high sensitivity of 100 megohms or 1/2 microamp.
- **Emission Test** at full rated cathode current spots the borderline types.
- **Shorts Test** picks out interelement shorts of 180K ohms or less. As you'll know the tube type and number you need is listed, and the Mighty Mite truly checks over 3000 tubes, hundreds more than old-fashioned testers, including all the latest domestic and foreign types.

Sencore's new TC142, the Mighty Mite V. Same reliability, same accuracy, with these new features to make the Mighty Mite V the most up-to-date tester of all.

- NEW**—Magnoval socket so you can check ED500, 6GB5, 6KG6, 19KF6, EL500, 6EC4, and many more.
- NEW**—Horizontal in-line switch layout saves setup time, makes the Mighty Mite V faster than ever.
- NEW**—Vinyl-clad steel case is more rugged than any other, stays new-looking longer.
- NEW**—Brushed chrome panel protected by detachable, hinged cover.

The new Mighty Mite V is truly Sencore's mightiest Mighty Mite and its still only ..... **\$74<sup>50</sup>**

In stock at your distributor now.

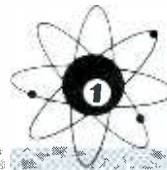

## SENCORE

NO. 1 MANUFACTURER OF ELECTRONIC MAINTENANCE EQUIPMENT  
426 SOUTH WESTGATE DRIVE, ADDISON, ILLINOIS 60101

Circle 28 on literature card

# TWO NEW "plastic view" screwdriver kits

EASY TO USE, CARRY & STORE

These neat, extremely compact kits fit hip pocket, tool box, boat kit, glove compartment . . . can also be hung on a wall. Durable "Plastic View" zipper case permits instant identification of tools.

Amber plastic (UL) Service Master handles are shockproof, breakproof, have patented spring holding device that accepts all Xcelite Series 99 blades — lets you add tools as needed at minimum cost.

Space saving, single-ended interchangeable blades . . . can be used with Xcelite extensions for extra reach.



**99PV-6**  
Handle and 3 slotted screwdriver blades (3/16", 1/4", 5/16" tips), 2 Phillips (#1, #2)

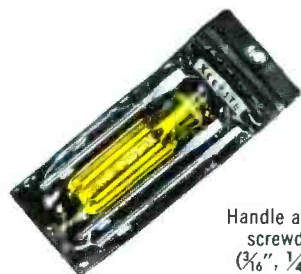

**99PV-4**  
Handle and 3 slotted screwdriver blades (3/16", 1/4", 5/16" tips)

WRITE FOR CATALOG 166



XCELITE, INC., 18 Bank St., Orchard Park, N. Y. 14127  
In Canada contact Charles W. Pointon, Ltd.  
Circle 29 on literature card

# BOOK REVIEW

**Electricity One through Electricity Seven:** Edited by Harry Mileaf; Hayden Book Company, Inc., New York, 1966; seven volumes, 940 pages, 6" X 9", soft cover; \$18.75.

Designed specifically to teach electricity, this seven-volume series begins with atomic theory and proceeds through the basics of electricity and electrical circuits to power sources and motors. Although each volume covers a given segment of electricity, the logical sequence of presentation assures continuity throughout the series.

The material covered in each volume is arranged so that only one new topic is discussed on each page. To reinforce the text, color illustrations that summarize important points are also included on each page. A summary of facts and a set of review questions are provided at the end of each lesson to increase retention and aid the reader in determining how well he is learning. Retention is also improved through the use of italicized key words in each topic and repetition of major points introduced in earlier topics.

The series begins with a discussion on atomic theory, electrical charges, electron theory, and the production of electricity. Electric current, the effects of electricity, magnetism, and electromagnetism are also included in volume one. Direct current, Ohm's law, Kirchhoff's law, superposition, and circuit types are covered in volume two. Volume three introduces alternating current and related subjects such as waveforms, AC circuits, inductors and inductive circuits, transformers, and capacitors and capacitive circuits. AC theory is continued in volume four, including LCR, RL, LC, and RC circuits; series-parallel and resonant circuits; vectors; and filters. Volume five discusses test equipment circuits and applications. Power sources such as batteries; photo, thermo, and solar cells; DC and AC generators; motor generators and dynamotors are presented in volume six. Volume seven covers motors.

Although the subject matter of this series is basic in nature, the method of presentation makes it useful as a review source for readers with a more advanced knowledge of electricity. ▲

# ARROW Automatic STAPLE GUN TACKERS

Specially designed for  
SAFE — FAST — SECURE  
WIRE & CABLE FASTENING

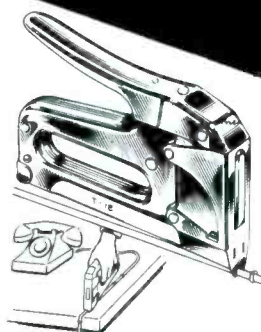

**No. T-18**  
For wires up to 3/16" in dia.  
Uses round crown staples in 3/8" leg only.

BELL, TELEPHONE, THERMOSTAT, INTERCOM, BURGLAR ALARM and other low voltage wiring.



**No. T-25**  
For wires up to 1/4" in dia.  
Uses round crown staples in 9/32", 3/8", 7/16", and 9/16" leg.

Fastens same wires as No. T-18

Also used for RADIANT HEATING CABLE

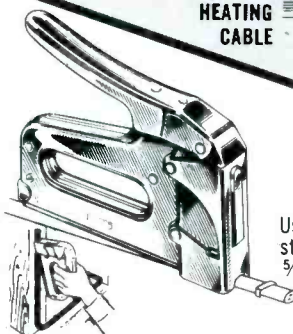

**No. T-75**  
For wires and cables up to 1/2" in dia.  
Uses tack-pointed staples in 9/16", 5/8" and 7/8" leg.

SHEATHED CABLE, RADIANT HEATING CABLE, WIRE CONDUIT, COPPER TUBING, DRIVE RINGS, ETC.

- All-steel, chrome finish.
- Jam-proof mechanism for trouble-free operation

**SAFE!** Driving blade automatically halts staple at right depth of penetration! Can't cut or injure wires and cables.

**FAST!** Powerful single stroke action shoots staples in 1/1000 of a second! Saves 70% in time, effort and efficiency!

**HOLDS!** Staple points diverge to imbed firmly in wood. Rosin-coated for tremendous holding power!

Write for catalog and information.

ARROW FASTENER COMPANY INC

Saddle Brook, New Jersey 07863

"Pioneers and Pacesetters  
For Almost A Half Century"

Circle 30 on literature card



# PHOTOFACT™ BULLETIN

PHOTOFACT BULLETIN lists new PHOTOFACT coverage issued during the last month for new TV chassis. This is another way PF REPORTER brings you the very latest facts you need to keep fully informed between regular issues of PHOTOFACT Index Supplements issued in May and September.

<b>Admiral</b>	1H1256-1, 1H1258-2, 1H1260-1, Chassis 1H1298-2, H12 .....	876-1
	G7, 4J4, 4JM .....	877-1
<b>Airline</b>	GEN-1367A, 63-1367 .....	876-2
	GEN-1867A/B, 63-1867, 1867 ..	878-1
<b>AMC</b>	P923 .....	867-3
<b>Arvin</b>	66K18 (Ch. 1.95701) Late Production .....	881-1
<b>Bradford</b>	BWGE-5621A .....	879-1
	BWGE-56739A, BWGE-56747A, BWGE-56754A .....	878-2
	56903 .....	881-2
<b>Dumont</b>	59P01 (Ch. 120814A) .....	877-2
Chassis	120822A, 35A .....	880-1
<b>Magnavox</b>		
Chassis	T921-01-AA .....	879-2
<b>Motorola</b>	A22TS-/20TS-/22TS-/23TS- Chassis 918A .....	880-2
<b>Packard Bell</b>		
	CSQ-302, 304 (Ch. 98C11) .....	878-3
<b>RCA</b>	CTC21A/AC/AD/B/C/D .....	881-3
Chassis	CTC25A/AA/B/C/XA/XAA/	
<b>Sears</b>	XAB/XB .....	879-3
	71011 (Ch. 562.10160) .....	877-3
<b>Toshiba</b>	719M1 .....	880-3

The following TV sets are given schematic coverage in the Extra Contents.

<b>Airline</b>	GMW-14447A, 57A .....	880-9S
<b>Hitachi</b>	CNA-1900T .....	879-10-S
<b>Philco</b>	17H22, 17J25 .....	867-11-S
	17J28, 17JT41 .....	877-10-S
<b>Sharp</b>	CN-32T .....	880-9-S

*the instrument with  
endless uses ... the all new  
improved completely solid state*

**SENCORE  
FS134  
FIELD  
STRENGTH  
METER**



only  
**199.50**  
lowest price going

HERE ARE JUST A FEW OF THE MANY USES ...



**INSTALLING AND CHECKING OUT DISTRIBUTION SYSTEMS**  
Qualify for this multi-million dollar business in hotel, motel, and hospital installations.



**COLOR INSURANCE**  
Be sure the signal is adequate on each channel for proper color TV operation.



**CHECK TRANSMISSION LINES**  
For the first time read actual db loss in either 75 or 300 ohm transmission lines.

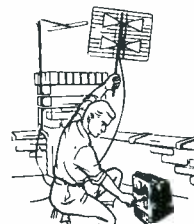

**INSTALLING UHF, VHF, AND FM ANTENNAS**  
Cut down installation time and pay for the FS134 in a short time on critical UHF as well as VHF and FM antennas.

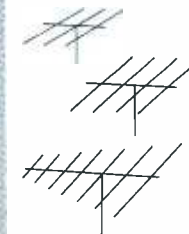

**COMPARE ANTENNAS**  
For actual db gain; see which is best for each location, both VHF and UHF. Also excellent for orienting "dishpans" for translator use at the high end of UHF band.



**CHECK ANY GENERATOR OUTPUT**  
For correct frequency and output all the way up to a tenth of a volt RMS. What a time saver when you want to know if your generator is putting out.

**PLUS: LOCALIZE NOISE AND INTERFERENCE**

Fine noise source fast; pick quiet locations for antenna installations or orient antenna away from noise when possible.

These are only a few uses of this UHF-FM-VHF accurately microvolt calibrated field strength meter. You can start paying for the FS134 tomorrow in the time saved today—if you see your Sencore distributor now. Why not pick up the phone and ask him to show you the new FS134?

SEE AMERICA'S MOST COMPLETE LINE OF PROFESSIONAL TEST INSTRUMENTS—AT YOUR DISTRIBUTOR'S NOW.



**SENCORE**

NO. 1 MANUFACTURER OF ELECTRONIC MAINTENANCE EQUIPMENT

426 SOUTH WESTGATE DRIVE, ADDISON, ILLINOIS 60101

Circle 31 on literature card

May, 1967/PF REPORTER 61

# FREE GIFT COUPONS on GC AEROSOL CHEMICALS



## non-drift tuner cleaner

GUARANTEED NON DRIFT COLOR TV TUNER CLEANER will not harm plastics. Cleans away oxidation, dust, dirt and grease from contacts and leaves a fine coating of protective lubricant.

**GC ELECTRONICS**  
Division of Hydrometals, Inc.  
400 S. Wyman Street  
Rockford, Illinois, USA

Circle 32 on literature card

# PRODUCT REPORT

for further information on any of the following items, circle the associated number on the Catalog & Literature Card.



### Portable Power Saw

(50)

This new, industrially rated, two-speed, electric, free-hand cutting saw, permits the operator to select the correct speed for any cutting job (metal or wood). An electronic speed control, conveniently located in the handle of this Wen Model 920 Zipp saw, enables the user to select the correct speed selection without any loss of power. Wood, metals (including sheet and pipe to 2" in diameter), masonite board, plastics, ceramic tile, wallboard, and other materials can be cut with this saw.

The saw is designed so that its curved foot plate enables it to start

its own inside cut. No adjustments are needed. Plunge cuts can be made rapidly without a starting hole. It can be used for cutting openings into wallboard, installing extra outlets, ductwork installation, and cutting conduit. Intricate scrollwork and fine patterns can be cut with a fine toothed blade (one of seven furnished with the saw). The 4¼ ampere, ⅓ H.P., 115-volt AC/DC motor and handle are offset so that the pattern line is visible when cross-cutting, ripping, or working in any position.

A finger tip control safety switch, built within the saw grip handle, releases and shuts off the power of the saw. A tapered, upright grip that can

## A Jackson SERVICE Latest Tube Test Data for owners of Jackson Testers

Supplements latest Model 658 and 648 Roll Charts

Type	Model 658						Model 648				
	Sec.	Heater	Circuit H&K	P&G	Plate	Grid Test	Heater Current	Fil.	D	E	Plate Test
5GS7	P	5.0P	123	ac689	40R	10WY•		5.6	A126	AC389*	47XZ
6AG9	T	5.0P	123	ac45	11R	25WY•		5.6	123	AC45	17YZ
	P	6.4L	C6	178	14R	10WY•		6.3	C6	179	31V
	T	6.4L	C4	a59	30R	10WY•		NOR-S switch in S position			
6G-B3	P	6.4M	123	ab560	20R	70VY•		6.3	C4	A59	16XZ
	6MG8	P	6.4J	129	ab358	47R	10WY•	6.3	A123	AB569	15W
8GU7	T	6.4J	127	a46	36R	10WY•		6.3	A125	C389	34XZ
	P	8.5K	127	a89	50Q	30VY•		6.3	127	A46	18YZ
8GU7	T	8.5K	123	a45	50Q	30VY•	A13.6J Z450	8.4	127	A89	10WY
	T	8.5K	123	a45	50Q	30VY•		8.4	123	A45	10WY

Complete low cost tube data subscription service available for Jackson and Mercury tube testers...write for information

**JACKSON TUBE TEST DATA DIV. 1744 Rockaway Ave., Hewlett, N.Y. 11557**

Circle 33 on literature card



# NOW... PERFECT COLOR TV

ELIMINATE FM and OTHER INTERFERENCE

With the Sensational

## NEW FINCO

FM Trap (Blocks Out FM)



MOUNTS EASILY BEHIND TV SET

MODEL 3006

Get pure color signals for perfect color reception. Use a Finco Model 3006 to stop interference and block out unwanted signals from FM, Citizens Band, Amateur transmitters, motors, autos, aircraft, and fluorescent lamps. Size: 4 1/2" x 2" x 1 1/2". Available at your Finco dealer.

Model 3006

Only \$6.25 List

### THE FINNEY COMPANY

34 W. Interstate St. Dept. 310  
Bedford, Ohio 44146

"FINCO ANTENNAS CAPTURE THE RAINBOW"

Circle 37 on literature card

be attached for extra-heavy work is also provided. The saw weighs 5 1/2 lbs. and measures 7" in length by 7 1/2" wide by 7" high. The heavy duty aluminum saw housing has a Ball Brite finish. Other features include heavy-duty oilite and roller bearings, heavy-duty hardened gears, and a three-wire, 6' cord with grounding adapter. Price is \$44.95.



### Solid-State Volt-Ohmmeter (51)

The new, lightweight, transistorized volt-ohmmeter shown here combines the portability of a VOM with the

## new Sams books

New 7th Edition of the famous HOWARD W. SAMS

### Transistor Substitution Handbook



Fully updated and accurately compiled by computer, this invaluable reference is now more complete than ever. Lists thousands of direct substitutions; includes biasing diagrams and polarity indications; shows manufacturers of transistors listed. Provides substitutions for all major classes of transistors: U. S., foreign (including replacements for many Japanese types), home entertainment, and industrial. For quick, easy reference, all transistor types are presented in a single numerical-alphabetical listing. A "must" reference for everyone concerned with the use of transistors. 128 pages; 5 1/2" x 8 1/2".

Order 20529, only \$175

### Slide Rule in Electronics

by Don Carper. Teaches the proper and efficient use of the slide rule—an ideal tool for making quick, accurate calculations in electronics math. Organized in 12 progressive lessons, this clearly written book explains basic mathematical principles relevant to electronics and shows how they are applied. Tells how to calculate resistance, reactance, impedance, current and voltage relationships, frequencies, phase angles, and many other factors. Includes practice problems and exercises. Ideal for home study. 160 pages; 5 1/2" x 8 1/2". Order 20532, only \$425

### Troubleshooting With the Oscilloscope, Rev. Ed.

by Robert G. Middleton. This updated and easy-to-understand book explains how to use the scope to isolate circuit troubles in any electronic equipment. First, you are shown how to operate a scope, and how to use the proper probes for various tests and measurements; then you learn which test signals are required, the type of waveforms to expect, and how to interpret them properly. You learn further how to isolate defective circuit stages or sections by waveform analysis; numerous waveforms associated with various defective components are shown. Also covers f-m stereo-multiplexing equipment testing, testing of solid-state devices, and use of triggered sweep scopes. 192 pages; 5 1/2" x 8 1/2". Order 20550, only \$395

### 101 Ways to Use Your Hi-Fi Test Equipment, 2nd Ed.

by Robert G. Middleton. This completely revised volume shows how to use harmonic-distortion meters, square-wave generators, intermodulation analyzers, and other specialized instruments for testing hi-fi equipment. Clearly explains the tests which can be performed by each instrument. Describes proper test setups, procedures, and how to evaluate results. Heavily illustrated. 160 pages; 5 1/2" x 8 1/2". Order 20552, only \$295

### Basic Electricity & an Introduction to Electronics

by the Howard W. Sams Technical Staff. New 2nd edition of this widely used textbook—now incorporates new suggestions and additions contributed by electronics instructors and students. Simply written for easy understanding and fully reinforced by the liberal use of diagrams and illustrations, the book begins with the fundamentals and progresses, step by step, through each phase of electricity. Once this groundwork is laid, the subject of electronics is explained clearly. Ideal for home study. 192 pages; 8 1/2" x 11". Order 20540, only \$395

### HOWARD W. SAMS & CO., INC.

Order from your Sams Distributor today, or mail to Howard W. Sams & Co., Inc., Dept. PFR-5 4300 W. 62nd Street, Indianapolis, Ind. 46268

Send me the following books:

20529  20550  20540  
 20532  20552

Send FREE Sams Booklist. \$\_\_\_\_\_enclosed

Name \_\_\_\_\_

Address \_\_\_\_\_

City \_\_\_\_\_ State \_\_\_\_\_ Zip \_\_\_\_\_

My Distributor is \_\_\_\_\_

TEXAS CRYSTALS is the line for you



CQC means CONTROLLED QUALITY CRYSTALS for...

- Color TV
- Citizen Band
- Commercial and Industrial Radio

See Your Parts Distributor



## TEXAS CRYSTALS

Div. of Whitehall Electronics  
1000 Crystal Drive  
Fort Myers, Fla. 33901  
Plants in Fort Myers and Los Angeles

Circle 36 on literature card

Color or Black & White TV respond to QUIETROLE like magic!



- Lubricates & Cleans
- Non-inflammable . . . Non-conductive . . . Non-corrosive
- Easy Spray or Dropper Application
- Nearly 20 Years of Outstanding Leadership
- Harmless to Plastics & Metal — Zero Effects on Capacity & Resistance

Acknowledged leadership by both manufacturers and servicemen. Silences noisy TV and radio controls with minimum attention. Mark-II for tuners . . . Spray-Pack for controls and switches . . . Silitron for general use.

Ask your distributor for Quietrole by name.



manufactured by QUIETROLE CO. Spartanburg, South Carolina

Circle 35 on literature card

# Why is a Vectorscope essential for Color TV servicing?

- 1 Check and align demodulators to any angle . . . 90°, 105°, 115° . . . accurately and quickly. No guesswork. New color sets no longer demodulate at 90°. Only with a Vectorscope can these odd angles be determined for those hard-to-get skin tones.
- 2 Check and align bandpass-amplifier circuits. Eliminate weak color and smeared color with proper alignment. No other equipment required. Only a V7 Vectorscope does this.
- 3 Pinpoint troubles to a specific color circuit. Each stage in a TV set contributes a definite characteristic to the vector pattern. An improper vector pattern localizes the trouble to the particular circuit affecting either vector amplitude, vector angle or vector shape. Only a V7 Vectorscope does this.



#### EXCLUSIVE FEATURES:

**Color Vectorscope:** Until now, available only in \$1500 testers designed for broadcast use. Accurately measures color demodulation to check R-Y and B-Y, for color phase and amplitude. A must for total color and those hard-to-get skin tones. **Self-Calibrating.** Adjust timing circuit without external test equipment. **Dial-A-Line.** Adjust horizontal line to any width from 1-4 lines. **Solid State Reliability** in timer and signal circuits. **Plus:** All Crosshatch, Dots, Vertical only, Horizontal only and Keyed Rainbow Patterns. RF at channels 3, 4 or 5. Video Output (Pos. and Neg. adjustable) for signal injection trouble-shooting. Red-Blue-Green Gun. Killer. All transistor and timer circuits are voltage-regulated to operate under wide line voltage ranges. Lightweight, compact—only 8¼x7½x12½". **NET 189<sup>50</sup>**

**ONE YEAR WARRANTY**

**V6-B** New, improved complete color bar generator with all the features of the V7 except the Vectorscope. Only **99.<sup>50</sup>**



For the full story, see your distributor or write for literature.  
Dept. PF-5  
**LECTROTECH, INC.**  
1221 W. Devon Ave., Chicago, Ill. 60626

Circle 38 on literature card

high input impedance of a VTVM. Designed to measure DC voltages, resistance, and AC RMS values, the **Triplet Model 600** has an accuracy of  $\pm 3\%$  of full scale on both AC and DC at 77°F.

The transistorized amplifier incorporated in this instrument uses a special Field Effect Transistor (FET) circuit to provide an input impedance of 11 megohms on all DC ranges except the 0.4-volt and 0.8-volt ranges, which have 2.75- and 3.5- megohm input impedances, respectively. The AC ranges have a minimum of 0.75 megohms. Frequency range is 15 Hz to 2 MHz. DC voltage ranges are .4, .8, 1.6, 4, 8, 16, 40, 160, 400, and 1600 volts. AC voltage ranges are 0, 4, 8, 16, 40, 160, 400, and 800. Ohms ranges are 1000, 10K, 100K, 1 Meg, 10 Meg, and 100 Meg.

A single selector switch knob is used to select all ranges and functions. One small, compact probe is used for all functions. A built-in sliding switch in the probe places a resistor in series with the instrument on DC voltage readings. The meter is a 5" type with a 4.125" scale length. The DC-AC RMS and zero center scales are black on white, while the ohms scale is red on white. Other features include a direct reading for FM discriminator measurements and a DC polarity reversing switch.

The outside dimensions of the instrument are 3 3/16" x 5 1/8" x 6 1/2". Weight is approximately 2 1/2 lbs. The unit, complete with full battery complement, is \$78.00. A leather carrying case is available for \$14.00.

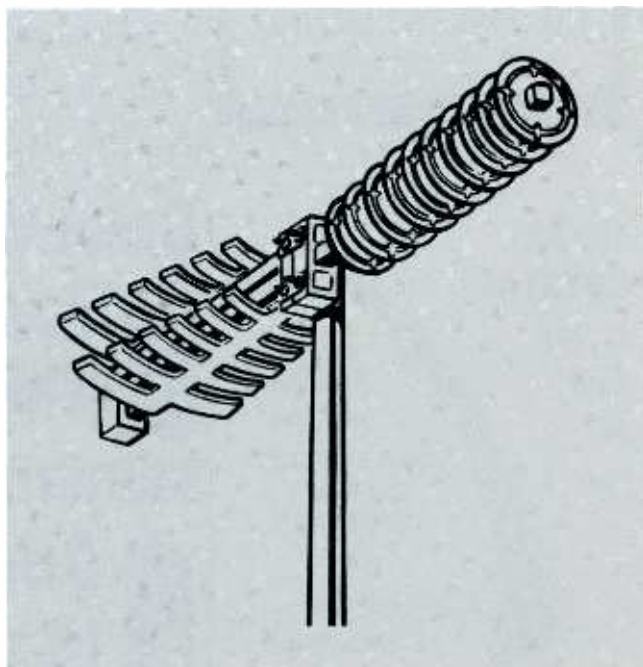

**UHF Color Antennas**

(52)

Because UHF signals are more susceptible to buildings, trees, and other obstructions, signal loss on this spectrum can become significant. UHF is more limited to line-of-sight distances than VHF, and its signals attenuate more swiftly. To help offset these factors, two new features have been incorporated in the new LPV-UCL series of Color Laser Antennas announced by **JFD Electronics Co.**

The first feature is the new disc-on-rod director system. Adapted from the high-gain antennas used for NASA, Apollo, and military radar, the disc shape increases the capture area to bring in much higher gain than thin-linear director elements. It also broadens the bandwidth and pulls in sharper color reception on all UHF channels. Its narrow beam width rejects ghosts, interference, and other undesirable signals. The disc-on-rod system is omni-polarized to



intercept UHF signals that often depart from horizontal polarization. The other feature is the new, wideband "zoned" trapezoid driver. This section of the antenna uses wide, log-periodic dipoles and delivers high gain and flat frequency response. It reinforces the performance of the disc-on-rod directors on the low end of the UHF spectrum.

The antennas are gold alodized for protection against corrosion and weather conditions. Four different models are available with ranges from 40 to 100 miles and priced from \$12.95 to \$27.50.



**Regulated Power Supply**

(53)

Variable, regulated DC plate voltages, bias voltages, and AC filament voltages are provided by a new compact power supply recently introduced by **Precision Apparatus**. Called the Model B-12 Regulated Power Supply, it provides service bench and circuit development users with regulated DC voltages from 0 to 400 volts and a bias supply from 0 to -150 volts. A 12.6-volt AC supply is also included. The front panel display includes variable range voltage controls and two double-jeweled D'Arsonval meters. Price is \$99.95.

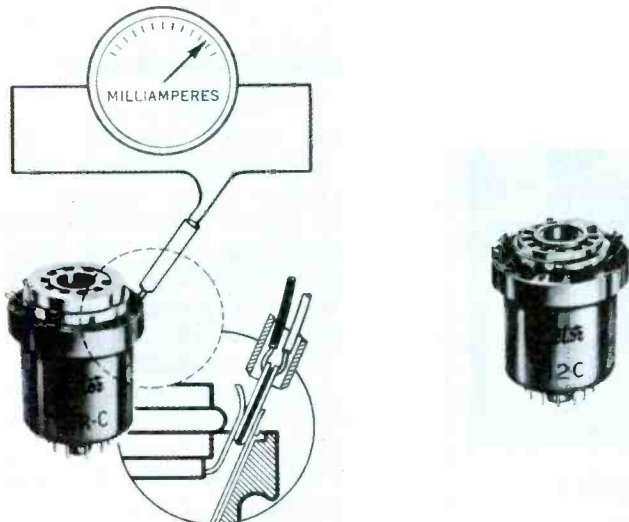

**Current Test Adapters**

(54)

The availability of two more Current Test Adapters is announced by **Vector Electronic Company**. These

**You can pay more  
but you buy less!**



**new Lectrotech V6-B  
color bar generator**

**99<sup>50</sup> brings you...**

- **Guaranteed performance . . . full one year warranty.**
- **A.C. operated solid state generator . . . no batteries to buy . . . no failures when needed most.**
- **Most stable generator of all . . . sharper, brighter patterns.**

The V6-B provides crystal-controlled keyed rainbow color display, all cross hatch, dots, vertical lines only, horizontal lines only, Red-Blue-Green gun killer, exclusive Dial-A-Line feature (horizontal line width adjustable), voltage-regulated transistor and timer circuits, simplified rapid calibration. Supplies adjustable dot size, RF output more than 10,000 mv, operates on channels 3, 4 or 5, has color level control for color sync servicing. Connects to antenna terminals (no connection needed inside of set). Power transformer-line isolated. Stable operation under wide voltage ranges assured by fully voltage-regulated circuits. Hand-wired reliability . . . no printed circuits. Fully enclosed test lead compartment. Rugged, caddy size unit built to withstand rigors of field servicing. Size: 7<sup>5</sup>/<sub>8</sub>"W, 3<sup>1</sup>/<sub>2</sub>"H, 9"D.

Weight: 5<sup>1</sup>/<sub>2</sub> lbs. Only **99<sup>50</sup>**

See your distributor or write for literature.

DEPT. PF-5

**LECTROTECH, INC.**

1221 W. Devon Ave., Chicago, Ill. 60626

Circle 39 on literature card

May, 1967/PF REPORTER 65

**NEW!** from **SECO**

**"IN-CIRCUIT"  
CURRENT CHECKER**

Eliminates most common cause of "callbacks" (unstable focus, shrinking pictures, etc.)! Should pay for itself on next months' calls alone!

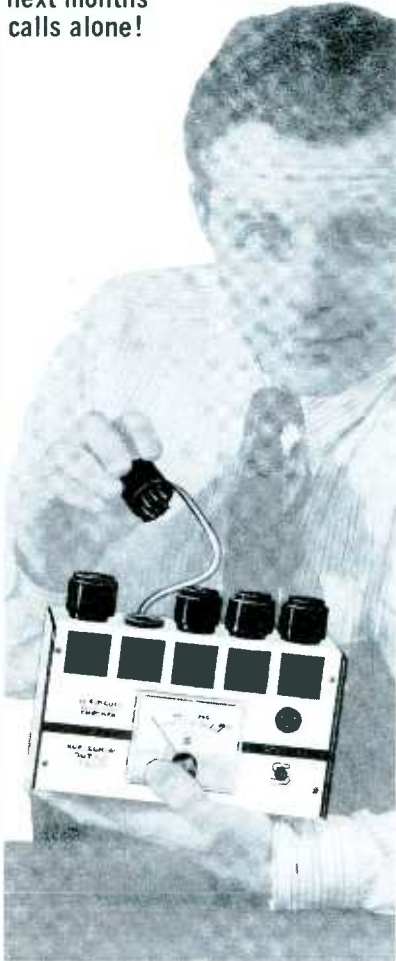

Nothing else like the HC-8 available! Tune horizontal drive and linearity for "dip"—and in seconds—you've got best possible focus, width and stability at minimum cathode current. Makes convergence adjustments faster, easier—longer lasting! Especially useful on color TV where a slight misadjustment of horizontal linearity or efficiency coils drives cathode currents sky high! 5 pre-wired sockets for all popular horizontal output tubes lets you plug into circuit fast—no clip-  
Model HC-8  
\$34.50  
Net  
ping or unsoldering of leads!

**ASK YOUR DISTRIBUTOR**  
or write for full details.

**SECO**  
**ELECTRONICS CORP.**

1001 Second St. So. • Hopkins, Minn. 55343

Circle 40 on literature card

66 PF REPORTER/May, 1967

new models permit current measurements on any pin position of Novar and Compactron tubes from the tube side of the chassis without cutting any leads. In the past, lack of a simple method to make current measurements, particularly in the high-voltage section of color television sets, has resulted in excessive tube failures because of improper current adjustment.

The Novar and Compactron Current Test Adapters, like their earlier counterparts for the 7-, 8-, and 9-pin tubes, have two spring test tab elements for each pin that break the circuit when a dual-sided probe is inserted in the test position. Probes are gripped by the test tabs and need not be held in position. Current is read on the meter connected to the two test leads. The same test adapters and probe also permit voltage and waveform readings on any pin position by merely connecting the leads jointly to the meter. Both adapters have mica-filled shells and keyways, and may be used in a horizontal or vertical position.

The new test adapters, designated Model T9RC and T12C, are priced at \$3.65 and \$3.85, respectively. P-2 Probes are 79c each when purchased with the adapters.



**Marker Generators**  
(55)

Two new marker generators for superimposing crystal-controlled AC or DC marks upon an oscilloscope display of response curves are available from **Jerrod Electronics Cor-**

**poration.** The Model CM-6 marker generator can be programmed to provide any desired fundamental frequency between 2 and 100 MHz. The rack-mounted Model CM-10 has a frequency range of 100 kHz to 100 MHz. Harmonics up to the 20th are visible in the higher frequencies (20 to 100 MHz), and harmonics up to the 10th are visible in the lower frequencies (100 kHz to 20 MHz). Proper choice and proper mixing will provide harmonic and sideband markers across a wide bandwidth.

The preamplifiers used in both generators have a gain of 40 dB minimum, and a maximum undistorted output of 5 volts into 100K ohms, or higher. Flatness is  $\pm 2$  dB from 20Hz to 20 kHz for the Model CM-6 and  $\pm 2$  dB from 20Hz to 50K Hz for the Model CM-10. Price of the Model CM-6 is \$365.00.

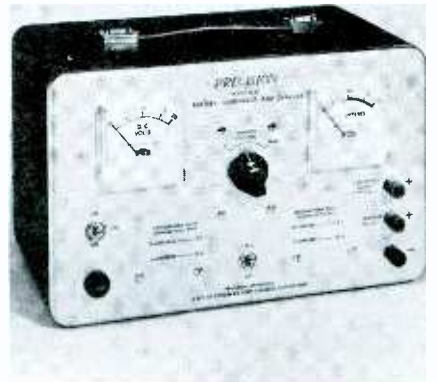

**Battery Eliminator and  
Charger**  
(56)

A new battery eliminator and charger incorporating a unique "low-ripple" output circuit designed to meet the special requirements of transistorized car radios and other electronic equipment of 6- and 12-volt ratings has been developed by **Precision Apparatus.** The Model B-10 Battery Eliminator and Charger provides a continuously variable output from 0 to 8 volts DC and 0 to 16 volts DC at both the low-ripple and standard output terminals. The standard output capacity at the 6-volt setting is 10 amps DC continuous and 20 amps DC intermittent. The output capacity of the 12-volt range is 6 amps DC continuous and 12 amps DC intermittent.





RCA  
Transistors  
Rectifiers  
Integrated  
Circuits

For  
EXPERIMENTERS  
HOBBYISTS  
HAMS  
and  
TECHNICIANS

LOOK FOR THIS  
DISPLAY AT YOUR  
RCA DISTRIBUTOR

Here displayed on the RCA Solid-State Center is the RCA SK-Series Transistors, Rectifiers, and Integrated Circuits; the new RCA 3N128 MOS Field-Effect Transistor; RCA's 40214 Silicon Stud Rectifier; and three RCA Experimenter's Kits. This new Solid-State Center, in addition to its host of devices, also includes technical literature to support the devices right on the rack. It's the "one-stop" answer to the solid-state needs of experimenter, hobbyist, ham, or the replacement requirements of the service technician.

All devices and kits are packaged in easily identifiable see-through packs for your convenience. Included with each device is broad performance data or specific ratings and characteristics where applicable.

RCA Solid-State Center Includes:

- RCA Experimenter's Kits. Three kits enable you to build a light dimmer or any one of 14 different circuits for dozens of applications around the house.
- RCA SK-Series "Top-of-the-Line" Devices: 17 Transistors, 2 Rectifiers, and 2 Integrated Circuits, for exper-

imenter or replacement use.

- RCA Technical Manuals. Four manuals include: RCA Experimenter's Manual, RCA Transistor Manual, RCA Linear Integrated Circuits Fundamentals Manual, and RCA Tunnel Diode Manual.
- RCA Solid-State Replacement Guide. Lists all RCA SK-Series "Top-of-the-Line" Transistors, Rectifiers, and Integrated Circuits and the more than 7,300 types which they replace.

Keep RCA Experimenter's Kits and the RCA SK-Series in mind when you're shopping for solid-state devices. Look for the RCA Solid-State Center. Now at your RCA Distributor. Do it today!

RCA Electronic Components and Devices, Harrison, N.J.



The Most Trusted Name in Electronics

**FIX'EM FAST!**  
**FIX'EM RIGHT!**

WITH

**JENSEN**

EXACT REPLACEMENT

**PHONO  
NEEDLES**

**PHONO  
CARTRIDGES**



**TAPE RECORDER AND  
PHONO DRIVE WHEELS,  
IDLERS, PULLEYS,  
BELTS, TIRES**

Complete line, top quality,  
all available at your  
friendly Jensen  
distributor's. Ask him  
for your set of Jensen  
catalogs, today!



**JENSEN**  
INDUSTRIES DIVISION

ELECTRO-VOICE, INC., Dept. 578R  
632 Cecil St., Buchanan, Michigan 49107



**CB Antenna Mount**  
(57)

A big problem for CB operators who don't relish drilling holes for their mobile antenna has been solved with a new type of trunk mount developed by **The Antenna Specialists Co.** The "Quick-Grip" device requires no holes for either cable or fasteners, and looks like a conventional permanent communications antenna installation, with neither cable nor fasteners visible.

The mount consists of a specially designed clamp that slips over the edge of the trunk lid. It is fastened and locked permanently in place by two sharply pointed, self-tapping Allen screws which lock into the underside of the lid. The assembly also supports the cable connector. The entire mount is then encased in a chrome-plated housing shaped like a section of a small inverted cone. This housing is positioned to slightly overlap the edge of the trunk lid, permitting the cable to be "snaked" through to the trunk interior without showing. A rubber grommet prevents surface marring and also bars surface water from entering.

The new Model M-161 "Quick-Grip" mount will accept any existing antenna with a  $\frac{3}{8}$ " hole requirement. Adapters are available to accommodate other antenna hole sizes. In addition, many of the company's standard mobile CB and professional antennas may be purchased complete with the new "Quick-Grip" mount. Model M-176, shown here, comprises a complete coil, shock spring, whip, and "Quick-Grip" mount. Prices include, \$7.50 for the mount alone and \$23.75 for the Model M-176 antenna. ▲

**impedance  
mismatch  
problems?**

When most voice coil impedances were either 3.2 ohms or 8 ohms, speaker replacement was relatively simple. Then came transistor sets, and equip-

ment without output transformers, and now voice coil impedances range all over the map.

It's important to remember that a mismatched impedance in a speaker replacement will almost surely create problems... from a loss of volume to a blown transistor.

**Quam...  
and only Quam...  
helps you avoid  
these problems  
these three ways:**

**1. WIDE CHOICE**—As Photofacts/Counterfacts participants, we know in advance what voice coil impedance the new equipment will require, so we generally have the right speaker in our comprehensive line *when you need it.*

**2. VERSATILE SPEAKERS**—Quam *multi-tap speakers* offer a choice of impedances in a single unit. Available in all the sizes you need for automotive replacement, Quam multi-taps handle 10, 20, or 40 ohm applications.

**3. SPECIAL SERVICE**—Just in case you run across an oddball, we offer this convenient exclusive: *any Quam speaker can be supplied with any voice coil impedance, only \$1.00 extra, list price.*



**QUAM**

THE QUALITY LINE

FOR EVERY SPEAKER NEED

**QUAM-NICHOLS COMPANY**

234 East Marquette Road • Chicago, Illinois 60637

Circle 43 on literature card

Circle 42 on literature card



# INDEX TO ADVERTISERS

May, 1967

Arrow Fastener Co., Inc. ....	60	Motorola Consumer Products, Inc. ....	13
Belden Mfg. Co. ....	33	Nortronics Co., Inc., Distributor Div. ....	58
B and K Mfg. Co., Div. of Dynascan Corp. ....	17	Oxford Transducer Co. ....	58
Blonder-Tongue Labs, Inc. ....	18	Quam-Nichols Co. ....	68
Bussmann Mfg. ....	20, 21	Quietrole Co. ....	63
Castle TV Tuner Service, Inc. ....	39	RCA Components and Devices (Entertainment Tubes) ....	cover 3
Channel Master Corp. ....	37, 38	RCA Components and Devices (Parts and Accessories) ....	54
Chemtronics ....	69	RCA Components and Devices (Semiconductor) ....	67
Cleveland Institute of Electronics ....	19	RCA Components and Devices (Test Equipment) ....	34
Eico ....	69	RCA Sales Corp. ....	50
Electronic Measurements ....	36	Sams, Howard W. & Co., Inc. ....	63
Electro-Voice, Inc. ....	68	Seco Electronics Corp. ....	39, 66
The Finney Co. ....	63, 69	SENCORE, Inc. ....	53, 55, 57, 59, 61
G.C. Electronics ....	62	Simpson Electric Co. ....	40
Genral Electric, Industrial Sales Div. ....	45	Sprague Products Co. ....	15, 16
Heath Co. ....	51	Teletone Co., Inc. ....	52
Jerrold Electronics Corp. ....	cover 2	Texas Crystals ....	63
JFD Electronics Co. ....	48, 49	Winegard Co. ....	31, 35
Lectrotech, Inc. ....	64, 65	Xcelite, Inc. ....	60
Littelfuse, Inc. ....	cover 4	Zenith Sales Corp.—Parts & Accessories ....	56
Mercury Electronics Corp. ....	62		
Miller, J. W. & Co. ....	52		



A NEW  
**TUNER CLEANER**  
*Specially*  
**FORMULATED**  
FOR  
**TV-TUNERS**  
USING  
**NUVISTORS & TRANSISTORS**

CAT. NO.  
800  
\$196  
DEALER  
NET

Nuvistors and Transistors are highly sensitive to drift from ingredients in most ordinary TV tuner cleaners. Drift has been found to cause call backs and expensive tuner repairs. For over 18 months CHEMTRONICS has been formulating and testing this new cleaner in both the lab and field. Under the most critical test, there has been NO DRIFT on scope patterns. We invite you to try this test yourself.

**NO NUVISTOR DRIFT**  
*Another FIRST from*



BROOKLYN

N. Y. 11236

Circle 44 on literature card

May, 1967/PF REPORTER 69

## **NEW** POWER FROM **FINCO**

**Model 65-3 VHF-TV ANTENNA AMPLIFIER**  
improves reception of WEAK VHF-TV signals in FRINGE AREAS even where strong local TV or FM signals are present. **AMPLIFIES UP TO 7 TIMES** for Better Color and B/W

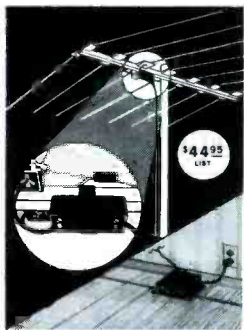

Model 65-3 VHF-TV ANTENNA AMPLIFIER

A two-transistor—amplifier. Engineered to provide the lowest noise and highest amplification with the most desirable over-load characteristics.

Amplifier used in conjunction with dual outlet power supply for one, two, or multiple set installations. 117 V 60 cycle input. AC power up to amplifier: 24 volts—60 cycle.

Let Finco solve your Color and B & W reception problems. Write for complete information, schematics and specifications. Form #20-357.

**THE FINNEY COMPANY**  
34 West Interstate St. • Bedford, Ohio 44014 • Dept.

Circle 46 on literature card

## **FREE!** the **NEW** 1967 **CATALOG** from **EICO®**



**electronic instruments**  
(both kit and wired)

Big 36-page catalog features many new models and "best buys." Explore Eico's complete line of 200 electronic kits and factory-assembled instruments for CB, ham, hi-fi, short wave communications, electronics testing and for teaching electronics.

**Write today!**

Eico Electronic Instrument Co., Inc.

131-01 39th Avenue,  
Flushing, New York 11352 PF-5

Send **FREE** 1967 Eico Catalog.

Name

Address

City

State  Zip

Circle 45 on literature card



# \$ FREES \$

## CATALOG AND LITERATURE SERVICES

\*CHECK "INDEX TO ADVERTISERS" FOR FURTHER INFORMATION FROM THESE COMPANIES

### ANTENNAS

75. **ALLIANCE** — Colorful 4-page brochure describing in detail all the features of Tenna-Rotors.
76. **ANTENNACRAFT** — 12-page catalog listing complete Antennacraft line of UHF, VHF & FM antennas for all types of installations.
77. **BLONDER-TONGUE** — Compact brochure detailing a line of all-channel products expressly designed to improve reception in the home and small MATV systems.
78. **COLORMAGIC**—Form FR-28-C describes a complete line of antennas and accessories.
79. **CORNELL-DUBILIER** — 16-page booklet illustrates color, black-and-white TV, and FM-stereo reception problems that are eliminated by the installation of a CDE antenna rotor system.
80. **DELHI**—Twelve-page catalog introducing a complete new line of home TV towers, ham towers, citizen's band towers, masts and telescoping masts.
81. **FINNEY** — Forms 20-338, 20,356, and 20-357 describing distribution amplifiers and antenna amplifiers for 300-Ohm and 75-Ohm TV and FM systems.\*
82. **JERROLD** — New 4-page full-color catalog describes the new Paralag Plus antennas.\*
83. **JFD** — Color Laser and LPV antenna brochures. New 1967 dealer catalog covering complete line of log-periodic out-door antennas, rotators, and accessories.
84. **MOSLEY** — Information on new Mosley MATV system for up to 8 TV/FM sets. Includes TV antenna, distribution system and outlets.
85. **PARKER**—Flyer sheet about a new tunable indoor antenna.
86. **WINEGARD** — 8-page color brochure on new Super-Colortron antennas: 5 VHF-UHF-FM, 4 VHF-FM, 3 UHF. Includes information on 6 new solid-state preamplifiers and 82-channel booster-couplers.\*

### AUDIO

87. **ATLAS SOUND** — Catalog 556-67 illustrates and describes many new models of public address loudspeakers, microphone stands, and accessories for commercial sound applications.\*
88. **DOBBS/STANFORD**—Flyer sheets on a line of tape recorders and microphones.
89. **ELECTRO-VOICE** — A comprehensive guide to microphones and microphone accessories is offered in pocket-sized brochure form.\*
90. **JENSEN**—New electronic musical instrument loudspeakers brochure, NY-2, containing newest additions to the line.
91. **3M** — Literature describing flat cable jumper systems.
92. **NUTONE** — 16-page full color booklet illustrating built-in stereo music, intercom, and radio systems.
93. **OXFORD TRANSDUCER** — Catalog sheets featuring speaker systems for automobiles.
94. **RACON** — Full line horn loudspeakers, sound columns and microphone stands are described in a new catalog.
95. **SWITCHCRAFT**—Bulletin 168 describes a new hi-fi/stereo speaker switching system. Models 641 and 642 sound control centers will control up to 8 complete stereo speaker systems.
96. **VIKING**—Brochures about Viking Model 230 and Magnecord Models 1028-1048.

### COMMUNICATIONS

97. **AMPHENOL** — 2-color spec sheets on new Model 650 CB transceiver and Model C-75 hand-held transceiver.
98. **COMO**—Flyer describing a line of business-band and public-service-band communications equipment.

99. **MOTOROLA** — New brochure tells how to reach people on-the-move through use of personal two-way radio.\*
100. **PEARCE-SIMPSON** — Brochures and flyers on the complete line of CB transceivers.

### COMPONENTS

101. **BUSSMANN**—New 1967 16-page car and truck fuse list. Shows what fuse protects —proper fuse to use and where fuse is located. Also shows what BUSS fuse to use in servicing foreign cars and trucks. Ask for BUSS Form AWC.\*
102. **CENTRALAB** — Catalogs offered on electrolytic capacitors, PEC's, and auto radio shafts and bushings.\*
103. **G.C.**—Phono drive wall chart and supplement.
104. **LITTEL FUSE** — Pocket-sized TV circuit breaker cross-reference gives the following information at a glance. Manufacturer's part number, corresponding Littelfuse part number, price, color or b/w designation. A second glance gives trip ratings and acquaints you with a line of caddies. Ask for CBCRP.\*
105. **QUAM-NICHOLS** — Quam-auto radio speaker replacement guide. Complete replacement information on front and rear-seat speakers for automobile radio models from 1955-1966.
106. **SONOTONE**—Data reference catalog on a line of nickel-cadmium batteries.
107. **SPRAGUE**—C617, a complete catalog of the Sprague line.\*
108. **SWITCHCRAFT** — Distributor bulletin D-816 describes Switchcraft's new "traffica-tored" audio dealer and distributor accessory merchandiser program.
109. **WORKMAN**—New coil catalog lists general and exact replacements for radio and TV schematic drawings and illustrations of all coils.\*

### SERVICE AIDS

110. **CASTLE TUNER** — How to get fast overhaul service on all makes and models of television tuners is described in leaflet. Shipping instructions, labels, and tags are also included.\*
111. **CHEMICAL ELECTRONIC ENGR.** — Brochure of contact cleaners for TV tuners and controls.
112. **ELECTRONIC CHEMICAL** — Catalog sheet on aerosol sprays for servicemen.
113. **MIDSTATE TUNER**—24-hour service on any make tuner is described in a colorful brochure.
114. **POMONA**—36-page catalog of the complete line of molded electronic accessories.
115. **QUALITY TUNER SERVICE** — Introductory letter describing costs and service on all makes of TV tuners. Repair tags and shipping labels included.
116. **RAWN**—Bulletins on repair ideas using Plas-T-Pair knob and plastic repair kits. Also, bulletins on tuner cleaners and circuit coolers. Includes price sheets.
117. **WILCO**—Flyer sheet on anti-static plastic cleaners.

### SPECIAL EQUIPMENT

118. **ELECTRONIC ALARMS** — Installation guide for burglar alarms.
119. **PERMA POWER** — Catalog sheet in Model G-670 solid-state garage opener.
120. **STACO** — New 6-page product guide contains information on a complete line of variable autotransformers and isolated variable transformers.

### TECHNICAL PUBLICATIONS

121. **CLEVELAND INSTITUTE OF ELECTRONICS**—Free illustrated brochure describing electronics slide rule and four lesson instruction course and grading service.\*
122. **MALLORY**—Free 32-page booklet "Tips for Technicians."\*
123. **PHILCO**—Information about Tech Data & Business Management service. Also, free parts catalog.\*
124. **RCA INSTITUTES** — New 1967 career book describes home study programs and courses in television (monochrome and color), communications, transistors, industrial, and automation electronics.\*
125. **SAMS, HOWARD W.**—Literature describing popular and informative publications on radio and TV servicing, communications, audio, hi-fi, and industrial electronics, including special new 1967 catalog of technical books on every phase of electronics.\*

### TEST EQUIPMENT

126. **B & K**—New 1967 catalog featuring test equipment for color TV, auto radio, and transistor radio servicing, including tube testers designed for testing latest receiving tube types.\*
127. **EICO**—New long-form catalog of the complete Eico line.\*
128. **HICKOK**—Short form catalog plus specification sheets on the Models GC 660 color generator, CR-35 CRT analyzer/rejuvenator, and 860 Injecto-Tracer.
129. **JACKSON**—New line folder or "Service Engineered, test equipment includes push-button-operated color-dot/bar generator.
130. **LECTROTECH**—Two-color catalog sheet on new Model V-6-B color bar generator, the latest improved model of the V-6. Gives all specs and is fully illustrated.\*
131. **MERCURY**—All-new-low-price color dot bar generator and Model 2000 conductance tube checker all for under \$100.
132. **PRECISION APPARATUS** — Illustrated catalog describing signal generators, oscilloscopes, and meters.
133. **SECO**—Operating manual for Seco's new Model 107C tube tester with constant voltage transformer and eye tube indicator for the grid circuit test.
134. **SEMITRONICS**—Brochure on the new Model 1000 transistor tester.
135. **SENCORE**—8-page full color catalog plus a new 4-page supplement catalog.\*
136. **SIMPSON**—New 1967 16-page test equipment brochure featuring a palm-sized VOM, Model 160.
137. **SINGER**—Catalog GD-1 describing frequency meters and standards receivers for the two-way radio communications service.
138. **TRIPLETT**—All test equipment catalog #50-T featuring VOM's, VTVM's, transistor analyzers, tube testers and accessories.\*

### TOOLS

139. **ARROW**—Catalog sheet showing 3 staple gun tackers designed for fastening wires and cables up to 1/2" diameter.
140. **ENTERPRISE DEVELOPMENT**—Time-saving techniques in brochure from Enteco demonstrate improved desoldering and resoldering methods for speeding and simplifying operations on PC boards.\*
141. **LUXO** — Flyers on counterbalanced and magnifying bench lamps.
134. **VACO PRODUCTS**—Catalog No. SD-123 on self-adjusting nut driver which selects right hex size from 1/4" to 7/16" automatically.
143. **WEN**—Four-page, four-color catalog features full line of single-post soldering guns.

### TUBES AND TRANSISTORS

144. **CALVERT**—Price lists on tubes and semiconductors and data sheets and catalogs on AEL semiconductors made in U. K.
145. **IR**—Transistor cross reference guide—22 pages of detailed specifications on universal silicon and germanium transistors and a complete listing of more than 5000 devices which they replace.
146. **RADIO CORP. OF AMERICA**—PIX 300, a 12-page product guide on RCA picture tubes covering both color and black-and-white. Includes characteristics chart, terminal diagrams, industry replacement, and interchangeability.\*





## WEAK COLOR?

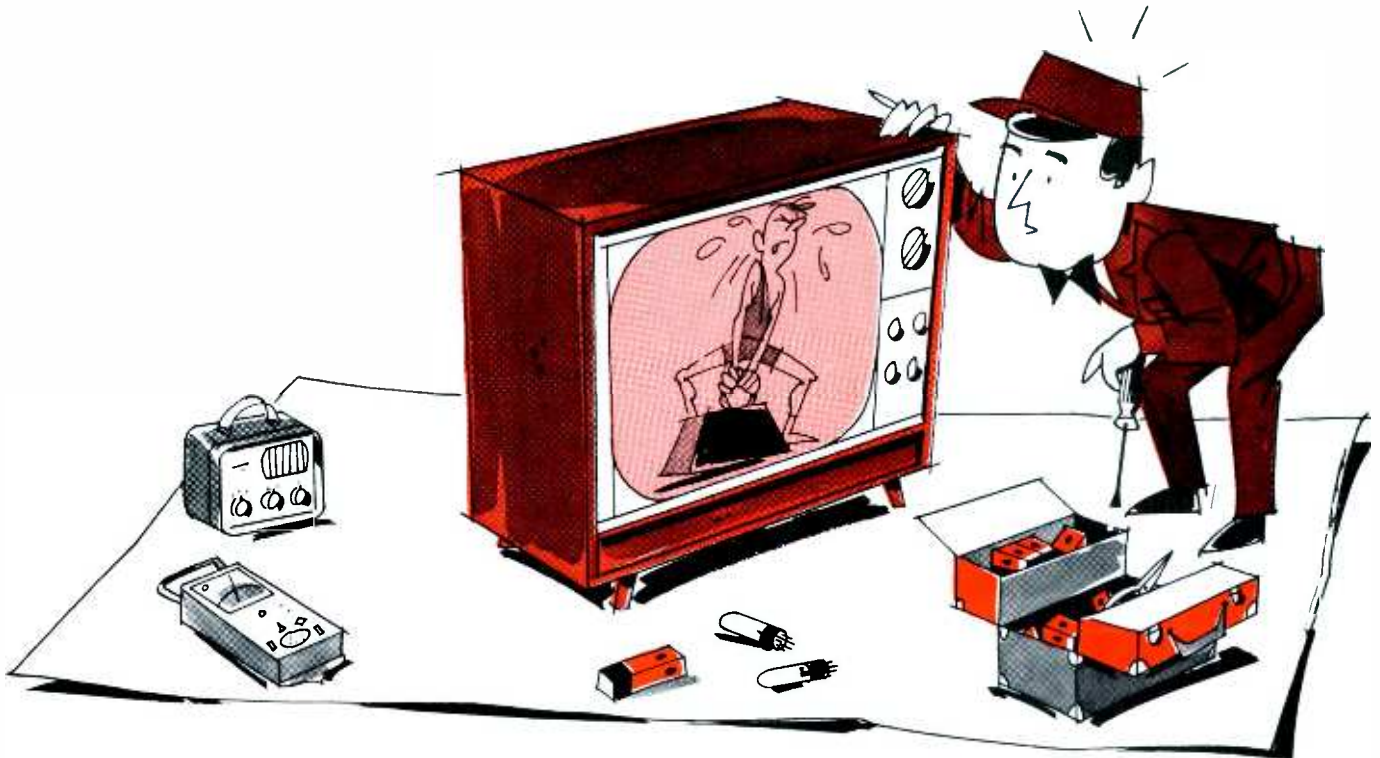

### Follow these steps to isolate the trouble area...

If colors lack full saturation, make sure that fine-tuning, brightness and color controls are set correctly. Then determine the receiver section in which signal is attenuated as follows:

1. Apply an rf color-bar signal at the antenna terminals.
2. Connect a scope at the video detector. Check amplitude of the color-bar pulses and sync pulses. They should be approximately the same. If color-bar pulses are attenuated, check for trouble, including poor bandpass, between the antenna terminals and the video detector.
3. If amplitudes are correct, look for trouble in the chroma section, as follows:
  - a. Check bar-pulse amplitude at input and output of bandpass amplifier.
  - b. Check bar signal at input and output of demodulators and color amplifiers. Note: Trouble in only one of these stages will produce a *shift* in colors, which will show up in the color-bar pattern. Loss of color saturation in the demodulators or color amplifiers, therefore, indicates trouble in a circuit common to the demodulators or color amplifiers.
4. Once the defective stage or section has been found, use voltage or resistance measurements to pinpoint the circuit defect.

This is another in RCA's continuing series of color TV service hints, to help make your job easier. Your RCA tube distributor can also make your job easier, because he's your best source for quality RCA receiving tubes for color TV, as well as for black-and-white TV, radio and hi-fi. You enjoy more customer confidence and satisfaction when you replace with RCA receiving tubes,

RCA ELECTRONIC COMPONENTS AND DEVICES, HARRISON, N. J.



The Most Trusted Name in Electronics

# Give yourself a break you can depend on!



actual size  
1 3/4" x 1/4" x 1/2"



#094077

#### CIRCUIT BREAKER CADDY

10 ratings, one each 2-1/4, 2-1/2, 2-3/4, 3, 3-1/4, 4, 4-1/2, 5, 6 and 7 amps.

#### SERVICE CADDY Breakers and Fuses

One service call is all—8 breakers—one rating each 2-1/4, 2-3/4, 3, 3-1/4, 4, 4-1/2, 5 and 7 amps and 30 fuses—five each type C3/10, C1/2, C3-1/2, N3/10, N7/10 and N1.



#094076

Designed for the protection of television receiver circuits, the Littelfuse Manual Reset Circuit Breaker is also ideally suited as a current overload protector for all types of electronic and electrical control wiring such as model railroads and power operated toy transformers, hair dryers, small household appliances, home workshop power tools, office machines and small fractional horsepower motors.

Available individually packaged one breaker per display card; or 5 breakers of same rating per unit pack or as complete, versatile assortments for shop use or replacements in the field.

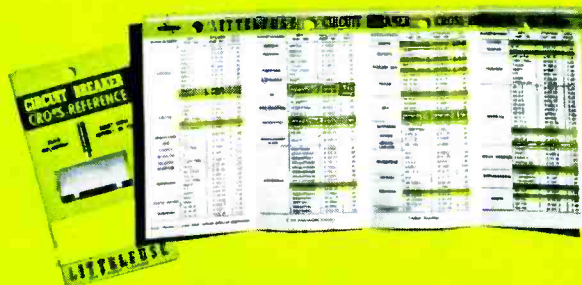

Included with each assortment:  
Pocket size cross reference on color and black/white TV circuit breaker applications.  
Form No. CBCRP-1266H

# LITTELFUSE

DES PLAINES, ILLINOIS

Circle 47 on literature card