

PF Reporter®

PHOTOFACT

the magazine of electronic servicing



1A 6K 1061 568
 R. A. FAARPTON
 FRAMPTON RADIO SERV.
 BOX 144
 FIDREDS PA. 16781

- Notes on Test Equipment
- Transistor Testers
- Audio Equipment
- Scope Probes

NEW! beginning in the APRIL issue
TUBE SUBSTITUTION
 Supplement
 (SEE PAGE 1 FOR DETAILS
 ON THIS NEW
 FEATURE!)

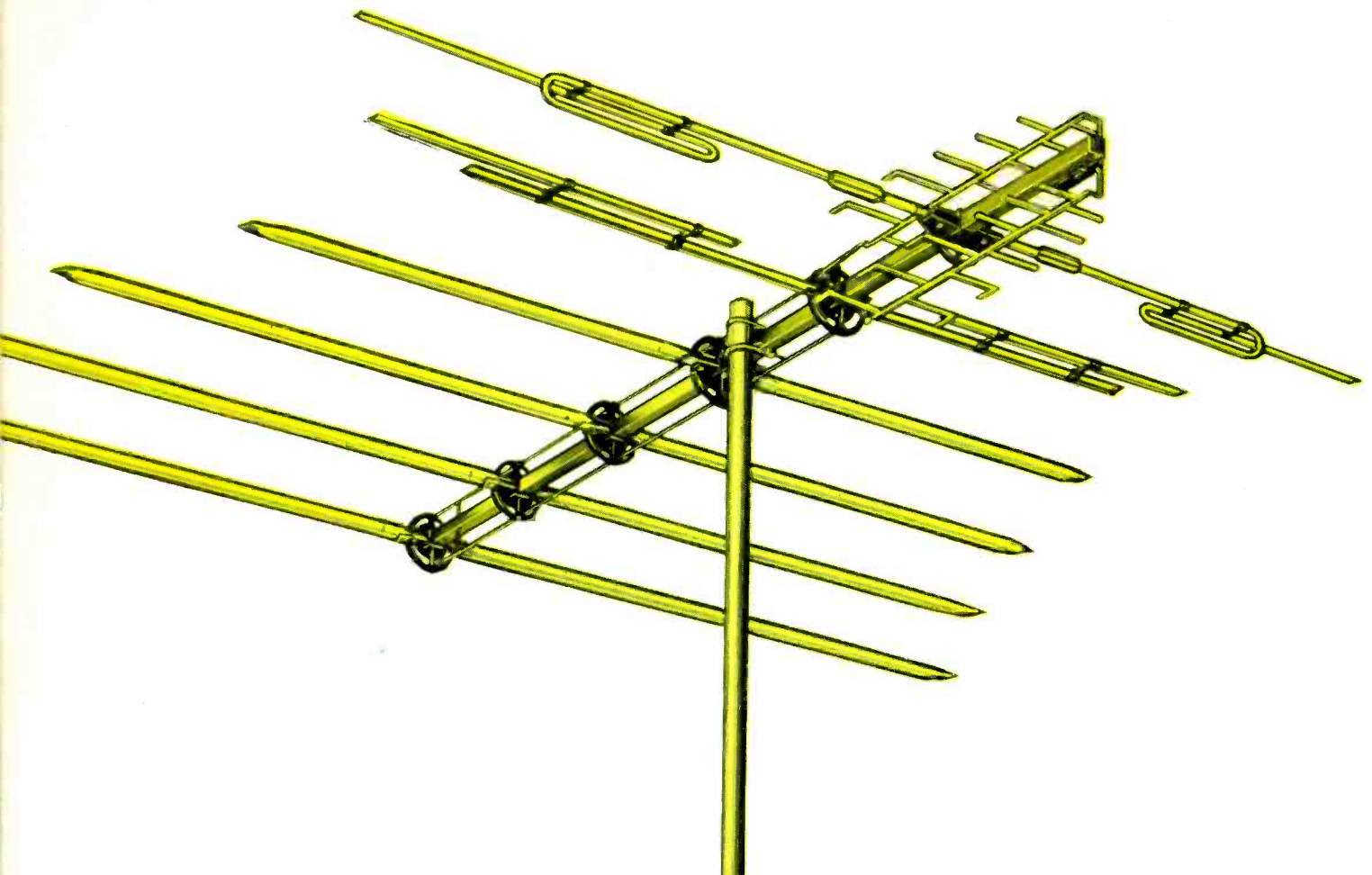

Fill the "profit gap" with the new Jerrold **VU FINDER** ^{T. M.} 82-channel antenna

Now—the economical new Jerrold VUfinder 82-channel antenna provides the best possible 300-ohm all-channel color TV and FM reception. The VUfinder joins Jerrold's Coloraxial Pathfinder and Paralog-Plus antennas to give you another chance to profit on Jerrold reception quality:

- Sharp directivity eliminates color ghosts
- Flatness of ± 1 db per channel assures greater color fidelity
- Color-distorting phase shifts are eliminated

The Jerrold VUfinder Antenna actually works on both high and low band channels simultaneously—making each element serve double duty. The models are short, easier to install, and offer less wind loading than ordinary antennas of comparable gain. And each antenna comes complete with a UHF/VHF frequency splitter for the back of the set.

Focus on Jerrold. First with the finest products and profits. For details on the Jerrold VUfinder 82-channel antenna, see your Jerrold distributor.

JERROLD®

DISTRIBUTOR SALES DIVISION
401 Walnut Street, Phila., Pa. 19105

Circle 1 on literature card



NEW! from **SECO**

"IN - CIRCUIT" CURRENT CHECKER

Eliminates most common cause of "callbacks" (unstable focus, shrinking pictures, etc.)! Should pay for itself on next months' calls alone!



Nothing else like the HC-8 available! Tune horizontal drive and linearity for "dip"—and in seconds—you've got best possible focus, width and stability at minimum cathode current. Makes convergence adjustments faster, easier—longer lasting!

Especially useful on color TV where a slight misadjustment of horizontal linearity or efficiency coils drives cathode currents sky high! 5 pre-wired sockets for all popular horizontal output tubes lets you plug into circuit fast—no clipping or unsoldering of leads!

Model HC-8
\$34⁵⁰
Net

ASK YOUR DISTRIBUTOR
or write for full details.

SECO
SECO
ELECTRONICS CORP.
1001 Second St. So. • Hopkins, Minn. 55343

Circle 2 on literature card



LETTERS TO the EDITOR

Dear Editor:

I've been a reader of your magazine since its inception. I think it's the best in the field. For electronic technicians it's a must.

I would like to see some articles on the European color systems, such as West Germany's PAL and France's SECAM. Also, what is Japan doing?

A. SKVARECK

Orange City, Fla.

We have outguessed you on this one. Negotiations are already under way to have an author in Great Britain write an article on European color systems.—Ed.

Dear Editor:

Just a line to let you know how much I enjoy your magazine. I generally read them from cover to cover. I have been most interested in your series of articles on square wave testing. However, it seems to me that there might be a simpler approach to the problem of integrated circuits that might be handled with less expensive and less complex equipment. Basically, there is nothing that the technician can do to these solid integrated circuits except replace them when they are found to be defective.

To me, it looks as if the introduction of integrated circuits will speed and simplify the servicing of electronic equipment provided that replacement parts are readily available. However, information about the input and output voltages and waveforms must be available to the technician. In any event, integrated circuits are going to be more and more frequently used, so anything that can be done to familiarize the technician with them will be most helpful.

W. WILSON

Pittsburgh, Pa.

Our intention in publishing the Advanced Servicing Techniques series was to instruct the technician in troubleshooting integrated circuits. If the function of the IC is known, the actual circuit configuration of the IC need not be known. Either the device works or it

doesn't. If not, it must be replaced. You can be assured that PHOTOFACT Folders will present the maximum amount of servicing information for integrated circuits.—Ed.

Dear Editor:

I enjoy your PF REPORTER very much—keep up the good work. Follow up articles similar to the one you had on electronics in medicine would be appreciated. Any info you can send me on servicing such medical equipment would be very much appreciated.

J. ZALESKI

Titusville, Fla.

The results of a reader survey we conducted approximately two years ago indicated that very few of our readers actually service medical equipment. If enough readers are interested in articles on medical equipment, we will do our best to provide them.—Ed.

Dear Editor:

Recently we had trouble with a TV using the multivibrator vertical oscillator-vertical output circuit. After much trouble and time, we fixed the set.

Since there is so much inherent interdependence in this type of circuitry and pulsed voltages preclude live-voltage testing, may we propose a Symfact or a series of articles on this circuit. We truly believe this could be a time-saving article for those technicians who will, I am sure, encounter defects in this type of circuit at one time or another.

Many thanks for PF REPORTER, which we have found to be an excellent tool. Whenever we "run out of gas" on a dog, we return to the old copies for renewed inspiration and leads.

O. KINBACHER

Babylon, New York

Suggestions from our readers are always welcome. How else can we know what our readers want and need. However, a very similar circuit was covered in the December, 1962 Symfact. We will continue to investigate the possibilities of another Symfact on this type of circuit.—Ed.

Winegard Introduces Super Compact Total Design Electronic SUPER COLORTRONS

Five 82-Channel Models
Four VHF/FM Models
Three UHF Models
...so revolutionary in design and concept,
they have 7 patents and patents pending

82-Channel Super Colortron
Model SC-82; \$54.95

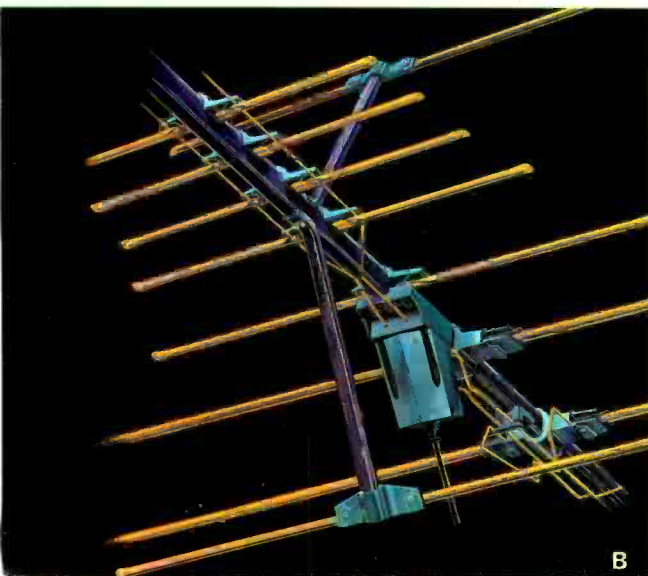
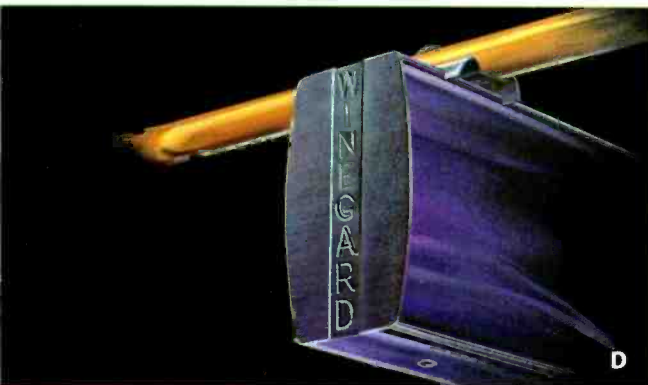

The World's First Total Design Antennas

New antennas come and go. But there's never been an antenna like the amazing Winegard Super Colortron. 12 models in all—totally designed with more exclusive electronic, construction and performance features than all other antennas combined. It's taken us a while to create and develop and perfect the Super Colortron. But it was worth the time. See for yourself. Read about the Super Colortron's exclusive features. Then call your Winegard distributor. Or write for full color, 8-page brochure.

(A) Total Design

Cartridge Pre-Amps:

Exclusive solid state, instant-loading cartridge pre-amps drop into totally enclosed, weatherproof cartridge housing at point of signal interception. Models for 82-channel (VHF-UHF) antennas, VHF only, UHF only—plus a color spectrum filter. Custom-match the Super Colortron to any reception requirements.

Total Design

Impedance Correlators:

Exclusive impedance correlators (2 patents pending) automatically increase 75 ohm driven elements to 300 ohms to provide 100% signal transfer from antenna to set. Enables antenna to be 20% more compact!

(B) Total Design

Vertical Resonant Reflectors:

Exclusive UHF vertical resonant reflectors achieve highest realizable gain on channels 14-83 because of exceptionally large vertical capture area. More UHF gain than any other 82-channel antenna design.

Total Design

Electro-Lens Director System:

Exclusive patented Electro-Lens system (U.S. Patent 2,700,105; Canada 511,984) absorbs entire signal and focuses it directly onto the driven elements to give Super Colortrons pinpoint directivity.

Circle 3 on literature card

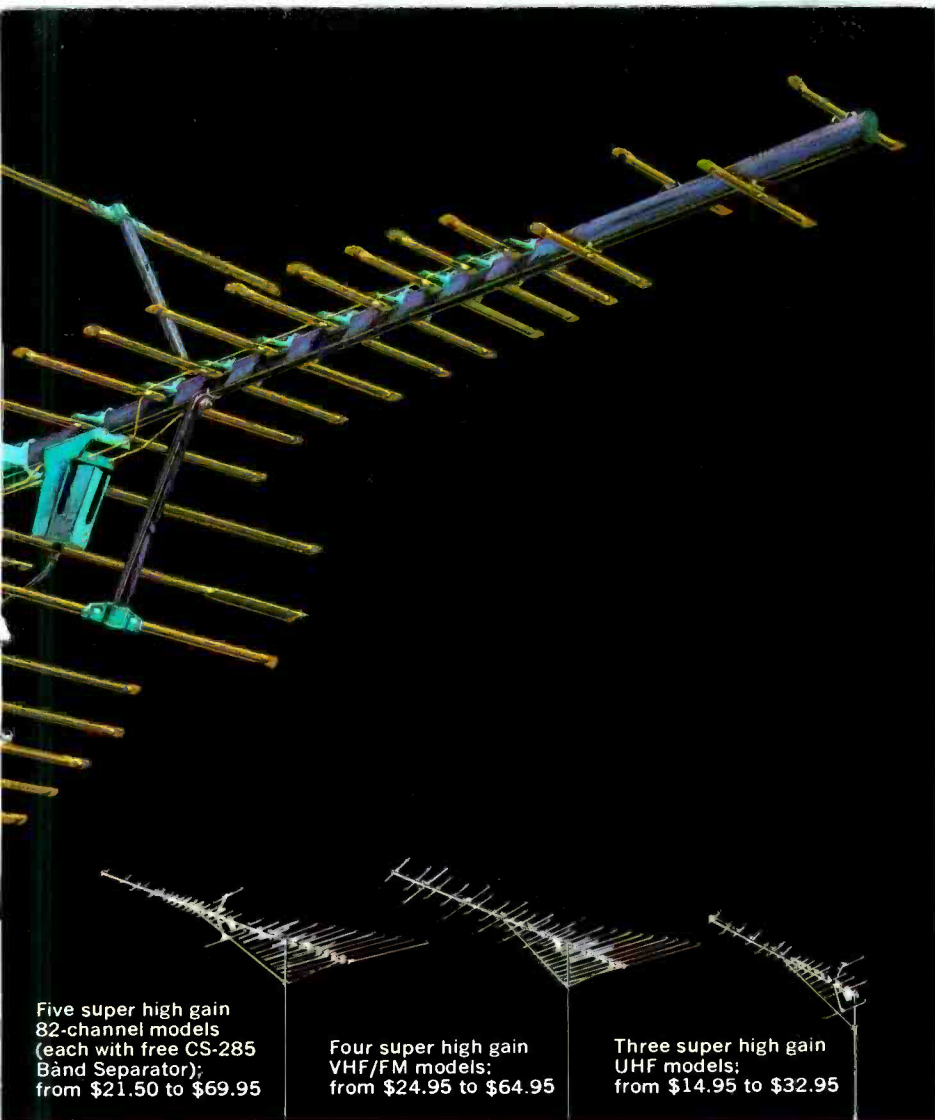

Five super high gain 82-channel models (each with free CS-285 Band Separator); from \$21.50 to \$69.95

Four super high gain VHF/FM models; from \$24.95 to \$64.95

Three super high gain UHF models; from \$14.95 to \$32.95

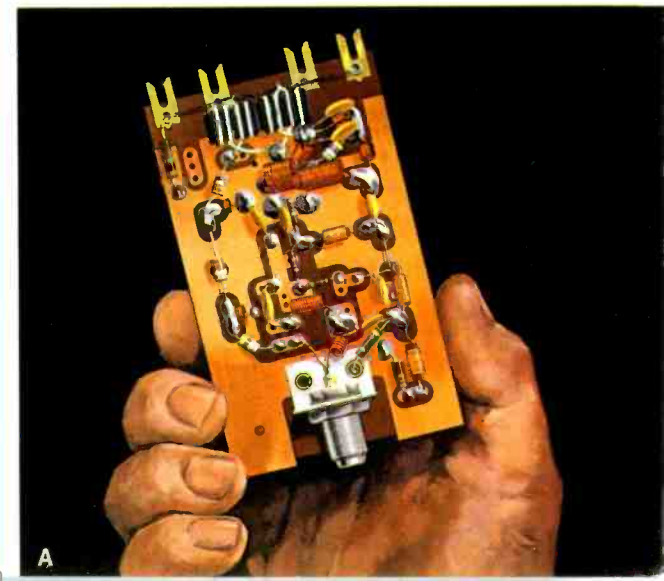
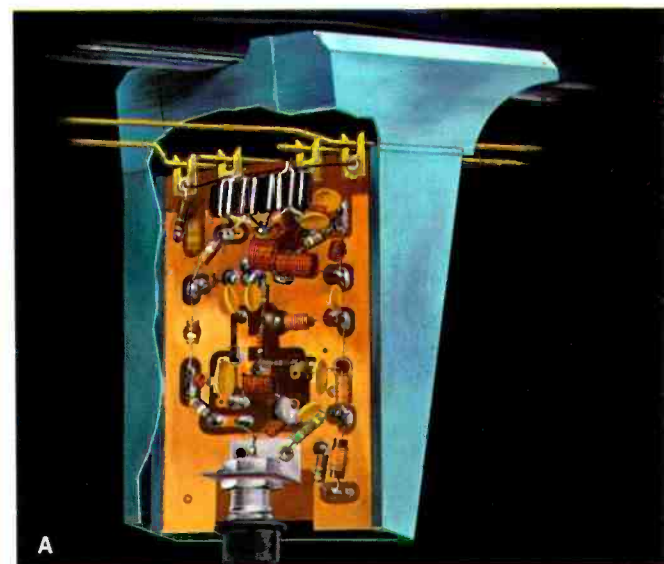
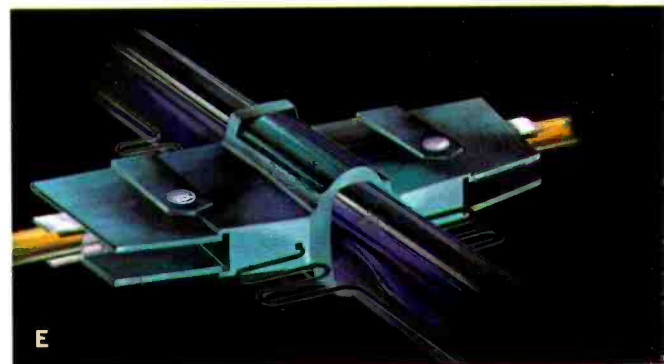
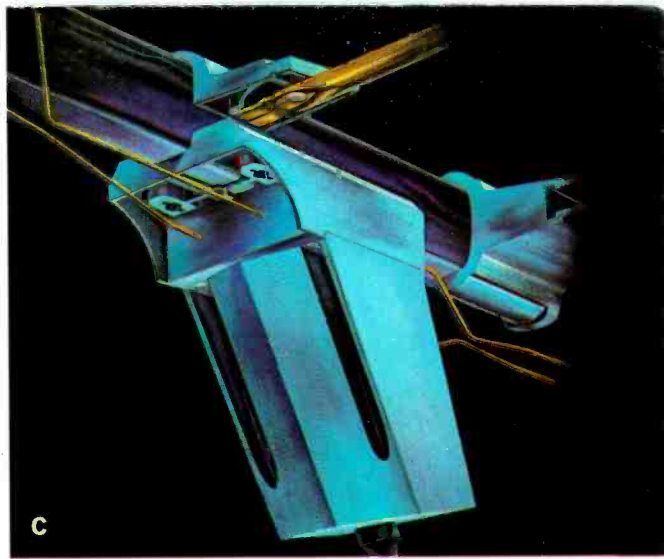

Total Design FM Control Element:

Exclusive FM element provides high gain on FM bands—and enables you to attenuate FM bands in areas where strong FM signals interfere with TV reception.

(C) Total Design Cartridge Housing:

Exclusive housing is an integral part of Super Colortron—built-in and permanent. Completely weatherproofed to protect solid state cartridge pre-amps and connections.

(D) Total Design Ellipsoidal Boom:

Exclusive boom is the first aluminum tubing shape engineered especially for antenna use. Proved far stronger than any other existing boom design.

(E) Total Design Wrap-Around Insulators:

Exclusive low loss dielectric insulators completely encapsulate and weatherproof elements and correlators at point of electrical contact. Hi-impact polystyrene. Provide perfect alignment of elements and eliminate sagging and loosening.

Total Design High Tensile Aluminum Elements:

Exclusive aluminum alloy has PSI rating of 38,000 as compared to 27,000 PSI for alloys used in other antennas. More than 49% stronger—and 29% more resistant to bend and wind distortion.

Total Design Wrap-Around Mast Clamp:

Exclusive mast clamp has 4 pair of locking jaws (not just 2) to automatically align antenna on mast and for greater strength and durability. Requires only one U bolt.

Total Design Gold Anodizing:

Exclusive Gold Anodizing is the only permanent gold finish used on any antenna—the only positive protection against corrosion and fading.

Total Design Assembly:

Exclusive construction makes the Super Colortron truly easy-to-install—unfolds in seconds—completely factory pre-assembled.



WINEGARD COMPANY, 3000 KIRKWOOD STREET, BURLINGTON, IOWA 52601

PF Reporter[®]

PHOTOFACT

the magazine of electronic servicing

VOLUME 17, NO. 3

MARCH, 1967

PUBLISHER
HOWARD W. SAMS

GENERAL MANAGER
DONALD W. BRADLEY

EDITOR
WILLIAM E. BURKE

MANAGING EDITOR
JAMES M. MOORE

ASSOCIATE EDITORS CONSULTING EDITORS
Thomas T. Jones Joe A. Groves
J. W. Phipps C. P. Oliphant

PRODUCTION MANAGER RESEARCH LIBRARIAN
Esther M. Rainey Mrs. Bonny Howland

CIRCULATION MANAGER
Pat Osborne

ART DIRECTORS
Louis J. Bos, Jr. & Robert W. Reed

PHOTOGRAPHY
Paul Cornelius, Jr.

ADVERTISING
SALES MANAGER
HUGH WALLACE

ADVERTISING SALES OFFICES

central and midwestern

ROY HENRY
Howard W. Sams & Co., Inc., 4300 W. 62nd St.
Indianapolis, Ind., 46206 • 317-291-3100

eastern

ALFRED A. MENEGUS
Howard W. Sams & Co., Inc., 3 W. 57th St.
New York, New York, 10019 • 212-688-6350

southwestern

MARTIN TAYLOR
P. O. Box 22025, Houston, Texas 77027
713-621-0000

western/Los Angeles

G. R. (JERRY) HOLTZ
The Maurice A. Kimball Co., Inc.
2008 W. Carson St., Suites 203-204
Torrance, Calif., 90501 • 213-320-2204

western/San Francisco

The Maurice A. Kimball Co., Inc.
580 Market St., Room 400
San Francisco, Calif., 90501 • 415-392-3365

Address all correspondence to PF REPORTER
4300 W. 62nd Street, Indianapolis, Indiana 46206



Copyright © 1967 by Howard W. Sams & Co., Inc. PF REPORTER is a trademark of Howard W. Sams & Co., Inc. No part of PF REPORTER may be reproduced without written permission. No patent liability is assumed with respect to use of information herein. Acceptance of advertising does not in any manner signify the products, policies and services so advertised have been approved, endorsed or recommended by this magazine.

Subscription Prices: 1 year—\$5.00, 2 years—\$8.00, 3 years—\$10.00, in the U. S. A., its possessions and Canada.
All other foreign countries: 1 year—\$6.00, 2 years—\$10.00, 3 years—\$13.00. Single copy 75¢; back copies \$1.

Indexed in Lectrodex. Printed by the Waldemar Press Div. of Howard W. Sams & Co., Inc.

CONTENTS

Previews of New Sets	1
<small>Admiral Model LKS6511M, Chassis 1H1298-2; Emerson Model 23T02, Chassis 120844A; Packard Bell Model CSW606, Chassis 98C15; Philco-Ford Model 855065EA, Chassis 17MT808.</small>	
Video Speed Servicing	5
<small>Service hints on Magnavox Chassis C/U45.01-00 and Zenith Chassis 24MC32,Z and 24MC42,Z.</small>	
Letters to the Editor	9
The Electronic Scanner	15
Audio Equipment Monte J. Hasso	20
<small>A look at some of the specialized equipment used in this field.</small>	
Transistor Testers Chris Edwards	24
<small>An analysis of currently available semiconductor testers—their features and uses.</small>	
Scope Probes J. W. Phipps	28
<small>Selecting the correct probe adds to the versatility of your scope and provides more accurate troubleshooting information.</small>	
New Tube and Transistor Data	32
Notes on Test Equipment T. T. Jones	38
<small>Lab reports on Mercury Model 1900 Color Generator and Semitron Model 1000 Transistor Tester and Set Analyzer.</small>	
Symfact: 110° Convergence Board	45
<small>Operation and trouble analysis of the three-section convergence yoke and associated circuitry.</small>	
The Troubleshooter	60
Color Countermeasures	62
Product Report	64
Service Puzzler	75
<small>An odd symptom on the screen of a portable.</small>	
Book Review	77
Free Catalog and Literature Service	80
Monthly Index on Free Literature Card	

ABOUT THE COVER

Selecting the proper test equipment can spell the difference between success and near success in solving a particularly difficult servicing problem. Equally as important is the choice of probe. All too often the effectiveness of a test instrument is nullified by the choice of probe. Our cover this month symbolizes this interdependence of test instruments and probes. Further information on this subject is provided in an article beginning on page 28 of this annual test equipment issue.

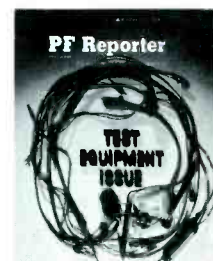

KWIKETTE⁺ Soldering Aids available these NEW ways...



Packet of 10
for 29¢



Package of 100
for \$2.79

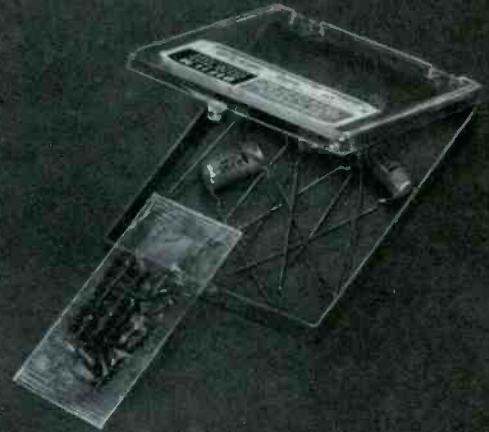

With all Sprague pre-packaged
wire-lead service-type capacitors
at no extra cost to you!

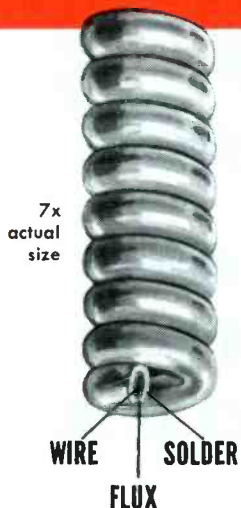

NOW...YOU CAN SAVE TIME, TROUBLE, AND \$\$\$\$ ON MORE SOLDERING JOBS

This is it: the revolutionary KWIKETTE that speeds component replacement . . . and practically lets you do "in-circuit" parts testing. This unique soldering aid is not just another wire spring connector. It features a Copperweld wire inner core, an intermediate layer of flux, and an outer jacket of solder . . . all you need is heat!

You can now buy KWIKETTES from your Sprague distributor in packages of 10 and 100. You'll also find them included with all Sprague pre-packaged wire-lead service-type capacitors . . . at no extra cost to you.

★Trademark

If you haven't tried KWIKETTES yet, do it now. They're the biggest boon to the service technician since the soldering gun!

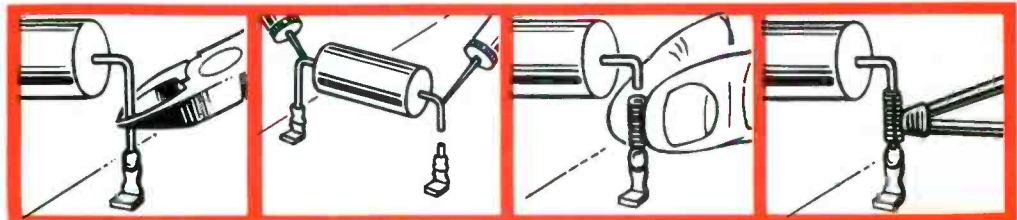

SNIP LEAD...

TEST...

SLIP ON KWIKETTE...

APPLY HEAT!

FREE TRIAL PACKAGE: A postcard request will bring you ten KWIKETTES for testing. Write to Sprague Products Co., 105 Marshall Street, North Adams, Massachusetts 01247. (Please include the name of your Sprague distributor.)

**DON'T FORGET TO ASK YOUR CUSTOMERS
"WHAT ELSE NEEDS FIXING?"**



For window-size blow-ups of this message, send 10¢ to Sprague Products Co., 105 Marshall St., North Adams, Mass., to cover handling and mailing costs.



YOUR TV TECHNICIAN GUARANTEES YOU THE BEST SEAT IN THE HOUSE!

Did you ever stop to think how many millions of dollars in entertainment your TV set brings you? A national half-hour show once each week costs its sponsor about \$7,000,000 a year. And you can watch it all for free . . . from the best seat in the house!

When something goes wrong, you can thank your local *independent technician* that it won't stay that way for long. Before you even got your set, he spent years of study in television techniques . . . repaired hundreds of sets . . . bought all kinds of necessary expensive test equipment to do the job right. That's why, when you

call him you'll find he already knows your set and has the knowledge and equipment to fix it promptly. Call him at the first sign of trouble, and you won't have to spend a single night without TV.

As a responsible member of your community, your service technician stakes his reputation on your satisfaction. He'll charge a fair price for his work, based upon his time and the quality of replacement parts he uses. But you'll be able to go back to enjoying millions in entertainment—all for free!

THIS MESSAGE WAS PREPARED BY SPRAGUE PRODUCTS COMPANY,

DISTRIBUTORS' SUPPLY SUBSIDIARY OF SPRAGUE ELECTRIC COMPANY, NORTH ADAMS, MASSACHUSETTS FOR . . .

YOUR INDEPENDENT TV-RADIO SERVICE DEALER

6S-205 R3

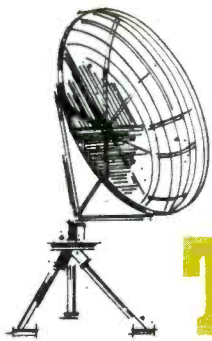

THE ELECTRONIC SCANNER

news of the servicing industry

Radio Most Popular

Radio is America's most popular entertainment, according to the **National Association of Music Merchants**. In fact, America has 25% more radios than people—242 million radios compared to a population of 195 million. The average U.S. family has four radios in its house.

Seven out of ten Americans listen to the radio every day and the most-listened-to programs on radio are music, according to the NAMM. Music is the most common interest of the entire family in terms of home entertainment and radio is the electronic device that delivers this to the home at the lowest cost.

Price has been a key element in making radios so common with total sales reaching 34 million annually. A typical U.S.-made transistor set costs just 25% of what it did seven years ago and imports, which account for half of all radios sold in the U.S., have dropped to an average wholesale price of \$5.95 with sets from Hong Kong wholesaling at an average price of \$2.57.

In the first nine months of 1966, Hong Kong alone sent 5,500,000 radios to the U.S., while Japanese exports of radios to the U.S. for the first nine months added up to 9,600,000.

Radio's penetration of the American home has been recognized by marketing experts and last year network radio had the biggest growth in advertising sales volume of all media, its 18% gain doubling even the percentage gain of television.

Americans are far ahead of the rest of the world in use of radios although half of our U.S. sets are foreign-made, mostly in the Far East. Compared to more than one set per person in the U.S., there's a set for every three persons in western Europe, one for every six people in Russia and one for every 40 in south-east Asia.

COMPLETE TUNER OVERHAUL

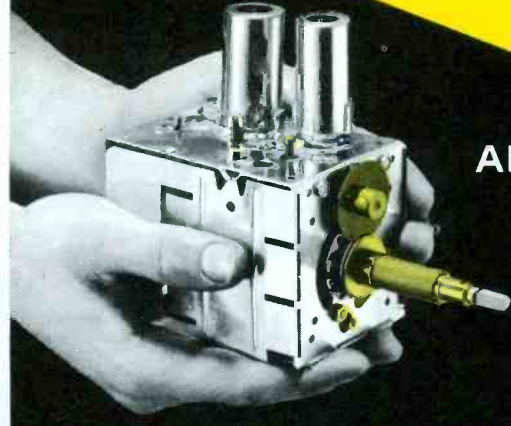

ALL MAKES — ONE PRICE

9.95

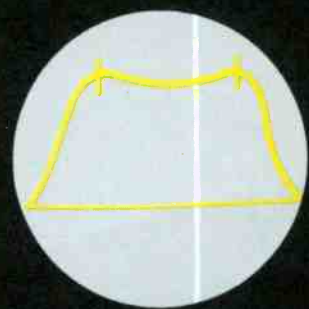

3.58

ALL LABOR AND PARTS (EXCEPT TUBES & TRANSISTORS)*

COLOR TUNERS

GUARANTEED ALIGNMENT — NO ADDITIONAL COLOR CHARGE

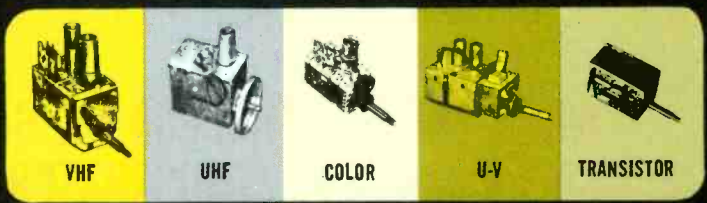

Simply send us the defective tuner complete; include tubes, shield cover and any damaged parts with model number and complaint. Your tuner will be expertly overhauled and returned promptly, performance restored, aligned to original standards and warranted for 90 days.

UV combination tuner must be single chassis type; dismantle tandem UHF and VHF tuners and send in the defective unit only.

Exact Replacements are available for tuners unfit for overhaul. As low as \$12.95 exchange. (Replacements are new or rebuilt.)

And remember—for over a decade Castle has been the leader in this specialized field . . . your assurance of the best in TV tuner overhauling.

Pioneers of TV  Tuner Overhauling

CASTLE TV TUNER SERVICE, INC.

MAIN PLANT: 5701 N. Western Ave., Chicago 45, Illinois
EAST: 41-90 Vernon Blvd., Long Island City 1, N.Y.

Circle 6 on literature card

This **Remington** PREMIER PORTABLE TYPEWRITER

FREE



**WHEN YOU BUY THIS RCA WR-64B
COLOR BAR/DOT/CROSSHATCH
GENERATOR...THE ESSENTIAL
COLOR TV TEST INSTRUMENT**

Here's a deal you can't afford to miss! A FREE Remington portable typewriter—yours when you purchase the most essential color-TV test instrument—the RCA WR-64B!

Just imagine how handy your new typewriter will be—in the shop or at home. You'll use it almost as much as you use the RCA WR-64B—standard of the color TV servicing industry.

Here's how to get your FREE Remington Typewriter. Mail in the warranty card plus the gold label from the shipping carton of your new RCA color bar generator to RCA Test Equipment Headquarters, Bldg. 17-2, Harrison, N.J. We will ship your new Remington portable typewriter to you direct, freight prepaid. But remember—this offer covers only equipment purchased between February 1, 1967 and May 15th, 1967. To allow for postal delay, we will honor cards postmarked up to May 31st.

Plan NOW to take advantage of this BIG offer—a FREE Remington portable typewriter with your purchase of an RCA WR-64B color bar/dot/crosshatch generator.



The standard of the Color-TV Servicing Industry. Generates all necessary test patterns—color bars, crosshatch, dots plus sound-carrier. Only \$189.50*

*Optional Distributor resale price. All prices subject to change without notice. Price may be slightly higher in Alaska, Hawaii, and the West.

Ask to see it at Your Authorized
RCA Test Equipment Distributor

RCA Electronic Components and Devices, Harrison, N. J.



The Most Trusted Name in Electronics

Finally somebody is helping...
helping you prepare for

The growing crisis in service

Motorola takes the bull by the horns . . . introduces
“on-the-job” technical training
for your men—with a greatly expanded
staff of technical personnel.

Home entertainment products are changing—fast. There’s more transistorization . . . and of course more color every year. This means great opportunity for service organizations that keep abreast. Well-informed technicians will be in even greater demand than they are now.

Motorola can help your service department be well prepared.

We have recently increased our staff of field technical personnel. It is their job to help provide you with Technical information for your men and to give some of the training your men will need to cope with this rapidly changing industry.



Each of our technicians has had extensive, practical consumer experience. They know their business—from your side of the fence. The training will be done *right in your place of business*. It will provide a valuable adjunct to the large-scale training meetings held by Motorola Regional Managers & Distributors.

Two hours will be spent in formal training. The remainder of the day will be spent working with your men *on your work* to give information—and to help find ways to make more profitable and productive use of service time. Get full information on availability of this training for your shop. Just call your Motorola Distributor.



MOTOROLA®

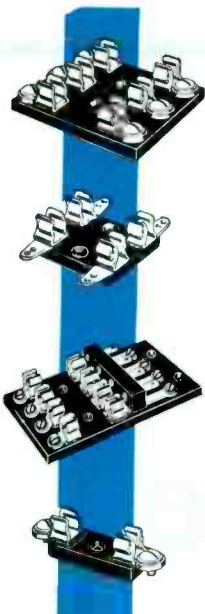

BLOCKS for BUSS FUSES

TYPES AVAILABLE
FOR ALL
APPLICATIONS

Single pole, multiple pole, small base, full base, molded base, laminated base, porcelain base for fuses from $\frac{1}{4}$ x $\frac{3}{8}$ inches up. Also signal type fuse blocks and special blocks of all types.

Tell us what you need or . . .

Write for BUSS Bulletin SFB

INSIST ON **BUSS**
QUALITY

BUSSMANN MFG. DIVISION McGraw-Edison Co., St. Louis, Mo. 63107

signals directly on motion picture film has been announced by the Revere-Mincom Division of **3M Company**.

Called the Electron Beam Recorder, the new device combines the speed and economy of film duplication with the image quality of magnetic video tape or live TV, 3M said.

"Under present systems, television images are photographed from the television screen itself," said Robert Herr, Revere-Mincom general manager. "The resultant product or kinescope contains much of the inherent noise disturbances and imperfections present on the tube's phosphor surface. Image quality of this film, when rebroadcast, is far below that of the original telecast."

A prime advantage of electron beam recording is that once the image has been photographed, duplication can be accomplished by conventional film duplicators, at a rate six times that of video tape duplications," Herr said.

Herr added that video tape plays an important role in the initial production stages. Tape originals are easier to produce and are less costly than film with the added flexibility of instant replay, re-use, and elimination of processing.

Electron beam recording, in operation, eliminates the conventional camera lens, cathode ray tube phosphor screen, and glass mask and mates a photographic film directly to a vacuum chamber. Electrons which normally produce an image on the phosphor screen, paint directly on the film. The result is a bright image of high resolution with reduced graininess and electrical noise.

BUSS: The Complete Line of Fuses and

All-Band MATV

In a recent press conference held in New York, **JFD Electronics** Company vice-president William Clancy stated: "We believe that the federal government, which is concerned about enhancing the growth of UHF, will soon require that multiple dwellings be equipped with master antenna systems that reproduce all television channels broadcast in the area."

Mr. Clancy further pointed out the paradox of requiring presently manufactured TV receivers to be of all-channel design, but not requiring that other receiving equipment (specifically MATV) follow this pattern.

To further bring home this point, and show what can be done, Mr. Clancy unveiled JFD's new "Smooth Line." This is a complete new line of MATV components designed for flat response and corrected tilt, so that no station—VHF or UHF—suffers distortion.

Potpourri

Mercury Electronics Corp. announced a new one year guarantee policy on all their test instruments. In making the announcement, president Harry M. Rich remarked: "We know of no better way to demonstrate the confidence we have in our products than to go beyond the conventional test equipment guarantee, and offer a full one year warranty on parts and workmanship under normal usage."

A new device for recording black-and-white television

TRON SUB-MINIATURE PIGTAIL FUSES

BODY SIZE ONLY
.145 x .300 INCHES

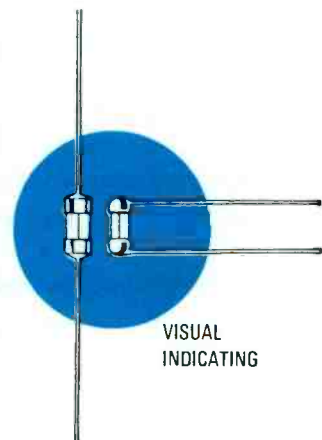

VISUAL
INDICATING

For use on miniaturized devices, or on gigantic space tight multi-circuit electronic devices.

Glass tube construction permits visual inspection of element.

Smallest fuses available with wide ampere range. Twenty-three ampere sizes from 1/100 thru 15 amps.

Hermetically sealed for potting without danger of sealing material affecting operation. Extremely high resistance to shock or vibration. Operate without exterior venting.

Tell us what you need or . . .

Write for Buss Bulletin SFB

INSIST ON **BUSS**
QUALITY

BUSSMANN MFG. DIVISION McGraw-Edison Co., St. Louis, Mo. 63107
Circle 9 on literature card

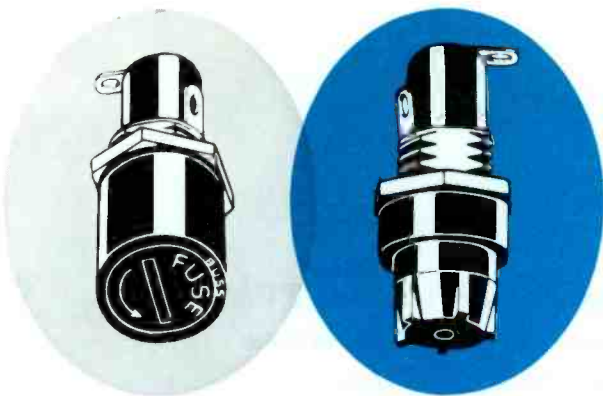

Screw type slotted knob that is recessed in holder body and requires use of screwdriver to remove or insert it.

Screw type knob designed for easy gripping, even with gloves. Has a "break-away" test prod hole in knob.

BUSS Space Saver Panel Mounted Fuseholders

Fuseholder only 1 1/4 inches long, extends just 3/32 inch behind front of panel. Takes 1/4 x 1 1/4 inch fuses. Holder rated at 15 ampere for any voltage up to 250.

Military type available to meet all requirements of MIL-F-19207A.

Write for BUSS Bulletin SFH-10

INSIST ON **BUSS**
QUALITY

BUSSMANN MFG. DIVISION, McGraw-Edison Co., St. Louis, Mo. 63107

Ray-O-Vac Division, The Electric Storage Battery Company is in the process of completing their move of technical personnel and equipment into a recently completed Ray-O-Vac Engineering and Development Center located in a 73,000 square foot building in Madison, Wisconsin.

The new building is designed to consolidate Ray-O-Vac Division's research, development and testing operations into a well-equipped single location.

Texas Instruments announced that it is starting construction of a new multi-million-dollar plant to provide approximately 185,000 sq ft of additional manufacturing and office space on the company's industrial site in Attleboro, Massachusetts. The multi-purpose building will house light manufacturing, research and development activities, and several administrative offices.

This new building will bring total manufacturing and office space owned by the company in Attleboro to approximately one million square feet, and presently there are more than 5,000 TI employees in the Attleboro area.

Vaco Products Company, manufacturers of tools and solderless terminals, moved its general offices to 510 North Dearborn Street, Chicago. The new quarters will double the amount of floor space, and provide for additional electronic order processing equipment, plus sales promotion facilities.

Fuseholders of Unquestioned High Quality

Expansions

Amphenol Corporation's Cable Division has announced plans to build a cable-manufacturing plant on an 18-acre tract in the industrial park at Danville, Kentucky.

An Amphenol spokesman said the division will construct an expandable 30,000-square-foot, single-story facility as soon as contractual arrangements can be made. The plant is scheduled for completion in the early fall of 1967 and will employ about 50 persons.

Amphenol Cable already has expanded twice in the last 18 months, first with the acquisition of Liberty Copper & Wire Company, Downers Grove, Ill., and then with the purchase of additional equipment for expanded plant facilities in Chicago.

A leading producer of public address loudspeakers, microphone stands, and accessories has announced the relocation from its Brooklyn factory to its new plant in Parsippany, N. J. According to Mr. Jerome W. Heller, Division Manager, **Atlas Sound** production capacity is 3 times greater as a result of the move.

Bogen Communications Division of Lear Siegler, Inc., has announced the purchase of Cardion Communications Corporation's B-250-VA4 transmitter product line.

The move enables Bogen to manufacture and supply directly the powerful 250-watt transmitters that are used in Pagemaster city-wide radio paging systems made by the company.

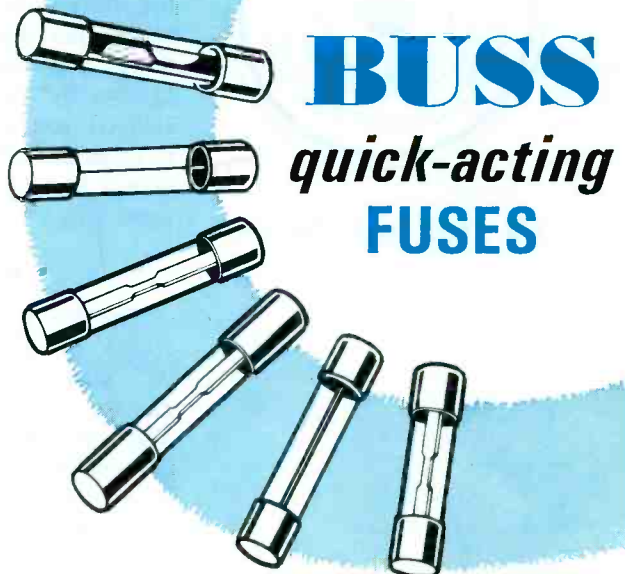

BUSS
quick-acting
FUSES

"Quick-Acting" fuses for protection of sensitive instruments or delicate apparatus;—or normal acting fuses for protection where circuit is not subject to current transients or surges.

Write for
BUSS
Bulletin SFB

INSIST ON **BUSS**
QUALITY

BUSSMANN MFG. DIVISION, McGraw-Edison Co., ST. LOUIS, MO. 63107

Circle 9 on literature card

March, 1967/PF REPORTER 19



Modern Hi-Fi sets require more than a VTVM for effective servicing. Here's a quick review of the instruments needed to keep these sets performing well.

AUDIO EQUIPMENT

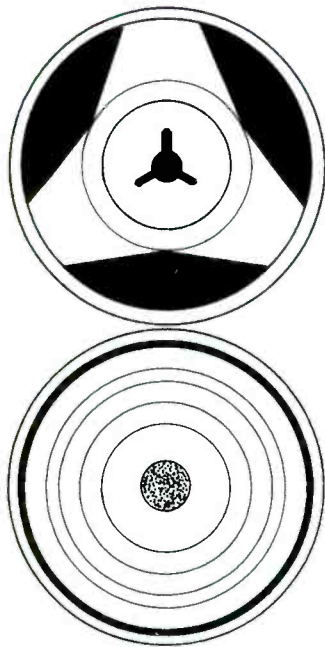

by Monte J. Hasso

Although the growth of the Hi-Fi portion of the industry cannot compare with color TV, there is an ever-increasing number of Hi-Fi instruments in the field. Many shops are unprepared to service these instruments when they arrive in the shop. True, many repairs can be made with a VTVM, but the majority of jobs require more equipment. The customers are developing more critical ears and will not accept the distortions, background noise, and hum that would have "gotten by" a few years ago. Specialized test equipment is needed to track down these problems. Let's take a look at some of this equipment.

AC VTVM

The AC VTVM is only a distant cousin of the all-purpose VTVM. AC instruments employ feedback circuits and highly damped meters. The sensitivity of the lowest scales is typically .03 volts full scale, though many instruments have a .01 scale. The frequency response is flat over the entire audio spectrum and usually about ± 1 dB from 10Hz to 500kHz. Fig. 1 shows the face of one of the instruments. Note the lack of a zero control. The circuits are designed so that the instrument is insensitive to minor line voltage variations and tube aging, and the zero control is unnecessary. Fig. 2 shows a block diagram of an AC VTVM circuit.

The input attenuator is frequency compensated so that it is essentially flat from 10Hz to 600kHz. The cathode follower stage is a low-noise triode impedance matching stage. It matches the high impedance input to the low impedance voltage divider. The 6EJ7 pentode amplifiers were chosen for their stability and high gain. The feedback network insures that they operate at about the same amount of gain throughout their useful life.

Not shown is the power supply. In this particular instrument (Eico 250) the power supply has a regulator tube, and a small AC voltage is applied to a tapped bleeder resistor to buck out stray hum.

Audio Signal Generators

Audio generators come in more shapes and sizes than people. They are of two general types though, the sine-wave, and the square-wave generators. They each have their advantages, though the square-wave generator is probably more versatile in the hands of a technician who knows how to use it. However, neither can completely replace the other, and it is advantageous to have both instruments. For the shop which has a limited equipment budget, the sine-wave generator is probably the best choice; the square wave can be added later. There also are some combination instruments available with both sine- and square-wave outputs.

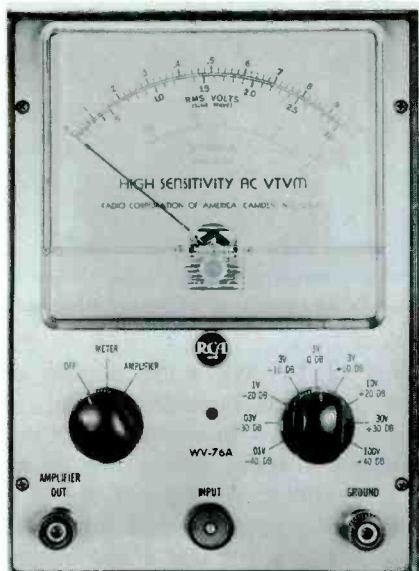

Fig. 1. Front panel of an AC VTVM.

With either type of generator, the output should be flat over the entire audio spectrum, or else the instrument should have a built-in voltmeter. This is to insure that the test signal will not cause the amplifier to show an uneven frequency response.

The generator should have a low output impedance, since it can be fed into either a low or high impedance amplifier input. A high impedance output may show serious distortion when fed to a low impedance input stage.

The main use of an audio generator is to check frequency response of a stage or system. This is done by connecting the equipment as in Fig. 3. The input level is advanced until unacceptable distortion is evident on the monitor (scope or distortion meter), and the level is noted. Measurements are made at several points in the audio spectrum and the response can be graphically recorded. The measured response can then be checked against the manufacturer's specifications to see if the equipment is operating properly.

A general idea of frequency response can be obtained by connecting a square-wave generator to the input and a scope to the output of the system under test. Measurements need to be taken only at 200 Hz and 2000 Hz. If the wave is square at the output at both these frequencies, then the

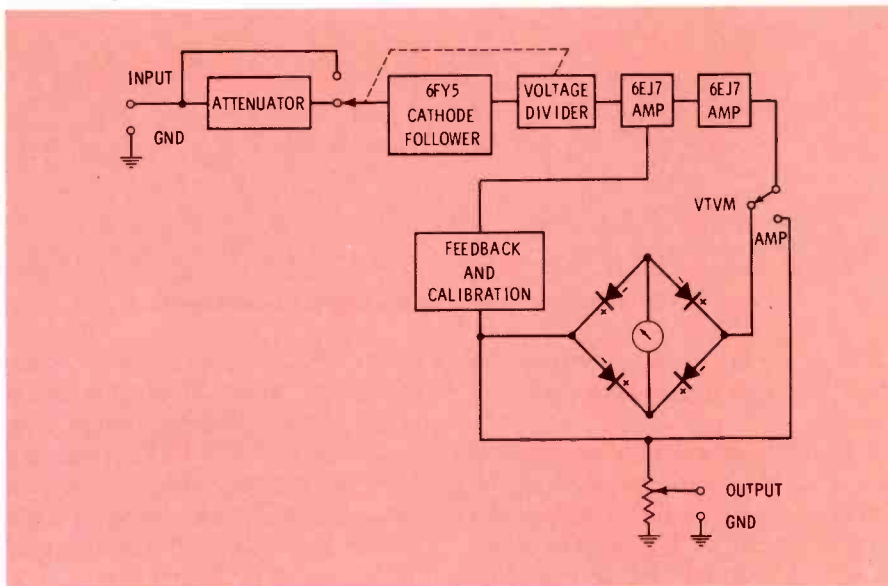

Fig. 2. Block diagram of an AC VTVM.

response is adequate from 20 Hz to 20 kHz. The reason is that the scope indicates any integration or differentiation of the input wave, which means poor low or high frequency response. Fig. 4 shows these waveforms. The square wave gives a good indication of the response about 1 octave either side of its actual frequency.

Distortion Analyzers

Again, there are two main types; Harmonic and Intermodulation distortion meters. Each has its advantage. The harmonic analyzer is usually the more inexpensive, and easier to operate. The intermodulation analyzer, on the other hand, gives a more accurate test of distortions which are most objectionable to the listener's ear. An in-depth article about the two instruments appeared in August 1966 PF REPORTER; this article in turn was taken from a portion of Howard Tremaine's fine book "Intermodulation and Harmonic Distortion" (Howard W. Sams catalog INT-1).

For harmonic-distortion analysis, a signal is fed to the instrument under test. The output is measured, and then a bandpass filter inserted in the analyzer so that the test signal is rejected. The second reading is the total harmonic level. The meter is usually calibrated directly in % total harmonics. Fig. 5 is a block diagram of this type of meter. The bandpass filter usually is tun-

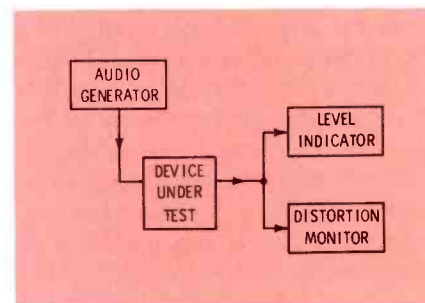
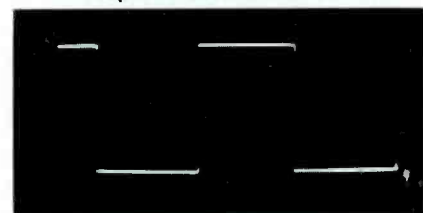
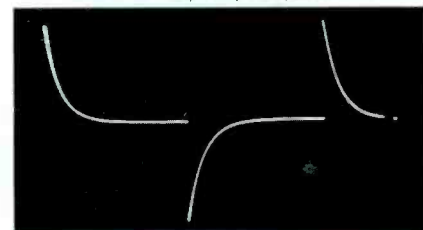

Fig. 3. Test setup for frequency response measurements.



A. Good frequency response.



B. Poor low frequency response.

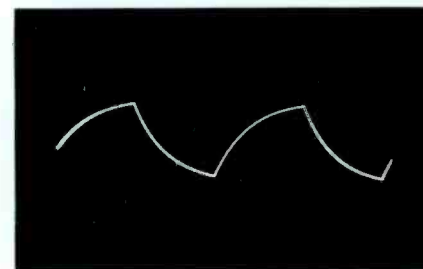

C. Poor high-frequency response.

Fig. 4. Waveform of the square-wave test of a system.

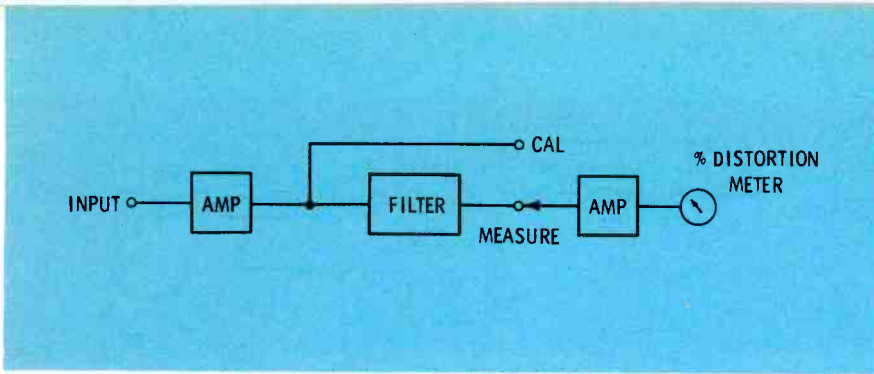

Fig. 5. Test setup for harmonic distortion measurements.

able over the audio spectrum so that test can be made at any frequency.

The intermodulation analyzer is quite a bit more complicated. A block diagram of the complete test setup appears in Fig. 6. The associated waveforms are shown. The distortion can be thought of as a beat-frequency, similar to that produced in a mixer stage of RF equipment. In audio instruments, IM distortion is usually quite objectionable, as compared to harmonic distortion. The reason is that the distortion products are unrelated to the fundamental signals. Harmonic distortion on the other hand is related to the desired signal, and as suggested by the name, sounds harmonious to the ear. However, neither type of distortion can be tolerated to any extent by Hi-Fi enthusiasts, so a distortion analyst is a must in any shop servicing Hi-Fi instruments. The two types of distortion often go hand-in-hand, that is, the causes are essentially the same, so shops with a limited budget can get by for a while with either instrument.

Miscellaneous Equipment

There are many other instru-

ments which are peculiar to audio servicing. Several manufacturers make audio wattmeters, often as a feature of an AC VTVM. These are quite convenient, however, they are not absolutely necessary, as the power across a load resistor may be computed by Ohm's law.

When checking power output against manufacturer's specifications, make sure that you are both speaking the same language. There are several different power specifications popular in the Hi-Fi field. Among these are ESWP (equivalent sine wave power), EIA Music Power, and sine wave power. These may differ radically, and the serviceman is most likely to measure sine wave power; the output across a resistive load with a single frequency input. ESWP is equal to 1.47 times sine wave power.

Another handy device in audio work is the phase checker. This instrument is used to check the phase match of the loudspeakers in a multispeaker system, or between left and right speakers in a stereo system. It is an extremely simple device. A simplified schematic for the RCA phase checker appears in Fig. 7. The two receptors act as microphones in series with the pri-

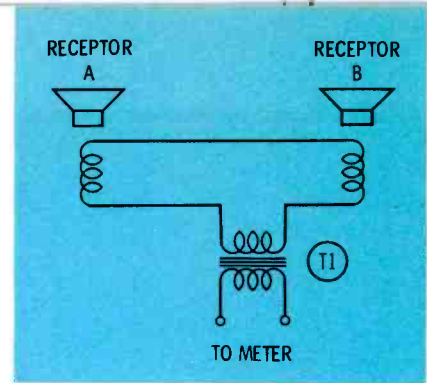

Fig. 7. Diagram of a phase checker.

mary of T1. When the outputs of the two speakers under test are in phase, the two microphones put out voltages in series aiding each other, and a voltage appears at the output of T1. If the speakers are out of phase, the voltages at the microphones are series opposing, and there will be no output at T1.

Further Reading

The audio equipment field is a big area. No one magazine article can do more than just scratch the surface. Fortunately there are many good books on the subject. A very good book on practical applications of audio equipment is "101 Ways to Use Your Audio Test Equipment" by Robert Middleton. This book shows how to check the sets against manufacturer's specs and has many tips and tricks of the trade which should prove invaluable.

Another good book is Howard Tremaine's "Audio Cyclopedia." This 1280-page book is one of the best references available on audio work in general, from acoustics and design through studio techniques and maintenance. It answers such questions as "What is the best height above floor level for a loudspeaker?" and "At what output level should a frequency response measurement be made on an amplifier?"

Both of the above books are available from Howard W. Sams & Co. "101 Ways" is catalog number TEM-5 (\$2.00), and "Audio Cyclopedia" is ACT-1 (\$19.95). ▲

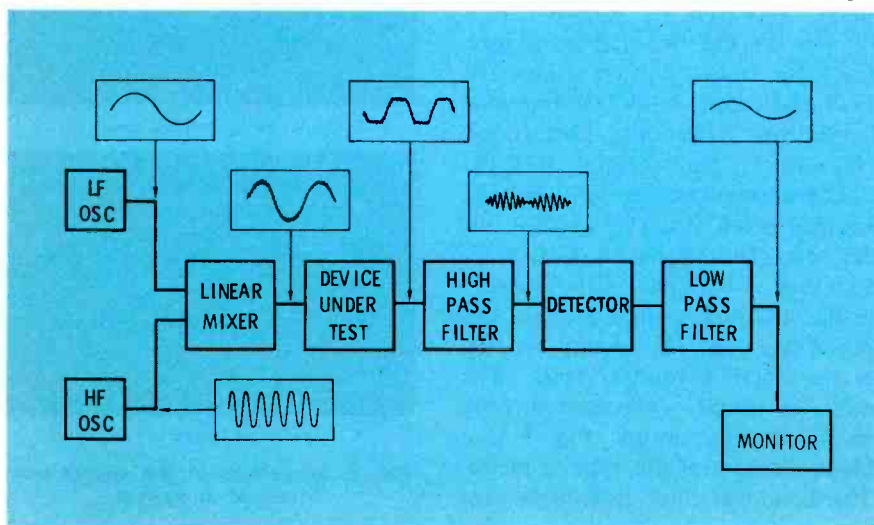

Fig. 6. Test setup for intermodulation distortion.

MOVING?

Don't lose touch . . .
RECEIVE PFR AS USAL
(INCLUDE OLD AND NEW ADDRESS)

PF REPORTER
CIRCULATION DEPT.

4300 W. 62nd St.,
Indianapolis, Ind. 46206

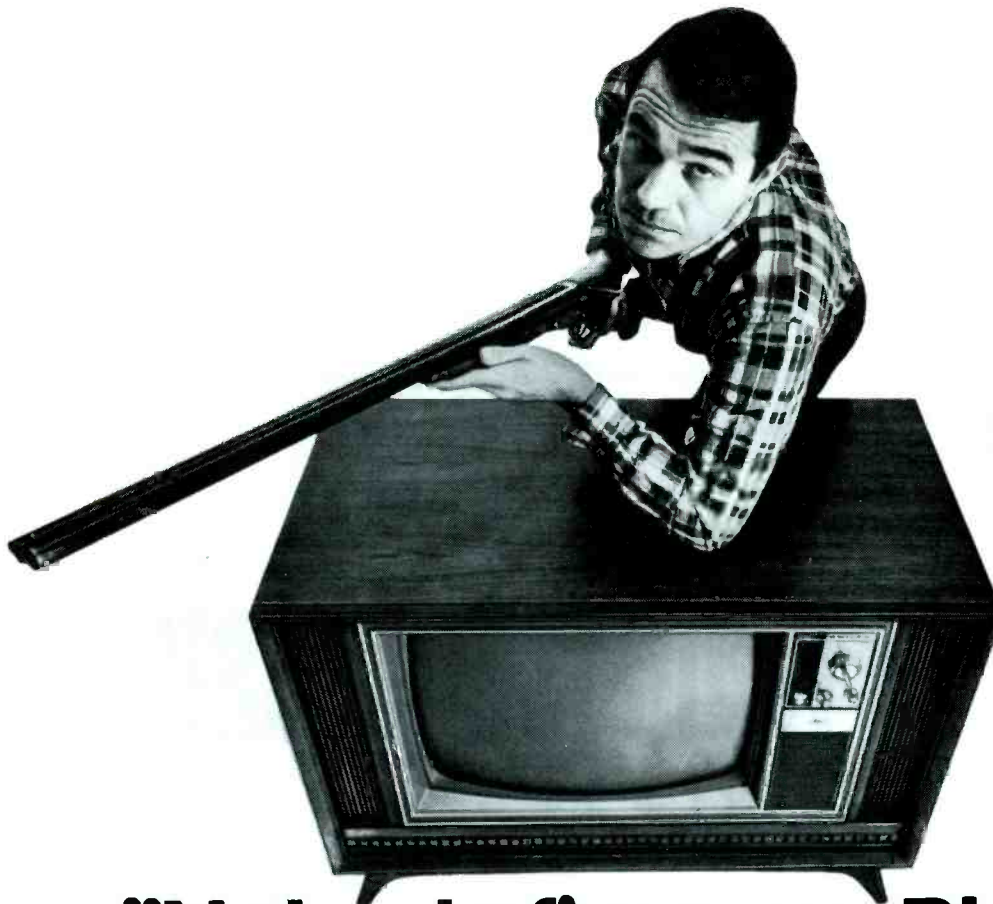

“Nobody fixes my Philco but a Philco technician!”

That color TV cost him \$500 and he wants a real specialist to fix it! Why don't you become the specialist? Give Philco Qualified Service and get the business.



Your service technicians can get all the training they need right there in your area. Local training meetings are held all over the country. Then, after the course, our Tech Data Service keeps them tuned in to what's new. And you get the fastest parts delivery in the industry. Philco Parts Distributors stock almost every part you'll ever need. Any part they don't have will be on its way to you by air within 24 hours through our Lifeline Emergency Service.

Get new customers — more business. Your shop can appear in our Yellow Pages listings, and you become your area headquarters for Philco Service. There's plenty of attractive identification material wherever your firm name is used.

Philco owners are sold on the idea of specialist service. Shouldn't you be? Your local Philco-Ford Distributor will give you all the details. Call him now and ask for the Service Manager.

Philco-Ford Corporation
Philadelphia, Pa. 19134



Circle 10 on literature card

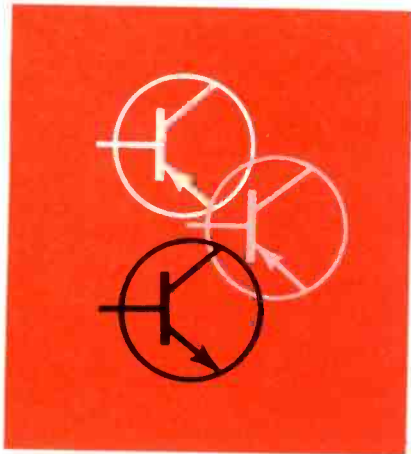

The key to efficient operation of a test instrument is knowing how it functions.

Here's the know-how on . . .

Transistor Testers

by Chris Edwards

The number of transistor testers available from test equipment manufacturers is increasing rapidly. It is time to take a close look at the models available, the tests they can accomplish, and the circuits they use.

In addition to the transistor test function, many instruments offer extra functions such as a power supply, signal generator, signal tracer, VTVM, voltmeter and ammeter, and tube tester. These extra measuring functions are usually switched and metered so that test leads do not have to be moved. Most instruments also offer in-circuit and out-of-circuit tests for transistors. Probably the most elaborate of the available instruments offers:

1. An in-circuit test.

2. An out-of-circuit test.
3. An RF signal generator.
4. An AF signal generator.
5. A metered supply to power the radio under test.
6. A VTVM.
7. An ohmmeter.

The actual transistor test is made in different ways, depending on instrument cost and manufacturer's preference. For instance, some make a check of actual DC or AC beta. Others make a relative reading which results in a GOOD/BAD meter indication.

The beta of a transistor is the ratio of collector current divided by base current when the transistor is connected in the common-emitter circuit. Since this circuit is the most commonly used, it is used in the majority of testers.

The primary function of the PN junction is to pass or to block current flow. The blocking action suggests a perfect junction; in practice this is not possible. Reverse leakage exists in any junction and is referred to as I_{CO} or I_{CBO} . As the subscript CBO implies, this is measured from collector to base with the emitter open.

Reverse leakage is a variable factor dependent on many conditions of the transistor. It is a good measure of transistor quality because, as leakage increases, transistor efficiency decreases. Leakage, as well as gain, can change with temperature. Tests should be made quickly, and sufficient time for junction cooling should be allowed. Never hold the transistor with a hand while it is being tested. The

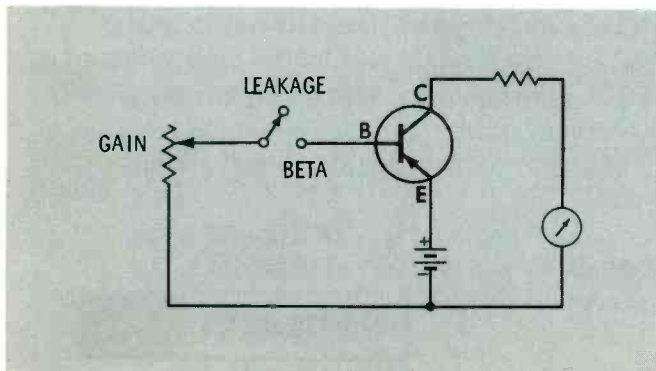

Fig. 1. Beta and leakage tests.

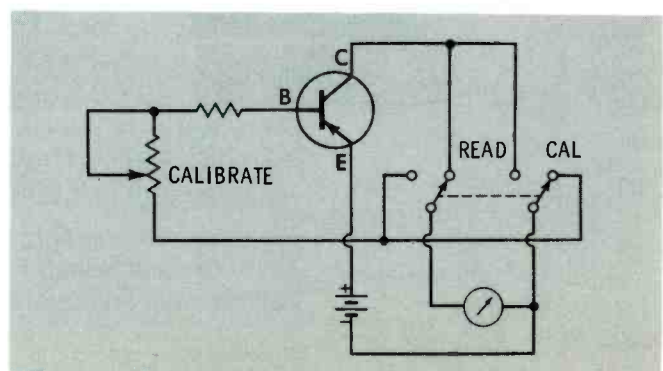

Fig. 2. A test for actual DC beta.

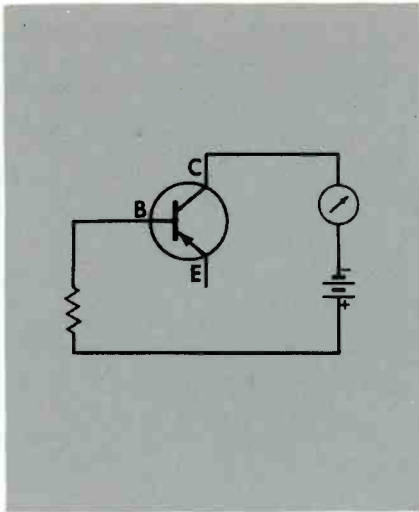

Fig. 3. I_{CEO} leakage test.

increase of temperature can cause a faulty reading.

Beta Tests

The simplest method of checking gain and leakage is shown in Fig. 1. For the leakage check, a voltage is applied between the emitter and collector, with the base open, and leakage current is read on the meter. When the switch is closed to read beta, a current is inserted into the base through the GAIN control. The control must be preset for the desired meter scale. The gain of the transistor is the meter reading in the beta switch position minus the leakage reading with the difference multiplied by the control setting.

A more elaborate test circuit is shown in Fig. 2. This circuit measures the actual value of DC beta. In the switch position shown, the meter is in the collector circuit and the CALIBRATE control must be set for exactly 1 ma of collector current. The switch is then set to the READ position, and the value of base current is read. The meter is calibrated for the ratio of base-to-collector currents. This is the beta of the transistor under test. This circuit is typical of most testers that read actual DC beta.

Leakage Tests

The majority of leakage tests measure I_{CEO} , the leakage between collector and emitter with the base open. The I_{CBO} , collector-to-base, leakage is not measured but does affect the I_{CEO} reading. Some instruments measure I_{CBO} with circuits similar to that in Fig. 3. The col-

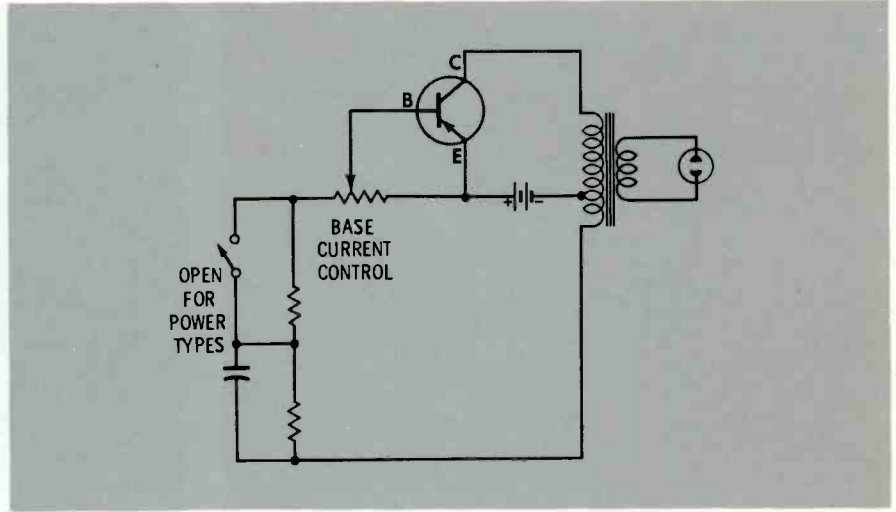

Fig. 4. Oscillator circuit for relative AC beta.

lector-to-base junction is reverse biased, and the emitter is open.

Relative AC beta can be checked with the circuit in Fig. 4. This is an oscillator circuit with the transistor being checked serving as the amplifying device. It can be used for both in-circuit and out-of-circuit checks. The in-circuit test is limited by the values of shunt impedance and capacitance in the circuit under test. A low value of impedance or a high capacitance can "swamp" the oscillator and stop the oscillations. Usually impedances above 150 ohms and capacitors below 0.5 mfd will not affect the circuit.

A direct measurement of AC beta is possible with the circuit in Fig. 5. A close look will reveal that this is a bridge circuit with R_1 , R_2 , the transistor being tested, and the resistor network forming the four legs of the bridge. An audio oscillator injects a calibrated signal into the base circuit. For a typical small-signal transistor, the calibrated AC

base current is 5 μ a. This current is measured by an AC voltmeter which is switched to read the voltage drop across the 50 Ω resistor in the base circuit.

To read AC beta, the AC voltmeter is switched to read the voltage drop across the 1 Ω resistor in the collector circuit.

The purpose of the bridge circuit is to enable this instrument to measure and then cancel the effects of the circuit impedance during an in-circuit test. Fig. 6 shows the bridge circuit for this function. The I_C potentiometer is set to zero to cut off the transistor. This removes the transistor impedance and leaves only the circuit impedance in the upper right-hand leg of the bridge. The ZOHMS potentiometers are then set for a null reading on the voltmeter connected across the bridge. The value of the circuit impedance can be read directly across from the calibrated ZOHMS dials.

The input impedance of the tran-

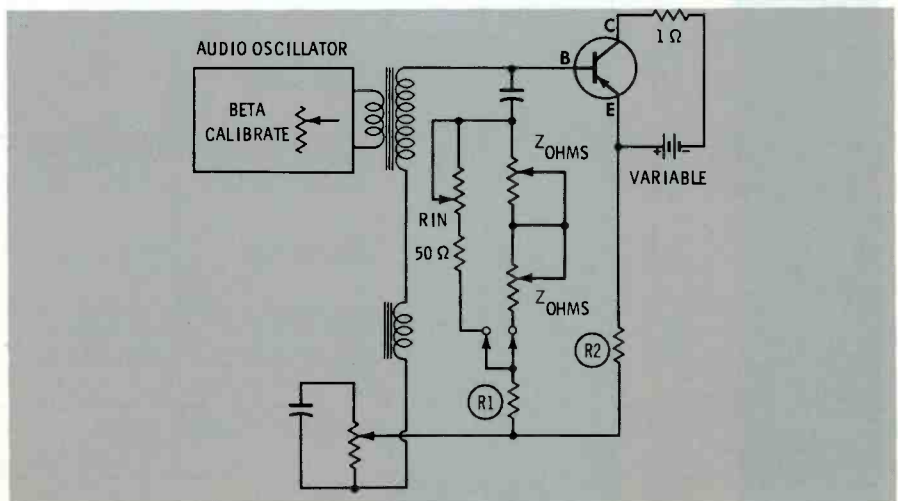

Fig. 5. Bridge circuit for AC beta.

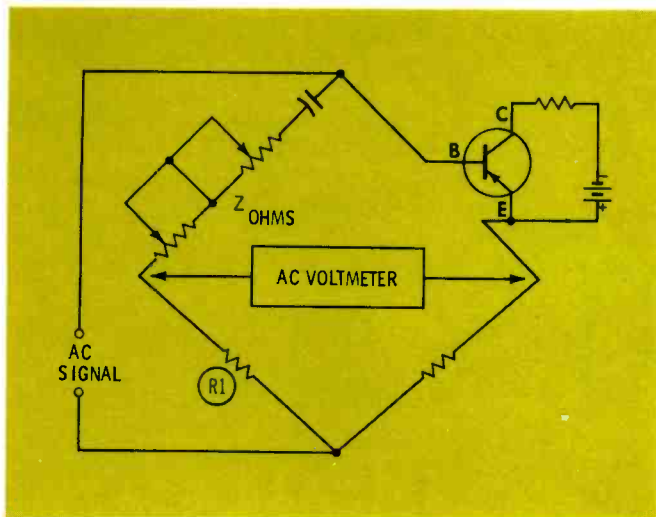

Fig. 6. Measurement of circuit impedance.

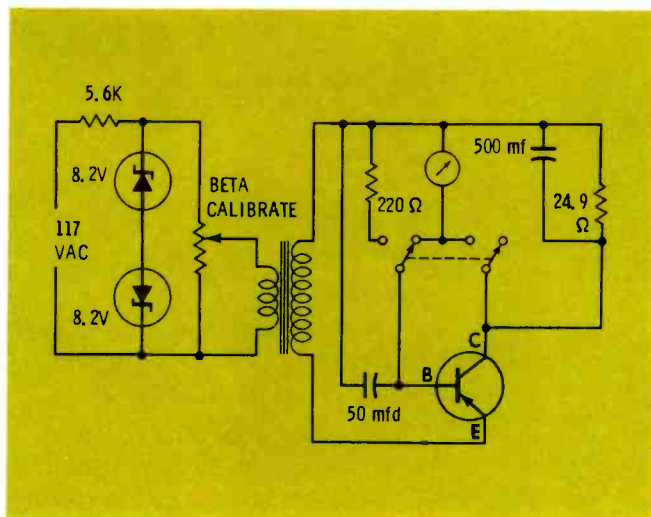

Fig. 7. Dynamic check of AC beta.

sistor itself is then measured by switching the R_{IN} potentiometer of Fig. 5 across the Z_{OHMS} potentiometers and setting the I_c potentiometer to bias the transistor on. A second null is found by varying the R_{IN} potentiometer. Now the circuit and transistor impedances are balanced out and only the AC beta of the transistor is effective in the circuit. These are the conditions

under which beta is measured in the circuit of Fig. 5.

A unique method of measuring AC beta is shown in Fig. 7. A signal from the AC line is coupled into the test circuit through the transformer. In the CAL position of the switch, the meter reads the voltage across the collector load resistor. The BETA CAL control is used to set the meter to full

scale; this equals approximately 2 ma of collector current.

When the switch is changed to read beta, the meter is transferred to read the voltage across the base resistor. The meter scale is calibrated directly in beta. Note that there are no DC power supplies in the circuit; the test is made under dynamic conditions simulating actual operation. ▲

MFR.	MODEL	I_{ceo}	I_{cbo}	SHORTS	GAIN TEST	OTHER TESTS	PNP/NPN	MISC. NOTES
B & K	960	✓	✓	✓	actual DC beta	in-circuit tests	switch	pwr. sup., sig. gen., VTVM pwr. sup., sig. gen., VOM
	970	✓	✓	✓	actual DC beta	in-circuit tests	switch	
EICO	680	✓	✓		actual DC beta	indirect AC beta	switch	VOM
HEATH	IM-30	✓	✓	✓	actual DC beta	checks diodes & DC alpha	switch	
HICKOK	800A	✓	✓	✓	good-bad scale	input and circuit Z	2 sockets	tube tester
	870	✓	✓	✓	actual AC beta		switch	
	890	✓	✓	✓	actual AC beta		switch	tube tester
	6000A	✓	✓	✓	good-bad scale		2 sockets	
MERCURY	1200	✓			good-bad scale		switch	tube tester tube tester
	2000				actual DC beta		switch	
SECO	100			✓	oscillator go/no-go	in-circuit tests in-circuit tests	switch	
	260	✓	✓	✓	oscillator go/no-go		switch	
SEMITRON	1000		✓	✓	actual DC beta	in-circuit osc. test	switch	E & I tests
SENCORE	TR115	✓	✓	✓	actual DC beta	checks diodes in-circuit tests	switch	checks diodes
	TR139		✓	✓	actual AC beta		switch	
SIMPSON	650				incremental DC beta	I_{co} test	switch	Adapter for Model 260
TRIPLETT	2590	✓	✓	✓	actual DC beta	checks Diodes I_{co} & Reach-thru tests	switch	actual DC beta
	3490A	✓	✓	✓	actual AC beta		switch	

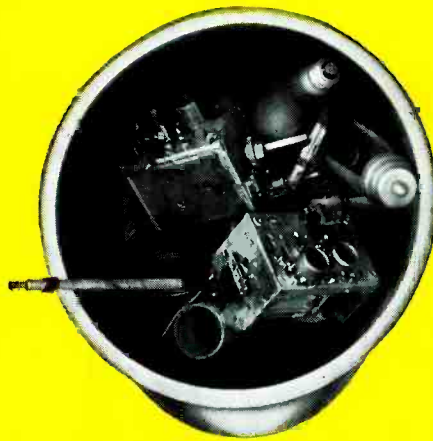

Scrap it!

WHY BOTHER REPAIRING IT...WHEN YOU CAN REPLACE IT FOR ONLY \$10.95?

(FACTORY ALIGNED)

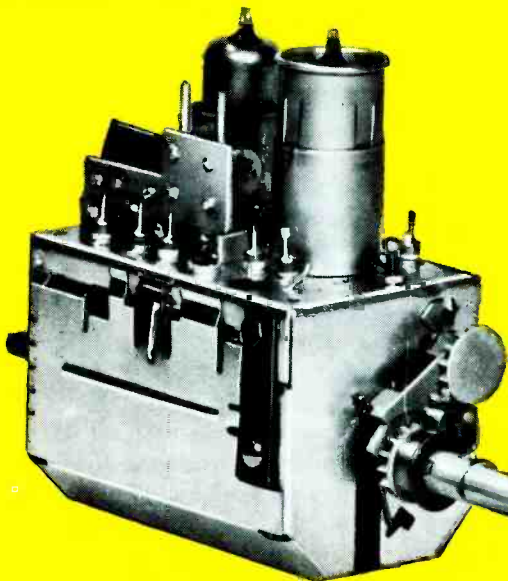

Repairing broken tuners is trouble. You pack it, mail it, wait for it, get it back, unpack it, install it . . . it's wait, wait, wait—and for what? A second-hand tuner.

Why bother? Simply replace broken tuners with a brand new Standard Kollsman Arbor Preset VHF Memory-fine tuner. All you do is fill out the coupon, we ship factory-to-you the same day. You get a new original equipment tuner and guaranteed customer satisfaction—for less money and less trouble.

Standard Kollsman Replacement Tuners offer the latest in design and the maximum in performance. Simply check your mounting space: SK Preset Height 4.58" max. to top of tubes; length 3.61" max.; Width 2.50" max. Shafts have extended "flats" . . . simply cut to proper length.

13 Position Switch	AR-250 (Parallel)	ARS-252 (Series)	AR4S-251 (Series AC-DC)
Antenna Input	300 ohms balanced to ground		
Intermediate Frequency	41.25 mc sound 45.75 mc video		
RF Amplifier Tube	6HQ5	2HQ5	3HQ5
Oscillator-Mixer Tube	6GX7	4GX7	5GX7
Heater	6.3 volts	600 ma	450 ma
B Plus	125-145 volts dc		

REMEMBER THESE STANDARD KOLLSMAN EXCLUSIVES

Memory Fine Tuning • Direct UHF Plug-in for Fast Replacement on 82-Channel Sets • Universal Mounting • 100% American Made • Preset Fine Tuning • Outstanding Oscillator Frequency Stability • 3-Position Detent Turret Switch for Positive Lock-in Tuning • Fits Most T.V. Sets Produced From 1956 to Now

sk Standard Kollsman
INDUSTRIES INC.
2085 NORTH HAWTHORNE AVE., MELROSE PARK, ILLINOIS

Circle 12 on literature card

Just fill out this coupon and enclose it, along with payment, for same-day shipment of your order.

Please rush _____ **sk** Arbor replacement tuner(s) at \$10.95 each

Quantity _____ Check M.O.
(Illinois customers add 4% tax)

Name _____

Company _____

Address _____

City _____ State _____ Zip _____

SCOPE PROBES

by J. W. Phipps

An understanding of the circuits and uses of typical scope probes will assure more accurate troubleshooting information and increase the value of your scope.

The versatility and accuracy of an oscilloscope is dependent, in part, upon the ability to perform voltage and waveform measurements without upsetting the operating characteristics of the circuit being tested. To meet this prerequisite, the instrument must be adaptable to a variety of circuit characteristics, including impedance, signal level, and frequency. Consequently, these same factors—impedance, signal level, and frequency—are what determine the limitation of a scope. Such limitations can be overcome, for the most part, by selecting a probe designed to compensate for both the characteristics of the circuit being tested and the design characteristics of the scope. In effect, the probe tailors the scope to the test application, or vice versa. The probes most commonly used with scopes are the shielded direct probe, low-capacitance probe (sometimes referred to as a high-impedance probe), and the demodulator probe. Other types include the capacitance voltage-divider probe, and the isolation probe. Although each probe has its own particular advantages, their use may overlap for some circuit applications.

Direct Probe

The input impedance of most scopes ranges from .5 megohms to about 5 megohms of resistance, shunted by a capacitance varying from 20 to 50 pf. This is the load felt by a circuit under test when an unshielded direct probe is used, as shown in Fig. 1. However, unshielded probes are seldom used with the scope because of their tendency to act as an antenna, thereby introducing spurious signals into the circuit being tested. Such spurious signals not only produce extraneous waveforms on the scope, but can also cause oscilla-

tions, upsetting the operation of the circuit under test. To prevent this lead reaction to stray fields, shielded cables are used.

Adding the shield to the test lead introduces an additional 25 to 50 pf of shunt capacitance to the overall input impedance of the scope and test probe. Fig. 2 illustrates the loading effect imposed upon the circuit by a scope and shielded direct probe. At lower frequencies, the total reactance of the shunt capacitance is high and does not appreciably increase the circuit loading; however, as the frequency of the signal increases, the reactance of the shunt capacitance decreases, and lowers the input impedance to the scope. This, in turn, increases the circuit loading and alters the characteristics of the signal. From this, it can be seen that frequency is one determining factor in the

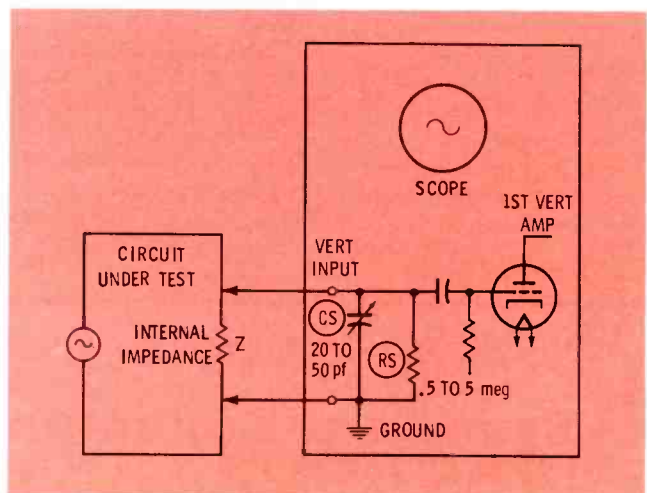
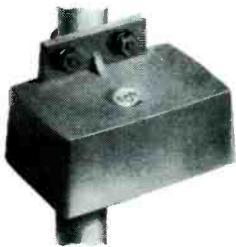

Fig. 1. Loading effect of unshielded probe.

RCA ANNOUNCES NEW ANTENNA ACCESSORIES ENGINEERED FOR COLOR TV

New catalog tells the full-line story.
Get it from your RCA Distributor.



5

RCA Deluxe Transistorized Antenna Amplifiers

... a full line of dual purpose units with the most advanced silicon transistors in high-gain, low-noise circuits. They are masterfully designed to bring in the sharpest picture on color or black and white TV. Or they can drive multiple receivers from a single antenna using RCA multi-set couplers as a small distribution system. Five types include: 300 ohm UHF type 10P223; 300 ohm VHF/FM type 10P213; 75 ohm coaxial VHF/UHF type 10P215 and 10P235; and 300 ohm VHF/UHF type 10P233—all with remote, A.C. operated power supplies.



4

RCA Deluxe Multi-Set Couplers

... UHF/VHF/FM 300 ohms, couple two or four sets to one antenna or amplifier. Channels 2 to 83, types 10P302 and 10P304. Also VHF/FM 75 ohm coaxial types 10P752 2-set coupler; 10P754 4-set coupler.



3

RCA Deluxe Band Splitters

... Separate UHF, VHF and FM signals from a single transmission line or combine separate antennas. 300 ohms. Three types include: 10P311 couples VHF/UHF signals to one line; 10A135 separates UHF and VHF at set; 10P312 separates UHF, VHF and FM.

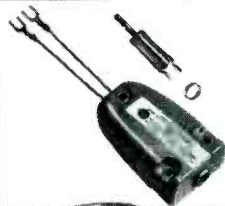

3

RCA Deluxe Coaxial-to-twin lead Transformers

... streamlined for fast installation. Coax plugs in using solderless connector. Terminals for twin lead connections. Models: 10P723 and 10P753 for indoor use and 10P375 for outdoor use.



2

RCA Deluxe Lightning Arrestors

... Positive contact with all varieties of twin-lead (flat, round, and oval). Eliminate lead stripping, insert line in slot, screw on cap for fast installation. Low insertion loss, does not increase VSWR of a good antenna even at critical UHF frequencies. Screw mount type 10A118; and strap-mount type 10A119.

When you buy antenna accessories bearing the
RCA Mark of Quality, you know they're reliable.

RCA PARTS AND ACCESSORIES, DEPTFORD, N.J.



The Most Trusted Name in Electronics

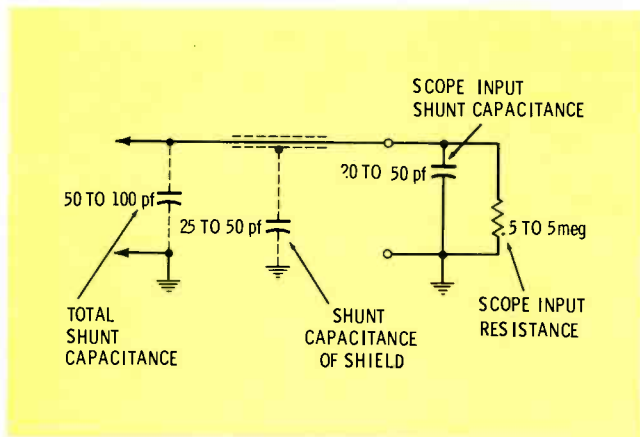

Fig. 2. Shield adds shunt capacitance to loading effect.

application of a direct probe.

The relative values of the scope input impedance and the impedance of the circuit under test must also be considered. To avoid excessive circuit loading, the scope input impedance should be at least 10 times the impedance of the circuit being tested. In Fig. 3, a scope and shielded direct probe are used to measure the ripple content of a low-voltage power supply. The reactance of the shunt capacitance to the 60-hertz ripple frequency is about 26 megohms. The reactance of the 250-mfd filter capacitor is about 10 ohms. Therefore, the ratio of the impedance of the reactive components more than meets the criteria required to avoid excessive loading. Fig. 4 shows a scope connected through a shielded direct lead to the grid of a vertical blocking oscillator. Again, the frequency involved is 60 hertz; however, in this case, the impedance at the point where the probe is applied is much higher, and offers 106 megohms of reactance to the 60-

hertz signal. Shunting this reactance with the 26.5 megohms of reactance produced by the shunt capacitance of the probe and scope will greatly load the circuit and upset its operating characteristics—even to the point of disabling it. From the foregoing comparisons, it can be seen why the impedance ratio between the circuit under test and the scope must also be considered.

Another factor limiting the test application of a shielded direct probe is the signal level. This factor is related directly to the fact that the blocking capacitor employed in the input circuit of most scopes is rated at about 600 volts. Obviously, if this level is exceeded, the capacitor will be destroyed and the input circuit to the scope could be seriously damaged. Aside from the loading effect of the scope input impedance, the direct probe does not attenuate the voltage being measured; what is applied across the probe tip is felt at the scope input. For this reason, the direct probe is not suitable for high-level

measurements beyond the working volt rating of the scope input blocking capacitor.

The fact that the direct probe does not attenuate the signal being measured (beyond the loading effect of the scope input impedance) is the one single advantage of the shielded direct probe. This absence of appreciable attenuation allows use of the full sensitivity of the scope.

Combination Isolating and Direct Probe

The probe shown in Fig. 5 is designed to overcome some of the disadvantages inherent in the simple, shielded direct probe. When the switch is closed, the 47K-ohm resistor provides increased resistive isolation between the circuit under test and the scope. One major advantage of increased resistive isolation is that it reduces the effects of the shunting capacitance associated with the direct shielded cable. For example, if a 200-kHz signal is being measured with a shielded direct probe, the effective reactance of 100 pf of shunt capacitance will be 8000 ohms. The circuit under test is therefore being shunted by only 8000 ohms. Add-

• please turn to page 42

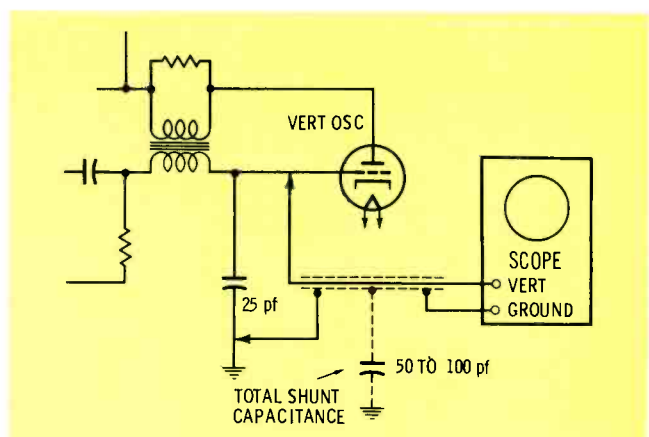

Fig. 4. High-Z circuit can be disabled by direct probe.

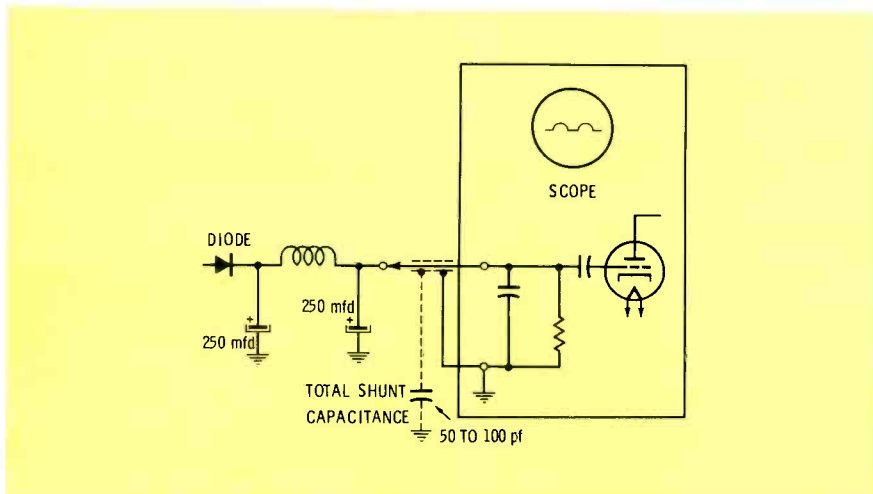

Fig. 3. Scope applied to low-impedance circuit.

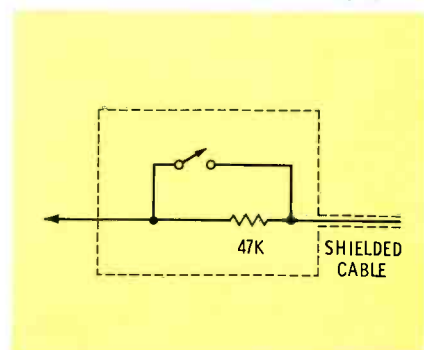
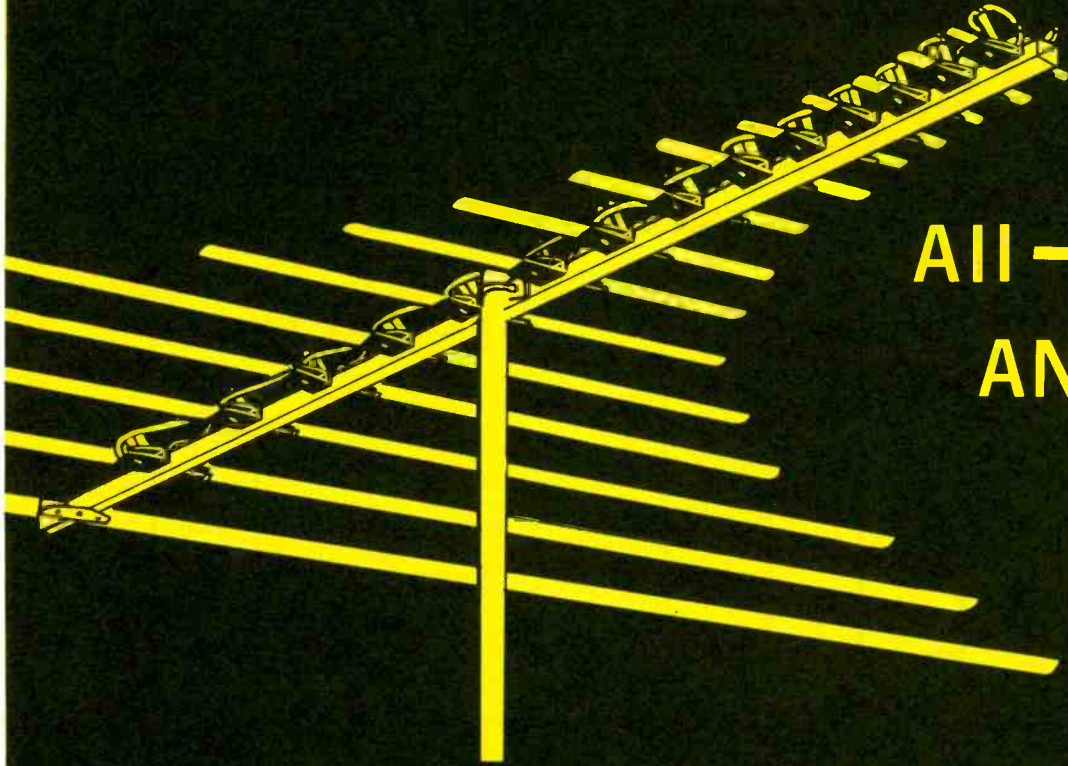

Fig. 5. Combination probe.

COLORMAGIC



**All-Channel
ANTENNAS
for
COLOR
and
Black
&
White**

Recommended by Leading TV Manufacturers!

**UHF VHF FM and FM Stereo
FROM ONE ANTENNA**

COLORMAGIC EXP SERIES ANTENNAS...
...ENGINEERED FOR PERFECT COLOR

*EXponential...a revolutionary COLORMAGIC design process employing the mathematical EXPonential Curve. The result of constant research and development, this remarkable series of antennas deliver an excellent signal for both All-Channel TV and FM without sacrificing any frequency. EXP antennas feature famous COLORMAGIC Gold-Guard finish, Compact Design, Rugged Construction, plus Ease of Assembly. There are 5 New Models to meet the requirements of every televiewing area.

SEE YOUR GC COLORMAGIC DISTRIBUTOR FOR THE COMPLETE EXP STORY.
IF NOT STOCKED LOCALLY WRITE US FOR THE NAME OF DISTRIBUTOR NEAREST YOU.....

**FREE UHF-VHF SPLITTER
INCLUDED WITH EACH ANTENNA**

MODEL A-1083

GC ELECTRONICS
Division of Hydrometals, Inc.
400 S. Wyman Street Rockford, Illinois, USA

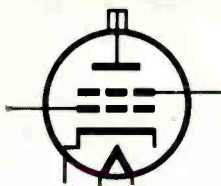

TUBE AND TRANSISTOR DATA

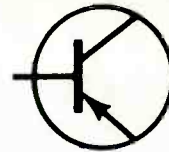

CATHODE-RAY TUBES

9WP4

Protection—tension band
Deflection—90°
Filament—12.0V @ 0.075A
Grid 2—100V
Neck Diam.—.788"

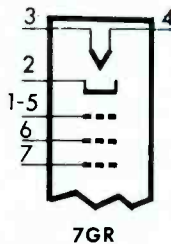

7GR

11KP4

Protection—tension band
Deflection—110°
Filament—6.3V @ 0.45A (11 sec)
Grid 2—50V

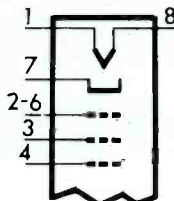

8HR

12BZP4

Protection—tension band
Deflection—104°
Filament—12.0V @ 0.157A (11 sec)
Grid 2—100V
Neck Diam.—.788"

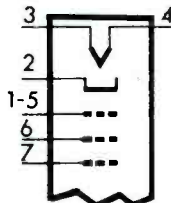

7GR

12CFP4

Protection—tension band
Deflection—110°
Filament—4.2V @ 0.45A (11 sec)
Grid 2—200V
Neck Diam.—.788"

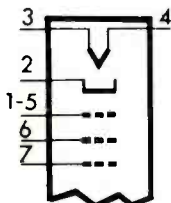

7GR

CATHODE-RAY TUBES

12CHP4

Protection—tension band
Deflection—110°
Filament—6.3V @ 0.45A (11 sec)
Grid 2—300V
Neck Diam.—.788"

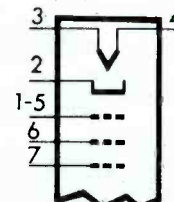

7GR

16CMP4A

Protection—tension band
Deflection—114°
Filament—6.3V @ 0.45A (11 sec)
Grid 2—300V

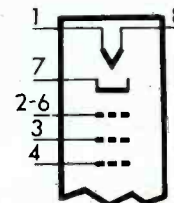

8HR

16CNP4

Protection—tension band
Deflection—104°
Filament—12.0V @ 0.157A (11 sec)
Grid 2—100V
Neck Diam.—.788"

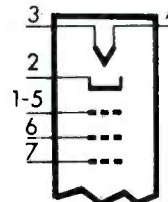

7GR

16CTP4

Protection—tension band
Deflection—114°
Filament—6.3V @ 0.45A (11 sec)
Grid 2—400V

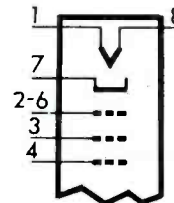

8HR

**WORLD'S LARGEST SELLING
AND WORLD'S NEWEST**

Hand Size V-O-M's



MODEL 310
World's Largest Selling
Volt-Ohm-Milliammeter

MODEL 310-C
World's Newest
Volt-Ohm-Milliammeter



**BOTH TESTERS
SHOWN
ACTUAL SIZE**

- 1** HAND SIZE AND LIGHTWEIGHT, but with the features of full-size V-O-M's.
- 2** 20,000 OHMS PER VOLT DC; 5,000 AC (310)—15,000 AC (310-C).
- 3** EXCLUSIVE SINGLE SELECTOR SWITCH speeds circuit and range settings. The first miniature V-O-M's with this exclusive feature for quick, fool-proof selection of all ranges.

SELF-SHIELDED Bar-Ring instrument; permits checking in strong magnetic fields. FITTING INTERCHANGEABLE test prod tip into top of tester makes it the common probe, thereby freeing one hand. UNBREAKABLE plastic meter window. BANANA-TYPE JACKS—positive connection and long life.

Model 310—\$42.00 Model 310-C—\$53.00 Model 369 Leather Case—\$4.00

ALL PRICES ARE SUGGESTED U.S.A. USER NET, SUBJECT TO CHANGE

THE TRIPLETT ELECTRICAL INSTRUMENT COMPANY, BLUFFTON, OHIO

310-C PLUS FEATURES

1. Fully enclosed lever range switch
2. 15,000 Ohms per volt AC (20,000 O/V DC same as 310)
3. Reversing switch for DC measurements

MODELS 100 AND 100-C

Comprehensive test sets. Model 100 includes: Model 310 V-O-M, Model 10 Clamp-on Ammeter Adapter; Model 101 Line Separator; Model 379 Leather Case; Model 311 leads. (\$78.00 Value Separate Unit Purchase Price.)

MODEL 100—U.S.A. User Net..\$74.00
MODEL 100 - C—
Same as above, but
with Model 310-C,
Net.....\$84.00



USES UNLIMITED: FIELD ENGINEERS • ELECTRICAL, RADIO, TV, AND APPLIANCE SERVICEMEN • ELECTRICAL CONTRACTORS • FACTORY MAINTENANCE MEN • ELECTRONIC TECHNICIANS • HOME OWNERS, HOBBYISTS
THE WORLD'S MOST COMPLETE LINE OF V-O-M's • AVAILABLE FROM YOUR TRIPLETT DISTRIBUTOR'S STOCK

CATHODE-RAY TUBES

16CUP4

Protection—tension band
Deflection— 114°
Filament—6.3 @ 0.45A (11 sec)
Grid 2—400V

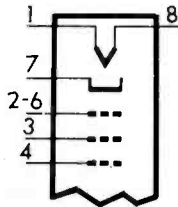

8HR

19FCP4

Protection band
Deflection— 114°
Filament—6.3V @ 0.45A (11 sec)
Grid 2—400

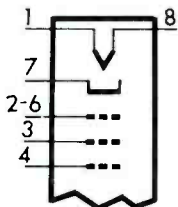

8HR

19FEP4B

Protection—tension band
Deflection— 114°
Filament—6.3V @ 0.45A (11 sec)
Grid 2—30V

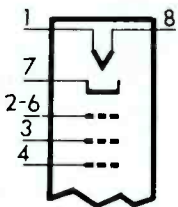

8HR

19FKP4

Protection—tension band
Deflection— 110°
Filament—6.3V @ 0.3A
Grid 2—300V

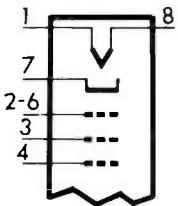

8HR

19FLP4

Protection—tension band
Deflection— 114°
Filament—6.3V @ 0.45A (11 sec)
Grid 2—300V

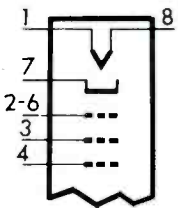

8HR

CATHODE-RAY TUBES

19GMP4

Protection—bonded glass
Deflection— 114°
Filament—6.3V @ 0.45A (11 sec)
Grid 2—50V

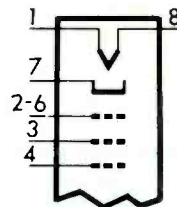

8HR

21FWP4

Protection—tension band
Deflection— 114°
Filament—6.3V @ 0.45A (11 sec)
Grid 2—400V

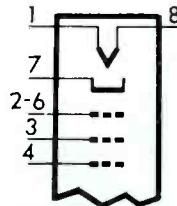

8HR

23ERP4

Protection—tension band
Deflection— 114°
Filament—6.3V @ 0.6A (11 sec)
Grid 2—300V

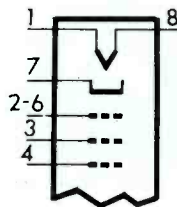

8HR

RECEIVING TUBES

3KT6

Video IF Amplifier
Fil.—3.5V @ 0.6A (11 sec)

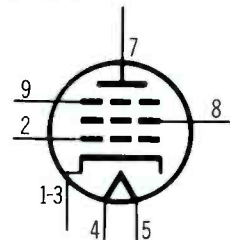

9PM

4KT6

Video IF Amplifier
Fil.—4.5V @ 0.45A (11 sec)

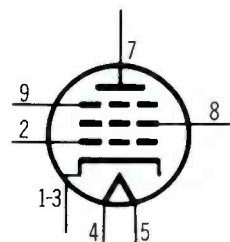

9PM

Getting a hernia and not getting paid for it?

Switch to Elmenco dipped Mylar®-paper capacitors and you won't have to worry about call-backs, lost profits, broken reputations or broken anything else.

The only ordinary thing about them is their price. You get capacitors that meet the requirements of high-reliability computer and missile systems. You get capacitors that hold their rating at 125°C continuous operation. Yet you get them at TV set prices.

Elmenco dipped Mylar-paper capacitors come in just about any value you need from .001 mfd to 1.0 mfd. And just about any TV rated voltage you need, too, from 100V through 1600V.

Ask your Authorized Arco Distributor to put them on your next order. Without fail.

Tell him you're counting on his support.

(While you're at it, ask about other Elmenco types: padders and trimmers; high voltage dipped micas.)

Arco Electronics

A Division of Loral Corporation
Community Drive, Great Neck, N. Y.
Dallas, Texas, Pasadena, California,
Menlo Park, California.

® DU PONT TRADEMARK.



Circle 15 on literature card

www.americanradiohistory.com

TRANSISTORS

2SA360

FM IF Amplifier
PNP—Germanium

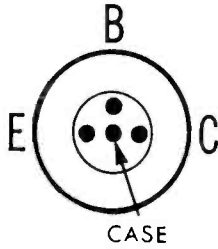

2SA368

FM IF Amplifier
PNP—Germanium

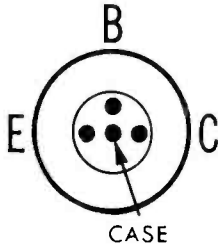

2SB155

FM IF Amplifier
PNP—Germanium

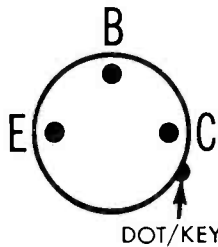

TRANSISTORS

2SB181A

Horizontal Output
PNP—Germanium

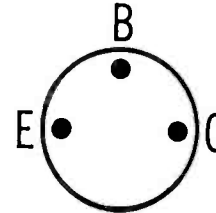

2SB405

Audio Output
PNP—Germanium

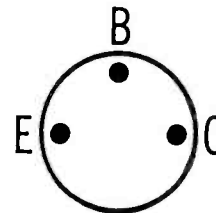

2SB407

Voltage Regulator
PNP—Germanium

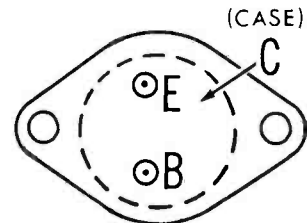

2SB457

Audio Output
PNP—Germanium

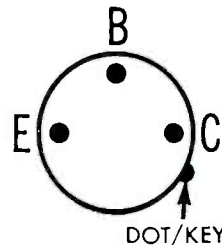

2SD178

Vertical Output
NPN—Germanium

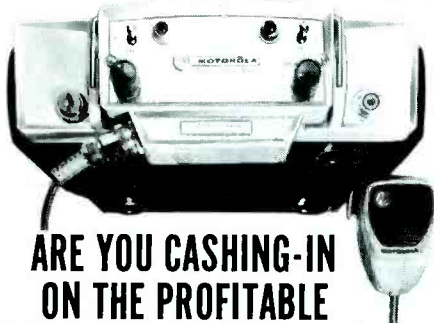
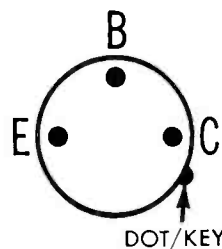

ARE YOU CASHING-IN ON THE PROFITABLE 2-WAY RADIO SERVICE BUSINESS?

- ★ Motorola will train you for this rewarding, elite profession
- ★ Send for our FREE EVALUATION EXAM. Prove to yourself that you are ready to learn FM 2-way radio servicing.

Opportunities in 2-way radio servicing are virtually unlimited. ■ Just one of the hundreds of successful Motorola Service Stations writes, "we would be pleased to interview any graduate of your school that has received some training in 2-way radio maintenance. We are an established firm, 10 years old, with a promise of expansion governed by our ability to obtain competent technicians." ■ Get all the facts today. There is no obligation and no salesman will call.



MOTOROLA TRAINING INSTITUTE

4545 West Augusta Blvd. • Chicago 51, Illinois • Dept. APX 710

- Send me FREE entrance exam.
- Send full details on Home Study Course on FM 2-way Radio Servicing
- Send me details on how you can help me prepare for an FCC License.

Name _____ Occupation _____

Address _____

City _____ Zone _____ State _____

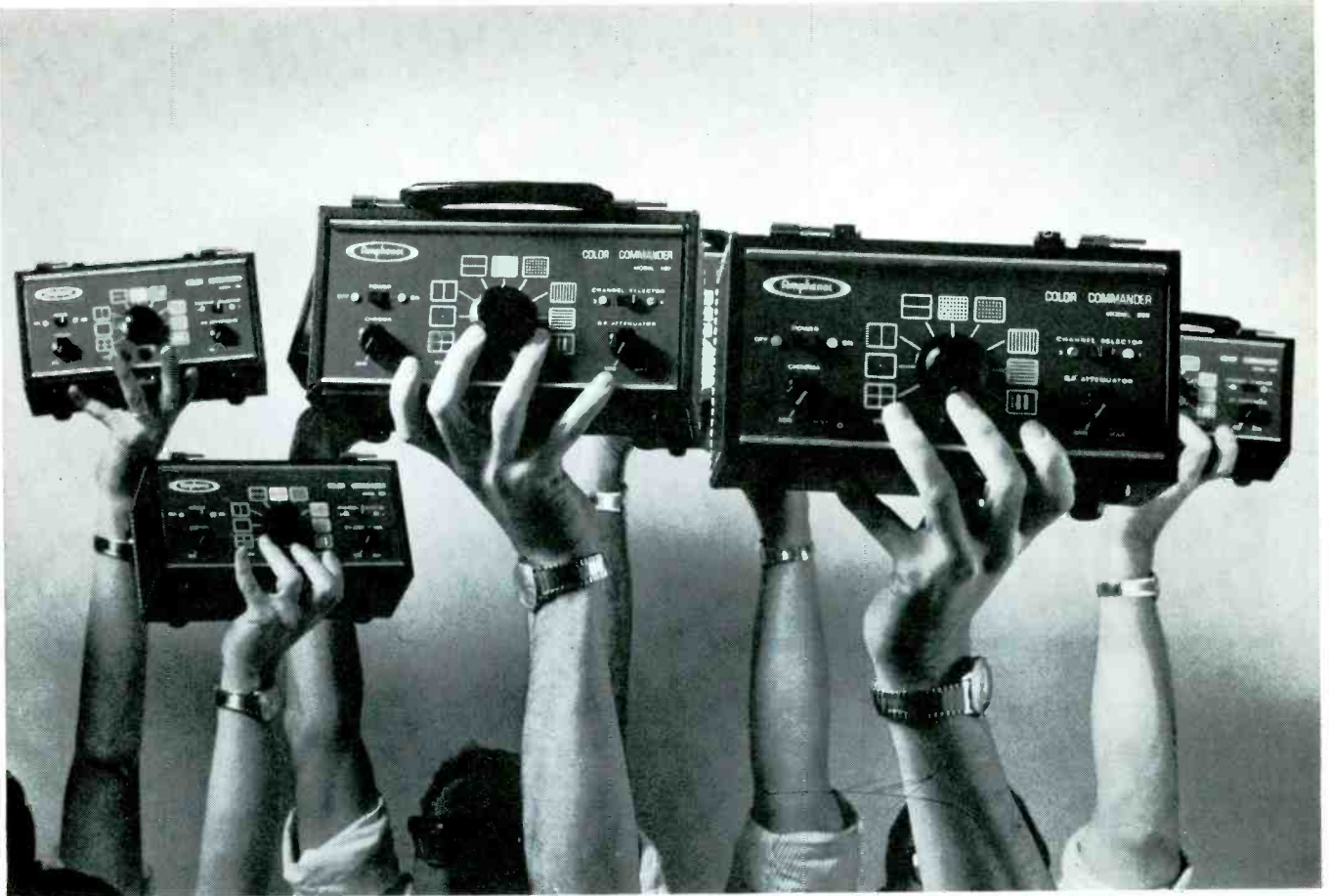

Suddenly, everyone's a Watch Watcher

We hate to say we told you so. But never-the-less, we told you so.

Service dealers everywhere have been watching their watches. And they've found we were right when we said the Color Commander could save enough time for two or three extra calls a day.

The reasons are simple.

The *single cross bar* gives fast, accurate reference for both vertical and horizontal raster centering, constant monitor of yoke leveling, and center reference for center purity adjustment.

For static convergence, the *single dot* pattern alone can save about fifteen minutes on your next call. Because it's an excellent quieting pattern, there's no need to pull an IF tube for purity check.

Everything about the Color Commander is simplified.

For instance, there's a *single vertical line*, for dynamic convergence at top center and bottom center, and a *single horizontal line*, for dynamic convergence left center and right center.

This simplicity adds up to easier, faster operation.

We could go on and on about the three color bar that's so much faster to work with than the old 10 bar patterns, the three to four aspect ratio cross-hatch for making height, width, and linearity adjustments, and all the rest.

But you're probably watching the time.

So just ask your Amphenol distributor salesman for a demonstration of this *super stable generator*. He'll be watching for your call.



NOTES ON TEST EQUIPMENT

*analysis of test instruments
...operation...applications*

by T. T. Jones

Solid-State Generator Features Small Dots

Mercury's new Model 1900 has some of the most up-to-date features we've seen in color generators. This unit has all of the main patterns — horizontal and vertical lines, crosshatch, dots, and keyed rainbow. It has the usual gun killers, frequency adjustable RF output, and

color level control. Just about all you'd want except 4.5-MHz audio carrier, which many servicemen don't use.

It has many little "extra" features which at first look are hidden. The horizontal and vertical lines are both adjustable in thickness with front panel controls. Fig. 2 shows a portion of the crosshatch pattern with these controls set for

the narrowest practical lines. The horizontal line is 1 scan line thick. The horizontal line pulse width is set so that it just begins to overlap. It can be set so that it is six scan lines thick. The vertical pulse is very narrow in the picture, but it can be set to about 3/8" width on a 21" screen. It follows that the dot size can be set from a very tiny dot to a 3/8" square.



Fig. 1. New solid-state color generator.

Mercury Model 1900 Specifications

Outputs:

10 Vertical lines, adjustable width. 14 Horizontal lines, adjustable thickness.
140 Dots, adjustable size.
Crosshatch.
10 Keyed rainbow bars, adjustable color level.

RF output:

Adjustable channel 3-5.

Gun killers:

100-K ohms.

Power requirements:

117 VAC 3 watts.

Size (HWD):

6¼" x 10" x 4½".

Weight:

4 pounds.

Price:

\$89.50.

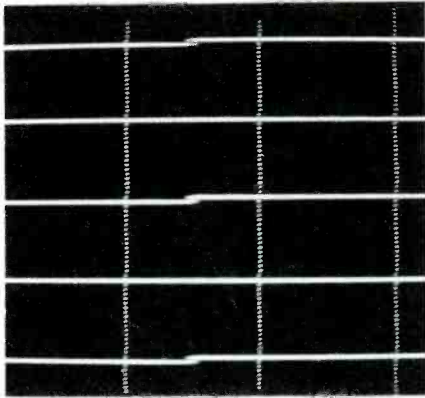

Fig. 2. Portion of crosshatch display.

Another operator convenience is that all internal adjustments can be reached through holes in the cabinet. The RF adjustment can be reached through the rear with a standard hex alignment tool. The Model 1000 is factory set to channel 3, and according to specs, may be adjusted to 4 or 5. The unit we tested however, had sufficient range to cover all channels on the lower band, 2 through 6.

All counter adjustments can be reached through the bottom of the Model 1000, with test jacks exposed at the rear. The unit should not need adjusting under normal use,

Transistor Multitester

Multitester is a name we think fits the Semitron Model 1000. The Semitronics Corp. calls it a Transistor Tester and Set Analyzer. No matter what you call it, it's a very versatile instrument.

It checks transistors for leakage and beta, both in-circuit and out-of-circuit. It also can be used as a diode tester, voltmeter, ammeter, and continuity checker. With a transistor in the test socket, it can be used as a signal generator; the output is a 5-kHz note with high harmonic content. The signal is useful at both

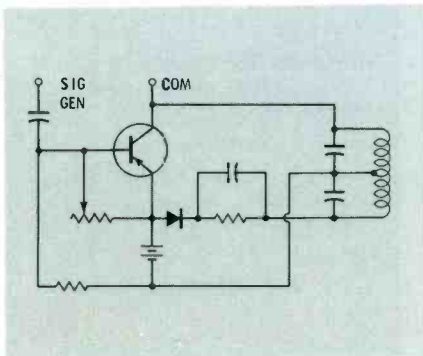

Fig. 5. Schematic of the generator.

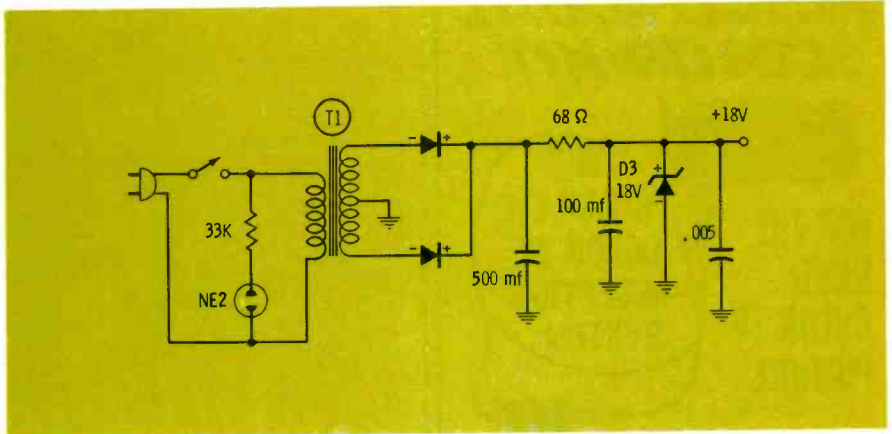

Fig. 3 Partial schematic of power supply.

as it has unijunction transistors in the counter stages, and shows very low drift. The color-crystal trimmer is also reachable through the rear panel.

The circuit is pretty much standard; it starts with a 189-kHz crystal oscillator and counts down to the vertical and horizontal sync rates. The horizontal lines are derived from a 900-Hz flip-flop oscillator. The pulse width of this oscillator is controlled by the front panel "HOR LINE ADJUST."

The power supply section (Fig. 3) is especially "beefy." Not only

is it a full-wave configuration, but very large filters are used, and then the output is regulated by zener diode D3. The DC output is nearly as pure as a battery source. This insures that there will be no false sync pulses caused by power supply ripple.

The unit is housed in a grey crackle-finish steel case, and has a convenient storage compartment for leads. The power lead is a standard TV jumper, and stores in the same compartment.

For further information circle 59 on literature card



Fig. 4. Model 1000 makes 8 tests.

audio and RF frequencies, so it can be injected anywhere in a receiver under test and traced through to

the speaker. The Model 1000 can also be used as a code-practice oscillator, if you want to be a Ham.

FINCO-AXIAL COLOR-KIT

FOR THE
BEST
COLOR TV
PICTURE

THE
COMPLETE
COLOR TV
RECEPTION
SYSTEM

VHF • UHF • FM • PASSES AC & DC
eliminates color-fade, ghosting and
smearing! Improves FM and Stereo, too!

FINCO-AXIAL COLOR-KIT, Model 7512 AB

High performance Indoor and Outdoor Matching
Transformers convert old-fashioned and inefficient
300 ohm hook-ups to the new Finco-Axial 75 ohm
color reception system. List price for complete kit
7512 AB \$8.95

7512-A Mast mounted matching transformer, list \$5.40

7512-B TV set mounted matching transformer
list \$4.15

FINCO-AXIAL SHIELDED COLOR CABLE, CX Series

Highest quality, 75 ohm swept co-axial cable (RG
59/U) complete with Type F fittings and weather
boot ready for installation.

Available in 25, 50, 75 and 100 foot lengths.
List price . . . \$5.55, \$8.65, \$11.50 and \$14.20

Write for Color Brochure Number 20-349

THE FINNEY COMPANY

34 West Interstate St., Dept. 310 Bedford, Ohio

Circle 17 on literature card

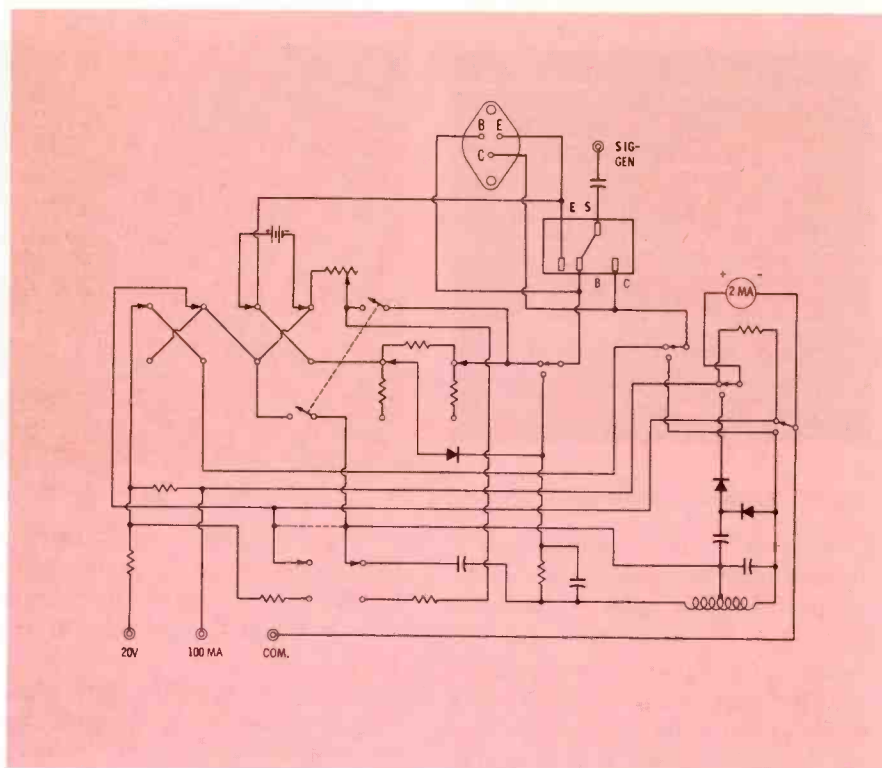
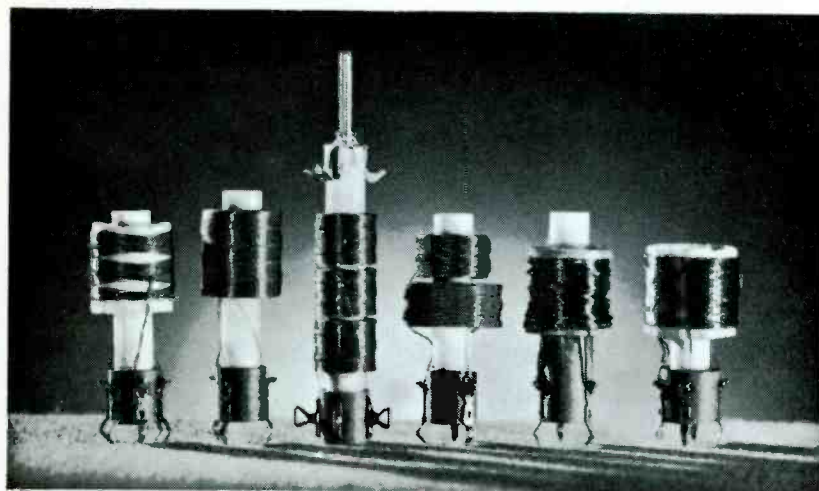

Fig. 6. Overall schematic.

The circuitry of the Model 1000 is extremely simple, yet quite complicated. This is because of the many functions, with several switches involved for each function. Any one individual test involves a simple

circuit, such as the signal generator shown in Fig. 5. However, the many different switches make the overall schematic resemble a maze (Fig. 6).

The whole instrument is housed in a bakelite case with a fold-over handle so the instrument can sit at an angle on the bench. The price is quite low—\$34.95 including all test leads.



Exact Replacement Sweep Circuit Coils for More than 25 Color TV Manufacturers

Color TV exact replacements for focus, convergence and sweep circuit coils are now available for sets made by manufacturers such as RCA • Philco • Westinghouse • Muntz • Motorola. Installation instructions and diagrams are included.



Write today for Color TV Coil Cross Reference Guide.

J. W. MILLER COMPANY

5917 SO. MAIN STREET • LOS ANGELES, CALIFORNIA 90003

SEE YOUR LOCAL DISTRIBUTOR FOR FULL LINE OF RF & IF COILS, CHOKES, FILTERS & TRANSFORMERS.

Circle 18 on literature card

Semitron Model 1000 Specifications

- DC Beta (H_{FE}):
0-400 in 3 ranges, out-of-circuit.
- AC Beta (H_{fe}):
In-circuit, uncalibrated
- DC Beta (power transistors):
0-200
- Diode:
Good-Weak-Poor scale
- Volts DC:
0-20 V
- Ma DC:
0-100
- Continuity (Ohms):
0-∞. 1000 ohms center scale
(must be calibrated).
- Signal Generator output:
1½ V p-p on fundamental
- Size (HWD):
5¼" x 7¼" x 3¼" o.a.
- Weight:
1½ lbs.
- Price:
\$34.95

For further information circle 60
on literature card

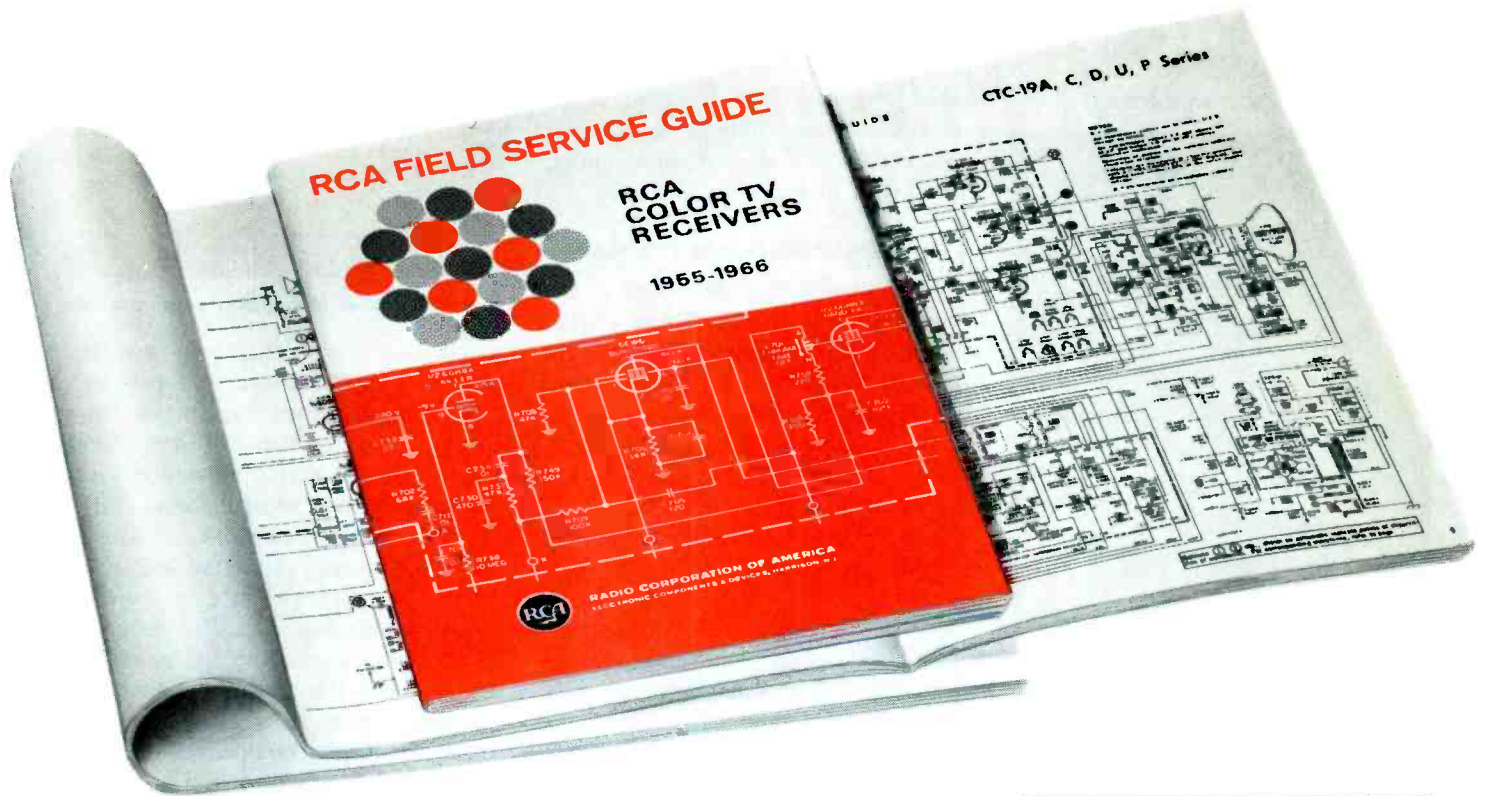

Get RCA's new field service guide FREE with your purchase of RCA's receiving tube Color Pack '67!

When you buy the RCA Color Pack '67 from your local participating RCA Tube Distributor, you get 21 popular RCA receiving tubes for color TV *plus* the new RCA Field Service Guide for the price of the tubes alone.

The RCA Field Service Guide helps you perform *all adjustments on an RCA color set that can be performed in the home with the aid of a color bar generator, including step by step procedure for replacing a color picture tube.*

WHAT THE GUIDE CONTAINS:

- Schematics on all RCA color sets for the last ten years
- Field service adjustments
- Parts lists
- Wave forms for majority of chassis
- Top and rear chassis views
- Photos of typical receivers
- Index of models from CTC2 through CTC20
- Convergence, purity and black and white setup adjustments
- Separate section on tuner schematics

Three part index lets you look up the set you are working on by model number, name or chassis number. The RCA Field Service

Guide will be your constant companion on house calls for RCA color sets.

Each Color Pack '67 contains one each of these tube types:

1V2	6BK4B	6EA8	6GH8A
3A3A/3B2	6CB6A	6EM7	6GU7
6AQ5A	6CC8A	6EW6	6JU8A
6AU4GTA	6DQ5	6FQ7/6CC7	6U8A
6AW8A	6DW4B	6CF7A	12BH7A
			12BY7A

See your participating RCA Tube Distributor now. Order the RCA Color Pack '67 and get your copy of the Field Service Guide FREE!

RCA Electronic Components and Devices, Harrison, N. J.



THE MOST TRUSTED NAME IN ELECTRONICS

SCOPE PROBES

(Continued from page 30)

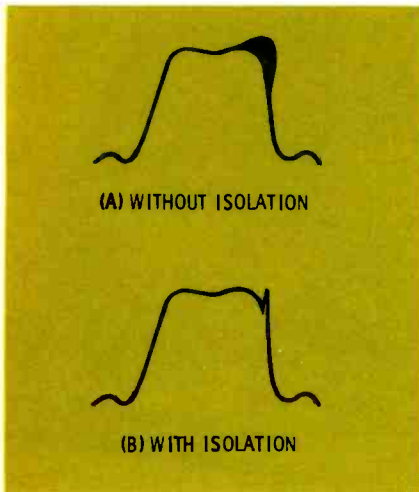

Fig. 6. Isolating resistor sharpens marker pip on response curve.

ing the isolation resistor assures a shunting impedance of at least 47K ohms — quite an increase over the relatively small impedance provided by the simple shielded direct probe. This added shunting impedance becomes even more significant at higher frequencies, where the shunting capacitance of the shielded direct probe can reduce the input impedance to only a few hundred ohms.

The addition of an isolation resistor in a probe is particularly useful when performing an IF sweep alignment. First, it helps filter out any IF signal which may have gotten through the detector, preventing such RF frequency components from reaching the scope and radiating back into the receiver. Also, together with the shunt capacitance of the shielded cable and scope input, it forms an in-

tegrating network to bypass and attenuate any frequency above several kilohertz. This high frequency attenuation results in a sharper marker pip on the response curve, as shown in Fig. 6.

Low-Capacitance Probes

As mentioned previously, the combined shunt capacitance of the shielded direct probe and scope input circuit produces a shunt capacitance of approximately 50 to 100 pf. At low frequencies, the reactance of this shunt capacitance is sufficient to maintain a relatively high input impedance with respect to the low impedance normally found in low-frequency circuits. However, 50 to 100 pf of shunt capacitance can cause serious distortion in the high-frequency, high-impedance circuits found in the sync and video amplifier sections of a TV receiver. Also, the loading effect of the scope input impedance can detune the resonant high-frequency circuits of these sections.

Adding an isolation resistor to the probe increases the input impedance and overcomes some of the effects of the shunt capacitance; however, as pointed out, the isolating resistor introduces an integrating action. This high-frequency attenuation is suitable for viewing a response curve or other waveform where high-frequency response is not needed, or not present. However, when viewing complex waveforms containing high-frequency components, the isolating resistor tends to round off all sharp wavefronts.

A small capacitor placed in series with the probe and scope shunt

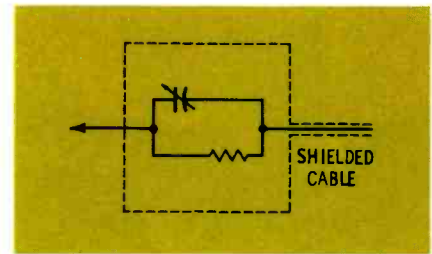

Fig. 7. Basic low-capacitance probe.

capacitance will effectively reduce the shunt capacitance and provide isolation. However, again we encounter the problem of frequency response—the series capacitor and input resistance of the scope form a differentiating network, resulting in low-frequency attenuation.

The low-capacitance (low-C) probe shown in Fig. 7 combines the advantages of both the isolating resistor and the series capacitor to provide decreased shunt capacitance, frequency compensation, and a known amount of signal attenuation. Obviously, knowing the exact amount of signal attenuation is an absolute must in determining the peak-to-peak amplitudes of a waveform.

Fig. 8 shows the low-C probe and its components in relation to the shunt capacitance of the shield and scope input, and the input resistance of the scope. The parallel combination of C1 and R1 are in series with the shielded cable and consequently in series with the scope input. Since C1 is in series with the combined shunt capacitance of the scope and shield, it decreases the total effective capacitance, thereby increasing the capacitive reactance. R1 acts as an isolating resistor, as described earlier, and also decreases the total input capacitance.

The two parallel circuits consisting of C1,R1 and C2,R2 are connected in series and act as a voltage divider, decreasing the amplitude of the measured signal. This attenuation is one minor disadvantage of the low-C probe, limiting its use to circuits having sufficient signal level to offset this inherent attenuation. Such circuit include the sync and video amplifiers stages in TV receivers.

To avoid waveform distortion, the voltage attenuation must be the same at all frequencies. Therefore, not only must C1,R1 be selected to

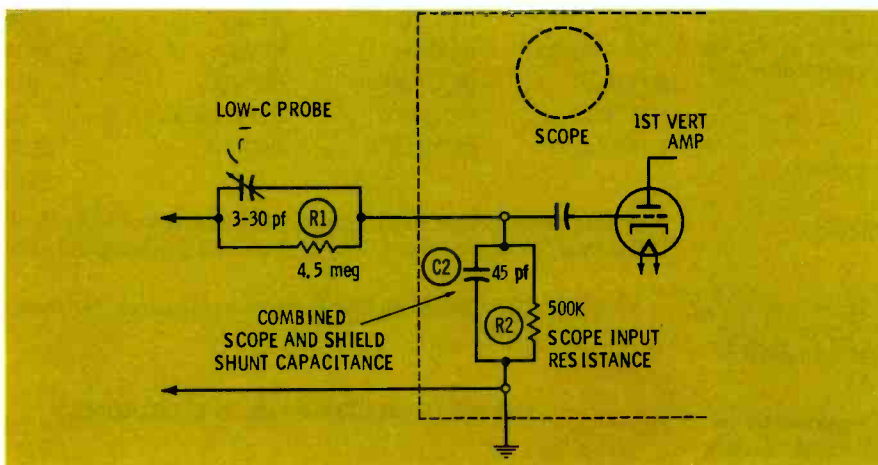

Fig. 8. Low-C probe in series with scope and cable input impedance.

NEW!

JFD® COLOR SHIELD-82 COAXIAL CABLEMATCH SOLVES THE 75 OHM INSTALLATION PROBLEM



If you've been vexed by the questionable need for a 300-75 ohm matching transformer at the antenna when installing coaxial cable, here's good news. The new JFD 75-ohm Color Shield-82 Coaxial Cablematch comes with the **matching transformer already attached** to the cable and ties directly to the 300 ohm output.

Solves two big antenna installation problems: (1) When you want to use coaxial cable simply connect JFD Color Shield-82 (with the "built-on" transformer) directly to the JFD LPV antenna terminals—for minimum possible loss, and, (2) save time and money by having the transformer as part of the 75 ohm cable (instead of the antenna).

No waste. No work. No separate parts or fittings to connect or disconnect. No losses through fittings and connectors. Simply beautiful! Beautifully simple! Great for color, too!

Available in three lengths at your JFD distributors, complete **WITH ATTACHED 300-75 OHM MATCHING TRANSFORMER**

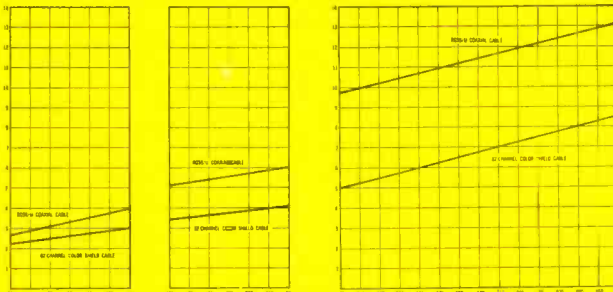

VHF INSERTION LOSS—JFD 82-CHANNEL COLOR-SHIELD CABLE VS RG58/U CO-AXIAL CABLE

UHF INSERTION LOSS—JFD 82-CHANNEL COLOR-SHIELD CABLE VS RG59/U CO-AXIAL CABLE

Whether you install antenna system in homes, motels, stores or multiple dwellings—rely on the new JFD 82-channel Color Shield-82 with pre-assembled matching transformer for the clearest pictures in sight—color, and black and white.

Model	Length	List
CS82-50	50 ft.	\$11.25
CS82-75	75 ft.	\$14.25
CS82-100	100 ft.	\$17.00

TO INSTALL COLOR SHIELD-82 COAXIAL CABLEMATCH DIRECTLY TO TV RECEIVER, USE A JFD 82-CHANNEL COLORMATCH/SPLITTER MATCHING TRANSFORMER ...

Model MT54
List \$3.50

VHF, UHF, FM Indoor 75-ohm-300 ohm Matching Transformer. With coaxial cable "F" fitting.

Accessories Included
1 "F" Connector

Model MT56
List \$7.50

2-Way Indoor 75 ohm-300 ohm Matching Transformer with separate VHF and UHF outputs, plus coaxial cable "F" fitting.

Accessories Included
1 "F" Connector

Model MT58
List \$8.95

3-Way Indoor 75 ohm-300 ohm Matching Transformer with VHF, UHF and FM outputs. With coaxial cable "F" fitting.

Accessories Included
1 "F" Connector

ATTRACTIVELY PACKED ON CONVENIENT CLEAR-PAK CARD



TO INSTALL COLOR SHIELD-82 COAXIAL CABLEMATCH DIRECTLY TO A 75 OHM AMPLIFIER OR SYSTEM, USE A JFD SIGNAL SPLITTER ...

Model SC42-75
List \$7.95

75 ohm VHF/UHF/FM single input—75 ohm VHF/UHF/FM two-set signal splitter. Includes coaxial cable "F" fittings.

Model SC72-75
List \$10.95

75 ohm VHF/UHF/FM single input—75 ohm VHF/UHF/FM four-set signal splitter. Includes coaxial cable "F" fittings.

See your distributor—or write for Form 6735.

JFD ELECTRONICS CO.

15th Avenue at 62nd Street, Brooklyn, N.Y. 11219

JFD International, 64-4 Woodside Ave., Woodside, N.Y. 11377 JFD Canada, Ltd., Canada
JFD de Venezuela, S.A., Avenida Los Haticos 125-37, Maracaibo, Venezuela

JFD®

Circle 19 on literature card



SCORE
with **Jif**
the **WINNER** among
CONTACT
& **CONTROL**
CLEANERS

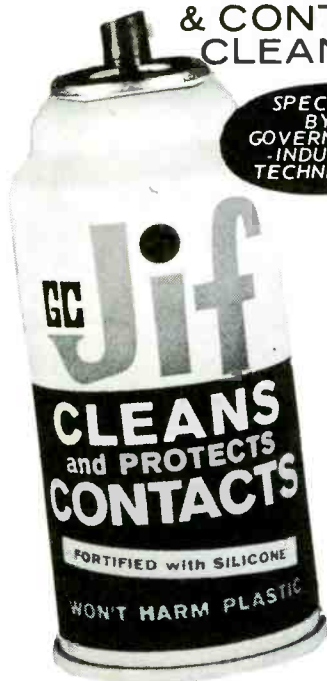

JIF Contact and Control Cleaner - cleans and lubricates plus providing contacts and controls with the longest possible protection. Won't harm plastics - contains no harsh solvents - formulated with silicone. Try JIF on your team of service aids. It's great

FREE GIFT COUPONS
on GC Aerosol Chemicals



GC ELECTRONICS
Div. of Hydrometals, Inc.
400 S. Wyman St.
Rockford, Ill., U.S.A.

Circle 20 on literature card

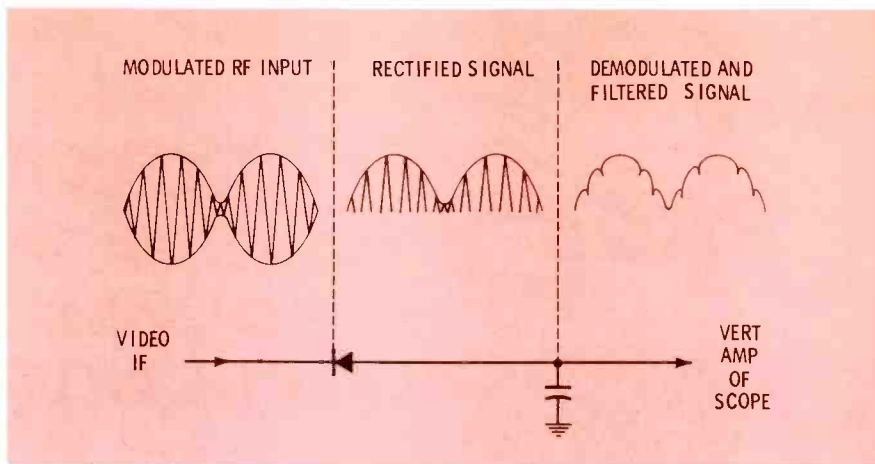

Fig. 9. Rectifying and filtering action of basic demodulator probe.

provide a voltage ratio of 100 to 1, 10 to 1, or some other fraction, but $C1, R1$ must be equal to $C2, R2$. With these two time constants equal, the voltage will be divided at all frequencies by the same ratio.

As an example, to construct a probe with a 10-to-1 ratio, $C1$ must be equal to $1/9$ the capacitance of $C2$, paralleled by a resistor nine times the value of $R2$. With these ratios satisfied, the input impedance is effectively shunted by ten times its former resistance, while the combined shield and scope input capacitance ($C2$) is reduced to $1/10$ its former value.

The probe components shown in Fig. 8 are for a 10-to-1 probe, with the component values selected for use with a scope having an input resistance of 500K ohms and a combined shield and input shunt capacitance of 45 pf. The formulas for determining the correct probe component values for the characteristics of a particular scope are:

$$R1 = R2 (A-1)$$

$$\text{and } C1 = \frac{C2}{(A-1)}$$

The component designations refer to the components in Fig. 8. "A" is the desired ratio; if a 10-to-1 ratio is desired, 10 will be substituted for "A," etc. $C1$ is normally a small adjustable ceramic with a minimum capacitance lower than the calculated value for the specific application (5 pf for the scope characteristics in this application).

In actual practice, after the probe is constructed (or pur-

chased), it should be connected to the scope, and the trimmer ($C1$) adjusted to provide uniform frequency compensation. This can be done by applying the output of a square wave generator to the probe, and adjusting $C1$ for the best square wave reproduction at 20 to 20,000 hertz. A sine-wave generator can also be used, with $C1$ adjusted for sine waves of equal amplitude at the frequency extremes.

Demodulator Probe

Servicing a television receiver often requires observation of the composite video signal in the tuner output or video IF circuits. Obviously, the RF frequencies of these circuits are beyond the frequency response of even a wide-band scope. Therefore, it is necessary to extract the video signal from the modulation envelope of the RF signal—a function normally accomplished by the video detector. However, since we are testing circuits prior to the video detector, we must, in effect, employ an auxiliary video detector in the scope input circuit. The demodulator probe is designed to serve this function.

The essential difference between a demodulator probe and a rectifier probe is that the demodulator probe must have a shorter time constant. The time constant of the filter circuit associated with the demodulator probe should be long enough to remove the high-frequency carrier, yet short enough to respond to the lower frequencies in the modulated envelope. The basic operation of the demodulator is shown in Fig. 9.

Two types of series demodulator probes are shown in Fig. 10.

• please turn to page 52



Controls And Yoke

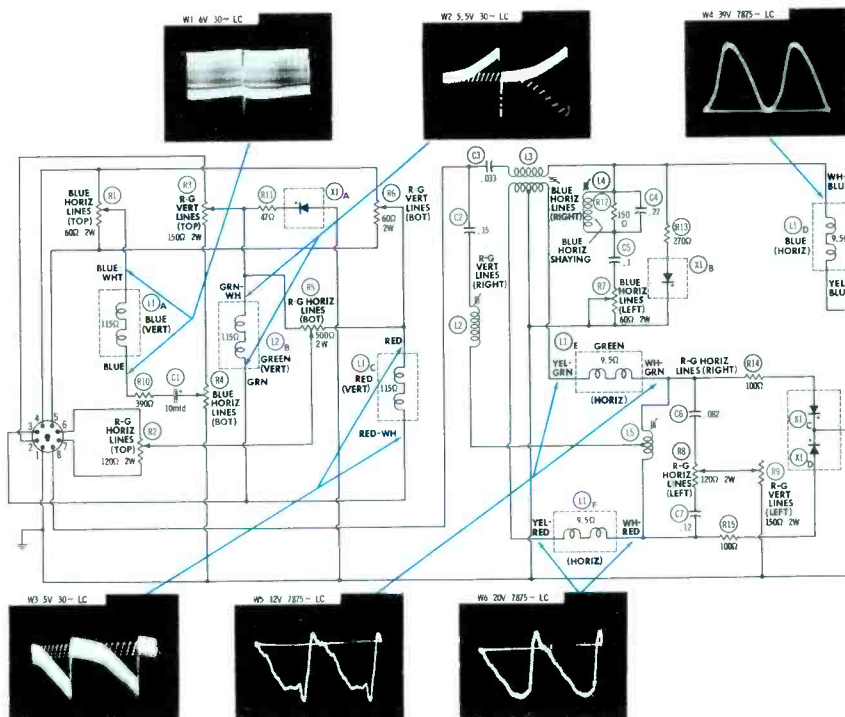

DC RESISTANCES taken with VTVM with interconnecting cable unplugged from main chassis. All controls set for proper convergence.

WAVEFORMS taken with wideband scope; low-capacitance probe (LC), connected across convergence yoke windings, used to obtain all waveforms shown.

Normal Operation

Convergence assembly alters path of three electron beams in picture tube so that they pass through same hole in aperture mask at any given instant. This is necessary since picture tube face plate is relative flat and beams sweep in an arc. Three beams will converge at center of screen, but without modifying path, beams will come together before reaching edges of face plate. Most popular method uses three section convergence yoke—one section for each beam. Each section consists of a permanent magnet for static or center convergence and an electromagnet with both vertical and horizontal windings for dynamic or edge convergence. Current through vertical and horizontal coils must have parabolic waveform for strong control of beams at edges, declining towards middle, and increasing to maximum again at edges. Waveforms from sweep circuits are shaped and mixed to supply proper control current across convergence yoke windings. Vertical waveforms are from separate windings on vertical-output transformer and output cathode. Horizontal pulse is from flyback winding. Circuitry shown here connects sweep waveforms to separate convergence board for shaping; resulting waveforms are connected to convergence yoke. While there is interaction between controls, convergence board circuitry is divided into two sections—vertical and horizontal. Vertical section controls converge red and green vertical lines at center and red-green-blue horizontal lines at top and bottom. Horizontal section controls converge red-blue-green horizontal center lines, and vertical lines at edges.

Operating Variations

- W1** Blue horizontal lines (bot) control changes angle of tilt of horizontal portion of waveform. Blue horizontal lines (top) varies spike amplitude and polarity.
- W2, W3** R-G vertical lines (bot) control changes spike amplitude and polarity. R-G vertical lines (top) varies tilt of horizontal portion of waveform. R-G horizontal lines (top) control changes amplitude and polarity of spike portion. R-G horizontal lines (bot) varies overall amplitude as well as tilt of sawtooth.
- W4** Blue horizontal lines (left) control varies amplitude of waveform. Blue horizontal lines (right) coil moves harmonic “bump” up and down declining portion of waveform.
- W5, W6** R-G horizontal lines (left) control moves hump up and down on declining portion of waveform. R-G vertical lines (left) control changes hump location on declining trace, overall amplitude, and angle of leading edge. R-G horizontal lines (right) and R-G vertical lines (right) coils vary overall amplitude.
- Blue Horizontal Shaping Coil Adjustment** Connect scope across blue horizontal winding (L1D) of convergence yoke and adjust coil so that harmonic “bump” is halfway up declining trace.

Symptom 1

Vertical Red Lines Displaced

Entire Screen Affected

R6 Wiper Arm Open

(R-G Vertical Lines (bot)
Control—60 ohms, 2W)

Symptom Analysis

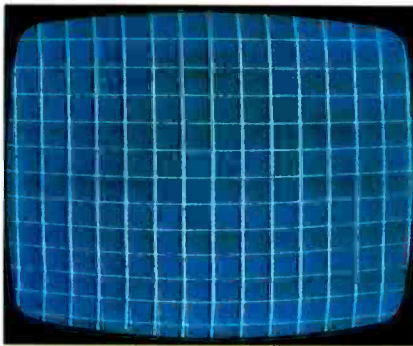

B-W picture has excessive red vertical fringing on picture information. Cross-hatch pattern shows red vertical lines bowed right of other lines at top, left in middle, right again at bottom. Green bowed opposite. Blue straight. R3 and R6 inoperative.

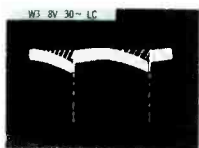
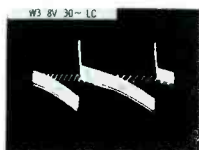
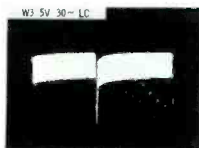

Waveform Analysis

Waveform W3 is slightly higher than normal 3 volts p-p, but normally, amplitude and polarity of spike can be changed to converge red and green vertical center lines with R6. Positive spike is connected to one end of R6, negative to other — center tap can be any amplitude of either polarity. Second and third pictures show W3 with R6 set at either end under normal conditions. Best clue from W3 is lack of tilt in horizontal portion.

Voltage and Component Analysis

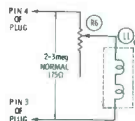

DC voltages are small and insignificant when troubleshooting convergence board. Resistance readings are best. Waveform analysis points to L1C and associated circuitry—resistance measurements in this area turn up good clue. Resistance between pins 3 and 4 of plug (plug disconnected) should be about 175 ohms maximum, but now reads about 3 megohms. Trouble can be quickly isolated with one or two more continuity checks. W3 is result of several input waveforms—loss of any one can make proper convergence impossible.

Best Bet: Scope; VTVM for resistance measurements.

Blue Horizontal Lines Bowed

Other Convergence

Near Normal

C1 Open

(Coupling Capacitor—10 mfd)

Symptom 2

Symptom Analysis

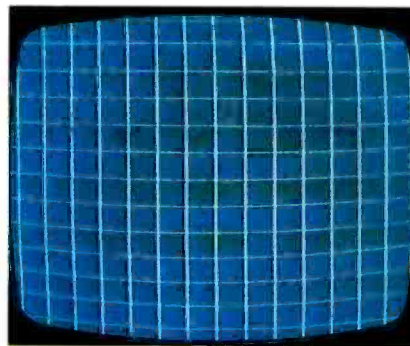

Black-and-white program has blue and yellow fringing on horizontal edges of picture information. Cross-hatch pattern shows blue horizontal lines bowed over entire screen. All other lines are straight and converged. R1 and R4 are inoperative.

Waveform Analysis

Amplitude of W1 approximately one hundred times higher than normal 6 volts p-p. W1 contains no vertical information. Second waveform is normal except R4, blue horizontal lines (bot) control, is at one end. Waveform with R4 at other end (not shown) is similar, except spike is positive going. Third waveform is also normal except R1, blue horizontal lines (top) control, is at maximum clockwise point to show tilting effect.

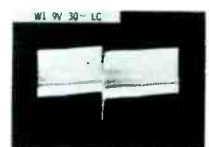

Voltage and Component Analysis

In this instance, resistance measurements only verify continuity of components in suspected circuit. Waveform analysis and component substitution are necessary to solve problem. L1A positions blue horizontal lines at top and bottom of screen. Normally, some horizontal information is induced into vertical windings (from horizontal winding). With C1 open, L1A is "floating"—vertical waveforms have no effect and induced horizontal information becomes much stronger, bending horizontal blue lines into near sine wave.

Best Bet: Scope; resistance measurements; component substitution.

Symptom 5

Horizontal Lines Not Converged

All Colors Affected

L3 Primary Open

(Blue Horizontal Lines Coil—Right)

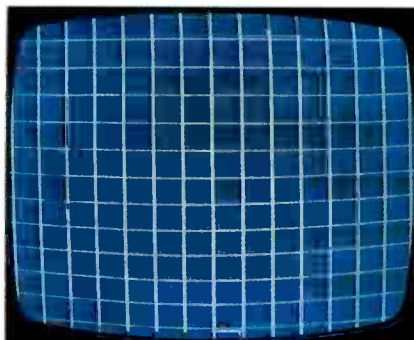

Symptom Analysis

B-w picture has blue and yellow fringing on horizontal edges. Cross-hatch shows horizontal lines bowed—blue more than others. Lines low at left and right edges, high in middle. Static convergence only makes edges more separated. Controls have little effect.

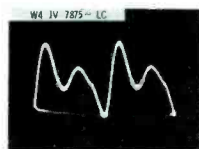

Waveform Analysis

Waveforms across horizontal convergence yoke coils are incorrect. W4 is almost nonexistent (1 volt, normally about 39 volts p-p) and content is distorted. W5 half normal amplitude (6 volts p-p, normally 12 volts p-p) and sharp change of direction in waveform is missing. W6 near normal amplitude, but looks more like sine wave than normal waveform. Horizontal input pulse at pin 8 of plug (not shown) is normal.

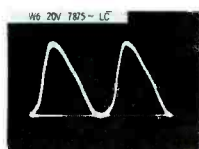
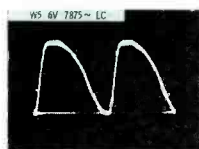

Voltage and Component Analysis

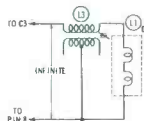

Symptom and waveform analysis indicate blue horizontal lines are affected most. Resistance check from junction of C3 and L3 to common shows open—normally 20 ohms. One or two more checks will isolate. L3 primary shapes horizontal pulse to some extent and couples it to blue horizontal circuitry. Tapped secondary of L3 supplies opposing horizontal pulses to red and green horizontal convergence circuits. Horizontal lines do not converge—blue because coil receives no signal, red and green because signal reduced.

Best Bet: Scope and symptom analysis; then VTVM.

Red Displaced

Both Horizontal and Vertical

L2 Open

(R-G Vertical Lines Coil—Right)

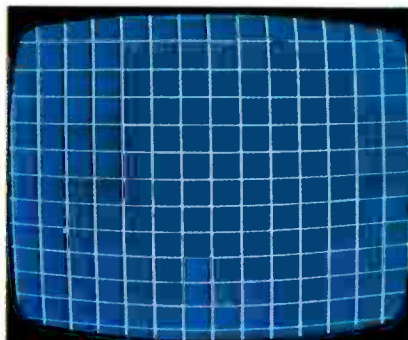

Symptom 6

Symptom Analysis

Green and blue converged over entire screen. Horizontal red lines low. Vertical red lines displaced to right of blue-green at either side, but to left in middle. Static convergence corrects horizontal and middle vertical lines, but makes red vertical at edges worse.

Waveform Analysis

W4 across horizontal blue winding of convergence yoke normal, both in amplitude and content. W5 and W6 both appear to have something missing. About all that shows in these waveforms is horizontal pulse from secondary of L3 (negative going across green winding and positive going across red). The polarity of these waveforms may be reversed by scope connections, but important point is that pulses are present and opposite.

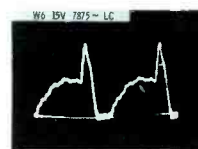
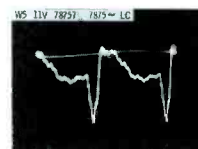
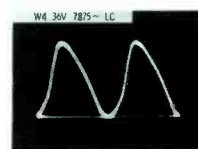

Voltage and Component Analysis

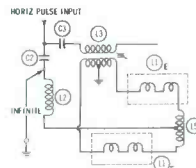

Horizontal input pulse is coupled through C2 to tuned circuit which is shock excited into oscillation by pulse. This produces sine wave at horizontal frequency that is connected to red and green circuitry and shaped by diodes X1C and X1D. Without this signal the only waveforms across red and green windings are opposing pulses from secondary of L3. Resistance checks in this circuitry give best clue—reading from junction of C2 and L2 to common (pin 1 of plug) is infinity—should be 15 to 20 ohms.

Best Bet: Scope; then resistance measurements.

NOW...a full-sized **VOM** in a palm sized "package"

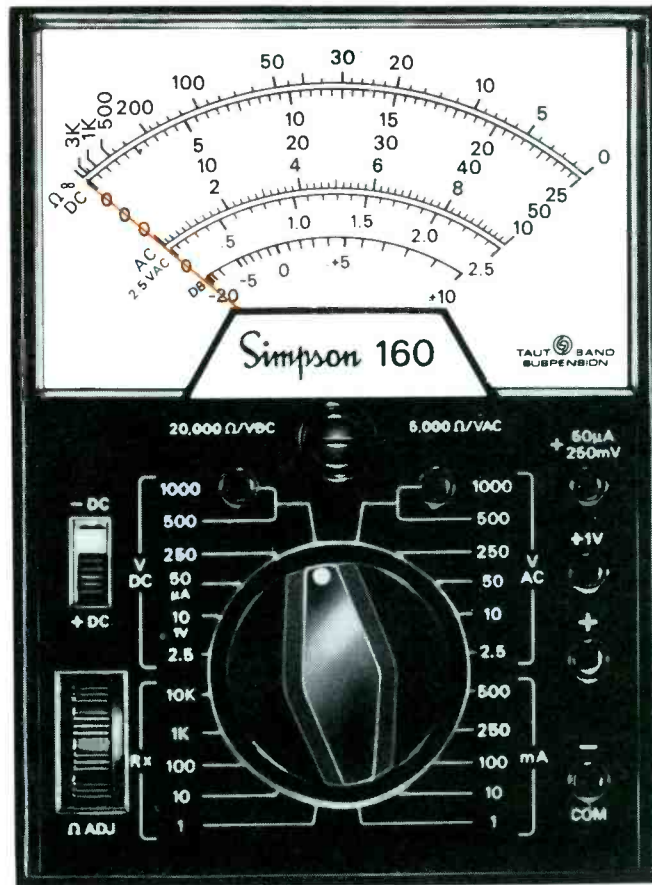
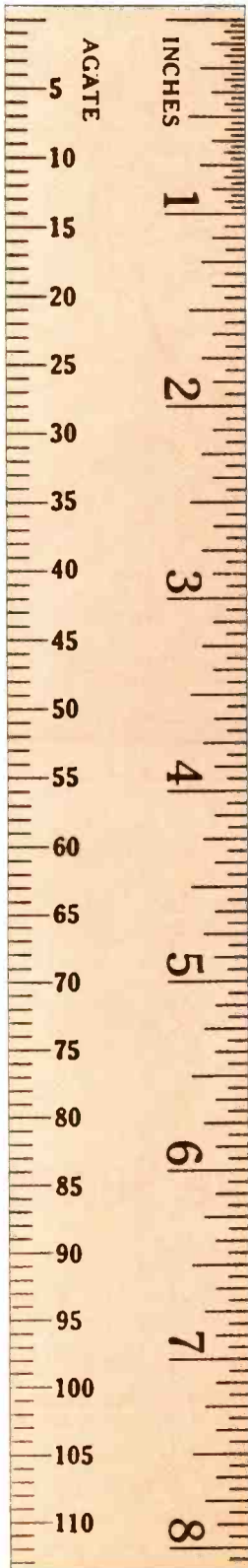

160 Volt-Ohm-Milliammeter
Complete with alligator clip
leads and operator's manual.
..... \$50.00



Carrying Case—
Cat. No. 2225 \$ 9.50
Accessory Leads—
Probe Tip Lead—
Cat. No. 2055 \$ 2.75

Simpson 160 Handi-VOM®

Simpson Handi-VOM gives you the ranges, the time-saving conveniences and the sensitivity of a full-sized volt-ohm-milliammeter—yet it's only 3-5/16" wide, weighs a mere 12 ounces. Recessed range-selector switch never gets in the way . . . polarity-reversing switch saves fuss and fumble. Self-shielded taut band movement assures high repeatability and freedom from external magnetic fields. Diode overload protection prevents burn-out—permits safe operation by inexperienced employees and students. The demand is BIG, so get your order in to your electronic distributor, TODAY!

RANGES

ACCURACY: $\pm 3\%$ FS DC, $\pm 4\%$ FS AC
DC VOLTS: 0-0.25, 1.0, 2.5, 10, 50, 250,
500, 1000 @ 20,000 Ω/v
AC VOLTS: 0-2.5, 10, 50, 250, 500, 1000
@ 5000 Ω/v
DC MICROAMPERES: 0-50
DC MILLIAMPERES: 0-1, 10, 100, 500
DB: -20 to +10, -8 to +22, +6 to
+36, +20 to +50
"0" REFERENCE: 1 MW into 600 Ω
RESISTANCE: Rx1, Rx10, Rx100, Rx100,
Rx10K
(30 Ω center)



DIVISION

Simpson
INSTRUMENTS THAT STAY ACCURATE

SIMPSON ELECTRIC COMPANY

5200 W. Kinzie Street, Chicago, Illinois 60644 • Phone: (312) 379-1121
Export Dept: 400 W. Madison Street, Chicago, Illinois 60606, Cable, Simelco

IN INDIA: Ruttonsha-Simpson Private Ltd., International House, Bombay-Agra Road, Vikhroli, Bombay

Representatives in Principal Cities
... See Telephone Yellow Pages

WORLD'S LARGEST MANUFACTURER OF ELECTRONIC TEST EQUIPMENT
Circle 20 on literature card

March, 1967/PF REPORTER 49

Color them green

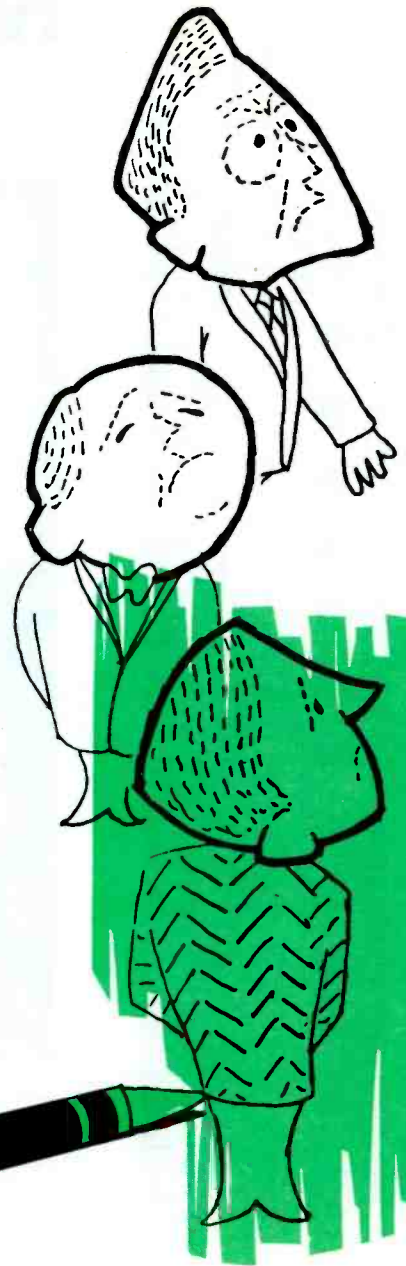

Channel Master's Crossfire Antenna Series has

...More dealers prefer Channel Master to any other brand (2 to 1 by survey of leading trade magazine).

...More have been sold (and are still being sold) than any other antenna in the history of television. And dealer acceptance is still growing.

...More dealers bought Crossfire antennas in January and February than in any previous first two month period.

No wonder other antenna manufacturers try so hard to re-work their own designs along the famous Channel Master

Crossfire lines.

But it just can't be done.

Legally, the Crossfire series is protected by five U.S. patents or patents pending.

And, in terms of mechanical and electronic design, the Crossfire series maintains a standard that has never been equalled.

Take mechanical design, for instance. Crossfire antennas have weathered six tough winters, verifying structural superiority originally proven in wind tunnel tests at the University of Miami hurricane test labs. Channel Master dealers ...who have just recorded the biggest

first-two-months Crossfire sales in history...can tell you many of those antennas went up to replace less rugged makes that couldn't take the winter storms.

Most, of course, were teamed up with new set sales to meet the critical demands of color reception. Because, when it comes to electronics, Channel Master Crossfire Series antennas set the industry pace for clean, crisp color as well as outstanding black and white and FM Stereo.

In seven VHF models of Color Crossfires, electronic leadership takes the form of Proportional Energy Absorption



our competition green with envy.

and gain-boosting Tri-Band Directors. Then there are the 82-channel Ultradyne Crossfires...6 of them...with the most advanced, self-coupling, UHF section ever developed, plus all the Color Crossfire features. Finally, the Coloray group provides television's first electronic ghost-killing service in an 82-channel model and two VHF/FM models. All are finished with Channel Master's famous golden E.P.C....the coating that has been adopted by the military

because of its weather protection.

Channel Master dealers know green is the color of envious competition. But they also know green is the color that lines their cash drawers when they meet the critical demands of Color head on with Channel Master Crossfire Antennas. Only Channel Master gives dealers full profit...then protects that profit from mail order and discounter inroads.

Color your cash drawer green. Call your Channel Master Distributor.



Ultradyne Crossfire Model 3634-G

The House of COLOR

CHANNEL MASTER®

ELLENVILLE, N.Y.

Circle 23 on literature card

© 1967 Channel Master Corp.

NEW POWER

FROM

FINCO

Model 65-3 VHF-TV ANTENNA AMPLIFIER

improves reception of WEAK VHF-TV signals in FRINGE AREAS even where strong local TV or FM signals are present. AMPLIFIES UP TO 7 TIMES for Better Color and B/W

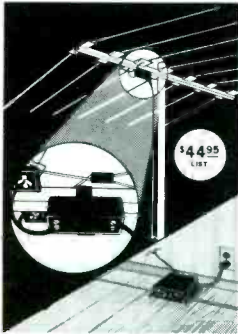

Model 65-3 VHF-TV ANTENNA AMPLIFIER

Let Finco solve your Color and B & W reception problems. Write for complete information, schematics and specifications. Form #20-357.

THE FINNEY COMPANY
34 West Interstate St. • Bedford, Ohio 44014 • Dept.

Circle 24 on literature card

A two-transistor-amplifier. Engineered to provide the lowest noise and highest amplification with the most desirable over-load characteristics.

Amplifier used in conjunction with dual outlet power supply for one, two, or multiple set installations. 117 V 60 cycle input. AC power up to amplifier: 24 volts-60 cycle.

SCOPE PROBES

(Continued from page 44)

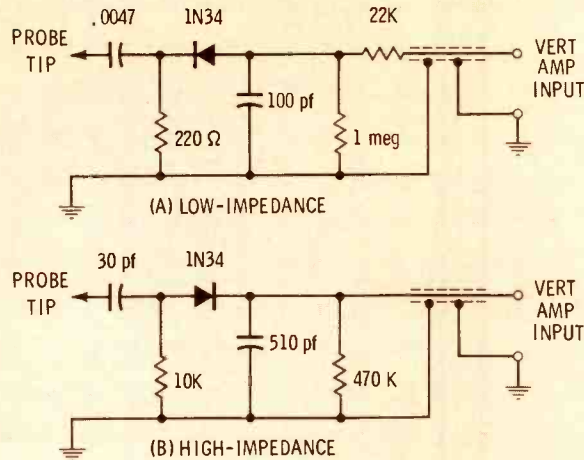

Fig. 10. Common series-type demodulator probes.

The low-impedance type is preferred over the high-impedance type because of its ability to swamp out the resonant response of the tuned circuit, thereby avoiding unwanted oscillation. Although the low-impedance probe has lower sen-

sitivity than the high-impedance type, and consequently, lower output voltage, this can be compensated for by increasing the vertical gain control of the scope.

The shunt-type demodulator probe illustrated in Fig. 11 has less

NEW FROM INJECTORALL



HERE'S PROOF!

PROOF that "SUPER 100" tuner cleaner is BETTER!

Tested by a leading independent laboratory against competitive products!

	SUPER 100	A	B	C
CLEANING	Excellent	Good	Fair	Fair
LUBRICATION	Good	Fair	Fair	Poor
PLASTIC ATTACK	None	None	None	None
FLAMMABILITY	None	None	None	None
CONDUCTIVITY	None	None	Slight	Slight
ANTI-STATIC PROTECTION	Excellent	Fair	Poor	Poor
DRIFT	None	Slight	Yes	Yes



SUPER 100 TUNER CLEANER . . . for COLOR and Black and White TV tuners
6 oz. spray can with INJECTORALL steel needle
CAT. NO. 100-6 net \$1.95

Buy it at your Electronic Parts Dealer.
For free catalog on the complete line, write to:

INJECTORALL ELECTRONICS CORP. • Great Neck, N. Y. 11024

Circle 26 on literature card



TYPE PCT . . . printed circuit electrolytics for exact replacement in AC-DC radios . . . made to exacting requirements of our manufacturing customers for easy installation and maximum performance.

PLANET SALES CORP.

64 NEW STREET
NUTLEY, NEW JERSEY 07110

Circle 25 on literature card

Let's talk sense about color TV lead-in!

The common sense of the situation calls for two 82-channel lead-ins for color and UHF TV... one to give a stronger signal in uncongested fringe areas where interference usually is not a serious problem. The other to give a much cleaner signal in congested or close-in areas where serious interference problems are likely to exist. This is why Belden gives you a choice—the *Color Guard Twins*.

8285 ▶

*Color Guard
Twin—Belden
Permohm**

Use to get stronger signals in uncongested fringe areas, like this . . .



You get an excellent color image . . . because in a 100-foot run, Permohm delivers 38% to 200% more signal voltage than RG-59/U with matching transformers and 23% to 80% more signal voltage than "Low Loss Coax" with transformers.

Permohm obtains the highest efficiency of any available unshielded 300 ohm line when exposed to weathering and industrial atmospheres. Low loss cellular polyethylene insulation around the conductors provides the necessary protection.

You don't need expensive transformers and connectors.

Choose the Color Guard Twin that gives your customer the best 82-channel color TV reception. Get complete information on the Belden Color Guard Twins.

CALL YOUR BELDEN ELECTRONIC DISTRIBUTOR.

Belden

BELDEN MANUFACTURING COMPANY • P. O. Box 5070-A • Chicago, Illinois 60680

Circle 27 on literature card

L
T
V

◀ **8290**

*Color Guard
Twin—Belden
Shielded Permohm**

Use to get cleaner signals in congested or close-in areas, like this . . .



Belden Shielded Permohm (8290) combines strong signal strength with the clean signal protection of shielded cable.

Shielded Permohm eliminates transmission line pickup of noise and ghost signals. You can install it easily anywhere . . . no need for standoffs, twisting, or inconvenient routing of lead-in. Tape it to a mast, route it through metal pipe, or bury it underground.

Beldfoil[†] shielding is used to shield against outside signal interference. The jacket is weatherproof polyethylene. The critical signal area is protected from rain, snow, salt, smog, fog and industrial contamination. No expensive transformers or connectors are needed.

Belden Trademarks Reg. U.S. Patent Office
*Patent No. 2,782,251 and Pat. Pending
†Patent No. 3,032,604

B-8-6

sensitivity than either type of series demodulator, and therefore, less signal amplitude at the output. However, unlike the series type, it effectively attenuates any hum voltages in (or on) the tested signal. Because of its low sensitivity, the shunt-type probe is not as adaptable to video IF signal tracing as the series type. In some applications, even the series-type demodulator probe does not provide enough voltage for proper waveform reproduction. As the video IF waveform is

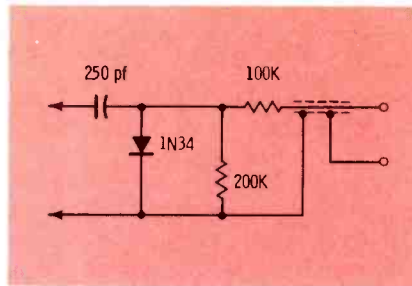

Fig. 11. Shunt-type demodulator probe has less sensitivity.

traced from the video detector input to the tuner output, the meas-

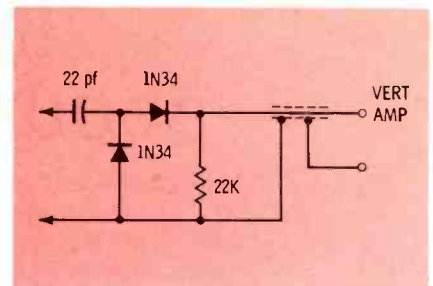

Fig. 12. Voltage doubler demodulator probe doubles sensitivity.

ured signal becomes increasingly smaller. To offset this decrease in signal amplitude, it is sometimes necessary to resort to the voltage-doubler-type of demodulator probe for waveform observations at the tuner output. This demodulator probe type is shown in Fig. 12. Because the voltage-doubler probe provides twice the sensitivity available with the series or shunt type, it is particularly useful for relatively low-level signal observation. However, there are two disadvantages to be considered with this

SHARP NEW BRITENER PROMOTION!

Free

SCISSORS

with your next pack of
Vu-Brites or Tu-Brites

This useful premium item is a cut above most "free gifts," just as Perma-Power Vu-Brites and Tu-Brites are a cut above most briteners. These are 6 and 8-inch straight, trimming scissors, nickel-plated, with magnetized blade tips... and they're included with both of these specially priced Britener Packs... available now from your distributor.



▶ **TU-BRITES**—If the base is right, the boost is right! 4 assorted Tu-Brites—only \$8.95—including the scissors!

▶ **VU-BRITES**—The world's best-selling Britener! 12 Series or 12 Parallel Vu-Brites—only \$9.95—including the scissors!



SHARP
SERVICEMEN
RELY ON
PERMA-POWER
TO GIVE
EXTRA LIFE
TO FADING
PICTURE
TUBES!

FINCO "has 'em both!"



Model #65-1
\$29.95
list

Model #65-2
\$39.95
list

BOOSTER COUPLERS FOR 300 OR 75 OHM For Deluxe Home or Commercial Use

Now available for either 75 OHM CO-AX or 300 OHM operation... you can't beat the price, quality and performance of Finco's famous 2-tube, 4-set VHF or FM Distribution Amplifiers. Finco challenges 'em all! Equip either model with Finco low loss splitters (#3001 or #3003) and you can drive up to 16 sets in a master antenna system!

All Finco Products Are Engineered for Color!



THE FINNEY COMPANY
34 West Interstate Street, Bedford, Ohio

PERMA-POWER COMPANY

5740 North Tripp Avenue—Chicago, Illinois 60646
Phone: (312) 539-7171

Circle 28 on literature card

Circle 29 on literature card

**STEP UP
TO THE
NEW**



CONTINENTAL
AMERICA'S FINEST,
MOST RELIABLE
TUBE
ANALYZER



**A "MUST" FOR MODERN SERVICING
... PRODUCTION LINE TESTING ...
QUALITY CONTROL ... LABORATORY.**

A True Gm Tester

- 5000 Cycle Gm Test
 - Full Cathode Emission Check
 - 100 Megohm Grid Leakage Test
- and Still the Speediest Tester in Town**

In a nut shell . . . here is how Sencore does it. Using only the first three controls, the MU140 becomes a speedy "Mighty Mite" cathode emission tester with grid leakage sensitivity checks up to 100 megohm . . . for fast on the spot service. Flip the last three switches into operation from the set-up data and the MU140 becomes a true mutual conductance tube tester using 5000 cycle square wave to completely analyze any tube. You can't go wrong. No more need to mess around with time-consuming old fashioned tube testers with up to fourteen knobs and a rough 60 cycle sine wave test. The Continental tests them all including foreign tubes . . . over 3000 in all. And, it's guaranteed against obsolescence too with replaceable "new socket" panel and controls so standard that the switch numbers correspond to the pin numbers shown in any tube manual. You can actually set up the Continental without the set-up data in the cover if the need should arise. Here is everything that you could want. Its famous four way independent tests make you a master of the art of tube testing . . . internal shorts test; full cathode emission test; 100 megohm grid leakage test; and to back you up on critical tubes . . . a superb mutual conductance test. The beautiful Continental is housed in a vinyl-clad solid-steel attache case with lustrous all-chrome front panel. Yet at a price below all competition.

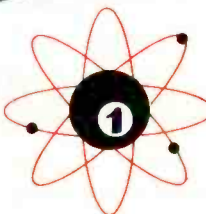

SENCORE

NO. 1 MANUFACTURER OF ELECTRONIC MAINTENANCE EQUIPMENT

426 SOUTH WESTGATE DRIVE, ADDISON, ILLINOIS 60101

Circle 26 on literature card

\$179.50

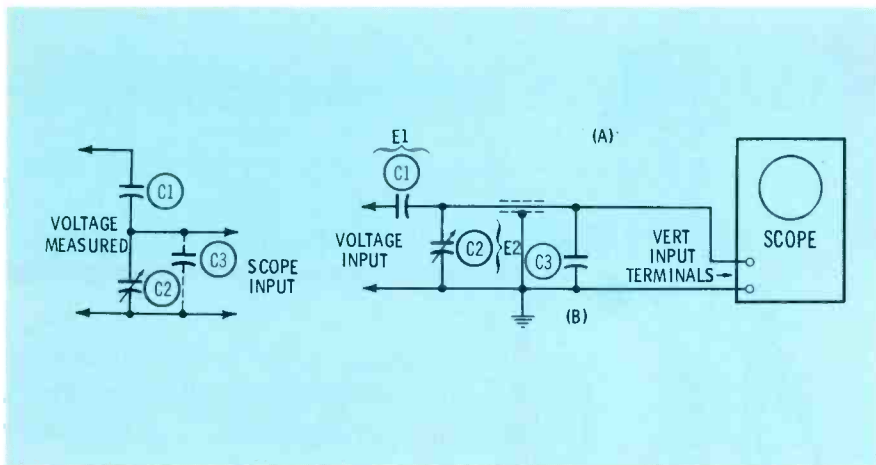

Fig. 13. Voltage dividing action of capacitance divider probe.

probe: (1) a lower input impedance than either the series or shunt demodulator probes, limiting its use to relatively low-impedance circuits, and (2) the frequency response is not as good as the series or shunt types.

It must be remembered that the demodulator probe is used only to determine the presence or absence of a signal at a particular stage. The loading effect of this probe makes accurate peak-to-peak voltage measurements impossible. Also,

most types of demodulator probes have poor high-frequency response, and as a result, horizontal sync pulses are usually attenuated and slightly rounded.

Capacitance-Divider Probe

Although the vertical input terminals of most scopes are rated at about 600 volts maximum, it is occasionally necessary to measure much higher voltages, such as those found in horizontal sweep circuits. The capacitance-divider, high-voltage probe makes it possible to meas-

Fig. 14. Two common types of high-voltage capacitance dividers.

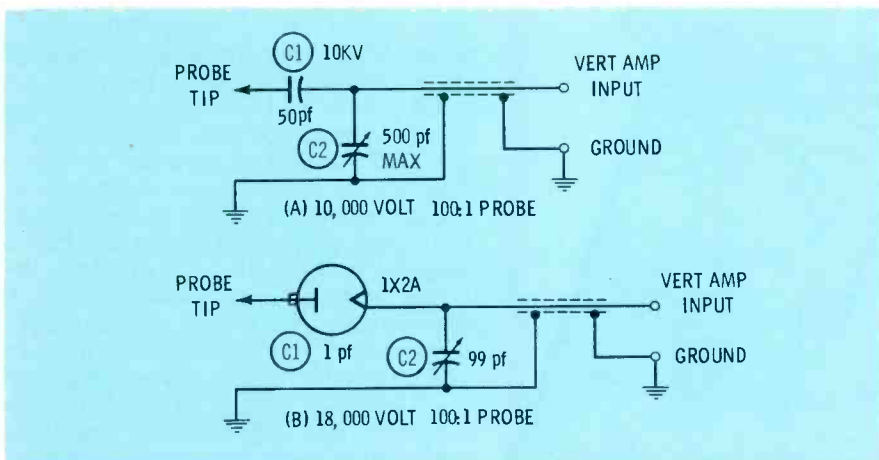

ASPIRING AUTHORS

Have you encountered a service problem that you would like to share with other readers of **PF REPORTER**? Write a description of the problem and your solution. Include rough sketches of schematics and mail to:

Editor, PF REPORTER
4300 W. 62nd St.
Indianapolis, Indiana
46206

Earn extra money during the summer slump.

KAY-TOWNES

UHF-VHF-FM antennas



ORIGINATORS and DESIGNERS
of the WORLD FAMOUS

CROSS PHASE CIRCUIT

Now Used By Most All Modern-Day Antennas

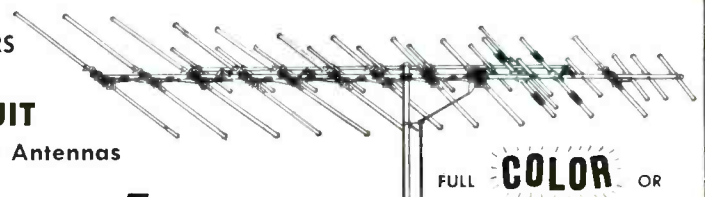

FULL **COLOR** OR
BLACK AND WHITE RECEPTION

KAY-TOWNES ANTENNA CO.
1511 DEAN AVE., ROME, GA. 30162

colorphase

CP-7, 11, 15, 19, 23, 28

Circle 31 on literature card

fast. accurate. versatile.

what else would you want from a tube tester?



money, of course.



We know that swift and sure tube testing makes servicing more profitable. So we created the Dyna-Jet 606 Tube Tester, the professional portable loaded with the most-wanted features. Multiple 13-socket design means only 4 test settings, yet it tests the latest miniature and color receiving tubes as well as older types.

It tests for all shorts, grid emission, leakage, gas. Checks cathode emission the accurate way—under simulated load conditions. Checks each section of multi-section tubes. And the 606's exclusive front panel adjustable grid emission test spots the "tough dogs" and the weak ones. With the 606, good tubes aren't rejected, bad ones show up fast. That means less callbacks, more tube sales, better profit . . . **MORE MONEY!**

Few test instruments pack the profit-per-square-inch as does the Dyna-Jet 606. It's another product of B & K electronic innovation . . . of B & K's policy to provide maximum value and maximum quality. And the B & K Professional Servicing Equipment emblem assures you . . . and your customers . . . that you use the finest equipment available. Model 606 Net: \$79.95



A DIVISION OF DYNASCAN CORPORATION

1801 W. Belle Plaine, Chicago, Illinois 60613

WHERE ELECTRONIC INNOVATION IS A WAY OF LIFE

Export: Empire Exporters, Inc., 123 Grand Street, New York, N. Y. 10013

Circle 32 on literature card

www.americanradiohistory.com

join the
P.O.M. Club!

(Photofact-of-the-
Month Club)

get full data coverage of
COLOR TV!

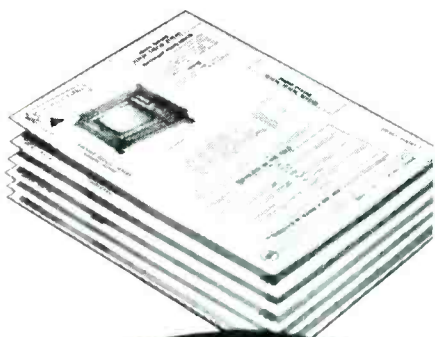

AT LEAST
6 COLOR TV
FOLDERS MONTHLY

only **PHOTOFACT**[®]
gives you the up-to-the-
minute data and know-how
you need to perform expert
Profitable Color TV Servicing

(and P.O.M. membership now brings you 20% more coverage monthly, including at least 12 b&w TV Folders, plus AC-DC, FM-AM, Stereo Hi-Fi, Record Changer, and Phono-graph coverage—at least 50 chassis each and every month—for less than 20¢ per chassis model!)

Act today—see your
SAMS Distributor

Circle 30 on literature card

ure horizontal sweep circuit voltages, and yet, not exceed the maximum input rating of the scope.

As shown in Fig. 13A, C1 and C2 are connected in series across the probe input. The input voltage divides across the two capacitors in inverse proportion to their capacitance. Since C1 is normally much smaller than C2, most of the input voltage will be dropped across this capacitor, leaving only a relatively small voltage across C2. The formula for expressing the relative component values of C1 and C2 for a particular voltage ratio is: $C_2 = C_1 (R-1)$, where R is the step-down ratio.

Referring to Fig. 13B, if C1 and C2 are chosen to produce a step-down ratio of 100 to 1, and a 10,000-volt signal is applied to the probe, E1 will equal 9,900 volts and E2 will equal only 100 volts—well within the maximum input limits of the scope. C3 is used to represent the combined shunt capacitance of the shielded cable and scope input circuit. Because this shunt capacitance is in parallel with trimmer C2, the probe will have to be recalibrated each time it is used with a different cable or scope. Calibration is accomplished as follows: (1) Connect the vertical terminals of the scope directly across a low-impedance, low-voltage source, and set the scope attenuator to the X100 position. (2) Vary the vernier attenuator for any convenient vertical amplitude and note the number of squares covered. (3) Connect the probe between the same voltage source and the vertical terminals of the scope. Advance the scope step attenuator to the "X1" position. The waveform should now occupy the exact same number of scale divisions as it did in step 2—if not, adjust the probe trimmer capacitor (C2) with a nonmetallic screwdriver until the waveform is the same. Once this is accomplished, the probe is calibrated to deliver to the scope 1/100 of any voltage applied to its tip.

Fig. 14 illustrates two commonly used types of 100-to-1 capacitance-divider probes. The probe in Fig. 14A is limited to 10KV by the breakdown rating of C1. This probe is suitable for measuring at the plate of the horizontal output tube or at

join the
P.O.M. Club!

(Photofact-of-the-
Month Club)

let the exclusive features of
PHOTOFACT[®]
troubleshoot for you in minutes!

OVER 40 GREAT FEATURES, INCLUDING:



Famous Standard Notation Schematic—always uniform, accurate, complete—includes waveforms, voltages and test points, alignment points, parts values, tube functions, etc.



Full Photo Coverage of the actual equipment makes identification of all components and wiring easy—you can see everything.

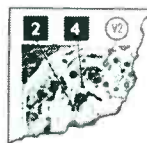

CircuiTrace[®] saves printed circuit board tracing time. This exclusive Sams system pinpoints junctions and test points on schematic and printed board.

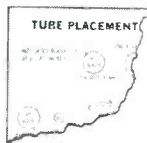

Tube Location Guide enables you to locate and replace proper tubes in seconds—a big time-saver on many repair jobs.



Unique Alignment System eliminates guessing; you get complete instructions with response curves, how to connect test equipment, proper adjustment sequence.

PLUS THESE IMPORTANT TIME-SAVERS:

- Tube Failure Check Charts
- Disassembly Instructions
- Field Servicing Notes
- Terminal Identification
- Complete Replacement Parts Lists
- Alternate Tuner Data
- Resistance Charts
- Dial Cord Diagrams
- Changer "Exploded Views," etc.

PHOTOFACT GIVES YOU EVERYTHING YOU NEED TO EARN MORE DAILY!

Act today—see your
SAMS Distributor

Circle 31 on literature card

the grid of the horizontal oscillator—actually, a 10-to-1 low-C probe can also be used here, but the 100-to-1 capacitance divider is preferred because its lower input capacitance detunes the circuit less. The probe shown in Fig. 14B is rated at 18,000 volts and can be used, along with a high-voltage filter capacitor, to measure the high voltage in some b-w receivers. However, in some large screen b-w sets, and in nearly all color receivers, the high voltage at the anode is beyond the maximum rating of this probe. The relative high voltage rating of this probe is possible because of the large breakdown voltage rating of the 1X2A used in the probe input in place of a conventional capacitor. The interelectrode capacitance of this tube is the equivalent of a 1-pf capacitor—with the added advantage of an 18,000 volt breakdown rating.

As implied previously, the 100-to-1 high-voltage, capacitance-divider probe can be used to measure the voltages at the horizontal oscillator grid and horizontal output plate. In addition, it can be used to measure the waveform across the horizontal deflection coils. The probe should *not* be used for measurements in the vertical sweep circuits. At such low frequencies, the shunt resistance and input capacitance of the scope react with the probe capacitance to cause differentiation. As a result, voltages at the vertical frequency would be greatly distorted.

Specific Probe Applications

The shielded direct probe is limited to low-impedance circuits having relatively low-level signals. In television servicing, such a probe is normally used only for checking the ripple frequency of the low-voltage power supply, or for checking the waveform at the damper cathode.

The 10-to-1 low-capacitance probe is more adaptable to television servicing and can be used for nearly all scope checks in the video amplifier, sync, vertical oscillator and sweep, and chroma circuits. In addition, it can be used to check the waveforms at the grids of the horizontal discharge and horizontal output stages, as well as the ver-

tical retrace blanking signal at the picture tube grid or cathode. Although the 10-to-1 low-C probe can be used in the horizontal AFC circuit and at the horizontal oscillator grid, the 100-to-1 capacitance-divider probe is preferred because it causes less circuit loading.

Other uses for the high-voltage, capacitance-divider probe include waveform and peak-to-peak voltage measurements at the plates of the horizontal output and damper stages. This probe can also be used to check the high-voltage ripple at the picture tube 2nd anode, provided a 250- to 500-pf filter capacitor is employed in series with it. The demodulator probe is limited to use in the video IF section and tuner output circuit.

Conclusion

There are five primary factors to be weighed when selecting a scope probe for a particular test application: (1) the input impedance of the scope, (2) the impedance of the circuit under test, (3) the frequency response of the scope, (4) the frequency of the signal to be measured, and (5) the relative amplitude of the signal. Disregarding any one of these considerations can result in inaccurate voltage measurements, or distorted waveforms that prove meaningless. Selecting the correct probe not only assures more accurate troubleshooting information, but also compensates for many of the characteristics that can limit a scope's usefulness in television servicing. ▲

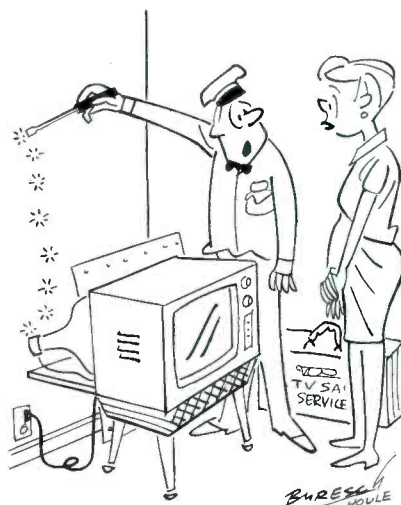

"That's part of the trouble."

Join the P.O.M. Club!

(Photofact-of-the-Month Club)

ONLY \$10 PER MONTH
brings you **20% MORE**
PHOTOFACT® coverage!



As a P.O.M. member, you get 6 new PHOTOFACT Sets every month to keep you ahead earning more—and you SAVE OVER \$60 PER YEAR! (Individually purchased Sets now sell for \$2.50 each.) Your 6 Sets come in sturdy file folders sealed in factory carton to insure perfect condition and completeness—easier-than-ever to file and use. To stay ahead, to save money—join the P.O.M. Club today!

SEE YOUR SAMS DISTRIBUTOR OR SEND ORDER FORM BELOW

HOWARD W. SAMS & CO., INC. Dept. PFF-3
4300 W. 62nd St., Indianapolis, Ind. 46268

Enroll me in the Photofact-of-the-Month Club. I agree to pay \$10 per month, and understand I will receive 6 current Photofact sets monthly to be delivered by my Sams Distributor (named below).

Name _____

Shop Name _____

Address _____

City _____ State _____ Zip _____

My Sams Distributor is: _____

Signed: _____

is a small indication on the DC ranges. This small deflection corresponds to .5 volts on the 10-volt DC range and is the same on all other ranges. I have replaced the batteries and checked the continuity of all the circuits. The only components I have not checked (and do not know how) are the meter movement and the two rectifiers. What is the proper troubleshooting procedure for test equipment and how can I check the meter movement?

C. B. KACZYNSKI

Cheektowaga, N.Y.

The arcing you are experiencing from the "S" winding of the flyback to the core is not easily corrected, and in many instances, the only positive solution is replacement of the flyback. However, in cases where the arcing has just begun and has not greatly deteriorated the winding insulation, it is possible to save the flyback by wrapping heavy plastic sheeting, or several layers of electrical tape, around the core at the point where the arcing has occurred. (This point is usually easily distinguished by a charred or blackened area on the core, or by a hole through the coil form.) After the core has been wrapped, apply anti-corona dope to both the wrapped portion of the core and the winding itself.

Troubleshooting VTVMs and VOMs need not be any more difficult than other electronic equipment—in most cases it is much easier. From your description of the trouble symptoms you are experiencing with the VOM, it can be seen that you are already aware of the proper troubleshooting procedure to be used with test equipment. Using the various functions of the VOM itself, you have, through the process of elimination, isolated the fault. The fact that all functions of the VOM were either inoperative, or gave an erratic indication, quickly pointed to a circuit or component that was common to all functions. In this particular VOM, as in most, this would point to either the meter movement, series resistor R1, or the test leads or sockets. Since a continuity check cleared the test leads, sockets, and associated wiring, only the meter movement and R1 remained as possible suspects. R1 can be checked easy enough; however, the meter movement is another matter. Never use another VOM to check the resistance of a meter movement—excessive current could possibly destroy the movement beyond repair. Instead, use the following procedure to determine the condition of the meter: Remove all connections to the terminals on the back of the movement case. Calculate the value of resistance needed for 2/3 full-scale deflection. In this case, since the full-scale current rating is 50ua with a 250mv drop across the movement, the value of series resistance required for full-scale deflection is 5K ohms ($R = .250/E0 \times 10^{-6}$). Meter deflection can be reduced to 2/3 full-scale by increasing the size of the series resistor by about 1/3, resulting in a resistance of 6650 ohms. A standard resistance value of 6800 ohms will serve the purpose. Connect the 68K ohm resistor and 1 1/2-volt dry cell in series across the meter. If the meter fails to deflect to approximately 2/3 full-scale, you can assume the meter movement to be defective. Never attempt to repair a defective meter movement; instead, return the meter movement to the manufacturer, according to instructions in the operation manual supplied with the VOM. (It is usually wise to write the manufacturer for shipping instructions before shipping the meter). ▲

You can pay more but you buy less!



new Lectrotech V6-B color bar generator

9950 brings you...

- Guaranteed performance . . . full one year warranty.
- A.C. operated solid state generator . . . no batteries to buy . . . no failures when needed most.
- Most stable generator of all . . . sharper, brighter patterns.

The V6-B provides crystal-controlled keyed rainbow color display, all cross hatch, dots, vertical lines only, horizontal lines only, Red-Blue-Green gun killer, exclusive Dial-A-Line feature (horizontal line width adjustable), voltage-regulated transistor and timer circuits, simplified rapid calibration. Supplies adjustable dot size, RF output more than 10,000 mv, operates on channels 3, 4 or 5, has color level control for color sync servicing. Connects to antenna terminals (no connection needed inside of set). Power transformer-line isolated. Stable operation under wide voltage ranges assured by fully voltage-regulated circuits. Hand-wired reliability . . . no printed circuits. Fully enclosed test lead compartment. Rugged, caddy size unit built to withstand rigors of field servicing. Size: 7 5/8"W, 3 1/2"H, 9"D.

Weight: 5 1/2 lbs. Only **9950**



See your distributor or write for literature.

DEPT. PF-2

LECTROTECH, INC.

1221 W. Devon Ave., Chicago, Ill. 60626

Circle 35 on literature card

FAST

COMPLETE OVERHAUL ON ALL MAKES OF TV TUNERS

Maximum Time In Shop 24 Hrs.

(WE SHIP C.O.D.)

\$9.50



Black &
White
or Color

VHF or
UHF

UV Combo's \$15.00

Price includes all labor and parts except Tubes, Diodes & Transistors. If combo tuner needs only one unit repaired, disassemble and ship only defective unit. Otherwise there will be a charge for a combo tuner. Ship tuners to us complete with Tubes, Tube Shields, Tuner Cover and all parts (including) any broken parts. State chassis, model number

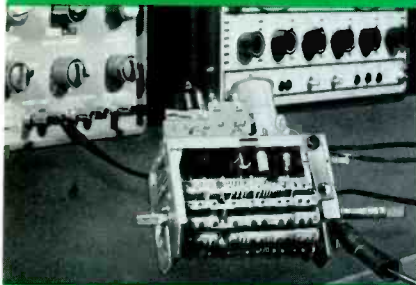

TRAINED TECHNICIANS with years of experience in this specialized field. All tuners are ALIGNED TO MANUFACTURERS SPECIFICATION on crystal controlled equipment and air checked on monitor before shipping to assure that tuner is operating properly.

GEM CITY TUNER REPAIR SERVICE

Box 6 Dabel Station
2631 Mardon Drive
Dayton, Ohio 45420

Circle 37 on literature card

62 PF REPORTER/March, 1967

COLOR

COUNTERMEASURES

SYMPTOMS AND TIPS FROM ACTUAL SHOP EXPERIENCE

Chassis: RCA CTC11

Symptom: Complete loss of contrast. Raster and color signals remain on screen.

Tip: Check for heater-cathode short in V24 (CRT).

Analysis: Heater of CRT is connected to B+. A heater-cathode short will place this B+ source on the cathode. The power supply filter will then filter out the luminance information normally present on the cathodes of the CRT. In addition, the +180 volts applied to the cathode will clamp the normal bias and in effect make the grids of the CRT positive with respect to cathode, allowing raster to remain on screen.

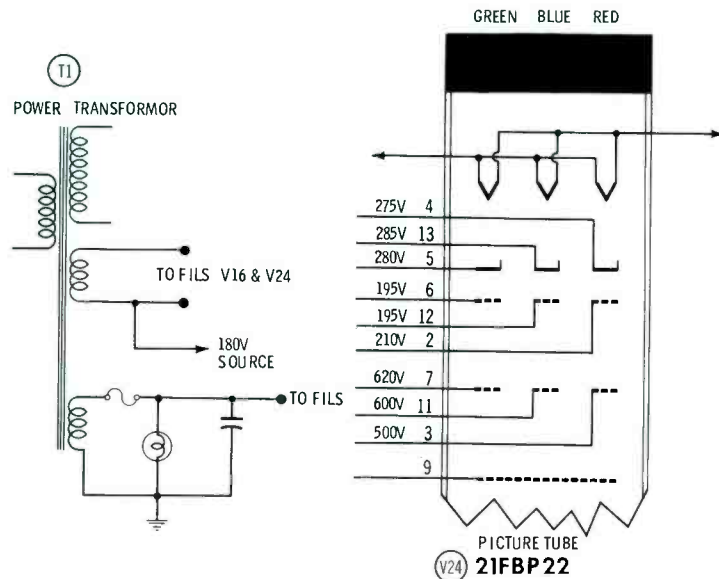

A **Jackson** SERVICE

Latest Tube Test Data for
owners of Jackson Testers

Supplements latest Model 658 and 648 Roll Charts

Type	Model 658							Model 648			
	Sec.	Heater	Circuit H&K	P&G	Plate	Grid Test	Heater Current	Fil.	D	E	Plate Test
5GS7	P	5.0P	123	ac689	40R	10WY•		5.6	A126	AC389*	47XZ
	T	5.0P	123	ac45	11R	25WY•		5.6	123	AC45	17YZ
6AG9	P	6.4L	C6	178	14R	10WY•		6.3	C6	179	31V
	T	6.4L	C4	a59	30R	10WY•		NOR-S switch in S position			
6G-B3	P	6.4M	123	ab560	20R	70VY•		6.3	C4	A59	16XZ
	P	6.4J	129	ab358	47R	10WY•		6.3	A123	AB569	15W
6MG8	P	6.4J	127	a46	36R	10WY•		6.3	A125	C389	34XZ
	T	6.4J	127	a46	36R	10WY•		6.3	127	A46	18YZ
8GU7	T	8.5K	127	a89	50Q	30VY•		8.4	127	A89	10WY
	T	8.5K	123	a45	50Q	30VY•	A13.6J 2450	8.4	123	A45	10WY

Complete low cost tube data subscription service available for Jackson and Mercury tube testers...write for information

JACKSON TUBE TEST DATA DIV. 1744 Rockaway Ave., Hewlett, N.Y. 11557

Circle 36 on literature card

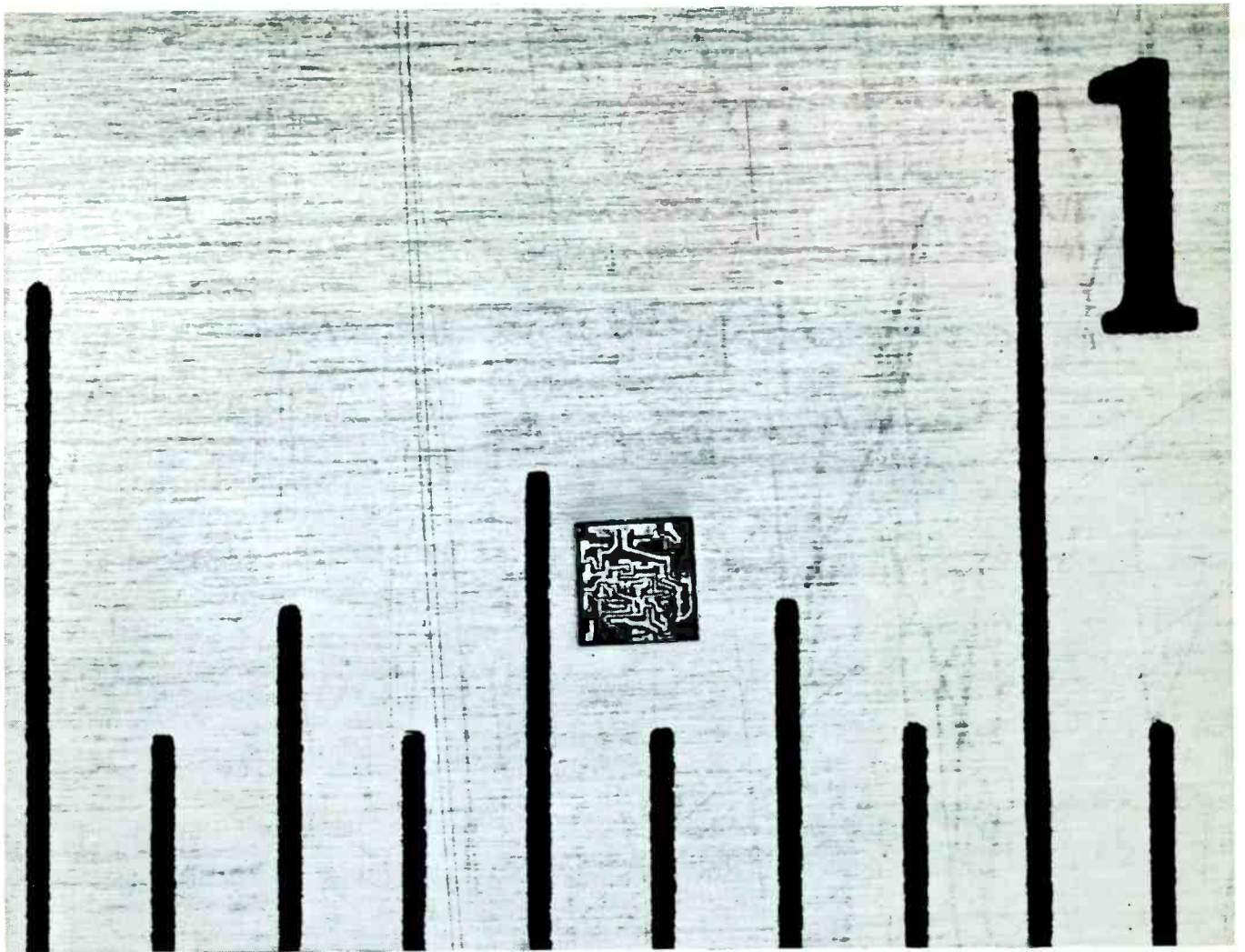

**At 1/20th of an
inch square it's
the biggest thing
in electronics**



(And RCA Victor is using it now)

RCA Victor was first to use integrated circuits in home entertainment products. Why? Because the integrated circuit is the most reliable circuit ever made for a consumer product. It's made in a room continuously cleansed of microscopic particles • Computer-controlled tests assure that it functions properly • Each is firmly mounted and connected to leads by ultrasonic bonding to enhance reliability (and that's what helps you sell). See your RCA Victor distributor today.



The Most Trusted Name
in Electronics

PRODUCT REPORT

for further information on any
of the following items,
circle the associated number on the
Catalog & Literature Card.



Tube Tester (65)

A new mutual conductance tube tester has been introduced by **Mercury Electronics Corporation**. Designated Model 2000, the new unit will test, under actual dynamic operating conditions, practically any tube type the technician may encounter in his every day work. It will also test transistors, diodes, and power rectifiers. A CRT adapter (offered at a small extra charge) enables the technician to check color and black-and-white picture tubes as easily as receiving tubes.

The unit will test all tube types for gas and grid emission, shorts, and leakage between any tube elements.

ZENITH LOG PERIODIC ANTENNAS

offer high
signal gain and
ghost rejection

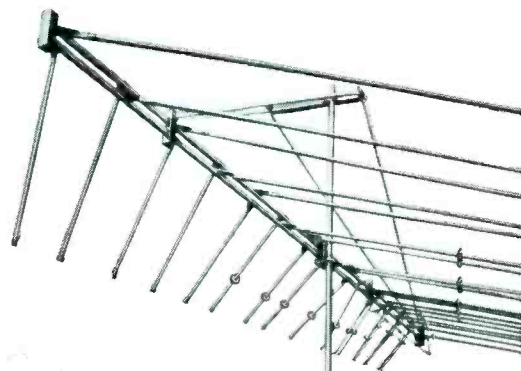

All-channel VHF/UHF/FM and FM Stereo

Developed by the University of Illinois antenna research laboratories, each Zenith log periodic antenna works like a powerful multi-element Yagi . . . not on just one or a few channels, but across the entire band it's designed for.

Order Zenith antennas and all genuine Zenith replacement parts and accessories from your Zenith distributor.

Also Zenith periodic antennas for

- UHF • VHF
- FM AND FM STEREO
- PLANAR HELICAL UHF

ZENITH

The quality goes in
before the name goes on

BUILT TO THE QUALITY STANDARDS OF ZENITH ORIGINAL PARTS

Circle 38 on literature card

Among the tube types that the tester accommodates are the new Magnovals, 7-pin Nuvistors, 10-pin Decals, Novars, foreign and hi-fi tubes, voltage regulators, battery-type tubes, auto radio hybrid tubes, thyratrons, and industrial tube types. The circuitry has been designed with a unique leveled switch principle to overcome obsolescence caused by new base pin arrangements or new internal jumpers in tubes.

The new tube tester features sockets of phosphor bronze construction and built-in custom pin-straighteners for all tube types. Additional features of the unit include automatic line voltage regulation and a 4½" D'Arsonval meter movement that is protected against accidental burn-out.

The tube tester is housed in a leatherette-covered carrying case and measures 18¼" x 10¾" x 4½". Price of the unit is \$99.95. The optional Model MH-3 Multi-Head CRT Adapter is priced at \$12.45.

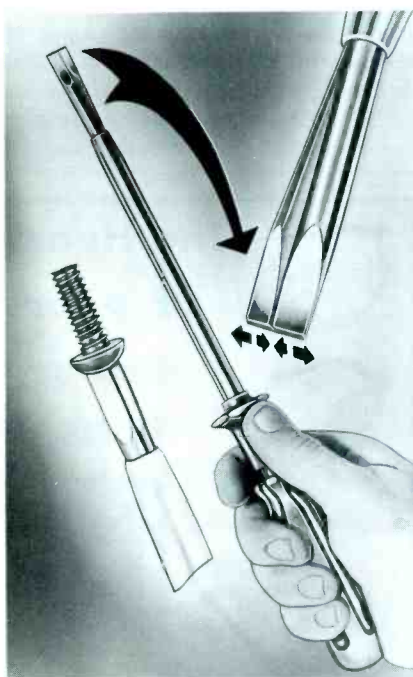

Screw Launcher
(66)

This tool makes the launching of stubborn screws in awkward situations a one-hand job. It is suitable for use in professional assembly work, production work, repair and maintenance jobs, and for the home workshop. The new **Vaco** Screw Launcher is equipped with a double-blade bit which fits into the slotted head of a screw. A metal sleeve then slides forward on the bit, causing the V-shaped blades at the end to move together. This blade action forms a

wedge that firmly grips the slot of the screw, holding it securely while the driving action is started. When the screw has been set, the driver is released from the slot by sliding the gripping sleeve back toward the handle. This relaxes the overlapping double blades, freeing the driver from the screw.

The tool is equipped with a "Comfordome" handle for comfort and driving power. The double-blade bit is made of durable spring steel and is available in ⅛", ⅜", and ¼" blade diameters, and three blade

lengths. The handles are color-coded to indicate size. There are eight sizes in all. Prices range from \$1.25 for the smallest size (over-all length of 5¾"), to \$2.05 for the largest size which is 11⅝" long.

100,000 ohm/volt Multimeter
(67)

This 100,000 ohms/volts (DC) multimeter is the latest addition to **Eico's** Truvohm line of imported, battery-operated multimeters. Designed to fulfill the precision and versatility requirements of electronic engineers,

Now, for men in electronics —“a whole new era of quick calculation”

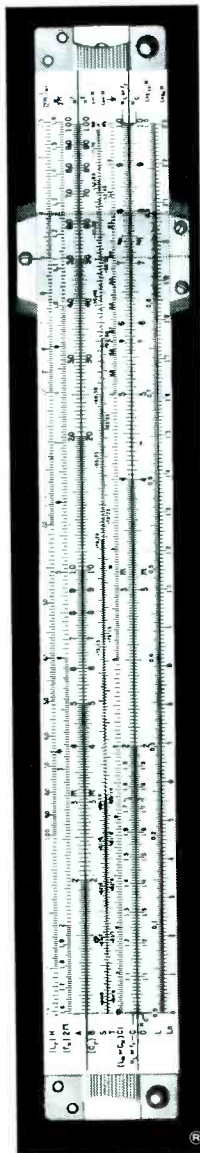

THERE MUST BE THOUSANDS OF PEOPLE in electronics who have never had the marvelous adventure of calculating problems with a single slide rule; other thousands have had to content themselves with a slide rule not specifically designed for electronics. For both groups, the new slide rule designed and marketed by Cleveland Institute of Electronics and built for them by Pickett will open a whole new era of quick calculations.

“Even if you have never had a slide rule in your hands before, the four-lesson instruction course that is included takes you by the hand and leads you from simple calculations right through resonance and reactance problems with hardly a hitch. If you already use a slide rule, you'll find the lessons a first-rate refresher course. And it explains in detail the shortcuts built into this new rule.”

From an article in
Radio Electronics Magazine

Want complete details about this time-saving new Electronics Slide Rule? Just mail coupon below...or write Cleveland Institute of Electronics, Dept PF-115 1776 East 17th St., Cleveland, Ohio 44114.

Mail this coupon for
FREE BOOKLET

How to Solve Electronics Problems in Seconds



With new Electronics Slide Rule and Instruction Course

CIE Cleveland Institute of Electronics
1776 E. 17th St., Cleveland, Ohio 44114

Please send me without charge or obligation your booklet describing the CIE Electronics Slide Rule and Instruction Course. Also FREE if I act at once: a handy pocket-size Electronics Data Guide.

Name _____ (please print)

Address _____

City _____ State _____ Zip _____

Accredited Member National Home Study Council
A Leader in Electronics Training... Since 1934

PF-115

How "saving" 50¢ can ruin a \$700 color TV system!

The coupler is probably the least expensive item in a home TV system . . . yet the wrong coupler can send the investment in a top-quality distribution system and TV set right down the drain.

At Blonder-Tongue, the same engineering skill and meticulous quality control goes into couplers that goes into our professional MATV products. The result: high isolation between sets, extremely low insertion loss and sharp pictures (they're backmatched).

Blonder-Tongue gives you variety, too . . . the widest variety of color-approved, all-channel coupler models in the industry:

A-102U/V—deluxe 300-ohm model connects 2 sets to one downlead.

A-104/UV—similar to A-102U/V except for 4 sets.

MDC-2VU—connects two coax (75-ohm) cables from TV sets to a single coax downlead.

TV-2—economy indoor model. Connects two sets to a single 300-ohm twin-lead. Not recommended for weak signal areas.

Quality combiners and splitters are also essential to a good all-channel color TV system. When you specify Blonder-Tongue, you get high quality, low loss and high isolation.

UVF-1—deluxe 300-ohm weatherproof model. Provides separate UHF, VHF and FM outlets from downlead carrying all three signals or feeds a single downlead from separate UHF, VHF and FM antennas.

UVF-C/S—a lower priced version of the UVF-1.

A-107—deluxe, weatherproof unit combines UHF and VHF antennas to one 300-ohm downlead or provides separate UHF and VHF output at set.

UV-C/S—indoor unit provides separate UHF and VHF outputs from a single 300-ohm cable carrying both signals, for connection to converter or TV set with separate UHF and VHF inputs.

Write for free catalog #74.

Blonder-Tongue Laboratories, Inc., 9 Alling Street, Newark, N.J.

Blonder-Tongue, the name to remember, for TV reception you'll never forget



technicians, and hobbyists, the Model 100A4 combines minimum circuit loading with a wide-range of applications. In addition to a 100,000 ohms/volt DC sensitivity, the multi-meter also features an AC input resistance of 12,500 ohms/volt. Other features include a double jewelled $\pm 2\%$ D'Arsonval meter movement; two-color, 4" mirror-back scale to



Circle 40 on literature card



The Heart of your Radio is Its

**INSIST ON
CQC***

*Controlled Quality Crystals available only from Texas Crystals dealers. Extensive precision testing throughout manufacture enables Texas Crystals to unconditionally guarantee their frequency control crystals. Use of Texas Crystals in space program and by other governmental agencies is evidence of the quality you can count on.

If your dealer can't supply your needs, send his name with your request for catalog to our plant nearest you.



TEXAS CRYSTALS

Division of Whitehall Electronics Corp.



1000 Crystal Drive 4117 W. Jefferson Blvd.
Fort Myers, Fla. 33901 Los Angeles, Calif. 90016
Phone: 813-936-2109 Phone: 213-731-2258

Circle 41 on literature card

Be a Bright Guy. Get your name into TV Guide up to 4 times this year.

Your Sylvania Distributor will put your name, your town and your phone number in TV Guide for your area as many as four times this year. And to make the most of it, we'll tie you into our big in-store display program. If you're a bright TV serviceman, you carry the most advanced replacement parts: Sylvania's famous *color bright 85*[®] color picture tube and receiving tubes.

Because you're an Independent, we're telling TV Guide readers you're in the best position to make an honest, unbiased recommendation on color set repairs. We list your name right on the facing page.

That's what our double-page, full-color ads in TV Guide, and the display program, are all about. Business for you. If you like the bright idea, see your Sylvania distributor and ask him to include you in.

Sylvania Electronic Tube Division, Electronic Components Group, Seneca Falls, New York 13148.

SYLVANIA

SUBSIDIARY OF
GENERAL TELEPHONE & ELECTRONICS **GTE**



Circle 42 on literature card

You earn your FCC First Class License

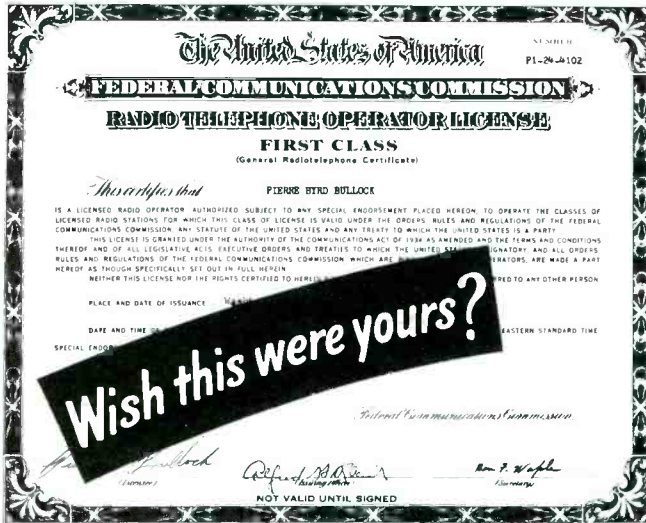

or your money back

THERE'S A WORLD OF OPPORTUNITY FOR THE MAN WITH AN FCC LICENSE

All it takes is a few spare hours a week and NRI's FCC License Course to open the way to increased opportunities in Communications. With an FCC License, you're ready to operate, service and install transmitting equipment used in aviation, broadcasting, marine, mobile and Citizens-Band communications.

What does it take? Men with absolutely no training or experience in Electronics complete the course in 10 months. A Technician or man with some background can easily cut that time in half. And because NRI has a greater enrollment than any other school of its type, training costs you less than comparable courses offered by other schools. Further, YOU MUST PASS your FCC exams or NRI refunds your tuition in full.

Get full details about NRI FCC License Course plus other home-study plans offered by NRI, oldest and largest school of its kind. Mail coupon. No obligation. No salesman will call. NATIONAL RADIO INSTITUTE, Washington, D. C.

Available Under NEW GI BILL. If you served since January 31, 1955, or are in service, check GI line in coupon.

MAIL for FREE CATALOG



NATIONAL RADIO INSTITUTE
Electronics Division
Washington, D. C. 20016 22-106

Please send me complete information on FCC License Training and other NRI courses, as checked below. (No salesman will call.)

- | | |
|--|---|
| <input type="checkbox"/> FCC License | <input type="checkbox"/> Radlo-TV Servicing |
| <input type="checkbox"/> Complete Communications | <input type="checkbox"/> Industrial Electronics |
| <input type="checkbox"/> Aviation Communications | <input type="checkbox"/> Electronics for Automation |
| <input type="checkbox"/> Marine Communications | <input type="checkbox"/> Basic Electronics |
| <input type="checkbox"/> Mobile Communications | <input type="checkbox"/> Math for Electronics |

Check for facts on new GI Bill.

Name _____ Age _____

PLEASE PRINT

Address _____

City _____ State _____ Zip _____
Code _____

ACCREDITED MEMBER NATIONAL HOME STUDY COUNCIL

eliminate parallax; a matched pair of silicon diodes to provide meter overload protection; and a high-impact case with integral handle for convenient positioning and portability. DC voltage ranges are 0-500 mv, 2.5, 10, 50, 250, 500, and 1000 volts. AC voltage ranges are 0-2.5, 10, 50 250, and 1000 volts. DC current ranges include 0-10 μ a, 250 μ a, 2.5ma, 250ma, and 10 amps. Resistance can be measured from 0 to 20 megohms in four steps. A decibel function is also included and extends from -20 dB to +62 dB in 5 ranges. The multimeter measures 7 $\frac{1}{2}$ " \times 5 $\frac{1}{4}$ " \times 3 $\frac{1}{4}$ ". Price is \$34.95, complete with batteries and test leads.

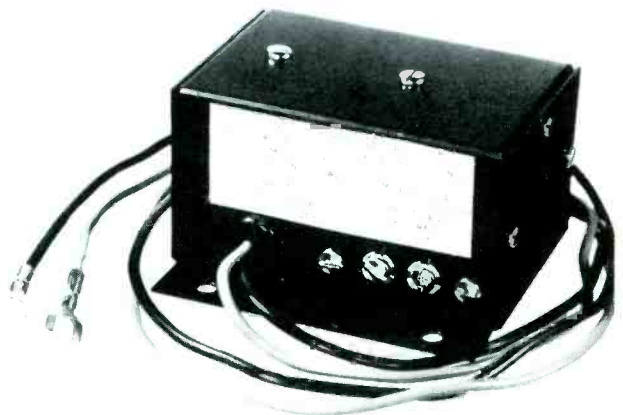

Inconverter And Voltage Regulator (68)

The ability to operate low-powered communications and other electronic equipment from practically any DC power source ranging from 6 to 32 volts is now possible with two new accessories from the E. F. Johnson Company. Called the In-Converter and the Voltage Regulator, these units can be used to operate equipment drawing up to 14 watts of power and can correct improper input voltages or incorrect polarity.

The In-Converter is particularly adaptable for installing a two-way radio system, auto tape player, car radio, auto reverberation unit, or other electric appliance in a foreign car with a 6-volt electrical system or in a vehicle that uses a positive ground. The unit has an input

we looked into your future, then created the "little corporal," a most remarkable CRT tester.

B & K has done it again . . . put you a "jump ahead" by looking into your future . . . your problems, *your* needs. This is the "Little Corporal," the CRT Rejuvenator and Checker, designed to provide maximum obsolescence protection by providing continuously variable voltages for all CRT elements. You can make the most accurate possible tests, even on future CRT types, because the heater

voltage is metered and is continuously variable from 0 to 13 volts with any tube heater current. And, using the required adaptors, you can test and correct all tube, transistor or integrated circuit black and white and color picture TV tube troubles (including GE 11" color and imported color tubes) in a few minutes . . . in the home or on the bench . . . without removing tubes from the TV set.

You can give new life to weak or in-operative picture tubes—prove to your customers their need for new tubes.

The "Little Corporal," another product of B & K electronic innovation, carries the B & K Professional Servicing Equipment emblem, your assurance . . . your customers' assurance . . . that you use the finest equipment made.

Model #465, Net: \$89.95.



A Division of
Dynascan Corporation
1801 W. Belle Plaine
Chicago, Illinois 60613



A Division of Dynascan
Where Electronic Innovation
Is A Way of Life

Circle 44 on literature card

Don't let Money-Making Technical Advances Pass You By!

RCA Institutes offers these four comprehensive home study courses especially designed to help build your income immediately:

COLOR TV

Take advantage of the growing profit potential in this area. Add color TV to your skills with this home training course, newly revised to include information on the latest techniques, receiver circuitry and equipment. Train under the direction of RCA Institutes... experts in Color TV home study training.



SOLID STATE ELECTRONICS

You get the necessary background for semiconductor technology including characteristics of tunnel diodes, rectifiers and other solid state devices. Transistor trainer also available.



AUTOMATION & INDUSTRIAL ELECTRONICS

Trains you for the many applications of automation electronics in industry and government including Photo-electronics, Digital Techniques, Synchros and Servomechanisms, Automatic Control Systems, Nuclear Instrumentation and many more!

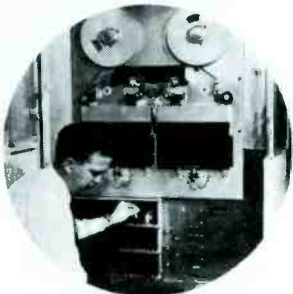

COMMUNICATIONS

Trains you to service and maintain 2-way radio communications on land, sea and air! Gives you the technical foundation for space communications.

You have no long-term obligations with RCA Institutes Liberal Tuition Plan. You only pay for lessons you order. Licensed by New York State Education Department. Approved for veterans.



of 6 or 12 volts DC and an output of 6 or 12 volts with either negative or positive polarity, or an output of 18 or 24 volts DC with the same polarity as the input.

The voltage regulator accepts any DC voltage from 24 to 32 volts and furnishes an output of 13 volts DC at 14 watts. Applications for the voltage regulator include material handling vehicles, aircraft, boats, and construction equipment. Prices of the voltage regulator are \$14.95 with positive ground and \$17.95 with negative ground. The In-Converter is priced at \$22.95.



Transistor Tester and Set Analyzer (69)

Completely selfpowered, this portable unit is actually 8 analyzers in 1 unit. Designed for bench or home-servicing, it can be used as a transistor tester, a diode tester, as a wattmeter, an ammeter, a signal generator, an in-circuit tester, and will also function as an AC and DC beta tester. The Semitronics Model 1000 Transistor Tester and Set Analyzer can check all transistors for gain, leakage, and oscillating ability, either in or out of the circuit. In addition, it can be used to determine whether a transistor is a P-N-P or N-P-N type. The unit can also be used as a signal tracer for detecting faults in transistor radios, hi-fi amplifiers, TV receivers, and similar electronic equipment. As a complete testing lab in one unit, the tester and analyzer can be used to check all sections of transistor receivers, including audio, IF, and RF circuits. The tester can be used to check battery voltage and current drain. It is designed to test both diodes and rectifiers. Sockets are conveniently mounted on the face of the instrument for testing both voltage- and power-type transistors.

Included with the unit (which comes completely wired, ready for bench or home use) is the *Semitronics Interchangeability Guide*, supplying replacement information on approximately 5,000 different semiconductors. Also included is a copy of the "Transistor Tester and Set Analyzer." This book not only supplies complete information on the operation and practical use of the unit, but also gives practical servicing hints. The complete package, consisting of the Model 1000 Transistor Tester and Set Analyzer

Send this coupon now for complete free information



RCA INSTITUTES, INC.

Home Study School, Dept. PF-37
350 West Fourth Street, N.Y., N.Y. 10014

Without obligation rush me free information on the following RCA Home Training Course: COLOR TV _____ SOLID STATE _____ COMMUNICATIONS _____ AUTOMATION & INDUSTRIAL ELECTRONICS _____

Name _____

Address _____

City _____ State _____

IN CANADA - The RCA Victor Company, Ltd.



RCA
 Transistors
 Rectifiers
 Integrated
 Circuits
 For
**EXPERIMENTERS
 HOBBYISTS
 HAMS
 and
 TECHNICIANS**

LOOK FOR THIS
 DISPLAY AT YOUR
 RCA DISTRIBUTOR

Here displayed on the RCA Solid-State Center is the RCA SK-Series Transistors, Rectifiers, and Integrated Circuits; the new RCA 3N128 MOS Field-Effect Transistor; RCA's 40214 Silicon Stud Rectifier; and three RCA Experimenter's Kits. This new Solid-State Center, in addition to its host of devices, also includes technical literature to support the devices right on the rack. It's the "one-stop" answer to the solid-state needs of experimenter, hobbyist, ham, or the replacement requirements of the service technician.

All devices and kits are packaged in easily identifiable see-through packs for your convenience. Included with each device is broad performance data or specific ratings and characteristics where applicable.

RCA Solid-State Center Includes:

- RCA Experimenter's Kits. Three kits enable you to build a light dimmer or any one of 14 different circuits for dozens of applications around the house.
- RCA SK-Series "Top-of-the-Line" Devices: 17 Transistors, 2 Rectifiers, and 2 Integrated Circuits, for exper-

imenter or replacement use.

- RCA Technical Manuals. Four manuals include: RCA Experimenter's Manual, RCA Transistor Manual, RCA Linear Integrated Circuits Fundamentals Manual, and RCA Tunnel Diode Manual.
- RCA Solid-State Replacement Guide. Lists all RCA SK-Series "Top-of-the-Line" Transistors, Rectifiers, and Integrated Circuits and the more than 7,300 types which they replace.

Keep RCA Experimenter's Kits and the RCA SK-Series in mind when you're shopping for solid-state devices. Look for the RCA Solid-State Center. Now at your RCA Distributor. Do it today!

RCA Electronic Components and Devices, Harrison, N. J.



The Most Trusted Name in Electronics

Circle 58 on literature card

March, 1967/PF REPORTER 71

WHAT'S SO GREAT ABOUT OAKTRON SPEAKERS

?

SUPPLYING
ALMOST
EVERY MAJOR
MANUFACTURER
OF RADIOS
AND TV,
OAKTRON
HAS ONE OF
THE WIDEST
RANGES OF
SPEAKERS
ON THE
MARKET.

THE
DISTINCTIVE
BLUE
SPEAKERS
FROM
OAKTRON
ALL HAVE
TRUE
ALUMINUM
VOICE
COILS

ALUMINUM VOICE COILS
ELIMINATE WARPAGE FROM
HUMIDITY AND OVERLOAD
HEAT. YOU GET INCREASED SEN-
SITIVITY AND LONGER LIFE. BETTER
QUALITY MEANS BETTER RELIABILITY.
BEST OF ALL, THEY COST NO MORE THAN
PLAIN SPEAKERS. CHECK YOUR LOCAL DIS-
TRIBUTOR FOR COMPLETE DETAILS OR WRITE

YOUR BLUEPRINT TO BETTER SOUND
 **OAKTRON**
INDUSTRIES, INC.
MONROE, WISCONSIN

Circle 45 on literature card

the Interchangability Guide, the book entitled "Transistor Tester and Set Analyzer," a transistor, and a set of needle-point test leads, is priced at \$34.95.



Battery Pack

(70)

A new, self-contained battery pack, especially designed to make all Courier solid-state CB rigs completely portable, has been introduced by **Courier Communications, Inc.** Model PAP-1 PORT-A-PAK, features a rechargeable nickel cadmium battery that provides continuous operation in the receive position for up to 8 hours and can be left on trickle-charge position continuously to insure ready-to-go operation, or can be recharged while in standby. The unit is reliable at all temperatures from -30°F to $+140^{\circ}\text{F}$ and cannot be damaged by overcharge when used with a CHARGE-A-PAK Battery Charger (Model CAP-1). When using PORT-A-PAK and CHARGE-A-PAK together, the Courier solid-state CB rig can be used as a base station.

The PORT-A-PAK is priced at \$59.95, complete with collapsible antenna, Texion carrying case, rechargeable battery, battery meter, charging connector, mounting hardware, microphone bracket and shoulder strap. CHARGE-A-PAK is priced at \$12.95.

TV-FM Antenna

(71)

The antenna shown here is one of 8 different models offered in the **JFD** LPV-TV/FM Color Log Periodic series. Designated Model LPV-TV-100, this 10 element log periodic is designed for color, VHF, (up to 125 miles) and FM stereo reception (up to 40 miles). Features of this antenna

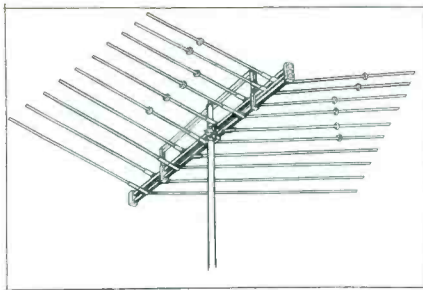

include capacitor-coupled dipoles which respond on the third harmonic mode, as well as the fundamental mode, resulting in more elements optimally tuned to work on both low- and high-band VHF channels. A low-impedance twin-boom feeder provides a better impedance match to the dipoles for increased signal transfer on all VHF channels. Also, an integrated transformer design achieves impedance match to the 300-ohm downlead. Dimensions of the antenna include a tip measurement of 92" and a boom length of 112¾". Weight is approximately 14½ lbs. The price of the Model LPV-TU100 is \$41.95. Other antennas in the series range in price from \$14.95 to \$79.95.



Anti-Static Record Spray
(72)

A special lubricant designed to prolong record life by reducing groove wear is now manufactured by **Colman Electronic Products**. Klear Tone Anti-Static Record Spray, No. 1632-65, is safe to use on all records, including the old shellac type. It is non-flammable and safe to use around all plastics used in photographs. In addition to cleaning and lubricating records with

a fine silicone film that prevents static build up, the record spray may be used to spray-clean dirty phono needles and cartridges. The price is \$1.79.

Sweep Circuit Replacement Coils
(73)

Exact replacement sweep circuit coils for color TV sets produced by more than 25 manufacturers have been introduced by the **J. W. Miller Company**. The focus, convergence, and sweep circuit coils are directly interchangeable with original coils in color TV sets by manufacturers such

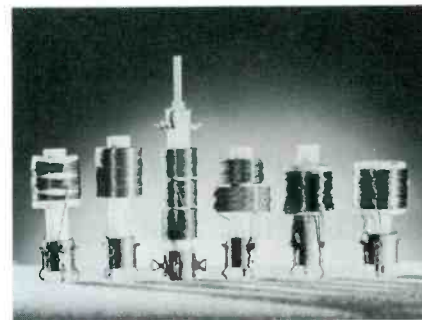

as RCA, Philco, Westinghouse, Motorola and Muntz. Single unit prices start at \$1.20.

How to break into the big money servicing 2-way radios!

HOW WOULD YOU LIKE to start collecting your share of the big money being made in electronics today? To start earning \$5 to \$7 an hour... \$200 to \$300 a week... \$10,000 to \$15,000 a year?

Your best bet today, especially if you don't have a college education, is probably in the field of two-way radio.

Two-way radio is booming. Today there are more than *five million* two-way transmitters for police cars, fire trucks, taxis, planes, etc. and Citizen's Band uses—and the number is growing at the rate of 80,000 new transmitters per month.

This wildfire boom presents a solid gold opportunity for trained two-way radio service experts. Most of them are earning \$5,000 to \$10,000 a year *more* than the average radio-TV repair man.

Why You'll Earn Top Pay

One reason is that the U.S. doesn't permit anyone to service two-way radio systems unless he is *licensed* by the FCC (Federal Communications Commission). And there aren't enough licensed electronics experts to go around.

Another reason two-way radio men earn so much more than radio-TV service men is that they are needed more often and more desperately. A two-way radio user *must* keep those transmitters operating at all times, and *must* have them checked at regular intervals by licensed personnel to meet FCC requirements.

This means that the available licensed experts can "write their own ticket" when it comes to earnings. Some work by the hour and usually charge at least \$5.00 per hour, \$7.50 on evenings and Sundays, plus travel expenses. Others charge each customer a monthly retainer fee, such as \$20 a month for a base station and \$7.50 for each mobile station. A survey showed that one man can easily maintain at least 15 base stations and 85 mobiles. This would add up to at least \$12,000 a year.

How to Get Started

How do you break into the ranks of the big-money earners in two-way radio? This is probably the best way:

1. Without quitting your present job, learn enough about electronics fundamentals to pass the Government FCC Exam and get your Commercial FCC License. Then start getting practical experience in servicing two-way radio systems in your area.
2. As soon as you've earned a reputation as an expert, there are several ways you can go. You can add mobile radio maintenance to the present services offered by your shop, or start your

own separate mobile radio business. You might become a franchised service representative of a big manufacturer and then start getting into two-way radio sales, where one sales contract might net you \$5,000. Or you may be invited to move *up* into a high-prestige salaried job with one of the major manufacturers.

The first step—mastering the fundamentals of electronics in your spare time and getting your FCC License—can be easier than you think.

Cleveland Institute of Electronics has been successfully teaching electronics by mail for over thirty years. Right at home, in your spare time, you learn electronics step by step. Our **AUTO-PROGRAMMED™** lessons and coaching by expert instructors make everything clear and easy, even for men who thought they were "poor learners." You'll learn not only the fundamentals that apply to all electronics design and servicing, but also the specific procedures for installing, troubleshooting, and maintaining two-way mobile equipment.

Your FCC License... or Your Money Back!

By the time you've finished your CIE course, you'll be able to pass the FCC License Exam with ease. Better than nine out of ten CIE-trained men are able to pass the FCC Exam, even though two out of three non-CIE men fail. This startling record of achievement makes possible our famous FCC License Warranty: you'll pass the FCC Exam upon completion of your course or your tuition will be refunded in full.

Find out more. Mail coupon for two FREE books, "How To Succeed In Electronics" and "How To Get A Commercial FCC License."

CIE
Cleveland Institute of Electronics
1776 E. 17th St., Dept. PF-34, Cleveland, Ohio 44114

Cleveland Institute of Electronics
1776 E. 17th St., Cleveland, Ohio 44114

Please send me without cost or obligation:
1. Your 40-page book "How To Succeed In Electronics" describing the job opportunities in Electronics today, and how your courses can prepare me for them.
2. Your book on "How To Get A Commercial FCC License."

Name _____ Age _____
(please print)
Address _____
City _____
State _____ Zip _____

Check here for G.I. Bill information.
Accredited Member National Home Study Council. PF-34

ENROLL UNDER NEW G.I. BILL
All CIE courses are available under the new G.I. Bill. If you served on active duty since January 31, 1955, or are in service now, check box in coupon for G.I. Bill information.

It will actually take you longer to read this advertisement than to install this new "Quick Grip" mobile antenna mount. No holes to drill. Cable is completely hidden. Makes the world's finest antennas the world's most practical.



Practically every A/S mobile CB antenna made may be ordered with a "Quick-Grip" mount, including all versions of the mighty Maggie Mobiles.

Model M-176, illustrated above. M-175, same coil and whip less spring. M-177 is "Quick-Grip" version of our great 18" Mighty-Mite. Mount only also available.

 **the antenna specialists co.** division of Anzac Industries, Inc.

12435 Euclid Ave., Cleveland, Ohio 44106
Export: 64-14 Woodside Ave., "Stripes of Quality"
Woodside, N.Y. 11377



CB Transceiver (74)

A new model has been added to General Electric's line of solid-state Citizen's Band transceivers. The Model Y7050 transmits and receives up to ten miles, depending on terrain and conditions. Either of two crystal-controlled frequencies—CB channel 11 or 16—may be used simply by flipping a channel selector switch.

A special feature of this walkie-talkie is power-source flexibility. It can be operated with standard "AA"

penlight batteries, or with rechargeable nickel cadmium batteries (optional). Also, with optional accessories, AC house current, a car cigarette lighter socket, or a 12-volt storage battery can be used to power the unit. Input power is 1½ watts. In addition to the 51" telescoping antenna, a jack is provided for connection to an external antenna. This feature, along with adaptability to a variety of power sources, makes the unit useable as a base station.

Each unit features a squelch control, for reduction of background noise, and a battery checking meter. The unit is supplied with "AA" batteries, earphones, and carrying case. Also included is an application form for a Citizens Band license—required by the FCC because of the unit's power output level. Application is by mail. The only requirements are that the applicant be 18 years of age and a U.S. Citizen.

The set weighs 1.7 lbs. with batteries, and measures 7⅝" high by 3¼" wide by 1⅝" deep. Optional accessories include an auto power cord, Ni-Cad rechargeable batteries, and combination AC converter/Ni-Cad battery charger. Price is \$125 per pair.



...and the public address system will use QUAM speakers!



MODEL 8C10PA

For top quality public address. This 8" speaker has a 10 oz. ceramic magnet, frequency response of 55-13000 Hz., easily handles 12 watts. One of 34 Quam speakers for sound system applications.

Men who specify loudspeakers in enormous volume have to be particular about quality and performance. That's why more and more sound system installers are developing the habit of specifying Quam.

It's a good habit to acquire, because Quam makes good speakers for public address, background music and other sound system needs, as well as for radio-tv-automotive replacements.

Whatever kind of speaker you need, look for Quam, the Quality line, in the red, white, and blue package at your distributor.

QUAM QUAM-NICHOLS COMPANY
234 E. Marquette Road—Chicago, Illinois 60637

SWITCH to Hi-Q

precision instrument switches!



#18 Series Switch available one to eight poles per deck. Meets MIL-S-3786-B.



This special switch and resistor assembly illustrates engineering to specific need.



#18 Series three deck three pole per deck switch with terminal boards.



Typical type CES six deck, single pole per deck multiple position switch.



Special design incorporating resistors and rear terminals to meet customer needs.



CES type switch with terminal boards. Available 1 3/4" to 8" square. Up to 144 shorting positions.



Hi-Q precision instrument switches readily fulfill standard, special, and military requirements at attractive prices through the use of modular stock units from which an almost unlimited series of configurations may be assembled...and minimum delivery time is guaranteed!

This kind of flexibility is typical of the engineering precision found in every feature—brush blades lapped and edges stoned; insulating parts custom drilled to critical tolerances; contacts of homogeneous alloys for minimum EMF, positive metal-to-metal wiping, and low electrical resistance; maximum contact wiping surface to distribute frictional wear and promulgate longer life. For installation flexibility, all units are available with either solder pot or turret type terminals.

The terminal board switch is a further indicator of the advanced engineering you may expect from Hi-Q. The use of terminal boards facilitates modular wiring harness design and reduces overall assembly costs.

Whatever your product, if design decision requires precision instrument switches, contact Hi-Q and see what they have to offer. It's quite probable that you won't find a better answer anywhere.



AEROVOX
CORPORATION
1100 CHESTNUT ST
BURBANK, CALIF.

Circle 49 on literature card

SERVICE PUZZLER

What circuit would you first suspect if you were confronted with the picture on the RCA portable (Chassis KCS 151) in Fig. 1? Read the following clues before making an educated guess.

The picture changes from the effect shown in Fig. 1 to a normal

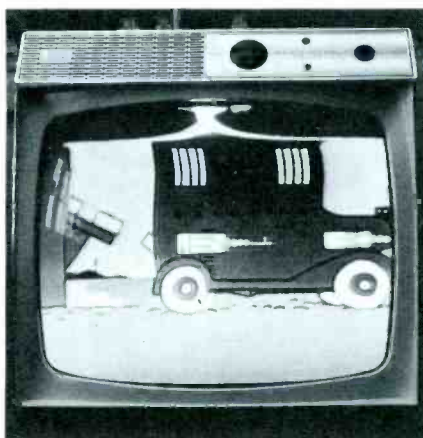

Fig. 1. Odd symptom displayed on screen of RCA portable.

picture, indicating an intermittent component. The effect stays at the top of the screen, even when the vertical is rolled, and it is not changed by height or linearity adjustments. The same effect is seen on a blank channel.

Right or Wrong?

After careful analysis, you should have concluded that the vertical pulse was killing the horizontal sweep shortly after the vertical retrace time. But how are the two getting together? How about a yoke short? The picture was still the same with a new yoke. Open filter

Color or Black & White TV respond to QUIETROLE like magic!



- Lubricates & Cleans
- Non-inflammable . . . Non-conductive . . . Non-corrosive
- Easy Spray or Dropper Application
- Nearly 20 Years of Outstanding Leadership
- Harmless to Plastics & Metal — Zero Effects on Capacity & Resistance

Acknowledged leadership by both manufacturers and servicemen. Silences noisy TV and radio controls with minimum attention. Mark-II for tuners . . . Spray-Pack for controls and switches . . . Silitron for general use.

Ask your distributor for Quietrole by name.



manufactured by
QUIETROLE CO.
Spartanburg, South Carolina

Circle 50 on literature card

Free Brochure

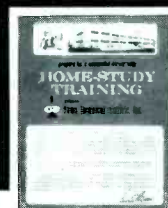

describes unique
**FCC 2nd Class
Radiotelephone
License Course**

developed by

**SAMS TECHNICAL INSTITUTE
FOR SUCCESSFUL HOME STUDY
Actually 3 Courses in 1!**

- * Comprehensive License Course based on the LATEST FCC EXAM...
- * Basic Course in actual, practical 2-WAY SERVICING...
- * An invaluable Course on the important subject of TRANSISTORS...

Fully covered by tuition refund policy

Write Today

Sams Technical Institute, Inc., PFS - 3
Home Study Division
1720 E. 38th St., Indianapolis, Ind. 46218

Send details on License Course

Name _____

Address _____

City _____

State _____ Zip _____

pack a
MARKSMAN
 in your caddy
 and get the job
 done
FASTER!



New MARKSMAN soldering irons by Weller deliver more heat **where you want it**, pack more punch for their ratings than higher priced irons that won't fit in your tube caddy.

Long reach and smaller size make MARKSMAN irons more maneuverable in confined areas, get you off the job quickly. And check these plus features:

- Stainless steel barrels
- Cool, unbreakable handles
- Plated solid copper tips
- Rugged, high-efficiency performance

Weller MARKSMAN irons are available in 25, 40, 80, 120 and 175 watt sizes priced from \$2.95 list. Get them from your electronic parts distributor.

WELLER ELECTRIC CORP., Easton, Pa.

In Canada: Kingston, Ontario. In England: Horsham, Sussex

WORLD LEADER IN SOLDERING TECHNOLOGY

Circle 51 on literature card

capacitor? Sounds logical, but the scope showed no such disturbance on the B+ line, and test capacitors shunted across the filters did not help. CRT blanking? No connection at all.

Solution

Study of the PHOTOFAC schematic (730-3) showed one possibility of an accidental cross-feed, and then only if C62 opened (Fig. 2).

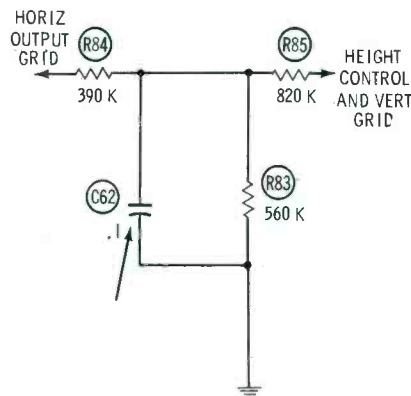

Fig. 2. Open capacitor causes symptom.

The scope showed both vertical and horizontal pulses on the capacitor when the trouble appeared on the screen. A new capacitor cured the trouble. Of course, a bad ground at C62 would also produce the same symptom.

Several schematics showed more models with the same circuit. These include RCA Chassis KCS 143, KCS 144, KCS 148, and KCS 149. All of these are 1965 models. ▲



Occasionally he hands out awards!



IS YOUR HI-FI PUTTING YOU IN THE BOXES

...OR THE BALCONY? An Oxford "Tempo" Hi-Fi Speaker can put you in the orchestra. Oxford speakers are a standard in high-fidelity response. They have extra-heavy ceramic magnets that give the power needed for a wide range of reproduction. "Tempo" speakers also feature Oxford's exclusive "Floating Suspension Surround," a resilient flexible edge which extends the low frequency spectrum without undesirable "hangover." Try your "test record" (each of us has a favorite . . . we tend to favor "Also Sprach Zarathustra") and try it with an Oxford "Tempo" Hi-Fi speaker. You'll be convinced.

Various models available including: 12" with built-in electrical crossover; 12" with built-in whizzer and mechanical crossover; 8" with built-in whizzer and mechanical crossover, and a 6 x 9 with a built-in whizzer and mechanical crossover. Write today for full information.

OXFORD TRANSDUCER COMPANY
A Division of
Oxford Electric Corporation

Visit display room 509-A
June 19th through 21st
Conrad Hilton Hotel, Chicago

3911 S. Michigan Ave.
Chicago, Ill. 60653

Circle 52 on literature card

BOOK REVIEW

How to Build Speaker Enclosures: Alexis Badmaieff and Don Davis; Howard W. Sams & Co., Inc., Indianapolis, 1966; 144 pages. 5½" x 8½", soft cover: \$3.25.

The volume begins with an evaluation of the five basic enclosure types: finite baffle, infinite baffle, bass reflex, horn projectors, and combination units. This is followed by an analysis of driver units, with statements regarding their limitations and effects of changing sizes and types.

Next, speaker and enclosure placement are considered, with particular emphasis on phasing, efficiency, and equalization, both electronically and mechanically. This involves discussion of phasing and crossover networks, and how they are best related to individual components.

In the work are photographs, graphs, curves, and construction plans (including material lists) for many examples of each type of enclosure, including complex folded horns and combination units. Information in the book is sufficient to permit an individual to design the changes required for adapting any specific unit to the particular room or driver unit with which it will be employed.

Concluding chapters deal with crossover networks and how their design is achieved. Graphs and charts indicate frequency and power demands of various orchestral groups, and for the "coil winders" there is sufficient information to permit construction of networks in the workshop or home. The chapter dealing with constructing and testing describes the materials, tools, and methods by which the most satisfactory results can be obtained. Testing techniques, from simple arrangements to elaborate professional setups, are then presented.

This book has been written for a wide range of readership and essentially requires little more knowledge than what a speaker is. Source material is from those who manufacture both enclosures and speakers of the professional type. The authors are engineers who have been engaged in the design of enclosures and speakers for commercial manufacture. ▲



**A NEW
TUNER CLEANER**

Specially
**FORMULATED
FOR
TV-TUNERS**

**USING
NUVISTORS &
TRANSISTORS**

Nuvistors and Transistors are highly sensitive to drift from ingredients in most ordinary TV tuner cleaners. Drift has been found to cause call backs and expensive tuner repairs. For over 18 months CHEMTRONICS has been formulating and testing this new cleaner in both the lab and field. Under the most critical test, there has been NO DRIFT on scope patterns. We invite you to try this test yourself.

NO NUVISTOR DRIFT
Another FIRST from



BROOKLYN

N. Y. 11236

Circle 53 on literature card

March, 1967/PF REPORTER 77

Solution to PFR PUZZLER

February Electronic Crossword

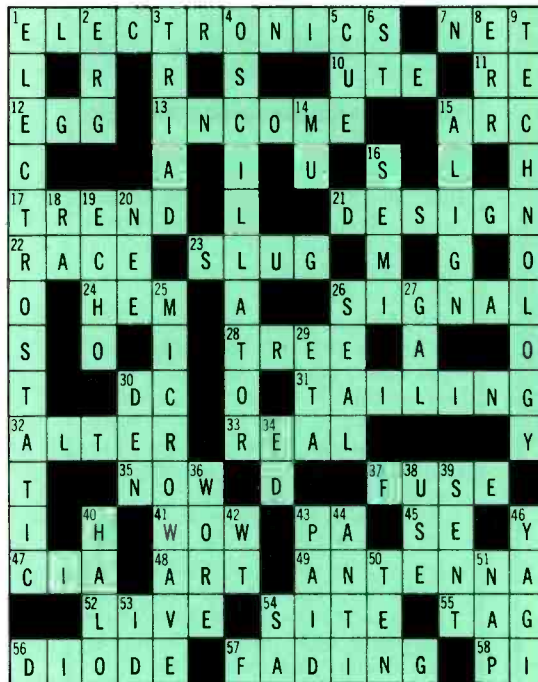

FAMOUS ZENITH QUALITY TUBES for greater reliability, longer life



TV Picture Tubes

A complete line of more than 200 top-quality tubes. For color, black-and-white, or special purposes.

Zenith black & white replacement picture tubes are made only from new parts and materials except for the glass envelope in some tubes which, prior to reuse, is inspected and tested to the same high standards as a new envelope. In Color tubes the screen, aperture mask assembly and envelope are inspected and tested to meet Zenith's high quality standards prior to reuse. All electron guns are new.

"Royal Crest" Circuit Tubes

A full line of more than 875 tubes . . . the same quality tubes as original Zenith equipment. Your assurance of the world's finest performance.

Order all genuine Zenith replacement parts and accessories from your Zenith distributor.

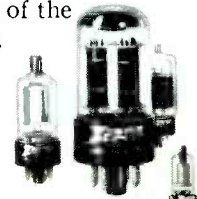

BUILT TO THE QUALITY STANDARDS OF ZENITH ORIGINAL PARTS



The quality goes in before the name goes on®

Circle 54 on literature card

ARROW

Automatic
STAPLE GUN TACKERS

Specially designed for
SAFE — FAST — SECURE
WIRE & CABLE FASTENING

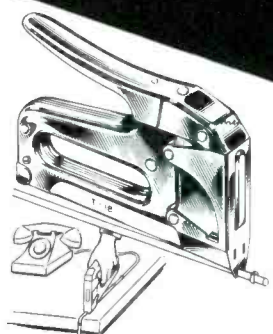

No. T-18
For wires up to
3/16" in dia.
Uses round crown
staples in
3/8" leg only.

BELL, TELEPHONE, THERMOSTAT,
INTERCOM, BURGLAR
ALARM and other
low voltage
wiring.

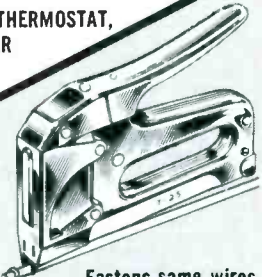

No. T-25
For wires up to
1/4" in dia.
Uses round crown
staples in 9/32",
3/8", 7/16", and
9/16" leg.

Fastens same wires
as No. T-18

Also
used for
RADIANT
HEATING
CABLE



No. T-75
For wires and
cables up to
1/2" in dia.
Uses tack-pointed
staples in 9/16",
3/8" and 7/8" leg.

SHEATHED CABLE, RADIANT
HEATING CABLE, WIRE
CONDUIT, COPPER
TUBING, DRIVE
RINGS, ETC.

- All-steel, chrome finish.
- Jam-proof mechanism for trouble-free operation

SAFE! Driving blade automatically halts staple at right depth of penetration! Can't cut or injure wires and cables.

FAST! Powerful single stroke action shoots staples in 1/1000 of a second! Saves 70% in time, effort and efficiency!

HOLDS! Staple points diverge to imbed firmly in wood. Rosin-coated for tremendous holding power!

Write for catalog and information.

ARROW FASTENER COMPANY INC
Saddle Brook, New Jersey 07863
"Pioneers and Pacesetters
For Almost A Half Century"

Circle 55 on literature card

INDEX TO ADVERTISERS

March, 1967

Amphenol Corp.	37
The Antenna Specialists Co., Division of Anzac Industries, Inc.	74
Arco Electronics	35
Arrow Fastner Co., Inc.	79
B&K Mfg. Co., Division of Dynascan Corp.	57, 69
Belden Mfg. Co.	53
Blonder-Tongue Labs, Inc.	66
Bussmann Mfg.	18, 19
Castle TV Tuner Service	15
Channel Master Corp.	50, 51
Chemtronics, Inc.	77
Cleveland Institute of Electronics	65, 73
Electro-Voice, Inc.	75
The Finney Co.	40, 52, 54
GC Electronics	31, 44
Gem City Tuner Repair Service	62
Injectrall Electronics Corp.	52
JFD Electronics Co.	43
Jerrold Electronics Corp.	Cover, 2
Kay-Townes Antenna Co.	56
Lectrotech, Inc.	60, 61
Littelfuse, Inc.	Cover, 4
Mercury Electronics Corp.	62
Miller, J. W. Co.	40
Motorola Consumer Products, Inc.	17
Motorola Training Institute	36
National Radio Institute	68
Oaktron Industries, Inc.	72
Oxford Transducer Co.	77
Perma-Power Co.	54
Philco-Ford Corp.	23
Planet Sales Corp.	52
Quam-Nichols Co.	74
Quietrol Co.	75
RCA Electronic Components and Devices (Semiconductor)	71
RCA Electronic Components and Devices (Test Equipment)	16
RCA Electronic Components and Devices (Entertainment Tubes)	Cover, 3, 41
RCA Institutes, Inc.	70
RCA Parts & Accessories	29
RCA Sales Corp.	63
Sams, Howard W. & Co., Inc.	58, 59, 79
Sams Technical Institute	75
Seco Electronics Corp.	9
SENCORE, Inc.	55
Simpson Electric Co.	49
Sprague Products Co.	13, 14
Standard Kollsman Industries, Inc.	27
Sylvania Electric Products Corp.	67
Texas Crystals	66
Triplet Electrical Instrument Co.	33
Weller Electric Corp.	76
Winegard Co.	10, 11
Zenith Radio Corp.	64, 78

new Sams books

BRAND-NEW UP-TO-DATE 10TH EDITION
of the famous HOWARD W. SAMS
Tube Substitution Handbook

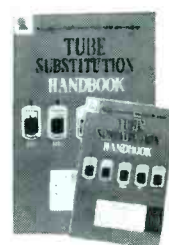

2-IN-1 PACKAGE!
Regular size for your bench—
Compact copy for your caddy

Here's what you get in this great low-cost package: 1. Latest 10th edition handbook (5 1/2 x 8 1/2" for bench use)—completely revised and expanded. The most complete, up-to-date direct tube substitution guide available. Now includes more than 11,300 substitutions for all types of receiving and picture tubes. Seven sections include:

1. Cross-reference of all American receiving types.
2. Picture tube substitutions.
3. Cross-reference of miniature tubes.
4. Industrial substitutions for receiving tubes.
5. Substitutions for communications and special-purpose tubes.
- 6, 7. Cross-reference of American and foreign tubes.
2. Caddy-size tube substitution handbook—contains the complete, identical data included in the larger edition—an ideal handy reference for outside calls. Each handbook tells you when and how to make proper substitutions. Both handbooks come in one vinyl-wrapped package. Order **TUB-10P \$225** Twin-Pak, both books for only **\$225**. Shop edition only (5 1/2 x 8 1/2"; 128 pages)—worth its weight in gold on your bench! Order **TUB-10, only \$175**

101 More Ways to Use Your Scope in TV, 2nd Ed.

by Robert G. Middleton. Newly revised handbook describes additional and somewhat more advanced uses of the scope not covered in the first volume. Includes use of lab-type triggered-sweep scopes as well as standard service type. Uses range from basic troubleshooting procedures to the more complex testing of circuit components. Explanations are easy to follow; each test describes equipment required, proper connections, test procedure and evaluation. Includes many actual photos of both circuit and specialized testing waveforms. 168 pages; 5 1/2 x 8 1/2". Order **TEM-7A only \$295**

Silicon Controlled Rectifiers

by Allan Lytel. A complete and clear explanation of the fast-growing SCR solid-state field. Explains principles of SCR operation and shows their use in a variety of practical control circuits. Clearly describes phase shift control of a-c and d-c power; discusses circuits such as ring counters, temperature controls, and voltage regulation. Includes informative chapter on SCR testing. An invaluable book for everyone who wants to be up on this important new solid-state development. 128 pages; 5 1/2 x 8 1/2". Order **SCL-1, only \$275**

How to Repair Small Appliances, Vol. 2

by Jack Darr. Makes it simple to repair seemingly complicated household appliances. Explains how to repair the following electrical appliances not covered in Vol. 1: Portable heaters, hair dryers, carving knives, tooth brushes, bottle warmers, sewing machines, and nine other electrical appliances. A remarkably useful guide for profit-making or money-saving repairs. Fully illustrated. 128 pages; 5 1/2 x 8 1/2". Order **APD-1, only \$275**

HOWARD W. SAMS & CO., INC.

Order from your Sams Distributor today, or mail to Howard W. Sams & Co., Inc., Dept. PF-3, 4300 W. 62nd Street, Indianapolis, Ind. 46268

- Send me the following books:
- TUB-10P TEM-7A APD-1
 TUB-10 SCL-1
- Send FREE Sams Booklist. \$_____enclosed

Name _____
Address _____
City _____ State _____ Zip _____
My Distributor is _____

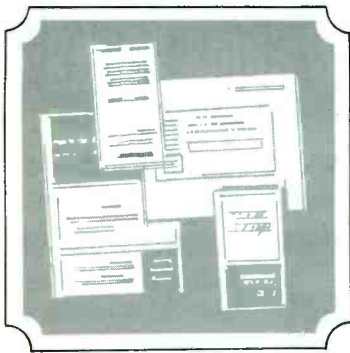

\$ FREES \$

CATALOG AND LITERATURE SERVICES

*CHECK "INDEX TO ADVERTISERS" FOR FURTHER INFORMATION FROM THESE COMPANIES

ANTENNAS

75. **ALLIANCE** — Colorful 4-page brochure describing in detail all the features of Tenna-Rotors.
76. **ANTENNA-CRAFT**—12-page catalog listing complete Antennacraft line of UHF, VHF & FM antennas for all types of installations.
77. **BLONDER-TONGUE**—Compact brochure detailing a line of all-channel products expressly designed to improve reception in the home and small MATV systems.*
78. **CORNELL-DUBILIER**—16-page booklet: "How to improve TV/FM Reception."
79. **FINNEY**—Forms 20-338, 20-356, and 20-357 describing distribution amplifiers and antenna amplifiers for 300-Ohm and 75-Ohm TV and FM systems.*
80. **GC ELECTRONICS** — Form FR-28-C, 8-page brochure about Colormagic antennas and coupler-splitters.*
81. **JERROLD**—New 4-page full-color catalog describes the new Paralog Plus antennas.*
82. **JFD**—Color Laser and LPV antenna brochures. New 1967 dealer catalog covering complete line of log-periodic outdoor antennas, rotators, and accessories.*
83. **WINEGARD**—8-page color brochure on new Super-Colorton antennas: 5 VHF-UHF-FM, 4 VHF-FM, 3 UHF. Includes information on 6 new solid-state preamplifiers.*

AUDIO

84. **ANDREA** — History booklet about the company, also full-line folder in color.
85. **ATLAS SOUND**—Catalog 556-67 illustrates and describes many new models of public address loudspeakers, microphone stands, and accessories for commercial sound applications.
86. **EICO**—Brochure on the new "Cortina" solid-state stereo system.
87. **KOSS**—Brochures on Rek-O-Kut turntables and personal listening products.
88. **OAKTRON**—"The Blueprint to Better Sound," an 8-page catalog of loudspeakers and baffles giving detailed specifications and list prices.*
89. **OLYMPIC** — Complete-line folders and catalog pages on color and black-and-white television, Hi-Fi, stereo/monaural phonos, radios and tape players.
90. **OXFORD TRANSDUCER** — Catalog sheets featuring speaker systems for automobiles.*
91. **STANFORD INTERNATIONAL**—Brochure about a new battery-operated tape recorder. Also, brochures about headphones and microphones.
92. **TRIAD**—Data sheet on 8 new line-matching transformers.
93. **VIKING**—Brochure about Model Studio 96 tape transport.

COMMUNICATIONS

94. **ACTION**—Wall mounted intercommunicating interphone providing hotline paging and selective buzzer calling for stores and factories.
95. **AMPHENOL** — 2-color spec sheets on new Model 650 CB transceiver and Model C-75 hand-held transceiver.*
96. **MOSLEY ELECTRONICS**—New 1967 deluxe citizens band antenna catalog.
97. **MOTOROLA**—New brochure tells how to reach people on-the-move through use of personal two-way radio.*
98. **POLYTRONICS**—Flyers about Poly Pup—a very small 7-channel CB transceiver,

and Duo-Com 123 3-watt Walkie-talkie.

99. **SHURE**—Data sheet on Ranger II noise-cancelling microphones.

COMPONENTS

100. **BUSSMAN**—Bulletin on BUSS Fustat Box Cover Units for protecting electrical tools against damage and burnout. Units fit standard outlet or switch box, have fuseholder plus a plug-in receptacle, pilot light, switch, etc. For detailed information ask for BUSS Bulletin SBCU.*
101. **CENTRALAB**—Catalogs offered on electrolytic capacitors, PEC's, and auto radio shafts and bushings.
102. **GC ELECTRONICS**—Catalogs FR15-G TV knob cross reference, FR-028-C antennas, and IR-7018-G transistor reference.*
103. **LITTELFUSE**—Pocket-sized TV circuit breaker cross-reference gives the following information at a glance: Manufacturer's part number, corresponding Littelfuse part number, price, color, and b/w designation. A second glance gives trip ratings and acquaints you with a line of caddies. Ask for CBCRP.*
104. **QUAM-NICHOLS** — Quam-auto radio speaker replacement guide. Complete replacement information on front and rear-seat speakers for automobile radio models from 1955-1966.*
105. **SONOTONE**—New revised cartridge replacement manual—SAC-25 (Rev. 12/66).
106. **SPRAGUE**—#C-617, a complete catalog of the Sprague line.*
107. **SWITCHCRAFT** — Bulletin D-814 describes Switchcraft's new "traffic-tailored" dealer audio-accessory merchandiser and merchandiser program.

SERVICE AIDS

108. **CASTLE**—How to get fast overhaul service on all makes and models of television tuners is described in leaflet. Shipping instructions, labels, and tags are also included.*
109. **CHEMTRONICS** — Flyer about a new cleaner especially for Navistor and transistor tuners.*
110. **CLEVELAND INSTITUTE OF ELECTRONICS** — New pocket-sized, plastic "Electronics Data Guide" of formulas and tables, including frequency and wavelength, dB formulas and table, antenna lengths, and color code.*
111. **ELECTRONIC CHEMICAL** — Catalog sheet on aerosol sprays for servicemen.
112. **MIDSTATE TUNER** — 24-hour tuner service is described in a colorful brochure.
113. **PERMACEL**—Brochures on a wide variety of adhesive tapes for the electronics industry.
114. **PERMA-POWER** — Flyer showing the complete line of TV tube brighteners and service accessories.*
115. **QUALITY TUNER SERVICE** — Introductory letter describing costs and service on all makes of TV tuners. Repair tags and shipping labels included.
116. **RAWN**—Bulletins on repair ideas using Plas-T-Pair knob and plastic repair kits. Also, bulletins on tuner cleaners and circuit coolers. Includes price sheets.

SPECIAL EQUIPMENT

117. **ADMIRAL**—Flyers on 2 new educational-style TV receivers.
118. **SONIC INDUSTRIES**—Bulletins on 2 new Police-band to AM-band converters. Small, solid-state, and low-priced.

119. **SQUIRES-SANDERS** — Bulletins on 2- and 6-meter Ham transceivers and a new solid-state CCTV camera.
120. **STACO** — Flyer describing 4 popular bench model variable autotransformers.

TECHNICAL PUBLICATIONS

120. **PHILCO**—Information about Tech Data & Business Management service. Also, free parts catalog.
122. **RCA INSTITUTES**—New 1967 career book describes home study programs and courses in television (monochrome and color), communications, transistors, industrial, and automation electronics.*
123. **HOWARD W. SAMS** — Literature describing popular and informative publications on radio and TV servicing, communications, audio, Hi-Fi, and industrial electronics, including special new 1967 catalog of technical books on every phase of electronics.*

TEST EQUIPMENT

124. **B & K**—New 1967 catalog featuring test equipment for color TV, auto radio, and transistor radio servicing, including tube testers designed for testing latest receiving tube types.*
125. **EICO**—1967 short-form catalog is 48 pages long. Describes a complete line of test instruments, CB and ham equipment, Hi-Fi components, and miscellaneous electronic equipment.
126. **HICKOK**—Specification information on new Models: CR-35 CRT rejuvenator tester, GC-660 solid-state color bar generator, 860 AM/FM signal tracer.
127. **JACKSON**—New line folder or "Service Engineered test equipment includes push-button-operated color dot/bar generator.*"
128. **ELECTROTECH**—Two-color catalog sheet on new Model V6-B color bar generator, the latest improved model of the V6. Gives all specs and is fully illustrated.*
129. **MERCURY**—1967 16-page booklet features the full line of test equipment for servicing color and black/white TV, radio, Hi-Fi, and communications equipment. Includes the new Model 1900 color generator and Model 2000 mutual conductance tube tester.*
130. **PRECISION APPARATUS**—Illustrated catalog describing signal generators, oscilloscopes, and meters.
131. **SECO**—New line folder featuring the new Model 107C Gm, Em, and grid circuit tube tester.*
132. **SEMITRONICS**—Brochure on the new Model 1000 transistor tester.
133. **SENCORE**—8-page full color catalog plus a new 4-page supplement catalog.*
134. **SIMPSON**—Flyer giving specifications of Model 604 multimeter for measuring and recording volts, amps, milliamps, and microamps.
135. **TRIPLETT**—Catalog D-66-I features the complete line of panel instruments.*

TOOLS

136. **ARROW**—Catalog sheet showing 3 staple gun tacks designed for fastening wires and cables up to 1/2" in diameter.*
137. **CHANNELLOCK**—General catalog #66 and price supplement on the complete tool line.
138. **ENTERPRISE DEVELOPMENT**—Time-saving techniques in brochure from Eudeco demonstrate improved desoldering and resoldering methods for speeding and simplifying operations on PC boards.
139. **LUXO**—Flyers on counterbalanced and magnifying bench lamps.
140. **VACO**—Catalog #SD-120 completely describes new Vaco screw launcher which holds, starts, and drives all straight-slot screws.
141. **WEN**—4-page 3-color catalog describes 9 new electric power drills. 1/4- to 1/2-inch capacity, light and heavy-duty use.

TUBES AND TRANSISTORS

142. **IR**—Transistor cross reference guide — 22 pages of detailed specifications on universal silicon and germanium transistors and a complete listing of more than 5000 devices which they replace.
143. **MOTOROLA** — Catalog HMA-27-R describes ratings and characteristics of all devices in HEP line, includes info on heat sinks, mounting kits, device outlines, and home project ideas.*
144. **NATIONAL SEMICONDUCTOR** — 18-page catalog of silicon transistor and IC's.
145. **RADIO CORP. OF AMERICA**—PIX 300, a 12-page product guide on RCA picture tubes covering both color and black-and-white. Includes characteristics chart, terminal diagrams, industry replacement, and interchangeability.*
146. **SEMITRONICS**—Flyer on the new HO-300 replacement transistor for horizontal and vertical output stages.
147. **WORKMAN**—Two new cross-references in vest pocket size. Miracle Five transistors, and circuit breakers.

Your local participating
RCA Tube Distributor invites you to

Step into the winner's circle

with 1967's greatest collection of
technical, service and promotional aids
to make your servicing jobs easier and
help you promote more business.



Get RCA's new Field Service Guide Free in the RCA Color Pack '67... This tremendously helpful book holds the schematics and field service adjustments of all color TV sets manufactured by RCA Victor from 1955 to 1966. With it you can do all adjustments possible with a color bar generator, including replacing a color TV tube... in the home. You get it FREE when you buy the RCA COLOR PACK '67 assortment of 21 popular RCA receiving tubes for color TV from your participating RCA Tube Distributor.

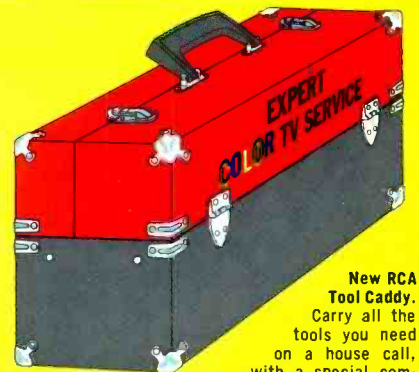

New RCA Tool Caddy.

Carry all the tools you need on a house call, with a special compartment for your model WV-38 VOM. Sturdy metal trays for different size tools fold out easily, fall back readily. Covered in strong SUPERWELD fabric with metal guards protecting the corners, it will take a lot of abuse. Note color TV service message on the side. 1A1630

48" Power Control Multiple Outlet Box. Centralize your power for 8 different operations. Maneuver your test equipment with greater efficiency. Has pilot light and switch and circuit breaker. 1A1619

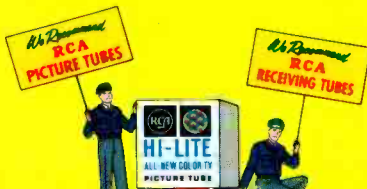

Mylar Decal for truck or window. Bright, bold colors on all-weather mylar send your color TV service message all over town on your truck. Put one in your store window, too. 1A1620

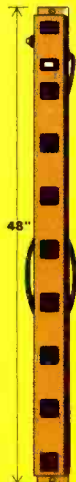

TV Cleaning Cloth Set. A set of two to take with you on house calls... one for the cabinet and one for the faceplate of the picture tube. 1A1627



Set of RCA Monogram Decals. In three sizes... a perfect way to dress up any surface that calls for product identification. 1A1624



Motion Display on RCA Receiving Tubes and Picture Tubes for Window or Counter. Ingenious, striking! Service truck moves back and forth atop a simulated color set. Draw attention to your window or counter with this novel display which promotes all of your services—color TV, black and white TV, radio and hi-fi. Electrically powered, it combines your receiving tube and picture tube story in one visually compelling unit. Put one in your window and watch the reaction! Two auxiliary serviceman pieces carrying additional service messages, can be used in conjunction with the center display or as separate units. 1A1621



The Agfa Isoflash Camera Kit... is also available with your purchase of RCA Receiving Tubes. You'll be a winner when you bring home this easy loading beauty complete with film, battery, bulb, flash cube adapter, carrying case and shoulder strap. 1A1629

Many other attractive and valuable items are available through THE WINNER'S CIRCLE program, including ad mats, RCA's Color TV Fastcheck series of helpful hints, the famous RCA Receiving Tube Manual, postcards and new business cards, and a bottle opener premium. Check with your local RCA tube distributor. He can supply you with the finest in receiving tubes for color and black-and-white TV, radio and hi-fi. And he can tell you how to STEP INTO THE WINNER'S CIRCLE.

Swingline Corrugated Carton Staple Extractor. One squeeze opens staples on corrugated cartons... easily, neatly and safely. 1A1626

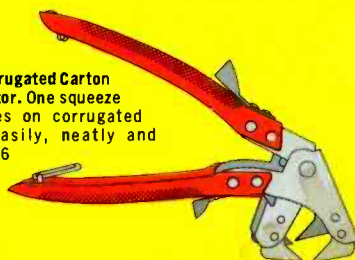

RCA Electronic Components and Devices, Harrison, N.J.



The Most Trusted Name in Electronics

Introducing a Complete Line of Littelfuse Quality Circuit Breakers



Actual Size
1 $\frac{3}{4}$ " x 1 $\frac{3}{16}$ " x $\frac{1}{2}$ "

Exact replacement from factory to you

Designed for the protection of television receiver circuits, the Littelfuse Manual Reset Circuit Breaker is also ideally suited as a current overload protector for model railroads and power operated toy transformers, hair dryers, small household appliances, home workshop power tools, office machines, small fractional horsepower motors and all types of electronic or electrical control wiring.

LITTELFUSE

DES PLAINES, ILLINOIS

Circle 57 on literature card