

# PF Reporter®

PHOTOFACT

*the magazine of electronic servicing*



12791 788 10380 1  
 BOX 144  
 FAYETTEVILLE, ARK. 72731  
 P. O. BOX 144  
 FAYETTEVILLE, ARK. 72731

- Removing the Barber Pole
- Symbol Standardization
- Ohm's Law for AC
- Industrial Electronics Notebook
- Symfact

# Going to profit here?

# Then profit here.

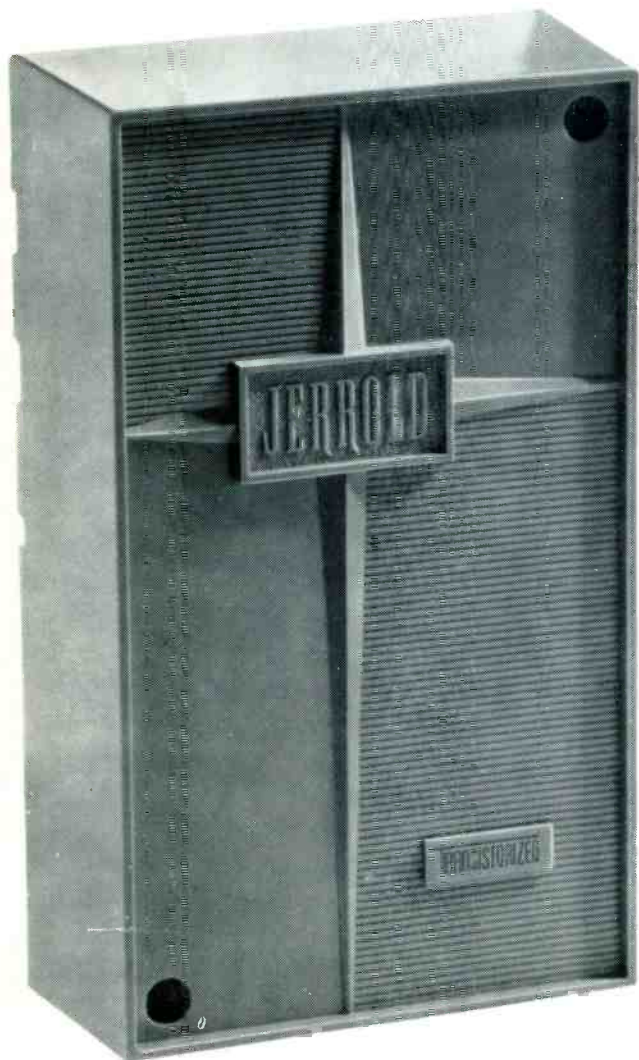
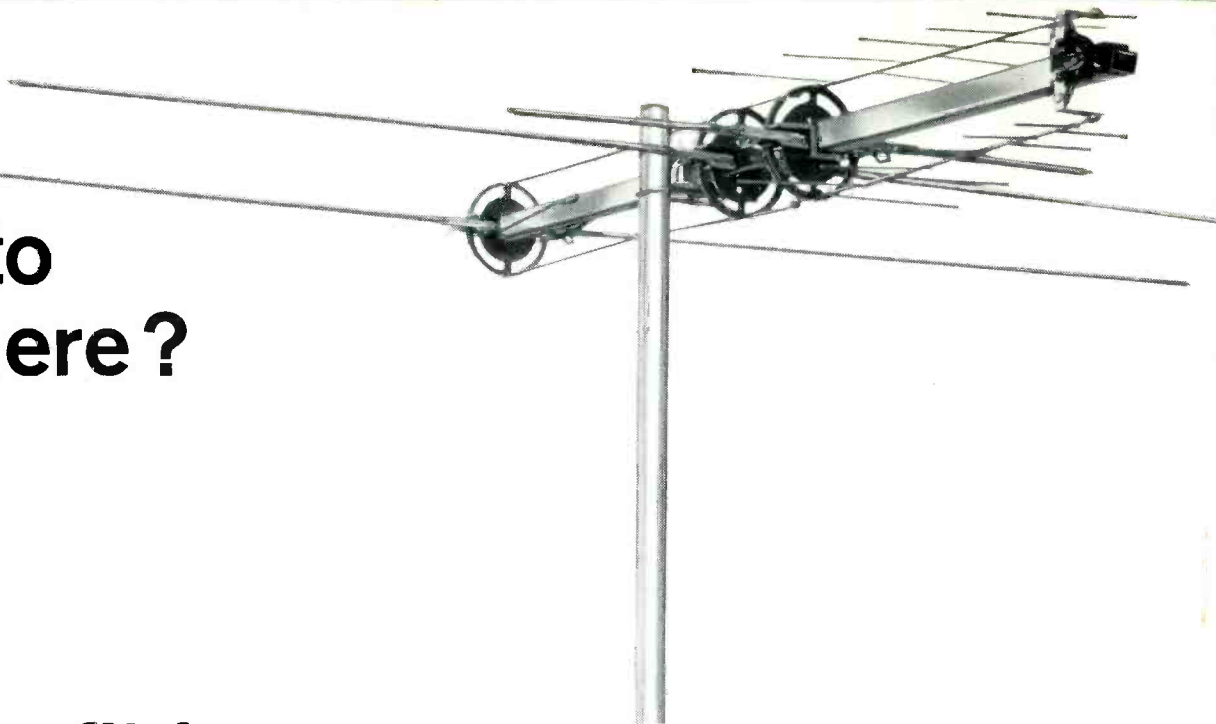

82 Channel TAC-4  
List Price \$72.50

VHF Only Model TC-88  
List Price \$39.95

## New Jerrold 82 Channel Coloraxial Home System makes perfect sales mate with Color TV Antennas

Look around you. Every home—every new housing development—is a potential profit-making sales spot for you and the TAC-4 Home Master TV System. Here's why:

*TAC-4 makes good color TV go a long way.* Every color TV set needs a top-grade antenna for good reception. TAC-4 makes this good reception possible anywhere in the house by providing extension antenna outputs in various rooms for portable TV and FM sets as well as extra sets. *You can tie-in a TAC-4 with every antenna sale.* And don't forget, it's a handy sales feature that housing developers like to use to help sell a home.

*TAC-4 handles all 82 TV channels* (color and black and white) as well as FM. It's the industry's *first* amplified coupler that can handle all present and future channels. Just connect the antenna to the input

and then connect four or more sets to the outputs.

*TAC-4 is easy to install.* Coaxial inputs and outputs make connections simple. Coaxial cable can be run right along with other electric wires—without interference with the signal. And coil backs are practically unheard of because the amplifier is completely solid-state.

*TAC-4 pleases customers.* It's the first truly professional installation for assuring better TV and FM reception anywhere in the house. It's the superior amplifier-coupler to sell with any TV set or antenna series. Sell them together. Customers get top reception. You get top profits.

For more details, see your distributor.

# JERROLD

DISTRIBUTOR SALES DIVISION  
401 Walnut St., Phila., Pa. 19105

Circle 1 on literature card



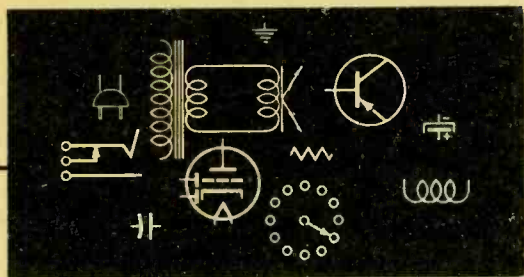

# Symbol Standardization

As a publisher in the electronics industry, Howard W. Sams & Co., Inc., has a vital interest in the standardization of schematic symbols. There is at present an industry-wide program to accomplish this. For many years now, each manufacturing company and sometimes, we suspect, each individual draftsman, had a different concept as to the proper method of symbolization.

The Electronic Industries Association (formed by participating electronics manufacturing concerns), in cooperation with the American Standards Association, has now published a list of graphical electronic symbols with the objective of simplification of symbols, reduction of drafting time, and a better understanding of schematics by all technicians.

We are reproducing a portion of the list as an aid to the technician. We feel that if all manufacturers and publishers were to adopt these symbols as standard, the time spent by technicians in interpreting symbols could be reduced greatly.

The Howard W. Sams & Co., Inc., is adopting these standard symbols in all of its publications.

## Definitions and Interpretation of Symbols

**Symbol**—A symbol is the aggregate of all its parts, but to improve readability, parts of a symbol, such as a multi-section capacitor, may be separated.

**Orientation of Symbol**—The orientation of a symbol on a drawing, including a mirror image, does not alter the meaning of a symbol.

**Arrow Heads**—Unless otherwise noted, no significance is placed on open or closed arrowheads.

**Angles of Lines**—Generally, the angle at which a connecting line is brought to a graphical symbol has no particular significance unless otherwise noted.

**Width of Lines**—The width of the line does not affect the meaning of a symbol.

## List of Symbols

### 1. Adjustability & Variability

#### (a) Coils



(b) Potentiometers—arrowhead parallel to symbol indicates direction of clockwise rotation viewed from knob, actuator, or mounted end.

(c) Capacitors—arrowhead indicates variability.

### 3. Antenna

#### 3.1 General



#### 3.1.1 Dipole

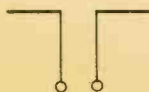

#### 3.1.2 Loop

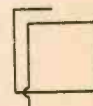

#### 3.1.3 Folded dipole

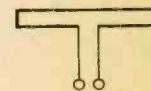

#### 3.1.4 Ferrite antenna

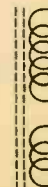

#### 3.1.5 Mono-pole



4. Arrester gap or spark gap

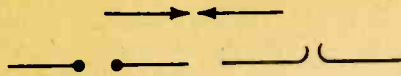

8.1.3 Adjustable or variable capacitor.



7. Battery

The long line is always positive, but polarity may be indicated in addition.

7.2 One cell



7.3 Two cells



7.3.1 Multiple cells

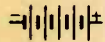

8.1.4 Adjustable or variable capacitors with mechanical linkage of units.



8.1.5 Feedthrough capacitor.



8. Capacitor

8.1 General—If it is necessary to identify the capacitor electrodes, the curved element shall represent the outside electrode in fixed paper-, mica-, ceramic-, and plastic-dielectric capacitors; the moving element in adjustable and variable capacitors; and the low-potential element in feedthrough capacitors.



8.1.1 Polarized capacitor (electrolytic)

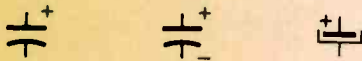

8.1.2 When multiple-section, electrolytic capacitors are diagrammed, each section must be identified with the appropriate symbol to correspond with the identifier used on the actual part.



8.1.2.1 Nonpolarized electrolytic capacitor.



8.1.2.2 Multiple sections in common container.



11. Circuit breaker

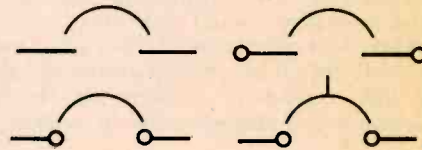

13. Circuit returns

The rake symbol may be used to indicate accessible metal ground, earth ground, the chassis, or where chassis ground is different or isolated. The other symbols may indicate ground, chassis ground, or B—.



16. Coil, relay



18. Connector—disconnecting device.

18.1 Female contact, commonly used for a jack or receptacle (usually stationary).



18.2 Male contact, commonly used for a plug (usually movable).



18.3 Separable connectors (shown engaged).



18.6 Communication (telephone) type connector.

18.6.1 Two-conductor jack.

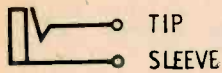

18.6.2 Two-conductor plug.

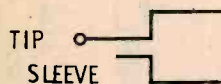

18.6.3 Three-conductor jack with two break contacts (normals) and one auxiliary make contact.

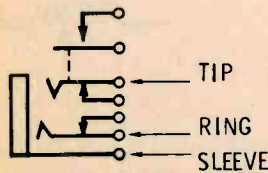

18.6.4 Three-conductor plug.



18.8 Connectors of the type commonly used for power-supply purposes (convenience outlets and mating connectors).

18.8.1 Female contact.

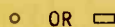

18.8.2 Male contact.

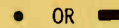

18.8.3 Two-conductor nonpolarized connector with female contacts.



18.8.4 Two-conductor nonpolarized connector with male contacts.



18.8.5 Two-conductor polarized connector with female contacts.



18.8.6 Two-conductor polarized connector with male contacts.

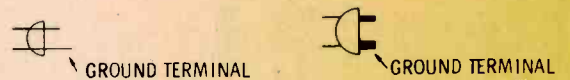

18.9.1 Phono-type connector plug.



18.9.2 Phono-type jack.



18.9.3 Wire end of female socket (cap).

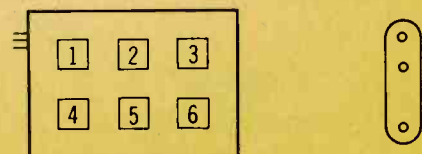

18.9.4 Pin end of male plug.

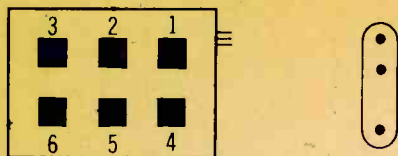

25. Core

25.1 General or air core

If it is necessary to identify an air core, a note should appear adjacent to the symbol of the inductor or transformer.

25.1.2 Adjustable core.



25.2.1 Laminated core.



25.2.2 Powdered-iron core.



25.3 Core of electromagnet.



31. Delay line.



36. Fuse.

36.1 General.



36.2 Special types



FUSIBLE RESISTOR

\* Indicate type by note: e. g., wire, link, etc.

42. Inductor.

42.1 General

Use symbols as shown unless otherwise indicated or required by special considerations.

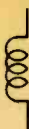

42.2 If it is desired especially to distinguish magnetic-core inductors:



42.3 Tapped, air core.

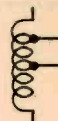

42.4 Adjustable inductor; arrowhead points in direction of adjustment location. Bottom of coil is at mounted end.

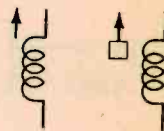

42.4.1 Adjustable inductor, air-core; arrowhead indicates movable tap. Unless noted, coil mounting end not specified.



42.7 Saturable-core inductor (reactor).

Polarity marks may be added to direct-current winding. Explanatory words and arrow are not part of the symbol shown.

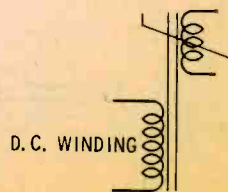

44. Lamp.

44.1 Ballast lamp (tube)

The primary characteristic of the element within the circle is designed to vary nonlinearly with the temperature of the element.





44.2 Lamp, fluorescent.



44.3 Lamp: glow, cold-cathode, neon.



44.4 Lamp, incandescent.



46. Machine, rotating.

46.2 Generator.



46.3 Motor.



46.12.1 Alternating current reversible motor.

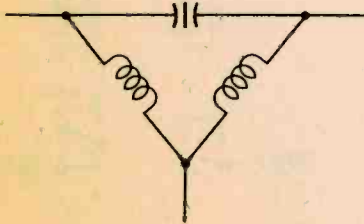

46.12.2 Alternating-current clock motor with time switch.

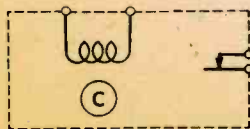

46.12.3 Phono motor.

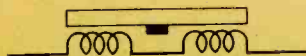

48. Meter—instrument.

Note—The asterisk is not a part of the symbol. Always replace the asterisk by one of the following letter combinations, depending on the function of the meter or instrument, unless some other identification is provided in the circle and explained on the diagram.

DB or DBM	DB (decibel) meter
MA	Milliammeter
O	Ohmmeter
R	Recording meter
T	Tuning meter
V	Voltmeter
VOM	Voltohmmer
VTVM	Vacuum tube voltmeter
VU	Volume indicator, audio level meter
W	Wattmeter



51. Microphone.

51.1 Ultrasonic microphone or transducer.

\* Indicate type by note: ceramic, crystal, dynamic, etc.

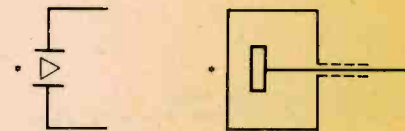

51.2 Audio-frequency microphone.

\* Indicate type by note.



56. Oscillator, signal generator, or unspecified alternating-current source.



58. Wiring.

58.5 Crossing of paths or conductors not connected. The crossing is not necessarily at a 90° angle.



58.6.2 Junction of connected paths, conductors, or wires.



58.8.1 Shielded single conductor.

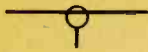

58.8.3 Two-conductor cable.

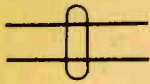

58.8.4 Shielded two-conductor cable, shield grounded.



61. Pickup head.

61.1 General.



61.2 Magnetic recording head.

\* Indicate by letter: RECORD, PLAYBACK, ERASE.



61.6 Stereo pickup.

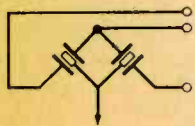

62. Piezoelectric unit.

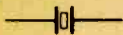

64. Receiver-earphone. headphone.

64.2 Headset. double.



64.3 Headset, single.



65. Rectifier, semiconductor.

65.1 General.

Note: Triangle points in direction of forward (easy) current as indicated by a DC ammeter, unless otherwise noted adjacent to the symbol. Electron flow is in the opposite direction.

65.2 Semiconductor rectifier.



65.2.2 Silicon controlled rectifier (SCR).

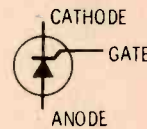

66. Relay.

Fundamental symbols for contacts, mechanical connections, coils, etc., are the basis of relay symbols and should be used to represent relays on complete diagrams.

66.2 Relay coil.



66.3 Relay contacts.

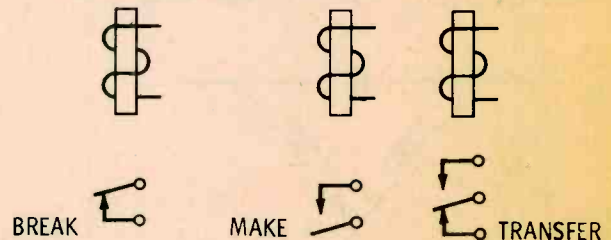

68. Resistor.

68.1 General.



68.2 Tapped resistor

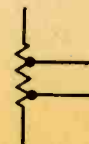

68.3 With adjustable contact.

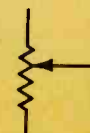



68.8.1 Symmetrical varistor, voltage-sensitive resistor, etc.

\* Indicate variable by letter  
 V voltage  
 I current  
 L light  
 T temperature



75. Speaker.



ELECTROSTATIC SPEAKER

73. Semiconductor devices.

73.9.1 Semiconductor diode.



73.9.2 Capacitive diode.



73.9.3 Breakdown (Zener) diode.



73.9.5 Tunnel diode.



73.10.1 PNP transistor.

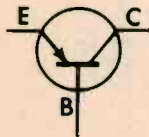

73.10.1.1 Transistor element connected to envelope.



73.10.2 NPN transistor.

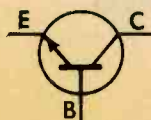

73.10.3 Unijunction transistor.



76. Switch.

Fundamental symbols for contacts, mechanical connections, etc., may be used for switch symbols. The standard method of showing switches is in a position with no operating force applied. For switches that may be in two or more positions and for switches that may be operated by some mechanical device, clarifying notes may be necessary to explain position shown and position at which actuation starts.

76.1 Single throw, general.



76.2 Double throw, general.



76.2.1 Two-pole, double-throw switch.



76.6 Push button.

76.6.1 Circuit closing (make).



76.6.2 Circuit opening (break).



76.6.3 Two circuit (transfer).



76.12 Selector or multiposition switch.

76.12.1 General.

BREAK  
BEFORE  
MAKE

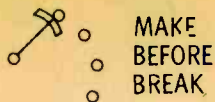

76.12.4 Segmental contact.

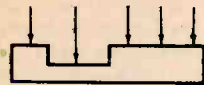
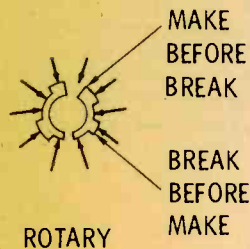

SLIDE

79. Test point, recognition symbol.

79.1 General.

Used to emphasize test-point location.



79.2.1 Test-point recognition for test jack and circuit terminal.

\* Reference designation. Not part of symbol.

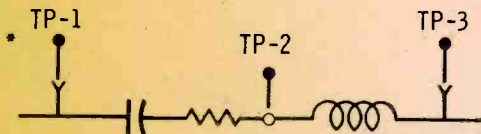

84. Thermistor.

"T" indicates that the primary characteristic of the element within the circuit is a function of temperature.

84.1 General.



86. Transformer.

86.1 General.



86.2 Magnetic-core transformer.

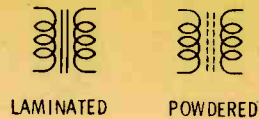

86.2.1 Shielded transformer.

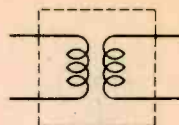

86.2.2 Transformer with magnetic core and shield.

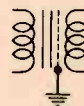

86.3 One winding with adjustable inductance.

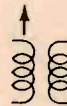

86.4 Each winding with separately adjustable inductance.

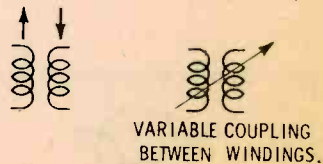

86.6 With taps, single phase.

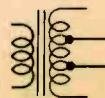

86.7 Autotransformer, single phase.



# COMPLETE TUNER OVERHAUL

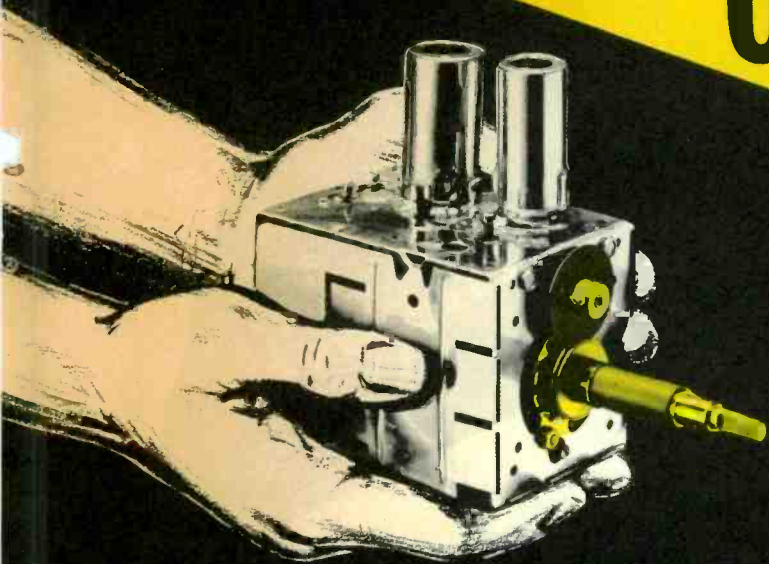

ALL MAKES — ONE PRICE

ALL LABOR  
AND PARTS  
(EXCEPT TUBES  
& TRANSISTORS)

**9.95**



VHF

UHF

COLOR

U-V

TRANSISTOR

## COLOR TUNERS



GUARANTEED COLOR  
ALIGNMENT — NO  
ADDITIONAL CHARGE

3.58

Simply send us the defective tuner complete; include tubes, shield cover and any damaged parts with model number and complaint. Your tuner will be expertly overhauled and returned promptly, performance restored, aligned to original standards and warranted for 90 days.

UV combination tuner must be single chassis type; dismantle tandem UHF and VHF tuners and send in the defective unit only.

Exact Replacements are available for tuners unfit for overhaul. As low as \$12.95 exchange. (Replacements are new or rebuilt.)

And remember—for over a decade Castle has been the leader in this specialized field . . . your assurance of the best in TV tuner overhauling.



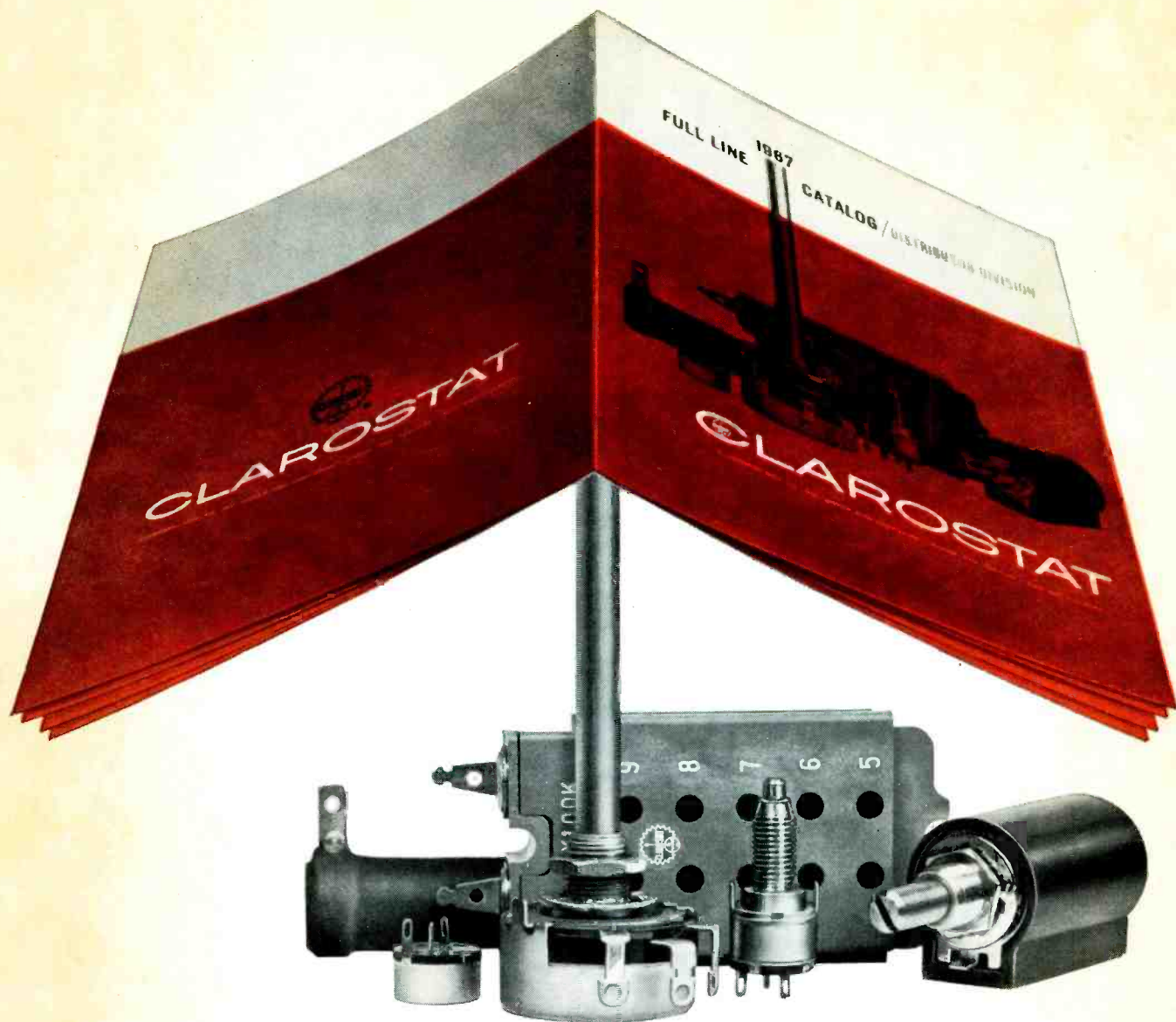

## COVERING ALL YOUR INDUSTRIAL / SERVICE REPLACEMENT REQUIREMENTS IN ONE CATALOG

Here is your own private warehouse in print—the new 1967 FULL LINE CLAROSTAT CATALOG of distributor products. Between its pages, you'll find everything you need to meet replacement and original equipment requirements with appropriate technical and application data.

At a glance, you can quickly select quality resistors, potentiometers and switches to meet every customer need. The full line of industrial, service and military components is available to you on an off-the-shelf, immediate delivery program through your local Clarostat distributor.

Ask him for a free copy of the new 1967 FULL LINE CLAROSTAT CATALOG, or write directly to

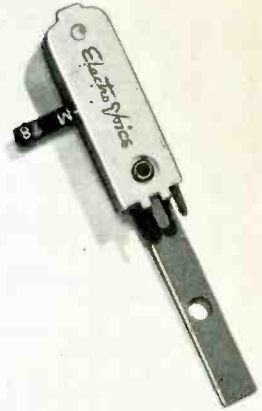
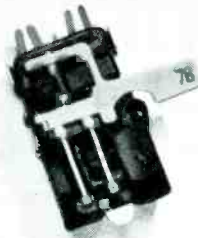
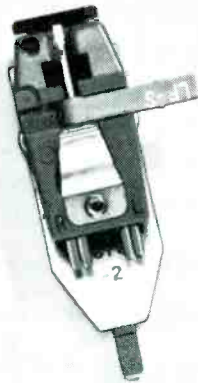
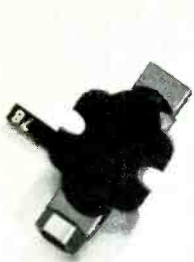

# How long was your distributor out of stock after these new cartridges were introduced?

It isn't easy to keep up with the many new phono cartridges being introduced these days. And if your distributor doesn't order until you ask for them — you're in trouble. After all, a delay of more than 24 hours can cost you plenty in customer goodwill — perhaps even a sale.

But that problem is eliminated when you deal with an Electro-Voice distributor.

Here's how. He can place a standing order with us. We ship every new model to him *automatically*, as soon as it comes out. He doesn't wait for an order, and neither do we.

This way, the new models are waiting for you *before* you need them. It's good business to see your E-V distributor — he's first with everything in needles and cartridges.

**Electro-Voice**®

The modern complete line of replacement phono cartridges

ELECTRO-VOICE, INC., Dept. 117R, 632 Cecil Street, Buchanan, Michigan 49107

Circle 4 on literature card

January, 1967 / PF REPORTER 11

# PF Reporter™

PHOTOFACT

the magazine of electronic servicing

VOLUME 17, No. 1

JANUARY, 1967

## CONTENTS

<b>Symbol Standardization</b>	<b>1</b>
A list of standard electronic symbols approved by the Electronics Industries Association	
<b>The Electronic Scanner</b>	<b>15</b>
<b>Intermittent and Time Lapse Sync Troubles</b>	<b>17</b>
Allan F. Kinckiner Case histories reveal causes and effective troubleshooting procedures.	
<b>Removing the Barber Pole</b>	<b>22</b>
Robert F. Heaton An understanding of circuit functions and symptoms, together with a systematic isolation procedure, quickly solves color sync failures.	
<b>The Case of the Bifilar Balun</b>	<b>24</b>
Jack Darr Rewinding solves the problem of no replacement.	
<b>Depreciation Reserves For Equipment</b>	<b>26</b>
Ralph H. Butz An introduction to the various methods of computing depreciation on test equipment, service vehicles, and other forms of tangible assets.	
<b>Ohm's Law For AC</b>	<b>28</b>
Robert G. Middleton A review of AC circuits involving Ohm's law, Pythagorean formula, power factor, and component characteristics.	
<b>Book Review</b>	<b>37</b>
<b>Notes on Test Equipment</b>	<b>38</b>
T. T. Jones Lab reports on Mercury Model 2000 Tube Tester and RCA Model WR-50B RF Signal Generator.	
<b>Symfact: Multiplex Amplifier and Doubler</b>	<b>41</b>
Operation and trouble analysis.	
<b>Industrial Electronics Notebook—Part I</b>	<b>45</b>
Ed Bukstein Becoming familiar with electronic circuit applications in industry.	
<b>The Troubleshooter</b>	<b>57</b>
<b>Product Report</b>	<b>61</b>
<b>Color Countermeasures</b>	<b>68</b>
<b>Free Catalog and Literature Service</b>	<b>72</b>
<b>Monthly Index on Free Literature Card</b>	

**publisher**  
Howard W. Sams

**general manager**  
Donald W. Bradley

**editor**  
William E. Burke

**managing editor**  
James M. Moore

**associate editors**  
Thomas T. Jones  
J. W. Phipps

**consulting editors**  
Joe A. Groves  
C. P. Oliphant

**research librarian**  
Bonny Howland

**production manager**  
Esther M. Rainey

**circulation manager**  
Pat Osborne

**art directors**  
Louis J. Bos, Jr. & Robert W. Reed

**photography**  
Paul Cornelius, Jr.

**advertising sales offices**  
Hugh Wallace, advertising sales manager

**central and midwestern**  
Roy Henry

Howard W. Sams & Co., Inc., 4300 West 62nd St.,  
Indianapolis, Ind., 46206

291-3100

**eastern**  
Gregory C. Masfield

Howard W. Sams & Co., Inc., 3 West 57th St.,  
New York 19, New York

MU 8-6350

**southwestern**  
C. H. (Jake) Stockwell

C. H. Stockwell Co., 4916 West 64th St.,  
Mission, Kansas, RA 2-4417

**western**  
Los Angeles Office

G. R. (Jerry) Holtz

The Maurice A. Kimball Co., Inc.  
2008 West Carson St., Suites 203-204

Torrance, Calif., 90501  
320-2204

**San Francisco Office**  
The Maurice A. Kimball Co., Inc.

580 Market St., Room 400  
San Francisco 4, California

EX 2-3365

Address all correspondence to PF REPORTER,  
4300 W. 62nd Street, Indianapolis, Indiana 46206



Copyright © 1967 by Howard W. Sams & Co., Inc.  
PF REPORTER is a trademark of Howard W. Sams & Co., Inc. No part of PF REPORTER may be reproduced without written permission. No patent liability is assumed with respect to use of information herein. Acceptance of advertising does not in any manner signify the products, policies and services so advertised have been approved, endorsed or recommended by this magazine.

Subscription Prices: 1 year—\$5.00, 2 years—\$8.00,  
3 years—\$10.00, in the U. S. A., its possessions and Canada.  
All other foreign countries: 1 year—\$6.00, 2 years—  
\$10.00, 3 years—\$13.00. Single copy 75¢, back copies \$1.

Indexed in Lectrodex.  
Printed by the Walaemar Press Div.  
of Howard W. Sams & Co., Inc.

### About the Cover

The technician with the frown is evidently having a bit of trouble "removing the barber pole". He won't get rid of it with that channel selector knob. We'll bet, however, that he'll never again have difficulties with chroma sync after reading the article starting on page 22.





# Did you ever...

... lift a wire-lead component from a printed wiring board for testing ?

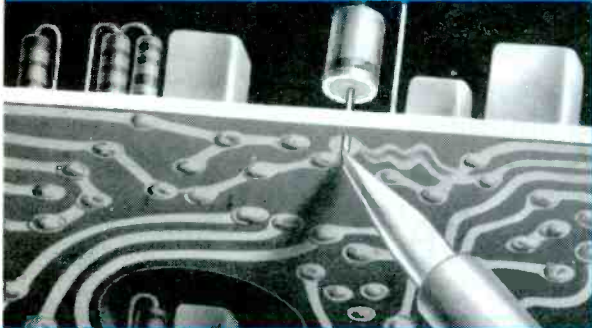

... test or replace a capacitor or resistor on a crowded tube socket ?

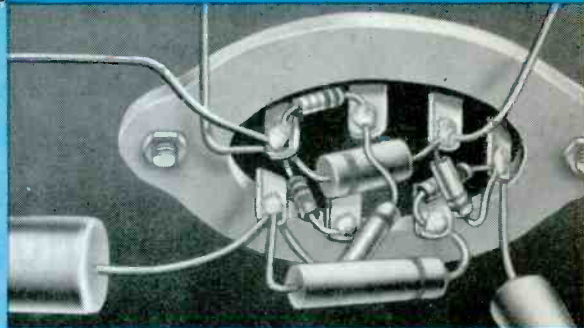

## CUT YOUR TIME IN HALF with **KWIKETTE\*** Soldering Aids ... the revolutionary

connectors that practically let you do "in-circuit" component testing!



(six times actual size)

The KWIKETTE SOLDERING AID is not just another wire spring connector! It has a Copperweld wire inner core, an intermediate layer of flux, and an outer jacket of solder . . . all you need is heat!

WIRE FLUX SOLDER

KWIKETTES are now included with ALL Sprague pre-packaged wire-lead service-type capacitors *at no extra cost to you!* Whenever you need replacements, insist on Sprague Capacitors from your parts distributor and you'll automatically get your KWIKETTE component connectors . . . the biggest boon to the service technician since the soldering gun!

### FREE TRIAL PACKAGE!

10 free KWIKETTE Soldering Aids are yours for the asking! Simply send your postcard request to KWIKETTE Center, Sprague Products Co., 105 Marshall Street, North Adams, Mass. 01247. Don't forget to include the name of your Sprague Distributor.

\* trademark

SNIP LEAD ...

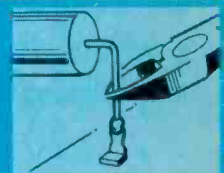

TEST ...

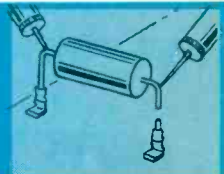

SLIP ON KWIKETTE ...

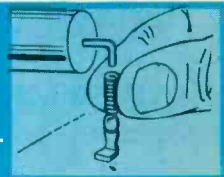

APPLY HEAT!

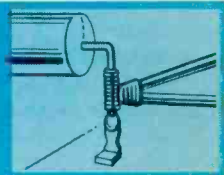

**SPRAGUE**<sup>®</sup>  
THE MARK OF RELIABILITY

WORLD'S LARGEST MANUFACTURER OF CAPACITORS

Circle 5 on literature card

65-6102P1

# WHY risk your reputation with "just-as-good" capacitors?

When you pay little or no attention to quality in tubular replacement capacitors, you leave yourself wide open for criticism of your work . . . you risk your reputation . . . you stand to lose customers. It just doesn't pay to take a chance on capacitors with unknown or debatable performance records when it's so easy to get guaranteed dependable tubulars from your Sprague distributor!

## There's no "maybe" with these 2 great **SPRAGUE DIFILM<sup>®</sup> TUBULARS!**

The ultimate in tubular capacitor construction. Dual dielectric . . . polyester film and special capacitor tissue . . . combines the best features of both. Impregnated with HCX<sup>®</sup>, an exclusive Sprague synthetic hydrocarbon material which fills every void in the paper, every pinhole in the plastic film *before it solidifies*, resulting in a rock-hard capacitor section . . . there's no oil to leak, no wax to drip. Designed for 105°C (220°F) operation without voltage derating.



**DIFILM<sup>®</sup> BLACK BEAUTY<sup>®</sup>**  
Molded Tubular Capacitors

The world's most humidity-resistant molded capacitors. Tough, protective outer case of non-flammable molded phenolic . . . cannot be damaged in handling or installation. Black Beauty Capacitors will withstand the hottest temperatures to be found in any TV or radio set, even in the most humid climates.



**DIFILM<sup>®</sup> ORANGE DROP<sup>®</sup>**  
Dipped Tubular Capacitors

A "must" for applications where only radial-lead capacitors will fit . . . the perfect replacement for dipped capacitors now used in many leading TV sets. Double-dipped in rugged epoxy resin for positive protection against extreme heat and humidity. No other dipped tubular capacitor can match Sprague Orange Drops!

For complete listings, get your copy of Catalog C-617 from your Sprague distributor, or write to Sprague Products Company, 105 Marshall Street, North Adams, Massachusetts 01247



WORLD'S LARGEST MANUFACTURER OF CAPACITORS





# The Electronic Scanner

news of the servicing industry

## Potpourri

The **Electronics Industries Association's** Citizens Band Section recently endorsed the efforts of the Federal Communications Commission in combating violations in Citizens Band Radio operations, and pledged full cooperation in aiding the FCC to solve the "growing problem of enforcement in the administration of Citizens Band operations."

It pledged an "affirmative approach" to the potential user in advertising and through distribution of "dos and don'ts" literature to purchasers of CB equipment, and encouragement of salesmen to provide guidance in the proper use of the equipment.

A nationwide program to support servicing retailers has now been set into operation by **Motorola Consumer Products**. A "Technical Training Rep." force of 50 men is now strategically located across the nation to train Motorola dealers and service companies so that they, in turn, will be better equipped to provide customer service. The territorial assignments are based on population density with an additional training task force of four men operating out of Chicago.

The "Technical Training Representatives" offer personalized, upgrading training sessions for consumer electronic service technicians in their place of business, with scheduling arranged by regional service managers. These individualized training sessions are scheduled for one full day or more.

S. R. "Ted" Herkes, president of Motorola Consumer Products, observed that the industry is "on the eve of the greatest technological advancement since the advent of television and the world ahead will be a solid-state world." Consumer electronic technicians must be trained to be ready to handle the products of this new era, he added.

Once trained in solid-state products, perhaps servicing dealers will rightfully gain some deserved recognition for their knowledge and investment and the essential role they perform, Herkes added.

**Muntz TV** has announced plans to change its name on January 1, 1967 to Television Manufacturers of America Co. The company explained to stockholders that the changing nature of the firm's business now calls for a more fitting name and identity. A substantial share of the company's sales now results from production of television and stereo brands other than the Muntz brand, including private label television sets. However, sale of Muntz brand television sets and stereo units will continue.



## "My shop's been loaded... since I got my FCC License."

"And I could kick myself for not getting it sooner. I'm pulling in all kinds of mobile, marine and CB business that I couldn't touch before; have even had some calls to work on closed-circuit television. I've hired two new men to help out and even with them, I'm two weeks behind."

And so it goes. Once you have that FCC ticket, you open the door to all kinds of new business. And that's not all. The knowledge you need to pass the FCC exam gives you a fundamental understanding of *all* electronics. You'll find you can do more work in less time...work on almost *any* kind of electronics gear.

What's the best way to get a Commercial FCC License...and still keep up with your work? Thousands of men will tell you "Cleveland Institute of Electronics." CIE has been preparing men for FCC License exams since 1934. What's more, they back their Home Study Licensing Programs with this remarkable money-back offer:

**A CIE FCC License course will quickly prepare you for a Commercial FCC License. If you fail to pass the FCC examination ...on the very first try...after completing your course, CIE will refund all your tuition. You get an FCC License...or your money back!**

And only CIE offers you new, up-to-the-minute lessons in all these subjects: Logical Troubleshooting, Laser Theory and Application, Micro-miniaturization, Single Sideband Technique, Pulse Theory and Application, Boolean Algebra, and many more.

Send coupon today for CIE's FREE informative book "HOW TO GET A COMMERCIAL FCC LICENSE." Cleveland Institute of Electronics, Dept. PF-33, 1776 East 17th Street, Cleveland, Ohio 44114.

**ENROLL UNDER NEW G.I. BILL.** All CIE courses are available under the new G.I. Bill. If you served on active duty since January 31, 1955, OR are in service now, check box in coupon for G.I. Bill information.

**MAIL COUPON TODAY FOR FREE BOOK**

**CIE** Cleveland Institute of Electronics  
1776 East 17th Street, Cleveland, Ohio 44114

Please send FREE book, "How To Get A Commercial FCC License."

Name \_\_\_\_\_ (please print)

Address \_\_\_\_\_

City \_\_\_\_\_ State \_\_\_\_\_ Zip \_\_\_\_\_

Occupation \_\_\_\_\_ Age \_\_\_\_\_

**Check here for G.I. Bill information**

Accredited Member National Home Study Council  
A Leader in Electronics Training... Since 1934 PF-33





Sales of FM radios will soar to new highs in 1967, according to a specialist in the radio receiver field. William B. Keepin, manager of the **Norelco** radio department of North American Philips, predicts sales of close to 12 million FM sets during the coming year—a 20% gain over 1966 estimated sales of nearly 10 million units. Currently this country's radio-listening public owns about 34 million FM receivers.

### Expansions

A three-year \$20 million program to expand the development and manufacture of semiconductor products was announced by **ITT Semiconductors Worldwide**. The \$20 million expenditure will be divided approximately 50% in the United States and 50% overseas. Included in the program will be the updating of semiconductor facilities in Lawrence, Mass. and Palo Alto, Calif., and a \$5.3 million expansion of the present West Palm Beach semiconductor manufacturing plant.

**Electrohome** of Canada recently opened its new \$4,-000,000 cabinet plant in Kitchener, Ontario.

The entire 450,000 square foot plant houses computerized and automated production systems for precision cabinet design. Electrohome's 500 craftsmen now work with electronic woodworking devices that enable one worker to perform ten operations within minutes.

With the opening of the new plant, skilled technicians and modern machines can now deliver a completed TV, Stereo, or Hi-Fi cabinet every 30 seconds.

An appropriation of approximately \$2 million for an immediate expansion of compactron facilities has been approved by the board of directors of **General Electric**. According to I. D. Daniels, Manager of Manufacturing for the Tube Department, "Compactrons should start coming off the first additional compactron production lines by January 1967, and all lines are scheduled to be in full production during the second half of the year."

### Sales

Record third quarter and nine month sales and a sharp increase in earnings were reported by **Admiral Corporation**. Consolidated sales in the third quarter were \$110,425,383, 58% higher than 1965 sales of \$69,826,396, and were also a record for any quarter. Earnings after taxes increased 95% to \$2,270,356, up from \$1,163,378 last year.

President Vincent Barreca said that substantial expenses in connection with major moves of military and consumer product manufacturing facilities and their related start-up costs were charged off during the third quarter, and the earnings for the 9-month period were 139% above last year.

• Please turn to page 70

# FAMOUS ZENITH QUALITY TUBES for greater reliability, longer life



### TV Picture Tubes

A complete line of more than 200 top-quality tubes. For color, black-and-white, or special purposes.

Zenith black & white replacement picture tubes are made only from new parts and materials except for the glass envelope in some tubes which, prior to reuse, is inspected and tested to the same high standards as a new envelope. In Color tubes the screen, aperture mask assembly and envelope are inspected and tested to meet Zenith's high quality standards prior to reuse. All electron guns are new.

### "Royal Crest" Circuit Tubes

A full line of more than 875 tubes . . . the same quality tubes as original Zenith equipment. Your assurance of the world's finest performance.

Order all genuine Zenith replacement parts and accessories from your Zenith distributor.



BUILT TO THE QUALITY STANDARDS OF ZENITH ORIGINAL PARTS

**ZENITH**

The quality goes in before the name goes on®

Circle 8 on literature card

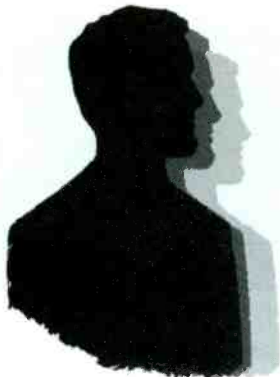

## Intermittent and Time Lapse Sync Troubles

by Allen Kinckner

Intermittent sync troubles, like most intermittent troubles, are often due to loose connections, unwanted contacts between wiring or components, or mechanically damaged components. It is perfectly normal for these conditions to occur.

In some receivers made between 1950 and 1955 terminal strips are fastened by soldering the mounting legs of the strips to lances punched in the chassis. As these sets became older, soldering operations on the wiring end of the mounting-leg terminal affected the soldering mounting and sometimes introduced cold joints. Another manufacturer used hollow sleeves riveted to the chassis for ground connections. The hollow sleeves were actually elongated hollow rivets; however, they were fragile, and the pressure necessary for metal-to-metal bonding resulted in slightly resistive connections. Vir-

tually every set maker has used tube-socket mounting rivets that served as ground contacts; the fiber shrank with age, the rivet became loose, and, again, a resistive connection resulted.

These conditions affect many phases of receiver operation and have continually plagued experienced servicemen. The most exasperating cases are those where picture stability is affected by a resistive connection that introduces distortion to the sync signal. One of the doggiest cases I can remember involved a Westinghouse Chassis V-2233-4. It had intermittent horizontal quivers, sometimes slight, sometimes more severe, and sometimes a complete tearout. Signals fed to the AFC tube, both the sync and the sample, looked normal when viewed at one-half horizontal frequency, but when the same signals were scoped at one-half vertical fre-

quency, a 60-cps hum was readily noted. The trouble was pinpointed to a resistive solder connection on the lance that mounted a terminal strip and also served as a ground for various components in the AFC circuit. Two mysteries surrounded this case: The bad connection also served as a ground for the vertical-output tube filament, but vertical deflection was not affected. The hum at varying levels was present at all times, but the trouble was intermittent. This last point, steady signal distortion but intermittent effect, is one of the imponderables encountered in servicing intermittent sync troubles.

### Localizing Source of Trouble

The general practice in scoping is on a stage-to-stage basis. In scoping sync systems, especially those with more than one stage, it is best to first scope the input signal and

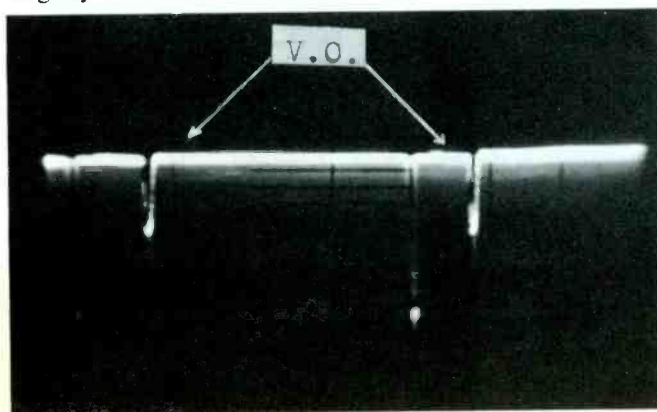

(A) V.O.—Vertical-oscillator pulse

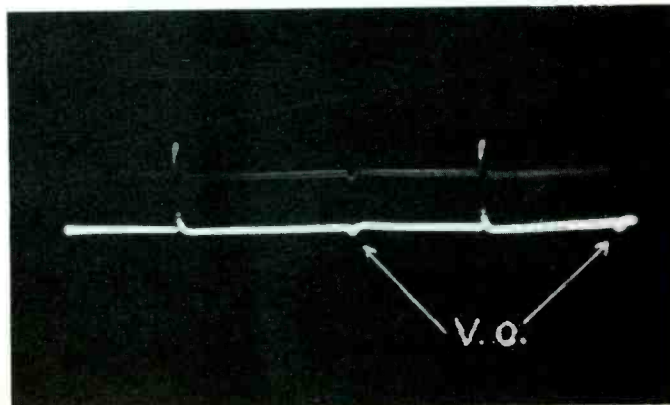

(B) Feedback pulse negative

Fig. 1. Oscillator pulse feeds back to sync output if integrator output is okay.



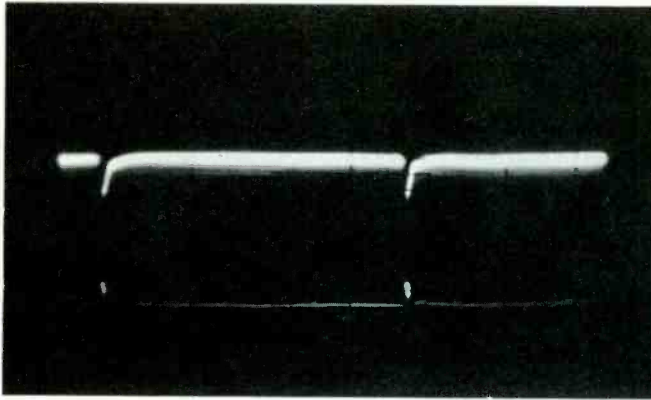

(A) Perfect sync signal

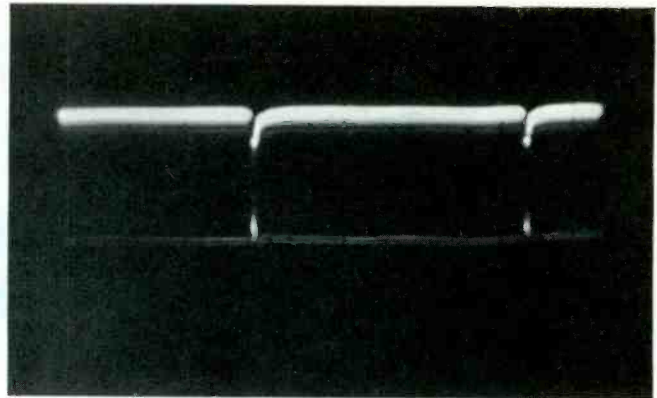

(B) Average sync pulse

Fig. 2. Perfect sync signal has even tip level, average signal is uneven.

then move to the output of the final stage. This procedure has several advantages. If trouble is originating within the sync system, it will show up as adequate or distorted sync signals. A normal sync signal indicates trouble in either the deflection oscillator, sync coupling capacitor, or vertical integrator. Condition of the integrator can be checked at the sync output. For example, if the sync pulse is getting through the integrator to the vertical oscillator, then the vertical oscillator signal will pass through the integrator and appear in the sync output as shown in Figs. 1A and 1B. These traces are best obtained by using line rather than internal sync for the scope.

A perfect sync signal, Fig. 2A, can only be obtained in receivers having some method of clipping the sync tips. The average sync signal is likely to be fuzzy at the tip level (Fig. 2B), indicating noise or variations in the tips of the horizontal sync. Both conditions are normal and are not representative of a fault that will affect picture synchronization. However, cases of poor syn-

chronization have been found when only a small amount of distortion was noticeable in the sync signal.

An RCA KCS68 had intermittent vertical sync and jitters. Sporadically the vertical-blanking bar would wander about half way down the raster (Fig. 3) then snap out of sight. Sometimes the picture would jitter slightly, or often it would lock perfectly. Scoping at the input grid of the vertical separator, pin 4 of V13 in Fig. 4, gave the normal trace in Fig. 5A. Moving the scope to the sync output, pin 5 of V15, showed the sync pulse was missing. Backtracking to the plate, pin 5 of V13, also revealed no sync signal. These conditions were noted when the vertical-blanking bar was wandering. During jitters, small sync signals were noted. When the picture was locked normally, W5B and W5C were found on the plates of V13 and V14, respectively. These waveforms indicated trouble in V13, but voltages on this tube didn't vary as the different troubles occurred. Probing around V13 revealed that the trouble was due to a loose connection of C75.

As was previously mentioned, a scope check of the sync output will indicate if signals are getting through the vertical integrator. You can check to see if sync is reaching the horizontal oscillator by scoping at the output side of the coupling capacitor. Sets using a synchoguide oscillator will display the signal shown in Fig. 6A. One case of infrequent horizontal tearout would not recur in the shop, even though the set was rack-checked for almost two days. Scoping the output side of the sync-coupling capacitor (which in synchoguides is the grid of the AFC stage) showed the crazy trace in Fig. 6B. The problem was caused by a defective filter capacitor. The interesting point is that the picture remained in sync even though the sync signal was greatly abnormal.

### Tube Tester Doesn't Always Tell

Even when intermittent sync trouble is caused by a tube, a cure is rarely possible on a service call. For example, if the trouble occurs at two- or three-minute intervals,

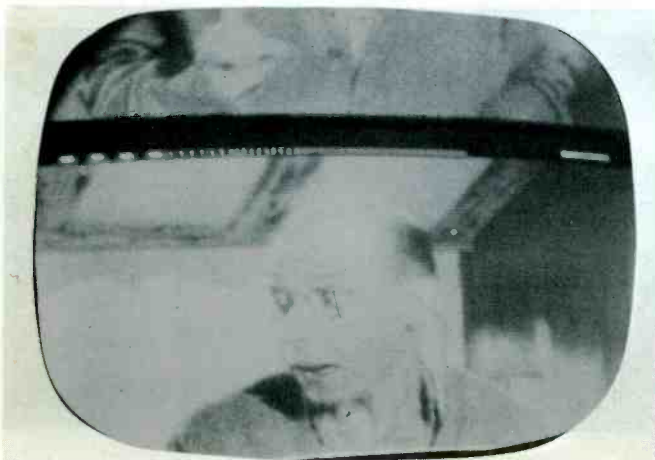

Fig. 3. Moving vertical-blanking bar.

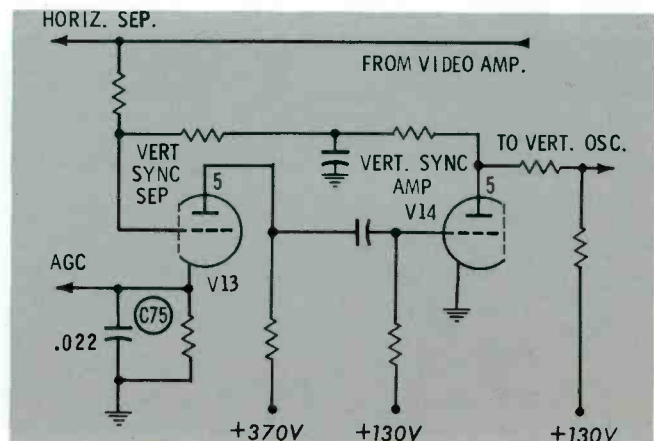
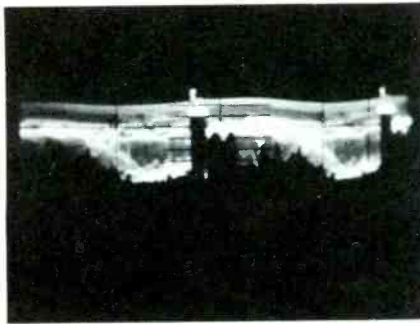
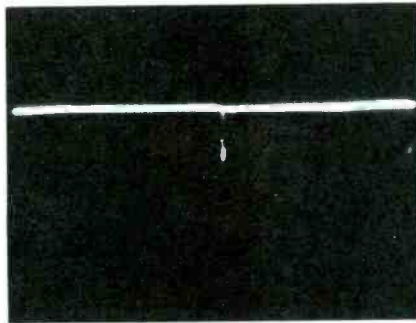

Fig. 4. Two-stage vertical-sync system found in RCA Chassis KCS68.





(A) Sync-separator input



(B) Sync-separator output

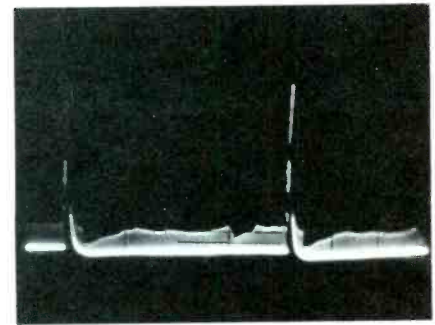

(C) Sync-amplifier output

Fig. 5. Appearances of the vertical-sync pulses taken at different points in the sync-separator circuit.

replacing the suspected tube(s) may result in normal operation only for the limited time allowed for house calls. In many instances, it will be found that the new tube(s) only increases the time between trouble appearances.

Intermittent rolling for short periods (about once or twice an hour) can really be a "dog" to locate. A fellow serviceman asked me to look at a Crosley 487 with this disease. I knew he was a thorough troubleshooter, one who substitutes all tubes, so I expected rough sailing. Once again the scope proved to be a time-saver. The sync-separator plate (the triode section of 6BA8) revealed the trace in Fig. 7A, but the grid of this tube showed a normal signal. The normal signal in Fig. 7B was obtained when the 6BA8 was substituted.

The defect in this 6BA8 is not revealed by a tube tester. The name of the trouble is *radiation*. The signal in the video-amplifier pentode

section radiates or couples into the triode section.

### Radiation

About two weeks after the incident with the Crosley, the same technician invited me to look at another set with the same infrequent rolling. My friend had already tried new tubes, and scope traces throughout the set were normal. With the LC probe on the separator plate, the normal signal distorted when I moved the set. As shown in Fig. 8, the vertical-sync pulses virtually disappeared. I made sure the probe contact was good, and then found that by flexing the chassis the trouble could be made to appear. The defect was eventually traced to a loose mounting screw holding the yoke.

An electrical analysis of the trouble revealed that with poor contact between the mounting strap and the yoke core a signal developed.

This signal was being picked up by the sync-separator grid. The high-impedance grid circuits of sync stages are prone to picking up radiation of unwanted signals originating in close proximity.

An RCA using a 6BU8 also presented a case of yoke radiation that caused intermittent vertical rolling. My first thought was that the recently replaced yoke was the cause. Then I noticed the replacement yoke had excessively long leads, and I remembered some instances in which lead length had caused trouble. The cure was to cut the leads down to about 5" so that they could not be too near the sync stage.

### Intermittents from Steady-State Defects

The level of the blackest picture signals in the composite video-sync signal is the primary factor explaining intermittent sync troubles when the sync or video systems have con-

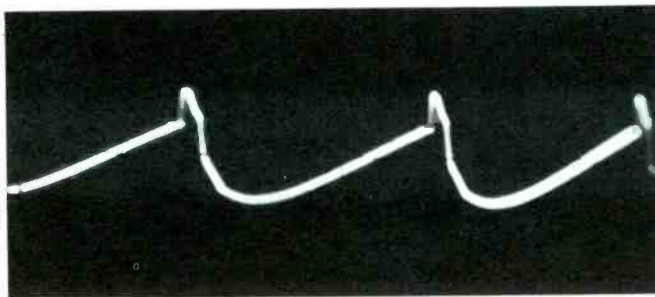

(A) Normal

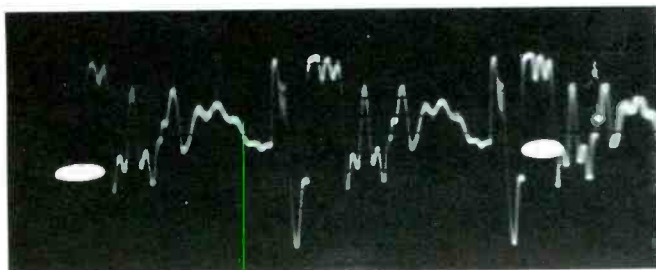

(B) Abnormal

Fig. 6. Waveforms obtained at grid of horizontal AFC.

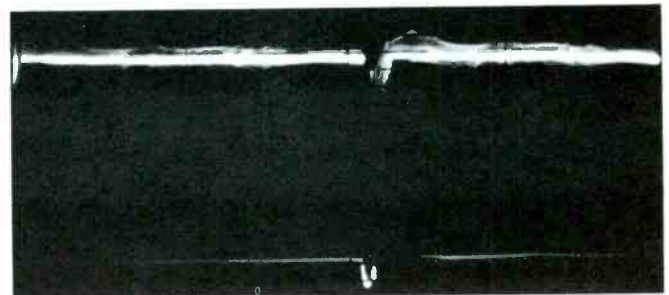

(A) Abnormal plate signal

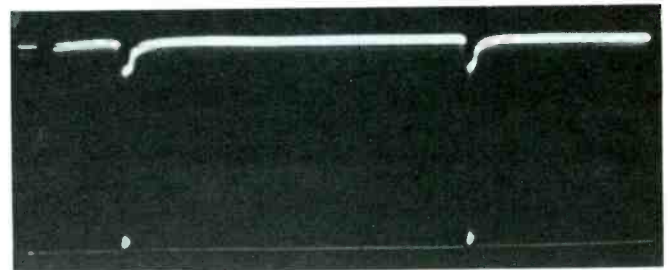

(B) Normal plate signal

Fig. 7. Trouble caused by 6BA8 tube.

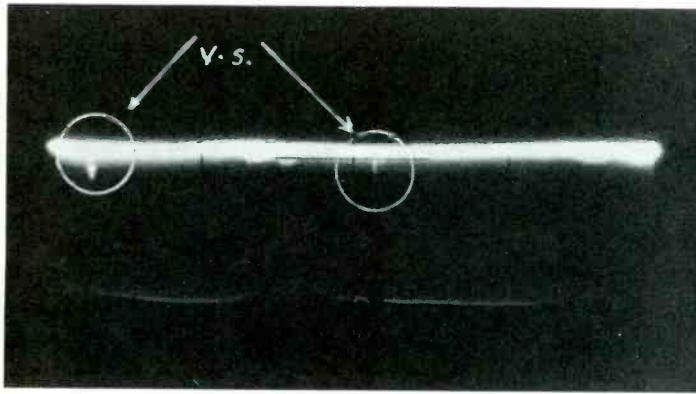

Fig. 8. Minute vertical-sync pulses.

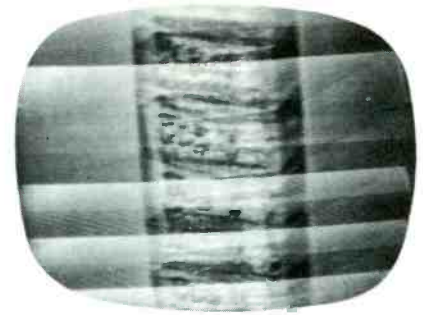

Fig. 10. Intermittent vertical sync.

stant defects. If the blackest picture signals are slightly below the blanking level (Fig. 9A), sync trouble will not result even though the video amplifier or the sync system has minor defects. However, when the blackest picture signals attain the blanking level, as they do during commercials or other high-contrast transmission (Fig. 9B), the high-level picture signals ride through the separator and precede the vertical sync pulse; vertical rolling or jitter results. Even when the separator is stripping below its proper level, the signals in Fig. 9A will be correctly synced, but the signals in Fig. 9B will result in a contaminated sync output (Fig. 9C). This contamination can cause horizontal sync trouble. Signal distortion in some video-amplifier pentodes produces intermittent sync when the com-

posite signal has high picture levels. With a normal composite-video signal, this same distortion has no effect.

Intermittent vertical flipping (Fig. 10) for short periods is frequently associated with steady distortion produced entirely within the video-amplifier stages. Figs. 11A, 11B, and 11C, found on the plates of 6BA8, 17BY7, and 6BH8, respectively, are some examples. The picture was steady when these signals were taken, but when the black picture signals reached the blanking level (Fig. 11D) the flipping burst occurred.

The conditions shown in Fig. 11 are limited to video-amplifier stages that are RC coupled to the video detector and thus have high input impedances. The effects of these distortions on the sync-separator

signals are widely variable. In some cases, the vertical-sync pulse groups are widened as in Fig. 7A; at other times, the dropout distortion shown in Fig. 12A takes place; and then again, the vertical sync may be attenuated as in Fig. 12B.

### More Video-Signal Distortion

Another class of intermittent vertical flipping with extremely critical sync has been traced to video-signal distortions. In one Motorola receiver, an open filter capacitor at the screen of a 12BY7 video amplifier caused the distortion shown in Fig. 13A. The condition in Fig. 13B was due to an open filter capacitor on the 150-volt line in an older Philco. An open filter capacitor on the B+ line produced the symptom in Fig. 13C in a Sears set. Notice that the sync-blanking levels and the

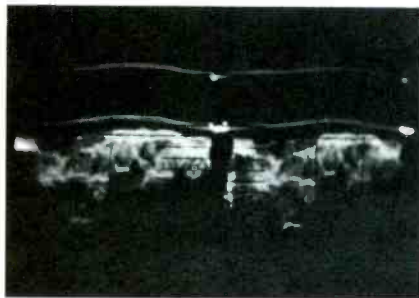

(A) No effect on sync

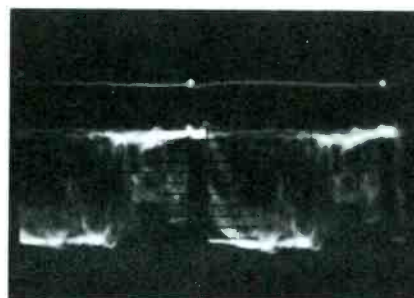

(B) Video in sync

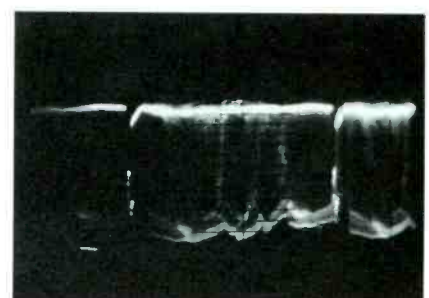

(C) Distorted sync pulses

Fig. 9. How composite signal can vary.

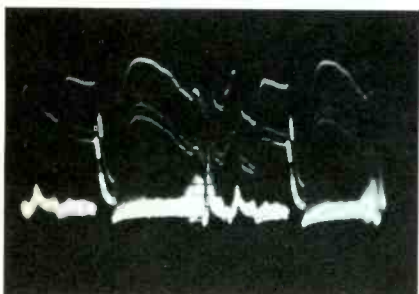

(A) Plate of 6BA8

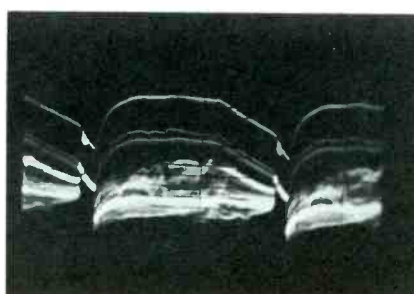

(B) Plate of 12BY7

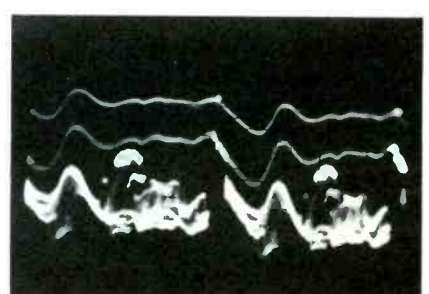

(C) Plate of 6AU8

Fig. 11. Distorted composite video.



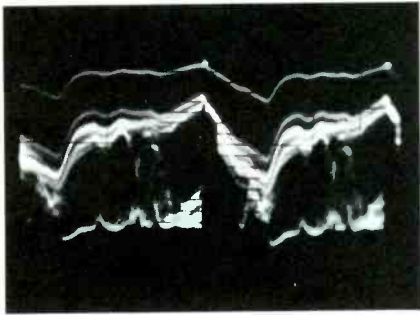

(D) Caused vertical roll

Fig. 11. Distorted composite video.

sync-tip levels do not contain an abnormal amount of ripple. The hash, or unwanted signal, directly on the bad capacitors is illustrated in Fig. 14A for the Motorola and Fig. 14B for the Philco (the Sears filter had a minimum amount of hash).

This form of distortion is low-frequency loss in the video signal. It is most evident in the portion of the composite video signal most closely associated with low frequency. Other forms of low-frequency troubles have been discussed in a previous PF REPORTER article on AGC filters.

#### Other Troubles

Other sync troubles are encoun-

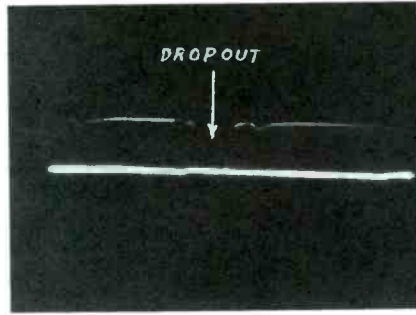

(A) Complete dropout

Fig. 12. Effect of distortion on sync.

tered frequently. One is the time-lapse sync trouble which occurs only after a normally operating receiver runs for a period of time. Since this trouble shows up virtually every time, it isn't precisely correct to consider it as an intermittent.

Another form of vertical instability is caused by the minute difference between the vertical-frequency rate in color and black and white. Since these troubles occur only in monochrome receivers during color reception, they are sometimes considered as intermittent troubles. This condition arises from interaction between the 60-Hertz power-line frequency and 59.94-Hertz vertical-sync frequency with color. This trouble is common in some designs

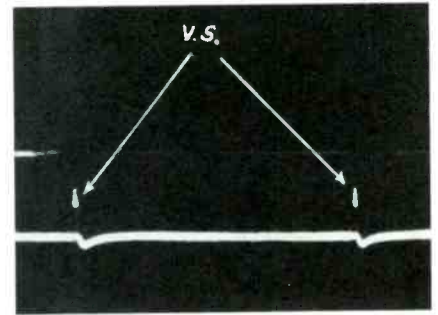

(B) Amplitude reduced

and has led to the issuance of a great many production-change bulletins by receiver makers.

#### Conclusion

The one point that cannot be emphasized too strongly in troubleshooting intermittent sync troubles is that here is a place to use an oscilloscope. Many intermittent sync troubles are due to defects that cause steady signal distortion. Remember, only a scope is capable of indicating the minute distortions that are responsible for the picture symptoms. The most critical examination may sometimes involve expanding the signal traces. The practice of examining video sync signals critically will pay off in time saved. ▲



(A) Motorola receiver

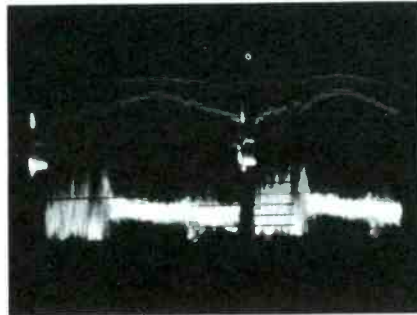

(B) Philco receiver



(C) Sears receiver

Fig. 13. Composite signal, sync low.

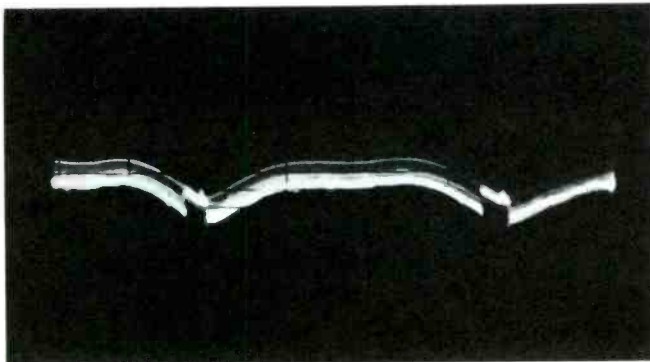

(A) In Motorola set

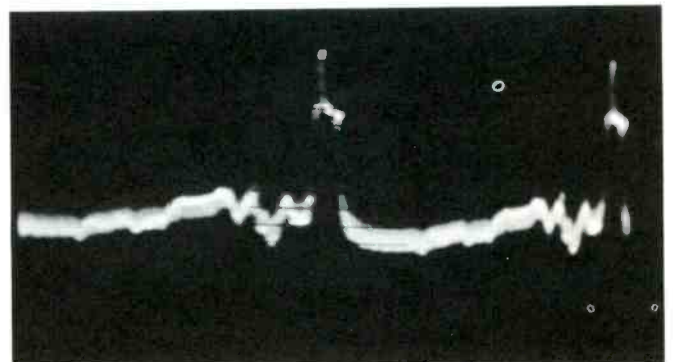

(B) In Philco set

Fig. 14. Signal on defective filter.



# REMOVING

# THE



# BARBER



# POLE

by Robert F. Heaton

In color television, removing the "barber pole" is slightly more difficult than removing the pole at a haircut shop. A loss of color sync often presents a challenge to the best service technicians. However, several factors can make the job a bit easier. Experience, of course, is most valuable in these circuits. Knowing how the circuit functions is even more valuable.

## Reactance Controlled Oscillator

The majority of color instruments presently in the field have similar color-sync stages. These circuits are centered around a reactance-controlled 3.58-MHz oscillator. Rapid repair of these stages follows naturally if: (1) the basic circuit functions are understood, (2) symptoms produced when color sync fails can be interpreted, and (3) a systematic procedure is developed to quickly isolate what circuit area is at fault.

The block diagram in Fig. 1 illustrates the most popular circuit configuration. The shaded blocks indicate those stages to concentrate on when failure of color sync causes multicolored stripes in the picture. To narrow our objective, let's assume the loss of color sync is a bench job; normal field service such as tube replacement has been to no avail. On the bench, we'll have readily available service data, color generator, scope, etc.

Color sync defects can be clas-

sified according to the results displayed on the screen. A complete loss of color sync—color bars on the screen, broken into a number of horizontal bands—is produced when the 3.58-MHz oscillator operates at the wrong frequency. Fig. 2 illustrates a small error; Fig. 3 shows a large frequency error.

Weak color sync is usually evidenced by good sync on strong signals. In other words, color sync is too critical. For example, sync slips out of lock when the fine tuning is only slightly mistuned from crossover; or color is locked on one station, out of sync on another. This problem, like weak horizontal sync in black-and-white circuitry, is perhaps the most difficult to solve. Successful troubleshooting often involves detailed circuit analysis using a scope and bar generator.

Incorrect colors, indicating improper phase relationships, may also be classified as color sync trouble. The color may be locked, but wrong hues are produced on the screen. This is because the tint control circuitry is generally located in the color sync section.

Other symptoms can be produced by failure in the 3.58-MHz oscillator circuitry. An inoperative oscillator causes a complete loss of color, for example. However, to narrow our thoughts, let's concentrate mainly on one of the three symptoms mentioned above—complete loss of sync.

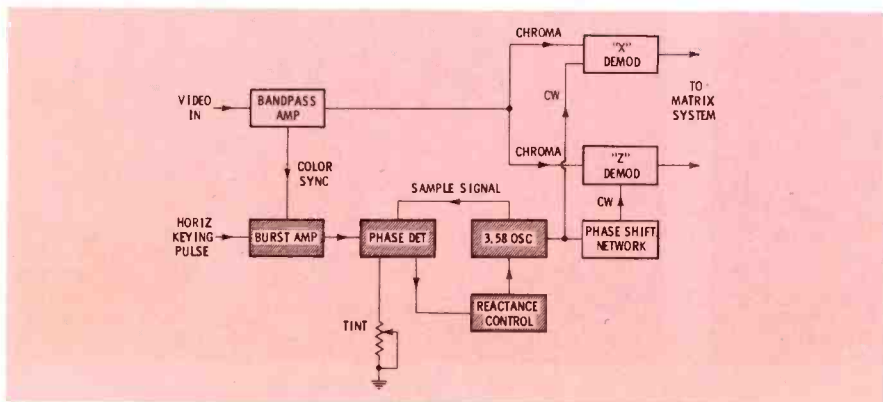

Fig. 1. Block diagram shows path of the burst signal.

Fig. 4 is a simplified breakdown of a phase detector/reactance controlled oscillator. Note the basic layout and learn to establish the major adjustments and operating particulars of this system. Then, regardless of the color instrument involved, a quick glance at the service schematic will show the key points for any similar circuitry.

Four major sections combine to form our sync system: the burst amplifier, phase detector, reactance control tube, and 3.58-MHz oscillator. In this closed loop system, the correct operation of the oscillator depends on correct operation of all four sections. Table I shows how these stages are similar to b-w stages.

## Complete Loss of Sync

The presence of fully saturated color on the screen, even though out of sync, helps pinpoint the defective stage. Our first suspicion—and first tests—should be in the reactance tube and oscillator circuits. The burst amplifier and phase detector are secondary choices.



Fig. 2. Keyed-rainbow pattern with a small color sync error.

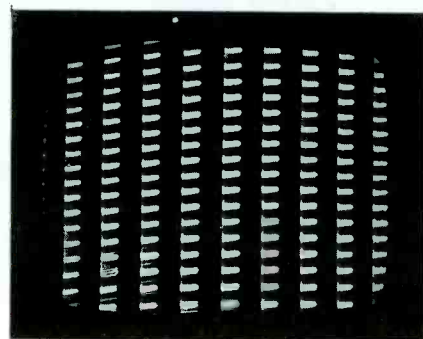

Fig. 3. Large sync error.

Here's the reasons:

1. High level color reaching the picture tube tells us the killer stage is cut off, permitting the bandpass stage to pass chroma to the color demodulators.

2. Killer cut-off voltage is obtained via circuits associated with the output of the burst amplifier, thus, separated color burst (sync) is probably reaching the phase detector. If sufficient burst were now present at the output of the amplifier stage, the result would be a no-color condition. It's a simple task to confirm our analysis.

#### Reactance-Oscillator Test

With a color bar signal applied, ground test point TP1 (using a short clip lead), and observe the screen pattern. This action virtually removes the burst amplifier and phase detector stages from influencing the frequency of the oscillator. As we'll see presently, the results of this simple test are two-fold; tying trouble to the reactance-oscillator or the burst-detector sections.

Grounding TP1 tells us if the

Table 1

Color Sync Stage	Similar B-w Stage
Burst Amp	Sync Sep.
Phase Det.	Horiz AFC Diodes
Reactance Tube	Horiz Osc Control
3.58-MHz Osc.	Horiz Osc.

3.58-MHz oscillator is capable of running at the correct frequency. Observe the screen for one of the following:

1. If the color bars become vertical (normally positioned) on the screen, become stationary, or slowly drift across the screen, then the oscillator and reactance stage are in good shape.

2. If the number of horizontal color bands (large frequency error, initially) decreases in number to three or four bands of solid colors, then the oscillator is probably okay; under these conditions, the initial loss of sync was not directly caused by the oscillator. Here, it's a good idea to make a slight adjustment of the oscillator frequency coil to

obtain "zero" beat — color bars slowly floating across the screen, setting the free running frequency as close to 3.58 MHz as possible.

3. If the color pattern remains out of sync when TP1 is grounded, then look for trouble directly in the reactance or oscillator stages. Voltage, resistance, and substitution tests will be necessary. Leave the test point grounded during trouble-shooting procedures, to keep the oscillator isolated from the other sections.

If color bars could be synced (results 1 or 2), then trouble is evident in the burst or phase detector stages. The following test helps to further isolate to a single stage.

Remove the clip lead from TP1; color sync will again be lost, because a defective phase detector or burst amplifier is causing a wrong correction voltage to be developed at the output of the phase detector (TP1). Under normal conditions, the phase detector has a balanced output (both diodes conduct equally) and the voltages at the junction of R1-R2 yield zero correction voltage. If an unbalanced condition develops, for any reason, the DC error voltage fed to the reactance tube pulls the oscillator off correct frequency, causing a loss of color sync. The amount of DC voltage error determines the frequency error of the oscillator.

The problem now is to determine which stage—burst amplifier or phase detector—is causing the error voltage to be developed. The next

test is to check the phase detector.

#### Phase Detector Test

Connect a short clip lead to the grid of the burst amplifier and ground. This action removes the incoming burst signal, permitting us to check the balance of the phase detector. Conduction of the detector diodes, under these conditions, is influenced only by the sample CW signal from the oscillator. Both diodes receive the same signal (anode and cathode tied together), and conduction of both diode sections should be equal, but opposite. Using your VTVM, perform the following:

1. At the output side of the phase detector, measure the anode and cathode voltages. If the voltages are equal and opposite the phase detector is balanced. Hence, the trouble probably exists in the burst amplifier circuit, which includes the secondary of the burst transformer T1.

2. If the voltages on the anode and cathode are unbalanced, the fault lies in the phase detector.

3. If the improper amount of equal voltage is developed, or if zero voltage is developed, check for loss of the sample signal from the oscillator. (The +28 and -28 voltages shown in Fig. 4 are typical with no burst input. For the correct values for any particular chassis the proper PHOTOFACT folder should be consulted. Possible causes of an unbalanced phase de-

• Please turn to page 53

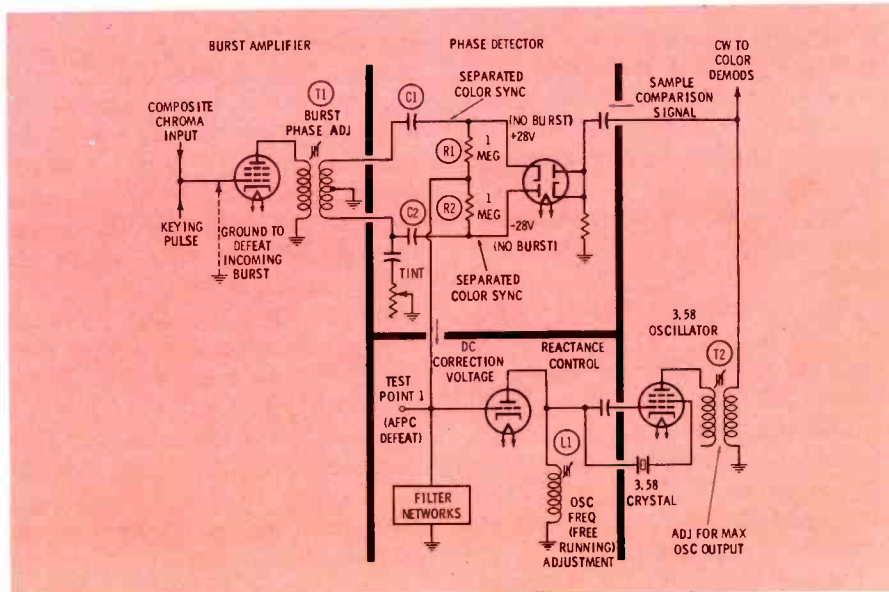

Fig. 4. Simplified schematic of chroma sync stages.



## THE CASE OF THE

# Bifilar Balun

by  
Jack Darr

The lightning flashed; the thunder roared; and my phone rang. "My TV set's out completely! No picture, just a lot of snow. I've got guests coming tonight to see a new show in color, and I want it fixed! Can you come right over?"

"Yes Ma'am!"

This was my best customer (a big antenna installation, one color and three b-w sets, stereo, and more stuff that you can shake a stick at). Besides this, she was a widow, and rich, and a very nice little old lady. Yes, ma'am; I'd be there.

It was a Zenith 25MC32 color chassis, and the picture was snowy; in fact, there was darn little picture at all. Remembering the storm, I asked "Was there a big flash of lightning around here this morning early?"

"Oh, my yes! I thought it'd break every window in the house. Terrible!"

Oh, oh. Take the back off and look at the tuner. Yep. There it was, or rather, there's where it used to be. The balun coil was a disaster area; little pieces of wire everywhere. Everywhere but where they ought to be. So, I pulled the tuner, and lit out for the shop (I love separate tuners!)

I called the distributor. Tragedy! No replacement coils, and none ex-

pected for a week! No replacement tuners, either, so I was desperate. I hung up and glared at it. Well, genius, don't just sit there looking stupid. Fix it!

Thank goodness, this wasn't one of those sub-miniature types buried deeper than a time capsule inside the tuner. I dug out the PHOTOFACT Folder (757-4) and looked at it. Didn't look too difficult (Fig. 1). There was enough left of it so that I could tell that the balun had been a bifilar-wound type; the original had green and white wires so that you could tell which was which. (There was enough of the insulation left so that you could see this.) There were two coils, spaced about 1/4-inch apart, on a nice big ferrite core mounted in snap-in brackets, and on top of the tuner, too. So, I made a rough sketch of the core, capacitors, and the little chokes in the FM traps, just for luck, and went looking for wire to rewind it with.

Hmm. No wire. My "replacement stock" of coil-rewinding wire was an ancient horizontal oscillator coil that I'd had for years, but this was too little. I needed a wire that would be about the same size as the original, so that I could hold the spacing, and so on. Back to the junk room.

About thirty minutes later, I came out dusty but happy, with

the field-coil of a 6-volt auto-radio speaker that had been hanging on the wall for maybe 15 years or so. Just right. Nice enameled wire about #24 or #26. This would let me rewind them and come out with about the same turn spacing that the original balun had before the catastrophe.

So, out with the core. The loupe showed me that there had been 6 turns in each coil, so this was nice; I wouldn't even have to take my shoes off to count up that many. Both coils were wound in the same direction; that was good. I scraped off what was left of the original and put a band of nail polish on one end so that I could tell which way to wind. (Turned out this wasn't necessary, but it was a nice thought anyhow.)

Hoo, boy. Well, start. Don't just sit there. I cut off two pieces of the field-coil wire about 12" long, and doubled them. Smoothing them out so that they laid side by side, I wound on 6 turns and twisted the ends to hold it. When I picked up the form to wind the second coil on, the first one promptly fell off and rolled under the bench. The heck with it; I wound on another one. At my age, this was a lot easier than stooping over that far. (and getting back up again—always the hardest part). With two coils on the form, I squirted the thing with



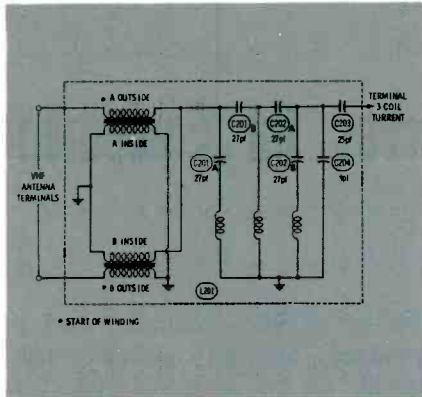

Fig. 1. Bifilar balun coil and FM trap with dual capacitors.

some silicone-resin lacquer to hold them in place, and went to get a cup of coffee while it dried. I knew if I stayed there, I'd start before the paint dried.

When I got back, it was dry. The coils were still loose, but the paint was dry. Oh, well. Now to hook them up. There are four coils, so I have 8 leads. To help hold down the confusion as much as possible, I named each one. "A—outside" (meaning the outside wire on one coil, at what was the outside end with the coil mounted in the clips) was also called the "start" end of the winding, and I put a little dot on the schematic to identify it. (Actually, it doesn't make any difference which end you call the start, as long as you can tell which coil is which. See Fig. 1 again.)

Now, I clipped off the ends of the coil wires, and tinned each one for about 1/4". Sucking an unfortunate fingertip that had somehow managed to get caught in the machinery, I spread them out, and clipped the coil into the brackets (Fig. 2.) Next, I sorted out the ends of each coil with the ohmmeter, and twisted their ends together so that I could tell which was which. Next, hook them up. Well, gotta start somewhere, so take the one thing you're sure of—the antenna terminals on the top. So, I hooked up "A-outside" to that one, using the "Start" lead. Now, where the heck does the other end go. Oh, I see; to the junction of two little capacitors. Hmmm. Only four capacitors in there, and I see 6 on the schematic. Get the loupe again! Oh. Two of them are duals; a close look shows that two of the little blobs have three leads each (C201 and C202, dual 27-pf ceramics).

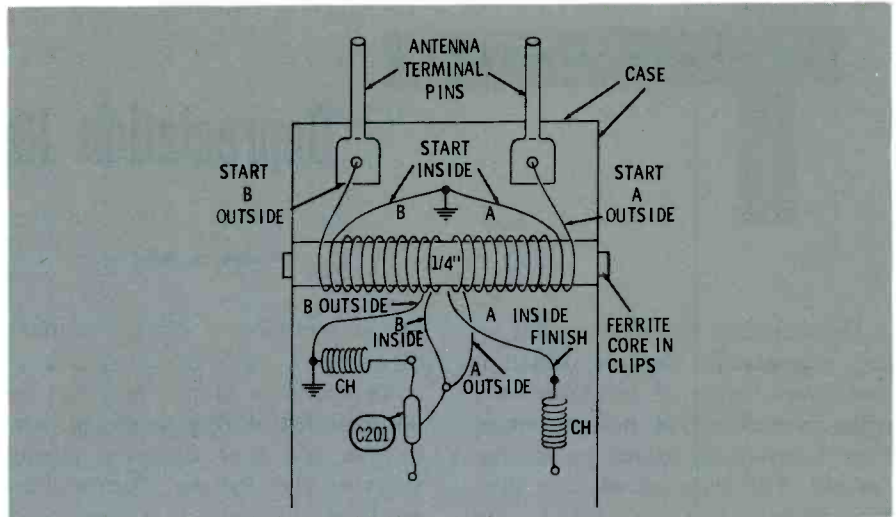

Fig. 2. Physical layout of the balun coil, FM trap, and antenna terminals.

There you are, you little dickens: A solder eyelet on the board, with a capacitor-lead and a lead from one of the trap coils in it. Up with the "tiny-tip" iron and stick the other end of "C-outside" there. That did it. Next, the other winding of coil A goes to—ground? Yep. OK. Now, the other end goes to—ground again? Yep. That's what I like about balun coils. They're such nice illogical-looking things. Now, for coil B.

I take the outside wire of "B", the start, and hook this to the other antenna terminal. The other end goes to ground again. Plenty of little ground-terminals around on the terminal board. On the inside wire of "B", the start end goes to ground, just for a change. There happens to be a ground terminal right between the antenna terminals (as you can see in Fig. 2) and this was where they'd been, so I stuck 'em back. The other end of "B-inside" goes to the junction of the capacitor and the end of the other coil. Nice; breaks the monotony of hooking everything to ground. (I was beginning to wonder if there were any hot wires on the thing) So, I tack this down, and somewhat to my surprise, I'm out of wires. That's all of them. Now, where was I? (Sitting here looking confused, that's where.)

Well, trace them all out again, just for luck. OK, looks good. Check the tubes, and look the tuner over carefully for any sign of other damage. Nope, can't see any. Now, we're off to see the widow. Arriving at her house with the tuner tucked under my arm and a smug

look on my face, I tell her, "Well, I think I've got it fixed. It was a little tricky, but I did it!" With this modest remark, she let me in, and I reinstalled the tuner.

Crawling out from behind the set and getting up (with some difficulty), I turned it on. Well! Low channel stations pretty good. Nice color, not too much snow, and I begin to feel pretty smart. Now, let's try the high channels. Woops! Frankly, they're what I'd call "lousy." Back to the low channels. Come to think of it, they don't look as clear as they did when I put the tuner in. Oh, oh.

So, acting on the old motto, "When trouble arises, look at the last thing *you* put in, stupid", I crawl around behind the set and look carefully at the balun again. An ohmmeter won't do a lot of good with all of those ground connections, so it's up to the calibrated eyeball. Did I bring the schematic with me? Certainly not; are you kidding? So, I sat there on the floor with my legs under the cabinet (only position you can get at the tuner) and went into a trance.

Hey! Wait one. The hot wire from the outside coil on "A" and the inside one on "B" should go to a dual capacitor, but not to a coil! Yet, I could see it firmly soldered to the junction of a coil and capacitor! Out to the truck and get the soldering iron. Unsolder the wires and pull them carefully out with the little dykes I carry in my pocket (you didn't think I'd bring a pair of long-noses, did you?). I start looking. Right next to it is

• Please turn to page 52



# Depreciation Reserves for Equipment

by  
Ralph H. Butz

Depreciating tangible assets—test equipment, service vehicles, and other forms of machinery—is often considered as nothing more than a device to reduce an income tax bill. The value of an asset usually declines in some ratio to the amount of depreciation allowed for tax purposes.

The U. S. Treasury Department recognizes the economic necessity of depreciation allowance. Therefore, the tax code permits a business to establish depreciation reserves during the useful life of an asset, so that its cost may be recovered by the time its profitable use has been exhausted.

It is probable that the liberal depreciation allowances permitted under the 1962 tax law will not continue to be available for an unlimited period of years. When it is no longer economically feasible to encourage business expansion with tax-saving incentives, and when additional revenue is needed, it is possible that such incentives as the investment tax credit on equipment purchases and the additional first year depreciation allowance will be rescinded.

In addition to the 7% investment tax credit on equipment purchases and the additional 20% first year depreciation allowance, some businesses have also used one of the various forms of accelerated depreciation to obtain maximum deductions for tax purposes.

What is depreciation? It is the steady decline in value of assets used to produce business income. The major factors responsible for the decline in value are wear and tear, obsolescence, and depletion. Under certain conditions, the rate of depreciation may be geared to production instead of a specific period of time. This would apply to manufacturing or processing operations where equipment would be considered as having a useful

life to produce a certain number of units.

Depreciation credits may not be accumulated during years of low income and later deducted during years of high income. Depreciation must be deducted each year, and the deduction must represent a reasonable allowance allocated annually over a period of years designated as “useful life of the equipment.” Also, the manufacture or processing of a certain number of units can be used as a basis for the rate of depreciation.

“Useful life” and “physical life” of equipment may differ to a large degree. When you estimate the useful life of equipment you are planning to use it only as long as it is considered efficient or profitable for your business.

What might be designated as the useful life of an item in one business might not be applicable in another business. This fact is recognized by the U.S. Treasury Department as indicated in the following statement: “The useful life of any item depends upon such things as the frequency with which you use it, its age when you acquire it, your policy as to repairs, renewals, replacements, the climate in which it is used. . . the normal progress of the arts, economic changes, inventions and other developments within the industry, trade or business.”

Property with a useful life of one year or less—such as small tools, accessories, books, etc.—is not depreciable, but is charged to expenses in the year purchased. Tangible assets with a useful life of more than one year are usually depreciated by using the straight-line method—deducting an equal amount each year. Other forms are authorized by the Treasury Department and may be used under certain conditions.

Tangible property with useful

life of six years or more, used to produce business income, may qualify for the additional 20% first year depreciation allowance in addition to the regular depreciation. If the property has useful life of more than four years, it may also qualify for the investment tax credit on purchased equipment.

Brown purchased equipment on January 1, 1966, for \$6,000, estimating its useful life as five years, with \$500 salvage value at the end of that period. When the salvage value of an item is 10% or less of the original cost, it may be disregarded for purposes of computing depreciation. Since the equipment has a useful life of less than six years, he is not entitled to the additional 20% first year depreciation allowance. The depreciation schedule, using the straight-line method, is as follows:

Cost of equipment		
January 1, 1966		\$6,000
1966 Depreciation		
20%	\$1,200	
1967 Depreciation		
20%	1,200	
1968 Depreciation		
20%	1,200	
1969 Depreciation		
20%	1,200	
1970 Depreciation		
20%	1,200	6,000

Assuming that Brown had estimated the useful life of the equipment as six years, enabling him to qualify for the additional 20% first year depreciation allowance, the straight-line depreciation schedule would change to:

Cost of equipment		
January 1, 1966		\$6,000
Less 20% additional		
1st year depreciation	1,200	
		4,800

• Please turn to page 54



**STEP UP  
TO THE  
NEW**



**CONTINENTAL**  
AMERICA'S FINEST,  
MOST RELIABLE  
TUBE  
ANALYZER



**A "MUST" FOR MODERN SERVICING  
... PRODUCTION LINE TESTING ...  
QUALITY CONTROL ... LABORATORY.**

**A True Gm Tester**

- 5000 Cycle Gm Test
- Full Cathode Emission Check
- 100 Megohm Grid Leakage Test  
and Still the Speediest Tester in Town

In a nut shell . . . here is how Sencore does it. Using only the first three controls, the MU140 becomes a speedy "Mighty Mite" cathode emission tester with grid leakage sensitivity checks up to 100 megohm . . . for fast on the spot service. Flip the last three switches into operation from the set-up data and the MU140 becomes a true mutual conductance tube tester using 5000 cycle square wave to completely analyze any tube. You can't go wrong. No more need to mess around with time-consuming old fashioned tube testers with up to fourteen knobs and a rough 60 cycle sine wave test. The Continental tests them all including foreign tubes . . . over 3000 in all. And, it's guaranteed against obsolescence too with replaceable "new socket" panel and controls so standard that the switch numbers correspond to the pin numbers shown in any tube manual. You can actually set up the Continental without the set-up data in the cover if the need should arise. Here is everything that you could want. Its famous four way independent tests make you a master of the art of tube testing . . . internal shorts test; full cathode emission test; 100 megohm grid leakage test; and to back you up on critical tubes . . . a superb mutual conductance test. The beautiful Continental is housed in a vinyl-clad solid-steel attache case with lustrous all-chrome front panel. Yet at a price below all competition.

**\$179<sup>50</sup>**

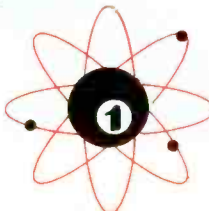

**SENCORE**

*NO. 1 MANUFACTURER OF ELECTRONIC MAINTENANCE EQUIPMENT*

426 SOUTH WESTGATE DRIVE, ADDISON, ILLINOIS 60101

Circle 9 on literature card



# OHM'S LAW for AC

by  
Robert G. Middleton

TV servicing is a highly competitive occupation. Efficiency in our job requires a good understanding of Ohm's law. Otherwise, we cannot analyze our measurements to localize defective receiver sections and to pinpoint faulty components. If we understand Ohm's law, we have the most powerful tool avail-

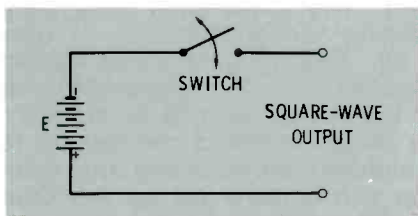

Fig. 1. A simple square-wave generator using a mercury switch.

able to tackle any electronic circuit. Most of us have a good understanding of Ohm's law for DC, but are a bit hazy concerning Ohm's

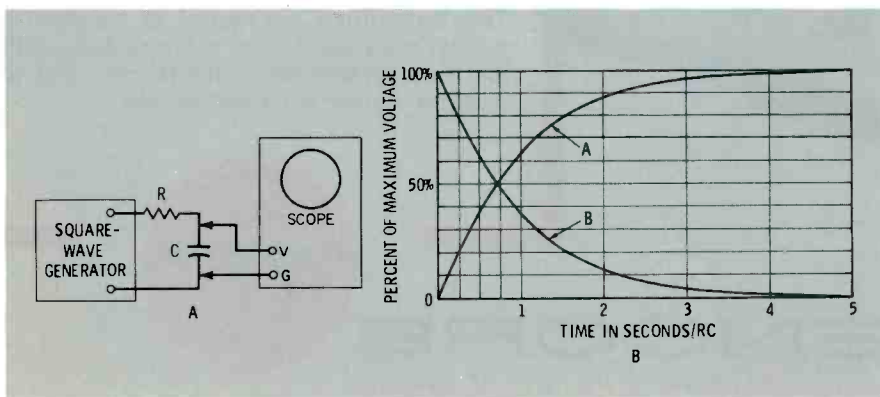

Fig. 2. Series RC circuit and chart showing voltage and current.

law for AC. Beginning technicians tend to feel that AC voltage and current are too difficult to understand, but this is not so. In fact, when the basic idea of an AC voltage or current is pointed out, the seeming difficulties disappear immediately.

## From DC to AC

There is a simple relation between DC and AC that can be shown in various ways. One way is depicted in Fig. 1. If the switch is left closed, we have a DC source. On the other hand, if the switch is opened and closed rapidly, we have a square-wave source. A square-wave is one basic type of AC. Note that in the past, mercury switches were widely used to change a DC source into a square-wave source as seen in Fig. 1. Today, we use vacuum tubes and transistors instead of mercury switches, but the operating principle is the same.

Next, observe Fig. 2. A series RC circuit is connected to a square-wave generator. This is an integrating circuit, with the scope connected across the capacitor. The voltage across the capacitor has a waveform that can be plotted by the universal time constant chart. In other words, the voltage rises across the capacitor as shown by curve A in Fig. 2B. At the same time, the current flow into the capacitor is shown by curve B. There is an important basic fact to be observed here: Note that the current flow into the capacitor has its maximum value when the current flow into the capacitor is zero. On the other hand, the voltage across the capacitor has its maximum value when the current flow into the capacitor is zero. This

is just another way of saying that the current leads the voltage in a capacitor. Beginning technicians often have a hard time understanding how current flow can be maximum when the voltage is zero. However, the mystery is quickly cleared up by observing the circuit action in Fig. 2A. The voltage rises gradually across the capacitor because  $Q = CE$ , where  $Q$  is the quantity of electricity in the capacitor. Or, we can say  $E = Q/C$ . Since  $Q = It$ , where  $t$  is the time, it is obvious that  $E$  will be zero when  $t$  is zero, and that  $E$  will increase as  $t$  increases. However,  $E$  does not increase beyond a certain point, because  $I$  is decreasing as  $t$  increases.

## Sine-Wave Voltage and Current

Now, let us use an audio oscillator instead of a square-wave generator to drive the RC series circuit. Fig. 3 shows the circuit arrangement. The voltage across the capacitor and the voltage across the resistor can be seen in Fig. 3B. Observe that the voltage across the resistor leads the voltage across the capacitor by  $90^\circ$ . This is the same as saying that the current in the capacitor leads the voltage across the capacitor by  $90^\circ$ . Why? It is because the voltage across a re-

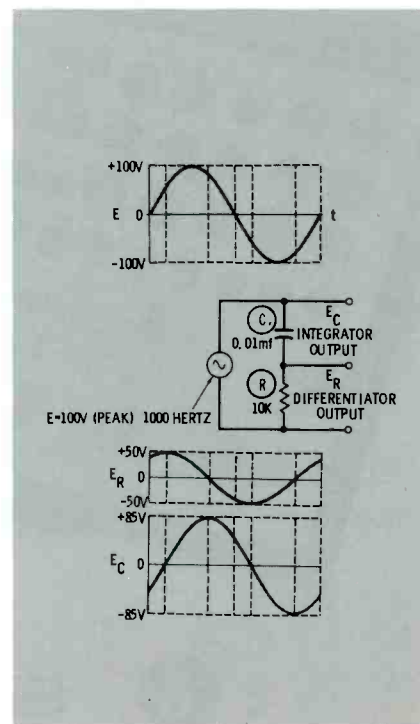

Fig. 3. Voltages across C and R of RC circuit with sine-wave input.

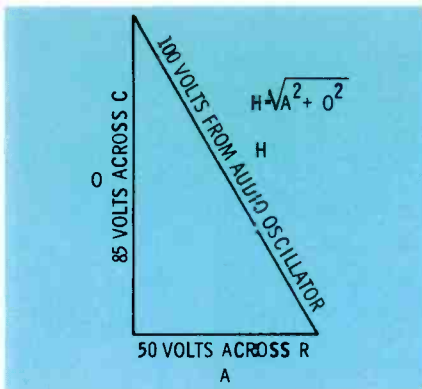

Fig. 4. Using right triangle and Pythagorean formula to add RC voltages.

sistor is in phase with the current through the resistor.

You will also observe a surprising fact in Fig. 3. Here we have a generator that drives the RC circuit with 100 volts p-p. Note carefully that the peak voltage across the capacitor is 85 volts, and the peak voltage across the resistor is 50 volts. In other words, the simple sum of  $E_R$  and  $E_C$  is 135 volts. How can the sum of the circuit voltages be greater than the source voltage? The mystery disappears when we observe that  $E_C$  and  $E_R$  are  $90^\circ$  out of phase. Therefore, we must add  $E_C$  and  $E_R$  vectorially at right angles, as shown in Fig. 4. This is the basic difference between AC circuits and DC circuits. We have to consider *phase* relationships when we analyze AC circuits.

### Voltages Around a Square-Wave Circuit

We saw in Fig. 4 how voltages add up around a sine-wave circuit. The vectors in Fig. 4 are merely a shorthand method of adding up the sine-wave voltages depicted in

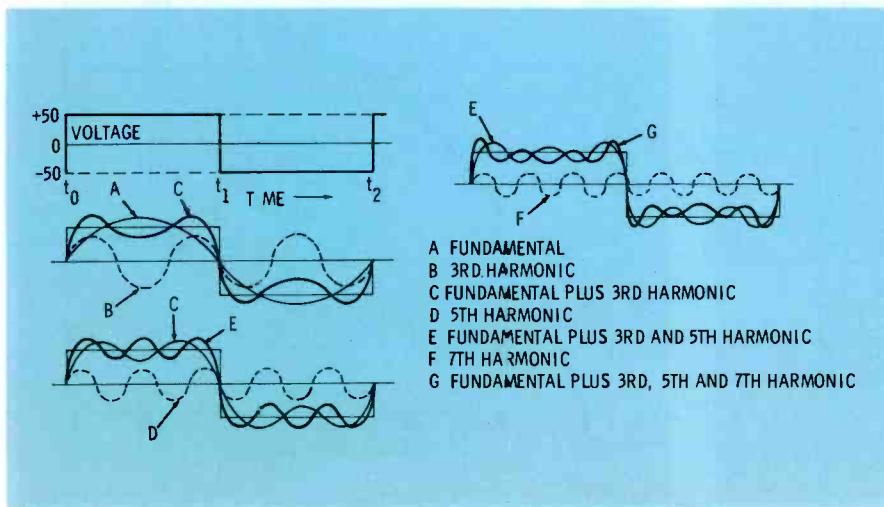

Fig. 7. Infinite number of sine waves in symmetrical square-wave.

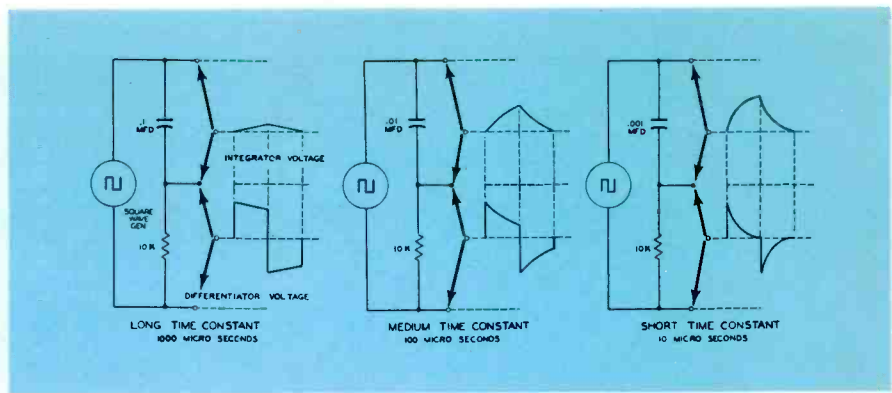

Fig. 5. Waveforms in RC circuits having different time constants.

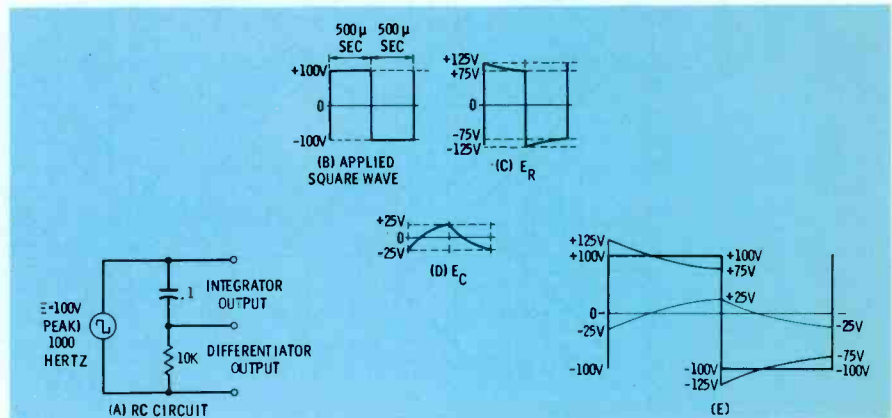

Fig. 6. Sum of voltages across R and C is equal to the applied square-wave voltage.

Fig. 3. We add the peak instantaneous voltages, taking the phases of the sine-waves into account. Next, we shall see that the voltages around a square-wave circuit also add up in basically the same manner. Fig. 5 shows voltage waveforms in series RC circuits that have different time constants. In every case, the sum of the instantaneous voltages across the resistor and capacitor add up to the applied square-wave voltage.

An RC circuit with all voltage values indicated is shown in Fig. 6. We expect that at each instant, the

sum of the voltages across R and C will be equal to the applied square-wave voltage. Fig. 6E shows that this is so. Fig. 6 is a bit more complicated than Fig. 4 because a square-wave cannot be drawn as a vector. Hence, we must add the entire waveforms across R and C to show that their sum at any instant is equal to the applied square-wave voltage. Note that both Fig. 6 and Fig. 4 are examples of Kirchhoff's law, which states that the sum of the voltage drops around a complete circuit is equal to the applied voltage.

It is sometimes asked why a square-wave cannot be represented by a vector. The answer to this question is shown in Fig. 7. Since a square-wave consists of a large

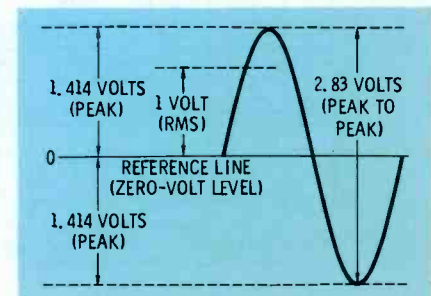

Fig. 8. Relation of peak, RMS, and peak-to-peak voltage values.



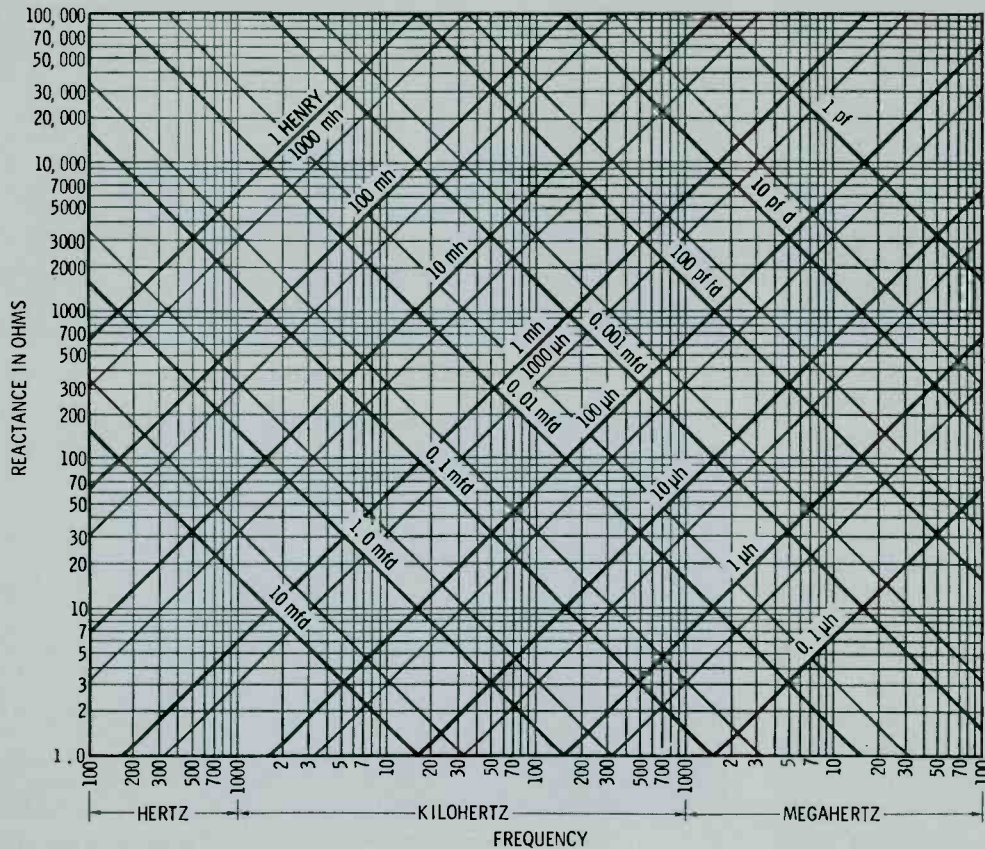

Fig. 10. Reactance versus frequency for inductors and capacitors.

number of sine waves (an infinite number of sine waves in the ideal case), and each sine wave corresponds to a vector, we would have to draw an infinite number of vectors to represent an ideal square-wave. Since this is impractical, we use the universal time constant

chart (Fig. 2B), instead. The waveforms in Fig. 6 have the same curvature (exponential shape) as the universal waveforms in Fig. 2B. The curvature may seem to be different simply because the various illustrations are drawn to different scales.

### Ohm's Law for a Capacitor

We know that Ohm's law for a resistor states that  $I=E/R$ . This law holds true whether we are speaking of DC values, peak AC values, peak-to-peak AC values, or rms values. It is only necessary that

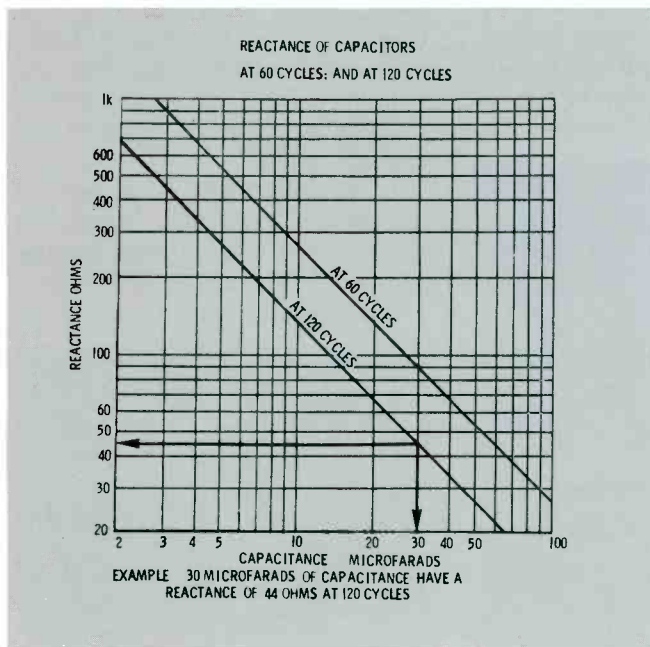

Fig. 9. Reactance of capacitors at 60 and 120 hertz.

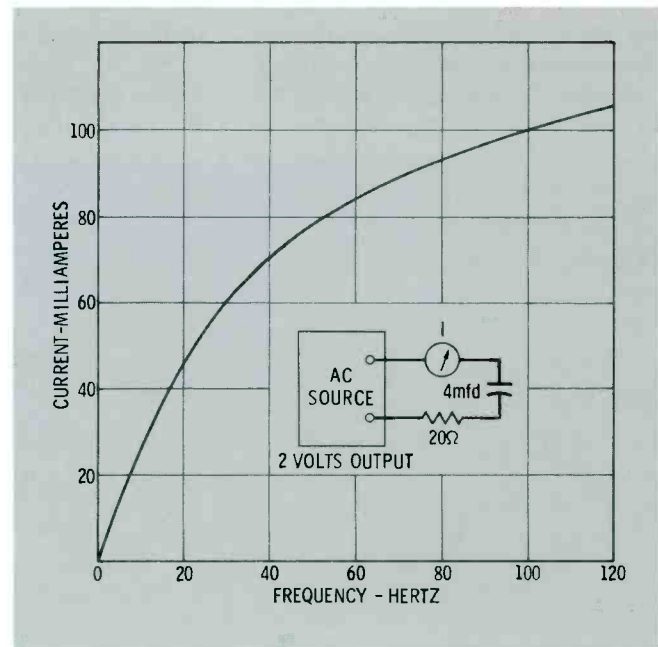
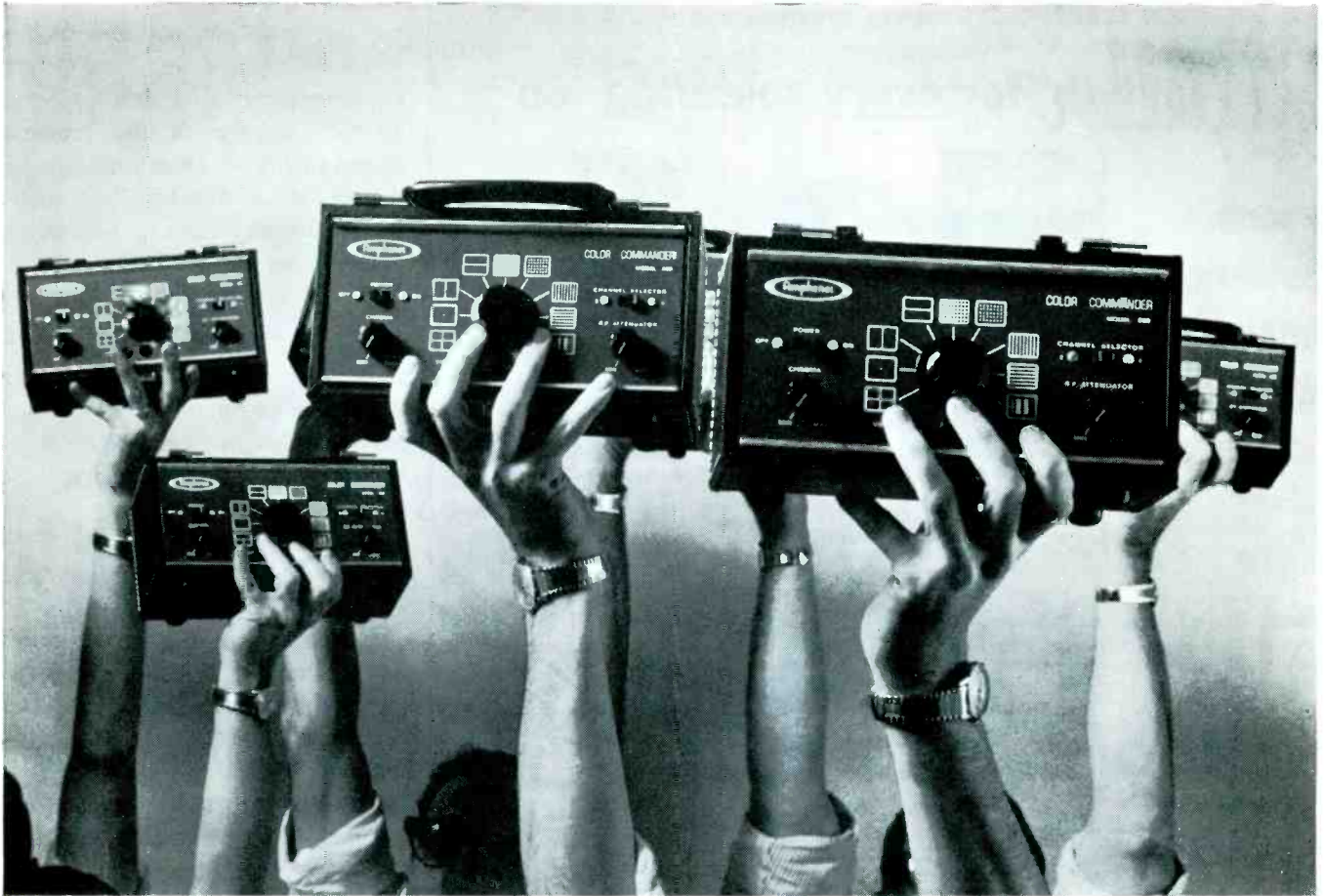

Fig. 11. Current versus frequency in a series RC circuit.





## Suddenly, everyone's a Watch Watcher!

And for a good reason. Service dealers found out we were right when we said Amphenol's Color Commander color bar generator would save them enough time for two or three extra service calls a day.

What's it all about? We're so sure we can save you as much as 18 minutes a call, we're including a \$10.95 Timex watch with every Color Commander purchased—just so you can prove it yourself.

And if the Color Commander doesn't save as much time as we say, return it within 10 days and keep the Timex watch with our compliments.

What makes us so sure? Amphenol's exclusive technique of color alignment which features a:

1. Single crossbar to immediately center the raster.
2. Single dot for fast, consistently accurate static convergence.
3. Three-bar color array to isolate your working bars—the 3rd, 6th and 9th.

### Join the Watch Watchers

If you take advantage of this limited-time offer today, your Color Commander can be paying for itself in extra income tomorrow. For the name of your nearest Amphenol distributor, contact your nearest Amphenol Sales Division office or write Dan O'Connell, Head Watch Watcher, Amphenol, Box 134, Broadview, Illinois 60153.

#### Watch Watcher Offer

With every lightweight, compact, completely solid-state Amphenol Model 860 Color Commander we'll include a \$10.95 Timex for you to time your savings. If the Color Commander doesn't save you time, return it within 10 days and keep the watch with our compliments.

**\$169.95\***

Model 860AC \$20.00 higher\*

\*Suggested resale prices



Circle 10 on literature card

SEE YOUR ELECTRONICS PARTS DISTRIBUTOR:

# Weller® for every soldering job

## Pencil Soldering Irons by Weller



"Marksman" Kit with pencil soldering iron; screwdriver, cone and chisel tips; handy soldering aid and a supply of solder. **\$444** list Model SP-23K.



"Marksman" Iron at popular price. Stainless-steel long-reach barrel. 1/8" replaceable tip. Maximum tip temperature, 750°F. **\$298** list Model SP-23.



Weller Iron is industrial rated, highly efficient. Does work of bigger irons. Only 7 7/8" long including the tip. 25 watts. 115 volts. **\$520** list Model WP-S.

## Temperature Controlled Soldering Unit

For universal hobby soldering, including heavy-duty metal work. Temperature control is in the tip. Interchangeable tips give a choice of 500°F, 600°F, 700°F and 800°F controlled temperatures. Operates on 24 volts. Complete with 3/16" 700°F tip and 60 watt, 120 volt, 50/60 cycle power unit with soldering pencil stand and tip cleaning sponge attached. **\$2600** list Model W-TCP.



## Dual Heat Soldering Guns

100/140 Watts. Two trigger positions let you switch instantly to high or low heat to suit the job. Tip heats instantly and spotlight comes on when trigger is pulled. Tip has exceptionally long reach. Model 8200. **\$695** list

145/210 Watts. A professional model with all Weller gun features; instant heat, dual heat, spotlights. Model D-440. **\$995** list

240/325 Watts. Heavy-duty model with all Weller gun features; instant heat, dual heat, spotlights. Model D-550. **\$1095** list



## Dual Heat Soldering Gun Kit

Includes Weller 100/140 watt dual heat gun, 3 soldering tips, tip-changing wrench, soldering aid, flux brush, supply of solder . . . all in a colorful utility case of break-proof plastic. Model 8200PK. **\$895** list



## Heavy-Duty Soldering Gun Kit

Features Weller 240/325 watt dual heat gun; tips for soldering, cutting and smoothing; tip-changing wrench; solder; metal-tone utility case of break-proof plastic. Model D-550PK. **\$1295** list



Utility Grade Solder On Hang Cards 5 feet of 40/60 alloy solder in each pack. Acid core, AC-40. Rosin core, RC-40. **39¢** list



Superior Grade Solder In Dispenser Tubes 10 feet of 60/40 alloy rosin-core solder in each tube. Number RC-60. **59¢** list

**WELLER ELECTRIC CORPORATION, Easton, Pa.**

WORLD LEADER IN SOLDERING TECHNOLOGY  
Circle 11 on literature card

we be consistent in the equation when we choose values. We can easily convert from one value to another by use of the relations shown in Fig. 8. Ohm's law for capacitors states that  $I = E/X_c$ , where  $X_c$  is the capacitive reactance in ohms. From the standpoint of arithmetic,

$$X_c = \frac{1}{(2\pi fC)},$$

where  $X_c$  is the reactance in ohms,  $\pi$  is equal to 3.1416,  $f$  is the frequency in hertz, and  $C$  is the capacitance in farads.

Fig. 9 shows how the reactance varies with capacitance at 60 and 120 hertz. At any given value of capacitance, the reactance at 60 hertz is double that at 120 hertz. At any given frequency, the reactance is halved when the capacitance is doubled. Of course, these facts are obvious from inspection of Ohm's law:  $I = E/X_c$ . Note that resistance is a voltage-current ratio:  $R = E/I$ . In the same manner, reactance is a voltage-current ratio:  $X_c = E/I$ . Technicians are busy people—they use timesavers whenever possible. Therefore, you should tack Fig. 9 over your service bench. It will throw immediate light upon many power-supply filter problems.

Of course, troubleshooting is often concerned with frequencies other than 60 to 120 hertz. The chart in Fig. 10 shows the reactance of just about any capacitor or inductor at any frequency that you might be concerned with in radio, audio, and TV troubleshooting. Note that Ohm's law for inductors is basically the same as for capacitors. In other words,  $I = E/X_L$ , where  $X_L$ , the inductive reactance in ohms, is equal to  $2\pi fL$ .

## Working With Impedance

When a circuit has both resistance and reactance, it is said to have a certain impedance, which is measured in ohms. Fig. 11 shows a series RC circuit, and how the current flow varies with frequency.



# FUSEHOLDERS FOR BUSS FUSES

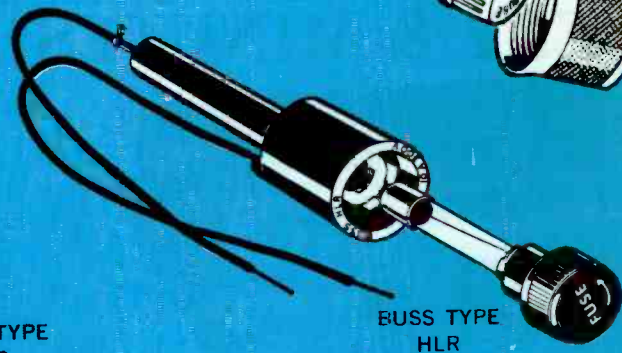
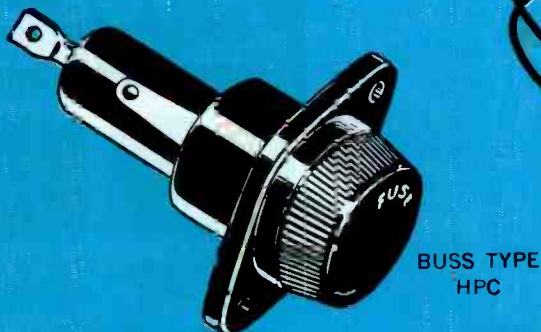
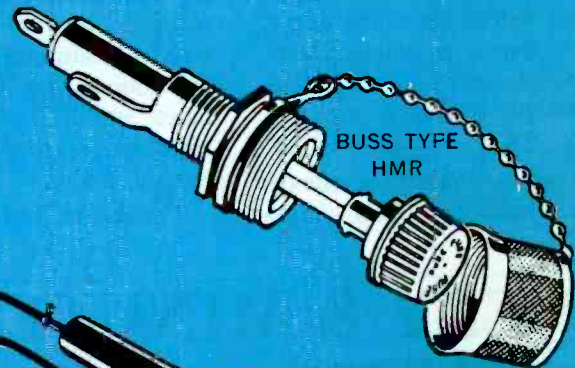
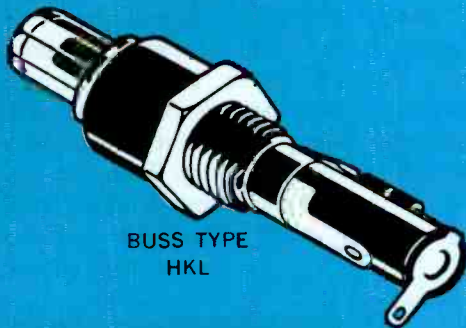
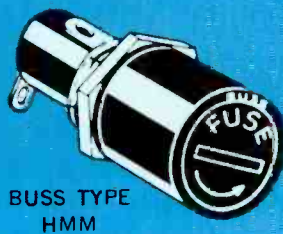
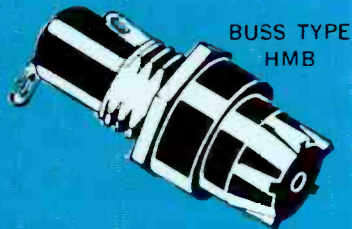

Panel mounted, in-the-line, lamp indicating, signal activating, visual indicating fuseholders—with solder terminals, quick-connect terminals or special terminals—for fuses from  $\frac{1}{4}$  x  $\frac{5}{8}$  inches and larger.

Fuseholders of various types to meet Commercial and Military specifications.

For full information on the many small dimension fuse mountings and companion fuses available from BUSS . . . write for *BUSS Bulletin SFB*.

**BE PROFIT WISE . . . INSIST ON BUSS QUALITY**

SUPPLIED THE ECONOMICAL WAY—THRU ELECTRONIC DISTRIBUTORS

BUSSMANN MFG. DIV. McGraw Edison Co. St. Louis, Mo. 63107

Circle 12 on literature card



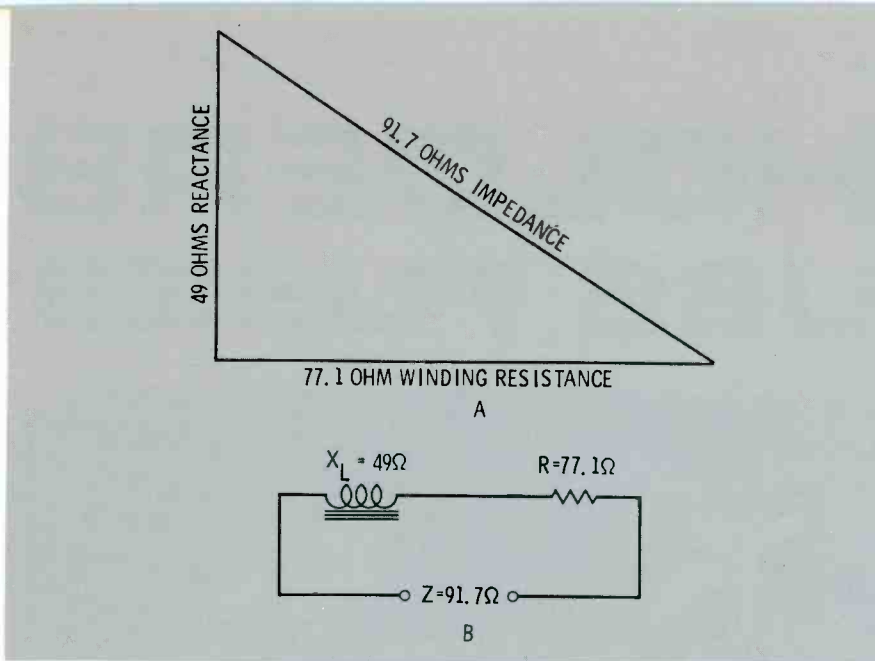

Fig. 12. Winding resistance of coil added to reactance gives impedance.

Ohm's law states that  $I = E/Z$ , where  $I$  is the current in amperes,  $E$  is the applied voltage in volts, and  $Z$  is the impedance in ohms. Reactance and resistance are added vectorially (right triangle), so that  $Z = \sqrt{R^2 + X^2}$ . Observe Fig. 12. Inductors have winding resistance. Therefore, inductors offer impe-

dance in an AC circuit. The winding resistance acts as if an ideal inductor were connected in series with a resistance. Accordingly, if an inductor has 49 ohms of reactance and 77.1 ohms of winding resistance, the impedance of the coil is 91.7 ohms.

Capacitors have very little re-

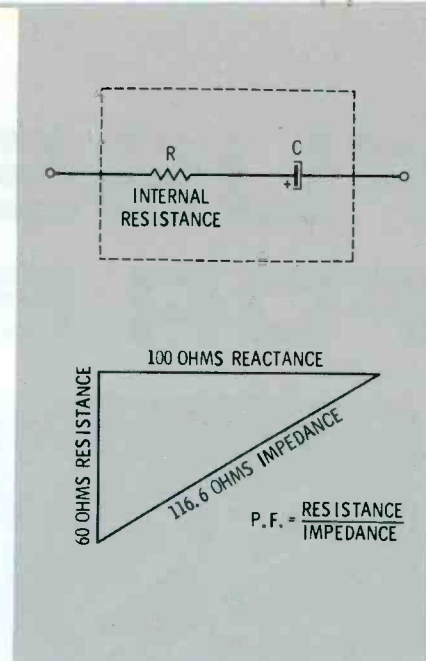
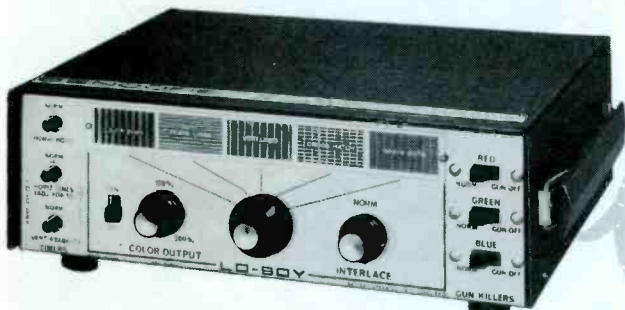

Fig. 13. Series resistance added to reactance of capacitor.

sistance, and in turn a capacitor is not, in the normal meaning, an impedance. Of course, if an electrolytic capacitor becomes defective, it will develop leakage resistance or a high-resistance film. Then, we must analyze the capacitor as an impedance. In Fig. 13A, the capacitor has

• Please turn to page 55

## EVERY 8 MINUTES...



### SOMEONE BUYS A NEW SENCORE CG10 LO-BOY STANDARD COLOR BAR GENERATOR

It's time you too switched to Sencore and saved \$100.00 in the bargain. The new compact LO-BOY is a solid Sencore value that outperforms the highest priced generators—and is already selling at the rate of one every 8 minutes.

Compare these features:

- Ten standard RCA licensed color bars plus all patterns found on more expensive generators.
- New patent pending counting circuits using silicon transistors. Crystal controlled timers for the utmost in stability.
- New front mounted timer controls for quick adjustment if they should ever jump. Absolutely eliminates timer instability.
- All solid state. Battery powered by long life "C" cells.
- HI in performance — LO in price. . . . (Less than the cost of a kit.) . . . only \$89.50

SENCORE CG138 LO-BOY—Just like CG10 except AC operated, 4.5 mc crystal controlled signal; recommended for troubleshooting. . . . only \$109.50



**SENCORE**

NO. 1 MANUFACTURER OF ELECTRONIC MAINTENANCE EQUIPMENT

426 SOUTH WESTGATE DRIVE, ADDISON, ILLINOIS 60101

Circle 14 on literature card

## FINCO "has 'em both!"



Model #65-1  
\$2995  
list

Model #65-2  
\$3995  
list

### BOOSTER COUPLERS FOR 300 OR 75 OHM For Deluxe Home or Commercial Use

Now available for either 75 OHM CO-AX or 300 OHM operation . . . you can't beat the price, quality and performance of Finco's famous 2-tube, 4-set VHF or FM Distribution Amplifiers. Finco challenges 'em all! Equip either model with Finco low loss splitters (#3001 or #3003) and you can drive up to 16 sets in a master antenna system!

All Finco Products Are Engineered for Color!



**THE FINNEY COMPANY**  
34 West Interstate Street, Bedford, Ohio

Circle 13 on literature card

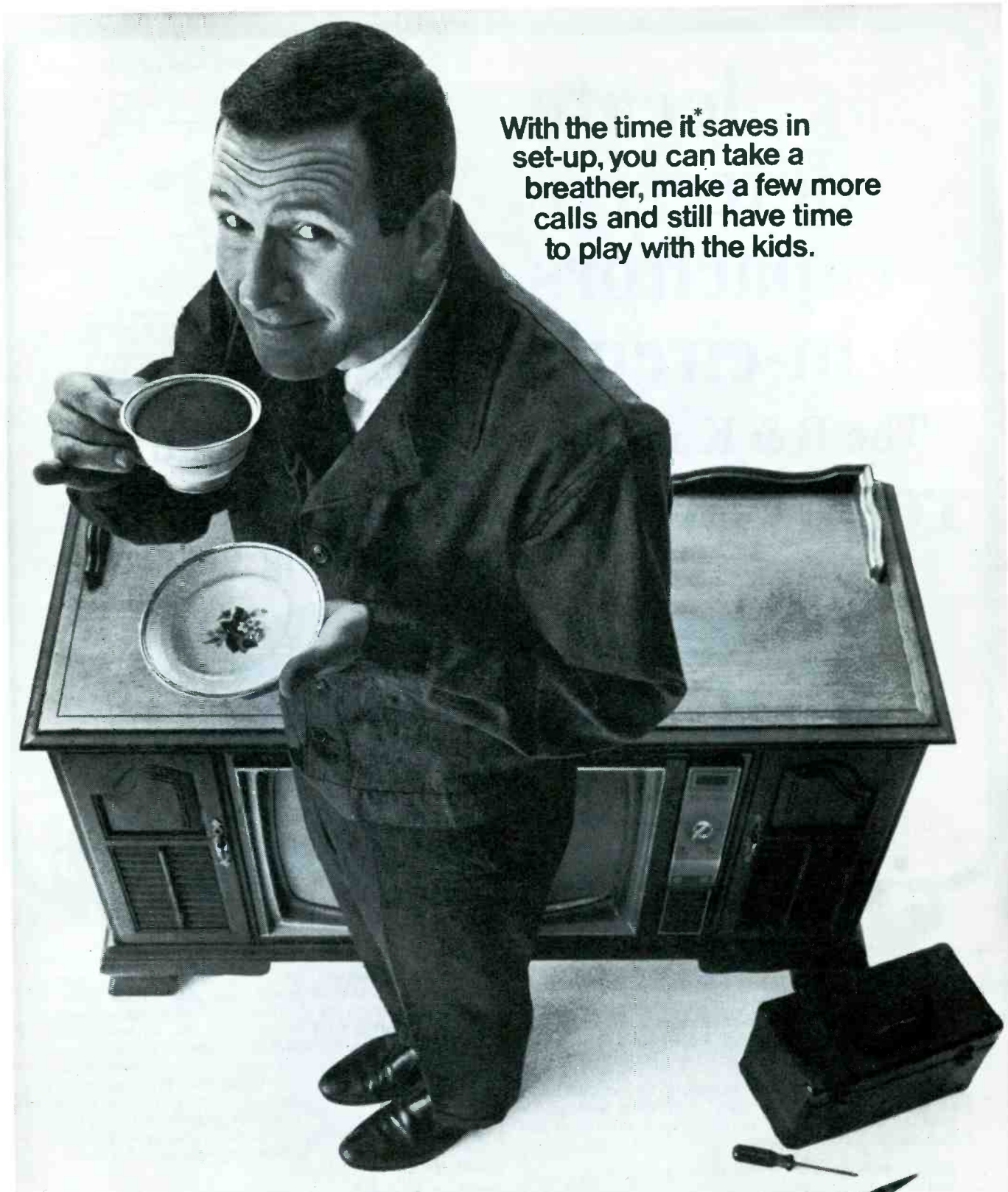

With the time it saves in set-up, you can take a breather, make a few more calls and still have time to play with the kids.

### \*RCA's new Hi-Lite Color Tube with Perma-Chrome

If you've been waiting half an hour for the picture tube to warm up every time you repair or install a set, here's good news. RCA's new rectangular Hi-Lite Color Tubes with Perma-Chrome lock colors in place instantly, eliminate distorted color as the set warms up. Colors are true and unchanging

from turn-on to turn-off. Saves hours of set-up time. New Hi-Lite Color Tubes with Perma-Chrome now in RCA Victor consoles. **New service switch in all 1967 color chassis.** Three-position for Normal, Service and Raster. When Raster is selected, all video and noise is removed from

the color picture tube, leaving a noise-free Raster. Purity is adjustable without removing an IF tube or using other means to remove noise and/or interference from the screen.



The Most Trusted Name in Electronics  
Tmk(s)®





# locate defective capacitors in-circuit

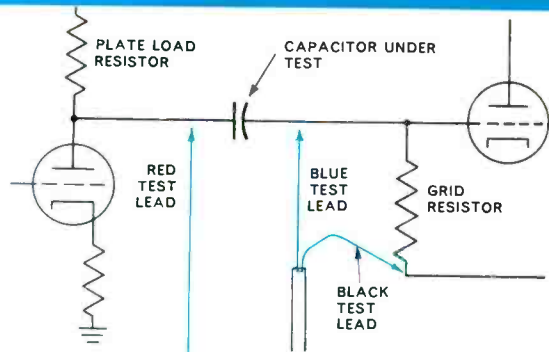

**3-LEAD LEAKAGE TEST:** One test lead is connected to the plate side of the capacitor and the ground lead to the grid leak return on the other side of the capacitor, and the meter is zeroed. The third test lead is then connected to the grid side of the capacitor and the meter scale shows the leakage directly in megohms.

The B & K model 801 capacitor analyst **really works** without unsoldering or altering circuitry

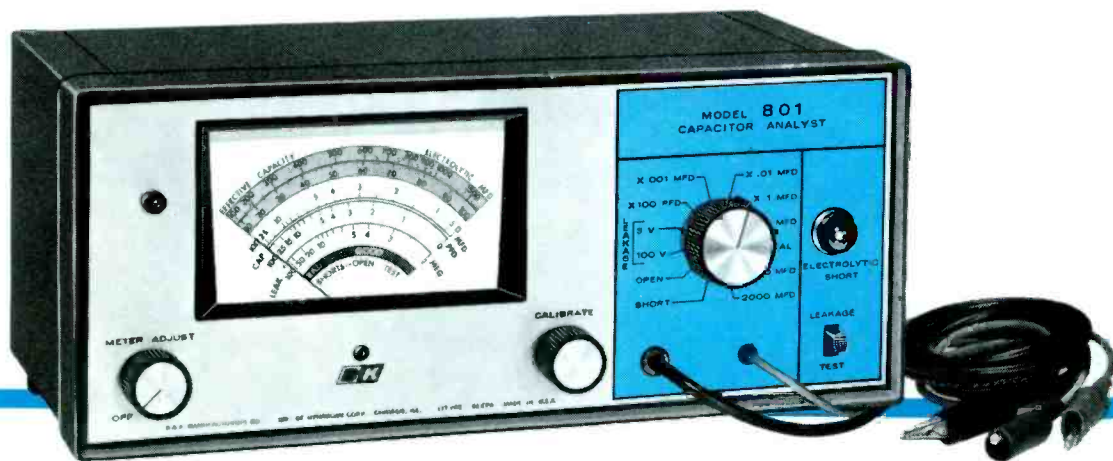

Both in-circuit and out-of-circuit capacitor testing can be done quickly and accurately with the new B & K Model 801 Capacitor Analyst. Foil, mica, general purpose and temperature compensating ceramic, and electrolytic capacitors can be accurately tested for leakage, capacitance, opens, and shorts.

**Leakage can be determined in-circuit.** The unique B & K 3-lead method permits a degree of accuracy not possible with any 2-lead tester. For normal circuits defective capacitors can be located immediately.

**Open capacitors** with values as low as 25 pF are easily located with the sensitive high-frequency-signal and resonant- $\frac{1}{4}$ -wave-transmission-line method.

**Electrolytic capacitors** are tested with a circuit that accurately measures their effective capacitance. Their inherent characteristics of variable equivalent series resistance and internal parallel resistance are automatically accounted for. Only one capacitor lead need be disconnected. The capacitor is charged and then discharged under load. High peak load currents up to 2 amperes ensure testing to in-circuit conditions. Unlike with other testers, capacitor can not be deformed by a reverse polarity voltage. The actual power transferred to a load is measured and the capacitance is read directly from the meter scale for immediate replacement decisions.

All these tests and short tests too are performed with the one set of test leads which is included with the instrument.

Here's the capacitor analyst that really works: B&K Model 801 quickly pays for itself with reduced shop time. Net \$109<sup>95</sup>

See your B & K distributor or write for catalog AP-22.



**B & K DIVISION OF DYNASCAN**

1801 W. BELLE PLAINE AVE. • CHICAGO, ILL. 60613

Export: Empire Exporters, 123 Grand St., New York 13, U.S.A.

Circle 15 on literature card



## BOOK REVIEW

**Communications Electronics Circuits: J. J. DeFrance;** Holt, Rinehart and Winston, New York, 1966; 548 pages, 6" x 9", cloth, \$9.50.

This book presents a detailed analysis of each of the principal circuits used in RF applications. Circuits are grouped according to purpose, such as RF voltage and power amplifiers, oscillators, modulators, and detectors. Complete chapters are devoted to combined circuits in transmitters and receivers. Frequency modulation is treated separately, as are transmission lines and antennas. Special chapters are given to resonant and coupled circuits, and to special transmitters.

Each circuit described is developed by mathematical analysis, and most circuits now in use are discussed. At the conclusion of each chapter are several pages of test questions and design problems. Their solutions require considerable review of each circuit and problem covered by the book.

This is a text on the subject and can be used as a handbook of RF design. The use of mathematics, extending to integration, is extensive, but does not preclude use of the volume without involved calculations. ▲



Still don't want to call a TV man?

# WHAT'S SO GREAT ABOUT OAKTRON SPEAKERS

# ?

SUPPLYING  
ALMOST  
EVERY MAJOR  
MANUFACTURER  
OF RADIOS  
AND TV,  
OAKTRON  
HAS ONE OF  
THE WIDEST  
RANGES OF  
SPEAKERS  
ON THE  
MARKET.

THE  
DISTINCTIVE  
BLUE  
SPEAKERS  
FROM  
OAKTRON  
ALL HAVE  
TRUE  
ALUMINUM  
VOICE  
COILS

ALUMINUM VOICE COILS  
ELIMINATE WARPAGE FROM  
HUMIDITY AND OVERLOAD  
HEAT. YOU GET INCREASED SEN-  
SITIVITY AND LONGER LIFE. BETTER  
QUALITY MEANS BETTER RELIABILITY.  
BEST OF ALL, THEY COST NO MORE THAN  
PLAIN SPEAKERS. CHECK YOUR LOCAL DIS-  
TRIBUTOR FOR COMPLETE DETAILS OR WRITE

YOUR BLUEPRINT TO BETTER SOUND  
 **AKTRON**  
INDUSTRIES, INC.  
MONROE, WISCONSIN

Circle 16 on literature card



# Notes on Test Equipment

analysis of test instruments... operation... applications

by T. T. Jones

## Mutual Conductance Tester

One of the more interesting of the many new test instruments is Mercury's new Model 2000 tube tester. This tester offers a variety of tests, and can test every known tube and transistor type, with the exception of the obsolete numbers such O1A, 27 etc.

The setup is very fast, thanks to the lever switches. Fig. 2 shows a portion of the set-up book, and shows, in the Gm-Em column, which levers must be thrown to each position. The levers are smooth and

lightly detented as is the SELECTOR switch. The latter controls heater voltage.

Another time-saver in the set up is the use of multiple sockets. The heaters are permanently wired in, with a separate socket for each known heater connection.

Switches 1 through 10 connect the load and bias voltages to the corresponding tube pins. Switch 11 selects the proper bias voltage, and 13 selects the plate voltage. Switch 12 selects the heater return circuit.

In addition to the mutual conductance test, there is a very sen-

sitive gas test. This is accomplished by tying the grid of the tube under

### Mercury Model 2000 Specifications

#### Tests Performed

Tubes: Shorts (1 MΩ sensitivity), Gas (150 MΩ sensitivity), Emmision, Mutual Conductance (0-5000 μmho, 0-25,000 μmho sensitivity).

Transistors: Leakage current, DC Beta (0-200)

#### Types Tested:

5 and 7 pin Nuvistor, 7 pin miniature, Octal, Loctal, Noval, Novar, Magnoval, Decal, 10-pin Sylvania, and Compactron, in all present basing configurations. CRT's with optional adaptor.

Power Requirements:  
117 VAC.

Size (HWD):  
4½" x 18¼" x 10¾"

Weight:  
9¾ pounds.

Price:  
\$99.95

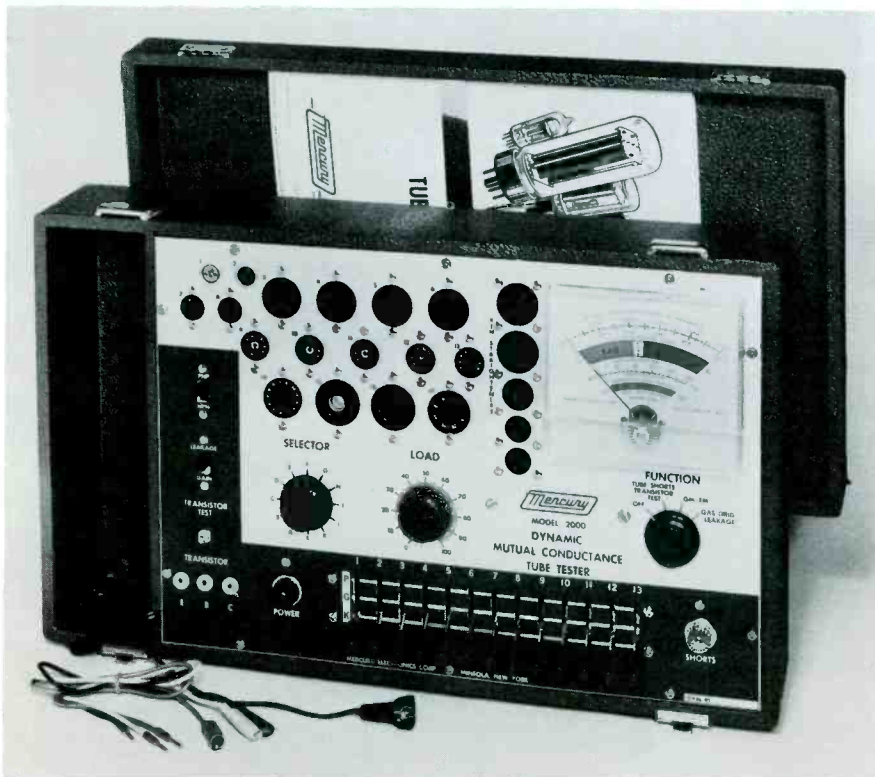

Fig. 1. Lever switches are featured in the Model 2000.

TUBE	Function	SHORTS	Bias	Em	Notes	GAL
6X4	...	...	...	...	...	...
6X5	...	...	...	...	...	...
6X6	...	...	...	...	...	...
6X7	...	...	...	...	...	...
6X8	...	...	...	...	...	...
6X9	...	...	...	...	...	...
6X10	...	...	...	...	...	...
6X11	...	...	...	...	...	...
6X12	...	...	...	...	...	...
6X13	...	...	...	...	...	...
6X14	...	...	...	...	...	...
6X15	...	...	...	...	...	...
6X16	...	...	...	...	...	...
6X17	...	...	...	...	...	...
6X18	...	...	...	...	...	...
6X19	...	...	...	...	...	...
6X20	...	...	...	...	...	...
6X21	...	...	...	...	...	...
6X22	...	...	...	...	...	...
6X23	...	...	...	...	...	...
6X24	...	...	...	...	...	...
6X25	...	...	...	...	...	...
6X26	...	...	...	...	...	...
6X27	...	...	...	...	...	...
6X28	...	...	...	...	...	...
6X29	...	...	...	...	...	...
6X30	...	...	...	...	...	...
6X31	...	...	...	...	...	...
6X32	...	...	...	...	...	...
6X33	...	...	...	...	...	...
6X34	...	...	...	...	...	...
6X35	...	...	...	...	...	...
6X36	...	...	...	...	...	...
6X37	...	...	...	...	...	...
6X38	...	...	...	...	...	...
6X39	...	...	...	...	...	...
6X40	...	...	...	...	...	...
6X41	...	...	...	...	...	...
6X42	...	...	...	...	...	...
6X43	...	...	...	...	...	...
6X44	...	...	...	...	...	...
6X45	...	...	...	...	...	...
6X46	...	...	...	...	...	...
6X47	...	...	...	...	...	...
6X48	...	...	...	...	...	...
6X49	...	...	...	...	...	...
6X50	...	...	...	...	...	...

Fig. 2. Chart shows typical set-up data.



test to a VTVM circuit. The sensitivity of the gas test is 150 M $\Omega$ .

The Model 2000 can also be used as an emission tester for those tubes which are impractical to test by the Gm method, such as the 6BK4, rectifiers, etc.

The transistor test is a very simple one, measuring leakage between collector and base, then applying forward bias for the beta measurement. The tests are made with a DC supply voltage.

A very helpful added feature is the line of pin straighteners just to the left of the meter. In addition to the usual 7- and 9-pin straighteners Mercury has included straighteners for Nuvistors, Novars, and compactrons. Most testers don't have even the 7- and 9-pin straighteners.

The unit is housed in a suitcase-style wood case, with leatherette covering. There is a large cable compartment which can hold the accessory CRT testing cable. This cable is available at extra cost (\$12.45) and enables the Model 2000 to test all CRT's including color types.

*For further information circle 52 on literature card*

### RF Signal Generator

Pictured in Fig. 3 is RCA's new WR-50B signal generator. At first glance, it appears to be an update of the older WR50A, which we analyzed in the June 1964 issue of PF REPORTER. After a look at the schematic, and a peek inside, about the only thing we could find that hadn't been radically changed were the knobs.

They also retained the same fine tank circuit components. As we noted before, the stability and calibration accuracy of the WR50 is exceptional for an instrument of this price range. We checked the drift on the WR50B, and from a cold start to an hour later, frequency moved less than 50 kHz at 30 MHz. Calibration accuracy is about as close as you can eyeball it at that frequency. We measured and found the accuracy was better than 1% on all bands.

Among the operational features new to the WR-50B is an attenuator for the Xtal oscillator. This in-



Fig. 3. RF Signal/Sweep Generator.

#### RCA WR-50B Specifications

##### Variable Oscillator

Frequency:

85kHz—40MHz in 6 bands.

(Has strong second harmonic to 80MHz).

Output:

50,000  $\mu$ V minimum on fundamental.

Calibration Accuracy:

$\pm$  2%.

Internal Modulator:

400Hz, 0-30%.

External Modulation:

15-kHz maximum frequency, 10 volts required for 30% modulation.

Sweep Oscillator

Center Frequency:

455kHz and 10.7MHz in 2 fixed bands.

Sweep Width:

Approximately 10% center frequency.

Crystal Oscillator

Frequency:

100kHz—15MHz.

Output:

20,000  $\mu$ V.

Internal Modulation:

approximately 20%

Audio Output:

8VRMS across 15 K ohms.

Attenuator

VFO & Sweep:

10-1 switch plus variable.

Xtal:

Additional 7-1 step.

Power Requirements:

105-130VAC 15 watts.

Size (HWD):

7 $\frac{3}{4}$ " x 5 $\frac{3}{8}$ " x 4 $\frac{3}{4}$ ".

Weight:

5 pounds.

Price:

\$65.

• Please turn to page 69



### A NEW TUNER CLEANER

*Specially*  
**FORMULATED**  
FOR  
**TV-TUNERS**

USING

**NUVISTORS & TRANSISTORS**

Nuvisitors and Transistors are highly sensitive to drift from ingredients in most ordinary TV tuner cleaners. Drift has been found to cause call backs and expensive tuner repairs. For over 18 months CHEMTRONICS has been formulating and testing this new cleaner in both the lab and field. Under the most critical test, there has been NO DRIFT on scope patterns. We invite you to try this test yourself.

**NO NUVISTOR DRIFT**  
*Another FIRST from*



BROOKLYN

N. Y. 11236

Circle 19 on literature card

January, 1967/PF REPORTER 39





**This Service-Dealer Just Earned a \$6.40 Profit in 7 minutes**  
**He Replaced a Portable TV Antenna With a New JFD Exact Replacement.**

**HOW? EASY.**

JFD Exact Replacement	
consumer price .....	\$7.40
Cost to service-dealer .....	— 4.00
Service-dealer profit on sale .....	\$3.40
Plus service charge for installation .....	+ 3.00
<b>Total Service-dealer profit .....</b>	<b>\$6.40</b>

33 million portable TV sets are now in use. Many of these portables will need an antenna replacement within the next 12 months. This adds up to a multi-million dollar market that's growing by 6½ million new portable TV sets each year.

You can make it your market overnight when you feature JFD Exact Replacement TV antennas. When you install a JFD Exact Replacement you make a tidy profit on the sale and the installation—in minutes.

Tens of thousands of smart service-dealers have been doing it since 1952 when JFD started it all with their Exact Replacement antenna line for portable TV sets—a line that now embraces 155 different models covering almost every portable TV antenna made.

JFD also provides you with dramatic displays and sales aids that establish you as portable TV antenna replacement headquarters in your area. See your distributor and get started today.

Write for 1967 JFD Exact Replacement Portable TV antenna catalog. See your SAMS Photofact folders for detailed information.

**ONLY receiving tubes are replaced more often than portable TV antennas!**

**JFD®**

**JFD ELECTRONICS CO.**

15th Avenue at 62nd Street, Brooklyn, N.Y. 11219

JFD International, 64-14 Woodside Ave., Woodside, N.Y. 11377    JFD Canada, Ltd., Canada  
 JFD de Venezuela, S.A., Avenida Los Haticos 125-97, Maracaibo, Venezuela

# Industrial Electronic Notebook

by  
Ed Bukstein

The basic circuits employed in industrial electronics — amplifiers, rectifiers, oscillators, etc.—are essentially the same as their counterparts in other types of equipment. The radio-TV technician can therefore examine an industrial diagram and recognize these familiar circuits in unfamiliar surroundings. Certain features of the industrial circuit, however, may seem strange or mysterious.

## Dual Primary Transformer

The radio-TV technician might be very much surprised, for example, when he discovers that power transformers in industrial equipment often have dual primary windings (Fig. 1). Actually there is nothing mysterious about the dual-primary transformer; it is employed to permit operation from either 115- or 230-volt power sources, both of which are generally available in industrial surroundings. The two 115-volt windings are connected in parallel for 115-volt operation, and in series for 230-volt use. The connections are made so that the magnetic fields produced by the two

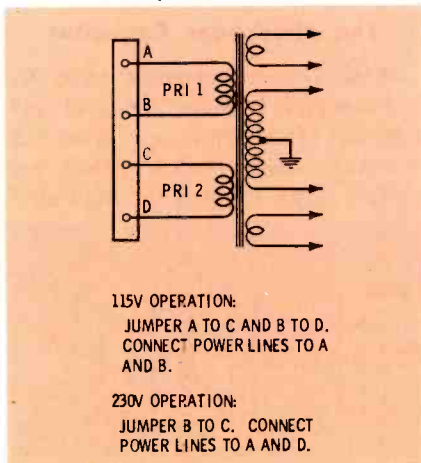

Fig. 1. Dual primary transformer for 115- and 230-volt operation.

windings aid rather than oppose each other.

## Manual/Automatic Control Circuits

The typical on-off device in radio and TV sets is a SPST switch in one side of the power cord. Industrial equipment, however, often employ a more elaborate turn-on and turn-off circuit. For example, automatic shutoff may be required in the event of inadequate flow in a water-cooling system, excessive temperature of critical components, opening of an access door, etc.

In the typical arrangement shown in Fig. 2, the start cycle is initiated by means of the ON push button, which completes the circuit to the coil of line contractor CR1. Normally open contacts CR1-B and CR1-C now close, and line voltage is applied to the equipment to be controlled—an X-ray machine, an induction heater, a motor-control unit, etc. In addition, a normally open contact, CR1-A closes in parallel with the pushbutton. The operator can now release the push button, and the contacts remain closed.

The power can be turned off either manually or automatically. Manual turn-off is accomplished by pressing the OFF button; this de-energizes the coil of CR1, and all of the CR1 contacts return to their normal (open) positions. Automatic turn-off is controlled by the normally closed contacts in series with the OFF button. These contacts are components of protective devices such as overload relays, flow switches, temperature limit switches, door interlock switches, etc. If any of these normally closed contacts should open, contractor CR1 is de-

energized and the equipment is disconnected from the line.

## Anti-Chatter Relay Circuit

Thyratrons are frequently employed as relay-controlling components. In the circuit shown in Fig. 3, the relay coil is connected in the plate circuit of the thyratron, and the grid is held negative by a control signal. The relay remains de-energized as long as the control signal is present. The control signal can be supplied by a phototube, temperature-sensing circuit, limit switch, etc. When the control signal is reduced or removed, the thyratron ionizes and the relay becomes energized.

Because the grid of a thyratron loses its effectiveness as a control element after the gas is ionized, some other means must be employed to de-ionize the thyratron. An AC plate supply performs this function in Fig. 3. The thyratron de-ionizes during each negative alternation of plate voltage, permitting the grid to regain its control function during the first negative alternation after the control signal has been restored to the grid.

During the interval when the con-

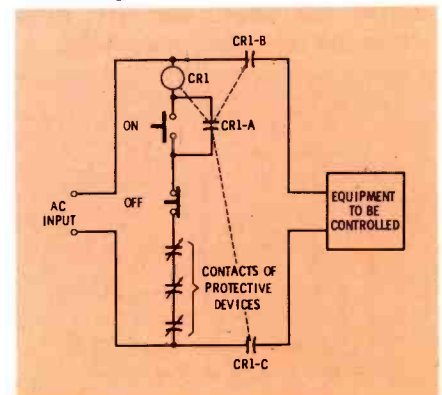

Fig. 2. Input circuit can be turned off automatically or manually.



trol signal is not present at the grid, the relay should remain energized. However, during each negative alternation of plate voltage, the relay will attempt to de-energize. This will cause the relay to chatter at the line frequency. To prevent this chatter, a capacitor is connected across the relay coil, as shown. This capacitor charges through the thyatron during the positive alternations of plate voltage. A resistor in series with the capacitor limits the surge current which might otherwise damage the thyatron. During the negative alternations of plate voltage, the discharge current of the capacitor keeps the relay energized. Therefore, the relay remains continuously energized during the interval when the control signal is not present at the grid.

### Voltage Regulation

Voltage regulation in industrial circuits is frequently more critical than the regulation required in radio and TV circuits. This is particularly true of the high-sensitivity circuits used for industrial measurement and automatic control. A simple but effective regulator circuit (shown in Fig. 4.) employs a voltage regulator tube connected across the output of the power supply. The voltage regulator tube is a cold-cathode, gas-filled diode. As is characteristic of gas-filled tubes, the voltage drop across the ionized gas remains constant. An increase of current flow through the tube will not produce an increase in the voltage dropped across the tube. The voltage across the tube remains constant because an increase of current is accompanied by a decrease in resistance of the ionized gas. Since the resistance decreases when current increases, the IR drop across the tube does not change.

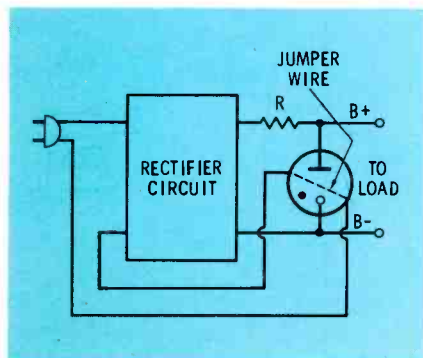

Fig. 4. Regulated output circuit.

Resistor R, in series with the regulator tube, "absorbs" the changes of supply voltage. If the line voltage should increase, for example, the regulator tube will draw more current. The voltage across R will increase, allowing the output voltage to remain relatively constant over a wide range of line voltage variations or load changes.

A jumper wire inside the regulator tube is connected between the two base pins. The purpose of this jumper is to protect the load circuit from the effects of excessive voltage. If the regulator tube is pulled out of its socket, during servicing procedures for example, less current will flow through series resistor R. Since the drop across R is now smaller, the output voltage increases and may damage the load. As shown in the diagram, the jumper wire in the tube is connected in series with the AC input. Therefore, removal of the tube from its socket will disconnect the input to the rectifier, preventing damage to the load.

### Modulated-Light Photorelay

Photoelectric relays are used extensively in industrial applications, such as production counting, bin-level control, automatic packaging, etc. Since these circuits must operate in well-lighted industrial environments, they must be designed to "ignore" ambient light. In most applications this is not a serious problem because the control light source is located within a few feet of the phototube. The intensity of the source, as seen by the phototube, is therefore considerably greater than the intensity of the background illumination. For this reason, the phototube can easily distinguish between the control light and the background light.

When the mechanics of the installation require that the control light source be located at a consid-

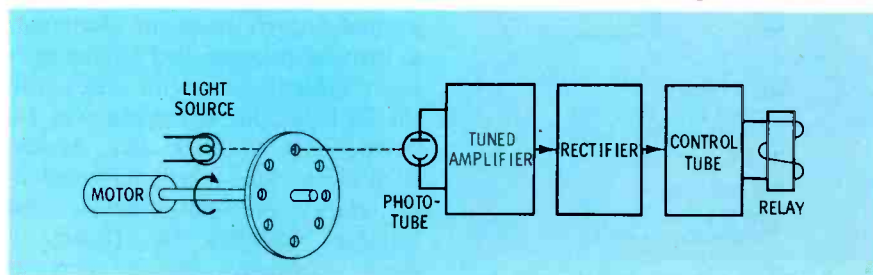

Fig. 5. Modulated-light photorelay.

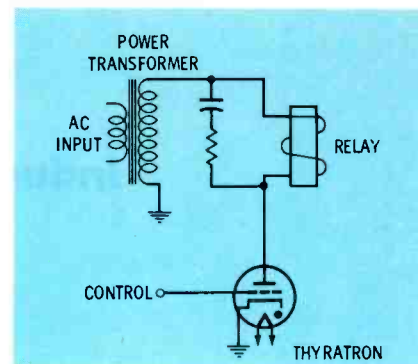

Fig. 3. Anti-chatter relay circuit.

erable distance, the phototube must "see" a weak control light against a strong background light. This problem is solved by the use of a control light whose characteristics differ from the background illumination. As shown in Fig. 5, the control light is modulated by a rotating disc. The circuit is so designed that it can distinguish this weak, flickering beam of light in the presence of a relatively constant background illumination. Systems of this type will operate reliably over distances of several thousand feet.

The motor-driven disc has a series of openings that "chop" the light beam at a rate determined by the number of holes and by the speed of the disc. Typically, the beam is chopped at a rate of 500 to 1500 hertz. Because the phototube amplifier is tuned to the chopping rate, it responds to the modulated light beam and ignores the steady background illumination. After amplification, the AC component of the phototube signal is rectified. The resulting DC potential biases the control tube below cutoff—or drives it into conduction if a *light-actuated* rather than a *dark-actuated* circuit is required.

### The Shockover Capacitor

A shockover capacitor (Fig. 6) is connected between the grid and cathode of a thyatron. With the thyatron biased below cutoff, no current flows through the load until



# This part speaks for the whole radio.



## This box speaks well of you.

To the listener, the speaker is the most important part of the radio. Reason enough that it be of the highest quality and reliability. And when it says Delco on the box you can be certain you've got it: genuine OEM quality.

Delco Radio Parts are designed by engineers who specialize in automotive radios. Delco Radio speakers, for example, provide greater efficiency and sensitivity per ounce of magnet than any other speakers built. And since nearly half the cars on the road



have Delco Radios as original equipment, you are assured of a vast pre-sold market.

Doesn't it make sense to stock the best for your customers?

They know Delco's reputation. So, the next time you reorder, remember your United Delco Supplier. He handles the most widely advertised, merchandised and recognized name in the parts business.

Why not let Delco Radio speakers say something nice about you?

Delco Radio, Division of General Motors, Kokomo, Indiana.

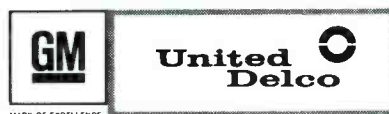

Circle 19 on literature card

**FINCO**  
"has 'em both!"



Model #65-1  
\$2995  
list

Model #65-2  
\$3995  
list

**BOOSTER COUPLERS FOR 300 OR 75 OHM**

For Deluxe Home or Commercial Use

Now available for either 75 OHM CO-AX or 300 OHM operation . . . you can't beat the price, quality and performance of Finco's famous 2-tube, 4-set VHF or FM Distribution Amplifiers. Finco challenges 'em all! Equip either model with Finco low loss splitters (#3001 or #3003) and you can drive up to 16 sets in a master antenna system!

All Finco Products Are Engineered for Color!



**THE FINNEY COMPANY**  
34 West Interstate Street, Bedford, Ohio

Circle 21 on literature card

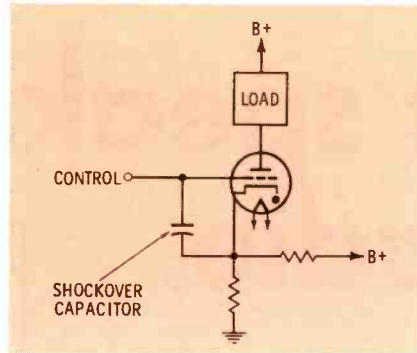

Fig. 6. Shockover capacitor used to prevent premature thyatron firing.

a positive control signal is applied to the grid. Were it not for the shockover capacitor, the thyatron would ionize as soon as the B+ voltage is applied (even if a positive control signal is not present at the grid). Such premature firing of the thyatron would occur because the thyatron behaves like a capacitive voltage divider. Since the cathode-to-grid capacitance and the grid-to-plate capacitance are in series with the load and the B+ supply, the application of B+ voltage charges the resulting series capacitances within the tube. The charge that builds up across the cathode-to-grid capacitance is positive at the

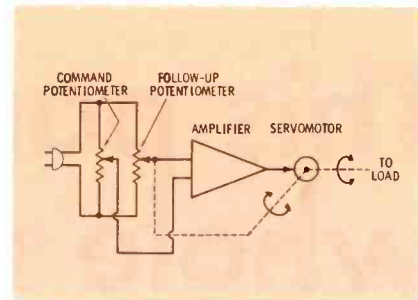

Fig. 7. Load position control employing servo system.

grid, and if high enough in amplitude, can fire the thyatron.

The voltage distribution in a capacitive voltage divider, is inversely related to capacitance; therefore, less voltage builds up across the larger capacitance. By increasing the cathode-to-grid capacitance of the thyatron, the shockover capacitor reduces the voltage to which this capacitance charges, and thereby prevents premature firing the thyatron. In addition, the shockover capacitor also serves to bypass spikes of noise voltage that might otherwise fire the thyatron.

**Load Positioning Control**

Servomechanisms are employed industrially for machine control and other load-positioning applications. As shown in Fig. 7, the mechanical load is positioned by a servomotor. This motor also drives the follow-up potentiometer through a speed-reducing gear. The command potentiometer is the manual control which permits the operator to move the load to the desired position. Because of the mechanical feedback from the motor to the follow-up potentiometer, this potentiometer is automatically adjusted to match the setting of the command control. If these two potentiometers are not at the same setting, a difference of potential will exist between their sliders. This voltage is amplified to drive the servomotor. When the motor has adjusted the follow-up potentiometer to a setting corresponding to that of the command control, there is no longer a difference of potential between the two sliders. Since there is no input to the amplifier, the motor now stops.

The direction of rotation of the servomotor is determined by the phase of the driving signal from the amplifier; therefore, the motor rotates in a direction determined by the direction in which the oper-

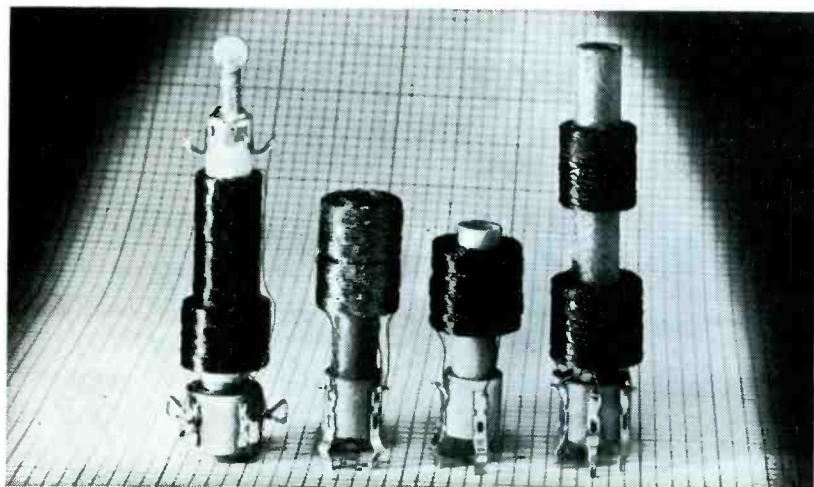

**Exact Replacement Linearity Coils for More than 25 Color TV Manufacturers**

Exact replacement Models 6347 and 6348 Red/Green Convergence . . . Model 6349 Horizontal Oscillator and Waveform . . . and Model 6350 Focus coils are for Color TV sets by manufacturers such as RCA • Admiral • GE • Silvertone • Emerson.



Write today for your Linearity Coil Cross Reference Guide.

**J. W. MILLER COMPANY**

5917 SO. MAIN STREET • LOS ANGELES, CALIFORNIA 90003

SEE YOUR LOCAL DISTRIBUTOR FOR FULL LINE OF RF & IF COILS, CHOKES, FILTERS & TRANSFORMERS.

Circle 20 on literature card



ator has turned the command shaft. In this manner the operator can position a heavy load simply by setting the command control. For applications requiring automatic control, the command shaft is adjusted by a motion-producing device. For example, a bellows responding to changes of air pressure can supply the force to position a low-torque potentiometer.

### Thermocouple Break Protection

Industrial temperature-controllers frequently employ thermocouples for sensing furnace temperature. The voltage from the thermocouple circuit is balanced against a reference voltage. When temperature is at the desired value, these two voltages cancel and no corrective action occurs. However, if the thermocouple voltage is either larger or smaller than the reference voltage, the difference voltage represents the errors of the system. The difference voltage is used to control a valve in the fuel line to the furnace, which adjusts the fuel flow to restore the temperature to the desired value. The difference voltage is also applied to a pen-type recording instrument which traces a graph of temperature versus time on a paper chart.

Because the thermocouple operates in a high-temperature environment, and in some applications is exposed to corrosive gases, it is subject to mechanical damage. If the thermocouple should open. It will no longer produce the voltage required to cancel the reference voltage. The circuit will interpret this as meaning "the furnace is too cold" and will cause the fuel valve to open wide. Consequently, the temp-

# You earn your FCC First Class License

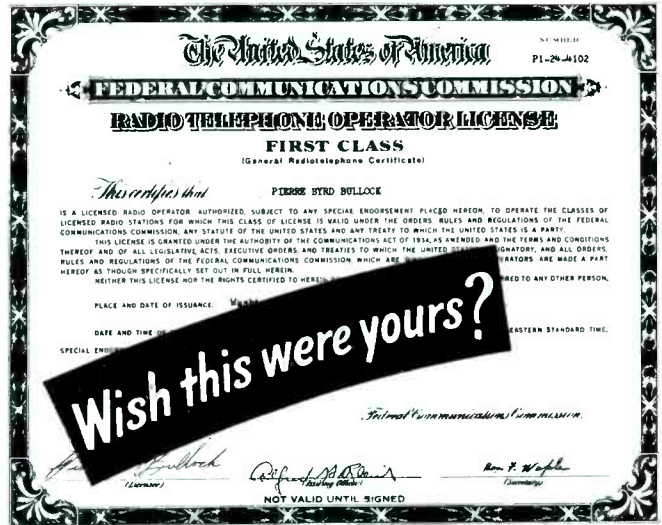

## or your money back

### THERE'S A WORLD OF OPPORTUNITY FOR THE MAN WITH AN FCC LICENSE

All it takes is a few spare hours a week and NRI's FCC License Course to open the way to increased opportunities in Communications. With an FCC License, you're ready to operate, service and install transmitting equipment used in aviation, broadcasting, marine, mobile and Citizens-Band communications.

What does it take? Men with absolutely no training or experience in Electronics complete the course in 10 months. A Technician or man with some background can easily cut that time in half. And because NRI has a greater enrollment than any other school of its type, training costs you less than comparable courses offered by other schools. Further, YOU MUST PASS your FCC exams or NRI refunds your tuition in full.

Get full details about NRI FCC License Course plus other home-study plans offered by NRI, oldest and largest school of its kind. Mail coupon. No obligation. No salesman will call. NATIONAL RADIO INSTITUTE, Washington, D. C.

**Available Under NEW GI BILL.** If you served since January 31, 1955, or are in service, check GI line in coupon.

### MAIL for FREE CATALOG



NATIONAL RADIO INSTITUTE  
Electronics Division  
Washington, D. C. 20016

22-106

Please send me complete information on FCC License Training and other NRI courses, as checked below. (No salesman will call.)

- |  |   |
|--|---|
| <input type="checkbox"/> FCC License             | <input type="checkbox"/> Radio-TV Servicing         |
| <input type="checkbox"/> Complete Communications | <input type="checkbox"/> Industrial Electronics     |
| <input type="checkbox"/> Aviation Communications | <input type="checkbox"/> Electronics for Automation |
| <input type="checkbox"/> Marine Communications   | <input type="checkbox"/> Basic Electronics          |
| <input type="checkbox"/> Mobile Communications   | <input type="checkbox"/> Math for Electronics       |

Check for facts on new GI Bill.

Name \_\_\_\_\_ Age \_\_\_\_\_

PLEASE PRINT

Address \_\_\_\_\_

City \_\_\_\_\_ State \_\_\_\_\_ Zip \_\_\_\_\_  
Code \_\_\_\_\_

ACCREDITED MEMBER NATIONAL HOME STUDY COUNCIL

## Brand NEW FROM HICKOK

### MODEL 209C 9-INCH VTVM



#### HIGHLIGHT FEATURES

- |   |   |
|---|---|
| <ul style="list-style-type: none"> <li>... Large 9" Display</li> <li>... Ultra Stable Circuitry</li> <li>... High Input Impedance</li> <li>DC—11 megohms</li> <li>AC—10 megohms, 11pf</li> <li>... AC Measurements Up To 200mc</li> <li>... High Accuracy</li> <li>DCV, ACV—±3%FS</li> <li>Ohms, Capacity—±3% ARC</li> <li>... Lightweight—15 lbs.</li> <li>... Fully Field Tested</li> </ul> | <ul style="list-style-type: none"> <li>... Measurement Ranges</li> <li>DC Voltage—0-1500v</li> <li>DC Current—0-1500ma</li> <li>AC Voltage (RMS)—0-1500v</li> <li>AC Voltage (P-P)—0-1500v</li> <li>Decibels—-10db to +66db</li> <li>Resistance—0.2 ohm to 1000 meg.</li> <li>Capacity—50pf to 2000Mfd</li> <li>Inductance—obtainable mathematically from scale readings</li> </ul> |
|---|---|

Price \$184.50

THE HICKOK ELECTRICAL INSTRUMENT CO. • 10514 Dupont Avenue • Cleveland, Ohio 44108

Circle 22 on literature card

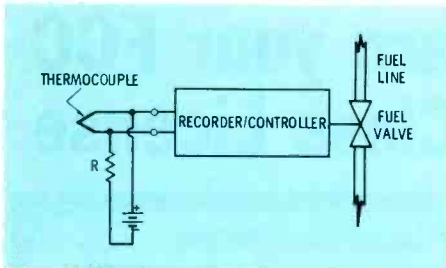

Fig. 8. Protected temperature control system using thermocouple.

erature of the furnace will rise above the desired value. Since the open thermocouple cannot sense this increase of temperature, the valve will open still wider and the temperature will increase still further. To safeguard the system against this runaway condition, a protective circuit is employed.

As shown in Fig. 8, a DC potential is applied to the thermocouple and series resistor R. Since the resistance of the thermocouple is extremely small compared to the value of R, practically all of the voltage appears across R. However, if the thermocouple should open, practically all of the voltage will appear across the open circuit. Because this voltage exceeds the reference voltage, the circuit interprets this to mean "the furnace is too hot". As a result, the circuit causes the fuel valve to close. In this manner, temperature runaway is prevented in the event the thermocouple opens.

#### Self-Latching Relay

Industrial circuits often require self-latching relay action. The relay energizes in response to a trigger signal and then remains energized after this signal is no longer present. This type of action can be accomplished with a mechanically locking relay. However, the same action can also be obtained with a relay of conventional construction as shown in Fig. 9.

A positive pulse applied to the grid drives the control tube into conduction. The relay now energizes and activates the controlled device—motor, lamp, bell, etc. An additional set of contacts establish another pathway for relay current through R and the reset switch. Since the relay coil now has a cur-

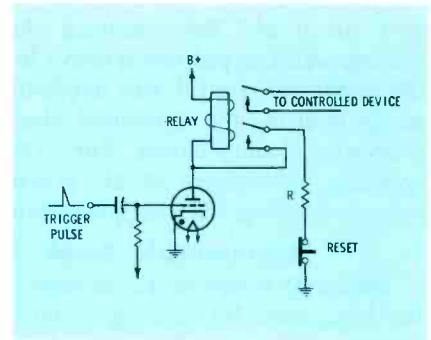

Fig. 9. Self-latching relay circuit.

rent path independent of the tube, the relay remains energized after completion of the trigger pulse to the grid.

By means of the reset switch, the operator can turn off the controlled device. The relay will now remain de-energized until another trigger pulse is applied to the tube. In some applications, the normally-closed contacts of another relay are connected in place of (or in series with) the manual pushbutton. This second relay, when energized, will release the first relay.

#### Conclusion

The preceding paragraphs have pointed out the fact that industrial electronic circuits are not mysterious black boxes or nightmares of complex control circuits using exotic or unconventional electronic components. Although some of the circuits might be unfamiliar, the technician need not shy away from the field of industrial electronics as long as he has a thorough basic understanding of electronic components. Part II of this article will introduce other industrial applications of electronics, including the differential transformer, phase-controlled rectifier, saturable reactor, and conductivity meter. ▲



## The Heart of your Radio is Its



### INSIST ON CQC\*



\* Controlled Quality Crystals available only from Texas Crystals dealers. Extensive precision testing throughout manufacture enables Texas Crystals to unconditionally guarantee their frequency control crystals. Use of Texas Crystals in space program and by other governmental agencies is evidence of the quality you can count on.

If your dealer can't supply your needs, send his name with your request for catalog to our plant nearest you.



## TEXAS CRYSTALS

Division of Whitehall Electronics Corp.

1000 Crystal Drive      4117 W. Jefferson Blvd.  
Fort Myers, Fla. 33901      Los Angeles, Calif. 90016  
Phone: 813-936-2109      Phone: 213-731-2258

Circle 24 on literature card

# GETS ALL 82 CHANNELS + FM!

UHF-VHF

FULL **COLOR** OR

BLACK AND WHITE RECEPTION

FREE UHF-VHF BAND SPLITTER

**KAY-TOWNES**

## Colorphase

COMBINATION ANTENNA

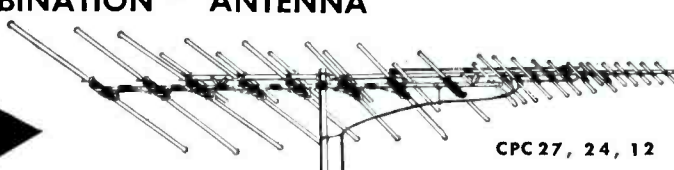

CPC 27, 24, 12



**KAY-TOWNES Antenna Co. 1511 Dean Ave., Rome, Ga. 30162**

Circle 23 on literature card





B&K MODEL 970 RADIO ANALYST

# SERVICE AM & FM AUTO AND TRANSISTOR RADIOS AT A PROFIT!

**NEW!**

Jobs that used to be unprofitable now go so quickly that you can make good money handling them! There are millions of auto radios and transistor radios in the field—portables, auto and table models, plus hi-fi and communications equipment. Instead of turning them away, you can turn them into money-makers with the B&K Model 970 Radio Analyst.

The 970 is effective because it's *accurate* and *complete*. Using the famous B&K signal injection technique, this all-in-one instrument provides the required dc power, lets you test power and signal transistors in and out of circuit; generates RF and audio signals, and includes a rugged, accurate VOM. Four functions in one compact package—with solid state reliability, B&K professional quality.

**LOW INVESTMENT—QUICK RETURN**

See your B&K Distributor or write for Catalog AP22-R

Net \$199<sup>95</sup>



**B & K DIVISION OF DYNASCAN**  
1801 W. BELLE PLAINE AVE. • CHICAGO, ILL. 60613

Export: Empire Exporters, 123 Grand St., New York 13, U.S.A.

## FEATURES:

### BUILT-IN POWER SUPPLY

**Auto Radios**—High current, low-ripple, for transistor, hybrid, and vibrator types.

**Transistor Portables**— $1\frac{1}{2}$  to 12 volts for battery substitution—plus separately variable voltage tap for bias.

### QUICK AND ACCURATE TESTING OF POWER AND SIGNAL TRANSISTORS

**In-Circuit**—stage by stage DC signal injection and sensitive metering of power supply current.

**Out-of-Circuit**—Direct Beta and Leakage meter scale readings. Easy balancing or matching.

### VERSATILE SIGNAL GENERATORS

**RF Generators**—provide broadcast and IF frequencies for both AM and FM bands.

**Audio Generator**—for AM or FM modulation of the RF signals, and for trouble-shooting audio circuits.

### RUGGED VOM

**Volt-OHM-Milliammeter**—with rugged, taut band meter—provides correct ranges for easy, fast servicing of all home and auto radios, as well as transistor portables.

**NOW!**

**Join the  
P.O.M. Club!**  
(Photofact-of-the-  
Month Club)

**ONLY \$10 PER MONTH  
brings you 20% MORE  
PHOTOFACT® coverage!**

**NOW! more current model  
coverage each month to keep  
you ahead earning more—  
AND YOU SAVE OVER  
\$60 PER YEAR!**

As a PHOTOFACT-OF-THE-  
MONTH CLUB member, you get  
6 new PHOTOFACT Sets every  
month—the world's finest  
TV-radio service data—with  
all the time-saving, profit-  
boosting help you want!

**AT LEAST  
6 COLOR TV  
FOLDERS MONTHLY**

*complete current coverage of  
at least 50 chassis each and  
every month for less than*

**20¢ per chassis model!**

To stay ahead, to save money (indi-  
vidually purchased sets now sell for  
\$2.50 each)—join the PHOTOFACT-  
OF-THE-MONTH CLUB now!



**20%  
more!**

**this great new monthly package  
exclusively for P.O.M. members!**

You get your 6 new PHOTOFACT Sets every  
month in sturdy new file folders sealed in  
factory carton to insure perfect condition  
and completeness—easier-than-ever to file  
and use. Now—only \$10 per month and  
you get 20% MORE COVERAGE!

**TRY A THREE-MONTH P.O.M. SUBSCRIPTION**

see how  
PHOTOFACT  
boosts your  
earning power!

subscribe through  
your Sams  
Distributor  
or use this  
handy  
order form

**HOWARD W. SAMS & CO., INC. Dept. PFF-1**  
4300 W. 62nd St., Indianapolis, Ind. 46268

Enroll me for a 3-month membership in the Photofact-of-the-  
Month Club. I agree to pay \$10 per month, and understand I  
will receive 6 current Photofact Sets monthly for 3 months to  
be delivered by my Sams Distributor (named below).

Name \_\_\_\_\_

Shop Name \_\_\_\_\_

Address \_\_\_\_\_

City \_\_\_\_\_ State \_\_\_\_\_ Zip \_\_\_\_\_

My Sams Distributor is: \_\_\_\_\_

Signed: \_\_\_\_\_

**Bifilar Balun**

(Continued from page 25)

another eyelet, with *nothing* in it but one lead from the capacitor, and the center one at that. This must be the place, as the old burlesque joke says. Anyhow, what have I got to lose? So, I work the wires into this one, solder them, and crawl out from under the cabinet again.

It's not easy to change channels with crossed fingers, but I did. Now, low band; maybe a little better. Good. Now, (cross feet too) the high band. The high band booms in clear as a bell. It's hard to give a Tarzan yell and beat your chest without making a sound, but I did it. So, I checked them all out again, for luck—color, snow, and so on—and then called the widow. She came in with two cups of coffee and a plate of cookies (Told you she was my best customer, didn't I?) We sat down and watched the thing while I made out the bill (and that coffee cooled. She made the best coffee in town, and also the hottest!)

The moral of this story is: If at first you don't succeed, go back and check to see what kind of a mistake you made the first time. Seriously speaking, any of these balun coils can be rewound in an emergency. Because of their broadband nature, they are not as critical as coils in more sharply tuned circuits. As long as you get the connections, the number of turns, and the polarities of the windings right, they seem to do as well as the originals. The big headache, of course, is identifying the wires, particularly if your replacement is color-coded like mine was—all red. An ohmmeter and a couple of twists in the wire will help. Don't be afraid to recheck each connection to make sure that you do have the right wire in the right place. Above all, make up a rough sketch of the coil, core, and other parts before you take anything out. There will usually be enough insulation left around each wire so that you can tell "what went where" (exact-duplicate replacements have the same color code as the original). However, rewinding can save you a lot of time, and make your "best customer" happy—this means a lot more than coffee and cookies. ▲



## Barber Pole

(Continued from page 23)

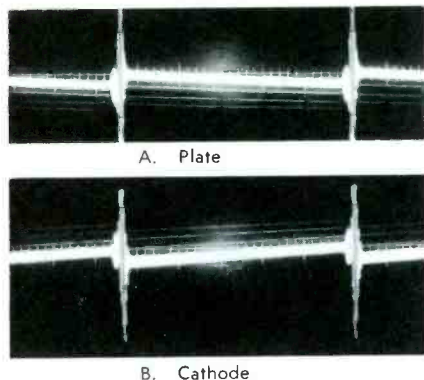

Fig. 5. Burst pulse at phase detector.

detector include mismatched resistors R1-R2, a shorted or leaky C1-C2, or unmatched diode sections of the tube. (Some sets use solid-state diodes, which, of course, are also subject to mismatch).

Assume the reactance oscillator and phase detector stages are operating normally. They've passed our simple but conclusive tests. The out-of-sync color bars (barring the possibility of some "odd" problem) must be due to interruption or distortion of the incoming burst signal, in the burst amplifier stage.

### Burst Amplifier Test

In our initial symptom analysis, we reasoned that some color burst was reaching the phase detector. Remember the bandpass stage is open, so the killer is at cut off; killer control voltage is initiated by the presence of color burst in the amplifier output. Our logical test then, is a waveform check for a clean burst signal of proper amplitude at the anode and cathode of the phase detector. For unbalanced operation of the phase detector with color sync applied, a similar burst signal must appear at both the anode and cathode of the detector. Figs 5A and 5B are typical of the burst waveforms at those points. Analyze the waveform checks as follows:

1. If the burst signal at either point is correct, the input circuit and operation of the burst amplifier tube can be considered proper. On the other hand, both signals missing or low in amplitude confirms improper operation of the amplifier.

2. If either waveform is missing or lower in amplitude than the other, the fault is a defect in the

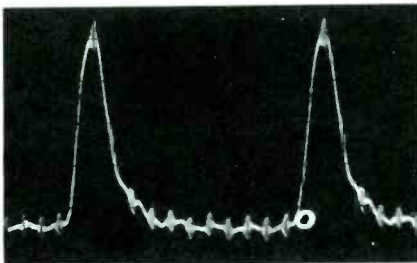

Fig. 6. Signal at grid of burst amp.

section associated with the wrong waveform. Possible causes include an open secondary section of T1, open C1-C2, or defects in the tint control network (and color killer coupling networks connected to the phase detector).

3. The burst transformer (T1) could be defective. A quick check can be made by performing the adjustment for T1 listed in the service data.

The burst amplifier functions much in the same manner as a sync separator. The tube is keyed on during horizontal retrace time; cut off during active scanning time. The grid receives both composite chroma video information and a keying pulse from the horizontal deflection system (Fig. 6).

If this waveform is low in amplitude, or the horizontal pulse is mistimed (color burst is not located at the upper tip of the keying pulse) the result could be a loss of color sync. However, the symptoms of this problem are usually good color lock on strong stations, poor lock on weaker stations.

### Summary

Servicing for loss of color sync can be facilitated by following a systematic isolation approach. The approach isn't unfamiliar—it can be likened to the quick checks used when servicing horizontal oscillator and AFC stages.

See if the oscillator can free-run at 3.58 MHz by defeating the phase detector circuit. Check for a balanced phase detector output. Check for the presence of proper color burst (sync) from the output of the burst amplifier. If an odd problem arises, try performing the alignment procedure outlined in service information for the particular chassis. If any adjustment fails to perform its function, check the components directly associated with the adjustments. ▲

ONE GREAT SOURCE  
FOR ALL YOUR  
rear seat  
**AUTO SPEAKER  
KIT needs!**

Simplify your inventory problems . . . elevate your quality image with one simple action. Standardize on the complete Oxford line of rear seat auto speaker kits. The Oxford line embraces three separate price and value ranges . . . the Custom line . . . the Deluxe line . . . and the Standard line. In all, there are 11 different speaker kits to choose from in these three ranges.

All are engineered to peak performance and value standards. Alnico V magnets and oversize gap clearances compatible to original automotive equipment are features of all three lines. Easy to install; solderless connectors used on all speakers. Top quality switches and faders featured throughout. Wire harnesses are completely assembled, and heavy gauge plastic coated wire are additional top quality hallmarks of the Oxford line. Both switches and controls are fungus and moisture resistant. All necessary hardware included.

Write for catalog A-105 today and learn how Oxford can make and save extra money for you!

**OXFORD TRANSDUCER  
COMPANY** A Division of  
Oxford Electric Corporation  
3911 S. Michigan Ave.  
Chicago, Ill. 60653

Circle 27 on literature card

# F. C. C. LICENSE TRAINING

by correspondence

The best there is!

Ask about our

**MONEY-BACK  
WARRENTY**

Approved for  
veterans and servicemen

For free information, write:

Dept. 69-S

**GRANTHAM SCHOOL  
OF ELECTRONICS**

1505 N. Western Ave.  
Hollywood, Calif. 90027

1966 Depreciation	16 2/3 %	\$800	
1967 Depreciation	16 2/3 %	800	
1968 Depreciation	16 2/3 %	800	
1969 Depreciation	16 2/3 %	800	
1970 Depreciation	16 2/3 %	800	
1971 Depreciation	16 2/3 %	800	4,800

However, Brown may decide, because of the nature of his business, that the depreciation period be limited to five years, using a method that permits him to establish a larger depreciation reserve during the first five years of use. He would then use the "Sum of the Years-Digit Method" of computing depreciation, which uses a different fraction each year. He would add 1 + 2 + 3 + 4 + 5, and the sum of the years would be 15. The tangible asset at the beginning would have a useful life of five years, therefore the depreciation for the first year would be 5/15 of

cost, 4/15 for the second year, etc. The schedule would then appear as:		
1966 Depreciation	5/15 of \$6,000	\$2,000
1967 Depreciation	4/15 of 6,000	1,600
1968 Depreciation	3/15 of 6,000	1,200
1969 Depreciation	2/15 of 6,000	800
1970 Depreciation	1/15 of 6,000	400
		<hr/> \$6,000

While Brown is evaluating methods to accumulate a large depreciation reserve during the first years of use, he might consider the "Declining Balance Method" as an alternative, which would permit him to compute depreciation at a rate as high as 40% annually (twice the straight-line rate) or the declining balance. The computation would show the following schedule:

Cost of equipment	January 1, 1966	\$6,000.00
1966 Depreciation	40% of \$6,000	2,400.00
		<hr/> 3,600.00
1967 Depreciation	40% of 3,600	1,440.00
		<hr/> 2,160.00
1968 Depreciation	40% of 2,160	864.00
		<hr/> 1,296.00
1969 Depreciation	40% of 1,296	518.40
		<hr/> 777.60
1970 Depreciation	40% of 777.60	311.04
		<hr/> 466.56

### Conclusion

The foregoing discussion is intended, primarily, to acquaint the dealer or self-employed service technician with the methods of computing depreciation on test equipment, service vehicles, and other forms of tangible assets used in maintaining a business. The choice of a particular method will depend on such factors as the useful life of the equipment and the period of time over which the depreciation is to be spread. This, of course, can be determined only by the dealer or service technician. ▲

## Brand NEW FROM Hickok

### MODEL GC-660—COLOR BAR GENERATOR

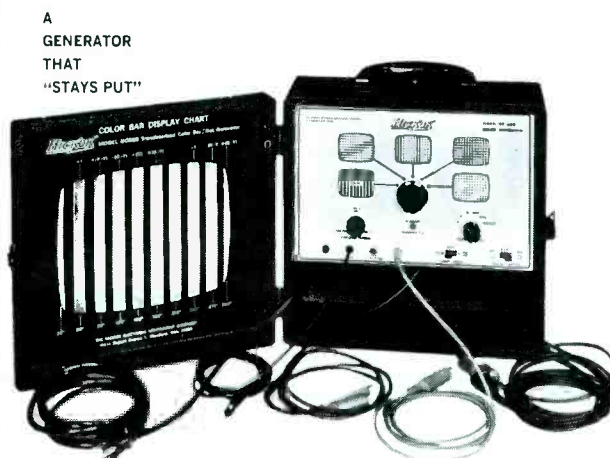

A  
GENERATOR  
THAT  
"STAYS PUT"

Price  
\$159.50

■ A proven, field-tested design ■ "Stays put"—designed for Alaskan cold and Florida heat and humidity\* ■ 0.1 μsec dots—plus a crosshatch pattern that doesn't "flicker" ■ Standard gated color bars at zero reference level—for correct color phasing adjustments.

Let's face it, the biggest problem you've had in using anybody's color generator has been having it work right every time you turn it on—you can't get much use out of a generator that wastes your time while you wait for it to settle down, lock in, and stay put. Hickok's new Model GC-660 has actually been tested for its ability to "stay put" not only in field tests but in a Military Standard Environmental Chamber. It's not perfect but we think it beats anybody else's. Why not ask your Hickok distributor for a demonstration and prove it to yourself?

THE HICKOK ELECTRICAL INSTRUMENT CO. • 10514 Dupont Avenue • Cleveland, Ohio 44108

Circle 29 on literature card



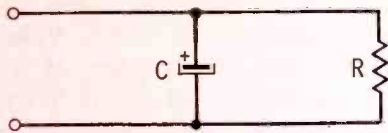

Fig. 14. Equivalent circuit of leaky capacitor.

series resistance present. Suppose the reactance is 100 ohms, and the series resistance is 60 ohms. Then, the impedance is 116.6 ohms. A capacitor checker indicates the *power factor* of the capacitor. The power factor is equal to the resistance in ohms (R) divided by the impedance in ohms (Z), or  $Pf = R/Z$ .

A good capacitor has practically zero resistance. Therefore, the power factor is equal to  $0/Z = 0$ . In other words, the power factor of a good capacitor is zero. On the other hand, suppose that a capacitor is nearly shorted; its impedance is practically the same as its resistance, and the power factor of the capacitor is equal to 1. We often speak of the power factor in percentage. Percentage means hundredths. For example, a power factor of 0.5 is equal to a power factor of 50%. Most capacitor checkers indicate the power factor as a percentage.

#### Equivalent Series and Parallel Resistance

When a capacitor is leaky, it is the same as if the capacitor were connected in parallel with a resistance, as shown in Fig. 14. This is a different configuration from that of Fig. 13. However, note carefully that every parallel RC circuit has an equivalent series RC circuit, as shown in Fig. 15.

1. The impedance of a series RC circuit is the hypotenuse of the triangle.
2. The impedance of a parallel circuit is the perpendicular dropped to the hypotenuse of the triangle.
3. If we have a given impedance Z, this impedance can be produced by  $R_s$  and  $X_s$ , or  $R_p$  and  $X_p$ .

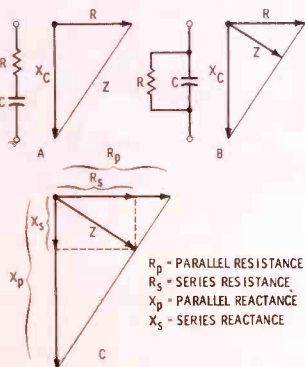

Fig. 15. Impedance of series and parallel RC circuits.

*the instrument with  
endless uses ... the all new  
improved completely solid state*

## SENCORE FS134 FIELD STRENGTH METER



only  
**199.50**

lowest price going

HERE ARE JUST A FEW OF THE MANY USES...



**INSTALLING AND CHECKING OUT DISTRIBUTION SYSTEMS**  
Qualify for this multi-million dollar business in hotel, motel, and hospital installations.



**COLOR INSURANCE**  
Be sure the signal is adequate on each channel for proper color TV operation.

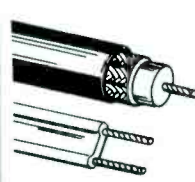

**CHECK TRANSMISSION LINES**  
For the first time read actual db loss in either 75 or 300 ohm transmission lines.

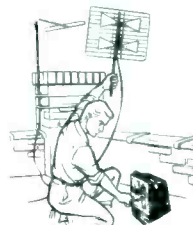

**INSTALLING UHF, VHF, AND FM ANTENNAS**  
Cut down installation time and pay for the FS134 in a short time on critical UHF as well as VHF and FM antennas.

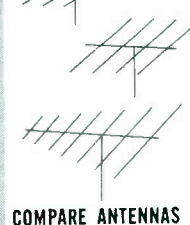

**COMPARE ANTENNAS**  
For actual db gain; see which is best for each location, both VHF and UHF. Also excellent for orienting "dishpans" for translator use at the high end of UHF band.

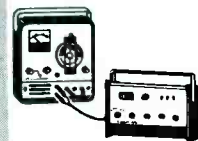

**CHECK ANY GENERATOR OUTPUT**  
For correct frequency and output all the way up to a tenth of a volt RMS. What a time saver when you want to know if your generator is putting out.

#### PLUS: LOCALIZE NOISE AND INTERFERENCE

Fine noise source fast; pick quiet locations for antenna installations or orient antenna away from noise when possible.

These are only a few uses of this UHF-FM-VHF accurately microvolt calibrated field strength meter. You can start paying for the FS134 tomorrow in the time saved today—if you see your Sencore distributor now. Why not pick up the phone and ask him to show you the new FS134?

SEE AMERICA'S MOST COMPLETE LINE OF PROFESSIONAL TEST INSTRUMENTS—AT YOUR DISTRIBUTOR'S NOW.

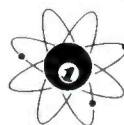

**SENCORE**

NO. 1 MANUFACTURER OF ELECTRONIC MAINTENANCE EQUIPMENT

426 SOUTH WESTGATE DRIVE, ADDISON, ILLINOIS 60101

Circle 30 on literature card

January, 1967/PF REPORTER 55

# PROFIT!

## Stock New Mosley Ham and CB Antennas

### The Classic 33

TRAP AMATEUR  
MASTER BEAM

a Tri-Band Beam

A 'Classic' Full Power rated addition to the Trap-Master family. Features a new matching system for added gain . . . 8 db. over reference dipole; 10.1 db. compared to isotropic source. Mosley advertising reinforces your selling efforts.

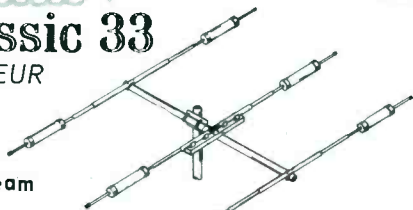

### LANCER 1000

AMATEUR MOBILE ANTENNA

for 10, 15, 20, 40 and 75/80 meters

This mobile antenna gives full 2 KW punch where it's needed the most. Rated for 1 KW AM/2 KW P.E.P. SSB input to the final on 5 bands. Minimum SWR. Be ready to cash in on Lancer 1000 sales. Stock up now!



### CADET CITIZENS BAND MOBILE ANTENNA

SUC-1

For temporary mobile installations on cars, boats etc. Features suction cup mount. Length 3'. No ground. Operates on all surfaces - - even wood and fiberglass.

PER-1

Similar to SUC-1 but designed for permanent installations.

Stock these profitable antennas now being advertised in CB publications.

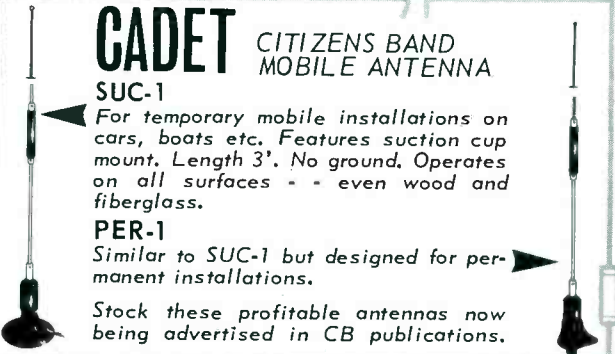

### STACK'IT CITIZENS BAND BEAMS

STACK'IT 3 (3 el.);  
STACK'IT 4 (4 el.);  
STACK'IT 5 (5 el.);  
These are new Mosley stacked beams now being announced to CB'ers. Beams and all parts - - - even coax, boom and hardware included. Be ready for CB Stack'it beam requests.

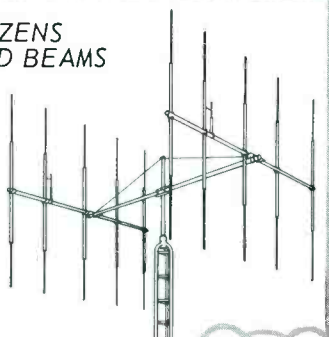

We see that comparatively high values of resistance and reactance connected in parallel have the same impedance as comparatively low values of resistance and reactance connected in series. Your capacitor checker measures the power factor of a capacitor, whether the resistance is in parallel, in series, or whether some of the resistance may be in parallel and some of the resistance in series. In any case, the power-factor reading is correct. However, it follows from Fig. 15 that a power-factor measurement alone cannot tell us whether the capacitor is leaky (parallel resistance present). Therefore, your capacitor checker also has a leakage test, to determine whether a poor power factor is being caused by leakage.

### Conclusion

We have seen how Ohm's law applies to AC circuits, and how AC voltages are added together. The meaning of reactance and impedance is evident, and we know how to find the reactance of a capacitor or an inductor by using a simple chart. We also recognize the meaning of power factor, and why a poor power factor does not necessarily mean that a capacitor is leaky. In the future, we will dig a little deeper into Ohm's law for AC circuits, and explain measurements of resistance, reactance, and impedance at broadcast, HF, and VHF frequencies. Such explanations should greatly simplify a number of practical problems confronted at the service bench. ▲

## Brand NEW FROM HICKOK

MODEL 860 INJECTO-TRACER



Price \$149.50

Combination signal tracer, signal generator and power supply for fast and profitable servicing of all types of AM and FM radios, including auto radios and TV sound circuits.

- Injects and picks up RF from 240 to 1750KC plus audio
- Covers 10.7MC FM IF
- Regulated, metered, high-current power supply
- Modern, reliable, all solid-state design.

SEE YOUR HICKOK DISTRIBUTOR FOR A DEMONSTRATION

THE HICKOK ELECTRICAL INSTRUMENT CO. • 10514 Dupont Avenue • Cleveland, Ohio 44108

Circle 32 on literature card

For more information write Ad no. 117

**Mosley Electronics, Inc.** 4610 N. Lindbergh Blvd.  
Bridgeton, Missouri 63042  
Circle 31 on literature card





# The Troubleshooter

answers your servicing problems

## Shadows and Increased Contrast

I am having double trouble with an RCA CTC11D chassis (PHOTOFACT Folder 550-2). What appear to be shadows flutter across the screen, particularly during warmup. The shadows do not pull or bend the raster or picture, but seem to be superimposed upon the picture.

The other trouble symptom is intermittent brightness modulation, with the picture becoming dark. Both trouble symptoms occur during both color and black-and-white reception. All tubes, including the picture tube, check good. I have been unable to detect any discrepancies in voltages or waveforms. I have recently replaced two multiple section filters in the chassis. Do you have any ideas on the possible cause or causes of the foregoing symptoms.

Cupertino, Cal.

WALTER W. ELLITT

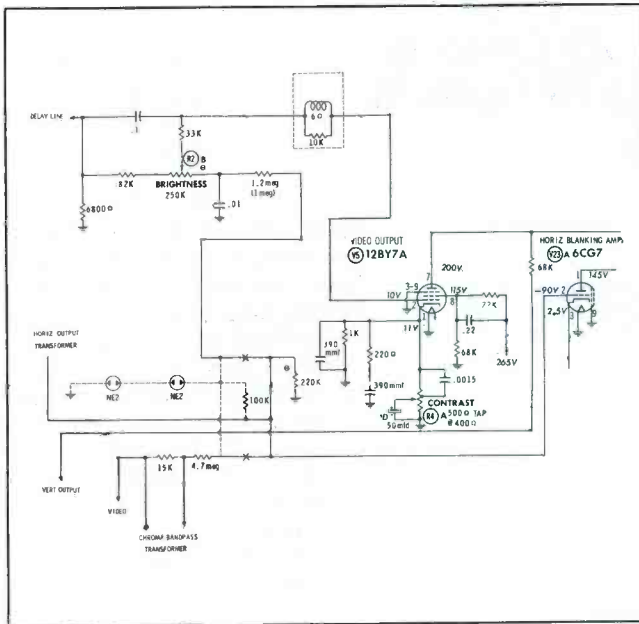

Your description of the shadow symptoms has not made it clear whether the shadow moves across the screen vertically or horizontally. A horizontal shadow or bar would indicate a slight 60- or 120-hertz hum caused by insufficient filtering in the low-voltage power supply. However, such hum normally produces a certain amount of picture bending or slight tearing as it moves across the screen. Since you have recently replaced what I assume to be the multiple section electrolytics in the low-voltage supply, it is possible that a bad solder connection is reducing the filtering action of one of the electrolytic sections. A quick scope check of the six low-voltage sources should provide the answer. If the shadow moves vertically across the raster, it could be caused by some form of external interference (a mild windshield wiper effect etc.). There are also internal causes of interference which could cause the same

Swingin'  
Combo  
for  
Top  
Performance!



## NEW SENCORE SM112B SERVICE MASTER VTVM/VOM

Here it is—the third generation of Sencore's famous Service Master—the two-in-one professional instrument that saves your time, speeds your service work, puts extra profits in your pocket.

- Just one function switch, one range switch and one probe provide all functions of VTVM and VOM.
- Voltage, current and resistance in 33 ranges — for accurate measurements anywhere, anytime.
- VTVM operates from 115v AC for precise bench or lab work; battery powered VOM gives you a 5000 ohms per volt meter.
- Lighted arrows automatically indicate VTVM scales.
- Large, easy-to-read 6-inch two percent meter covers all measurements.
- Handsome new styling in tough, vinyl-clad steel case.
- Optional high voltage probe attaches for measuring up to 30,000 volts DC.

So why use two when one will do—the new Sencore SM112B. Truly professional **\$79.95**

High Voltage Probe HP118 ..... **\$7.95**

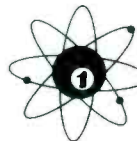

**SENCORE**  
NO. 1 MANUFACTURER OF ELECTRONIC MAINTENANCE EQUIPMENT  
426 SOUTH WESTGATE DRIVE, ADDISON, ILLINOIS 60101

Circle 33 on literature card

January, 1967/PF REPORTER 57

new!



Example:  
82 Channel  
MATV System

# NEW WINEGARD 82 CHANNEL MATV SYSTEM...

## Includes Revolutionary New VHF-UHF "V.I." Variable Isolation Line Tap-Offs\*

Now you can run practically any number of TV sets for 82 channel reception without UHF conversion by using Winegard's flexible MATV system.

A new solid state UHF amplifier, Model A-222 teams up with any Winegard VHF amplifier to a single 82-channel trunk line. Delivers full gain on both the VHF and UHF bands plus FM.

A unique feature of the system is Winegard's new series of 82 channel "V.I." variable isolation line taps.\* At last, you can have uniform 82 channel signal distribution to each tap-off in the system without compromise of picture quality.

All Winegard amplifiers, splitters, line taps—everything—from the antenna to the set are perfectly matched and designed to operate at top efficiency on all 82 channels. The ideal MATV system for stores, apartments, motels, schools and institutions.

Ask your distributor or write for Fact-Finder #248.



**Winegard**  
ANTENNA SYSTEMS

3000 Kirkwood Street • Burlington, Iowa 52601

Circle 34 on literature card

\*Patent Pending

Just a flick of the wiper arm up front permits you to vary the isolation to any value between 10 and 25 db—makes balancing of the line quick, simple and accurate. V.I. Taps accept new low loss foam cable, provide positive connection for all types of trunk lines. Winegard V.I. Taps include ivory wall plate to match standard AC outlets. Available in flush or surface mount, 300 and 75 ohm. All models designed for VHF, UHF and FM.

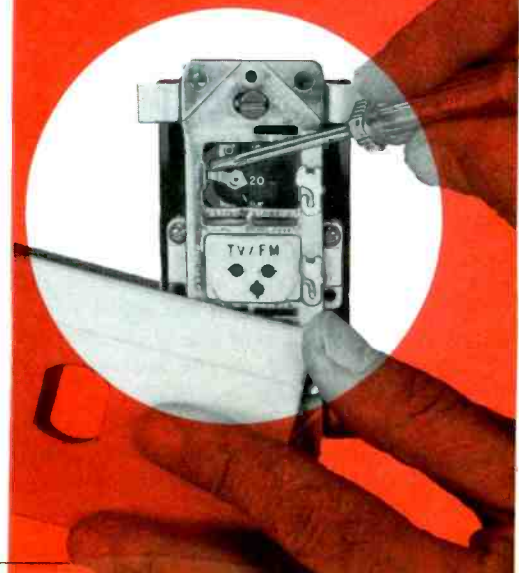



symptom, such as video getting into the horizontal sweep circuit.

The darkening of the picture sounds like excessive contrast caused by either a video overload or a defect within the brightness or contrast circuits. While it is doubtful that an AGC circuit defect is causing the trouble, it would not hurt to eliminate this section as a possible source of trouble by clamping. The most likely source of trouble will be found in the unique brightness control circuit (shown here) employed in this chassis. Early versions of this chassis used two NE2 neon lamps to provide regulation of the fixed bias supplied to the grid circuit of the video output tube and chroma bandpass amplifier. The many instances of failure of these neon regulators has produced insufficient and intermittent brightness symptoms, which at the same time seemed to be caused by the video circuit. If the problem chassis uses the neon lamps, the circuit should be modified as shown on the schematic. Another possible cause of what appears to be excessive contrast or overload is a defective 2-mfd capacitor from the cathode to screen of the first video amplifier. This overload effect is particularly noticeable when the set first comes on. A quick check can be performed by clipping one end of the capacitor—the set operates better without the capacitor than it does with a defective one.

### Delayed Height

The raster of a Motorola Chassis WKTS-584 (PHOTOFACT Folder 692-2) fails to expand to full height for 5 to 8 minutes after the set is turned on. What are the most likely faults that will cause slow warmup symptoms.

Cincinnati, Ohio

ERNEST BONEM

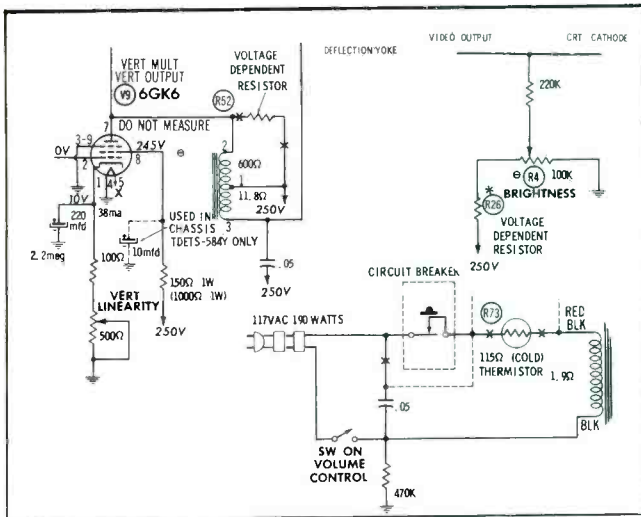

Defective thermistors and voltage dependent resistors (VDR) are possible causes of slow warmup. The trouble symptom will usually pin point the defective component. As an example: In the case of delayed height, such as you describe, the most probable fault exists within the vertical sweep circuit (R52, the VDR in the plate circuit of the vertical output stage). If the slow warmup symptom was a dim raster, the most likely candidate would be R26, the VDR in the brightness control circuit. A combination of symptoms such as reduced height, unstable sync, and dim raster would probably be caused by a defective component in the low-voltage power supply (thermistor R73). There are other causes of slow warmup, such as increased resistance of a fixed heater-voltage dropping resistor, or a marginal cathode bypass capacitor or input filter capacitor.

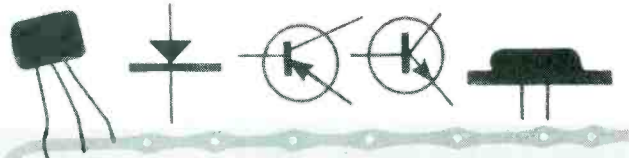

## TEST TRANSISTORS IN SECONDS in circuit

TR139  
89<sup>50</sup>



Also check all  
transistors, diodes,  
and rectifiers out  
of circuit for true AC beta  
and Icbo leakage.

Your best answer for solid state servicing, production line testing, quality control and design.

Sencore has developed a new, dynamic in-circuit transistor tester that really works—the TR139—that lets you check any transistor or diode in-circuit without disconnecting a single lead. Nothing could be simpler, quicker or more accurate. Also checks all transistors, diodes and rectifiers out of circuit.

**BETA MEASUREMENTS**—Beta is the all-important gain factor of a transistor; compares to the gm of a tube. The Sencore TR139 actually measures the ratio of signal on the base to that on the collector. This ratio of signal in to signal out is true AC beta.

**ICBO MEASUREMENTS**—The TR139 also gives you the leakage current (Icbo) of any transistor in microamps directly on the meter.

**DIODE TESTS**—Checks both rectifiers and diodes either in or out of the circuit. Measures the actual front to back conduction in micro-amps.

**COMPLETE PROTECTION**—A special circuit protects even the most delicate transistors and diodes, even if the leads are accidentally hooked up to the wrong terminals.

**NO SET-UP BOOK**—Just hook up any unknown transistor to the TR139 and it will read true AC beta and Icbo leakage. Determines PNP or NPN types at the flick of a switch.

Compare to laboratory testers costing much more. . . \$89.50

See America's Most Complete Line of Professional  
Test Instruments — At Your Distributor Now.



NO. 1 MANUFACTURER OF ELECTRONIC MAINTENANCE EQUIPMENT

**SENCORE**

426 SOUTH WESTGATE DRIVE, ADDISON, ILLINOIS 60101

Circle 35 on literature card

January, 1967/PF REPORTER 59

# A dozen ways to cut down on color call-backs.

In color TV set repair, these 12 Sylvania tubes do most of the work. They cut down on call-backs because their quality is assured by thorough testing before they leave our plant.

Sylvania makes color replacement receiving tubes for every major color TV set manufactured. Available quickly from your Independent Sylvania Distributor.

**SYLVANIA**  
SUBSIDIARY OF  
GENERAL TELEPHONE & ELECTRONICS **GTE**

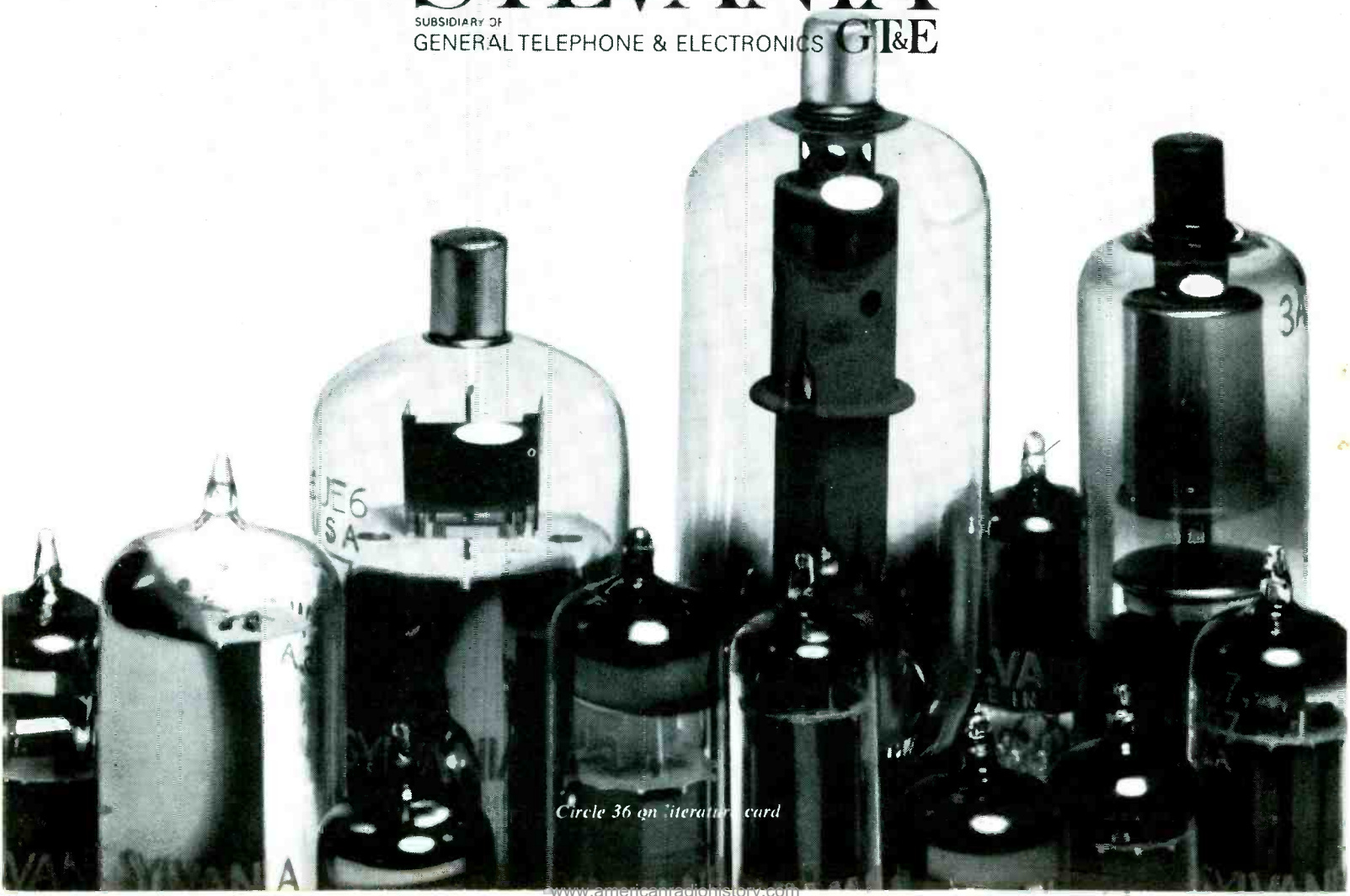

Circle 36 on literature card



# Product Report

For further information on any of the following items, circle the associated number on the Catalog & Literature Card.



**Reactance Slide Rule**  
(154)

This reactance slide rule is a helpful, time-saving means for solving resonant frequency, capacitive reactance, inductive reactance, coil "Q", and dissipation factor problems that cover a frequency range from 5 hertz to 10,000 MHz. Price of the Shure Brothers slide rule is \$1.00.



**Industrial Potentiometer**  
(155)

The 7/8" potentiometer shown here has a precision molded thermo-plastic case, with grooved interior to assure helix integrity of its low temperature coefficient wire element and to provide 0.25% independent linearity. Maximum versatility of adjustment is provided by a shaft which accommodates either a knob or a screwdriver.

The IRC type 8400 offers resistance values from 100 ohms to 100K,  $\pm 5\%$ . Units are rated 2.0 watts at 25°C, and operate over a temperature range of  $-55^\circ$  to  $+105^\circ$ C.

at last...  
instant color patterns  
at your finger tips...  
zero warm-up time



## THE ALL NEW SENCORE CG135 DELUXE TRANSISTORIZED COLOR GENERATOR

The big push is on in Color TV. Equip yourself now with the new, solid state Sencore CG135 and cash in on the zooming volume of new service business as Color-TV booms! Instant, service-ready RCA standard color bars, cross-hatch, white dots and individual vertical and horizontal bars enable you to set up or trouble-shoot more Color TV sets per day; earn top money in this fast growing service field. It's an analyzer too: Color gun interruptors, unmodulated video for chroma circuit trouble isolation and unmodulated sync pulses to keep Zenith receivers in sync for this test, make color trouble shooting a snap. Sturdy all-steel construction for rugged, heavy duty in the field or shop. Another Best Buy in profit-building service instruments **\$149<sup>95</sup>** from Sencore at

COMPARE THESE FEATURES: SEE WHY THE CG135 IS IN A CLASS BY ITSELF

- Solid state construction employs high priced GE "Unijunctions" to develop six "jump out proof counters" that guarantee stable patterns at all times with no warm-up
- Standard RCA licensed patterns as shown on schematics throughout the industry
- Handy universal color gun interruptors on front panel
- Lead piercing clips insure non-obsolence
- CRT adaptors optional
- Crystal-Controlled 4.5mc Sound Carrier Analyzing Signal to insure correct setting of fine tuning control
- RF output on Channel 4 adjustable to Channel 3 or 5 from front of generator when Channel 4 is being used
- No batteries to run down; uses 115 V AC
- Less than one foot square, weighs only 8 lbs.

professional quality — that's the difference!

**SENCORE**  
426 SOUTH WESTGATE DRIVE • ADDISON, ILLINOIS

Circle 37 on literature card

January, 1967/PF REPORTER 61

# Why professional MATV installers are fussy about matching transformers

The purpose of a matching transformer is to match 300- to 75-ohm, or 75- to 300-ohm impedance... and match it precisely! Otherwise you get all the problems of mismatch—poor color, smear, ghosting, snow. And installers of coax systems know that Blonder-Tongue is famous for its honest-to-goodness UHF/VHF/FM matching transformers that offer really precise match at all frequencies.

Next time try one of these all-channel, color-approved matching transformers:

**MT-283**—Deluxe indoor or outdoor UHF/VHF/FM network. Great for matching all-band antennas to coaxial downlead, or 300-ohm set impedance to 75-ohm coax downlead. Mast-mounting hardware and mating male coax connector supplied.

**Cablematch U/V** — Indoor model. The same unit used in all-channel MATV systems! Features spade lugs for easy connection to 300-ohm TV set terminals. Mating Autoplug for coax supplied.

In addition to these all-channel models, B-T offers a wide choice of VHF/FM matching transformers to meet any need.

Quality matching transformers like these are just one more reason why you should go Blonder-Tongue from antenna to TV set terminals. Write for free catalog #74.

Blonder-Tongue Laboratories, Inc., 9 Alling Street, Newark, N.J.

*Blonder-Tongue—the name to remember, for TV reception you'll never forget*

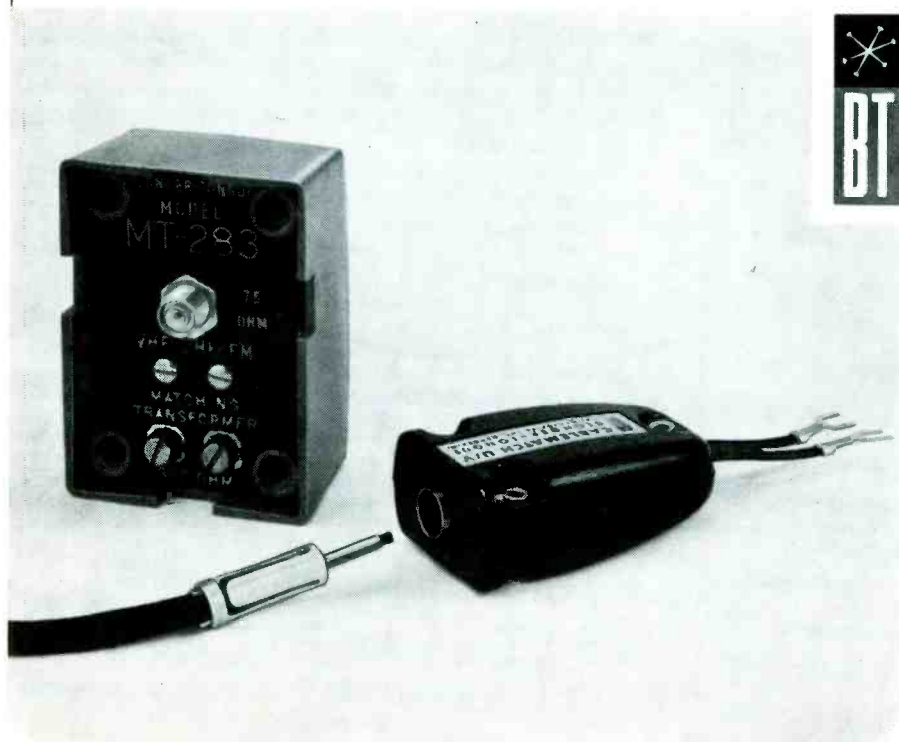

**Tuner Cleaner**  
(56)

A new tuner cleaner, formulated to cope with the added sensitivity of nuvistor and transistor tuners, is announced by Chemtronics. Lab tests of the new No. 800 Tun-O-Lube Nuvistor/Transistor Tuner Cleaner were performed by injecting a simulated

## ELIMINATE CALL-BACKS

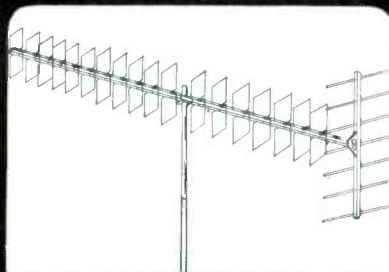

### Revolutionary MODEL UPW UHF PASSIVE WAVE ANTENNA

This system in which there are no electrical connections,

**PROVIDES HIGH GAIN ACROSS THE ENTIRE UHF BAND**

and eliminates noise caused by loose elements at high frequencies. High overall gain across the entire UHF band makes this antenna more desirable than any frequency conscious yagi types being marketed today. Excellent color reception assured. More gain than a Parabolic. Top quality construction.

*Write for literature and low retail prices. All inquiries given prompt attention.*

**S & A ELECTRONICS INC.**

Manufacturers of the TARGET ANTENNA  
206 West Florence Street • Toledo, Ohio 43605  
Phone 419-693-0528

Circle 38 on literature card



TV signal into TV tuners, using a 6MHz bandwidth. The resultant waveform was observed on a scope while the tuner cleaner was applied over and over. No measurable frequency deviation was noted on the scope. Lab tests have been going on for over 18 months on all new TV tuners as fast as they are introduced on the market. Simultaneously with lab tests, key servicing centers handling large numbers of sets of all makes were chosen and similar tests performed on actual "in-repair" sets. The tuner cleaner is safe to use on all plastics used in TV tuners. Price is \$1.98.

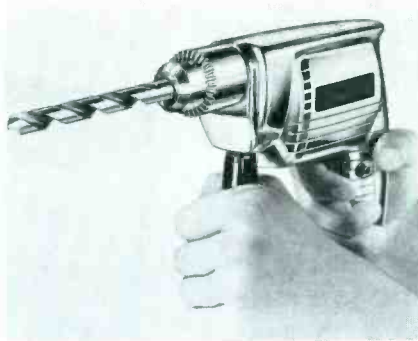

and ball thrust spindle bearings assure smoother running performance. The motor and other power controll-

ing components are contained in a compact, die cast aluminum housing with life-time, tarnish-proof Ball-Brite finish.

The unit is equipped with a 1/2" geared Jacobs chuck with key, locking trigger with safety release, and 6 ft three-wire cord. It weighs 5 1/4 lb. and measures 9 1/4" x 7 1/4" x 2 1/2". The drill comes packaged in its own plastic encased container with a four-color labeled outer shipping carton showing the tool in action and applications. Price of the 1/2" drill is \$29.95.

### Compact Power Drill (57)

A new compact, 1/2" drill with a 3.5-ampere, 115-volt AC high-torque motor which operates at a constant speed of 1100 RPM, has been introduced by **Wen Products, Inc.**

The high-torque motor is designed with welded burnout-proof armature. Needle bearings at heavy thrust points



**TYPE IL . . .** why use old fashioned wax end-filled cardboard capacitors in radio repairs? Avoid call-backs with Planet type IL dual section tubular electrolytics . . . hermetically sealed in aluminum tubes with wax impregnated insulating jacket. Planet IL's are also available in 450 volts for TV servicing. Ask for them by type number at your distributor.

## PLANET SALES CORP.

64 NEW STREET  
NUTLEY, NEW JERSEY 07110

Circle 41 on literature card



## Perk it up with Perma-Power COLOR-BRITE

Perma-Power does for color TV sets what we've done for millions of black and white CRT's: adds an extra year of useful picture tube life.

When a color tube begins to fade, **COLOR-BRITE** instantly brings back the lost sharpness and detail. It provides increased filament voltage to boost the electron emission and return full contrast and color quality to the 3 gun color picture tube.

**COLOR-BRITE** is automatic . . . no switching or wiring. Just plug it in. Your delighted customers will brighten up as fast as their color sets!

*Model C-501, for round color tubes.*

*List Price \$9.75*

*Model C-511, for rectangular color tubes.*

*List Price \$9.75*



**COLOR-BRITE** is a Hue-Brite product from Perma-Power, famous in TV service for b & w Vu-Brites and Tu-Brites.

## Perma-Power COMPANY

5740 N. TRIPP AVE., CHICAGO, ILLINOIS 60646

PHONE (312) 539-7171

Circle 40 on literature card

January, 1967/PF REPORTER 63

## Nowhere Else Can You Get All Of These Features For Less Than \$875



The New Heath IO-14... a 5" DC to 8 MHz Scope with continuous duty ratings, triggered sweep, 0.25 u sec coaxial vertical input and time base... factory assembled & tested for \$399.00... kit only \$299.00

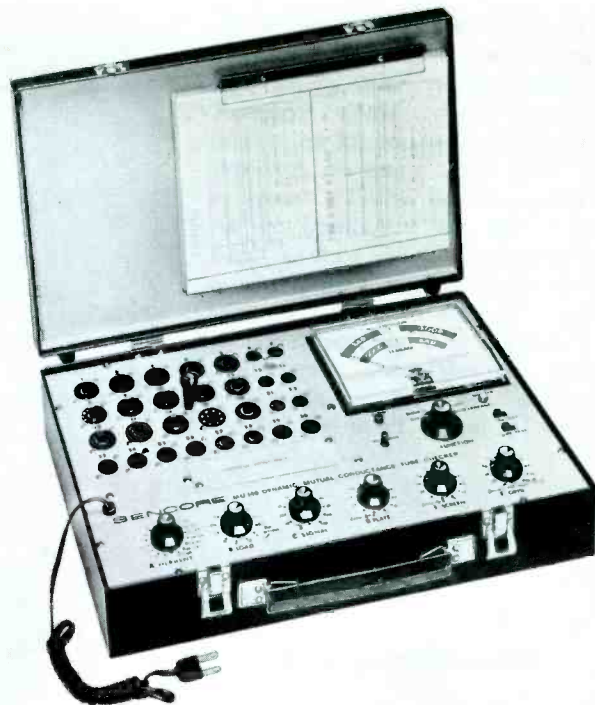

### Mutual Conductance Tube Checker

(58)

A new mutual conductance tube checker, using a 5-kHz squarewave for Gm tests, has been announced by Sencore. Compact and completely portable, the all-purpose MU140 Continental is designed for fast, accurate, true mutual conductance tests with readings in actual micromhos.

Featuring an automatic biasing system, the Gm tester circuit actually biases the tube with the correct bias voltage at the current selected for the plate circuit. This eliminates a set-up control, and reduces possible errors in set-up and readings.

In checking amplifiers and rectifiers, the unit pulls the actual rated cathode current from the tube under test to measure its current emitting capabilities. The tube tester also provides hi-sensitivity grid leakage tests to spot leakage as small as 100 megohms, plus shorts tests that reveal shorts of 180k ohms between elements.

The unit can be used for checking all TV and radio tubes, including Novars, Compactrons, Nuvistors, Magnovals and foreign tubes. Space is also provided for additional sockets to accommodate future tubes with different base arrangements. Protection against obsolescence is thus assured.

The attache-type case is made of mar-resistant vinyl-clad steel. The unit, complete with tube chart, is priced at \$179.50.

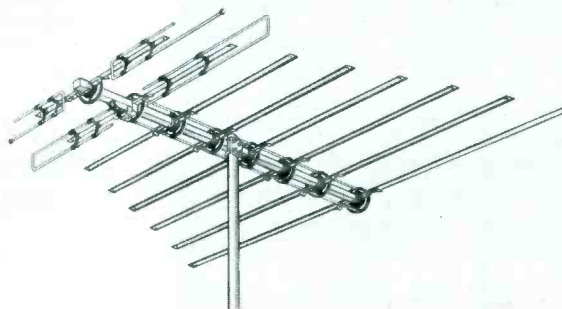

### TV-FM Antennas

(59)

A new line of television antennas is now available from Jerrold Electronics. Called Paralog-Plus, the new series of

The Heath IO-14 Features The Engineering And Quality Components You Expect Only In Higher Priced Oscilloscopes. For example, switches are ball-detent type; all major control potentiometers are precision high-quality sealed components; all critical resistors are 1% precision; and vertical signal delay is provided through high-linearity coaxial delay lines. Here is the ultra-stable, low-noise performance demanded from a truly professional industrial, academic, electronic engineering laboratory oscilloscope. Check the prices and specifications yourself, and you'll agree the Heath IO-14 gives a new meaning to 'scope value.

Kit IO-14 (with standard P-2 phosphor), 53 lbs.....	\$299.00
Assembled IO-14 (P-2 phosphor), 47 lbs.....	\$399.00
Assembled IO-14S (with long persistence P-7 phosphor for bio-medical or industrial use), 47 lbs.....	\$410.00
Kit PK-1, Low-Capacitance Probe, 1 lb.....	\$4.95

**IO-14 SPECIFICATIONS** — (Vertical) Sensitivity: 0.05 v/cm AC or DC. Frequency response: DC to 5 MHz, -1 db or less; DC to 8 MHz, -3 db or less. Rise time: 40 nsec (0.04 microseconds) or less. Input impedance: 1 megohm shunted by 15 uuf. Signal delay: 0.25 microsecond. Attenuator: 9-position, compensated, calibrated in 1, 2, 5 sequence from 0.05 v/cm. Accuracy: ±3% on each step with continuously variable control (uncalibrated) between each step. Maximum input voltage: 600 volts peak-to-peak; 120 volts provides full 6 cm pattern in least sensitive position. (Horizontal) Time base: Triggered with 18 calibrated rates in 1, 2, 5 sequence from 0.5 sec/cm to 1 microsecond/cm with ±3% accuracy or continuously variable control position (uncalibrated). Sweep magnifier: X5, so that fastest sweep rate becomes 0.2 microseconds/cm with magnifier on. (Overall time base accuracy ±5% when magnifier is on.) Triggering capability: Internal, external, or line signals may be switch selected. Switch selection of + or - slope. Variable control on slope level. Either AC or DC coupling. "Auto" position. Triggering requirements: Internal; 1/2 cm to 6 cm display. External: 0.5 volts to 120 volts peak-to-peak. Horizontal input: 1.0 v/cm sensitivity (uncalibrated) continuous gain control. Bandwidth: DC to 200 kHz ±3 db. General: SADP81 or SADP2 Flat Face C.R.T. interchangeable with any SAD or 5AB series tube for different phosphor characteristics. 4250 V. accelerating potential. 6 x 10 cm edge lighted graticule with 1 cm major divisions & 2 mm minor divisions. Power supply: All voltages electronically regulated over range of 105-125 VAC or 210-250 VAC 50/60 cycle input. (Z Axis) Input provided. DC coupled CRT unblanking for complete retrace suppression. Power requirements: 285 watts. 115 or 230 VAC 50-60 Hz. Cabinet dimensions: 15" H x 10 1/2" W x 22" D. Includes clearance for handle and knobs. Net weight: 40 lbs.



**FREE 1967 Heathkit Catalog**  
Use this coupon for your free copy.

Heath Company, Dept. 25-1  
Benton Harbor, Michigan 49022

Please send FREE Heathkit Catalog & Information describing the New Heathkit IO-14 Oscilloscope

Enclosed is \$ \_\_\_\_\_, plus shipping.

Please send model \_\_\_\_\_

Name \_\_\_\_\_

Address \_\_\_\_\_

City \_\_\_\_\_ State \_\_\_\_\_ Zip \_\_\_\_\_

Prices & specifications subject to change without notice. TE-155



antennas utilize a Bi Modal director system in which the parasitic elements combine two high-band directors into a single director covering the entire low band, plus all FM channels. The driven elements work in two modes simultaneously:  $\frac{1}{2}$  wavelength mode for low-band channels and  $\frac{3}{2}$  wavelength mode for high-band channels. Thus, each element serves double duty.

Characteristics of the new antennas include a response of  $\pm 1$  dB per channel and impedance matching to both 300- and 75-ohm outputs. Mechanical features include self-cleaning wedge snap locks, which actually tighten in wind; Cyclocac insulators, providing 4" separation of feed lines to eliminate shorting due to salt spray or ice build-up; a corrosion resistant finish; dual square boom construction; and grounded transmission lines to prevent build-up of static electricity.

The eight models in the new series range in price from \$17.95 for Model PIX-35 with 4 driven elements, to \$81.95 for Model PIX-225 with 10 driven elements and 9 parasitic elements.

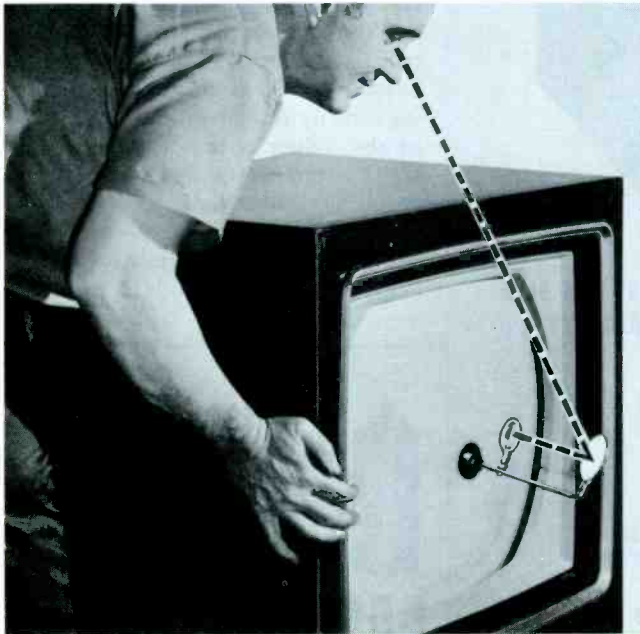

**Color TV Service Aid**  
(60)

A new service aid which permits the serviceman to observe an enlarged view of the TV screen while working on controls in the back of the set is introduced by the **B&K Division** of the Dynascan Corp. Dyanascope consists of a  $2\frac{1}{4}$ " diameter mirror attached to one end of a 6" stainless steel rod with a suction cup at the other end. Mounted in the middle of the rod is a  $1\frac{1}{2}$ " diameter, three-power, magnifying lens. The serviceman simply attaches the unit to the TV screen with the suction cup and adjusts the mirror and lens for viewing from the back of the set. Then, while adjusting controls for static convergence, dynamic convergence, and color purity, he looks over the top of the set to observe the changes on the screen. The wasted time and motion of having to constantly walk back and forth between the front screen and rear controls is eliminated.

The unit is furnished with a plastic carrying case, designed to fit easily in a tube caddy or other service case. To simplify storage and prevent damage, the mirror folds down and the magnifying lens can be removed from the rod for insertion into a special protective pocket in the carrying case. Price of the unit is \$7.95.

# New! All-channel COLORITE

## 300 ohm shielded cable



**CAT. NO. 847**

- Assures superior color reception on all 82 channels.
- Eliminates costly matching of transformers and coaxial cable fittings.
- Reduces radiation and outside interference.
- Eliminates transmission line pick-up of ghost signals and automobile noise.
- Attached drain wire. Easy to install anywhere.

Low loss twin cellular polyethylene tubes encapsulated in aluminum foil shield. Spaced for proper impedance. Non-contaminating, non-deteriorating brown polyethylene jacket. Get the facts on this all-new, all-channel cable now. Send for **FREE SAMPLE** and spec. sheet.

**INTERNATIONAL  
WIRE & CABLE CO.,**  
1300 W. Fletcher Street  
Chicago, Illinois 60657



Circle 42 on literature card

January, 1967/PF REPORTER 65

**"I was TROUBLE-SHOOTING  
in the DARK 'til Sencore's Scope  
Showed Me What Color Waveforms  
Really Look Like."**

Only  
**199<sup>50</sup>**



PS 127 5" WIDE BAND  
OSCILLOSCOPE

Technicians everywhere are talking about the PS127 5" Wide Band Oscilloscope. Try one and you, too, will send us comments like these—

"So easy to use! With my Sencore scope I can read high or low frequency signals without band switching. As easy to use as a voltmeter."—R. L., Portland, Ore.

"I've only had my PS127 a couple of months, but it's more than paid for itself already with the extra jobs I've been able to handle."—S. O., New Orleans, La.

"With the direct peak-to-peak readout I can compare voltage readings to those on the schematic without wasting valuable time setting up my scope with comparison voltages."—J. M. F., Plymouth, Michigan.

"Those Sencore exclusives really sold me, like the extra 500KC Horizontal Sweep range and the free high voltage probe."—D. N., Brooklyn, N.Y.

You'd expect a wide band scope of this quality to cost at least double."—W. L., Chicago, Ill.

"With the PS127, I find I can trouble-shoot those tough ones twice as fast as before—especially color TV."—F. C., Burlingame, Calif.

"Once I compared the specs, I knew Sencore had the best buy in scopes. We now have three PS127's in our shop."—J. S., Ft. Lauderdale, Fla.

#### SPECIFICATIONS

Vert. Freq. Resp. 10 CPS to 4.5 MC  $\pm$  1 db, - 3 db @ 6.2 MC • Rise Time .055 Microseconds • Vert. Sens. .017 Volts RMS/inch • Horiz. Freq. Resp. 10 CPS to 650 KC • Horiz. Sens. .6 Volts RMS/inch • Horiz. Sweep Ranges (10% overlap) 5 to 50 CPS, 50 to 500 CPS, 500 CPS to 5 KC, 5 to 50 KC, 50 to 500 KC • Input Impedance 2.7 megohms shunted by 99 MMF, 27 megohms shunted by 9 MMF thru low-cap. jack • High Voltage Probe 5000 Volts Max. • Dimensions 12"x9"x15½", Wt. 25 lbs. • Price Complete \$199.50



NO. 1 MANUFACTURER OF ELECTRONIC MAINTENANCE EQUIPMENT

**SENCORE**

426 SOUTH WESTGATE DRIVE, ADDISON, ILLINOIS 60101

Circle 44 on literature card

#### Inverter

(61)

This new inverter which plugs into a cigarette lighter socket, is specially designed to compensate for low-power factor in tape recording. The transistorized unit can be used to operate TV sets, lights, tools and many household appliances. It can also be used for citizen's band equipment and public address systems.

The **Electro** inverter delivers 125 watts continuous AC power from a 12-volt car, boat, or plane battery, or from any 12-volt DC source.

Features of the unit include: automatic overload protection, a charge indicator light that shows the condition of the battery, and gives a low-charge warning, and a "start" switch that provides rapid starting of light bulbs, motors, etc. A battery clip adapter kit is available for connecting directly to battery terminals if use of the lighter socket is not desired. Units are supplied with complete operating instructions, and performance curves. The unit measures 3½" x 6¼" x 6¼" and weighs 6¾ lbs. Price is \$54.50.

**...JUST WHAT  
THE TV  
PROBLEM  
ORDERED!**

**QUIETROL**

- Lubricates and Cleans
- Apply With Spray or Dropper
- Non-inflammable . . . Non-conductive . . . Non-corrosive
- Harmless to plastics & metal — zero effects on capacity & resistance — "for color & black & white".

Quietrol is preferred by manufacturers and servicemen alike. Quiets noisy TV and radio controls. Mark-II for tuners, Spray-Pack for controls & switches, Silatron for general use.

At Your Distributor . . . Ask for Quietrol by Name.



manufactured by  
**QUIETROL CO.**

Spartanburg, South Carolina

Circle 43 on literature card





**Event Counter**  
(62)

The new DP-140 Event Counter and Slave Plug-in extends the application of Hickok's DMS-3200 Digital Measuring System to provide inexpensive, all-electronic counting and display of totalized count of events in both industrial and laboratory applications. A single plug-in/main frame combination provides a three-digit display and additional combinations may be added in cascade to provide six-, nine-, or twelve-digit display. The combination may also be used to extend the readout of Hickok's DP-150# 1-MHz Frequency Counter to a simultaneous six-digit display of frequency or period. Operation may be remotely controlled to "start count," "stop count," "resume count," or "reset." Sensitivity is 100 millivolts.

The unit is small in size and weighs only 2¾ pounds. Price of the DP-140 is \$75.00. Price of the DMS-3200 Main Frame is \$320.00.

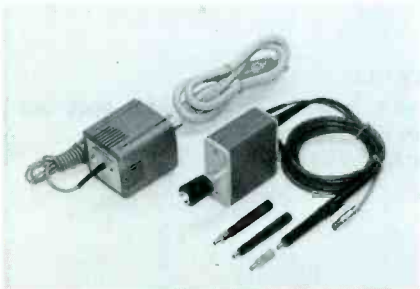

**Miniature General-Purpose Probe**  
(63)

A miniature, 10X attenuation probe, designed for portable and general-purpose oscilloscopes in the DC to 33 MHz range, has been announced by Tektronix, Inc. The P6012 has a convenient adjustment that enables it to compensate for oscilloscope or plug-in unit input capacitances of 15 to 47pf. The small size and lightness of the probe makes it particularly useful in applications

where accessibility to circuitry is difficult.

Risetime of the probe is approximately 5 nanoseconds. Input resistance is 10 megohms. Input capacitance is approximately 11.5pf, with a 3.5-foot cable and approximately 14.5pf with a 6-foot cable. Voltage rating is 500 V DC, AC peak, or DC and AC peak combined. Peak-voltage derating is necessary for CW frequencies above 6 MHz — typically 105 V at 30 MHz. Price of the probe is \$27.00. ▲

## CORRECTION!

**The Triplet Model 630 advertised on page 75 in the November PF REPORTER should have been priced at \$55, and the Model 630A at \$65.**

# Now, for men in electronics —“a whole new era of quick calculation”

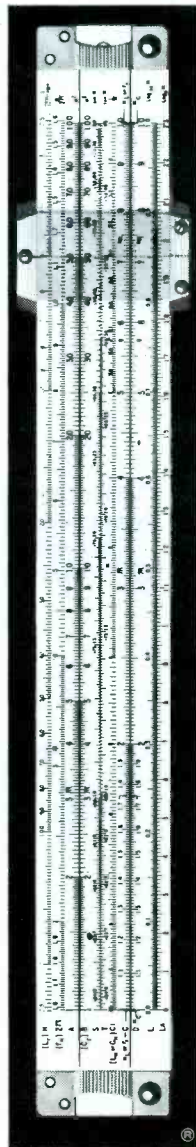

**T**HERE MUST BE THOUSANDS OF PEOPLE in electronics who have never had the marvelous adventure of calculating problems with a single slide rule; other thousands have had to content themselves with a slide rule not specifically designed for electronics. For both groups, the new slide rule designed and marketed by Cleveland Institute of Electronics and built for them by Pickett will open a whole new era of quick calculations.

“Even if you have never had a slide rule in your hands before, the four-lesson instruction course that is included takes you by the hand and leads you from simple calculations right through resonance and reactance problems with hardly a hitch. If you already use a slide rule, you'll find the lessons a first-rate refresher course. And it explains in detail the shortcuts built into this new rule.”

From an article in  
**Radio Electronics Magazine**

Want complete details about this time-saving new Electronics Slide Rule? Just mail coupon below... or write Cleveland Institute of Electronics, Dept. PF-113, 1776 East 17th St., Cleveland, Ohio 44114.

Mail this  
coupon for  
**FREE BOOKLET**

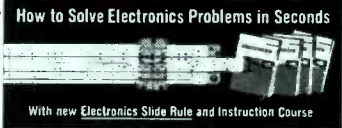

**CIE** Cleveland Institute of Electronics  
1776 E. 17th St., Cleveland, Ohio 44114

Please send me without charge or obligation your booklet describing the CIE Electronics Slide Rule and Instruction Course. Also FREE if I act at once: a handy pocket-size Electronics Data Guide.

Name \_\_\_\_\_ (please print)

Address \_\_\_\_\_

City \_\_\_\_\_ State \_\_\_\_\_ Zip \_\_\_\_\_

Accredited Member National Home Study Council  
A Leader in Electronics Training... Since 1934

PF-113

Circle 46 on literature card

# Why is a Vectorscope essential for Color TV servicing?

- 1 Check and align demodulators to any angle . . . 90°, 105°, 115° . . . accurately and quickly. No guesswork. New color sets no longer demodulate at 90°. Only with a Vectorscope can these odd angles be determined for those hard-to-get skin tones.
- 2 Check and align bandpass-amplifier circuits. Eliminate weak color and smeared color with proper alignment. No other equipment required. Only a V7 Vectorscope does this.
- 3 Pinpoint troubles to a specific color circuit. Each stage in a TV set contributes a definite characteristic to the vector pattern. An improper vector pattern localizes the trouble to the particular circuit affecting either vector amplitude, vector angle or vector shape. Only a V7 Vectorscope does this.



## LECTROTECH V7 color vectorscope/generator

### EXCLUSIVE FEATURES:

**Color Vectorscope:** Until now, available only in \$1500 testers designed for broadcast use. Accurately measures color demodulation to check R-Y and B-Y, for color phase and amplitude. A must for total color and those hard-to-get skin tones. **Self-Calibrating.** Adjust timing circuit without external test equipment. **Dial-A-Line.** Adjust horizontal line to any width from 1-4 lines. **Solid State Reliability** in timer and signal circuits. **Plus:** All Crosshatch, Dots, Vertical only, Horizontal only and Keyed Rainbow Patterns. RF at channels 3, 4 or 5. Video Output (Pos. and Neg. adjustable) for signal injection trouble-shooting. Red-Blue-Green Gun. Killer. All transistor and timer circuits are voltage-regulated to operate under wide line voltage ranges. Lightweight, compact—only 8¼x7½x12½". **NET 189.50**

**ONE YEAR WARRANTY**

**V6-B** New, improved complete color bar generator with all the features of the V7 except the Vectorscope. Only **99.50**

For the full story, see your distributor or write for literature.

Dept. PF-1

**LECTROTECH, INC.**  
1221 W. Devon Ave., Chicago, Ill. 60626

Circle 47 on literature card

## Color Countermeasures

Symptoms & Tips From Actual Shop Experiences.

**Chassis:** ZENITH 26KC20

**Symptoms:** Diathermy type RF interference in picture when tuned to higher channels and radiating into other sets in the near vicinity. Disabling the high voltage eliminates the trouble.

**Tip:** Dress and reroute wire on pin #6 of 6JH8 B-Y demodulator tube if necessary. If not already installed, insert a ferrite bead, Zenith part #149-171 on the wire where it junctions at the tube socket pin.

**Chassis:** GE CB (early runs)

**Symptom:** Insufficient width

**Tip:** Add an 82 pf 6KV cap from junction of L43 and flyback to ground. This cap has been added to all late production runs.

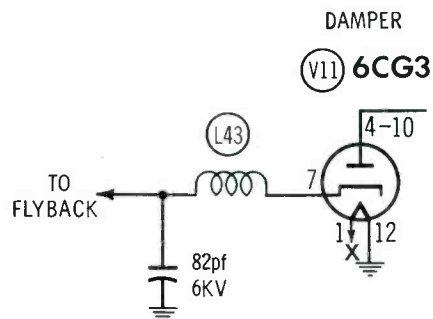

**Chassis:** Motorola TS 914

**Symptom:** Weak color, color indicator light goes out when color control is turned up.

**Tip:** Check for open L21.

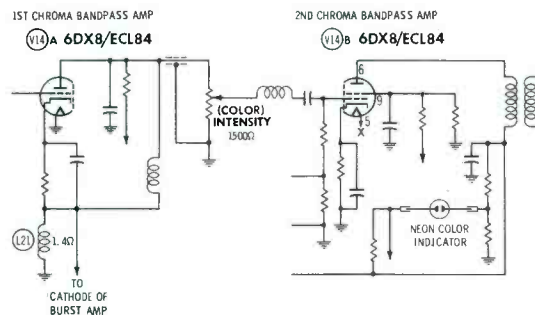



## Notes On Test Equipment

(Continued from page 39)

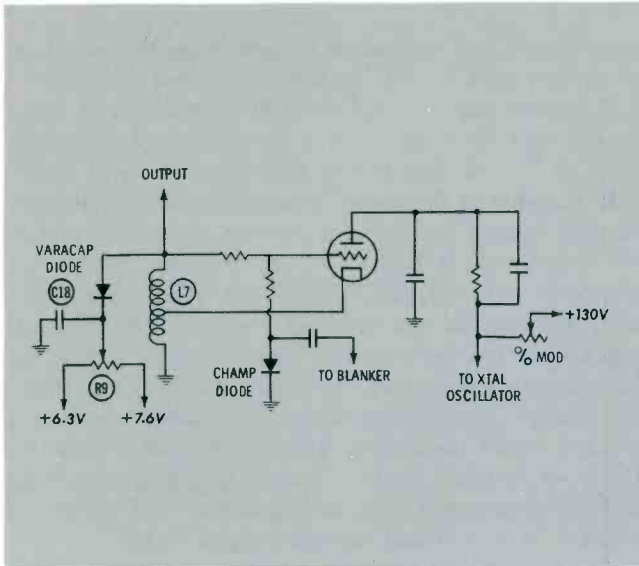

Fig. 4. Simplified oscillator schematic.

sure that the marker amplitude will not be too great if you happen to get a super-active crystal. The audio cable has been eliminated, and instead there is now an RCA-type phono jack at the front panel. This jack is used for both audio out and external modulation in.

The biggest news in the "B" through, is the addition of sweep outputs. The B model costs about \$5 more than the A did, and for this, the purchaser gets a sweep generator in addition to the RF generator.

The oscillator is shown in Fig. 4. This is a much simplified diagram, as the oscillator does double duty, both sweeping and as a conventional Hartley oscillator, and covers eight separate bands. The heart of the sweeper is the tank circuit made up of L7, C18, and CR3. At rest, this circuit resonates at 455 kHz, as CR3 acts as a small-value capacitor. C18 is a relatively large value capacitor and is essentially a short circuit for RF, thereby grounding the anode of CR3. An AC voltage applied to CR3 causes its capacity to vary, proportional to the voltage change. R9 is a sweep linearity control; the DC voltage applied to CR3 through R9 tends to distort the capacity curve change, according to the position of the control arm.

The change of capacity of CR3 changes the resonant frequency of the tank and therefore the output frequency of the oscillator. A blanking voltage is applied to the grid of the oscillator. Through careful choice of components, the oscillator is allowed to conduct only while the frequency is rising. As the voltage across CR3 reverses and the output frequency starts to decrease, the tube is cutoff and does not resume oscillating until the tank frequency again begins to rise; the net result is a scope trace showing a zero base line.

The sweep frequency and blanking are keyed to line frequency, therefore the unit can be used with any scope which has a line sweep position. (Providing it doesn't present too much phase shift.)

The sweep width is about 10% of center frequency, so the bands swept are about 400-500 kHz, and 10.2-11.2 MHz. Any crystal in these bands may be used as a marker by merely plugging it into the Xtal jack. ▲

# You can pay more but you buy less!



## new Lectrotech V6-B color bar generator

### 99<sup>50</sup> brings you...

- Guaranteed performance . . . full one year warranty.
- A.C. operated solid state generator . . . no batteries to buy . . . no failures when needed most.
- Most stable generator of all . . . sharper, brighter patterns.

The V6-B provides crystal-controlled keyed rainbow color display, all cross hatch, dots, vertical lines only, horizontal lines only, Red-Blue-Green gun killer, exclusive Dial-A-Line feature (horizontal line width adjustable), voltage-regulated transistor and timer circuits, simplified rapid calibration. Supplies adjustable dot size, RF output more than 10,000 mv, operates on channels 3, 4 or 5, has color level control for color sync servicing. Connects to antenna terminals (no connection needed inside of set). Power transformer-line isolated. Stable operation under wide voltage ranges assured by fully voltage-regulated circuits. Hand-wired reliability . . . no printed circuits. Fully enclosed test lead compartment. Rugged, caddy size unit built to withstand rigors of field servicing. Size: 7<sup>5</sup>/<sub>8</sub>"W, 3<sup>1</sup>/<sub>2</sub>"H, 9"D.

Weight: 5<sup>1</sup>/<sub>2</sub> lbs. Only

### 99<sup>50</sup>



See your distributor or write for literature.

DEPT. PF-1



## LECTROTECH, INC.

1221 W. Devon Ave., Chicago, Ill. 60626

Circle 47 on literature card

# 4 ways to increase your income

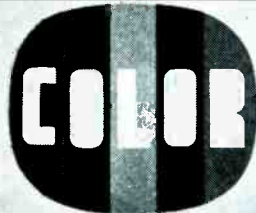
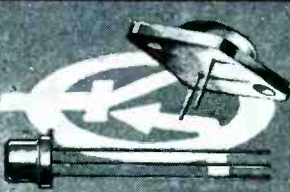
RCA Institutes, Inc. offers these four comprehensive home study courses especially designed to help build your income immediately!

	
<p><b>COLOR TV</b> Add profitable color TV to your skills with this home training course, newly revised to include information on the latest techniques, receiver circuitry and equipment. Train under the direction of RCA Institutes...experts in Color TV home study training.</p>	<p><b>TRANSISTORS</b> You get the necessary background for semiconductor technology including characteristics of tunnel diodes, rectifiers and other solid state devices. Transistor trainer also available.</p>
	
<p><b>AUTOMATION ELECTRONICS</b> Trains you for the many applications of automation electronics in industry and government including Photoelectronics, Digital Computer Techniques, Synchros and Servomechanisms, Automatic Control Systems, and many more!</p>	<p><b>MOBILE COMMUNICATIONS</b> Trains you to service and maintain 2-way radio communications on land, sea, and air! Gives you the technical foundation for space communications!</p>

Take advantage of RCA's Liberal Tuition Plan. You only pay for lessons you order; and have no long-term obligations. Licensed by New York State Education Department. Approved for Veterans.

## RCA INSTITUTES, INC.

A Service of Radio Corporation of America  
350 West Fourth Street, New York, N.Y. 10014



The Most Trusted Name in Electronics

SEND THIS COUPON NOW FOR COMPLETE FREE INFORMATION

RCA INSTITUTES, INC. Home Study School, Dept. PF-17  
350 West Fourth Street, N.Y., N.Y. 10014

Without obligation, rush me free information on the following RCA Home Training Course:  COLOR TV  TRANSISTORS  MOBILE COMMUNICATIONS  AUTOMATION ELECTRONICS

Name \_\_\_\_\_ Age \_\_\_\_\_

Address \_\_\_\_\_

City \_\_\_\_\_ Zone \_\_\_\_\_ State \_\_\_\_\_

## Scanner

(Continued from page 16)

### Sales

A 41% sales gain for the first nine months of 1966 was reported by **Amphenol Corporation**. Net earnings for the period were \$4,224,610, compared to \$2,537,427, for the same period of 1965. Consolidated sales for the first three quarters were \$113,146,408 compared to \$79,995,885 for the first nine months of 1965.

**E. F. Johnson Company** announced record sales and earnings figures for the nine months ended September 30. Sales were \$10,851,998, an increase of 18.7% compared with \$9,139,349 for the same period last year, and after tax net earnings rose to \$1,380,902, an increase of 26.3% over last year. In commenting on the company's continuing favorable growth rate, President Edgar F. Johnson says, "We have no worries about a 'peace depression' because of a very small reliance on military orders. The radio communications field is acknowledged to be expanding and Johnson's position in it is strong and growing soundly."

Nine months' net sales and earnings of **Littelfuse, Inc.** were at record levels. Sales were \$8,667,148 compared with \$7,202,119 for the like period in 1965. Earnings were \$268,558 whereas in 1965 they were \$261,329.

Third quarter and nine month sales and earnings of **Oak Electro/Netics** reached record levels, with third quarter net income tripled over the 1965 period. Consolidated net sales for the first nine months of 1966 totaled \$47,122,018, a 20% increase over the \$39,107,043 reported last year. Nine months earnings increased 80% to \$1,578,864, compared with the \$875,479 in the same 1965 period.

A PERFORMANCE PROVEN PRODUCT

FROM **HICKOK**

MODEL 288AX—AM-FM SWEEP AND MARKER GENERATOR



Price \$355.00

A truly versatile signal generator ■ 100KC to 110MC in 8 bands, frequency modulated ■ 35KC to 160MC in 8 bands amplitude modulated ■ Audio output from 20-15,000 cycles ■ Built-in db meter ■ 100/1000KC crystal reference.

AVAILABLE FROM YOUR LOCAL HICKOK DISTRIBUTOR

THE HICKOK ELECTRICAL INSTRUMENT CO. • 10514 Dupont Avenue • Cleveland, Ohio 44108

Circle 45 on literature card



# INDEX TO ADVERTISERS

JANUARY, 1967

Amphenol Corp. .... 31	Littelfuse, Inc. .... cover 4
B & K Mfg. Co., Division of Dynascan Corp. .... 36, 51	Mosley Electronics Inc. .... 56
Blonder-Tongue Labs, Inc. .... 62	National Radio Institute .... 49
Busmann Mfg. .... 33	Oaktron Industries, Inc. .... 37
Castle TV Tuner Service .... 9	Oxford Transducer Co. .... 53
Chemtronics, Inc. .... 39	Perma-Power Co. .... 63
Clarostat Mfg. Co., Inc. .... 10	Planet Sales Corp. .... 63
Cleveland Institute of Electronics 15, 67	Quam-Nichols Co. .... 71
Delco Radio .... 47	Quietrole Co. .... 66
Electro-Voice, Inc. .... 11	RCA Components and Devices (Entertainment Receiving Tubes) ..... cover 3
The Finney Co. .... 34, 48	RCA Institutes, Inc. .... 70
Grantham School of Electronics .... 54	RCA Sales Corp. .... 35
Heath Co. .... 64	S and A Electronics .... 62
Hickok Electrical Instrument Co. ..... 49, 54, 56, 67	Sams, Howard W. & Co., Inc. .... 52, 71
International Wire and Cable .... 65	SENCORE, Inc. 27, 34, 55, 57, 59, 61, 66
JFD Electronics Co. .... 40	Sprague Products Co. .... 13, 14
J. W. Miller Co. .... 48	Sylvania Electric Products Co. .... 60
Jerrold Electronics Corp. .... cover 2	Texas Crystals .... 50
Kay-Townes Antenna Co. .... 50	Weller Electric Corp. .... 32
Lectrotech, Inc. .... 68, 69	Winegard Co. .... 32
	Zenith Radio Corp. .... 16



...and the public address system will use QUAM speakers!



MODEL 8C10PA

For top quality public address. This 8" speaker has a 10 oz. ceramic magnet, frequency response of 55-13000 Hz., easily handles 12 watts. One of 34 Quam speakers for sound system applications.

Men who specify loudspeakers in enormous volume have to be particular about quality and performance. That's why more and more sound system installers are developing the habit of specifying Quam.

It's a good habit to acquire, because Quam makes good speakers for public address, background music and other sound system needs, as well as for radio-tv-automotive replacements.

Whatever kind of speaker you need, look for Quam, the Quality line, in the red, white, and blue package at your distributor.

**QUAM** QUAM-NICHOLS COMPANY  
234 E. Marquette Road—Chicago, Illinois 60637

Circle 49 on literature card

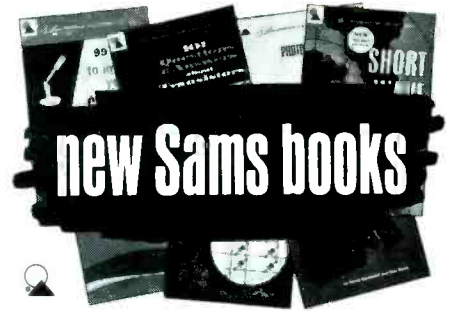

## new Sams books

### 99 Ways to Improve Your CB Radio

by *Len Buckwalter*. Tells how to operate, service, and maintain CB equipment for optimum performance. Describes desirable antenna systems; explains how to suppress noise; covers alignment, repair, and maintenance; discusses useful accessories. Includes tips on operating methods—mike techniques, how to evaluate S-units, operating positions, etc. Invaluable to anyone in CB radio. 128 pages; \$250  
5 1/2 x 8 1/2". Order ICB-1, only.

### How to Build Speaker Enclosures

by *Alexis Badmaieff & Don Davis*. Provides a wealth of practical and theoretical information on the "whys" and "hows" of constructing top-quality speaker enclosures. Includes detailed drawings and instructions for building all basic types of enclosures. Explains advantages and disadvantages of each type; discusses speaker drivers, crossover networks. Written by two of the nation's leading acoustical engineers. 144 pages; 5 1/2 x 8 1/2". \$325  
Order SEB-1, only.

### 101 Questions & Answers About Transistors

by *Leo G. Sands*. This unique book provides through a series of key questions and answers, a basic understanding of transistors, their theory and application. Covers: Transistor Characteristics; Audio Applications; Radio Applications; Oscillators; Control Applications. Fully illustrated. 112 pages; \$250  
5 1/2 x 8 1/2". Order QTS-1, only.

### PHOTOFACT® Guide to TV Troubles. 2nd Ed.

by *Howard W. Sams Editorial Staff*. Over 200 photos of actual TV picture defects are keyed to specific defective components in typical circuits, so that the source of the trouble is located in minutes. Quick checks are outlined to help you determine rapidly which section is at fault. Includes recent TV models. 192 pages; 5 1/2 x 8 1/2". Order PFG-2, only. \$395

### Short-Wave Listener's Guide. Enlarged 2nd Ed.

by *H. Charles Woodruff*. An essential book for short-wave fans. Lists all short-wave stations by country, city, call letters, frequency, power, and transmission time. Now includes stations in the newly recognized countries, along with Voice of America and Radio Free Europe stations. Also contains a listing of stations operating behind the Iron Curtain. Includes time conversion chart and handy log. 80 pages; \$175  
5 1/2 x 8 1/2". Order SLG-2, only.

### Understanding Telemetry Circuits

by *John D. Lenk*. Telemetry is moving into industry and more and more technicians are required to service the newly developed systems. This book provides an excellent understanding of the four basic telemetry techniques currently in common use. Each of the techniques and its circuitry is explained in detail. 160 pages, 5 1/2 x 8 1/2". Order UTL-1, only. \$325

### Electronics in Oceanography

by *L. George Lawrence*. Provides a comprehensive description of modern electronic systems used for gathering and interpreting oceanographic data. Chapters cover: Basic characteristics of oceanography; Measurement of salinity; Measurement of magnetism; Investigations of gravity; Electronic sound navigation ranging; Temperature measurements; Electronic pressure measurement; Measurement of light; Surface ranging and navigation; Electricity and marine animals; Submarines for Oceanography. 288 pages; 5 1/2 x 8 1/2". \$495  
Order EOL-1, only.

## HOWARD W. SAMS & CO., INC.

Order from your Sams Distributor today, or mail to Howard W. Sams & Co., Inc., Dept. PF-1  
4300 W. 62nd Street, Indianapolis, Ind. 46268

Send me the following books:

ICB-1  QTS-1  SLG-2  EOL-1  
 SEB-1  PFG-2  UTL-1

Send FREE Sams Booklist. \$\_\_\_\_\_enclosed

Name \_\_\_\_\_

Address \_\_\_\_\_

City \_\_\_\_\_ State \_\_\_\_\_ Zip \_\_\_\_\_

My Distributor is \_\_\_\_\_



# FREE Catalog and Literature Service

\*Check "Index to Advertisers" for further information from these companies.

## ANTENNAS

75. **ALLIANCE**—Colorful 4 page brochure describing in detail all the features of Tenna-Rotors.
76. **ANTENNA DESIGNS**—Color brochures #868A & F-879 for new signal multiplier combination VHF-UHF-FM antennas.
77. **ANTENNACRAFT** — Four-color catalog sheet about the new "Big-Shot-8" VHF-UHF-FM antenna designed for city and suburban use.
78. **BLONDER-TONGUE**—Compact brochure detailing a line of all-channel products, expressly designed to improve reception in the home and small MATV systems.\*
79. **CORNELL-DUBILIER** — New revised booklet shows how to use rotors to best advantage, depicts complete CDE rotor line.
80. **FINNEY**—Form 20-353 about the Finco-Axial 75-ohm antenna system for UHF-VHF and FM.\*
81. **JERROLD**—New 4-page full-color catalog describes the new Paralog Plus antennas.\*
82. **JFD** — Color Laser and LPV antenna brochures. New 1967 dealer catalog covering complete line of log-periodic outdoor antennas, indoor antennas, rotators, and accessories.\*
83. **WINEGARD** — Literature on new 82-channel 2-set coupler; new 82-channel variable line tapoffs; new VHF-UHF matching transformers and color brochure on new sales aids.\*

## AUDIO

84. **ATLAS SOUND**—Catalog 556-67 illustrates and describes many new models of public address loudspeakers, microphone stands, and accessories for commercial sound applications.
85. **HARTLEY**—New series of speaker systems using 18 inch and 24 inch woofers. Price Range \$500-600 per unit.
86. **JENSEN**—New brochure No. OJ featuring a full line of rear seat speakers.
87. **NUTONE** — 16-page full-color booklet illustrating built-in stereo music, intercom, and radio systems.
88. **OAKTRON** — "The Blueprint to Better Sound," an 8-page catalog of loudspeakers and baffles giving detailed specifications and list prices.\*
89. **OLYMPIC RADIO & TV** — Complete line folders of black-and-white and color televisions plus individual spec sheets on all items including stereo-phon-radio.
90. **OXFORD TRANSDUCER** — Catalog sheets featuring speaker systems for automobiles.
91. **PERMA-POWER**—Catalog sheet about a new 25-watt solid-state megaphone.\*
92. **SONOTONE**—Set of 3 microphone frequency demonstration charts.
93. **STANFORD INTERNATIONAL**—Brochure about a new battery-operated tape recorder.

## COMMUNICATIONS

94. **AMPHENOL**—2-color spec-sheets on new Model 650 CB transceiver and Model C-75 hand-held transceiver.\*
95. **MOSLEY ELECTRONICS** — New 1967 deluxe citizens band antenna catalog.\*
96. **MOTOROLA**—New brochure tells how to reach people on-the-move through use of personal two-way radio.
97. **RAYTHEON**—Brochures about Webster mobile antennas and accessories for CB and Amateur bands. Also, Raytel TWR 8, 9, 11, & 11T CB transceivers.
98. **SONAR**—Fly sheet about models FR 101 & 102 FM monitor receivers.

## COMPONENTS

99. **BUSSMANN**—Protection for Mobile Radio and Telephone equipment is made easy with a TRON Waterproof Fuseholder. This in-the-line fuseholder is readily installed in the circuit and protects the fuse against water, moisture, dirt and corrosive fumes. Ask for BUSS Bulletin SHF-11.\*
100. **CENTRALAB**—Catalogs offered on electrolytic capacitors, PEC's and auto radio shafts and bushings.
101. **DIALIGHT**—New catalog on sub-miniature indicator lights for translucent panel edge lighting.
102. **GC ELECTRONICS**—FR-029E Electrocraft wall charts on plugjacks, binding post etc.
103. **LITTELFUSE**—Pocket-sized TV circuit breaker cross-reference gives the following information at a glance: Manufacturer's part number, corresponding Littelfuse part number, price, color or b/w designation. A second glance gives trip ratings and acquaints you with a line of caddies. Ask for CBCRP.\*
104. **OAK**—New eight-page two-color catalog describes a full line of rotary, pushbutton, lever and slide switches available from electronic distributors throughout the country. Form SP-228.
105. **QUAM-NICHOLS** — Catalog #66 listing public address, sound systems, high fidelity, automotive and radio-TV replacement speakers.\*
106. **SPRAGUE**—#C-617, a complete catalog of the Sprague line.\*
107. **SWITCHCRAFT**—Catalog A-401b illustrates audio mixers, speakers, controls, couplers, adapters, selector switches, molded cable assemblies and a wide variety of audio connectors. Detailed electrical data is provided.

## SERVICE AIDS

108. **CASTLE**—How to get fast overhaul service on all makes and models of television tuners is described in leaflet. Shipping instructions, labels, and tags are also included.\*
109. **CHEM SPRAY AEROSOLS**—Bulletin about PLYTEX PCA tuner cleaner.
110. **CLEVELAND INSTITUTE OF ELECTRONICS** — New pocket-sized, plastic "Electronics Data Guide" of formulas and tables, including frequency and wavelength, dB formulas and table, antenna lengths, and color code.\*
111. **ELECTRONIC CHEMICAL**—Brochure of aerosol chemicals for controls, tuners, and tape heads. Also brochure on Frigid-Air.
112. **MIDSTATE TUNER** — 24-hour tuner service is described in a colorful brochure.
113. **PRECISION TUNER**—Literature supplying information on complete low-cost repair and alignment service for any TV tuner.
114. **QUALITY TUNER SERVICE**—Introductory letter describing costs and service on all makes of TV tuners. Repair tags and shipping labels included.
115. **RAWN**—Bulletins on repair ideas using Plas-T-Pair knob and plastic repair kits. Also, bulletins on tuner cleaners and circuit coolers. Includes price sheets.

## SPECIAL EQUIPMENT

116. **ELECTRONIC ALARMS** — Complete step-by-step installation instructions for burglar alarms.
117. **PERMA POWER**—New leaflet describes Perma-Power's new Electro-Lift Garage Opener.\*

118. **SKYDYNE** — Thermoplastic cases for portable equipment are described in 8-page catalog #850. Included are complete specifications and dimensions for all standard, off-the-shelf units.
119. **TERADO**—Flysheet about the Trav-Electric #50-160 power supply.

## TECHNICAL PUBLICATIONS

120. **PHILCO**—Information about Tech Data & Business Management Service. Also, free parts catalog.
121. **RCA INSTITUTES**—New 1967 career book describes Home Study Programs and Courses in Television, (monochrome and color Communications, Transistors, Industrial and Automation Electronics.\*
122. **RIDER**—Latest catalog listing practical technical paperbacks for the ham, hobbyist, and industrial technician.
123. **HOWARD W. SAMS**—Literature describing popular and informative publications on radio and TV servicing, communications, audio, hi-fi, and industrial electronics, including special new 1967 catalog of technical books on every phase of electronics.\*

## TEST EQUIPMENT

124. **B & K**—New 1967 catalog featuring test equipment for color TV, auto radio, and transistor radio servicing, including tube testers designed for testing latest receiving tube types.\*
125. **EICO**—1967 short-form catalog is 48-pages long. Describes a complete line of test instruments, CB and ham equipment, hi-fi components, and miscellaneous electronic equipment.\*
126. **HICKOK**—Specification sheets on Model GC 660 color generator, Model 860 signal tracer, and Model 209C VTVM/capacitance meter.\*
127. **JACKSON**—Catalog on "Service Engineered" test equipment featuring the new X-100 color generator.
128. **LECTROTECH**—Two-color catalog sheet on new Model V6-B color bar generator, the latest improved model of the V6 color bar generator. Gives all specs and is fully illustrated.\*
129. **MERCURY**—New 1967 catalog illustrating the complete test equipment line.
130. **PRECISION APPARATUS**—Illustrated catalog describing signal generators, oscilloscopes and meters.
131. **SECO**—New line folder featuring the new Model 107C Gm, Em and grid circuit tube tester.
132. **SEMITRONICS**—Brochure on the new Model 1000 transistor tester.
133. **SENCORE**—8-page full color catalog plus a new 4-page supplement catalog.
134. **SIMPSON**—Flyer giving specifications of Model 604 multicoorder for measuring and recording volts, amps, milliamps, and microamps.
135. **TRIPLETT**—Catalog D-66-I features the complete line of panel instruments.

## TOOLS

136. **ARROW**—Literature describing 3 staple guns.
137. **ENTERPRISE DEVELOPMENT**—Time-saving techniques in brochure from Endeco demonstrate improved desoldering and resoldering methods for speeding and simplifying operations on PC boards.
138. **LUXO**—Flyers on counterbalanced and magnifying bench lamps.
139. **VACO**—Catalog #SD-120 completely describes new Vaco screw launcher which holds, starts, and drives all straight slot screws.
140. **XCELITE**—Form S766 describing 2 new Series 99 "Plastic View" kits, each containing a plastic handle and a selection of interchangeable screwdriver blades.

## TUBES AND TRANSISTORS

141. **IR**—Bulletin C-102 describing the new molded 1-Watt Zener voltage regulator series.
142. **RADIO CORP. OF AMERICA**—PIX 300, a 12-page product guide on RCA picture tubes covering both color and black-and-white. Includes characteristics chart, terminal diagrams, industry replacement, and interchangeability.\*
143. **WORKMAN**—Two new cross references in vest pocket size. Miracle Five transistors, and circuit breakers.



# Lists more than 1300 receiving tubes



The most popular receiving tube manual in the electronics industry has been revised and updated again! More than 600 data-packed pages offer you additional text information on general system functions, tuned amplifiers, wideband (video) amplifiers, and TV circuitry including scanning, sync, and both horizontal and vertical deflection. Text writeups of *all* circuits in the circuit section explain in detail the functions of the various stages, aiding in the construction of these circuits. Data on color and B/W picture tubes, voltage reference tubes, voltage regulator tubes. Updated Applications Guide.

Whether you're a service technician, engineer, radio amateur, hobbyist or student... the new RC-25 receiving tube manual is a reference work that just has to be in your technical library. Order yours today from your nearest Authorized RCA Tube Distributor.

Only  
**\$1.25\***  
\*Suggested  
Price

RCA Electronic Components and Devices, Harrison, N.J.



The Most Trusted Name  
in Electronics

# CIRCUIT BREAKER CADDIES



CADDY #094077

10 circuit breakers, trip ratings: 2.25, 2.5, 2.75, 3, 3.25, 4, 4.5, 5, 6, and 7 amps.



CADDY #094076

8 circuit breakers, trip ratings: 2.25, 2.75, 3, 3.25, 4, 4.5, 5, and 7 amps.

30 Popular Fuses: 5 each — N 3/10, N 7/10, N 1, C 3/10, C 1/2, C 3-1/2.

Circuit breakers and fuses at your finger tips for instant servicing in field and shop. For color and black/white TV sets.

# LITTELFUSE

DES PLAINES, ILLINOIS

Circle 51 on literature card