

# PF Reporter™

PHOTOFACT

*the magazine of electronic servicing*

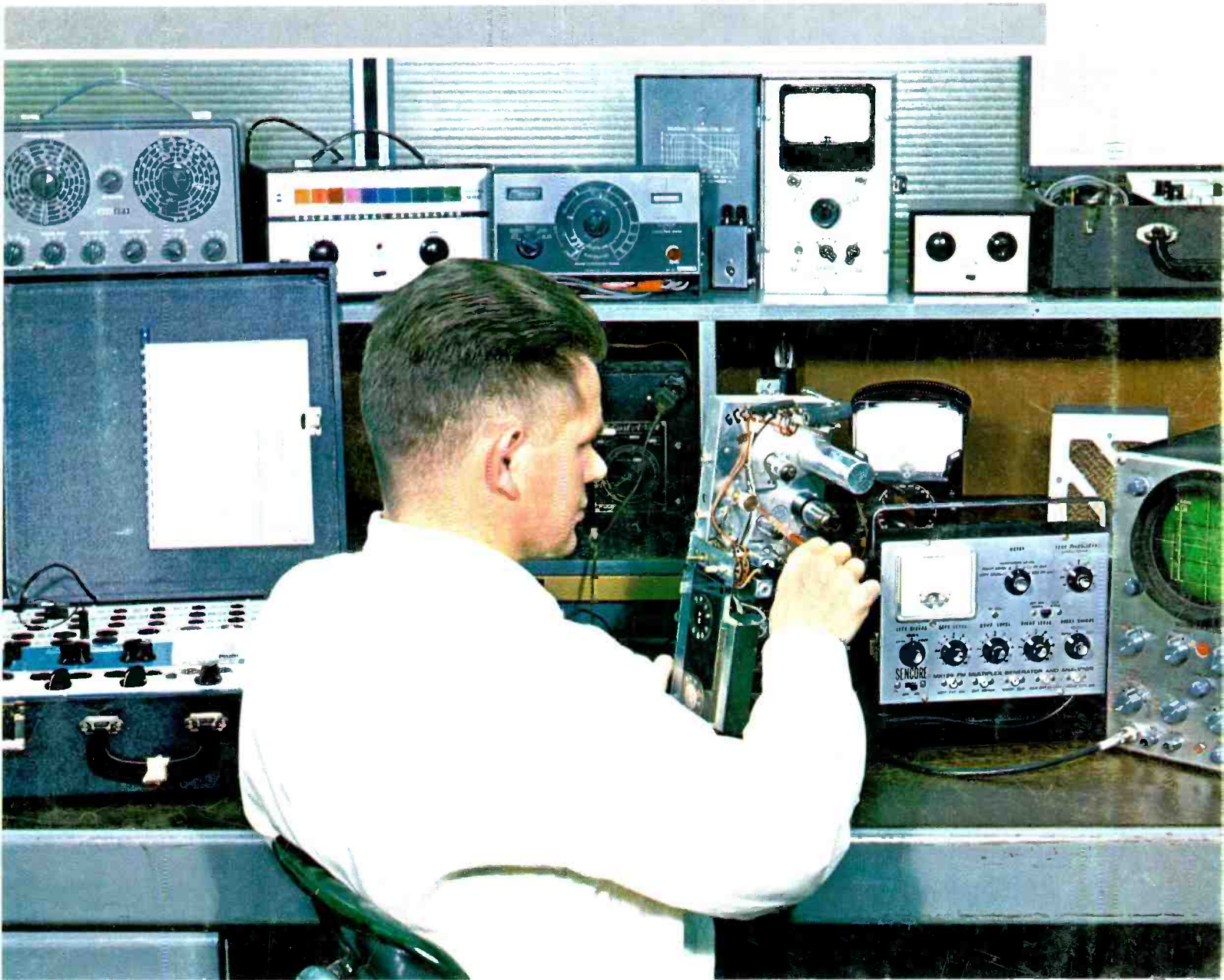

### SPECIAL TEST EQUIPMENT ISSUE

Meter Repair for Steady Hands

Converting Scopes to Triggered Sweep

Checking Color TV with B/W Equipment

Plus many more

IN SC 4277 1966  
 WM. M. DAVIS  
 RADIO & TV SERVICE  
 118 RIVERSIDE AVE.  
 CANYON CITY, COLO.

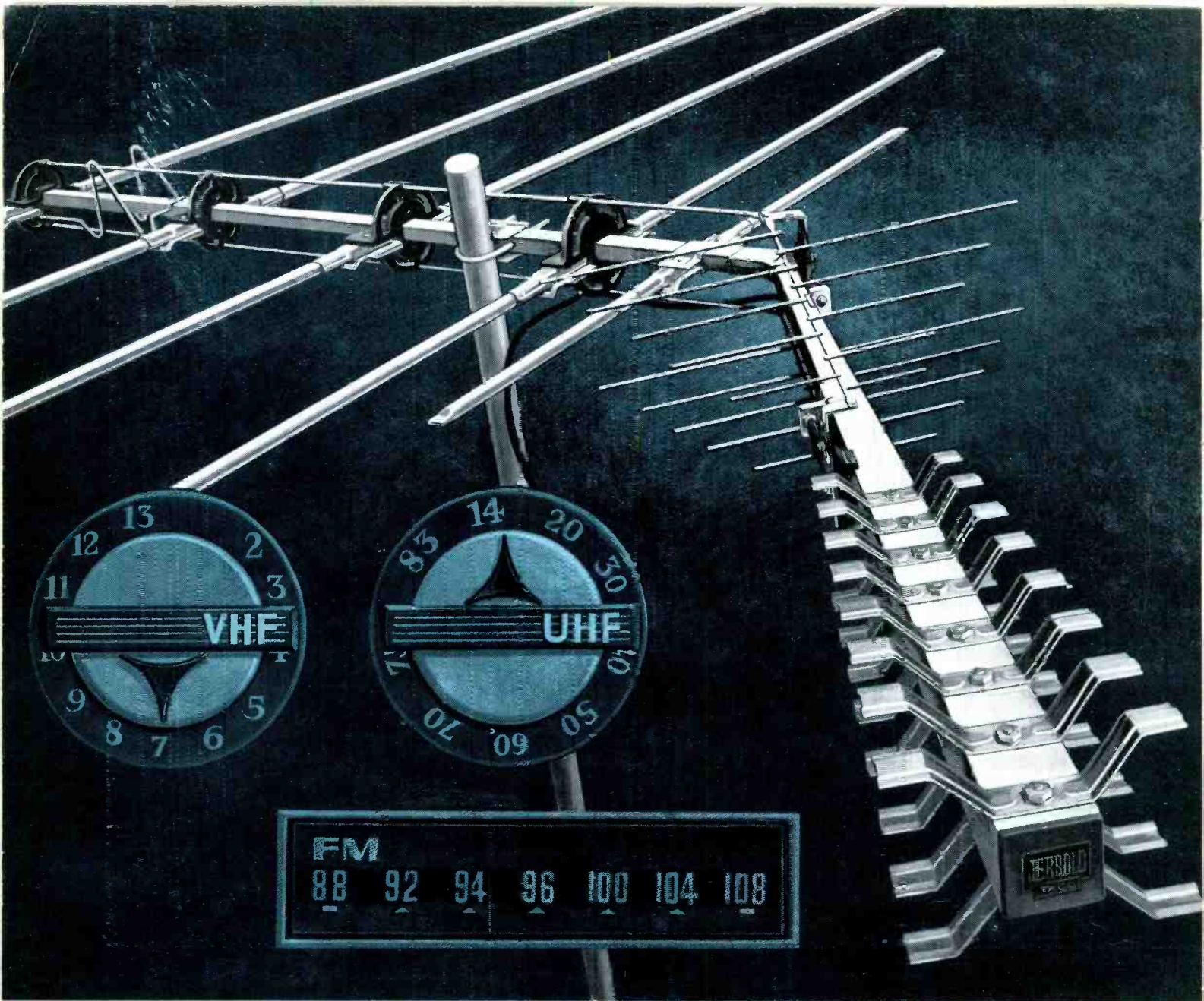

**NOW...FIRST ALL-CHANNEL ANTENNA WITH INDIVIDUAL UHF and VHF ORIENTATION, 75- OR 300-OHM OUTPUT**

**New JERROLD Coloraxial**

**Pathfinder**<sup>TM</sup>

Here's the antenna to answer every VHF, UHF, and FM reception need from metropolitan to deep-fringe areas... Jerrold's new Coloraxial PATHFINDER.

The new PATHFINDER (Series PAB and PXB) is a unique combination—a cascaded-periodic VHF antenna plus an advanced-design UHF section, all in one pre-assembled unit. Both 75-ohm Coloraxial and 300-ohm models for every taste and budget. And look at the prices—as low as \$21.95!



VHF and UHF sections may be individually oriented for maximum directivity. While you get all the flexibility of separate VHF

and UHF antennas, PATHFINDER eliminates the splitters (with their inherent losses) needed to couple separate antennas with a common download.

Take advantage of the growing UHF and FM stereo markets by selling this all-purpose high-gain antenna. Rugged square-boom construction and Golden Armor corrosion-resistant finish assure long life. Flat response across entire band (channels 2-83), low VSWR, excellent front-to-back ratio make PATHFINDER a "natural" for easy sales and satisfied customers. Talk to your Jerrold distributor today, or write for complete information. *Jerrold Electronics Corporation, Distributor Sales Division, 401 Walnut St., Philadelphia, Pa. 19106.*

Circle 1 on literature card

# Understanding Color-Bar Generators

by Robert G. Middleton

Various types of color-pattern and color-bar generators are in everyday use. Some of these generators are quite simple, while others are fairly complex. The simplest type is the unkeyed-rainbow or color-display generator. It supplies an offset color-subcarrier signal, also called a sidelock signal or linear-phase sweep. A "rainbow" spectrum of color-difference hues is displayed on the screen of a color picture tube. This display should not be confused with a conventional rainbow spectrum, since the colors and their sequence are somewhat different.

## Analysis of the Offset Color Subcarrier

To understand how a rainbow display is produced, observe that the chroma demodulators in a color receiver (Fig. 1A) are phase detectors. The output from a demodulator depends on the phase of the input chroma signal with respect to burst phase. In turn, the signals fed to the three guns of the color picture tube vary with the phase of the input chroma signal. If the phase of the chroma signal is progressively changed from 0° to 360°, the succession of colors depicted in Fig. 1B will be displayed on the screen of the color picture tube.

The frequency of the color burst is 3.579545 mc. A simple rainbow generator could consist of a phase-modulated 3.579545-mc oscillator. However, because the color receiver contains a R-Y output is passing through its peak, the B-Y output will be passing

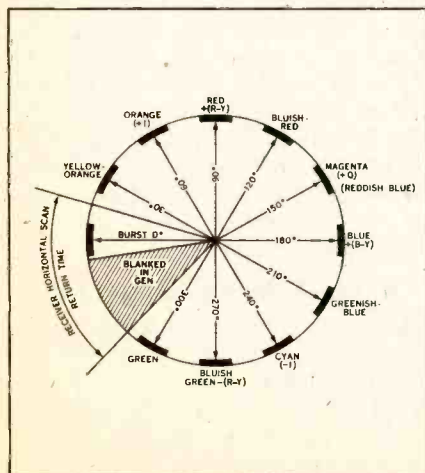

Fig. 1. Hue depends on chroma phase.

subcarrier oscillator, an expedient is possible which permits a CW generator to serve as a rainbow generator. The color receiver reinserts the subcarrier into the chroma signal at each demodulator; hence, a 3.579545-mc signal is already present. To display a rainbow pattern it is necessary only to provide an input chroma signal producing the effect of phase modulation.

This is done by applying a CW chroma input that has a frequency of 3.563795 mc. This is the so-called offset color-carrier frequency; note that it is 15,750 cycles less than the burst frequency. Turn your attention to what happens in one of the chroma demodulators—for example, the R-Y demodulator. When an offset color-subcarrier signal (3.563795-mc sine wave) is applied to the R-Y demodulator, it will beat with the subcarrier-oscillator signal (3.579545-mc sine wave). In turn, the output from the R-Y demodulator will be a 15,750-cps sine wave, the difference between these two frequencies (3.579545 - 3.563795).

## Linear Phase Sweep

Output from the R-Y demodulator will start at zero, rise to a maximum, and then decrease to zero, following a sine-wave pattern. Note that this is exactly the same output obtained if the applied chroma signal has a frequency of 3.579545mc and is progressively shifted (modulated) in phase. In other words, the output from the demodulator represents a linear-phase modulation of the color subcarrier and is accordingly called a linear-phase sweep. But a rainbow pattern generator obtains the effect of a linear-phase sweep by applying an unmodulated 3.563795-mc sine wave to the chroma demodulators.

Of course, there is a somewhat similar sine-wave output from the B-Y demodulator, with a frequency of 15,750 cps. However, the B-Y demodulator output will be shifted 90° with respect to the R-Y demodulator output. To put it another way, when the

Material for this article was adapted from the Howard W. Sams book "Know Your Color-TV Test Equipment" by Robert G. Middleton.

through zero. Turning to the G-Y matrix, it is apparent that the G-Y output will also be shifted in phase, and it will pass through zero at a different time from either the R-Y or B-Y output.

## Waveform of Simple Rainbow Signal

The most economically priced rainbow generators have only a 3.563795-mc sine-wave output (Fig. 2A). Other rainbow generators supply the rainbow signal with horizontal sync pulses, as illustrated in Fig. 2B. Note that the individual subcarrier cycles are visible in Fig. 2A, whereas they are not seen individually in Fig. 2B. The reason for this is that the first photo was taken using a high-speed sweep in the oscilloscope. However, this was not possible in the second photo, because the horizontal sync pulses can be displayed only when the scope sweep is 15,750 cps or less. In this example the scope was set to a 7,875-cps deflection rate.

It is not essential to have horizontal sync pulses in a simple rainbow signal; they are often omitted for reasons of economy. Normal output waveforms for R-Y, B-Y, I, and Q demodulators are shown in Fig. 3. These are 15,750-cps sine waves that are interrupted at the ends by the burst-gate pulse present in the receiver system. Note that the phase of each waveform is dif-

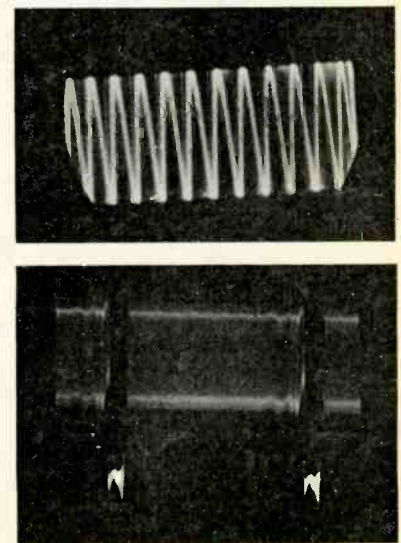

Fig. 2. Rainbow generator outputs.

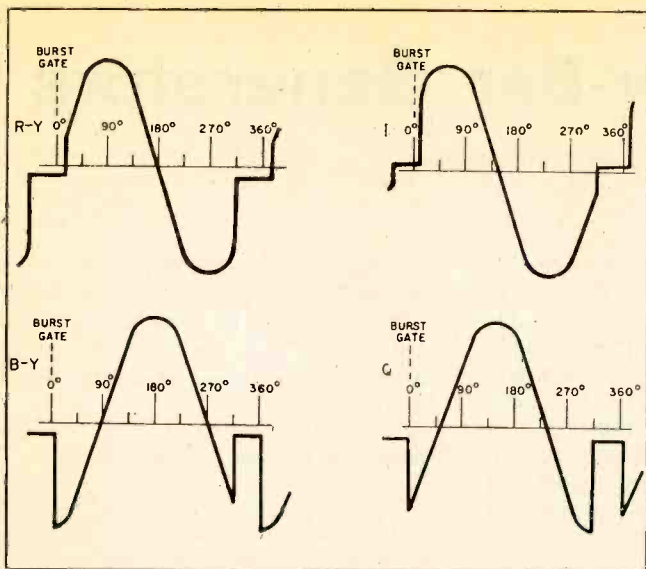

Fig. 3. Demodulator output waveforms.

ferent for the reasons previously discussed. Since the R-Y and B-Y demodulators have a 90° phase difference, circular waveforms are displayed by a rainbow signal in a vectorgram test, as shown in Fig. 4.

**Stability Considerations**

You may have made the experiment of displaying rainbow patterns by injecting the 3.56-mc CW output from a signal generator into the video section of a color-TV receiver. In such case you will recall how carefully the generator must be tuned to make the rainbow pattern lock into color sync. Although the pattern remains fixed on the screen for a while, it then begins to "pull" to the right or to the left, wavers, and finally breaks color sync lock. The signal generator must then be returned carefully to display again the rainbow pattern. This is a practical demonstration of the fact that service-type signal generators tend to drift slightly in frequency, and the basic circuitry of such generators is

not entirely suited to the requirements of color-pattern generators.

It will be found that a highly stable reference-frequency source is as necessary in a color-pattern generator as in a white-dot or crosshatch generator. In fact, the accuracy must be even higher if true colors are to be displayed. According to NTSC standards, the color-subcarrier oscillator must have an accuracy of  $\pm 10$  cps in 3.579545mc. This precise control of frequency is maintained by color-TV transmitting stations, although it is difficult to realize this accuracy in service-type color-pattern generators. However, stable quartz-crystal oscillators are used in service-type instruments which provide a satisfactorily stable reference frequency.

The same requirement for frequency stability is met in rainbow-pattern generators as in NTSC color-bar generators. Under ideal circumstances, a rainbow generator operates on a reference frequency of 3.563795 mc  $\pm 10$  cps. Hence, stable quartz-crystal

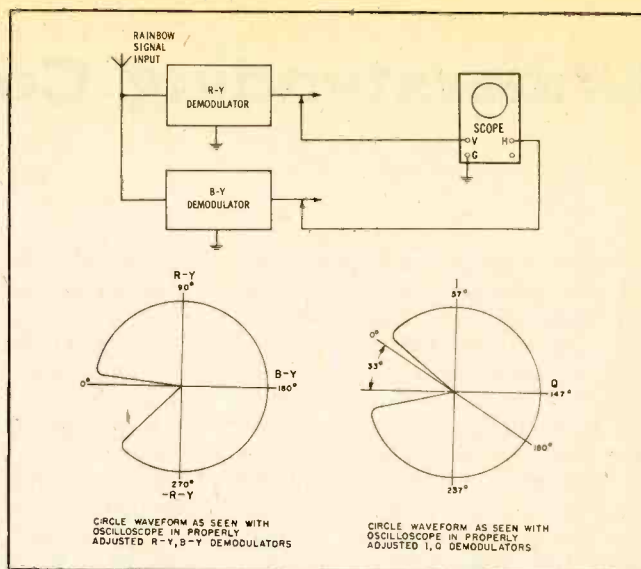

Fig. 4. Rainbow-signal generator vectorgrams.

oscillators are also necessary in rainbow-type instruments.

**Rainbow-Generator Configuration**

Fig. 5 shows the circuit for a simple rainbow generator, comprising a 3.563-795-mc (nominally 3.56) oscillator and a modulated RF oscillator. Trimmer capacitor C46 is connected across the crystal to provide exact adjustment of the offset color-subcarrier frequency. This is a maintenance control. The 3.56-mc output is taken from the cathode of the rainbow oscillator. Plate modulation is employed, with the output from the rainbow oscillator coupled through C42 to L4. Modulated RF output is taken from the cathode of the RF oscillator tube.

To permit testing on a clear channel in various localities, the RF oscillator can be switched to operate on any one of the low VHF channels. Trimmer C41 permits the RF oscillator to be adjusted exactly to the picture-carrier frequency. Uniform output on the various channels is maintained by changing the plate voltage of the RF oscillator. This is the purpose of the voltage divider comprising R50 through R54. Since the RF output tends to decrease as the oscillating frequency is increased, more B+ voltage is automatically used on the higher-frequency channels.

**Keyed-Rainbow Generator**

Keyed-rainbow generators are more elaborate than simple generators in that the rainbow is switched off and on as required to display rainbow color bars on the picture-tube screen. Ten bars are displayed, as illustrated in Fig. 6. A definite advantage of the keyed display is that chroma phases are identified at 30° intervals by the rainbow bars. This feature makes it

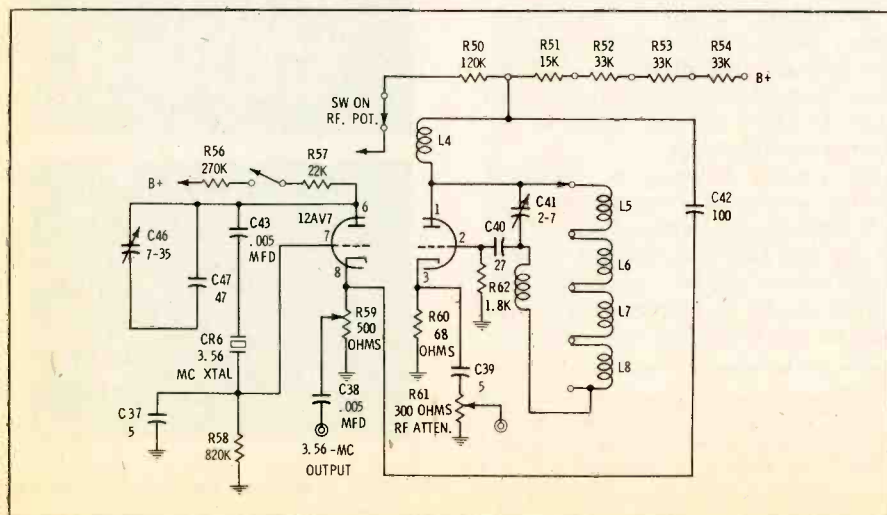

Fig. 5. Configuration of a simple rainbow generator.

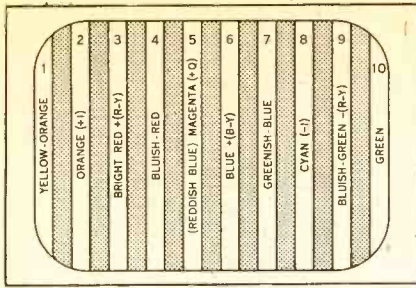

Fig. 6. Color-bar pattern display showing order of the color bars.

much easier to analyze the pattern for defective reproduction, and it also facilitates scope waveform analysis when troubleshooting the chroma circuitry in a color receiver.

Although ten rainbow bars are displayed in the picture-tube pattern, there are 11 bursts in a keyed-rainbow signal, as shown in Fig. 7. The first burst following the horizontal sync pulses does not appear on the picture-tube screen because it occurs during horizontal flyback. This burst enters the color-sync section of the receiver, just like a conventional color burst. Thus, the subcarrier oscillator in the receiver is locked to the phase of the first burst in the keyed-rainbow signal.

Note the difference between the burst provided by a keyed-rainbow generator and the color burst which is transmitted from a broadcast station. The generator supplies a color sync signal that is 15,750cps less than the frequency of an NTSC color sync signal. However, a color receiver locks on the phase of the rainbow signal, although it cannot lock in with the frequency of the rainbow signal. This type of color sync is called sidelock.

Fig. 8 shows the normal demodulator output waveforms seen when a keyed-rainbow signal is applied to a color receiver. Compare these patterns with those illustrated in Fig. 3. Obviously, the keyed-rainbow pattern makes it much easier to check phases by simply counting the pulses along the waveform. Each pulse is shifted from adjacent pulses by 30°. Observe how I and Q demodulator phases are separated by 90°. Similarly, R-Y and B-Y phases are separated by 90°. On the other hand, the G-Y phase does not have a 90° separation from any of the foregoing signals; this consideration is explained in detail subsequently.

#### Generator Circuitry

A typical configuration for a keyed-rainbow generator is seen in Fig. 9. V6A is a crystal-controlled oscillator using a 3.56-mc crystal in a Pierce oscillator circuit. This 3.56-mc output is coupled from plate pin 6 of V6A to the grid, pin 2 of V6B through capacitor C28. Also coupled to grid

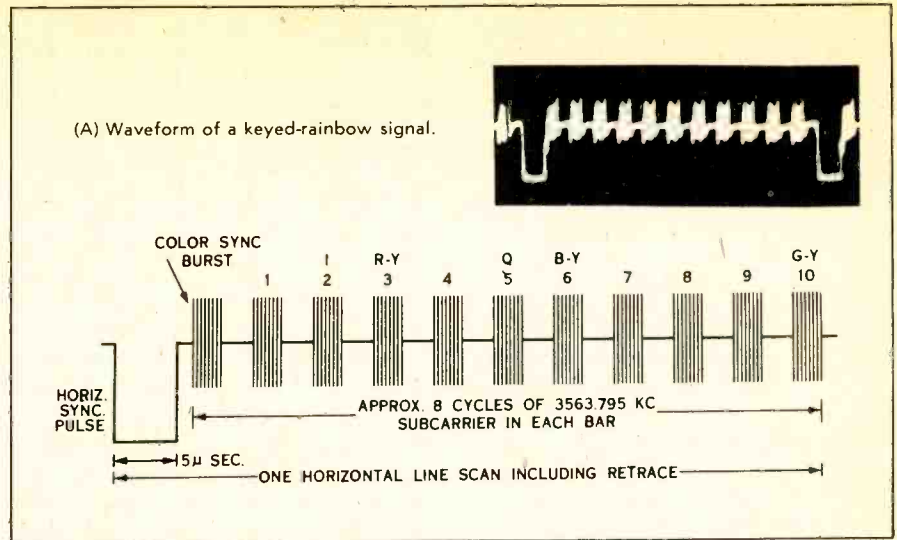

Fig. 7. Keyed-rainbow signal characteristics.

pin 2 through capacitor C29 are high-level 189-kc square wave pulses from plate pin 6 of V1B. These pulses drive the grid to cutoff over their negative excursion and gate the tube into conduction over only their positive excursion. This gated (keyed) rainbow signal is then fed to the sync mixer, thence to the RF modulator.

Because of the small values of V6B load resistor R31 (connected to pin 1), coupling capacitor C27, and its subsequent resistive load, the keying pulses feed through as differentiated spikes. These spikes provide a white leading edge and a black trailing edge on the rainbow color bars. In effect, these are vertical-line signals which are accepted by the Y amplifier in the color receiver, but which are rejected by the receiver chroma circuitry. Consequently, the spikes give a means of checking "color fit"; the rainbow color bars are normally displayed exactly flanked by the white and black vertical lines without overlap.

All present-day keyed-rainbow generators are combined with white-dot and crosshatch generators, because they are used primarily as installation instruments. Since installation procedures entail both convergence adjustments and a check of color phasing adjustments, technicians prefer to have all necessary signals available from one compact generator. Economy is also realized because many of the pulse signals required to produce white-dot or crosshatch patterns are also utilized to produce the keyed-rainbow waveform. Moreover, the same modulator and RF oscillator are employed for both functions.

#### Burst-Phase Color-Signal Generator

Fig. 10 depicts a chroma-signal generator which is not of the rainbow

type, since the oscillator operates at 3.579545mc. It is an unkeyed configuration; thus, a color receiver "sees" the chroma at burst phase. No RF oscillator is used in this simplified instrument. Instead, the output leads are connected in parallel with the antenna to the receiver. Thus, when the receiver is used to station, RF voltage from the antenna flows into the generator as well as into the receiver.

Oscillator output in Fig. 10 is taken from the cathode of the 12AT7 and is fed into the 1N81A diode (CR3), which operates as a modulator. The 3.58-mc voltage feeds into diode CR3 via C28, while RF voltage from the antenna feeds into the diode via C29. In the diode, the 3.58-mc voltage modulates the incoming RF voltage, and some of the modulated RF signal feeds back out of the generator to the receiver. Note that a 60-cps voltage switches the modulator diode CR3 off and on.

Consequently, the color bar recurs at a 60-cps rate and displayed horizontally on the screen of the color

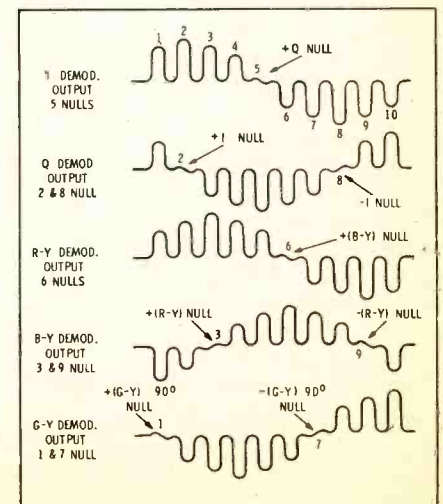

Fig. 8. Demodulator output waveforms.

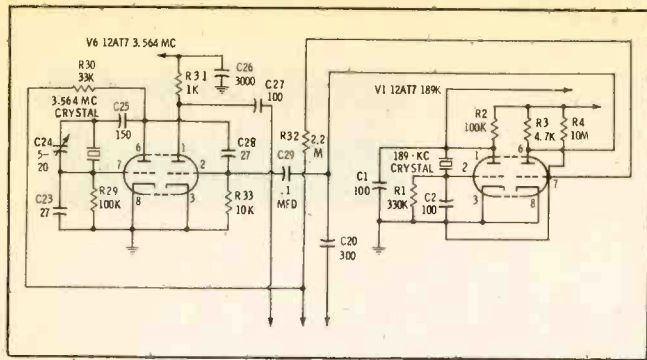

Fig. 9. Keyed-rainbow generator circuit.

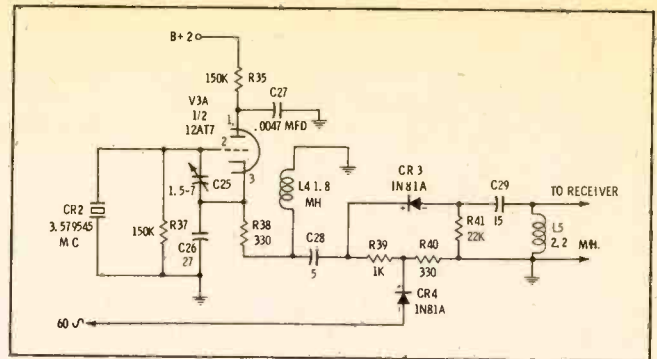

Fig. 10. A simple generator providing a burst-phase signal.

picture tube. It occupies about two-thirds of the total screen height. This color bar is always superimposed on a black-and-white picture from a TV station, since the receiver must be tuned to a station before the generator will produce a modulated-RF output signal. Trimmer capacitor C25 is a maintenance control which is set to tune the crystal exactly to the color-burst frequency. No operating controls are provided in this type of color-bar generator.

To check the setting of the hue control in a color receiver, the green and blue guns are temporarily disabled, leaving a red field on the screen of the color picture tube—only the red gun is operating in the picture tube at this time. A burst-phase chroma signal has the  $-(B-Y)$  phase, which produces zero response from the red gun, provided that the hue control in the receiver is adjusted properly. The operator inspects the red field on the picture tube screen and carefully adjusts the hue control to make the bar invisible. If the hue control is not set correctly, the bar signal will be visible in the background of the red field.

In addition to the configuration shown in Fig. 10, this color-signal generator also provides circuitry for producing white dots, crosshatch, vertical lines and horizontal lines. However, sync pulses are not generated, and the patterns are locked by injecting the flyback pulse from the receiver into the generator. A separate lead is used for this purpose. Because of the extreme simplification employed, the instrument has been made unusually compact and low-priced. It is primarily for installation use and is not intended as a bench troubleshooting generator.

### Single-Bar NTSC Generator

Various NTSC color-bar generators are available which display a single color bar at a time. It is customary to provide the primary and complementary colors, as well as several chroma

test signals. For example, a typical generator of this type supplies red, green, blue, magenta, cyan, yellow, R-Y, B-Y, G-Y, and G-Y/90° bars. Any one bar may be obtained at a time. An NTSC generator produces correct hues at specified saturation with horizontal sync, blanking, and burst at proper pedestal position. Display of correct hues requires appropriate signal amplitudes and phases. Table 1 indicates the chroma phase angles and brightness levels for the primary and complementary colors.

Table 1. Chroma, Phase, and Brightness Characteristics

COLOR	PHASE ANGLE	BRIGHTNESS LEVEL
Yellow	12.0°	.89
Red	76.5°	.30
Magenta	119.9°	.41
Blue	192.0°	.11
Cyan	256.5°	.70
Green	299.9°	.59

Fig. 11 illustrates the appearance of a single color bar on the screen of a color picture tube and the waveform for a yellow color bar. A block diagram of a single-color-bar generator is shown in Fig. 12. Development of

a red color-bar signal, for example, takes place as follows. A 3.579545-mc (nominally 3.58-mc) color subcarrier signal is generated by a crystal-controlled oscillator. This 3.58-mc signal is fed to the burst gate, which conducts briefly following each horizontal sync pulse. Eight or nine cycles of the 3.58-mc signal are passed at this time to produce the color burst seen on the back porch of the horizontal sync pulse in Fig. 11B.

Output from the 3.58-mc oscillator is also applied to a delay line producing a phase shift of 76.5° as specified in Table 1 for a red bar. This delayed 3.58-mc signal is then fed to the chroma gate, which conducts during part of the forward scan. During the gate conduction time, the delayed 3.58-mc signal is passed to produce the 3.58-mc chroma component seen in Fig. 11B. Keying of the burst and chroma gates is accomplished as follows. Output from the 15,750-cps blocking oscillator (Fig. 12) is shaped into a suitable pulse which then triggers the burst multivibrator. This is a one-shot multivibrator that generates a gating pulse of precise width.

The pulse output from the burst multivibrator is applied to the burst gate, which is switched on for the duration of the pulse. Next, the output from the burst gate is inverted in preparation for combining the color burst with the other components of the color-bar signal. A branch line from the burst multivibrator feeds the output pulse to a delay line, which imposes a delay equal to the time from the trailing edge of the color burst to the leading edge of the 3.58-mc chroma component (Fig. 11B). After being suitably delayed, the pulse passes through a pulse shaper (Fig. 12) to form a trigger impulse for the chroma multivibrator. This is a one-shot multivibrator that produces a gating pulse of precise width. Output from the chroma multivibrator is applied to the chroma gate, which is switched on for the duration of the pulse.

A branch line from the chroma multivibrator is connected to a clipper

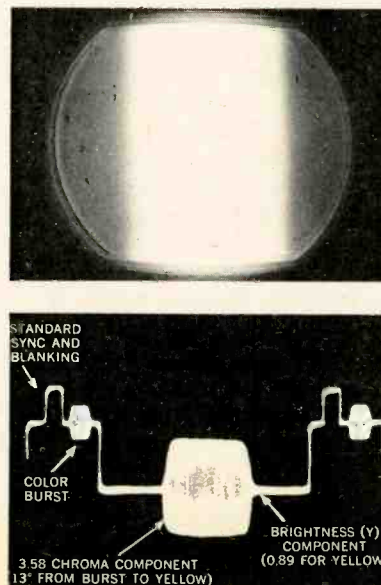

Fig. 11. Typical single color-bars.

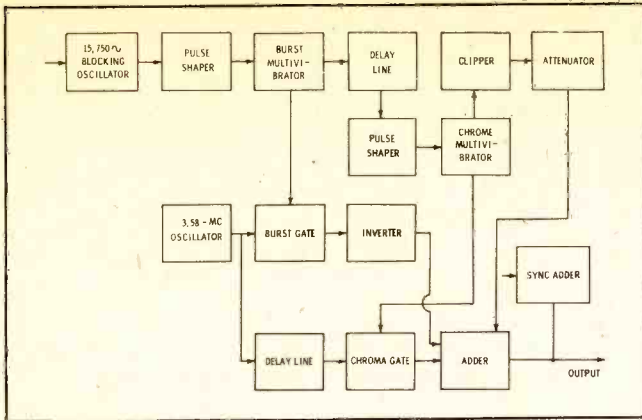

Fig. 12. Block diagram of a single-color-bar generator.

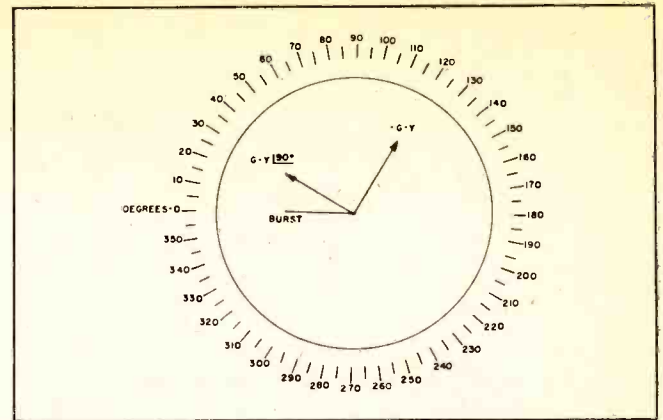

Fig. 13. Relation of G-Y/90° to burst and G-Y phases.

which processes the pulse for use as a Y or luminance signal (Fig. 11B). An attenuator (Fig. 12) reduces the output from the clipper to correct amplitude for the particular color bar; for example, the Y component in Fig. 11B has an amplitude equal to 0.89 of the white level. If a red bar is being generated, the clipper output is attenuated to 0.3 of white level. The Y signal is combined with the color burst, chroma, and sync in adders or mixers.

Only the color-bar signals are generated with a Y component. The chroma-bar signals (R-Y, B-Y, G-Y, and G-Y/90°) are centered on black level — their Y component is zero. This signal characteristic follows from the fact that chroma-bar signals are *color-difference* signals in which the brightness component has been subtracted from the complete color signal. Fig. 13 depicts the relation of G-Y/90° to burst and G-Y phases. Note that G-Y/90° is in quadrature to G-Y. Put another way, this is the same relation as R-Y to B-Y, or I to Q. Just as an R-Y demodulator nulls on a B-Y signal, a G-Y demodulator or matrix nulls on a G-Y/90° signal.

### Circuit Description

Fig. 14 shows the color-subcarrier oscillator configuration. A tuned-grid tuned-plate circuit is used, with adjustable plate tuning provided by trimmer capacitor C46. Miller-effect coupling from plate to grid results in transfer of a portion of this capacitance

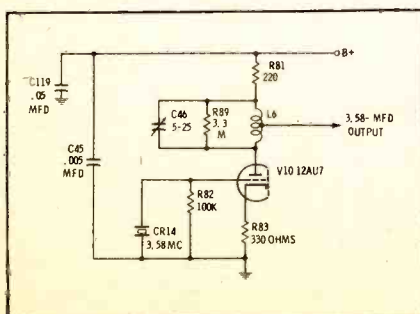

Fig. 14. Color subcarrier oscillator.

to the grid circuit. Hence, quartz crystal CR14 can be tuned slightly by adjustment of C46. This is a maintenance control. R82 operates as a grid-leak resistance. Note that R89 is of no electrical significance in the plate circuit; it is employed merely as a winding form to support L6. The 3.58-mc output is taken from a tap on L6 near AC ground to provide a low-impedance output. In turn, the oscillator is lightly loaded, assisting in maintaining stable operation.

### Burst and Chroma Gates

Output from the subcarrier oscillator is applied to voltage divider R84 and R85 (Fig. 15). This reduces the 3.58-mc voltage to a suitable value for driving the grid of burst-gate tube V7A. A branch lead from the junction of R84 and R85 is fed to the input of an artificial delay line. This particular delay line comprises R115, L102 (which is wound on R106), C103, L103 (which is wound on R107), C19, C104, and R102. The exact time delay can be adjusted by trimmers C103 and C104. Note that a separate delay line is required for each color, and that various delay lines are switched into or out of the circuit by a function switch. The particular line shown is used only to produce the "yellow" phase delay.

A tap on the delay line feeds the 3.58-mc signal to the grid of chroma-gate tube V8A. Thus the signal at the chroma gate lags the burst signal by 12°, as specified in Table 1 for a yellow hue. Outputs from the burst-gate and chroma-gate tubes are combined, and they appear across the common plate-load impedance (L3, C36, and R65). Trimmer C36 is a maintenance control that permits tuning L3 to exactly 3.58-mc. Although the amplitude of the chroma signal is fixed, the amplitude of the burst signal is adjustable by varying the value of R63.

Note that gating pulses are fed to the screen grids of V7A and V8A. No DC voltage is applied to the screen grids. Hence, these tubes are normally cut off, and no 3.58-mc signal appears at the plates. However, when a positive gating pulse is applied to the screen grid, the tube is switched into operation and amplifies the 3.58-mc signal for the duration of the gating pulse. The burst-gating pulse arrives before the chroma-gating pulse, because the chroma component follows the color burst, as seen in Fig. 11B. Observe also that the burst-gating pulse has a shorter duration than the chroma-gating pulse. Thus, V7A and V8A conduct alternately.

Disregarding L102 and L103, the

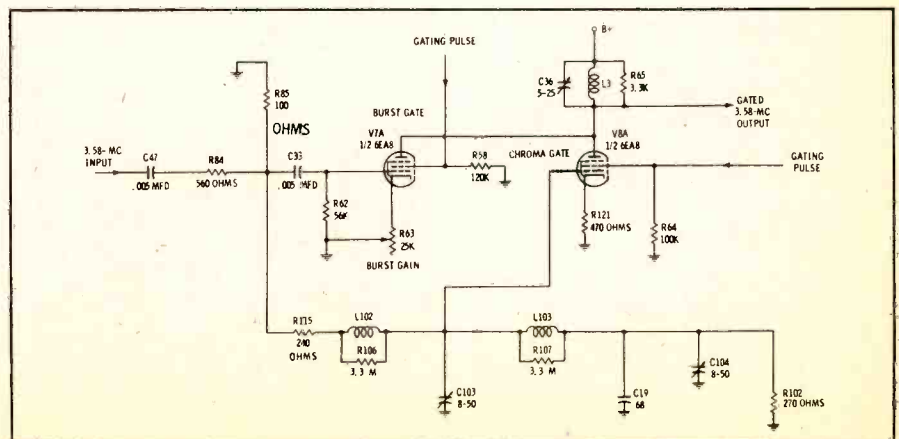

Fig. 15. Burst and chroma-gate circuitry.

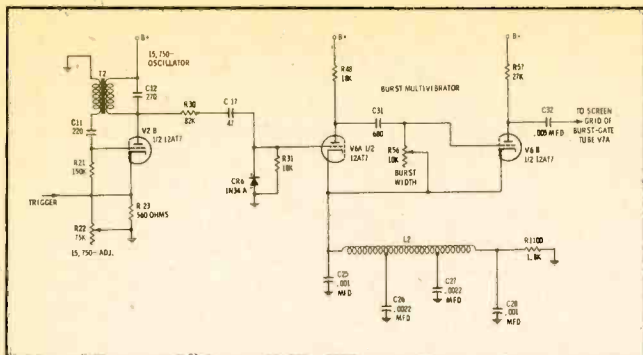

Fig. 16. Burst-gating pulse is formed in this circuit.

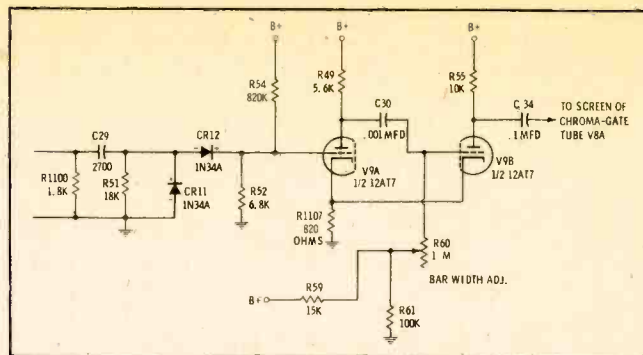

Fig. 17. Chroma-gating multivibrator circuit.

applied signal flows through R115 (Fig. 15) into C103, C19, and C104. Series resistance followed by shunt capacitance forms an integrating circuit, and the output rises gradually in this type of RC circuit. In other words, the output lags the input. Coils L102 and L103 have a certain impedance at 3.58-mc, and in the first analysis can be considered as AC resistances inasmuch as they oppose current flow. The coils contribute to the basic integrating action and delay buildup of the output voltage. Since the impedances of the coils can be varied by adjusting the trimmer capacitors, the exact amount of delay can be set to the desired value.

**Generation of Gating Pulses**

Burst-gating pulses are formed in the network shown in Fig. 16. V2B is a 15,750-cps blocking oscillator which generates a pulse output at its plate. This pulse is narrowed and clipped in passage through R30, R31, C17, and CR6; thus, it is shaped into an accurate trigger pulse. Tubes V6A and V6B operate in a one-shot multivibrator circuit. After the circuit is triggered, it goes through one cycle of operation and generates a pulse of precise duration. The one-shot multivibrator then rests, and does not generate another pulse until the next trigger arrives. One-shot action results from a high cathode bias developed by R1100 on V6A.

**Chroma-Gate Multivibrator**

Refer to Fig. 16. A delay network is connected in the common-cathode circuit of V6A and V6B. This network consists of L2, C25, C26, C27, C28, and R1100. Resistor R1100 is the

terminating resistance for the delay line. A short time after V6A and V6B are cycled, the negative pulse at their cathodes appear across R1100. This pulse is processed to serve as a trigger pulse for the chroma-gate multivibrator, as shown in Fig. 17. To process the pulse, it is first differentiated by C29 and R51. Differentiation results in the production of both positive and negative spikes. Only the positive spikes are desired in order to trigger V9A.

Note that the negative spikes "see" a low resistance to ground through CR11, and they are thereby clipped from the differentiated waveform. On the other hand, the positive spikes "see" a low resistance through CR12, and they pass to the grid of V9A. V9A and V9B comprise a one-shot multivibrator circuit. A positive output pulse of precise width is generated at the plate of V9B for each trigger pulse applied to V9A. However, this chroma-gating pulse is delayed, and its duration is longer than the burst-gating pulse. The duration of the chroma-gating pulse is determined by the setting of R60. This pulse keys the chroma-gate tube.

**Development of the Y Signal**

Next, a branch circuit is used to

process the chroma-gating pulse for further use. A Y signal is required for a complete color signal. It is generated as shown in Fig. 18. The positive pulse from the plate of V9B is coupled through C35, resulting in the pulse acquiring both a positive and a negative excursion. CR301 clips off the negative excursion, thus providing a uniform base line. At this point the pulse has too much amplitude to serve as a Y signal; hence, resistor R122 is used as a voltage divider to reduce the pulse amplitude. In the complete color-bar generator, a different value of R122 is switched into the circuit when a different color signal is selected. A value of 11K is used when a yellow bar is being generated.

V8B inverts the pulse polarity so that the output from the plate is a negative pulse. To compensate for the tube tolerances, a gain control (R70) is provided in the cathode circuit of V8B. Output from the Y adder (V8B) is fed to the burst, chroma, and sync in much the same way as previously described for white-dot and crosshatch generators. Regardless of the color being generated, the amplitude of the horizontal sync pulse is constant. On the other hand, the amplitudes of the Y signal and the chroma signal are

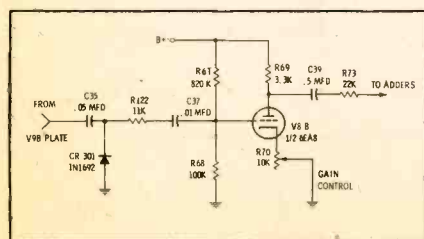

Fig. 18. Y-shaper and adder.

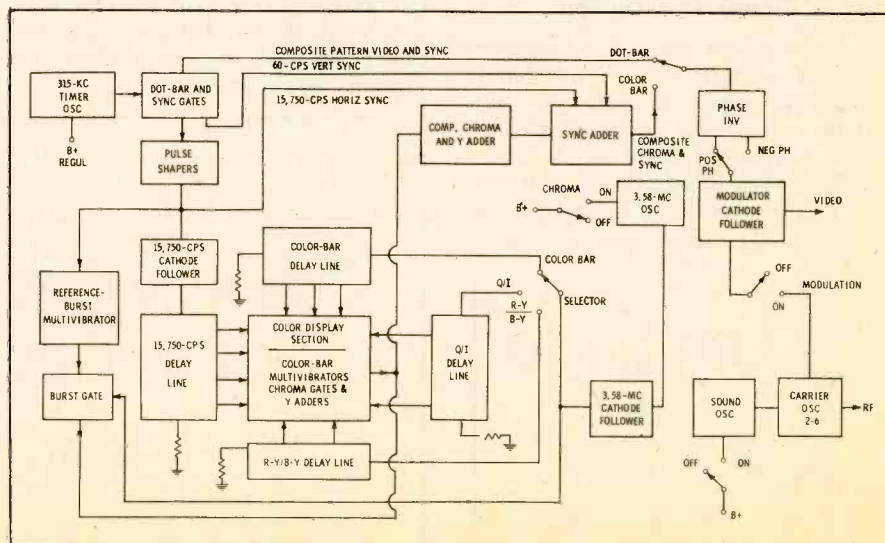

Fig. 19. Block diagram of a multiple-bar NTSC generator.



changed when the function switch is set for various colors.

### Multiple Color-Bar Patterns

Basically, the same principles described are used to generate multiple color-bar patterns. However, circuitry details are necessarily more complex; for example, electronic switching is used instead of manual switching. A block diagram for a multiple color-bar generator is shown in Fig. 19. The Y signal is produced by mixing square or rectangular waves as depicted in Fig. 20. These waveforms have amplitudes corresponding to the brightness levels of green, red, and blue (the primary colors). Thus, the "green" square wave has a relative amplitude of 0.59, the "red" wave 0.30, and the "blue" wave 0.11. These rectangular waves occur in time relationships as seen in Fig. 20.

When the three waveforms are combined in an adder, the Y signal for a multiple color-bar pattern is obtained. Primarily-color Y levels are obtained without overlap of the waveforms. On the other hand, complementary colors have Y levels produced by overlapping a suitable pair of primary-color waveforms. For example, yellow is obtained by overlapping green and red. Since green has an amplitude of 0.59 and red has an amplitude of 0.30, the Y signal for yellow has an amplitude of 0.89.

Characteristics of the NTSC system specify that the amplitude of the Y signal shall correspond only to the brightness of a color. Hue corresponds to the phase of the chroma signal, and saturation corresponds to the amplitude of the chroma signal. Relative amplitudes and phases for the three primary chroma signals are shown in Fig. 21A. Observe that the resultant of the red and blue chroma signals is equal and opposite to the green chroma signal (Fig. 21B). This simply means that if all three primary chroma sig-

nals are mixed together, they will cancel out to zero.

This basic fact is used to advantage in the design of multiple color-bar generators. When a white bar is generated, it is obtained by combining red, green, and blue chroma signals. The combination obviously results in a Y signal only, because the three chroma signals cancel out as seen in Fig. 21B. In turn, a self-checking feature is afforded by an NTSC multiple color-bar generator. If the circuit adjustments should drift so that the red, green, and blue chroma signals do not have correct amplitudes and/or phases, the chroma signals do *not* cancel out on the white bar. Instead, more or less 3.58-mc "fuzz" appears on the Y signal. This is a trouble symptom which informs the operator that his generator is out of adjustment.

### Output Facilities

Simple color generators often have an RF output only, and an RF attenuator may be provided. In such case the generator provides a fixed medium-level output such as 5000 microvolts. This level will not overload a normally operating color receiver, and the usual differences in receiver sensitivity are automatically compensated by the AGC system. More elaborate color generators have an RF attenuator which permits adjustment of the RF output level over a wide range. In turn, the performance of the receiver can be easily checked under simulated fringe-area conditions.

Larger generators often provide video-frequency output in addition to RF output. A video-output attenuator is omitted in the lower-priced models. In such cases the video output has a fixed level, which is typically 2 volts peak-to-peak. This output is useful for injecting the color signal at the video-detector output in a receiver when trouble is suspected in the RF or IF sections. However, it may not always

be possible to use the video-output signal in this manner, because it might have incorrect polarity for the particular receiver. The video output can be fed directly to a wide-band scope, and this test provides a convenient check on the color-signal waveform to determine whether the generator might need adjustment.

Elaborate color-bar generators have a video-signal attenuator that permits adjustment of the video-output level. A typical generator can be adjusted for an output from zero to 2.5 volts peak-to-peak. Moreover, such generators have a video polarity-reversing switch so that the video signal can always be injected at the video-detector output in a color receiver, regardless of the detector polarity. A 4.5-mc sound signal is often provided to permit a check of sound interference in color receivers. When rejection of the sound signal is inadequate, the 4.5-mc signal beats with the 3.58-m signal, and produces a visible 920-kc interference pattern on the screen of the color picture tube.

### Common Troubles in Color-Pattern and Color-Bar Generators

Weak or otherwise defective tubes are the most common troublemakers in color generators. In case the tubes have been cleared from suspicion, the most likely culprits are capacitors. First consider the symptoms of filter-capacitor trouble in an unkeyed-rainbow generator. Serious leakage in filter capacitors reduces the B+ voltage and the output signal is weakened; if the B+ voltage falls below a critical value, either the RF oscillator or subcarrier oscillator, or both, will suddenly drop out and no color pattern will be displayed.

On the other hand, when the DC voltage remains about normal but the ripple becomes excessive, shading is seen in the rainbow pattern. That is,

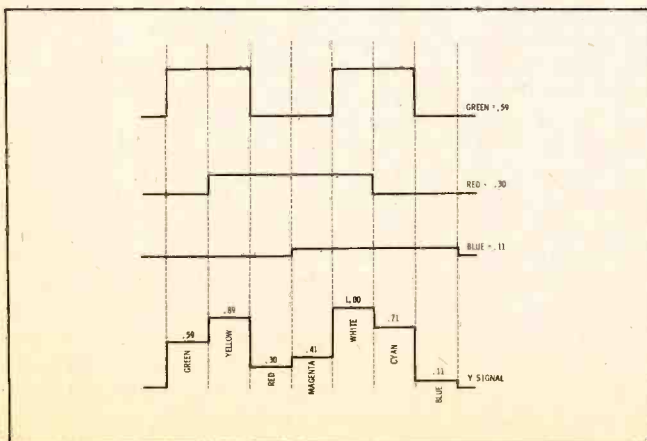

Fig. 20. Formation of Y signal for an NTSC display.

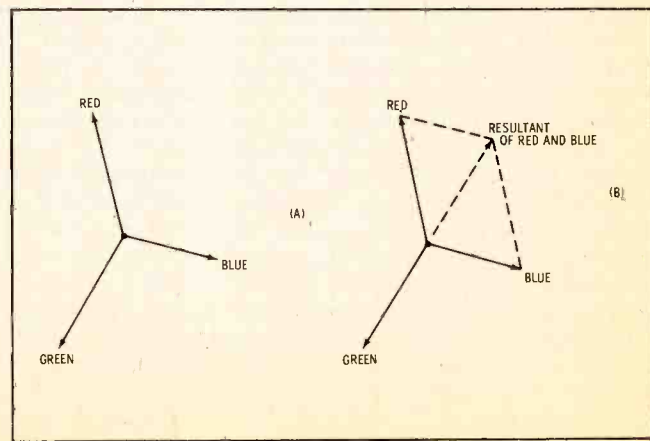

Fig. 21. How chroma signals cancel on a white bar.

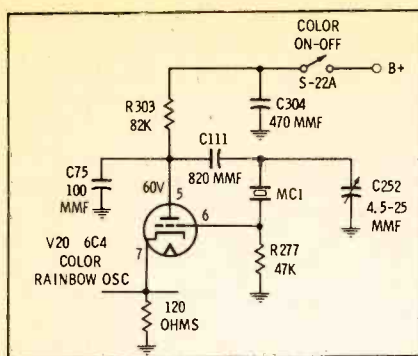

Fig. 22. Simple rainbow oscillator.

the top of the pattern may be quite dim, while the bottom portion is excessively bright, or vice versa. Quite possible a dark hum bar will also be observed drifting up or down the screen. Thus, the symptoms of power-supply trouble are easily recognized and can be quickly localized in a simple rainbow generator. If an unkeyed-rainbow generator provides horizontal and vertical sync pulses, vertical sync lock is usually disturbed by excessive power-supply ripple — the pattern jitters and varies in height as the hum bar drifts off-screen at the top or bottom.

#### Subcarrier Oscillator Frequency

The circuit for a simple unkeyed-rainbow generator is shown in Fig. 22. Crystal MC-1 must be tuned as closely as possible to 3.563795mc — otherwise, the rainbow pattern will be “pulled” to the right or left of the picture-tube screen. A trimmer capacitor is used to tune the quartz crystal. If this capacitor is shorted, the circuit does not oscillate and there is no signal output. On the other hand, if C252 is open, the pattern will either pull severely or lose color sync completely. The crystal oscillates at too high a frequency and cannot be tuned when the trimmer capacitor is open.

Next, consider the situation in which C252 is not defective, but is misadjusted. In such case, the rainbow colors appear shifted to the left or right on the screen of a normally operating color receiver. To calibrate the rainbow oscillator, proceed as follows. Tune in a color program on a normally operating color receiver, and adjust the controls for proper reception. Disable the control-AFC network in the receiver and adjust the color-subcarrier oscillator in the receiver to obtain normal color reproduction. This is a free-wheeling adjustment, and the colors will tend to drift back and forth through their normal hues. The receiver is now free-wheeling about 3.58-mc—it can now be used as a frequency reference.

Disconnect the antenna, and connect the rainbow generator to the

receiver. Trim the rainbow oscillator (by adjusting C252 in Fig. 22) until a normal rainbow pattern free-wheels on the picture-tube screen. The rainbow crystal (MC-1 in Fig. 22) is then tuned very closely to 3.56 mc. With the calibration completed, restore the operation of the color-AFC network in the receiver. You will then see a normal stabilized rainbow pattern on the picture-tube screen with colors orange, red, magenta, blue, cyan, and green from left to right. Although calibration can be made without disabling the color-AFC network in the receiver, this method permits a closer adjustment, because there is no AFC action to mask the trimmer adjustment.

Suppose C75 in Fig. 22 is shorted. If so, there is no output from the rainbow oscillator. Conversely, if C75 is open, the circuit will continue to oscillate at slightly lower output and with a small frequency shift. If C111 in Fig. 22 is shorted, the circuit continues to oscillate; however, B+ voltage then appears across C252 as well as across the crystal, which is not desirable. On the other hand, if C111 opens up, the circuit will not oscillate. C304 is a decoupling capacitor which minimizes pattern interference caused by RF energy gaining entry into the oscillator circuit; it also minimizes entry of rainbow-signal voltage into the B+ system.

Output from the rainbow oscillator modulates an RF oscillator; a typical configuration is shown in Fig. 5. The RF oscillator operates at a chosen picture-carrier frequency. If C42 is open, there is no modulation on the RF carrier. However, if C42 is leaky or shorted, output from the oscillator will be weak or absent. Otherwise, the RF-oscillator circuitry is conventional.

#### Keyer Troubles

A keyed-rainbow generator has a keyer circuit following the rainbow oscillator. Fig. 23 shows a typical configuration. Output from the 3.56 (rainbow) oscillator is applied to the grid of the keyer tube through a 27-mmf coupling capacitor. Also applied to the keyer grid is a 189-kc square-wave voltage. The square wave drives the keyer tube into and out of conduction, thus “chopping” the rainbow signal into chroma bars. If the 27-mmf capacitor is open, no chroma bars appear; instead, only keying transients (vertical black and white lines) appear on the picture-tube screen. If the 27-mmf capacitor is leaky, DC volt-

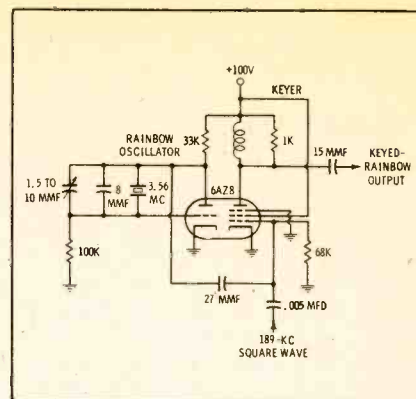

Fig. 23. Keyed-rainbow circuit.

age keyer tube; in turn, the chroma bars become abnormally wide. The keyer tube runs hot and soon becomes damaged if the 27-mmf capacitor leaks substantially.

Suppose the 0.005-mfd capacitor in Fig. 23 opens up; then, an unkeyed-rainbow pattern appears on the picture-tube screen. If the 0.005-mfd capacitor is leaky, D-C voltage from the plate of the 189-kc square-wave shaper tube (not shown in Fig. 23) bleeds through to the grid of the keyer tube. The chroma bars then become abnormally wide because the square wave cannot drive the keyer tube completely to cutoff. As before, the tube runs hot and can be damaged if the 0.005-mfd capacitor leaks excessively.

Display of an unkeyed-rainbow pattern can also result from defects in the 189-kc square-wave shaper or 189-kc oscillator circuits. Troubleshooting these sections of a keyed-rainbow generator is the same as with a white-dot or crosshatch generator. Output from the keyer tube is fed through a 15-mmf coupling capacitor (Fig. 23) to the RF section. If the 15-mmf capacitor opens, the RF output is then unmodulated, and no chroma bars appear on the picture-tube screen. Conversely, if the 15-mmf capacitor shorts, the symptom is the same, because B+ voltage from the keyer tube “kills” the action of the intermediate shaper tube (not shown in Fig. 23).

Aside from defective tubes, most keyer troubles are caused by faulty capacitors, as would be expected. However, to check further, measure the resistors in the keyer and associated circuitry with an ohmmeter. Resistors are most likely to increase in value or open up, although they will occasionally decrease in value or become intermittent. Dirty or erratic socket contacts are sometimes confused with resistor defects, simply because socket trouble is not ordinarily suspected. In rare cases, the keyer plate-load coil might open, causing smeared edges on the chroma bars. ▲

# Complete TUNER REPAIR for only

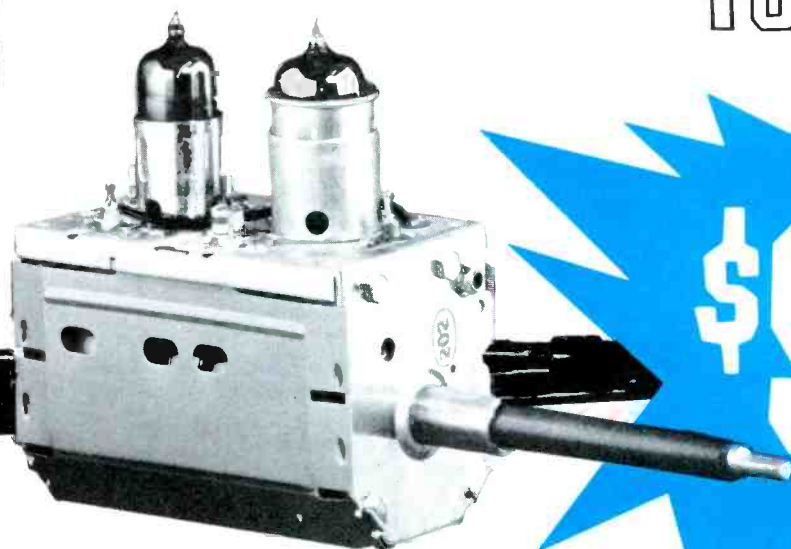

**\$9.50**

Sarkes Tarzian, Inc., largest manufacturer of TV and FM tuners, offers unexcelled tuner overhaul and factory-supervised repair service. Completely-equipped and conveniently-located Service Centers offer fast, dependable and factory-supervised repair service on all makes and models. Centers are staffed by well-trained technicians, assisted by engineering personnel.

Tarzian-made tuners received one day will be repaired and shipped out the next. More time may be required on other makes. Every channel—not just the channels existing in any given area—is checked and re-aligned per orig-

inal specifications. Exclusive cleaning method makes the tuner look—as well as operate—like new.

Cost, including ALL labor and parts (except tubes) is only \$9.50 and \$15 for UV combinations. No additional charge. No hidden costs. Too, you get a full, 12-month warranty against defective workmanship and parts failure due to normal usage.

Always send TV make, chassis and Model number with faulty tuner. Check with your local distributor for Sarkes Tarzian replacement tuners, parts or repair service. Or, use the address nearest you for fast, factory-supervised repair service.



## TUNER SERVICE CORPORATION

*(Factory-supervised tuner service authorized by Sarkes Tarzian)*

MIDWEST—817 N. Pennsylvania St.,  
Indianapolis, Ind. Box 1642  
Tel: 317-632-3493

EAST — 547-49 Tonnele Ave., Jersey City, N. J.  
Tel: 201-792-3730

WEST—

**SARKES TARZIAN, Inc.**  
Tuner Service Division

10654 Magnolia Blvd.,  
N. Hollywood, Calif.  
Tel: 213-769-2720



MANUFACTURERS OF TUNERS, SEMICONDUCTORS, AIR TRIMMERS, FM RADIOS, AM-FM RADIOS, AUDIO TAPE and BROADCAST EQUIPMENT

Circle 2 on literature card

March, 1966/PF REPORTER 9

# PF Reporter™

PHOTOFACT

the magazine of electronic servicing

VOLUME 16, No. 3

MARCH, 1966

## CONTENTS

**Understanding Color-Bar Generators** Robert G. Middleton 1  
8-page book section gives many interesting facts about a popular piece of color test equipment.

**Letters to the Editor** 13

**The Electronic Scanner** 15

**Soldering for Techs** David I. King and Norman D. Tanner 18  
A pictorial presentation of how it should and shouldn't be done.

**Soldering** David I. King 20  
An understanding of the principles helps eliminate poor joints.

**Tube and Transistor Data** 24  
Information on latest releases.

**Servicing Mobile Radio with a Scope** Leo G. Sands 30  
Here too, scopes can save time, increase profits.

**Meter Repair for Steady Hands** 32  
Minor repairs may be made in your shop.

**Converting Scopes to Triggered Sweep** Robert G. Middleton 34  
Simple modification adds versatility.

**Checking Color TV with B/W Equipment** John D. Lenk 40  
Most tests can be made with sweep and marker generators.

**Notes on Test Equipment** Paul Smith 45  
Lab reports on the SECO Model 900 Color-Bar Generator and the RCA Model WR-52 MPX Generator.

**SYMFACT: B&K 1076** 53  
See what happens to voltages and waveforms when troubles occur.

**Book Review** 69

**The Troubleshooter** 74

**Product Report** 78

**Free Catalog and Literature Service** 92

**Monthly Index on Free Literature Card**

**publisher**

Howard W. Sams

**general manager**

Donald W. Bradley

**editor**

William E. Burke

**managing editor**

James M. Moore

**ass't to the editor**

Norman D. Tanner

**associate editors**

Arnold E. Cly

David I. King

**consulting editors**

Joe A. Groves

C. P. Oliphant

**research librarian**

Bonny Howland

**production manager**

Esther M. Rainey

**circulation manager**

Pat Tidd

**art directors**

Louis J. Bos, Jr. & Robert W. Reed

**photography**

Paul Cornelius, Jr.

**advertising sales offices**

Hugh Wallace, advertising sales manager

**midwestern**

Roy Henry

Howard W. Sams & Co., Inc. 4300 West 62nd St.,

Indianapolis, Ind., 46206

291-3100

**central**

Paul Houston

Howard W. Sams & Co., Inc. 4300 West 62nd St.,

Indianapolis, Ind., 46206

291-3100

**eastern**

Gregory C. Mosefield

Howard W. Sams & Co., Inc. 3 West 57th St.

New York 19, New York

MU 8-6350

**southwestern**

C. H. (Jake) Stockwell

C. H. Stockwell Co., 4916 West 64th St.

Mission, Kansas, RA 2-4417

**western**

Los Angeles Office

G. R. (Jerry) Holtz

The Maurice A. Kimball Co., Inc.

2008 West Carson St., Suites 203-204

Torrance, Calif., 90501

320-2204

**San Francisco Office**

The Maurice A. Kimball Co., Inc.

580 Market St., Room 400

San Francisco 4, California

EX 2-3365

Address all correspondence to PF REPORTER,

4300 W. 62nd Street, Indianapolis, Indiana 46206



Copyright© 1966 by Howard W. Sams & Co., Inc. PF REPORTER is a trademark of Howard W. Sams & Co., Inc. No part of PF REPORTER may be reproduced without written permission. No patent liability is assumed with respect to use of information herein. Acceptance of advertising does not in any manner signify the products, policies and services so advertised have been approved, endorsed or recommended by this magazine.

Subscription Prices: 1 year—\$5.00, 2 years—\$8.00, 3 years—\$10.00, in the U. S. A., its possessions and Canada. All other foreign countries: 1 year—\$6.00, 2 years—\$10.00, 3 years—\$13.00. Single copy 50¢; back copies 65¢

Indexed in Lectradex.

Printed by the Waldemar Press Div. of Howard W. Sams & Co., Inc.

### About the Cover

Our cover this month illustrates a technician engaged in aligning a stereo FM receiver. For this job, he is using four of the instruments on his bench.

A good understanding of today's instruments helps the technician to a quicker and easier repair. Articles on test equipment are found throughout this issue.

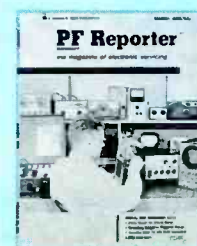

# **KWIKETTE**\* SOLDERING AIDS...

the revolutionary new connectors  
that make **QUICK** work of parts replacement!

**WIRE + FLUX + SOLDER, ALL in One!**

The 3-in-1 KWIKETTE is not just another wire spring connector . . . Copperweld wire inner core, an intermediate layer of flux, and an outer jacket of solder . . . **ALL YOU NEED IS HEAT!**



Nine times  
actual size

Once again, Sprague helps the TV-radio service industry by solving difficult servicing problems . . . parts replacement on printed wiring boards, in "inaccessible" chassis nooks, and on crowded terminal lugs. Mechanically sturdy and electrically reliable, the KWIKETTE provides *quick*, expert, "one-handed" soldered connections as easy as A-B-C!

**A** SNIP LEAD...  
it's quick!

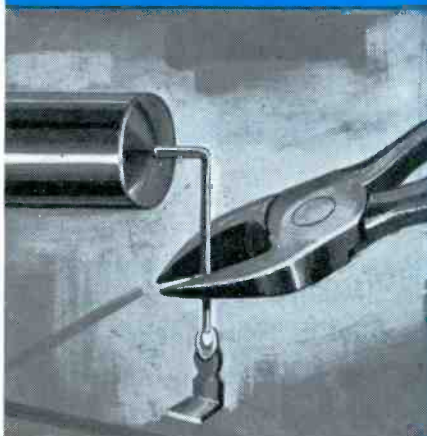

**B** SLIP ON KWIKETTE...  
it's quick!

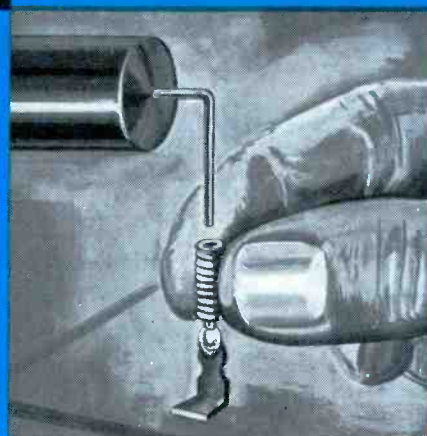

**C** APPLY HEAT...  
it's quick!

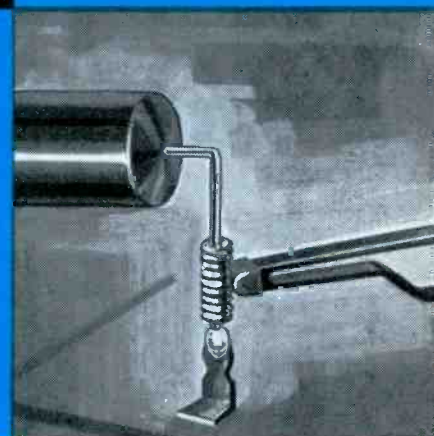

**NOBODY ELSE HAS KWIKETTE CONNECTORS . . .  
YOU GET 'EM ONLY FROM SPRAGUE PRODUCTS!**

KWIKETTES are now being packed with Sprague Atom<sup>®</sup> Capacitors at no extra cost to you! Whenever you need tubular electrolytics, insist on pre-packaged Sprague Atoms from your parts distributor and you'll automatically get your KWIKETTE component connectors . . . the biggest boon to the service technician since the soldering gun!

\*Trademark

WORLD'S LARGEST MANUFACTURER OF CAPACITORS

Circle 3 on literature card



For window-size blowups of this message, send 10¢ to Sprague to cover handling and mailing costs.

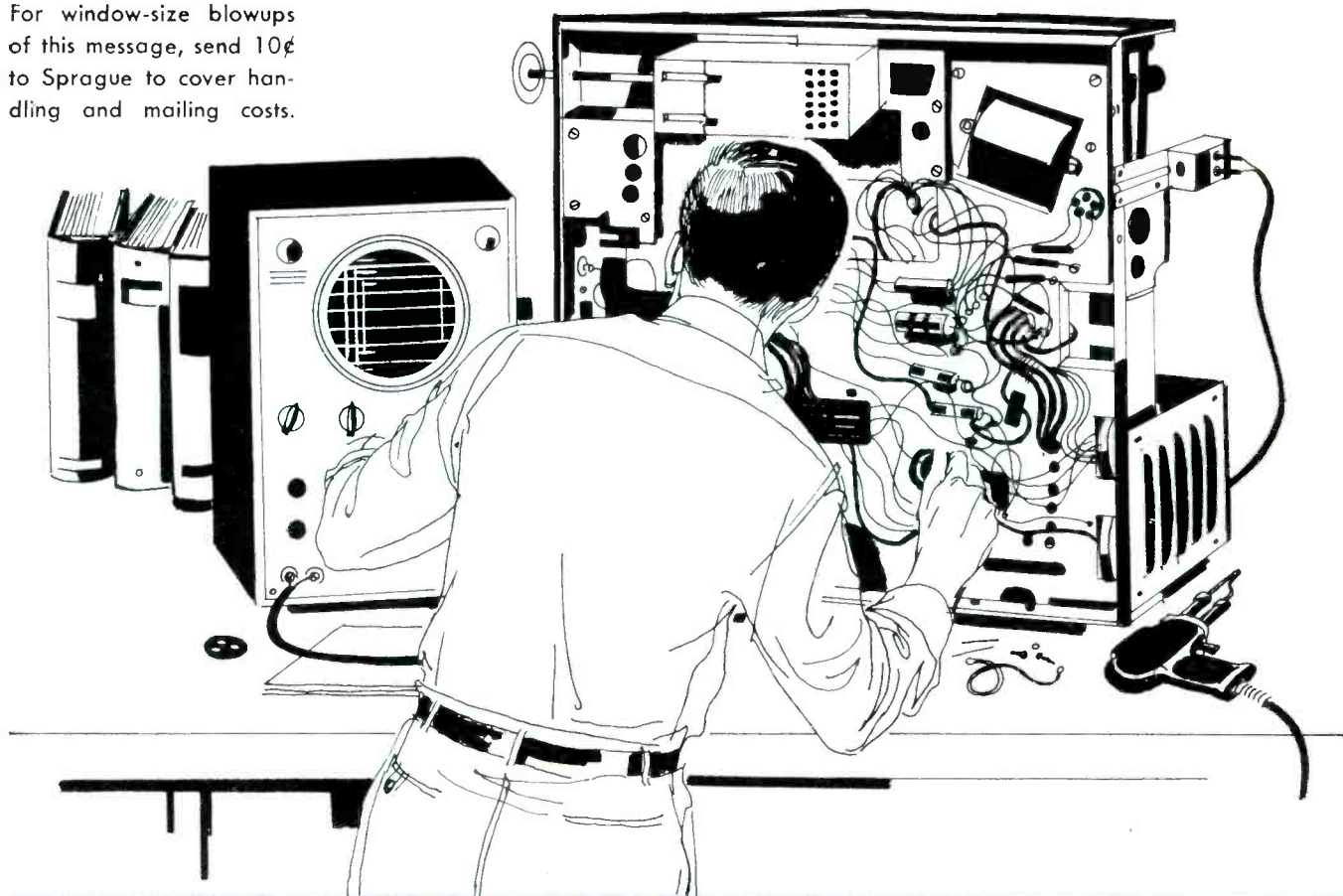

**More than 5600 ft. of circuitry ... 590 parts ...  
and he has to know how to fix 'em all!**

**YOUR TV SET** is the most complicated piece of equipment you've ever owned. It represents a considerable investment of money. It provides your family with a wealth of entertainment pleasure. You value it highly.

Nobody is more aware of these facts than your neighborhood TV-Radio technician. And because he stakes his reputation on your satisfaction, *he strives to be worthy of your trust in him.* He achieves this by years of training and practice in electronic theory and application. He equips himself with expensive but essential test equipment, tools, and service

manuals. He spends countless hours keeping up-to-date on new developments, new circuits, new trouble-shooting techniques.

His training and experience qualify him as a modern, professional expert. As such, he asks a fair, professional price for his services. Since he will not use cut-rate methods or cut-rate parts in your TV set, he cannot offer cut-rate prices. *Remember, you get only your money's worth in TV-Radio service. When you are taken in by a "bargain-type" offer, you can expect to get "bargain-type" service. BEWARE THE SERVICE BARGAIN!*

**THIS MESSAGE WAS PREPARED BY SPRAGUE PRODUCTS COMPANY**  
DISTRIBUTORS' SUPPLY SUBSIDIARY OF SPRAGUE ELECTRIC CO., NORTH ADAMS, MASS., FOR

**YOUR NEIGHBORHOOD TV-RADIO TECHNICIAN**



## Letters to the Editor

Dear Editor:

In regard to Mr. Fournier's letter about weak audio trouble in an Airline TV (January 1966), he can connect pins 1 and 2 of the 6BQ5 socket together and solve his problem. Most 6BQ5's do not use both pins 1 and 2 for the control grid but only pin 2. This chassis has the grid connection to pin 1 of the socket. If only pin 2 is used in the tube, you can have an open grid circuit.

N. N. JONES

Lebanon, Indiana

Actually, pin 1 of the 6BQ5 is listed as an internal connection. Some manufacturers tie tube pins 1 & 2 together — others do not. It is possible that pin 1 could be tied to any other pin, even the screen or plate; for safety's sake, we would not advise tying pins 1 and 2 together. A better solution is to transfer all connections from pin 1 to pin 2. Then any 6BQ5 will work. —Ed.

Dear Editor:

I am a regular reader of your magazine and think it is very good. The 5-year index in the January 1966 issue makes my copies 10 times as valuable and is one way you have it over all the others. Thank you for it.

In your October 1965 issue, page 14, you presented a couple of problems. I looked at the first one, subtracted 12 from 46, halved this, and got the answer without a pencil. I then turned to the answers and almost fell out of my chair at the exhibition of knowledge necessary for solving the problem. I am not trying to be nasty, but am using this to illustrate a point. I believe a goodly share of the writers in our field like to do things that way; believe me, that doesn't help us any when we are on the trail of a stinky capacitor that is acting like a yo-yo. Thanks again for the index.

GORDON HATHAWAY

Put In Bay, Ohio

The cumulative indexes are presented for just this purpose—to make all issues of the PF REPORTER as valuable as the latest. The problems were presented as an attempt to demonstrate involved logic. Mr. Hathaway has shown us that he too can use logic to arrive at an answer. —Ed.

### HONESTLY!

I answered the 'phone,  
A woman roared—  
Heard I'd fixed her set  
With a "cheater cord"

—Phyllis Barlow

# 9<sup>50</sup>

ALL PARTS

(except tubes)

Plus Shipping Charge

# QUALITY TV TUNER SERVICE

# 24 hrs.

Service

Most Makes

### UHF - VHF - COLOR - (COMBOS. - 14.50)

15 YEARS OF TUNER EXPERIENCE

- 1 Year Warranty
- Tuners completely cleaned and checked
- Open Account on approved credit
- Dist. write for price structure



Pack Tuner Carefully  
— Insure Package —  
Include all parts  
(Broken or not)

**QUALITY TUNER SERV.**

5142 W. 25th St.  
CHICAGO, ILL. 60650

Circle 5 on literature card

# Jackson

IT'S THE FINEST

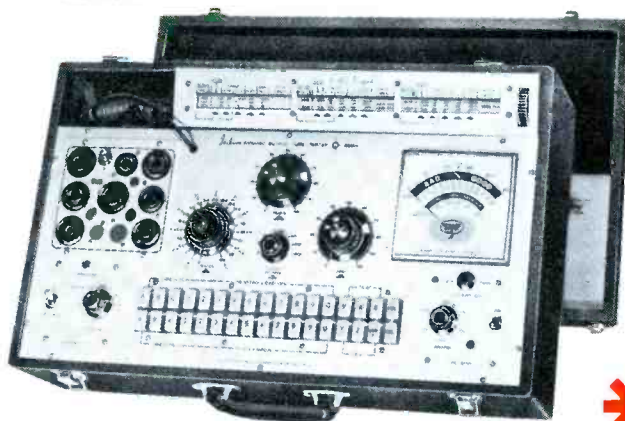

**is \$234.95**  
**too much to pay for a**  
**TUBE TESTER?**

It can be too much if you have little use for a tube tester. But if you are a technician on the go, who believes an investment in top equipment is a sound investment in your own skill, ability and livelihood, then the Model 658-1 DYNAMIC OUTPUT TUBE TESTER is your greatest bargain. No other tube tester available makes so many accurate tests on more tubes, so quickly. Makes a true rectifier test, handling high current types with ease • tests grid leakage up to 80 megohms • heater current on series string tubes • heater continuity without warm-up • indicates striking point and operating range for regulator and reference tubes • provides the right sensitivity for triple shorts sensitivity test on each tube • dynamic test for eye tubes • accurate test on all 12-volt hybrid tubes • famous Jackson life-line test. Among the many extraordinary features of the Model 658-1 is the brilliant dynamic output principle, providing the most valid kind of test for amplifiers, by considering the entire output curve of the tube—not just a small portion. Fast push-button sequence switching makes set-up time less than tube warm-up time. Convenient angled view zig-zag color coded roll chart is read right on the panel. Don't settle for less than the ultra reliability of the Model 658-1.

\*Model 658-1 DYNAMIC OUTPUT TUBE TESTER...Net...\$234.95

See your Jackson distributor, or write for catalog

## JACKSON ELECTRICAL INSTRUMENT COMPANY

35 Windsor Avenue, Mineola, New York 11501

Export: Morhan Exporting Corporation  
458 Broadway, New York 13, N. Y.

IF IT'S A JACKSON...IT'S THE FINEST

Circle 6 on literature card March, 1966/PF REPORTER 13

# NEW SIMPSON 7-INCH VTVM MODEL 312

*Immediate delivery from Electronic Distributor stock.*

## Extra Wide Frequency Response. 40% Less Circuit Loading Than Conventional VTVMs.

Here's a rundown on all the goodies Simpson has packed into this new VTVM. With its accessory probe, you can make measurements from 10 KC to 250 MC at  $\pm 1$  db. With its 16 megohm (rather than 11) input resistance, you don't have to worry about circuit loading. Moreover, you can run your tests with a tracking error of less than 1%. And don't worry too much about meter burnout. There's a specially designed protection circuit. You can handle solid state testing easily and accurately because of the  $\frac{1}{2}$ -volt DC range. Accuracies are  $\pm 3\%$  (FS) on all AC and DC ranges. Resistance accuracy is  $\pm 3^\circ$  of arc. Model 312 has a big, easy-to-read 7-inch meter housed in a rugged phenolic case. Operating line voltage is 105/125 V, 50/60 cps. High voltage and RF probes available. See Bulletin 2070; copies sent on request. Model 312 price... **\$79<sup>95</sup>**



### RANGES:

- DC VOLTAGE: 0-0.5, 1.5, 5, 15, 50, 150, 500, 1500 (16 Megohms input impedance)
- AC VOLTAGE: (R.M.S.): 0-1.5, 5, 15, 50, 150, 500, 1500 (1 Megohm minimum input impedance)
- AC VOLTAGE: (Peak to Peak): 0-4, 14, 40, 140, 400, 1400, 4000
- RESISTANCE: RX1, RX10, RX100, RX1K, RX10K, RX100K, RX1M (10 ohm center)
- FREQUENCY RESPONSE:  $\pm 3\%$  from 15 cps to 3 megacycles per second on all AC voltage ranges through 150 volts. With R.F. Probe: 10KC to 250 MC  $\pm 1$  db. R.F. probe usable up to 40 volts rms.



**SIMPSON ELECTRIC COMPANY**  
5209 W. Kinzie Street, Chicago, Ill. 60644 • Phone: (312) ESTbrook 9-1121  
Representatives in Principal Cities . . . . See Telephone Yellow Pages  
Export Dept: 400 W. Madison St., Chicago, Ill. 60606 Cable, Amergaco

In India: Ruttonsha-Simpson Private Ltd., Vikhroli, Bombay

**WORLD'S LARGEST MANUFACTURER OF ELECTRONIC TEST EQUIPMENT**

*Circle 7 on literature card*





# The Electronic Scanner

news of the servicing industry

## Imported U.S. Brand TV and Radio Sales on Increase

Imported radios and TV receivers sold under U.S. brand names increased sharply during the first half of 1965, the **Electronic Industries Association** Marketing Services Department reported.

Sales of imported radios bearing U.S. brands accounted for 10.8% of total radio imports during the first half of 1965, compared to 7.5% in 1964. Sales of imported TV receivers comprised 63% of total TV receiver imports during the first six months of 1965, as against 54% in 1964.

During 1961, imported radios totaled 12.2 million units, or 52% of all U.S. sales. For the next two years, these sales remained constant at 13.6 million units, or 58% of annual U.S. radio sales. By the first half of 1965, however, imported radios declined in U.S. sales, falling to 6.5 million units, or 54.5% of total U.S. sales.

Factory sales of U.S.-produced television receivers amounted to 4.6 million units during the first half of 1965, or 92% of total U.S. sales. However, in 1960, U.S.-produced receivers accounted for 99% of all U.S. sales.

Similarly, U.S.-produced phonographs show a gradual decline in sales. Factory sales during the first six months of 1965 represented 91% of total U.S. sales, compared to 97% in 1960.

The United States has been traditionally a large market for tape recorders exported from foreign countries, especially Japan. However, imported recorders sold under U.S. brand names constitute an insignificant portion of total imports, since only 160,000 units, or 1.2%, were sold in the first half of 1965.

**TABLE I**  
**RADIOS\***  
(Thousands of units)

Year	Total U.S. Sales	Factory Sales U.S. Produced	Total Imports	Imported U.S. Brand	Imported Foreign Brand
1963	23,441	9,818	13,623	620	13,003
1964	23,423	9,819	13,604	1,017	12,587
1965 (Jan.-June)	11,964	5,448	6,516	703	5,813

\*Excludes (1) automobile radios, (2) radio/phonograph combinations, and (3) radio/television combinations.

**TABLE II**  
**MONOCHROME AND COLOR TELEVISION\***  
(Thousands of Units)

Year	Total U.S. Sales	Factory Sales U.S. Produced	Total Imports	Imported U.S. Brand	Imported Foreign Brand
1963	7,982	7,591	391	174	217
1964	9,764	9,049	715	383	332
1965 (Jan.-June)	4,985	4,574	411	257	154

\*Includes TV-Phonograph and/or TV-Radio Combinations.

## Philco, RCA, Zenith Skyrocket Color TV Tube Manufacture

Philco Corporation will spend about \$20 million to build and equip a color television tube manufacturing plant at

# COMPLETE TUNER OVERHAUL

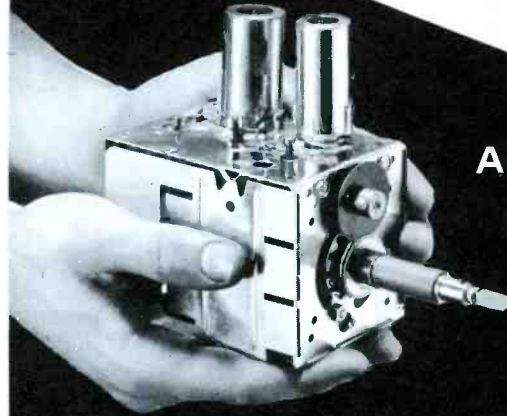

ALL MAKES —  
ONE PRICE

**995**

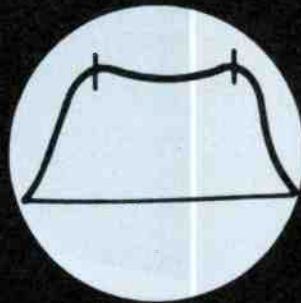

3.58

ALL LABOR AND PARTS  
(EXCEPT TUBES & TRANSISTORS)\*

## COLOR TUNERS

GUARANTEED COLOR ALIGNMENT — NO ADDITIONAL CHARGE



Simply send us the defective tuner complete; include tubes, shield cover and any damaged parts with model number and complaint. Your tuner will be expertly overhauled and returned promptly, performance restored, aligned to original standards and warranted for 90 days.

UV combination tuner must be single chassis type; dismantle tandem UHF and VHF tuners and send in the defective unit only.

Exact Replacements are available for tuners unfit for overhaul. As low as \$12.95 exchange. (Replacements are new or rebuilt.)

And remember—for over a decade Castle has been the leader in this specialized field . . . your assurance of the best in TV tuner overhauling.

Pioneers of TV



Tuner Overhauling

# CASTLE

TV TUNER SERVICE, INC.

MAIN PLANT: 5701 N. Western Ave., Chicago 45, Illinois

EAST: 41-90 Vernon Blvd., Long Island City 1, N.Y.

CANADA: 136 Main Street, Toronto 13, Ontario

\*Major Parts are additional in Canada

Circle 8 on literature card

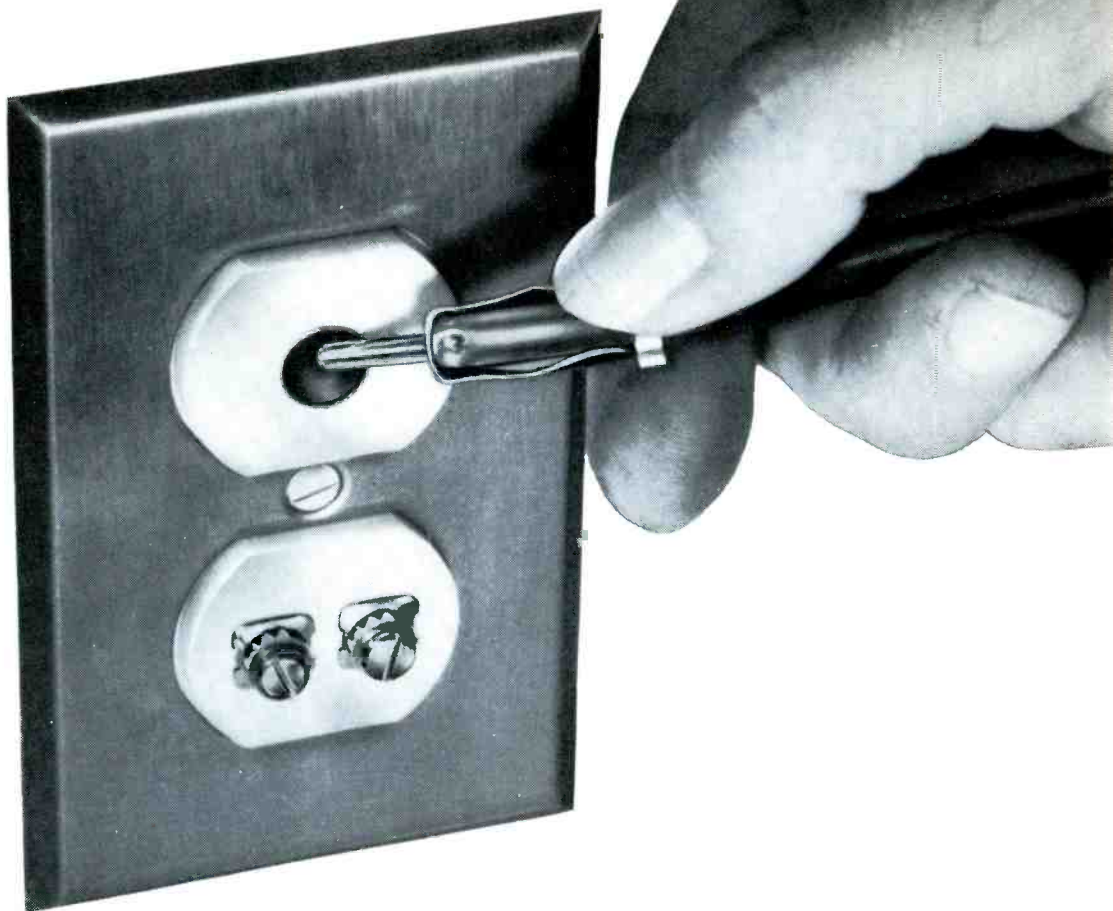

# The most important connection you can make for FULL PROFITS from FULL-HOUSE TV!

The demand for multiple outlet, Master Antenna TV installations has entered a totally new phase ...one which goes far beyond the already big market for commercial applications and reaches to millions of newly created multiple set homes.

Color TV...as well as increasing FM multiplex popularity is the big reason why. Every homeowner who buys a color set instantly becomes a prospect for a residential MATV installation to operate two, three, or more receivers with maximum quality reception from one antenna.

New Channel Master mass production tech-

niques on the same precision-quality, commercial-grade MATV components designed for big building applications have resulted in equipment price reductions that average 25% and more per installation. For MATV installing companies this means more volume and profit from highly competitive commercial jobs. For radio-TV service dealers it means an opportunity to get started in a totally new, high-income business meeting the booming demand for residential master antenna systems. The market is here now. And, it represents business that only you...a qualified service technician...can get.

IMPORTANT...Contact your Channel Master distributor now for details on a complete MATV system design and installation course.

## CHANNEL MASTER

ELLENVILLE, N.Y.



Circle 9 on literature card

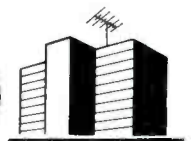

# TRIPLET

# EXTRA QUALITY IS HIDDEN\*

## MODEL 630 V-O-M PRICE \$5500

Standard Of The Industry



### USES UNLIMITED:

- Field Engineers
- Application Engineers
- Electrical, Radio, TV, and Appliance Servicemen
- Electrical Contractors
- Factory Maintenance Men
- Industrial Electronic Maintenance Technicians
- Home Owners, Hobbyists



### FACTS MAKE FEATURES:

- 1** Popular streamlined tester with long meter scales arranged for easy reading. Fuse protected.
- 2** Single control knob selects any of 32 ranges—less chance of incorrect settings and burnouts.
- 3** Four resistance ranges—from .1 ohm reads direct; 4½ ohm center scale; high 100 megohms.

Attention to detail makes the Triplet Model 630 V-O-M a lifetime investment. It has an outstanding ohm scale; four ranges—low readings .1 ohm, high 100 megs. Fuse affords extra protection to the resistors in the ohmmeter circuit, especially the X1 setting, should too high a voltage be applied. Accuracy 2% DC to 1200V. Heavy molded case.

*†630A same as 630 plus 1½% accuracy and mirror scale only \$6500*

**TRIPLET ELECTRICAL INSTRUMENT COMPANY, BLUFFTON, OHIO**

### RANGES

DC VOLTS	0-3-12-60-300-1,200-6,000 at 20,000 ohms per volt.
AC VOLTS	0-3-12-60-300-1,200-6000 at 5,000 ohms per volt.
OHMS	0-1,000-10,000.
MEG OHMS	0-1-100.
DC MICRO-AMPERES	0-60 at 250 millivolts.
DC MILLI-AMPERES	0-1.2-12-120 at 250 millivolts.
DC AMPERES	0-12.

DB: -20 to +77 (600 ohm line at 1 MW).

OUTPUT VOLTS: 0-3-12-60-300-1,200; jack with condenser in series with AC ranges.

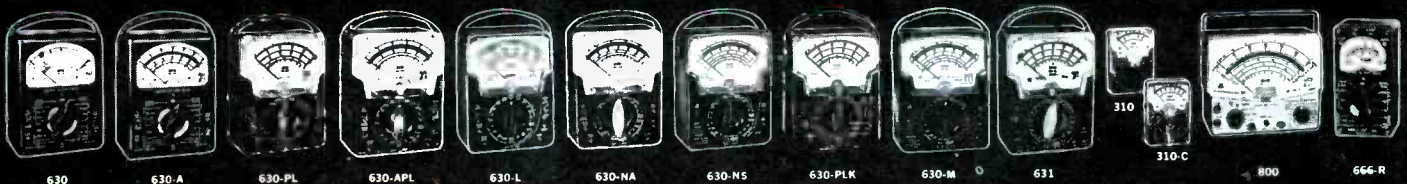

THE WORLD'S MOST COMPLETE LINE OF V-O-M'S. AVAILABLE FROM YOUR TRIPLET DISTRIBUTOR'S STOCK.

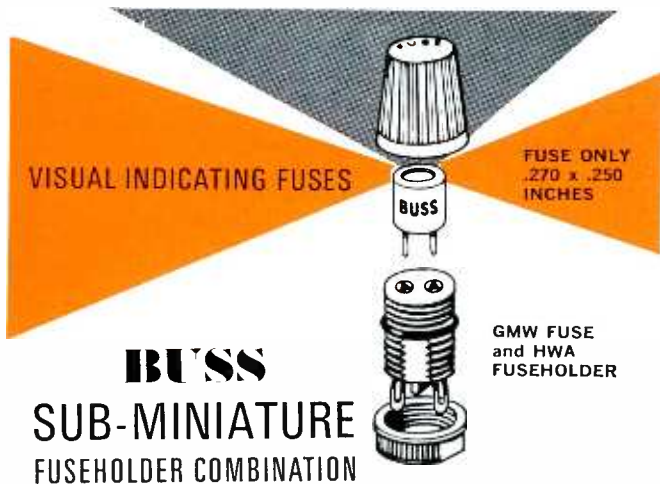

## BUSS SUB-MINIATURE FUSEHOLDER COMBINATION

For space-tight applications. Fuse has window for inspection of element. Fuse may be used with or without holder.

Fuse held tight in holder by beryllium copper contacts assuring low resistance.

Holder can be used with or without knob. Knob makes holder water-proof from front of panel.

Military type fuse FM01 meets all requirements of MIL-F-23419. Military type holder FHN42W meets all military requirements of MIL-F-19207A.

Write for BUSS Bulletin SFB

INSIST ON **BUSS**  
**QUALITY**

BUSSMANN MFG. DIVISION, McGraw-Edison Co., ST. LOUIS, MO. 63107

# BUSS: The Complete Line of Fuses and . . . .

Lansdale, Pa. The new plant will be in operation early in 1967, and by the end of that year will be producing 200,000 tubes yearly. Ultimate capacity of the plant will be 500,000 tubes annually.

The corporation also plans:

1. An investment of approximately \$2 million in an expansion of Lansdale Division's Microelectronics Operation. This expansion will triple the operation's production capacity by the end of 1966, also creating 350 additional jobs.

2. An investment of about \$2 million by Philco's WDL Division to establish a development test center at its complex at Palo Alto, California, to demonstrate use of Philco products in satellite support systems and systems application of microcircuitry.

3. A 17% increase over Philco's 1964 corporate dollar sales, an 18% increase in U.S. consumer products dollar sales, a 16% increase in sales by the balance of the company, and a year-end backlog of government orders nearly 50% greater than at the end of 1964.

The new Lansdale plant will have the flexibility to manufacture rectangular tubes in all sizes from 15 to 25 inches. The plant will continue to produce black-and-white tubes.

RCA Victor Company, Ltd. has announced plans to spend \$25 million to establish a color television picture tube manufacturing facility in the largest single expansion program in the history of the Canadian electronic industry.

The new plant, to be located in Midland, Ontario, will have an annual capacity of more than 300,000 rectangular color picture tubes upon its completion in mid-1967. Construction of the plant is expected to begin early in 1966. RCA Victor Company, Ltd. is the Canadian subsidiary of the Radio Corporation of America.

Canadian television stations will start colorcasting in October, but more than one and one-half million Canadian homes are within viewing range of U.S. border stations now broadcasting a majority of their programs in color. Annual sales

of color sets in Canada is expected to reach 300,000 in several years.

Canadian broadcasters are scheduled to begin color transmission on October 1, with full-scale color telecasts starting January 1, 1967.

RCA has also announced that it plans to build a \$26 million color television picture tube manufacturing plant in Scranton, Pa.

Work on the new building will start immediately, and limited production is expected to be underway by late 1966, with tubes available in early 1967. The plant will manufacture color TV picture tubes in a variety of sizes. Currently, RCA makes rectangular tubes in 25 and 19-inch sizes, with a new 15-inch tube scheduled to go into production during the first quarter of 1966.

Zenith Radio Corporation has announced a \$17 million manufacturing facilities program that will increase by more than 50% the production capacity of picture tubes by the end of 1966, and that will substantially step up black-and-white picture tube output.

The major portion of the expansion program is earmarked for the purchase and equipping of a 628,000 square foot plant in Melrose Park, Illinois, as a highly automated color TV picture tube facility.

First phase of the new expansion program is scheduled to begin in April 1966, when the Melrose Park plant will be modified to accommodate installation of highly mechanized color tube processing equipment. With the new facility operative in 1967, Zenith anticipates its picture tube production to reach 2 million annually.

Zenith purchased the modern plant from United Biscuit Company of America. The award-winning building, constructed for food processing under rigid hygienic conditions, is so designed as to make it readily adaptable to the ultra-clean environment needed for color tube manufacture.

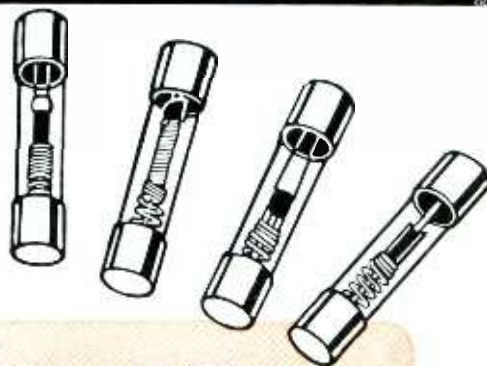

## FUSETRON dual-element Fuses slow blowing

Write for  
BUSS  
Bulletin SFB

"Slow blowing" fuses prevent needless outages by not opening on harmless overloads—yet provide safe, protection against short-circuits or dangerous overloads.

INSIST ON **BUSS**  
**QUALITY**

BUSSMANN MFG. DIVISION, McGraw-Edison Co., ST. LOUIS, MO. 63107  
Circle 11 on literature card

## BUSS SHIELDED FUSEHOLDERS

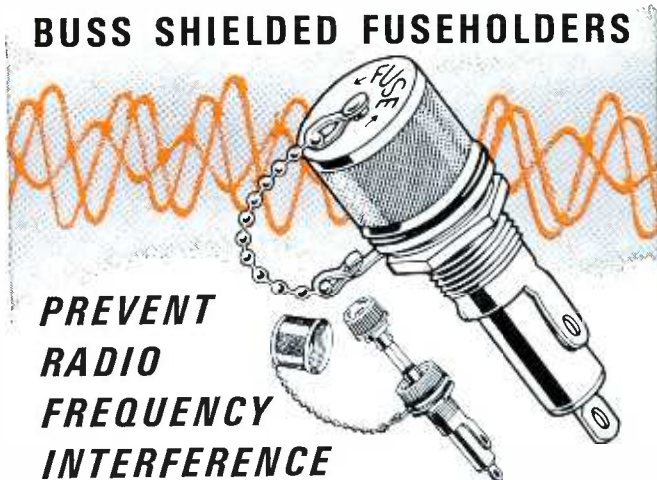

**PREVENT  
RADIO  
FREQUENCY  
INTERFERENCE**

For use where fuse and fuseholder could pick up radio frequency radiation which interferes with circuit containing fuseholder—or other nearby circuits.

Fuseholder accomplishes both shielding and grounding.

Available to take two sizes of fuses— $\frac{1}{4} \times 1\frac{1}{4}$ " and  $\frac{1}{4} \times 1$ " fuses.

Meet all requirements of both MIL-I-6181D and MIL-F-19207A.

Write for BUSS Bulletin SFH-12

**INSIST ON BUSS  
QUALITY**

BUSSMANN MFG. DIVISION, McGraw-Edison Co., ST. LOUIS, MO. 63107

and conditions relating to the merger. Also, consummation of the merger is subject to the approvals of shareholders of each company and to the approval of the Federal Communications Commission and other appropriate government agencies, and to the obtaining of a favorable tax ruling.

American Broadcasting Companies, Inc., will continue to have autonomous operation by its present management, as a separate subsidiary of ITT.

Stockholders of **Rye Sound Corp.**, Mamaroneck, N.Y., have voted to change name to **Rye Industries, Inc.** Rye Sound will remain as a division of the new corporation, a manufacturer and importer of electronic components for home and industry.

### Average Phono Needle 2½ Years Old

Most Americans use their hi-fi phonograph needles three times longer than they should. The average needle is worn out after about ten months of play — yet the average needle gets changed only every 2 1/2 years, according to a survey by **Jean Industries**. Overcoming this procrastination on the part of your customers can help you reap greater needle profits.

Most users figure that, as long as there is no audible sound distortion, they can continue to use the needle. That just isn't so. It is normally impossible to tell when the needle is worn down until after it has done irreparable damage to records, and you should point out this fact.

The life of a phonograph needle can be measured the same way you judge when your car is due for an oil change. Have your customers keep track of the number of hours the needle is played. Most sapphire-type needles are good for about 60 hours. ▲

## Fuseholders of Unquestioned High Quality

### Industry Transactions

**Tube Agency Corporation** has acquired the Tube Tester Division of **GC Electronics**. Tube Agency sells and distributes General Electric tubes exclusively to the tube operators' market, as well as providing tube checkers and tube checker services.

Former GC tube checkers may now be purchased from the Tube Agency Corporation who will maintain and provide service parts, tube charts, and other data on all existing tube checkers manufactured by GC Electronics.

This transaction was culminated so that GC could make available additional engineering, production, and warehouse facilities to expand further its Colormagic television antenna programs and related products.

The acquisition of the instrument line of **Precision Apparatus, Inc.** has been announced by **Dynascan Corporation**, Chicago. Precision meters, oscilloscopes, generators, and other test equipment will be manufactured in Chicago and will be marketed independently of Dynascan's B&K test equipment line.

The **American Broadcasting Companies, Inc.**, and **International Telephone and Telegraph Corporation** have jointly approved a merger of the two companies on the following basis:

ITT will issue .5719 of a share of common stock and .5719 of a share of a new convertible preference stock for each share of ABC common stock. The convertible preference stock will be convertible on a share-for-share basis into ITT common stock and will carry a cumulative dividend equal to twice the dividend on ITT's common stock, but not less than \$2.40 per share. This new preference stock cannot be called for ten years. In the eleventh year, the initial redemption price is \$150 per share, decreasing thereafter at \$5 per year to a minimum of \$100.

The approvals by each company are subject to the execution of a mutually agreeable contract containing complete terms

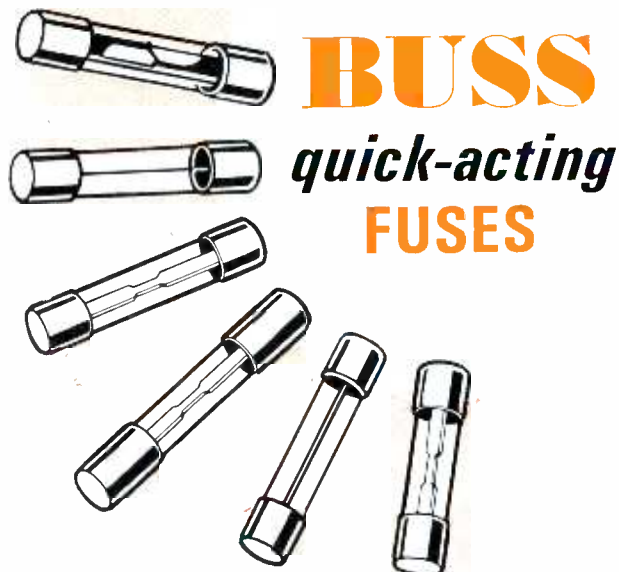

**BUSS**  
quick-acting  
**FUSES**

"Quick-Acting" fuses for protection of sensitive instruments or delicate apparatus;—or normal acting fuses for protection where circuit is not subject to current transients or surges.

Write for  
BUSS  
Bulletin SFB

**INSIST ON BUSS  
QUALITY**

BUSSMANN MFG. DIVISION, McGraw-Edison Co., ST. LOUIS, MO. 63107  
Circle 11 on literature card

# SOLDERING for Techs

by David King and Norman Tanner

Soldering has always required skill: in the past, some components were heat sensitive and required care; soldering irons or bits were cumbersome and took time to heat. Today, the situation is more complex: almost all components used for solid-state circuits are heat sensitive, and PC boards are easily damaged by heat. Desoldering tools, anti-wicking devices, heat sinks, and soldering irons with some form of temperature control are necessities.

It's far beyond the scope of this feature to present all the hints and tips for soldering. However, if you have one or more, please write and tell us about them. We will appreciate the information.



1

Soldering/desoldering tools; transformer varies temp, prevents AC leakage.

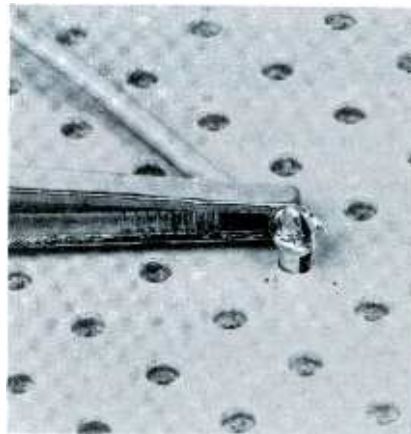

2

Solid mechanical connect must be made or cold solder joint will result. Anti-wicking tool prevents solder flow up wire, protects insulation.

3

This is not the proper way to solder a connection. The connection should be heated; then solder should be applied to the connection, not to the solder-gun tip. A cold solder joint may result using method shown here.

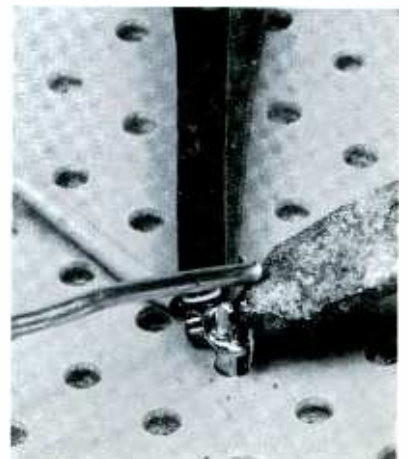

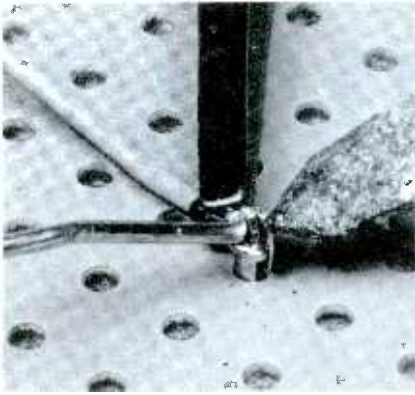

**4** Shown here is the proper method for applying solder. The connection is first heated by the solder-gun tip. Next while the hot tip is pressed against the connection, solder is applied to a point slightly away from the tip. Heat from the joint melts the solder, insuring a good bond.

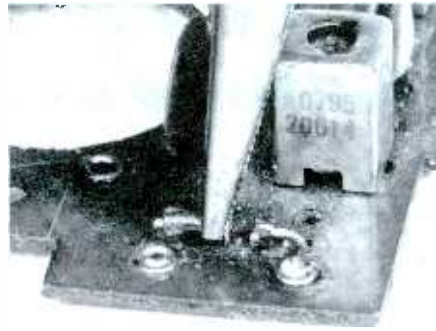

**6** PC-board foil is quite heat-sensitive, making component substitution a problem. If the component is definitely defective, as is this charred resistor, replacement can be made from the top of the board; the foil need not be disturbed. First, crush the defective component with needle-nose pliers; then, if necessary, remove the rest with diagonal cutters.

**7** Next, carefully trim the edges and form two loops as shown here. Always be certain that you have sufficient wire with which to work. In addition, tin the wire loops to reduce the amount of heat required to solder the new component. Then wrap the part's leads around the loops.

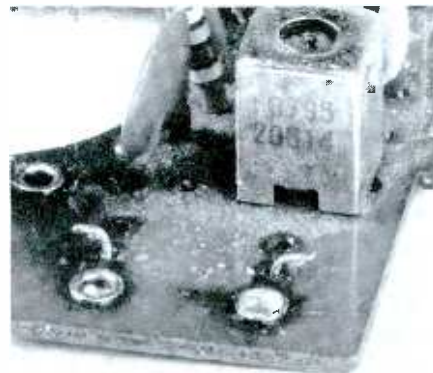

**8** Shown above is the finished repair. After the leads are wrapped around the loops, both joints are soldered. The foil hasn't been disturbed, and all work has been done on top of the PC board—this method is a timesaver.

**9** Some components can't be removed by cutting on top of the board. The cup shown below draws solder from terminals which can then be straightened.

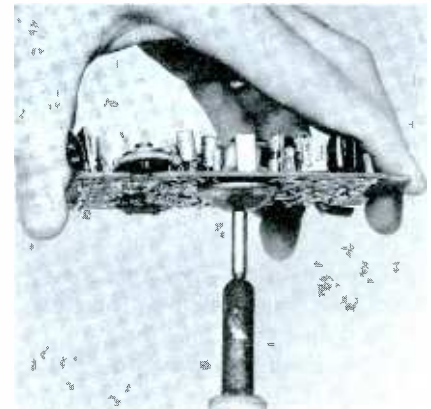

**10** A split-end soldering tip is also useful for straightening terminals.

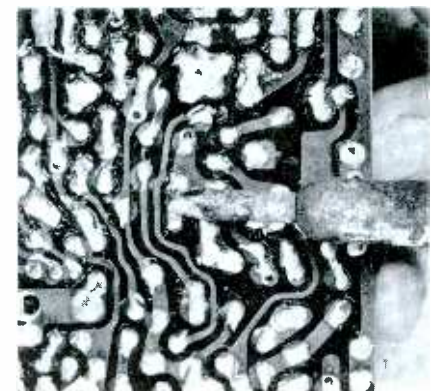

**5** Below is a good solder bond. Note that the solder is lustrous, as 60/40 solder should be. There's no sharply defined edge between the solder and the terminal; instead, the solder edges have a feathered appearance. Outline of wire is clearly visible indicating a solder bond. Only exception is solder joints for high-voltage; make them round and smooth.

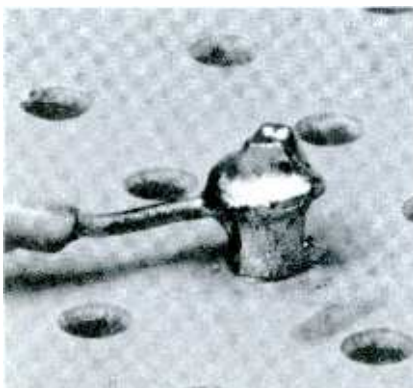



# SOLDERING

*Once an Art-Now a Science*

By Dave King

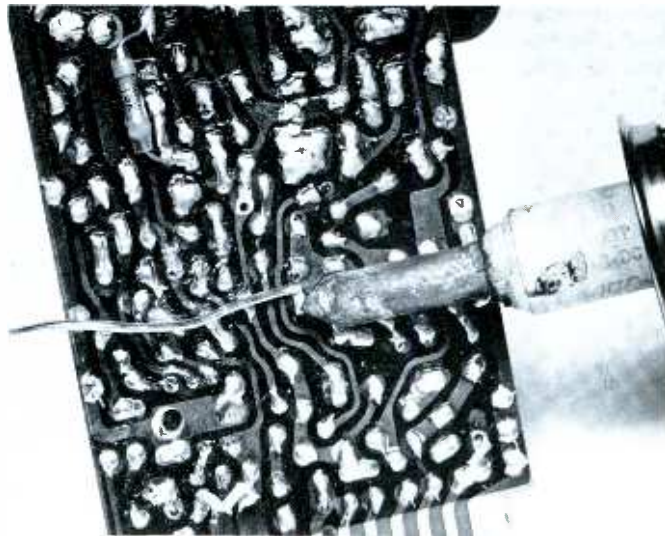
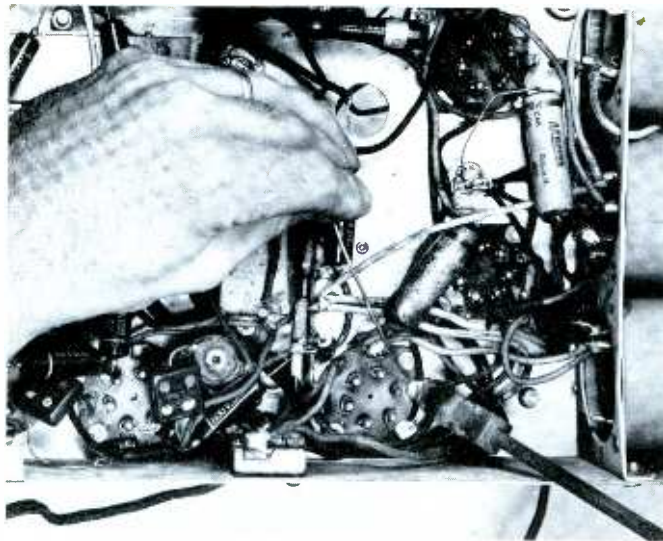

Did you know that soldering is the oldest known method for metal-lically joining metals? Indeed, the art of soldering is probably as old as civilization itself. Existing arti-facts such as a silver vase from Tello, Mesopotamia, prove that the use of silver solder was quite com-mon earlier than 2800 B.C. No one knows for certain when solders were first used; but one can conjecture that some artisan living in Sumer, the cradle of civilization, discovered that an alloy of gold and copper melted at a lower temperature than either gold or copper and could then be used to join solid metals.

Use of tin/lead solder was quite common in the Roman Empire. Lead sheets were cut, then formed into pipe and soldered together for use as water pipes. The Roman word for lead, *plumbum*, still exists in our language as the root for *plumber* and *plumbing*.

Tin/lead solders and other solders were increasingly used during medieval times, as soldering played an important part in the growth and development of the metal arts and crafts. In addition, solder was often an important ingredient in the mix-tures used by those pseudoscientists, the alchemists.

The introduction of canned foods at the beginning of the Twentieth Century created far greater demand for solders. Afterwards, the auto-motive industry, followed by the electronics industry, increased the total use of solder. For example, between 1949 and 1959, solder con-sumption increased from 50 thou-sand to 85 thousand *tons* of solder per year.

## Solder as a Science

During the last ten years, in-creased growth of the electronics industry has induced a significant

change. This change is not as much in technique as in the philosophy of soldering. It is no longer an art (as it has been considered for so many centuries); it is a *science*. The aero-space and computer industries and the military have placed far greater demands on reliability of equipment. As an example, North American Aviation's Autonetics Division re-ports that 15 billion solder-joint hours were accumulated on the Min-uteman Project with no reported failures. With such demands for reliability, soldering must be con-sidered as an exact, precise *science*, not an *art*.

## Principles of Soldering

Just as it's possible to drive a car without knowing anything about engines, transmissions, and the like, it's quite possible for a person to make good solder joints without un-derstanding how and why the solder



bond is made. Yet, no professional racer is ignorant of the operation of his engine; the same should be true of those who use soldering in their professions.

To explain fully the formation of a solder bond, several terms with which the reader may not be familiar will be used; a brief explanation follows:

- (1) *Surface tension* results from the attraction of molecules on the surface of a given substance. As one example, consider falling drops of water; the water molecules attract each other and tend to reduce the surface area to form a sphere. Gravity prevents the formation of a true sphere; instead a teardrop shape results. Surface tension on a small drop of mercury is so great that a sphere (or ball) results.
- (2) *Interfacial tension* exists between two substances, like (for example) a ball of molten solder and the metal upon which it sits. Both surface tension and interfacial tension act to reduce the area of contact between a liquid (such as molten solder) and the substance upon which it sits.
- (3) *Capillary action* or *capillary force* causes a liquid to flow along the surface of a dissimilar substance. Notice how water tends to flow up the sides of a soda straw; this is capillary action. Another example is the flow of kerosene up the wick in a lamp. *Wetting* is another term for *capillary action*.

#### Wetting

Suppose that a droplet of molten solder is placed upon a copper surface. Three major forces will affect the shape of the solder droplet. Sur-

face tension will tend to form the solder droplet into a sphere thereby minimizing contact with the base metal (copper). Interfacial tension will also tend to reduce area between the solder droplet and the base metal. Only capillary action will cause the solder to flow over and wet the surface of the metal. In order for *wetting* to occur, the base metal must be extremely clean; no oxides, oils, or dirt can be permitted to interfere with molecular attraction between the base metal and solder.

Fig. 1 shows a solder droplet placed upon an oily copper surface. Note the almost spherical shape of the top of the droplet; flattening of the bottom resulted from gravity. No bond was formed with the copper, since presence of oil prevented wetting. In Fig. 2 some paste flux was placed on the oily copper surface, and the copper was heated slightly before the molten droplet was placed on the copper. Here, it appears that wetting began but stopped before a full bond could be made; this is commonly called a *cold solder point* or *dewet*. More paste flux and heat were applied to the oily copper surface in Fig. 3; observe how the solder droplet has wetted the surface. Flux vapor, used to clean the oil from the copper surface, prevented oxidation, thus permitting wetting. A good solder bond will result only if sufficient flux and heat is present to allow force from capillary action to exceed surface and interfacial tension.

#### The Solder Bond

So far only the wetting of a single surface has been described. If two wires are to be soldered, they must first be mechanically joined, then heated; solder is then applied. With sufficient heat, plus the protection

and cleaning produced by the flux, the solder will melt and wet the mechanical connection, forming a solder bond. Strength of this bond is dependent upon:

1. Chemical bonds—Both metallic compounds and alloys are formed with the base metals and solder during wetting.
2. Physical bonds—For wetting to occur, the base metal surface must be sufficiently clean for solder molecules to contact those of the base metals. Interatomic forces between the solder and base metal create a great adhesive force, further strengthening the solder bond. For maximum strength the solder should be between .003" and .005" thick.

#### Fluxes

Flux actually means flow. As Figs. 1, 2, and 3 show, without flux, wetting will not occur; a solder bond cannot be formed. Flux aids wetting by: (1) removing oxides, oils, and dirt; (2) promoting heat transfer; and (3) preventing further oxidation by blanketing the base-metal surface.

#### Corrosive Fluxes

All fluxes are corrosive to some extent but rosin leaves a noncorrosive residue. Corrosive or acid fluxes leave a corrosive residue which must be washed off. Primary advantage of corrosive flux is its superiority in removing oxides and dirt. Salts such as zinc and ammonium chloride are most often used as acid fluxes. Residues are usually washed away with detergent and water or a mild hydrochloric acid solution. Danger of corrosion makes the use of corrosive fluxes unsuitable for electronics work.

• Please turn to page 71



Fig. 1. Surface Tension exceeds capillary force; thus, no bond is formed.

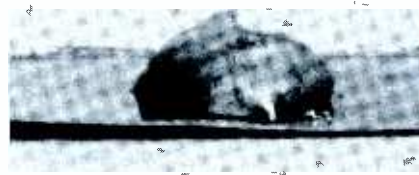

Fig. 2. Capillary force slightly exceeds surface tension: dewet results.



Fig. 3. Capillary force greatly exceeds surface tension: wetting results.

# TUBE and TRANSISTOR DATA

Many of our readers have written us complaining about the time lag between the appearance of new vacuum tubes and transistors and their inclusion in specification manuals. This time lag is unavoidable, but we can ease the information shortage. This is the beginning of a new department for the PF REPORTER. At first, we will catch up on the new tubes registered by the Electronic Industries Association and the new transistors that have appeared in PHOTOFACT Folders during the past six months. Subsequently, each month we will present those appearing during the previous month.

## RECEIVING TUBES

### 6AC9/8AC9

Pentode—TV-IF Amplifier  
Dual Diode—Horizontal Phase Detector  
Fil.—6.3V @ 0.6A (11 sec)  
8.4V @ 0.45A (11 sec)

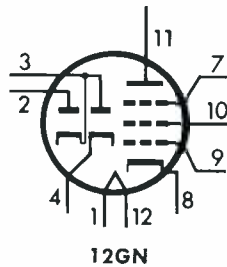

12GN

### 1BG2

High-Voltage Rectifier  
Fil.—1.4 @ 0.575A  
PIV.—18KV @ 0.35ma



### 20AQ3

Damper  
Fil.—20.2V @ 0.45A  
PIV.—7.5V @ 220ma

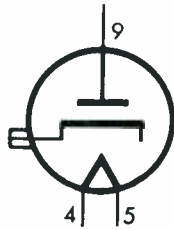

9CB

### 3BH2

High-Voltage Rectifier  
Fil.—3.15V @ 0.37A  
PIV.—35KV @ 1.7ma



1-5-9 | 2-4-8

NOVAR

### 1AY2

High-Voltage Rectifier  
Fil.—1.25V @ 0.2A  
PIV.—26KV @ 0.5ma  
Similar to 1B3GT



### 9BJ11

TV-IF Amplifiers  
Fil.—9.6V @ 0.45A (11 sec)

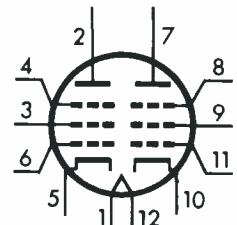

12FU

### 1BC2

High-Voltage Rectifier  
Fil. 1.25V @ 0.2A  
PIV.—18KV @ 0.5ma



9RG

### 8BM11

TV-IF Amplifiers  
Fil.—8.4V @ 0.45A (11 sec)

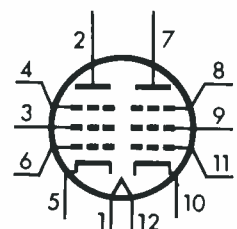

12FU

**8BQ11/11BQ11**

TV-IF Amplifiers  
Fil.—8.4V @ 0.6A (11 sec)  
11.2V @ 0.45A (11 sec)

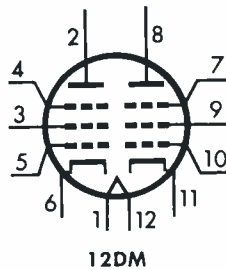

**6JM6A/17JM6A**

Horizontal Output  
Fil.—6.3V @ 1.2A/16.8V @ 0.45A (11 sec)

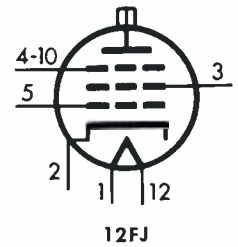

**6CD3/34CD3**

Damper  
Fil.—6.3V @ 2.5A/34.5V @ 0.45A (11 sec)  
PIV.—6KV @ 350ma

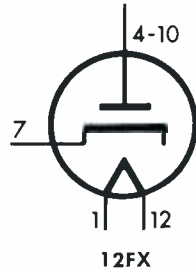

**6JN6A/12JN6A/17JN6A**

Horizontal Output  
Fil.—6.3V @ 1.2A/12.6V @ 0.6A (11 sec)  
16.8V @ 0.45A (11 sec)

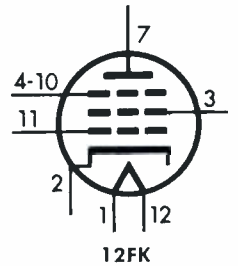

**6CE3/34CE3**

Damper  
Fil. 6.3V @ 2.5A/34.5V @ 0.45A (11 sec)  
PIV.—6KV @ 350ma

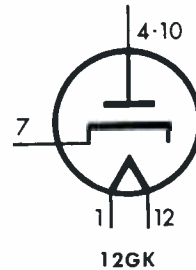

**6JX8**

Heptode—Sync Separator  
Triode—Sync Amplifier  
Fil.—6.3V @ 0.3A

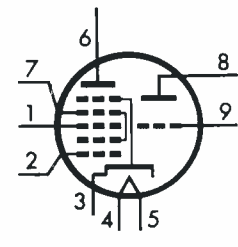

**6EC4/28EC4/42EC4**

Damper  
Fil.—6.3V @ 2.1A/28.0V @ 0.45A/42.0V @ 0.3A  
PIV.—5.6KV @ 440ma

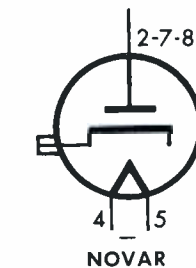

**21JZ6**

Horizontal Output  
Fil.—21.0V @ 0.45A (11 sec)

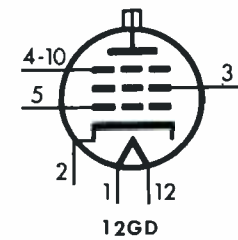

**12HG7**

Video Amplifier  
Fil.—6.3 or 12.6V @ 0.52 or 0.36A

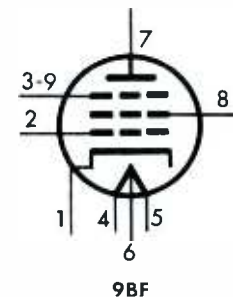

**21KA6**

Horizontal Output  
Fil.—21.0V @ 0.45A (11 sec)

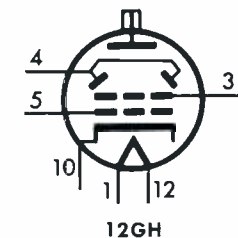

**6JF6/22JF6**

Horizontal Output  
Fil.—6.3V @ 1.6A/22.0V @ 0.45A (11 sec)

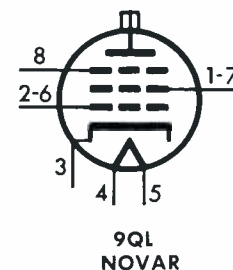

**9KC6**

Chroma Bandpass or Video Amplifier  
or Color Demodulator  
Fil.—8.7V @ 0.45A (11 sec)

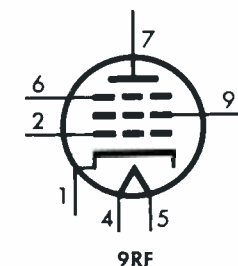

# CATHODE-RAY TUBES

## 11HP4

Protection—tension band  
 Deflection—110°  
 Filament—6.3V @ 0.45A (11 sec)  
 Grid 2—150V

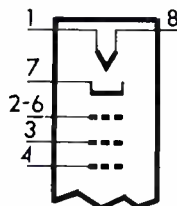

8HR

## 12BNP4/12BNP4A

Protection—tension band  
 Deflection—110°  
 Filament—6.3V @ 0.45A (11 sec)  
 Grid 2—250V

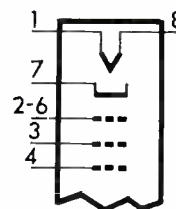

8HR

## 11LP4

Protection—none  
 Deflection—110°  
 Filament—6.3V @ 0.3A  
 Grid 2—400V

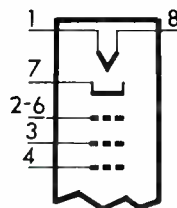

8HR

## 12BRP4

Protection—filled rim  
 Deflection—90°  
 Filament—12.6V @ 0.08A (11 sec)  
 Grid 2—30V  
 Neck Diam.—0.855"

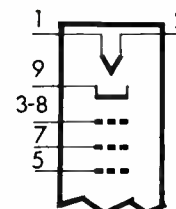

9RS

## 12BEP4

Protection—filled rim  
 Deflection—110°  
 Filament—6.3V @ 0.45A (11 sec)  
 Grid 2—30V

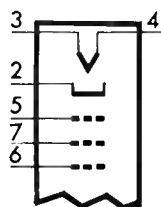

7FA

## 14BDP4

Protection—bonded glass  
 Deflection—70°  
 Filament—6.3V @ 0.6A  
 Grid 2—300V

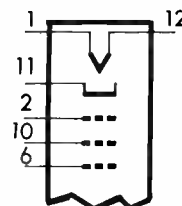

12L

## 12BFP4

Protection—none  
 Deflection—110°  
 Filament—4.2V @ 0.45A (11 sec)  
 Grid 2—200V  
 Neck Diam.—0.787"

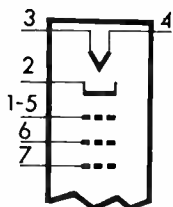

7GR

## 15JP4

Protection—filled rim  
 Deflection—110°  
 Filament—6.3V @ 0.45A (11 sec)  
 Grid 2—50V

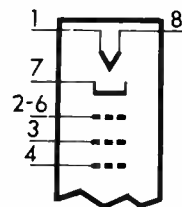

8HR

## 16BXP4

Protection—filled rim  
 Deflection—114°  
 Filament—6.3V @ 0.45A (11 sec)  
 Grid 2—35V

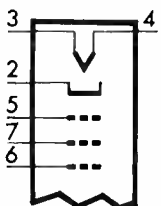

7FA

## 16CDP22

Protection—none  
 Deflection—90°  
 Filament—6.3V @ 0.9A  
 Grid 2—200V

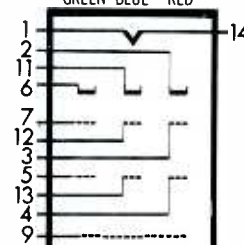

14BE

## 16CEP4

Protection—tension band  
 Deflection—114°  
 Filament—6.3V @ 0.45A (11 sec)  
 Grid 2—400V

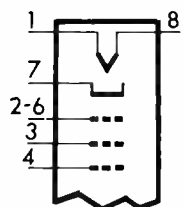

8HR

## 16CKP4

Protection—tension band  
 Deflection—114°  
 Filament—6.3V @ 0.3A (14 sec)  
 Grid 2—400V

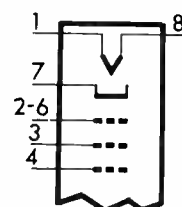

8HR

**17EFP4**

Protection—none  
 Deflection—110°  
 Filament—6.3V @ 0.45A (11 sec)  
 Grid 2—400V

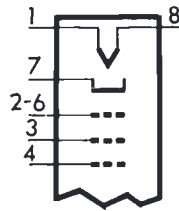

8HR

**19FBP4**

Protection—filled rim  
 Deflection—114°  
 Filament—6.3V @ 45A (11 sec)  
 Grid 2—50V

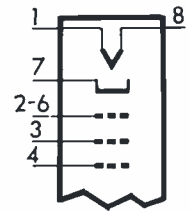

8HR

**19DWP4**

Protection—tension band  
 Deflection—114°  
 Filament—6.3V @ 0.45A (11 sec)  
 Grid 2—400V

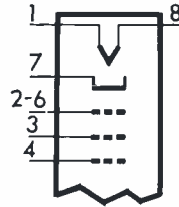

8HR

**19FHP4**

Protection—tension band  
 Deflection—114°  
 Filament—6.3V @ 0.6A (11 sec)  
 Grid 2—400V

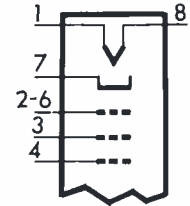

8HR

**19EAP4**

Protection—tension band  
 Deflection—114°  
 Filament—6.3V @ 0.45A (11 sec)  
 Grid 2—50V

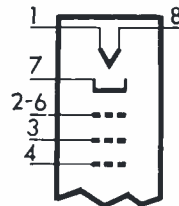

8HR

**19FJP4**

Protection—tension band  
 Deflection—114°  
 Filament—6.3V @ 0.45A (11 sec)  
 Grid 2—300V

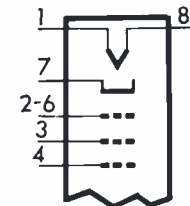

8HR

**19EHP4A**

Protection—tension band  
 Deflection—114°  
 Filament—6.3V @ 0.6A (11 sec)  
 Grid 2—300V

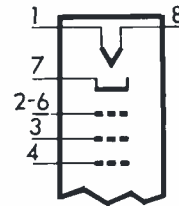

8HR

**21FBP22A**

Protection—none  
 Deflection—70°  
 Filament—6.3V @ 1.8A  
 Grid 2—400V  
 Rare—earth phosphor

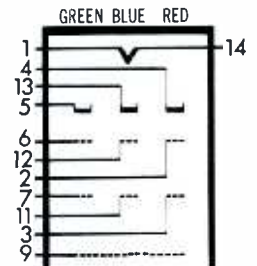

14AU

**19EKP4**

Protection—filled rim  
 Deflection—114°  
 Filament—6.3V @ 0.45A (11 sec)  
 Grid 2—45V

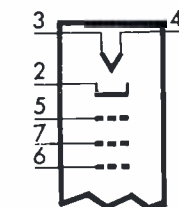

7FA

**21FJP22A**

Protection—bonded glass  
 Deflection—70°  
 Filament—6.3V @ 1.8A  
 Grid 2—400V  
 Rare—earth phosphor

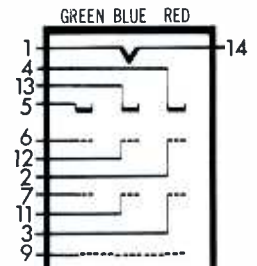

14AU

**19EZP4**

Protection—filled rim  
 Deflection—114°  
 Filament—6.3V @ 0.45A (11 sec)  
 Grid 2—45V

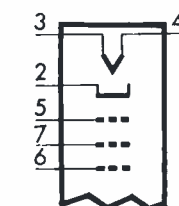

7FA

**21FUP4**

Protection—filled rim  
 Deflection—114°  
 Filament—6.3V @ 0.45A (11 sec)  
 Grid 2—50V

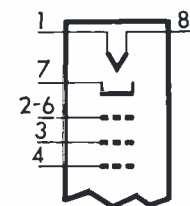

8HR

# TRANSISTORS

**AC151**  
Audio Amplifier  
PNP—Germanium

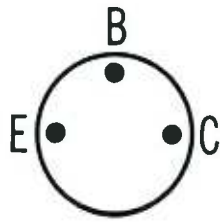

**2SA58**  
RF Amplifier  
PNP—Germanium

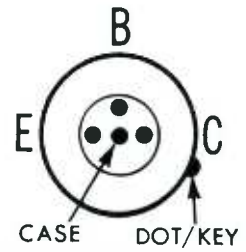

**AC172**  
Audio Amplifier  
PNP—Germanium

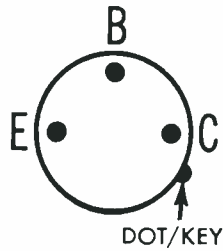

**2SA71**  
VHF Amplifier  
PNP—Germanium

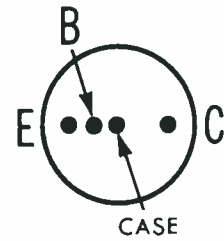

**AF115**  
VHF Amplifier  
PNP—Germanium

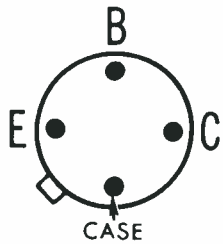

**2SA101**  
RF Amplifier  
PNP—Germanium

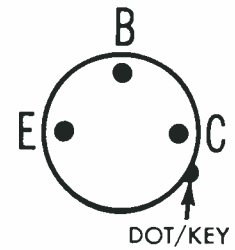

**2N2494**  
VHF Amplifier  
PNP—Germanium

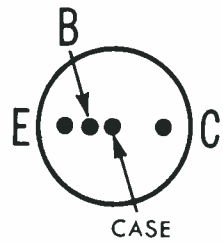

**2SA102BA**  
RF Amplifier  
PNP—Germanium

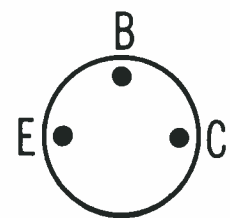

**2SA15V**  
Audio Amplifier  
PNP—Germanium

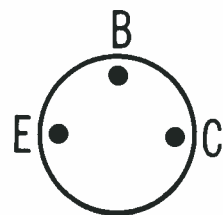

**2SA147**  
RF Amplifier  
PNP—Germanium

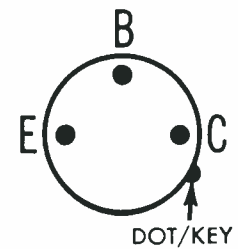

**2SA52**  
Audio Amplifier  
PNP—Silicon

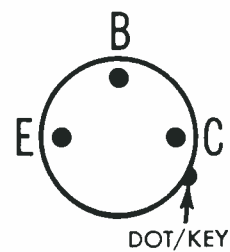

**2SA162**  
Video-IF Amplifier  
PNP—Germanium

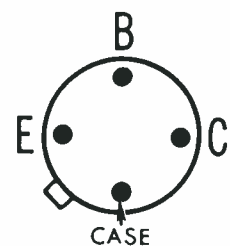

**25A166**  
Video-IF Amplifier  
PNP—Germanium

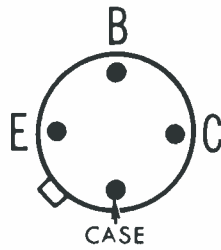

**25A219**  
Audio Amplifier  
PNP—Germanium

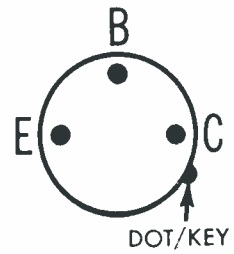

**25A198**  
Audio Amplifier  
PNP—Germanium

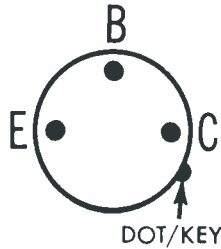

**25A223**  
Video Amplifier  
PNP—Germanium

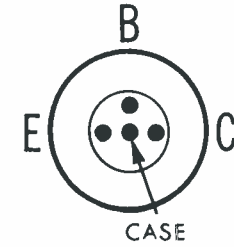

**25A202**  
Audio Amplifier  
PNP—Germanium

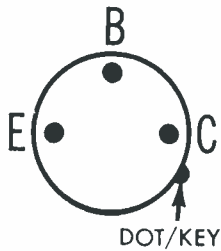

**25A229**  
VHF Amplifier  
PNP—Germanium

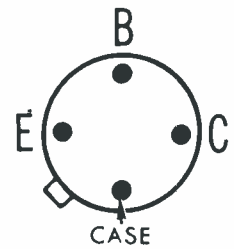

Every No-Noise Aerosol Product  
**Guaranteed**  
Non-Flammable  
Non-Toxic and  
Won't Affect Plastics

**"NO NOISE"**

Insist On This Trusted  
**NAME BRAND**  
Avoid Risky "Private Labels"

"No Noise" PRODUCTS ARE  
PERFECT FOR COLOR TV

- Volume Control & Contact Restorer
  - Tuner-Tonic with Perma-Film
  - EC-44 For Electrical Contacts
  - Tape-Reco Head Cleaner
- FREE 5" plastic extender push-button assembly for pin-point application with all No-Noise products.

**ELECTRONIC CHEMICAL CORP.**  
813 Communipaw Avenue, Jersey City 4, N. J.

Circle 71 on literature card

## the SWITCHMATCH

with POSITIVE  
TERMINATION



1. ELIMINATES CROSS-TALK BETWEEN CABLE AND ANTENNA DUE TO T-15 TRANSFORMER BUILT IN.
2. CONVENIENT SWITCH WHEN CHANGING FROM ANTENNA TO CABLE.
3. HIGH ISOLATION BETWEEN CABLE AND ANTENNA TO INSURE POSITIVE TERMINATION.

WRITE TODAY for complete catalog and price lists . . . . .

MODEL  
No. 6175

**CRAFTSMAN**  
ELECTRONIC PRODUCTS, INC.

133 WEST SENECA ST.  
Area Code 315

MANLIUS, N. Y. 13104  
Phone OVerbrook 3-9105



Circle 72 on literature card

# Servicing

---

## Mobile Radio

---

### with a SCOPE

The versatile oscilloscope can help you in servicing two-way radio.

by Leo G. Sands

The oscilloscope is probably the least-used instrument in the mobile-radio shop, although it is one of the most valuable servicing tools. It can be used wherever AC power is available; or, even in the field when using a DC-to-AC inverter to operate it from a battery. Some types, which are operated from self-contained batteries, are nice to have but quite expensive. The newest AC-operated scopes are much smaller and lighter than in the past and many are useful at frequencies up to 12 mc. Several recently available items are rated flat from DC to 4.5 mc, but are often useful well above 10 mc.

For mobile-radio servicing, your scope should be capable of DC measurements as well as at frequencies up to 4.5 mc or higher. When set for DC, such a scope can be used in lieu of a VOM or VTVM for making DC-voltage measurements and for monitoring limiter, AVC, and discriminator circuits.

#### DC Measurements

With the horizontal sweep set to

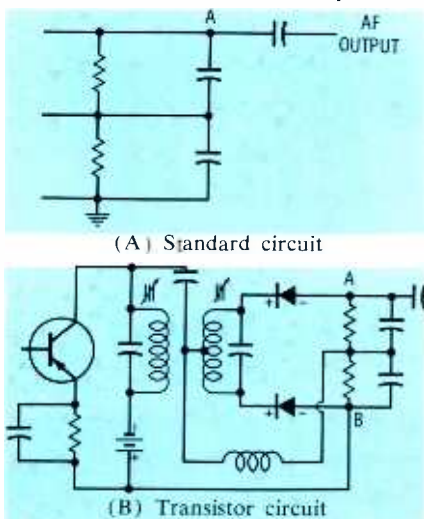

Fig. 1. Discriminator test points for scope during FM alignment procedure.

zero and the scope vertical input set for DC, a dot appears at the center of the screen when the DC-input voltage is zero. The dot moves upward or downward to assume a new position, the direction of movement depending upon the polarity of the DC-input voltage.

For setting an FM discriminator, use a VTVM with center-scale zero, so the discriminator can be tuned for zero output when using an unmodulated input test signal. A DC scope can be used for the same purpose and is probably easier to read at the zero voltage point, since the line becomes a dot, and it is not necessary to keep resetting the zero point. A scope can also be used for monitoring limiter voltage when aligning an FM receiver, or AVC voltage when aligning an AM receiver.

For FM-discriminator alignment, the vertical input of the scope is connected to Point A as shown in Fig. 1A, and the scope ground lead is connected to the receiver chassis. The same is true in the case of a solid-state receiver, except when Point B (Fig. 1B) is not at DC-ground potential. In that case, the scope ground is connected to Point B, but care must be exercised to prevent the scope chassis from making contact with the receiver chassis.

For aligning a tube-type FM receiver, the scope's vertical input may be connected across R1 to monitor limiter voltage when the circuit shown in Fig. 2 is used, and when the input is an AM or unmodulated test signal. If the grid resistor is shunted from grid to ground, the scope can be connected to the limiter through an RF probe. For aligning AM receivers, the scope input is usually connected across the AVC buss.

Some scopes are equipped with

an internal zener-diode reference voltage for calibration, which makes it possible to read DC voltages from the scope screen with approximately the same accuracy as with a VTVM.

#### Sweep Alignment

While most technicians peak a receiver's IF and RF circuits with an AM or unmodulated test signal while monitoring limiter or AVC voltage, the correct bandpass characteristics can be more easily preserved by using a sweep generator, in which case a scope is required.

To align an FM receiver, the scope's vertical input is connected across the grid resistor (Point A in Fig. 2) or to the limiter grid through a probe. To align an AM receiver, the vertical input of the scope may be connected to the detector side of the last IF transformer through a probe. The sweep-signal output of the sweep generator is connected to the scope's horizontal input to apply a 60-cps sine wave as the sweep signal. The RF output of the sweep generator is fed through a small capacitor to the grid of the stage ahead of the one being aligned, and is moved back stage by stage as the alignment proceeds toward the receiver's front end.

The sweep generator is set to the applicable IF or RF frequency, and the sweep may be set at 100 kc initially and then reduced until the

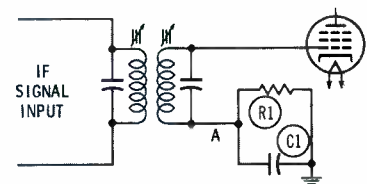

Fig. 2. Monitor limiter voltage at point A when using AM input signal.



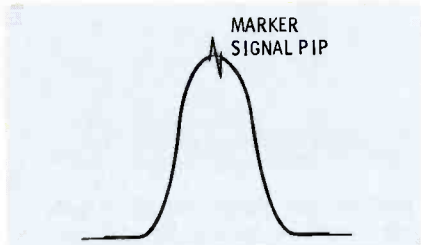

Fig. 3. Bandpass curve showing a marker pip to mark center of passband.

trace on the scope screen is of suitable width. The bandpass of a receiver, as seen on the scope screen, should look approximately like the one shown in Fig. 3. It is important that the center of the waveform be at exactly the right IF or RF frequency. This can be determined by also applying a frequency-marker signal. Sweep generators are often equipped with a built-in marker generator; but, for best accuracy, an external crystal-controlled marker generator, or a frequency meter, should be used.

### FM-Detector Adjustment

As discussed earlier, the usual way of adjusting an FM discriminator is to set it for zero output on a VTVM, using an unmodulated test signal. This technique is by no means ideal, since the response can be nonlinear even if it appears to be correctly adjusted. A better job can be done with a scope and a sweep generator. The vertical input of the scope is connected to the output of the discriminator as shown in Fig. 4. The RF output of the sweep generator is fed to the grid of the limiter stage immediately preceding the discriminator. Both the

primary and secondary of the discriminator IF transformer are tuned until the waveform is balanced, as shown in Fig. 5A. This waveform is obtained with the scope being swept by the sine-wave signal from the sweep generator. By setting the scope sweep to twice the sweep-rate frequency, which is usually 60 cps, and using the scope's internal sawtooth generator, a double pattern is obtained which looks something like the one shown in Fig. 5B. This pattern may be a better one for checking out discriminator balance for some technicians but the choice is a purely personal one.

Many FM receivers now employ a gated-beam FM discriminator, which is much easier to adjust than the conventional discriminator. As shown in Fig. 6A, there is a parallel resonant circuit connected to the quadrature grid of the tube. The slug of its coil, L, is adjusted (when listening to an FM signal) for maximum audio recovery. No meters are required. However, a more accurate job can be done by looking at the IF signal at grid 3 with a scope. Use a low-capacity probe and adjust L for maximum signal amplitude with an unmodulated signal applied.

The receiver's audio output may also be monitored with the scope while feeding a tone-modulated FM signal into the receiver and adjusting L for maximum amplitude and for minimum distortion of the tone signal. The test point (TP) shown in Fig. 6A is used when aligning the preceding stages. A VTVM can be connected there, or a scope can be

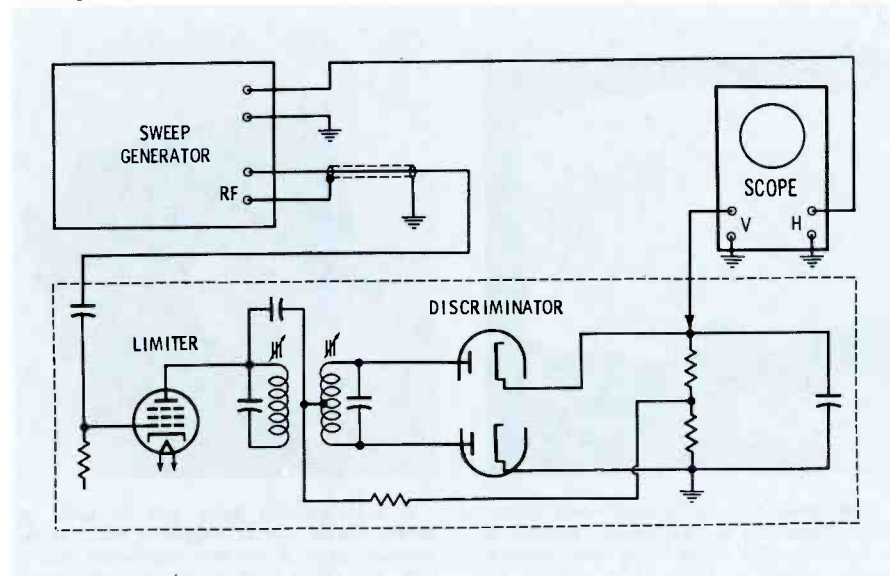

Fig. 4. Equipment properly set up for tube-type FM discriminator alignment.

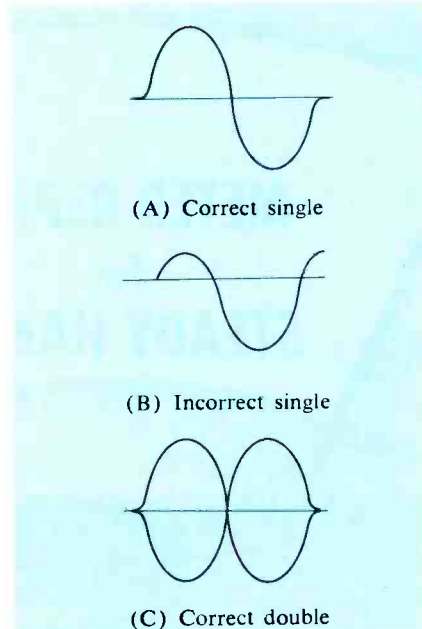

Fig. 5. Output waveforms from FM discriminator using sweep-signal input.

used to monitor this point when using the sweep-generator alignment technique.

Another type of FM detector, which is similar to the gated-beam discriminator, is shown in Fig. 6B. The tube is a 6DT6 or other sharp-cutoff pentode. The quadrature coil (L) is tuned for maximum DC voltage across R1, as monitored by a scope (set for DC); the test signal is unmodulated.

The preceding stages may be aligned by connecting a scope to grid 1 through an RF probe when using an AM test signal, or through

• Please turn to page 65

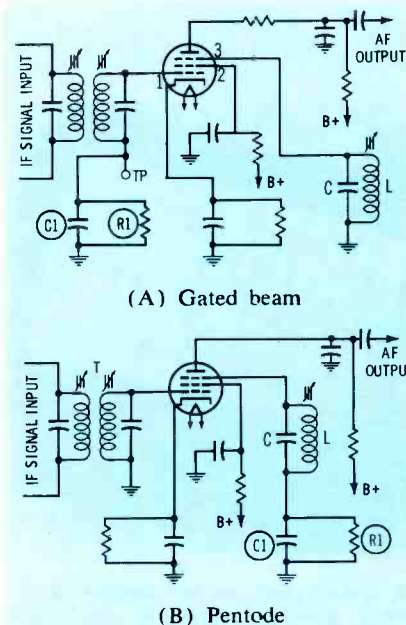

Fig. 6. Tube-type FM-discriminators.

# METER REPAIR for STEADY HANDS

Are there useless meters in your shop? There needn't be. Minor repairs can be made by anyone with steady hands. If the needle hangs up somewhere on the scale, if the glass is broken, if the reading changes when the meter is moved from a vertical to a horizontal position, the meter can usually be repaired with a minimum of effort.



Recommended tools include: Pencil iron, jeweler's screwdrivers, small socket wrenches, small end wrenches, nonmagnetic tweezers, small pocket-type screwdriver, and clean rubber mat.

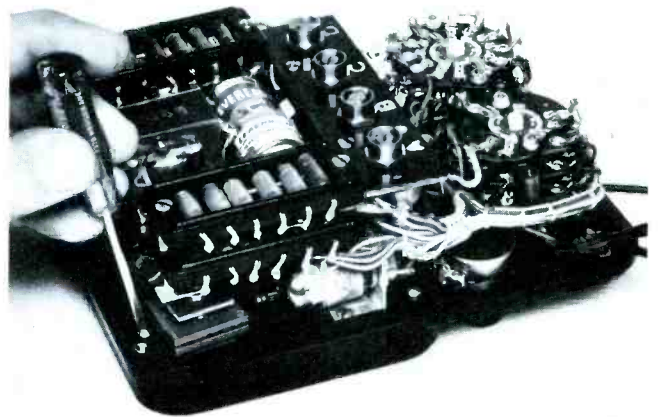

Access to the meter mounting screws is usually gained after the instrument back is removed. The meter is secured by 2 to 4 screws entering from the rear. Captive screws with mounting nuts are also used. Removal of the screws shown releases the meter cover in this instrument. In others, entire meter is released, then cover can be removed.



A broken glass can be changed by removing mounting screws or clips. Your neighborhood hardware store can provide you with a replacement cut to size. Order single-weight glass.

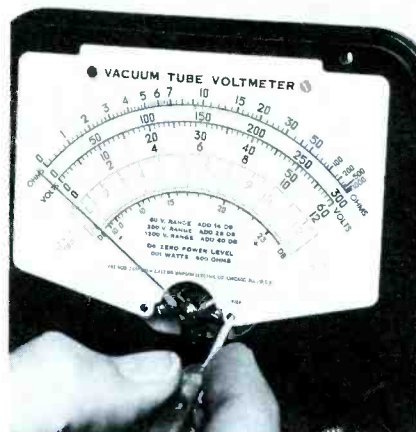

With meter cover removed, scale is exposed. Mounting screws usually number 2 or 4. Use small screwdriver and remove screws carefully. Don't drop screws or lockwashers into meter movement.



A high-intensity lamp can be used to detect visible dirt or magnetic particles in magnet gap. A slightly moistened toothpick will often remove the dirt. Magnetic particles must be removed with tweezers.

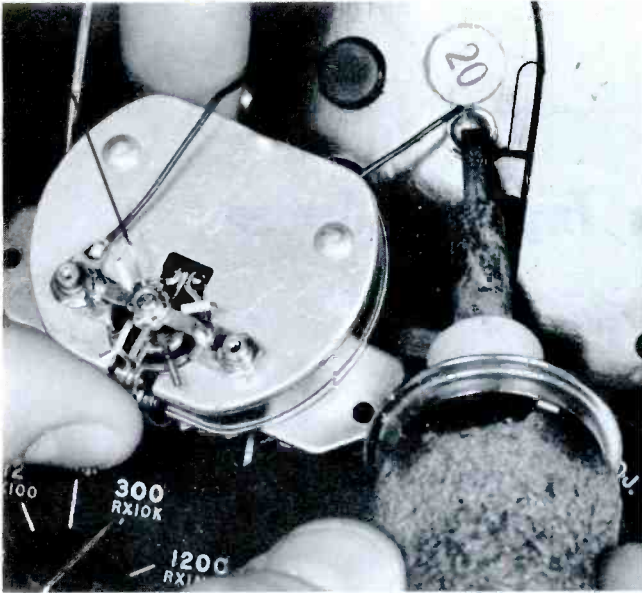

Unsolder meter leads. Avoid use of soldering gun unless mounting studs are large. The magnetic field of a gun can damage the meter. Pencil iron will usually do the job. Meter and pointer are vulnerable—handle carefully.

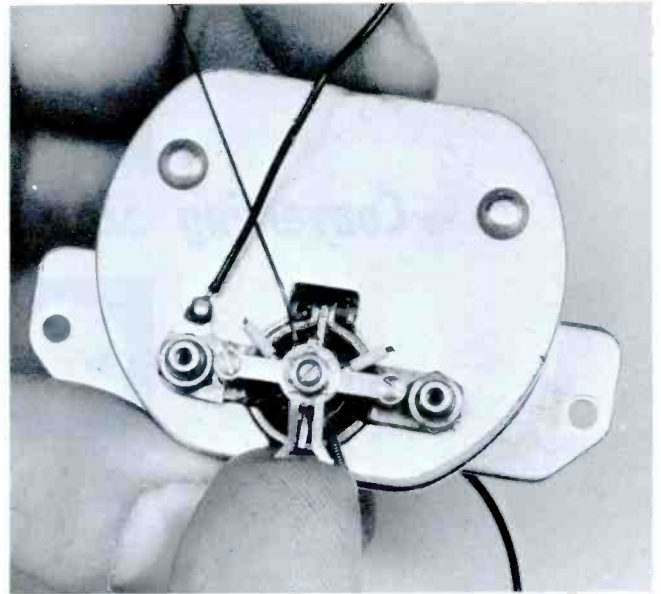

Hold sheet of white paper behind meter and look through magnet gap. Dirt and magnetic particles can be seen easily. Check armature bobbin for burnt or frayed wires. If these are visible, meter is beyond your repair.

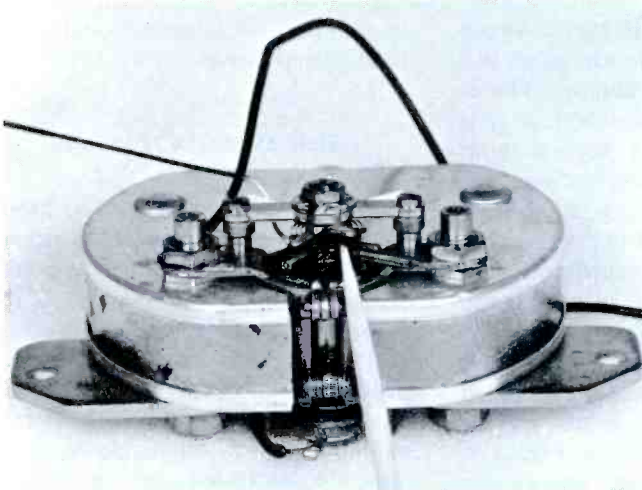

Check hairsprings at top and bottom. Spring should make a perfect flat spiral and be soldered at both ends. Overlapped or tangled springs can be released with toothpick. Kinked springs can be gently straightened with tweezers.

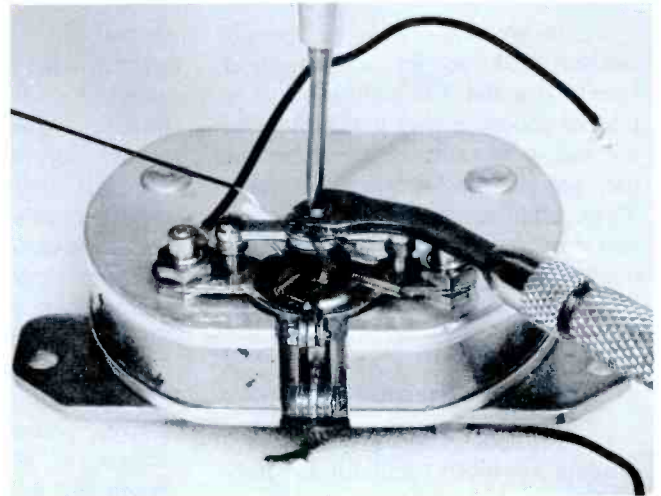

Loosen bearing shaft locknut with wrench. Turn screw clockwise very gently until resistance is felt, then back screw off  $\frac{1}{2}$  turn. Hold screw stationary and tighten locknut. Grasp pointer and the rear extension gently, and check vertical movement, which should be very slight.

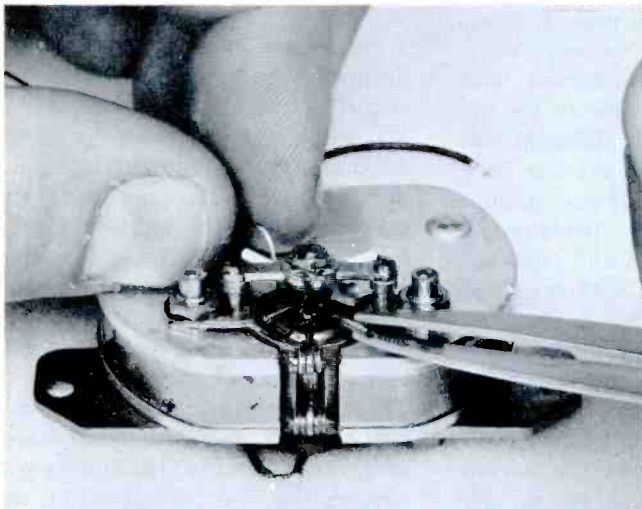

If meter readings change when physical position is changed, counterweights need to be adjusted. Grasp pointer gently whenever weight is moved to prevent bending of meter pivots. Use a trial-and-error method until movement is minimized.

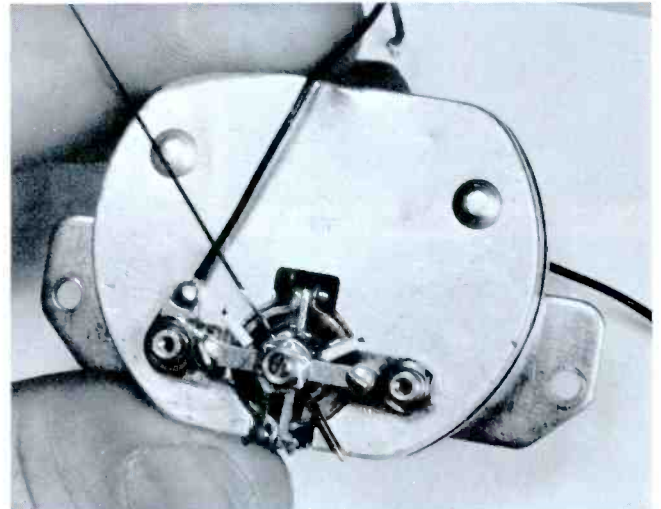

Set zeroing arms at top and bottom to their center positions. Set zero screw on meter front to its zero position so that the pin will engage slot in top arm when cover is replaced. Back arm may have to be moved later to insure correct range of zero screw.



## Converting Scopes to Triggered Sweep



Add this useful feature  
to your shop scope

by Robert G. Middleton

There are many ways to convert conventional scopes to triggered sweep. For the TV technician, it is best to choose a way that maintains all the conventional functions of the scope, plus triggered sweep. Thus, when you convert your scope, you do not change any of the functions with which you are familiar—you merely add the triggered-sweep function for use as desired.

### General Considerations

Conventional scopes use a free-running sawtooth oscillator for hor-

izontal deflection. Triggered-sweep scopes use a sawtooth generator which is not free-running. Therefore, a sawtooth waveform is generated only when a vertical-input signal is applied. The leading edge of the input signal triggers the sawtooth generator, and one sweep excursion occurs. The sawtooth generator then remains inactive until the next leading edge arrives.

This means that before the leading edge of a vertical-input signal arrives, you see only a spot on the screen, as illustrated in Fig. 1A. When the leading edge arrives, the beam deflects horizontally, as seen in Fig. 1B. In turn, a waveform can be greatly expanded merely by advancing the horizontal sweep-rate control. Suppose you wish to measure the rise time of an amplifier—you make a squarewave test, and expand the leading edge of the reproduced square wave sufficiently so that you can observe the rise time on the scope screen. If you attempt this with ordinary free-running sweep, an overlapped and confused pattern results. But with triggered sweep, the leading edge is clear and distinct, as seen in Fig. 2.

It would be helpful to read the article "Learning About Triggered-Sweep Scopes" in the March 1965 issue of PF REPORTER. Follow-up articles in subsequent issues will also be useful. The following information takes up where the preceding articles left off, and describes

how to convert a conventional scope to triggered sweep.

### Eico Model 427 Scope

We will start with the Eico Model 427, a typical general-purpose scope. This scope has flat response from DC to .5 mc, and is 6 db down at 1 mc. If you should wish to wide-band the scope, the article "Modernizing Your Scope" in the March 1965 issue of PF REPORTER explains how to do it. However, if you are interested only in testing audio equipment, the scope does not need to be wide-banded.

To add a triggered-sweep function to the Eico Model 427, the following operations are performed. Fig. 3 shows the circuit diagram of the horizontal-sweep section. The first step is to make the sweep oscillator, V5, a one-shot multivibrator. R66, 4700 ohms, is grounded. The resulting cathode bias does not cut off the oscillator, and it operates in the free-running mode. To obtain triggered sweep, we add variable cathode bias by connecting a 50-kc potentiometer in series with the 4700-ohm resistor, as shown in Fig. 4. Then, when all the resistance is cut out, you obtain a horizontal trace, as illustrated in Fig. 1B. But as you advance the 50-k potentiometer, the multivibrator suddenly stops, and you obtain only a spot on the screen, as in Fig. 1A. Next, if you apply a



(A) Spot resting; not triggered



(B) Scope triggered

Fig. 1. Trigger control of CRT beam.

# Every time Si Costa replaces a picture tube, he makes a friend.

Si can't afford to have people get sore at him. So when a picture tube goes on the blink, he plays it smart. He recommends and uses Philco Starbright 20/20. Si's found that Philco parts mean no costly callbacks. That's why he sticks with Philco parts almost all the way.

In fact, Si figures that it really doesn't pay to use anything less than Philco quality and dependability. Anything less only means extra trouble for his customer. Which could mean extra trouble for him.

And what's more, 99 times out of 100, when he needs a part, he finds it right at his Philco Distributor's. The hundredth time his part is shipped to him in 24 hours or less through Philco's Emergency Lifeline Service. That's some service.

Philco's Tech Data Service keeps Si up to the second on how to service Philco's new products. And he gets all the facts faster, fuller and at a lower cost than any other service.

Add to this a complete accident insurance plan for his men and himself, and you can see that Si Costa is a mighty happy man. You can be, too. Talk to your Philco Parts Distributor, or contact Parts & Service Department, Philco Corporation, Tioga & "C" Streets, Philadelphia, Pa. 19134

PARTS & SERVICE DEPARTMENT

**PHILCO**

A SUBSIDIARY OF *Ford Motor Company*

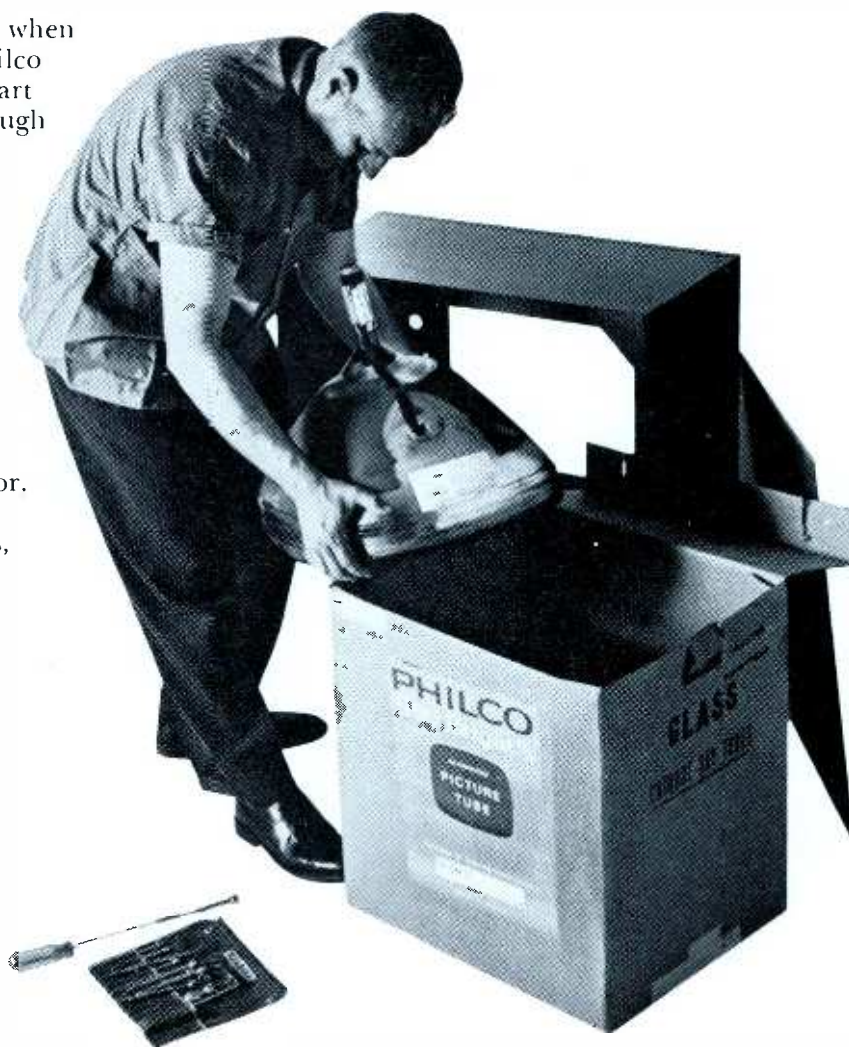

Circle 12 on literature card

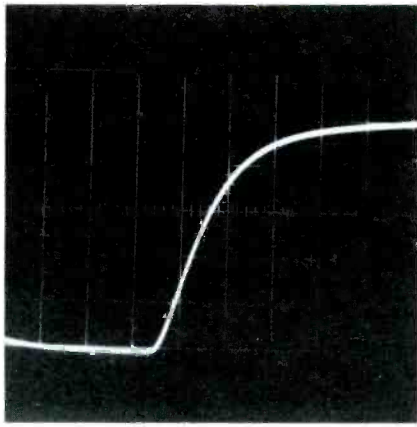

Fig. 2. Measuring amplifier rise time.

square-wave signal to the scope, a pattern appears (the multivibrator is triggered by the square-wave signal). If you advance the horizontal sweep speed, the leading edge expands, as seen in Fig. 2.

The 50 k potentiometer in Fig. 4 is both a trigger-level and an operating control. Hence, you must mount the potentiometer on the front panel of the scope. There are three ways to do this. First, you can drill the panel and mount the potentiometer beside the sweep-selector control. Or, you can remove the small pilot lamp and mount the potentiometer in the hole where the neon bulb is normally placed. A

third way is to replace the sweep-vernier control with a dual potentiometer; one that has both a 15-meg section and a 50 k section.

You can operate on triggered-sweep function with the sync-selector control set either to +sync or to -sync. The waveform shown in Fig. 2 merely turns upside down when the internal sync polarity is reversed. Since the amplitude of the internal sync signal changes when the vertical-gain control is varied, you must set the 50 k potentiometer accordingly. It is advisable first to set the vertical-gain control for the desired pattern height on the screen, such as  $\frac{2}{3}$  of full screen. Then adjust the 50 k potentiometer for triggered-sweep operation. As soon as you have passed into the triggered-sweep mode, the horizontal-deflection rate can be speeded up without the appearance of an overlapped and confused pattern.

### Calibrating the Sweeps

With the choice of operating the scope on either free-running or triggered sweep, you will be concerned with calibrating the sweeps. For this purpose, it is advisable to calibrate with the sweep-vernier con-

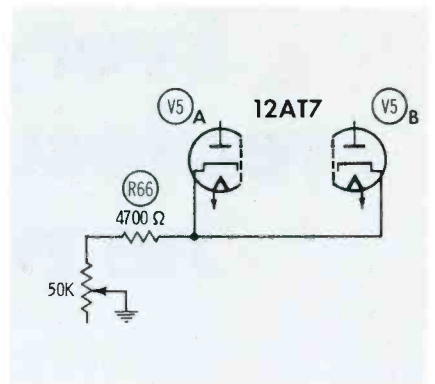

Fig. 4. Variable cathode bias added.

rol set to zero, because the zero setting is definite. If you should calibrate with the sweep-vernier control set to "5", for example, the re-settability would be as accurate on the triggered-sweep function. However, you may wish to calibrate the sweeps (the four positions of S3-B in Fig. 3) with the sweep-vernier control set to zero as well as with a setting at "5". This will provide twice as many calibrated-sweep positions.

Calibration is made on the basis of a sine wave having an accurate frequency, as illustrated in Fig. 5. The scope is operated in its triggered-sweep mode. A good audio oscillator is a suitable source of ac-

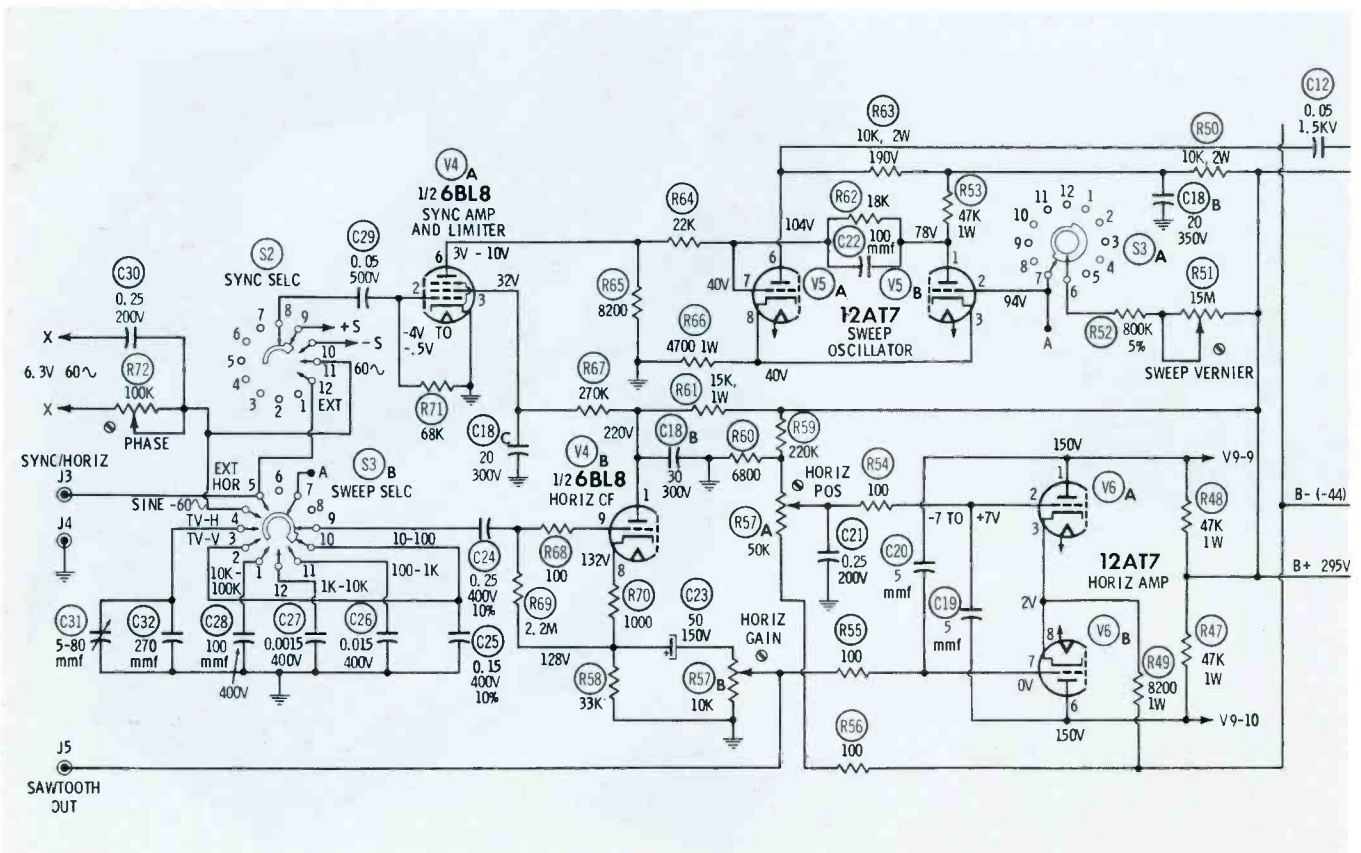
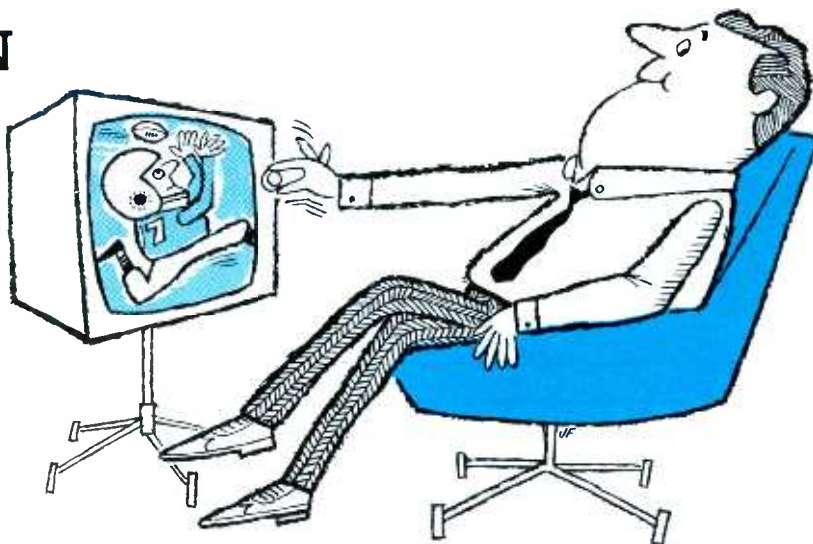

Fig. 3. Horizontal-sweep section of general purpose scope with necessary circuit changes for triggered sweep use.

GET SUPERIOR 82-CHANNEL  
COLOR TV RECEPTION WITH

# NEW BELDEN 8290

SHIELDED PERMOHM\*  
LEAD-IN



Until the introduction of Belden 8290 Shielded Permohm TV lead-in cable, there were serious limitations in the effectiveness of the various lead-in cables available, whether twin lead or coaxial.

Here Roland Miracle, electronic engineer of the Belden Manufacturing Company, discusses the problems and the reasons why Belden 8290 Shielded Permohm is the all-purpose answer for 82-channel and color TV reception.

**Q.** What problems have been experienced in using twin lead cables other than 8290?

**A.** Most installers have found out that using flat ribbon or tubular 300 ohm line for UHF and color installations is unsatisfactory. When these lines encounter dirt, rain, snow, salt, smog, fog, or industrial deposits, the impedance drops abruptly, the attenuation soars and the picture is lost.

To overcome this problem, Belden developed its 8285 Permohm line which encapsulates the flat twin lead in a low loss cellular polyethylene jacket. This keeps all of the surface deposits out of the critical signal areas—regardless of weather conditions.

Although this was a major improvement, there still remain the problem of electrical interference signals from automotive ignition systems, reflected TV signals and extreme electrical radiation which could be picked up by the lead-in to create ghosts and static lines in the picture.

**Q.** Then, is this why many people recommend coaxial cable as TV lead-in?

**A.** Yes. Because of the incorporation of a shield, coaxial cable has an advantage over unshielded twin lead.

**Q.** Then, why isn't coaxial the total answer?

**A.** Coaxial cable has much higher db losses per hundred feet than twin lead. Although the shield in coaxial cable does reduce lead-in pick-up of interference signals, it is not as effective as a 100% Beldfoil\* shield.

Another way to put this is that 8290 delivers approximately 50% of the antenna signal through 100 feet of transmission line at UHF while coaxial cable can deliver only 15% to 20%, frequently not enough for a good picture. Even at VHF, the higher losses of a coaxial cable may be intolerable, depending on the signal strength and the length of the lead-in.

The following chart spells this out conclusively. We have compared RG 59/U Coax to the new Belden 8290 Shielded Permohm. All 300 ohm twin leads, under ideal weather conditions, have db losses similar to 8290.



CHANNEL	MC	db LOSS/100' 8290	db LOSS/100' COAX (RG 59 Type)
2	57	2.1	2.8
6	85	2.6	3.5
7	177	3.7	5.2
13	213	4.1	5.9
14	473	6.1	9.2
47	671	7.3	11.0
83	887	8.3	13.5

Capacitance: 8290—8.3 mmf/ft. between conductors  
Coax—21 mmf/ft.

Velocity of Propagation: 8290—71.2%  
Coax—65.9%

**Q.** Won't the use of matching transformers improve the efficiency of a coaxial cable system?

**A.** No! The efficiency is further reduced. Tests show that a pair of matching transformers typically contribute an additional loss of two db, or 20% over the band of frequency for which they are designed to operate. Incidentally, transformer losses are not considered in the chart.

**Q.** How does 8290 Shielded Permohm overcome the limitations of other lead-ins?

**A.** 8290 is a twin lead with impedance, capacitance, velocity of propagation and db losses which closely resemble the encapsulated Permohm twin lead so that a strong signal is delivered to the picture tube. At the same time, 8290 has a 100% Beldfoil shield which prevents line pick-up of spurious interference signals. In short, 8290 combines the better features of twin lead and coaxial cable into one lead-in.

**Q.** What about cost?

**A.** In most cases, 8290 is less expensive than coax since matching transformers are not required. The length of the lead-in is also a factor in the price difference. The cost of coaxial cable installations can vary tremendously, depending upon the type and quality of matching transformers used. If UHF reception is desired, very high priced transformers are required.

**Q.** Is 8290 Shielded Permohm easy to install?

**A.** Yes! Very! It can be stripped and prepared for termination in a manner similar to 300 ohm line without the use of expensive connectors. It also can be taped to masts, gutters or downspouts, thus reducing the use of standoffs. There is no need to twist 8290 as the shield eliminates interference problems. It is available from your Belden electronic distributor in 50, 75, and 100 foot lengths, already prepared for installation, or 500' spools.



8-11-5



BELDEN MANUFACTURING COMPANY  
P. O. Box 5070-A • Chicago, Ill. 60680  
\*Belden Trademark Reg. U.S. Pat. Off.

Circle 13 on literature card

curate frequencies. The horizontal-gain control must be referenced, just as the sweep-vernier control. It is advisable to calibrate with the horizontal-gain control set to maximum. When the sweep selector is in its first position, the pattern of Fig. 5 will be obtained when the audio oscillator is set to 25 cycles per second. In other words, four horizontal divisions represent 1/25 second, or one division represents .01

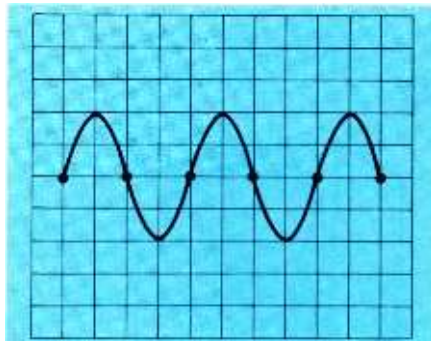

Fig. 5. Checking scope sweep timing.

second. The scope has been calibrated on the first position of the sweep selector.

But it is probable that you will not measure exactly 1/25 second. The measured time might be shorter. If this occurs, shunt a small fixed capacitor of suitable value (or trimmer capacitor) across C25 in Fig. 3. Thereby, the sweep can be adjusted to exactly .01 second per horizontal division. Again, the measured time may be longer than .01 second. In this event, use a trimmer capacitor as before, but select a slightly smaller value for C25. Since commercial capacitors marked .15 mfd have a tolerance spread, this selection is easily made.

Next, advance the sweep selector to its second position. The pattern of Fig. 5 will result when the audio oscillator is set to 250 cycles per second in a typical case. Thus, four horizontal divisions represent .004 second, while one division represents .001 second. As before, it is quite likely that you will not measure exactly 1/250 second. If the sweep speed is slightly faster than .001 second per division, a trimmer capacitor connected across C26 in Fig. 3 will provide the exact sweep speed. On the other hand, if the sweep speed is slower than .001 second per division, replace C26 with a capacitor on the low side of tolerance, and a trimmer capacitor will then establish a sweep speed of exactly .001 second per division.

In the third position of the sweep selector, follow the same procedure to adjust the sweep speed to exactly .0001 second, or .1 millisecond per division. In the fourth position of the sweep selector, adjust the sweep speed to exactly .01 millisecond per division (10 microseconds per division). This completes the basic sweep-calibration procedure. If you choose to calibrate with the sweep-vernier control set to "5", instead of zero, the sweep speeds will be approximately twice as fast on each setting of sweep-selector control.

It is highly desirable to calibrate the sweep-selector speeds to exact decimal values, such as .01, .001, .0001, and .00001 second per horizontal division, because measurements of rise time are then easy to

# Who has the largest selection of semiconductor replacements in the world?

**Semitronics!** Surprised? Did you know that more service technicians, engineers and experimenters buy the Semitron brand than any other in the world for replacement. There are three main reasons. **First, SELECTION.** Semitronics has more types available, off the shelf, than any other source. **Second, QUALITY.** Semitronics always exceed minimum specs for ratings and reliability. **Third, PRICE.** The word is getting around fast. At Semitronics, you always get **more for your money.** Want to prove it? Get the world's most complete Interchangeability Guide (8 Page Booklet or Wall Chart) and price list on semiconductors. Get it FREE at your Semitron distributor or send 25¢ directly to Semitronics to cover handling costs. Do it now! You'll be amazed at the savings at Semitronics.

**Semitronics**  
CORPORATION

Dept. PF-3

265 CANAL STREET  
NEW YORK, N.Y., 10013  
PHONE: (212) 226-5401-2

Please send me the Semitron Interchangeability Guide for 25¢ each to cover handling & postage.

- 8 Page Booklet ..... 8½" x 11"  
 Wall Chart ..... 22" x 26½"

Name.....

Address.....

City/State..... Zip  
Code.....

• Please turn to page 70



# successful service shop beats rising costs with B&K television analyst



*"As every serviceman knows, major TV repairs represent an increasingly large part of the service business and the average time per repair has increased"...*

says Willard Horne of Horne Radio and Television in Evanston, Illinois.

After more than 25 successful years in the service business, twenty of them in the same location, Mr. Horne can be considered an authority on how to keep a business profitable. Mr. Horne says, "In order to be successful, our 3-man shop has to be competitive on the large jobs as well as the small ones. With the increase in bench time that we were experiencing and the limitations on what we could charge, there was a reduction of profit that had to be stopped. Then we bought a B&K Model 1076 Television Analyst."

"Now our customers get the same extra-value service on the big repairs and the small ones," said Mr. Horne. "We use the Television Analyst for troubleshooting a wide variety of complaints, particularly for those that require touch-up align-

ment, location of IF overloads and color convergence. We are more competitive now that we use the B&K Television Analyst because we spend far less time on the jobs that used to be dogs, with benefits both to the shop and our customers."

B&K Model 1076 Television Analyst checks every stage in a black and white or color TV receiver. Nine VHF RF channels, 20 to 45 MC IF, audio, video, sync, bias voltage and AGC keying pulse are available. The model 1076 provides its own standard test pattern, white dot, white line crosshatch, and color bar pattern slide transparencies. It includes a blank slide which can be used for closed-circuit-TV display floor promotion. Its net price is \$329.95.

*Find out how you will increase your TV service profits with a B&K Model 1076. See your distributor or write for Catalog AP 22.*



**B & K MANUFACTURING CO.**  
DIVISION OF DYNASCAN CORPORATION  
1801 W. BELLE PLAINE AVE. • CHICAGO, ILL. 60613

Export: Empire Exporters, 123 Grand St., New York 13, U.S.A.

checking  
COLOR-TV

with

B/W  
equipment

Extend the uses of your  
present equipment

by John D. Lenk

It is possible to check the circuits of a color TV receiver with standard black-and-white test equipment. This is not to suggest that a color generator can be eliminated for the service technician who specializes in color or who foresees an ever increasing number of color sets coming into his shop. However, as a temporary measure, or in an emergency, color TV tests can be made with conventional black-and-white sweep and marker generators.

For example, it is possible to perform these tests on color TV with black-and-white equipment:

1. Produce a rainbow display, or several such displays;
2. Check the overall chroma-channel response;
3. Check frequency response and gain of the bandpass amplifier;
4. Adjust the color-subcarrier trap;
5. Check the combined response of the bandpass amplifier and the B-Y demodulator, R-Y demodulator, or G-Y matrix;
6. Check the combined response of the picture detector, bandpass amplifier, and the B-Y demodulator, R-Y demodulator, or G-Y matrix;
7. Check the frequency response of the Y-amplifier, the chroma demodulator, or the chroma matrix;
8. Check color sync lock or stability;
9. Substitute a signal for a dead color-subcarrier oscillator;
10. Check and adjust the color-phasing (quadrature) transformer;
11. Check plate tuning of the subcarrier oscillator;
12. Check tuning of the reactance tube plate circuit;

13. Check demodulation linearity. The following explains how these tests can be made.

### Producing A Rainbow Display

It is fairly simple to produce a rainbow display using two conventional signal generators, or a sweep generator with a built-in marker generator. All that is required is a crystal diode (such as a 1N34), and a 300-ohm terminating resistor. Both the sweep and marker outputs are fed through the diode and across the terminating resistor as shown in Fig. 1. The crystal diode acts to modulate the generator signals upon each other. The modulated output is applied to the receiver antenna input.

Set the receiver controls as for normal color reception. Adjust the sweep width to zero and tune the sweep generator to the picture carrier of the channel in use. Any channel can be used, but it is desirable to use an inactive channel in case there might be some interference. Now tune the marker generator near the 3.58-mc color-reference-oscillator frequency. When you reach the color-subcarrier frequency, there should be a solid color on the receiver screen. There is no way to predict which color

you will get since the color depends upon the phase relationship between the receiver reference oscillator and the marker generator. When a *solid color* is obtained, lower the marker-generator frequency by 15,750 cps. This exact frequency difference may be difficult to pick out on the dials of most shop-type marker generators. But if you will carefully lower the marker-generator frequency, a rainbow display should flash into sync on the screen. You can also get this same rainbow display by setting the marker generator output 15,750 cps above the 3.58-mc point (solid color). However, the rainbow color sequence will be reversed.

It should be noted that this rainbow display will not be "keyed." There will be no vertical bars separating the colors and no way of establishing the exact phase relationship between the colors. But the rainbow will be complete and, if the receiver is operating properly, will be in the normal sequence (orange at the left, then bright red, blue, and green at the right). On many sets you may have to advance the brightness control to see the complete rainbow properly.

If you wish to display two rainbows, lower the marker generator 31,500 cps below the 3.58-mc reference oscillator. You can display three rainbows by adjusting the marker generator to 47,250 cps below the 3.58-mc (solid-color) point. The color sequence will remain the same regardless of how many rainbows are displayed; but with two or more rainbows you will also get the color of the burst signal (a yellow-green), normally lost in the retrace on a single rainbow display.

If the marker generator is not accurately calibrated at 3.58-mc (actually the correct frequency is 3.579-545 mc), you can calibrate the generator with a crystal from a color receiver (or an NTSC-type generator, if one is available). It is good to have at least one of your shop generators calibrated to the color-subcarrier frequency if you anticipate any amount of color work.

Calibration procedure is simple. Connect the generator output in series with the crystal to the input of a VTVM as shown in Fig. 2. The VTVM must be set to a very low AC scale or an RF probe must be

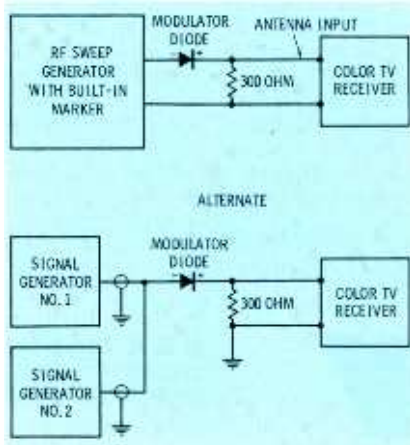

Fig. 1. Set-ups for rainbow display.

# Compare Color Generators

look at the rest... and you'll buy the best, new B&K model 1245

The all solid-state B&K Model 1245 Color Generator duplicates the waveforms transmitted by a color TV station.

Adherence to these waveforms makes it easy to converge the color tube, check sync and make other raster adjustments... and the color generator with station quality signal will be able to sync next year's sets. Generators with compromise waveforms do not give you this obsolescence protection.

Here are oscilloscope photographs from the outputs of two typical competitive color generators, one transistorized and one tube type, and the B&K Model 1245. The detailed analysis with each photograph shows a few of the reasons why you'll save time and effort with B&K.

## COLOR

## CROSSHATCH

### STANDARD STATION SIGNAL

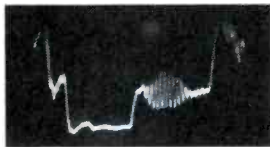

One horizontal sync pulse with its color burst.



Two lines showing horizontal sync pulse with black and white tv signal.

### TRANSISTORIZED B&K MODEL 1245



Good duplication of station signal including back porch. If the set won't sync, the set is defective.

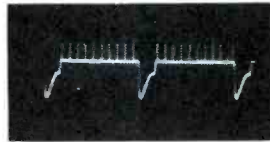

Well defined back porch on horizontal sync pulse permits accurately setting color killer and almost eliminates need to adjust brightness and contrast.

### TRANSISTORIZED GENERATOR A



No back porch causes unstable color sync. Burst amplitude compression may permit sync on wrong color bar.

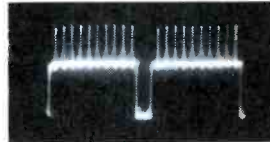

Square wave horizontal sync pulse with no back porch and poor dc coupling forces adjustments of brightness, contrast & fine tuning to obtain usable pattern.

### GENERATOR B

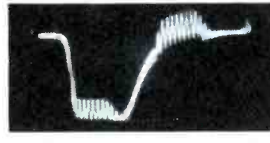

No back porch; color information on top of sync-pulse makes sync difficult on some sets.

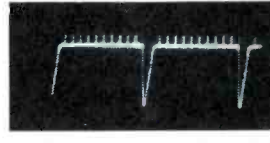

Complete absence of any back porch necessitates readjustment of brightness, contrast and fine tuning to obtain a usable pattern.

See your B&K Distributor for a demonstration or write for Catalog AP22.

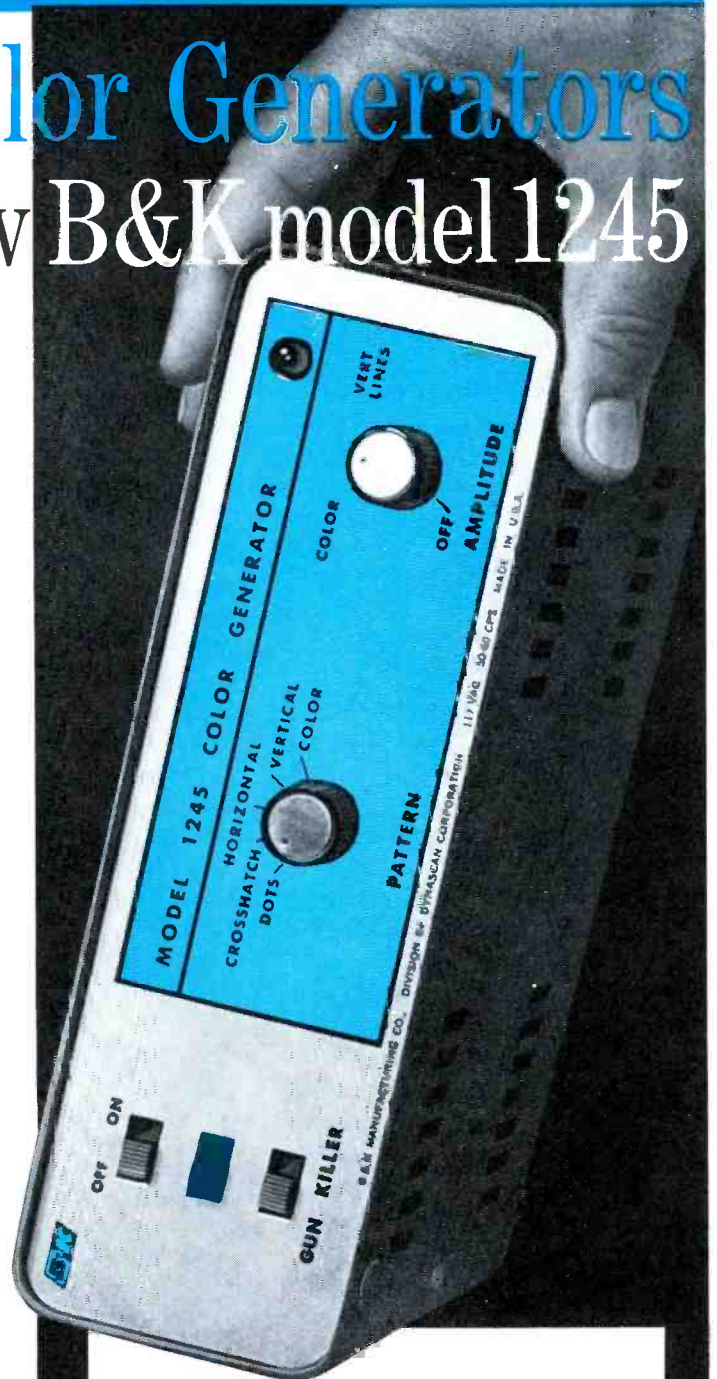

For the first time, with the no-compromise waveforms from the B&K Model 1245, it is possible to accurately set the color killer threshold control with a color generator.

The miniature size and convenience of the Model 1245 match its performance. It provides crystal-controlled keyed rainbow color bar display, and dot, crosshatch, horizontal line and vertical line patterns as well as gun killer controls that will work with any picture tube. Size only  $2\frac{7}{8} \times 8\frac{1}{2} \times 8\frac{3}{8}$ ". Net \$134<sup>95</sup>.



**B & K MANUFACTURING CO.**  
DIVISION OF DYNASCAN CORPORATION  
1801 W. BELLE PLAINE AVE. • CHICAGO, ILL. 60613

Export: Empire Exporters, 123 Grand St., New York 13, U.S.A.

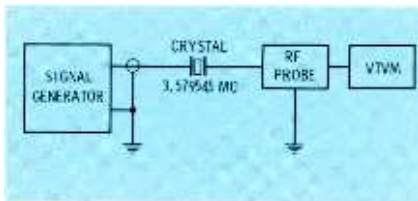

Fig. 2. Marker generator calibration.

used. Increase the generator output until there is a reading on the VTVM. Slowly tune the generator across the 3.58-mc point. When you hit the crystal frequency, the VTVM needle will jump. Don't be misled by slow variations in VTVM reading since such variations are probably the fault of the generator. When the crystal and generator are at the same frequency, the pointer will jump or flick noticeably.

### Checking Overall Chroma Response

Once you have completed the set-up for the rainbow display, the next logical step is to test the overall chroma-channel response. That is, check the overall bandwidth straight through from the tuner to the grids of the picture tube. The set-up is identical to that of the rainbow display, except that a VTVM is connected to each of the three grids (red, blue and green) in turn.

With the VTVM connected to a grid and the sweep generator set to the picture carrier frequency with zero sweep width, tune the marker generator to the color-subcarrier frequency. Again, you should get a solid color. Note the VTVM reading. If possible, set the VTVM scale or the sweep-generator output control so that the VTVM indicates a whole number such as 1 volt, 10 volts, etc., when the marker generator is set to exactly 3.58-mc (solid color). In any event, note the VTVM reading. Then increase the marker-generator frequency above the 3.58-mc point until the VTVM reading drops to .707 or about 71% of the reading at 3.58-mc. Next, lower the marker-generator frequency below the 3.58-mc point until the VTVM reading again drops to .707 of the reading at 3.58-mc. Repeat the test for each picture-tube grid.

The total spread between the upper and lower .707 points is the overall chroma-channel response or bandwidth. The total spread should

be at least 1 mc, and should be approximately equal on either side of the 3.58-mc point (0.5-mc on either side). If you get this approximate bandwidth, and a proper rainbow display set-up, here is how you considered as operating properly. If not, the next step is to check the individual circuits.

### Quick Check of Color Sync

Before you disconnect the rainbow, display set-up, here is how you can make a quick check of the color-sync circuits.

Tune in a single rainbow display as previously described. Slowly rotate the marker-generator dial back and forth while carefully watching the rainbow display. If the color-sync circuits are operating properly, the rainbow pattern will pull to the right when the marker-generator dial is rotated in one direction and to the left when the dial is rotated in the opposite direction. If the rainbow pattern "breaks" easily, rather than pulling, the color-sync circuits are at fault. If the break occurs in both directions, the reactance tube and/or the burst amplifier should be checked first. If the break is in one direction only, the color-AFC control probably requires adjustment, or the AFC circuits are defective.

A typical sync circuit is shown in Fig. 3. Here, the burst amplifier, phase detector, reactance tube, and oscillator provide the 3.58-mc signal for the color demodulators. The burst amplifier and phase detector compare the phase of the trans-

mitted burst signal to the phase of the 3.58-mc crystal oscillator. The phase-detector output is a DC correction voltage that controls the reactance modulator which, in turn, controls the 3.58-mc oscillator. If the variable DC voltage is present and the circuits do not respond, or if the DC voltage is absent, there will be no color sync. By applying a variable DC voltage to the reactance-tube input (test point A), you can quickly determine whether the circuits will respond to a simulated synchronizing signal. Use a variable AGC-bias supply as the source. Connect the source to test point A, and vary the source voltage and polarity until a color pattern of the proper sequence is obtained. If service data is available on the receiver, set the DC source to the approximate voltage from the phase detector. Normally, this is on the order of one or two volts for most sets.

If the color pattern is displayed when the simulated DC voltage is applied, the trouble is probably in the burst amplifier or the phase detector. These stages can be checked by tube substitution and voltage/resistance checks. If the color pattern is not displayed, the trouble can be in the reactance tube or crystal oscillator, or in the demodulators themselves. First let's check the reactance tube and crystal oscillator.

### Checking Reactance Tube and Crystal Oscillator

These color stages can be checked by tube substitution and voltage/resistance

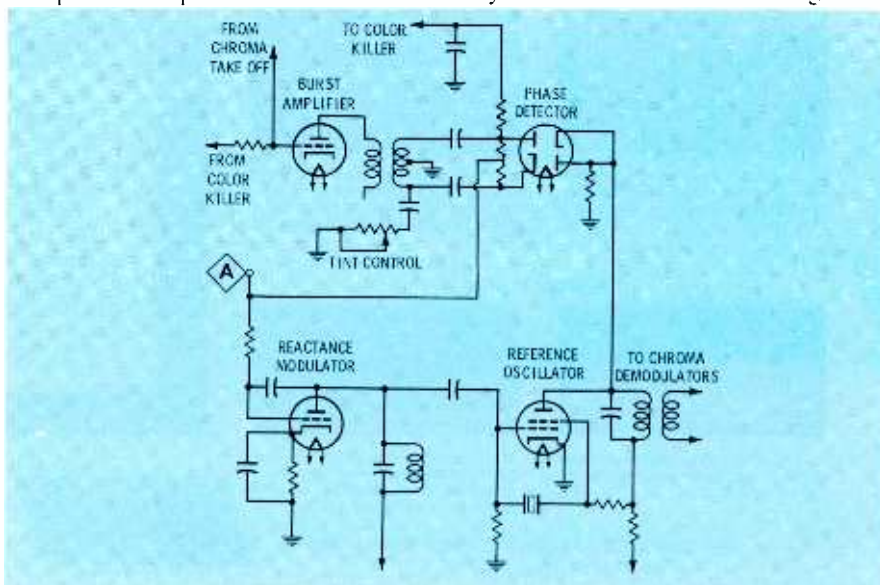
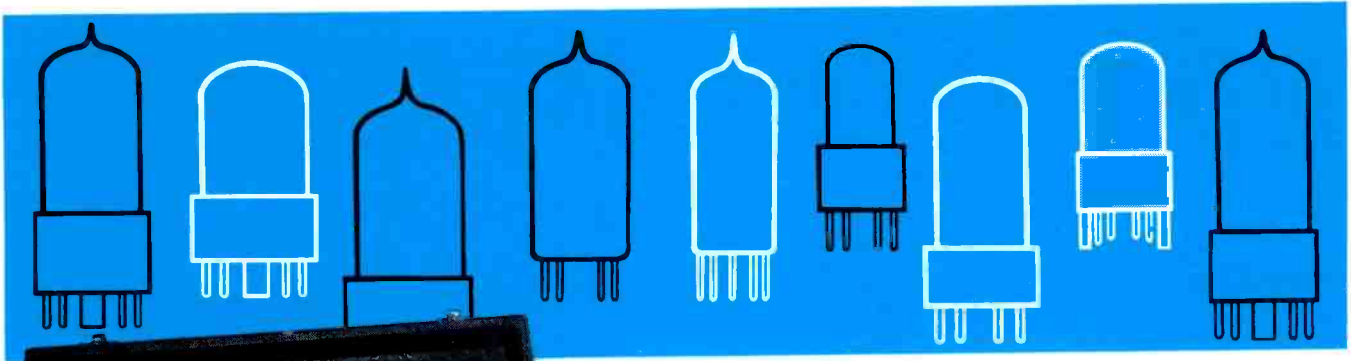

Fig. 3. Burst amplifier, phase detector, reactance tube, and oscillator circuits.



*New design for color  
...and all other!*

**QUICK-CHECKS  
MORE COLOR  
TV TUBES  
WITH  
Gm\* ACCURACY**

\* *Makes test under actual  
set-operating conditions*

# NEW B&K model 707 DYNAMIC MUTUAL CONDUCTANCE TUBE TESTER *with obsolescence protection*

You're always ahead with B&K. The new "707" gives you the famous B&K professional tube-testing speed and efficiency—plus the ability to test more color TV tubes with Gm\* accuracy.

Provides multiple-socket section to quick-check most of the TV and radio tube types the *true dynamic mutual conductance way\**—plus simplified switch section to check other tube types in Dyna-Jet emission circuit. Also includes provision for future new sockets.

You can quickly check all the tubes in the set, detect hard-to-locate weak tubes that need replacement... sell more tubes, save call-backs, and make more profit. *Makes test under set-operating conditions.* Checks each section of multi-section tubes separately. Checks for *all* shorts, grid emission, leakage, and gas. Makes quick "life" test. Exclusive adjustable grid emission test provides sensitivity to over 100 megohms. *Quickly pays for itself.* Net, \$189<sup>95</sup>

**Tests:**

New and old TV and Radio Tubes. Tests Nuvistors, Novars, 10-pin tubes, 12-pin Compactrons, European Hi-Fi tubes, Voltage Regulators, and Most Industrial types.

*See your B&K Distributor or Write for Catalog AP22-R*

**NEW TUBE INFORMATION SERVICE**  
Keep your tube tester up-to-date. Subscribe now to tube information service, available every 3 months.



**B & K MANUFACTURING CO.**  
DIVISION OF **DYNASCAN CORPORATION**  
1801 W. BELLE PLAINE AVE. • CHICAGO, ILL. 60613

Export: Empire Exporters, 123 Grand St., New York 13, U.S.A.

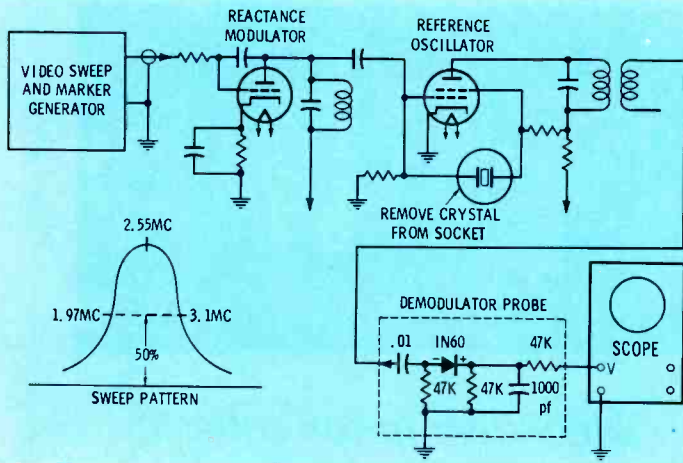

Fig. 4. Checking reactance-tube plate tuning.

sistance checks. Such tests will locate any major problem in the stages. However, the reactance-tube plate coil and/or the crystal-oscillator plate coil can be tuned so badly that they are operating on the borderline.

To check the reactance-tube plate tuning, connect the equipment as shown in Fig. 4. The sweep and marker generator should be connected to the reactance-tube grid. The scope vertical input should be connected to the terminals of the 3.58-mc crystal socket through a demodulator probe, which can be made up as shown in Fig. 4. The 3.58-mc crystal should be removed. Set the sweep generator to a center frequency of 2.55 mc and the sweep width to approximately 1 to 4 mc. The sweep pattern should appear similar to that of Fig. 4. If the theoretical sweep pattern is shown in the receiver service data, the actual pattern should be checked against this information. However, in most sets, the peak should occur at 2.55 mc, while the 50% points should occur at 1.97 and 3.1 mc. The reactance-tube plate coil should be tuned to

these valves if necessary. Usually, the plate coil is tunable from about 2 to 3.3 mc.

To check the reference-oscillator plate tuning, connect the equipment as shown in Fig. 5. The sweep and marker generator should be connected to the terminals of the 3.58-mc crystal socket (with the crystal removed). The scope vertical input should be connected to the R-Y demodulator output through a 100K-ohm resistor. Set the sweep generator to a center frequency of 3.62 mc, since the crystal-oscillator plate tank operates on the high side of resonance. The sweep pattern should appear similar to that of Fig. 5, with the peak at 3.62 mc (for most sets) and the 50% points at 3.35 and 3.88 mc. The crystal-oscillator plate coil should be tuned to these values if necessary. Usually, the plate coil is tunable from about 3.3 to 3.9 mc.

Once the reactance tube and crystal oscillator have been checked and cleared, the next step is checking the demodulators.

### Demodulator Alignment

There are two ways to check de-

modulator alignment. Both ways provide a simultaneous check of demodulator response.

The first way involves the rainbow pattern already discussed. Connect the sweep and marker generator through a diode modulator and tune for a rainbow display. Then connect the scope to the B-Y and R-Y demodulators as shown in Fig. 6. Adjust the scope controls until you get a circle. If you cannot get a good circle by adjusting the scope vertical and horizontal gain, the color phasing (quadrature) transformer is not properly adjusted or the demodulators are not linear. (Do not expect a perfect circle) Also, it may be possible that the scope leads will have enough capacitance to give a false reading. Therefore, if possible, use low-capacitance probes.

If the pattern is a straight line, it is likely that one of the demodulators is completely dead. If the pattern is an inclined ellipse, try adjustment of the quadrature transformer. If you can round out the ellipse with slight adjustment of the quadrature-transformer slugs, you can forget any slight difference in

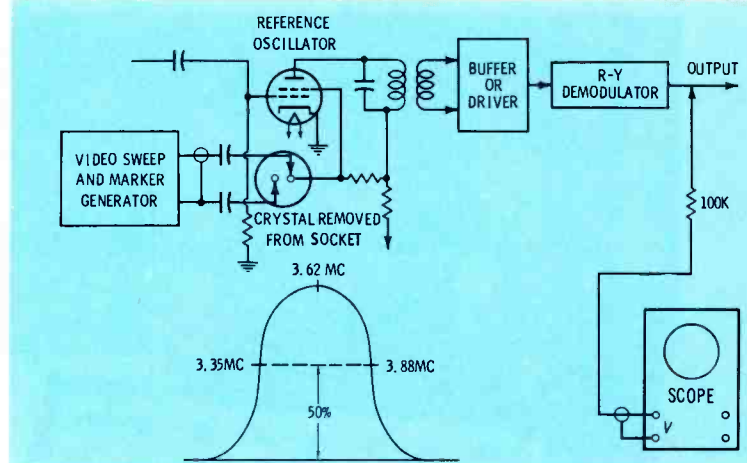

Fig. 5. Reference-oscillator plate tuning test.

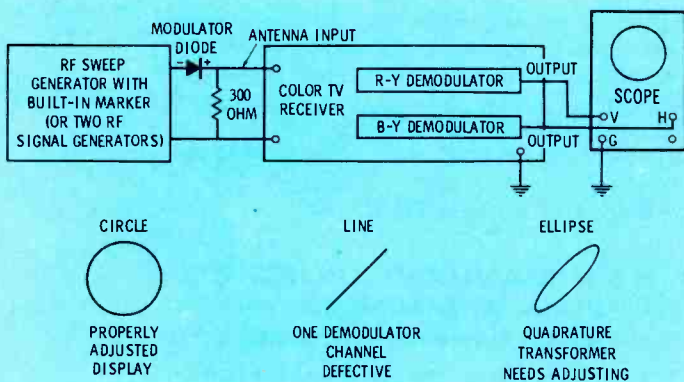

Fig. 6. Checking both demodulators with rainbow.

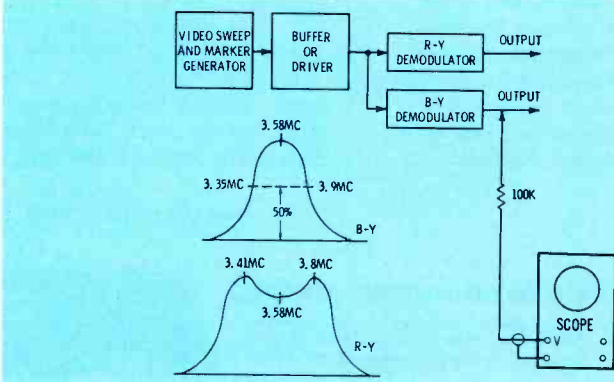

Fig. 7. Individual demodulator alignment test.



# Notes on Test Equipment

by Paul C. Smith

*analysis of test instruments... operation... applications*

## RCA Model WR-52A Specifications

**RF Signal Output:**  
 Carrier Frequency 100mc  
 Center frequency adjustable  $\pm 800$ kc.  
 Subcarrier Frequency 19kc  
 Crystal controlled  $\pm 2$  cps  
 FM Modulation

Left stereo signal  
 Right stereo signal  
 Internal Test (L+R subcarrier modulation)

Monaural FM

**Deviation**  
 Adjustable 0 to 75kc

**Sweep Signal**  
 Center Frequency 100mc  
 Sweep Deviation Rate 60cps  
 Sweep Width  
 Adjustable 0 to 750kc

**RF Output Level**  
 Adjustable up to 0.1 volt, rms, approx.

**Composite Signal**  
 Output Left stereo signal  
 Right stereo signal  
 Internal Test (L&R subcarrier modulation)

**Audio Output**  
 400cps, 1000cps, 5kc, 19kc  
 (Crystal controlled),  
 38kc, 67kc, 72kc  
 Percent distortion of 400-cps,  
 1000-cps, and 5-kc Frequencies  
 less than 2%

**Composite Signal/Audio Output Level**  
 0 to 12 volts, P-P, open circuit. Impedance 5000 ohms

**Power Requirements**  
 115-125 VAC, 60-cps, 40 watts

**Features**  
 Subcarrier frequency is crystal controlled. Internal test signal provided. Input terminals for external audio modulating signal. Permanently attached output cables: RF cable terminated for 75-ohm and 300-ohm receiver input. Front-panel RF deviation meter.

**Size (HWD)**  
 10"  $\times$  13 1/2"  $\times$  8"

**Weight**  
 12 3/4 lbs

**Price**  
 \$250.00

The RCA WR-52A (Fig. 1) provides a wide variety of signals suitable for aligning and troubleshooting stereo FM receivers and multiplex adapters.

A front-panel meter is provided for monitoring signal levels during level adjustments. The meter indicates RF deviation of both stereo and monaural FM signals and has a reference calibration mark for setting the 19-kc subcarrier level.



Fig. 1. Shows the new RCA Model WR-52A stereo-FM generator.

Two cables are permanently attached to the front panel: A direct un-terminated cable, COMP SIG/AUDIO, for use with the composite stereo signal and audio signal outputs; and RF OUT,

a terminated cable for RF output to a 75-ohm or 30-ohm receiver antenna input.

### OUTPUT SIGNALS:

**RF OUT cable:** A 100-mc sweep signal is provided with the FUNCTION switch at PF SWEEP. Sweep rate is 60 cps, and sweep deviation is adjustable from 0 to 750kc. When the FUNCTION switch is at AUDIO/MONO, a monaural FM signal is obtained, modulated at the frequency indicated by the FREQUENCY switch setting. FM stereo output for either left or right channel is available when the FUNCTION switch is at the STEREO LEFT or STEREO RIGHT position.

**COMP SIG/AUDIO cable:** Provides a composite signal when the FUNCTION switch is set to either of the stereo positions. Provides a sine-wave signal when the FUNCTION switch is set to the AUDIO/MONO position. Sine-wave frequencies available are 400 cps, 1000 cps, 5kc, 19kc, 38kc, 67kc, and 72kc. The 19-kc and 38-kc signals are crystal controlled. A block diagram of the generator circuitry appears in Fig. 2.

### Controls and Terminals

#### CONTROLS AND TERMINALS:

**Function:** A 5-position switch that

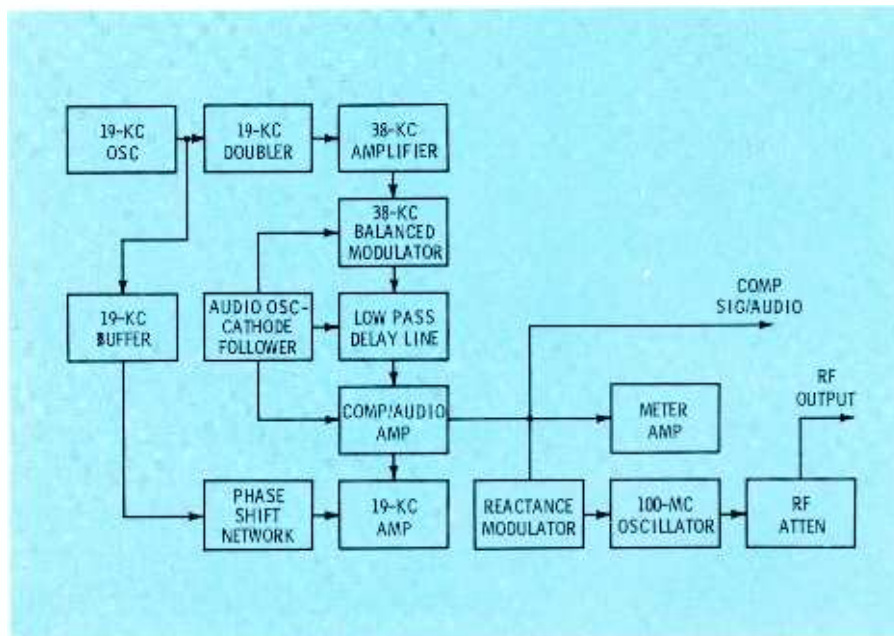

Fig. 2. Block diagram of generator circuitry.

# Heard the great **VIDOR** is



Get set, America. Make room for IRC's high-quality, high-profit battery...VIDOR! A complete line of transistor and general purpose batteries. The same fine quality you associate with British hi-fi, record changers and other products from Great Britain. Get all the profitable details from your IRC representative right away. Consumer and Distributor Products Division, IRC, Inc., Philadelphia, Pa. 19108.



*Circle 17 on literature card*



# news? here!



Transistor

General Purpose



OHMITE  
1000 OHM  
1/2 WATT 10%  
RC20GF102K

Little Devil® Composition Resistors



Type AB 2-Watt Molded Pots

## five ways to stop customer “static”



Gold-Bonded Germanium Diodes



OHMITE  
BROWN

Brown Devil® Wire-Wound Resistors



OHMITE  
995-5A

Series 99 Wire-Wound Resistors

Customer “static” is hard on the ears . . . hard on profit. But you’re always safe with Ohmite quality replacements in your repair jobs. Order Little Devils in handy cabinet assortments or on Tally-Tape; all popular sizes and values. Select AB Pots from 50 ohms to 5 megohms in several shaft lengths. Choose from ninety 1N types of diodes. Get Brown Devils from 3 to 20 watts in 0.5-ohm to 100K-ohm values. Order Series 99 resistors in 1½, 2¼, 3¼, 5, 11 watt sizes from 1 to 51,000 ohms. Ask your distributor for the latest edition of Ohmite’s Stock Catalog 30.

Be right with



# OHMITE

RHEOSTATS • RESISTORS • VARIABLE TRANSFORMERS • TAP SWITCHES  
TANTALUM CAPACITORS • RELAYS  
R.F. CHOKES • SEMICONDUCTOR DIODES

Circle 18 on literature card

48 PF REPORTER/March, 1966

selects the internal signals available at the two output cables as follows:

1. RF sweep—Provides RF sweep signal as described under OUTPUT SIGNALS.
2. AUDIO/MONO — Provides sine-wave signal as selected by FREQUENCY switch. Also provides Monaural FM at the RF OUT cable.
3. Stereo Left—Provides a standard stereo “left” composite signal.
4. Stereo Right—Provides a standard stereo “right” composite signal.
5. Int Test—Provides an internal signal for maintenance checks or adjustments as described in the operator’s manual.

**FREQUENCY:** An 8-position switch providing the seven frequencies mentioned under OUTPUT signals. The eighth position, marked EXT AF INPUT, allows an external audio signal to modulate the stereo signal. The signal is applied to the EXT AF INPUT terminals. The first three positions, 400 cps, 1000 cps, and 5kc connect these signal frequencies as stereo modulation when the FUNCTION switch is in the stereo positions. When the FUNCTION switch is in the AUDIO/MONO position,

any of the seven audio frequencies can be connected to the COMP SIG/AUDIO output cable.

**RF CARRIER:** This control permits setting the 100-mc oscillator on either side of the 100-mc center so that a quiet point on the FM band can be located.

**RF ATTEN:** Adjust the level of the RF output.

**RF DEVIATION/SWEEP WIDTH/AUDIO LEVEL/COMP SIG LEVEL:**

**RF Deviation:** Adjusts the FM deviation of the 100-mc RF oscillator. The RF Deviation is indicated on the panel meter.

**Sweep Width:** Adjusts the sweep width of the 100-mc RF sweep signal from 0 to 750kc. (Applies when FUNCTION switch is set to RF SWEEP.)

**Audio Level:** Adjusts the level of the audio signal. (Applies when FUNCTION switch is set to the AUDIO/MONO position.)

**Comp. Sig. Level:** Adjusts the level of the composite stereo signal obtained from the COMP SIG/AUDIO cable. (Applies when the FUNCTION switch is set to one of the three stereo positions.)

**SUBCARRIER SWITCH:** A 3-position switch marked 19kc OFF, NOR-

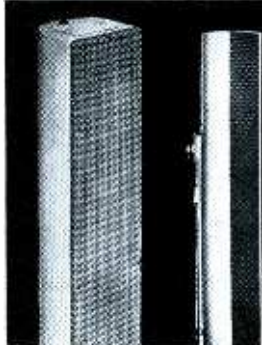

When the Job Calls for  
**SOUND COLUMNS**

22°-36°  
VERTICAL

120°-160°  
HORIZONTAL

## BE COLUMN RIGHT

When the job calls for columns—the controlled distribution of sound to cope with acoustic feedback—all the reasons add up to specifying “Columair” C-46 and C-66 columns by ATLAS SOUND.

**EFFECTIVENESS**—Feedback-generating low frequencies have been engineered out deliberately. Focused dispersion pattern controls “howl” in reverberant trouble spots by restricting coverage to audience.

**CONVENIENCE**—Compact design fits neatly anywhere with handling ease that king-size sound columns cannot match. Exclusive “EASY-MOUNT” brackets by ATLAS SOUND simplify installation and critical aiming for accurate coverage. Neutral-finish metal enclosure blends with decor. For special matching, grill cloth replacement and refinishing are easy. The SS-4 Stand and MK-1 Attachment Kit make child’s play of portable applications and rental jobs.

**ECONOMY**—You can afford better coverage at “Columair” budget prices. C-46 (Six 4” speakers, 20 watts), \$37.50 Net. C-66 (Six 6” speakers, 40 watts), \$57.00 Net. SS-4 Stand, \$13.50 Net. MK-1 Kit, \$1.20 Net.

For full specifications on “Columair” sound columns—and for the ATLAS SOUND answer to all your needs in public address speakers and microphone stands—write for Catalog PFC-13



**ATLAS SOUND**, Division of  
AMERICAN TRADING AND PRODUCTION CORPORATION  
1419-51 39th Street, Brooklyn, New York 11218

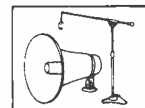

THIRTY YEARS OF LEADERSHIP IN COMMERCIAL SOUND

Circle 19 on literature card

# First UHF/VHF/FM 2-83 antenna that really works in fringe areas

## New Winegard Chroma-Tel CT-100



NEW! Model CT-100 \$52.50

Winegard's sensational new CT-100 Chroma-Tel has 29 elements in all. And they're all working to provide the finest all-band reception (UHF-VHF-FM) even in difficult fringe areas.

In addition to those 29 elements, the CT-100 incorporates a unique matching network that guarantees maximum signal transfer to the downlead—and on all channels 2-83 plus FM. Gives sharpest color and black & white reception.

And like all Chroma-Tels, it has Winegard's exclusive Chroma-Lens Director System (intermixes both VHF and UHF directors on the same linear plane without sacrificing

performance) . . . and our Impedance Correlators (special phasing wires that automatically increase the impedance of Chroma-Tel's elements to 300 ohms).

That's Winegard's new CT-100 Chroma-Tel. Bigger and better. But not too big. The full-line of Winegard Chroma-Tels still offers half the bulk; half the wind loading; half the truck space; and half the weight of all other all-band antennas—and at much lower prices. No wonder Winegard Chroma-Tels (now 4 models) are the hottest performing, hottest selling all-band antennas on the market! Better call your Winegard distributor or write for Chroma-Tel Fact Finder 242.

Model CT-40 \$17.50

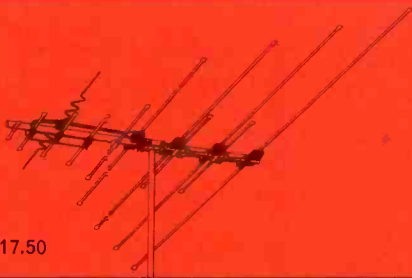

Model CT-80 \$27.50

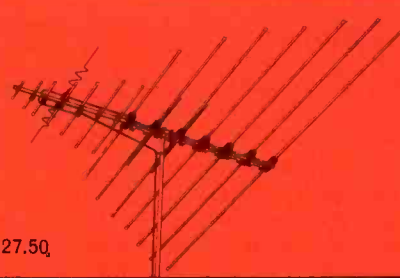

Model CT-90 \$37.50

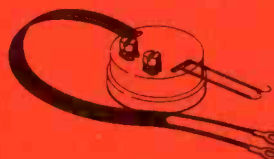
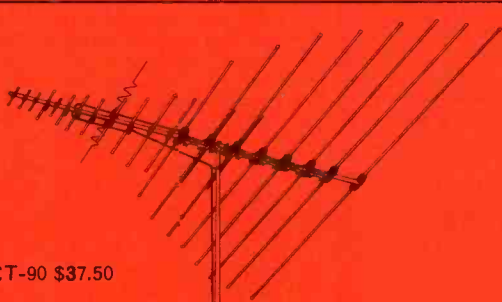

### FREE!

Every Winegard Chroma-Tel, including the new CT-100, comes complete with free CS-283 UHF-VHF Signal Splitter. Hangs behind set and separates UHF and VHF signals coming from antenna to the two pairs of set terminals.

**Winegard** ANTENNA SYSTEMS. Winegard Co. • 3000 Kirkwood • Burlington, Iowa 52602

Circle 20 on literature card

[www.americanradiohistory.com](http://www.americanradiohistory.com)



MAL, and SET 19kc SUBCARRIER. The first position disables the 19-kc oscillator to prevent distortion of the monaural FM signal. The NORMAL position of the switch is used for all functions other than monaural FM and 19-kc subcarrier adjustment. The third position of the switch is used, together with the 19-kc SUBCARRIER LEVEL control, for setting the proper subcarrier level, as indicated on the panel meter.

The Model WR-52A Simulator is supplied with a cable-holding bracket that mounts on the rear of the case. The bracket can either be installed or left unmounted, as desired. A very comprehensive operator's manual is provided, containing a complete description of the instrument, specifications, control functions, operating instructions, stereo FM theory and circuitry, schematics, waveforms, typical alignment of a multiplex receiver, maintenance procedures, and a replacement-parts list.

Signal waveforms of the instrument were checked in our laboratories and agreed with the waveforms pictured in the operator's manual. The multiplex section of an FM stereo receiver was aligned, using the WR-52A, and right-

and left-channel separation achieved was highly satisfactory.

### Color Generator

This solid-state color-bar generator (Fig. 3) will provide the following patterns on a color TV receiver: clear raster, color bars, dots, cross-hatch, vertical lines, and horizontal lines. In addition, three slide switches allow individual control of the color guns for making such adjustments as color purity and demodulator phasing.

All controls are mounted on the front panel, and cables extend from the rear. The cables are (1) a power cord for connecting to 105/125-volt, 50/60-cps power, (2) a shielded RF cable for connecting to the antenna terminals of the receiver, and (3) a cable with four color-coded terminals for connecting to the chassis and the three color-gun grids. Cords and cables can be stored in slotted compartments at the rear of the generator.

The all-solid-state feature gives immediate warm-up, and zener-diode regulation of the power supply minimizes frequency drift in the oscillator and countdown sections of the gen-



Fig. 3. The Seco Model 900 Color-bar generator.

erator. The unit uses twelve transistors, five unijunction transistors, five diodes, and one zener diode.

The RF signal is tunable through channels 2, 3, and 4 by means of the front panel CHANNEL TUNER control. This allows the generator to be set to the most favorable point on the receiver response curve, regardless of receiver tuning. Generator tuning is in effect for all six positions of the PATTERN SELECTOR control.

CLEAR RASTER: In this position of the pattern-selector control, the generator supplies vertical and horizontal sync signals to produce a clear raster for purity tests and gray-scale tracking. The normal sync signals as re-



## DO YOU HAVE A PROFITABLE TV SERVICE BUSINESS?

If you've "worked-like-a-demon" to build up your business now is the time to reap the money harvest!

You can become a successful retail electronics merchant by combining your service business with a PARTS UNLIMITED ELECTRONICS CENTER FRANCHISE to become part of a national retail electronics chain geared to bring you more profit by our bulk purchasing . . . management know-how . . . advertising and promotion . . . plus expert business advice to help you move ahead! You not only remain an independent businessman with your own business, but also join in a group merchandising effort that supplies consumers with nationally advertised and private brand merchandise at low prices! CHOICE FRANCHISES for PARTS UNLIMITED ELECTRONIC CENTERS are available in the New York Metropolitan area only — some are now in operation, other locations may be selected.

If you are financially independent — have the necessary drive to succeed, then you should investigate your opportunity to obtain what we claim is the finest franchise available in the retail electronic merchandising field today! Write giving details about yourself and business experience to MR. H. SHLAFER.



**PARTS UNLIMITED ELECTRONIC CENTERS**  
733 Bloomfield Avenue, Bloomfield, New Jersey  
☆☆☆ Centers throughout America ☆☆☆

Circle 21 on literature card

**WHATEVER YOUR COMMUNICATIONS YOU NEED Frequency Controlling TEXAS CRYSTALS**

Unconditionally Guaranteed

Whether on land, sea or air, your radio communications will be more dependable with TEXAS CRYSTALS . . . made with the same precision, care and quality as those supplied to numerous space projects. And, you'll appreciate the attractive prices. Send for descriptive catalog today.

If your dealer can't supply your TEXAS CRYSTALS needs, send his name with your order to our plant nearest you.



## TEXAS CRYSTALS

A Division of Whitehall Electronics Corp.

1000 Crystal Drive Fort Myers, Florida  
4117 W. Jefferson Blvd. Los Angeles, California  
Phone 813 WE 6-2109 Phone 213 731-2258

Circle 52 on literature card

ceived from a television station are designed to produce 30 fields per second beginning at the horizontal retrace, and 30 fields per second beginning in the center of the screen. These fields are interlaced to make 525 horizontal lines on the raster. In the Model 900, interlace is abandoned, and the generator is designed to produce 60 identical fields per second. This makes for a brighter, steadier pattern, but with half the usual number of lines. The Model 900 did, in fact, produce very steady line and dot patterns when tested on a color receiver in our labs.

### SECO Model 900 Specifications

#### Color Pattern:

Standard RCA keyed color bars produced by "offset-carrier" system. Ten bars spaced at 30 electrical degrees.

#### Color Oscillator

3.563795 mc, crystal controlled and tunable.

#### RF Carrier:

Tunable through channels 2, 3, and 4. Modulated with color bars or convergence signals, or sync only (clear raster).

#### Dots

90 dots, adjustable size.

#### Cross-Hatch:

9 vertical lines, 10 horizontal lines.

#### Vertical Lines:

9 vertical lines (adjustable width).

#### Horizontal Lines:

10 horizontal lines.

#### Color Gun Killer:

Passive network for shorting gun grids individually (100K, each grid).

#### Features:

All-solid-state, instant warmup. Single-trace horizontal line system (eliminates interlace swim). Crystal-controlled signal to count-down circuit for sync, dots, and lines.

#### Power Requirement:

105-125 volts, 50/60 cps, 12 watts.

#### Size (HWD):

3½" × 10½"  
× 8½"

#### Weight:

6 lbs

#### Price:

\$129.95

• Please turn to page 58

# ONLY CHEMTRONICS TOP QUALITY PROVEN AEROSOL QUALITY CHEMICALS SHOULD BE USED IN ANY TV SET

OVER 1,000,000 CANS SOLD



## TUN-O-LUBE

TRIPLE ACTION TUNER CLEANER  
CLEANS • LUBRICATES • PROTECTS  
WILL NOT DETUNE TV TUNERS • WILL  
NOT HARM PLASTIC PARTS • SAFE  
NON-FLAMMABLE  
3 OZ. SPRAY CAN .98¢  
8 OZ. SPRAY CAN 1.98

## TROL-AID

CONTROL & CONTACT CLEANER  
NON-FLAMMABLE • PROVIDES  
LONGER-LASTING PROTECTION  
AGAINST NOISE AND OXIDATION •  
SAFE FOR PLASTIC PARTS  
3 OZ. SPRAY CAN .98¢  
8 OZ. SPRAY CAN 1.98

MANUFACTURERS OF  
NO-ARC • FROST-AID  
MASK-N-GLAS • KLEER SPRAY  
Write for Illustrated Catalog



1260 RALPH AVE.  
BROOKLYN, NEW YORK 11236

Circle 23 on literature card



**TYPE PCT . . .** printed circuit electrolytics for exact replacement in AC-DC radios . . . made to exacting requirements of our manufacturing customers for easy installation and maximum performance.

**PLANET SALES CORP.**

225 Belleville Ave.  
Bloomfield, New Jersey

Circle 22 on literature card

**NEW!**



**ARROW'S  
T-18 Low Voltage Wire  
STAPLE GUN**  
For Fastening Any  
Inside or Outside  
Wire Up to 3/16" in Diameter

Takes a  
3/8" leg  
staple  
with 3/16"  
crown.

- Telephone wire
  - Intercom wire
  - Bell wire
  - Thermostat wire
  - Radiant heating wire
  - Hi-Fi, Radio & TV wires
- Tapered striking edge gets into close corners!

Steel wire staples available in brown, ivory, beige or natural; bronze and monel staples also available.



Circle 24 on literature card

for the traffic outlet  
that doesn't want to lose a sale...  
**RCA's NEW LAZY SUSAN FULL-LINE BATTERY CENTER**



15" wide, 15" deep, 28" high, plus header.

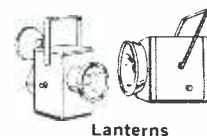
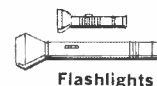
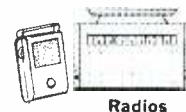

The base section can also be used as a showcase for transistor radios and other battery-operated devices.

Now display *and* sell up to 40 different battery types for radios, toys, flashlights, hearing aids, cameras and industrial and commercial applications. Batteries can be grouped by application for faster service, easier inventory control. RCA's Lazy Susan Full Line Battery Center (1P1214) is a clear extruded vinyl plastic showcase with revolving shelves of high impact styrene. Solid brass trim adds strength to the unit. It's attractive, durable and convenient. Latched half doors in the rear allow easy access to battery stock. Don't let those potential sales walk by... contact your RCA Battery Distributor... and start making your battery business that much better.

RCA ELECTRONIC COMPONENTS AND DEVICES, HARRISON, N. J.



The Most Trusted Name in Electronics



## Video Stages

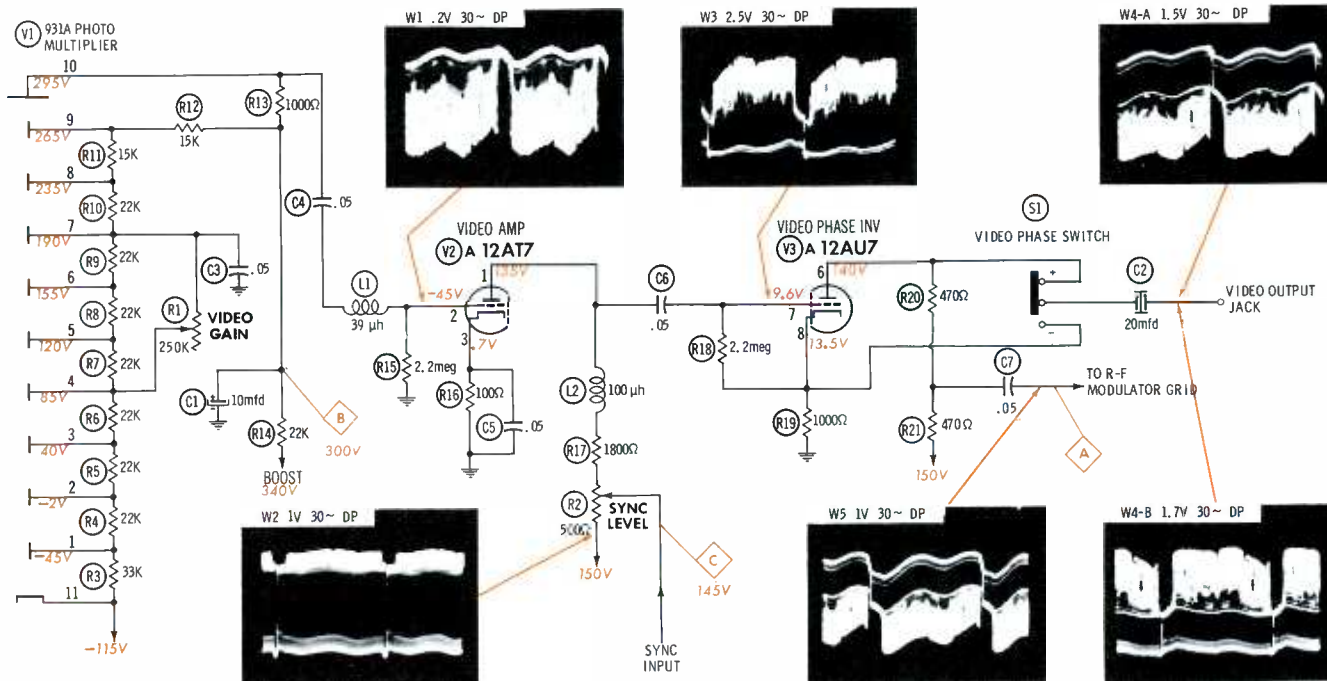

DC VOLTAGES taken with VTVM; test-pattern slide inserted in analyst which is connected to antenna terminals of normally operating television receiver.

WAVEFORMS taken with wideband scope; controls on TV set and analyst adjusted for normal picture and sound. Direct probe (DP) used to obtain all waveforms.

### Normal Operation

B&K Television Analyst (Model 1076) is flying spot scanner video-signal generator. It is essentially broadcast station with circuits for developing video, sync, sweep, audio, RF, and color signals. Circuits shown here develop and amplify video signal, and mix synchronizing information with video. Composite video signal is coupled to video-output jack and RF modulator stage. Photomultiplier tube V1 monitors scanner tube which is similar to TV picture tube. Light beam from scanner tube causes V1 to conduct—opaque portions of pattern insert block beam and V1 does not conduct. Video signal developed across R13 corresponds to pattern insert. Plate of V1 is connected to boost; cathode to negative supply for necessary bias voltage. Video-gain control (R1) determines multiplying action of V1; hence level of video signal. C4 couples signal to video amplifier V2A—high-frequency response is improved by L2, C5, and R16. Sync-level control R2 is part of plate-load resistance of both V2 and sync-phase tube. Composite sync signal is mixed with video signal in plate circuit of V2 by this coupling. Composite video signal is coupled through C6 to phase inverter V3A. V3 is biased so that signals at plate and cathode are of equal amplitude but naturally are of opposite polarity. Video phase switch (S1) reverses polarity of signal at front-panel video output jack. Composite video signal is also coupled from junction of R20 and R21 to grid of RF modulator tube. Modulator output is mixed with generated RF and fed to RF-IF output jack.

### Operating Variations

**V1** DC voltage varies on elements of V1 according to setting of R1. With control at minimum, resistance is minimum by-passing elements 4 thru 7. Without multiplying action of these elements there is practically no tube conduction and little or no signal is developed across R13. Plate voltage is 280 volts at minimum setting of R1 and 295 volts at maximum. Other voltages vary accordingly.

**V2 PIN 1** No DC voltage variations between signal and no-signal readings. However, sync-phase tube plate is supplied from wiper arm of R2; thus, B+ at plate of V2A varies 2.5 volts with control setting.

**V3A** DC voltages on this tube do not change with signal-level changes. Grid signal changes slightly because even with video cut off by R1 composite sync signal is still present.

**WAVEFORMS** Amplitude of W1 is determined by setting of R1. W2 amplitude is changed by R2, since this control varies B+ supply to sync-phase tube. This control can be adjusted by: 1. Turn R1 to *minimum*, 2. Connect oscilloscope to point A. 3. Adjust R2 for waveform amplitude of approximately .35 volts peak-to-peak. Sync pulse should be 30% of total amplitude of W4A with gain control set to produce normal picture on properly operating TV set.

## Symptom 1

### Hum Bars

Sync Critical

### C1 Open

(Boost Filter—10 mfd)

#### Symptom Analysis

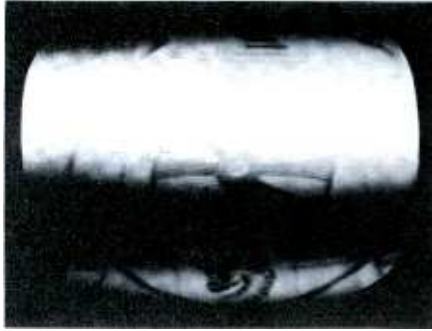

Picture has several hum bars—similar to cathode short in IF amplifier of TV set. Picture will sync but hold-control settings are critical. Horizontal bending is evident with picture in sync vertically. Hum bars look similar to pattern caused by open lid of Analyst.

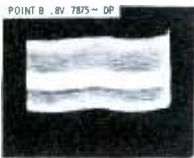
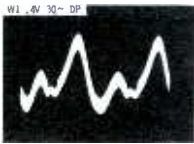
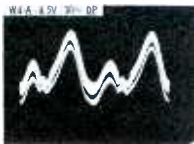

#### Waveform Analysis

Content and amplitude of composite video signal (W4A) shows why hum bars are in pattern. Small amount of video information is riding on high amplitude (4.5V) ripple. Normal amplitude of W4A is 1.5 volts peak-to-peak. Although not shown, W4B, W5, and W3 also have symptom. W1 has high ripple indicating trouble in V1 or associated circuitry. Scope at point B shows boost ripple greatly increased—.8 volts p-p compared to normal .03 volts.

#### Voltage and Component Analysis

NO  
VOLTAGE  
CLUES

All DC Voltages are within normal tolerance, so meter is no help locating trouble. DC voltages on V2 and V3 normally do not change with variations in signal level, and voltages on elements of V1 vary only slightly depending on adjustment of video gain control R1. As C1 decreases in value, filtering action on boost is reduced, and ripple induced into V1 plate circuit becomes more predominant. Sync is affected because sync pulses become only a small percentage of V3 output. Defective B—source filtering could give same symptom.

Best Bet: Careful scope work will pinpoint trouble.

### Horiz Hold Critical

(Sync Level Control—500 ohm)

### R2 Wiper Arm Open

Vertical Hold Also Unstable

## Symptom 2

#### Symptom Analysis



Picture displayed on normally operating TV looks like receiver has sync-separator trouble—horizontal will sync but has pulling and bending. Vertical rolls intermittently and picture appears to be overloading. Sync is more critical at lower video-gain adjustments.

#### Waveform Analysis

Output of this section of analyst (W4A, W4B, or W5) is logical place to start troubleshooting video-sync problems. W4B shows why sync is unstable—sync pulse is absent. W3 indicates sync pulse is not being lost in phase-inverter stage and points to video-amplifier plate circuit since this is where sync is mixed with video. Although distorted and increased in amplitude—18 volts P-P, normal 1 volt, P-P—W2 is present and further isolates trouble.

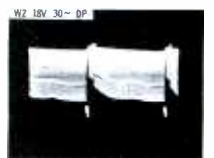
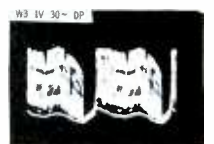
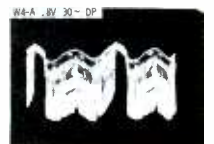

#### Voltage and Component Analysis

C -80V

Video amplifier (V2A) plate voltage and phase inverter (V3A) voltages are within tolerance. Voltage at point C is best clue. Voltage here will normally vary with sync-level adjustment from 145 to 150 volts but is now -80 volts. Sync pulses come from sweep circuits of analyst and are shaped and limited in sync-phase section. Without plate voltage, sync stage merely capacitively couples sweep signals to point C. When troubleshooting analyst, remember most circuits operate similar to TV, but signals are fed in opposite direction.

Best Bet: Scope isolates; VTVM locates.



## Video Weak

No Vertical Sweep

Symptom 3

### R14 Increases in Value

(Voltage Divider Resistor—22K)

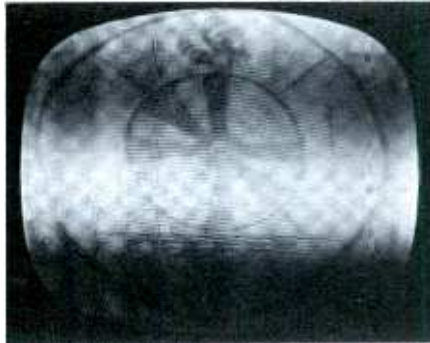

Symptom Analysis

Picture on normally operating TV is faint and washed out. Symptom resembles TV with defective video amplifier except horizontal and vertical sync is excellent. Pattern is weak when using either video output (+ or -) or RF-IF output. Trouble is indicated in video stages.

#### Waveform Analysis

W4A or B confirms suspicions of lack of video information reaching this point. Composite sync signal is near correct amplitude but video information is almost nonexistent. Signal here should be similar in amplitude and content to signal coupled to video amplifier of TV set. W3 also contains little video information. Extremely low amplitude, (.03 volts P-P, compared to .25 volts normal) of W1 shows V1 or associated circuitry is at fault.

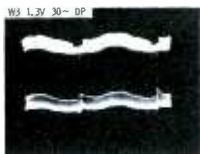
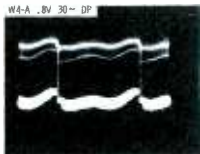

#### Voltage and Component Analysis

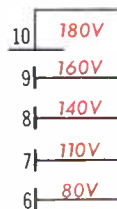

Voltage at plate of V1 (180 volts—normal is 295 volts) is best clue. Other voltages on V1 are proportionately reduced further isolating trouble to R14. Increased resistance of R14 lowers plate voltage and decreases difference of potential between plate and cathode of V1—normally 410 volts, now only 295 volts. Multiplying action of tube is lowered, hence output signal is reduced. Loss of B—source voltage, insufficient light striking cathode of V1 due to dirt accumulation on glass envelope, or weak scanner tube causes similar symptom.

Best Bet: Scope isolates; VTVM pinpoints.

## Video Weak

Vertical Sync Unstable

Symptom 4

### C6 Leaky

(Coupling Capacitor—.05 mfd)

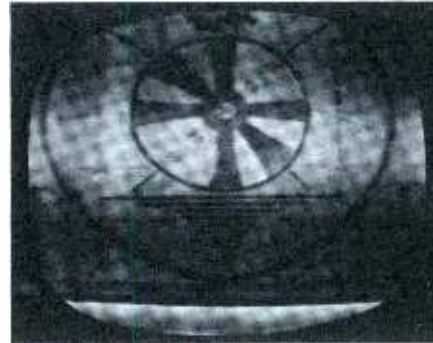

Symptom Analysis

Pattern is weak and has "graying" almost "snowy" appearance; sync is unstable. Video gain control operates but must be at maximum to obtain pattern on TV. When using RF-IF output, picture can be improved slightly by adjusting RF-IF attenuator to maximum.

#### Waveform Analysis

Both amplitude and content of W4A are good indications of trouble. Waveform is distorted and measures .45 volts peak-to-peak—normal is 1.5 volts. W4B and W5 are similarly distorted and reduced in amplitude. W3 also shows suppressed sync pulses and reduced amplitude—.85 volts peak-to-peak, normal is 2.5 volts peak-to-peak. Near normal amplitude and shape of W1 isolates symptom to video amplifier (V2A) and associated circuitry.

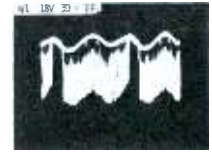
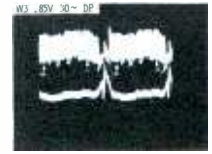
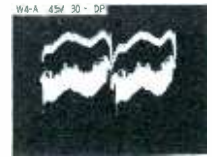

#### Voltage and Component Analysis

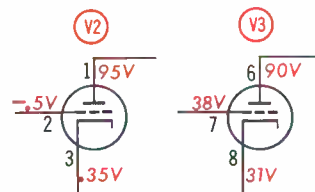

V3A voltages are far from normal—90 volts on plate is well below normal 140 volts—grid reads 38 volts (normal is 9.6v) and is higher than cathode which shows 31 volts compared to normal 13.5 volts. V2A plate voltage is also low—95 volts. Combination of incorrect voltages throws strong suspicion on coupling capacitor C6. Leaky C6 distorts composite video signal and upsets normal operating bias of video phase inverter (V3A) causing lowered output waveforms which, in turn, cause weak picture. Suppressed sync pulses cause weak sync.

Best Bet: Scope, followed by VTVM.

## No Video Output

### Symptom 5

RF-IF Output Normal

### C2 Open

(Video Jack Coupler—20 mfd NP)

#### Symptom Analysis

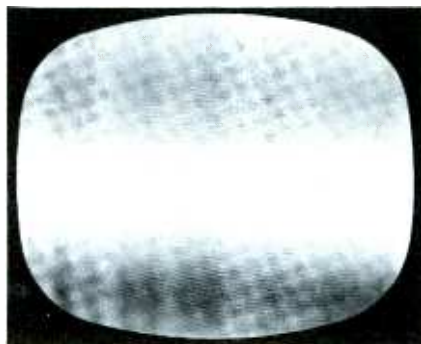

Screen is black—no video information whatsoever—when using video output jack of analyst. Video gain control does not change symptom. Picture is normal and all controls operate normally when using RF-IF output. Audio is available only when using RF-IF output.

#### Waveform Analysis

Waveforms at video-output jack (W4A and W4B) show only radiated sync pulse and "hash." This proves only what was already suspected—that no video information is reaching this point. However, absence of even sync pulse, which is generated in analyst, indicates entire composite video signal is lost. Normal W5 definitely isolates trouble to video phase switch, coupling capacitor C2, or leads and connections associated with these components.

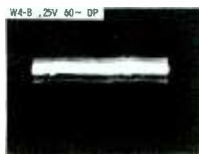
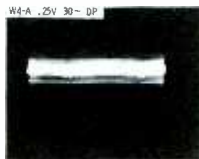

#### Voltage and Component Analysis

NO VOLTAGE CLUES

All DC voltages are normal and offer no assistance in locating defective component. Careful circuit analysis reveals that all three tubes must be operating properly in order for composite video signal to be coupled to modulator stage and impressed on output of RF-IF oscillator. Dirty or defective video phase switch could cause similar symptom or symptom where only either positive going or negative going signal is missing. If C2 shorted, either plate or cathode B+ would be coupled to video jack and TV circuits under test would be upset.

Best Bet: Careful symptom analysis; then scope check.

## RF-IF Signal Weak

Video Output Usable

### R21 Increases in Value

(V3A Plate Load Resistor—470 ohm)

### Symptom 6

#### Symptom Analysis

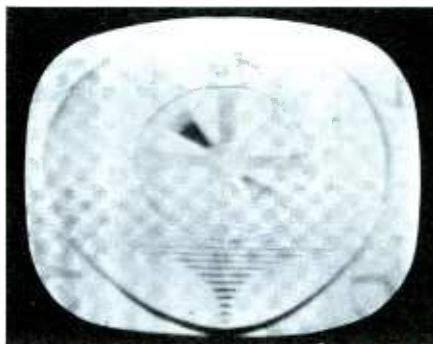

RF-IF output is weak, washed out, and smeared. RF-IF attenuator control operates normally. Video gain control is operative and picture is better at lower settings. Video-output-jack signal seems to drive output stages of TV okay but "+" signal appears stronger than usual.

#### Waveform Analysis

W5 has normal content but amplitude is approximately 4 times normal (4 volts vs. 1 volt). Plate of V3A (W4A) is also increased in amplitude. However, W4B (cathode of V3A) shows normal content but amplitude is less than normal (1 volt vs. 1.7 volt). Normally W4A and W4B are nearly same amplitude—only reversed. Abnormally high amplitude of W4A and W5 along with slightly reduced W4B point to trouble in video phase inverter stage (V3A).

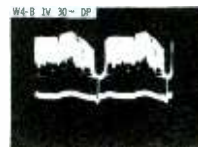
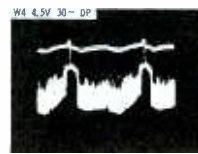

#### Voltage and Component Analysis

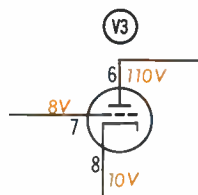

Best voltage clues are on elements of V3A. Voltage at plate is only 110 volts compared to normal 140 volts; grid and cathode voltages are reduced proportionately. By checking plate voltage further, exact trouble can be found. R20 and R21 are both normally 470-ohm resistors and voltage drop across them should be equal. But with symptom there is 5-volt drop across R20 and 35 volts across R21. Reduced plate voltage changes bias of V3A and causes high-amplitude waveform to be coupled to RF modulator—causing overmodulation.

Best Bet: Scope, then VTMM.

# You'll star in TV Guide

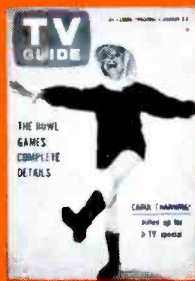

If you're "the right TV serviceman?"

## Get the jump on profitable color set repairs.

Your Sylvania distributor will put your name, your town, your phone number in *TV Guide* as many as four times this year. If you're the right TV serviceman.



The right TV serviceman—Mr. Right—is any Independent Service Dealer who carries the most advanced replacement parts: our *color bright 85™* picture tubes and our color receiving tubes. He may also carry competing brands. So he's in a position to give unbiased opinions on color set repairs.

This is what our double-page, full-color localized ads explain to *TV Guide* readers. Just see your Sylvania distributor and the ads will tell all those TV set owners about you. How about it, Star?

Sylvania Electronic Tube Division, Electronic Components Group, Seneca Falls, New York 13148.

**SYLVANIA**  
SUBSIDIARY OF  
GENERAL TELEPHONE & ELECTRONICS **GTE**

Circle 25 on literature card

March, 1966/PF REPORTER 57

**GREATEST**  
*Breakthrough*  
**IN**  
**COLOR TV**  
**SERVICING**

**THE ONLY**  
**TV TUNER CLEANER**  
**GUARANTEED**  
**NOT TO DETUNE**  
**COLOR SETS**



**NEW!**  
**COLOR**  
**LUBE**  
**NON-DRIFT TUNER CLEANER**



**Safe For Plastics**  
**NON FLAMMABLE**  
Specially designed to clean and  
lubricate **ALL COLOR T.V. TUNERS**  
CONTAINS **MIRACLE TC 5**

**NOW AT ALL DISTRIBUTORS**  
**DEALER NET \$2.39**



**1260 RALPH AVENUE**  
**BROOKLYN, NEW YORK 11236**

Circle 26 on literature card

**Notes**

(Continued from page 51)

**COLOR BARS:** Ten standard RCA keyed color bars are produced by the "offset-carrier" method. The color bars are spaced 30 electrical degrees. The color signal is generated by a crystal oscillator operating at 3.563795 mc. The front-panel control marked **COLOR QUALITY** allows fine tuning of this signal for minimum "barber-pole" effect on the color bars. The **COLOR OUTPUT** control changes the amount of color signal driving the modulator.

**DOTS:** Sync, dot, and line signals originate with a crystal oscillator operating at 189.080 kc. After proper shaping, this signal is used for vertical lines and dots. It also triggers a series of unijunction ring counters that supply signals for horizontal sweep, horizontal lines, and vertical sweep. The dot pattern consists of 90 dots arranged in ten horizontal rows of nine dots each. Dot size is varied by turning the **DOT SIZE** control.

**CROSS-HATCH:** The cross-hatch pattern consists of nine vertical and ten horizontal bars. This pattern is useful for dynamic convergence, linearity, and overscan adjustments.

**VERT LINES:** With the pattern-selector control in this position, nine

vertical lines are produced on the receiver screen. Width of the vertical lines is controlled by the **DOT SIZE** control. This pattern is generally used for adjusting dynamic vertical convergence.

**HORIZ LINES:** The generator signal produces ten horizontal lines on the screen. Because there is no interlace, each horizontal sweep line is traced twice in each frame, resulting in a higher brightness level. Horizontal lines are useful in making dynamic horizontal convergence adjustments.

**COLOR-GUN KILLERS:** Three slide switches, designated R, B, and G, on the front panel provide a convenient means for disabling the color guns. The red-, green-, and blue-coded clips on the cable are connected to the corresponding color-gun grids, and the black clip is connected to the receiver chassis. When any switch is moved to the **OFF** position, a 100K resistor is connected from gun grid to chassis ground, effectively disabling that portion of the color gun.

The Model 900 Color Generator is accompanied by an operator's manual covering specifications, control and switch functions, troubleshooting and alignment methods, Model 900 circuit theory, block diagram, schematic, and parts list. ▲

**Know how to spot head wear?**

**These unretouched photos show you how!**

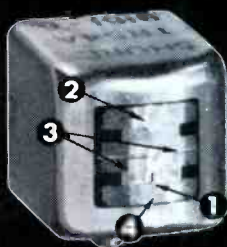

**"LOOK"**—Look for: (1) the gap; (2) depressions, gouges, score marks; or (3) angled wear lines on either side of pole pieces.

**"TOUCH"**—Run your fingernail across face of head vertically and horizontally in both directions. Can you feel (4) rough surfaces, sharp edges, or catch your nail on (5) a weargroove?

**OR "LISTEN"**—Use our AT-100 Test Tape or play a pre-recorded tape with good "highs" as offered by Latin-type music or Violins. Do the "highs" sound flat, mushy or distorted?

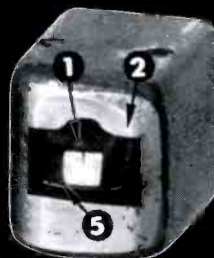

**IF ANY OF THESE**  
**CONDITIONS EXIST—**  
**REPLACE THE HEAD!**

**FOR VISUAL**  
**COMPARISON...**  
take a look at this  
new Nortronic head.



Your tape head wears every time you use your recorder, and as it wears, the brilliant realism of tape is lost! Pressure pads and the magnetic tape itself, both cause wear. The oxide coating used on the tape is an abrasive which slowly grinds away the face of the head—and pressure pads cause uneven wear. For top performance, intimate tape-to-gap contact is essential . . . and poor contact, due to wear, results in severe high frequency losses, erratic output, loss of output!

**See your local Nortronic Dealer!**  
Protect your investment in tape and equipment by replacing worn heads with full-fidelity Nortronic precision replacements.

**Nortronic**®

8167-A 10th Ave. No. • Minneapolis, Minn. 55427

Circle 27 on literature card

## Checking Color

(Continued from page 44)

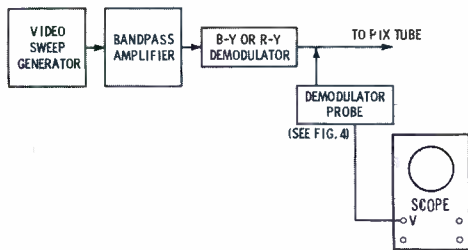

Fig. 8. Monitoring B-Y or R-Y out.

linearity between the B-Y and R-Y demodulators. But if you cannot get a circle after extensive adjustment of the quadrature transformer (the pattern remains an ellipse), one of the demodulators is at fault.

The second method of checking demodulator alignment involves feeding a sweep and marker signal into the buffer or driver amplifier ahead of the demodulators and checking the response of each demodulator separately. This will reveal a defective demodulator stage and provide

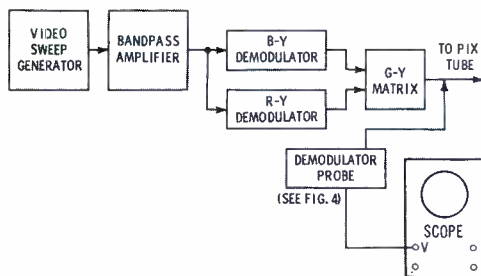

Fig. 9. Checking bandpass amplifier.

a means of adjusting the quadrature transformer.

Connect the sweep and marker generator to the amplifier grid as shown in Fig. 7. Remove the 3.58-mc crystal from the reference oscillator. Connect the scope vertical input through a 100K resistor to the R-Y demodulator and the B-Y demodulator in turn. Set the sweep generator to a center frequency of 3.58mc. Typical sweep patterns for both the B-Y and R-Y demodulators are shown in Fig. 7. In both

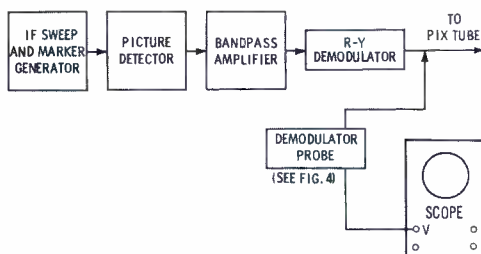

Fig. 10. Picture detector output test.



Look what's happened to the RCA WR-51A FM Stereo Signal Simulator

...it got to be the WR-52A...

**NEW, REDESIGNED AND IMPROVED**

Last year we decided to make a few improvements in our WR-51A Stereo FM Signal Simulator... for two years THE established test instrument for multiplex stereo servicing. We intended to call it the WR-51B. But one thing led to another and we made so many extensive improvements that we virtually had a new instrument on our hands. You're looking at it: the NEW RCA WR-52A STEREO FM SIGNAL SIMULATOR. We've added an RF Deviation Meter to measure the modulation level of both stereo and monaural FM signals. The meter is also used to accurately establish the level of the 19 Kc subcarrier. We've included provisions for modulating left or right stereo signals with an external monaural source. We've added a switch to disable the 19 Kc oscillator to provide a low-distortion monaural FM output. We've added a new frequency (72 Kc)... required, along with the 67 Kc frequency, for trap alignment in some sets.

These features, together with numerous internal circuit design changes have resulted in a vastly improved, almost completely new instrument. And, the RCA WR-52A includes all those features that made its predecessor such a valuable servicing tool.

■ COMPOSITE STEREO OUTPUT—for direct connection to multiplex circuit

Choice of left stereo and right stereo signals

■ RF OUTPUT—for connection to receiver antenna terminals

100 Mc carrier, tuneable

Choice of FM signals—left stereo, right stereo, monaural FM, internal test and 60 cycle FM sweep

FM stereo deviation adjustable from 0-100%

100 Mc sweep signal adjustable from 0 to more than 750 Kc at a 60 cps rate

RF output attenuator

■ CRYSTAL-CONTROLLED 19 Kc SUBCARRIER ( $\pm 0.1\%$ )

■ SINE WAVE FREQUENCIES

Three low-distortion frequencies—400 cps, 1 Kc, 5 Kc

Two crystal-controlled frequencies—19 and 38 Kc

Additional frequencies—67 and 72 Kc for trap alignment

■ READILY PORTABLE—weighs only 12¾ pounds, measures 13½" by 10" by 8"

■ COMPLETE WITH WIRED-IN CONNECTING CABLES

We also raised the price... just 50 cents. The WR-52A is now \$250.00.\* Ask to see it at your Authorized RCA Test Equipment Distributor.

\*Optional distributor resale price, subject to change without notice. May be slightly higher in Hawaii and the West.

RCA ELECTRONIC COMPONENTS & DEVICES, HARRISON, N.J.



The Most Trusted Name in Electronics

SEE YOUR ELECTRONICS PARTS DISTRIBUTOR:

# Weller® for every soldering job

## Pencil Soldering Irons by Weller

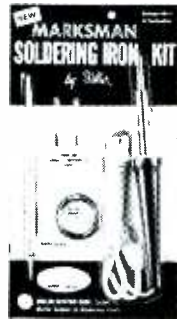

"Marksman" Kit with pencil soldering iron; screwdriver, cone and chisel tips; handy soldering aid and a supply of solder. **\$4.44** list Model SP-23K.



"Marksman" Iron at popular price. Stainless-steel long-reach barrel. 1/8" replaceable tip. Maximum tip temperature, 750°F. **\$2.98** list Model SP-23.



Weller Iron is industrial rated, highly efficient. Does work of bigger irons. Only 7 7/8" long including the tip. 25 watts. 115 volts. **\$5.20** list Model WP-S.

## Temperature Controlled Soldering Unit

For universal hobby soldering, including heavy-duty metal work. Temperature control is in the tip. Interchangeable tips give a choice of 500°F, 600°F, 700°F and 800°F controlled temperatures. Operates on 24 volts. Complete with 3/16" 700°F tip and 60 watt, 120 volt, 50/60 cycle power unit with soldering pencil stand and tip cleaning sponge attached. Model W-TCP. **\$26.00** list



## Dual Heat Soldering Guns

100/140 Watts. Two trigger positions let you switch instantly to high or low heat to suit the job. Tip heats instantly and spotlight comes on when trigger is pulled. Tip has exceptionally long reach. Model 8200. **\$6.95** list

145/210 Watts. A professional model with all Weller gun features: instant heat, dual heat, spotlights. Model D-440. **\$9.95** list

240/325 Watts. Heavy-duty model with all Weller gun features: instant heat, dual heat, spotlights. Model D-550. **\$10.95** list



## Dual Heat Soldering Gun Kit

Includes Weller 100/140 watt dual heat gun, 3 soldering tips, tip-changing wrench, soldering aid, flux brush, supply of solder... all in a colorful utility case of break-proof plastic. Model 8200PK. **\$8.95** list



## Heavy-Duty Soldering Gun Kit

Features Weller 240/325 watt dual heat gun; tips for soldering, cutting and smoothing; tip-changing wrench; solder; metal-tone utility case of break-proof plastic. Model D-550PK. **\$12.95** list



Utility Grade Solder On Hang Cards 5 feet of 40/60 alloy solder in each pack. Acid core, AC-40. Rosin core, RC-40. **39¢** list



Superior Grade Solder in Dispenser Tubes 10 feet of 60/40 alloy rosin-core solder in each tube. Number RC-60. **59¢** list

WELLER ELECTRIC CORPORATION, Easton, Pa.

WORLD LEADER IN SOLDERING TECHNOLOGY

Circle 29 on literature card

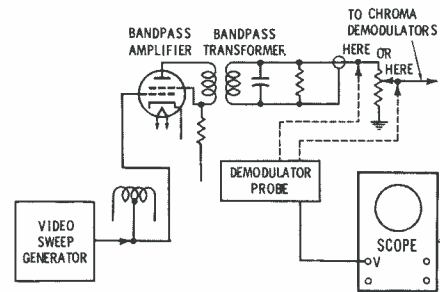

Fig. 11. Checking bandpass amplifier.

circuits you should get a peak at 3.58mc. However, the B-Y demodulator will usually provide a single peak, while the R-Y demodulator will provide two peaks with 3.58mc at the valley. If you do not get a response at one of the two demodulator outputs, you have found the problem area. Likewise, if the response patterns show either demodulator to be off frequency, adjustment of the quadrature transformer should bring it back to a peak of 3.58 mc. If you adjust the quadrature transformer to bring one demodulator into frequency, check the other demodulator to assure that the adjustments have not interacted.

If the demodulators and sync circuits check out, and you still have a problem, start signal tracing from the bandpass amplifier or picture detector straight through to the picture tube. Again, this can be done with a conventional sweep and marker generator.

## Basic Signal Tracing

The basic signal tracing for the color circuits is essentially the same as that for black-and-white circuits. A sweep and marker signal of appropriate frequency is fed to the input, and the output is monitored on an oscilloscope (wide-band), using a demodulator probe. Figs. 8 through 11 show the connections. In Fig. 8 the sweep is fed to the bandpass input, while the scope monitors the B-Y or R-Y demodulator out-

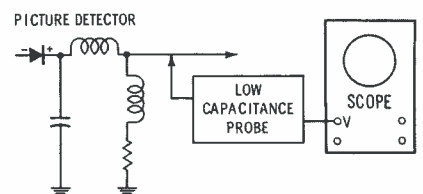
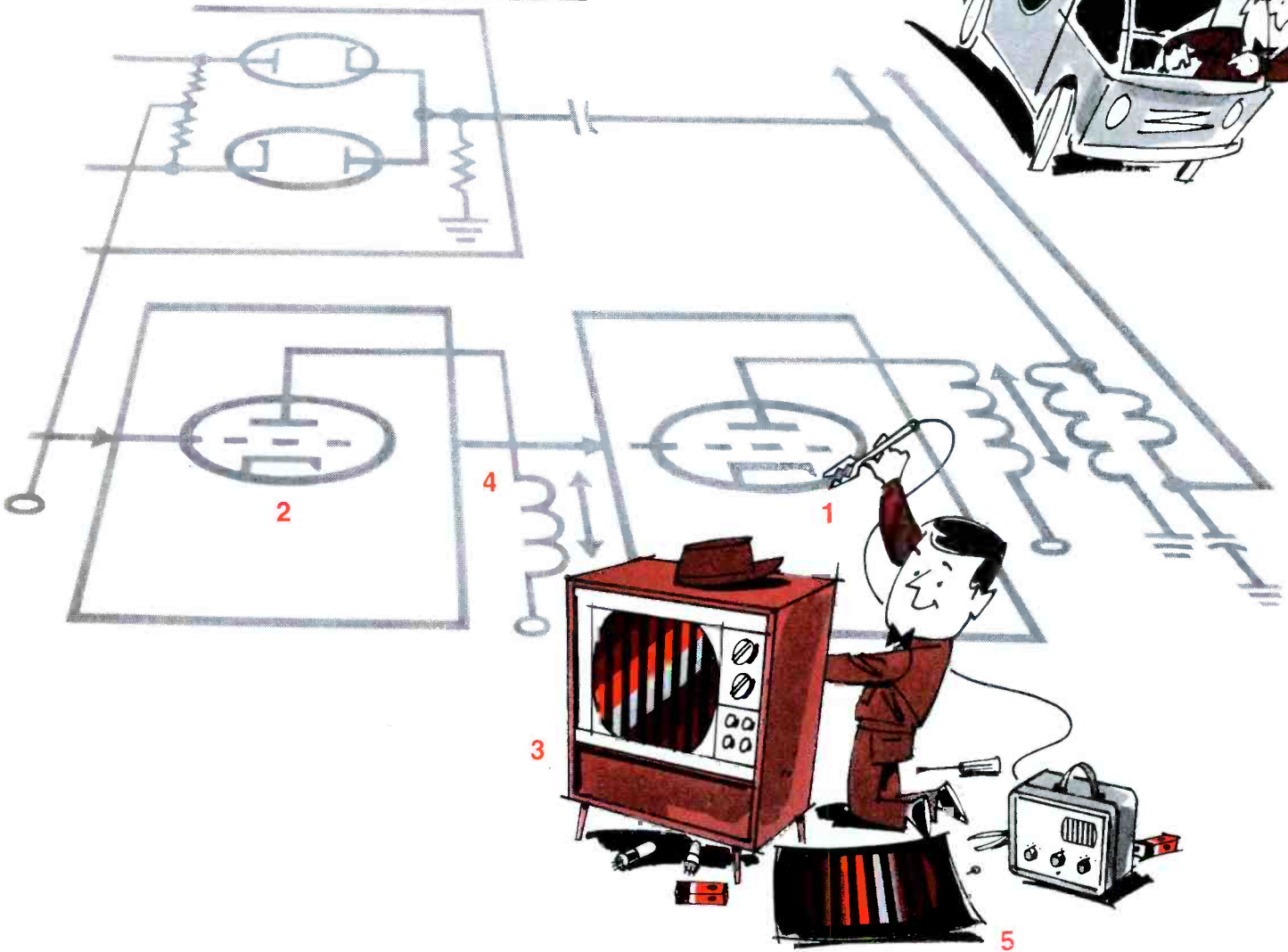
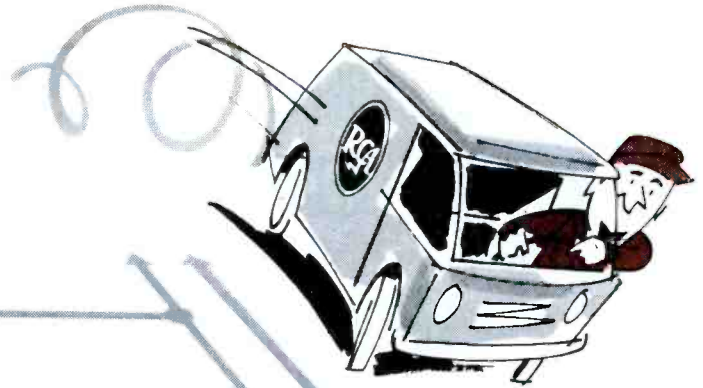

Fig. 12. Color test of video detector.



## Loss of color sync? TRY ADJUSTING THE PLATE COIL...

Loss of color sync is often caused by a defective 3.58-Mc/s oscillator. In some receivers, it may also be caused by misadjustment of the plate coil in the reactance tube control circuit. Next time you run into this trouble, follow this simple procedure and it may save you a time-wasting callback.

1. Connect a color-bar generator such as the RCA WR-64B to the receiver and get the ten-color bar pattern on the picture tube.
2. Short the control grid of the reactance tube to ground.
3. The bars may have bands or blocks of color across them. These bands are "beats" resulting from difference between the local oscillator and transmitted signal frequencies. These colors may drift diagonally across the bar giving a "barber pole" effect, or they may be locked into the bars in blocks of different hues.
4. Slowly adjust the reactance tube plate coil with an alignment tool. Turn the slug in the direction which reduces the number of color bands or blocks across the bars.

5. Adjust for a zero-beat condition. At zero beat, the bars will display individual solid colors from top to bottom. These colors may be locked in or they may drift slowly from bar to bar. Remove the short from the reactance tube grid and re-adjust the plate coil for solid lock-in of the color bars.

If you can get an exact zero-beat condition, it is an indication that the oscillator tube is good. If it is necessary to replace the oscillator tube, be sure to adjust the circuit for zero-beat as shown in step 5.

This color TV service hint is the first of a series of service hints from RCA. For satisfied customers and fewer callbacks, always replace with ultra-reliable RCA receiving tubes.

RCA ELECTRONIC COMPONENTS AND DEVICES, HARRISON, N. J.



The Most Trusted Name in Electronics

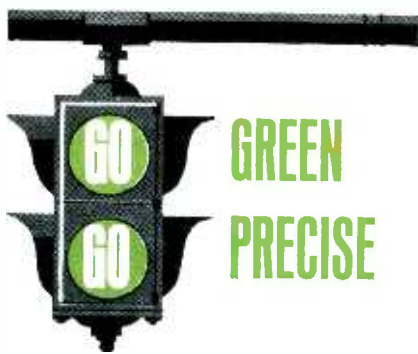

**GREEN  
PRECISE**

**FOR RELIABLE  
TEST MEASUREMENTS**

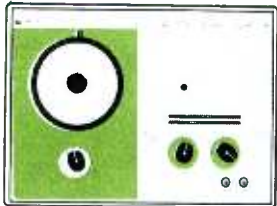

**MODEL 636**

**AF SINE SQUARE GENERATOR** — 20 cps to 200 kc in four ranges. Less than 0.25% sine wave distortion at 10 vrms into 600 ohms load.

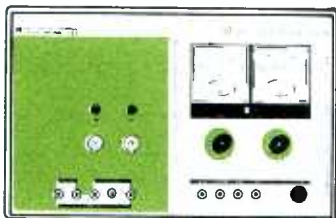

**MODEL 780**

**CONTINUOUSLY VARIABLE REGULATED VOLTAGE SUPPLY** — Regulated dc output from 0 to +400 v at 150 ma, and 0 to -150 v bias. Also provides unregulated ac. Meters for voltage and current.



**MODEL 905**

**VACUUM TUBE VOLTMETER** — Comes with assembled dc/ac-ohms probe. Direct reading of p-p voltages. Separate ac low voltage scale. Low 0.5 vdc range for transistor circuit measurements.

Go with the new **PRECISE Green Line**. It's the scenic route for your test measurements — headed straight for value and accuracy. These unique instruments have color dynamic front panels featuring easy-on-the-eyes Green to aid readability and accuracy. New functional design and layout make operation fast and foolproof. Underneath, they're hopped up with sophisticated circuitry checked out for reliability. That's why, now more than ever, you'll find the going's smoothest with **PRECISE** test instruments. Go all the way with **PRECISE** scopes, VTVMs, power supplies, signal generators, tube testers, decade boxes and probes.

**PRECISE ELECTRONICS**  
Division of Designatronics, Inc.  
Mineola, L. I., N. Y.

Circle 31 on literature card

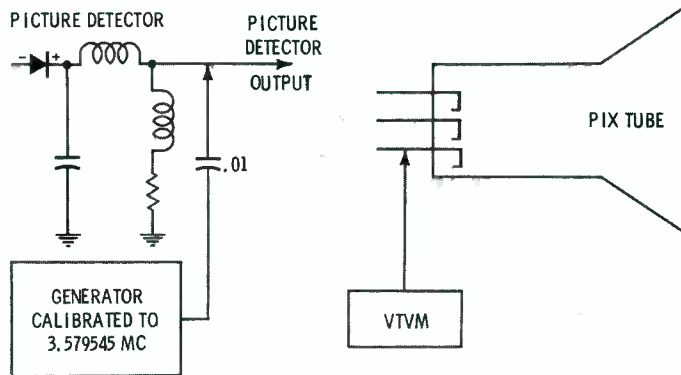

**Fig. 13. Y-amplifier color-subcarrier trap adjustment.**

put. Fig. 9 illustrates essentially the same test, except that the scope monitors the G-Y matrix output on sets with matrix circuits. Fig. 10 includes the picture detector, and uses an IF sweep instead of a video-frequency sweep. Fig. 11 shows the connections for checking only the bandpass amplifier.

Adjust the oscilloscope controls as you would for any sweep-frequency response tests. It is best to adjust the controls so that the zero frequency point is as the end of the base line of the scope's horizontal sweep. When you connect the scope probe to the B-Y or R-Y output, remove the socket from the color

picture tube. Use the same probe as shown in Fig. 4.

Before making any detailed signal tracing tests, check to see that the tuner, IF stages, and video detector are capable of passing a color signal. There are several ways to do this. One way is to apply the rainbow display, then check the picture-detector output. The connections are shown in Fig. 12. To insure that you are actually observing a video signal, temporarily disable the marker-generator output to see if the video signal disappears from the scope trace. Obviously, if there is no color output from the video detector, you cannot expect the color circuits to produce a display.

#### Miscellaneous Tests

It is possible to perform a number of color tests with a conventional RF signal generator.

The output of a signal generator that has been accurately calibrated to 3.579545 (as previously described) can be substituted for a dead color-subcarrier reference oscillator. Simply remove the crystal from its socket and connect the signal generator output to the socket terminals. Of course, the generator output will probably be much lower than that of the crystal oscillator, but it should be strong enough to show that the receiver will operate. Likewise, the pattern or picture will not stay in sync, but you can carefully tune the 3.579545-mc output to restore sync temporarily.

The output of an accurately calibrated signal generator at 3.579545 mc can also be used to adjust a color-subcarrier trap in a Y-amplifier. The connections are shown in Fig. 13. With the signal applied, adjust the trap for a minimum reading on the VTVM.

there's  
**EXTRA PROFIT in NOISECTOMIES\***

**QUIETROLE**  
IS HARMLESS TO PLASTICS

Harmless to metal... non-conductive, non-inflammatory and non-corrosive. Zero effect on capacity and resistance.

\* a simple quick operation performed by Doctors of Electronics with the aid of Quietrole to cure scratchy, noisy tuners and controls of TV and radio. Fast set recovery with no ill side-effects assured. Saves time... makes money for servicemen.

At Your Distributor Ask for Quietrole by Name.

manufactured by  
**QUIETROLE CO.**  
Spartanburg, South Carolina

Circle 32 on literature card





**This new  
Zenith antenna  
doesn't believe  
in ghosts**

## **Zenith Wavemagnet® indoor TV antenna**

Designed for clear, sharp, all-channel (2 to 83) reception in color or B&W, the Zenith Wavemagnet antenna meets the quality standards set for Zenith "original parts"... your assurance of the world's finest performance.

The VHF and UHF elements are heavy chrome-plated. Separate lead-in cables for UHF and VHF correspond to the input arrangement of every new all-channel TV receiver.

This new design features a special network providing substantial step-up of basic dipole impedance, resulting in a lower voltage standing wave ratio (VSWR) than the ordinary VHF indoor antennas. This reduces snow effect, reflections and ghosts.

Optimum UHF performance is achieved with two full-size UHF loops, arranged one behind the other, that are carefully phased through a coupling network through the entire UHF spectrum from 470 to 890 megacycles. The increased sensitivity develops an exceptionally high front-to-back ratio equal to that in many outdoor antennas. This is remarkably effective in reducing ghosts and man-made interference.

Order the new Wavemagnet antenna (Part Number 973-56) and other genuine Zenith replacement parts and accessories from your Zenith distributor.

**ZENITH**<sup>®</sup>

*The quality goes in  
before the name goes on<sup>®</sup>*

Specifications subject to  
change without notice

# STANDARD KOLLSMAN Television Stars

*Featuring the fastest rising star in the TV tuner industry.*  
Now available for replacement profits.

## NEW STANDARD KOLLSMAN COLOR and black and white VHF ARBOR TUNER WITH PRE-SET FINE TUNING

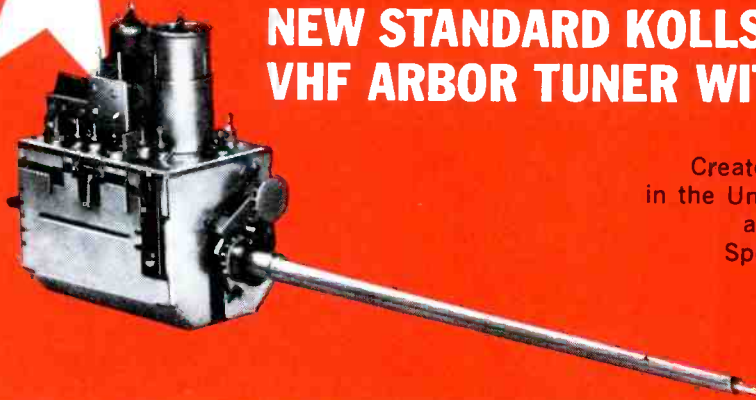

*Guaranteed positive adjustment to eliminate service callbacks.*  
Created to replace TV tuners in practically every set manufactured in the United States since 1956. A simple adjustment of the knob automatically adjusts the oscillators for easy, perfect tuning. Specially designed brackets permit simple installations in any position—guaranteed to eliminate all previous mechanical problems of replacement installations.

Three new models to sell.  
New SKi Arbor Tuner installed with the SKi UCT-051 UHF Tuner converts any set into a modern 82 channel TV.

### Sell the custom look STANDARD KOLLSMAN BUILT-IN Transistorized UHF Converter

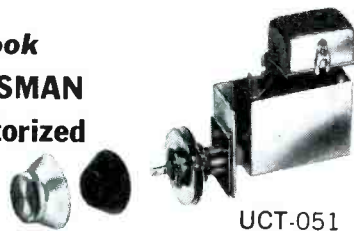

UCT-051

Easily installed in about 45 minutes

- Best performance—low noise
- Fits all consoles, table models and most portables
- Compact size: 5½" x 1½" x 3¾"; weight 1¼ lbs.
- Easy to read dial calibrated to read at any angle regardless of installation position
- Easy tuning high-ratio ball bearing drive
- Reliable service-free tuning element
- All UHF channels—14 through 83
- Built-in safeguards against interference with other TV sets in vicinity
- Excellent for replacement of defective tuners
- Quick and easy way to make TV trade-ins saleable

### IF STANDARD KOLLSMAN MADE IT, STANDARD KOLLSMAN WILL FIX IT

- Only brand new parts used
- 48 hour service on all SK tuners
- Latest testing techniques to assure proper alignment
- No hidden costs—\$11.50 plus parts . . . \$13.50 maximum cost
- \$3.00 Trade-in allowance on new tuner.
- 6 month guarantee
- Special shipping cartons to avoid damage in transit

### INTRODUCING WORLD'S MOST BEAUTIFUL BEST PERFORMING TRANSISTOR UHF CONVERTER



Model TA

- Earns more profit because it's easier to sell
- More picture power with latest nuvistor amplifier circuits
- Easy tuning
- Exceeds minimum F.C.C. requirements for spurious radiation specifications
- Very low drift
- Easy hook up
- All channels 14 through 83
- U.L. listed
- Full year warranty on all parts and workmanship.

### NEW UHF TRANSLATOR MULTI PURPOSE TEST EQUIPMENT AND DEMONSTRATOR

- Translates VHF to UHF even when no UHF signals are on air
- Saves Time Servicing all Channel TV Sets
- Easier to Sell
- All Channel TV sets



VUT-1

**FOR MORE PROFIT FOR THE SERVICE DEALER • GREATER CUSTOMER SATISFACTION**

**GUARANTEED BY THE WORLD'S LARGEST  
MANUFACTURER OF TELEVISION TUNERS**



**Standard Kollman  
INDUSTRIES INC.**

2085 NORTH HAWTHORNE AVE., MELROSE PARK, ILLINOIS

Circle 34 on literature card.

## Mobile Radio

(Continued from page 31)

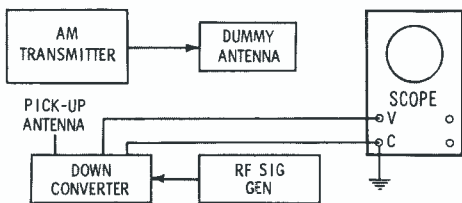

Fig. 7. Checking VHF RF envelope for modulation percentage.

a low-capacity probe when using an unmodulated signal. Adjust the stages for maximum signal indication on the scope. If there is a limiter stage ahead of the detector, however, it is better to monitor the signal at the limiter input.

After the receiver has been aligned, the detector-input transformer (T, Fig. 6B) should be tuned for best signal-to-noise ratio with a very weak FM signal applied. If the FM signal is tone modulated, the audio output of the receiver can be monitored with a scope and the best signal-to-noise ratio can be noted visually. The final tuning consists of trimming coil L for best audio recovery and signal-to-noise ratio, and minimum audio distortion.

## Transmitter Servicing

A wideband scope can be used for direct observation of RF signals in transmitters at stages operating at frequencies below approximately 12 mc. To observe signals at higher frequencies, a "down converter" can be used (Fig. 7). This is simply a mixer stage into which the test signal is injected along with a reference signal from a local oscillator. The oscillator may be built into the down converter or obtained from an external signal generator. In a pinch, an RF probe can be used as a mixer by feeding the reference signal into it through a small capacitor, along with the test signal. However, a down converter with a tuned output circuit, tuned to the desired difference frequency, is better.

For example, to observe a 162.55-mc signal, you can use a 160 mc signal as a reference to obtain a 2.55 mc signal (well within the response range of a wideband scope.)

By observing the RF signal, it is possible to detect hum and unwanted AM on an FM signal. This is also a good way to check the modulation percentage of AM transmitters. The waveforms for various percentages of modulation are shown in Fig. 8. By cutting off the

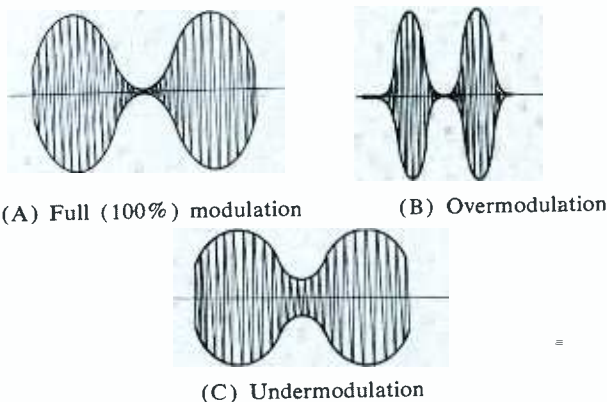

Fig. 8. AM RF waveforms showing modulation levels.



## Now Americas Number ONE Tube Checker . . .

Checks compactrons, novars, nuvitors, 10 pins and the latest 10 pin used in many new color TV sets, plus over 1200 foreign tubes. The Mighty Mite is so popular because it checks each tube for:

- **GRID LEAKAGE** of as little as 1/2 microamp or 100 megohms
- **EMISSION** at tubes full rated cathode current
- **SHORTS** of 180K or less between elements

## With These New Exclusive Mechanical Features . . .

- New third hand set-up book holder.
- New removable hinged cover
- New taut band meter

Get your Mighty Mite from your distributor now, and join the more than 30,000 Mighty Mite users the world over. **\$74.50**

# SENCORE

426 SOUTH WESTGATE DRIVE • ADDISON, ILLINOIS  
Circle 35 on literature card

March, 1966/PF REPORTER 65



Again from **JFD**<sup>®</sup>

the first major VHF antenna advance  
since the invention of the JFD LPV Log Periodic!

Developed at the JFD Antenna-Research Laboratories, Champaign, Illinois under the  
direction of Dr. Paul E. Mayes, co-inventor of the acclaimed LPV Log Periodic concept.

*the remarkable new*

**JFD**<sup>®</sup> **LPV-TV**<sup>®</sup>  
**COLOR**  
**LOG PERIODIC**

for channels 2 to 13 and FM/Stereo

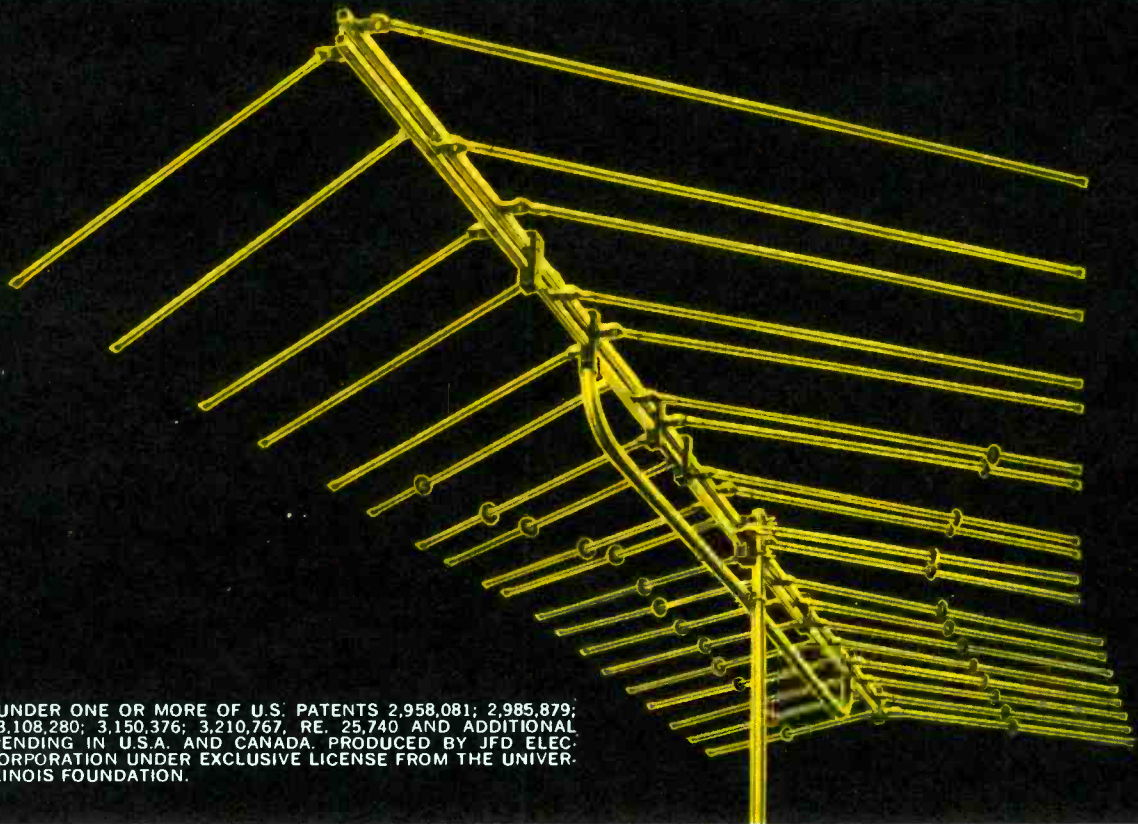

LICENSED UNDER ONE OR MORE OF U.S. PATENTS 2,958,081; 2,985,879;  
3,011,168; 3,108,280; 3,150,376; 3,210,767, RE. 25,740 AND ADDITIONAL  
PATENTS PENDING IN U.S.A. AND CANADA. PRODUCED BY JFD ELECTRONICS CORPORATION UNDER EXCLUSIVE LICENSE FROM THE UNIVERSITY OF ILLINOIS FOUNDATION.

Circle 36 on literature card

# WIFIJECH

While our LPV-TV series was undergoing development in Champaign, Ill., it was assigned the code name: WIFIJECH.

For good reason.

Its performance objectives were to surpass every competitive make—model for equivalent model—in gain, directivity, response, V S W R, & F/B ratio.

Did the new LPV-TV come through?

—All the way! Its performance is the proof!

Now at your JFD LPV distributor.

Seven LPV-TV models to choose from — meet any location or budget needs!

Write for LPV-TV brochure 1039.



## BY FAR—the best antenna for VHF COLOR performance because it combines...

- The electronic perfection of the patented frequency independent Log Periodic concept of the University of Illinois Antenna Research Laboratories.
- New capacitor-coupled Cap-Electronic elements that respond on the third harmonic mode for highest effective gain. More harmonically resonant elements mean higher signal-to-noise ratios, better ghost rejection, sharper directivity on high VHF band—where it's most needed, especially in color.\*
- True dual-band directors separately tune to high and low bands for added gain and directivity on all channels.
- Flat frequency response ( $\pm 1/2$  db across entire channel) for studio-quality color regardless of channel tuned.

New LPV-TV Log Periodic antenna series incorporates new capacitor-coupled element concept for improved response, especially in color, on channels 2 to 13.

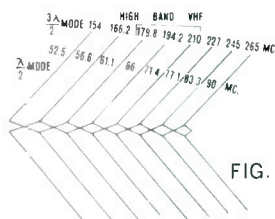

FIG. 1 (Note that only three dipoles resonate at frequencies in the high VHF band.)

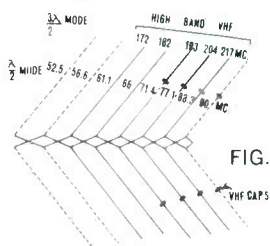

FIG. 2

Fig. 1 shows how a VHF log periodic with eight conventional V-dipoles might look.

The resonant frequencies of the dipole elements in the low VHF band are indicated near midpoint of each dipole. The  $3/2$  wavelength resonant frequencies are indicated near the ends of each dipole.

However, by introducing parallel plate capacitors into the dipoles and by carefully adjusting the value of this capacitance and its position on the dipole, as shown in Figure 2, the resonant frequencies of the dipole can be shifted in the  $3/2$  wavelength mode. In this way, the dipole can be made to resonate at two desired frequencies: e.g., 88 and 216 mc.

Result: the active region in the high band extends over five of the eight original dipoles instead of three, as in Fig. 2, with a performance improvement of 66 $\frac{2}{3}$ %. The new capacitor-coupled dipoles also present more capture area on the low band than ordinary dipoles. Thus LPV-TV antennas offer, on both bands, higher and more uniform gain, lower side-lobe levels, narrower beamwidths, for vastly improved ghost rejection (see Fig. 3).

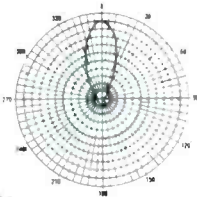

FIG. 3

**VHF** — up to 50 miles  
**FM** — up to 30 miles  
 Model **LPV-TV3**  
 3 Cell System (single-crossarm)  
 With electronic "ghost-killing" trap  
**\$14.95** list

**VHF** — up to 75 miles  
**FM** — up to 40 miles  
 Model **LPV-TV5**  
 6 Active Cell & Director Cap-Electronic Element System  
**\$23.95** list

**VHF** — up to 100 miles  
**FM** — up to 50 miles  
 Model **LPV-TV7**  
 8 Active Cell & Director Cap-Electronic Element System  
**\$31.95** list

**VHF** — up to 125 miles  
**FM** — up to 50 miles  
 Model **LPV-TV10**  
 10 Active Cell & Director Cap-Electronic Element System  
**\$41.95** list

**VHF** — up to 150 miles  
 Model **LPV-TV13**  
 13 Active Cell & Director Cap-Electronic Element System  
**\$49.95** list

**VHF** — up to 175 miles  
 Model **LPV-TV16**  
 16 Active Cell & Director Cap-Electronic Element System  
**\$59.95** list

**VHF** — up to 200 miles  
 Model **LPV-TV19**  
 19 Active Cell & Director Cap-Electronic Element System  
**\$79.95** list

### JFD ELECTRONICS CORPORATION

15th Avenue at 62nd Street, Brooklyn, N. Y. 11219  
 JFD International, 64-14 Woodside Ave., Woodside, N. Y. 11377  
 JFD Canada, Ltd., Canada

See what's NEW from JFD at BOOTH 2101 in San Francisco Parts Show June 3, 4, 5

before you buy any  
color generator...  
get all the facts



only one\* has all  
these features and  
it's only 99<sup>50</sup>

## LECTROTECH V6

Any comparison will prove that the Lectrotech V6 truly stands alone. Provides all of the time-tested standard features plus many Lectrotech exclusives for the fastest, most reliable color installation and servicing. The V6 gives you: Crystal-controlled keyed rainbow color display • All cross hatch, dots, vertical lines only, horizontal lines only • Red-blue-green gun killer (usually extra or not available on other color bar generators) • Exclusive Dial-A-Line feature (Horizontal adjustable 1 to 4 lines wide) • Exclusive solid state reliability • Exclusive voltage-regulated transistor and timer circuits • Exclusive simplified rapid calibration • Off-On Standby Switch • Adjustable dot size • Color level control • Connects to antenna terminals (no connections needed inside of set) • Power transformer-line isolated, to prevent shock hazard • Lightweight and portable, only 4½" H. x 7¾" W. x 10¾" D. Weight, 7½ lbs.

\*Except our own V7

**ONE YEAR WARRANTY**

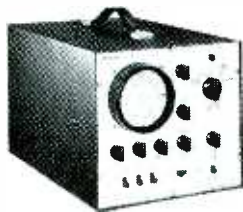

**V7** Sensational new Lectrotech V7 — the only complete Color TV Test Instrument.

Has all the features and performance of the V6 PLUS Lectrotech's exclusive built-in Color Vectorscope for simplified visual color servicing.

Complete.....only **189<sup>50</sup>**



See your distributor or write for details before you buy any color generator. Dept PF-3

**LECTROTECH, INC.**  
1221 Devon Avenue • Chicago, Illinois 60626

Circle 37 on literature card

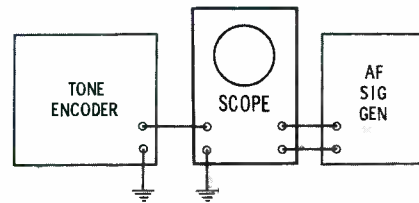

Fig. 9. Checking tone-encoder waveform and frequency.

scope's horizontal sweep to produce a vertical-line trace, modulation balance can be noted. The beam should expand vertically and horizontally by the same amount when talking into the microphone or applying a test tone to the transmitter's audio-input connection.

A scope can also be used for checking the performance of modulator systems (speech amplifier and modulation limiter). An audio test signal is fed into the transmitter's microphone-input circuit, and the waveform of the audio signal being fed to the phase modulator of an FM transmitter is observed on a scope. In an AM transmitter, the signal at the output of the modulator can be observed.

The distortion and frequency response of the modulator system can be checked by tuning the audio-signal generator and by varying its output level. If the modulation limiter is functioning correctly, the audio-output level should not rise above the point that produces almost 100% modulation (maximum allowable deviation in an FM transmitter) when the test signal level is increased. It may increase when an extraordinarily strong audio signal is fed into the system, but the limiting should be effective over a range of at least 20 db.

By observing the audio signal with a scope, the distortion produced by limiting action can be observed easily. If the audio-signal generator can produce square-wave signals as well as sine-wave signals, you can apply a square wave to the system and note the effects on its shape; don't expect to get as clean a square-wave output as in a hi-fi system, because the frequency response of the modulator is limited for better intelligibility, in most communications transmitters.

### Tone Squelch Checks

A scope is very handy for checking tone-squelch encoders. You can observe the waveform and, by using an audio-signal generator as a reference as shown in Fig. 9, you can measure the tone frequency. You can also observe the tone waveform at the input of a tone decoder after it has passed through a transmitter and receiver.

### Summary

A wideband scope is an invaluable tool for servicing mobile-radio equipment. However, to do a thorough job, it should be capable of measuring DC as well as AC, AF, and RF. It can be used for many purposes, including checking vibrators, transistor switching, and silicon-controlled rectifier operation in power supplies, as well as for measuring dynamotor ripple. When its versatility and capabilities are thoroughly understood the communications technician will find the scope a very valuable instrument on his two-way bench. ▲

# NEW

**AKTRON**  
INDUSTRIES, INC.

# REAR SEAT SPEAKER KIT

COMPLETE NOTHING ELSE TO BUY  
ALUMINUM VOICE COIL SPEAKER  
SOLDERLESS HOOK-UP  
FADER CONTROL GIVES COMPLETE  
SPEAKER BALANCE  
MULTI-IMPEDENCE SPEAKER  
LOUVERED, CHROME PLATED GRILL  
COMPLETE INSTALLATION BROCHURE  
EYE CATCHING  
PROTECTIVE DISPLAY PACKAGING



STANDS BY ITSELF

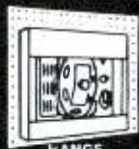

HANGS FROM PEGBOARD



Circle 39 on literature card

## BOOK REVIEW



**Basic Electronics: "Autotext" — A Programed Course in Circuits;** RCA Institutes, Inc., Edited by Jack W. Friedman, Harry G. Rice, and Gerald McGinty; Prentice-Hall, Inc., Englewood Cliffs N. J., 1965. 534 pages. 6" x 9", hard cover; \$13.

Programed instruction methods have been around for several years. However, their departure from traditional instruction methods is great enough that a brief description is given here for those who may not be familiar with them. Instead of presenting a chapter unit followed by a series of questions at the end, programed instruction uses as a unit a sentence or short paragraph followed by a question. Emphasis is thus given each small idea unit, or "frame," of information; answer sheets are included for answer verification. The advantage claimed for programed instruction is that the immediate reinforcement of each segment of information as it is given increases the student's retention of the subject matter.

This book is designed to introduce electronic circuits to the beginner who has had no experience with electronic circuits. The first circuit shown is that of a flashlight; next, simple schematic diagrams are introduced. In the following sections, concepts such as electron flow and potential difference are introduced by using analogies to physical objects such as waterfalls.

As the text progresses, more complex circuits are discussed. Batteries, DC circuits, resistance, magnetism, DC meter theory, generators, transformers, AC, inductance, and capacitance are, in turn, covered; the text is heavily supplemented with schematic diagrams, drawings, and photos. The final lesson covers AC circuits, and simple trigonometry is introduced. ▲



## Can you service mobile radio and CB?

It's a big business . . . and getting bigger every day. There are thousands of mobile radio systems now in use plus thousands more marine and CB sets. **BUT . . . ONLY MEN WITH COMMERCIAL FCC LICENSES ARE LEGALLY AUTHORIZED TO SERVICE THEM.** Don't let this profitable new business get away from you. At home, in your spare time, a Cleveland Institute training program will prepare you for the tough new FCC License Exam . . . is backed by this remarkable offer: "If you complete the CIE program yet fail the FCC License Exam specified, *all* tuition will be refunded".

Get details. Send coupon for our book "How to Get a Commercial FCC License". No obligation. Cleveland Institute of Electronics, Dept. PF 28, 1776 E. 17th St., Cleveland, Ohio 44114.

Cleveland Institute also offers the following Electronics courses: Electronics Technology, Industrial Electronics, Broadcast Engineering, and Electronic Communications.

ACT NOW . . . SEND COUPON FOR FREE BOOK

### Cleveland Institute of Electronics

1776 E. 17th St., Dept. PF-28  
Cleveland, Ohio 44114

Please send me your free brochure "How to Get a Commercial FCC License".



Occupation \_\_\_\_\_ Age \_\_\_\_\_

Name \_\_\_\_\_  
(Please Print)

Address \_\_\_\_\_ County \_\_\_\_\_

City \_\_\_\_\_ State \_\_\_\_\_ Zip \_\_\_\_\_

Now training over 15,500 students through Electronics Home Study.

# NEW

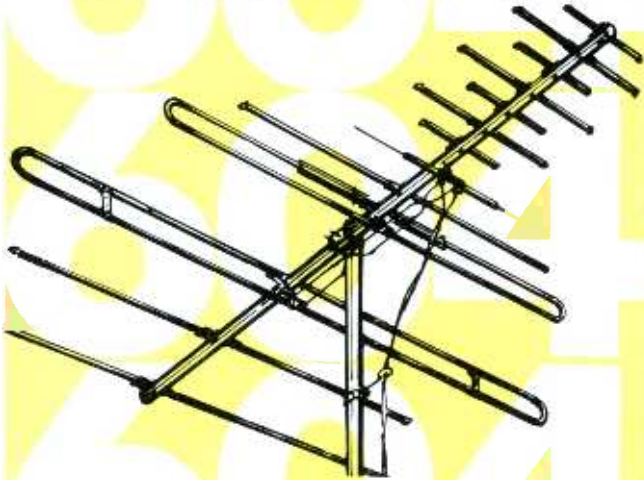

## CHANNEL-SPANNER

# 604

## FOR TOTAL RECEPTION!

This beautiful all-band (UHF-VHF-FM) antenna insures your customers of getting full value for their antenna dollar. Built with Antennacraft's famous automatic hardware and rugged construction, this antenna takes less time and effort to install than comparable antennas of any other brand.

The Model 604 is designed for color or black and white UHF or VHF TV plus FM multiplex reception and only one lead-in wire is required.

The Model 604 lists for only \$24.95. Other models are available from \$17.95 to \$59.95 list.



NEW SHOW in San Francisco See us in Room 327 Civic Auditorium  
Circle 40 on literature card

## Converting Scopes

(Continued from page 38)

make—you can “read the screen” and make necessary calculations mentally, without pencil and paper. To avoid the necessity for frequent recalibration, it is a good practice to power the scope from an automatic line-voltage regulating transformer. This prevents the sweep calibration from varying with line-voltage changes. Even with the precaution of stabilizing the line voltage, there is a small drift of sweep speed after an extended period of time. This drift results from aging tubes and from the tendency of fixed resistors to increase in value as time goes by. Of course, capacitors in the sweep sections also may gradually become leaky. Hence checks of sweep calibration must be made from time to time to maintain the best possible accuracy.

## Other Considerations

Expensive professional scopes have a very low hum level. However, the hum level of a service-type scope may be visible in the pattern. To reduce the hum level below visibility, we must first determine the source or sources of the hum. These sources are:

1. Insufficient power-supply filtering.
2. Stray fields entering the cathode-ray tube.
3. Stray fields entering high-impedance circuits.
4. Heater-cathode leakage in a tube that operates with its cathode above ground.

Correction of heater-cathode leakage is obvious — check the tubes and replace them if necessary. Insufficient power-supply filtering is also easily remedied; simply increase the value of the filter. To check for fields entering the cathode-ray tube, shunt all four deflection plates to ground through large bypass capacitors. Then, if you cannot obtain a small sharp spot by adjustment of the focus and astigmatism controls, you know that stray fields are entering the CRT. To solve this problem enclose the CRT in a magnetic shield — preferably made of mu metal.

Sometimes you can get noticeable improvement by reorienting the power transformer, but this is generally insufficient if the hum level is quite noticeable — only good shielding of the CRT will kill the hum. High-impedance circuits, such as the vertical step attenuators are also frequent offenders. If the hum is coming from this source, you will observe the highest hum level on the most sensitive setting. Corrections of the difficulty requires enclosing the high-impedance section in a metal shield box.

After you have converted your scope and can operate on triggered sweep with a clear, sharp pattern, remember to be careful not to burn the screen. When a waveform is greatly expanded, its brightness decreases in proportion; therefore, it is necessary to turn up the intensity control. Now, if you disconnect the input signal and do not turn down the intensity control, the screen will be burned, because the pattern becomes merely an intense spot on the screen. Keeping this danger in mind will avoid the expense of CRT replacement from carelessness. ▲



## Soldering

(Continued from page 23)

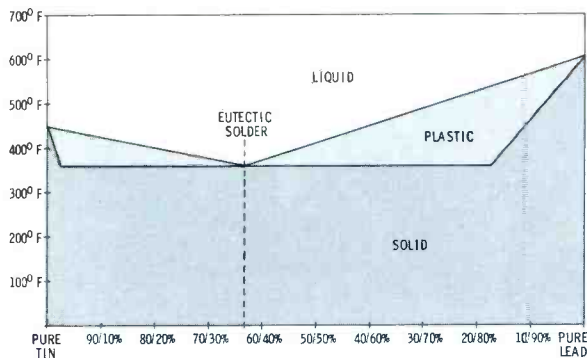

Fig. 4. Graph shows melting stages of lead/tin solder.

### Noncorrosive Fluxes

As was stated before, all fluxes are corrosive; however, residues from rosin are relatively inert. Despite the advantages of being noncorrosive (in its solid state), relatively safe, and easy to use, rosin is not very active flux. Base-metal surfaces must be clean—and preferably tinned—before soldering.

The active ingredient in rosin is abietic acid, a mild acid. Rosin flux activity can be increased by the addition of some forms of amine hydrochloride; this additive cleans the surface at temperatures slightly below soldering temperature, then decomposes and becomes a vapor at soldering temperatures. Residues from activated solder are relatively noncorrosive.

### Solders

Solders are usually divided into two classes: (1) hard solders used for brazing and silver soldering, with melting temperatures above 750°F; and (2) soft solders which are alloys of bismuth/cadmium, bismuth/lead, and tin/lead, all of which melt at temperatures less than 750°F.

Fig. 4 shows the melting points of various compositions of tin/lead solders. Note that the transition to both the plastic and liquid states for the combinations occurs at lower temperatures than for pure tin or lead.

General-purpose solders for the automotive and canning industries range from 25% to 45% tin. These are inexpensive sturdy solders; however; they become liquid at higher temperatures than eutectic solder. Low temperature and absence of a plastic state makes eutectic



Fig. 5. Soldering iron uses sensor for temperature control.

# NEW

## colorstar

# 638

## 75 OHM, VHF TV ANTENNA

True 75 ohm antennas that require no matching balun at the antenna. Only at the set must a balun be used to match the 300 ohm input of a standard TV set.

Coaxial cable fittings are furnished to be used with RG11/U or RG59/U cable. Wet weather, salt conditions, ignition noise or the proximity of metal objects or power lines does not affect the signal transmitted to the set.

The Model 638 is designed for color or black and white VHF TV and lists for only \$44.95. Other models are available from \$12.95 up.

**ANTENNACRAFT**  
 BETTER BUILT FOR BETTER PERFORMANCE  
 Automatic Channel Selector TV ANTENNAS  
 BURLINGTON, IOWA

NEW SHOW in San Francisco  
 See us in Room 327 Civic Auditorium  
 Circle 41 on literature card

# You earn your FCC First Class License

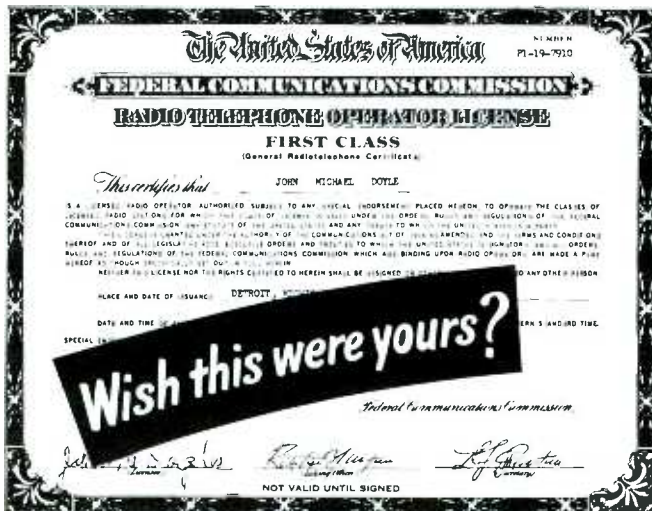

## or your money back!

### THERE'S A WORLD OF OPPORTUNITY FOR THE MAN WITH AN FCC LICENSE

All it takes is a few spare hours a week and NRI's FCC License Course to open the way to increased opportunities in Communications. With an FCC License, you're ready to operate, service and install transmitting equipment used in aviation, broadcasting, marine, mobile and Citizens-Band communications.

What does it take? Men with absolutely no training or experience in Electronics complete the course in 10 months. A Technician or man with some background can easily cut that time in half. And because NRI has a greater enrollment than any other school of its type, training costs you less than comparable courses offered by other schools. Further, YOU MUST PASS your FCC exams or NRI refunds your tuition in full.

Get full details today about NRI FCC License Course plus 9 other home-study instruction plans offered by NRI, oldest and largest school of its kind. Mail coupon for free catalog. There's no obligation. No salesman will call. NATIONAL RADIO INSTITUTE, Washington, D.C.

### MAIL NOW for FREE CATALOG



NATIONAL RADIO INSTITUTE  
Electronics Division  
Washington, D. C. 20016 22-036

Please send me complete information on FCC License Training and other NRI courses, as checked below. (No salesman will call.)

- |                                                  |                                                     |
|--------------------------------------------------|-----------------------------------------------------|
| <input type="checkbox"/> FCC License             | <input type="checkbox"/> Radio-TV Servicing         |
| <input type="checkbox"/> Complete Communications | <input type="checkbox"/> Industrial Electronics     |
| <input type="checkbox"/> Aviation Communications | <input type="checkbox"/> Electronics for Automation |
| <input type="checkbox"/> Marine Communications   | <input type="checkbox"/> Basic Electronics          |
| <input type="checkbox"/> Mobile Communications   | <input type="checkbox"/> Math for Electronics       |

Name \_\_\_\_\_ Age \_\_\_\_\_  
PLEASE PRINT

Address \_\_\_\_\_

City \_\_\_\_\_ State \_\_\_\_\_ Zip \_\_\_\_\_

ACCREDITED MEMBER NATIONAL HOME STUDY COUNCIL

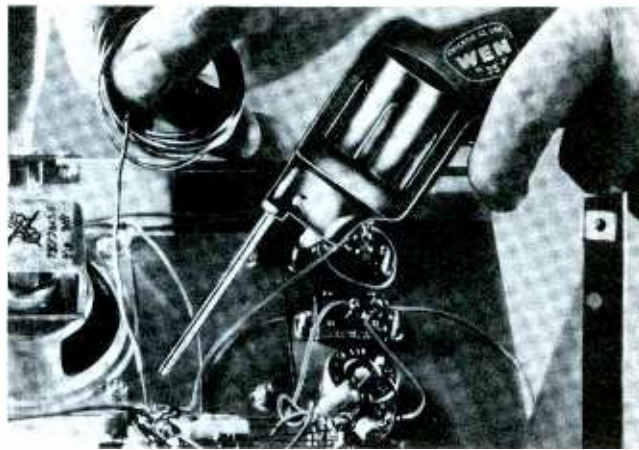
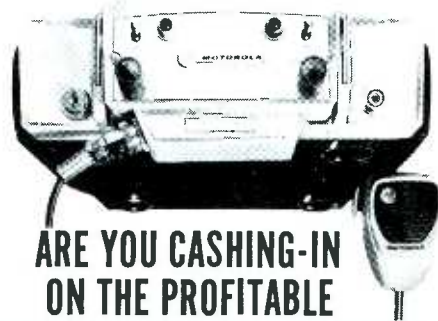

Fig. 6. Soldering pistol designed for constant temperature.

solder particularly useful in electronics work; there is less possibility of component damage with lower temperatures, and the direct transition to a liquid state makes this solder easier to work with. Eutectic solder is approximately 63% tin, 37% lead; hence, it is more expensive than those solders containing less tin. Also, solders containing silver and other metals added to tin and lead are now on the market. These alloys are designed primarily for PC-board use; the added metals tend to reduce copper and silver scavenging.

### Soldering Methods

Until the first patent was given, in 1893, for an electrically heated iron, all soft soldering was done



## ARE YOU CASHING-IN ON THE PROFITABLE 2-WAY RADIO SERVICE BUSINESS?

- ★ Motorola will train you for this rewarding, elite profession
- ★ Send for our FREE EVALUATION EXAM, Prove to yourself that you are ready to learn FM 2-way radio servicing.

Opportunities in 2-way radio servicing are virtually unlimited. Just one of the hundreds of successful Motorola Service Stations writes, "we would be pleased to interview any graduate of your school that has received some training in 2-way radio maintenance. We are an established firm, 10 years old, with a promise of expansion governed by our ability to obtain competent technicians." Get all the facts today. There is no obligation and no salesman will call.



### MOTOROLA TRAINING INSTITUTE

4545 West Augusta Blvd. • Chicago 51, Illinois • Dept. APX611

- Send me FREE entrance exam.
- Send full details on Home Study Course on FM 2-way Radio Servicing
- Send me details on how you can help me prepare for an FCC License.

Name \_\_\_\_\_ Occupation \_\_\_\_\_

Address \_\_\_\_\_

City \_\_\_\_\_ Zone \_\_\_\_\_ State \_\_\_\_\_



Fig. 7. Resistance-soldering unit provides high temperature in small area.

with a soldering *copper* or *bit*. The bit was usually heated over an open flame, and temperature control was nonexistent. Since delicate PC boards can be damaged by excessive temperatures, many irons used today have some form of temperature control.

In the unit shown in Fig. 5, the sensor mounted above the tip controls the tip temperature. Similar developments for temperature controls are now also used for pistols; Fig. 6 shows one example.

Although resistance-soldering devices have been in existence for some time, only recently have they become quite popular. Advantages for use in microcircuits and other applications requiring large quantities of heat in minute areas have increased the use of resistance-soldering equipment in electronics. Basically, these units use a large current which creates a high temperature only at the tips. Conductor size throughout these systems is large, except at tips where cross-sectional area is small. High resistance causes heat to be generated only at the tips. Fig. 7 shows one example of a resistance-soldering unit.

Solder pots, such as the one shown in Fig. 8, are often used in industry; PC-board soldering is only one application. Components to be soldered are fluxed, then dipped into the pot; solder will coat the fluxed areas. Similarly, wave-soldering and cascade-soldering methods are also being used in production-line work. In both methods the PC board is



Fig. 8. Parts are fluxed then dipped in pot. Solder adheres to fluxed area.

passed over a flowing stream of solder.

### Conclusion

As electronic devices become smaller, methods of soldering will continue to change. Soldering is no longer a craft or an art; it is a precise science. Since radio-TV technicians must service much of this equipment, a knowledge of the *science of soldering* should certainly aid a technician in using this important, yet often neglected, technique. ▲

## MID-STATE TUNER IN '66

ABSOLUTE 24 HR. SERVICE, A NECESSITY AT MID-STATE

UHF \$9.50  
VHF  
COLOR



Absolute 24 hour service is a necessity at Mid-State, regardless of manufacturer. Mutilated and damaged tuners may take slightly longer if major parts are not in present stock. All units tracked and aligned to factory specifications with crystal controlled equipment. 90 day warranty.

Put your confidence in Mid-State to take care of your tuner servicing. Send complete with Model and serial numbers and all damaged parts.

**COMBO'S — \$17.50**  
Major parts, tubes, transistors charged at net price.

Distributors: Write for Price Sheet

### MID-STATE TUNER SERVICE

1502 So. College Ave.  
P. O. Box 1141 D-1  
Bloomington, Indiana, Tel. 336-6003

Circle 44 on literature card

## FREE!

NEW MERCHANDISING AIDS  
BIG PROFITS WITH ROBINS<sup>M</sup>  
RECORDING HEADS

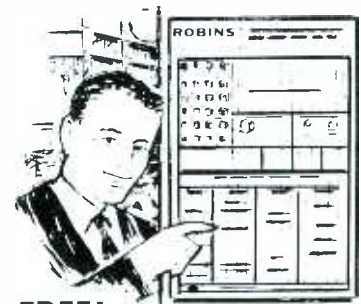

FREE!

- ✓ LARGE RECORDING HEAD REFERENCE WALL CHART
- ✓ HEAD SPEC. CHART
- ✓ WINDOW BANNERS
- ✓ INFO... WHERE TO GET ROBINS EXACT REPLACEMENT RECORDING HEADS!

TAPE RECORDER SALES—REPAIRS are BOOMING! Repairs are profitable when you use ROBINS HEADS! Write for FREE Merchandising Aids and info...

**ROBINS** INDUSTRIES CORP.  
15-58 127th STREET, FLUSHING, N. Y. 11356

Circle 45 on literature card

March, 1966/PF REPORTER 73

a new money-making,  
traffic-building tube tester

for you or your customer!



## THE ALL NEW SENCORE TC131 SEMI-AUTOMATIC TUBE CHECKER

After thousands of requests here is the "counter/bench" version of the famous Sencore Mighty Mite Tester; designed for the ultimate in tube checking thoroughness and operational simplicity! Designed for two-way use — as a professional shop tester and customer self-service unit. Tests over 2500 tubes — including Nuvistors, Compactrons, 10-pins, Novars, Magnovals and foreign tubes with a big 6-inch meter for easy reading. Semi-automatic; simply turn function control to any test and watch lighted arrow on meter automatically stop on right scale. User can't go wrong — no guess work — everything is read right on the meter (no tricky neon lights to misread); only 3 set-up controls. Easy to read, speed-indexed set-up cards make every test fast and sure. Like the famous Mighty Mite, the TC131 uses 100-megohm grid leakage sensitivity to spot those "tricky" tubes other testers miss; tests inter-element shorts and makes cathode emission tests under full operating levels. A real profit maker as a counter checker or self service tube seller in your shop . . . and it's only

**\$129<sup>95</sup>**

See your distributor about the big TC131 trade-in deal.

professional quality — that's the difference!

# SENCORE

426 SOUTH WESTGATE DRIVE • ADDISON, ILLINOIS  
Circle 46 on literature card



## The Troubleshooter

answers your servicing problems

### Needs an Explanation

Here in Kansas City there are three active VHF TV stations—channels 4, 5, and 9. With this one exception, all TV sets I have seen produce a snowy raster when the tuner is positioned to an inactive channel. I have an Admiral portable Model P9414, Chassis D42-1, that works normally on the active channels; but, when the VHF tuner is positioned to an unused channel, it has a raster but absolutely no snow is present. Hash is present in the speaker, but even the hash is of very low volume and a faint motorboat sound can be heard in the background.

I am curious as to why this set operates abnormally on the unused channels. Any explanation of this phenomena would certainly be appreciated.

B. THOMAS

Kansas City, Mo.

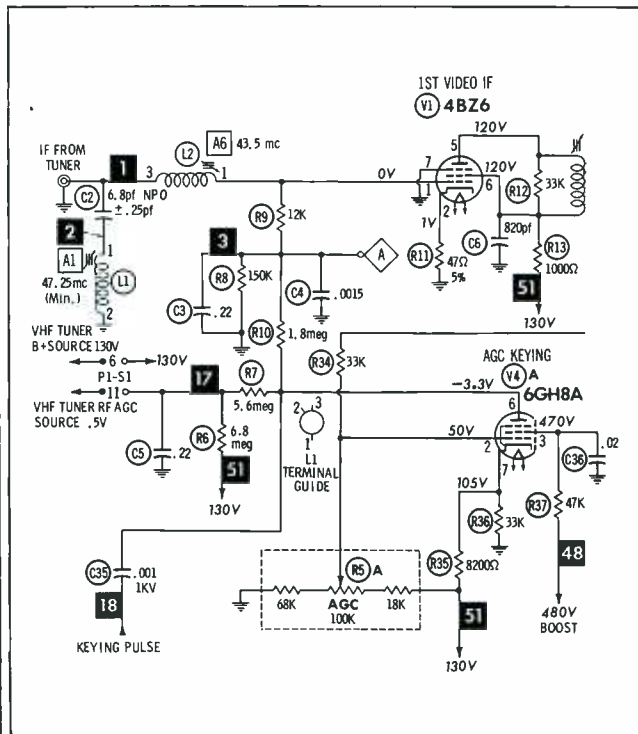

The reason for a snow-free raster on inactive channels in your Admiral TV (covered in PHOTOFACT Folder 758-1) is most likely caused by an excessive AGC voltage. If the RF amplifier and first video-IF amplifier are not allowed to conduct on inactive channels, the screen will show a line raster. The noise cannot pass through the IF strip if the IF tubes are cut off by the AGC voltage.

# **FINCO<sup>®</sup>-AXIAL**

## **COLOR-KIT**



### **FINCO-AXIAL COLOR-KIT, Model 7512 AB**

High performance Indoor and Outdoor Matching Transformers convert old-fashioned and inefficient 300 ohm hook-ups to the new Finco-Axial 75 ohm color reception system.

List price for complete kit . . .  
7512AB . . . . . \$8.95

7512-A Mast mounted match-  
ing transformer . . . list \$5.40

7512-B TV Set mounted match-  
ing transformer . . . list \$4.15

### **FINCO-AXIAL SHIELDED COLOR CABLE, CX Series**

Highest quality, 75 ohm swept  
coaxial cable (RG 59/U) com-  
plete with Type F fittings, weath-  
er boot ready for installation.

Available in 25, 50, 75 and 100  
foot lengths. List price . . . \$5.55,  
\$8.65, \$11.50 and \$14.20.

Write for Color Brochure # 20-349

**the  
complete  
color TV  
reception  
system**

### **For the best color TV picture**

*eliminates color-fade, ghosting and smearing!  
Improves FM and Stereo, too!*

### **QUICK, EASY INSTALLATION**

ENJOY brilliant "TV-Studio" color reception today by changing  
over to the new Finco-Axial Color Reception System. NOW,  
color fade, ghosts and smears are a thing of the past. Finco-Axial  
shields color sets against signal loss . . . eliminates outside  
interference and mismatch problems.

**THE FINNEY COMPANY 34 WEST INTERSTATE STREET, DEPT. 310 BEDFORD, OHIO**

*Circle 47 on literature card*

# Model 501 COMPONENT SUBSTITUTOR

...the instrument acclaimed by servicemen, engineers and school shops now available in a **wire-it-yourself KIT!**

step-by-step illustrated instructions make the Model 501 easy-to-build...

Substitutes for any one of over 80 component values

Will substitute up to 4 different components at the same time

A surge protector switch prevents arcing, sparking, or heating of electrolytics

Electrolytics are discharged automatically

See the Model 501 at your distributor... or write for complete specifications



**\$25.95** Net

Model 501K Kit

**\$39.95** Net

Model 501 Wired

...places a complete range of components at your fingertips for fast substitution ...



The Model 501 provides all the substitutes for electronic components you want and need in your every day work... Carbon Resistors—Power Resistors—Capacitors—Electrolytics—Crystal Diodes—Selenium Power and Silicon Power Rectifiers.



**ELECTRONICS CORPORATION**

manufacturers of quality electronic products  
315 Roslyn Road, Mineola, N. Y. 11501

EXPORT: Mathan Exporting Corp., 416 Broadway, New York, N. Y. 10013

# Model 501 COMPONENT SUBSTITUTOR

...the instrument acclaimed by servicemen, engineers and school shops now available in a **wire-it-yourself KIT!**

step-by-step illustrated instructions make the Model 501 easy-to-build...

Substitutes for any one of over 80 component values

Will substitute up to 4 different components at the same time

A surge protector switch prevents arcing, sparking, or heating of electrolytics

Electrolytics are discharged automatically

See the Model 501 at your distributor... or write for complete specifications

You can check to see if the condition is caused by an excessive AGC voltage by measuring this voltage at the input to both the tuner and the first IF-amplifier grid. Rotate the AGC control—at minimum setting there should be maximum snow in the raster.

The AGC voltage should increase when the receiver is matic were taken with no signal applied to the antenna tuned to a station signal.

## Same Station Three Times

Will you please help me with a Mopar auto radio Model 842HR (covered in PHOTOFAC Folder 347-8)? The trouble is that two of our local radio stations come in at three different frequencies on the dial. The set does not have enough volume, and only the strong stations can be received. The set has -0.5 volts on the grid of the RF amplifier and -0.4 volts on the grid (pin 7) of the converter.

I have replaced the RF-amplifier, converter, and phase-inverter tubes. I also installed a new filter capacitor and substituted all the .01 capacitors.

LUTHER M. HURDT

Anderson, S.C.

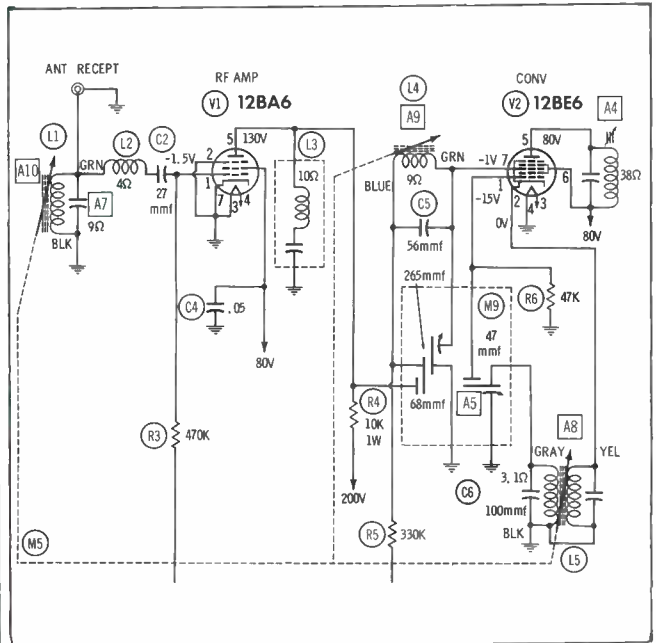

From the symptoms you describe, it would seem the trouble is in the RF amplifier and tuning circuits. Thoroughly check the component combination M9. Also check or replace all the components associated with the RF amplifier tube, V1.

## Snow in Color

I have an RCA color set, Model 21CT660U, covered in PHOTOFAC Folder 314-9) that has excessive noise specks (slightly like snow) in the color picture. The interference can be reduced by adjusting the fine tuning, but it is still noticeable and somewhat irritating.

Circle 48 on literature card

The snow can be minimized by adjusting the killer-threshold control; however, I have to be careful when rotating this control or I get color snow in the black-and-white picture.

I have changed the 6AZ8 color killer and the 6AN8 chroma-reference-oscillator tube, but this didn't improve the condition. Can you help me?

ROBERT E. BONE

St. Louis, Mo.

*It would seem that the snow in your color receiver is being caused by trouble in the tuner or video-IF stages—most likely the tuner. The area of the trouble can be narrowed down by scoping the video signal at the output of the video detector. If this signal is snowy, the trouble is in the front end of the receiver. If this signal should be clean, then check the chroma bandpass stages.*

*You can isolate the trouble even further by using a detector probe and scoping the signal at the input to each of the video-IF stages. Should the snow be present at the grid of the first-IF stage, then the tuner is definitely the culprit.*

*The exact setting of the fine tuning is much more critical for reception of color than on a black-and-white program. To correctly adjust the fine tuning, rotate it to the cross-over point and then turn slightly in the opposite direction.*

*It is normal for the killer-threshold control to act as it does in your particular set. This control should be adjusted just below the point necessary to eliminate colored snow in the black-and-white picture. If this control is misadjusted, you will either eliminate the color information on a color program or get colored snow when viewing a monochrome signal.* ▲

compare Mercury's new advanced

## Model 801A CRT Color Tester-Reactivator

with others costing much more...

...you'll agree it's your best buy!

• TESTS • REPAIRS • REACTIVATES

all

See the Model 801A  
CRT Color Tester-  
Reactivator at your  
distributor...or write for  
complete specifications



The brilliantly engineered circuit of the Model 801A is designed to take the guesswork out of testing, repairing, and reactivating all color and B/W picture tubes—whether in or out of the set. It boasts a wealth of engineering features not found in more costly instruments...  
"flameout burnout protection" to prevent damage to tube...no adapters required...exclusive Multi-Head enables you to give every important test to all picture tubes with a single cable and test head. The Model 801A inspires customer confidence and helps make new picture tube sales easier.

**\$59.95**  
Net



**ELECTRONICS CORP.**

manufacturers of quality electronic products  
315 Roslyn Road, Mineola, N.Y. 11501

Export: Morhan Exporting Corp., 438 Broadway, New York, N.Y. 10013

## GAS WELDING TORCH



Uses **OXYGEN**  
and **LP GAS**

- Completely self-contained.
- Produces 5000° pin-point flame.
- Welds, brazes, solders.
- Hundreds of lightweight uses.
- Suggested list — \$19.95.

GET COMPLETE DETAILS AT MOST INDUSTRIAL DISTRIBUTORS, OR WRITE TO MICROFLAME, INC.



**MICROFLAME, INC.**

7800 COMPUTER AVENUE  
MINNEAPOLIS, MINNESOTA 55424



Circle 50 on literature card

Circle 49 on literature card



# Product Report

For further information on any of the following items, circle the associated number on the Catalog & Literature Card.

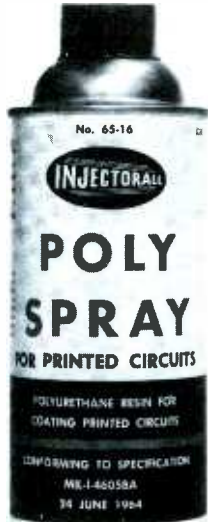

**Aerosol Spray**  
(75)

A polyurethane composition packaged by **Injectorall** can be sprayed on printed

circuits after a repair and will form a transparent coating that has resistance to moisture and abrasion. It also tends to prevent deterioration of performance by damping vibration of the parts of the printed circuit. The 16-oz spray can sells for \$2.28.



**Lube Kit**  
(76)

Lubricants that are a necessity with technicians, mechanics, and hobbyists are contained in one plastic-sealed pack-

age. **Workman Electronic Products'** Model LK5. The package contains an aerosol can of contact cleaner, an aerosol can of fine oil, and dispensers of oil, graphite, and grease. These tubes of lubricant are fitted with a stainless steel needle to get into limited spaces, and the aerosol cans are provided with extension tubes for the same purpose.



**Distribution Amplifier**  
(77)

Designed for small commercial and

## tests all tubes!

*Popular low cost tester—complete with adapter for more than 400 Cathode Ray Picture Tubes!*

**MODEL 88**—Tests receiving tubes including novars, nuvistors, newest 10-pin tubes, compactrons and magnovals. PLUS: Picture tube adaptor with 12-pin socket fits more than 400 cathode ray picture tubes including 110° deflection types. Grid Circuit Test, Tube Merit Test and Filament Test . . . quickly find cathode emission leaks, shorts, grid emission, gas error, filament continuity and cathode-to-heater emission. Stationary receiving tube chassis. Complete with speed-indexed setup data, pin straighteners and 12-pin picture tube socket on 2-foot cable.

**OTHER SECO TUBE TESTERS:** Model 98—grid circuit, heater current and tube merit tester; Deluxe Model 107B—grid circuit, dynamic mutual conductance and cathode emission tube tester.

**\$74<sup>50</sup>**

Dealer Net

**new!** All-Transistor Color Bar Generator

Model 900 sets new standards in engineering and design. True precision instrument offering brightest dots; purest color quality; exceptionally square wave shapes! Takes the "guess" out of color TV servicing.

**\$129<sup>95</sup>**  
Dealer Net

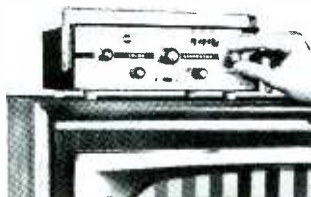

**Model 810** Motor Speed and Torque Control

Controls speed of hand power tools up to 1/2 H.P. with one dial—exclusive torque control on other dial. For 115 VAC.

**\$39<sup>95</sup>** Dealer Net

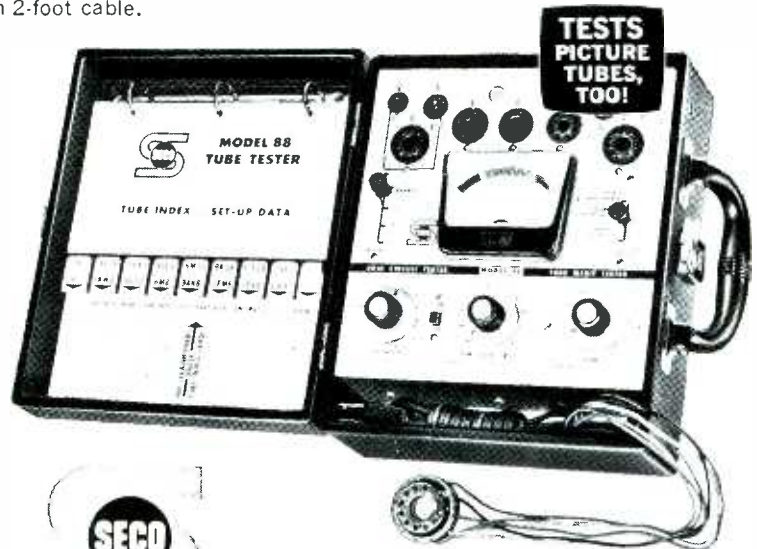

**SECO ELECTRONICS CORP.**  
1207-B So. Clover Dr., Minneapolis, Minn. 55420

Circle 51 on literature card



# The mighty Ultradyne!

(Now that we've filled in the empty spaces, how can you even mention any other antenna line in the same breath)

And that goes for **COLOR** and black-and-white on all 82 channels . . . or UHF only . . . and FM and FM Stereo.

This line (with four brand-new models added) is complete. And the concept completely new. The result, in the Ultradyne Crossfires and Ultradyne Coloray, is the most powerful 82-channel color antenna series yet achieved. A model for every area, pocketbook, and performance need.

Each with the highest gain. Higher than any log periodic type of antenna. In fact, here is the first high-gain FM and FM Stereo performance ever developed in VHF/UHF antennas. Truly amazing front-to-back ratios, too. Over 15:1 across the entire UHF band. How did we do it? Not with mirrors.

World's best selling! The Ultradyne Crossfires are based on the same VHF principle which has made the Channel Master Crossfires the best-selling antennas in TV history. But with the remarkable new UHF antenna design added.

As for UHF only, Ultradyne UHF antennas are the first in history to provide automatic impedance match with any 300 ohm VHF antenna. No coupler is required when Ultradyne is used in conjunction with any 300 ohm VHF antenna such as the Color Crossfire.

Extras? Uniquely constructed. All antennas feature our famous EPC "Golden Overcoat". And each 82-channel model comes with a U-V band-splitter (model 0032).

Mighty! That's the word.

**CHANNEL MASTER** Ellenville, New York

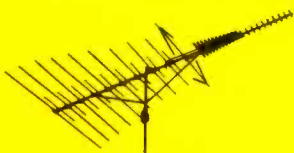

UHF/VHF Ultradyne Crossfire. New Model 3632G for deeper fringe. Sug. List: \$69.95.

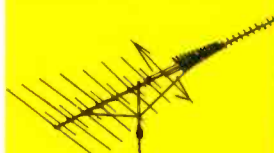

UHF/VHF Ultradyne Crossfire. New Model 3633G for fringe. Sug. List: \$59.95.

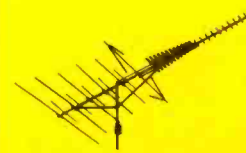

UHF/VHF Ultradyne Crossfire. New Model 3634G for near fringe. Sug. List: \$49.95.

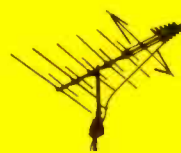

UHF/VHF Ultradyne Crossfire. New Model 3638 near fringe. Same VHF gain as 3634G, less UHF gain. Sug. List: \$39.95.

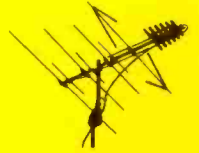

UHF/VHF Ultradyne Crossfire. New Model 3639G for near suburban to metropolitan. Same VHF gain as Color Crossfire, same UHF gain as 3638G. Sug. List: \$29.95.



UHF/VHF Ultradyne Coloray. New Model 3637G. Famous Ghost-Killer. Sug. List: \$29.95.

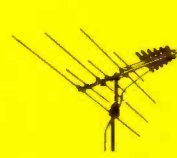

UHF/VHF Ultradyne Crossfire. New Model 3640G metropolitan. Slightly less VHF gain than 3639G, same UHF gain. Sug. List: \$22.95.

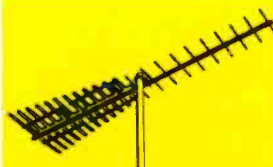

UHF Ultradyne. New Model 4314G for near fringe to fringe. Sug. List: \$24.95.



UHF Ultradyne. New Model 4313G for suburban to near fringe. Sug. List: \$17.95.

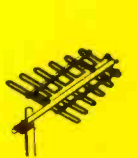

UHF Ultradyne. New Model 4315G for metropolitan to suburban. Sug. List: \$11.50.

©1966 Channel Master Corp.

# With this tiny chip, RCA launches the biggest



( Solid Integrated Circuit shown actual size.  
So small it cannot be manipulated by  
human fingers—yet it is a complete elec-  
tronic circuit containing 24 transistors  
and diodes and all interconnecting wiring. )

# revolution in TV circuits since the coming of color.

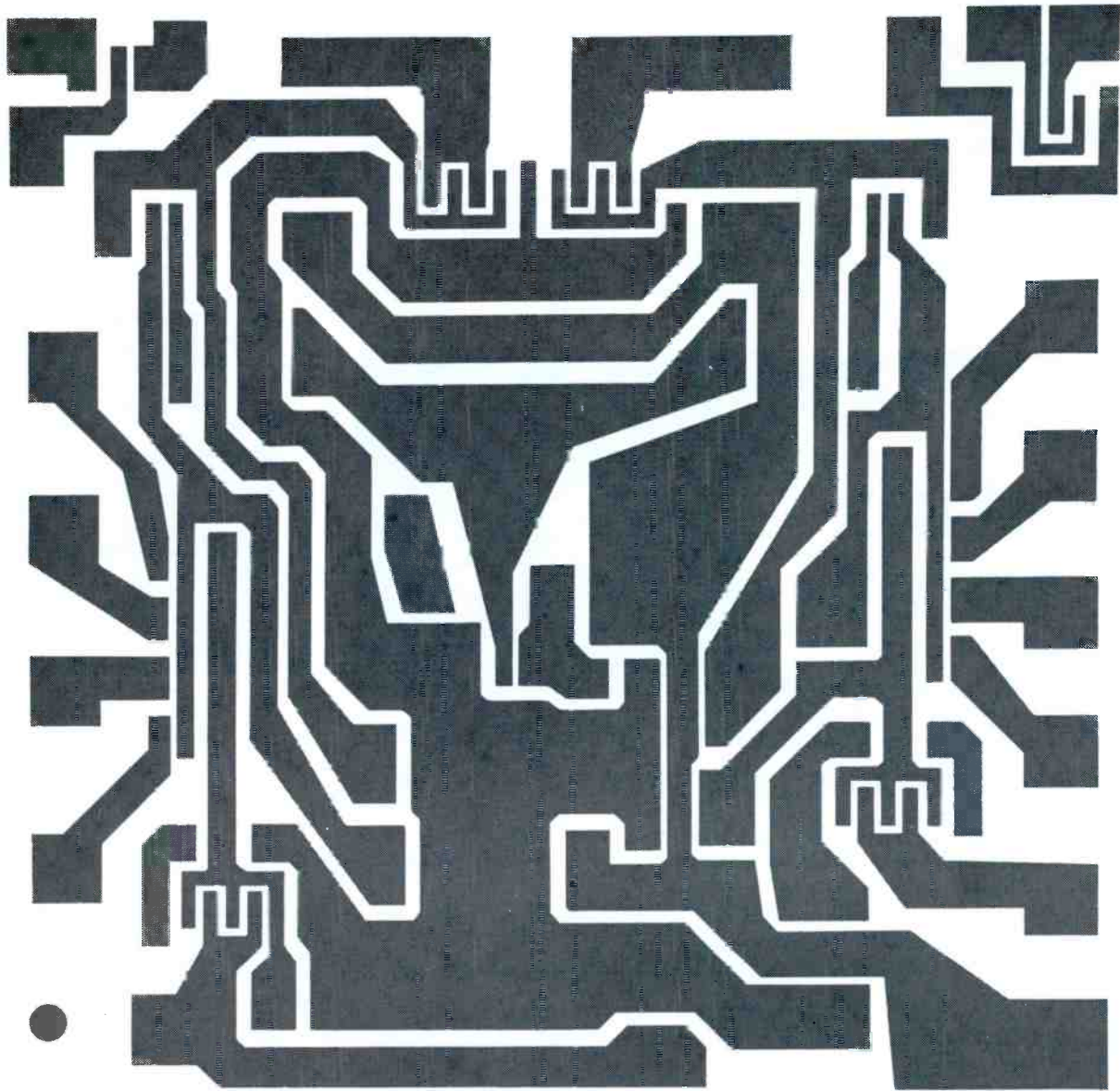

(Solid Integrated Circuit used in RCA Spectra 70 computer shown 10,000 times actual size — actual size shown on opposite page.)

## **RCA uses Solid Integrated Circuits in space vehicles ... in Spectra 70 Computers ... and is now building them into the sound systems of some RCA Victor Color TV and black and white TV sets. Solid Integrated Circuits are the latest in a series of space age advances over old-fashioned handwiring.**

What's an RCA Solid Integrated Circuit? It is a tiny block of silicon incorporating matched transistors, resistors and diodes. Formed at 2000 degrees F. and hermetically sealed against the elements, these virtually indestructible circuits are mounted on RCA Solid Copper Circuits of proven dependability. RCA Solid Integrated Circuits are such a giant step toward the future that they

will ultimately prove more meaningful than the big leap from vacuum tubes to transistors. It was the reliability of integrated circuits that caused them to be designed for use in the electronic systems of space vehicles where size, weight and reliable performance are absolutely critical. The use of these new circuits in RCA Victor TV is but one of the early steps in this electronic

revolution—a step that was vital to approach the perfection we seek in circuit function performance. RCA engineers and scientists are now engaged in the task of broadening the application of this new space age marvel. Out of their efforts will come a new and even higher standard of reliability for all RCA Victor home entertainment and other RCA products.

COME INTO THE SPACE AGE WITH



THE MOST TRUSTED NAME IN ELECTRONICS

## PRECISION TUNER SERVICE

P. O. BOX 272

1210 S. WALNUT ST.

BLOOMINGTON, IND.

EDISON 99653

**7.95**  
V or U

COMBO PLUS  
9.95 POSTAGE

6 MONTH WARRANTY



All Types T.V. Tuners Cleaned, Repaired and Aligned to Factory Specifications. Same day in shop service on most Tuners. Price Includes Minor Parts, Major Parts at Cost Price. We use Original Parts if possible. State Make Model and Enclose all Parts and Tubes. Pack Well and Insure.

ALSO HAVE LARGE STOCK OF EXCHANGE TUNERS, WRITE FOR TYPES AND PRICES.



## An alert electronics technician has just turned you in!

It's night! The tinkling smash of a window breaks the silence! But even before a hand can reach the latch, an electronic "hot-line" has been silently triggered. The police are on the way!

Millions are spent every year for security, but most schools and industrial buildings still have no electronic alarm protection.

*Here's how you can cash in on this multi-million dollar market!*

YOU can introduce the SOUND SENTINEL ALARM in your area! The SOUND SENTINEL is a brand new, unique, revolutionary invention that electronically converts any intercom or PA system into a foolproof, building-wide, audio security system.

Many SOUND SENTINEL units are in use in our area right now. They are effective! They're easy to sell! Their low price is the most competitive.

ACT TODAY! Put your valuable technical skill to work in this new highly profitable field.

Be that alert electronics technician! Fill out the coupon below and become a distributor of SOUND SENTINEL Alarm Systems.

### Technical Data ON THE SOUND SENTINEL ALARM ACTIVATOR

The SOUND SENTINEL system components consist of a 10 watt Bogen amplifier sequentially operated with transistorized circuitry. Single control adjustment, with two wire hook-up, and a seven day program timer.



A few of your prospects include public schools—banks—discount stores—industrial plants—public and gov't buildings.

### INCREASE YOUR INCOME—MAIL TODAY

MAIL TO:  
**SOUND SENTINEL, INC.**  
55 Mass. St.  
Nunda, N. Y.



PF

Please send more free details telling me how I can start my own distributorship of SOUND SENTINEL systems.

Name \_\_\_\_\_

(Print Clearly)

Street \_\_\_\_\_

City \_\_\_\_\_

State

Zip

deluxe home distribution systems, this 4-set VHF-TV and FM distribution amplifier delivers 8 db gain at each of the 4 output terminals. The 65-1, when used with Finco Model 3001 or 3003 splitters, can feed 16 or even more sets, depending on signal level and line-length losses. The unit is housed in a perforated steel cabinet that measures 6 5/16" x 3 7/16" x 3 9/16".

Specifications are: 300-ohm input impedance at 300-ohm impedance at each outlet; response within  $\pm 1/4$  db across each 6-mc channel; noise figures of less than 4 db on low band and 5 db on high band. The coupler uses two 7HA5 tubes and a silicon diode rectifier.



### Phono-Cartridge Display/Dispenser

(78)

This counter display/dispenser features a clear plastic window for up-front display of phono cartridges. The display is constructed of hardwood and metal. The Sonotone unit is being offered to dealers through a "loader" type promotion. To obtain the display/dispenser, place an order with Sonotone for 85 of its replacement cartridges (any mix), including at least three of the firm's *Velocitone* cartridges.

The display measures 15 1/4" x 13 1/2" x 8 1/2" and is finished in gold and black. It holds a total of 125 Sonotone cartridges, including three *Velocitones*, plus an assortment of replacement needles.



### Cable Clamps

(79)

Electronic cable now can be held in place without screws or other mechanical

# If this year's phono cartridges look new...and just a bit revolutionary...

## they are!

In 1965 Admiral, Motorola, Philco, V-M and Zenith all introduced superb new phonographs using a unique new series of ceramic phono cartridges.

With these ingenious designs, the Tetrad Corporation takes its place as one of the brightest innovators in the phono cartridge field. And it's a testimonial to their creative design that already hundreds of thousands of Tetrad cartridges have been installed by many of America's leading phonograph manufacturers.

There's just one problem: Tetrad sells only to manufacturers. So how can you get replacements for your customers?

Well, you might place separate small orders with all the phonograph distributors — but this is time consuming and costly. So Tetrad made it possible for you to buy all 24 new cartridge models — every needle, too — from just one source. Your E-V distributor.

Why were we chosen to handle Tetrad replacements? It's a natural. We're the aggressive new leader in needles and cartridges, with a deep involvement in modern cartridge design (and many significant innovations of our own)! Most significant to you, E-V is determined to be first with the cartridges and needles you need to keep in step with a fast-changing market.

Come to your Electro-Voice distributor for Tetrad cartridges, of course. But don't stop there. We didn't!

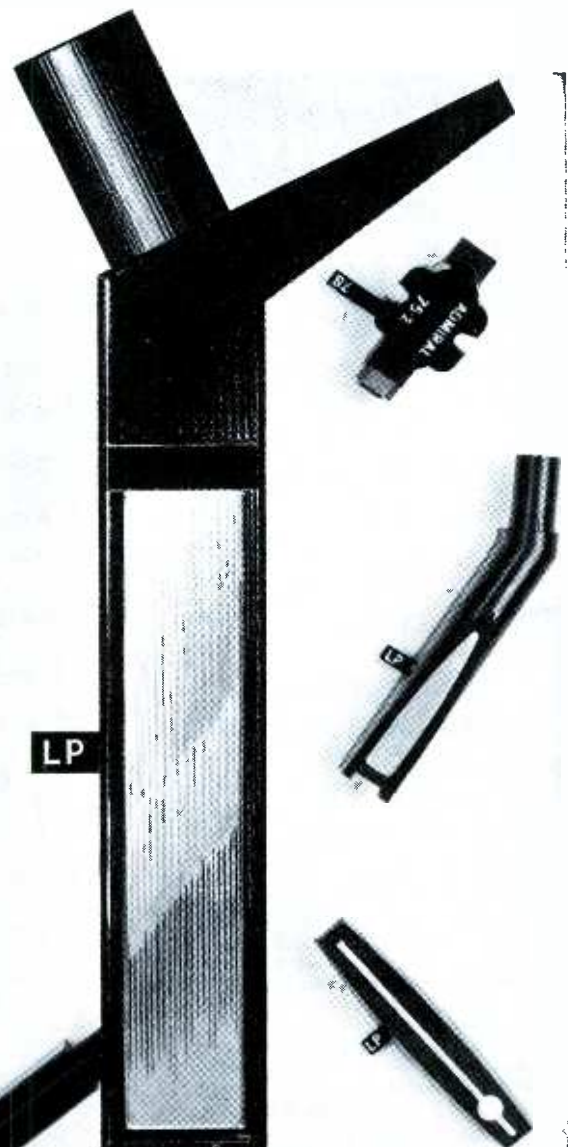

**Electro-Voice®**

The modern complete line of replacement phono cartridges

ELECTRO-VOICE, INC., Dept. 367R, 632 Cecil Street, Buchanan, Michigan 49107

Circle 57 on literature card

March, 1966/PF REPORTER 83

hundreds of  
antennas  
BUT  
ONLY ONE  
THAT'S  
EXACTLY  
RIGHT  
for UHF  
Reception  
at its VERY  
BEST!

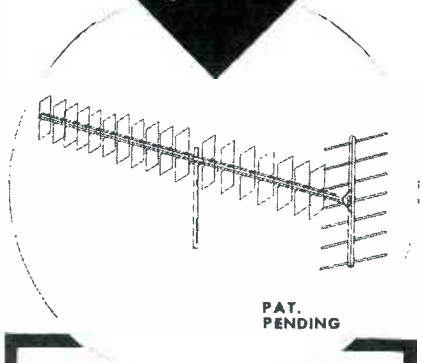

PAT.  
PENDING

### Revolutionary MODEL UPW UHF PASSIVE WAVE ANTENNA

Constant impedance transition is provided from a Wave Guide Element System to a balanced transmission line in a proportional additive manner. This system in which there are no electrical connections,

PROVIDES HIGH GAIN ACROSS THE ENTIRE UHF BAND

and eliminates noise caused by loose elements at high frequencies. High overall gain across the entire UHF band makes this antenna more desirable than any frequency conscious yagi types being marketed today. Excellent color reception assured. More gain than a Parabolic. Top quality construction.

Write for literature and low retail prices. All inquiries given prompt attention.

**S & A ELECTRONICS INC.**

Manufacturers of the TARGET ANTENNA  
206 West Florence Street • Toledo, Ohio 43605  
Phone 419-693-0528

Circle 58 on literature card

fasteners. The 3M Company's "Scotchflex" brand adhesive cable clips are constructed of polyvinylchloride with a foam adhesive backing. This backing allows the clamp to be mounted firmly to any clean, dry surface, including such areas as electronic-equipment chassis, walls, desks, etc. The clamps are available in four sizes to handle bundles or jacketed cable from 1/8" to 1/2" diameter.



Experimenter Kits  
(80)

Three experimenter's kits, offered by RCA, will permit the experimenter and hobbyist to build electronic control devices such as motor-speed controls,

warning flashers, battery chargers for 6- and 12-volt batteries, light dimmers, light- and heat-activated controls for automatic lighting and heating, and overload and synchronous switches.

The basic kit, Silicon Controlled Rectifier Experimenter's Kit KD2105, includes one silicon controlled rectifier, five silicon rectifiers, and two transistors. A comprehensive 80 page manual, Experimenter's Manual KM-70, gives step-by-step instructions for the construction of each control circuit. Ten separate control circuits can be built with the components supplied in the basic kit. Two kits, Add-On Heat Sensor Experimenter's Kit KD2110 and Add-On Light Sensor Experimenter's Kit KD2106, can be used with the basic kit to permit the construction of more exotic control devices. The KD2110 kit contains three thermistors (high, low, and room temperature), and the KD2106 kit contains one photo-cell.

Eleven of the fourteen circuits described in the manual can be constructed on a single standard chassis; the other three, which require step-down transformers, use a second standard chassis.

All three kits are available from stock. The optional distributor resale prices of the kits are: KD2105—\$9.95; KD2110—\$2.45; KD2106—\$2.75; and \$9.95 for kit manual KM-70.

SAVES  
your back...

SAVES  
your time...

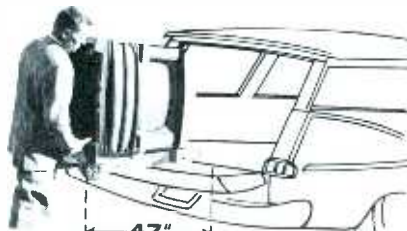

## YEATS SHORTY DOLLY for RADIO and TV

just 47 inches high for STATION WAGONS  
and PANEL PICK-UPS



FOLDING PLATFORM  
15 1/4" x 24 1/2" top.  
Snaps on or off.  
(Platform only)  
\$11.95

Designed for TV, radio and appliance men who make deliveries by station wagon or panel truck... the short 47 inch length saves detaching the set for loading into the "wagon" or pick up. Tough, yet featherlight aluminum alloy frame has padded felt front, fast (30 second) web strap ratchet fastener and two endless rubber belt step glides. New folding platform attachment, at left, saves your back handling large TV chassis or table models. Call your YEATS dealer or write direct today!



YEATS  
Model No. 5  
Height 47"  
Weight 32 lbs.



FURNITURE PAD

### "Everlast" COVER AND PADS

YEATS semi fitted covers are made of tough water repellent fabric with adjustable web straps and soft, scratchless white flannel liners. All shapes and sizes — Write



TV COVER

**YEATS**

APPLIANCE DOLLY SALES COMPANY

1307 W. Fond du Lac Ave. • Milwaukee, Wisconsin

Circle 59 on literature card

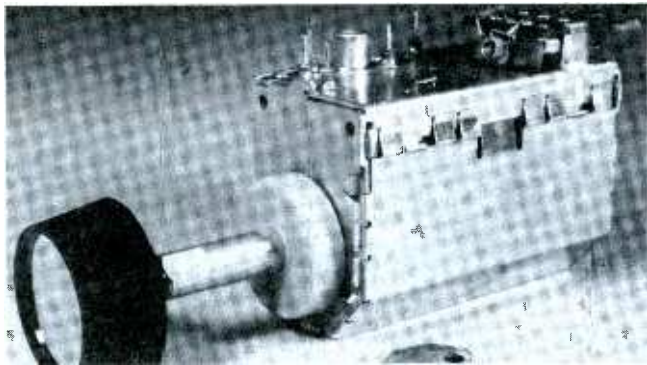

**Compact VHF Tuners**  
(81)

This all-transistor turret-type tuner is used for transistorized TV's. Its size is 2½" x 1½" x 3", but allows accessibility to all components. The transistors contribute to the small size, light weight, and low power consumption. **Electro-Netic Steel, Inc.**, manufacturer of this Model V102 tuner, also offers Model V105 which has an RF tube and two transistors, and Model V106 with a nuvistor and two transistors. Both are otherwise the same as the V102. Shafts of different lengths, insulated from the chassis, may be added to a unit. All tuners have preset fine tuning and in integrated switch to power an external UHF tuner.



**Base-Station Microphone**  
(82)

The Models 619 and 719 base-station press-to-talk microphones are manufactured by **Electro-Voice** for ham, CB, business-communications, or paging use. The Model 619 is a dynamic microphone, and the 719 is a ceramic version of the same basic design. Identical in appearance, both models are constructed with communications-gray die-cast stands and contrasting chrome-plated die-cast heads. Each model weighs two lb.

For grip-to-talk operation, the switch may be moved from the base into the upper part of the stand. The DPDT switch operates both voice and relay circuits with the option of electronic switching at the end of the cable with no modifications. The 619 response is 70 to 10,000 cps at -57 db. Response of the more economical 719 ceramic microphone is 80 to 7000 cps at -56 db. Both models are omnidirectional and are furnished with heavy-duty cable. The Model 719 lists at \$27.50, and the Model 619 has a list price of \$47.50.

**top money maker in  
the service business**

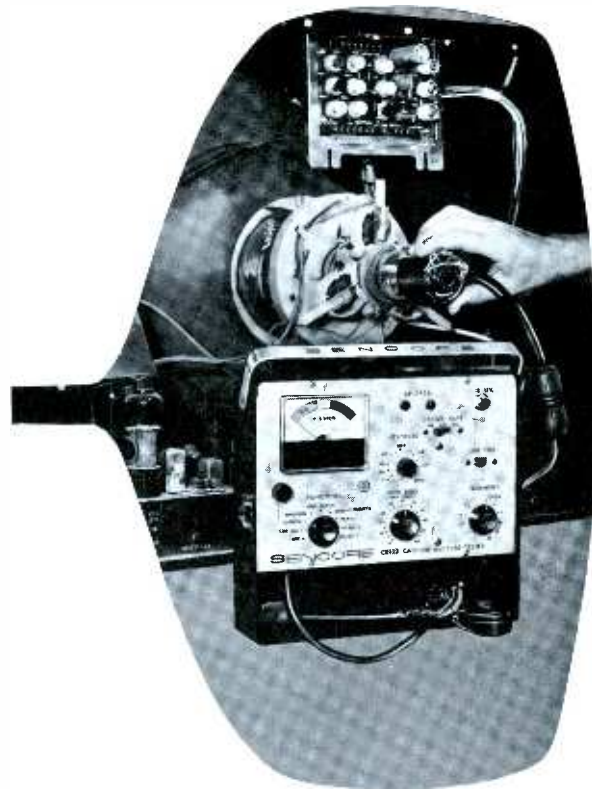

## NEW IMPROVED SENCORE CR133 CRT CHECKER & REJUVENATOR

The new, improved CR133 CRT Checker is designed to test all present picture tubes — and it's ready for future tubes too! Two plug-in replaceable cables contain all sockets required. The compact, 10 lb., CR133 checks CRT emission, inter-element shorts, control grid cut-off capabilities, gas and expected life. Checks all tubes: conventional B&W, new low drive B&W, round color tubes and new rectangular color picture tubes. Exclusive variable G2 Volts from 25 to 325 Volts insures non-obsolescence when testing newly announced "semi-low" G2 CRT tubes. New Line Voltage Adjustment insures the most accurate tests possible. Uses well-filtered DC for all checks to avoid tube damage and reading errors. Color guns are individually tested as recommended by manufacturers. Exclusive automatically controlled rejuvenator applies rejuvenation (ACR) voltage as required by individual tube condition; precisely timed to prevent over-rejuvenation or tube damage. The ACR feature is most useful for color tube current equalization to insure proper tracking. Hand-wired and steel-encased for protection of meter and panel in truck or shop, the new improved CR133 is only . . . **\$89<sup>95</sup>**

The latest, most improved version of the CR128, the new CR128A, is similar to the CR133, but without line adjust or plug-in cables. Now only \$74.95.

*professional quality — that's the difference!*

# SENCORE

426 SOUTH WESTGATE DRIVE • ADDISON, ILLINOIS

Circle 60 on literature card

March, 1966/PF REPORTER 85

# NOW! Save up to \$60 per year on the

## JOIN THE NEW PHOTOFAC<sup>®</sup>-OF-

**STARTING IN JULY, 1966!  
6 New Photofact Sets per  
month—20% more coverage  
than ever before—FOR  
ONLY \$10 PER MONTH!**

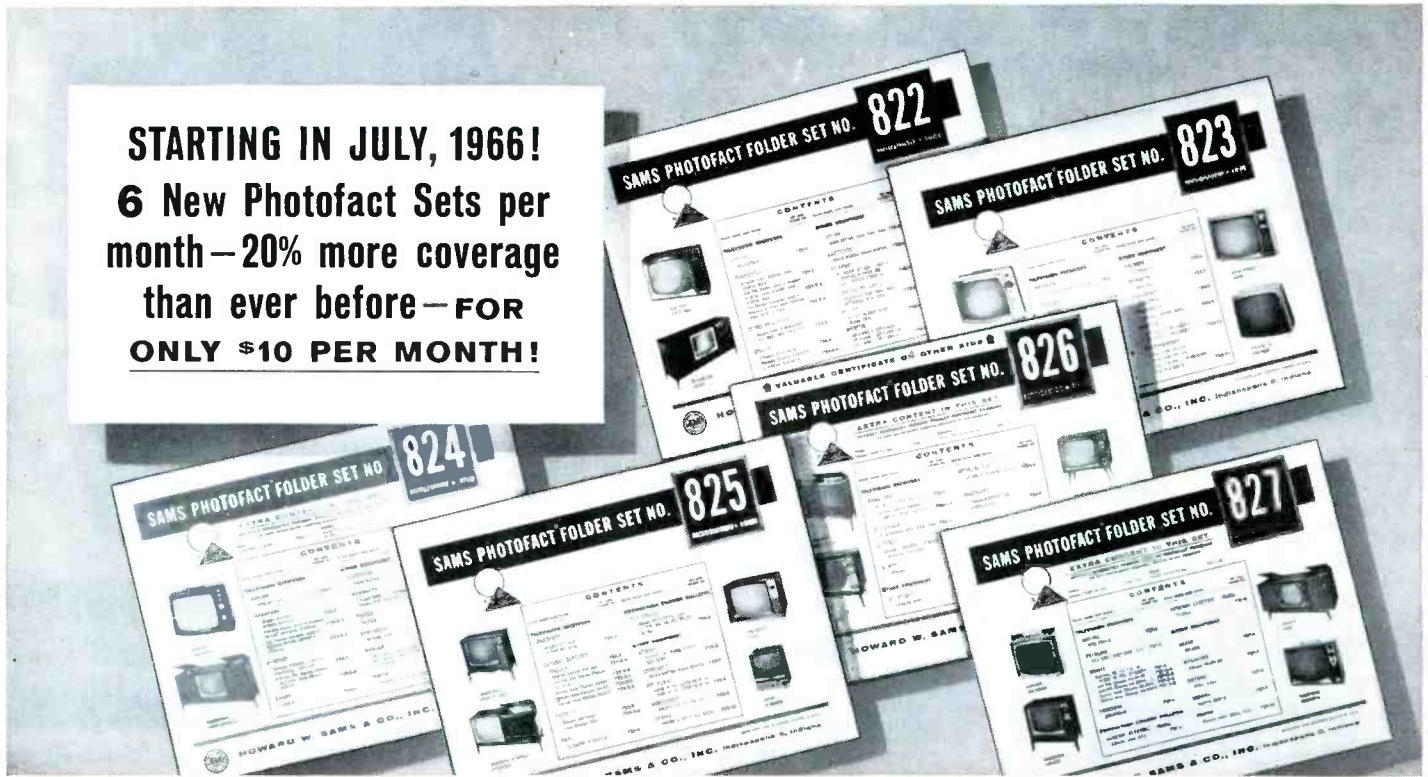

### Now! maximum coverage of equipment you service most!

- ★ **MORE TV COVERAGE**  
5 Color TV models per month  
More Black & White TV coverage
- ★ **MORE AC-DC COVERAGE**
- ★ **MORE AM-FM MODELS**
- ★ **MORE STEREO HI-FI COMBINATIONS**
- ★ **MORE RECORD CHANGER COVERAGE**
- ★ **MORE PHONOGRAPH COVERAGE**

complete service data on at least  
50 chassis each and every month  
to meet all your service needs!

**now only \$10 per month**

Membership in the new Photofact-of-the-Month Club now brings you 20% more coverage monthly—saves you \$5 per month, up to \$60 per year! You get *more* of the famous PHOTOFAC time-saving, troubleshooting help—*everything* you need to earn more daily. Take the *right* step to faster, more profitable servicing—enroll now with your Sams Distributor as a member of the new Photofact-of-the-Month Club—or send in the membership form today!

**ENROLL TODAY IN THE PHOTOFAC-OF-THE-MONTH CLUB**

**use the  
handy coupon**

Circle 54 on literature card



# world's finest TV-radio service data!

## **THE-MONTH CLUB** — membership starts in July, 1966

### only \$10 per month brings you 20% more monthly current Photofact service data coverage to boost your daily earnings

#### How the Photofact-of-the-Month Club benefits you

##### *more for your service data dollar*

Starting in July, 1966, as a member of the P.O.M. Club, you get 6 new Photofact Sets monthly (20% more coverage) for just \$10 per month! You save \$5 per month—\$60 per year (regular price for individually purchased Photofact Sets is \$2.50, effective July 1, 1966). Now you can keep right up with the flood of current equipment output. Now you get the world's finest service data on at least 50 different chassis each month—to help you turn out more repairs daily, with a bigger profit on every job.

##### *how this is possible*

We have explained the new Photofact-of-the-Month Club plan to hundreds of electronic technicians. From what they have told us, and from their enthusiastic response, we expect to add substantially to the thousands of present monthly subscribers to Photofact. This means we can effect greater economies through large-volume production, and that's what makes possible not only lower costs to P.O.M. Members, but greater coverage than ever before. It's as simple as that!

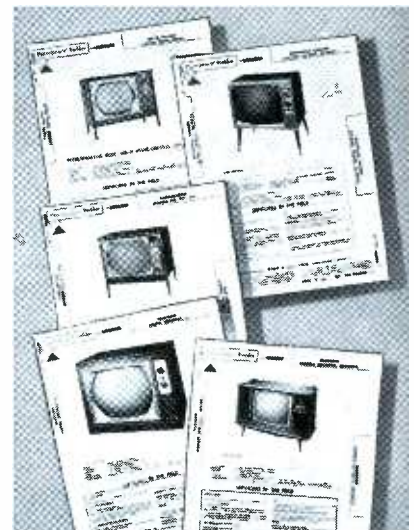

#### **IMPORTANT NEWS FOR OUR THOUSANDS OF PRESENT PHOTOFAC T SUBSCRIBERS**

Your loyalty through the years is deeply appreciated. You will automatically be enrolled as a charter P.O.M. Club member. Starting in July, 1966, you will receive 6 Photofact Sets monthly (20% more coverage), and pay only \$10 per month. Your subscription to Photofact becomes more valuable than ever.

#### **HERE'S ALL YOU DO TO BECOME A MEMBER OF THE NEW**

#### **PHOTOFAC T OF THE MONTH CLUB**

See your Sams Distributor today, or fill out and mail the membership form below. That's all there is to it. Do it today! It's the opportunity you've been looking for—the chance to be a regular Photofact subscriber at the price you can afford. Get started on the road to the kind of profits you've always wanted.

#### **Current COLOR TV coverage**

Now—as a P.O.M. Club member, you will get a minimum of 5 Photofact Color TV Folders per month—you keep right up with the biggest growing profit opportunity in the service field.

#### **BONUS File Drawers**

As a P.O.M. member, you are also eligible for the Bonus Photofact File Drawer offer.



### **DO IT TODAY...**

#### **Fill Out This Form For Membership In The Photofact-Of-The-Month Club**

**HOWARD W. SAM S & CO., INC.**

4300 West 62nd Street, Indianapolis, Indiana 46206

PFF-3

Please enroll me as a new member of the Photofact-of-the-Month Club. I agree to pay \$10 per month for my membership, and understand my subscription will begin with the July, 1966

issue, consisting of 6 current Photofact Sets, to be delivered by my Sams Distributor (named below).

Name \_\_\_\_\_

Business Name \_\_\_\_\_

Address \_\_\_\_\_

City \_\_\_\_\_ State \_\_\_\_\_ Zip \_\_\_\_\_

My Sams Distributor is: \_\_\_\_\_ Sign here: \_\_\_\_\_

**sign up now  
and save!**

# NEW FROM POMONA ELECTRONICS: COLOR CRT TEST SOCKET ADAPTER

## MINIATURE DIHEPTAL For Color Television Picture Tubes

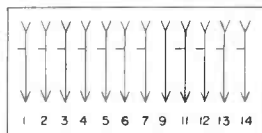

Schematic

Ideal for making measurements of voltage, resistance, and video from the base of the picture tube. The test socket adapter is inserted between the CR Tube base and its socket. This completes the circuit and makes all connections readily accessible. Measurements can be made without tracing circuit wiring to test points below the chassis, thereby saving

valuable time and increasing efficiency in trouble shooting.

**Features**—provision for accepting bases equipped with spark gaps.

Rugged, compact, easy to use. Built to Pomona Electronics' high standards of quality in materials and workmanship.

MODEL 2380

NET \$4.95

## POMONA ELECTRONICS CO., INC.

1500 East Ninth Street, Pomona, California 91769 / Telephone (714) 623-3463

Circle 62 on literature card

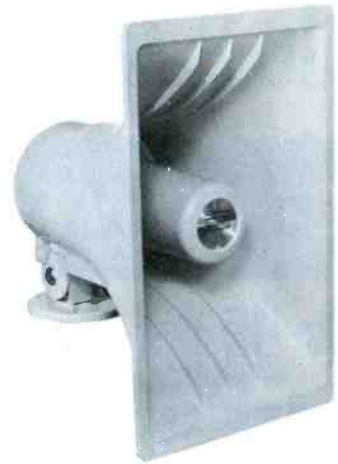

Paging Speaker  
(83)

This 30-watt paging projector has been designed for both voice and music reproduction. The **Electro-Voice** PA 30 rectangular horn provides a 90° x 120° dispersion angle, and the molded housing resists abuse, weather, and deterioration. A swivel bracket allows the horn to be rotated to either the horizontal or vertical axis without affecting directional setting. Should adjustment of the horn direction be required, only a single wing nut need be loosened for repositioning. The mounting bracket of the unit is usable for mobile applications as well as fixed installations. The instrument weighs 7½ lbs. and sells for \$34.50.

## J. W. Miller 4th Video IF replacement for more than 20 Color TV manufacturers

Model 6037 Fourth Video IF Transformer is a high quality replacement for most Color TV sets.

Cross Reference Guide No. 6037 listing manufacturers, models and part numbers has been prepared for quick, easy comparison. Included are a schematic diagram and installation instructions.

Write today or mail reader service card for your copy.



## J. W. MILLER COMPANY

5917 South Main Street • Los Angeles, California 90003

See your local distributor for the full line of RF and IF coils, chokes, filters and transformers.

Circle 63 on literature card

## PRECISION TV CLARIFIER

Effectively traps unwanted Signals

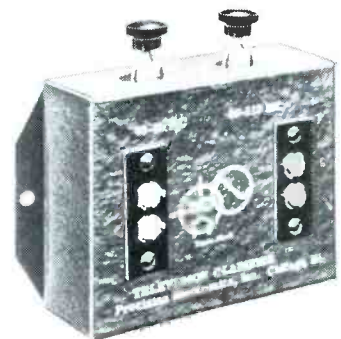

**Brighter, clearer TV pictures  
with one simple installation . . .**

Removes annoying signals that cause picture distortion in TV receivers from FM, amateurs, short-wave, diathermy, ignition, and adjacent channels. No technical knowledge required . . . easy to mount and install. Ghosts, lines, herringbone patterns, tears, wavy effects are removed or reduced simply by adjusting the two control knobs. Matches any antenna. Only 7.50

Also available:

Model 202. Signal Tracer with AF Probe. . . . 59.95



See your distributor or write Dept. PF-3  
**PRECISION ELECTRONICS, INC.**  
9101 King Street, Franklin Park, Illinois

Circle 74 on literature card



**Low Distortion Audio Generator**  
(84)

Based on a highly reliable circuit, this new instrument is specially suited for testing audio amplifiers or other applications where a stable, accurate audio sine wave is essential. The frequency-determining elements of the EICO Model 378 are set by positive setting detent switches that select combinations of 1% resistors and 2% capacitors which comprise the frequency-selecting network. This method of tuning assures accurate, repeatable setting to any individual frequency between 1 cps and 110 kilocycles.

The output level of this instrument can be set with precision between 0 and 10 volts RMS on a 4½ inch, 2% full-scale accuracy meter. Below 1 volt RMS output, the instrument is provided with a switch-selected internal 600-ohm load that can be disconnected as desired. The kit is \$49.95; factory-wired, \$69.95.



**Demo Tapes Included  
With Tape Recorders**  
(85)

Point-of-purchase demonstration tapes, calling attention to features of **Craig Panorama's** Vista 910 Stereo Tape Recorder, Vista 212 battery-operated and Vista 525 AC-operated units, are now included with all of these models.

Less than one minute in duration, the demo tapes point up the single "T" function control for play/record, rewind and fast forward, incorporated in all three units, and Automatic Level Control for the Vista 212 and Vista 525. Automatic Level Control allows the unit to seek its own volume level requiring no at-

**THE FINISHING  
TOUCH THAT  
MARKS A PRO!**



IN ELECTRICAL WORK—  
IN PAINTING

Goes on in seconds—  
dries in minutes!

**KRYLON...  
AMERICA'S NO. 1 SPRAY PAINT**

Circle 65 on literature card

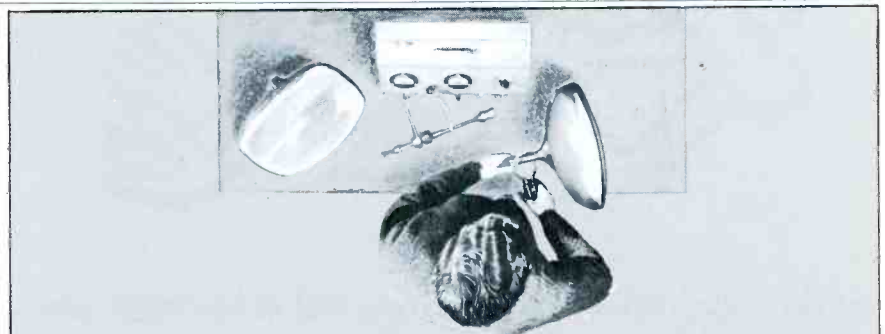

**This man made an extra \$6000 last  
year rebuilding picture tubes.**

You can make even more. Just this easy:

1. Realize there is an exploding demand for rebuilt picture tubes right where you live.
2. Send for the free full-facts story on how Windsor equipment can make you money in this lucrative, virtually untapped market.

That's it. Windsor will show you how to rebuild any tube made — black-and-white or color.

And, as has happened to so many others, we may just change your entire way of life — the way you'd like it. So don't wait. Contact us direct, or circle our number right now.



**WINDSOR ELECTRONICS, INC.**  
999 North Main Street  
Glen Ellyn, Illinois 60137

Circle 64 on literature card

# Why break your back

!



## Let the Ungar HOT-VAC De-Soldering Tool do the tough jobs

Trouble melts away. The new Ungar Hot-Vac gives you finger tip control for printed board rework and repair. Hot-Vac makes it possible to remove components 50% faster than any other method. One hand operation frees the other for component handling. A special **ungarized white** coating on the



inner surface of the Hot-Vac tip and solder collector prevents sticking and clogging. A pffft-squeeze of the bulb discharges molten solder. Your local Ungar distributor will be happy to give a Hot-Vac demonstration and complete information, or send coupon below for detailed literature.

### SEND FOR COMPLETE INFORMATION ON HOT-VAC TODAY!

Ungar Electric Tools, 2701 W. El Segundo Blvd.  
Hawthorne, California 90252 • Dept. P.F.R

Name (Please Print) \_\_\_\_\_ Title \_\_\_\_\_  
Company \_\_\_\_\_  
Address \_\_\_\_\_  
City \_\_\_\_\_ State \_\_\_\_\_ Zip \_\_\_\_\_



tention from the user. Also included are several extra feet of blank tape so prospects can involve themselves in self-demonstrations of the solid-state 2-speed tape recorders.



**Contact Cleaner**  
(86)

This cleaner may be sprayed directly into operating relays or contacts that are carrying current. **KLEENALL** is non-conductive, nonflammable, nontoxic and contains no oil or carbontetrachloride. It comes in a pressurized spray can with plastic nozzle extension. ▲

## GET YOUR FIRST CLASS COMMERCIAL F.C.C. LICENSE

or Your Money Back!

The Grantham F. C. C. License Course by correspondence will prepare you to *pass* the F.C.C. examination for your first class radiotelephone license. We know this, but of course you do not really know if it is true. Therefore, we make this offer: After completing this course if you should fail to pass the F.C.C. exam for this license, Grantham will *refund all of your tuition payments!*

Read complete details in our new 1966 catalog of courses. For this free catalog, write:

**Dept. 69-C**  
**Grantham School of Electronics**  
**1505 N. Western Ave.**  
**Hollywood, Calif. 90027**

Circle 67 on literature card

for successful

# COLOR TV servicing

own these SAMS BOOKS



**Color TV Training Manual, New Second Edition.**  
by C. P. Oliphant & Verne M. Ray. This newly revised comprehensive manual is the most up-to-date guide available for technicians preparing to service color TV receivers. Full information on: Colorimetry; Requirements of the Composite Color Signal; Make-up of the Color Picture Signal; RF and IF Circuits; Video, Sync & Voltage-Supply Circuits; Bandpass Amplifier, Color-Sync and Color-Killer Circuits; Color Demodulation; Matrix Section; Color Picture Tube & Associated Circuits; Set-up Procedure; Aligning the Color Receiver; Troubleshooting. Includes full-color illustrations invaluable for setup, alignment, and troubleshooting. 224 pages; 8½ x 11". **\$595**  
Order **TVC-2, only**

### Color TV Servicing Made Easy

by Wayne Lemons. Written in "made easy" style. Takes the mystery out of color TV servicing. Familiarizes you with color principles and setup adjustments; thoroughly covers color circuitry, adjustments, and servicing of all color TV sets produced to date. This book will help to put you into this fast-growing, profitable service work. 128 pages; 5½ x 8½". Order **CSL-1, only**. **\$250**

### Know Your Color-TV Test Equipment

by Robert G. Middleton. Explains clearly and easily the function and circuit action of each color TV test instrument. Covers: White-Dot and Cross-Hatch Generators, Color-Pattern and Color-Bar Generators, Rainbow and NTSC Generators, Principles of Video-Frequency Sweep Generators and Testing, Lab-type equipment, and valuable setup information. Profusely illustrated. 160 pages; 5½ x 8½". Order **KOC-1, only**. **\$250**

### Color TV Trouble Clues

Invaluable field-tested guide to trouble clues and procedures for color TV receiver repair. Describes types of troubles encountered, troubleshooting techniques, alignment and sync problems, convergence, etc. Includes data on use of test equipment to speed color TV servicing. Fully illustrated with photographs and schematics. A "must" for color TV service technicians. 96 pages; 5½ x 8½". **\$195**  
Order **COL-1, only**

### 101 Ways to Use Your Color TV Test Equipment

by Robert G. Middleton. Written in the time-tested formula acclaimed by thousands of TV technicians. Shows you practical uses for your test equipment to diagnose color TV circuit troubles quickly and easily. Describes proper equipment hookups, how to evaluate test results, how to check instruments; includes time-saving techniques. 144 pages; 5½ x 8½". Order **TEM-9, only**. **\$250**

### Color TV Guidebook

A special Howard W. Sams publication about color TV servicing techniques, equipment required, and related subjects. General information includes outlook for color TV manufacturers, broadcasting networks, and technicians. Specific sections deal with starting a color TV service business, troubleshooting and repair techniques, antennas, color tube stocking, transistorized color TV, small-town color TV problems, new circuits and developments. **\$100**  
8½ x 11". Order **PFR-1, only**

## HOWARD W. SAMS & CO., INC.

Order from your Sams Distributor today, or mail to Howard W. Sams & Co., Inc., Dept. PF-3  
4300 W. 62nd Street, Indianapolis, Ind. 46206

Send me the following books:  
 TVC-2     KOC-1     TEM-9  
 CSL-1     COL-1     PFR-1  
 Send FREE Sams Booklist. \$ \_\_\_\_\_ enclosed

Name \_\_\_\_\_

Address \_\_\_\_\_

City \_\_\_\_\_ State \_\_\_\_\_ Zip \_\_\_\_\_

My Distributor is \_\_\_\_\_

## INDEX TO ADVERTISERS

MARCH, 1966

Arrow Fastner .....	51
Atlas Sound .....	48
Antennacraft Co. ....	70, 71
Belden Mfg. Co. ....	37
B & K Mfg. Co., Div. of Dynascan Corp. ....	39, 41, 43
Bussman Mfg. Div. ....	18, 19
Castle TV Tuner Service .....	15
Channel Master Corp. ....	16, 79
Chemtronics, Inc. ....	51, 58
Cleveland Institute of Electronics .....	69
Craftsman Electronic Products, Inc. ....	29
Electronic Chemical Corp. ....	29
Electro-Voice .....	83
Finney Co. ....	75
Grantham School of Electronics .....	90
I. R. C., Inc. ....	46, 47
Jackson Electronic Instrument Co. ....	13
JFD Electronics Corp. ....	66, 67
Jerrold Electronics .....	cover 2
Krylon, Inc. ....	89
Lectrotech, Inc. ....	68
Littlefuse, Inc. ....	cover 4
Mercury Electronics Corp. ....	76, 77
Microflame, Inc. ....	77
Midstate Tuner .....	73
Miller, J. W., Co. ....	88
Motorola Training Institute .....	72
National Radio Institute .....	72
Nortronics Co., Inc. ....	58
Oaktron Industries, Inc. ....	69
Ohmite Mfg. Co. ....	48
Parts Unlimited Electronics .....	50
Philco Corp. ....	35
Planet Sales Co. ....	51
Pomona .....	88
Precise Electronics .....	62
Precision Electronics, Inc. ....	88
Precision Tuner Service .....	82
Quam-Nichols Co. ....	91
Quality Tuner Service .....	13
Quietrole Co. ....	62
RCA Components & Devices ..cover 3, 52, 59, 61	
RCA Sales Corp. ....	80, 81
Robins Industries Corp. ....	73
Sarkes Tarzian, Inc. ....	9
S and A Electronics .....	84
Sams, Howard W. & Co. ....	86, 87, 91
Seco Electronics, Inc. ....	78
Semitronics Corp. ....	38
SENCORE, Inc. ....	65, 74, 85
Simpson Electric Co. ....	14
Sound Sentinal Co. ....	82
Sprague Products Co. ....	11, 12
Standard Kollsman Industries, Inc. ....	64
Sylvania Electronic Product, Inc. ....	57
Texas Crystals .....	50
Triplet Electrical Instrument Co. ....	17
Ungar Electric Tools .....	90
Weller Electric Corp. ....	60
Winegard Co. ....	49
Windsor Electric Co. ....	89
Yeats Appliance Dolly Sales, Inc. ....	84
Zenith Radio Corp. ....	63

brand new  
... and very important...

# QUAM COLOR TV REPLACEMENT SPEAKERS PREVENT COLOR PICTURE DISTORTION

OFTEN CAUSED BY STRAY  
MAGNETIC FIELDS FROM  
ORDINARY LOUDSPEAKERS



When you use an ordinary loudspeaker in a color TV set, you're looking for trouble... picture trouble. The external magnetic fields from standard loudspeakers will deflect the primary color beams, causing poor registration and distorted pictures.



## QUAM RESEARCH SOLVES THIS PROBLEM

An entirely new construction technique, developed in the Quam laboratories, encases the magnet in steel, eliminating the possibility of stray magnetic fields and the problems they cause! These new Quam speakers have been eagerly adopted by leading color TV set manufacturers. Quam now takes pride in making them available for your replacement use. Five sizes (3" x 5", 4", 4" x 6", 5¼", 8")... in stock at your distributor.

# QUAM

QUAM-NICHOLS COMPANY

234 E. Marquette Rd. • Chicago, Ill. 60637

Circle 68 on literature card



# FREE Catalog and Literature Service

\*Check "Index to Advertisers" for further information from these companies.

Please allow 60 to 90 days for delivery.

## ANTENNAS & ACCESSORIES

90. *ALLIANCE* — Colorful 4-page brochure describing in detail all the features of *Tenna-Rotors*.
91. *ANTENNACRAFT* — Literature featuring 3 new 75-ohm, all-channel TV antennas available in factory-built or kit form.\*
92. *CORNELL-DUBILIER* — New 3-color 8-page booklet titled "All Channel Reception" on rotor systems.
93. *FINNEY* — Form 20-340 describes 75-ohm gamma matched single channel Yagi antennas for master systems.\*
94. *JERROLD* — Colorful 28-page booklet describes Coloraxial line of products, gives installation tips. Has color photographs of TV screens with reception problems.
95. *JFD* — New 1966 dealer catalog covering complete line of log-periodic outdoor antennas, indoor antennas, rotators, converters, amplifiers, masting, splitter-couplers/combiners, matching transformers, lightning arrestors, antenna mounts, and hardware.\*
96. *TRIO* — Brochure on installation and materials for improving UHF translator reception.
97. *WINEGARD* — 12-page brochure "Color Spectacular" featuring antenna products designed for color TV use.\*
98. *ZENITH* — Information bulletin on antennas, rotors, batteries, tubes, power converters, record changers, picture tubes, wire, and cable.\*

## AUDIO & HI-FI

99. *ADMIRAL* — Folders describing line of equipment; includes black-and-white TV, color TV, radio, and stereo hi-fi.
100. *ATLAS SOUND* — Catalog No. 565 illustrating public-address loudspeakers, microphone stands, and accessories for commercial sound applications.\*
101. *ELECTRO-VOICE* — Needle and cartridge replacement guide gives replacement data and specs for complete *Tetrad* and *Euphonics* line.\*
102. *GIBBS* — Brochure describing complete line of low priced automobile reverberation amplifiers.
103. *JENSEN* — Multicolored 24-page catalog No. 165-L featuring speakers and headphones. Also, 22-page catalog No. 680 supplying phono-cartridge list and cross-reference.
104. *NEUTONE* — Two full-color booklets illustrating built-in stereo music systems and intercom-radio systems. Includes specifications, installing ideas, and prices.
105. *OAKTRON* — "The Blueprint to Better Sound," an 8-page catalog of loudspeakers and baffles giving detailed specifications and list prices.\*
106. *OXFORD TRANSDUCER* — 4-page catalog describing three lines of automobile rear-seat speaker kits.
107. *PERMA-POWER* — Catalog B-278 describes Ampli-vox line of sound systems.
108. *PHONOIA* — Full-color 18½" x 12" brochure depicting full line of phonographs, tape recorders, and consoles.
109. *QUAM-NICHOLS* — Catalog 65 listing replacement speakers for public address systems, hi-fi, auto radio, and radio-TV applications.\*
110. *ROBINS* — Flyer sheet showing merchandising display of tape accessories.
111. *SONOTONE* — New cartridge and needle cross-reference guide with over 5,700 entries. Includes replacement data for imported sets.

## COMMUNICATIONS

112. *AMECO* — Flyer sheet describing equipment and accessories for ham and CB use.
113. *EICO* — Data sheet on Model 753 Tri-Band transceiver and other ham gear, plus full-line catalog.
114. *MOSLEY ELECTRONICS* — Catalog covering complete 1966 line of Citizens-band equipment.
115. *PEARCE-SIMPSON* — Specification brochure on IBC 301 business-band two-way radio, *Companion II*, *Director*, *Escort II*, *Guardian 23*, and *Sentry* Citizens-band transceivers. "The Modern Approach to Business Communications" concerning land mobile radio service for businessman.

## COMPONENTS

116. *BUSSMANN* — 16-page form AWC shows fuse locations and sizes for cars and trucks. Covers 12 years, includes many foreign cars.\*
117. *GC ELECTRONICS* — Cross-reference FR-605-G for TV-knob replacement. Catalog FR-66-TD listing TV antennas and accessories. Brochure FR-171-A and catalog FR-66-A covering audio accessories and solid-state modules. Wall chart FR-250-W providing cross-reference for tape and phono drives and belts. Wall chart FR-209-E listing test prods, plugs, and jacks.
118. *M* — Brochures and stuffers depicting products, specifications, and installation methods for electrical cables, connectors, splicing kits, and flat-cable systems for audio equipment.
119. *MILLER* — Cross reference guide for 4th video IF transformer replacements for sets of 24 manufacturers.\*
120. *OAK* — Form SP 214 covers expanded line of switches. Rotary, slide, pushbutton and others. Forms SP 186 and SP 187 are price and comparison sheets.
121. *RCA* — New 6-page colorful brochure on complete line of battery merchandise displays.\*
122. *SPRAGUE* — Handy chart lists most popular sizes of electrolytics for color TV sets, referenced to set manufacturer.\*
123. *SWITCHCRAFT* — Bulletin 157 describes constant impedance 7-way wall-mount speaker selection switch.
124. *WORKMAN* — Form X-47 describes non-inductive ceramic resistors used in color TV sets.

## SERVICE AIDS

125. *CASTLE* — How to get fast overhaul-service on all makes and models of television tuners is described in leaflets. Shipping instructions, labels, and tags are also included.\*
126. *CLEVELAND INSTITUTE OF ELECTRONICS* — New pocket-sized, plastic "Electronics Data Guide" of formulas and tables, including frequency and wavelength, db formulas and table, antenna lengths, and color code.\*
127. *PRECISION TUNER* — Literature supplying information on complete low-cost repair and alignment service for any TV tuner.\*
128. *RAWN* — Bulletins offered on uses of Plast-Pair and tuner cleaner.
129. *YEATS* — The new "back-saving" appliance dolly Model 7 is featured in a four-page booklet describing feather-weight aluminum construction.

## SPECIAL EQUIPMENT

130. *ACTION SYSTEMS* — Broadline catalog 701 describes intercom, background music, and telephone equipment.
131. *GREYHOUND* — The complete story of the speed, convenience, and special service provided by the Greyhound Package Express routes.
132. *INTERNATIONAL RECTIFIER* — Flyer describing K-200 electronic ignition system.
133. *SETCHELL-CARLSON* — Multicolor sales brochure describing Unit-Ized construction color and B + W TV receivers.

## TECHNICAL PUBLICATIONS

134. *CLEVELAND INSTITUTE OF ELECTRONICS* — Free illustrated brochure describing electronics slide rule and four-lesson instruction course and grading service.
135. *HOWARD W. SAMS* — Literature describing popular and informative publications on radio and TV servicing, communications, audio, hi-fi, and industrial electronics, including special new 1966 catalog of technical books on every phase of electronics.\*
136. *RCA INSTITUTES* — 64-page book, "Your Career in Electronics" detailing home study courses in telecommunications, solid-state electronics, and drafting. Preparation for FCC license, and courses in mobile communications and computer programming also available.\*

## TEST EQUIPMENT

137. *B & K* — New 1966 catalog featuring test equipment for color TV, auto radio, and transistor radio servicing, including tube testers designed for testing latest receiving tube types.\*
138. *HICKOK* — New flyer detailing selected items of service test equipment.
139. *JACKSON* — Folder showing complete line of service test equipment.
140. *MERCURY* — Folder supplying information on complete line of test equipment.\*
141. *SECO* — Catalog sheet No. 90065 describing Model 900 color-bar generator and Models 88, 98, and 107 B tube testers.\*
142. *SEMITRONICS* — Flyer sheet describing *Meter Sentry* low-cost overload protection device for all types of meter movements.\*
143. *SENCORE* — New catalog describing the Econoline models, also 4-color catalog on depicting over 26 other instruments.\*
144. *SIMPSON* — Flyer giving specifications of Model 604 Multicorder for measuring and recording volts, amps, milliamps, and microamps.\*
145. *TRIPLETT* — New test-equipment catalog 48-T featuring VOM's, VTVM's, tube testers, and transistor analyzers.\*

## TOOLS

146. *ARROW* — Flyer sheet illustrating three staple guns and showing uses.
147. *ENTERPRISE DEVELOPMENT* — Time saving techniques in brochure from Eudeco demonstrate improved desoldering and resoldering techniques for speeding and simplifying operations on PC boards.
148. *LUXO* — 20-page illustrated catalog of incandescent and fluorescent bench lamps. Includes magnifying types for printed circuit and other close work.

## TUBES

149. *IEC* — Flyer sheet listing line of tubes for use in home-entertainment equipment.

# RCA rare-earth Hi-Lite Color TV Picture Tubes

for every smart  
customer who wants  
a superior color picture

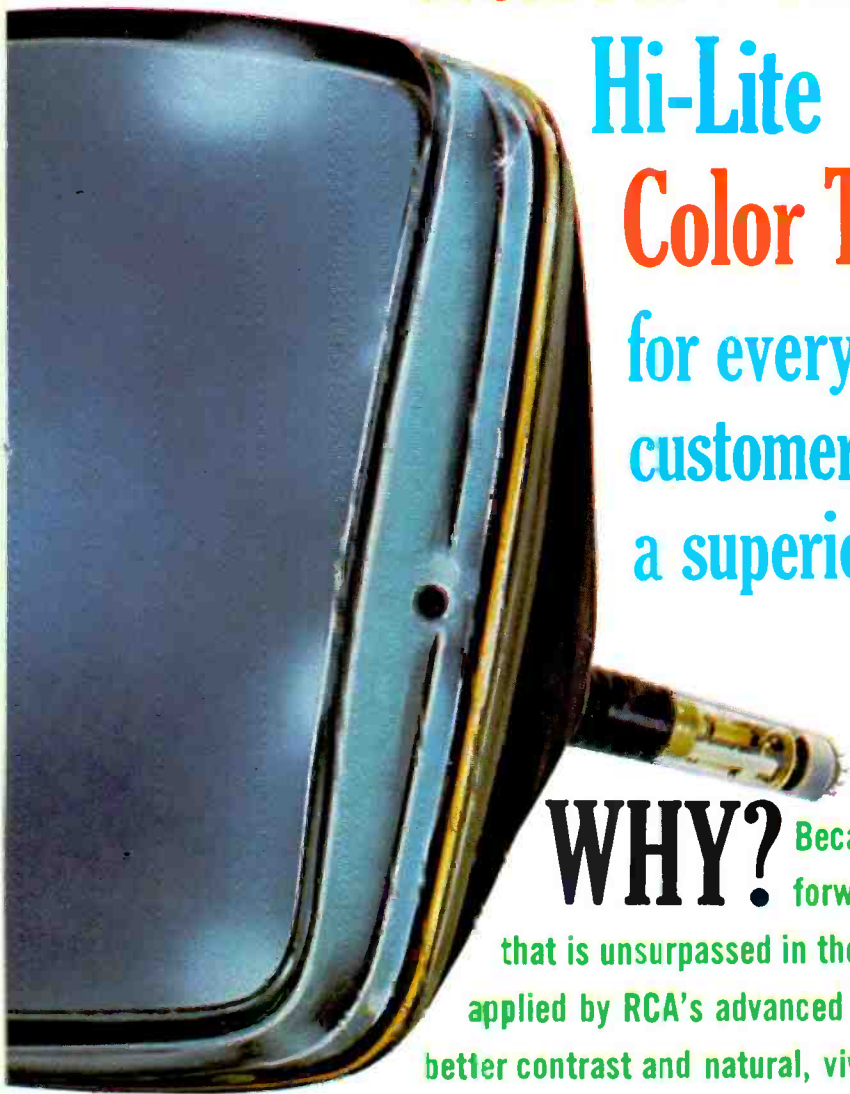

**WHY?** Because RCA's Hi-Lite line represents a big step forward in color picture brightness—brightness that is unsurpassed in the color TV industry. Rare-earth phosphors applied by RCA's advanced screening methods create brighter reds, better contrast and natural, vivid colors . . . Everything the smart customer wants. Are you ready to service your smart customers? Keep posted. See your RCA Distributor today.

RCA ELECTRONIC COMPONENTS AND DEVICES, HARRISON, N.J.



The Most Trusted Name in Electronics





# LOOK WHAT'S HATCHING IN **COLOR TV**

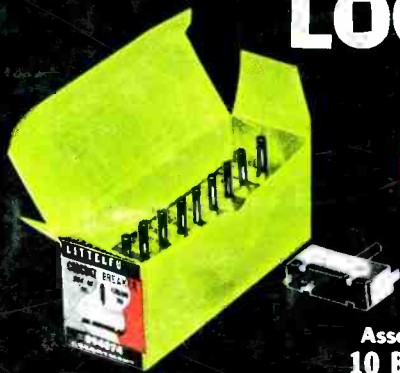

Assortment #094074  
**10 BULK BREAKERS**



Assortment #094073  
**10 CARDED BREAKERS**

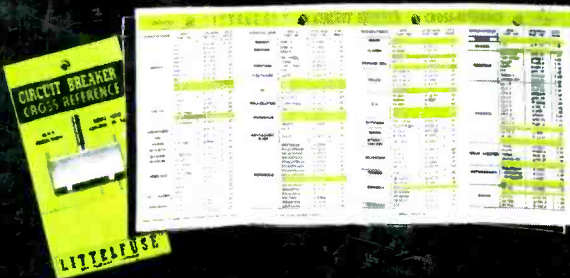

**A COMPLETE ASSORTMENT  
OF CIRCUIT BREAKERS FOR  
COLOR TV APPLICATIONS**

Ten breakers, seven ratings in one handy box for 100% replacement needs. Assortment available consisting of breakers on individual display cards or in bulk.

Included with each assortment: Pocket size cross reference on color and black/white TV circuit breaker applications. Form No. CBCRP865H.

# LITTELFUSE

DES PLAINES, ILLINOIS

Circle 71 on literature card