

PF Reporter™

PHOTOFACT

the magazine of electronic servicing

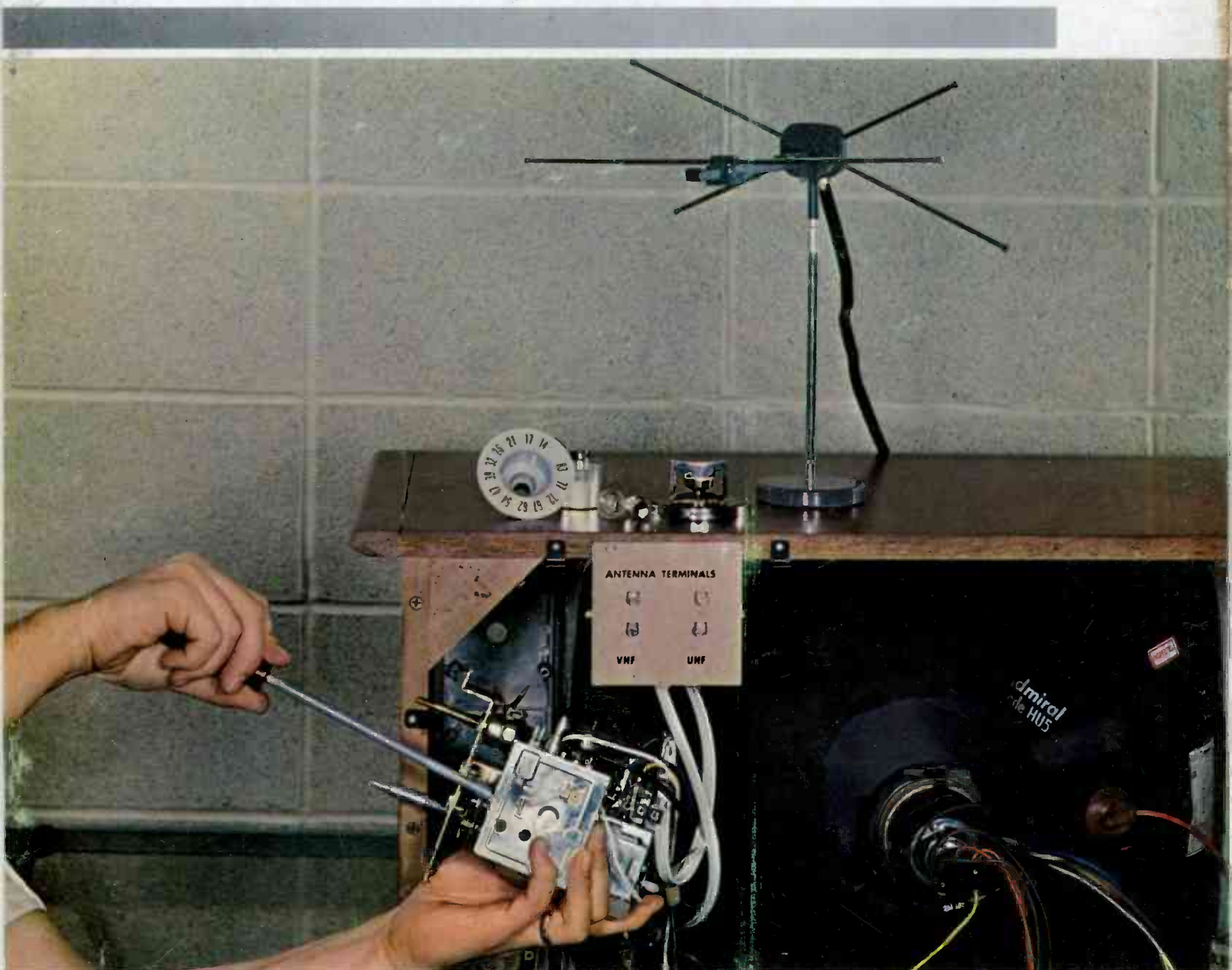

IA 50 3879 568
 SAVUEL SACHS
 2244 NORTH 10TH ST.
 PHILADELPHIA, PA. 19133

- 12 Years of UHF
- Stand up to the Intermittent
- Extend Two-Way Range . . . Reduce Noise
- Other servicing features
- Plus Annual Subject-Reference Index

Be super-critical.

Whether you're looking for the fun and economy of building quality kits or you want ready-to-use factory-wired equipment — before you buy, examine carefully. Compare

EICO with anybody else — feature for feature, chassis for chassis, part for part. The more critical you are, the more you'll see for yourself that your best buy is EICO.



Over 3,000,000 EICO instruments now in use! Preferred by engineers, scientists, technicians and students. EICO equipment is available nation-wide through 2500 EICO dealers.



New Model 435 — DC Wideband Scope. Top-quality DC 4.5mc scope with 3" flat-face CRT. Zener calibrator: Outperforms 5" scopes three times its size, facilitates on-location color TV and other servicing. \$99.95 kit, \$149.95 wired.



New Model 342 — FM Multiplex Signal Generator. Design lab quality. Both composite audio and FM RF outputs. Inputs for stereo audio source for store demonstrations, critical A/B listening tests. \$149.95 wired.



New Model 965 — FaradOhm Bridge/Analyzer. 9-range, low-voltage capacitance-resistance bridge safely measures even 1-volt electrolytics. Metered bridge balance, leakage test voltage (6 DC VTVM ranges 1.5-500V), leakage current (11 DC VTAM ranges 0.15ua-15ma). DC VTVM & VTAM externally usable. \$129.95 wired.



New Model 1030 — Regulated Power Supply. Speeds troubleshooting, design work, production line testing, electronics teaching. Variable bias and plate sources regulated to 1/2 of 1%: 0-150V @ 2ma; 0-400V @ up to 150ma. Ripple less than 3mv rms. Unregulated fil. volts of 6.3V & 12.6V, @ 3A. Switchable, monitoring milliammeter and voltmeter. \$59.95 kit, \$99.95 wired.



New Model 378 Audio Generator. Near-distortionless sine wave generator (< 0.1% 20-20,000c) providing fast, convenient, switch-selection of frequencies from 1c to 1,000c (1c steps 10c-100c, 10c steps 100c-1kc, 100c steps 1kc-10kc, 1kc steps 10kc-100kc). 8-pos. 10db/step output attenuator & fine attenuator. Output meter (4 1/2" 200ua) with 8 voltage ranges & db scale. \$49.95 kit, \$69.95 wired.



Model 232 Peak-to-Peak VTVM. A must for color or B & W TV and industrial use. 7 non-skip ranges on all 4 functions. With Uni-Probe. \$29.95 kit, \$49.95 wired.



New Model 779 — Sentinel 23 CB Transceiver. 23-channel frequency synthesizer provides crystal-controlled transmit and receive on all 23 channels. No additional crystals to buy ever! Features include dual conversion, illuminated S/R/F meter, adjustable squelch and noise limiter, TVI filter, 117VAC and 12VDC transistorized dual power supply. Also serves as 3.5 watt P.A. system. \$169.95 wired.



New Model 712 — Sentinel 12 Dual Conversion 5-watt CB Transceiver. Permits 12-channel crystal-controlled transmit and receive, plus 23-channel tunable receive. Incorporates adjustable squelch & noise limiter, & switches for 3.5 watt P.A. use, spotting, & Part 15 operation. Transistorized 12VDC & 117VAC dual power supply. \$99.95 wired only.



New Model 753 — The one and only SSB/AM/CW Tri-Band Transceiver Kit. 200 watts PEP on 80, 40 and 20 meters. Receiver offset tuning, built-in VOX, high level dynamic ALC. Unequaled performance, features and appearance. Sensationally priced at \$179.95 kit, \$299.95 wired.



New Model 3566 — All Solid-State Automatic FM MPX Stereo Tuner/Amplifier. No tubes, not even nuvistors. Delivers 112 watts IHF total to 4 ohms, 75 watts to 8 ohms. Completely pre-wired and pre-aligned RF, IF and MPX circuitry, plus plug-in transistor sockets. \$219.95 kit (optional walnut cabinet \$14.95), \$325.00 wired including walnut cabinet. UL approved.



Model ST70 70-Watt Integrated Stereo Amplifier. Best buy of highest ranked stereo amplifiers according to independent testing. \$99.95 kit, \$149.95 wired. ST40 40-Watt Integrated Stereo Amplifier, \$79.95 kit, \$129.95 wired. ST97 Matching FM MPX Stereo Tuner, \$89.95 kit, \$139.95 wired.

EICO Electronic Instrument Co., Inc.
131-01 39th Ave., Flushing, N. Y. 11352

Send for **FREE** catalog describing the full EICO line of 200 best buys and name of nearest dealer. I'm interested in:

- test equipment
- hi-fi
- ham radio
- CB

Name _____

Address _____

City _____

State _____ Zip _____

1945-1965: TWENTY YEARS OF LEADERSHIP IN CREATIVE ELECTRONICS

1965

SUBJECT

REFERENCE

INDEX

This code of symbols is used to identify regular department locations in the subject page listings: CCM, Color Countermeasures; Sym, *Symfact*®; TE, Notes on Test Equipment; TS, The Troubleshooter; and VSS, Video Speed Servicing.

AFC

Common cathode, operationJan 6
TroubleshootingJan 6

AGC

Auto radio, inJan 58
Blanking bar to locate faults inAug 54
Chart for troubleshootingApr 78
Filter and distribution pathsAug 31
Filter troublesAug 32
Fullwave doubler systemJan 58
Halfwave systemJan 58
Picture overloaded due
to faultyVSS Feb 7
Takeoff networkSym Feb 27
Transistor leaky in auto radioJun 42
Troubleshooting
—auto radioJan 58
—lipsApr 33
—TVAug 31
Voltage chart for locating
troubleApr 78
Voltage insufficientTS Sep 85

ALIGNMENT

AM IFFeb 32
CB receiverMay 30
CB transmitterMay 31
Chroma bandpassNov 115
Chroma input coilNov 115
Color syncCCM Apr 77
Color TV, overallNov 47
High-voltage regulatorMay 65
Instrument setupOct 72
Instruments needed for TVOct 72
Modulation, CB, checkingMay 81
Procedure to follow for TVOct 73
Test equipment for colorNov 47
Tools for transistor setsJun 35
Trap misadjustment in color setNov 30
TunerNov 47
VSM (video-sweep
modulated)Nov 114
Video IFNov 48
Waveforms for sweepJan 28

ANTENNAS

Adjusting two or moreJul 26

Amplifier

—circuitsApr 44
—troubleshootingApr 46
Blow-down, avoiding
—factors to considerJul 27
—material and equipment,
—selectingJul 29
—wind pressure, determiningJul 27
Boosters and preamps, repairingApr 44
Connecting two or moreJul 25
Failures, spottingJul 31
Fringe-area installationJul 28
Grounding, proper procedureFeb 13
Horizontal stacksJul 25
Maintenance ofJul 30
Multiple systems, phasingJul 24
Pads vs matching transformersOct 94
Patterns
—singleJul 24
—stackedJul 24
PreamplifiersFeb 84
—servicing with sweep
generatorApr 82
—troubleshootingApr 47
—typical circuitsApr 44

Safety precautions when installing

Feb 13

Stereo FM

Aug 48

Systems, multiple

—E-planeJul 24

—H-planeJul 24

300-ohm padsOct 33

Tower

—crank downJul 54

—guywires forJul 54

—maintenanceJul 30

UHF

—bowtieJul 32

—colinear arrayJul 32

—corner reflectorJul 33

—disc-rodJul 46

—log-periodicJul 32

—parabolicJul 33

—planar-gridSep 90

—yagiJul 32

Vertical stackingJul 26

Windload effects, overcomingJul 27

Yagi, dual elementJul 83

AUDIO SYSTEMS

See also SOUND SECTION, TV
Acoustics, measuringAug 36

Amplifier circuits

—common baseAug 3
—common cathodeAug 2
—common emitterAug 3
—grounded gridAug 2

Amplifier defects

—low-gainAug 3
—humAug 3
—noiseAug 3
—oscillationAug 3

Attenuators, types ofOct 32

Bass compensatorJul 83

Buzz—caused by tube-socket

leakageJan 44

Buzz and hum inJan 27

Distortion problemsMar 52

Filter buzzJan 44

Frequency response, measuringMar 50

Gain, measuringMar 56

Harmonic distortionMar 52

.....Aug 1

High-level circuitsAug 6

Interference, scope analysis

to locateJan 27

Low-level circuitsAug 2

Medium-level circuitsAug 4

Output power, measuringMar 54

Output stage balance,
how toTS Oct 104

Output-transformerless circuitsAug 6

Output tube gassyJan 44

Paraphase amplifierAug 5

Phase distortionAug 2

Phono and tape recorder

cleaningAug 29

Push-pull outputAug 5

Ripple waveforms, normal

and abnormalJan 26

Tests and measurementsMar 50

TroubleshootingAug 1

AUTO RADIOS

AGC circuitsJan 58

Antenna-trimmer adjustmentFeb 32

Batteries weakJun 42

Front end, checkingApr 60

Hybrid—troubleshootingApr 56

Oscillation, cause ofJan 60

Oscillator-checksJun 32

—defectsApr 56

—slug adjustmentFeb 27

Strong-signal distortion	Jan 58
Transportable	
—1958 Pontiac and Oldsmobile	Jun 42
—1959, 1960 Buick, Oldsmobile, and Pontiac	Jun 43
—servicing	Jun 42
Voltage readings in AGC circuits	Jan 58
Volume fades	TS Aug 64

BOOK REVIEWS

<i>Acoustical Tests and Measurements</i>	Jul 60
<i>Basic Theory and Application of Transistors</i>	May 51
<i>Electronic Voltmeters</i>	Sep 88
<i>Handbook for Electronic Engineers and Technicians</i>	Dec 45
<i>How to Make More Money in Your TV Service Business</i>	Apr 83
<i>How to Service UHF TV</i>	Nov 119
<i>Radio and Television Receiver Circuitry and Operation</i>	Jun 66
<i>Servicing Garage Door Openers</i>	Mar 87
<i>Transistor AF and RF Circuits</i>	Jun 71

BOOST

Vertical sweep insufficient, DuMont Chassis 120642 VSS	Apr 5
Voltage low, Admiral Model 20SY4LS	TS Jan 69
Voltage low, Philco Chassis 14N50	VSS Feb 8

BUSINESS

Accountant, assistance from	Dec 32
AM-FM transistor repair, fees for	Oct 34
Antennas and towers, selling and servicing	Jul 31
Audio rental, leasing, and sales	Aug 24
Books for improving	Jan 52
CATV—as new line of	May 12
—effects on service shops	Feb 42
CB rules, new	Jan 62
CB-TVI problems	May 68
Citizens band	
—sales	Jan 64
—service	Feb 58
Color servicing, net profit picture	Nov 45
Color TV, more money	Nov 44
Customers, handling	Nov 15
Electronic servicing, future of	May 21
	Apr 36
FCC Rules on CB	May 44
Microwave servicing as new field	Mar 41
Radar	
—finding customers	Feb 39
—maintenance as new field	Apr 38
—pricing service	Feb 40
TV sales	
—points to make and when	Oct 49
—self confidence	Oct 50
—showroom condition	Oct 49
Technical training, obtaining	Sep 30
Technician	
—appearance	Nov 15
—hiring	Sep 30
Test equipment	
—specializing servicing	Mar 36
—trading old for new	Mar 93
Training programs for technicians	Sep 30

CABLE TV

growth of	Feb 42
-----------	--------

Effect on independent servicemen	Feb 42
	May 12
Questions and answers concerning	Feb 42

CAPACITORS

Charge vs discharge time	Aug 31
Electrolytics, square-wave testing	Jul 36
High-voltage types	Jul 62
Leakage test with square wave	Oct 31
Open test with square wave	Oct 31
Paralleling	Jul 62
RC circuits, square-wave testing	Aug 33
Ring test for	Jul 37
Square-wave testing of	Jul 36
Transistorized circuitry, for	Jul 37
Tuned circuit	Feb 83

CAPACITOR TESTERS

B & K Model 801	TE Aug 39
EICO Model 965	TE Oct 54
Mercury Model 1400	TE Jul 39
Sprague Model TO-6	TE May 74

CARTRIDGES (PHONO)

Elliptical-stylus	May 86
-------------------	--------

CHEMICALS

Adhesives	
—plastic repair, for	May 54
—speaker repair, for	May 54
—use in servicing	May 52
Carbon tet, dangerous	Oct 13
Contact cleaner	Sep 90

CITIZENS BAND

Accessories for	Feb 58
Alignment	May 30
Business application	Jan 64
Crystals	Feb 84
Current drain, checking	May 60
Customers	
—finding	Feb 60
—keeping	Feb 60
Equipment display	Feb 58
FCC, how affects	May 44
Future of	Jan 62
HELP transceiver	Sep 90
Increase range	Dec 23
Interference on TV	May 68
Mobile-unit installation	May 32
Modulation checks	May 81
New rules	Jan 62
Petitions to FCC	Sep 18
Reduce noise	Dec 23
RF circuits in	Sep 82
Rule changes	May 44
Rules governing service	Jan 65
Sales and service	Feb 58
Service policies	Feb 62
Transceiver tester	Sep 89

COILS

DC resistance	Apr 35
Distributed capacitance	Apr 35
Installation hints	Apr 81
Low-Q	Jun 50
Properties of	Apr 34
Skin effect	Apr 35
Square-wave testing	Jun 50
Types of	Apr 34

COLOR COUNTERMEASURES

Brightness insufficient	May 79
	Sep 75
Color bars damage CRT	Mar 66
Color picture drifts	May 79
Convergence problems	Dec 67

Zenith 29JC20—weak color	Jan 56
Zenith Chassis 26KC20, 25LC20, 25LC30 blooming and poor focus	Jul 81
Zenith Chassis 27KC20, brightness uncontrollable	Aug 66
Zenith receivers, b-w picture precedes color	Apr 77
Zenith receivers, raster missing, high voltage weak	Apr 77

COLOR GENERATORS

B & K Model 1240	TE Mar 62
Demodulator operation, for checking	Mar 39
Hue, checking	Mar 38
Lectrotech Model V7	TE Apr 54
Paco Model G36	TE Jan 73
Patterns produced, typical	Mar 38
Scope patterns produced by	Mar 39
Seco Model 980	TE Jun 55
SENCORE Model CG135	TE Jul 40
Use of	Mar 38

COLOR TV

ADG circuit analysis	
—Packard-Bell	Sep 87
—RCA	Sep 48
—Zenith	Sep 50
ADG troubleshooting	Sep 48
Alignment	
—chroma input coil	Nov 115
—factors governing	Nov 28
—overall	Nov 47
Automatic degaussing circuits	Sep 48
B-W picture precedes color picture	CCM Apr 77
Background-control adjustment	Sep 34
Bandpass amplifier	
—circuits	Nov 2
—hum	Jul 44
Blooming and poor focus (Zenith Chassis 26KC20, 25LC20, 25LC30)	CCM Jul 81
Blooming severe (Dumont Chassis 14M91)	VSS Apr 7
Blue missing	Sym Nov 65
Boost voltage low	CCM Sep 75
Brightness insufficient, color missing (Philco Chassis 14M91)	VSS Apr 7
(Magnavox 45 Series)	CCM May 79
(Philco Chassis 14M91)	VSS Apr 7
(RCA Chassis CTC5)	TS May 77
Brightness reduced, green missing	Sym Nov 64
Brightness uncontrollable (Zenith Chassis 27KC20)	CCM Aug 66
Cables, extension for 25" receivers	Jul 13
Chassis layout	
—Admiral Chassis G11	Nov 32
—Magnavox Chassis T904	Nov 33
—Motorola Chassis TS912	Nov 33
—Motorola Chassis TS914	Nov 34
—Packard-Bell Chassis 98C8	Nov 34
—RCA Chassis CTC15	Nov 35
—RCA Chassis CTC17	Nov 35
—Setchell-Carlson Chassis U800	Nov 59
—Sylvania Chassis D01	Nov 59
—Westinghouse Chassis V-2476-1	Nov 60
—Zenith Chassis 25MC36	Nov 65
Chroma bandpass alignment	Nov 115
Chroma sync, burst amp (Magnavox 45 Series)	Sym Mar 27

Color displaced	Jul 41
Color incorrect	Sym Mar 28
	July 44
Color missing, b-w normal	Nov 84
	VSS Apr 8
	Sym Mar 29
Color picture drifts (Zenith Chassis 29JC20)	CCM May 79
Color sync, loss of	Jul 41
	Sym Mar 29
Color-sync stages	Nov 3
Color washed out	Sym Nov 64
Color weak or missing	Sym Mar 28
Convergence improper, Philco Chassis 14M91	VSS Apr 8
CRT, damage from color-bar pattern	CCM Mar 66
CRT sizes	Nov 1
Degaussing tool	July 82
Demodulators	Nov 4
Difference amplifiers	Sym Nov 63
Filament open (RCA Chassis CTC9)	TS May 78
Gray-scale adjustment impossible	Nov 68
Gray-scale tracking	Sep 33
Green weak	Sym Nov 66
Guide to chassis layout	Nov 32
Height insufficient (Philco Chassis 14M91)	VSS Apr 8
Highlights green, lowlights red	Nov 71
High voltage and focus, troubleshooting	Nov 41
High-voltage regulation poor (RCA Chassis CTC5)	Nov 111
High-voltage regulators	May 62
Horizontal sweep and high voltage	Nov 6
Horizontal sweep and sync, troubleshooting	Nov 117
Horizontal sync critical	TS Aug 64
Interference, internal	Nov 70
Kit form	Nov 97
Low-voltage stages, troubleshooting	Nov 40
Luminance channels	Nov 1
Misalignment	Jul 44
1966 circuits	Nov 1
Outlook for future	Nov 45
Parts stock guide	Feb 22
Performance checks	Nov 29
Picture symptoms for home servicing	Jul 41
Pincushion circuits	Nov 8
Pincushion corrector (Zenith 25MC36 chassis)	Jun 39
Power supplies	Nov 8
Raster dim, video normal	Nov 67
Raster impurity (DuMont Chassis 120642)	VSS Apr 6
Raster missing, high voltage weak (Zenith receivers)	CCM Apr 77
Red smeared	Sym Nov 66
Red weak	Sym Nov 65
Retrace lines	Nov 72
Ringings caused by misalignment	Nov 29
Screen-control adjustment	Sep 34
Service, how to increase	Nov 44
Setup procedure	Sep 34
State-of-art report	Nov 52
Station on wrong channel	Nov 82
Temperature adjustments	Sep 33
Test jigs, information on	TS Apr 73
3.58-megacycle oscillator dead	Jul 44
Tuner AFC discriminator	Nov 113
Tuner AFC, troubleshooting	Nov 37

VHF oscillator, automatic frequency control	Nov 36
Vertical-hold critical	Nov 110
Vertical hold erratic (DuMont Chassis 120642)	VSS Apr 5
Vertical hold unstable	VSS Apr 5
Vertical jitter, impure raster	Nov 78
Vertical sweep —insufficient	VSS Apr 5
—missing (DuMont Chassis 120642)	VSS Apr 6
—troubleshooting	Nov 40
Waveform checkpoints in	Mar 40
Waveforms, how to analyze	Nov 38
Weak color—fringe area	CCM Jan 56
X demodulator dead	Jul 44
Zenith 25MC36 Chassis	Jun 38

COMMUNICATIONS

Business radio	Jan 62
CB alignment	May 30
CB customers, finding and keeping	Feb 58
CB rules	Jan 62
CB sales methods	Feb 60
CB servicing	Feb 62
FCC Rule changes	Jan 62
Final amplifiers	Sep 84
FM RF circuits using transistors	Sep 84
FM transceiver	Sep 84
HELP transceiver	Jul 21
Transistors in RF circuits	Sep 76

CRT's

(see PICTURE TUBES)

DIODES

Regulators, shunt	Jun 3
-------------------	-------

FIELD-STRENGTH METERS

Hickok Model 235A	TE Nov 90
Jerrold Model 704B	Mar 46
Sadelco Model FS2	Jul 84
Solid-state	Jun 4

FILAMENT CIRCUITS

Open (RCA Chassis CTC9)	TS May 78
-------------------------	-----------

FLYBACK TRANSFORMERS

(see HORIZONTAL-OUTPUT TRANSFORMERS)

FM RADIO

IF alignment	Feb 33
Tracking adjustments	Feb 32

GENERATORS

(see SIGNAL GENERATORS)

GUIDES

Accessory probes	Mar 60
CB-communications tube usage	May 18
Color chassis layouts	Nov 32
Color TV parts	Feb 22
High-voltage regulator troubles	May 62
Resistors, fusible	Dec 55
Stock, TV tubes	Apr 20
Transistor radio importers and manufacturers	Jun 22
UHF antennas	Jul 32

HI-FI SYSTEMS

Hum (Symphonic models)	TS May 77
Output stage, how to balance	TS Oct 103

HIGH VOLTAGE

Loss of	TS Oct 104
Missing or reduced	Jan 2
Missing (Westinghouse Model H-K3821)	TS Apr 75
Regulator adjustments	May 65
Regulator troubleshooting	May 62

HORIZONTAL OSCILLATOR

Cathode-coupled multivibrator	Jan 5
Common-cathode AFC	Jan 6
Drive line—remedies for	Jan 4

Off frequency	Jan 5
Sine wave	Jan 8
Synchroguide	Jan 7
Theory of operation	Jan 5
Tube burns-out	TS Jul 80

HORIZONTAL-OUTPUT TRANSFORMERS

Overheating	Jan 3
	TS Jul 79
Resistance checks of	Jan 3
Shorted turns	Jan 3

HORIZONTAL SWEEP

Bias voltage missing (Admiral Model 20SY4LS)	TS Jan 69
Boost defect	Jan 3
Boost filter capacitor leaky	VSS Feb 8
Dim raster	Jan 4
Drive insufficient	Jan 2
Drive line, causes for	Jan 4
Flyback and yoke circuit operation	Jan 4
High-voltage regulation, poor	Nov 111
Linearity adjustments	Jan 4
Linearity faults —left side compressed	Jan 4
—right side compressed	Jan 4
Nonlinearity	Feb 82
No raster, causes for	Jan 2
Output tube gets red hot	TS Mar 104
Picture narrow (Philco Chassis 12N51A)	TS Jan 67

Raster

—blooming	TS Mar 104
—missing	Sym Sep 57
—narrow	Sym Sep 58
Transistor circuits	Oct 29
Troubleshooting	Jan 1
Width adjustments	Jan 4
Width and arcing caused by incorrect line voltage	Feb 66
Width and height insufficient, transistorized sets	Sym Oct 70
Width insufficient	Jan 3
	VSS May 8
	Sym Sep 56

Width reduced, buzz in sound

	VSS Sep 8
Yoke or flyback, shorted	Jan 3

HORIZONTAL SYNC

Bars in top of picture	Aug 32
Cathode-coupled multivibrator, circuit explanation	Jan 5
Common-cathode AFC, circuit explanation	Jan 6
Critical, shaded bar on left side of raster	VSS Feb 6
Critical, vertical also critical	Sym Jul 67
Drive waveform distorted	Jan 5
Erratic	TS Jun 71
Hold control requires constant readjustment	VSS Jul 7
Hold drifts out of range	VSS Sep 5
Horizontal hold unstable	VSS Jul 6
Jitter and vertical roll	VSS Jul 8
Jitter picture	TS Apr 74
Jittery when set is cold (Admiral Chassis 19G3-D)	TS May 76
Loss of	Jan 6
	Sym Feb 28
Loss of, vertical also affected	VSS Feb
Noise-canceller effects	Se
Noise interference (DuMont Chassis 120591A)	VSS
Oscillator operates at incorrect frequency	

Pulling in raster	VSS Feb 7
Pulses clipped	Sep 40
Scope for troubleshooting	Sep 39
Sine-wave oscillator, circuit explanation	Jan 8
Synchroguide oscillator, circuit explanation	Jan 7
Tearing severe	Sep 79
Troubleshooting	Jan 5
Unstable	Sym Feb 30
Unstable, vertical jitter	Sep 40
Unstable, vertical roll (RCA Chassis KCS136YA)	VSS May 6
Weaving and twisting	Sep 40

HUM

Bandpass amplifier, in	Jul 44
Bar in picture	Sym Oct 69
Cancellation, transistor power supply	Sym Oct 64
Color-bar pattern distorted, caused by	Jul 41
Difference amplifier, in	Jul 44
Electrolytic leakage, causing	Feb 50
No audio	Sym Jan 22
X demodulator	Jul 44

IF SECTION OF TV

Alignment	Nov 48
Oscillation in picture	VSS Feb 7
Stagger-tuned 2nd and 3rd stages	Sym Apr 27
Waveforms for aligning	Jan 28

INDUSTRIAL ELECTRONICS

Microwave equipment, typical	Mar 41
Microwave servicing	
—differential gain in phase, checking	Mar 42
—noise-power ratio	Mar 43
—transmitter output measuring	Mar 43
Radar	
—circuit analysis	Apr 38
—location of units	Apr 76
—manufacturers	Feb 79
—servicing	Feb 38
	Apr 38
—troubleshooting	Jul 72
Solid-state relays	Jun 54
Tools for servicing radar	Feb 40
Tubes, radar	Feb 39

INTERCOMS

All-master system	Sep 64
Checkout of	Sep 70
Circuit analysis	Sep 65
Distribution-master system	Sep 64
Single-master system	Sep 61
Transistor types	Sep 66
Troubleshooting	Sep 66

INTERFERENCE

CB in television	May 68
Electric fence, from	TS Mar 105
Herringbone pattern	TS Oct 103
Horizontal line, caused by open AGC filter	Aug 52
Internal in color set	Nov 70
Oscillation, Barkhausen	Jul 34
RF, finding and curing	Jul 34
Sources for tracing	Jul 35
Symptom identity	Jul 35
Techniques for locating	Jul 35
Transient	Jul 34
Types of	Jul 34

INTERMITTENT TROUBLES

Color picture drifts (Zenith Chassis 29JC20)	CCM May 79
Connector, erratic in transportable car radio	Jun 42

Volume varies (Zenith Chassis 14L30)	VSS May 8
--------------------------------------	-----------

MISCELLANEOUS

ASCAP and BMI, role in background music	Aug 51
Background music	
—license, obtaining	Aug 50
—restrictions and fees governing	Aug 51
Import trends	Sep 46

MULTIPLEX

Circuit analysis	Oct 38
Demodulators, biphase detection	Oct 40
FCC requirements	Oct 38
Generator, Heath Model IG-112	TE Jul 38
Generator operation	TE Feb 74
Hiss caused by 38-kc oscillator	Oct 39
Indicator lamps	Oct 40
Receivers	
—all transistorized	Aug 27
—hybrid	Aug 47
—servicing	Aug 48
Solid-state circuits	Aug 27
Squelch circuits	Oct 39

NOTES ON TEST EQUIPMENT

Acme Model PS39590, "Scope-O-Trol"	Sep 51
B & K Model 801, Capacitor Checker	Aug 39
B & K Model 1240, Color Generator	Mar 62
EICO Model 342, Multiplex Generator	Dec 48
EICO Model 369, Sweep Generator	Apr 50
EICO Model 435, DC Oscilloscope	Aug 39
EICO Model 965, Capacitance and Resistance Analyzer	Oct 54
EMC Model 107A, VTVM	Nov 88
Heath Model IG-112, Stereo Generator	Jul 38
Heath Model IM-13, VTVM	Sep 51
Heath Model IO-12, Oscilloscope	Jan 70
Hickok Model 235A, Field-Strength Meter	Nov 90
Hickok Model 580, Tube Tester	Apr 52
Hickok Model 727, Multiplex Generator	Feb 74
Jackson Model 825, CRT Tester	May 71
Lectrotech Model V7, Color Generator	Apr 54
Mercury Model 202E, Tube Tester	Oct 54
Mercury Model 1400, Capacitor Checker	Jul 39
Paco Model G36, Color Generator	Jan 73
RCA Model WO-91B, Oscilloscope	Oct 58
RCA Model WT-115A, CRT Tester	Mar 64
Seco Model 980, Color Generator	Jun 55
SENCORE Model CG135, Color Generator	Jul 40
SENCORE Model CR128, CRT Tester	Feb 77
SENCORE Model CR133, CRT Checker	Sep 52
SENCORE Model PS127, Oscilloscope	May 71
SENCORE Model TC131, Tube Tester	Nov 94
Sprague Model TO-6, Capacitor Checker	May 74

Triplet Model 3490-A, Transistor Tester	Mar 66
---	--------

OSCILLOSCOPES

Cathode-follower input	Mar 6
Crosstalk in	Mar 7
DC response	Mar 8
DC wideband, EICO Model 435	TE Aug 39
Driver-stage improvements	Mar 4
Heath Model IO-12	TE Jan 70
High-frequency compensation	Mar 1
High-voltage hum	Mar 7
Hum problems in	Mar 7
Modifying output stage	Mar 1
Preamplifier circuits	Mar 5
Push-pull output	Mar 1
RCA Model WO-91B	TE Oct 58
SENCORE Model PS127	TE May 71
Sensitivity, testing	Mar 4
Triggered-sweep, advantages of	Mar 100
Triggered-sweep, how they work	Mar 99
Triggered-sweep vs conventional	Mar 100
Vertical attenuator, adjusting	Mar 6
Vertical bounce, eliminating	Mar 5
Widebanding vertical amplifier	Mar 1

PA SYSTEMS

Leasing, rental, and sales	Aug 24
----------------------------	--------

PHONOGRAPHS

Belt-drive mechanisms, cleaning	Aug 29
Idler-drive maintenance	Aug 29
Tools and materials for cleaning	Aug 29

PICTURE SYMPTOMS

Brightness control has no effect	TS Oct 103
Ghost	Sym Apr 30
Video and sound missing	Sym Apr 29
Video and sound weak (DuMont Chassis 120642)	VSS Apr 6
Video weak, fringe channels missing	Sym Apr 28
Video weak, smeared	Sym Apr 29
Video weak, sound reduced	Sym Apr 28
Video weak, sync critical	Sym Apr 30

PICTURE TUBES

Bonded types	Feb 36
Color-bar-pattern damage to color tube	CCM Mar 66
Color CRT sizes	Nov 1
Comparison of round and rectangular	Feb 36
Construction of	Feb 36
Mounting techniques	Feb 36

POWER SUPPLIES

B+ paths, tracing	May 34
Color TV	Nov 8
Transistor regulators	Jun 3
Transistorized TV	Sym Oct 67
Troubleshooting	TS Feb 72
Variable transformers for checkout	Feb 64
Voltage-divider networks	Feb 52

PREVIEWS OF NEW SETS

Admiral Model LG5315, Chassis G-1263-1	Jul 1
Airline Model GST-4615A	Apr 1
Curtis-Mathes Chassis TV19-2	Sep 1
Delmonico Model UHF-19	Feb 1
Emerson Model D2011, Chassis 120744G	Feb 2
General Electric Model M403AVY, Chassis DA	Apr 2
Grundig Model TV59T50	Feb 3
Magnavox Model 1U107, Chassis U49-01-00	May 1
Olympic Model K-985, Chassis NAP	May 2

Packard Bell Model 23K6, Chassis 88-16C	May 3
Panasonic Model AN-16	Sep 2
Philco Model N1200 BR	Jul 2
RCA Model AF-020J, Chassis KCS152A	Apr 3
RCA Model AG-159E, Chassis KCS149AA	Sep 3
Sears Model 5170, Chassis 562.10102	Jul 3
Sony Model TV5-305UW	Sep 4
Sylvania Model 23L133CU, Chassis 585-1	Apr 4
Westinghouse Model H-P8020, Chassis V-2478-2	May 4
Zenith Chassis 25MC33	Jul 4
Zenith Model M2231LU, Chassis 14M27	Feb 4
PROBES	
Demodulator	Jun 2
Guide, cross-reference	Mar 60
RADIO	
(Also see AUTO and TRANSISTOR)	
AM IF alignment	Feb 32
Buzz and hum, cures for	Jan 26
Intermittent volume in AC-DC sets	TS Jan 68
Variable line transformer for troubleshooting	Feb 69
RASTER (FAULTS)	
Absent	Jan 2
Blooming, picture narrow	TS Oct 104
Brightness cannot be varied (Zenith color receiver Chassis 27KC20)	CCM Aug 66
Brightness control has no effect	TS Oct 104
Brightness insufficient (Magnavox 45 series)	CCM May 79
Brightness reduced (RCA Chassis CTC5)	TS May 77
(RCA Chassis CTC15)	CCM Sep 75
Brightness reduced, video normal in color receiver	Nov 67
Dim or absent	Jan 2
Extinguish, impossible to	Sym Jul 66
Height insufficient	Sym May 26
Height insufficient, vertical linearity poor (RCA Chassis KCS136YA)	VSS May 6
Missing	Sym Sep 57
—no high voltage	VSS Sep 5
—sound normal	TS Feb 72
Narrow	Sym Sep 58
Picture dim	VSS Feb 8
Picture elongated	VSS Sep 5
Picture takes excessive amount of time to fill screen	VSS Jul 7
Shaded bar on left (DuMont Chassis 120591A)	VSS Feb 6
Vertical deflection lost	Sym May 26
Vertical linearity incorrect (RCA Chassis KCS136YA)	VSS May 5
Vertical sweep collapses after set is on for an hour (Zenith Chassis 14L30)	VSS May 7
Vertical sweep missing	VSS Jul 6
	VSS Sep 7
	VSS Apr 6
Width insufficient	Sym Feb 29
(Philco Chassis 14N50)	VSS Feb 8
(Zenith Chassis 14L30)	VSS May 8
RECORD CHANGERS	
Buzz—caused by tube socket leakage	Jan 44
Buzz and hum, cures for	Jan 27

Drive-belt slippage, eliminating	May 58
Ripple waveforms, normal and abnormal	Jan 26
RECTIFIERS	
Solid-state circuits	Jun 1
RESISTORS	
Fusible, guide to	Dec 55
Integrated networks, square-wave testing	Oct 30
Pads and attenuators	Oct 32
RC circuits, square-wave testing	Aug 33
Square-wave tests for	May 37
Voltage dividers, as	Feb 52
	May 34
SCOPES	
DC wideband, EICO Model 435	Aug 39
Heath Model IO-12	TE Jan 70
Modernizing the older models	Mar 1
RCA Model WO-91B	TE Oct 58
SENCORE Model PS127	TE May 71
Triggered-sweep, advantages of	Mar 100
Triggered-sweep, how they work	Mar 99
Triggered-sweep vs conventional	Mar 100
SEMICONDUCTORS	
4-layer diodes	Jun 48
PIN diode	Jun 63
Silicon controlled rectifier	Jun 73
Tunnel diodes	Jun 46
Varactors	Jun 48
Zener diodes	Jun 46
SHOP TALK	
AGC Filter and Distribution Faults	Aug 31
Curing Buzz, Hum, and Other Noises	Jan 26
Improving TV receivers	Nov 50
Rectangular CRT's	Feb 36
SIGNAL GENERATORS, AUDIO	
Solid-state	Jun 6
SIGNAL GENERATORS, RF	
Alignment, for	Feb 33
Solid-state	Jun 7
Stereo FM, Heath Model IG-112	TE Jul 38
SOUND DETECTORS, TV	
'BN6 circuit	Sym Jan 21
SOUND SECTION OF TV	
Audio diminishes with rotation of contrast	VSS Feb 8
Audio intermittent	VSS Jul 6
Audio missing in transistor set	Sym Aug 60
Buzz—caused by open quadrature	Sym Jan 24
Buzz, garbled and weak audio, no raster—transistor sets	Sym Oct 68
Buzz, video overload	Sym Feb 30
	VSS Jul 5
Distorted	Sym Jan 22
Distorted, height and width insufficient, transistor receiver	Sym Oct 70
Intermittent	VSS Jul 8
(RCA Chassis KCS136YA)	VSS May 6
(Zenith Chassis 14L30)	VSS May 8
Missing	Sym Jan 22
	Sym Feb 29
Missing—caused by open buzz control	Sym Jan 23
Missing—caused by open takeoff coil	Sym Jan 22
Missing, loud hum	VSS Feb 6
No audio	VSS Sep 6

No sound, raster and picture normal	Sym Jul 68
Reduced volume, buzz	VSS Sep 7
Ripple, how to decrease	Jan 27
Sound and raster absent, transistor set	Sym Oct 70
Sound intermittent, picture also intermittent	VSS Jul 7
Sound missing, picture also missing	Sym Jul 66
Sound weak, 60-cps hum (Magnavox Chassis CT372)	TS Apr 74
TRANSISTOR RECEIVER	
—audio missing	Sym Jun 28
—buzz, audio reduced	Sym Jun 30
—volume insufficient	Sym Jun 29
Transistor sound IF, with ratio detector	Sym Jun 27
Transistorized output with driver	Sym Aug 59
Volume decreases as set warms up	VSS Jul 5
Volume intermittent (Zenith Chassis 14L30)	VSS May 8
Volume reduced in transistor set	Sym Aug 60
Volume reduced, video overloaded	Sym Jul 68
Waveforms for troubleshooting	Jan 27
Weak	Sym Jan 22
Weak and distorted (Zenith Chassis 14L30)	VSS May 7
Weak, interference in picture	Sym Jul 67
SPEAKERS	
Pads and attenuators, use of	Oct 33
Repair, how to	May 52
SQUARE-WAVE GENERATORS	
Analysis of	Apr 79
Capacitor checking, for	Jul 36
Equipment setup for checking resistance	May 38
Inductors, for testing	Jun 50
Multiple-terminal networks, for checking	Oct 93
	Dec 18
RC circuits, for testing	Aug 33
Resistors, for checking	May 38
Termination	May 39
STEREO FM	
Demodulators, biphase detection	Oct 40
FCC requirements	Oct 38
Generator, EICO Model 342	Dec 48
Generator, Heath Model IG-112	TE Jul 38
Hiss caused by 38-kc oscillator	Oct 39
Hybrid receivers	Aug 47
Indicator lamps	Oct 40
Solid-state servicing	Aug 48
Solid-state units	Aug 28
Squelch circuits	Oct 39
Transistors in	Oct 39
SYMFACT®	
Audio output, push-pull with driver	Aug 59
'BN6 sound detector	Jan 21
Chroma sync, burst amp	Mar 27
Difference amplifiers, R-Y, B-Y, and G-Y	Nov 63
Horizontal-output stage	Sep 55
Power supply, transistor sets	Oct 67
Stacked B+, audio output as voltage divider	
Stagger-tuned IF, 2nd and 3rd stages	
Sync separator/AGC, compactron	

Transistor sound IF, with ratio detector	Jun 27
Vertical output, 2nd half of multivibrator	May 25
Video-AGC-sync takeoff circuits	Feb 27
SYNC	
(Also see HORIZONTAL and VERTICAL)	
Absent, horizontal and vertical	Sep 40
	Sym Dec 38
(RCA Chassis KCS136YA)	VSS May 6
Critical, video weak	Sym Jul 66
Horizontal jitter and vertical roll	VSS Jul 8
Horizontal tearing	Sep 79
Instability	Sep 40
	Sym Dec 39
Intermittent, caused by open B+ filter	Sym Jul 67
Picture jittery, sync unstable	VSS Sep 7
Takeoff networks	Sym Feb 27
Unstable	Sym Feb 30
	VSS Sep 6
	TS Aug 64
	VSS May 7
Vertical and horizontal lost	Sym Feb 28
	VSS Feb 6
Vertical weak, horizontal pulling	VSS Feb 7
Vertical roll, horizontal instability	VSS Sep 8
Video contamination	Sep 43
TAPE RECORDERS	
Brake mechanism, cleaning	Aug 30
Cartridge-type for autos	Aug 25
Clutches, servicing	Aug 30
Drive-belt slippage, eliminating	May 58
Idler drive, maintenance	Aug 29
Tape-head, maintenance	Aug 30
Tape-splicing kit	Sep 91
Tools and materials for cleaning	Aug 29
VOX	
—rectified-type, circuit analysis	Oct 37
—repair of	Oct 99
—simple amplified, circuit analysis	Oct 36
—troubleshooting	Oct 37
VOX, convert to	Apr 85
TELEVISION	
Alignment	
—instruments needed	Oct 72
—overall	Nov 47
—procedure to follow	Oct 73
Brightness and height insufficient, transistor set	Sym Oct 68
Color-TV waveform analysis	Nov 38
Contrast, modifications to improve	Nov 50
Dead receiver	TS Feb 72
Picture snowy, transistor set	Sym Oct 69
Power supply, transistor	Sym Oct 67
RF interference, finding and curing	Jul 34
Receivers for 1966	Oct 1
Sales, new and used	
—salesmanship	Oct 50
—showroom condition	Oct 49
Sound and raster absent, transistor set	Sym Oct 70
Sound garbled, no raster, transistor set	Sym Oct 68
Transistorized circuits	Oct 29
Tuner alignment	Nov 47
VHF-station activity	Jan 30
Waveforms, composite video	Feb 34

TEST EQUIPMENT

Acme Model PS39590, Scope Calibrator	Sep 51
Alignment, color TV	Nov 47
Audio oscillators, solid-state	Jun 7
Audio tests and measurements, for	Mar 50
B & K Model 801, Capacitor Checker	Aug 39
Cost of purchasing new	Mar 94
Depreciation	Mar 96
EICO Model 369, Sweep Generator	Apr 50
EICO Model 435, DC Oscilloscope	Aug 39
EICO Model 965, Capacitance and Resistance Analyzer	Oct 54
EMC Model 107A, VTVM	Nov 88
ESCO Model XT-1 Transistor Tester	Aug 57
Graphic-level recorder	Aug 38
Heath Model IG-112, Stereo FM Generator	Jul 38
Heath Model IM-13, VTVM	Sep 51
Heath Model IO-12, Oscilloscope	Jan 70
Hickok Model 235A, Field-Strength Meter	Nov 90
Hickok Model 580, Tube Tester	Apr 52
Hickok Model 727, Multiplex Generator	Feb 74
Lectrotech Model V7, Color-Bar Generator	Apr 54
Mercury Model 202E, Tube Tester	Oct 54
Mercury Model 1400, Capacitor Checker	Jul 39
Meter protection, solid-state	Jun 2
Microwave	Mar 41
Oscilloscope, updating	Mar 1
Paco Model G36, Color Generator	Jan 73
Purchasing new instruments	Mar 93
RCA Model WO-91B, Oscilloscope	Oct 58
Repair your own	Mar 32
Seco Model 980, Color Generator	Jun 55
SENCORE Model CG135, Color Generator	Jul 40
SENCORE Model CR128, CRT Tester	Feb 77
SENCORE Model CR133, CRT Checker	Sep 52
SENCORE Model TC131, Tube Tester	Nov 94
Sound-level calibrator	Aug 44
Sound-level meter	Aug 37
Specialists, meet two	Mar 36
Trading old for new	Mar 93
Transceiver tester	Sep 89
Transistorized	
—field-strength meter	Jun 4
—frequency meter	Jun 4
—signal generator	Jun 6
—voltmeter	Jun 5
Unijunction transistors in	Jul 40
Updating old instruments	Mar 93
VOM, uses for	Mar 70
Wave analyzer	Aug 37
THEORY	
AGC circuits	Apr 32
Audio circuits	Aug 1
Books, technical	Jan 52
Color generators	Jan 73
Horizontal-AFC circuit	Jan 5
Horizontal-output circuit	Jan 1
Resistive voltage dividers	May 34

Test equipment, solid-state	Jun 1
Triggered-sweep scopes, learning about	Mar 99
Tubes as voltage dividers, how they work	Mar 82
Voltage division	Feb 52
TOOLS	
Color-TV degausser	Jul 82
Desoldering	Aug 72
Seizers, miniature	Feb 84
Special uses for	Mar 91
Transistor servicing, for	Jun 34
Types, new and unusual	Mar 88
Wire cutter	Jun 78
TRANSFORMERS AND COILS	
Square-wave tests of	Jun 50
Variable line	Feb 64
Variable line, applications for	Feb 64
Variable, to locate horizontal-sweep problems	Feb 66
TRANSISTORS	
AGC, auto radio	Jan 58
Audio amplifiers, in	Aug 27
Audio circuits, in	Aug 3
Bias, checking	Sep 36
Circuit fundamentals	Sep 36
Construction of	Sep 76
Epitaxial types	Sep 78
FM multiplex, used in	Oct 39
FM RF section, in	Aug 27
Impedance matching	Sep 81
Industrial relays, as	Jun 54
Leakage, determining	Oct 88
Mesa construction	Sep 78
New types	Oct 76
PNP or NPN, determining	Sep 81
Planar type	Sep 13
Power supply, TV	Sym Oct 67
Power-type	Sep 92
Silicon controlled rectifiers	Jun 73
Stereo FM, in	Aug 28
Test-equipment circuits	
—meter protection	Jun 2
—power supplies regulated	Jun 3
—rectifier	Jun 1
—signal generators	Jun 6
—signal measuring devices	Jun 4
—voltmeters	Jun 5
Tester, ESCO Model XT-1	Aug 57
Tester, Triplett Model 3490-A	TE Mar 66
Unijunction	Jul 40
VHF front-end, in	Sep 76
TRANSISTOR RADIO	
Alignment difficulties	Dec 65
Audio and IF stages, checking	Oct 35
Batteries, troubles caused by	Oct 35
Common troubles in	Sep 38
Distortion in	Sep 38
FM defects	Oct 98
Guide to importers and manufacturers	Jun 22
Miniature sets, servicing	Jun 34
Modules in	Oct 98
Motorboating	Oct 98
Printed-board repair	Jun 40
Tools needed for repair	Oct 35
Voltage check chart	Oct 35
TRANSISTOR TESTERS	
ESCO Model XT-1	Aug 57
Triplett Model 3490-A	TE Mar 66
TRANSISTOR TV	
Audio missing	Sym Aug 60
	Sym Aug 62
—slight buzz	Sym Jun 28
Audio output, push-pull with driver	Sym Aug 59
Brightness and height insufficient	Oct 68

Buzz, audio weakSym Jun 30
 Height and width
 insufficientSym Oct 70
 Horizontal-sweep circuit
 operationOct 29
 Picture snowySym Oct 69
 Picture stretched and bentSym Oct 69
 Power supplySym Oct 67
 Printed-board repairJun 40
 Ratio-detector transformer
 openSym Jun 28
 Sound and raster absentSym Oct 70
 Sound garbled, no rasterSym Oct 68
 Sound IF, with ratio
 detectorSym Jun 27
 Transistor replacement, criticalOct 88
 Troubleshooting proceduresOct 88
 Vertical sweep
 —height troublesJun 37
 —sync troublesJun 37
 —3-stageJun 36
 —troubleshootingJun 37
 Vertical-sweep circuit operationOct 29
 Volume insufficientSym Jun 29
 Volume reducedSym Aug 60
 Volume weak, slight buzzSym Jun 29

TROUBLESHOOTER, THE
 AGC insufficient, RCA
 Chassis KCS81ASep 85
 Alignment difficulties,
 transistor radioDec 65
 Boost voltage low, Admiral
 Model 20SY4LSJan 69
 Brightness control has no effect,
 Philco Chassis 13N52Oct 103
 Brightness reduced (RCA
 Chassis CTC5)May 77
 Filament open (RCA
 Chassis CTC9)May 78
 Herringbone patternOct 103
 High voltage missing,
 Westinghouse Model
 H-K3821Apr 75
 Horizontal bends, Magnavox
 36 seriesDec 66
 Horizontal flutter when set is cold,
 Admiral Chassis 19G3-DMay 76
 Horizontal jitter, RCA
 Model 21S353Apr 74
 Horizontal lines in picture,
 Emerson Chassis 1282XJun 70
 Horizontal-output tube gets red
 hot, Muntz Model 2158AMar 104
 Horizontal sync critical, Admiral
 Model T-1000Aug 64
 Horizontal sync erratic,
 Hoffman Model 637Jun 71
 Hum in Symphonic hi-fiMay 77
 Narrow picture, Philco
 Chassis 12N51AJan 67
 Negative picture, Olympic
 Chassis GBFeb 70
 Oscillator faults, Ford
 Model 74BFDec 65
 Picture blooms, RCA
 Chassis KCS47EMar 104
 Raster missing, Zenith
 Chassis 16D25QOct 104
 Receiver dead, Crosley
 Chassis 431Feb 72
 Sound weak, 60-cps hum,
 Magnavox Chassis CT372Apr 74
 Tube burnout, instant, Silvertone
 Chassis 528.51108Jul 80
 Vertical jitter, Philco
 Chassis 8171Jan 68
 Vertical linearity poor,
 Westinghouse Chassis
 V2311-45Jul 79

Vertical roll, Bradford
 Model 91199ASep 86
 Vertical roll, Sylvania
 Model 1712303SSep 85
 Vertical sync weak, Magnavox
 45 seriesDec 66
 Volume fades, auto radio,
 Ford Model 3TBDAug 64
 Volume intermittent, Zenith
 Model L507Jan 67

TUBES
 Audio output as voltage
 dividerSym Jul 65
 Burnout, repeatFeb 68
 CB-communications tube-
 usage guideMay 18
 CaddyAug 70
 Caddy stockJan 33
 Emission, checkingApr 67
 Evaluate in-circuitApr 62
 Gas. test forApr 69
 Instant burnout (Silvertone
 Chassis 528.51108)TS Jul 80
 Leakage, test forApr 70
 Manual, card styleMay 80
 New typesJan 33
 Noise, test forApr 69
 Parameters ofApr 62
 TV stock guideApr 20
 TV usage guideJan 33
 Testing in circuitApr 66
 Transconductance, checkingApr 67
 Triode voltage dividerMar 82
 Types introduced in '65 TVApr 87
 Voltage dividers, used asMar 82

TUBE TESTERS
 CRT checker, Jackson
 Model 825TE May 71
 CRT checker, SENCORE
 Model CR133TE Sep 52
 CRT rejuvenator and tester,
 RCA Model WT-115ATE Mar 64
 CRT tester, SENCORE
 Model CR128TE Feb 77
 CRT testers
 —automatic rejuvenationMar 106
 —filament-voltage controlMar 35
 —G2 voltage controlMar 35
 —gun-killer switchMar 35
 —line-voltage controlMar 35
 —new types availableMar 35
 —test sockets availableMar 35
 Emission typesMar 34
 Hickok Model 580TE Apr 52
 Mercury Model 202ETE Oct 54
 Mercury Model 1101May 87
 Mutual-conductance typesMar 34
 New types availableMar 34
 Repair, how toMar 33
 SENCORE Mitey-Mite IVSep 92
 SENCORE Model TC131TE Nov 94

TUNERS, TV
 AlignmentNov 47
 Automatic control of
 VHF oscillatorNov 36
 Balun coil openVSS Feb 7
 Hybrid-type VHFSep 91
 Pads and attenuators, use ofOct 33
 Station on wrong channelNov 82
 UHF, push-button tunerJul 18

TWO-WAY RADIO
 (See COMMUNICATIONS)

UHF TELEVISION
 Antenna, disc-rodJul 46
 Color receptionDec 58
 CP's grantedJan 30

ETVJan 30
 Map of all stationsJan 31
 State-by-state breakdownJan 30
 Station activityJan 30
 Twelve years of progressDec 16

VERTICAL SWEEP
 Height inadequate, DuMont
 Chassis 120642VSS Apr 5
 VSS Apr 8
 VSS May 6
 Height insufficientSym May 26
 Height and width insufficient,
 transistor setsSym Oct 70
 Instability, DuMont
 Chassis 120591AVSS Feb 5
 Intermittent, disappears after
 set plays for about an hour
 (Zenith Chassis
 14L30)VSS May 7
 Jittery pictureVSS Feb 5
 Linearity poorVSS May 5
 Sym May 27
 TS Jul 79
 MissingVSS Apr 6
 VSS Jul 6
 VSS Sep 7
 No vertical deflectionSym May 26
 Pincushion corrector (Zenith
 Chassis 25MC36)Jun 39
 Raster compressed at
 bottomSym May 28
 Transistor circuitsOct 29
 Transistor receivers
 —distortionJun 58
 —height troublesJun 37
 —sync troublesJun 37
 Video in blanking pulseTS Jun 70

VERTICAL SYNC
 Critical, caused by open
 AGC filterAug 32
 Critical, horizontal also
 criticalSym Jul 67
 Hold control requires
 constant readjustmentVSS Jul 8
 Hold erraticVSS Apr 5
 Hold unstableVSS Apr 5
 IntermittentVSS Feb 8
 Jitter, impure picture in
 color receiverNov 78
 Loss ofSym Feb 28
 Loss of, horizontal
 also affectedVSS Feb 6
 Picture jitteryTS Jan 68
 Sep 40
 Nov 108
 RollVSS May 6
 TS Sep 85
 Roll affected by heatVSS Sep 6
 Roll after warmupTS Sep 86
 Roll and horizontal jitterVSS Jul 8
 Roll, linearity poorSym May 27
 Transistor sets, troubles inJun 37
 UnstableJan 66
 Sym Feb 30
 Unstable, horizontal pullingVSS Feb 7

VIDEO (FAULTS)
 Negative pictureTS Feb 70
 No pictureSym Feb 29
 Oscillation in pictureVSS Feb 7
 OverloadVSS Feb 7
 Sym Feb 30
 VSS Jul 5
 Overload, buzz in soundVSS Jul 5
 Overload, sync criticalVSS May 7

Overload, volume reduced	Sym Jul 68
Picture absent, sound missing	VSS May 5
Picture diminishes with rotation of contrast	VSS Feb 8
Picture intermittent, sound also intermittent	VSS May 8
	VSS Jul 7
Picture missing, caused by leaky B+ filter	Sym Jul 66
Picture smeared	Sym Feb 29
Picture and sound missing	Sym Apr 29
Picture washed out	VSS Feb 8
	Sym Feb 28
Picture weak, sound reduced	Sym Apr 28
	VSS May 5
Weak and smeared	Sym Apr 29
Weak, fringe channels missing	Sym Apr 28
Weak, sync critical	Sym Jul 66

VIDEO AMPLIFIER AND OUTPUT	
Contrast, modifications to improve	Nov 50
Takeoff networks	Sym Feb 27
VIDEO SPEED SERVICING	
Andrea Chassis BR-T1VW-319	Sep 5
DuMont Chassis 120591A	Feb 5
DuMont Chassis 120642	Apr 5
Emerson Chassis 120515-C	Sep 7
General Electric Chassis QY	Jul 5
Olympic Model 6P25	Jul 7
Philco Chassis 14M91	Apr 7
Philco Chassis 14N50	Feb 7
RCA Chassis KCS136YA	May 5
Zenith Chassis 14L30	May 7
VOM's	
Calibration	Mar 32
Inductance, measuring with	Mar 74
Inter-electrode leakage in CRT, for checking	Mar 70
Repair, how to	Mar 32

Resistance of meter movement, determining	Mar 70
Signal tracing with	Mar 74
Solid-state	Jun 5
Unusual applications for	Mar 70
VTVM's	
EMC Model 107A	TE Nov 88
Heath Model IM-13	TE Sep 51
WAVEFORMS	
Chroma bandpass amplifier	Nov 38
Color sync	Nov 39
Sweep alignment	Jan 28
Sync signal	Jan 66
Understanding	
—composite video signal	Feb 34
—horizontal components	Feb 33
—vertical components	Feb 33
YOKES	
Pincushion distortion	Feb 37
Shorted winding	Jan 3

INDEX OF TITLES

1965 PF REPORTER Subject Reference Index	Dec 1
AFC for Color Tuners	Nov 36
AGC Filter and Distribution Faults	Aug 31
AGC Servicing Magic	Apr 32
ASCAP and BMI	Aug 50
Acoustics Can Be Measured	Aug 36
Adhesives for Service Jobs	May 52
Advanced Techniques for Future Servicing	Apr 36
Analysis of Color-TV Waveforms	Nov 38
Arbitrating Problems of CB-TVI	May 68
Audio Servicing From A to Z	Aug 1
Audio Testing and Measurements	Mar 50
Automatic Degaussing	Sep 48
Books As A Service Tool	Jan 52
CATV Revisited	Feb 42
Can An Accountant Help You?	Dec 32
Casebook for Color Techs	Nov 67
Chasing Faults in Intercoms	Sep 61
Collection of Color TV Troubles	Nov 40
Color by Kit	Nov 97
Color Parts Guide	Feb 22
Curing Buzz, Hum, and Other Irritating Noises	Jan 26
Extend 2-Way Range	
Reduce Noise	Dec 23
Filter Buzz	Feb 50
Finding and Curing RF Interference	Jul 34
Finding and Keeping CB Customers	Feb 58
Finding Test Points on Printed Boards	Dec 30
Guide to Accessory Probes	Mar 60
Guide to Color-Set Chassis Layout	Nov 32
Guide to Fusible Resistors	Dec 55
Guideposts to Color Servicing	Nov 28
Highlights of 1966 TV Lines	Oct 1
Home Servicing by Picture Symptoms	Jul 41
Horizontal Troubleshooting From A to Z	Jan 1
How Many Uses for a VOM	Mar 70
How Transistor Amplifiers Work	Sep 36
Hybrids on the Auto Bench	Apr 56
Improving TV Receivers	Nov 50
In-Circuit Tests Evaluate Tubes	Apr 62
Installing A CB Mobile Unit	May 32
Instruments for Microwave Servicing	Mar 41
Introducing Zenith's 25" Color	Jun 38

Keep AM-FM Portables Working	Oct 34
Keep It Clean	Aug 29
Know Your '66 Color Circuits	Nov 1
Latest Circuits for FM Stereo	Oct 38
Learning About Triggered-Sweep Scopes	Mar 99
Linear Sweep for Flat CRT's	Feb 36
Maintenance of Antennas and Towers	Jul 30
Make Money in Rentals, Sales, Leases	Aug 24
Making Color Servicing Big Business	Nov 44
Making Money With Tinyvision Receivers	Oct 28
Meet A Test Equipment Specialist	Mar 36
Meet the . . . Istor Family	Oct 76
Microservicing in Pocket Portables	Jun 34
Modernizing Your Scope	Mar 1
New CRT and Tube Testers	Mar 34
New Form of UHF-TV Antenna	Jul 46
New Rules Spur Business Use of CB	Jan 62
Overall Alignment in Color Receivers	Nov 27
Overcoming Wind-Load Effects	Jul 27
Phasing Multiple-Antenna Systems	Jul 24
Radar Maintenance Is Easy—Part 1	Feb 38
Radar Maintenance Is Easy—Part 2	Apr 38
Radar Maintenance Is Easy—Part 3	Jul 72
Repair Your Own Test Equipment	Mar 32
Repairing Amplified Antennas	Apr 44
Repairing Etched Circuit Boards	Jun 40
Report on UHF Station Activity	Jan 30
Sales Tips for New and Used TV	Oct 49
Servicing Auto-Radio AGC	Jan 58
Servicing Vertical Sweep in Transistor Sets	Jun 36
Shortcuts Through Transportable Car Radios	Jun 42
'63-'64 TV Tube Usage Guide	Jan 33
Sly Old VOX (Recorder), The	Oct 36
Solid-State Circuits in Test Equipment	Jun 1
Solid-State RF Circuits	Sep 76
Solid-State Relays for Industry	Jun 54
Source Guide to Manufacturers and Importers, Transistor Radios	Jun 22

Square-Wave Testing for Inductors	Jun 50
Square-Wave Testing in Resistive Circuits	May 37
Square-Wave Testing of Capacitors	Jul 36
Square-Wave Tests for 3-Terminal Networks	Oct 30
	Dec 18
Stand Up to the Intermittent	Dec 26
State-of-Art Report on Color TV	Nov 52
Stereo With Transistors	Aug 26
Stock Guide for TV Tubes	Apr 20
Stock Guide of Communications Tubes	May 18
Sync System Service Suggestions	Sep 39
Testing 3-Terminal Networks	Aug 33
Tools—Extra Hands for Busy Techs	Mar 88
Tracing B+ Feed Paths	May 34
Tracking Adjustments for AM-FM	Feb 32
Tracking Gray-Scale in New Color Sets	Sep 33
Trade Old Test Equipment for New	Mar 93
Training Systems for Modern Technicians	Sep 30
Trends in Electronic Importing	Sep 46
Troubleshooting High-Voltage Regulators	May 62
Tubes As Voltage Dividers	Mar 82
12 Years of UHF	Dec 16
UHF Antennas for 1965	Jul 32
Understanding Pads and Attenuators	Oct 32
Unlocking Secrets of TV Alignment	Oct 72
Unusual CB Alignment Characteristics	May 30
Unwinding the Mystery of Coils	Apr 34
Using Color Generators	Mar 38
Variable Line Transformer As A Troubleshooting Aid	Feb 64
Voltage Division and How It Works	Feb 52
Watch How Schematics Grow	Oct 52
Waveforms for Sweep Alignment	Jan 28
Waveforms Save Analysis Time	Feb 34
What's Wrong With This Waveform	Jan 66
Where Stands CB With FCC?	May 44
Zeners, Tunnels, Mesas—So What's New?	Jun 46

Complete TUNER REPAIR for only

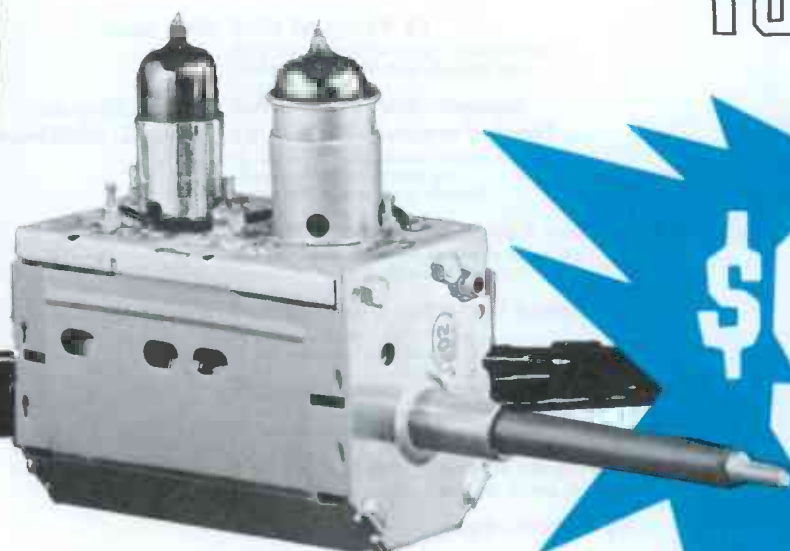

\$9.50

Sarkes Tarzian, Inc., largest manufacturer of TV and FM tuners, offers unexcelled tuner overhaul and factory-supervised repair service. Completely-equipped and conveniently-located Service Centers offer fast, dependable and factory-supervised repair service on all makes and models. Centers are staffed by well-trained technicians, assisted by engineering personnel.

Tarzian-made tuners received one day will be repaired and shipped out the next. More time may be required on other makes. Every channel—not just the channels existing in any given area—is checked and re-aligned per orig-

inal specifications. Exclusive cleaning method makes the tuner look—as well as operate—like new.

Cost, including ALL labor and parts (except tubes) is only \$9.50 and \$15 for UV combinations. No additional charge. No hidden costs. Too, you get a full, 12-month warranty against defective workmanship and parts failure due to normal usage.

Always send TV make, chassis and Model number with faulty tuner. Check with your local distributor for Sarkes Tarzian replacement tuners, parts or repair service. Or, use the address nearest you for fast, factory-supervised repair service.

TUNER SERVICE  CORPORATION

(Factory-supervised tuner service authorized by Sarkes Tarzian, Inc.)

547-49 Tonnelle Avenue, Jersey City, N.J.
Tel: 201-792-3730

SARKES  TARZIAN

TUNER SERVICE DIVISION

537 S. Walnut Street, Bloomington, Indiana
Tel: 812-332-6055

WEST—10654 Magnolia Blvd., N. Hollywood, Calif.
Tel: 213-769-2720

MANUFACTURERS OF TUNERS, SEMICONDUCTORS, AIR TRIMMERS, FM RADIOS, AM-FM RADIOS, AUDIO TAPE and BROADCAST EQUIPMENT

Circle 2 on literature card

December, 1965/PF REPORTER 9

PF Reporter™

PHOTOFACT

the magazine of electronic servicing

VOLUME 15, No. 12

DECEMBER, 1965

CONTENTS

publisher
Howard W. Sams

editor
Forest H. Belt

managing editor
James M. Moore

ass't to the editor
Norman D. Tonner

associate editors
Arnold E. Cly
David I. King

consulting editors
William E. Burke
Joe A. Graves
C. P. Olliphant

research librarian
Bonny Howland

production manager
Esther M. Rainey

circulation manager
Pot Tidd

Katherine Krise, Ass't.
Cora La Von Willard, Ass't.

art directors
Louis J. Bos, Jr.
Robert W. Reed

advertising & editorial assistants
Hazel Boyer
Rebecca Clingerman

photography
Paul Cornelius, Jr.

advertising sales offices
Hugh Wolloce, advertising sales manager

midwestern
Paul N. Houston
PF REPORTER, 4300 West 62nd Street,
Indianapolis, Ind., 291-3100

eastern
Gregory C. Masefield
Howard W. Sams & Co., Inc. 3 West 57th Street,
New York, N. Y., MUrroy Hill 8-6350

southwestern
C. H. (Jake) Stockwell
C. H. Stockwell Co., 4916 West 64th St,
Mission, Kansas, RAndolph 2-4417

western
G R. Holtz
The Maurice A. Kimball Co., Inc.
Los Angeles area: 2008 West Carson Street,
Suites 203-204, Torrance, Calif. 90501,
320-2204; and 580 Market Street,
Room 400, San Francisco 4, Calif. EXbrook 2-3365

Address all correspondence to
PF REPORTER, 4300 W. 62nd Street
Indianapolis, Indiana 46206



Copyright© 1965 by Howard W. Sams & Co., Inc.
PF REPORTER is a trademark of Howard W. Sams
& Co., Inc. No part of PF REPORTER may be
reproduced without written permission. No patent
liability is assumed with respect to use of
information herein. Acceptance of advertising does
not in any manner signify the products, policies
and services so advertised have been approved,
endorsed or recommended by this magazine.

Subscription Prices: 1 year—\$5.00, 2 years—\$8.00,
3 years—\$10.00, in the U. S. A., its possessions and Canada.
All other foreign countries: 1 year—\$6.00, 2 years—
\$10.00, 3 years—\$13.00. Single copy 50¢; back copies 65¢.

Indexed in Lectrodex.
Printed by the Woldemar Press Div.
of Howard W. Sams & Co., Inc.

1965 Annual Subject Reference Index	1
Letters to the Editor	14
The Electronic Scanner	15
12 Years of UHF Alan James	16
A first-hand report on experience, past and present, with UHF TV reception.	
Square-Wave Tests for Three-Terminal Networks David I. King and Robert G. Middleton	18
Advanced Service Techniques—A review of the important fundamentals already presented in the series.	
Extend Two-Way Range . . . Reduce Noise Jack Darr	23
Electrical disturbances at the receiving end of a two-way system also affect its range.	
Stand Up to the Intermittent Wayne Lemons	26
Don't let this breed of "tough dog" get you down.	
Finding Test Points on Printed Boards	30
Picture Story—The camera shows how to pinpoint those elusive circuit points.	
Can an Accountant Help You?	32
Chances are he can. Here are some of the ways.	
Symfact®: Sync Separator/AGC (Compactron)	37
See what happens to voltages and waveforms when troubles occur.	
Sync Troubles	43
Book Review	45
Notes on Test Equipment Arnold E. Cly	48
Lab reports on the EICO Model 342 FM Multiplex Generator.	
Fusible-Resistor Cross-Reference Guide	55
From A to Z About TV	62
The Troubleshooter	65
Color Countermeasures	67
Solution to November Puzzler	67
PFR Puzzler	68
Product Report	69
Free Catalog and Literature Service	74
Monthly Index on Free Literature Card	

ABOUT THE COVER

Miniature antennas and tuners are going to become a familiar sight to service technicians as UHF grows. A review of UHF development over the years in one area begins on page 16.



Have you tried **KWIKETTE**[★] connectors?

Not just another wire spring connector!
The 3-in-1 KWIKETTE is brand new and different...
Copperweld wire inner core, a layer of flux, and
an outer jacket of solder... all you need is heat!
Makes one-handed soldering possible!

Once again, Sprague helps the TV-radio service industry by solving two increasingly serious problems . . . parts replacement in those "inaccessible" chassis nooks, such as crowded tube sockets, as well as soldering onto printed wiring boards.

Mechanically sturdy and electrically reliable, the revolutionary KWIKETTE provides fast, expertly-soldered connections as easy as A-B-C!



Ten times
actual size

A

**Snip
Lead**



B

**Slip on
KWIKETTE**

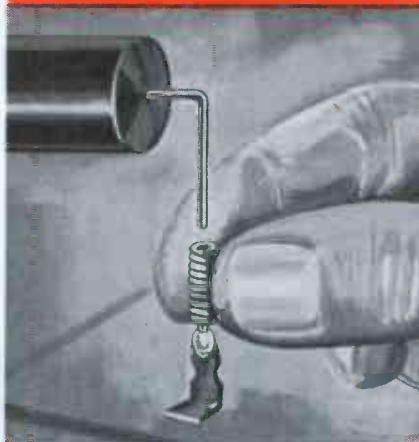

C

**Apply Heat,
Connection Made!**



***NOBODY ELSE HAS KWIKETTE CONNECTORS...
YOU GET 'EM ONLY FROM SPRAGUE PRODUCTS!***

KWIKETTES are now being packed with Sprague Atom[®] Capacitors at no extra cost to you! Whenever you need tubular electrolytics, insist on pre-packaged Sprague Atoms from your parts distributor and you'll automatically get your KWIKETTE component connectors . . . the biggest boon to the service technician since the soldering gun!

★TRADEMARK

WORLD'S LARGEST MANUFACTURER OF CAPACITORS

65 4104 RL

Circle 3 on literature card

SPRAGUE[®]

THE MARK OF RELIABILITY

December, 1965/PF REPORTER 11

You've got no business advertising in the Yellow Pages.

(Unless you want
more business.)

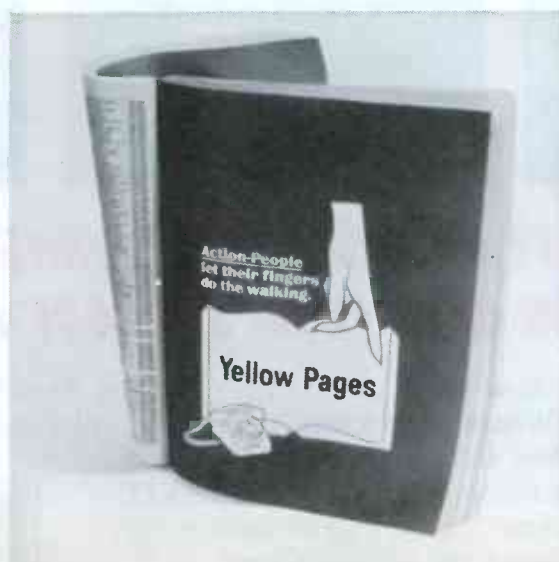

Action-people find it here first—fast.

NEW from

FINCO



BOOSTER-COUPLER

Model No. 65-1 List \$29.95



UHF CONVERTERS

Model U-Vert 300 List \$39.95

Model U-Vert 200 List \$26.90

Model U-Vert 100 List \$19.95

ALL FINCO PRODUCTS "COLOR"
ARE ENGINEERED FOR

The BOOSTER-COUPLER

"for Deluxe Home and Commercial Use"

Two tube, 4 set VHF-TV or (FM) Distribution Amplifier for home and small commercial distribution systems . . . with low loss splitters (FINCO #3001 or #3003) can feed 16 or more sets, depending on signal level and line length losses. FEATURES:

- On-Off Switch
- AC convenience receptacle
- Ventilated perforated steel cabinet 6 $\frac{5}{16}$ " x 3 $\frac{7}{16}$ " x 3 $\frac{1}{16}$ "
- Metal enclosed to eliminate shock hazard
- Easy access for tube servicing
- Convenient, easy mounting . . . bracket and screws supplied
- UL listed AC cord
- 117 Volts, 60 cycles
- Attractive appearance with rugged commercial construction
- No strip terminals
- Minimum "snow" (very low noise figure)
- 100% test for all electronic characteristics

The CONVERTERS

"That challenge all competition"

FEATURES:

- Drift free fine tuning
- Post conversion signal amplification
- Solid state chassis – shockproof
- Convenient AC outlet on converter
- Exact input-output impedance match
- Lighted dial tuning
- Full color and black-white signal conversion
- High gain – low noise
- Conforms to FCC radiation specifications
- Easy installation – UL approved
- Instant warm-up – Operates at Channel 5 or 6
- A model for every reception area

Write for beautiful color brochures – Numbers 20-338 and 20-377

Atlanta
Fort Worth
Kansas City
Chicago
Cleveland
Detroit

THE FINNEY COMPANY

34 West Interstate Street Bedford, Ohio 44014 Dept. 310

New York
Pittsburgh
San Francisco
Los Angeles
Boston
Albany

Circle 5 on literature card

FIRST AND ONLY compact Scrulox[®] screwdriver sets

Increasing use of Scrulox square recess screws in appliances, radios, TV sets, electronic instruments... even the control tower at Cape Kennedy... has created a need. A need for compact, versatile driver sets. Small enough to tuck in a pocket. Complete enough to be practical on shop bench or assembly line.

Now, here they are... from Xcelite, of course.



PS44
COMPACT
CONVERTIBLE SET

Five color coded midget Scrulox drivers—#00 thru #3

One midget nutdriver—1/4" hex
"Piggyback" torque amplifier handle increases reach and driving power

See-thru plastic case doubles as bench stand

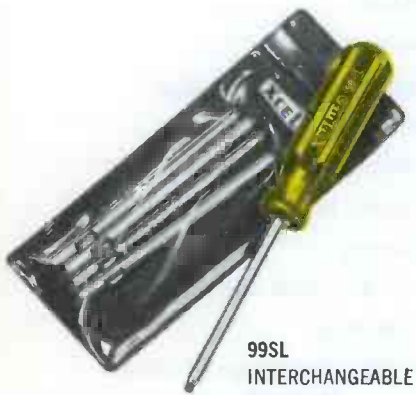

99SL
INTERCHANGEABLE
BLADE KIT

Five Scrulox blades—#00 thru #3
Shockproof, breakproof, Service Master handle
Durable, see-thru plastic case



XCELITE, INC., 18 BANK ST., ORCHARD PARK, N. Y.
Circle 6 on literature card

Letters to the Editor

Dear Editor:

I was pleased to see the way you passed along to your readers the safety advice from the booklet "Strange Killer."

In the same issue (October 1965) a "Mr. Name Withheld" gave us readers two easy problems to solve (*Letters to the Editor*, page 14). I say they are easy because they are met and solved daily in the life of the technician:

1. There is an asymmetrical waveform on the face of the scope. The peak-to-peak voltage is 46 volts; the positive swing is 12 volts more than the negative swing. What is the negative voltage amplitude of this waveform?
2. A 3-ohm resistor is connected in parallel with a 4-ohm resistor. What is the total circuit resistance in ohms?

Both of the problems can be solved without the use of algebra. By drawing to some scale:

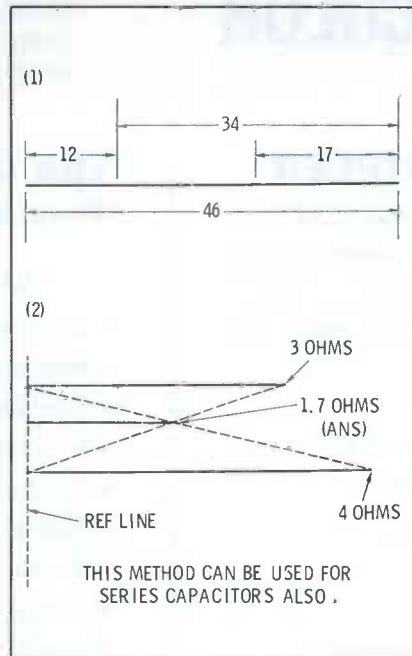

MELVIN T. HYATT

Prairie Village, Kansas

These graphical solutions can be real timesavers, and they can be shown mathematically to be valid. But to apply them to the solution of our original problems, you first have to recognize the analogies between those problems and the examples given here. And to do that, you have to analyze the problems—which brings us back to our original point, the application of logic.—Ed.

Dear Editor:

In the article "Hybrids on the Auto Bench" (April 1965 PF REPORTER), you stated that a battery can change polarity if the residual voltage has fallen to near zero. I would like to know how this condition can occur in a battery. How low must the voltage be before such a condition takes place, and what can be done to correct this condition?

This is my first issue of the PF REPORTER, and I must say your magazine has all I want and more. Keep up the good work.

MICHAEL MATTHEWS

Corona, N.Y.

In a fully charged lead-acid battery, the active material of the positive plate is lead peroxide, and that of the negative plate is pure sponge lead. All the acid is in the electrolyte, and the specific gravity is maximum. As the battery discharges, some of the acid forms a chemical combination with both plates, changing them to lead sulphate and producing water. If the battery is completely discharged, both plates will have changed to lead sulphate, and it is possible to recharge the battery with the opposite polarity. A condition such as this can only occur with a fully discharged lead-acid battery; also, the charging voltage must be applied with the wrong polarity to change the polarity of the battery.—Ed.

Dear Editor:

Many of your readers may be interested to know that tube charts for Precision tube testers may be obtained from Coletronics Service, Inc., 1744 Rockaway Avenue, Hewlett, L.I., N.Y. 11557.

LARRY'S ELECTRONIC SERVICE
Brooklyn, N.Y.

Dear Editor:

Your article "AGC Filter and Distribution Faults" in the August 1965 PF REPORTER is one of the best I have seen in the 43 years that I have done radio and TV servicing. It was very timely and a big help to me. I had on my bench a set that had the same condition as shown in Fig. 9 of the article and found the cause to be just as you described.

Please keep up the good work.

HENRY W. ALTMAN
Port Charlotte, Florida

Comments like yours are music to our ears, Henry. We're always pleased to learn that our efforts have benefited our readers.—Ed.



The Electronic Scanner

news of the servicing industry

Antenna Improvement Program

Recent studies by KIRO-TV, Seattle, and KSL-TV, Salt Lake City, disclosed that large numbers of television receiving installations are not equipped with proper antennas. A campaign has been launched by the Association of Maximum Service Telecasters, Inc. (MST) and the American Institute for Better Television Reception, to acquaint television dealers and the public with the need for adequate television receiving antenna installations. The necessity for maintaining receiving antennas in proper condition is also being stressed.

The studies at KIRO-TV and KSL-TV convinced them that an unexpectedly high percentage of television viewers did not realize the importance of installing and maintaining adequate receiving antennas, particularly for color reception. Perhaps even more serious, they feel, large numbers of television dealers are either unaware of the problems or haven't had the need made sufficiently clear to them. The present campaign is aimed at educating both the viewer and the dealer, and at encouraging development of receiving antennas that meet the requirements of individual installations.

Communications Leadership

"Only a fundamental change in the policies and regulations governing America's international communications can safeguard our leadership in satellite and global communications." So said Chairman David Sarnoff of the **Radio Corporation of America** in a speech not long ago. "We must look for entirely new procedures, attuned to the realities of the Space Age, if our communications services are to function in harmony with the new technology and if America is to maintain its leadership in this vital field."

Barriers exist between voice and nonvoice communications in the international field and prevent interconnection of international communications with domestic telephone facilities. This outmoded international communication structure could be modernized and strengthened through unification of present international voice and data facilities.

Faced by increased competition from abroad, America cannot, General Sarnoff felt, successfully operate a system of global communications with one company responsible for voice transmission, with five others handling data transmission, and with unresolved jurisdictional lines between the single American satellite entity — Comsat — and all the international communications carriers.

General Sarnoff suggested that a single company in the international voice and data field would be in keeping with the historic tradition of private enterprise. "It would give new cohesion to our entire communications structure and automatically solve the problem of providing interconnection for the flow of international traffic with the established domestic facilities."

Looking beyond the present, the RCA executive asserted that, "within a decade, and possibly less, it will be technically feasible to broadcast directly into the home from synchronous satellites. All of the basic components and technology already exist for radio and television broadcast transmitters to operate in space." This ability of countries to broadcast directly into the homes of other countries will penetrate many barriers, with unpredictable social, political, and economic results. Forms of jurisdiction must be established to prevent the television spaceways from degenerating into a confusion

• Please turn to page 64

COMPLETE TUNER OVERHAUL

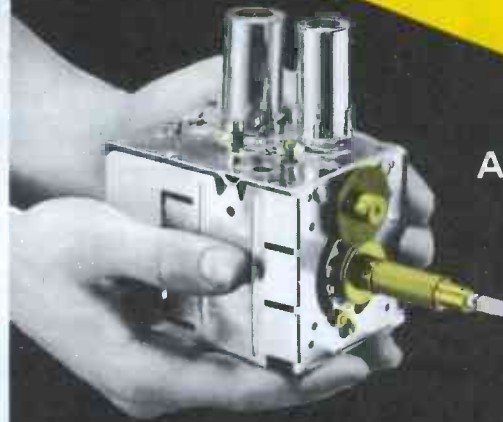

ALL MAKES —
ONE PRICE

9.95

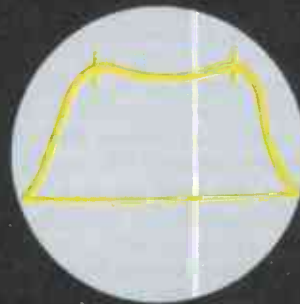

3.58

ALL LABOR
AND PARTS
(EXCEPT TUBES
& TRANSISTORS)*

COLOR TUNERS

GUARANTEED COLOR
ALIGNMENT — NO
ADDITIONAL CHARGE



VHF



UHF



COLOR



U-V



TRANSISTOR

Simply send us the defective tuner complete; include tubes, shield cover and any damaged parts with model number and complaint. Your tuner will be expertly overhauled and returned promptly, performance restored, aligned to original standards and warranted for 90 days.

UV combination tuner must be single chassis type; dismantle tandem UHF and VHF tuners and send in the defective unit only.

Exact Replacements are available for tuners unfit for overhaul. As low as \$12.95 exchange. (Replacements are new or rebuilt.)

And remember—for over a decade Castle has been the leader in this specialized field . . . your assurance of the best in TV tuner overhauling.

Pioneers of TV



Tuner Overhauling

CASTLE TV TUNER SERVICE, INC.

MAIN PLANT: 5701 N. Western Ave., Chicago 45, Illinois

EAST: 41-90 Vernon Blvd., Long Island City 1, N.Y.

CANADA: 136 Main Street, Toronto 13, Ontario

*Major Parts are additional in Canada

Circle 7 on literature card

1953 1965

12 YEARS OF UHF

More than a decade of TV progress.

By Alan James

In areas that expect to get a UHF station sometime, service technicians and viewers alike wonder just how UHF will work. Service-shop owners need to know what servicing problems to expect. The All-Channel Law requires that new sets receive both UHF and VHF, but in any town that gets a UHF station in the next couple of years, there will be many older sets to be converted. There will be new antennas to install, but how and where? Many questions cause uncertainty among those who will be responsible for insuring that viewers receive the new UHF station.

This article looks at this UHF situation through the eyes of one who lived through the very changeover so many dread without knowing exactly why. His story answers questions we've heard from all over the country about UHF. Finally, in talking with technicians who have lived with UHF for 12 years, the author finds how those early problems have been solved and explains the few that remain.

If there's any possibility UHF might come to your town, read this article. It may help you be ready.
—The Editor

There had been an air of excitement around our store all day. As 7:00 P.M. drew closer, anticipation reached a high pitch in every technician in the shop. None of us had even gone out to eat, for we didn't want to miss any action in case it started early.

The day was February 1, 1953; the place, Peoria, Illinois. For weeks we had been getting ready for this night, because it would put an end (we hoped) to snowy and fading television. We were finally to have our own local station—Channel 43, WEEK-TV, was to sign on at 7:00. The fuzzy and unpredictable pictures from 100 miles or more away, the huge wind-catching antennas mounted with rotators on 40' to 80' towers—all that was about to end. Imagine how anxious we were.

Most of the sets we were going to watch at this momentous occasion were equipped with continuous-tuning converters, because the converter strips and single- and dual-channel converters couldn't be adjusted until after sign-on. We'd heard that indoor antennas would work okay at UHF, so we had some strange little antennas sitting around on top of the sets.

At 7:00 sharp, we started twirling dials, searching for the signal. Nothing! We picked up a couple of strange blips we later learned were

oscillator interaction, but a TV signal—no! They're late, we decided; so we sent out for more coffee.

Finally, about quarter of 8:00, some knob-twirler sang out, and there on the screen, twinkling at us through dense snow, was a big round circle that said "WEEK-TV, Channel 43, Peoria, Illinois." UHF had come to town!

Low-Power Difficulties

The snow on the TV screen that chilly February night was disappointing. We had expected something better. We tried several sets, but without much luck. A few of the strip conversions wouldn't show enough picture to tune by. By 9:00 that night, we felt we weren't much better off than we had been with VHF from 100 miles away.

WEEK-TV had come on the air with only 100 watts output; they hadn't been able to get the final amplifier installed. To make it worse, their antenna tower was only partially erected, so they had very little height other than the hill they were on. Our troubles (and theirs) were only beginning.

Peoria and East Peoria are situated astride the Illinois River where it narrows at the lower end of Lake Peoria. Part of the town and its suburbs are along the river, about 450' above sea level; the rest lies on and beyond bluffs and hills that, to the west, reach as high as 900'. On the East Peoria side, toward the transmitter site, hills and hollows spread out like fingers—creating some of the deadest spots you could imagine for receiving a low-power channel 43 at 650 mc.

Next morning, we put a 30' pipe on top of our shop, with a four-stack bowtie antenna pointed toward the station. When the test pattern came on the air about 10:00, we saw a pretty good picture on the sets we had converted. This blew the story we'd heard that indoor antennas would be okay.

A lot of our customers weren't as lucky as we. Rooftop antenna installations helped in many cases; but there were also those who lived beyond the high terrain west of town, or around the hill up the river, or in those winding hollows on the East Peoria side. UHF shadows in all those places literally shut out the signal.

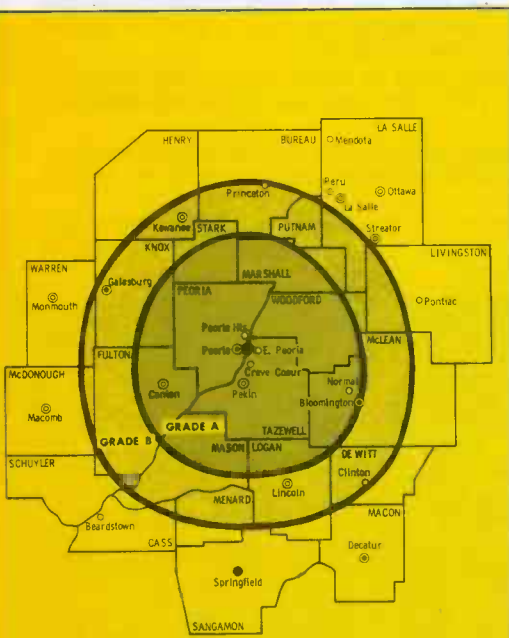

The station, whose managers were having as much trouble explaining to would-be viewers as we were, began finishing the tower job. With each step, slightly fewer shadows were noticeable, although they were far from eliminated. But then suddenly, just at the tower reached full height and the effective radiated power (ERP) reached 2000 watts, everything got worse! It seems standing waves were developing on the transmission line at the station and causing a lot of problems for everyone. And what do you suppose happened to us? Every bowtie we had installed, which we had painstakingly oriented for best signal, had to be repositioned. We all spent a lot of cold days scurrying around roofs with a converted field-strength meter, hunting for that elusive UHF signal.

In eight weeks we felt we'd been through about everything; the town was quieting down. Signals weren't everything we'd expected, but they were generally better than the old long-distance VHF. At least they didn't fade out. Well . . . not yet, anyway. And then came Spring! One rosy Monday morning, while the air still had a bite in it, the leaves seemed to have popped out all at once on every tree in town. By noon, we were wishing we could disconnect the phone. Calls and more calls. You guessed it—everywhere there was a marginal UHF signal, the leaves were fouling it up. Back to the rooftops went the antenna crews, feeling anything but cheerful those bright Spring days.

After six months at 2000 watts, the station boosted power to 250 kw ERP. We began then to find signals like we had first expected. The hollows and ridges and spots behind the hills were still poor, and some outlying wooded areas had trouble when leaves were wet; but careful probing with a field-strength meter, and sometimes with special antennas, took care of most problem cases.

During the few months WEEK-TV was the only television station in Peoria, we discovered much about high-channel UHF. We learned to carry a dozen 6AF4 tubes when we left in the morning on service calls, for even good ones oscillated poorly at channel 43, and

we had to replace many that were only marginally weak by other standards. We found that airplane flutter rarely effected UHF; nor was UHF bothered by ignition interference, diathermy, or signals from two-way or amateur transmitters. Passing autos and large trucks caused mild flutter effects if the antenna was in a weak spot, but nothing to compare with the old weak-signal days of VHF.

More Signals, More Work

On October 20 of that same year, a second station came to Peoria—WTVH on channel 19. This one didn't monkey around long until it was on the air with a half-million watts ERP. But here we were with problems again! Try explaining to a customer why he gets a new station better than he gets the old one; some of ours seemed to feel we'd been fooling them about channel 43. In a few odd locations, the old station could be picked up better than the new one; explain that to someone who knows the new station has double the power.

Back to the rooftops. Antenna crews by this time felt they knew the roofs of Peoria better than they knew the streets. We persevered, however, and found new solutions—always with antennas. In one particularly tough spot, we used a double four-stack antenna with flat-screen reflectors to pick up channel 43, orienting the array to a strong reflection from a hill across the river. Beside that one, we mounted a corner-reflector bowtie to eliminate severe ghosting on 19; we finally aimed the corner-reflector in a generally upriver direction, not knowing from just where we were getting the good signal but assuming that front-lobe and side-lobe pickup were cancelling the unwanted signal—at any rate, we ended up with a single picture of fair quality. Then we found we couldn't feed them both down the same line (as we had done with others), so we ran two lead-ins and installed a low-capacitance knife switch for changing antennas.

That winter, we found that antennas didn't have to be reoriented to allow for the lack of leaves. So, ever after, we rechecked any wintertime installation in the spring

when leaves were out. Repositioning wasn't always necessary, but it was needed often enough to justify checking. After that winter, we felt we had relatively smooth sailing.

The Story Today

A few weeks ago, I visited Peoria after an absence of several years. The service technicians and television viewers have had 12 years to evaluate UHF television under just about all conditions. I was curious how they felt about it by this time.

I found a lot of changes: WEEK-TV now operates on channel 25; WTVH is now WIRL-TV, and a third station, WMBD-TV, now operates on channel 31. WEEK-TV has added a satellite near Tonica, Illinois—WEEQ-TV on channel 35.

Operating powers and antenna conditions aren't the same any more, either. WIRL-TV says their channel-19 effective radiated power is 186 kw visual, 18.6 kw aural, and their antenna height is 750' above average terrain. WEEK-TV lists their new channel-25 ERP at 562 kw visual, 112 kw aural, with antenna 675' above average terrain. WMBD-TV, on channel 31, boasts 678 kw visual and 339 kw aural, at 670'. Coverage contours of the three stations, as reported in *TV Factbook*, look approximately as shown on the opposite page.

The satellite, WEEQ-TV, at Tonica—operated manually by WEEK-TV for the LaSalle-Peru-Oglesby, Illinois area—reports a grade-A signal contour of slightly more than 10 miles. Their ERP is 15 kw visual, 8.5 kw aural, and antenna height is 440' above average terrain. WEEQ-TV retransmits telecasts from WEEK-TV, as would be expected of a satellite, but inserts its own identification, has many of its own advertisers, and originates its own news shows.

Viewing radius for the Peoria stations naturally includes grade-B signals, too. For the three, this contour adds another official 15 miles of effective viewing. I asked several servicemen how far away they found usable signals. Every one of them felt the 40-mile radius contained a good signal, with only a few shadow areas behind sharp hills.

•Please turn to page 58

SQUARE-WAVE TESTS

for Three-Terminal NETWORKS

by David I. King and
Robert G. Middleton

Preceding articles in our "Advanced Service Techniques" series have introduced you to these basic principles of square-wave testing:

1. A square wave is made up of a fundamental sine wave plus an infinite number of its odd-order harmonics.
2. Square-wave analysis of components and networks will indicate the presence of inductance, capacitance, and resistance.
3. RC, or time constant, of a network can be determined by square-wave tests. If either value, resistance or capacitance, is known, the other can be easily calculated. Since RC measurements can test all components within a network, individual component checks need not be performed.

These basic concepts may seem difficult to learn, but they must be thoroughly understood before more complex techniques are introduced. With this in mind, this review, based upon Robert G. Middleton's previous articles, has been written.

A wideband triggered-sweep scope, such as those described in the March 1965 PF REPORTER article "Learning About Triggered-Sweep Scopes," was used in obtaining the photos in this article. If you can arrange to use a scope such as this, try to do so. Even if you can't, at present, get to one of these scopes, follow with us. Information here and in coming articles will be invaluable in the future. —The Editor

Three-terminal networks can usually be classified as *differentiators* or *integrators*. Both are series resistance-capacitance circuits; but the differentiator output is developed across the resistor, while the inte-

grator output is developed across the capacitor. Fig. 1 shows three sets of differentiator-circuit component values and their effects upon a 500-cps square wave. Waveforms indicate that circuit constants deter-

mine the shape and p-p amplitude of the output.

Resistance - capacitance circuit time constant, RC, in seconds is the product of resistance in megs and capacitance in mfd:

RC = resistance × capacitance
Charge time t, in seconds, is determined by half the applied square-wave period; period is the reciprocal of frequency;

$$t = \frac{1}{2} \times \frac{1}{\text{frequency}}$$

For example, the relationship between t and RC in Fig. 1A is:

$$\begin{aligned} RC &= 1 \text{ meg} \times .01 \text{ mfd} \\ &= .01 \text{ sec, or } 1 \text{ msec} \end{aligned}$$

$$\begin{aligned} t &= \frac{1}{2} \times \frac{1}{500 \text{ cps}} = .001 \text{ sec, or } 1 \text{ msec} \\ RC &= 10t \end{aligned}$$

Here, the capacitor charges .1 volt during one half cycle, then charges .1 volt in the opposite direction the next half cycle; its charge is added to the p-p output amplitude. Output amplitude W1B is thus increased .1 volt over that of input W1A; still, the sum of instantaneous voltages across the resistor and capacitor equals the input voltage.

In Fig. 1B, RC = t. Here, the capacitor charges to 63% of the p-p input voltage W2A during t; consequently, p-p amplitude at W2B is 1.63 volts. In the network of Fig. 1C, RC = t/10. During t the capacitor charges to 100% of p-p input voltage W3A. As a result, the p-p amplitude of W3B is twice that of input W3A.

Differentiation means to break up into small parts. Output waveforms in Fig. 1 show that: As RC becomes smaller with respect to t, the square wave is broken into a series of frequencies with maximum amplitude developed for the highest

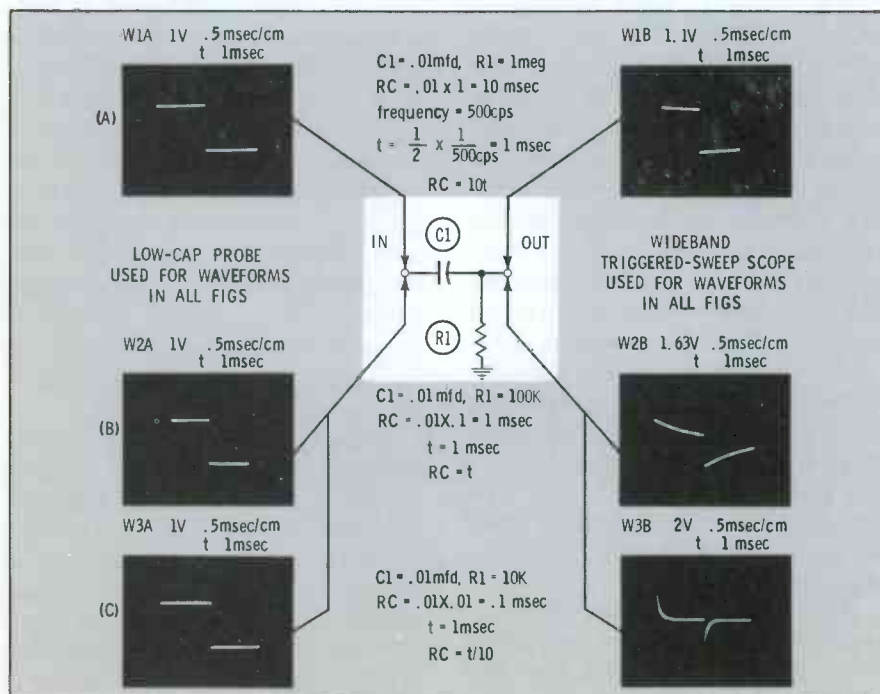

Fig. 1. Relationship between charge time t and RC determines output waveform.

frequency elements. Capacitive reactance attenuates low-frequency elements developed across the resistor — only high-frequency elements remain. If RC is greater than 10t, the differentiator may be used as a coupling circuit—output waveform isn't greatly altered. If RC is less than 10t, the output-waveform leading-edge shape will be similar to that of the input, and lagging-edge shape will depend upon RC.

Differentiator Tests

You can test components in a differentiator by applying a square wave and observing the output. Find the square-wave frequency at which the p-p output voltage equals 1.63 times the input; at this point, $t = RC$. If the value is above tolerance, resistance is increased; if it's below tolerance, capacitance is decreased. (Capacitors seldom increase, and resistors seldom decrease in value.) Resistance can usually be measured with an ohmmeter; capacitance value can then be rapidly calculated: if $t = RC$, then $t/C = R$.

Integrator Circuits

Three time constants are shown for the integrator circuit in Fig. 2; relationships between t and RC are identical to those in Fig. 1. Here, however, output is developed across the capacitor, not the resistor. Note Fig. 2A: $RC = 10t$. Waveform W1B developed across the capacitor is sawtooth shaped—only low-frequency elements of the square wave remain; also, p-p amplitude is decreased to .1 volt. In Fig. 2B, $RC = t$. Output amplitude W2B is increased to .63 volt, and the waveform leading edge is sharper. In Fig. 2C, $RC = t/10$. The output p-p amplitude equals that of input W3A; the amplitude of the high-frequency elements is increased, as the sharper waveform leading edge indicates. These waveforms clearly show that the integrator output depends on the relationship of t to RC. As in the differentiator, the reactance of the capacitor increases for low-frequency elements; but here, high-frequency elements are dropped across the resistor—only low-frequency elements are then developed across

the capacitor output. To integrate means to unite: As RC becomes greater with respect to t , square-wave elements are summed up, and the output becomes closer to DC.

Testing Integrators

Minimal calculation is needed if you use the rise-time test (Fig. 3) for an integrator. Decrease the square-wave frequency until the top portion of the square wave is flat (Fig. 2C is a good example); next expand the sweep on the scope to ease measurement of time interval between points at 10% and 90% of maximum amplitude (Fig. 3A)—this is rise time. Fig. 3B indicates that a capacitor charges from 10% to 90% of input voltage in 2.2 RC:

$$\begin{aligned} \text{Rise time} &= 2.2 RC; \\ \frac{\text{Rise time}}{2.2} &= RC \end{aligned}$$

A change in RC value can be analyzed in the same manner as with differentiators—decreased RC indicates capacitance decrease, and increased RC indicates resistance increase.

You may encounter difficulty with rise-time measurements if RC is greater than 100 msec, since the low scope sweep rate produces flicker which causes inaccuracy. In this case, plot t against RC to determine the relationship of p-p output to input. If $t = RC$, the p-p

output is .63 times the input voltage. If $t = RC/10$, the p-p output is .1 times the input voltage. Use this second method only if rise-time measurement is impractical.

More Complex Circuits

Fig. 4A shows a more complex integrator circuit, and Fig. 4B shows its equivalent. Thevenin's theorem can be used to show that: (1) the voltage applied to C1 is equal to the voltage across R2, and (2) C1 charges through the equivalent resistance of R1 and R2 in parallel.

In Fig. 4B, a source equal to the voltage across R2 is connected to the equivalent circuit of Fig. 4A:

$$\begin{aligned} E_{R_2} &= \frac{R_2}{R_1 + R_2} \times E_{in} \\ &= 1 \times \frac{300K}{100K + 300K} = .75 \text{ volt,} \end{aligned}$$

R3 is 75K (equivalent to 100K and 300K in parallel). Output amplitude and waveshape are identical to those in Fig. 4A. With the square-wave input frequency set for $t = RC$, the p-p output is .63 times the input: $.75 V \times .63 = .47$ volt. The generator output impedance limits the accuracy if R1 isn't more than 10 times the source impedance. The output impedance of the generator used here is 600 ohms; accuracy would be limited if R1 were less than 6K. If care is taken to avoid inaccuracies, the equivalent

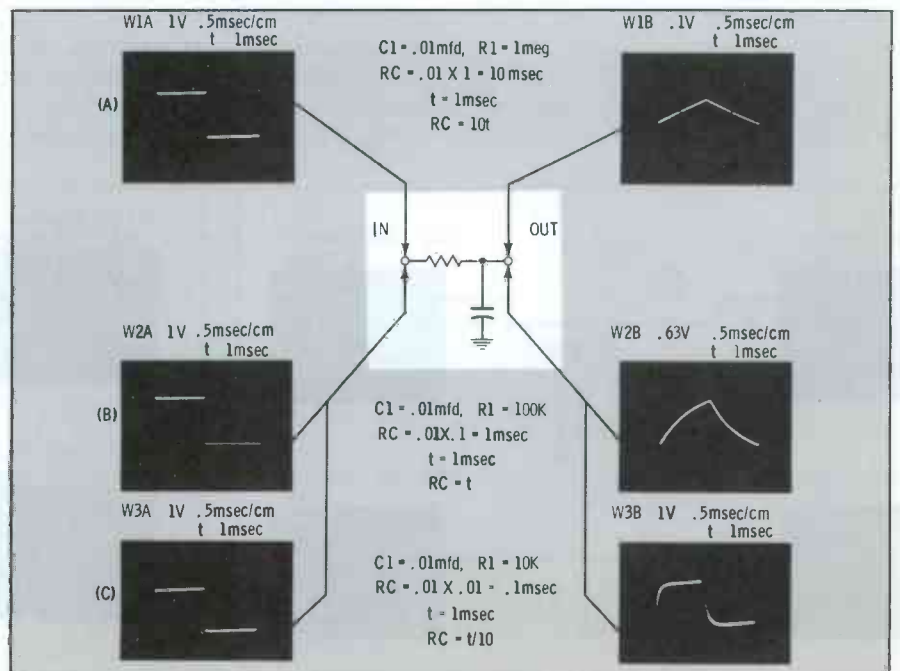

Fig. 2. Integrator output contains low-frequency elements of applied square wave.

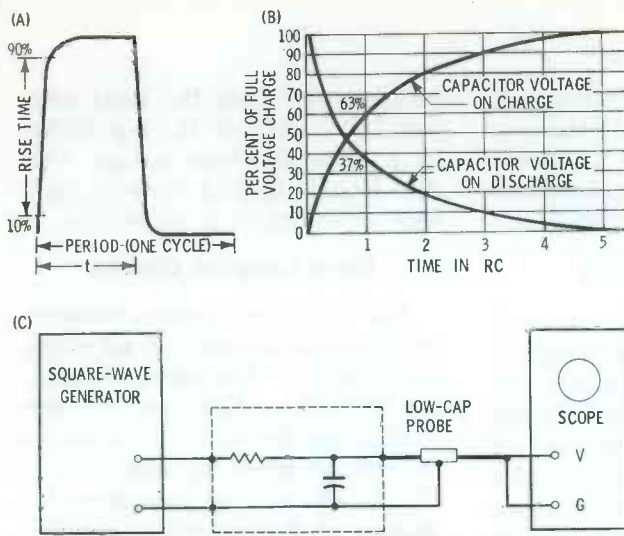

Fig. 3. Find RC by measuring rise time. (Rise time = 2.2 RC.)

circuit of Fig. 4B can be tested in the same way as those in Fig. 3.

Impractical Test

A complex differentiator is shown in Fig. 5A. Application of Thevenin's theorem in this case is difficult because the square-wave generator output impedance forms an integrating circuit with C_2 . Note the rounded leading edge of input W1A compared to that of W2A. Also, W1B and W2B are not identical. Another method must be used to test complex differentiators.

Reliable Test for All RC Circuits

In Fig. 6A, the complex differentiator from Fig. 5A has been altered. Across C_1 a 10K resistor has been added to make two networks with equal time constants:

$$R_1 C_1 = R_2 C_2$$

The rounded leading edge of W1A indicates that this circuit still

loads the square-wave generator. Note the change in W1B. The scope sweep speed is increased to 50 usec/cm to measure rise time, but it is still noticeable that the top of W1B is flat (Fig. 6); amplitude is .5 volt. In W1B (Fig. 5) the top begins to tilt downward immediately; in addition, the amplitude is .6 volt. In Fig. 6, the W1A and W1B wave shapes are identical. The amplitude of W1B is determined by the voltage divider formed by the two resistors.

W2B in Fig. 6 shows even greater change from W1A of Fig. 4. Addition of a .03-mfd capacitor across the 100K resistor increases the output amplitude to .75 volt and decreases the rise time to that of the input—7 usec. The output waveform at all frequencies is identical to the input if $R_1 C_1 = R_2 C_2$. Only at extremely high frequencies will unavoidable stray capacitance and inductance upset this relationship.

Fig. 7 shows a circuit equivalent

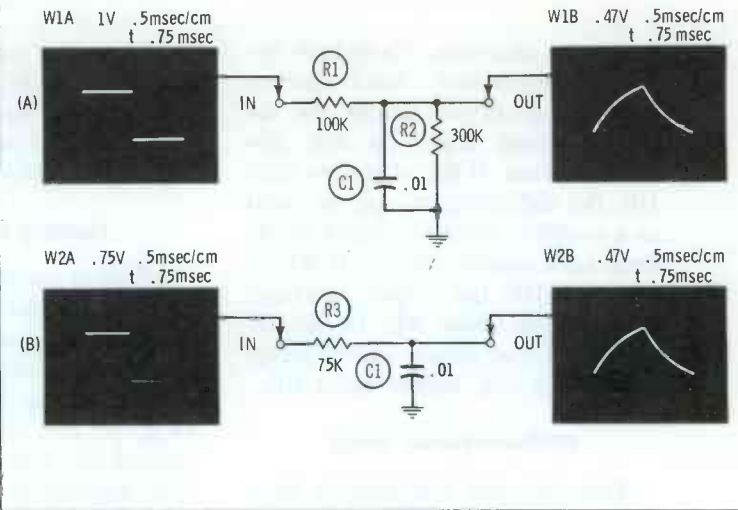

Fig. 4. Output waveforms prove circuit is integrator equivalent.

to that in Fig. 6B. The junction between capacitive and resistive halves of this circuit is opened to show relationships. R_1-R_2 and C_1-C_2 each form voltage dividers. Neither the purely resistive nor the purely capacitive divider changes the input waveform shape—the reactance and resistance ratios are the same for all frequencies. If $R_1 C_1 = R_2 C_2$, the voltages at the capacitive and resistive divider junctions are equal. No current flows between the junctions even if they are connected to form a network like those in Fig. 6. The input and output waveforms remain identical.

However, if $R_1 C_1 \neq R_2 C_2$, the voltages at the divider junctions are unequal. Current will flow between the resistive and capacitive branches if the junctions are connected. The transfer of current between branches means that they no longer behave as purely resistive and reactive paths; the network does not behave

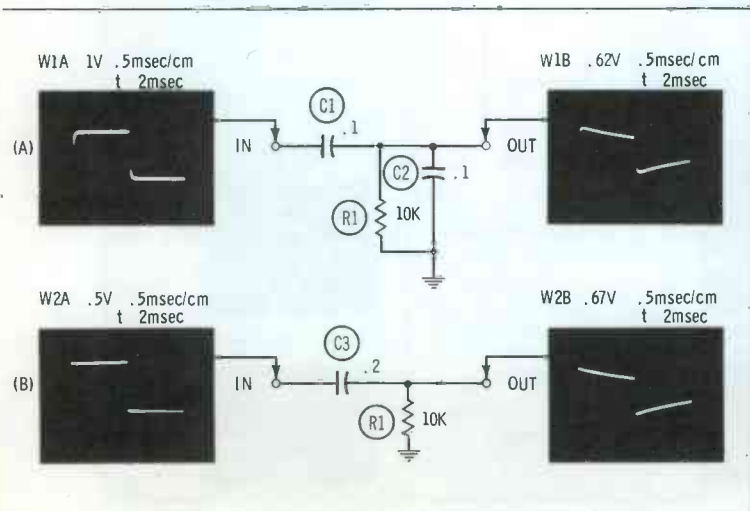

Fig. 5. Generator internal resistance prevents accurate test.

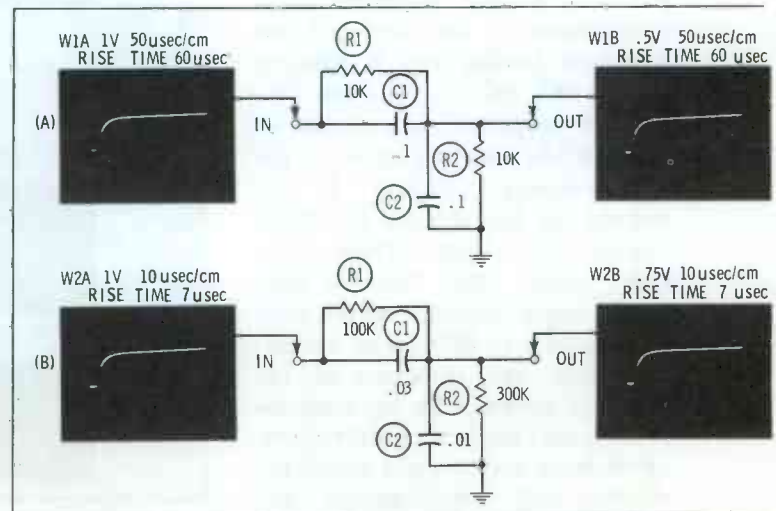

Fig. 6. Input, output are identical: RC series = RC shunt.

Get Trouble-Free Fuse Protection in Wet Locations with a . . .

Another
outstanding
development
by the makers
of BUSS Fuses

PICTURE
APPROXIMATELY
ACTUAL
SIZE

TRON

In-the-Line WATERPROOF FUSEHOLDER

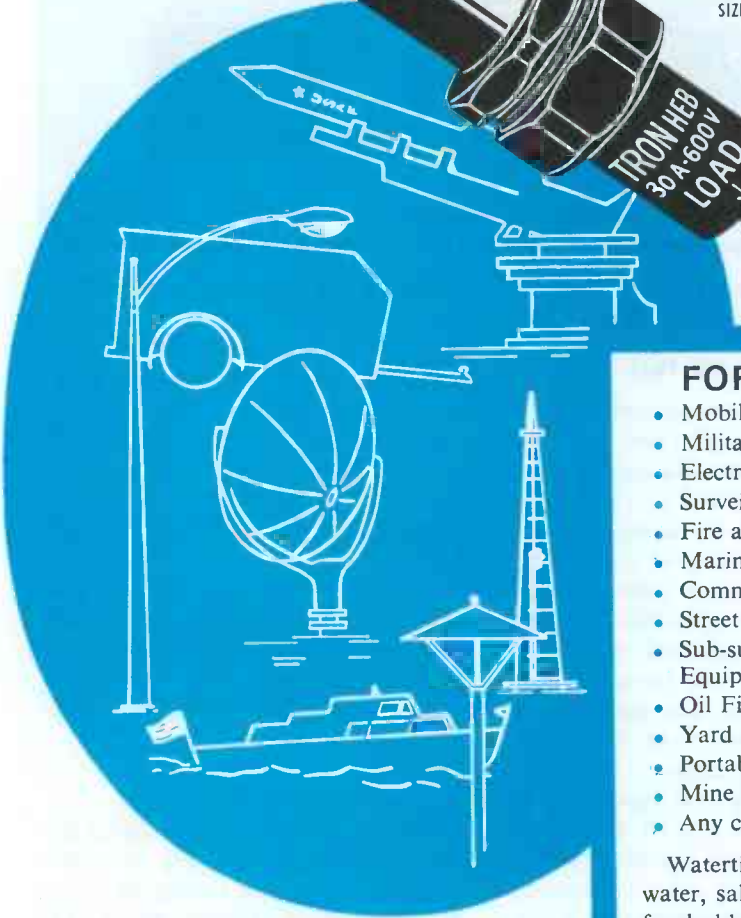

FOR USE ON:

- Mobile Power Supply Units
- Military Field Applications
- Electronic Components at Missile Sites
- Surveillance Equipment
- Fire and Police Call Systems
- Marine Equipment
- Communications Equipment
- Street or Highway Lighting Standards
- Sub-surface Junction Boxes Supplying Lighting or Equipment Circuits
- Oil Field Equipment
- Yard Lights
- Portable Outdoor or Construction Equipment
- Mine Equipment or
- Any circuit operating in exposed locations.

Watertight construction; resistance to damage by weather, water, salt spray or corrosive fumes permit use of TRON fuseholders in exposed locations where safety and long life are of vital importance.

For Protection of Circuits of 600 Volts or Less

TRON Waterproof Fuseholders fill the need for a watertight holder that is easy to install to give fuse protection to circuits in exposed locations.

Crimp-Type Tubular Terminals Available in Many Sizes

The crimp-type tubular terminals on TRON fuseholders are available in sizes to take many sizes of solid or stranded wire.

If desired, Load-side terminals can take one size wire, while Line-side terminals take another size wire.

A crimpable insulating sleeve covers each terminal. This provides a good surface for taping after crimping. When properly taped the crimped terminal is completely insulated and waterproof.

CAN BE USED AS TAP-OFF CONNECTOR

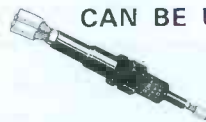

TRON Waterproof Fuseholders can also be used as Tap-Off connectors by having the

Line-side terminal large enough to permit the two ends of the Line-wire to be crimped into it. This eliminates costly line connections and labor.

Two Models Available

Both rated at 30 amps. at 600 volts or less

The TRON HEH Fuseholder takes fuses 13/32 inch diameter by 1 1/2 inches long.

The TRON HEH Fuseholder takes fuses 13/32 inch by 1 3/8 inches long.

Write for BUSS Bulletin SFH-11

INSIST ON

BUSS QUALITY

BUSSMANN MFG. DIVISION, McGraw-Edison Co.
St. Louis, Mo. 63107

Circle 8 on literature card



Now — a "Scanner" for 25-50 mcs and 150 mcs!

- Rotate beam electronically, instantaneously. No mechanical rotor.
- Omni-directional position for monitoring.
- Min. 6 db gain (ref. drooping ground plane), 18 db f-to-b ratio in beam mode.
- Stress-designed for 100 m.p.h. winds.
- Power rating: 500 watts.
- Every unit individually tuned to exact freq. Each receives system checkout.

PROFESSIONAL Scanner

pat. pend.

electronic, sector-phased
omni-beam antennas

the antenna specialists co.

Div. of Anzac Industries, Inc.
12435 Euclid Ave.,
Cleveland, Ohio 44106
Export Div.,
64-14 Woodside Ave.,
Woodside, N.Y. 11377



"Stripes of Quality"

Circle 9 on literature card

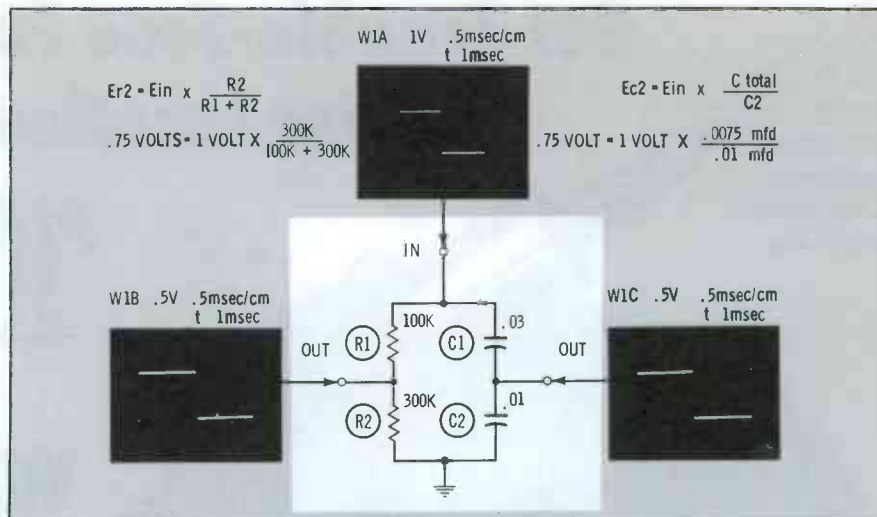

Fig. 7. Circuit equivalent to that in Fig. 6B shows voltage-waveshape relationships.

as the one shown in Fig. 7, and the output waveform is distorted.

RC = RC Test

You can add components to each half of both simple and complex differentiators and integrators as is done in Fig. 6. If $R_1C_1 = R_2C_2$, the output waveform is identical to the input, and the ratio of p-p output to input amplitude is determined by the resistive (or capacitive) divider. You need only calculate the values needed to make both branches have equal RC and the ratio between p-p input and output. Next, sweep the square-wave generator frequency through the range corresponding to $t = 10RC$ to $t = RC/10$. If the output waveform isn't identical to the input throughout that frequency range, some component value is outside tolerance. Probably you will use substitution boxes for this test; make sure that leads to the substitution capacitor are as short as is pos-

sible. (Lead length to the substitution-box resistor isn't as critical—Q is much lower.) Inaccuracies in the test setup can cause ringing, overshoot, or rounded leading edges of the waveform. Usually, components tested will be rated for 20% tolerance; also, tolerance ratings for added components must be considered.

Comparison of rise time, p-p amplitude, or lagging-edge tilt between input and output waveforms should indicate less than 20% variation if components are rated for 20% tolerance.

Applications

In-circuit tests can be used on de-energized equipment. Fig. 8 shows a typical setup for testing an inter-stage coupling circuit on a PC board. Capacitor C1 can't be tested accurately with a capacitor checker unless it's disconnected, because R3

• Please turn to page 42

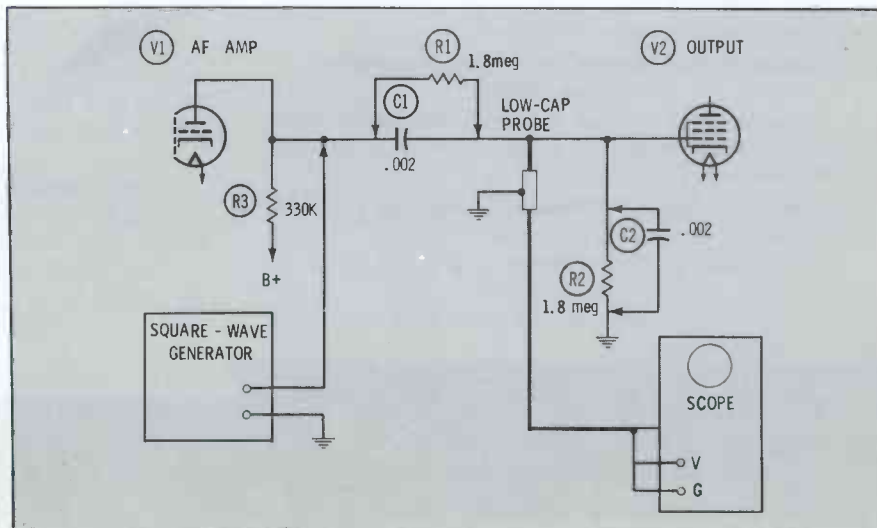

Fig. 8. You needn't unsolder anything to perform square-wave test of C1 and R2.

extend

TWO WAY

These hints will increase performance.

by Jack Darr

RANGE . . . Reduce Noise

The range of a two-way radio does not depend entirely on how far the RF carrier can be received; it depends on how far the messages can be *understood*. While carrier power is important, *readability* is equally important. The phrase "I read you" means exactly that: the listener has heard and understood the message. Anything that interferes with readability cuts down the range and usefulness of the system.

Since the change to narrow-band FM, range and intelligibility have been more of a problem. The audio recovery is reduced, and more noise is audible, while, at the same time, less audio power is provided in the output. Electrical noise from the vehicle becomes more troublesome. Natural noise is still not a serious problem; the man-made noises, plus certain troubles in the radio sets themselves, are far more annoying. Let's look at some of these annoyances and see what can be done to prevent them.

Installation of the mobile units is a major factor. Every possible electrical noise must be eliminated from the automobile engine and electrical system. Resistor spark plugs, liberal by-passing of all noise sources, plus tight grounding and bonding are a necessity. For units normally working at long ranges,

the fully shielded ignition system may be needed. The techniques and materials used are well-known; they're basically the same as those used on BC auto radios. The primary difference is that these techniques are performed to a greater degree of perfection.

Coaxial bypass capacitors are more efficient at VHF frequencies. (Some coaxial types are shown below and to the right in Fig. 1; a standard unit is on the left.) Alternators give less electrical noise than

the old generator/voltage-regulator systems. However, when alternators do give trouble, it is harder to cure. The best remedy for alternator noise is a fully shielded two-section LC filter, installed in series with the lead from battery to radio (Fig. 2). These filters are commercially available, or you can make one in the shop. In extreme cases, this filter can be *tuned* to the carrier frequency. However, the standard brute-force filter will normally do a good job.

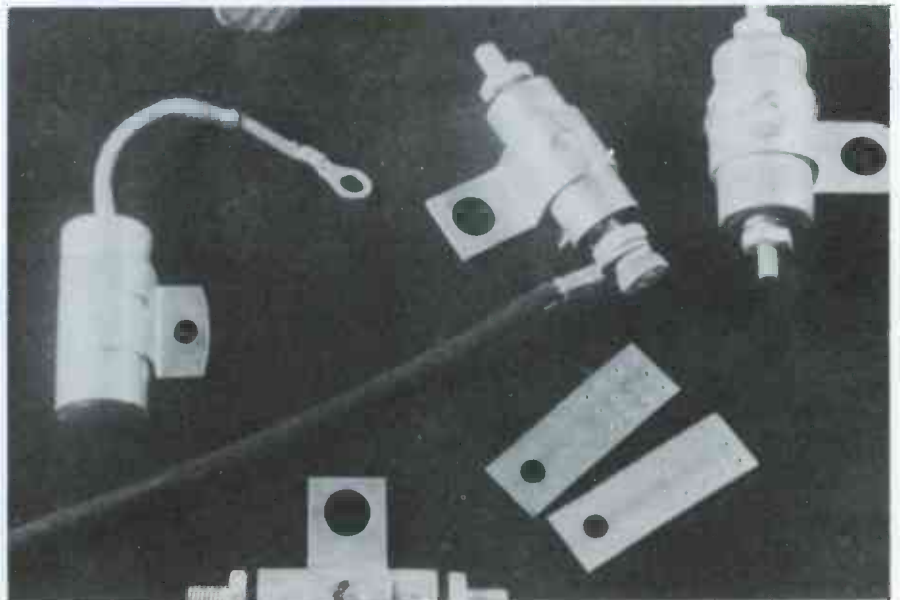

Fig. 1. Coaxial capacitors (shown at right) are more efficient in reducing noise.

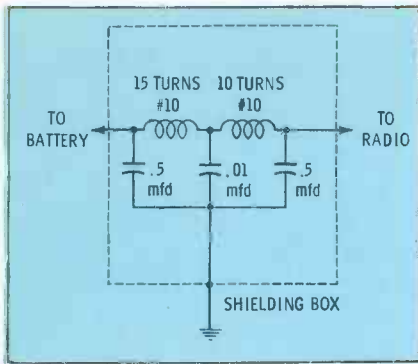

Fig. 2. Filter removes alternator hash.

Antenna connections must be clean and tight—especially the grounding. An intermittent ground on the antenna base is often unsuspected and can cause a lot of difficulty. Be sure it is clean and tight.

When you want to locate noises in a squelch-equipped receiver, run the vehicle into the shop, or at least near enough to the shop that a weak signal from the AM signal generator can be picked up. Set the generator for an unmodulated signal, and use only enough output to operate the squelch circuit of the receiver. This allows you to hear any vehicle noise and also simulates fringe-area operation. Simply opening the squelch control will *not* do the same thing! There must be a signal passing through the receiver before the noise can be heard.

Overmodulation

In narrow-band systems, modulation swing must be set precisely. Even in FM, overmodulation will result in distortion. As you know, this was not a problem with the wideband sets, but it very definitely is now. With only 2.5 kc either side of the carrier, overmodulation of the transmitter can cause the signal to swing outside the receiver pass-band. Fig. 3 shows what happens:

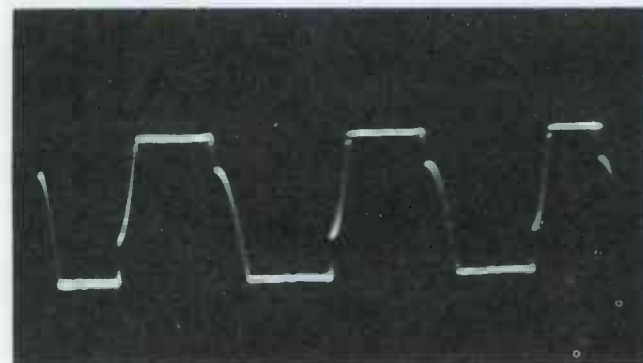

Fig. 4A. A good vibrator gives this square-wave pattern.

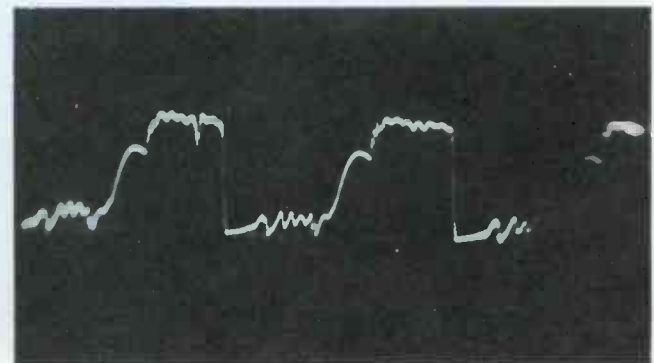

Fig. 4B. Ragged tops indicate poor contacts on vibrator.

especially at long ranges, the signal will be chopped into bursts and will be nearly unreadable.

Automatic-deviation-control circuits are used in most of the better transmitters. Even so, misadjustment of this circuit will still allow the transmitter to overmodulate. These control circuits prevent overmodulation of the transmitter from such things as the operator shouting into the microphone, etc. But, for best results they must be properly and precisely set with a modulation monitor so that the maximum modulation swing is not exceeded. The transmitter audio circuits must be checked for distortion, proper amplification, and correct clipping action. In most sets, modulation controls are simple diode clippers. However, bad diodes or incorrectly adjusted circuits can cause trouble.

The microphone is also important, especially in mobile units. Microphones of all types suffer from rough handling, moisture, age, and so on. Microphone deterioration often appears as low output or distortion, rather than a complete failure, such as a broken cable or an open switch.

Transistor amplifiers are used with dynamic and variable-reluctance mobile microphones. These must be carefully checked for output and tone quality. Dirty switch contacts in the microphone can reduce the supply voltage or cause chopping of speech. Electrolytic capacitors were a common trouble in the earlier units. In a few cases, the capacitors were defective, but the trouble was caused most often by poor joints in the capacitor mountings. Microphones can be checked most easily by substitution; the absolute output of a cartridge is very low and hard to measure ac-

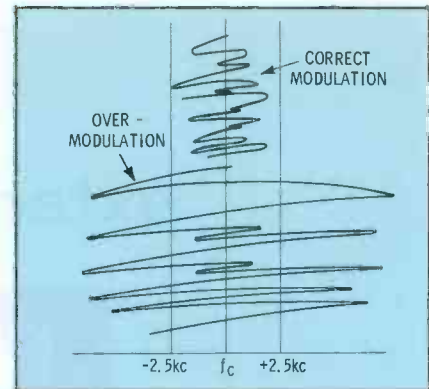

Fig. 3. Overmodulation distorts signal.

curately. (Incidentally, some of the diaphragm-type microphones, such as a dynamic, can be checked by feeding an audio signal into them, as you would a speaker, and listening! Any distortion or weakness can be spotted by comparing the audible signal with that from a unit known to be good.)

Receiver Troubles

Overall RF sensitivity of the receiver is quite important. Check alignment carefully, peaking all stages for maximum quieting. RF tuning should be rechecked *after* the set is reinstalled in the automobile. This will assure you that the vehicle's antenna is properly matched to the receiver input. It's best to use a weak AM signal; too much signal during this test will obscure the correct peak of the antenna-trimmer setting.

Practically all receivers use the Foster-Seeley discriminator because of its simplicity and ease of adjustment. This discriminator must be adjusted correctly to get maximum response from the signal with minimum noise and maximum quieting. The discriminator-circuit center frequency should be checked every time the set is serviced.

• Please turn to page 44

The cover gives you the whole story.



The United Delco box tells you for sure you're getting a replacement radio part of the same high quality as the original.

And it tells you who authored it, too. Namely, Delco Radio.

So, if you'd like to hang on to your reputation and customer goodwill, just ask yourself this next time you order transistors:

Do they come individually packed in a distinctive box? (Bushel buying is for potatoes, not transistors.)

Do they carry an easy-to-read, can't-make-a-gooof number?

Are the numbers—and the transistors—grouped in such a way that you can service more car radios with fewer parts?

Is there a good chance that the parts are original equipment on nearly half of the car radios on the road?

Delco Radio transistors are all of these, and you can get them from your United Delco supplier. He handles the most widely advertised, merchandised and recognized

name in the parts business—United Delco.

That's how your customers know a good part when they see it.



DELCO RADIO, Div. of General Motors, Kokomo, Ind.

Circle 10 on literature card

stand up to the

INTERMITTENT

Tips for making the trouble occur.

by Wayne Lemons

Since the early days of radio, no one thing has taken more joy out of life for the electronics technician than a stubborn intermittent. Unfortunately, there is no cure-all for this on-again, off-again, unrepentant TV trouble. There are, however, several approaches that work well in a given situation. The first approach we will analyze is a mental one educators sometimes refer to as *mind-set*. Basically, mind-set is simply deciding to take action rather than sidestepping the problem and working on something that promises quicker results. If the technician doesn't believe he can find the trouble, he probably won't. Should he take the attitude that he is more capable of finding the trouble than the circuit is of concealing it, however, he often has the battle more than half won. I imagine every experienced technician has had days

when the intermittents were no problem. If he thought back he'd probably discover these were the days when his self-confidence was strongest. So, first decide you can do it, and then get the job done.

Now I'd be the last person in the world to say that just deciding to do a job is all there is to it. As a matter of fact, you are unlikely to develop mind-set until you know as much as possible about the problem and how to use the tools of the trade, whether they be mental or physical. Let's look into some methods for conquering the intermittent that have been proven successful.

First, get as much information as you can from the set owner. This is not as easy as it may sound, because the owner doesn't speak your technical language. You must ask questions that get to the heart of the problem. If you ask what the

owner thinks the trouble is, you will probably get a highly original answer, such as "There musbe a short sommers."

Ask questions similar to these: Does the picture go off with the sound? Does the picture get narrow before it goes off? Does the picture start moving up or down or get diagonal bars in it before it goes out? Is there any odor when the set acts up? Are there any unusual noises associated with the trouble? Do all stations go off? How long has the set been giving this trouble? Has it gotten worse? Does the trouble occur when the set is first turned on or after it has played several hours? Is there anything you do to make the trouble go away temporarily? Does the trouble occur at some particular time of day or night? Did the trouble start after some new parts had been installed?

Of course, in specific instances there are other questions that should and would be asked, but these give you an idea of how information may be extracted from the customer. By asking questions of this nature, you'll usually get most of the information you need. Quite often the trouble may actually be hidden right in the customer's complaint, and who knows better than he what it is?

Once you have the customer's information, what then? Will you start by immediately pulling the chassis and digging inside? Personally, I

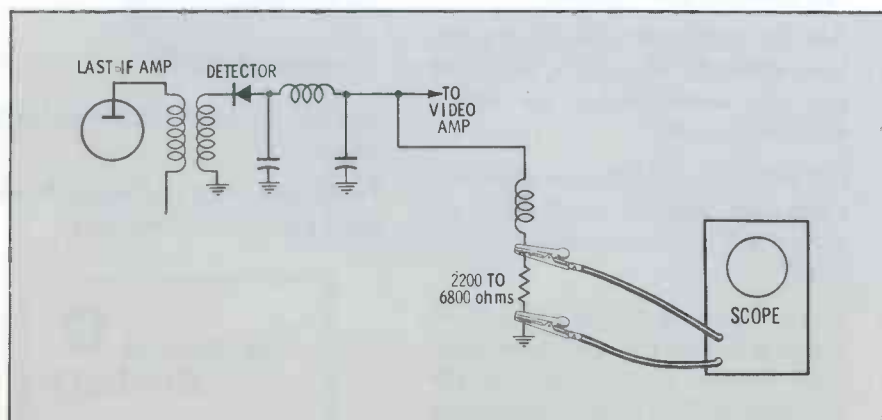

Fig. 1. Video-detector load resistor is ideal place to monitor intermittents.

think this is a mistake made by too many technicians. As valuable as the customer's information is, it is even more useful when it is coupled with your own interpretation of the trouble. Turn the set on and let it play before you even remove the back. See if the intermittent occurs. Remember, don't spend too much time in the home on an intermittent. Get the set into the shop where you can watch its actions while doing other work. Of course, if you see the trouble occur in the home, then determine if the intermittent is caused by a condition peculiar only to the home environment, such as high power-line voltage, inadequate ventilation, etc.

Explain to the customer that you must take his set to the shop so that it can be monitored with the proper instruments. Also explain that you won't be able to detect any trouble as long as the set is playing well. If the customer is not willing to allow you the necessary time to repair an intermittent, don't take the job. Nothing is more bothersome than an intermittent that seems to be repaired but actually is only hiding until you return the set.

When you see the trouble for yourself, then what? By now you probably know what circuit the trouble is in, but if you don't, at least you know what the symptom looks like, and you're ready to pull the chassis, if that seems necessary. In most cases it is, because even tube replacement may be a mistake at

this point. If you do replace a suspected tube, you must then fire up the set and wait to see if the trouble recurs. This is usually the exact time the intermittent goes into hiding. Instead of changing tubes, carefully pull the chassis and, using a scope or whatever instrument is indicated, try to localize the trouble. A good way to start, if the trouble is in the picture, is to connect your scope across the detector load resistor (Fig. 1). When the intermittent occurs, notice if the distortion shows up. In almost every case, this will tell you whether the trouble is before or after the detector. Once you discover which way to look, you are well on the way to pinpointing the intermittent part. Use as many circuit monitors as possible. Tie your VTVM to the AGC or B+ line. If the trouble is in the sound section, place the VTVM across the ratio-detector load resistor. Or in the case of a gated beam detector, put the meter on AC and monitor the audio at the output-tube grid. Where to connect the monitoring instruments is an art that must be developed for each general family of troubles. Sophisticated test equipment is not absolutely necessary; your VTVM or scope will do the job if you use them properly.

Heat

A large percentage of intermittents is caused by temperature changes that normally occur inside

the TV receiver. When some part is beginning to deteriorate, it often becomes highly sensitive and maddeningly temperamental when the surrounding temperature changes. The problem is further complicated because removing the chassis from the cabinet gives more air circulation and allows the circuit to seem entirely normal on the bench. There are two or three ways to overcome this obstacle. One is to wrap the set in a blanket (Fig. 2), but you must be sure the blanket doesn't get so close to the high-power tubes that it catches fire. This method entails another problem: when you remove the blanket for making checks, you must work fast because the set will be cooling off again.

Usually, a much more satisfactory way (especially if you are reasonably sure which section of the receiver is causing the trouble) is to use your soldering iron. Move it close to suspected parts, and heat them considerably above room temperature (Fig. 3). The big advantage in this is to locate the heat-sensitive part almost immediately. With the blanket method, all parts are heated, and you still have the job of localization.

As an example of the soldering iron method, let's suppose the set has an intermittent vertical roll. With the chassis out of the cabinet, take a soldering iron and hold it close to each resistor and capacitor in the suspected section for a short



Fig. 2. Covering the set will cause components to heat.

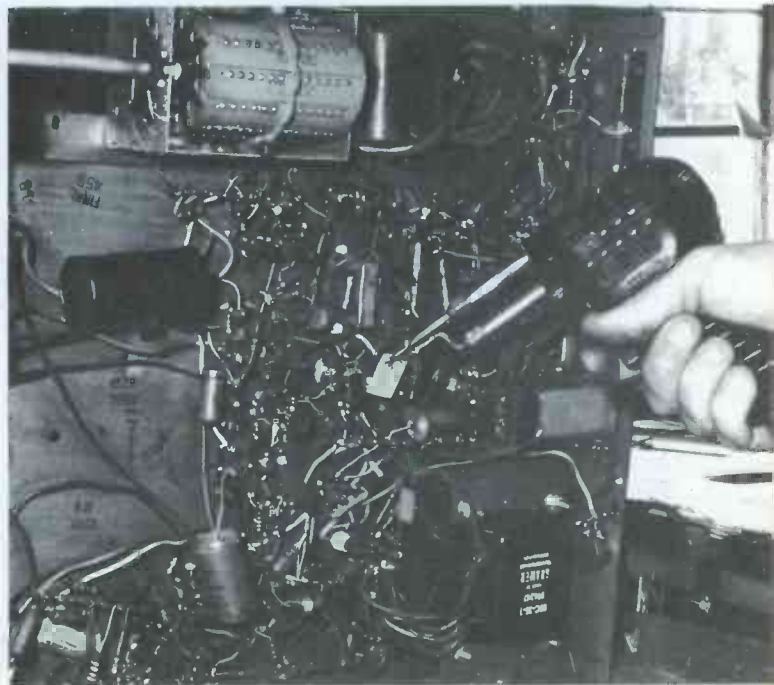

Fig. 3. Heating the defective component causes symptom.



new
8290
Shielded Permohm*
 Shown Actual Size



82 Channel TV lead-in

for the strongest, cleanest picture
 signal and best color... ever!

- Provides 82 channel color reception
- Less installation time and cost
- Eliminates transmission line pick-up of noise and ghost signals
- No expensive matching transformers required
- Can be installed anywhere

Photos courtesy of WGN-TV.

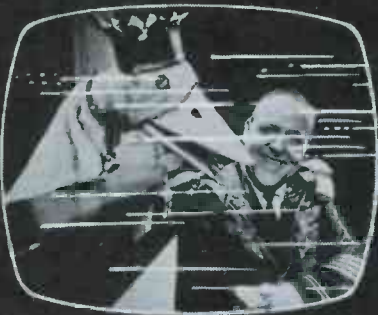

Unshielded twin-lead
 Severe picture disturbance
 due to ignition noise.



Coaxial Cable
 Ignition noise minimized—
 but not eliminated.



*** Shielded Permohm**
 Eliminates automobile
 ignition noise.

■ New 8290 Shielded Permohm TV Lead-in combines the strong signal strength of twin-lead with the clean signal protection of shielded cable. Because it is a balanced line for 300 Ohm TV antennas and receivers, *costly matching transformers and connectors are eliminated.*

8290 is specifically designed for superior color reception on all 82 channels. The twin-lead is encapsulated in low-loss cellular polyethylene insulation, Beldfoil** shielded against all outside disturbances, and protected with a weatherproof

*Belden Trademark—Reg. U.S. Pat. Off.

jacket. A drain wire is provided for grounding the shield to the chassis. The need for stand-offs, twisting or routing of lead-in is eliminated. 8290 can be taped directly to a mast or tower, routed through metal pipe, buried underground, or even installed in rain filled gutters to reduce installation time and cost.

Ask your distributor about 8290 Shielded Permohm TV Lead-in cable, today! Or, write P. O. Box 5070-A for complete information.

**Belden U.S. Patent 2,782,251 and patent pending

BELDEN MANUFACTURING COMPANY

Belden

P.O. Box 5070-A • Chicago, Illinois 60680

Circle 11 on literature card

time. When you come to the sensitive one, the picture will start to roll, and you can be pretty sure you have found the trouble. Or perhaps the sync gets critical after the set plays an hour or so. Do the same thing in the sync circuit. You'll find the culprit quite often.

Other Kinds

Other intermittents occur because of high or low power-line voltage. Every technician should have some method of varying the line voltage by about 20%. You must remember, however, that with the chassis out of the cabinet parts will run considerably cooler and the voltage change may not cause the intermittent to happen. In other words, the trouble may be due to heat.

You can use a large pasteboard box, one large enough to cover the set, and leave only the bottom of the chassis exposed for testing. The box and the application of higher or lower voltage will usually make the intermittent come out into the open which will save much time.

There are mechanical intermittents that take place, but these should respond to a mechanical diagnosis. For example, the set may go off or produce distortion in the picture or sound when it is moved. The first things to check in these cases are the antenna lead and other common trouble spots. Nothing is more embarrassing than finding an obvious broken wire (or a "short sommers") after the chassis has been pulled and a good deal of time spent in checking for a more sophisticated defect.



"Don't let him fool you! I've heard about his vacations to Paris, the Caribbean, the Bahamas—"

Conclusion

Remember to set your mind to finding the trouble, use the tools at your command, and get busy. Don't put it off! If you start right in and resolve that you can fix any trouble that a circuit can be sneaky enough to hide, you can make the intermittent bite the dust faster than Matt Dillon can pull leather.

One last word of caution: Always make sure, or as sure as you can, that you have actually found the de-

fective parts causing the intermittent. Intermittents, being rather unsavory characters anyhow, often lie low when the law starts after them, coming out only when there isn't much chance of getting caught.

Don't let apparent cures fool you. As has been said before somewhere, if you step on a dog's tail, he yells at the other end. If you push on one part in the chassis it may effect a temporary cure on the other side. Moral: Don't let a sneaky intermittent ruin your reputation. ▲

The famous MERCURY Model 1101 TUBE TESTER NOW in a wire-it-yourself KIT!

*illustrated
step-by-step
instructions
make the
Model 1101
easy-to-
build...*

**A PORTABLE
MASTERPIECE**
Modern, airplane
luggage design
scuff-proof gray
case...Weighs
only 4 lbs. 8 3/8"
x 11 3/8" x 3 3/4".

**EMPLOYS EXCLUSIVE
2-POINT TEST PRINCIPLE**

- ✓ assures a 100% short test (shorts are one of the most common causes for tube failure)...they cannot get by the Model 1101
- ✓ assures that all sections of multi-section tubes will be fully tested
- ✓ your greatest safeguard against obsolescence

See your parts distributor...
or write for complete catalog

\$34⁹⁵ Net
 Model 1101K...Kit.....
 Model 1101...Wired... **\$49.95** Net

MERCURY ELECTRONICS CORPORATION
manufacturers of quality electronics products
 315 Roslyn Road, Mineola, New York 11501
 Exporta Morhan Exporting Corp., 458 Broadway, New York, N.Y. 10013

Circle 12 on literature card

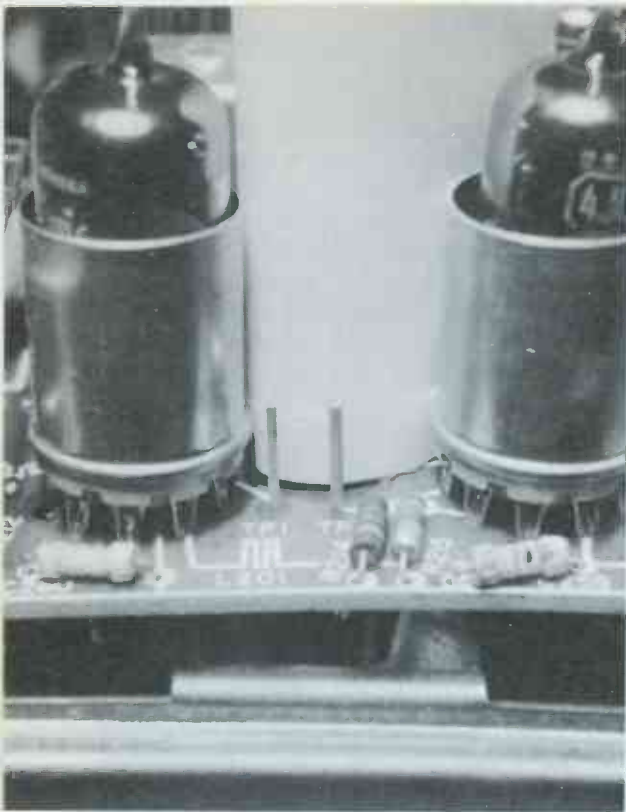

All of us use test points when we troubleshoot radio or television circuits. By making checks at specific points, we can readily determine the operation of an entire section—such as a tuner, video amplifier, or vertical-sweep circuit. After we locate the defective area, we find the exact trouble by conventional tests. Assuming that we know what part of the circuit we want to use for a test point, the next step is to locate it on the chassis. But how do you find a test point on an etched circuit board when the components are on one side and the wiring on the other? These photos show some possibilities.

Finding Test Points *On* **Printed Boards**

Many large boards have some kind of circuit diagram on the component side to show the path of the wiring on the reverse side. By counting the tube-socket pins, you can identify test points with the elements of a tube.

The service data will usually tell you, but what can you do if a schematic is not available? You can follow the signal path by viewing the reverse side of the radio and observing the positions of IF transformers, detector, etc.

It is more difficult to find test points on a small radio chassis where the size does not permit such a diagram. You can make a visual examination with a magnifier to find bad solder joints or cracks in the board, but the big puzzle is: what components are connected by this wiring?

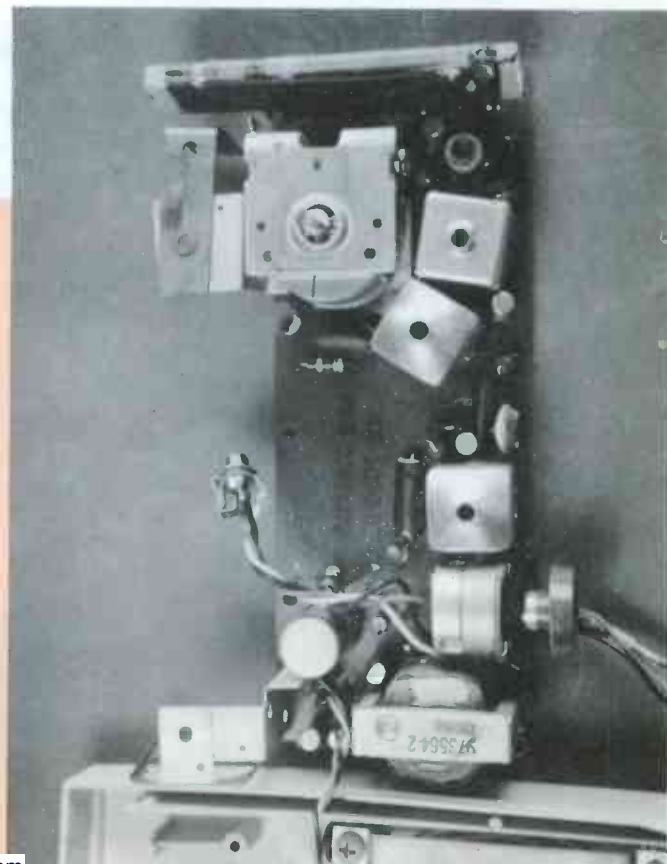
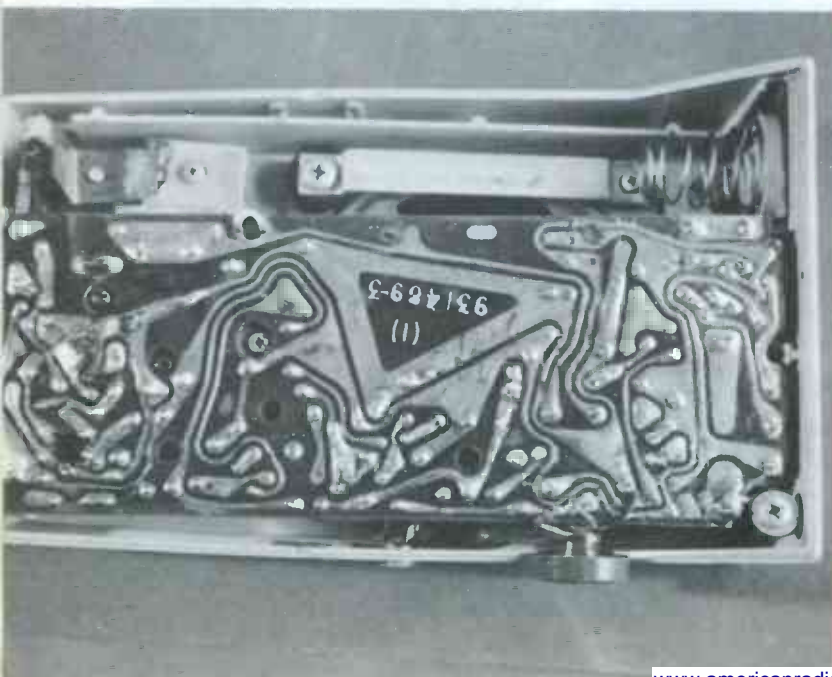



Another helpful method for signal tracing is to make the connection between the components visible. You can do this by viewing the component side of the board and placing a light on the opposite side. A plain light bulb or penlight will do.



The reverse method may also be used; that is, position a light on the component side of the printed board and look at the wiring side. This procedure is sometimes quite helpful, although in most cases it is less satisfactory than lighting the wiring side.

The preceding tests should have localized the trouble spot; now we must concentrate on smaller test points. A dental mirror will help in seeing the under side of the transistors, and an external transistor will help visualize pin connections.

Large components whose functions cannot be mistaken make good landmarks for circuit tracing. These include tuning capacitors, volume controls, transformers, and diodes. The volume control is handy test point for overall check of audio circuit.

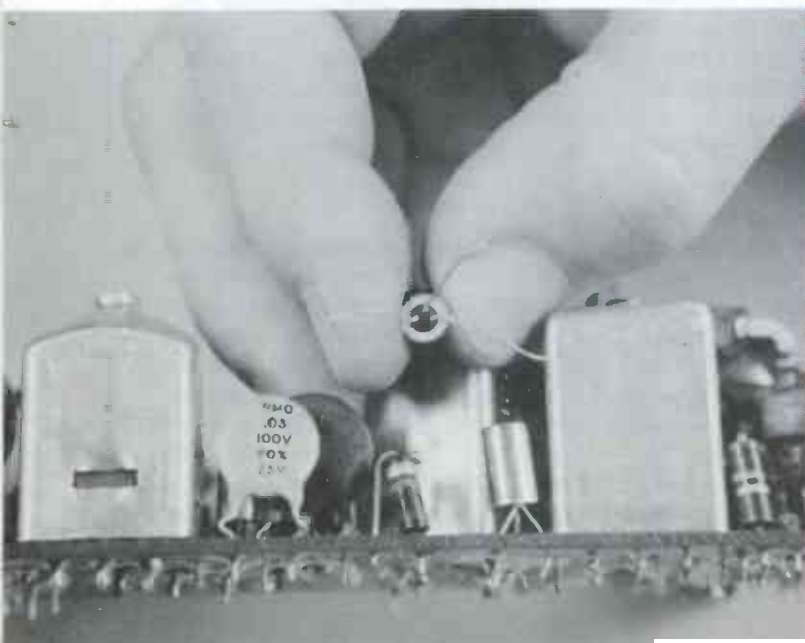

can an
ACCOUNTANT
help you?



These consultants
may save you dollars.

by David I. King

One measure of the efficiency of your business operation is the accuracy and completeness of its records. This does not mean you must build a paperwork empire to have an efficient operation; to the contrary, a paperwork empire is a sign of inefficient accounting methods. An efficient, accurate, complete accounting system need not be complex, but it must be well organized.

Many small businessmen do not keep adequate records, and radio-TV repair-shop owners are certainly no exception. Without complete records, a shopowner is never certain of his financial condition. Often an accountant is called in only at year's end (or tax time) to put existing records in order and make an annual statement of total profit or loss. Therefore, information necessary for business decisions throughout the year is available only at this time. Often, it's too late to prevent costly mistakes.

There are many ways that you, the shopowner, can provide yourself with records of your business operation:

1. You can keep your own records—if you have time. The disadvantage is that if business volume increases, you have less time to spend on records, and resulting inefficient management

may then destroy profits from increased business.

2. Turn responsibility for your records over to your wife. If she fully understands your business and is a good bookkeeper, then you're most fortunate!
3. If your shop is large enough to need an office girl, keeping records can be made one of her duties. An accountant can then be hired only for annual inventory and tax purposes.
4. You may, if you own a really large shop, decide to hire a full-time accountant. (Radio-TV repair shops this large are few.)
5. If your shop is small or medium-sized, you can use an outside accountant to handle all records, including those for tax purposes.

Why Use An Accountant?

Owners of small shops are often reluctant to hire an accountant. Profit margin is so small that the expenditure for an accountant's services may seem too great. Yet, if the individual owner doesn't keep adequate records, it's probable that he will lose more money through poor management (caused by the lack of complete records) than if he had hired an accountant. Accounting service is not expensive—*NARDA Cost-of-Doing-Business Survey* for

1964 shows that *NARDA* members spent only .55% of gross sales for accounting and legal services combined. Perhaps you are not familiar with all the services accountants make available; here are the major ones.

Bookkeeping

Before a meaningful record of business transactions can be made, all income and expenses must be recorded. Usually, an accountant collects all bills, invoices, check stubs, receipts, and other transaction statements, then itemizes them to get a full report of profit or loss.

The method used to collect this information varies. Often, a box is left with the shopowner, and he deposits in it all his receipts and bills, etc. These are then collected weekly, biweekly, or monthly.

Profit-Loss Statement

Results from income and expenses are compiled by the accountant and submitted to the shopowner in a report that is usually called a *profit-and-loss statement*. An example is shown in Fig. 1. The top section shows total income. The cost of goods sold is subtracted to give gross profit. Next, total operating expense is subtracted to give gross profit. Finally, total operating ex-

pense is subtracted from gross profit to give net gain/loss.

Percentages

To the profit-loss statement the accountant may add *percentages*; here, they are listed in relationship to total income. The center percent column is for the current month, while the percent column to the far right shows percentages from the beginning of the year to date.

These percentages are invaluable for detecting variations in the relationships among net gain, gross profit, cost of goods sold, and operating expense. For example, a sharp increase in the cost-of-goods-sold percentage is an indication of possible inventory problems; or it might indicate a decrease in income from service and labor sales. Although percentages won't always specify the cause of trouble, they are valid indicators of its existence.

Expense Breakdown

Operating expense can be listed in many ways. In the report in Fig. 1, for example, there are no fuel or heating expenses or personal property taxes for this particular month; yet, previous payments are shown in the balance-to-date column, and a percentage is listed showing the relationship to total income since the beginning of the year.

A breakdown of expenses informs the shopowner:

1. Where his money is going.
2. How much is being spent for any item.
3. The relationship in percentage (when given) of any expense to total income.

The shopowner has a monthly report of all expenses. He can then make corrections for any expense that seems excessive. Ideal figures can be determined for expense items, and procedures can be devised for reducing expenses until they approach the ideal. Since net gain can be increased by *decreasing* operating expense as well as *increasing* total income, an accurate account of all expenses is most important to the business owner.

Taxes

Modern-day local, state, and federal tax laws are so complicated that few shopowners have time or incentive to learn them; instead, they usually hire an accountant to compute

ACCOUNT DESCRIPTION		CURR PERIOD	PERCENT	BAL TO DATE	PERCENT
INCOME	100				
SERVICE PARTS SOLD	110	1,502.74		11,195.12	
TV & HI FI SALES	111	4,880.10		34,656.88	
APPLIANCE SALES	112	1,488.27		11,246.39	
OTHER SALES	113	533.01		4,395.49	
SERV & LABOR SALES	120	1,427.20		8,982.88	
OTHER INCOME	180	39.75		339.47	
TOTAL		9,871.07		70,816.23	
COST OF GOODS SOLD	210	5,042.47	51.08	36,896.34	52.10
TOTAL		5,042.47	51.08	36,896.34	52.10
GROSS PROFIT		4,828.60	48.92	33,919.89	47.90
OPERATING EXPENSE	300				
OUTSIDE LABOR	301	138.39	1.40	391.09	.55
WAGES & SALARIES	305	606.40	6.14	3,967.05	5.60
SOC SECURITY TAXES	314			130.69	.18
PERS PROPERTY TAXES	315			124.68	.18
LICENSES & TAXES	316	5.05	.05	50.95	.07
GROSS INCOME TAXES	318			18.81	.03
FUEL OR HEATING	320			201.23	.28
UTILITIES	330	56.63	.57	326.88	.46
TELEPHONE TELEGRAPH	335	21.87	.22	210.03	.30
IESA SCHODL	350	4.28	.04	96.12	.14
ADVERTISING	360	502.41	5.09	2,316.28	3.27
AUTO OR TRUCK	361	69.96	.71	262.76	.37
CLEANING & LAUNDRY	363			18.50	.03
TRASH	365			3.00	.00
DUES & SUBSCRIPTIONS	366			110.95	.16
FREIGHT & DELIVERY	368	11.15	.11	121.54	.17
INSURANCE	369	84.46	.86	431.08	.61
INTEREST	370	6.62	.07	340.61	.48
PROFESSIONAL SERVICE	371	30.00	.30	262.50	.37
RENT	372	200.00	2.03	1,600.00	2.26
REPAIRS & MAINT	373	20.00	.20	32.50	.05
SUPPLIES & POSTAGE	375	9.51	.10	465.11	.66
TRAVEL	377			61.08	.09
TOTAL		1,766.73	17.90	11,543.44	16.30
NET GAIN/LOSS		3,061.87	31.02	22,376.45	31.60

Fig. 1. Profit-loss statement itemizes income vs expense and lists percentages.

their taxes. Accountants have to know tax laws—they make their living by performing these services. Still, the very best accountant cannot list exemptions to which the shopowner is entitled if accurate records of all expenses are not available. As a result, the shopowner with an inefficient accounting system can lose money by paying unnecessary taxes.

The Accountant As A Consultant

In addition to the previously mentioned services, an accountant is a valuable consultant. His experience and knowledge of business procedures are among his most valuable assets. An accountant must be an authority on local, state, and federal tax laws. He can show you ways to avoid unnecessary taxes. He may also be able to help you minimize losses due to depreciation. You can usually call upon your accountant to help set up your inventory. Even if you've had a great deal of experience with inventory procedure, an accountant can probably give you time- and effort-saving hints. Your accountant may have a means of

predicting your inventory. By developing a *cost factor* for goods sold, he can estimate your actual inventory. This estimate is valuable if you are in doubt as to whether you should make new orders or continue with present stock.

Summary

Not all accountants offer every service described here; some will offer more, others fewer. All are in business just as you are, and most are very conscientious. One accountant sums up his views like this: "The accountant is the watchdog for the individual client . . . Proper accounting is as important to a businessman as the product he sells."

If you are handling your own records and have any doubts about their accuracy or completeness, definitely consider getting an accountant. You'll probably find that this service will more than pay for itself.

The author wishes to express his gratitude to Dick Glass, president of the National Electronics Association, Walter Akers, and many others for their invaluable aid. ▲

The first completely new antenna concept in years...

Revolutionary **CHANNEL** **ULTRADYNE SERIES**

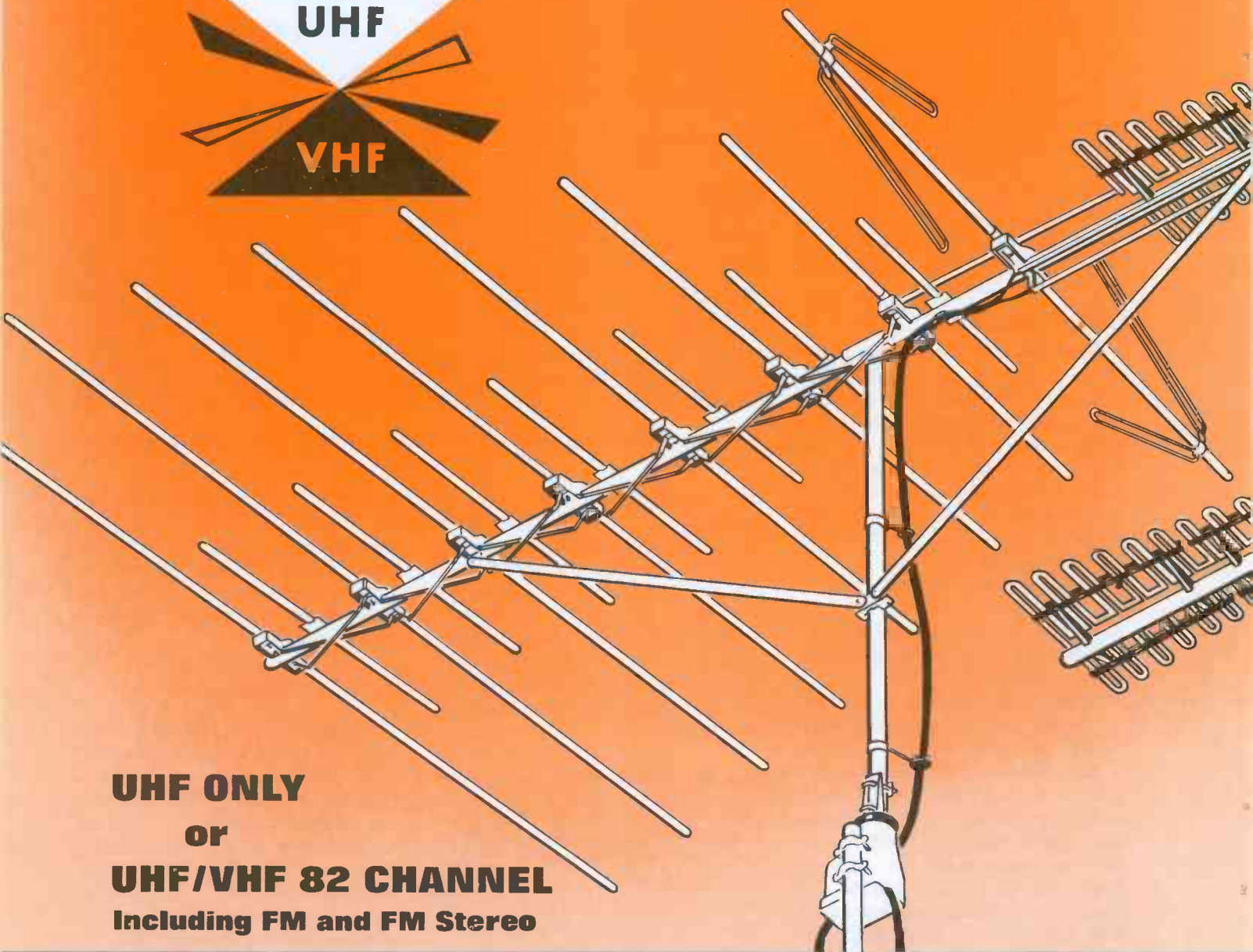

UHF ONLY
or
UHF/VHF 82 CHANNEL
Including FM and FM Stereo

Model 0032 U-V Band Splitter included with all 82 channel antennas.

BREAKTHROUGH!

Five new ULTRADYNE CROSS-FIRE antenna models provide the first high gain FM and FM Stereo performance ever attained in an 82 channel TV antenna. Channel Master's exclusive, patented Tri-Band Directors make it possible. All ULTRADYNE series antennas feature the famous EPC golden coating.



Model 3632G
for deep fringe areas

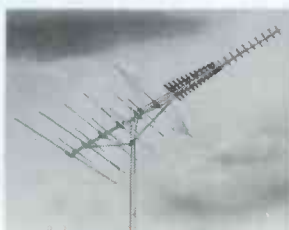

Model 3634G
for near fringe areas

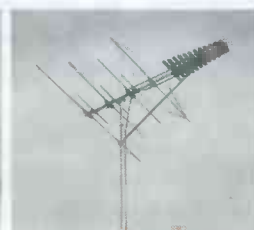

Model 3635G
for suburban areas

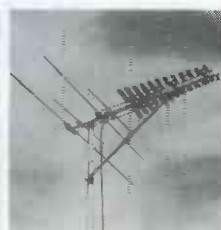

Model 3636G
for metropolitan areas

MASTER®

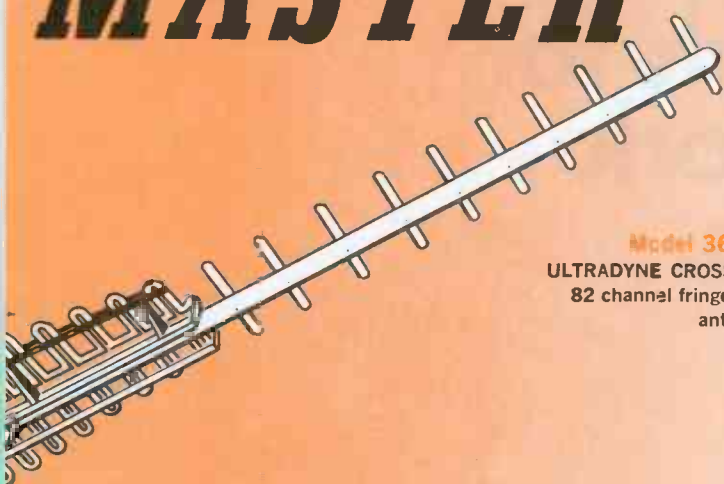

Model 3633G
ULTRADYNE CROSSFIRE
82 channel fringe area
antenna.

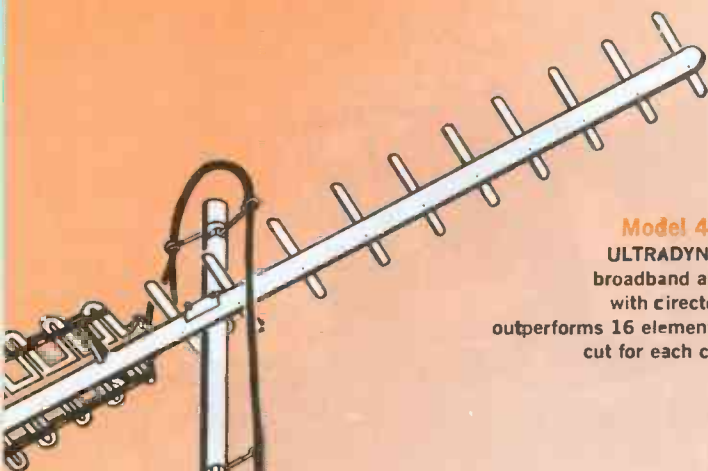

Model 4314G
ULTRADYNE UHF
broadband antenna
with directors . . .
outperforms 16 element Yagis
cut for each channel

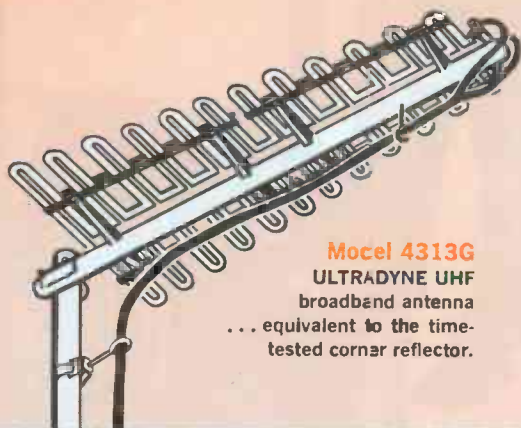

Model 4313G
ULTRADYNE UHF
broadband antenna
. . . equivalent to the time-
tested corner reflector.

BREAKTHROUGH!

The amazing electronic ghost-killing power of Channel Master's famous Coloray antenna is now combined with the ULTRADYNE principle to create an 82 channel antenna for superb color reception as well as FM and FM Stereo in ghost-plagued areas.

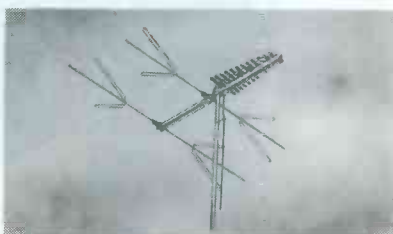

Model 3637G
ULTRADYNE COLORAY

Circle 13 on literature card

COLOR AGE

BREAKTHROUGH!

Model for model, new ULTRADYNE CROSSFIRES are the highest gain, highest front-to-back ratio 82 channel antennas ever developed. Unprecedented acceptance has made Channel Master Color Crossfires the best-selling VHF-FM antennas in TV history. Now, in combination with the ULTRADYNE UHF antenna, new standards of 82 channel performance are achieved.

BREAKTHROUGH!

Obsoletes so-called log periodic antennas. ULTRADYNE antennas, employing an entirely new principle, have higher gain than any log periodic antenna type on the market.

BREAKTHROUGH!

"Built-In" 300 ohm impedance actually makes the ULTRADYNE function as a length of 300 ohm transmission line at VHF. This eliminates the need for an antenna coupler when the ULTRADYNE is used in conjunction with any 300 ohm VHF antenna such as Channel Master's Famous Color Crossfires (models 3617G, 3610G, 3611G, 3612G, 3613G, 3614G, and 3615G).

BREAKTHROUGH!

Fantastic front-to-back ratios . . . over 15:1 across the entire UHF band.

BREAKTHROUGH!

Unique construction. Two stamped aluminum sections make up the entire driven element section of the antenna. This means precise control of dimensions and the elimination of connection and corrosion problems.

BREAKTHROUGH!

Three separate United States patents and two patents pending cover the exclusive design features of Channel Master's new ULTRADYNE series. No other antenna line incorporates such important technical advances. Yes, from the standpoint of gain, front-to-back ratio, impedance, construction simplicity and versatility, no other antenna comes close to the ULTRADYNE series. No wonder the entire industry knows that the truly significant advances in antenna design traditionally come from . . .

CHANNEL MASTER ELLENVILLE, NEW YORK
World's Largest Manufacturer of TV/FM Reception Equipment

Ed Leahy doesn't work for us. We work for him.

Ed Leahy believes in being his own boss. Which is what Ed likes about running his own Philco Qualified Service Center. It means that, with no strings attached, he gets better training, better service and more benefits than any other manufacturer offers.

When he needs a part, he gets it fast. His Philco Parts Distributor has what Ed needs right on hand. But even if Ed gets a job like fixing a 1947 model, he knows the oddball part he needs will be shipped in 24 hours or less through Philco's Lifeline Emergency Service.

Ed keeps up on new products with Philco Tech Data Service. He tried other services and found out that he gets the facts sooner, better and at lower cost from Philco.

Ed likes Philco's "fringe benefits," too. A complete accident insurance program for himself and his men. Advice on business management, found in Philco's popular "Service Businessman" magazine. He gets extra business, too, when his name appears under a Philco listing in the Yellow Pages.

Ed Leahy has it good. You can, too. Talk to your Philco Parts Distributor or contact Parts & Service Department, Philco Corporation, Tioga and "C" Streets, Philadelphia, Pa. 19134.

PARTS & SERVICE DEPARTMENT
PHILCO[®]
A SUBSIDIARY OF *Ford Motor Company*



Circle 14 on literature card

MASTER®

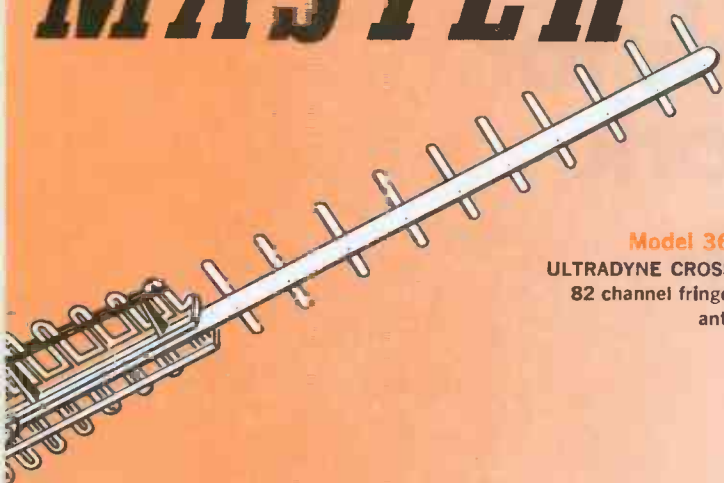

Model 3633G
ULTRADYNE CROSSFIRE
82 channel fringe area
antenna.

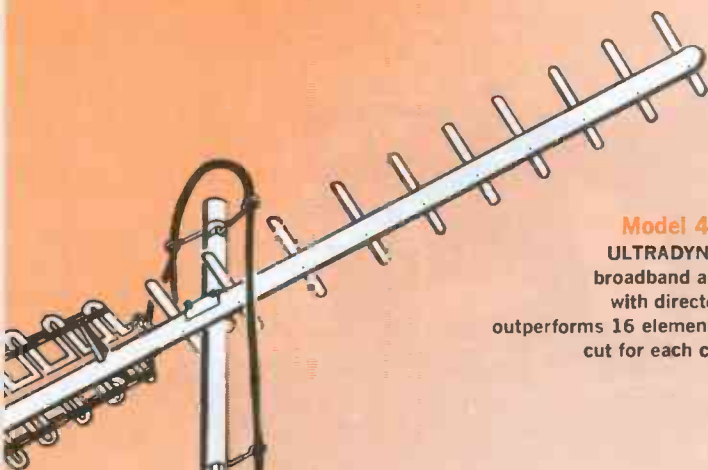

Model 4314G
ULTRADYNE UHF
broadband antenna
with directors . . .
outperforms 16 element Yagis
cut for each channel

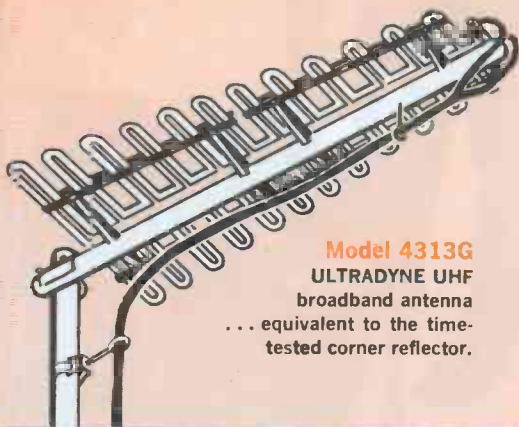

Model 4313G
ULTRADYNE UHF
broadband antenna
. . . equivalent to the time-
tested corner reflector.

BREAKTHROUGH!

The amazing electronic ghost-killing power of Channel Master's famous Coloray antenna is now combined with the ULTRADYNE principle to create an 82 channel antenna for superb color reception as well as FM and FM Stereo in ghost-plagued areas.

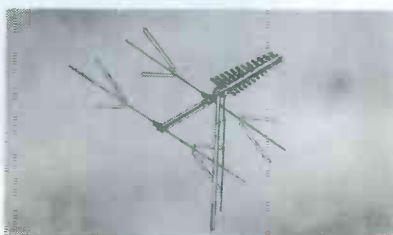

Model 3637G
ULTRADYNE COLORAY

Circle 13 on literature card

COLOR AGE

BREAKTHROUGH!

Model for model, new ULTRADYNE CROSSFIRES are the highest gain, highest front-to-back ratio 82 channel antennas ever developed. Unprecedented acceptance has made Channel Master Color Crossfires the best-selling VHF-FM antennas in TV history. Now, in combination with the ULTRADYNE UHF antenna, new standards of 82 channel performance are achieved.

BREAKTHROUGH!

Obsoletes so-called log periodic antennas. ULTRADYNE antennas, employing an entirely new principle, have higher gain than any log periodic antenna type on the market.

BREAKTHROUGH!

"Built-In" 300 ohm impedance actually makes the ULTRADYNE function as a length of 300 ohm transmission line at VHF. This eliminates the need for an antenna coupler when the ULTRADYNE is used in conjunction with any 300 ohm VHF antenna such as Channel Master's Famous Color Crossfires (models 3617G, 3610G, 3611G, 3612G, 3613G, 3614G, and 3615G).

BREAKTHROUGH!

Fantastic front-to-back ratios . . . over 15:1 across the entire UHF band.

BREAKTHROUGH!

Unique construction. Two stamped aluminum sections make up the entire driven element section of the antenna. This means precise control of dimensions and the elimination of connection and corrosion problems.

BREAKTHROUGH!

Three separate United States patents and two patents pending cover the exclusive design features of Channel Master's new ULTRADYNE series. No other antenna line incorporates such important technical advances. Yes, from the standpoint of gain, front-to-back ratio, impedance, construction simplicity and versatility, no other antenna comes close to the ULTRADYNE series. No wonder the entire industry knows that the truly significant advances in antenna design traditionally come from . . .

CHANNEL MASTER ELLENVILLE, NEW YORK
World's Largest Manufacturer of TV/FM Reception Equipment

Ed Leahy doesn't work for us. We work for him.

Ed Leahy believes in being his own boss. Which is what Ed likes about running his own Philco Qualified Service Center. It means that, with no strings attached, he gets better training, better service and more benefits than any other manufacturer offers.

When he needs a part, he gets it fast. His Philco Parts Distributor has what Ed needs right on hand. But even if Ed gets a job like fixing a 1947 model, he knows the oddball part he needs will be shipped in 24 hours or less through Philco's Lifeline Emergency Service.

Ed keeps up on new products with Philco Tech Data Service. He tried other services and found out that he gets the facts sooner, better and at lower cost from Philco.

Ed likes Philco's "fringe benefits," too. A complete accident insurance program for himself and his men. Advice on business management, found in Philco's popular "Service Businessman" magazine. He gets extra business, too, when his name appears under a Philco listing in the Yellow Pages.

Ed Leahy has it good. You can, too. Talk to your Philco Parts Distributor or contact Parts & Service Department, Philco Corporation, Tioga and "C" Streets, Philadelphia, Pa. 19134.

PARTS & SERVICE DEPARTMENT

PHILCO®

A SUBSIDIARY OF *Ford Motor Company*



Circle 14 on literature card

Compactron

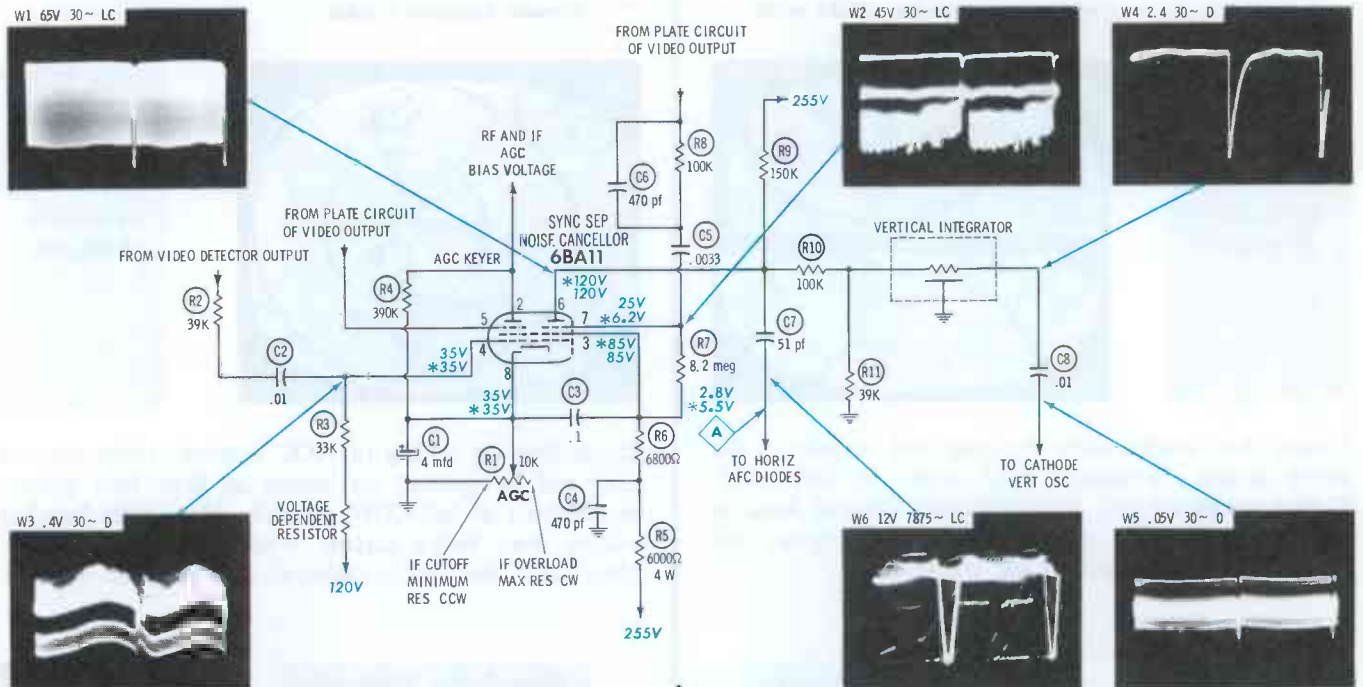

DC VOLTAGES taken with VTVM, on inactive channel; antenna terminals shorted. *Indicates voltage taken with signal present — see "Operating Variations."

WAVEFORMS taken with wideband scope; TV controls set to produce normal picture and sound. LC (low-cap), D (direct) probes are used where indicated.

Normal Operation

One-third of 6BA11 compactron serves as sync separator in Zenith Chassis 14N26; operates same as BU8 family of tubes. Composite video signal from detector has negative-going sync pulses and is coupled to pin 4 (noise-limiting grid). Normally, this signal (W3) is relatively low in amplitude and, when free of noise, has little effect on tube conduction. However, should interference appear, negative-going noise spikes send tube deeper into cutoff for their duration and prevent distortion of sync pulses (W1) at pin 6. Actual average conduction of sync separator is controlled mainly by screen grid, pin 3; this point is set so that only upper 30% of video signal brings tube out of cutoff, permitting only sync pulses to appear in output (pin 6). Pips at bottom of W1 are vertical-sync tips; white area represents horizontal-sync pulses when scope sweep is at 30 cps. W1 is coupled to integrator circuit, which passes only vertical-sync pulses, and to horizontal AFC circuit. Pins 3, 4, and 8 are all common to AGC section of 6BA11. As control in cathode circuit is set for minimum resistance (CCW rotation), grid bias between pins 4 and 8 goes more positive. Tube conducts more. Thus, AGC voltage at pin 2 (plate) goes more negative and is applied to video-IF grids—causes IF cutoff. When control is rotated CW, adding cathode resistance, bias tends more negative; tube conduction is less. This reduces negative AGC bias on video IF's, and eventually causes IF overloading. During either cutoff or overload of IF's, video is blocked; doesn't reach sync-input grid (pin 7), thus affects operation of sync-separator section.

Operating Variations

- Pin 6** Strength of signal has no effect on DC voltage. 95 volts on pin 6 coincides with loss of sync as AGC control is turned and approaches either maximum or minimum position.
- Pin 7** When AGC control is rotated CCW, at point where picture just loses sync before blanking out, voltage is 26 volts. In CW direction: 47 volts when picture loses sync prior to overload. Weak signal produces only 13.5 volts.
- Pin 3** Adjusting AGC control through entire range has no affect on voltage reading. Variations in signal strength produce no discernible voltage changes.
- Pin 4** Reducing resistance on cathode (AGC toward CCW position) causes 10-volt reduction when sync falls out, 20-volt gain with increased resistance (CW) in cathode is to sync-loss point. Voltage doesn't vary with signal.
- Pin 8** Voltage varies from 27 volts (AGC CCW to loss-of-sync) to 55 volts (control toward CW rotation until sync is lost). Weak signal doesn't affect voltage at all.
- WAVEFORMS** All waveforms except W3 show no change in amplitude with different signal strengths. W3 amplitude increases from .2 volts p-p to .25 volts p-p as signal grows weaker.

Horizontal Bending

Vertical Sync Intermittent

Symptom 1

C5 Slightly Leaky

(Sync-input Capacitor—.0033 mfd)

Symptom Analysis

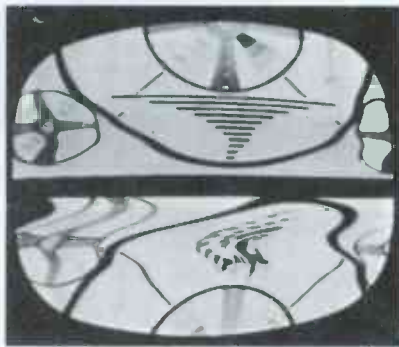

Picture has considerable bending and weaving over entire screen. Horizontal hold seems to lock solid. Picture tends to roll intermittently. Vertical hold is touchy, but locks in strong. Occasionally, picture will lock with vertical blanking bar visible.



Waveform Analysis

W6 amplitude has increased 70% and reveals much video information with horizontal sync pulses at AFC diodes. This explains why changes in picture content affect degree of horizontal bending. W1 shows 30% amplitude increase, which indicates tube gain is excessive; also, observe much video overriding sync pulses (compare with normal W1). This demonstrates tube's failure to separate video from sync pulses.

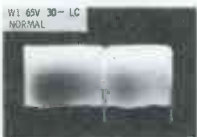
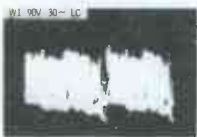

Voltage and Component Analysis

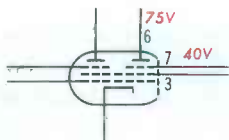

Plate voltage is down 35%, B+ supply is normal. R9 measures okay, so tube must be drawing excessive current. Voltage on screen grid is correct, but voltage on pin 7 has increased from 6.2 volts to 40 volts. Voltage increase on sync-input grid has raised average conduction of tube. Change in tube's conduction level permits amplification of entire composite-video signal. Leaky C5 is allowing part of video-output-plate voltage to appear at pin 7. Disconnect pin-7 end of C5 and check with VTVM to verify.

Best Bet: Scope, then VTVM

Horizontal Bending

Vertical Sync Normal

Symptom 2

C3 Shorted

(Screen Bypass—.1 mfd)

Symptom Analysis

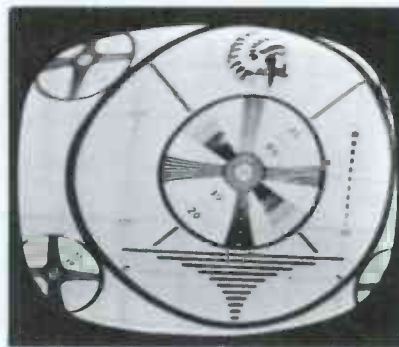

Depending on setting of AGC control, video may or may not be present on screen at first; best picture is obtained at full-CCW position. Horizontal bending occurs over entire screen. Vertical sync is normal. Only AGC and horizontal-sync circuits seem affected.

Waveform Analysis

Scope check shows horizontal-sync pulses (W6) are slightly attenuated; also sawtooth appearance denotes they are integrating slightly. W1 amplitude is down 50%; however, horizontal-sync pulses (white area) are attenuated more than vertical, which accounts for normal vertical sync. W2 is normal. Tube gain is low, which also affects AGC section. Circuits of pins 3 and 4 are suspicious since they are common to both AGC and sync separator.



Voltage and Component Analysis

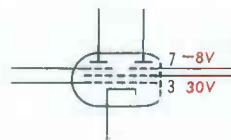

Voltages on pins 4, 6, and 8 are normal. Pin 7 has -8 volts, and screen grid measures 30 volts. Since voltages at pins 3 and 8 are identical, C3 is good suspect. Resistance check discloses C3 has leakage of 220 ohms. Screen voltage leaks through C3 and AGC control to ground. Low screen voltage slows electron flow through tube and permits electrons to collect on pin 7, which accounts for -8 volts on sync-input grid. Since C3 is shorted, large voltage drop across R6 causes its 1/2-watt rating to be exceeded. Replace it.

Best Bet: VTVM will find trouble

Horizontal Sync Critical

Symptom 3

Picture Shifted to Left

C7 Slightly Leaky

(Horizontal-Sync Coupling Capacitor—51pf)

Symptom Analysis

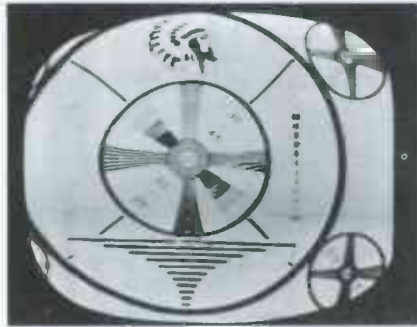

Horizontal hold critical with little range. One-eighth turn either direction from lock-in position throws horizontal out of sync. When locked horizontally, picture is shifted slightly to left side of CRT. Vertical sync normal; attention should be on horizontal sync pulses.

Waveform Analysis

W2 is normal with proper amplitude. W1 reveals healthy vertical and horizontal sync pulses with sufficient gain, verifying separator tube is performing its job and amplifying pulses properly. Scope check of W6 uncovers distorted reduction in peak-to-peak voltage. C7 would seem likely suspect since W1 has normal sync pulses and amplitude. Voltage and resistance checks will give more positive indication of condition of C7.

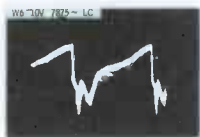
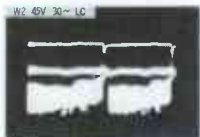

Voltage and Component Analysis

A 13V

All voltages on sync-separator tube are normal. DC voltage check at common cathodes of horizontal-AFC diodes show voltage increase from 3.5 volts to 13 volts. Suspect horizontal-sync-coupling capacitor is shorted. Resistance measurement confirms C7 has leakage. Leakage voltage through C7, with correction voltage developed by horizontal-AFC diodes, decreases grid bias on horizontal-AFC tube and increases its plate current. This current change is reflected to horizontal-oscillator-grid bias and upsets oscillator operation.

Best Bet: Scope helps, VTVM locates

No Vertical Sync

Horizontal Sync Normal

C8 Open

(Vertical-Sync Coupling Capacitor—.01 mfd)

Symptom 4

Symptom Analysis

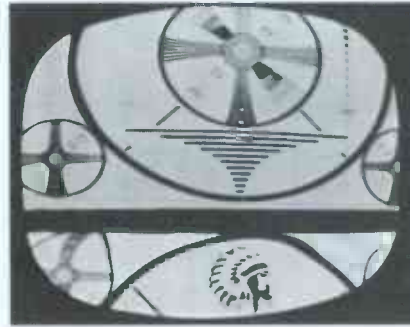

Picture rolls, and vertical hold has no control over sync. Vertical-blanking bar floats either up or down, depending on vertical-hold control setting. Vertical sync is impossible. Horizontal sync locks solid and horizontal-hold control has normal adjustment range.

Waveform Analysis

Scope observation of W1 discloses proper sync pulses available for both oscillator-input circuits. Since horizontal sync is normal, attention is on vertical-sync input circuit. To view vertical-sync pulse without vertical output feedback, vertical oscillator is disabled. W4 shows normal sync pulse is passing through integrator; however, moving scope to look at W5 reveals absence of sync pulse. This suggests that C8 is probably open.

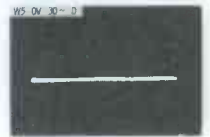
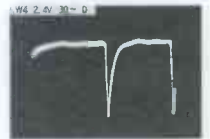

Voltage and Component Analysis

NO VOLTAGE CLUES

All voltages are normal on sync-separator tube. Horizontal oscillator locks in sync properly, and horizontal-hold control has normal range—indicates sync separator is operating and horizontal-sync pulses are present on plate; thus, no reason to believe vertical-sync pulses are absent. Resistance measurements of R10 and R11 are correct. Continuity check reveals vertical-integrator network is not open. Only circuit path remaining for sync pulse to reach vertical oscillator is C8. Substitution of C8 returns vertical sync.

Best Best: Scope is conclusive

Vertical Sync Weak

Horizontal Hold Normal

R10 Value Increased

(Voltage Divider and Plate Load Resistor—100K)

Symptom 5

Symptom Analysis

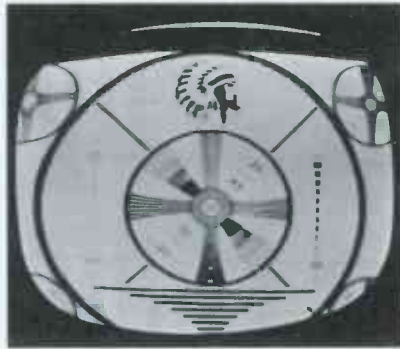

Vertical-hold control will hardly sync picture. Slightest signal interference causes picture to roll, and vertical-blanking bar has tendency to float through screen. Horizontal sync appears normal. Would seem vertical-sync pulse is greatly attenuated.

Waveform Analysis

Scoping W1 reveals 160 volts p-p (normal is 65) 60% increase in sync pulses, yet vertical sync is weak. Tube current rise is indicated; however, AGC is normal (cathode is common to both sections of tube, so current increase should effect AGC). W5 uncovers attenuation of vertical-sync pulses (vertical oscillator must be disabled to extinguish feedback pulse). Moving scope to W4 reveals same attenuation. R10, R11 integrator are suspects.

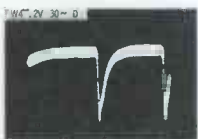
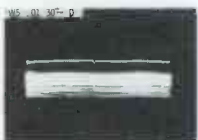

Voltage and Component Analysis

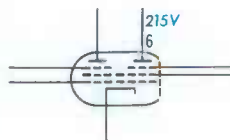

Voltages read correctly on all points except pin 6; voltage here has increased 80%. Since cathode voltage has not changed, tube current must be normal. Vertical-integrator network has continuity and should pass vertical-sync pulses. Plate circuit has voltage divider network consisting of R9, R10, and R11 are also plate-load resistors for separator tube. Should R10 increase in value, voltage-divider action affects DC and plate-load action affects signal. Resistance check shows R10 has increased to 4.7 meg.

Best Bet: Scope first, then VTVM.

No Sync

Horizontal and Vertical Both Affected

R9 Value Increased

(B+ Supply Resistor for Separator Plate—150K)

Symptom 6

Symptom Analysis

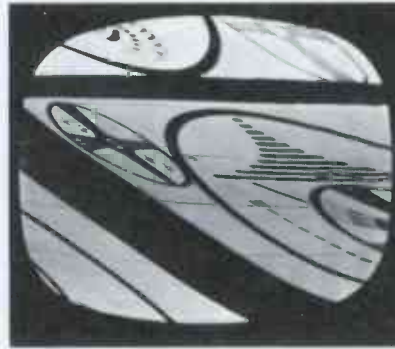

Picture rolls vertically and horizontally at same time. Horizontal and vertical hold controls fail to lock picture. Controls can be set to place picture on CRT, but slightest interference causes rolling or horizontal drift. Defective component affects both sync pulses.

Waveform Analysis

Since both vertical and horizontal sync pulses are affected, first scope check should be at input of sync separator circuit. Pin 7 of sync separator (W2) has normal pulses reaching tube. This eliminates possibility of defects in video output or sync coupling components. Next place to observe sync pulses would be at separator plate. W1 contains neither vertical nor horizontal sync pulses. Logic would point to trouble in plate circuit.

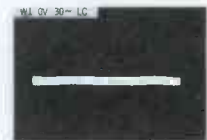

Voltage and Component Analysis

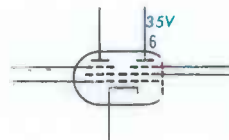

B + voltage on cathode and pin 4 is normal; also, voltages on screen and sync-input grid are correct. This indicates both B + supplies feeding sync-separator stage are normal. Pin 6 measures 35 volts; this significant reduction in voltage points to trouble in plate circuit. Tube could not possibly conduct with such low-plate voltage. Resistance checks are next. R11 measures as it should and R10 has the correct value; however, R9 has increased to 1 meg and is attenuating supply voltage to pin 6.

Best Bet: VTVM pinpoints defect.



U.H.F.

HERE TO STAY

More and more UHF television stations and UHF translator stations are going on the air every day across the country. And the number is increasing rapidly. UHF is accepted... is here to stay.

Every new UHF station represents a whole new untapped profit area for electronics distributors and independent television repair men. Most of the existing television sets now in use were manufactured prior to 1965, and are not equipped with UHF reception. Every TV set owner in your trading area is practically a sure sale for a UHF television converter... *either a built-in or "on-the-top" unit.*

NOW, WHICH MAKE ARE YOU GOING TO SELL TO INSURE HIGH PROFITS?

It's always smart business to stick with a winner. Wherever UHF has gone on the air—Los Angeles, Chicago, Detroit, Boston, Philadelphia,—Standard Kollsman UHF Converters have consistently been Number 1 in distributor preference, dealer preference and consumer preference. *And in the small translator communities, SK's superior performance at the top of the band makes it especially preferred.*

Standard Kollsman quality and dependability means a Final Sale—No Returns. Reliable, service-free tuning elements. Built-in safeguards against spurious radiation. Guaranteed by the world's largest manufacturer of television tuners.



Standard Kollsman
INDUSTRIES INC.

2085 NORTH HAWTHORNE AVE., MELROSE PARK, ILLINOIS

sk means Final Sale, No Returns — Service-free Tuning Element, No Spurious Radiation — Guaranteed 1 Yr. by the World's Largest Manufacturer of T. V. Tuners

Circle 16 on literature card

www.americanradiohistory.com

As 2-Set
Coupler, Gives
Each Set Min.
of 7db Gain



Extends
Rabbit Ear
Range
in Medium
Signal
Areas

Use it to
Cut Snow on
Weak Channels

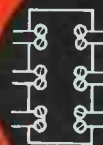

Boosts
Signals
to a
4 or 6 Set
Coupler



REPLACES EC-230

THIS IS THE ALL NEW WINEGARD BC-107... MOST VERSATILE BOOSTER-COUPLER IN ITS PRICE CLASS



Extra Terminals
let you boost
Signal to Single
TV or FM Set
With Minimum
12db Gain

What makes the BC-107 such a special booster-coupler? Well, for one thing, the BC-107 eliminates the 3 to 4db loss inherent in 2 set couplers. In fact, it actually gives a 7db boost to both sets connected to it. Now you can easily connect 2 sets to one antenna in fringe areas and get perfect reception on both sets—in color or black and white. An extra set of terminals lets you use the BC-107 as a booster for 1 set with a minimum of 12 db gain.

This powerful, transistorized unit also has linear frequency response across both TV and FM bands and an exact match into 300 ohms. This means No

Smear, No Ghosts, No Picture Degradation, No Interference Between Sets.

Works with TV and FM signals from 25 to 45,000 microvolts. Has one 300 ohm input, three 300 ohm outputs, no-strip terminals, 110V-AC cord, and a brand new casing of high impact polystyrene, specially designed for the neatest, simplest indoor installation possible.

Write today for complete details or ask your distributor about the BC-107 from Winegard . . . Hottest new number in the Red Hot Booster-Coupler Market.

\$18⁹⁵
list

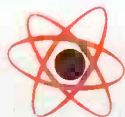

Winegard Co.

3000 KIRKWOOD BOULEVARD • BURLINGTON, IOWA
Circle 17 on literature card

Square-Wave Tests

(Continued from page 22)

and R2 provide a shunt leakage path through the power supply. With square-wave tests you needn't disconnect C1.

Shunt R2 with a .002-mfd capacitor, and shunt C1 with a 1.8-meg resistor:

$RC = RC = .002 \text{ mfd} \times 1.8 \text{ meg} = .0036 \text{ sec}$ or 3.6 msec. Sweep the square-wave-generator frequency from 14 cps ($t = 10RC$) to 1400 cps ($t = RC/10$); throughout this range, input and output waveforms should be identical, and the p-p output voltage should be .5 times the input:

$$\frac{1.8 \text{ meg}}{1.8 \text{ meg} + 1.8 \text{ meg}} = .5$$

If the output waveform and amplitude is outside 20% tolerance, C1 or R2 is defective. This test will not pinpoint the defective component, but it has allowed you to check both components rapidly without unsoldering them.

Conclusion

You can use square-wave tests to analyze three-terminal networks rapidly. These techniques have many advantages, but remember:

1. Precautions must always be taken to insure that inaccuracies are not introduced by the test—test equipment limitations and substitution - component tolerances must be considered.
2. Accuracy of any test depends upon the equipment used. Sophisticated test equipment needed for square-wave tests is expensive and requires practice and skill for proper use.

In the near future, familiarity with square-wave tests will probably be mandatory for efficient servicing of much home-entertainment equipment. Motorola has displayed microcircuit TV for military use; microcircuit broadcasting equipment is already on the market. Future servicing techniques will certainly involve other methods along with square-wave tests, but basic principles will be similar.

Your ability to service these future devices can depend upon your ability to adopt these advanced techniques; learn them *now*, and you'll be that much ahead. ▲

Sync Trouble

One of our readers has informed us of a sync problem he had in a Model 800 B 148 DuMont television receiver (covered in PHOTO-FACT Folder 608-1). We feel this information is worth passing along to the rest of you servicemen.

The problem was critical vertical sync—the picture could be synchronized vertically only for a few seconds. Horizontal sync was also unstable and would tend to lock in out of phase. The waveform at the sync separator plate (pin 8 of V5) showed small horizontal sync pulses and virtually no vertical sync pulses. Voltage checks revealed abnormally low voltage on the plate of the sync separator.

After making rather extensive checks and substitutions, the solution came when pin 1 of K2 was disconnected (vertical integrator

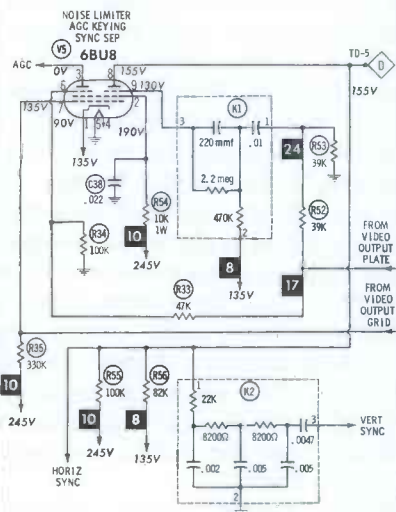

network) from the printed circuit board. This caused horizontal sync to be restored to normal; also, the sync-separator plate voltage returned to normal. Vertical sync was missing because the vertical-sync input path was opened. It was assumed the trouble had been located; replacing K1 proved it had—operation returned to normal.

Apparently, the trouble was caused by leakage in one of the capacitors inside the integrator unit. This leakage was lowering the plate voltage and consequently, greatly reducing the amplitude of both the vertical and horizontal sync pulses.

We would like to thank Mr. Sweeney for providing us with this information, and feel sure that our readers will also be grateful for his thoughtfulness. ▲

PRECISION TUNER SERVICE

P. O. BOX 272

1210 S. WALNUT ST.

BLOOMINGTON, IND.

EDISON 99653

7.95
V or U
COMBO PLUS POSTAGE
9.95

6 MONTH WARRANTY



All Types T.V. Tuners Cleaned, Repaired and Aligned to Factory Specifications. Same day in shop service on most Tuners. Price Includes Minor Parts, Major Parts at Cost Price. We use Original Parts if possible. State Make Model and Enclose all Parts and Tubes. Pack Well and Insure.

ALSO HAVE LARGE STOCK OF EXCHANGE TUNERS, WRITE FOR TYPES AND PRICES.

Circle 19 on literature card

Jackson

...IT'S THE FINEST

Ask
30,000 servicemen
what they think
about their
Model 648
DYNAMIC
TUBE TESTER

Over 30,000 Model 648 Tube Tester owners are Jackson's greatest boosters. They speak with authority, because they have used the Model 648 right in the field and found it provides more accurate checking of all tube types. *It's a fact!* Thousands of Model 648s are providing more years of service than any other tube testers in its price class as it is completely versatile for all new and old tube types. Jackson engineers have designed the tube socket layout to simplify changing, thereby practically eliminating obsolescence. Model 648 owners particularly appreciate the exclusive color keyed panel and push-button sequence switching which makes set-up time less than warm-up time... the angled view zig-zag exclusive color-coded roll chart conveniently located on upper part of panel. Why not put the Model 648-1 to work now? You too will become its greatest booster.



Model 648-1
DYNAMIC TUBE TESTER \$179⁹⁵_{Net}

Check all the Model 648-1 features at your Jackson distributor, or write for catalog

JACKSON ELECTRICAL INSTRUMENT COMPANY

124 McDonough Street, Dayton 2, Ohio

Export: Morhan Exporting Corporation
458 Broadway, New York 13, N.Y.

IF IT'S A JACKSON...IT'S THE FINEST

Circle 18 on literature card

**"TAKING THE
COUNTRY BY
STORM!"**

**THE ALL NEW
IMPROVED
SENCORE
TC136 MIGHTY MITE IV**



Now Americas Number ONE Tube Checker...

Checks compactrons, novars, nuvistors, 10 pins and the latest 10 pin used in many new color TV sets, plus over 1200 foreign tubes. The Mighty Mite is so popular because it checks each tube for:

- **GRID LEAKAGE** of as little as 1/2 microamp or 100 megohms
- **EMISSION** at tubes full rated cathode current
- **SHORTS** of 180K or less between elements

With These New Exclusive Mechanical Features...

- New third hand set-up book holder.
- New removable hinged cover
- New taut band meter

Get your Mighty Mite from your distributor now, and join the more than 30,000 Mighty Mite users the world over. **\$74.50**

SENCORE

426 SOUTH WESTGATE DRIVE • ADDISON, ILLINOIS

Circle 20 on literature card

Extend Two-Way Range

(Continued from page 24)

If you're servicing a receiver that has been converted to narrow-band, make sure that the discriminator circuit has been modified. These circuits must be changed to alter the slope of the S-curve. Otherwise, you won't get maximum audio recovery from the reduced swing of the signal.

If a vibrator power supply is used, check for noise. Old vibrators, and those with poor contacts, will cause hash not only in the receiver but also in the transmitted carrier. In most of these power supplies, the vibrators work on both transmit and receive. Your scope can serve as a useful preventive-maintenance tester. Any sign of poor contact on either point will be immediately apparent. Connect the scope directly across the primary contacts, and you'll see the characteristic square-wave shape as in Fig. 4A. Bad contacts will show raggedness and distortion as in Fig. 4B. For a definite check, replace the vibrator; if the new one shows a good square wave, the old one was bad. This method will pinpoint those units that would otherwise fail in service.

Defective tubes are a common source of noise. Intermittent shorts, leakage, etc., cause hash and popping noises when the vehicle is moving. Dirty socket contacts are another common cause. Removing all tubes and spraying the sockets with a good contact cleaner during regular maintenance is a good way to avoid future trouble. While feeding a weak signal through the receiver, tap all tubes and crystals and listen for noise.

These same precautions should apply to the multiple-conductor plugs used on trunk-mounted radio sets. Even if the plug is tightly held in place by a large screw, it is entirely possible that some of its many contacts are dirty. Take it out and check the pins; if they are dull or show signs of corrosion, clean the entire assembly. Spray contact cleaner, preferably the type which leaves a residual film of lubricant, into the socket, and insert and remove the plug several times.

Trunk-mounted sets are subjected to dirt, moisture, and having large objects thrown on them. Make sure the plugs are adequately protected.

On control heads, cables can be kicked loose by the driver's or passenger's feet; keep these cables tied or taped out of the way.

Don't Forget The Speaker

Finally, be sure to check the speakers. Mobile radios use small PM speakers enclosed in heavy metal cases, and many technicians tend to overlook them while servicing the radios since the speaker isn't removed from the vehicle. As an example, this writer once worked hard all afternoon trying to find the cause of a bad case of audio distortion. After checking everything several times, I happened to think of the speaker. Substituting another one cleared up the whole problem! The original was filled with dust and had been wet at some time in the past; the cone looked like a dishrag that had been dragged in the mud. So, don't overlook the obvious or easy things. They are often the right answer to some puzzling service problems. ▲

BOOK REVIEW

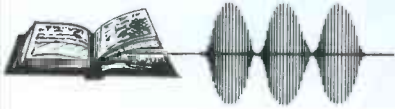

Handbook for Electronic Engineers and Technicians; Harry E. Thomas; Prentice-Hall, Inc., Englewood Cliffs, N. J., 1965; 427 pages, 7"x9³/₄", hard cover, \$15.

Although much of the information given in this reference handbook is slanted toward military hardware and its applications, it should be of value for use in nonmilitary applications. EIA, U.I., and NEMA standards are included; for example, the component-parts section and many of the circuits and measurement techniques given are useful for both civilian and military applications.

Mechanical-construction considerations are covered in the first six chapters. Chapters one and two describe tools and techniques used for drafting; chapters three and four list methods and tools used for chassis construction. These first four chapters should be a particularly useful reference for those who, although they have little contact with construction processes, must be familiar with all mechanical requirements and standards. The fifth chapter describes electronic components and their characteristics. Photos, tables, graphs, and drawings provide handy reference data on markings, tolerances, temperature characteristics, and applications. Chassis assembly and wiring is covered in the sixth chapter.

A brief summary of math is given in the seventh chapter; slide-rule use, algebra, standard scientific notation, trigonometry, vectors, and binary numbers are all discussed. The eighth chapter introduces methods of laboratory organization.

Chapters nine through nineteen describe various techniques for measuring individual component characteristics, frequency, waveforms, vacuum-tube and semiconductor characteristics, micro-wave-equipment parameters, transmitter and receiver characteristics, and radar-system characteristics. The twentieth chapter concerns synchro- and servo-system applications and testing. Chapter twenty-one, the last chapter, describes power-supply design methods.

There are six appendices at the back of the book which supplement data contained in the text. Included are schematic symbols, a glossary of electronic terms and abbreviations, receiving-tube characteristics and basing diagrams, a list of JEDEC registered semiconductor characteristics, fuse data, and much other reference information. ▲

9⁵⁰

ALL PARTS

(except tubes)

Plus Shipping Charge

QUALITY

TV TUNER

SERVICE

24 hrs.

Service

Most Makes

UHF - VHF - COLOR - (COMBOS. - 14.50)

15 YEARS OF TUNER EXPERIENCE

- 1 Year Warranty
- Tuners completely cleaned and checked
- Open Account on approved credit
- Dist. write for price structure



Pack Tuner Carefully
— Insure Package —
Include all parts
(Broken or not)

QUALITY TUNER SERV.

5142 W. 25th St.
CHICAGO, ILL. 60650

Circle 22 on literature card

Make 1966 your
year to "cash in"
on the hot
Business/Industrial
2-Way Radio market!

Johnson can show you how
with the nation's top AM line!

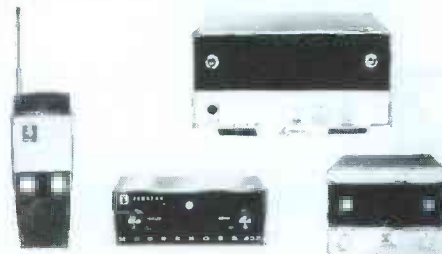

Make your New Year's Resolution now to look into a market you may be missing! Sure, you can sell Citizens Band equipment for many Business Industrial applications—and we recommend it! However, our 25 to 50 Mc. AM BUSINESS INDUSTRIAL 2-WAY LINE opens *new* profit potential for you in 1966!

Get the facts . . . Johnson has the equipment, experience and marketing support to enable you to get your share of this expanding, profitable market!

Shouldn't you be selling Johnson
Business/Industrial Two-Way Radio?

E. F. JOHNSON COMPANY

7689 Tenth Ave. S. W. • Waseca, Minn.



GET THE FACTS! Send today for informative
booklet with AM and FM marketing facts!

Circle 21 on literature card

MAKE THIS A COLOR-FILLED HOLIDAY SEASON

with valuable premiums and G-E tubes



COLOR TV COMPONENTS

Look at these valuable premiums . . . there's something for everyone on your Christmas gift list . . . and they're all available with purchases from General Electric's line of receiving tubes, the line with more tubes for color TV applications. Make this a real color-filled holiday—stock up on G-E color components and earn brand name merchandise for your family, friends, or yourself. Ask your G-E Distributor*. Premiums available from October 21 through December 15. **Distributor Sales, Owensboro, Kentucky** 285-08

*Premiums available at option of your G-E Tube Distributor.



WHITE DRESS SHIRT

Pima cotton oxford man's dress shirt with precision needle tailoring. Popular button-down collar with box-pleat back. Sanforized. White only, in neck sizes 14 to 17, sleeves 32 to 35.

Order ETR-4329

BATES TABLECLOTH & NAPKINS

Perfect for the lady of the house. Set includes one 52" x 52" tablecloth in 100% cotton with four matching napkins of pure Irish linen. Completely washable. Specify choice of orange/brown with orange napkins, brown/green with gold napkins, or blue/green with turquoise napkins.

Order ETR-4323



STRUCTO AUTO TRANSPORT

All-metal toy auto transport, multi-colored with two metal cars. Ramp extends for loading. Length 21 7/8"

Order ETR-4327

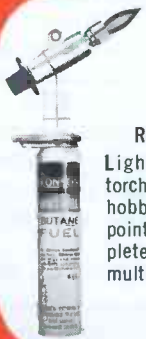

RONSON BUTANE TORCH

Lightweight, easy-to-handle torch has many household and hobby uses. Adjusts from pin-point to blowtorch flame. Complete with large-size Ronson multi-fill fuel container.

Order ETR-4328



D'ORSAY PERFUME SET

What lady wouldn't appreciate this. Set includes 3 oz. Nuage Parfume spray mist plus 1 dram flaconette of Parfum de Bain bath scent. Matched fragrance set comes gift boxed.

Order ETR-4326



TIMEX WATCH

Regular size man's watch with chrome plated bezel, sweep second hand, radio-lite dial. Features Timex unbreakable mainspring; is shock resistant, gift boxed.

Order ETR-4333



G-E CHRISTMAS LIGHT SET

Your choice of either 10-lamp multiple indoor set or 15-lamp outdoor set. Both sets feature all-green, extra-durable sockets and cords. Use season after season.

Order ETR-4334 (Indoor),
ETR-4335 (Outdoor)



KODAK CAMERA OUTFIT

Famous Hawkeye Instamatic F® outfit comes complete with camera with wrist strap, 1 Kodapak cartridge, 4 AG-1 flashbulbs, 2 AAA-size batteries, flashguard, and instruction book.

Order ETR-4332



PILE LINED JACKET

Stylish year-round Cougar jacket in 100% cotton poplin with 100% Orlon pile lining. Completely wash 'n wear, full zipper front, two slash pockets. Beige only in sizes 36, 38, 40, 42, 44, 46.

Order ETR-4330



MEN'S STRETCH HOSE

Three pairs 100% nylon stretch hose, one each of black, cordovan, and navy. Fits sizes 10-13. Available either Regular or Calf-length.

Order ETR-4325
(Regular)
ETR-4324 (Calf-length)



G-E CLOCK RADIO

Popular G-E AM clock radio features famous Snooz-Alarm® and Muted Slumber Switch. Handsome white cabinet; 4" Dyna-power speaker; built-in ferrite rod antenna; drift compensation and automatic volume control.

Order ETR-4331

GENERAL ELECTRIC



Notes on Test Equipment

analysis of test instruments... operation... applications

by Arnold E. Cly

MPX Alignment Generator

FM stereo broadcasting has been around since June 1961. Many stations have added this type of transmission to their programming since that date, and one could predict that



Fig. 1. This generator has many signals for multiplex testing and alignment.

more will join the trend. This, of course, is brought on by increased FM-stereo receiver sales, and more consumer sales mean additional service business.

The FM-stereo receiver requires perfect alignment of the multiplex stage if the listener is to gain the full enjoyment of stereo broadcasting. The service technician needs to be equipped to perform this alignment job to assure his customers their stereo units are in top-notch operating condition. The EICO Model 342 FM multiplex

generator, shown in Fig. 1, can fill this need.

The Model 342 has a stereophonic output signal that may be coupled directly to the multiplex section; also, a frequency-modulated stereophonic RF output is available to be coupled to the antenna input terminals, if desired. The carrier frequency of this RF signal is adjustable from 97 to 103 mc.

A block diagram of the multiplex generator is presented in Fig. 2. A 19-kc (± 2 cps) crystal-controlled oscillator drives a 19-kc doubler stage, which in turn feeds a 38-kc amplifier. The output of the 38-kc amplifier is coupled to the modulation unit; also, the modulation unit receives, through the SIGNAL switch, a 1-kc signal that represents right- and left-channel information.

The internal L/R audio signal, de-

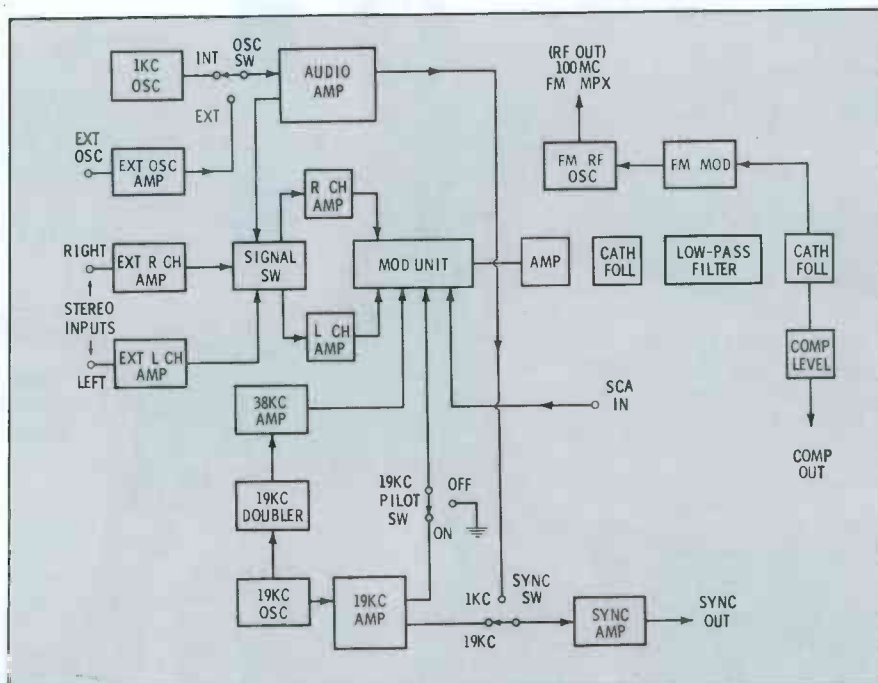

Fig. 2. Block diagram reveals signal paths of the 342 FM multiplex generator.

Season's Greetings

-To Our Many Good Friends!



Circle 24 on literature card

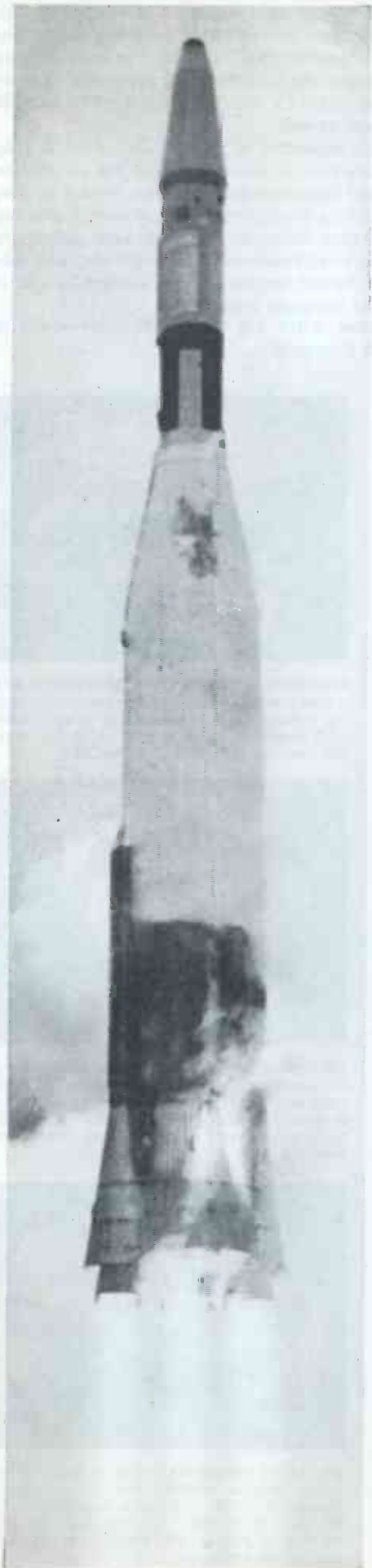

National Aeronautics and Space Administration

America's most successful space programs have it.

RCA Victor Color TV has it.



The reliability of RCA circuitry. The solid kind.



Solid Copper circuit, shown, from RCA Victor Color TV.

RCA Solid Copper Circuits won't come loose. Won't short circuit. Won't go haywire. They're the latest advance over old-fashioned "hand wiring" and bring Space Age dependability to Color TV.



The Most Trusted Name in Electronics

Tmk(s)©

The move's on to



JERROLD

Coloraxial

TM

**best for color and black-&-white
...best for FM...best for business**



COLORAXIAL PATHFINDER VHF / UHF / FM ANTENNAS

• The first all-channel line featuring 75-ohm output and individual orientation of VHF and UHF sections. Separate-antenna flexibility, without splitter loss. Five models, PXB-30, 45, 50, 70, 90.

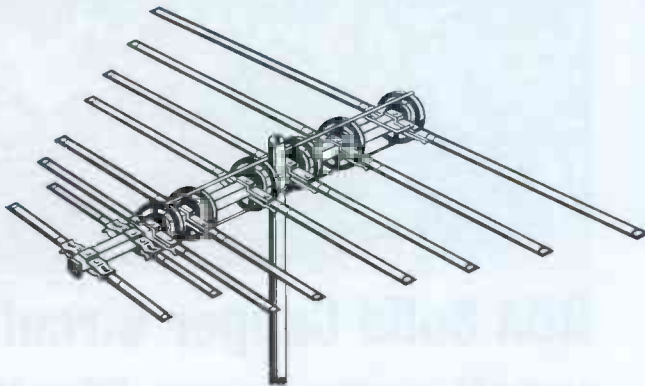

COLORAXIAL PARALOG TV ANTENNAS • The renowned line of seven Paralog VHF antennas now available with 75-ohm output. Models PAX-40, 60, 100, 130, 160, 190, and 220—for metropolitan to deepest fringe reception areas.

COLORAXIAL COLORGUARD ANTENNAS AND KITS • Three 75-ohm models (CAX-16, 17, and 18), plus kit (Model K-CAX-16) including antenna, 5-foot mast, tri-mount, cable, and set-mounting T378 matching transformer.

COLORAXIAL FM ANTENNAS • Don't forget, FM stereo needs Coloraxial too! Jerrold offers two types, a complete line in each: 75-ohm Paralog (Models FMPX-8, 10, and 16) in log-periodic form; and the five-element Stratophonic FM Yagi (Model FAX-5), also available in kit with mast, tri-mount, cable, and set-mounting matching transformer—everything you need for a complete Coloraxial stereo installation.

The days of twinlead are numbered. Both the trade and the public are moving unmistakably towards COLORAXIAL, the revolutionary shielded coaxial antenna system—not only for great color TV, but for black-&-white and FM stereo as well.

So important is 75-ohm Coloraxial in your future that Jerrold now offers you a complete line of Coloraxial antennas with 75-ohm output; matching transformers for converting existing 300-ohm antennas for Coloraxial operation; Coloraxial Powermate preamplifiers; and 50- and 75-foot lengths of factory-swept Coloraxial cable complete with fittings.

Now is the big season for color—cash in with Coloraxial.



COLORAXIAL MATCHING TRANSFORMERS AND KITS

• Mast-mounting Model T0-374A converts any existing antenna to 75-ohm Coloraxial output. Model T378 mounts on set to match it to 75-ohm co-ax. Also available as a set in Kit Model CAT-2.



COLORAXIAL SHIELDED CABLE • The heart of every Coloraxial installation — highest-quality RG-59/U cable with fittings already attached. 50 or 75 feet of cable in package. Kit Model K-CAB-50 has 50-ft. cable and one each of the matching transformers described above.



COLORAXIAL POWERMATES • Coaxial versions of the famous antenna amplifiers that set an industry standard. Model SPC-103 has two transistors, Model SPC-132 "DE-SNOWER" has five. Both are pre-matched to antenna and receiver—no matching transformers necessary.



**JERROLD
ELECTRONICS CORPORATION**

Distributor Sales Division
15th & Lehigh Avenue, Philadelphia, Pa. 19132

EICO Model 342 Specifications

Separation:

40 db minimum from 200 cps to 10 kc; 30 db minimum from 50 cps to 15 kc.

Carrier Suppression:

40 db minimum below maximum composite-signal level.

Composite Signal Output:

0-5 volts p-p, variable; output impedance 1500Ω.

Internal Oscillator:

Approximately 1 kc; total harmonic distortion less than .3%.

External Oscillator Input:

1 volt rms input for maximum composite-signal output; input impedance 10K; input provides ±.5 db response from 20 cps to 20 kc.

Stereo Source Input:

1 volt rms input each channel for maximum composite-signal output; input impedance 1 meg; input amplifier stages provide required FM preemphasis.

FM Multiplex RF Output:

200 mv; output impedance 60Ω; adjustable from 97 to 130 mc.

FM Modulation Frequency Response:

20 cps to 150 kc ±.5 db.

Deviation Control:

To ±75 kc (100% modulation); below .25% distortion at maximum deviation.

Pilot Frequency:

19 kc ±2 cps (crystal controlled); adjustable phase (±30° with respect to carrier), adjustable amplitude (0-15% of maximum composite signal).

SCA Input:

Input impedance 10K

Features:

Signal selection: L+R, L-R, L only, R only, 19-kc pilot only, stereo source. Oscilloscope sync signals: 1-kc internal or external and 19-kc pilot in phase with composite output pilot.

Power Requirement:

117 volts, 60 cps, 36 watts.

Size (HWD):

8½" x 5¾" x 12½"

Weight:

10 lb.

Price:

\$149.95 (factory wired only)

veloped by a 1-kc oscillator stage, is fed to the OSC INT/EXT switch; when this switch is set in INT position, the 1-kc signal is coupled to an audio amplifier. The audio amplifier operates

as a phase-splitter and provides outputs of the 1-kc signal at its plate and cathode. These outputs are applied to the SIGNAL switch. The two signals, 180° out of phase, are then coupled to the right- and left-channel amplifiers through the SIGNAL switch. The opposing polarity of these two signals permits the 38-kc signal, which is also fed to the modulation unit, to sample the channels alternately at a 38-kc rate. These sampling signals are combined in a resistive adding network in the modulation unit.

The crystal-controlled 19-kc oscillator also feeds an amplifier that couples the 19-kc signal to the modulation unit. This signal path is through the PILOT ON-OFF switch. The 19-kc signal is combined in the resistive adding network of the modulation unit as were the L/R sampling signals mentioned above. The collection of these signals comprises the composite-stereo signal, without the SCA signal (67-kc subcarrier). The SCA signal can be applied to the modulator, via an input jack, from an external signal source. The circuit that connects the 19-kc signal to the PILOT ON-OFF switch incorporates both PILOT PHASE and LEVEL controls. The PHASE control positions the 19-kc signal for proper synchronization with the 38-kc subcarrier; the LEVEL control permits adjusting the level of the 19-kc signal from 8% to 10% of the composite output signal, as specified in the FCC-approved FM-stereo system.

The composite-stereo output signal is coupled from the modulating unit to an amplifier that feeds the composite signal to a cathode follower. The follower passes the signal to a low-pass filter network designed to eliminate harmonics generated in the modulator. The filtered composite signal is then applied to another cathode follower which feeds the signal to two separate circuit paths. One path connects to the COMPOSITE LEVEL control; it in turn couples the signal to the COMPOSITE signal output jack for connection directly to the multiplex stage of the receiver under test. The other signal path leads to the FM modulator and oscillator stages, through the deviation control. This permits signal coupling to the FM antenna terminals and allows the composite signal to pass through the entire FM receiver.

On the front panel is an EXT OSC jack that provides for injection of any desired range of audio frequencies from an external generator. This may be used for evaluation and design of multiplex circuits whenever the 1-kc internal oscillator frequency is not suitable.

Protects Meter
Movements From
All Overloads
for LIFE!

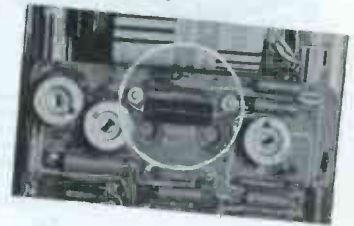

Metergard

For all VOMs and Voltmeters
Installed in minutes on any meter, such as the Simpson 260 or Triplett 630, etc. Positively prevents meter movement burnout or damage regardless of overload. Accuracy not affected by more than ¼ of 1%. No moving parts, nothing to wear out. End the time loss, expense and aggravation of meter movement repair due to damage or burnout.

ONLY 2⁹⁵
GUARANTEED

Your VTVM will
never need an-
other battery
for LIFE!



with

Lectrocell

A miniaturized regulated power supply that replaces the battery in VTVM's. Furnishes 1.5 VDC for measuring resistance. Exact size and shape of battery it replaces. Installs in minutes... simply connect 3 wires and you're all set!

ONLY 3⁹⁵
GUARANTEED



See your Lectrotech Rep.
or write for details.

DEPT. PF-12

LECTROTECH INC.
1221 W. DEVON • CHICAGO, ILL. 60626
Circle 25 on literature card



Little Devil® Composition Resistors

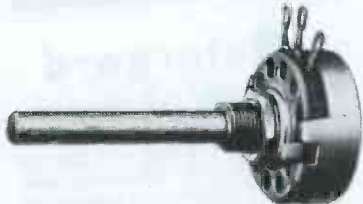

Type AB 2-Watt Molded Pots

five ways to stop customer “static”



Gold-Bonded Germanium Diodes



Brown Devil® Wire-Wound Resistors



Series 99 Wire-Wound Resistors

Customer “static” is hard on the ears . . . hard on profit. But you’re always safe with Ohmite quality replacements in your repair jobs. Order Little Devils in handy cabinet assortments or on Tally-Tape; all popular sizes and values. Select AB Pots from 50 ohms to 5 megohms in several shaft lengths. Choose from ninety 1N types of diodes. Get Brown Devils from 3 to 20 watts in 0.5-ohm to 100K-ohm values. Order Series 99 resistors in 1½, 2¼, 3¼, 5, 11 watt sizes from 1 to 51,000 ohms. Ask your distributor for the latest edition of Ohmite’s Stock Catalog 30.

Be right with



OHMITE

RHESTATS • RESISTORS • VARIABLE TRANSFORMERS • TAP SWITCHES TANTALUM CAPACITORS • RELAYS R.F. CHOKES • SEMICONDUCTOR DIODES

Circle 28 on literature card

52 PF REPORTER/December, 1965

Also on the front panel is a SYNC OUTPUT jack which is fed from a cathode follower. This provides a low-impedance output and isolation from external loading effects. Signals applied to this cathode follower are selected by the SYNC switch: the internal 1-kc or external oscillator signal, depending on the position of the osc switch, or the 19-kc oscillator output. The 19-kc SYNC OUTPUT is used for pilot-phase adjustment; the others are used for scope sync. These uses are fully explained in the maintenance section of the operating manual supplied with the instrument.

On the rear panel are two input jacks marked STEREO RIGHT and LEFT. These inputs permit the output of any stereo source (an example would be a stereo phono or tape recorder) to be fed through the Model 342 and modulated to provide composite FM-stereo program-type material. Coupling this signal to the antenna terminals of an FM-stereo receiver will produce a stereo program output from the receiver. This is useful for demonstration when stereo broadcasts are not available.

The SIGNAL switch on the front panel selects the desired signal for tests or alignment of the multiplex section of a receiver. When this switch is in STER position, the instrument is set up so a stereo source may be coupled to the L and R rear input jacks. The output is then taken from the FM MPX RF cable and applied to the FM receiver’s antenna terminals.

The 19-kc position on the SIGNAL switch couples a signal from the 19-kc oscillator to the COMP output jack when the 19-kc PILOT switch is in the ON position. This provides a signal which is injected to the multiplex section to peak the 19-kc and 38-kc coils and transformers. The L-R and L+R positions on the SIGNAL switch select either of these signals for coupling to the COMP output jack. These signals are useful where the multiplex section of a receiver has two separate paths for the L-R and L+R information. Should either circuit be suspected, the corresponding signal can be applied from the Model 342 to determine these circuits.

The settings for the final steps of multiplex alignment are marked L and R on the SIGNAL switch. The 19-kc PILOT switch is set to the ON position, and either the left- or right-channel signal, whichever is selected, is coupled to both the COMP OUTPUT and the FM MPX RF output cable. Switching back and forth between the L and R signals permits precise touchup adjust-

**WORLD'S
FINEST
5-CORE
SOLDER**

**ERSIN
MULTICORE**

**NEW EASY
DISPENSER
PAK ONLY 69¢**

BUY IT AT RADIO-TV PARTS STORES

Multicore Sales Corp. Westbury, N.Y. 11591
Circle 27 on literature card

looking for connectors
to fit your
Foreign
tape recorder?

YOUR NEARBY SWITCHCRAFT AUDIO DEALER TALKS YOUR LANGUAGE!

Stop searching. Those hard-to-find miniature, multi-pin connectors for imported tape recorders, dictation machines, audio and P.A. equipment are at your local Switchcraft dealers now! 2 to 7 pin, male, female . . . for Sony, Norelco, Grundig-Majestic, Korting, Uher, Panasonic, Telefunken, etc. Original equipment precision, quality and fit.

Write for complete catalog C-503 and a list of dealers who stock these connectors.

SWITCHCRAFT®

5573 Elston Ave., Chicago, Ill. 60630

Circle 26 on literature card

There's BIG MONEY in SMALL master-antenna SYSTEMS

...and JERROLD makes the work easy

DON'T pass up the profits waiting in the small motels, apartment houses, schools, and TV dealers' showrooms in your area. They all need a low-cost, efficient master-antenna system. And you're the logical one to install these systems ... quickly, easily, profitably.

Jerrold gives you a honey of a package for these installations. You can vary it a hundred ways according to your needs.

GIBRALTAR Amplifier, Model 3440



Heart of the system is the new solid-state GIBRALTAR amplifier. Low noise figure (less than 6 db) means GIBRALTAR works well even in weak-signal areas. High output capability (more than 150,000 microvolts) lets it work in very-strong-signal areas without overload. High gain (25 db avg. hi band; 23 db avg. lo band and FM), consistent performance and maintenance-free reliability make GIBRALTAR the ideal amplifier for every small VHF system you install.

VARIABLE-TAP Room Outlets, Model VT-300

These attractive, low-priced wall outlets give you a choice of three isolation values simply by the turn of a screw. Model VT-300 is matched to 300-ohm twinlead. Also available as Model VT-75, with coaxial outlet to receiver. Ivory-colored cover plate mounts flush to wall; decorative without painting, but accepts paint readily. VARIABLE-TAPS are the newest member of the Jerrold line aimed at making your small systems installations easy and profitable.



JERROLD

THE NATION'S FOREMOST
MANUFACTURER OF ANTENNA
SYSTEMS EQUIPMENT

TYPICAL SYSTEM COST FOR 20 OUTLETS

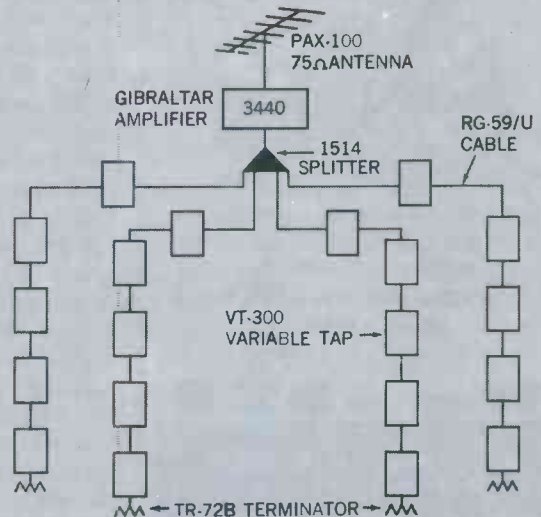

	Dealer Price
Model PAX-100 75-ohm antenna	\$ 25.77
Model 3440 Gibraltar amplifier	53.70
Model 1514 4-way splitter	9.14
20 Model VT-300 Variable-Tap outlets @ \$2.15	43.00
Miscellaneous (mast, mount, hardware, fittings, etc.)	20.00
Cable (500 ft. of RG-59/U)	20.00
Total Materials	\$171.61
Labor (16 hours @ \$5 per hour)	80.00
	\$251.61
Suggested installed price to customer	350.00

YOUR PROFIT \$98³⁹

Above is shown a typical system layout, along with a bill of materials and your average profit on installation of a 20-tap system in a motel, school, or dealer showroom in your area. Start now to earn BIG profits on small systems like this—send the coupon for complete information.

JERROLD ELECTRONICS CORPORATION

Distributor Sales Division
15th & Lehigh Ave., Phila., Pa. 19132

I'm interested in cashing in on the small antenna-systems business.

- Send me complete information.
 Have your technical rep call on me.

Name _____

Company _____

Address _____

City _____ State _____ Zip _____

CHEK-IT CIRCUIT TESTER

FOR ONLY **\$1.49** DEALER NET
LESS BATTERIES

**BATTERY OPERATED
TESTS WITH POWER OFF**



MADE IN
U.S.A.

- CONTINUITY • FUSES • SWITCHES
- CHIMES • APPLIANCES • MOTORS
- BUZZERS • PUSH BUTTONS
- AUTO IGNITION and VOLTAGE REGULATORS, ETC.

ASK YOUR ELECTRONIC
PARTS DISTRIBUTOR FOR

WEP MODEL NO. **BZ5**

MANUFACTURED BY

WORKMAN

SARASOTA FLORIDA

Electronic
PRODUCTS INC

Circle 31 on literature card

ments in the multiplex section to obtain maximum separation between the L and R channels.

The COMPOSITE LEVEL control affects only the level of signal at the COMP OUTPUT jack. The ON-OFF switch is also located on this control and is actuated when the control is advanced from its maximum counterclockwise position.

A field test verified the accuracy and versatility of the Model 342. The signal from the 100 MC FM MPX output jack was very stable. There was no need to keep retuning the receiver while adjusting the multiplex section. It was found, however, that the AFC circuit of the receiver had to be disabled; interaction between the AFC and the 19-kc pilot signal had a tendency to kill the 19-kc signal.

In our lab we set up the 342 to provide us with a stereo signal at the 100 MC FM MPX output. A stereo phonograph was used as a signal source; its output was coupled to the stereo input jacks at the rear of the multiplex generator. Output from the phono-pickup cartridge itself was insufficient to drive the FM stereo receiver, so the signal was taken from the external speaker jacks of the amplifier associated with the stereo phono. The RF cable from the 100 MC FM MPX output was con-

nected to the FM antenna terminals of the FM stereo receiver we used. The stereo receiver was tuned to 100 mc, and the stereo information from the phono came through loud and clear.

We also aligned the multiplex section of an FM stereo receiver using the 342. The entire job was done without any misfortune or generator problems. Everything performed in a normal manner.

The operating manual supplied with the Model 342 FM multiplex generator is very comprehensive. Instructions are given which cover each test the instrument will perform. A section at the back of the manual is devoted to maintenance procedures; these include alignment and adjustment that may be needed as the instrument ages. The front part of the manual gives a detailed explanation of FM-stereo signal makeup and transmission. ▲

For further information circle 67 on literature card.

Erratum

In the October "Notes on Test Equipment" item describing the Mercury Model 202E (page 54), the price was listed incorrectly. Correct price for the Model 202E is \$109.95.

Now, get genuine Magnavox parts and tubes fast

through five strategically located Regional Parts Depots.

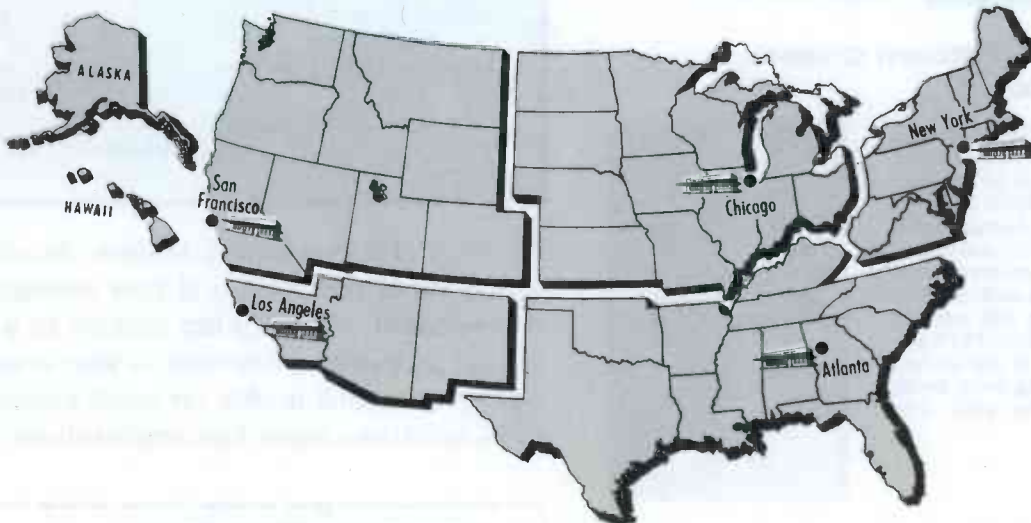

WESTERN DIVISION
Magna-Par Co.
1364 San Mateo Avenue
South San Francisco
Calif. 94080
Phone: 415 871-5080

SOUTHWESTERN DIVISION
B & D Electronics Inc.
Box 1217, Studio City Station
North Hollywood, Calif. 91604
Phones: 213 877-4794 or
213 766-3542

MIDWEST DIVISION
Certified Electronic Dist. Inc.
5959 W. Fullerton Avenue
Chicago, Illinois 60639
Phone: 312 622-2291

SOUTHERN DIVISION
Magna-Par Co.
487 Armour Circle N.E.
Atlanta, Georgia 30324
Phone: 404 875-7123

EASTERN DIVISION
Magna-Par Co.
370 North Street
Teterboro, New Jersey
07608
Phone: 201 288-4540

Phone, wire, or mail your orders to the Depot covering your area.

THE MAGNAVOX COMPANY

FORT WAYNE, INDIANA

Circle 30 on literature card

FUSIBLE RESISTOR

CROSS REFERENCE GUIDE

Manufacturer	Part No.	Value Ohms Watts	Manufacturer	Part No.	Value Ohms Watts	Manufacturer	Part No.	Value Ohms Watts		
Admiral	61A19	7.5 5	Chevrolet	43X0431-001		Muntz	120	*		
	61A19-2	7.5 5			4.7 5		RW-005-13	5 5		
	61A28-3	5 5		7270608†	.47 *		not avail.	4.7 5		
	61B43-10†	47 1		7276499	.33 *		Nordmende	409.030†	1.5K 5	
	61B48-1†	5.5 *		7281027	.51 *			00038CTZ100†		
	61C43-5†	47 1		7281890	.47 *			100	5	
	61C43-7†	11 2		7287480	.68 1			00038CTZ1000†		
	61C43-8†			Coronado	TRP-28		4.7 5		1K	5
		1080 2			V24002		4.7 *	Oldsmobile	0038CZT†	1.5K 5
	Airline	E2311†		22 5			024-201116	4.7 3		7276499
B154089-1-6		7.5 5		24B1116	4.7 5		7281027	.51 *		
R-1409		5.5 5		43X0431-001			7281890	.47 *		
672†		130 4			4.7 5	Olympic	7286602	.68 *		
V24002		4.7 *		46M-23018	9 5		R-1409	5.5 5		
14135†		47 5		46M-25577	4.7 5		RE3823	7.5 5		
20E1042		7.5 5		816†	22 5		RE32681†	7.5 5		
43X380		7.5 5	Crosley	154089	7.5 5	Opel	7276499	.33 *		
43X397		7.5 15	Decca	RW10-1†	22 3	Packard-Bell	not avail.	7.5 5		
43X431		4.7 *	DuMont	397148†	22 5		73500	5.6 *		
Ambassador	43X0431-001			02310001	7.5 5	J. C. Penney	43X431	4.7 *		
	46M-20681	5.6 5	Emerson	394158	5 5	Philco	33-1334-17†			
	46M-22301	9.1 5		394216	5 7		20	3		
	46M-23018	9 5		397103	1 *		33-1366-2	5.6 5		
	259V002H01			397118	6 *		33-1366-3	5.6 5		
		7.5 *		397133	22 5		33-1366-7	5.6 *		
	259V004M01			397216	62 *		33-1366-9	5.6 *		
		4.7 5	Firestone	24B1116	4.7 5		76-13605-2	1.45 *		
	672†	130 4		43X380	7.5 5	Phonola	14135†	47 *		
	24-1073	5 5		46M-23018	9 5	Pontiac	7276499	.33 *		
Artone	24-1073	5 5	GE	ET14X183	3.6 7		7281890	.47 *		
	24B1116	4.7 5		ET14X191	5 5		7287480	.68 1		
Arvin	47727-3†	11 * TC	Hallicrafters	024-201116		RCA	100117	5.6 5		
		(cold)			4.7 3		100117B	5 *		
		22		24-1073	5 5		103824	4.7 5		
		(hot)		24-1116	4.7 5		114966	5 10		
	47727-5†	33 *		24B1011	7.2 5		942924-4	.35 *		
	47727-6†	16 *		24B1116	4.7 5	Raytheon	46M-23018	9 5		
	47727-7†	20 * TC		25B1004	7.5 5	Sentinel	B154089-1-6	7.5 5		
		(cold)		4762	7.5 *		20E1042	7.5 5		
		45	Hoffman	25B1011	7.2 5		240074-1	5 *		
		(hot)	Hyda Park	24077-1	5 5		240601-1	7.5 5		
47727-8†	22 5	Magnavox	240074-1	5 *	Silvertone	S43-1007	7.5 5			
68504-130	4.7 10		240080-19	4.7 *		T43-1007	7.5 5			
Bendix	325-0134-13†			240084-2†	22 *		24-1073	5 5		
		47 5		240084-3†	22 *		24-1116	4.7 5		
	268021-1	5.6 5		240601-1	7.5 5		25B-1011	7.2 5		
	Bradford	V24002	4.7 *	Majestic	B-6,326-1	7.5 5		43-4-1	22 3.25	
		43X0431-001		Majorette	not avail.	47 *		43-1007	7.5 5	
			4.7 5	Mopar	7281890	.47 *		43-1008	7.5 5	
	Buick	7276499	.33 *		7286602	.68 *		43-1009	5 5	
		7281027	.51 *	Motorola	1K1027	7.5 5		43-1011	5 *	
		7281890	.47 *		1K711027	7.5 5		61-191-0	4.5 10	
		7286602	.68 *		1K711574	5 5		14135†	47 3	
CBS	31000472	7.5 6		17A700149	5 5		16825†	95 3		
	Cadillac	7270608†	.47 * TC		17A711027	7.5 5	Sonora	R1409	5.5 5	
	7281027	.51 *		17A711500	7.5 5	Spartan	270074-1	5 5		
	7281890	.47 *		17A791166	7.5 5	Sparton	PA4227	7.5 5		
	7286602	.68 *		17A791696	5 5	Studebaker	7276499	.33 *		
Capehart	453924B-1	7.5 5		17C67673A01			7281890	.47 *		
	Catalina	V24002	4.7 *			5 10	7287480	.68 1		
	43X086-001†			17K738862	7.5 5	Sylvania	187-0028	7.5 5		
		22 *		17K742136	5 5		187-0053	4.7 5		
				65A61832A01†			189-0046	4.7 5		



TYPE L . . . for long, long years of service life ask your distributor for PLANET LYTICAPS, the universal replacement type electrolytic capacitor. Available in a wide range of capacities in voltages from three to five hundred. LYTICAPS are "Engineered for Quality".

PLANET SALES CORP.

225 Belleville Ave.
Bloomfield, New Jersey

Circle 33 on literature card

Manufacturer	Part No.	Value		Manufacturer	Part No.	Value		
		Ohms	Watts			Ohms	Watts	
Symphonic	A16120†	47	2	Westinghouse	V-16023-1	7.5	5	
	A16121†	22	3		25V020H73†	100	3	
TraVler	E47†	47	*	251V020H23†	100	3		
	F6	5	*	251V020H66†	5.6	8		
	F6-1	5.6	5	251V020H73	100	3		
	F8	7.5	5	251V035H02	33	*		
	F15	5	5	251V036H01	5	7		
	F23	4.7	*	259V002H01	7.5	5		
	TV-F-6	5	5	259V002M01	7.5	5		
				259V004M01	4.7	5		
Truetone	not avail.	7.5	*	Zenith	WC14132†	47	*	
	E27†	27	*		63-3269	7.5	5	
	E47†	47	*		63-3287	6	5	
	024-201116	4.7	3		63-3644	6	5	
	24B1116	4.7	5		63-4450	6	10	
	43X380	7.5	5		63-5193†	22	4	
	43X397	7.5	*		63-5306†	33	*	
	43X398	7.5	*					
	43X0398-001†	4.5	*					
		46M-2557	4.7		5			
	46M-20681	5.6	5					
	46M-23018	9	5					
	224-200002	10	10					
	816†	22	5					
V.M.	12472†	22	*					
	17829†	27	*					
Wells-Gardner	43X380	7.5	5					

* Wattage not given by mfr.

† Non-TV Equipment

TC Temperature-Compensating

Now — FOR THE FIRST TIME . . .

ONE ANTENNA FOR BOTH 75 and 300 OHMS!

WITH NO MATCHING TRANSFORMER NEEDED

NOW You can make ALL the sales for both 75 and 300 ohm installations with KAY-TOWNES STARFIRE Antennas. No matching transformer necessary at antenna.

OUTPERFORMS 15-ELEMENT MODELS

The new 11-element STARFIRE is designed to eliminate the need for stocking two antennas usually necessary to satisfy both 75 and 300 ohm use and by actual test provides better performance than 15-element models of either impedance.

ELIMINATES MATCHING TRANSFORMER

The new KAY-TOWNES STARFIRE has extremely high level gain and is matched to both RG59U cable and 300 ohm lead-in wire.

- Designed for Color — Ideal for Black and White
- Cuts Your Inventory Cost
- Faster installation — comes folded, completely assembled with mast-clamp and all hardware mounted.

GENUINE GOLD ANODIZED
NOT A SPRAY TO WASH AWAY!

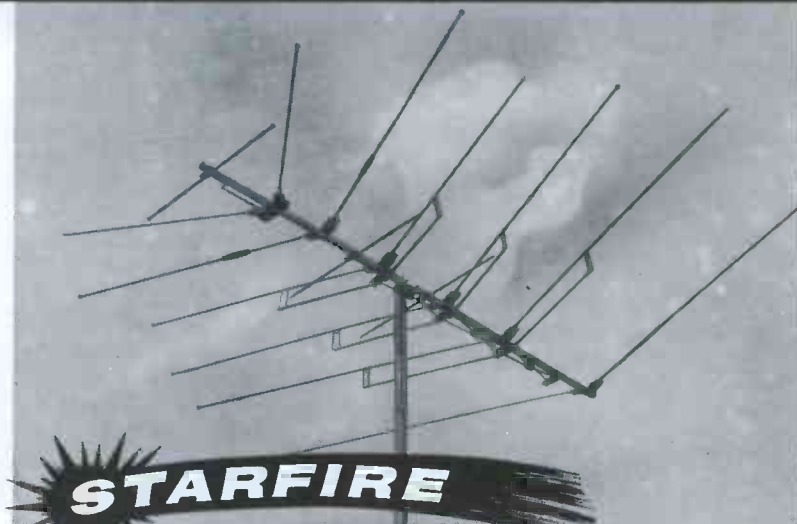

STARFIRE

SF-11-C

LIST PRICE
\$24⁵⁰



QUALITY : PERFORMANCE • ECONOMY

KAY-TOWNES
antenna company

HEADQUARTERS OFFICE AND PLANT — 1511 DEAN AVE., ROME, GA. 30162
ALSO MANUFACTURING AND SALES OFFICE IN RINCON, PUERTO RICO

OVER 800 ANTENNA MODELS FOR EVERY AREA . . . EVERY PURPOSE

Circle 32 on literature card

Use this check list before you install a home TV distribution system

	COAXIAL VHF	TWINLEAD* VHF	COAXIAL UHF/VHF	TWINLEAD* UHF/VHF AND UHF ONLY
Channels received	2-13	2-13	2-83	2-83 (14-83 for UHF only)
Color reception when properly installed	Excellent	Excellent	Excellent	Excellent
Cable loss: @ channel 13 for VHF only @ channel 83 for UHF/VHF	4 db (foam filled) 6 db (solid)	1.8 db/100 ft. @ Channel 13	9 db (foam filled) 13 db (solid)	5.6 db/100 ft. @ Channel 83
Loss increase when wet	Nil	Negligible	Nil	Negligible
Reception when run near or through small metal areas	Excellent	Excellent when properly installed	Excellent	Excellent when properly installed
Reception when run near or through considerable amounts of metal	Excellent	Not recommended	Excellent	Not recommended
Ease of installation	More difficult	Easy	More difficult	Easy
Extra parts required	Connectors, matching transformers	None	Connectors, matching transformers	None
Performance in strong-signal areas	Excellent	Excellent—fair**	Excellent	Excellent—fair**
Performance in weak-signal areas	Excellent	Excellent	Excellent	Excellent
Cable pickup of interference (ignition, appliances, etc.)	None***	None—slight**	None***	None—slight**

*A high quality, low-loss foam encapsulated cable type **Depends upon local conditions***Poorly designed accessories will pickup interference.

Once you know the facts—there is one best choice for your home system—Blonder-Tongue. Whether you prefer 300 ohm or a 75 ohm coax system, Blonder-Tongue has the products you'll need. There is only one way you can protect your home TV system against obsolescence when new UHF stations come on the air—that's with a Blonder-Tongue all-channel UHF/VHF system.

Blonder-Tongue products designed for all-channel home systems include: All-channel signal amplifiers (V/U-All-2 indoor and U/Vamp-2 mast mounted); all-channel couplers (A-102-U/V two-set and A-104-UV four-set). Rounding out the all-channel concept are UHF/VHF matching transformers (Cablematch U/V set mounted; MT-283 mast-mounted) and the TF-331-U/V flush-mounted feed-thru.

Take your pick. Blonder-Tongue makes them all—and all are "Color Approved". Buy the line with 15 years of quality leadership. Write for free booklet "How to Plan a Color-Approved Home TV System".



BLONDER-TONGUE

9 Alling Street, Newark, New Jersey 07102
home TV accessories • closed circuit TV •
community TV • UHF converters • master TV

Circle 34 on literature card

December, 1965/PF REPORTER 57

at last...
instant color patterns
at your finger tips...
zero warm-up time



THE ALL NEW SENCORE CG135 DELUXE TRANSISTORIZED COLOR GENERATOR

The big push is on in Color TV. Equip yourself now with the new, solid state Sencore CG135 and cash in on the zooming volume of new service business as Color-TV booms! Instant, service-ready RCA standard color bars, cross-hatch, white dots and individual vertical and horizontal bars enable you to set up or trouble-shoot more Color TV sets per day; earn top money in this fast growing service field. It's an analyzer too: Color gun interruptors, unmodulated video for chroma circuit trouble isolation and unmodulated sync pulses to keep Zenith receivers in sync for this test, make color trouble shooting a snap. Sturdy all-steel construction for rugged, heavy duty in the field or shop. Another Best Buy in profit-building service instruments from Sencore at

\$149⁹⁵

COMPARE THESE FEATURES: SEE WHY THE CG135 IS IN A CLASS BY ITSELF

- Solid state construction employs high priced GE "Unijunctions" to develop six "jump out proof counters" that guarantee stable patterns at all times with no warm-up
- Standard RCA licensed patterns as shown on schematics throughout the industry
- Handy universal color gun interruptors on front panel
- Lead piercing clips insure non-obsolence
- CRT adaptors optional
- Crystal-Controlled 4.5mc Sound Carrier Analyzing Signal to insure correct setting of fine tuning control
- RF output on Channel 4 adjustable to Channel 3 or 5 from front of generator when Channel 4 is being used
- No batteries to run down; uses 115 V AC
- Less than one foot square, weighs only 8 lbs.

professional quality — that's the difference!

SENCORE

426 SOUTH WESTGATE DRIVE • ADDISON, ILLINOIS

Circle 35 on literature card

12 Years of UHF

(Continued from page 17)

Two servicemen described a shadow effect I remember slightly from the early days—one that television repairmen in the area called "waterfall effect." Essentially, it means that dead spots become much less pronounced at a distance from the transmitter, particularly at high ERP. As a result, behind-the-hill problems upriver from Peoria still exist, as do dead spots in the finger-like hollows in East Peoria; farther out, though, signals seem to slide over the hills more easily, and fewer dead spots are found.

"Beyond 40 miles," one large service operator told me, "our customers put up tall pipes or towers and use high-gain UHF antennas. We've sold several sets 60 miles away." Asked about antenna costs: "Well, we have a real hot model we sell for \$15.95, and double-stack it for \$24.95 if the customer needs that much gain. We'll put it on a guyed 20' pipe on the roof for a little over \$50. Sometimes the price depends on the lead-in run or mounting problems; and we charge mileage on top of any installation fee."

What about antennas in the local area? Are indoor antennas okay now that the stations are high-powered? "Yes and no," one shop's antenna crew said. "It all depends on what part of town you're talking about. We don't worry much about it. The customer tries an indoor job, and if he doesn't like it we go out and put up a bowtie on a 5' pipe. At \$19.95, the cost is no problem." Another shop foreman added, "Around here, we just include a simple bowtie installation with every new set. Then we have no worry whether an inside antenna is satisfactory."

The Color Picture

How is color on UHF? I've heard different opinions all over the country. In Peoria, however, where they've had color since 1955, everyone I talked to insists it's better than on VHF they've seen in other towns. The field rep of one color-set manufacturer felt the same. "It's hard to put your finger on just what it is that's better," he said, "but, from seeing a lot of both, I've concluded that color on UHF is somehow sharper or crisper than on VHF." He added, "I've no way to prove this; it's just an opinion."

One thing is sure: color is okay on UHF.

What is the antenna situation with color sets? Are they necessary? "Yes!" declared every service technician I asked. "I'd bet 99% of the color sets in this town use outside antennas." Asked how this compares with monochrome sets, they agreed that about 80% of black-and-white receivers in Peoria are fed from outdoor antennas. One shop owner suggested, "This may be because of the low cost of a UHF installation. People put one up just to be sure they get a good signal." A new-set salesman for one sizable store said, "We wouldn't even consider installing a color set without an aerial. We'd just be asking for trouble."

Any problem with color out in the fringe beyond 40 miles? Very little, according to the installation man for one company. "We just put up a good antenna . . . but we'd have to do that for a black-and-white set, too," he says, adding, "We put up a few towers with both UHF and VHF antennas—the VHF to bring in channel



FREE!

From now through December 15, 1965

Get a Color-TV TEST Picture Tube with every RCA WR-64B Color Bar/Dot/Crosshatch Generator you buy

Yes! You read right!

From now through December 15, 1965—with every purchase of an RCA WR-64B Color Bar Generator—you get a FREE color-TV TEST picture tube for use in your color-TV test jig. This is a 21-inch 70° round color-TV TEST picture tube, electrically guaranteed six months from first installation date. These tubes will have minor mechanical (not electrical) defects... they're not quite good enough to go into a new TV set but perfectly adequate for testing purposes.

How to get your FREE Color Test Tube

Simply buy an RCA WR-64B Color Bar Generator—THE essential color-TV test instrument—between now and December 15, 1965. Fill out your warranty registration card and attach the red identification label on the WR-64B carton. Send them to RCA, Test Equip-

ment Headquarters, Bldg. 17-2, Harrison, N.J. We send you the tube (either from Lancaster, Pa. or Marion, Ind.) freight charges collect. To allow for postal delay, we will honor cards received up until December 31st.

Don't miss out on this never-before offer. You've got to have a color-bar generator anyway—so be sure you buy it now—at the regular price—while you can get a FREE color test tube.

\$189.50*

Optional distributor resale price; subject to change without notice. Price may be higher in Alaska, Hawaii and the West.



RCA WR-64B Color Bar/Dot/Crosshatch Generator

RCA ELECTRONIC COMPONENTS AND DEVICES, HARRISON, NEW JERSEY



The Most Trusted Name in Electronics

**a new money-making,
traffic-building tube tester**

for you or your customer!



**THE ALL NEW SENCORE TC131
SEMI-AUTOMATIC TUBE CHECKER**

After thousands of requests here is the "counter/bench" version of the famous Sencore Mighty Mite Tester; designed for the ultimate in tube checking thoroughness and operational simplicity! Designed for two-way use — as a professional shop tester and customer self-service unit. Tests over 2500 tubes — including Nuvistors, Compactrons, 10-pins, Novars, Magnovals and foreign tubes with a big 6-inch meter for easy reading. Semi-automatic; simply turn function control to any test and watch lighted arrow on meter automatically stop on right scale. User can't go wrong — no guess work — everything is read right on the meter (no tricky neon lights to misread); only 3 set-up controls. Easy to read, speed-indexed set-up cards make every test fast and sure. Like the famous Mighty Mite, the TC131 uses 100-megohm grid leakage sensitivity to spot those "tricky" tubes other testers miss; tests inter-element shorts and makes cathode emission tests under full operating levels. A real profit maker as a counter checker or self service tube seller in your shop . . . and it's only

\$129⁹⁵

See your distributor about the big TC131 trade-in deal.

professional quality — that's the difference!

SENCORE

426 SOUTH WESTGATE DRIVE • ADDISON, ILLINOIS
Circle 37 on literature card

3 from Champaign. Even when these are out on our own fringe, the UHF signal is more consistent for color reception than the VHF signal is. There's more fading on channel 3 than on our stations." I wasn't able to verify this last with other technicians, but it was an interesting observation.

And Other Comments

I heard other miscellaneous comments while I was in this locale of 12-year UHF. Here are a few of them:

"I think we make a lot more money than technicians in VHF areas. We have 6AF4's still giving us trouble. We get more antenna jobs because they're important."

"We still have a lot of tuner trouble. We work on the old tube-type ones, but these little postage-stamp jobs . . . we just send them to the factory. You can get an exchange deal in most cases, so they're not worth bothering with on our own bench."

"I think the All-Channel Law is fine. In fact, I'd like to see the VHF band done away with altogether." I asked this technician why. His reply was lengthy and thought-provoking: "We now have two tuners to worry with, and all the switching and driving junk that go with them. It'd be a lot better to have one tuner with all the stations on one dial. Less trouble and easier to operate. Then we could also have better UHF tuners and they'd cost less. UHF has none of the interference problems VHF has—hams, CB'ers, diathermy, police radios, and all that. Who cares if you can't get it quite as far away? With CATV systems going in all over, the fringe people will be covered anyway. Besides, the government could just assign more of them (UHF stations) closer together; that'd take care of any dead spots. I'll bet the UHF people would be glad to see VHF stations go. Then everyone would have about the same coverage areas; as it is now, the V's have an advantage."

Others voiced various feelings. "Wish we could use more inside antennas" . . . "Hate those areas close in where we have to point antennas in three different directions; nobody wants a rotator" . . . "Sure do like the tiny antennas we use" . . . "No use trying to work on a UHF tuner" . . . "No problems with color" . . . "Glad to see transistor UHF tuners; don't have to replace so many 6AF4's" . . . "Hate to see transistor UHF tuners; don't sell as many 6AF4's" . . . and so on.

Conclusions

Coming away from my trip into the 12-year past, I felt that the problems we had those first few months are largely nonexistent now. Greater power and better frequencies for the stations have helped a lot. I saw better UHF antennas for fringe use than any we had in the early days of 1953.

After 12 years, though, the main difference I noted is in the attitude of the service people themselves. Peoria technicians look on UHF with the same take-it-for-granted attitude a technician anywhere has for the form of TV used in his locality.

Fears expressed around the country that UHF may not be a desirable form of television transmission may be groundless. At least 12 years of experience in Peoria seem to say so. ▲



The quality goes in before the name goes on

Now available in your area... ZENITH QUALITY SPEAKERS AND CHANGERS FOR WORLD-FAMOUS SOUND REPRODUCTION

Zenith famous Micro-Touch® record changers, universal loudspeakers and long-life batteries meet the famous quality standards set for Zenith "original" parts . . . your assurance of the world's finest performance.

Wherever you are located, there's a Zenith Distributor near you who can supply you quickly on a day-to-day basis.

ZENITH QUALITY "STEREO PROFESSIONAL" AND "STEREO PRECISION" MICRO-TOUCH RECORD CHANGERS

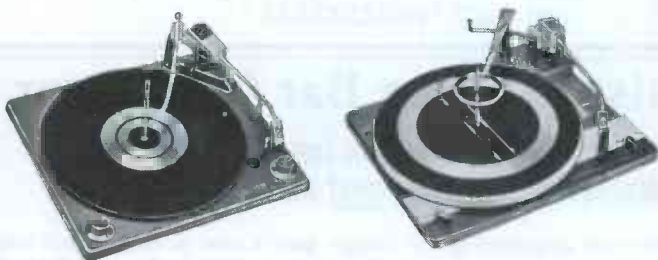

With Micro-Touch 2G Tone Arm with "Free Floating" cartridge that makes it impossible to accidentally ruin records. It's the world's most imitated tone arm . . . the finest tone arm in any automatic changer. Finest stereo separation, finest stereo sound.

Both record changers automatically play ten 33 $\frac{1}{3}$, twelve 45, ten 16 $\frac{2}{3}$, or ten 78 RPM records; automatically play intermix of 10" and 12" same-speed records. Automatic shut-off. New 11" turntable. Heavy-duty turntable motor reduces rumble and wow, gives smooth, constant speed. Both changers complete with adapter cables.

Solid walnut base with natural oil walnut color finish also available for both changers.

COMPLETE LINE OF ZENITH QUALITY UNIVERSAL LOUDSPEAKERS

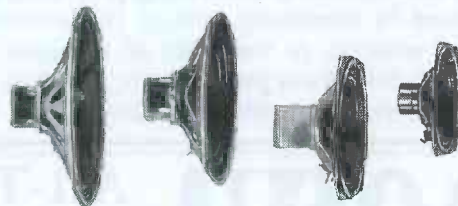

Full line of 32 popular sizes provide a Zenith Quality loudspeaker for practically any purpose . . . stereo, radio, TV, car radio. They're dependable and rugged. Outstanding power and frequency response make Zenith the finest replacement loudspeaker for servicemen around the country.

ZENITH QUALITY LONG-LIFE "TRANSISTOR BLEND" BATTERIES



Zenith long-life batteries with "Transistor Blend" electrolyte are designed specifically for transistor radios. Zenith's famous Positive Quality Control assures that all batteries meet Zenith's high standards. Zenith features a complete line of batteries for transistor and portable radios, flashlights and farm packs.

Now display cases for Zenith Long-Life Batteries are available from your Zenith Distributor!

Check the Yellow Pages for the Zenith Distributor nearest you.
Or write to Zenith Sales Corporation, Parts & Accessories Division,
5801 West Dickens Avenue, Chicago, Illinois 60639,
for Distributor name and information on Zenith Quality
changers, speakers and batteries.

Specifications subject to change without notice.

Circle 38 on literature card

FREE
with your
purchase of a
PHOTOFACT®
Library...

★
sells at retail for
\$149.50

now yours

FREE

with the purchase of a
Photofact Library
consisting of 225 Sets or
more...**ACT NOW**—get the
Encyclopedia in time for
your family Christmas!

the supreme *Christmas Gift*
for your family...the famous 14-volume
NEW STANDARD ENCYCLOPEDIA!



give your family this wonderful gift—
give your earning power a big boost with
PHOTOFACT—world's finest TV-radio service data

Now, more than ever, it pays to own a PHOTOFACT Library—the time-saving, troubleshooting partner guaranteed to help you earn more daily. Now, you can start or complete your PHOTOFACT Library the special Easy-Buy way, and get absolutely FREE with your purchase, the famous 14-volume NEW STANDARD ENCYCLOPEDIA. It's a great reference library for all the family—complete, authoritative, indispensable. Retail for \$149.50—yours absolutely FREE with the purchase of a PHOTOFACT Library consisting of 225 Sets or more!

THERE ARE 4 CONVENIENT WAYS TO SELECT YOUR PHOTOFACT LIBRARY

1. Complete your present PHOTOFACT Library.
2. Order a PHOTOFACT "Starter" Library—225 Sets (Sets 451-675—coverage from 1959 to 1964—only \$14.29 per month).
3. Order by brand name and year—see the handy selection chart at your distributor.
4. Order a complete PHOTOFACT Library—and the famous 14-Volume New Standard Encyclopedia is yours FREE!



ORDER YOUR PHOTOFACT LIBRARY NOW—AND GET YOUR FREE STANDARD ENCYCLOPEDIA

See your Distributor for the full details of the PHOTOFACT-Encyclopedia Deal, or send coupon at right! Also ask about a Standing Order Subscription to current PHOTOFACT and Specialized Service Series (FREE File Cabinets available with Subscriptions). **ACT NOW!**

SEE YOUR DISTRIBUTOR OR SEND COUPON TODAY

OWN A PHOTOFACT LIBRARY THE EASY-BUY WAY:

- Only \$10 down • 30 months to pay
- No interest or carrying charges • Prepaid transportation
- Add-on privilege of a year's advance subscription to current Photofact data, on the same Easy-Buy contract
- Save 30¢ per Set—special \$1.95 price applies on Easy-Buy (instead of regular \$2.25 price)

THERE'S NEVER BEEN A DEAL TO EQUAL THIS!

GET THE DETAILS NOW

HOWARD W. SAMS & CO., INC.

Howard W. Sams & Co., Inc., Dept. PFF-12
4300 W. 62nd St., Indianapolis, Ind. 46206

Send full information on the PHOTOFACT Library-Encyclopedia Deal, and details of the Easy-Buy Plan

My Distributor is: _____

Shop Name _____

Attn. _____

Address _____

City _____ State _____ Zip _____

**top money maker in
the service business**



NEW IMPROVED SENCORE CR133 CRT CHECKER & REJUVENATOR

The new, improved CR133 CRT Checker is designed to test all present picture tubes — and it's ready for future tubes too! Two plug-in replaceable cables contain all sockets required. The compact, 10 lb., CR133 checks CRT emission, inter-element shorts, control grid cut-off capabilities, gas and expected life. Checks all tubes: conventional B&W, new low drive B&W, round color tubes and new rectangular color picture tubes. Exclusive variable G2 Volts from 25 to 325 Volts insures non-obsolence when testing newly announced "semi-low" G2 CRT tubes. New Line Voltage Adjustment insures the most accurate tests possible. Uses well-filtered DC for all checks to avoid tube damage and reading errors. Color guns are individually tested as recommended by manufacturers. Exclusive automatically controlled rejuvenator applies rejuvenation (ACR) voltage as required by individual tube condition; precisely timed to prevent over-rejuvenation or tube damage. The ACR feature is most useful for color tube current equalization to insure proper tracking. Hand-wired and steel-encased for protection of meter and panel in truck or shop, the new improved CR133 is only . . . **\$89⁹⁵**

The famous CR128 CRT Checker and Rejuvenator is similar to above, but with a three position G2 slide switch and without Line Voltage Adjustment at \$69.95

professional quality — that's the difference!

SENCORE

426 SOUTH WESTGATE DRIVE • ADDISON, ILLINOIS

Circle 42 on literature card

Electronic Scanner

(Continued from page 15)

of sounds and images. Further, American interests must be preserved and our continued leadership assured in the new era of space communications.

These factors are food for thought among all who make their living in the fields of communication and home entertainment equipment.

Two-Way Radio—Too Big for Its Britches

Time was when people communicated face to face, by smoke signals, or by the written word. Then modern science moved in. People talked to each other miles apart via telephone, listened to others over radio, or saw them on television.

Police departments picked up the idea of two-way radio, which revolutionized their method of operation. Others began to realize that the benefits of two-way radio could be applied to their activities. Fire departments, county sheriff and highway maintenance departments, state and federal governmental agencies, utilities, forestry and conservation organizations, etc. started using it.

The concept soon carried over into the transportation field. One of the most widely known users was the taxicab company, but applications spread to include railroads, trucking companies, and special industrial operations.

Until 1958, the vast business community, made up of thousands of different kinds of companies both large and small, were not eligible to operate two-way radio systems. It was then that the FCC established what is known as the Business Radio Service, allocating a segment of frequencies for businesses. During that first year, some 9000 business-radio stations were licensed, with the users installing 80,000 transmitters. In the seven years since, the number of users across the country has grown to 80,000 operating 150,000 transmitters. The projection for 1970 is 400,000 users with over 1,000,000 transmitters.

Why have so many businesses gotten excited about two-way radio? The reasons are several, but they add up to one big reason: Two-way radio makes more money for its users than it costs. The key to it all is immediate contact with the field. The service or delivery truck, the supervisor or salesman, the president of the company — all can be reached in seconds, while they're in motion. The office doesn't have to wait for them to phone in, perhaps too late to be of help.

This flexibility of instant contact pays off in major ways. Everyone benefits. The customer gets good service; the company makes the most of its people and vehicles.

All this has happened in just the seven years since the FCC gave business the go-ahead to use two-way radio. The number of users has been increasing by a greater percentage every year. Greatest growth is in metropolitan areas. With this continued growth, there's also a growing question as to whether many more businessmen will be able to take advantage of two-way radio. The frequencies on which the systems are licensed are getting crowded. This is true not only of the Business Radio Service, which has now grown to be the biggest of them all, but of all the radio services. One frequency in Los Angeles is shared by 62 business-radio users. The average number of users on a single channel in metropolitan areas is something over 20.

Various associations have been studying the frequency-congestion problem, and a number of approaches are being formulated and considered. One is a total redivision of the entire spectrum under which all broadcasting services (television, regular radio, telephone, aviation communications) operate. Another idea calls for making maximum utilization of the spectrum; where frequencies are not being employed for television in a certain area, for example, use them for two-way radio communication.

The answer may not come for awhile, since the problem is complex. But it is one of the most important problems that must be tackled and solved if present users are to continue getting the most from their two-way radio systems and if new users are to have the opportunity to go on the air. ▲



The Troubleshooter

answers your servicing problems

No Signal Above 900 kc

Could you tell me why Ford Model 74BF car radio (covered in PHOTOFAC Folder 399-6) completely blanks out when the dial is turned to 900 kc or above? It operates properly on the low-frequency end of the band. Adjusting the oscillator trimmer (A5) helps a little. I have replaced C9 but the new capacitor didn't help.

JOHN R. ZANATH

Aliquippa, Pa.

The local oscillator in your Ford auto radio is not oscillating above 900 kc. A defective converter tube (V2), low plate sup-

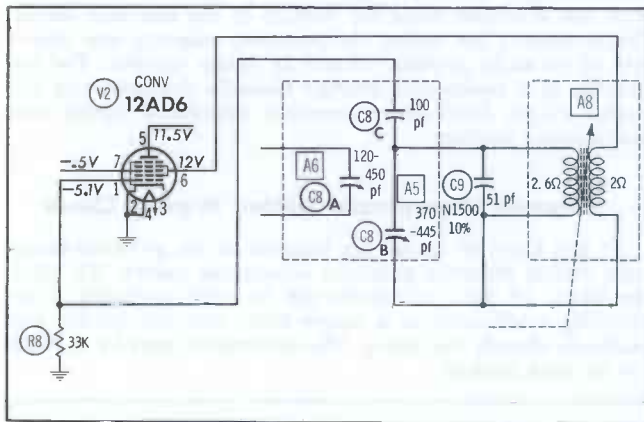

ply voltage, or defective grid-leak components (C8C and R8) could cause the oscillator to stop functioning above a certain frequency. Also, it's possible that a tuning slug is shorting its coil windings when the dial is rotated to 900 kc or above.

Alignment Problem

I have a Sonic-Aire Model SA-137 transistor radio which has given me fits in trying to align and get the front end to track. I can't find a listing for this radio in PHOTOFAC Index. I have the schematic that came with the set and will send it along. However, as you can see there aren't any alignment instructions on the schematic. Any help you can give me will surely be appreciated.

W. MALONE, JR.

Wilmington, Ohio

Fashion a loop of several turns of insulated wire and connect it to the signal generator output. Set the signal generator for a 400-cps modulated signal. Radiate a signal into the receiver by placing the loop close to its antenna. Connect a VOM across the speaker voice coil, and set the volume control at maximum. In the following procedure, keep the generator output as low as possible, but maintain a suitable meter reading. Set the radio dial and the signal generator to 1600 kc. Adjust the oscillator trimmer for maximum deflection on the meter. Now, set the dial and the generator to 1400 kc and adjust the RF trimmer for maximum reading on the VOM. Next, position the dial and the generator for a 600-kc output, and adjust the oscillator and RF coil slugs for maximum indication on the meter. Go back to the first step (1600-kc adjustment) and repeat the 1600-, 1400-, and 600-kc adjustments until no further improvement can be obtained.



"My shop's been loaded . . . since I've had my FCC License."

"And I could kick myself for not getting it sooner. I'm pulling in all kinds of mobile, marine and CB business that I couldn't touch before; have even had some calls to work on closed-circuit television. I've hired two new men to help out and even with them, I'm two weeks behind."

And so it goes. Once you have that FCC Ticket, you open the door to all kinds of new business. And that's not all. The knowledge you need to pass the FCC exam gives you a fundamental understanding of all electronics. You'll find you can do more work in less time . . . work on almost any kind of electronics gear.

What's the best way to get a Commercial FCC License . . . and still keep up with your work? Thousands of men will tell you "Cleveland Institute of Electronics". CIE has been preparing men for FCC License exams since 1934. What's more, they back their Home Study Licensing Programs with this remarkable money-back offer:

A CIE FCC License course will quickly prepare you for a Commercial FCC License. If you fail to pass the FCC examination . . . on the very first try . . . after completing your course, CIE will refund all your tuition. You get an FCC License . . . or your money back!

Send coupon today for CIE's FREE informative booklet "HOW TO GET A COMMERCIAL FCC LICENSE". Cleveland Institute of Electronics, Dept. PF-26, 1776 E. 17th St., Cleveland, Ohio 44114.

SEND COUPON TODAY FOR FREE BOOKLET

Cleveland Institute of Electronics

1776 E. 17th St., Dept. PF-26
Cleveland, Ohio 44114

Please send FREE Booklet "HOW TO GET A COMMERCIAL FCC LICENSE", without obligation.



Your occupation _____

Name _____ Age _____
(please print)

Address _____ County _____

City _____ State _____ Zip _____

A leader in Electronics Training . . . since 1934

Bends

After spending many hours trying to correct severe bending on a Series 36 Magnavox television receiver, I finally came up with a solution in which I thought your readers might be interested. Several component parts and tubes were checked and substituted in an attempt to correct the trouble, but all efforts were fruitless. I discovered that pin 5 (filament) of the 6CG7 (horizontal-oscillator) had a poor ground connection. By connecting a heavier bond from pin 5 to the chassis in place of the original ground connection to the printed circuit board, I entirely corrected the horizontal bending. Since the original repair, we have corrected several cases of severe bending (some intermittent) in Series 36 receivers by using this same method. We now incorporate this circuit change on all of these particular chassis that happen to be in the shop for repair.

ERNEST C. MOORE

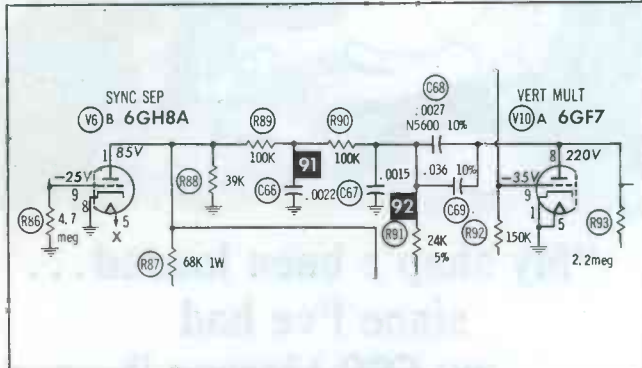

Insufficient Sync

We have serviced several Series 45 Magnavox color television receivers that had weak vertical sync. This problem was solved

Me...? Rebuild Color Tubes???

Why Not!

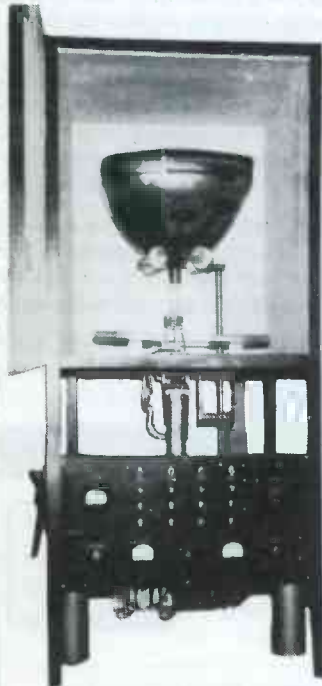

Windsor Equipment
Handles Color & Bond-
ed-Face As Well As
Black-and-White Tubes.

So What?

Rebuilding with Wind-
sor is a **QUALITY**
PROCESS . . . and
PROFITABLE !!!

Rebuild Color Tubes for
a Cost of \$11.75 each
... You Sell them for???

Windsor Equipment
pays for itself in a few
months.

Financing Available
Free Training at our
Plant

Write for our Booklet "The Open Door to TV Profits"

WINDSOR ELECTRONICS, INC.

Equipment Division
999 N. Main St., Glen Ellyn, Illinois

by shunting R90 (100K resistor) with a short piece of wire and removing capacitor C67 (.0015 mfd) from the circuit. The vertical sync was then solid with no apparent ill effects on set operation.

ERNEST C. MOORE

Rushville, Ind.

Needs A Suitable Load

Recently I have had several high-powered audio amplifiers brought into my shop for repair. My experience with this type equipment is limited. I am never quite sure what the proper load should be across the secondary of the output transformer. The outputs of the units I have worked on recently have varied from 15 to 50 watts per channel.

Could you help me in determining what kind of speakers and loading methods are required to service this type of equipment properly?

Ellenwood, Ga.

JOHN C. GRAY

Across the output transformer terminals, use a resistor that matches the output impedance. For example, connect a 16-ohm non-inductive 50-watt resistor across the 16-ohm output terminals of a 25-watt amplifier. As a safety precaution, always use a resistor twice the wattage of the amplifier output. Proper loading for testing the frequency response and distortion of an audio amplifier should be purely resistive. The impedance of a loudspeaker changes radically throughout its frequency range; furthermore transients introduced during tests may damage speakers.

Grounded-Receptacle Outlet Wiring Check

As you know all houses are required to use grounded-receptacle outlets wherever grounded objects are nearby. To check the wiring of these receptacles can be quite confusing. I am attaching a schematic of a simple tester that will quickly and positively identify the wiring. This information may be of some use to your readers.

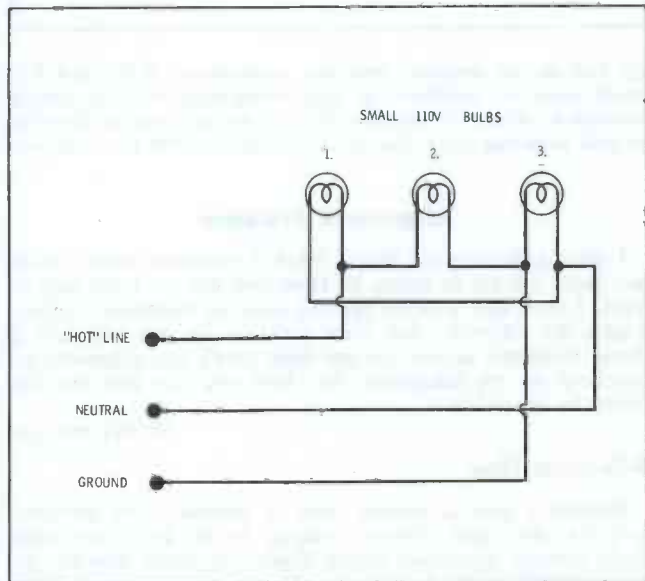

Three 110-volt bulbs are connected to a three-pronged male electrical connector.

As shown in the schematic, when the unit is plugged into a properly wired outlet, lights 1 and 2 will light and 3 will not. If lights 1 and 3 are lit and 2 is off, the line and neutral wires are reversed. If light 1 is on and lights 2 and 3 are only dimly lit, the ground wire is open or disconnected. If light 2 is on and lights 1 and 3 are dim, the neutral wire is open. The conditions can be listed right on the unit for easy reference.

W. W. HENSLER

Indianapolis, Indiana

Circle 44 on literature card

COLOR COUNTERMEASURES

Symptoms and service tips from actual shop experience

Chassis: Zenith (all chassis)

Symptom: Horizontal and vertical dynamic convergence controls have no effect on display presented on CRT. This condition may appear intermittently.

Tip: Check for defective selenium rectifier X3, located on convergence panel assembly. Replace with Zenith part #212-25 or use the replacement listed in the appropriate PHOTOFACT Folder.

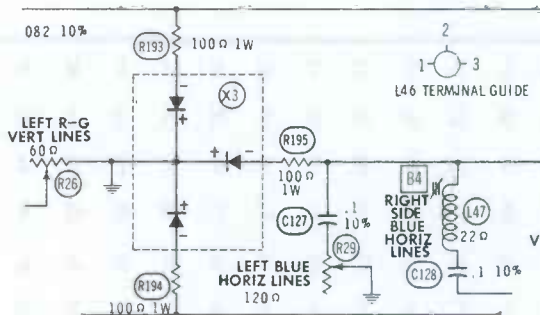

Answer to November's Puzzle.

(See page 68 for December Puzzle.)

Below 20—Don't expect all answers to be obvious.

21-24—Try more approaches for finding the answer.

25-28—You are hesitant to give up, but work a little harder.

29-30—Bravo! You approach problems from all directions.

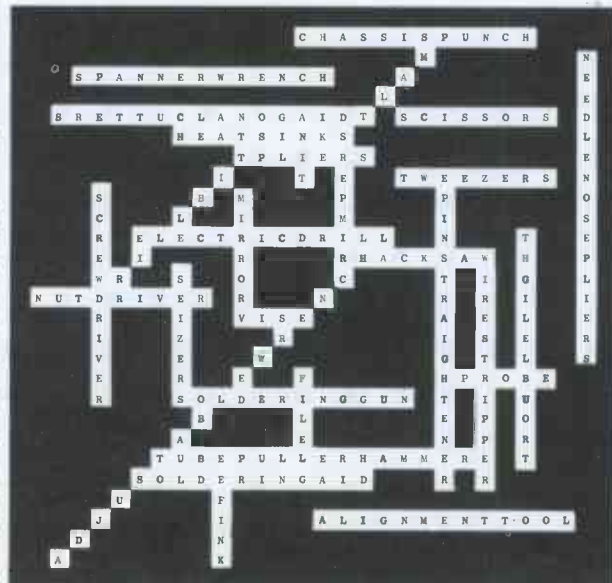

PINPOINT COLOR TV TROUBLES IN SECONDS...

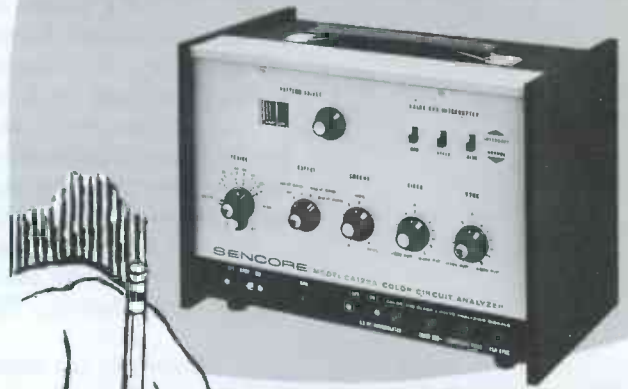

WITH THE NEW IMPROVED SENCORE CA122(A) COLOR CIRCUIT ANALYZER

It's a standard ten color bar generator; produces vertical lines, horizontal lines, crosshatch, and adjustable dots, PLUS a complete TV analyzer for color and B&W—at less money than color generators only. Here is what the CA122(A) will do for you by tried and proven signal injection into these stages.

UNIVERSAL TUNER SUBSTITUTE for Color (or B&W). A must to check tuner restriction of RF color signal.

BANDPASS AND CHROMA AMPS signal Injection for color trouble isolation.

EACH IF STAGE to quickly isolate a stage with low gain.

CHECKOUT COLOR DEMODULATORS for troubles or phase adjustments.

VIDEO AMPS from detector to the CRT tube, up to ± 30 VPP.

SYNC CIRCUITS; vertical and horizontal pulses to quickly isolate sync faults.

4.5 MC IF for signal injection up to the audio discriminator.

AUDIO AMPS; 900 cycles for injection right up to the speaker.

PLUS:

The CA122(A) is not only a color generator and analyzer, but provides color gun interruptors for purity adjustments and a shading bar pattern for color temperature control settings. You get all this for only.....

\$18750

39G12 Rectangular color tube adaptor.....

\$495

See your distributor today. He has the CA122(A) in stock now.

SENCORE

426 SOUTH WESTGATE DRIVE

ADDISON, ILLINOIS

Circle 45 on literature card

PFR Puzzler

This month's puzzle contains 30 words relating to semiconductors. Some of these words are the actual names of semiconductor devices; others are words associated with the properties of semiconductors. These words are scattered throughout the puzzle, some interlocking with another word. They may be discovered by reading left-to-right, right-to-left, up, down, or diagonally.

See how many of these thirty semiconductor terms you can locate. The answers and a score chart will appear in the January PF REPORTER.

(Answer to last month's puzzle is on page 67.)

H	O	M	E	Z	E	N	E	R	R	L	R	P	T	C	O	L	L	E	C	T	O	R	J	I	M	P	T
Z	T	A	R	S	M	L	C	O	C	T	N	D	R	M	A	N	L	P	G	E	R	M	A	N	I	U	M
C	O	L	J	U	N	C	T	I	O	N	C	L	Z	C	G	A	L	D	P	Q	Z	W	Y	F	R	J	V
D	C	V	I	D	K	S	Z	A	L	V	Y	R	C	S	N	E	Z	Y	O	F	J	C	B	E	Q	A	J
A	Q	R	P	C	I	L	Y	H	V	M	J	D	I	O	D	E	F	R	Q	Z	Y	R	A	N	A	L	P
M	Z	I	O	S	C	R	X	C	A	E	F	L	D	F	O	L	D	Y	R	A	F	G	Q	C	Z	N	L
O	N	Z	N	C	X	T	S	U	G	L	I	E	H	T	A	S	E	M	Y	Q	N	R	Z	E	L	Q	C
D	F	A	T	C	R	A	E	Q	R	C	L	S	C	C	O	T	M	Y	U	L	C	R	G	I	B	E	O
A	R	O	T	C	A	R	A	V	O	F	B	E	T	V	Z	X	I	Y	E	I	O	A	D	T	X	Y	M
T	W	R	L	U	O	A	Y	N	X	Q	F	R	F	B	T	U	T	L	Z	T	N	E	T	I	A	E	B
T	E	R	I	C	N	L	C	D	Q	F	E	C	D	F	R	P	T	Q	S	A	C	E	D	F	M	Z	Q
A	M	L	C	F	Q	N	M	Z	E	G	I	X	J	Z	E	C	E	I	O	T	P	T	L	U	A	S	P
P	M	A	C	R	M	L	E	D	A	E	T	Q	Y	Z	R	C	R	T	B	O	A	Y	A	E	Z	M	P
E	G	F	R	T	P	C	L	L	A	R	Q	T	E	Z	R	A	T	C	E	V	T	B	Z	A	S	D	G
G	R	E	A	T	M	E	A	E	H	C	N	A	L	A	V	A	G	H	T	N	G	T	I	U	A	F	H
F	I	E	L	D	I	S	T	O	R	U	Z	G	H	L	O	Q	R	A	C	T	V	X	C	S	Y	U	O
R	O	M	T	F	Z	A	F	P	O	Z	R	C	A	P	H	I	Z	U	F	Q	C	P	G	H	T	M	B
C	O	M	N	E	P	A	U	L	J	O	M	T	Y	A	P	O	C	P	T	Y	D	F	Q	R	A	O	G
N	O	I	T	C	N	U	J	I	N	U	Z	M	I	T	Q	P	A	L	C	O	R	A	C	E	U	J	R
A	P	U	U	T	J	A	C	K	O	T	M	B	C	N	A	J	L	M	C	L	T	Q	R	F	G	P	M
O	A	I	T	Q	B	P	O	M	C	F	G	Z	T	C	R	C	F	G	K	L	M	Z	T	A	R	O	A
B	E	C	K	Y	L	M	T	P	R	O	T	S	I	R	Y	H	T	Z	A	A	B	O	T	U	R	C	Z
X	T	F	O	E	R	A	T	D	C	A	S	R	T	J	M	P	Q	E	A	Z	T	G	T	H	I	L	O
A	C	P	O	R	B	C	R	T	U	C	A	T	H	O	D	E	F	Z	T	A	R	T	G	O	Q	P	B
E	R	I	L	P	B	I	X	T	G	V	E	S	T	E	R	O	T	Q	A	L	P	H	A	A	P	E	X
P	L	A	Y	O	F	P	U	Z	Z	L	E	O	M	I	T	C	L	U	E	R	O	M	A	N	E	N	T
T	O	W	E	T	C	P	Q	A	R	O	T	S	I	M	R	E	H	T	S	Y	P	Q	M	A	B	O	T
E	S	A	B	H	E	T	R	O	G	H	J	F	O	O	T	B	A	L	L	Z	B	E	L	B	E	T	A

Product Report

For further information on any of the following items, circle the associated number on the Catalog & Literature Card.



Transistor/Diode Checker
(59)

This instrument can be used to check all types of germanium and silicon junction transistors and diodes, including small-signal and high-power types. The Workman "Transitest" gives an indication of transistor or diode condition by means of a tone signal (generated by a self-contained oscillator circuit). The tester is battery operated and cannot damage transistors or diodes even if improperly connected. Each transistor is identified as to PNP or NPN type as part of the test procedure. The unit measures 3 3/4" x 6 1/4" x 1/8", and the price is \$12.95 (less batteries).



Tape Recorder for Cars
(60)

Illustrated is an automotive tape sound system which can play back through the car radio as well as record. It can be removed easily from the car for use as a completely portable and separate recorder. The Norelco "Car-Mount," a two-part unit, comprises a universal mounting and the "Carry-Corder 150." The "Car-Mount" is connected to the auto radio, and the mounting unit is attached below the dashboard with a special adapter inserted into the radio antenna. The "Carry-Corder" is

then placed into the mounting's custom-designed tray.

The unit is self-powered, and battery life is extended, since playing the recorder through the car radio instead of its own amplifier reduces the power drain by almost 50%.

Tape cartridges snap into the unit and provide one hour of recording or listening time.

The "Car-Mount" mounting sells for less than \$30. The "Carry-Corder" retails for less than \$120.

easy to sell...
a snap to use...
and nothing to service



harman kardon

the NEW

COMMANDER

all-solid-state AM/FM tuner

Model CAT-1000 • \$250⁰⁰ LIST

Here's the latest addition to the Harman-Kardon *Commander* line of quality commercial sound equipment. The new Model CAT-1000 is the finest all-solid-state AM/FM tuner in the popular-price category. There's not a single tube in this tuner—not even a nuvistor tube. Thus, your customer is assured of completely drift-free performance with no warm-up, no realignment problem ever.

The attractive, heavy extruded front panel features an illuminated slide-rule dial with flywheel tuning, D'Arsonval tuning meter, and power indicator light. Front-panel controls: power and AM/FM selector switches, tuning knob. The CAT-1000 is supplied complete with protective metal enclosure—ready to stand on a shelf or under a counter. Two program output jacks on the rear apron let you use this one great AM or FM source to feed two systems simultaneously.

Your customers will welcome the reliability of the new CAT-1000; you'll welcome the fact that this tuner *stays sold*—without callbacks. Write for complete technical data. Harman-Kardon, Inc., Commercial Sound Division, 15th & Lehigh Avenue, Philadelphia, Pa. 19132. A subsidiary of The Jerrold Corporation.

Circle 46 on literature card

AGC PROBLEMS?

SENCORE BE113 ALIGN-O-PAK
DUAL TV BIAS SUPPLY

... a *MUST* for AGC trouble shooting; Quickly isolates the problem by direct substitution of TV AGC voltage with a variable bias supply. A *MUST* in B&W TV alignment, and *NOW*; a *MUST* for Chroma Bandpass amplifier alignment in color TV sets. The BE113 ALIGN-O-PAK provides all the voltages recommended by TV manufacturers with two non-interacting bias supplies of 0 to 20 volts DC with less than 1/10th of 1% ripple with calibration accuracy better than standard battery tolerances. Eliminate those messy time consuming batteries and get your BE113 from your distributor today.



\$12.75

SENCORE 426 South Westgate Drive • Addison, Illinois 60101

Circle 48 on literature card

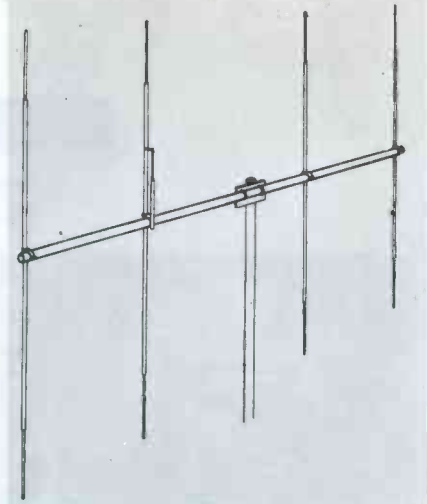

Four-Element Antenna

(61)

This bidirectional base-station antenna operates in the 27-mc Citizens band. The *Scotch-Master* is designed to give a gain of 8.7 db over a 1/4 wave dipole (or 11.2 db compared to an isotropic source), a front-to-back ratio of 20 db, and a VSWR of 1.5/1. Wind-load rating is 80-mph, EIA standard. Stacking kits are available for connecting two antennas together for an additional gain of 3 db (11.7 db gain over 1/4 wave dipole or 14.2 db compared to isotropic source). The *Mosley A-411-S* is constructed of high-tensile-strength aluminum and has an assembled weight of 15 lb.



Tri-Band SSB/AM/CW

(62)

This three-band SSB/AM/CW Transceiver is for use in the 20-, 40-, and 80-meter amateur radio bands. The *EICO 753 "Tri-Band"* transceiver may be used at fixed locations or as a mobile station, for manual push-to-talk or automatic-voice-controlled (VOX) radio-telephone operating, or for radiotelegraph communication employing grid-block keying.

During transmission, power input is 200 watts PEP for SSB or CW, and 100 watts for AM. Power output is rated at 120 watts PEP for both SSB and CW, and 30 watts for AM. The transmitter employs a pi network to enable matching into 40-80 ohm antenna systems.

Receiver sensitivity is better than one microvolt for 10-db signal-to-noise ratio. Selectivity, provided by a crystal-lattice bandpass filter, is 2.7 kc at 6 db. A product detector is used for SSB and

BLANKET THE MARKET...

with **OXFORD Transducer**
rear seat **AUTO SPEAKER KITS**

Now, one great line . . . OXFORD TRANSDUCER . . . gives you blanket coverage of the auto rear seat speaker kit field. OXFORD gives you three separate price and value levels the *CUSTOM* line . . . the *DELUXE* line and the *STANDARD* line. In all, there are 11 different speaker kits to choose from.

All kits are designed and engineered to the highest performance standards, to give top satisfaction to you and your customer. Alnico V magnets, and oversize gap clearances, compatible to original automotive equipment used throughout the entire line. Easy to install, no soldering; solderless connectors used on all speakers. Top quality switches and faders throughout the entire line. Wiring harnesses are completely assembled and heavy gauge plastic coated wire are but two of the extra quality features of the entire line. Switches and controls are both fungus and moisture resistant for longer life and trouble-free operation. Complete with all necessary hardware.

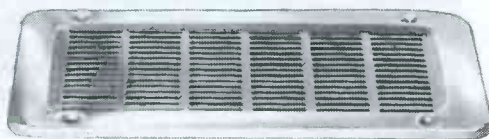

Get the complete story on the OXFORD TRANSDUCER line of 11 different auto rear seat speaker kits . . . and "BLANKET THE MARKET". Write for Catalog A-105:



OXFORD
TRANSDUCER COMPANY

Division of OXFORD ELECTRIC CORPORATION

3911 South Michigan Avenue
Chicago, Ill. 60653

CW reception, and a triode detector for AM. An external linear amplifier can be used with the transceiver.

The 753 is priced at \$179.95 in kit form and at \$299.95 factory-wired—less power supplies and speaker. The power requirements are 750 volts DC at 300 ma, 280 volts DC at 170 ma, —100 volts DC at 5 ma, and 12.6 volts at 3.8 amps.

These voltages are provided by the accessory Model 751 AC supply/speaker console, which is priced at \$79.95 as a kit and \$109.95 wired. The transceiver measures 5 $\frac{3}{16}$ " x 14 $\frac{1}{4}$ " x 1 $\frac{1}{4}$ ".

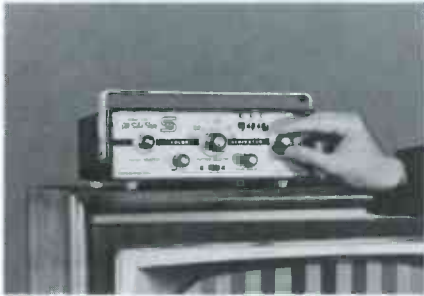

Color-Bar Generator

(63)

Solid-state circuitry eliminates the need for warm-up time in Seco's Model 900 color-bar generator. Instead of conventional oscillator dividers it employs uni-junction-transistor switches as counters for a more uniform square wave. Zener-

Save Time on PC Board Repairs!



Melted solder disappears up hollow tip into tube

The ENDECO Desoldering Iron Removes Soldered Components in seconds... without damage!

Endeco melts solder, then removes it by vacuum • Leaves terminals and mounting holes clean • Resolders too • One-hand operation • Temperature controlled for continuous use • Ideal for use with shrinkable tubing • 4 tip sizes • Quickly pays for itself in time saved • Only \$18.75 net.

SMALLER SIZE AVAILABLE. SEE YOUR DISTRIBUTOR OR WRITE:



ENTERPRISE
DEVELOPMENT
CORPORATION

5151 E 65TH • INDIANAPOLIS, IND. 46220

Circle 39 on literature card

great profits

(small inventory)



Imagine—just 6 Sonotone® crystal cartridges replace 146 models. In micro-miniatures, the Sonotone Micro-Ceramic® series updates to 1965 performance almost any phonograph using a ceramic cartridge produced within the past 20 years.

Replacements in transistor phonographs? The "24T", "27T" and "35T" Micro-Ceramics are the answer. For the world's "safest cartridge," try the "21TR" with its fully retractable, hinged mounting bracket, bottoming button and Sono-Flex® stylus. Replacements in the top-end hi-fi models? The audiophile-accepted Sonotone "ST" series is your best bet. And from the standpoint of customer satisfaction, only Sonotone cartridges are equipped with the virtually indestructible Sono-Flex stylus.

Now the clincher: Sonotone cartridges are direct replacements in more than 15 million phonographs in which they are original equipment.

These are just a few of the reasons you need stock fewer Sonotone cartridges than other brands—and still have the right replacement for just about every phonograph that comes into your shop. For comprehensive cartridge replacement guide, write:

SONOTONE

and o products

Sonotone Corp., Electronic Applications Div., Elmsford, N. Y.
Export: Singer Prods. Co., Inc., N.Y.C., Cable: EXRECNS, N.Y.

Circle 49 on literature card

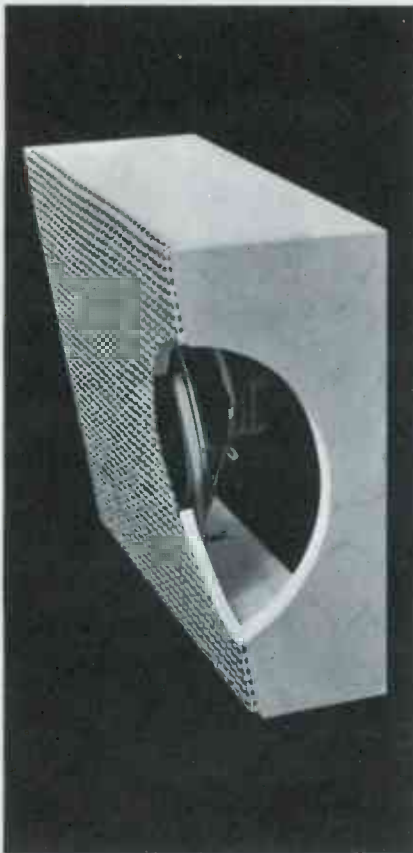

**GET PLUS
PERFORMANCE
FROM
OAKTRON
SPEAKERS**

All Oaktron speakers feature the exclusive Aluminum Voice Coil. This tempered, all aluminum form eliminates warpage from humidity changes and from severe overload. The unique aluminum Voice Coil also provides increased sensitivity and longer speaker life.

A complete range of sizes and styles are available in Oaktron Baffles. Styled in smart furniture finish, Oaktron Baffles feature 1/2" hardwood, double strength interlocking corners, and solid glued and stapled grills.

For complete information, write today for your **FREE** Catalog.



OAKTRON INDUSTRIES, INC., MONROE, WIS.

Circle 51 on literature card

diode regulation in the power supply and crystal-controlled oscillators are included to provide improved stability. The unit includes a tuner that permits the channel frequency to be varied to match that of the receiver.

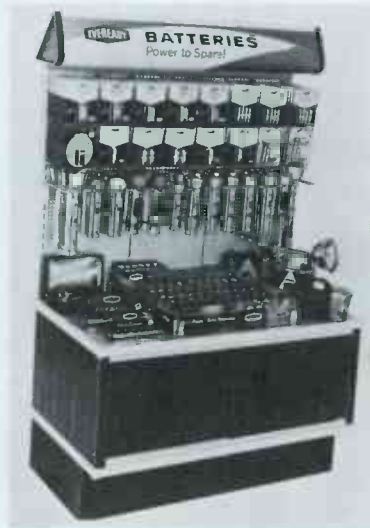

Battery Display

(64)

This steel display unit holds flashlights, lanterns, and batteries, including blister-packed transistor batteries. Union Carbide Corporation's Cordless Corner, No. 1800, is topped by an illuminated sign,

and its entire width beneath the display counter is available as storage space. Each display unit is available free with a suggested order.



Color CRT Test Adapter

(65)

Existing color CRT-test equipment may be converted to test 90° color tubes with this test-adaptor socket. The device, manufactured by **Pomona Electronics**, accepts Motorola 23EGP22, RCA 25AP22, and other color CRT's with miniature diheptal 14BE basing; it also fits those bases equipped with spark gaps. Net price of the Model 2276 is \$5.95.



**ONLY
SENCORE
RUGGEDIZED
EQUIPMENT WILL TAKE
THIS PUNISHMENT**

The boss didn't believe us, so we borrowed his new Cadillac and came to a dead stop on top of one of the new all steel Sencore cases . . . and without an ounce of damage. We wanted to prove once and for all that only Sencore was rugged enough for constant field use. We doubted that you would run over your new Mighty Mite tube tester, CRT checker, solid state color generator, or any of the other fine Sencore time saving testers but we do know that you toss them around plenty . . . all day long. This requires all steel construction. Only Sencore has a complete line of all steel ruggedized testers. Wood and fabric just aren't good enough for today's technician on the go. That's why Sencore is the World's leaders in portable testers.

SENCORE ■ 426 WESTGATE ■ ADDISON, ILLINOIS

Circle 50 on literature card

new SAMS BOOKS

Transistor Etched-Circuit Projects



by James Kyle. The only complete book available on etched-circuit construction for experimenters, hobbyists, and students. Unique, easy-to-use negatives are included right in the book; just clip them out and follow the simple instructions. You can build 30 fascinating projects; each is explained so that you gain a fuller understanding of the principles involved. One chapter also tells

you how to design and photo-etch your own projects; a list of suppliers of materials required for photo-etching is included. The only book of its kind, packed with building fun and valuable instruction. 144 pages; 5½ x 8½". \$2.95
Order TCK-1, only

Second-Class Radiotelephone License Handbook

NEW 3RD EDITION OF THIS AUTHORITATIVE BOOK by Edward M. Noll. This newly revised and completely updated edition of the popular handbook for second-class license holders and aspirants, covers all the latest FCC Rules and Regulations governing this class. Contains all the necessary questions and answers to pass Elements I, II, and III of the current FCC examination for a second-class license. Easy-to-read text serves as a refresher and study guide on communications and two-way radio equipment. 320 pages; 5½ x 8½". \$3.95
Order QAN-2, only

RECENTLY PUBLISHED BESTSELLER

Color TV Training Manual, New Second Edition

by C. P. Oliphant & Verne M. Ray. This newly revised comprehensive manual is the most up-to-date guide available for technicians preparing to service color TV receivers. Full information on: Colorimetry; Requirements of the Composite Color Signal; Make-up of the Color Picture Signal; RF and IF Circuits; Video, Sync & Voltage-Supply Circuits; Bandpass Amplifier, Color-Sync and Color-Killer Circuits; Color Demodulation; Matrix Section; Color Picture Tube & Associated Circuits; Setup Procedure; Aligning the Color Receiver; Troubleshooting. Includes full-color illustrations invaluable for setup, alignment, and troubleshooting. 224 pages; 8½ x 11". \$5.95
Order TVC-2, only

How to Build Proximity Detectors & Metal Locators

by John Potter Shields. Now—a how-to-do-it book for experimenters and students showing how to build various types of proximity detectors and metal locators. Easy-to-build low-cost projects demonstrate the principles and applications of these devices; includes the Theremin, a musical proximity detector. Projects progress from the very simple to the more complex devices; each is accompanied by illustrated assembly instructions and a complete list of parts required. 128 pages; 5½ x 8½". \$2.50
Order PDS-1, only

ABC's of Silicon Controlled Rectifiers

by Allan Lytel. An introduction to an important new electronic development—silicon controlled rectifiers (SCR). These solid-state devices are capable of switching currents on and off thousands of times per second. Explains the principles of SCR operation; discusses types of input signals required and how they may be obtained using capacitors, unijunction transistors, and saturable reactors. Outlines phase-shift control of a-c and d-c power. Includes typical SCR circuits and applications (as in light dimmers); describes many other uses which formerly required bulky mechanical or electron tube components. 128 pages; 5½ x 8½". \$1.95
Order CRL-1, only

HOWARD W. SAMS & CO., INC.

Order from your Sams Distributor today, or mail to Howard W. Sams & Co., Inc., Dept. PF-12, 4300 W. 62nd Street, Indianapolis, Ind. 46206

Send me the following books:

- TCK-1 TVC-2 CRL-1
 QAN-2 PDS-1

Send FREE Sams Booklist. \$_____ enclosed

Name _____

Address _____

City _____ State _____ Zip _____

My Distributor is _____

INDEX TO ADVERTISERS

DECEMBER, 1965

A. T. & T.	12
Antennacraft Co.	48
Antenna Specialists Co.	22
Belden Mfg. Co.	28
Blonder Tongue Labs	57
Busmann Mfg. Div.	21
Castle TV Tuner Service	15
Channel Master Corp.	34, 35
Chemtronics, Inc.	73
Cleveland Institute of Electronics	65
Delco Radio Div.	25
EICO Electronic Instrument Co., Inc. Cover 2	
Enterprise Development Co.	71
Finney Co.	13
General Electric	46, 47
Harmon-Kardon	69
Jackson Electrical Instrument Co.	43
Jerrold Electronics	51, 53
Johnson, E. F. Co.	45
Kay-Townes Antenna Co.	56
Lectrotech, Inc.	51
Littelfuse, Inc.	Cover 4
Magnavox	54
Mercury Electronics Corp.	29
Multicore Sales	52
Oaktron Industries, Inc.	72
Ohmite Mfg. Co.	52
Oxford Transducer Co.	70
Philco Corp.	36
Planet Sales Co.	56
Precision Tuner Service	43
Quality Tuner Service	45
RCA Electronic Components and Devices	59, Cover 3
RCA Sales Corp.	49
Sams, Howard W. & Co., Inc.	63, 73
Sarkes Tarzian, Inc.	9
Seco Electronics, Inc.	62
SENCORE, Inc.	44, 58, 60, 64, 67, 70 72
Sonotone Corp.	71
Sprague Products Co.	11
Standard Kollsman Industries, Inc.	41
Switchcraft, Inc.	52
Windsor Electric Co.	66
Winegard Co.	42, 73
Workman Electronic Products, Inc.	54
Xcelite, Inc.	14
Zenith Radio Corp.	61

Winegard

Dealer of the month

No. 43 of a series

Jim Frantz says, "Our thanks go to the Winegard Co. for developing what we believe to be the finest antenna line available."



Winegard salutes Frantz Antenna Service, Doylestown, Pennsylvania.

It wasn't by chance that Frantz Antenna Service found Winegard products to be the best in the business. Jim Frantz says, "We tried all the new antennas from all the major manufacturers, giving each one the same tests, and from our results we picked Winegard over the rest. With Winegard, we are always confident that we've done the best job possible in delivering the best TV reception in both color and black & white, even in difficult reception areas."

Jim added that he also appreciates the fact that whenever he runs into a particularly troublesome problem, he can count on receiving fast assistance from an expert Winegard representative.

The confidence Jim Frantz has shown in Winegard comes from installing Winegard products and seeing them in action. He is one more important service dealer who knows Winegard's standards of excellence first hand.

Winegard Co.

Antenna Systems

3000 Kirkwood • Burlington, Iowa

Circle 54 on literature card

December, 1965/PF REPORTER 73

**BLACK/WHITE
OR
COLOR**

**THE ONLY SAFE NON-DRIFT
TV TUNER
CLEANERS**

AVAILABLE AT ALL DISTRIBUTORS

CHEMTRONICS

BROOKLYN, N. Y. 11236

Circle 53 on literature card



FREE Catalog and Literature Service

*Check "Index to Advertisers" for further information from these companies.

Please allow 60 to 90 days for delivery.

ANTENNAS & ACCESSORIES

75. **ALLIANCE** — Colorful 4-page brochure describing in detail all the features of *Tenna-Rotors*.
76. **ANTENNACRAFT**—Literature featuring 3 new 75-ohm, all-channel TV antennas available in factory-built or kit form.*
77. **BLONDER-TONGUE** — Booklet titled "How to Plan a Home TV System" containing information on required components and cable with diagrams of actual systems. Written for both homeowner and technician.*
78. **FINNEY** — Catalog 20-337 covering U-Vert series UHF converters and catalog 20-338 on Model 65-1 distribution amplifier.*
79. **JERROLD** — Colorful six-page brochure describing and explaining coax, matching transformers, and antenna amplifiers.*
80. **JFD**—Literature on complete line of log-periodic antennas for VHF, UHF, FM, and FM stereo. Brochure showing converters, amplifiers and accessories; also complete '64-'65 dealer catalog plus dealer wall chart of antenna selection by area.
81. **STANDARD KOLLSMAN** — Catalog sheet on Model TA transistorized UHF converter and transistor converter kit.*
82. **TRIO**—Brochure on installation and materials for improving UHF transistor reception.
83. **WINEGARD** — 12-page brochure "Color Spectacular" featuring antenna products designed for color TV use.*
84. **ZENITH**—Information bulletin on antennas, rotators, batteries, tubes, power converters, record changers, picture tubes, wire, and cable.*

AUDIO & HI-FI

85. **ADMIRAL** — Folders describing line of equipment: includes black-and-white TV, color TV, radio, and stereo hi-fi.
86. **CINE SONIC** — Data sheets describing rental service which supplies background music prerecorded on 7", 10½", and 14" reels of tape—stereo or mono.
87. **EUPHONICS** — Jumbo 8-page 4-color brochure introducing *Miniconic* semiconductor stereo phono cartridge. This presentation also covers principles and history of disc recording, stereo theory, cartridge design factors, and characteristics of different cartridges.
88. **JENSEN**—Multicolored 24-page catalog 165-L featuring complete line of headphones, speaker systems, and speaker kits.
89. **NUTONE**—Two full-color booklets illustrating built-in stereo music systems and intercom-radio systems. Includes specifications, installing ideas, and prices.
90. **OKTRON**—"The Blueprint to Better Sound," an 8-page catalog of loudspeakers and baffles giving detailed specifications and list prices.*
91. **OXFORD TRANSDUCER**—4-page catalog describing three lines of automobile rear-seat speaker kits.
92. **QUAM-NICHOLS** — Catalog 65 listing replacement speakers for public address systems, hi-fi, auto radio, and radio-TV applications.
93. **ROBINS** Form 851 featuring tape editing workshop and phono-record care kit.

COMMUNICATIONS

94. **EICO**—Data sheet on Model 753 *Tri-band* transceiver and other ham gear, plus full-line catalog.*
95. **E-Z WAY PRODUCTS**—Information on crank-up, tilt-over towers for amateur radio, Citizens band, and industrial communications.

96. **GENERAL RADIOTELEPHONE** — Operation and instruction manuals on BB-10 and BB-30 business radios, MC-7 and MC-8 CB transceivers, and SB-72 single-sideband receiver.
97. **E. F. JOHNSON**—Information on Citizens band, industrial radio, and radio-paging communications equipment.
98. **MOSLEY ELECTRONICS** — Catalog covering complete 1966 line of Citizens-band equipment.
99. **PEARCE-SIMPSON** — Specification brochure on IBC 301 business-band two-way radio *Companion II*, *Director*, *Escort II*, *Guardian 23*, and *Sentry* Citizens-band transceivers. "The Modern Approach to Business Communications" concerning land mobile radio service for businessman.
100. **SONAR RADIO**—Specification sheet on Model FM-40 business radio.

COMPONENTS

101. **BUSSMANN**—Bulletin SHF-11 on new waterproof in-the-line fuseholder for use on any circuit of 600 volts or less operating in exposed locations. Two fuseholders are available; one for 13/32"x1½" fuses, another for 13/32"x1¼" fuses.
102. **CENTRALAB**—4-page catalog describing in detail the complete line of miniature electrolytic capacitors.
103. **GC ELECTRONICS** — Cross-reference guide FR-605-G for TV knob replacement; catalog FR-66-TD listing TV antennas and accessories; brochure FR-171-A and catalog FR-66-A covering audio accessories and solid-state modules; also information on test prods, tape and phono drives, and belts.
104. **LITTELFUSE** — New circuit-breaker cross-reference brochure.*
105. **ONEIDA**—New catalog pages listing line of hardware, switches, resistors, and other replacement components.
106. **SONOTONE**—Technical brochure RA-112 describing sealed nickel-cadmium batteries.*
107. **SPRAGUE** — Latest catalog C-616 with complete listing of all stock parts for TV and radio replacement use.*
108. **SWITCHCRAFT**—Product bulletin No. 155 describing a push button that lights without a lamp or power supply. Mounts on any push-button switch plunger with .050"x.187" dimensions.*
109. **TRW**—General catalog No. 166 covers all standard capacitors offered by company. Technical information on tolerance, reliability, and other characteristics of capacitors.

SERVICE AIDS

110. **CASTLE**—How to get fast overhaul service on all makes and models of television tuners is described in leaflets. Shipping instructions, labels, and tags are also included.*
111. **ELECTRONIC CHEMICAL** — Catalog sheet describing aerosol cleaners for electrical contacts, volume controls, and tape heads.
112. **PRECISION TUNER**—Literature supplying information on complete low-cost repair and alignment services for any TV tuner.*
113. **RAWN** — Detailed instruction sheets on TV knob and plastic repairs with *Plas-T-Pair*.
114. **WALLIN-KNIGHT**—Folder on Reflect-O-Scope, a tool for static convergence of color TV receivers.
115. **YEATS**—The new "back-saving" appliance dolly Model 7 is featured in a four-page booklet describing feather-weight aluminum construction.

SPECIAL EQUIPMENT

116. **ATR** — Descriptive literature on selling new all-transistor *Karadio* Model 707, having retail price of \$29.95. Other literature on complete line of DC-AC inverters for operating 117-volt PA systems and other electronics gear.
117. **GREYHOUND** — The complete story of the speed, convenience, and special service provided by the Greyhound Package Express routes.
118. **PERMA-POWER** — Four-page catalog, GB281, illustrating solid-state garage-door operator using pulse tone modulation.

TECHNICAL PUBLICATIONS

119. **CLEVELAND INSTITUTE OF ELECTRONICS**—Free illustrated brochure describes electronic slide rule and four-lesson instruction course and grading service.*
120. **GRANTHAM**—Catalog describing home-study and resident courses in electronics leading to job objectives, FCC license, and ASEE degree.
121. **HOWARD W. SAMS** — Literature describing popular and informative publications on radio and TV servicing, communications, audio, hi-fi, and industrial electronics, including special new 1966 catalog of technical books on every phase of electronics.*
122. **RCA INSTITUTES** — 64-page book, "Your Career in Electronics" detailing home study courses in telecommunications, industrial electronics, TV servicing, solid-state electronics, and drafting. Preparation for FCC license, and courses in mobile communications and computer programming also available.*

TEST EQUIPMENT

123. **B&K**—New 1966 catalog featuring test equipment for color TV, auto-radio, and transistor radio servicing, including tube testers designed for testing latest receiving tube types.
124. **HICKOK**—New 1965-66 short-form catalog listing test equipment for radio and TV servicing.
125. **JACKSON**—New 8½" x 11" catalog listing full line of test equipment.*
126. **LECTROTECH**—Bulletins on Metergards, Lectrocells, V-6 and V-7 color-bar generators, CRT-100 picture tube analyzer, and Model U-75 UHF translator.*
127. **MERCURY**—Folder supplying information on complete line of test equipment.*
128. **SECO**—Catalog sheet No. 90065 describing Model 900 color-bar generator and Models 88, 98, and 107B tube testers.*
129. **SENCORE**—Latest information on TC-136 tube tester and SS137 sweep-circuit analyzer.*
130. **SIMPSON** —Flyer giving specifications of Model 604 Multicorder for measuring and recording volts, amps, milliamps, and microamps.
131. **TRIPLETT** — Complete information on burnout-proof VOM Model 630-PLK.
132. **WATERMAN**—Technical data on OCA-11B industrial oscilloscope.
133. **WORKMAN**—Information on transistor-diode checker using a transistorized audible signal with self-contained oscillator circuit.*

TOOLS

134. **ARROW**—Catalog sheet describing uses, prices, and construction features for staple guns.
135. **ENTERPRISE DEVELOPMENT** — Time-saving techniques in brochure from Endeco demonstrate improved desoldering and resoldering techniques for speeding and simplifying operations on PC boards.*
136. **XCELITE**—Product bulletin on two new pocket-size screwdriver sets designed to simplify assembly and service work involving Scrulox recess screws.*

TUBES & TRANSISTORS

137. **SEMITRONICS**—8-page semi-conductor replacement and interchangeable guide, featuring exact replacements for almost 5,000 semi-conductors.

USE THE HANDY CARD BELOW TO OBTAIN FREE CATALOGS & LITERATURE

As a service to its readers, PF REPORTER makes this postpaid card available for your convenience in obtaining current manufacturers' literature.

To use the card simply:

- Circle the numbers corresponding to the numbers of the items appearing either on page 74 or in the "Product Report" department.
- Print your name and address and check your occupation in the spaces provided.
- Tear out lower half of this insert and place in mailbox.

Note the deadline date — Requests received after this cannot be handled.

Subject Index on Reverse Side

DECEMBER, 1965

Please indicate number of items you have circled →

OFFER EXPIRES FEBRUARY 1, 1966

1	2	3	4	5	6	7	8	9	10	11	12	13	14	15	16	17	18	19	20	21	22
23	24	25	26	27	28	29	30	31	32	33	34	35	36	37	38	39	40	41	42	43	44
45	46	47	48	49	50	51	52	53	54	55	56	57	58	59	60	61	62	63	64	65	66
67	68	69	70	71	72	73	74	75	76	77	78	79	80	81	82	83	84	85	86	87	88
89	90	91	92	93	94	95	96	97	98	99	100	101	102	103	104	105	106	107	108	109	110
111	112	113	114	115	116	117	118	119	120	121	122	123	124	125	126	127	128	129	130	131	132
133	134	135	136	137	138	139	140	141	142	143	144	145	146	147	148	149	150	151	152	153	154
155	156	157	158	159	160	161															

Print plainly or type below

Name _____

Firm _____

Firm Address _____

City _____

Zone _____

State _____

Did you receive this issue through

Distributor Subscription

Please check business

classification:

Independent Radio, TV Serv-

iceman

Full time Part time

Retailer with Service Depart-

ment

Industrial Electronics Service

Owner or Manager

Service Manager

Employee

Other (Specify occupation and title)

Subscription Offer

Enter my subscription to PF REPORTER

3 Years \$10.00 2 Years \$8.00 1 Year \$5.00

Bill Me Remittance Enclosed

Extend Present Subscription

BOOK REVIEW

Handbook for Electronic Engineers and Technicians 45

RADIO

Alignment, front-end
Oscillator quits above 900 kc
(Ford Model 74BF) TS 65
..... TS 65

BUSINESS

Accountant
—bookkeeping methods 32
—services offered 33
Records, importance of keeping 32

TELEVISION

Convergence problem CCM 67
Horizontal bends TS 66
Intermittent troubles
—heat-sensitive components 27
—soldering iron to locate 27
—troubleshooting 26
Sync trouble 43

COMMUNICATIONS

Two-way radio
—microphones used with 24
—noise reducing in 23
—overmodulation 24
—receiver troubles 24

UHF

—antenna considerations 16
—color reception 58
—Peoria story 16
Vertical sync weak TS 66

COMPONENTS

Guide to fusible resistors 55

TEST EQUIPMENT

Multiplex Generator, EICO Model 342 48

GENERAL SERVICING

Square-wave tests
—differentiator circuits 19
—integrator circuits 19
—RC networks 20
PC boards
—component location 30
—test-point location 30

SYMFACT®

Sync separator/AGC 37
(Note: Code letters TS and CCM indicate
The Troubleshooter and Color Counter
measures, respectively.)

FIRST CLASS

PERMIT No. 1076

Indianapolis, Ind.

BUSINESS REPLY MAIL

No Postage Necessary If Mailed in the United States

POSTAGE WILL BE PAID BY—

Reader's Literature Service Dept.

PF REPORTER

4300 WEST 62ND STREET
INDIANAPOLIS, IND. 46206

Indispensable!

*The brand-new
RCA RC-24
receiving tube
manual*

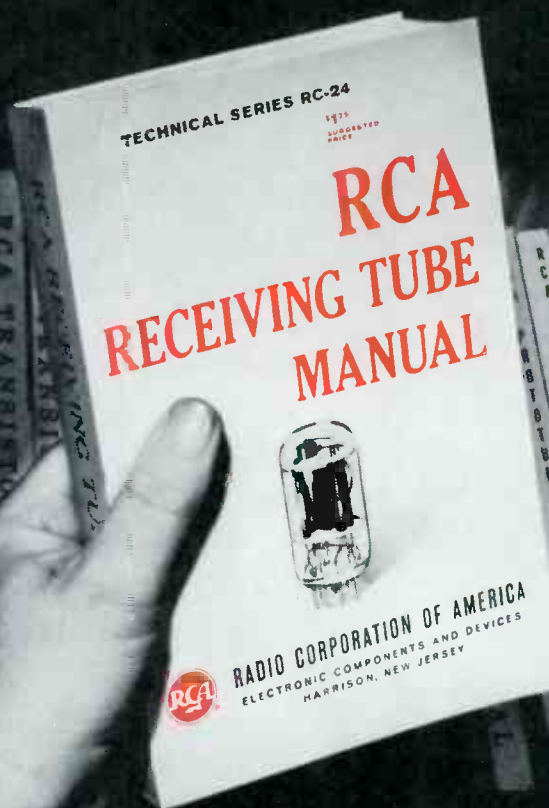

*Complete-authoritative
A must in every
technical library
A must on every work bench
More compact and easier
to read than ever before*

Technical design and applications data on more than 1200 receiving tubes. Check these NEW features and improvements not included in previous editions:

- ✓ Additional data on 100 new tube types
- ✓ Revised circuits section with new, simple format
- ✓ Updated picture tube characteristics chart
- ✓ Revised and updated Applications Guide
- ✓ New tube index section for ready reference
- ✓ Data section on active types only. (Discontinued and replacement types appear in a separate section.)
- ✓ Additional text material on TV in the tube applications section

Everyone concerned with electronics needs this manual... service technicians, engineers, radio amateurs and hobbyists. Order yours today from your nearest Authorized RCA Distributor.

Only \$1.25*
*Suggested Price

RCA Electronic Components and Devices, Harrison, N.J.



The Most Trusted Name in Electronics

EXACT REPLACEMENT direct from factory to you

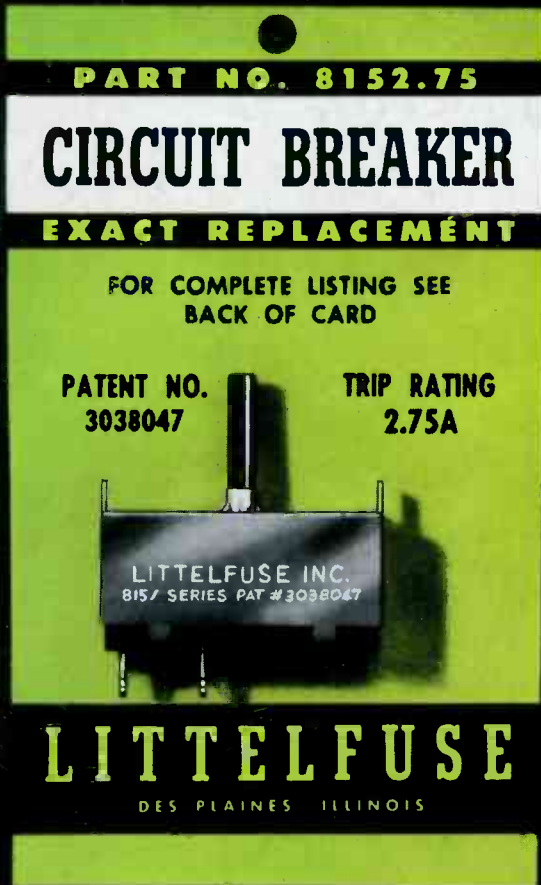

packaged
for your
particular needs



Complete range of high quality circuit breakers to cover every replacement need, packaged for your convenience individually on a display card or 5 per box.

Also, available in 10 card assortment (9 separate ratings) or 10 breakers per unit box (9 separate ratings).

LITTELFUSE

DES PLAINES, ILLINOIS

Circle 57 on literature card