

JUNE, 1964

50 CENTS



PHOTOFACT **PF REPORTER**

PHOTOFACT

including **Electronic Servicing**

A.C. transistor sym

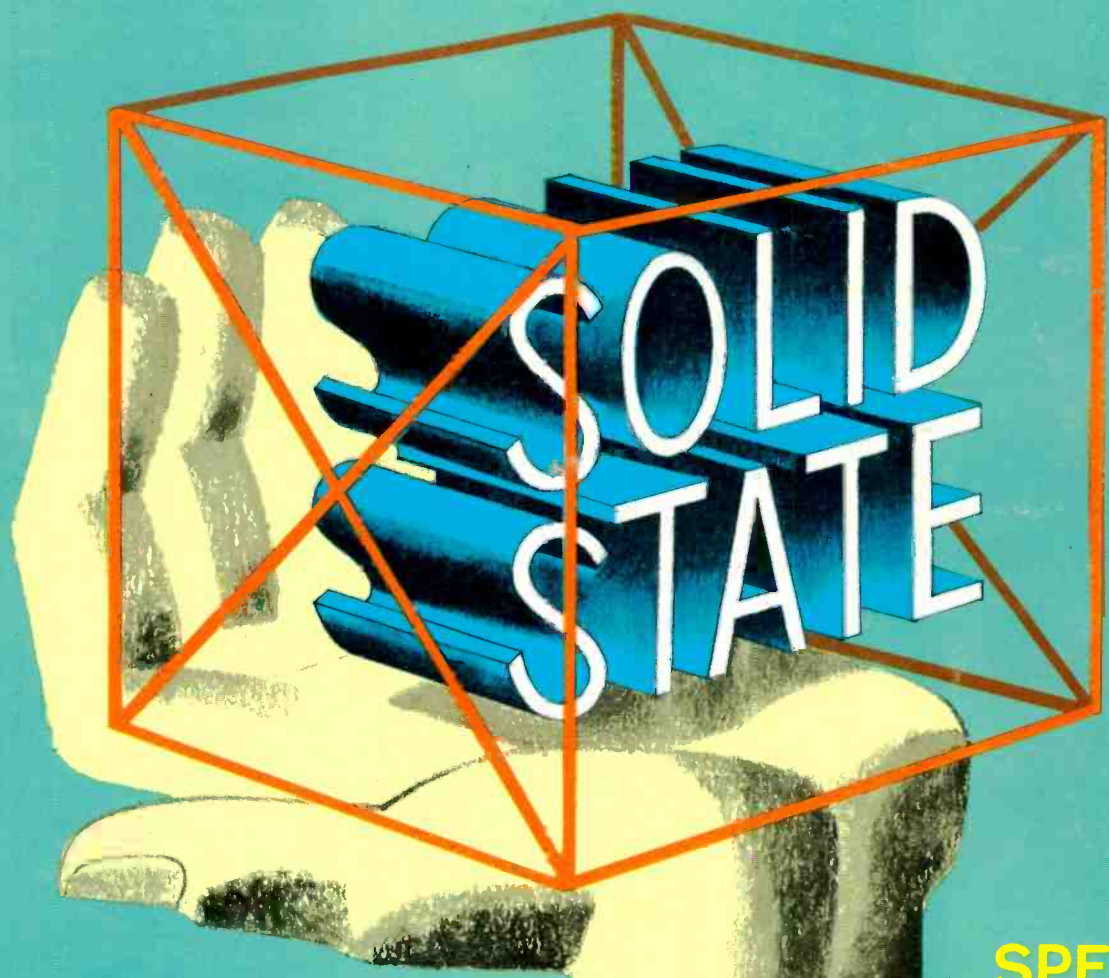

SPECIAL ISSUE

also Scoping in
Transistor Radios

Industrial Semi-
conductors at Work

Field-Effect Transistor

ETDREB, PA.
BOX 148
EMERSON RADIO SERV.
R. F. EYARREN
1A OF 122 507

Cash in on a natural!

A Hot Item, A Receptive Market, Top Profit



VERBA-MATIX *The Prestige* Auto-Radio Reverberation System

Exclusive Gyro-Balanced Suspension Eliminates "Bump Boom"

More QUALITY, more FEATURES, more VALUE and more PROFIT FOR YOU

Reverberation Systems are the fastest selling electronic automotive accessories this year. They're even standard option on all cars of the Big 3. Cash in now by selling the one Reverberation Package that offers you and your customer the most!

A handsomely packaged, quality system... only VERBA-MATIX has all these features...

- 4 Transistors ● Heavy 7 oz. Ceramic-Magnet Speaker
- Complete Control Panel (with Reverb % Control)
- No Drilling, No Screws—Unbelievably Simple Installation
- Fits All Cars, Neg. or Pos. Ground (12 volt) . . . All Speakers, 2 to 40 ohms ● No Noise When Driving Over Bumps.

Here's how it works: VERBA-MATIX electronically delays signal to rear speaker, creating exciting stereo effects never before possible in an automobile. AND—you have complete control over percentage of reverberation at all times!

Complete system includes: Dual-control panel, a 4 transistor amplifier, 6 x 9" rear speaker, deluxe speaker grille, mounting kit and complete instructions.



kinematix, inc.

2040 W. WASHINGTON BLVD., CHICAGO, ILLINOIS 60612 • AREA CODE 312 • 666-0066

Distributors: Phone collect when ordering or calling for prices and information

Manufacturers of
the amazing IMPUL.
World's fastest
selling Wireless
FM Microphone.



Circle 1 on literature card

www.americanradiohistory.com

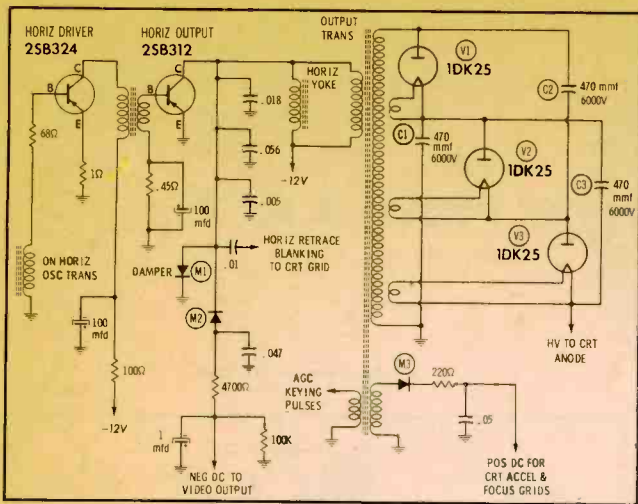

Fig. 3. Transistorized horizontal sweep and high-voltage circuits.

the line-cord is inserted into a special socket on the battery pack. The rectifier then supplies DC to the battery, and an ammeter is switched into the battery circuit to indicate when charging is completed. The alkaline storage battery used in this set provides a playing time of approximately 5 hours, after which a 10-hour recharging period is necessary.

Horizontal Sweep—High Voltage

The transistorized horizontal sweep system is an adaptation of the familiar flyback circuit. At the end of each scanning line, the horizontal output stage is cut off—interrupting the current through the flyback transformer and yoke. The flyback circuit is tuned so that it will generate a large spike of voltage in response to cutoff, and this spike is utilized as an input for the high-voltage rectifier. The retrace pulse tends to set up oscillations in the flyback system, but these oscillations are damped so that the stored energy in the circuit is gradually released. The decreasing current through the yoke results in practically linear horizontal sweep over the left half of the screen.

The current through the horizontal output stage is several times as great as in a tube circuit. (The special high-frequency power transistors used in horizontal sweep applications have current ratings similar to those of auto-radio output transistors.) However, the voltages and resistances in the horizontal sweep section are much lower in transistorized circuits than in tube circuits; this promotes simplicity in design and troubleshooting. The flyback pulse generated at the collector of the horizontal output transistor measures only about 100 volts peak-to-peak; therefore, ordinary test equipment can safely be used to check all points in the circuit except the high-voltage rectifier.

In a typical output stage (Fig. 3—also from the *Mitey-5*), the flyback transformer and the horizontal windings of the yoke are connected in parallel between the main DC source and the collector of the transistor. Thus, the collector load consists mainly of inductance, and the desired sawtooth wave of current through the yoke can be obtained by applying a square

pulse of voltage to the transistor. In this specific circuit, the transistor is “gated off” at retrace time by a positive pulse at the base. During the rest of the cycle, the signal holds the base at a slightly negative voltage; this small forward bias is sufficient to keep the transistor conducting at saturation.

A substantial current must flow in the low-impedance base circuit of the output stage, as well as in the collector circuit. To provide adequate input signal current without loading the oscillator stage, an intermediate circuit (commonly called a *driver*) serves as a power amplifier for the oscillator signal. The retrace pulse from the oscillator may force the driver transistor either into conduction (as in the circuit of Fig. 3) or into cutoff. In the latter case, an “inductive kick” may produce a peak pulse voltage several times greater than the supply voltage at the collector of the driver transistor. The driver transformer, an impedance-matching type, usually delivers from 5 to 10 volts peak-to-peak to the base of the output stage.

During the latter part of each scanning cycle, as the PNP output transistor in Fig. 3 conducts, current passes up through the yoke and transformer windings from the -12 volt source. Following the retrace spike, the direction of current reverses; a gradually decreasing current flows up through the damper diode M1 and down through the yoke and output transformer. Unlike a tube, the horizontal output transistor comes out of cutoff just after the retrace pulse ends, and it provides a secondary current path in parallel with the damper. (In transistors, some conduction in the emitter-collector circuit is possible in the reverse direction from normal.)

The collector circuit of the output stage includes one or more capacitors for tuning the flyback system to establish the correct retrace period and pulse amplitude.

Transistorized horizontal sweep systems include at least two auxiliary circuits (besides the HV rectifier) that supply high DC voltages to other points in the set. Although these have the same general function as the boost circuit in a tube TV, they are not boost sources in the strict sense of the word; they merely rectify samples of the flyback pulse. Since they are not required to generate an operating voltage for the horizontal output stage, and since they place only a light load on the flyback, they have comparatively little interaction with the rest of the sweep circuit.

The need for these extra voltage sources is dictated almost entirely by the demands of the cathode-ray tube. CRT types used in transistor sets can operate at somewhat lower voltages than in tube sets, but these voltages are still far above the level of most transistor circuits. Two specific voltages are needed:

1. Operating potentials for the accelerating and focusing grids, of the CRT. Always positive, this supply voltage is usually 100 to 250 volts DC.
2. Collector-supply voltage for the video output transistor, high enough to permit signal-voltage fluctuations of 25 to 50 volts across the collector load. The supply voltage is usually 50 to 100 volts, and may be either positive or negative—depending on the design of the video stage.

Rather than to use special semiconductor diodes in the high-voltage rectifier circuit, manufacturers of present transistor TV's are choosing to use two or three subminiature tubes in a voltage-multiplier arrangement. As in ordinary TV sets, filament power for the HV tubes is obtained from extra windings on the flyback transformer. Output voltages range from 5 to 10 kv.

The high-voltage rectifier in several transistorized models is basically a voltage tripler. However, the input is not a symmetrical waveform, as would be required for a true “tripling” action; on the other hand, neither is it a simple positive spike. The waveform contains damped oscillations in addition to the spike, and the negative peaks of these oscillations can be rectified to produce greater output than from simple half-wave rectification of the positive pulses.

In Fig. 3, tubes V1 and V3 are driven into conduction on the large positive flyback pulses, while V2 conducts on negative swings of the waveform coupled to its cathode via C2. All three capacitors C1, C2, and C3 are kept charged to a level that results in a DC output voltage of more than twice the value of the AC input voltage.

A different HV circuit, from Sony Model 8-301W (Fig. 4), is a full-wave doubler using only two tubes. The input waveform at terminal 7 of the flyback contains a strong negative-going spike that drives V1 into conduction. The active

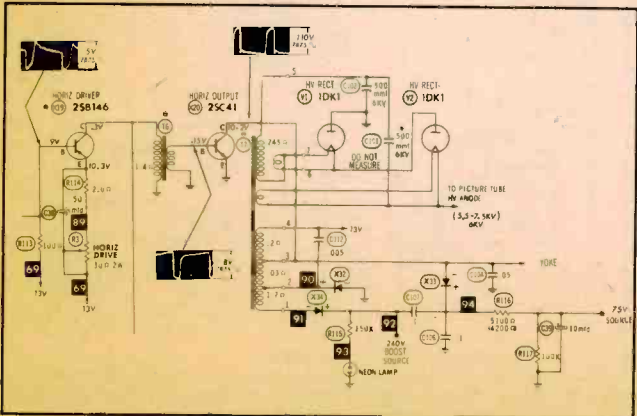

Fig. 4. NPN horizontal output stage driving a bridge HV rectifier.

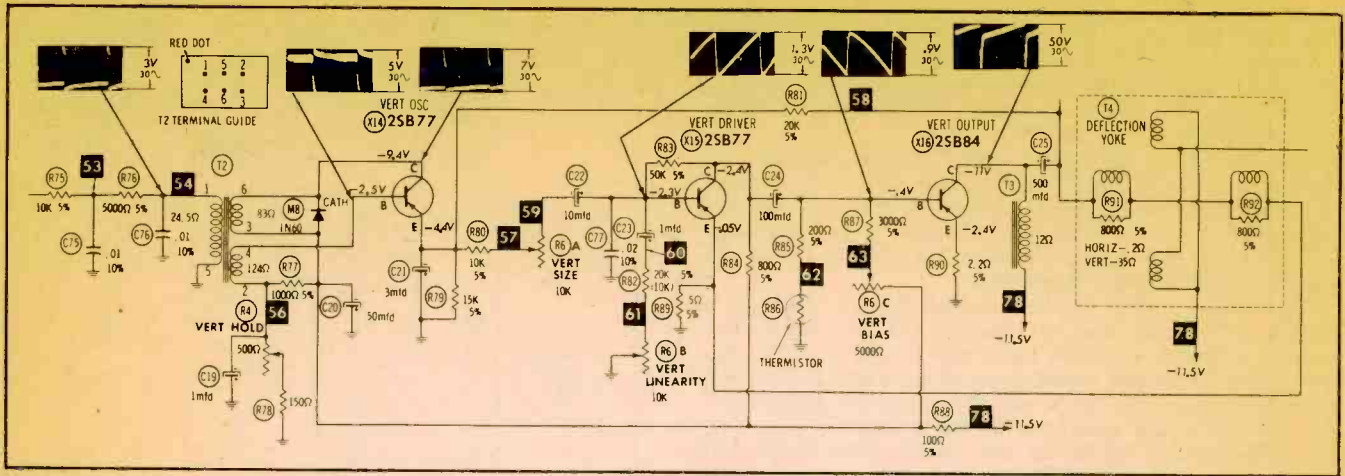

Fig. 7. Typical vertical sweep system in Sharp Model TRP 804 contains three distinct stages.

this is the most widely used arrangement in transistorized horizontal circuits.

Vertical Sweep

The stage lineup is usually the same in the vertical sweep section as in the horizontal section: blocking oscillator, driver, and power output. Typical circuitry—from Sharp Model TRP-804—is shown in Fig. 7.

The circuit of X14 oscillates by means of feedback from collector to base. Conduction lasts for only a small fraction of each cycle (marked by positive pulse at collector and negative pulse at emitter); current through the transistor is rapidly stopped by blocking of the base. The stage remains cut off until the blocking bias has been dissipated (or until a sync pulse arrives). The vertical hold control, as in a tube circuit, regulates the discharge rate of the bias network and thus sets the free-running frequency of the oscillator.

A sync signal is coupled into the oscillator circuit by way of a tertiary winding on blocking transformer T2. Inverted by T2, the sync pulse is negative at the base. Diode M8 across the collector winding of T2 limits the negative-going inductive spike produced by cutoff of the transistor; this not only protects the transistor from damage, but also minimizes the feedback of unwanted pulses into the sync circuit.

The transistorized vertical sweep system requires a sawtooth-shaped drive voltage, because its load circuit contains a significant amount of resistance in proportion to its low inductance. Accordingly, in Fig. 7, the conduction pulse of the oscillator is converted to a sawtooth wave by the RC circuit R79-C21 at the emitter of X14. Conduction of the transistor charges C21 (top plate negative); then, while the transistor is blocked, the capacitor discharges through R79.

The signal current applied to driver transistor X15 is adjustable by means of VERT SIZE control R6A. The wave-shape can be modified with VERT LINEARITY control R6B, part of an RC filter in the base circuit of the driver. Another factor in linearity correction is the feedback from the yoke circuit to the emitter of X14 via R81. In addition, note that R89 serves as a ground return for both the emitter of X15 and the low side of the yoke, thereby offering another feedback path.

Output transistor X16 is a power type with a "diamond"-style case. The base-bias voltage divider includes a control for bias adjustment, as well as a thermistor to make automatic bias corrections in case of temperature changes. The output stage is capacitively coupled to the yoke, because direct coupling would admit enough DC to the yoke coils that severe decentering of the raster would result.

The normal battery potential—slightly under 12 volts—is sufficient for operation of the vertical output stage. The "inductive kick" produced by cutoff of the output transistor is responsible for the 50-volt spike at the collector. This pulse is fed to the grid for vertical retrace blanking, using a coupling circuit very similar to those in tube receivers.

Two-stage vertical circuits have been used in a few transistor TV sets—for example, the Panasonic Mitey-9 (Fig. 8). The oscillator in this set takes over the function of the driver circuit as well; the strength of its output is varied with the height control, which is somewhat similar in function to the horizontal drive control in Fig. 4.

The oscillator operates basically the same as the circuit in Fig. 7, but its output is taken from the collector instead of the emitter. When the transistor conducts, its collector voltage goes less negative than the supply voltage, the three 300-mfd

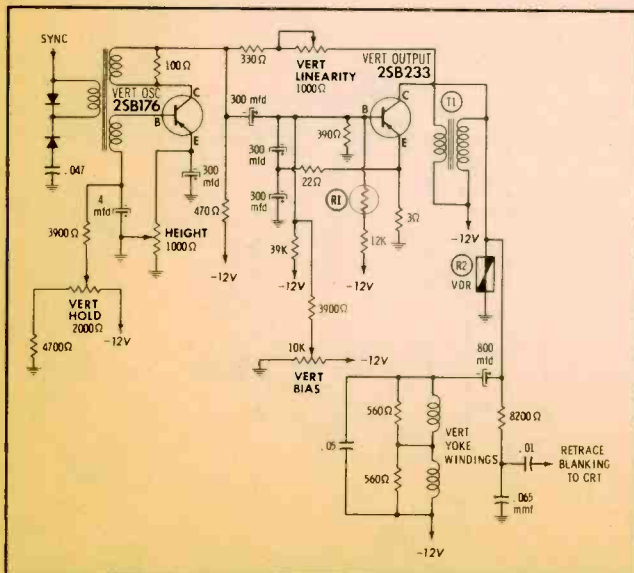

Fig. 8. Two-stage vertical section with complex linearity control.

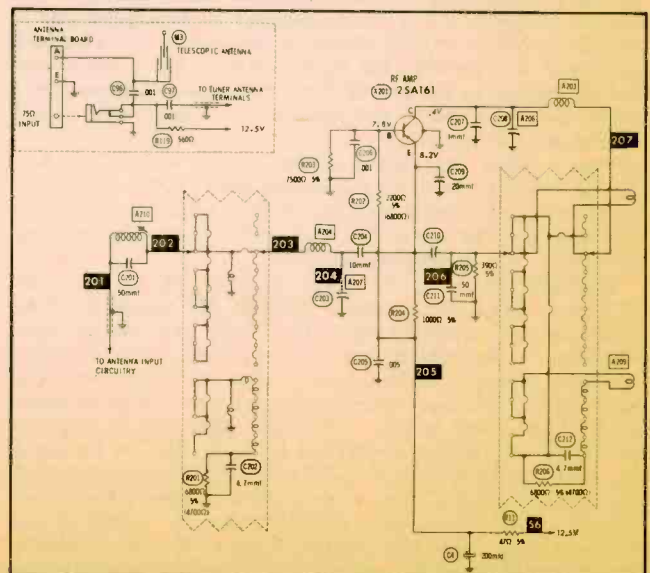

Fig. 9. This common-base RF amplifier is not controlled by AGC.

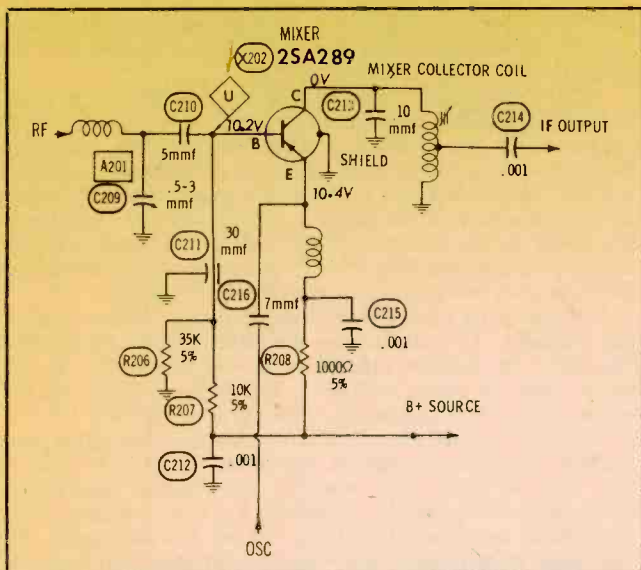

Fig. 10. Transistorized mixer has layout similar to tube circuit.

capacitors are charged, and a rapid positive swing appears in the drive signal. Between pulses of conduction, the capacitors discharge to produce the negative-going slope of voltage needed for proper driving of the output stage. (A gradual, linear increase in collector current is desired.)

A controllable amount of "linearizing" feedback is returned from output transformer T1 to the sawtooth-forming circuit. In addition, there is a feedback path from the emitter to the base circuit of the output transistor, comparable to the cathode-grid feedback network frequently used in tube output stages. For further stabilization, a VDR (voltage-dependent resistor) is included in the output collector circuit, and a form of automatic linearity control is furnished by R1 in the base circuit of the output stage. This component, called a *posistor* by the manufacturer, has a high positive temperature coefficient; it introduces the same type of correction as a thermistor, but in the reverse direction.

Now that we have inspected some representative power-supply and sweep circuits, let's see how transistorized receivers process the TV station signal.

RF Tuner

As a rule, transistorized TV tuners are somewhat smaller physically than their counterparts in tube-equipped sets—but not ultraminiaturized. Most models have three stages (RF amplifier, mixer, and oscillator) using diffused-base or other special high-frequency transistors. There are usually four sets of tuning coils; RF input, RF output, mixer input, and oscillator. Rotating discs, rather than wafers or turret strips, are the predominant type of switch mechanism. One disc, with coils mounted on both sides, is used for each circuit; typical coil arrangements are shown schematically in Fig. 9.

The RF stage shown in this figure (from Sony Model 5-303W) is a *common-base* circuit with signal paths similar to those in a grounded-grid tube stage. Capacitor C206 holds the base at RF ground; the signal enters at the emitter and leaves at the collector. Stray coupling of in-phase signal energy back from collector to emitter tends to cause regeneration; to prevent the circuit from breaking into oscillation, it is neutralized by negative feedback through C210.

This circuit, like several others in commercial use, receives no AGC bias voltage. Large fluctuations in DC operating conditions are thus avoided, and it is easier to maintain proper tuning and stability. (Signal overloading, if it should occur, is corrected simply by adjusting the antenna.)

On the other hand, practical RF-AGC systems have been designed and are being employed in various transistor TV's. The larger Sony receiver (Model 8-301W) has an arrangement peculiarly suited to transistor circuits: The main supply voltage to the RF amplifier is varied slightly by the action of the AGC circuit. This method of operation is workable because the gain of some types of transistors can be varied by means of a change in emitter-to-collector voltage or current, as well as by a change in base-to-emitter bias.

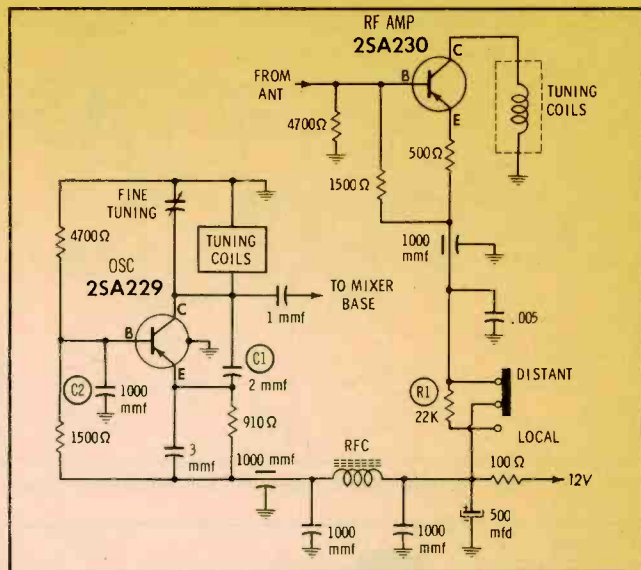

Fig. 11. Oscillator, RF gain-control circuit in transistor TV tuner.

A more familiar type of AGC, utilizing a variable bias voltage on the base of the RF amplifier, is found in some sets. For example, Panasonic receivers use a positive-going AGC voltage to reduce the gain of a common-emitter, PNP-type circuit. Incidentally, common-emitter RF stages are found in more different models of TV sets than are common-base stages. They, too, require neutralization to stabilize their operation; the neutralizing circuits are reminiscent of those in triode tube RF amplifiers.

Another circuit that shouldn't look too unfamiliar is a typical transistorized mixer (Fig. 10). It accepts inputs from the RF and oscillator stages, and the collector circuit is tuned to the difference between the two input frequencies: the IF. In the Sharp circuit shown here, the emitter is the injection point for the oscillator signal; some other tuners have this signal going to the base.

Most transistorized oscillators are of the type presented in Fig. 11. This circuit can be considered as a type of Colpitts oscillator with feedback from collector to emitter; it can also be regarded as a common-base stage in which a natural tendency to regeneration is encouraged by connecting C1 between collector and emitter. C2 shunts VHF signals from the base to ground. The set from which this circuit was taken—Channel Master Model 6565—has an individual oscillator-tuning slug and coil for each high-band VHF channel. Low-band channels have incremental coils with a separate slug to adjust each channel.

Fig. 11 also shows the simple two-set gain adjustment for the RF amplifier of this set. When the LOCAL-DISTANT switch is in

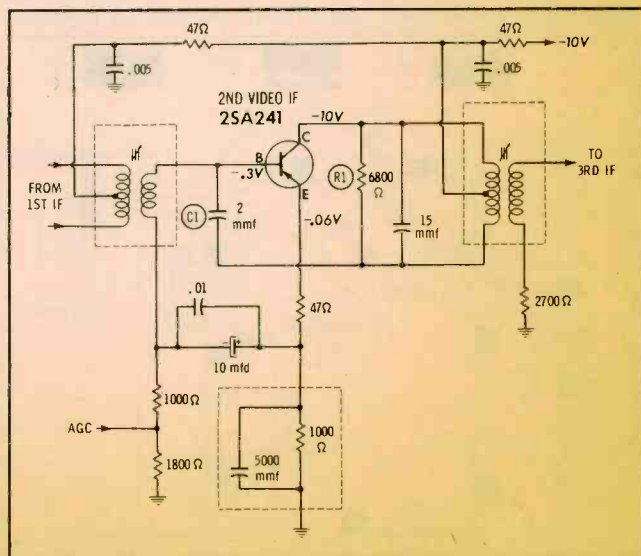

Fig. 12. Primary of the IF transformer is split for neutralization.

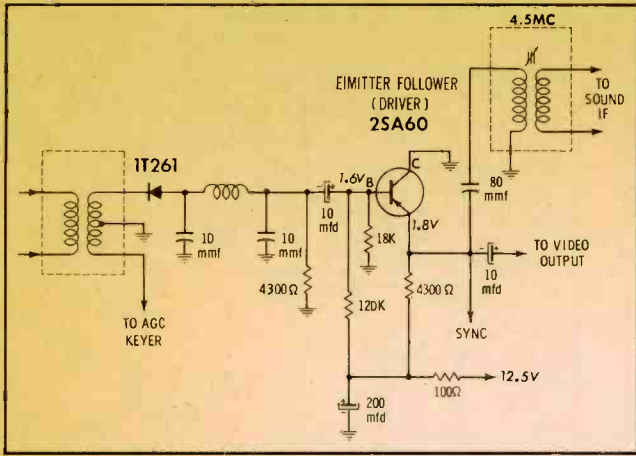

Fig. 13. Video-detector output goes to emitter-follower driver.

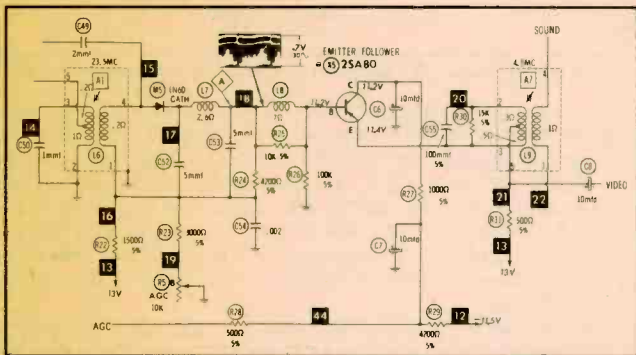

Fig. 14. In this circuit, the emitter follower is also AGC amplifier.

the DISTANT position, the full value of the tuner supply voltage is fed to the emitter of the RF stage. Switching to LOCAL puts R1 in series with the supply lead; this reduces the emitter voltage (and the base voltage in proportion), thus lowering RF gain.

Video IF

Most of today's transistorized sets—even "tinyvision" models—have a four-stage IF strip with PNP transistors. Generally, the first two stages are controlled by AGC. Operating frequencies in the 21-27 mc range are quite common, although some sets have a 41-mc IF. The simpler designs include only one trap, tuned to the sound-carrier frequency within the IF pass band (often 22.25 mc). Other sets have a more elaborate first IF stage that includes adjacent-channel traps.

The signal is ordinarily coupled from stage to stage through single-tuned transformers. Small fixed capacitors are connected

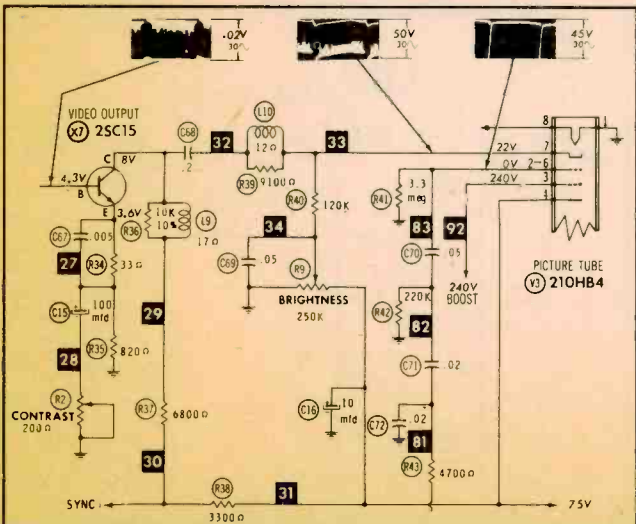

Fig. 15. The video output stage requires unusually high DC supply.

across the primary windings for tuning, and resistors are also shunted across the primaries to broaden the bandpass of the coupling circuits by lowering their Q.

All the IF stages, being high-gain, high-frequency triode amplifiers, require neutralization. This is accomplished in various ways, one of which is diagrammed in Fig. 12. Here, the primary winding of each interstage transformer is tapped, and the tap is connected to the power-supply line. The signal in the lower half of the primary is then opposite in phase to the signal in the collector circuit. When the lower signal is coupled back to the base via C1, it cancels the signal that is fed back from collector to base inside the transistor.

This particular circuit is from the Panasonic *Mitey-5*, which has a negative DC output from the power supply. Some other receivers with positive supplies have very similar IF circuits, except that the supply voltage is fed to the emitter, and the center tap of the transformer primary is grounded.

Although the type of neutralization just described is the most popular in current-production sets, other methods are also in use. For example, the necessary out-of-phase feedback is obtained in Sharp sets by connecting a 5-mmf capacitor from the base of each stage to the base of the previous stage. The interstage transformers have tapped primaries, but only for impedance-matching purposes.

Present designs do not provide for field adjustment of neutralizing networks, since such a procedure is seldom necessary. Alignment techniques are much the same as for tube receivers.

Video Detector and Driver

The video detector in most transistorized TV's is exactly the same germanium-diode circuit found in most tube TV's. The output impedance of this detector, although it is low in comparison with tube circuits, is too high to match the desired input impedance of a transistorized video output stage. To provide the needed isolation between the detector and output, a common-collector *driver* is almost always inserted between these two stages. This extra circuit is also called an *emitter follower* because it serves the same function as a cathode follower tube. The peak-to-peak signal voltage at the emitter is practically the same as at the output of the detector—usually less than 1 volt.

In most cases, the output terminal of the emitter follower also serves as a takeoff point for the sync, AGC, and inter-carrier sound signals. There are various exceptions; for instance, in the Sony Model 5-303W (Fig. 13) a signal is tapped off at the detector transformer to be rectified and amplified by the AGC system.

This set uses capacitive coupling in the video section. Note the large values of capacitance needed to couple the low-frequency components of the video signal through these relatively low-impedance circuits.

The somewhat different arrangement used in the Sharp Model TRP-804 is shown in Fig. 14. The detector produces a sync-positive output signal, something seldom (if ever) seen in tube sets. The demodulated signal is DC-coupled to the

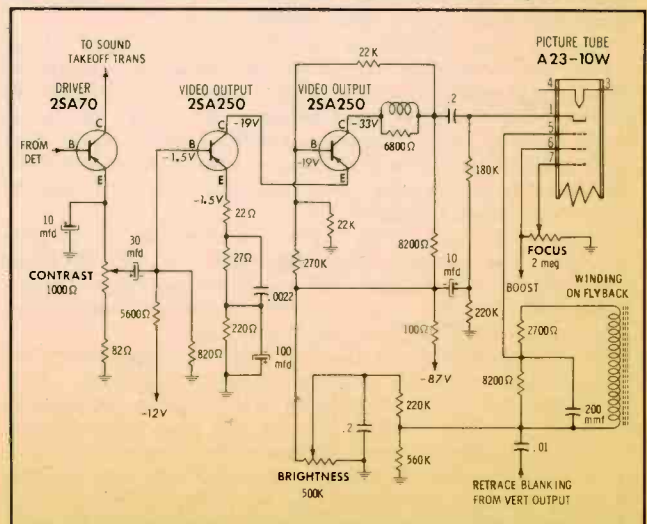

Fig. 16. Cascade video circuit features horizontal retrace blanking.

emitter follower, which also serves as an AGC amplifier. The DC collector voltage, which varies with signal content, is applied to the AGC line. A control in the detector circuit sets the AGC level by varying the bias voltage on the base of the emitter follower. The video output circuit of this receiver consists of two stages.

Video Output and CRT

Of the four signal paths branching out from the video detector-driver circuitry, the path leading to the picture tube will be discussed first.

The small CRT's used in transistor sets are basically scaled-down versions of large picture tubes, and the video drive requirements have not been greatly reduced. Therefore, the video output amplifier must develop a video signal voltage of at least 30 to 50 volts peak-to-peak. Conventional transistor output stages are not well suited to this role, but satisfactory video output stages have been designed using special high-frequency transistors with high breakdown-voltage ratings. As previously mentioned, the exceptionally high DC supply voltage needed by such a stage is obtained by rectifying and filtering horizontal flyback pulses.

The circuit in Fig. 15—from Sony Model 8-301W—is powered by the 75-volt source that was diagrammed in Fig. 4. Note that the collector voltage of output transistor X7 is only 8 volts in the absence of a signal; this means the total voltage drop across collector load resistors R37 and R38 is $(75 - 8)$ or 67 volts. As the collector current is varied by the input signal, the voltage drop in the collector load fluctuates sufficiently to develop the 50-volt output signal shown in the schematic. Power dissipation is only moderate, since the current in this relatively high-impedance circuit is rather low.

Also connected to the 75-volt source is the brightness control, which varies the CRT cathode voltage—just as in a typical all-tube receiver. The rest of the CRT gun circuits, including a vertical retrace-blanking network at the grid, are also quite conventional.

One particular feature not typical of transistorized circuits is the sync takeoff connection in the collector circuit of X7. Most transistor sets use a lower-level sync input signal, taken from an earlier point in the video path.

The emitter circuit of X7 contains the contrast control (a gain adjustment) and a network that helps to broaden the frequency response of the stage. C67 bypasses high-frequency components of the video signal around R34, but presents a higher reactance to low-frequency components. Therefore, R34 introduces some degeneration at low frequencies, to counterbalance high-frequency losses elsewhere in the circuit. Peaking coils in the collector circuit are also used to raise the gain at high frequencies.

Some manufacturers use two transistors in the video output stage. In the Panasonic Mitey-9 (Fig. 16), a pair of PNP units are series-connected across a -87 volt source in a configuration similar to a cascode RF or stacked IF circuit. In this manner, a weak input signal is amplified to a peak-to-peak value of 60 volts.

The contrast control simply varies the proportion of the driver signal fed to the output circuit. The brightness control varies the DC grid voltage on the CRT; it is connected to the grid through a complex circuit that injects both vertical and horizontal retrace blanking pulses. Still another control is provided to adjust the voltage on the focusing anode of the picture tube.

CRT types, designations, and basing arrangements are not standardized to a great degree. Tubes tend to be divided into two general categories based on size: 4½" to 6" in "tinyvision" sets, and 8" to 10" in larger models. One reason for the multiplicity of types is the gradual adoption of square-cornered screens.

AGC System

There are almost as many different approaches to AGC circuit design as there are models of transistor TV receivers. Amplified systems are used, as a rule, and keyed AGC has even been adopted in some sets. Input and output voltages vary over a much smaller range than in tube circuits, in keeping with the generally low operating voltages employed with transistors. As earlier sections of this article have already noted,

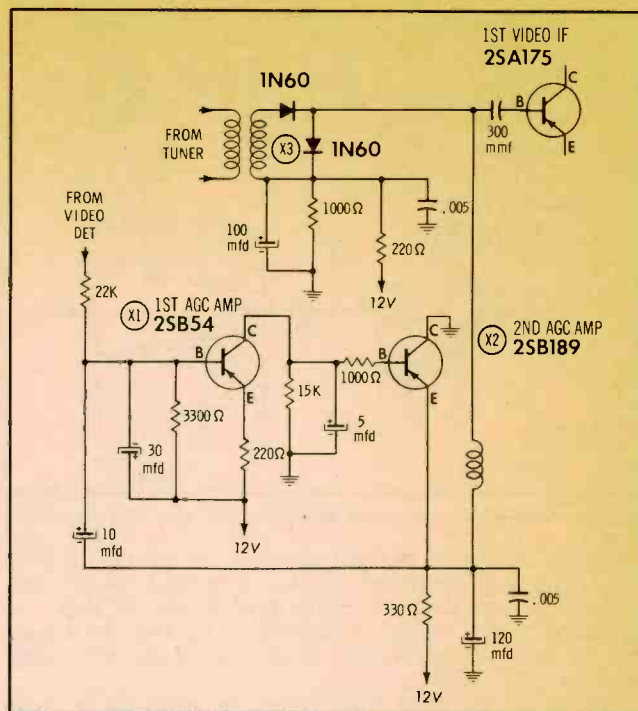

Fig. 17. This amplified AGC circuit has unorthodox control method.

only the first one or two IF stages are AGC-controlled, and AGC to the tuner may be omitted entirely.

In the conventional means of control, the AGC system reacts to an increase in signal strength by decreasing the forward bias between base and emitter of the controlled stages—thereby reducing their gain. The PNP transistors used in most IF strips therefore require a positive-going AGC bias. Occasionally a set will be encountered in which the AGC voltage seems to shift in the wrong direction; this merely means that a different type of control, termed *forward AGC*, is being used. If a rise in AGC output causes an increase in forward bias, the result is an increase in collector current. This causes a greater voltage drop across a resistor in the collector or emitter circuit, and reduces the collector-to-emitter voltage. Certain types of high-frequency transistors respond to such a reduction by decreasing the gain of the stage.

In the simplest type of AGC system, the video driver stage also serves as an AGC amplifier. The circuit of Fig. 14 is one example of this configuration. A more elaborate system (Fig. 17—from the Channel Master Model 6565) includes a two-stage, DC-coupled AGC amplifier. The input voltage from the video detector is highly positive under no-signal conditions, but becomes less positive as signals of increasing strength are applied. X1 is then driven into conduction, and its collector voltage changes in a positive direction. This causes a similar change at the emitter of X2, so that a positive control voltage is fed to the IF strip.

Oddly, this voltage is not used to vary the bias on any IF

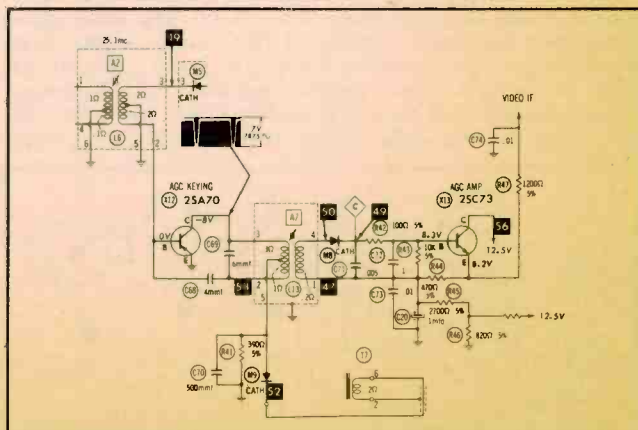

Fig. 18. AGC input is demodulated after passing through keyer stage.

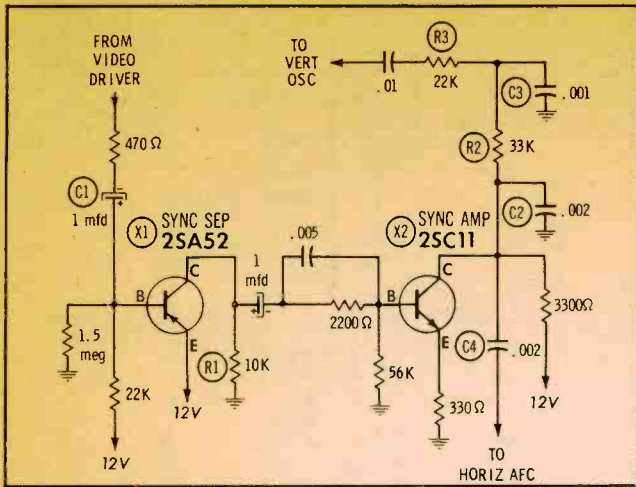

Fig. 19. Two-stage sync circuit uses both PNP and NPN transistors.

amplifier. Instead, it gradually applies a forward bias to diode X3, a damping component, causing it to load the IF input transformer and limit the signal input to the IF strip. No automatic control voltage is furnished to the tuner of this set, but RF gain can be manually adjusted by means of a LOCAL-DISTANT switch (Fig. 11).

One of several keyed AGC systems in actual use is shown in Fig. 18. In the Sony Model 5-303W, a video signal is taken from detector transformer L6—prior to demodulation—and fed to transistor X12. This stage conducts only when a negative keying pulse is applied to the collector from flyback transformer T7; thus, the video signal is sampled only at horizontal retrace time. The output of X12 is coupled to a demodulator and filter circuit that develops a positive output voltage proportional to signal strength. Increasing the input makes X13 conduct harder, driving the emitter voltage in a positive direction. This voltage is filtered and sent to the bases of the first and second IF amplifiers, where it acts to reduce forward bias.

Sync

Most transistorized receivers include at least two sync stages. Each one operates as a simple switch—remaining in cutoff most of the time, but being driven into collector-current saturation whenever a sync pulse occurs in the input signal. This mode of operation is maintained by using NPN transistors with positive-pulse inputs and PNP transistors with negative-pulse inputs. When the transistor conducts, its internal voltage drop falls to a very low value in comparison with the voltage drop across the collector load resistor; thus, the pulse developed across the load may have an amplitude almost as great as the supply voltage.

As in tube circuits, the first sync stage usually has the primary function of separating the sync pulses from the composite video signal. Later stages improve the pulse shape and establish the correct polarities and amplitudes for application to the vertical and horizontal oscillators.

Fig. 19 shows a Channel Master sync section that corresponds closely to a dual-triode tube circuit. The input signal, taken from the output terminal of the common-emitter video driver stage, contains negative-going sync pulses. The RC network in the base circuit provides self-bias that supplements the small amount of fixed bias applied to the transistor. The bias circuit automatically adjusts itself to changes in signal

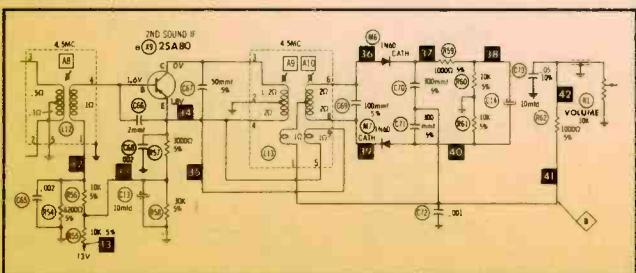

Fig. 21. Dual-diode sound detectors are almost invariably used.

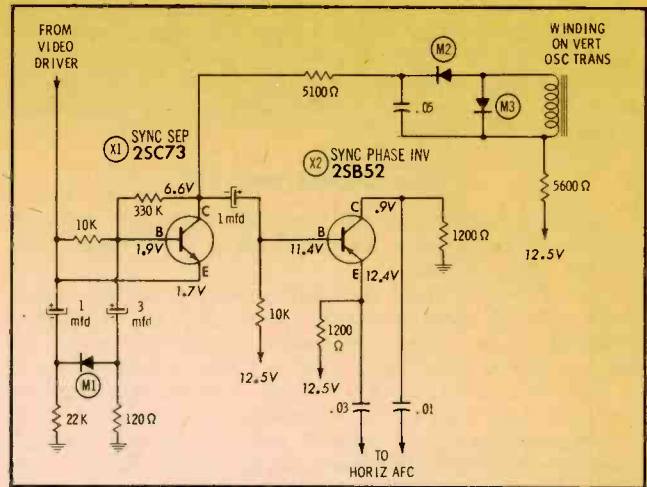

Fig. 20. Noise-limiting sync separator followed by phase inverter.

strength, since these cause variations in the charge on C1; the principle is the same as for grid-leak circuits of tube sync separators, although the polarity of the signal and bias voltages is opposite to that encountered with tubes.

Each incoming sync pulse brings X1 momentarily out of cutoff, developing a positive pulse across R1. This pulse causes X2 to conduct; since the second stage also inverts the signal, the output of the sync section is a train of negative pulses. The signal is fed through an integrator (R2, C2, R3, C3), and the resulting 60-cps negative spike is applied to the base of the PNP vertical oscillator transistor to trigger it into conduction. In addition, pulses are coupled through C4 to the common-cathode horizontal AFC circuit shown in Fig. 6.

A somewhat different approach to sync-circuit design is illustrated in Fig. 20. In the Sony Model 5-303W, the sync separator uses an NPN transistor in a common-base circuit; an input signal is obtained by connecting the emitter directly to the emitter of the video driver transistor (SYNC connection in Fig. 13). The input and output signals both contain negative sync pulses.

The network including M1 is a noise limiter that modifies the base bias on X1 to oppose the effect of strong negative noise spikes in the input signal. Vertical sync is tapped off at the collector of X1; the coupling circuit includes diodes M2 and M3, which let the sync signal pass through, but prevent the vertical oscillator waveform from being fed back into the sync separator.

X2, a phase splitter, is concerned only with the horizontal sync signal. It develops negative pulses at the emitter and positive pulses at the collector; these are delivered to the balanced dual-diode AFC circuit presented in Fig. 5.

Sound

In transistorized TV sound systems, the 4.5-mc intercarrier signal from the video driver is usually passed through two stages of sound IF amplification before being demodulated. The circuits have many features in common with video IF stages; for example, note the neutralization circuit (including C66) in Fig. 21.

In the same figure, note that the receiver (Sharp Model TRP-804) uses a ratio detector with two crystal diodes to recover the audio signal. Some other sets have discriminators. In either case, operation is almost the same as in a circuit using a 6AL5 tube.

Audio circuits resemble those of large transistor radios; for instance, the stage lineup is likely to consist of an audio driver and a push-pull power amplifier with 200 to 500 ma output. Earphone jacks are usually provided as a supplement to the small round or oval speaker.

Conclusion

The evolution of transistor TV circuits is bound to speed up as transistorized sets grow in popularity. However, the circuits described in this article are the major ones you will be working with in the near future. ▲

Tarzian offers
**FAST, DEPENDABLE
 TUNER REPAIR
 SERVICE (ALL
 MAKES)**

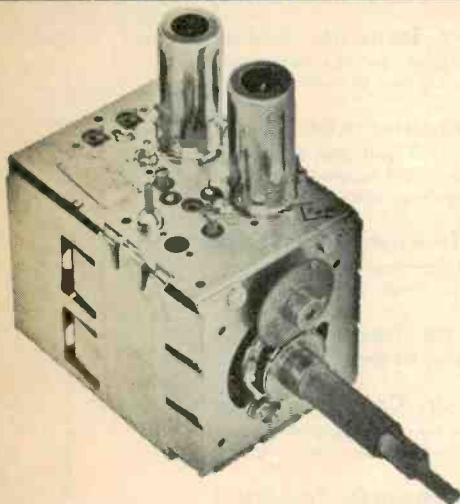

It just makes sense that a manufacturer of tuners should be better-qualified, better-equipped to offer the most dependable tuner repair and overhaul service.

Sarkes Tarzian, Inc. pioneer in the tuner business, maintains two complete, well-equipped Factory Service Centers—assisted by Engineering personnel—and staffed by specialized technicians who handle **ONLY** tuner repairs on **ALL** makes and models.

Tarzian-made tuners received one day will be repaired and shipped out the next. Allow a little more time for service on other than Tarzian-made tuners.

Tarzian offers a 12-month guarantee against defective workmanship and parts failure due to normal usage. And, compare our cost of \$9.50 and \$15 for UV combinations. There is absolutely no additional, hidden charge, for **ANY** parts except tubes. You pay shipping costs. Replacements on tuners beyond practical repair are available at low cost.

Ⓢ Tarzian-made tuners are identified by this stamping. When inquiring about service on other tuners, always give TV make, chassis and Model number. All tuners repaired on approved, open accounts. Check with your local distributor for Sarkes Tarzian replacement tuners, replacement parts, or repair service.

 **SARKES TARZIAN, INC.**
 Bloomington, Indiana

MANUFACTURERS OF TUNERS . . . SEMICONDUCTORS . . . AIR TRIMMERS . . . FM RADIOS . . . AM/FM RADIOS . . . AUDIO TAPE . . . BROADCAST EQUIPMENT

ONLY
\$9.50
INCLUDING

ALL PARTS
 (except tubes)
and LABOR

24-HOUR SERVICE
1-YEAR WARRANTY

**TWO SERVICE CENTERS
 TO SERVE YOU BETTER**

**See your distributor, or use the
 address nearest you for fast fac-
 tory repair service**

537 South Walnut St.
 Bloomington, Indiana
 Tel: 332-6055

10654 Magnolia Blvd.
 North Hollywood, Calif.
 Tel: 769-2720

publisher
Howard W. Sams

editor
Forest H. Belt

managing editor
George F. Corne, Jr.

associate editors
James M. Moore
Stuart N. Soll
Norman D. Tanner

consulting editors
William E. Burke
Joe A. Groves
C. P. Oliphant

production manager
Robert N. Rippy

circulation manager
J. A. Vitt

circulation fulfillment
Pat Tidd, Mgr.
Katherine Krise, Ass't.
Cora La Von Willard, Ass't.

art directors
Gene La Rue
Robert W. Reed

advertising & editorial assistants
Hazel Boyer
Rebecca Clingerman

photography
Paul Cornelius, Jr.

advertising sales offices
Dave Milling, advertising sales manager

midwestern

Hugh Wallace
PF REPORTER
4300 West 62nd Street,
Indianapolis 6, Ind.
AMinster 1-3100

eastern

Gregory C. Masefield
Howard W. Sams & Co., Inc.
3 West 57th Street,
New York, N. Y.
MJrray Hill 8-6350

western

The Maurice A. Kimball Co., Inc.
2550 Beverly Blvd., Los Angeles 57, Calif.
DUunkirk 8-6178; and 530 Market Street,
Room 400, San Francisco 4, Calif. EXbrook 2-3365

Address all correspondence to
PF REPORTER, 4300 W. 62nd Street,
Indianapolis 6, Indiana



Copyright© 1964 by Howard W. Sams & Co., Inc.
PF REPORTER is a trademark of Howard W. Sams
& Co., Inc. No part of PF REPORTER may be
reproduced without written permission. No patent
liability is assumed with respect to use of
information herein. Acceptance of advertising does
not in any manner signify the products, policies
and services so advertised have been approved,
endorsed or recommended by this magazine.
Subscription Prices: 1 year—\$5.00, 2 years—\$8.00,
3 years—\$10.00, in the U.S.A., its possessions and Canada.
All other foreign countries: 1 year—\$6.00, 2 years—
\$10.00, 3 years—\$13.00. Single copy 50¢, back copies 65¢.

Indexed in *Lectrodex*.
Printed by the Waldemar Press Div.
of Howard W. Sams & Co., Inc.



PF REPORTER

including Electronic Servicing

VOLUME 14, No. 6

JUNE, 1964

CONTENTS

Solid-State TV Circuits from A to Z Thomas A. Lesh	1
Book Section—A technical roundup from all the popular models.	
Letters to the Editor	14
The Electronic Scanner	16
The Troubleshooter	18
Scoping in Transistor Radios Allan F. Kinckiner	24
Shop Talk—These tips show how to save valuable time in troubleshooting.	
Symfact: Transistor AGC Circuit (Keyed and Amplified)	27
See what happens to voltages and waveforms when troubles occur.	
Me? Do Transistor Servicing? Wayne Lemons	32
Quicker Servicing—An old hand tells how to avoid "beginner's blues."	
Casebook for Transistor Techs	34
A notebook of hints for the practical serviceman.	
Symfact, Jr: Converter Stage	36
Complete troubleshooting analysis for three common symptoms in radios.	
Guide to Transistor Importers	38
Up-to-date listing of sources for information on foreign portable radios.	
Choosing New Lines of Business Forest H. Belt	44
Dollar and Sense Servicing—Avoid the pitfalls of unplanned expansion.	
Field-Effect Transistors Rufus P. Turner	52
How and why these modern semiconductors function as they do.	
Industrial Semiconductors at Work Leo G. Sands	56
Servicing Industrial Electronics—A quick rundown on the many types of special devices, written for the busy technician.	
Notes on Test Equipment Stephen Kirk	66
Lab reports on RCA Model WR-50A Signal Generator and Zenith Model SPTE-1 Stereo FM Generator.	
Product Report	78
Free Catalog & Literature Service	80
Monthly Index on free literature card	

ABOUT THE COVER

The modern trend is to think of semiconductor devices in terms of solid-state, in comparison with tube devices which are considered open-construction. In keeping with electronics progress, we dedicate this issue to the many types of solid-state equipment that finds its way into the progressive service shop these days, beginning with a section on transistor TV's that starts on page 1.



QUESTION:

ANSWER:

When it comes to electrolytic capacitors, why do more than half of the nation's Radio-TV Service Technicians prefer to do business with Sprague Distributors?

Because they don't want makeshift substitutions or multi-rating "fits-all" capacitors. They insist on exact replacements, which are always available through Sprague Distributors everywhere.

SPRAGUE **TWIST-LOK**[®] CAPACITORS... 1701 different ratings and sizes... the world's most complete selection of **EXACT** replacements!



We don't have to tell you that it's easier to service with exact replacements. And we don't have to tell you that it's better, too. When sets are designed, specific capacitance values are used for peak operation, so it takes exact replacements to restore original set performance.

And who better than Sprague knows which values and sizes are needed in the replacement market? Sprague, the world's largest component manufacturer, has the most complete specification file on original set requirements. That's why you're always right when you service with Sprague TWIST-LOK exact replacements!

GET YOUR COPY of Sprague's comprehensive Electrolytic Capacitor Replacement Manual K-106 from your Sprague Distributor, or write Sprague Products Company, 105 Marshall Street, North Adams, Massachusetts.



WORLD'S LARGEST MANUFACTURER OF CAPACITORS

Circle 3 on literature card

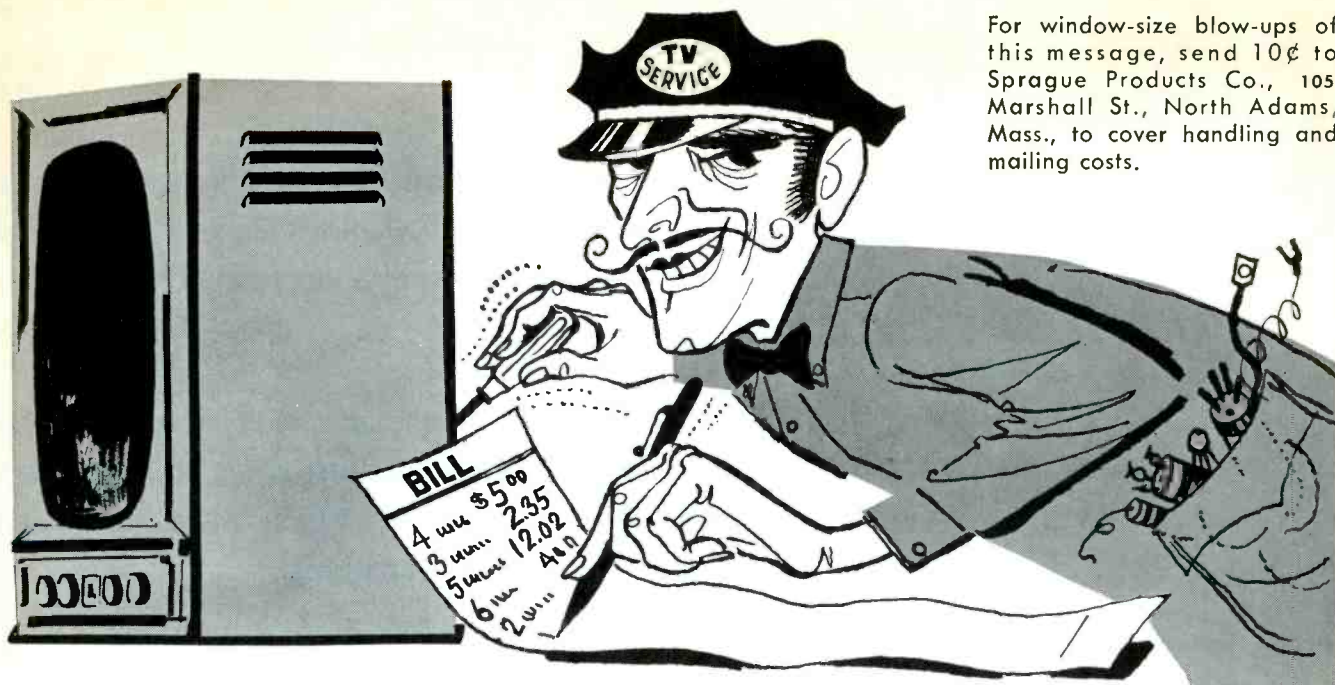

For window-size blow-ups of this message, send 10¢ to Sprague Products Co., 105 Marshall St., North Adams, Mass., to cover handling and mailing costs.

ARE TV SERVICE DEALERS GYPS?

Every so often, some magazine or newspaper sounds off about TV-radio service shops.

"Service technicians are a bunch of gyps," is the general theme. "They'll clip you if you don't watch out."

They might just as well write the same thing about doctors, lawyers, storekeepers, auto mechanics—or anyone else. There are gyps in every line of business. Actually the percentage in TV-radio is lower than in most.

The average service technician is a hard-working, straight-shooting individual. Rather than gyp customers, he is far more likely to spend more time on a job than he knows he will be paid for—simply as a matter of personal pride in doing things right.

We recently heard about someone's TV set going bad. A service technician called for it with his truck and returned it in good working condition within 48 hours. His bill came to \$10 for service plus \$2.68 for replacement parts.

The set owner argued that this was too much—yet he would never dream of complaining to the medical specialist who charged him \$10 for a 15-minute office visit; the lawyer whose bill for writing a simple will was \$75; or the garage man who laughingly admits that he charges \$5 for "just raising the hood" of a car.

In one of our very large cities, the Better Business Bureau received fewer than 500 complaints about serv-

ice in a year. Most of the complaints came from folks who expected first-class reception in doubtful fringe areas; who tried to operate their sets without suitable antennas; or who had bought sets "wholesale" at ridiculously low prices from cut-rate dealers who could offer little or no service.

Actually, it takes almost as long to become a good service technician as it does to train for any other profession. Beyond this, it calls for regular study to keep up with the constant stream of new developments. Also, it requires a surprisingly big investment in test instruments, manuals, and other shop equipment. The modern TV or radio receiver is by far the most intricate piece of equipment the average person ever owns or uses.

Service technicians are not fly-by-night businessmen—99 out of 100 run their businesses properly. The other one per cent—the gyps—can usually be spotted a mile away. Nine times out of ten, they are the shops that feature "bargain" prices and ridiculously liberal service contracts. And their victims are generally set owners who expect to beat the game by "getting something for nothing."

Good television sets or good TV service are not things to be bought on a "bargain counter" basis. Set owners who recognize this aren't likely to get gyped.

Instead, they'll find that they get more real value for their television entertainment dollars than for any other dollars they spend!

THIS MESSAGE WAS PREPARED BY SPRAGUE PRODUCTS COMPANY,
DISTRIBUTORS' SUPPLY SUBSIDIARY OF SPRAGUE ELECTRIC COMPANY, NORTH ADAMS, MASSACHUSETTS, FOR . . .

YOUR INDEPENDENT TV-RADIO SERVICE DEALER

65-123-63

Circle 4 on literature card

BEST PROFESSIONAL VTVM VALUE

EICO 232 peak-to-peak VTVM featuring exclusive Uni-probe® (U.S. Pat.)

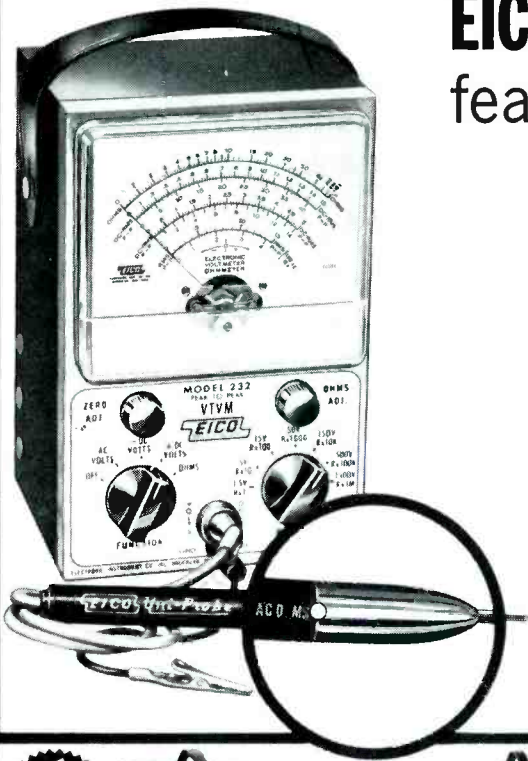

Deluxe VTVM for color & B & W

- Calibration without removing from cabinet
- Measure directly p-p voltage of complex & sine waves: 0-4, 14, 42, 140, 420, 1400, 4200
- DC/RMS sine volts; 0-1.5, 5, 15, 50, 150, 500, 1500 (up to 30,000 volts with HVP probe, & 250 mc with PRF probe)
- Resistance ranges: 0.2 ohms to 1000 megs in 7 ranges
- 7 non-skip ranges on every function
- 4 functions: + DC Volts, - DC Volts, AC Volts, Ohms.
- Uniform 3 to 1 scale ratio for extreme wide-range accuracy
- Large 4 1/2" meter in can't-burn-out circuit
- Zero center for TV-FM discriminator alignment
- Smart professional styling—new satin finish etched panel with contrasting knobs and meter and grey wrinkle steel case.

Kit \$29.95; wired \$49.95.

Exclusive UNI-PROBE: (pat. pending) Terrific timesaver, performs all functions: A half turn of probe-tip selects DC or AC-Ohms

EICO KITS FOR 1964

BEST BUY SCOPES



EICO 460 WIDEBAND 5" SCOPE For color & black-and-white TV servicing. Easily reproduces 3.58 mc color TV synchronizing burst. Vert. amp. flat from DC to 4.5 mc, usable to 10 mc; 25 mv rms/inch sensitivity. Horiz. amp. flat from 1 cps to 400 kc; 0.6 v rms/inch sensitivity. Automatic sync. Sweeps from below 10 cps to 100 kc. Kit \$89.95; Wired \$129.50.



EICO 427 ADVANCED GENERAL PURPOSE 5" SCOPE High sensitivity scope has all the facilities and quality demanded for servicing audio, communications and industrial equipment. Vert. amp. flat from DC to 500 kc, -6 db at 1 mc; 3.5 mv rms/cm sensitivity. Horiz. amp. flat from 2 cps to 450 kc; 0.18 v rms/cm sensitivity. Automatic sync. Sweeps from 10 cps to 100 kc. Kit \$69.95; Wired \$109.95.



EICO 430 PORTABLE GENERAL PURPOSE 3" SCOPE Remarkably fine compact scope. Excellent for servicing audio, communications, and industrial equipment. Ideal as a ham shack monitor. Flat-face 3" CRT with mu metal shield eliminates affects of external fields. Vert. amp. flat from 2 cps to 500 kc, -6 db at 1 mc; 25 mv rms/cm sensitivity. Horiz. amp. from 2 cps to 350 kc, 0.25 v rms/cm sensitivity. Sweeps from 10 cps to 100 kc. Kit \$69.95; Wired \$99.95.



EICO 955 IN-CIRCUIT BRIDGE-TYPE CAPACITOR TESTER Unique shunt-resistance balancing* provision, permits in-circuit short checks even in the presence of as little as 1 ohm shunt resistance. Sensitive open check down to 15 μmf normally, adjustable to as little as 5 μmf. Wien Bridge capacity measurements from 0.1 to 50 μf. Kit \$19.95; wired \$39.95 *Pat. applied for.

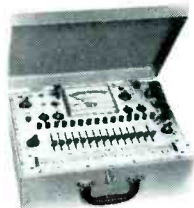

EICO 667 DYNAMIC CONDUCTANCE TUBE & TRANSISTOR TESTER Combines mutual conductance test with a peak emission test—gives a single reading of tube quality. Also spots bad NPN and PNP transistors by gain and leakage tests. New 1964 design has sockets and settings for the latest receiving types, including 5 and 7-pin nuvistors. Also tests novars, 10-pin miniatures, and compactrons, many low-power transmitting and special-purpose tubes, voltage regulators, electron-ray indicators, etc. Multi-circuit lever switch; 13 tube-element pushbutton switches. 4 1/2" meter; roll-chart in snap-in window. Kit \$79.95; wired \$129.95.
EICO CRU CRT ADAPTER—Adapts 667 to test all color and B & W CRT's. Wired \$9.95.



EICO 369 TV/FM SWEEP GENERATOR WITH BUILT-IN POST INJECTION MARKER Feeds only the sweep signal to the circuit under test or alignment. A demodulator picks off the response signal and feeds it to a mixer stage where the markers are added before scope display. Thus, troublesome interaction effects are eliminated. Sweep generator has controllable inductor sweep circuit (all electronic) with no mechanical parts to wear and give trouble, and 5 fundamental ranges from 3.5 to 316 mc. Variable frequency marker provides output on 3 fundamental ranges from 2 to 60 mc., and 60 to 225 mc range on harmonics. 4.5 mc crystal supplied for rapid check of marker generator alignment. Kit \$89.95; wired \$139.95.

FOR COLOR AND B & W



TOP-NOTCH TRANSISTOR TESTING TEAM
EICO 1020 POWER & BIAS SUPPLY with 0.005% ripple. Continuously variable metered output voltage, 0-30 VDC at 150 to 300mA. Kit \$23.95; wired \$29.95.



EICO 680 TRANSISTOR & CIRCUIT TESTER Measures basic characteristics of signal and power transistors. Provides DC current, DC voltage (20K ohm/volt), and resistance ranges normally needed for transistor work. Kit \$25.95; wired \$39.95.

EICO Electronic Instrument Co., Inc. PF-6
131-01 39th Avenue, Flushing, N.Y. 11352

Send new 1964 catalog featuring more than 230 EICO Products.

NAME _____

ADDRESS _____

CITY _____ ZONE _____ STATE _____

Add 5% in West

ATR PRODUCTS FOR MODERN LIVING



NOW...
THE FABULOUS
***G. E. COMBO**

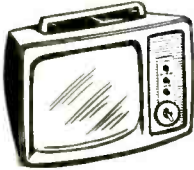

PLAYS ANYWHERE
ON 110 AC OR 12V DC
BATTERY CURRENT
For
Auto • Boat • Plane
Camps • Picnic • Trailer

ATR MODEL 12T-RME-1 INVERTER... \$39⁹⁵
*G.E. MODEL M110Y 11" PORTABLE TV \$99⁹⁵

*Available at G.E. TV Dealers

Both Only **\$139⁹⁰** Retail
THE **ATR** MODEL 12T-RME-1 ONLY ONE
OF A FAMILY OF FAMOUS DC-AC **INVERTERS**

Also NOW...

HAND WIRED—
NO PRINTED
CIRCUITRY

ATR ALL-TRANSISTOR
ULTRA COMPACT
UNIVERSAL MODEL 707



Karadio
IN DASH...
UNDER DASH...

Complete with variable tone control... R. F. stage
... Built-in speaker... and External speaker jack.

ATR MODEL 707... \$29⁹⁵ Retail

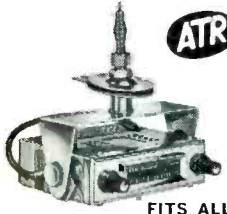

ATR ALL-TRANSISTOR
ROOF-MOUNT and
IN-DASH MODELS
TRUCK

Karadio
MODEL TR-720

FITS ALL TRUCKS • BOATS •
STATION WAGONS
INSTANT PLAY... POWERFUL

Complete with patented antenna-yoke assembly.
(U.S. Patent No. 3,087,118. Canadian Reg. 575,567)

ATR MODEL TR-720... \$44⁹⁵ Retail



ATR "A" Battery
ELIMINATOR

For Demonstrating and
Testing Auto Radios—
TRANSISTOR or VIBRATOR
OPERATED!
Designed for testing D.C.
Electrical Apparatus on Reg-
ular A.C. Lines.

MAY ALSO BE USED AS A BATTERY CHARGER
MODEL 610C-ELIF... 6 volts at 10 amps. or 12 volts
at 6 amps. Shipping weight 22 lbs.

USER NET PRICE \$55⁰⁰

ATR AUTO RADIO and
COMMUNICATION
LONGER-LIFE
VIBRATORS



"The Best by Test!"

SEE YOUR ELECTRONIC PARTS DISTRIBUTOR OR
WRITE FACTORY FOR LITERATURE & DEALER PRICES
ATR ELECTRONICS, INC.
Quality Products Since 1931
St. Paul, Minnesota 55101—U.S.A.

Circle 5 on literature card

Letters to the Editor

Dear Editor:

The general information supplied in Larry Allen's article "Servicing Procedures for Transistor Ignition Systems" (February PF REPORTER) should aid the service technician greatly in his initial approach to servicing these units. However, I'd like to point out an important correction: In Fig. 4, page 68, diode M1 actually serves to keep the emitter-base junction of X1 reverse biased during cutoff; this provides more rapid switch-off and assures minimum transistor leakage at higher operating temperatures.

FRANK ANDERSON

Anderson Engineering
Wrentham, Mass.

Many thanks, Frank, for helping us catch this one.—Ed.

Dear Editor:

I'd like to make tape recordings of customers' phone calls. Also, I'd like to rig it up so that incoming calls could be recorded while I'm out of the shop. I've heard about this, and I wonder if you could tell me of an inexpensive circuit for doing it?

GLENN HOWE

Aransas Pass, Tex.

Tape recording telephone conversations is illegal except under certain conditions. For example, a recurring beep tone must be provided to inform the person on the other end of the line that the conversation is being recorded. In addition to the legal aspects of phone "tapping" with recorders, the phone company may have rules that could lose you your phone line altogether if you are caught with this "foreign attachment" connected to your phone instrument. The easiest and safest way for you to provide such facilities in your shop is through your local phone company. They can usually provide an attachment that will record your conversations while you are talking on the phone and automatically answer your phone and take messages while you're out.—Ed.

Dear Editor:

While the May article, "Care and Choosing of Tape Heads," seems to cover the subject well, two errors made their way into the discussion. On page 30, in the reference to gap width the units should be micro-inches, not mils; and the dimension within the parentheses should be .00016".

In the third column on page 31, the bias oscillator should be disabled, rather than the collector.

NEAL F. WELNAK

Chicago, Ill.

Right you are, Neal; looks like our decimal points got away from us.—Ed.

Protects Meter Movements From All Overloads for LIFE!

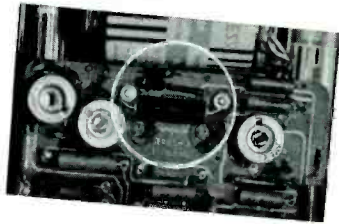

Metergard

For all VOMs and Voltmeters

Installed in minutes on any meter, such as the Simpson 260 or Triplett 630, etc. Positively prevents meter movement burnout or damage regardless of overload. Accuracy not affected by more than 1/4 of 1%. No moving parts, nothing to wear out. End the time loss, expense and aggravation of meter movement repair due to damage or burnout.

ONLY 2⁹⁵

GUARANTEED

Your VTVM will never need another battery for LIFE!

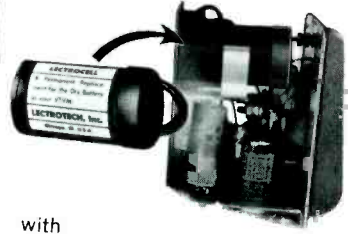

with

Lectrocell

A miniaturized regulated power supply that replaces the battery in VTVM's. Furnishes 1.5 VDC for measuring resistance. Exact size and shape of battery it replaces. Installs in minutes... simply connect 3 wires and you're all set!

ONLY 3⁹⁵

GUARANTEED



See your distributor today; if he does not stock these units, send check or M.O. direct to DEPT. P-6

LECTROTECH INC.
1377 W. DEVON • CHICAGO, ILL. 60626

Circle 6 on literature card



COLORMAGIC

Patent Pending

FHR

FUNDAMENTAL HARMONIC RESONANCE...GC'S EXCLUSIVE DESIGN PROCESS!

Colormagic elements resonate on the fundamental harmonics within both the high and low bands. Colormagic FHR outperforms the average second harmonic TV element by producing a tight, laser-linked directivity of signal...higher gain! It's in the elements!

GC "GOLD-GUARD" anodizing process guards against pitting, chipping, rust and corrosion...makes the Colormagic series the best protected, all-weather line available!

GC "SOLID-SEMBLED" construction insures quick, easy installation...rigid-lock elements snap securely into place!

Compare! Colormagic Antenna Systems offer pencil-point polar patterns...laser-linked directivity...flat plateau response curve...no traps or peaks...excellent for color or black & white TV reception.

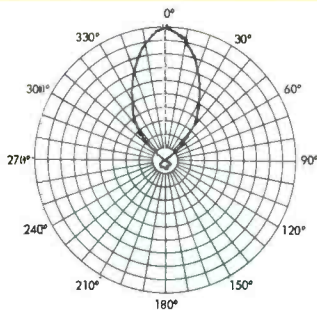

15 All-New Colormagic Combo. Couplers permit cross-direction reception of UHF-VHF-FM antenna combinations...each unit encased in high-impact polystyrene case...supplied with stainless Steel mounting strap. Complete sales program available.



See your GC Distributor! He'll fill you in on this "prestige" package. **CONSIDER THE ELEMENTS INVOLVED!** ...then GO COLORMAGIC! If not stocked locally, write us for name of Distributor nearest you.

GC ELECTRONICS CO.
Division of Textron Electronics, Inc.

Western Plant: 3225 Exposition Place, Los Angeles 18, Calif.
MAIN PLANT: 400 S. Wyman St., Rockford, Ill., U.S.A.

Circle 7 on literature card

GOOD NEWS FOR EASTERN TV SERVICEMEN...

CASTLE TV TUNER-EAST HAS MOVED TO NEW LOCATION WITH IMPROVED FACILITIES

In Long Island City near Postal Concentration Center to provide faster service by mail.

All other U.S. and Canadian Servicemen will get the same fast service from CASTLE-CHICAGO and CASTLE-CANADA.

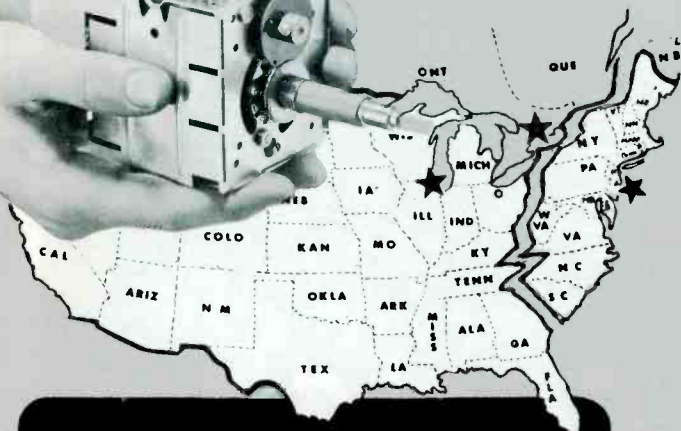
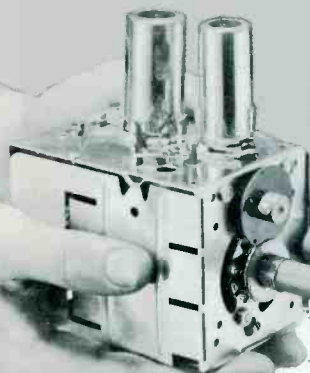

**ALL MAKES
ALL LABOR
AND PARTS
(EXCEPT TUBES)*
ONE PRICE**

995

THIS ONE LOW PRICE INCLUDES ALL UHF, VHF AND UV COMBINATION* TUNERS

Simply send us your defective tuner complete; include tubes, shield cover and any damaged parts with model number and complaint. 90 Day Warranty.

Exact Replacements are available for tuners unfit for overhaul. As low as \$12.95 exchange. (Replacements are new or rebuilt.)

*UV combination tuner must be of one piece construction. Separate UHF and VHF tuners must be dismantled and the defective unit only sent in.

Pioneers in TV



Tuner Overhauling

CASTLE

TV TUNER SERVICE, INC.

EAST: 41-90 Vernon Blvd., Long Island City 1, N. Y.

MAIN PLANT: 5701 N. Western Ave., Chicago 45, Illinois

CANADA: 136 Main Street, Toronto 13, Ontario

*Major Parts are additional in Canada

Circle 8 on literature card



The Electronic Scanner

news of the servicing industry

Converting VHF to UHF

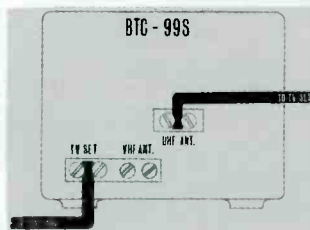

A simple method of converting VHF signals to UHF (for testing) has been devised by **Blonder Tongue**. The TV technician can take an unamplified, single-tube converter and wire it backwards. Instead of changing UHF to VHF, the converter changes a local VHF channel to UHF. This technique is especially useful to technicians in VHF-only areas that have a new UHF channel going on the air. The diagram illustrates how the Model BTC-99 can be connected to supply UHF signals. The unit is most effective with channel 5 or 6, but any low channel will work if the signal is strong enough.

Central Parts Depot

A central parts depot has been opened in Melrose Park, Ill. by **Sylvania**. Home-entertainment and commercial electronics parts will be shipped to all areas of the country from this central location. The depot will stock over 75,000 types of components for television, stereophonic phonographs, radios, and closed-circuit TV cameras.

Tuner Repairs



The East Coast plant of **Castle TV Tuner Service** has been moved from Cliffside Park, N.J. to 41-98 Vernon Boulevard, Long Island City, N.Y.

Castle's new facilities, at the foot of the Owensboro bridge near a Postal Concentration Center, will offer quicker service to servicemen in the New York area and provide faster mail service to all East Coast customers. Servicemen located in the West and Midwest use either of Castle's two other plants, located at Chicago, Ill. and Toronto, Can.

WWV Changed

National Bureau of Standards radio stations **WWV** and **WWVH** recently began transmitting a new schedule of Geophysical alerts. The alerts are broadcast during the 19th and 49th minutes of each hour in Morse code at 7 wpm, and are preceded by the letters "GEO." The system is as follows: five M's = magnetic storm; five N's = magnetic quiet; five C's = cosmic-ray-event; five S's = solar activity; five Q's = solar quiet; five W's = stratospheric warning; five E's = no alert. On April 1, 1964 the clocks that control NBS broadcasts were retarded 100 milliseconds (by international agreement) to synchronize with time signals broadcast by Argentina, Australia, Canada, Czechoslovakia, Italy, Japan, South Africa, Switzerland, United Kingdom, and United States.

New Division



A recently formed division of **Regency Electronics, Inc.**, called **Regency Avionics**, will be located in a new facility at 6909 East 32 St., Indianapolis, Ind. The division will design and manufacture electronics equipment for aviation industry. This move will expand Regency Electronics' sales and engineering facilities as well as increase production capability. Avionic products will be distributed nationally through company sales representatives. ▲

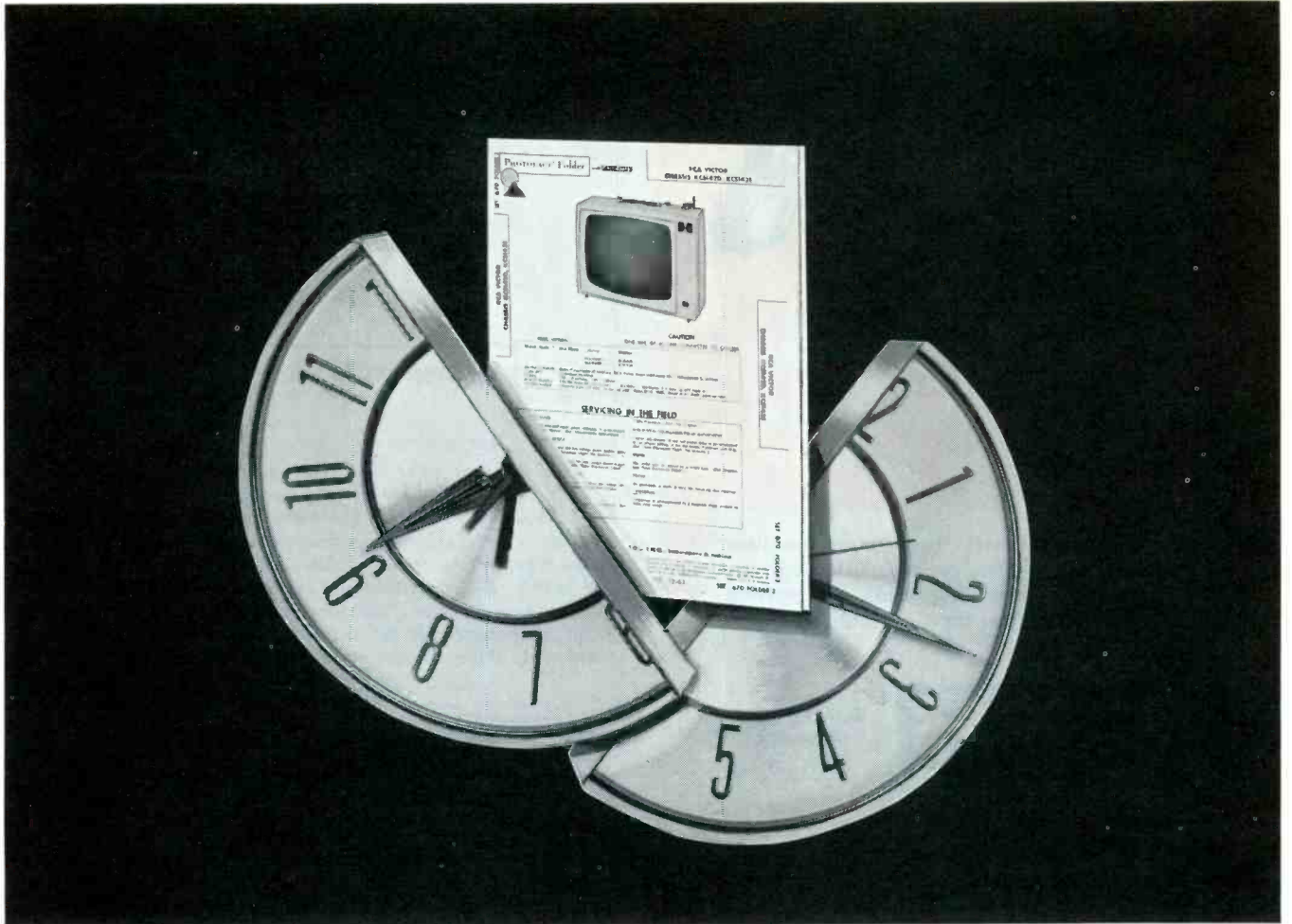

"cuts servicing time in half"

A lot of technicians use just these words to describe PHOTOFACT. One typical letter (unsolicited) puts it like this:

"The PHOTOFACT Library has cut my servicing time in half and has more than paid for itself already. In the best words—PHOTOFACT keeps my business in the black."

Saving time is the key to bigger profits in electronic servicing. PHOTOFACT

does just that—slows down the clock so you get up to twice as many repairs done each day—and boosts your earnings.

There are over 40 time-saving features in every PHOTOFACT Folder which will help speed your TV-Radio troubleshooting. (Best, too, for cutting time on these tough-dog jobs.)

Users don't measure PHOTOFACT by its pennies-per-page cost. It's the

time-halving, profit-making worth of PHOTOFACT that counts.

Of course, you can get along without PHOTOFACT—a few do—and maybe they're making a living. But it's the hard way.

Doesn't it make good sense to see your Sams Distributor today for details on an Easy-Buy PHOTOFACT Library and Standing Order Subscription?

Or use the coupon below.

A PHOTOFACT LIBRARY PAYS ITS OWN WAY—

Now, more than ever, it pays to own PHOTOFACT—the world's finest TV-radio service data. Now, you can start or complete your PHOTOFACT Library this Easy-Buy Way:

Only \$10 down • 30 months to pay • No interest or carrying charges • Prepaid transportation • Add-on privilege of a year's advance subscription to current PHOTOFACT on the same Easy-Buy contract • Save 30¢ per Set—special \$1.95 price applies on Easy-Buy (instead of the regular \$2.25 price).

4 Ways to Select Your PHOTOFACT Library: 1. Complete your present PHOTOFACT Library. 2. Order a PHOTOFACT "Starter" Library—180 Sets (Sets 301 to 480—coverage from 1955 to 1960—only \$11.36 per month). 3. Order by brand name and year—see the handy selection chart at your Distributor. 4. Order a complete PHOTOFACT Library—get FREE file cabinets, plus a selection of invaluable books and Electronics Courses.

SEE YOUR SAMS DISTRIBUTOR FOR FULL DETAILS, OR MAIL COUPON ▲

Howard W. Sams & Co., Inc., Dept. PFF-6
4300 W. 62nd St., Indianapolis 6, Indiana

Send **FREE Photofact Cumulative Index**

Send full information on Easy-Buy Plan

Enter my Photofact Standing Order Subscription

My Distributor is _____

Shop Name _____

Attn. _____

Address _____

City _____ Zone _____ State _____

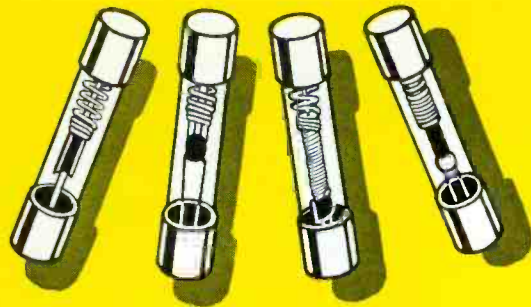

FUSETRON dual-element Fuses

time—delay type

“Slow blowing” fuses that prevent needless outages by not opening on motor starting currents or other harmless overloads—yet provide safe protection against short-circuits or dangerous overloads.

BUSS

Write for BUSS
Bulletin SFB

BUSSMANN MFG. DIVISION, McGraw-Edison Co., St. Louis, Mo. 63107

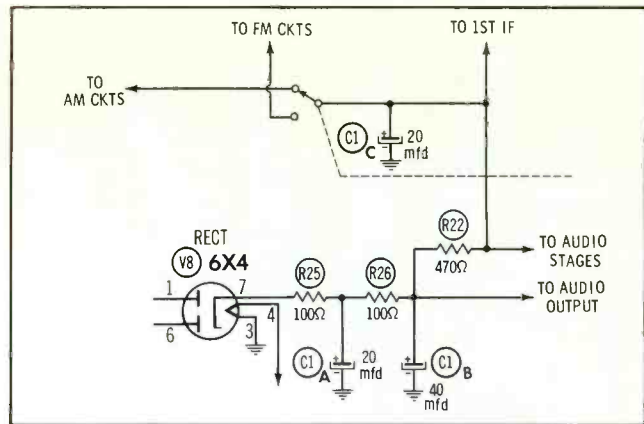

the same thing happens. Can you give me any idea where the trouble is?

W. T. NOVAK

Baltimore, Maryland

All indications point to a short or near-short at the junction of R22 and C1C. One good procedure is to disconnect all leads from this point and check the resistance of each lead to ground. A precheck before unsoldering all these leads will indicate whether the trouble exists in both positions of the AM-FM switch. B+ is switched off the circuits not in use and if the short disappears in one position or the other, you can eliminate those components. If the switch position makes no difference, check only those circuits connected directly to this B+ point.

Leave It Out?

We have had three GE Model 21C138 TV receivers come in with capacitor C3 shorted. This is an 80-mfd 200-volt electrolytic between cathode of audio output (135-volt source) and 275-volt B+ line. What, if any, purpose is served by this capacitor? Have left it out of one set as an experiment and

BUSS: 1914-1964, Fifty years of Pioneering....



The Troubleshooter

answers your servicing problems

Lost Audio

A Chevrolet Model 987727 car radio on my bench has very little audio output. By listening closely, I can just barely hear it. All voltages are with 15% of those shown in PHOTOFAC, right up to the output-transistor collector which measures 0 volts. Every major part has been substituted with the exception of the driver transformer. Can you help me find the signal?

BILL MILLER

Gary, Indiana

One characteristic of transistor output stages used in auto radios is that the transistor will fail if the set is operated with no speaker connected. An interlock at the speaker-connecting terminal guards against this. With no speaker connected, the interlock grounds the collector. Pushing the speaker connector on the post opens the interlock. Have you overlooked this interlock switch? It can be disconnected by a piece of paper slipped between the contacts. Make sure you remove the paper later!

Old Smoky

I have a Truetone Model D2020 AM-FM radio in which I cannot get any low B+ voltage. Resistor R22 (470 ohms) begins to smoke after the set has been on about a minute. I removed the electrolytic capacitor and substituted another and

New! BUSS SPACE SAVER PANEL MOUNTED FUSEHOLDER



Actual Size

Only 1 1/8 inches long . . .
Extends just 29/32 inch
behind front of panel

- Fuseholder takes 1/4 x 1 1/4 inch fuses. Converts to 9/32 x 1 1/4 inch fuses simply by changing screw type knob. Holder is rated at 30 ampere for any voltage up to 250.
- Also available in military type which meets all requirements of MIL-F-19207A.

BUSS

Write for BUSS
Bulletin SFH-10

BUSSMANN MFG. DIVISION, McGraw-Edison Co., St. Louis 7, Mo.

Circle 10 on literature card

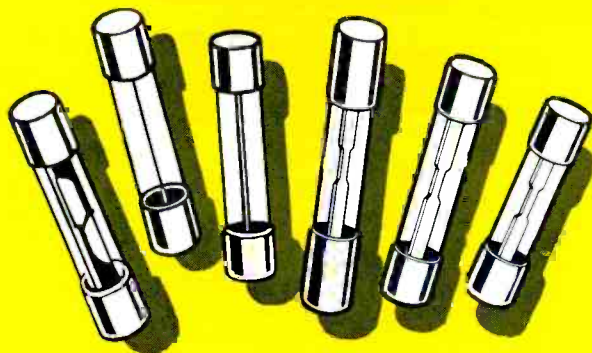

BUSS quick-acting Fuses

"Fast Acting" fuses for protection of sensitive instruments or delicate apparatus;—or normal acting fuses for protection where circuit is not subject to starting currents or surges.

BUSS

Write for BUSS
Bulletin SFB

BUSSMANN MFG. DIVISON, McGraw-Edison Co., St. Louis, Mo. 63107

split-chassis set); we've substituted the electrolytics in the RF chassis and still haven't fixed the set. We had another set just like this one, so we switched the RF chassis and got a normal picture. We still cannot find the trouble in the original chassis. We have checked everything we can think of. Do you have any ideas?

CAMPUS TV SERVICE

Fort Collins, Colo.

The schematic in PHOTOFAC Folder 201-7 shows that the interconnecting cable is wired into the RF chassis and plugs into the sweep chassis. When you switched chassis, you also switched this cable. Better check for unsoldered or broken wires and for short circuits in the cable.

Noisy Auto

The trouble in a Ford Model 94BF auto radio is a ripping or buzzing sound. I have changed the electrolytics, but this did not help. With the battery eliminator, the radio works perfectly. In the car, with the key on but without the motor running, the radio still gives out the ripping noise. I hooked the scope to the battery lead to the radio and could see the pulses on this line. What procedure should I follow?

PETER GERNAT

Warren, Ohio

Since the radio produces this noise with the motor off, you can discount the motor as a source of trouble. Connect a heavy clip lead from the radio case to the grounded pole of the battery. This will eliminate any poor ground connection. Remove the radio from the dash and connect it up while it is laying on the floor (use extension leads of necessary). This will eliminate a possible twisted mounting which could flex the circuit board and cause an intermittent condition. Disconnect the antenna and check for noise. Bring the battery eliminator out to the car (with a long extension cord) and connect it to the radio. If the noise disappears, it is in the car's electrical system and is entering the set on the battery lead; if the noise still persists, discount the electrical system and suspect the antenna and lead in.

▲

...New Developments in Electrical Protection

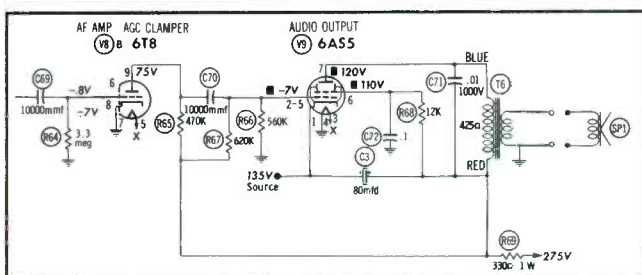

can see or measure no change in operation. What is your opinion?

DEAN ELDER

Green River, Wyo.

The main purpose of capacitor C3 is to serve as a smoothing filter between the 275V supply and the 135V source. When C3 is left out of the circuit, you may have trouble with audio variations on the 135V line affecting the video IF's via the screen grids. This trouble will appear as bars in the picture, which increases and decreases as the sound level varies.

We have found it advisable to replace this capacitor with a 350V unit which will better withstand the voltage peaks in the audio circuits. Also make sure that C71 and C72 are not open. Check grid bias on the audio output tube. Too much negative bias will increase the voltage drop across the tube and overload C3.

A Wedge

We are having trouble with a Philco Model AT1718. The trouble seems to be in the yoke but a new yoke did not cure the fault. The raster is hard to describe. Vertical sweep is complete on the left side but tapers top and bottom to about half normal sweep on the right. The edges of this taper are considerably brighter than normal, and no picture is visible. All new electrolytics have been installed in the sweep chassis (this is a

Save Assembly Time with Quick-Connect Terminals on BUSS Fuseholders

Eliminates soldering. Permits
use of pre-assembled harness.
Reduces assembly time.

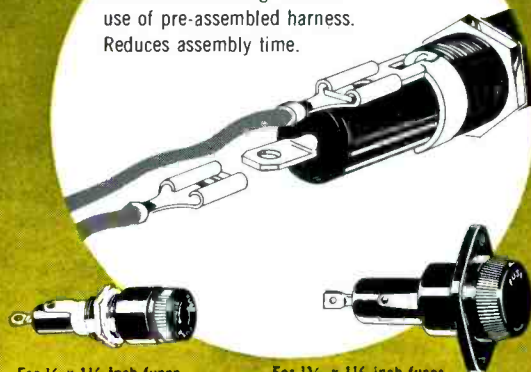

For 1/4 x 1 1/4 Inch fuses
Series HJ, HK, and HLD

For 1 1/2 x 1 1/2 inch fuses
Series HPC

BUSS

Write for BUSS
Bulletin SFB.

BUSSMANN MFG. DIVISON, McGraw-Edison Co., St. Louis 7, Mo.

Circle 10 on literature card

June, 1964/PF REPORTER 19

Winegard COLORTRON Antenna



The Colortron Antenna's "BALANCED DESIGN" is the Winegard secret of superior color reception!

It takes a combination of high gain, accurate impedance match, complete band width and pinpoint directivity to make the perfect color antenna. Only the Winegard Colortron gives you all 4 with **BALANCED DESIGN**.

What is Balanced Design? It's not enough to design an antenna for high gain alone and expect good color reception. A high gain antenna without accurate impedance match is ineffective. Or an antenna with good band width but poor directivity characteristics is unsuitable for color. The Winegard Colortron is the one antenna with *balanced design*, excellence in *all* the important characteristics that a good color antenna requires.

For example:

Gain and Bandwidth—A superior color antenna must have high gain and complete bandwidth as well. But the response must be *flat* if it is to be effective. Peaks and valleys in the curve of a high gain antenna can result in acceptable color on one channel and poor color on another.

No all-channel VHF-TV antenna has more gain with complete bandwidth across each and every channel than the Colortron. Look at the Colortron frequency response in this oscilloscope photo.

Note the consistent high gain in *all* channels. Note the absence of suck-outs and roll-off on end channels. The flat portion of the curve extends on the low band from the channel 2 picture carrier past the channel 6 sound carrier. On the high band, it is flat from the channel 7 picture carrier to the channel 13 sound carrier. There is less than 1/2 DB variance over any channel.

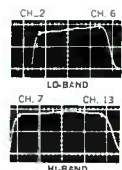

Impedance Match—the two 300 ohm "T" matched Colortron driven elements have far better impedance match than *any* antenna using multiple 75 ohm driven elements. The Colortron transfers *maximum* signal to the line without loss or phase distortion through mismatch. Winegard's "T" matched driven elements cost more to make, but we know the precision results are well worth the added manufacturing expense . . . because a mismatched antenna causes loss of picture quality which *might* get by in black & white, but becomes highly disturbing in color.

The oscilloscope photo here shows the Colortron VSWR curve (impedance match). No current VHF-TV antenna compares with it across all 12 channels.

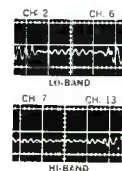

...made for color!



Directivity—Equally important for superior color pictures is freedom from interference and ghosts. Therefore, an antenna with sharp directivity and good signal-to-noise characteristics is necessary. Extraneous signals picked up at the back and sides produce objectionable noise and ghosts in black and white reception . . . frequently ruin color reception.

Winegard's Colortron has the most ideal directivity pattern of any all channel VHF antenna made. It has no spurious side or large back lobes . . . is absolutely dead on both sides. Colortron does not pick up extraneous signals, and even has a higher front-to-back ratio than a single channel yagi.

Look at this Colortron polar pattern. No other VHF-TV antenna has sharper directivity on a channel-for-channel comparison.

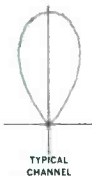

BALANCED DESIGN COLORTRONS HAVE SUPERIOR MECHANICAL FEATURES, TOO!

Every square inch of the Colortron has been engineered for maximum strength, minimum weight and minimum wind loading. Even the insulators are designed for low wind resistance. The result

is a streamlined, lightweight antenna that stays stronger longer. Colortrons have been wind tested to 100 mph.

Colortrons are simpler to put up, too. Easier to carry up a ladder and mount on a high mast. No extra weight and bulk to frustrate the antenna installer.

And, you can see the difference in quality when you examine a Winegard COLORTRON. The GOLD ANODIZED finish is bright weather-proof gold that *won't fade*, rust or corrode. It's the same finish specified by the Navy for military antennas. Full attention is paid to every detail.

Winegard Helps You Sell—does more national advertising than all other brands combined. When you sell Winegard, you sell a brand your customer knows . . . backed by a *written factory guarantee of satisfaction*.

It's not surprising that Winegard leads the field in the number of antennas installed with color sets. And Colortrons have been installed by the hundreds of thousands for black and white sets too—for the antenna that's best for color is best for black and white as well. Why don't you try a *balanced design* Colortron and see for yourself?

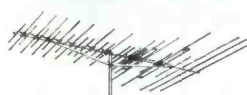

COLORTRON ANTENNA
Model C-44 • Gold Anodized • \$84.95



COLORTRON ANTENNA
Model C-43 • Gold Anodized • \$51.90



COLORTRON ANTENNA
Model C-42 • Gold Anodized • \$34.95



COLORTRON ANTENNA
Model C-41 • Gold Anodized • \$24.95



Winegard Co.

3009-F KIRKWOOD • BURLINGTON, IOWA

Circle 11 on literature card

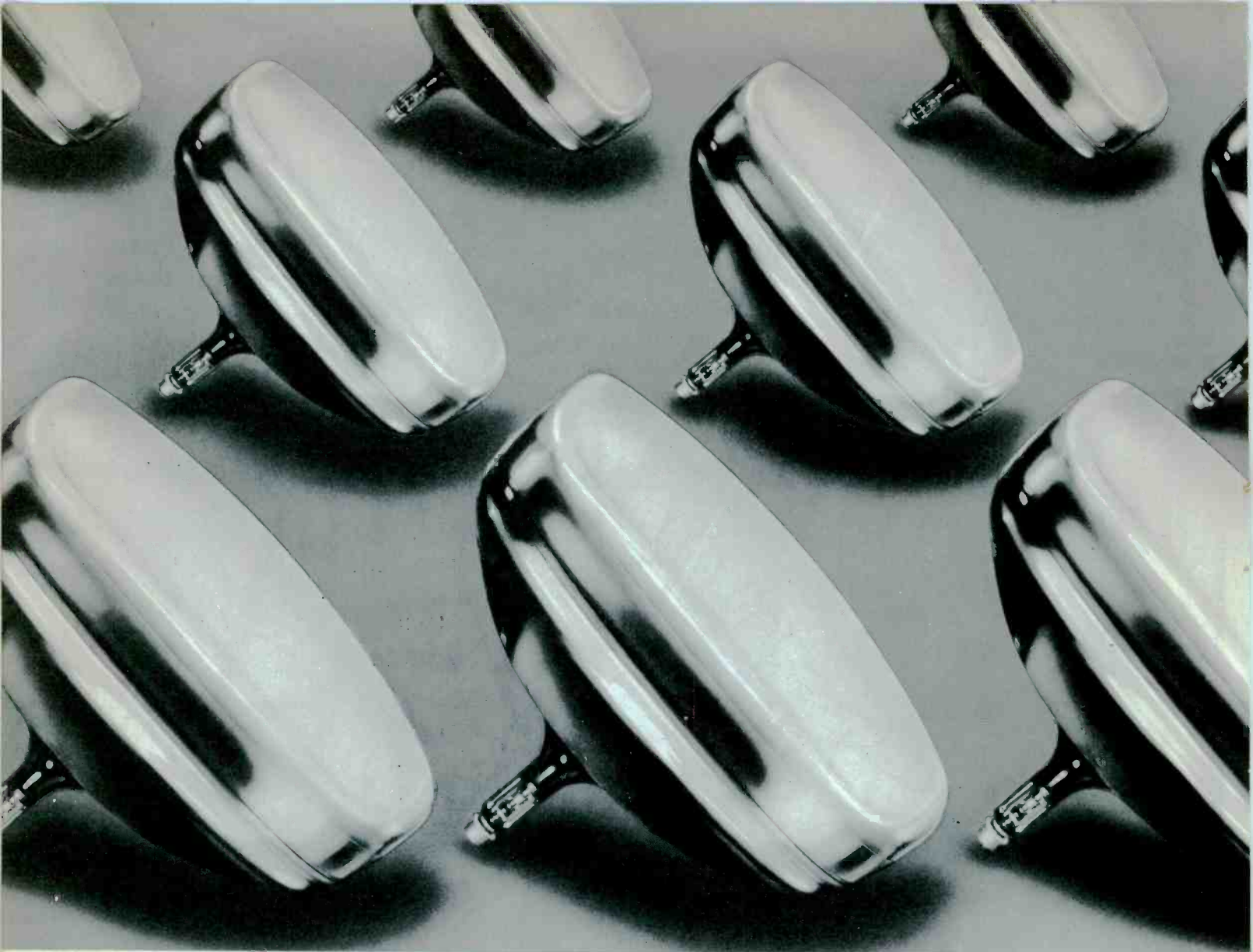

THE QUALITY OF YOUR SERVICE DEPENDS ON THE PARTS YOU USE...DEPEND

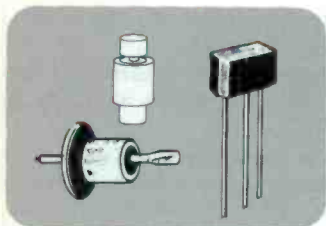

Diodes, Rectifiers, Condensers and Resistors
Complete variety for all makes and models.

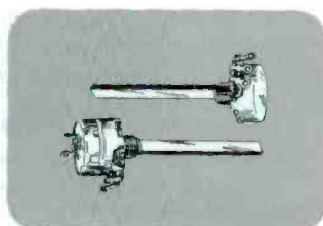

Universal Controls
With or without on-off switch. Standard taper, 3 inch shaft, half flat. 1 meg, 2 meg, 500 K. Complete selection. Fit Philco and other makes.

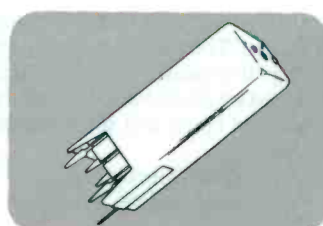

I.F. Transformers
For printed circuits, 4 lug, 5 lug or 6 lug types . . . to fit Philco or other makes. Dependable Philco Quality.

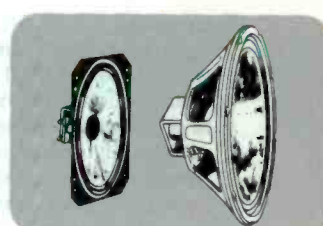

Replacement Speakers
All sizes, round, oval or rectangular types. 3.2, 8, 16, 20 ohms. From tiny 1 3/4" to giant 15" sizes.



Philco Receiving Tubes
To fit any make, any model TV or radio, manufactured to exact Philco standards, thoroughly inspected. Original factory cartons.



Rotary Switch Antenna
High gain type with 6 position switch for best possible signal selectivity. 3 section brass dipoles. Padded cast iron base.



Contact Cleaner
Philco TV and Radio Contact and Control Cleaner, Lubricant in self spray can, complete with protective cap and spray nozzle.



Philco TV Yoke
Genuine Philco TV yokes, made to original factory specifications. Accurately wound and inspected. Packed in individual boxes, ready to install.

There's a Philco Fully Stocked Parts Center Near You!

IF YOU NEED A PHILCO PART...YOU CAN GET IT FAST...HERE'S WHY

1. Philco has a nationwide network of Parts distributors—THERE'S one in your area.
2. Philco distributors are backed up by Parts Warehouses with millions of dollars in Parts inventory.
3. NEW Parts for NEW Philco models are shipped automatically along with the NEW products.
4. All Parts orders are handled by experienced Parts specialists.
5. ALL EMERGENCY orders are transmitted over the nation's largest industrial communications system and processed within 24 hours.

Whatever you need—whenever you need it—if it's a Philco Part just dial your Philco distributor. He has thousands of Philco Parts right now on his shelves. If the item you need is temporarily out of stock—he can get it for you FAST. You may DEPEND on your Philco Parts distributor.

Customer Confidence Begins When You Use Genuine Philco Star Bright 20/20 Picture Tubes

Every CR Tube you replace represents a high-dollar service sale for you . . . and your customer. Play it safe with a brand that's known for Quality . . . PHILCO. All material and parts used in the manufacture of Philco Star Bright 20/20 Picture Tubes are new except for the envelope, which prior to reuse, has been inspected and tested to the same standards as new envelopes.

ON YOUR PHILCO DISTRIBUTOR FOR ALL YOUR PARTS AND ACCESSORIES



M62A 4-speed Record Changer
Intermixes all size records. Light-weight tone arm with retractable scratch protection assembly and famous Euphonics U8 cartridge. Changer ideal for built-in installations or "modernizing" record playing equipment. Template and instructions included.

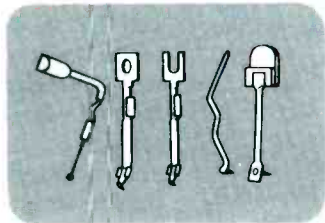

Philco Phono Needles
A complete selection of types and numbers for Philco and most all other makes. Carefully made, attractively-packaged. ALL TIP TYPES and sizes, including Diamond. Special now available—"THE BIG 18 KIT." This attractive compact metal case contains 18 of the industry's fastest selling needles.

Your Philco Distributor Features These Famous Makes

PHILCO • PHILCO-Bendix • CROSLY • EVEREADY Batteries and Flashlights • CAROL Cables • GOODRICH V-Belts • GC Products • AUDIOTEX • WALSCO Products • COLORMAGIC

Philco Parts are Available Through a nationwide network of Parts Distributors. Mail the Coupon Today for the Name of the One Nearest You.



Philco Parts & Service Operations
C & Tioga Streets, Phila. 34, Pa.

I am interested in receiving information about special Philco Parts offers, prices and facts. Please send me the name of the nearest Parts distributor.

Name _____

Address _____

City _____ Zone _____ State _____

PARTS AND SERVICE OPERATIONS

PHILCO®

A SUBSIDIARY OF *Ford Motor Company*

SCOPING

in

TRANSISTOR RADIOS

by Allan F. Kinckiner

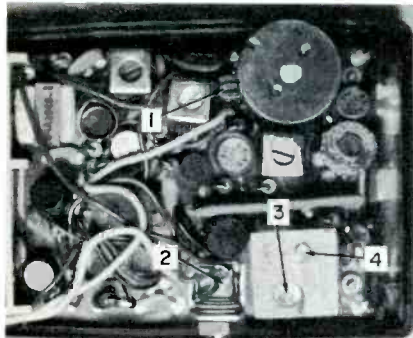

Fig. 1. Scoping points in transistor radios.

Recommending that the oscilloscope be used for troubleshooting transistor radios is in no wise meant to infer that other techniques should be relegated to the scrap heap. Instead, the scope is used in conjunction with techniques such as current measuring, voltage reading, signal injection, or signal tracing. Before scoping is attempted, total current

should be measured; then, after the scope has localized the stage at fault, voltage readings will usually pinpoint the defective component. The use of the scope is predicated on the premise that the most significant factors in the radio are its signals—not the voltages at various points nor the amount of current it consumes.

Troubleshooting With the Scope

Many transistor portable radios are constructed similar to that shown in Fig. 1. This construction supplies some "Rapidly-Identified" points where scope tracing will convey considerable information. The RI points in Fig. 1 coincide with similarly marked RI points of the schematic in Fig. 2. Another design exposes the conductor side of a printed-wiring board when the case is opened. In these sets the same RI points can be uncovered by removing the radio from its case entirely, or the scoping points can be determined directly by referring to the CircuitTrace® photo in the PHOTOFACT Folder.

Preliminary Scoping

The numbers assigned to our RI points suggest the order in which scope traces are taken. RI-1, for instance, fairly well divides the set into two groups of stages, the audio and the RF. If no signal can be found, it definitely indicates a fault in the preceding stages; if a normal signal can be scoped, it indicates the fault is in following stages. It is often surprising to find the front-end section of a receiver is bad, when other tests (audio-input disturbing or total-current measuring) suggest trouble in the audio stages.

Scoping RI-1

Attach the low-capacitance

probe to the high end of the volume control as shown in Fig. 3, connect the scope ground connection to set ground, and orient the set for maximum pickup of the strongest local station. Then carefully and slowly tune the dial in the vicinity of the selected station frequency, closely watching the screen of the scope. If the antenna, oscillator, and IF stages are all operating, a trace (as in Fig. 4) will appear on the scope. In a normally operating radio, the voltage of the audio signal at RI-1 will range from .3 to .5 volt.

The Probe

Before proceeding to further scope tracing, a discussion of the choice of probe might be fitting. It is not always necessary that a low-capacitance (low-cap) probe be used as suggested, but a low-cap probe will be used for some of the following tests because it doesn't "load" the circuits. Commercially available probes usually have attenuation factors of 10:1; therefore it requires at least 1.5 volt to obtain a vertical trace of one inch on the average scope. This being the case, the low voltages found in transistor sets will result in extremely small deflections. A commercial probe can be modified by changing the series resistor and capacitor to values approximately two-thirds the regular value. This remedy will not load the circuits to any appreciable degree but it will give an apparent increased sensitivity to the scope. A direct probe can be used at all points except RI-3 without seriously detuning the circuits.

• Please turn to page 71

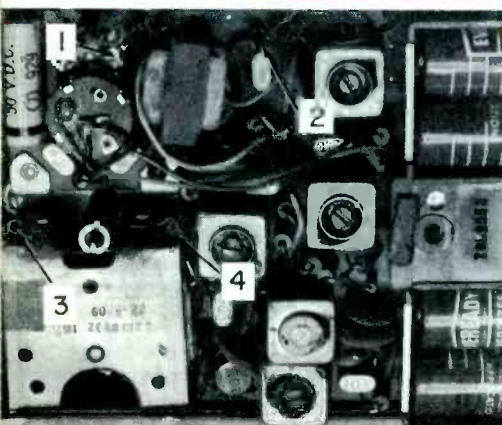
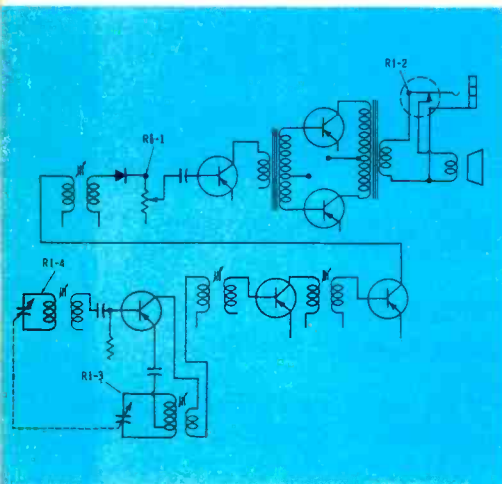

Fig. 2. Typical transistor portable circuit.



Fig. 3. Low-C probe at top of volume control.



There's more profit in your hands with ITT tubes

Yes, you can pocket extra profit when you stock ITT receiving tubes . . . with full confidence that you are giving your customers the finest replacement tubes money can buy.

Your customers will appreciate it, too, because they know ITT's international

reputation for quality and leadership in electronics.

ITT can provide this "extra value" of finest quality at higher profit margins because ITT products are available from 154 factories and laboratories in 24 countries. Brands without these world-

wide resources cannot offer you these advantages.

Ask your local distributor about ITT tubes. He'll give you *extra profit* details.

ITT Distributor Products Division, International Telephone and Telegraph Corporation, Box 99, Lodi, New Jersey.

Circle 12 on literature card

ITT

What's all this talk about "exact replacement" Twist-Prong Electrolytics?

What is an "exact replacement?" To CDE it's the proper capacitor to do the job intended—available when you need it. To others, it means number matching by the service technician—matching the numbers on the old unit with those of the replacement—without regard to availability or cost. CDE's new Twist-Prong line is based on our service-oriented definition.

Matching numbers may be fun, but there comes a time when it's a losing game. In Twist-Prongs the growth in ratings used in original equipment has been phenomenal. Even the loudest advocates of number matching have to hedge. One advertises over 1700 "exact replacements" — catalogs about 1200—and, of that 1200, lists possible alternates for 297 "if the listed capacitor is not available." Then, there's the problem of popular and "less popular items" — or, you're lucky if your distributor has the number you're trying to match in stock.

To Cornell-Dubilier, the availability of a proper replacement to do the job intended is most important. That's why we've designed a complete new Twist-Prong line for the professional electronic service technician. It's a line that recognizes the broad tolerances inherent in electrolytic manufacture and widely recognized throughout the industry—a fact you've used repeatedly in making replacements. It's a line that enables your distributor to have a complete stock so units will be available when you need them. It's an "exact replacement" line in the proper sense of the word.

Only the CDE Twist-Prong line is designed to make your job easier. A new Twist-Prong Replacement Guide and Cross Reference details manufacturers recommended in-stock replacements for every current Twist-Prong rating. The line is listed, too, in the new CDE Replacement Component Selector. Ask your distributor for copies today and end the old fashioned matching numbers game.

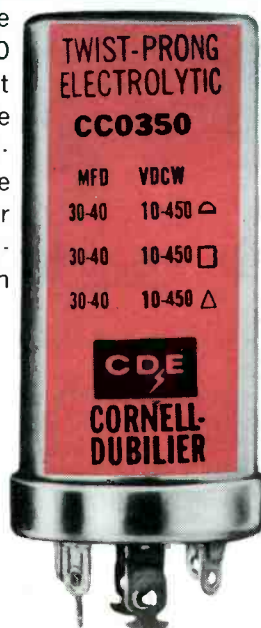

CDE **CORNELL-DUBILIER**
INNOVATION WITH RELIABILITY

Circle 13 on literature card

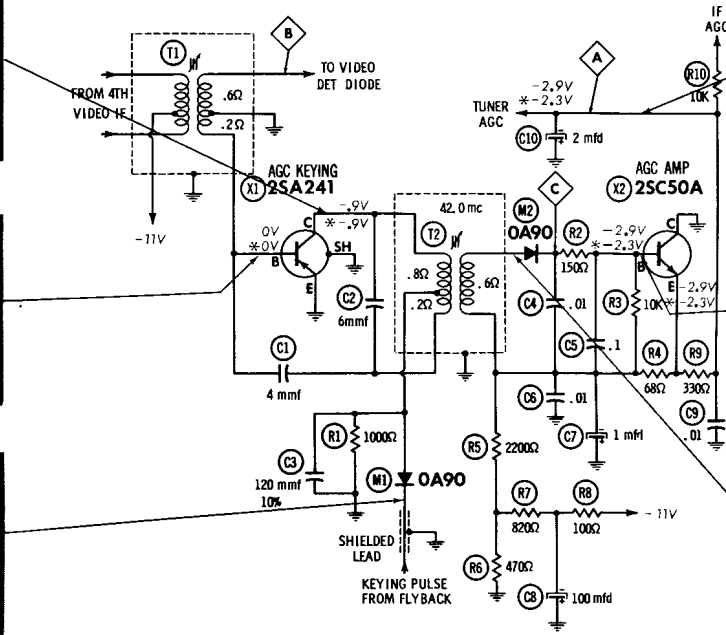
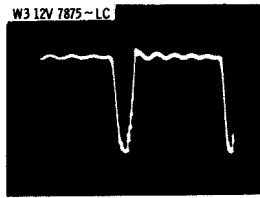
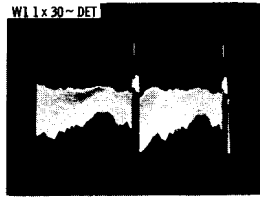
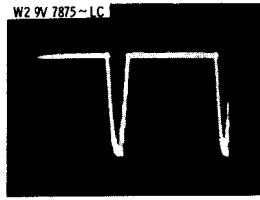

Keyed-Amplified

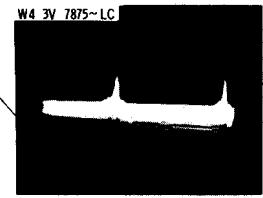
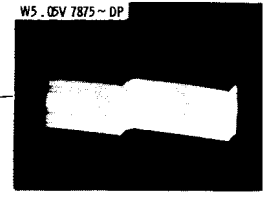
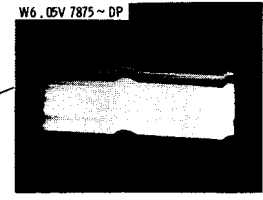

DC VOLTAGES taken with VTVM, on inactive channel; antenna terminals shorted. *Indicates voltages with signal present—see "Operating Variations."

WAVEFORMS taken with wideband scope; TV controls set for normal contrast. DET (detector), LC (low-cap), and DP (direct) probes used where indicated.

Normal Operation

Keyed AGC circuit shown here (from Panasonic Model Mitey 5) is similar to that in several imported transistor TV's. After four stages of amplification, IF signal is coupled to T1; secondary of transformer is tapped to form two sources of video-IF signals—one for video detector diode and one for base of AGC transistor X1. X1 is simply another IF amplifier, whose output is peaked at 42-mc (other sets may use different peaking point). X1 is keyed by negative-going pulse fed to collector; keying pulse is coupled from flyback winding via M1. X1 samples video signal only when pulse causes conduction—during horizontal retrace time. Output of X1 is bursts of 42-mc video, pulsed at horizontal rate. Amplitude of pulses is determined by strength of IF signal at base of X1. M2 detects positive portion of signal, which is then filtered by network C4-R2-C5. Base of X2, then, receives filtered DC voltage developed by M2, proportional to signal strength. R3, R4, R5, R6, R7, and R8 are voltage dividers that supply bias to base and emitter of X2. Supply lines are thoroughly decoupled by C6, C7, and C8. X2 (NPN) functions as DC emitter follower; amplified AGC voltage is taken from emitter. Negative AGC voltage is filtered by R9, C9, and C10, and fed to tuner; AGC to IF's is via R10. Other sets may use positive AGC voltage (see "Solid-State TV" in this issue for details). As you'll see throughout Symptoms, procedure of clamping AGC in transistorized TV's remains one of best ways to confirm AGC troubles.

Operating Variations

- X1** DC voltages on base and collector don't change with or without signal. W1, taken at base with detector probe, remains fairly constant with all signals from strong local stations (due to AGC action). Amplitude of W2 (collector) is not affected by presence or absence of signal. However, test probe at this point causes noise in picture and sound; sync action is also affected to some degree. Designation of 2x, etc., indicates waveform amplitude compared with normal 1x amplitude of W1.
- X2** -2.9 volts at base and emitter will change to average -2 volts with ordinary signal. Strong station decreases voltage to -1.7 volts; fringe station, back to no-signal value.
- A** Resting AGC voltage (-2.8 volts without signal) is reduced on strong station to -1.7 volts. Bias in IF stages becomes more positive and reduces gain. On weak stations, AGC is -2.9 volts (more negative) and IF gain is near maximum.
- C** DC voltage here varies from -1.9 volts with strong local station to -3 volts with fringe-area station. Pulsed RF signal in W4 is good check to prove signal is passing X1 and T2.

Horizontal Pulling

SYMPTOM 1

Top of Raster Affected

M1 Open

(Filter Diode for Pulse)

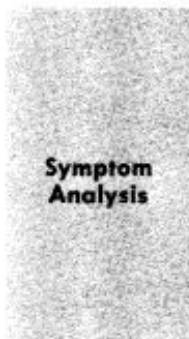

On all local stations, picture pulls at top of screen, has overloaded appearance; buzz is predominant in sound. Fringe-area stations produce normal picture. Clamping AGC line results in normal picture on all channels, pointing to AGC defect.

Waveform Analysis

W1 is normal, except for doubled amplitude (2x); no clue here, unless exact amplitude was known previously. Lack of keying pulse in W2 naturally means that AGC circuit cannot function. W2 shown here was taken with detector probe, and reveals some video signal being coupled across X1. Normal keying pulse in W3, when coupled with lack of pulse in W2, pinpoints trouble to open M1, or defective connection on printed circuit board.

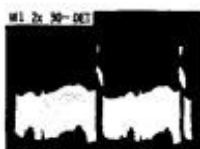

Voltage and Component Analysis

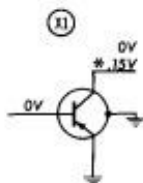

Positive DC voltage on collector of X1 with signal, and zero without, make good voltage clues to trouble in keying stage. X1 conducts normally on negative horizontal pulses, and DC voltage can be measured across R1. Without keying pulse, X1 is cut off, and M2 never receives pulsed IF signal to rectify. With X1 inoperative, base of X2 is at no-signal bias potential—even with station tuned in. AGC voltage remains at no-signal value, so IF stages run at high gain. Open R1 or flyback winding would cause similar symptom.

Best Bet: Scope to isolate; ohmmeter to confirm.

Slight Horizontal Bending

SYMPTOM 2

Reduced Video

M1 Shorted

(Filter Diode for Pulse)

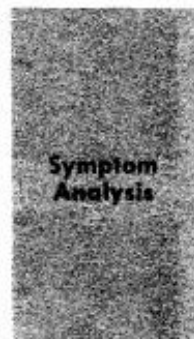
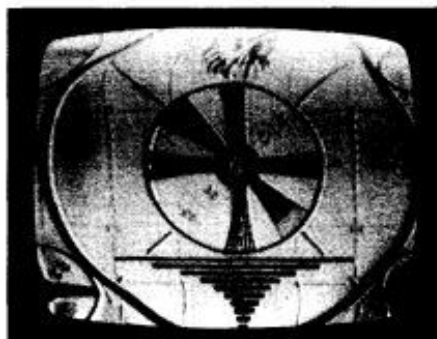

Bending and pulling over entire screen; more severe on strong local channels. Pix tube presentation has appearance of video or AGC trouble rather than defect in one of horizontal sync stages. However, clamping AGC line fails to improve picture.

Waveform Analysis

Most logical scope check is at output of video detector. Scoping there at 7875 cps (see waveforms) reveals large spike in horizontal sync region (compare with normal). Interference like this is usually caused by radiation or unwanted coupling within receiver. Suspicion is placed on AGC again. W1 (not shown) looks normal; W2, however, offers clue—notice ripple on baseline. W6 (not shown) is normal, so interference isn't coupled via AGC line.

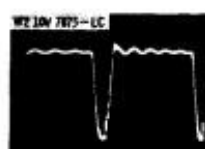
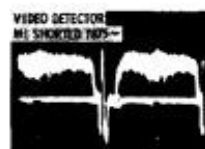

Voltage and Component Analysis

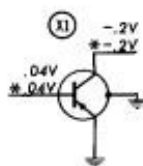

DC voltages on base and collector of X1 confirm suspicion of trouble in AGC circuit. Positive voltage on base and only -0.2 volts on collector should lead to further checking in circuit, and discovery of faulty M1. Direct radiation of interfering pulse from M1 (acting as resistor) to video detector circuit is suspected for several reasons: AGC source is clean (no ripple); lead that couples pulse from flyback is shielded (to prevent possible radiation); M1 is physically located on printed circuit board near video diode.

Best Bet: Clamp AGC; then scope; VTVM last.

Picture Washed Out

SYMPTOM 3

Sound Normal

R9 Increased in Value

(AGC Decoupling Resistor—330 ohms)

Symptom Analysis

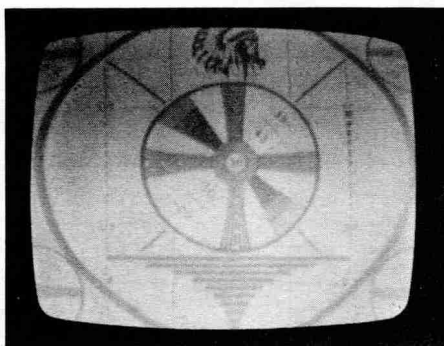

No picture on fringe channels, and only weak video on strong local stations. Vertical and horizontal sync is stable, and contrast and brightness controls are operative. Trouble could be caused by defect located in front-end, video, or AGC stages.

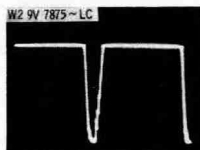
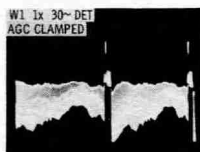
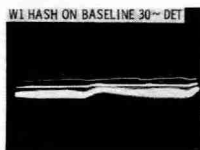

Waveform Analysis

W1 contains no readable signal—just hash on baseline. However, it does offer clue that trouble isn't in video amplifier; similar waveform is present at Point B. Clamping AGC line at Point A returns W1 to normal, indicating defect in AGC circuit. W2 offers no clue—it's normal. In transistor sets such as this one, it may be necessary to vary value of clamping voltage when switching to different channels. Minute voltage changes usually affect operation.

Voltage and Component Analysis

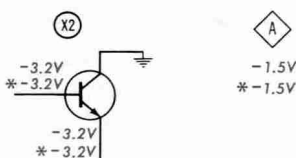

Voltages on X2 don't vary as they should when switching from local to fringe stations. Voltage at Point A offers clue—it's down to -1.5 volts; notice emitter of X2 reads -3.2 volts. Under normal conditions, voltage at A is about same as that at emitter; instead, 1.7 volts is dropped by R9. Decrease in negative AGC voltage shifts bias on tuner and IF transistors, lowering their gain, producing a weak picture. In this instance, R9 had increased to approximately $15K$. If value reaches as much as $50K$, both video and sound are lost.

Best Bet: Bias box and VTVM will locate trouble.

Overloaded Picture

Intermittent Vertical Roll

SYMPTOM 4

X1 Leaky

(AGC Keying Transistor)

Symptom Analysis

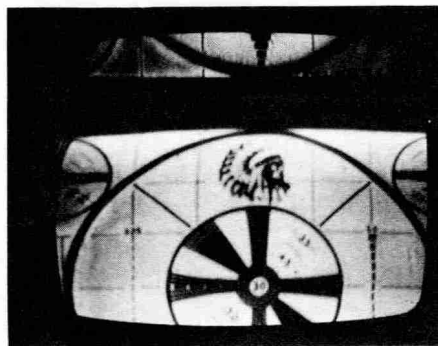

Sound is normal on all channels. Picture has severe overload condition on strong local stations; on fringe stations, set seems almost normal. Vertical sync is lost occasionally. Clamping AGC line corrects condition—pointing to trouble in AGC circuit.

Waveform Analysis

Only clue offered by W1 is amplitude—twice as great as normal; slight reduction of vertical sync pulse won't attract attention. With AGC clamped, W1 is normal—proving front-end stages are okay. W2 is also normal, offering no clue to trouble. Strange shape of W4 (very little RF and keying pulses are ringing), considering good signals applied to base and collector of X1, narrows trouble to X1 itself or collector-circuit components.

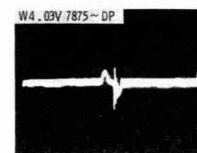
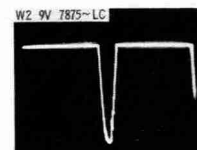
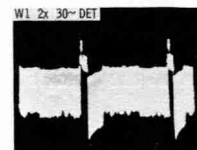

Voltage and Component Analysis

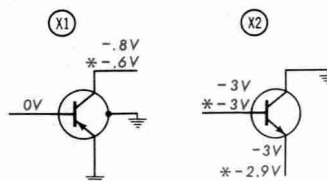

Faulty X1 might be overlooked since waveforms on base and collector look normal. However, collector voltage (-0.6 volts, fluctuating with signal) looks a little suspicious; when considered with improper W4 (M2 input), narrows possibilities to T2, C2, X1, or M2. Voltages on X2 offer more proof of trouble in X1 stage—they don't change appreciably with or without signal. Check on condition of T2 and M2 is necessary before concluding X1 is bad. In this instance, X1 had developed base-collector leakage (Icbo).

Best Bet: Bias box, scope, then VTVM solves problem.

Picture Washed Out

SYMPTOM 5

Sound Weak

R8 Increased in Value

(Bias Supply Resistor—100 ohms)

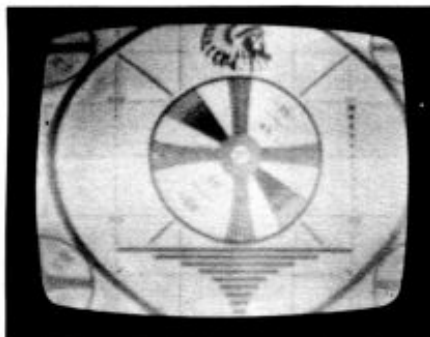
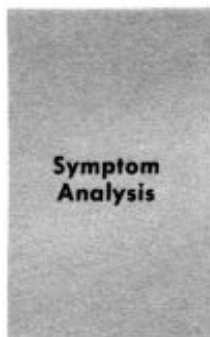

Picture is weak and sound contains hissing noise on all local channels. No picture or sound on fringe-area signals. Contrast control is operative, but can't be set to give good picture. No snow is present. Clamping AGC line restores set to normal operation.

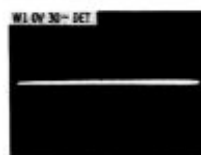

Waveform Analysis

Lack of signal in W1 shows only that no IF signal is reaching this point; IF's probably blocked, because no snow is visible. If signal were being lost between T1 and base of X1, no-signal AGC voltage would likely cause overloading—not weak video. Clamping AGC line with approximately -2.5 volts returns picture and W1 to normal. Keying pulse is good in W9; W4 (not shown) is also good with AGC clamped, so trouble must be in X2 stage.

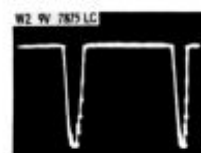
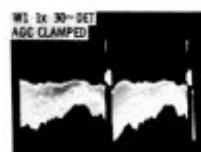

Voltage and Component Analysis

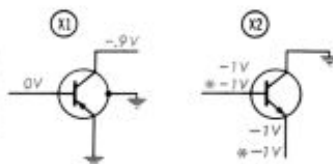

Voltages on X1 are normal. Voltages on base and emitter of X2 (with or without signal) offer strong clue to trouble. Normal -2.9 volts is only -1 volt; most likely cause is upset in resistive bias network. Both R6 and R8 are prime suspects. Lowered negative voltage on AGC line fed to front-end stages reduces gain, producing weak picture. Here, value of R8 had increased to approximately 3000 ohms; a further increase would result in total loss of picture and sound. A check on condition of other bias resistors is callback insurance.

Best Bet: Bias box and VTVM will locate trouble.

Weak Picture

SYMPTOM 6

Buzz in Sound

X2 Leaky

(DC Amplifier Transistor)

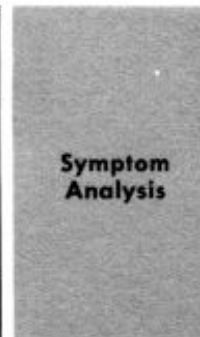
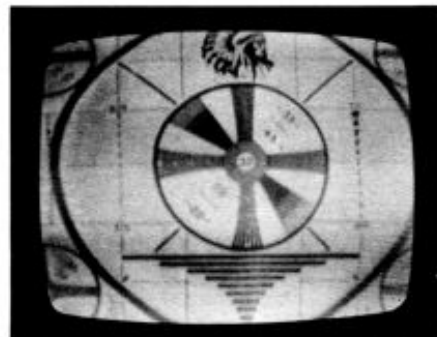

Picture is very weak on local channels—even with contrast control set at maximum. Vertical and horizontal sync are lost intermittently on some channels, are critical on others. Picture and sound from fringe-area stations are lost completely.

Waveform Analysis

Here, as in Symptom 5, check of W1 indicates signal isn't passing front-end stages. Clamping line at Point A, however, returns W1 and set operation to normal. Notice how helpful bias box is for servicing transistorized sets. Thus, one simple check, when AGC is suspected or even hinted, can save valuable time. Next logical scoping point is W2; it's normal, suggesting tests in next stage—X2. Waveforms in this stage (W5 and W6) don't offer clue.

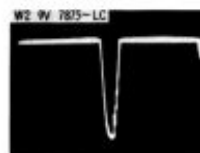
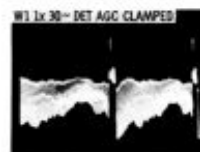
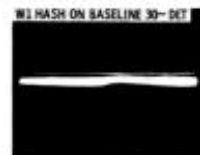

Voltage and Component Analysis

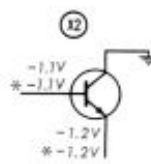

Voltages on base and emitter of X2, with or without signals, are proof of trouble in X2; all readings are down 50%. Supply voltage is okay at source. Bad resistors in bias network could be causing trouble, so each should be checked. Defective X2 (Icbo or base-to-collector leakage) provides unwanted path to ground for bias voltage, drastically upsetting operation of X2. Since emitter voltage is source of AGC, gain of RF-IF stages is affected. A leaky or shorted C6, C7, C9, or C10, or open supply resistors, could cause similar symptoms.

Best Bet: VTVM for voltage and resistance tests.

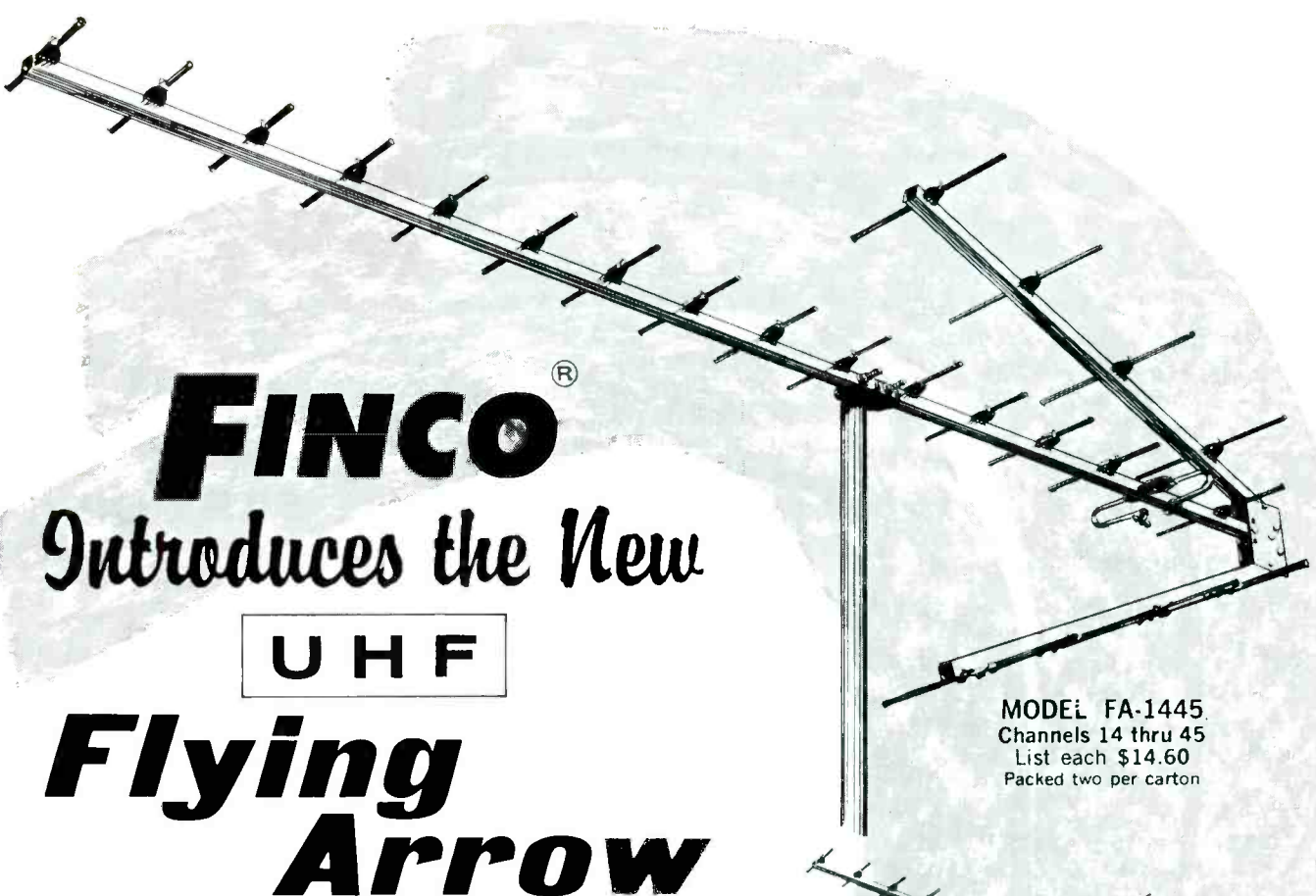

FINCO[®]

Introduces the New

UHF

Flying Arrow

A silver aluminum 16 element corner reflector yagi, which gives the advantages of front to back ratio and vertical plane pattern of the corner reflector to the narrow horizontal plane pattern of the multiple element yagi. Recommended for fringe area reception.

Compare Finco's Advantages

QUESTION	FINCO FA SERIES	COMPETITION
Aluminum boom?	Yes	No — plated steel
Aluminum elements?	Yes	No — plated steel; not a question if it will rust, only a question of when.
One piece boom?	Yes	No
Light weight for handling and mast load?	Yes (2¼ lbs.)	No (5¼ lbs.)
Elements foldable to avoid bending in shipment?	Yes	No
Aluminum dipole terminal?	Yes	No — steel.
Aluminum screw and nut at terminals?	Yes	Yes
Positive location of dipole on boom?	Yes (preassembled)	No — loose in carton.
Tubular corner reflector "booms"?	Yes	No — channel section used, allowing torsional vibration.
Folded dipole for proper impedance match to 300 OHM line?	Yes	No—delta match used which is more frequency sensitive (less band width).

MODEL FA-1445
Channels 14 thru 45
List each \$14.60
Packed two per carton

MODEL FA-4570
Channels 45 thru 70
List each \$14.60
Packed two per carton

MODEL FA-7083
Channels 70 thru 83
List each \$14.60
Packed two per carton

A FINCO EXCLUSIVE

FINCO'S remarkable product performance is made possible through actual nationwide field research by the incomparable FINCO Mobile Laboratory Fleet—a group of science units dedicated to better TV•FM reception quality.

THE FINNEY CO.

34 W. Interstate
Bedford, Ohio 44014



WRITE FOR CATALOG NO. 20-250

Circle 14 on literature card

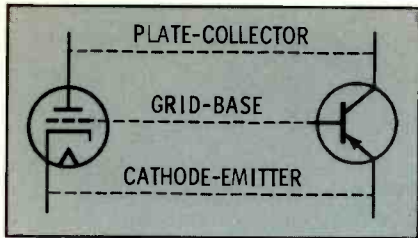

Fig. 1. The transistor and triode are similar.

Whether we like it or not, transistor servicing is here to stay. Every day transistor radios, amplifiers, and other devices stream relentlessly out of manufacturing plants. These units do require installation, maintenance, and adjustment. Because the transistor circuits are generally no more complicated (and often less so) than tube circuits, we should take a vital interest in the servicing of these new products.

Transistor Terms

A transistor isn't built like a tube, doesn't look much like a tube, nor does it amplify in the same way that a tube does. However, for clarity and simplicity in understanding the operation of a transistor it can always be compared to or contrasted with a tube.

Thinking in transistor terms is an important first step in learning the transistor servicing art. If we know what we are talking about, we're on the road to proficiency in servicing transistor products. Although most of us probably know what the emitter, collector, and base of a transis-

tor are, and to which element in a tube they vaguely correspond, let's review these points briefly. Fig. 1 illustrates all these comparisons.

First, what is the emitter? Obviously, it must be the element of a transistor that *emits* (or at least is said to). In a tube the heated cathode *emits* electrons. We thus have the first comparison—the emitter of a transistor and the cathode of a vacuum tube.

Next, let's take a look at the collector of the transistor; its purpose must be to *collect* something. The corresponding element in a tube is the plate; it *collects* the electrons being emitted by the cathode, and it could safely be referred to as a collector. So we have the second comparison—the collector corresponds to the plate of a tube.

Third, we have an element in the transistor called the base; it is used to *control* the current flow between the emitter and the collector. In a tube this corresponds with the *control* grid. So then, the base corresponds to the control grid of a tube.

The foregoing are comparisons only for the sake of pegging in your memory the names and functions of the transistor elements. It would be entirely wrong to say that these elements compare in every way to the corresponding elements in tubes. There are several differences but, for the sake of servicing, these differences need not cloud the issue.

Lead Recognition

The external lead arrangements of a transistor should also be wedged firmly into your memory so you can make voltage and other checks quickly and systematically without having to refer to a transistor manual, except for special types. Three rules that will help you to remember the lead arrangements are:

1. The base lead is usually the middle one.
2. If one lead is marked in any way, it is generally the collector lead.
3. With the leads pointed toward you, the physical positioning of most transistor leads corresponds to the schematic symbol (Fig. 2).

That last rule needs some explanation. Fig. 2 shows a lead arrangement that does not have a specific collector marking but our Rule 1

ME?

DO TRANSISTOR SERVICING?

by Wayne Lemons

still applies. Note how the position of the leads does correspond exactly to the schematic symbol of the transistor. Fig. 3 shows a triangular lead arrangement with the collector marked (Rule 2), and we can also apply Rule 1. Here again we must rely on the transistor symbol. With the collector at the top, the emitter and base leads fall in their proper order.

A few transistors, such as some surface-barrier types, violate Rule 3 even though Rules 1 and 2 apply. In these cases the base and emitter leads are reversed, as in Fig. 4.

Polarity of Voltages

Once we have become familiar with the names and positions of the transistor elements, we need to know what voltages to expect on transistors. We know there are two general types of transistors—the PNP, which is most popular, and the NPN. What is the real difference between these two types? For servicing, the one real difference is that these two types of transistors have opposite bias and collector voltages. The PNP transistor should have negative collector and bias voltages while the NPN transistor should have positive collector and bias voltage. For checking voltages on the two types, all we do is reverse the meter leads when going from one

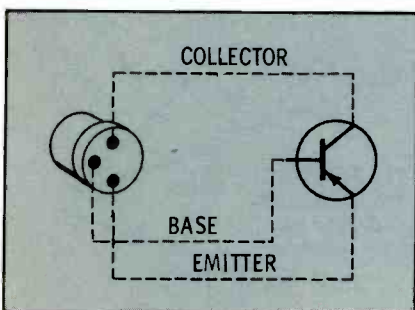

Fig. 2. Physical lead arrangement conforms to the transistor symbol used in most schematics.

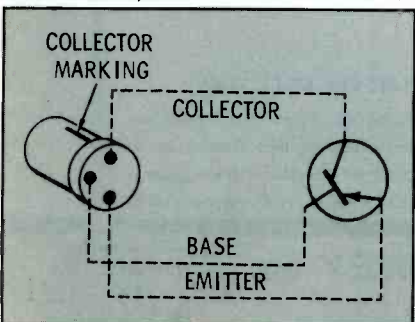

Fig. 3. Using the transistor symbol as an aid in finding base, collector, and emitter leads.



type to the other.

But, you say, how can I remember which type should have which voltage? The easy way is to go by the center letter in the designation. PNP, with the *N* in the center, tells us the collector and bias voltages should be negative. For NPN, with the *P* in the center, the opposite polarity is required—positive collector voltage and positive bias.

What about collector and bias voltages; where do we read them from? They are read in the same manner as voltages on the elements of a tube. If we measure the bias voltage of a tube, we measure between the grid and cathode; the plate voltage would be between the plate and cathode. Notice here that we specify *cathode*. In tube circuits, it is common practice to read these voltages to ground (B—minus or common), but only because the cathode is usually at—or very near to—ground or common potential.

For transistor circuits, the bias voltage should be read between the base and emitter; the collector voltage should be read between the collector and emitter. Reading either of these voltages with respect to ground can easily lead to errors in interpretation because the designer may have chosen either a positive or a negative ground. In Fig. 5 we have two sketches of a transistor

circuit typical of those in a transistor radio. In Fig. 5A the voltages listed are read with respect to ground, and in Fig. 5B they are read with respect to the emitter. You can see in Fig. 5B how much easier it is to tell that the bias and collector voltages are negative. When you start, it is least confusing to use the emitter of a stage as the reference point when you are reading bias and collector voltages. However, many schematics list only readings taken to ground, so you have to use your judgment as to which is the best method for you to use.

How Critical are Bias Voltages?

Bias voltages are not so critical as you might sometimes imagine. In a strict technical sense, of course, we have to say a transistor is biased by current not voltage. However, we must have voltage to produce the current, and the voltage is easiest to measure. If we measure the specified amount of bias voltage and if it is of the same polarity as the collector, there must be current flow in the base-emitter circuit, which is what we're looking for.

In checking through schematics you may find that many different bias-voltage readings are listed for similar transistor types. Don't let this disturb you, since transistor biasing is not too critical—within certain limits. For example, you may find that a radio you are checking has only .1 volt of bias while the schematic may call for .15 volt. This does not necessarily mean you have found a trouble, nor that your radio will play less vigorously. Most low-power transistors (the type used in all portable transistor radios for all stages) will operate at full gain with a .1-volt bias *if* that bias is of the correct polarity. Increasing the bias to .15 volt increases the collector current but does not normally increase the transistor gain. This is so because transistors, in common with triode tubes, have a bias "plateau" around which a change in bias does not affect the actual gain but only the current the stage draws.

Most transistors, except in audio output stages, are biased so they have an emitter current of about 1 ma. If an emitter resistor is used, you can check the emitter current by measuring the voltage drop. For example, if the emitter circuit has a

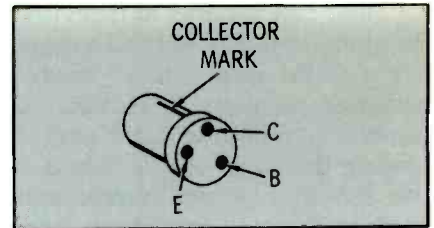

Fig. 4. Leads of surface-barrier transistor.

1000-ohm resistor and an emitter current of 1 ma, there should be about 1 volt dropped across the resistor; a 470-ohm resistor should have about a .45-volt drop. One milliamperes of emitter current is considered as a design standard, but some transistors may have half as much or twice as much current.

There is only one circuit in which you may be confused by taking the bias-voltage readings between the base and the emitter. This is in oscillator circuits or converter circuits. Here you may find the bias polarity opposite to the collector polarity (Fig. 6). This is so only because you are reading the DC bias and not the *instantaneous* voltage that appears between the base and emitter. Part of the instantaneous voltage is the negative excursion of the oscillator feedback voltage, and this voltage will trigger the transistor back into conduction on part of each half-cycle.

If you wish to see if a transistor oscillator is working, simply measure the bias voltage and then disturb

• Please turn to page 75

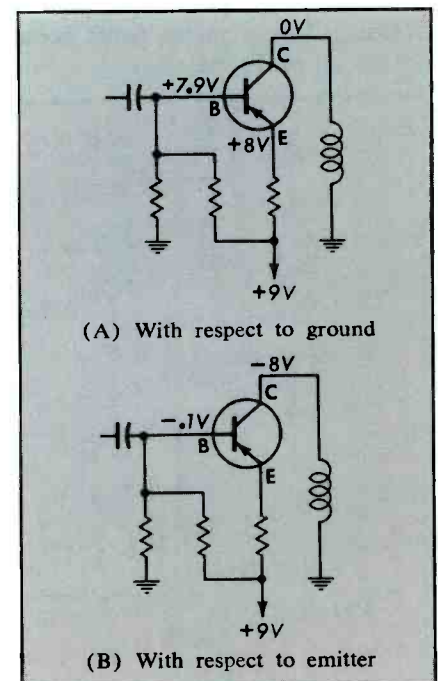

Fig. 5. Reading circuit voltages with a VTVM.

These case histories of radio troubles were specially selected to cover some of the more difficult troubleshooting problems. Each case describes in detail the exact steps in finding the cause of a certain trouble. You may believe, in some cases, that there is a simpler or better approach to track down the fault. This point we don't wish to argue, since there is seldom a *best* way to do anything; there are certainly more ways than one to skin a cat, but the results are substantially the same.

In transistor servicing, though, time is a prime object. Seemingly crude methods, such as bypassing each electrolytic in a weak or oscillating radio, may seem unsavory to the plodding analyst; but if it locates the trouble three or four times faster than other methods, who can say it is really crude?

Weak and Distorted Sound

Most distorted radios are also weak. Find the distortion, and the volume will probably return to normal. Distortion generally occurs in audio stages (Fig. 1), so this will be our "target area."

Step 1: Connect radio to power supply. Check current drain with volume turned down.

Result: Approximately 8 ma of current drain.

Decision: 8 ma is probably correct for this model.

Step 2: Tune in station, increase volume, and check current drain.

Result: Current meter reads about 20 ma on peaks.

Decision: Output-stage bias is probably okay.

Step 3: Measure bias on each output transistor, between base and emitter.

Result: Bias on each transistor is about .1 volt.

Decision: Seems normal.

Step 4: Check base-to-emitter bias on driver stage.

Result: Reads about .2 volt.

Decision: This reading probably normal.

At this point the distortion could be localized with a signal tracer. However, before resorting to a signal tracer let's check the output and driver transformers with an ohmmeter.

Step 5: Check each half of output transformer primary (from D to E and from F to E in Fig. 1).

Result: Each half checks about 20 ohms.

Decision: Transformer probably okay since both resistances are almost identical.

Step 6: Check secondary halves of driver transformer (A to B and C to B).

Result: Each half checks about 20 ohms.

Decision: This is considerably less than 105 ohms indicated on schematic. However, reading may be low because of forward resistance of output transistors.

Step 7: Reverse ohmmeter leads so transistors will be reverse-biased. Again read resistance of secondary windings.

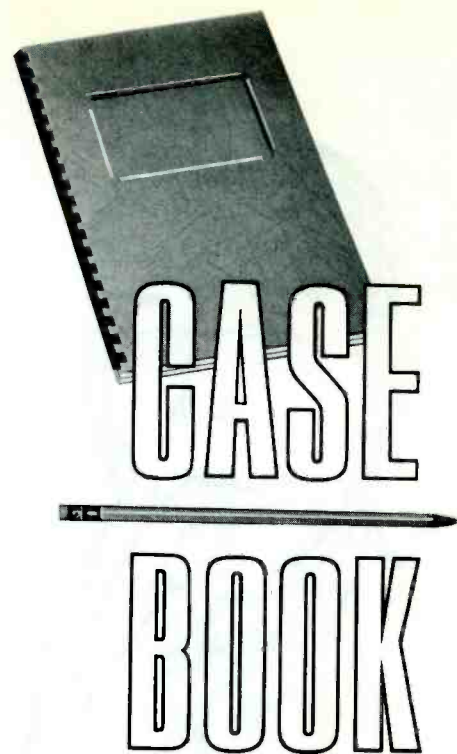

Result: One half reads 105 ohms, and other half reads 85 ohms.

Decision: Shorted windings in driver transformer are causing distortion. To doublecheck diagnosis, disconnect lead A and measure resistance again; still 85 ohms.

Afterthoughts: A defective output transistor may cause symptoms and ohmmeter readings similar to those described above. However, this was unlikely here because the transistor showed diode action (revealed by the resistance measurements). Had the transistor been partially or completely shorted, reversing the test leads would have had no effect on the reading across one half of the transformer—it would have stayed at 20 ohms. A new transformer eliminated the distortion and restored normal volume.

Weak Sound, No Distortion

Trouble could be in any stage—RF, converter, IF, or audio. Systematic checks must be made to isolate the trouble area.

Step 1: Connect radio to power supply. Check current drain at minimum volume.

Result: Current drain 11 ma.

Decision: Probably about normal—however, not conclusive. Find out if trouble is in audio or front-end stages.

Step 2: With set on, rotate volume control while holding speaker close to ear.

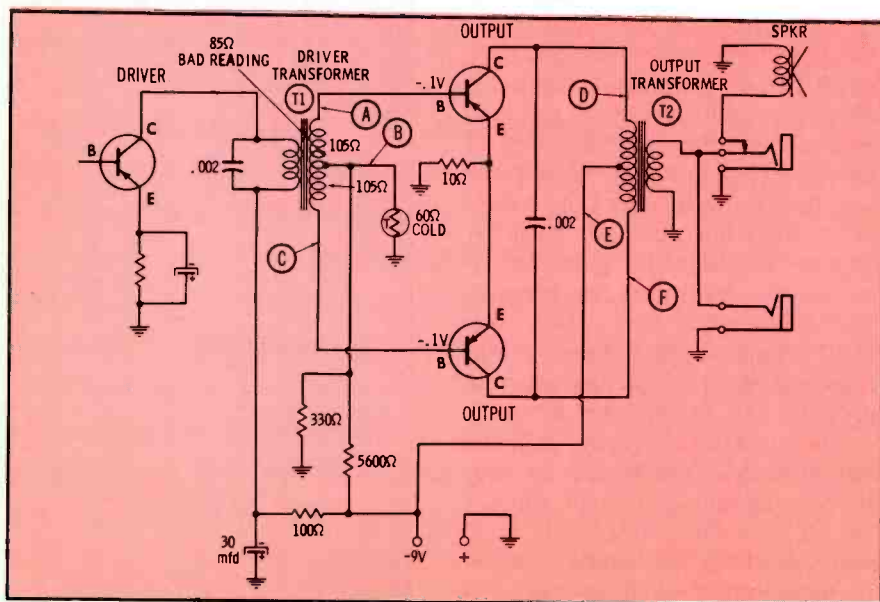

Fig. 1. Distortion is usually caused by a defect in audio circuit.



Most Popular Type

Normal Operation

Converter circuit shown here is typical of those used in hundreds of modern transistor radios. Primary winding of ferrite-rod antenna L1, in conjunction with tuning capacitor C2A and trimmer capacitor C1A, form tunable RF input circuit. Selected station signal is coupled to base of X1 via secondary of L1 and C3. Oscillator portion of converter stage is tuned by combination of C1B, C2B, and L2. Oscillator coil L2 in this circuit is air-core type; frequency limits of tank circuit can be changed only by adjustment of trimmer C1B. (In a number of receivers, oscillator coil is slug-tuned with powdered-iron core.) Collector winding of L2 supplies feedback energy for tank, to sustain oscillations. Tank winding of L2 is tapped to supply proper amount of injection voltage (via C5) for mixing with incoming RF signal in X1. Output IF frequency (455 kc) is developed in L3 and coupled to IF amplifiers. Operating voltage for this receiver (6 volts) is obtained from four series-connected D cells, and negative side of supply returns to chassis ground. X1 is PNP type, so emitter receives positive 4-volt power via R3, while collector is returned to ground (negative). Bias for base of X1 is developed by resistive divider network R1-R2 across power supply.

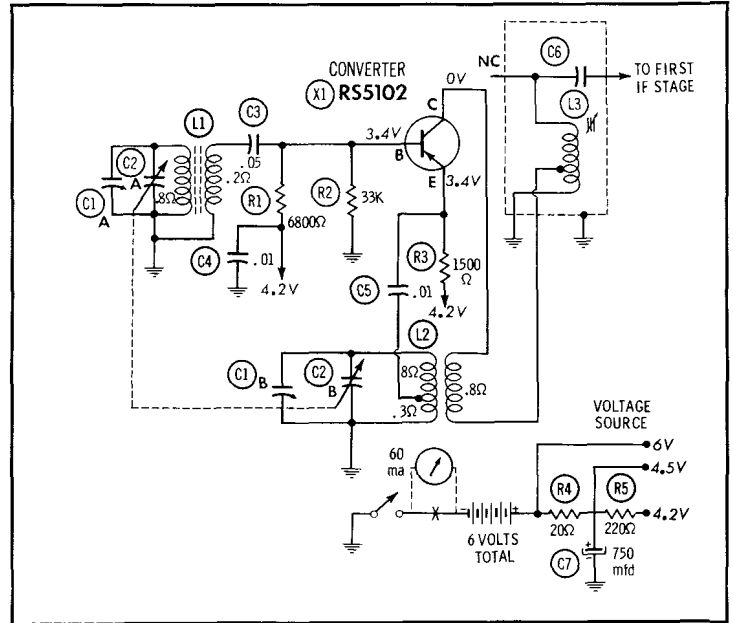

Variations

No noticeable change in operating voltages or total current when signal is applied. Normal idling current for set is 60 ma; with single-ended output, current drain doesn't depend so much on setting of volume control as in receivers with push-pull.

SYMPTOM 1

Dead Receiver

No Noise in Speaker

C5 Open

Analysis

A pop in speaker is heard each time set is turned on, then off; this is clue that output stages are active. With maximum setting of volume control, no noise is heard when set is tuned across band. Quick check by touching volume control arm with finger produces low hum in speaker—further proof audio is working. Conclusion of symptom analysis is that trouble is most likely in some front-end stage. Symptom of this nature is characteristic of dead oscillator.

Troubleshooting Procedures

Quickest way to check for possibility of inoperative oscillator is by injecting unmodulated CW signal into mixer stage, thus simulating local oscillator signal. Tuning gang is initially set to center of rotation, and signal generator is adjusted to approximately 300 kc. Injecting CW signal to emitter of X1 will immediately produce noise in output—if IF and mixer are okay. (It may be necessary to experiment with amount of signal injected from generator; use minimum that will still produce oscillation from most units.) If stations can be heard when frequency dial is rotated (on either radio or generator), bad oscillator is positively confirmed. RF circuit is cleared if reception is nor-

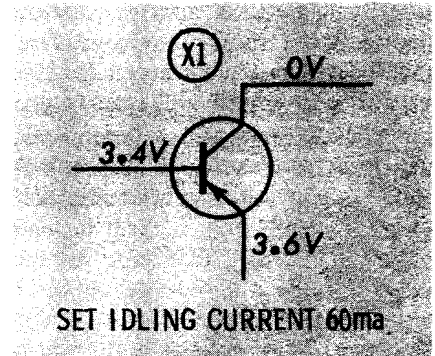

mal. Voltages on X1 offer only vague clue to trouble—even when compared with normal values. 3.4 volts on base is normal (with or without signal); emitter voltage (3.6 volts) is .2 volts higher than normal, indicating more conduction through transistor, caused by less bias. Voltage change could be due to loss of injection signal from tank circuit. Still using minimum signal, inject CW at top of L2; no response (unless signal is increased) is indicative of open C5.

SYMPTOM 2

Slight Distortion

Distant Stations Missing

X1 Leaky

Analysis

Strong station signals are slightly distorted at all settings of volume control. On medium strength signals, volume must be adjusted to maximum for normal listening. Distant stations cannot be received at all. Distortion could be caused by defect in audio stages—most likely place. Fact that distant stations are missing, however, gives valid hint of trouble in some front-end stage. Symptoms suggest voltage checks throughout converter and IF amplifiers are in order.

Converter stage doesn't draw enough current in most transistor receivers to permit tracing trouble by total current drain. In this receiver, disabling converter causes no noticeable change in 60-ma idling current. Voltage checks on IF amplifiers fail to reveal any out-of-tolerance readings. DC voltages on X1 are far from normal and offer definite clue to upset in operating bias of stage. Base voltage has decreased to 1.1 volts; emitter to only 1 volt. Base-bias resistors R1 and R2, and emitter resistor R3 are suspects; if they are okay, leaky X1 is next best bet. (If C3 or C5 were leaky, only one voltage would shift so drastically, not both.) Base-to-collector leakage (approximately 6800 ohms in this instance) causes

Troubleshooting Procedures

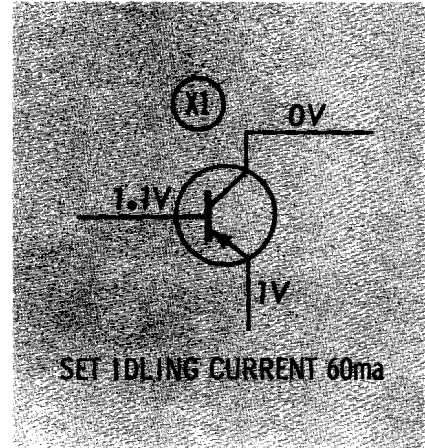

decrease in current through X1, drops emitter voltage, shifts operating point (off curve) of X1, and reduces gain. Nearby stations are received because signal is strong enough to force on through low-gain converter. Distant stations are too weak to get through converter stage without amplification. When transistor leakage is suspected, it's often easier merely to slice printed foil going to transistor leads than to unsolder and remove the unit for ohmmeter checks.

SYMPTOM 3

Intermittent Set

Jarring Helps Sometimes

Poor PC Connection

Analysis

Customer will complain that receiver plays for awhile, then goes dead; other times it won't even start playing. When set is dead, touching finger to arm of volume control produces hum in speaker, so audio stages are active. Shaking or jarring receiver, or pressing on printed-circuit board, sometimes produces sound; other times, not. Problem must be caused by broken printed foil or by intermittent connection to some circuit component. Since audio remains active, trouble must be in stages before volume control.

Any checks must be performed with receiver inoperative—trouble present. Audio stages can be ignored, for they remain operative. Substituting CW signal for local oscillator—to see if it's working—fails to return set to operation. Injecting modulated signal at 455-kc IF frequency at collector of X1 is next logical step, and checks condition of all IF stages at once. Generator signal can be heard in output, clearing all stages except converter. Signal injection to base provides clue that trouble is located in or around X1: generator output must be increased to be heard. If X1 were amplifying signal normally, tone heard in speaker should have

Troubleshooting Procedures

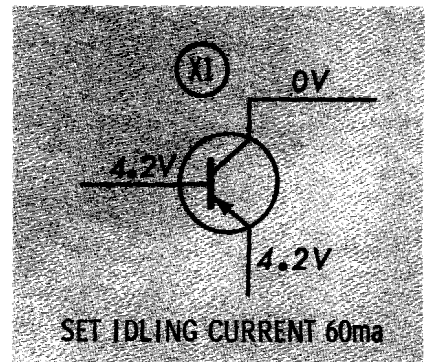

increased—not decreased; at worst, it should have remained the same. Voltages on base and emitter of X1 confirm that transistor isn't operating. Full 4.2-volt source voltage appears at base, implying that divider-resistor ground return may be open. With X1 thus cut off, no collector or emitter current can flow so no voltage is dropped across emitter resistor R3. In this instance, poor solder joint at printed board and junction of R2 caused intermittent operation.



Guide to Importers

More than two years ago (January 1962), we published a guide to help servicers of transistor radios locate the

source of various brands. The number of specific brands has almost gotten out of hand. Literally hundreds of different

brand names have been introduced; often, several names apply to the same basic set or chassis.

This revised version includes almost 250 of the most popular brands that are being distributed on a national basis. There are many others, usually private brands of only limited production or sold in only a small area of the country. As readers and importers encounter additional brands and notify us of them, we will try to locate the source and add them to this guide; then we can publish an updated version periodically. This reader service should help all of you who have heretofore avoided transistor repairs because such source information has been hard to find.

Acme	86	Commodore	37	Hemisphere	115	Mitsubishi	93	Sonnet	15
Air Chief	54	Concertone	8	Hemotape	74	MMA	87	Sony	121
Airline	95	Concord	38	Hi-Delity	108	Monacor	94	(Radio Div.)	
Aiwa	117	Constant	29	Hilton	132	Monarch		Sony	128
Akkord	115	Consul Deluxe	59	Hitachi	69	Nanola	82	(Tape Rec. Div.)	
Aladdin	112	Continental	40	Honeytone	15	(Nanao)		Sovereign	25
Alaron	19	Coronado	58	Holiday	112	National	91	Spica	112
Alpha	134	Coronet	13	Hosho	38	NEC	76	Standard	122
Ambassador	5	Corvair	141	Imperial	66	Nipco	104	Star-Lite	124
AMC	3	Cosmopolitan	49	Intermark	73	Nippon Columbia	104	Stenorette	45
Americana	112	Craig	41	International	7	Noam	99	Stenotape	10
Amertone	7	Crest	134	Invicta		Nobility	98	Stuzzi	51
Angel	13	Crestline	29	Invictor	137	Nordmende	125	Sudfunk	44
Apolo		Crown	71	Ionic	13	Norelco	101	Summit	126
Apolex	11	Daltone	43	ITT	70	Nova-Tech	102	Superex	127
Apolec		Delmonico	44	Jacquar	97	Omega	100	Supreme	129
Ardley	138	Ebner	53	Jefferson-Travis	50	Omscolite	104	Suburbia	100
Argonne	81	Ehr-Corder	13	Juliette	136	Onkyo	116	Tandberg	130
Arleigh	12	Eldorado	35	Kalimar	75	Oritone	15	Telefunken	9
Arrow	13	Electra	48	Kaytone	77	Pacific	105	Tempest	18
Audio	16	Empire	138	Ken	78	Panasonic	91	Ten	116
Audion	16	Engineers	114	Kensington	131	Peerless	106	Three Star	96
Aud-I-Tone	40	Eterna	49	Kent	79	Pendleton	77	Times	15
Autovox	17	Evans	86	Knight	6	Penncrest	107	Titan	40
Baylor	133	Ever-Play	64	Kobe	68	Perdio	110	TMK	137
Becker Auto Radio	21	Excel	141	Kogyo	68	Petite	85	Tokai	135
Beniida	89	Executive	15	Kowa	80	Philips	101	Toko	15
Best Tone	22	Falcon	108	Lafayette	81	Phono Trix	92	Toptone	61
Blaupunkt	20	Family	13	Lic	84	Plata	77	Toshiba	141
(Auto Radio)		Fen-Tone	53	Lincoln	6	Playboy	126	Trancel	141
Blaupunkt	109	Fi-Cord	67	Linmark	120	Raleigh	77	Transette	42
Bona	13	Fidelity	114	Little Pal	86	Realistic	110	Transitone	111
Boothco	24	Fleetwood	41	Lloyd's	83	Realtone	111	Tunico	89
Bradford	62	Fountain	66	Longwood	80	Remington	77	Tussah	143
Brenell	53	Four Star	55	Lucor	85	Renown	98	TWI	142
Brighton	1	Freeman	56	Maco	91	Rhapsody	19	Uher	88
Brother	25	Fujico	15	Manhattan	86	Riviera	112	Valiant	144
Browni	26	Fuji Denki	47	Mansun	86	Roberts	113	Vesper	15
Bulova	27	Fujitone	13	Mantone	86	Robin	31	Victoria	31
Butoba	123	Fujiya	57	Mark	134	Ross	114	Viscount	39
Calrad	28	Geloso	10	Marvel	86	Sampson	115	Vista	41
Candle	30	General	140	Masterwork	36	Sansei	47	Warman	145
Canton-Son	29	Global	90	Matsushita	91	Sanshin	15	Wilco	116
Capri	96	Golden Shield	60	Mayfair	14	Satellite	23	Windsor	146
Channel Master	33	Grand Prix	2	Melodic	80	Saxony	139	Yaou	134
Cipher	73	Grundig	63	Mel Rose	52	Seminole	118	Yashica	147
Citroen	56	Hadson	32	Minico	13	Sharp	119	York	98
Claricon	103	Halco	68	Minute-Man	72	Sheraton	25	Zepher	46
Clairtone-Braun	34	Harlie	65	Mirandette	4	Skymaster	98		
Columbia	36	Harpers	66	Miranda		Sonate	24		

1. A & A Trading Co.
1140 Broadway
New York, N.Y.
2. A & S Trading Co.
124 West 30 Street
New York, N.Y.
3. Aimcee Wholesale Corp.
1400 Broadway
New York 18, N.Y.
4. Allied Impex Corp.
300 Park Avenue, S.
New York, N.Y.
5. Allied Purchasing Co.
401 Fifth Avenue
New York, N.Y.
6. Allied Radio
100 North Western Avenue
Chicago 80, Ill.
7. Amerex Trading Co.
444 Fifth Avenue
New York, N.Y.
8. American Concertone Div.
Astro-Science Corp.
9731 Factorial Way
South El Monte, Calif.
9. American Elite, Inc.
48-50 34 Street
Long Island City, N.Y.
10. American Geloso Electronics, Inc.
251 Park Avenue South
New York 10, N.Y.
11. Apolo Electric Co.
P.O. Box 1221
Studio City Station
North Hollywood, Calif.
12. Arel Corp.
39 30 Street
Queens, N.Y.
13. Arrow Trading Co.
1133 Broadway
New York, N.Y.
14. Artic Import
1024 West Randolph Street
Chicago 7, Ill.
15. Associated Importers
34 Dore Street
San Francisco, Calif.
16. Audion Importers
18 West 27 Street
New York, N.Y.
17. Autovox Corp. of America
250 West 57 Street
New York 19, N.Y.
18. Azad International
1133 Broadway
New York, N.Y.
19. B & B Import-Export Co.
15755 Wyoming Avenue
Detroit 38, Mich.
20. Robert Basch Corp.
40-25 Crescent Street
Long Island City, N.Y.
21. Becker Autoradio U.S.A., Inc.
613-19 South 24 Street
Philadelphia 46, Pa.
22. Best Tone Electronics
295 Fifth Avenue
New York, N.Y.
23. Best of Tokyo
11 West 42 Street
New York, N.Y.
24. T. R. Booth & Co.
12 North Spring Street
Waukegan, Illinois
25. Brothers International
36-50 38 Street
New York, N.Y.
26. Charles Brown & Co.
1170 Broadway
New York, N.Y.
27. Bulova Watch Co.
Bulova Park
Flushing 70, N.Y.
28. Burstein-Applebee Co.
1012-14 McGee Street
Kansas City 6, Mo.
29. Canton-Son, Inc.
12 West 27 Street
New York, N.Y.
30. Candle America Corp.
Los Angeles, California
31. Capital Appliance Distr. Div.
1201 West Washington
Indianapolis, Ind.
32. Carolina Mfg. Co.
315 Fifth Avenue
New York, N.Y.
33. Channel Master Corp.
Ellenville, N.Y.
34. Clairtone Sound Corp., Ltd.
18-25 26 Road
Long Island City 2, N.Y.
35. A. Cahen & Sons, Inc.
27 West 23 Street
New York, N.Y.
36. Columbia Records Sales Corp.
1080 Goffe Road
Hawthorne, N.J.
37. Commodore Import Corp.
507 Flushing Avenue
Brooklyn 5, N.Y.
38. Concord Electronics Corp.
809 North Cahuenga Boulevard
Los Angeles 38, Calif.
39. Consolidated Sewing Machine Corp.
520 West 34 Street
New York, N.Y.
40. Continental Merchandise Co.
236 Fifth Avenue
New York 1, N.Y.
41. Craig Panorama, Inc.
3412 South Lacienga Boulevard
Los Angeles, Calif.
42. Custom Importing Co.
1519-21 Atlantic Street
North Kansas City 16, Mo.
43. Dalamal & Sons
1185 Broadway
New York, N.Y.
44. Delmonico International
50-35 56 Road
Maspeth 78, N.Y.
45. Dejur-Amsco Corp.
Northern Blvd. at 45 Street
Long Island City, N.Y.
46. Eastern Associates, Ltd.
40 Spear Street
San Francisco, Calif.
47. Eisenberg & Co.
52 Broadway
New York, N.Y.
48. Electra Industries Co.
1204 Broadway
New York, N.Y.
49. Elize Mercantile of New York
1140 Broadway
New York, N.Y.
50. Emerson Radio & Phono Corp.
524 West 23 Street
New York 11, N.Y.
51. Ercona Corp.
432 Park Avenue South
New York 16, N.Y.
52. Federal Aides Corp.
875 Broadway
Brooklyn, N.Y.
53. Fen Tone Corp.
106 Fifth Avenue
New York, N.Y.
54. Firestone Tire & Rubber Co.
1200 Firestone Parkway
Akron, Ohio
55. Fortune Star Products
1207 Broadway
New York, N.Y.
56. Freeman Electronics Corp.
729 North Highland Avenue
Los Angeles 38, Calif.
57. Fujiya Corp., Ltd.
45 West 21 Street
New York, N.Y.
58. Gamble-Skogmo, Inc.
15 North Eighth Street
Minneapolis 3, Minn.
59. General Consolidated, Ltd.
87 Dell Glen Avenue
Lodi, New Jersey
60. Golden Shield Corp.
Great Neck, N.Y.
61. Goshu Trading Co.
50 Broad Street
New York, N.Y.
62. W. T. Grant Co.
1441 Broadway
New York 18, N.Y.
63. Grundig-Triumph-Adler Sales Corp.
845 Third Avenue
New York 22, N.Y.
64. Gulton Industries, Inc.
212 Durham Avenue
Metuchen, N.J.
65. Harlie Transistor Prod.
393 Sagamore Avenue
Mineola, L.I., N.Y.
66. Harpers International, Inc.
315 Fifth Avenue
New York, N.Y.
67. Karl Heitz, Inc.
480 Lexington Avenue
New York, N.Y.
68. Helen Associates
125 Fifth Avenue
New York, N.Y.
69. Hitachi Sales Corp.
666 Fifth Avenue
New York, N.Y.
70. ITT Distributor Products Div.
P.O. Box 99
Lodi, N.J.
71. Industrial Suppliers Co.
755 Folsom Street
San Francisco, Calif.
72. Intercontinental Industries, Inc.
555 West Adams Street
Chicago 6, Ill.
73. Inter-Mark Corp.
29 West 36 Street
New York 18, N.Y.
74. Interocean Merchandise Corp.
44 Whitehall Street
New York, N.Y.

75. Kalimar, Inc.
2644 Michigan Avenue
St. Louis 18, Mo.
76. Kanematsu New York
1 Whitehall Street
New York, N.Y.
77. Kaysons International, Ltd.
506 West Pico Boulevard
Los Angeles, Calif.
78. Ken Electronics
500 Fifth Avenue
New York, N.Y.
79. Kent Overseas, Inc.
14 West 23 Street
New York, N.Y.
80. Kowa American, Inc.
230 Fifth Avenue
New York, N.Y.
81. Lafayette Radio Co.
111 Jerico Turnpike
Syosset, L.I., N.Y.
82. Leopold Sales Corp.
Box 276
Highland Park, Ill.
83. Lloyd Trading Co.
1147 South Hope Street
Los Angeles, Calif.
84. Lucky International
1155 Broadway
New York, N.Y.
85. Lucor Electronics, Inc.
22-14 40 Avenue
Long Island City 1, N.Y.
86. Manhattan Novelty Co.
263-265 Canal Street
New York, N.Y.
87. Manufacturers Marketing Assn., Inc.
1 North LaSalle Street
Chicago 2, Ill.
88. Martel Electronic Sales
645 North Martel
Los Angeles 36, Calif.
89. Marubeni Iida
39 Broadway
New York, N.Y.
90. Masuyama International Corp.
214 West 14 Street
New York, N.Y.
91. Matsushita Electric Corp.
200 Park Avenue
New York 17, N.Y.
92. Matthew Stuart & Co., Inc.
156 Fifth Avenue
New York, N.Y.
93. Mitsubishi Electric Corp.
119 East Lake Street
Prudential Plaza
Chicago 1, Ill.
94. Monarch Electronics International
North Hollywood, Calif.
95. Montgomery Ward & Co.
619 Chicago Avenue
Chicago, Ill.
96. Nason Trading Co.
303 Fifth Avenue
New York, N.Y.
97. National Silver Co.
241 Fifth Avenue
New York, N.Y.
98. N.Y. Merchandise Co.
32 West 23 Street
New York, N.Y.
99. Noam Electronics Corp.
11 West 42 Street
New York 36, N.Y.
100. North American Foreign Trading
220 Fifth Avenue
New York, N.Y.
101. North American Philips Co., Inc.
30-10 Review Avenue
Long Island City, N.Y.
102. Nova-Tech, Inc.
1721 Sepulveda Boulevard
Manhattan Beach, Calif.
103. Olson Radio Corp.
260 South Foreg Street
Akron, Ohio
104. Omscolite Corp.
Stokley Street & Roberts Avenue
Philadelphia, Pa.
105. Pacific Import Co.
149 Fifth Avenue
New York, N.Y.
106. Peerless Telerad, Inc.
14 West 29 Street
New York 1, N.Y.
107. J. C. Penney Co., Inc.
330 West 34 Street
New York 1, N.Y.
108. Petely Enterprises, Inc.
300 Park Avenue, S.
New York, N.Y.
109. Pickens Distributors, Inc.
64-01 Woodside Avenue
Woodside 77, N.Y.
110. Radio Shack Corp.
730 Commonwealth Avenue
Boston 17, Mass.
111. Realtone Electronics
71 Fifth Avenue
New York 3, N.Y.
112. Republic Transistor Corp.
170 Broadway
New York 38, N.Y.
113. Robert Electronics, Inc.
5978 Bowcroft Street
Los Angeles 16, Calif.
114. Ross Electronics
320 West Ohio Street
Chicago 26, Ill.
115. The Sampson Co.
2242 South Western Avenue
Chicago 8, Ill.
116. Sanyo Trading Co.
149 Broadway
New York, N.Y.
117. Selectron Int'l. Co., Inc.
4215 West 45 Street
Chicago, Ill.
118. Sans & Streiffe
8400 Brookfield Avenue
Brookfield, Ill.
119. Sharp Electronics Corp.
1270 Avenue of the Americas
New York 20, N.Y.
120. Shriro Trading Corp.
276 Park Avenue, S.
New York, N.Y.
121. Sony Corp. of America
580 Fifth Avenue
New York 36, N.Y.
122. Standard Radio Corp.
410 East 62 Street
New York, N.Y.
123. Stanford Int'l.
569 Laurel Street
San Carlos, Calif.
124. Star-Lite Electronics Corp.
37 West 23 Street
New York, N.Y.
125. Sterling Hi-Fidelity, Inc.
22-14 40 Avenue
Long Island City 1, N.Y.
126. Summit International Corp.
44 Whitehall Street
New York, N.Y.
127. Superex Electronics Corp.
4-6 Radford Place
Yonkers, N.Y.
128. Superscope, Inc.
8150 Vineland Avenue
Sun Valley, Calif.
129. Supreme Merchandise Co., Inc.
1140 Broadway
New York 1, N.Y.
130. Tandberg of America
8 Third Avenue
Pelham, N.Y.
131. Terra International
3 East 28 Street
New York, N.Y.
132. Tessler Industries, Inc.
One Park Avenue
New York, N.Y.
133. Texoma Wholesale Jewelers
512 South Akard Street
Dallas, Texas
134. Alfred Toepfer
1 Broadway
New York, N.Y.
135. Tokai Corp. of America
500 Fifth Avenue
New York 36, N.Y.
136. Topp Import & Export, Inc.
35 N.E. 17 Street
Miami, Fla.
137. Toyomenka, Inc.
2 Broadway
New York, N.Y.
138. Trade Distributors, Inc.
260 Fifth Avenue
New York, N.Y.
139. Trans-Aire Electronics Corp.
393 Segamore Avenue
Mineola, N.Y.
140. Trans-America Import & Export Co.
116 South Michigan Avenue
Chicago 3, Ill.
141. Transistor World Corp.
513 West 24 Street
New York 11, N.Y.
142. Transworld Industrial Corp.
5204 Hudson Avenue
West New York, N.J.
143. Tussah Corp.
1412 Broadway
New York, N.Y.
144. Valiant Importers
6 West 48 Street
New York 36, N.Y.
145. Warman Precision Products Corp.
172 Madison Avenue
New York 16, N.Y.
146. Windsor Pen Co.
88 3 Avenue
Brooklyn, N.Y.
147. Yashica, Inc.
50-17 Queens Boulevard
Woodside 77, N.Y.

Half of all TV lead-in cable needs replacement...now!

TV lead-in cable should be replaced at least once every two years. Hot summers, cold winters, and salty air do the dirty work... and the picture suffers.

This means that you have a made-to-order replacement market. Automotive garages make extra profits by selling replacement spark plugs and fan belts. You can make extra profits simply by telling your customer how his old deteriorated cable keeps him from getting the best possible picture.

Tell him about the best... Belden. It is an insurance policy against weak signals and reception failure. And there is a Belden lead-in cable for every requirement, including Permohm* for areas of salt or industrial contamination, Weldohm† with 2½ times the flexing strength of ordinary lead-in, Celluline* for resistance to sun and wind, RG59/U for multi-set operation and areas of extreme interference, neutral color Decorator lead-in, plus regular 300-ohm line, 150-ohm line, and 75-ohm line. Call your Belden jobber.

power supply cords • cord sets and portable cordage
electrical household cords • magnet wire • lead wire



*Belden Trademarks and Patents—U.S. Patent No. 2782251 and 2814666

†Belden Trademark—Reg. U.S. Pat. Off.

8-3-3



**Be a Cartoon
Gag Writer!**
**Win a \$25.00
Savings Bond**

Send us your gag ideas for future cartoons. For each of your gag ideas used, we'll send you a \$25 Savings Bond. Write Belden Manufacturing Company, Attention: Mrs. Madelsa Allison, P.O. Box 5070-A, Chicago, Illinois 60680.

*This month's winner: Charles W. Forster,
3744 Charles Street, San Diego 6, California



Circle 15 on literature card

Exclusive

RCA Victor Color TV

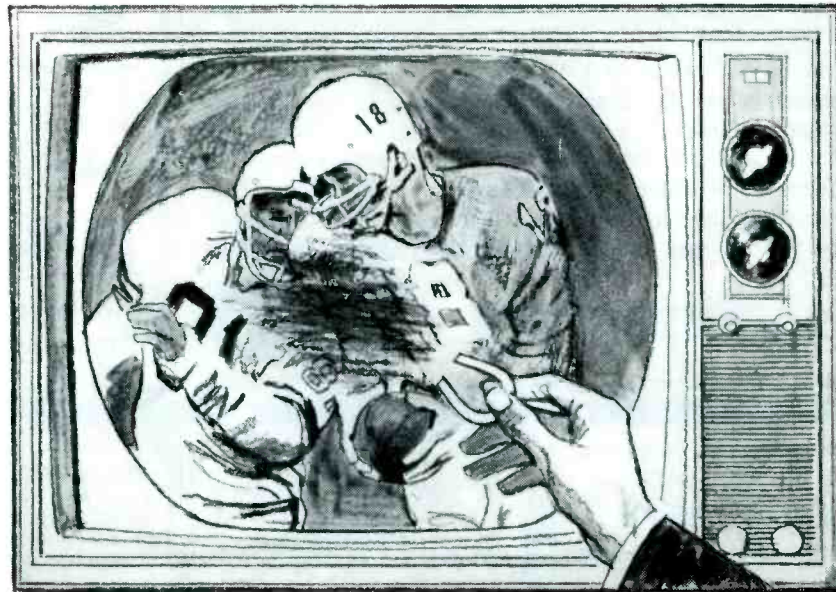

Magnetism can cause impurities...

in the color picture—a weak pocket magnet can easily demonstrate this effect. In the home, as you know, magnetic distortions may be caused by moving the set in relation to the earth's magnetic field or they can sometimes be caused by nearby electric appliances.

To “cancel” the magnetism and restore natural color...

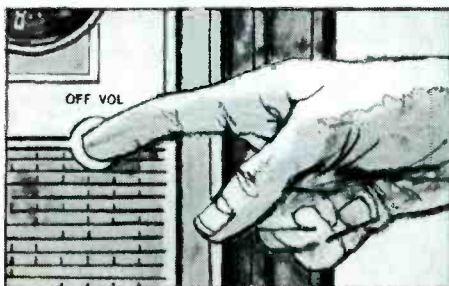

simply turn off the set, let it cool 4 or 5 minutes, then turn it back on. That's all—no more need for a separate degaussing coil! The RCA Victor Automatic Color Purifier acts *every time the set is turned on* from a cool start. Color is bright, sharp, true—free of impurities caused by magnetism. The RCA Victor Automatic Color Purifier also removes unwanted color areas from the black and white picture. Here's another major “first” from RCA Victor that can give you a profitable advantage in extra sales . . . and in service savings!

SEE WALT DISNEY'S "WONDERFUL WORLD OF COLOR," SUNDAYS, NBC-TV NETWORK

degausses itself!

Gives you 3 big advantages!

1

Floor models always ready for best color picture!

Ever lost a sale because your floor demonstrator needed degaussing? The RCA Victor Automatic Color Purifier cleans up that problem . . . the set always shows unsurpassed natural color. And with a swivel or caster model, you can quickly demonstrate how color TV can now be moved about without worry of magnetic distortion!

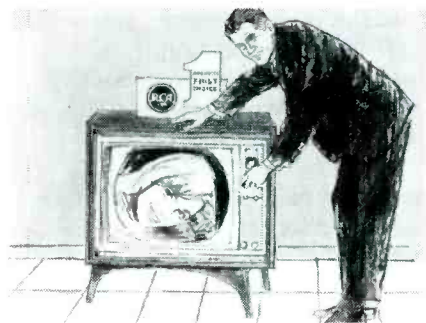

2

Faster, easier setup in customer's home!

The RCA Victor Automatic Color Purifier eliminates the need for you to perform time-consuming degaussing when you deliver the new Mark 10 color TV set. This makes setup faster, easier . . . freeing you for more profitable TV servicing. The Automatic Color Purifier is standard on all Mark 10 models except the price leaders.

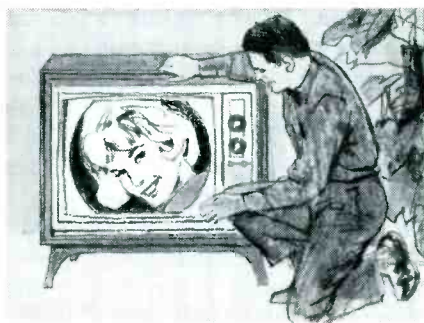

3

Reduces unprofitable callbacks!

The RCA Victor Automatic Color Purifier will end those degaussing "nuisance" calls that can eat up service time and profits. They're a nuisance to customers, too! Increased customer satisfaction is sure to follow from this new RCA Victor "first"—and remember, a satisfied customer is very often your best salesman.



Make sure you get your share of the big Color TV sales forecast for '65...get with RCA Victor!



The Most Trusted Name in Television

Tmk(s)®

SEE THE RCA COLOR TV CENTER AT THE WORLD'S FAIR



by Forest H. Belt

Competition in the radio and television servicing business is undoubtedly stiffer than at any time in the past. Servicing businesses can be categorized as full-time shops, serious part-time shops (usually in the garage or basement, although several have business establishments), and "moonlighters" or "fly-by-nights." Among most technicians, the moonlighter is the untrained would-be technician who isn't satisfied with being a do-it-yourselfer—he insists he can repair other people's sets, too. The serious part-timer, on the other hand, has the needed training, equipment, and inventory to do a good job of servicing; he is part-time mostly because he hasn't promoted his business to the point where he can make a full-time living from it. Four out of five of these technicians are conscientious and capable, and have an earnest desire to get into full-time servicing.

With the competition from these other types of radio and TV servicers, the full-time shop finds itself at times in the position of having too little work to justify its employee roster and overhead. At such times, some shop owners spend their time bemoaning the competition; other, more progressive owner-businessmen spend the slack time thinking up ways to bring in more work.

There are several approaches to developing additional servicing business. One is, of course, to increase the number of radio-television cus-

tomers. Ad programs and promotions often help, but results are hampered by the original problem—not enough customers to go around, at least for the present time.

Another approach for the progressive shop is that of expanding into new lines of business. This approach has the advantage of being a fairly permanent cure for the business doldrums; in fact, it must also be considered that, once additional types of service are undertaken, to back out would be detrimental to the business reputation. Consequently, serious consideration must be given to several factors before a decision can be made to branch into a specific sideline.

Important Considerations

Probably the first important question is: What line of additional servicing am I interested in? There are several from which to choose. Some shops don't yet handle color TV; others have hesitated indefinitely about getting into transistor servicing (see "Me? Do Transistor Servicing?" in this issue); industrial electronics is an important branch of servicing that is open to the competent serviceman; communications and Citizens-band servicing are growing by leaps and bounds; photo-flash and similar photographic equipment are mostly electronically operated nowadays; and in case you're situated in a geographically suitable location, the fields of marine and aviation communications

and navigation equipment (for private craft) are very thinly populated with competent technicians. This list is far from all-inclusive, and many readers can add at least one or two additional possibilities from their own experience.

Having picked one or more lines of possible interest, it remains to evaluate the impact of adding this line of servicing activity to your present operation. Involved will be your present personnel, facilities and equipment, inventory, shop location and layout, and the market (the need for this service in your area). Let's detail each of these.

Personnel

Will your present staff be sufficient to handle the additional activity and work load? Will it be necessary to add one or more technicians? Don't forget that adding another staff member will increase more than just your salary expenditures; insurance, payroll taxes, workmen's compensation and unemployment insurance, extra bookkeeping, more hand tools, added equipment—all these costs will rise when you add one man to your present staff of technicians.

If you will need an extra man, is such a man available? Can you promote one of your present technicians into the new activity, and hire a new man for the radio-TV portion of your business, or will the new man have to be a specialist in the area of business into which you plan to go? What is the supply of competent technicians in your locality? Will you have to "import" a man, with consequent moving expenses?

Be extremely careful in evaluating additional personnel needs. Consider whether the new business activity will be seasonal or can be depended on to continue strong for some time to come. It creates a very poor reputation for your business if you get the habit of hiring good technicians and then laying them off soon when business slacks; soon the really competent ones will avoid your operation. Make sure your business will justify hiring a man to stay, before you spend money hiring him.

How about additional training for your present staff? How about for yourself? Perhaps more technical training or factory clinics can up-

you get **PRODUCT PLUS** *from your Sylvania Distributor*



Must-Reading since 1930—Sylvania News

Sylvania and its distributors have long known that it pays to keep their customers informed. That's why 35,000 dealers today receive, read and depend on Sylvania News for useful information. Now in its 35th year of continuous publication, the News is still one of the most important dealer publications in the industry. ■ Dealers aren't the only ones who read Sylvania News—it also serves some 70,000 distributors, engineers and technical service men. Are you getting your copy? It's free. You can request it by asking your Sylvania distributor or dropping a line to: Editor, Sylvania News, 1100 Main Street, Buffalo, N. Y. 14209.

SYLVANIA
SUBSIDIARY OF
GENERAL TELEPHONE & ELECTRONICS **GTE**

Circle 16 on literature card

FREE!

2 EXTRA DE-SOLDERING TIPS WORTH \$1.20...



when
you buy
the *Ungar* #270
De-Soldering Kit

ONLY \$5.83 EACH AT YOUR AUTHORIZED DISTRIBUTOR

Buy this kit, and mail the enclosed bonus coupon to Ungar. We will send you #861 Triangle Tip and #863 Cube Tip... a \$1.20 value - absolutely FREE.

The Ungar #270 Kit meets every requirement for fast, safe, easy component desoldering and removal. Avoids lug breaking, shorting and printed board rupturing.

Ungar's De-Soldering Kit speeds up work and increases efficiency. Here's how: The slotted tip melts solder quickly so that lugs bent close to the

printed board can be lifted and straightened out in a fraction of the time.

The bar tip makes it easy to de-solder all multiple straight line network components.

A variety of cup tips is a must for de-soldering tube sockets or i-f transformers. The Ungar kit includes the 5/8", 3/4", and 1" size - a complete assortment for most jobs.

The two FREE tips are ideal for electrolytic capacitor removal, tube socket, pins, and harness leads.

BONUS OFFER

FREE...A DE-SOLDERING BOOKLET

For Just Visiting Your Authorized Ungar Distributor! Get it now!

UNGAR ELECTRIC TOOLS

ELECTRONIC DIVISION OF ELDON INDUSTRIES, INC., Hawthorne, Calif. 90252

grade your present technicians or yourself enough so you won't need additional people to carry the new servicing activity. This possibility is especially significant if you are adding the new activity to replace some of your radio-TV servicing volume. Consider the training viewpoint thoroughly, for this is a way to make yourself and your technicians more valuable to you and to themselves. A well-trained man can contribute more to the profits of your business than a poorly trained one; and the former is worth many dollars more in salary.

Facilities

Evaluate your present shop size and layout in the light of your intended switch to additional servicing business. Is there room for it? Will you need another bench, or perhaps need to modify an old one? Will you need drive-in facilities for any reason? How about parking space? Storage space for new inventory or another vehicle? You may want to consider expanding your present shop, or you may discover you would have to move to another location to facilitate the new line of business. If moving is the only solution, the costs of any such move will be an important factor in your decision.

How will a locality change affect your present radio-television business? It is not too likely you will want to drop that activity completely, so it is important to consider what effects your new servicing line will have on your present customers.

Additional Equipment

Are there any special testing instruments you'll have to buy to make sure you can do a good job of servicing the new line of equipment? The costs of test equipment in some lines can be quite high; in others, there will be very little additional investment required. Just be sure you're not planning to "make do" when special instruments are truly needed. This is a sure road to business suicide; you can ruin your reputation before you've had time to develop a good one. It is more important to have the proper equipment for any new servicing line than it is for the line you're already servicing. You'll be watched more closely, and your servicing methods

Circle 17 on literature card

NEW

IMPROVED

MIGHTY MITE!

NEW

Lower voltage checks for Nuvistors and all new frame grid tubes, as demanded by tube manufacturers, but not found on other tube checkers.

NEW

Speedy indexed set-up cards to reduce "look-up" time. No more cumbersome booklets, or incomplete charts.

NEW

Simplified panel layout reduces set-up time — prevents set-up errors.

NEW

Streamline styling with rounded corners and rubber feet, prevents rattling furniture — presents that "Professional look".

fast, accurate, never lets you down . . .

New Burn-out, stick proof meter!



NEW TC 130

Checks them all . . .

including Novars, Compactrons, Nuvistors, 10 pin tubes — plus Picture Tubes!

only

\$74.50

Only 7 Lbs. . .
Smaller Than A Portable Typewriter

Here's the famous MIGHTY MITE, America's fastest selling tube checker, with an all-new look and many new exclusive features. MIGHTY MITE III brings you even greater portability, versatility and operating simplicity beyond comparison. Controls are set as fast and simply as A-B-C right from the speedy set-up cards in the cover. The new functional cover can be quickly removed and placed in a spot with more light for faster reading of the set-up data or "cradled" in the specially designed handle as a space saver as shown above. New unique design also prevents cover from shutting on fingers or cutting of line cords as in older models.

In a nut shell . . . the MIGHTY MITE III is so very popular because it checks for control grid contamination and gas just like the earlier "eye tube" gas checkers (100 megohm sensitivity) and then with a flick of a switch, checks the tube for inter-element shorts and cathode emission at full operating levels. Sencore calls this "the stethoscope approach" . . . as each element is checked individually to be sure that the tube is operating like new. User after user has helped coin the phrase "this checker won't lie to me". Most claim that it will outperform large mutual conductance testers costing hundreds of dollars more and is a real winner in finding those "tough dogs" in critical circuits such as color TV and FM stereo.

**See Your Parts Distributor-- And See
The Mighty Mite III For Yourself!**

SENCORE

426 SOUTH WESTGATE DRIVE
ADDISON, ILLINOIS

Circle 18 on literature card

SUPER 1483-G

OUT PERFORMS

ALL OTHERS

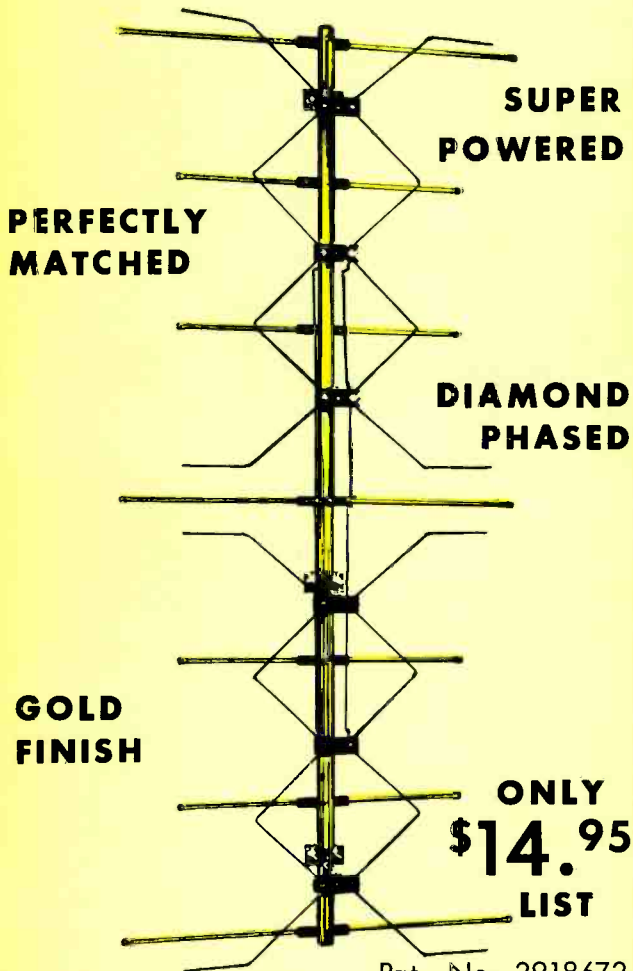

If it's the best in UHF television reception you're after, then it's the SUPER 1483 G you need. You can't buy another brand that's "just as good" because no one makes one. The SUPER 1483 G is a new conception in antenna designing that completely obsoletes all other UHF antennas. Perfect matching is obtained with the new diamond-phased driven elements. This extremely close matching results in sharper pictures and longer range reception than ever before possible.

The SUPER 1483 G is ruggedly built to provide years of satisfactory service. All aluminum construction (including aluminum lead-in terminals) with a super strong, long lasting Dura-Gold finish and extra high-impact plastic insulators make this the best looking, longest lasting, highest performing UHF antenna on the market.



BETTER BUILT FOR BETTER PERFORMANCE

ANTENNA CRAFT

Automatic Channel Selector
TV ANTENNAS
BURLINGTON, IOWA

Circle 19 on literature card

scrutinized more carefully, than if you have had long experience in the new line.

When you consider equipment, don't forget to include the hand tools, tube caddies, VOM's, and any other standard equipment a new technician may need. Whether you budget this extra expense along with the expense of hiring a new man, or list it along with the added equipment expense, just be sure it is included in your overall evaluation of the pro's and con's of entering the new line.

You may also find it necessary to add another vehicle to your fleet. If so, don't forget the costs of insurance, licenses, gas, and maintenance. An extra man may make the vehicle necessary, or the need may derive from having to carry special equipment or unusual inventories from one job to another. Don't forget about parking or garage space, which we've already outlined in our discussion of facilities.

Inventory

Very often the most significant expenditure connected with a new line of business is the extra inventory needed to give your new customers prompt service. You may need special tubes or transistors on your shelves. You may have to stock an extra tube or parts caddy for the technician to carry on the job. (In some of the categories we've mentioned, it is impossible to bring the equipment to the shop; the technician must carry a reasonably complete supply of parts with him.)

Check your local parts distributors; some handle industrial parts in addition to their usual radio-TV parts stock, and other carry communications tubes and parts. Learn who these distributors are and familiarize yourself with their stock; you may be able to get by with somewhat less inventory than you would otherwise need to stock. If your new business shows signs of being very active, you may find a progressive, far-thinking distributor who would be interested in carrying a limited amount of special inventory for you—after all, that is his business. Remember, however, his business is to make a profit, just as yours is; don't expect him to carry slow-moving inventory just to make it convenient for you.

You'll find most manufacturers of specialized electronic equipment make fairly speedy parts shipments; they do this to make service easier and quicker for owners of their units. In some cases, you may be able to find a manufacturer who will consign to you a supply of basic parts for their equipment, just to have competent service in an area. Make as many such contacts in your chosen field as you can. They can be valuable in helping you provide competent and efficient service to your new customers.

The Market

Just how badly needed is the service you propose to offer? How much competition will you be facing? How many prospective customers can you list? How many dollars of income per month or year can you anticipate from these customers? What are they doing for service right now? Who is getting their present service money?

The time you spend thoroughly and realistically surveying the market won't net you an immediate dime,

Small Inventory

DELCO SERVICE "DS" TRANSISTORS WILL REPLACE VIRTUALLY EVERY TRANSISTOR NEEDED FOR NEARLY ALL RADIO REPAIRS

Broad Coverage

DELCO TYPE	APPLICATION	BASE DIAGRAM	TYPES TO BE REPLACED
DS25 R.F.-I.F. AMPLIFIER CONVERTER	MAXIMUM RATINGS AT 25°C PNP V _{CB} 32V V _{CE} 32V I _C 5 MA I _B 1 MA GAIN 20-34 DB POWER 80 MW		2N111 2N680 2N336 2SA1814 2SA203 AF114 6T780 85322 1109 610036 1 121 206 2N111A 2N686 2N45 2SA840 2SA213 AF115 6T780R 85323 7183 610036-2 121 207 2N112 2N679 2N52 2SA1824 2SA214 AF116 6T781 85324 11282 61004 121 208 2N112A 2N644 2N51 2SA1828A 2SA215 AF117 6T781R 85325 11233 61006 121 219 2N114 2N685 2SA13 2SA187 2SA219 AF120 6T780 85326 11286 61005 121 220 2N125 2N684 2SA12C 2SA110 2SA224 AF124 6T6 85383 11383 61008 121 234 2N126 2N615 2SA11 2SA21 2SA225 8A6A 6F12 85384 11384 61001 121 235 2N127 2N644 2SA13 2SA12 2SA226 AF154 6F20 85385 11454 61007 121 238 2N130 2N617 2SA17 2SA124 2SA280 CR780 422 85181 12429 61010 121 240 2N180 2N680 2SA20 2SA121 2SA290 CR786 61220 85122 7440 61010 121 241 2N218 2N641 2SA30 2SA132 2SA261 2N 19 802 85103 7241 86 46 2 201241-1 2N219 2N642 2SA37 2SA138 2SA280 2N 21 8020 85201 7628 86 47 2 201241-2 2N240 2N107 2SA69 2SA137 2SA285 2N 22 80 4 85202 7629 86 48 2 201241-3 2N241 2N108 2SA57 2SA141 2SA288 2N 24 80 4 85203 7630 86 49 2 201241-13 2N249 2N110 2SA42 2SA287 2N 26 80 4 85204 7631 86 50 2 201241-13A 2N250 2N111 2SA28 2SA145 2SA286 2N28 80 4 85205 7632 9101 201241-14 2N251 2N112 2SA48 2SA149 2SA289 2N29 80 4 85206 7633 9102 201241-15 2N252 2N113 2SA41 2SA150 2SA292 2N30 80 4 85207 7634 9103 201241-15A 2N253 2N114 2SA20 2SA151 2SA337 2N31 80 4 85208 7635 9104 201241-16 2N254 2N115 2SA27 2SA153 2SA358 2N32 80 4 85209 7636 9105 201241-17 2N255 2N116 2SA23 2SA154 2SA357 2N33 80 4 85210 7637 9106 201241-18 2N256 2N117 2SA40 2SA156 2SA359 2N34 80 4 85211 7638 9107 201241-19 2N257 2N118 2SA41 2SA157 2SA360 2N35 80 4 85212 7639 9108 201241-20 2N258 2N119 2SA20 2SA151 2SA337 2N36 80 4 85213 7640 9109 201241-21 2N259 2N120 2SA27 2SA153 2SA358 2N37 80 4 85214 7641 9110 201241-22 2N260 2N121 2SA23 2SA154 2SA357 2N38 80 4 85215 7642 9111 201241-23 2N261 2N122 2SA40 2SA156 2SA359 2N39 80 4 85216 7643 9112 201241-24 2N262 2N123 2SA41 2SA157 2SA360 2N40 80 4 85217 7644 9113 201241-25 2N263 2N124 2SA20 2SA151 2SA337 2N41 80 4 85218 7645 9114 201241-26 2N264 2N125 2SA27 2SA153 2SA358 2N42 80 4 85219 7646 9115 201241-27 2N265 2N126 2SA23 2SA154 2SA357 2N43 80 4 85220 7647 9116 201241-28 2N266 2N127 2SA40 2SA156 2SA359 2N44 80 4 85221 7648 9117 201241-29 2N267 2N128 2SA41 2SA157 2SA360 2N45 80 4 85222 7649 9118 201241-30 2N268 2N129 2SA20 2SA151 2SA337 2N46 80 4 85223 7650 9119 201241-31 2N269 2N130 2SA27 2SA153 2SA358 2N47 80 4 85224 7651 9120 201241-32 2N270 2N131 2SA23 2SA154 2SA357 2N48 80 4 85225 7652 9121 201241-33 2N271 2N132 2SA40 2SA156 2SA359 2N49 80 4 85226 7653 9122 201241-34 2N272 2N133 2SA41 2SA157 2SA360 2N50 80 4 85227 7654 9123 201241-35 2N273 2N134 2SA20 2SA151 2SA337 2N51 80 4 85228 7655 9124 201241-36 2N274 2N135 2SA27 2SA153 2SA358 2N52 80 4 85229 7656 9125 201241-37 2N275 2N136 2SA23 2SA154 2SA357 2N53 80 4 85230 7657 9126 201241-38 2N276 2N137 2SA40 2SA156 2SA359 2N54 80 4 85231 7658 9127 201241-39 2N277 2N138 2SA41 2SA157 2SA360 2N55 80 4 85232 7659 9128 201241-40 2N278 2N139 2SA20 2SA151 2SA337 2N56 80 4 85233 7660 9129 201241-41 2N279 2N140 2SA27 2SA153 2SA358 2N57 80 4 85234 7661 9130 201241-42 2N280 2N141 2SA23 2SA154 2SA357 2N58 80 4 85235 7662 9131 201241-43 2N281 2N142 2SA40 2SA156 2SA359 2N59 80 4 85236 7663 9132 201241-44 2N282 2N143 2SA41 2SA157 2SA360 2N60 80 4 85237 7664 9133 201241-45 2N283 2N144 2SA20 2SA151 2SA337 2N61 80 4 85238 7665 9134 201241-46 2N284 2N145 2SA27 2SA153 2SA358 2N62 80 4 85239 7666 9135 201241-47 2N285 2N146 2SA23 2SA154 2SA357 2N63 80 4 85240 7667 9136 201241-48 2N286 2N147 2SA40 2SA156 2SA359 2N64 80 4 85241 7668 9137 201241-49 2N287 2N148 2SA41 2SA157 2SA360 2N65 80 4 85242 7669 9138 201241-50 2N288 2N149 2SA20 2SA151 2SA337 2N66 80 4 85243 7670 9139 201241-51 2N289 2N150 2SA27 2SA153 2SA358 2N67 80 4 85244 7671 9140 201241-52 2N290 2N151 2SA23 2SA154 2SA357 2N68 80 4 85245 7672 9141 201241-53 2N291 2N152 2SA40 2SA156 2SA359 2N69 80 4 85246 7673 9142 201241-54 2N292 2N153 2SA41 2SA157 2SA360 2N70 80 4 85247 7674 9143 201241-55 2N293 2N154 2SA20 2SA151 2SA337 2N71 80 4 85248 7675 9144 201241-56 2N294 2N155 2SA27 2SA153 2SA358 2N72 80 4 85249 7676 9145 201241-57 2N295 2N156 2SA23 2SA154 2SA357 2N73 80 4 85250 7677 9146 201241-58 2N296 2N157 2SA40 2SA156 2SA359 2N74 80 4 85251 7678 9147 201241-59 2N297 2N158 2SA41 2SA157 2SA360 2N75 80 4 85252 7679 9148 201241-60 2N298 2N159 2SA20 2SA151 2SA337 2N76 80 4 85253 7680 9149 201241-61 2N299 2N160 2SA27 2SA153 2SA358 2N77 80 4 85254 7681 9150 201241-62 2N300 2N161 2SA23 2SA154 2SA357 2N78 80 4 85255 7682 9151 201241-63 2N301 2N162 2SA40 2SA156 2SA359 2N79 80 4 85256 7683 9152 201241-64 2N302 2N163 2SA41 2SA157 2SA360 2N80 80 4 85257 7684 9153 201241-65 2N303 2N164 2SA20 2SA151 2SA337 2N81 80 4 85258 7685 9154 201241-66 2N304 2N165 2SA27 2SA153 2SA358 2N82 80 4 85259 7686 9155 201241-67 2N305 2N166 2SA23 2SA154 2SA357 2N83 80 4 85260 7687 9156 201241-68 2N306 2N167 2SA40 2SA156 2SA359 2N84 80 4 85261 7688 9157 201241-69 2N307 2N168 2SA41 2SA157 2SA360 2N85 80 4 85262 7689 9158 201241-70 2N308 2N169 2SA20 2SA151 2SA337 2N86 80 4 85263 7690 9159 201241-71 2N309 2N170 2SA27 2SA153 2SA358 2N87 80 4 85264 7691 9160 201241-72 2N310 2N171 2SA23 2SA154 2SA357 2N88 80 4 85265 7692 9161 201241-73 2N311 2N172 2SA40 2SA156 2SA359 2N89 80 4 85266 7693 9162 201241-74 2N312 2N173 2SA41 2SA157 2SA360 2N90 80 4 85267 7694 9163 201241-75 2N313 2N174 2SA20 2SA151 2SA337 2N91 80 4 85268 7695 9164 201241-76 2N314 2N175 2SA27 2SA153 2SA358 2N92 80 4 85269 7696 9165 201241-77 2N315 2N176 2SA23 2SA154 2SA357 2N93 80 4 85270 7697 9166 201241-78 2N316 2N177 2SA40 2SA156 2SA359 2N94 80 4 85271 7698 9167 201241-79 2N317 2N178 2SA41 2SA157 2SA360 2N95 80 4 85272 7699 9168 201241-80 2N318 2N179 2SA20 2SA151 2SA337 2N96 80 4 85273 7700 9169 201241-81 2N319 2N180 2SA27 2SA153 2SA358 2N97 80 4 85274 7701 9170 201241-82 2N320 2N181 2SA23 2SA154 2SA357 2N98 80 4 85275 7702 9171 201241-83 2N321 2N182 2SA40 2SA156 2SA359 2N99 80 4 85276 7703 9172 201241-84 2N322 2N183 2SA41 2SA157 2SA360 2N100 80 4 85277 7704 9173 201241-85 2N323 2N184 2SA20 2SA151 2SA337 2N101 80 4 85278 7705 9174 201241-86 2N324 2N185 2SA27 2SA153 2SA358 2N102 80 4 85279 7706 9175 201241-87 2N325 2N186 2SA23 2SA154 2SA357 2N103 80 4 85280 7707 9176 201241-88 2N326 2N187 2SA40 2SA156 2SA359 2N104 80 4 85281 7708 9177 201241-89 2N327 2N188 2SA41 2SA157 2SA360 2N105 80 4 85282 7709 9178 201241-90 2N328 2N189 2SA20 2SA151 2SA337 2N106 80 4 85283 7710 9179 201241-91 2N329 2N190 2SA27 2SA153 2SA358 2N107 80 4 85284 7711 9180 201241-92 2N330 2N191 2SA23 2SA154 2SA357 2N108 80 4 85285 7712 9181 201241-93 2N331 2N192 2SA40 2SA156 2SA359 2N109 80 4 85286 7713 9182 201241-94 2N332 2N193 2SA41 2SA157 2SA360 2N110 80 4 85287 7714 9183 201241-95 2N333 2N194 2SA20 2SA151 2SA337 2N111 80 4 85288 7715 9184 201241-96 2N334 2N195 2SA27 2SA153 2SA358 2N112 80 4 85289 7716 9185 201241-97 2N335 2N196 2SA23 2SA154 2SA357 2N113 80 4 85290 7717 9186 201241-98 2N336 2N197 2SA40 2SA156 2SA359 2N114 80 4 85291 7718 9187 201241-99 2N337 2N198 2SA41 2SA157 2SA360 2N115 80 4 85292 7719 9188 201241-100 2N338 2N199 2SA20 2SA151 2SA337 2N116 80 4 85293 7720 9189 201241-101 2N339 2N200 2SA27 2SA153 2SA358 2N117 80 4 85294 7721 9190 201241-102 2N340 2N201 2SA23 2SA154 2SA357 2N118 80 4 85295 7722 9191 201241-103 2N341 2N202 2SA40 2SA156 2SA359 2N119 80 4 85296 7723 9192 201241-104 2N342 2N203 2SA41 2SA157 2SA360 2N120 80 4 85297 7724 9193 201241-105 2N343 2N204 2SA20 2SA151 2SA337 2N121 80 4 85298 7725 9194 201241-106 2N344 2N205 2SA27 2SA153 2SA358 2N122 80 4 85299 7726 9195 201241-107 2N345 2N206 2SA23 2SA154 2SA357 2N123 80 4 85300 7727 9196 201241-108 2N346 2N207 2SA40 2SA156 2SA359 2N124 80 4 85301 7728 9197 201241-109 2N347 2N208 2SA41 2SA157 2SA360 2N125 80 4 85302 7729 9198 201241-110 2N348 2N209 2SA20 2SA151 2SA337 2N126 80 4 85303 7730 9199 201241-111 2N349 2N210 2SA27 2SA153 2SA358 2N127 80 4 85304 7731 9200 201241-112 2N350 2N211 2SA23 2SA154 2SA357 2N128 80 4 85305 7732 9201 201241-113 2N351 2N212 2SA40 2SA156 2SA359 2N129 80 4 85306 7733 9202 201241-114 2N352 2N213 2SA41 2SA157 2SA360 2N130 80 4 85307 7734 9203 201241-115 2N353 2N214 2SA20 2SA151 2SA337 2N131 80 4 85308 7735 9204 201241-116 2N354 2N215 2SA27 2SA153 2SA358 2N132 80 4 85309 7736 9205 201241-117 2N355 2N216 2SA23 2SA154 2SA357 2N133 80 4 85310 7737 9206 201241-118 2N356 2N217 2SA40 2SA156 2SA359 2N134 80 4 85311 7738 9207 201241-119 2N357 2N218 2SA41 2SA157 2SA360 2N135 80 4 85312 7739 9208 201241-120 2N358 2N219 2SA20 2SA151 2SA337 2N136 80 4 85313 7740 9209 201241-121 2N359 2N220 2SA27 2SA153 2SA358 2N137 80 4 85314 7741 9210 201241-122 2N360 2N221 2SA23 2SA154 2SA357 2N138 80 4 85315 7742 9211 201241-123 2N361 2N222 2SA40 2SA156 2SA359 2N139 80 4 85316 7743 9212 201241-124 2N362 2N223 2SA41 2SA157 2SA360 2N140 80 4 85317 7744 9213 201241-125 2N363 2N224 2SA20 2SA151 2SA337 2N141 80 4 85318 7745 9214 201241-126 2N364 2N225 2SA27 2SA153 2SA358 2N142 80 4 85319 7746 9215 201241-127 2N365 2N226 2SA23 2SA154 2SA357 2N143 80 4 85320 7747 9216 201241-128 2N366 2N227 2SA40 2SA156 2SA359 2N144 80 4 85321 7748 9217 201241-129 2N367 2N228 2SA41 2SA157 2SA360 2N145 80 4 85322 7749 9218 201241-130 2N368 2N229 2SA20 2SA151 2SA337 2N146 80 4 85323 7750 9219 201241-131 2N369 2N230 2SA27 2SA153 2SA358 2N147 80 4 85324 7751 9220 201241-132 2N370 2N231 2SA23 2SA154 2SA357 2N148 80 4 85325 7752 9221 201241-133 2N371 2N232 2SA40 2SA156 2SA359 2N149 80 4 85326 7753 9222 201241-134 2N372 2N233 2SA41 2SA157 2SA360 2N150 80 4 85327 7754 9223 201241-135 2N373 2N234 2SA20 2SA151 2SA337 2N151 80 4 85328 7755 9224 201241-136 2N374 2N235 2SA27 2SA153 2SA358 2N152 80 4 85329 7756 9225 201241-137 2N375 2N236 2SA23 2SA154 2SA357 2N153 80 4 85330 7757 9226 201241-138 2N376 2N237 2SA40 2SA156 2SA359 2N154 80 4 85331 7758 9227 201241-139 2N377 2N238 2SA41 2SA157 2SA360 2N155 80 4 85332 7759 9228 201241-140 2N378 2N239 2SA20 2SA151 2SA337 2N156 80 4 85333 7760 9229 201241-141 2N379 2N240 2SA27 2SA153 2SA358 2N157 80 4 85334 7761 9230 201241-142 2N380 2N241 2SA23 2SA154 2SA357 2N158 80 4 85335 7762 9231 201241-143 2N381 2N242 2SA40 2SA156 2SA359 2N159 80 4 85336 7763 9232 201241-144 2N382 2N243 2SA41 2SA157 2SA360 2N160 80 4 85337 7764 9233 201241-145 2N383 2N244 2SA20 2SA151 2SA337 2N161 80 4 85338 7765 9234 201241-146 2N384 2N245 2SA27 2SA153 2SA358 2N162 80 4 85339 7766 9235 201241-147 2N385 2N246 2SA23 2SA154 2SA357 2N163 80 4 85340 7767 9236 201241-148 2N386 2N247 2SA40 2SA156 2SA359 2N164 80 4 85341 7768 9237 201241-149 2N387 2N248 2SA41 2SA157 2SA360 2N165 80 4 85342 7769 9238 201241-150 2N388 2N249 2SA20 2SA151 2SA337 2N166 80 4 85343 7770 9239 201241-151 2N389 2N250 2SA27 2SA153 2SA358 2N167 80 4 85344 7771 9240 201241-152 2N390 2N251 2SA23 2SA154 2SA357 2N168 80 4 85345 7772 9241 201241-153 2N391 2N252 2SA40 2SA156 2SA359 2N169 80 4 85346 7773 9242 201241-154 2N392 2N253 2SA41 2SA157 2SA360 2N170 80 4 85347 7774 9243 201241-155 2N393 2N254 2SA20 2SA151 2SA337 2N171 80 4 85348 7775 9244 201241-156 2N394 2N255 2SA27 2SA153 2SA358 2N172 80 4 85349 7776 9245 201241-157 2N395 2N256 2SA23 2SA154 2SA357 2N173 80 4 85350 7777 9246 201241-158 2N396 2N257 2SA40 2SA156 2SA359 2N174 80 4 85351 7778 9247 201241-159 2N397 2N258 2SA41 2SA157 2SA360 2N175 80 4 85352 7779 9248 201241-160 2N398 2N259 2SA20 2SA151 2SA337 2N176 80 4 85353 7780 9249 201241-161 2N399 2N260 2SA27 2SA153 2SA358 2N177 80 4 85354 7781 9250 201241-162 2N400 2N261 2SA23 2SA154 2SA357 2N178 80 4 85355 7782 9251 201241-163 2N401 2N262 2SA40 2SA156 2SA359 2N179 80 4 85356 7783 9252 201241-164 2N402 2N263 2SA41 2SA157 2SA360 2N180 80 4 85357 7784 9253 201241-165 2N403 2N264 2SA20 2SA151 2SA337 2N181 80 4 85358 7785 9254 201241-166 2N404 2N265 2SA27 2SA153 2SA358 2N182 80 4 85359 7786 9255 201241-167 2N405 2N266 2SA23 2SA154 2SA357 2N183 80 4 85360 7787 9256 201241-168 2N406 2N267 2SA40 2SA156 2SA359 2N184 80 4 85361 7788 9257 201241-169 2N407 2N268 2SA41 2SA157 2SA360 2N185 80 4 85362 7789 9258 201241-170 2N408 2N269 2SA20 2SA151 2SA337 2N186 80 4 85363 7790 9259 201241-171 2N409 2N270 2SA27 2SA153 2SA358 2N187 80 4 85364 7791 9260 201241-172 2N410 2N271 2SA23 2SA154 2SA357 2N188 80 4 85365 7792 9261 201241-173 2N411 2N272 2SA40 2SA156 2SA359 2N189 80 4

how often could you have used...

**an
Xcelite
"Seizer"?**

Handy as an extra hand or helper. Clamps lightly or tightly ... for moments or minutes.

two-position snap-lock

slim, serrated jaws

Outreaches, out-holds needle-nose pliers. Hardly a spot too small for it. Approx. 6" long. Dozens of uses: Holds and positions wires for soldering ... retrieves small parts from inaccessible places ... it's a heat sink. Two-position snap-lock won't slip, yet releases with a twist of the fingers. All stainless steel — precision machined and tempered for smooth action and years of service.

2 Models: No. 43H curved nose and No. 42H straight — Ask your distributor to show you Xcelite Seizers today.

XCELITE

XCELITE, INC., 18 Bank St., Orchard Park, N. Y.
Canada: Charles W. Pointon, Ltd., Toronto, Ont.
Circle 21 on literature card

but it can save you from wasting the many dollars we've already discussed as possible expenditures. Don't try to fool yourself into thinking there's a market where none exists; it won't help your business reputation in the slightest to make a flop of your new venture.

Promotion

Lastly, add to your expenditures estimate the costs of promoting your new line of business. How do you plan to let your prospective customers know your facilities are available? Direct mail? Advertisements? Personal calls (don't forget, salaries must be paid for in this activity, too)? Whatever the means, you must somehow tell your message to your customer-to-be. Seldom will new business just come to you.

Plan your promotion for strong impact. Your aim is to build a volume of business as rapidly as possible. Once built, don't let the volume dwindle because you've not followed up your promotions. You may want help in planning your promotional campaigns, since so much depends on the results you get. Some manufacturers will be willing to help you round up customers who own their equipment; distributors can often assist in finding customers; the telephone yellow pages may offer ideas; and of course there are professional advertising and publicity agencies who can help.

Making the Decision

Put your market-survey figures on paper. How do they compare with the possible expenditures you've already calculated? It seems needless to say, but don't forget that the income must exceed the expenditures (including salary and overhead costs) by a considerable amount before you can count a profit from the venture. And if you can't profit from your investment, there is little reason to embark on the new venture at all.

If you really have no idea which line of business you'd prefer to expand into, compile estimates of the costs we've listed above; do it for every possible field of expansion you can imagine. This may take some time, but fill in your spare minutes with getting all this information down on paper. Prepare a file folder for each possibility. This

information-gathering period can extend over weeks, months, even years.

When you're ready to seriously consider a new line, take your folders one at a time and compare the possible income with the possible expenditures. Don't pull punches. You're not interested in getting into a new business unless you can make some money at it. Be realistic with all your evaluations.

Then pick from the group the one which offers the most opportunity for profit with the least investment of time and money. Select the most profitable, or the one you'd like most to enter, and get busy preparing for it. The longer you wait, the greater will be the likelihood that someone else will do it first, and the less your profit.

Don't discard the other files and ideas. Keep updating them as time passes. Who knows? Next year may show a definite difference in one of those fields. You may be better prepared financially to take on a new line; a competitor in that field may have gone out of business; you may since have hired an expert in that line; the field itself may have expanded into a boom in your locality. Consider all possibilities, and keep a sensitive finger on the pulse of industry developments; you will find yourself in the enviable position of having the jump on most of your neighboring shops in taking advantage of opportunities to enter new lines of business. ▲



helps you make more money
than any other test instrument

Checks CRT emission, interelement shorts and grid cutoff in a jiffy.

NEW

IMPROVED

CRT

CHECKER

and rejuvenator

Only tester that checks all black and white and color tubes without adaptors.

Uses DC on all tests, as recommended by tube manufacturers.

Exclusive automatic controlled rejuvenation (ACR) insures just the right amount of rejuvenation for each job. You just push the button: The ACR circuit takes over and applies rejuvenation voltage for just the right amount of time.

All hand-wired — all American made.

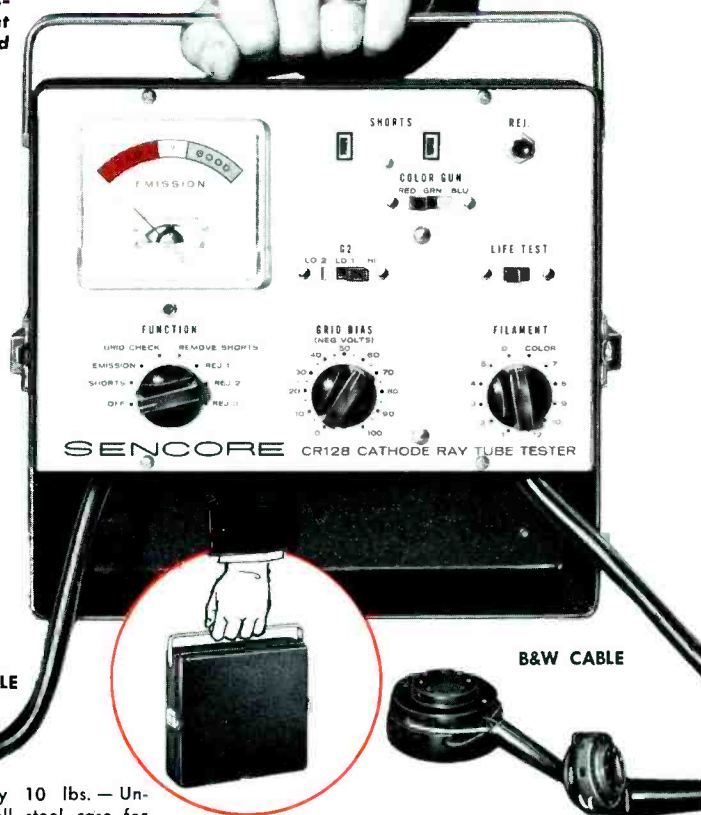

COLOR CABLE

B&W CABLE

Weights only 10 lbs. — Unbreakable all steel case for home or shop.

SENCORE CR128

\$69⁹⁵

Here is a new CRT checker and rejuvenator with the latest in design but at a price far below testers that check round color tubes only. The CR128 checks them all; conventional black and white tubes, new low drive B&W tubes, round color tubes and the recently announced rectangular color tubes.

Tests made are standard in the industry, using DC for all checks to prevent damage and erroneous readings. Color guns are tested individually as recommended by CRT manufacturers. Procedures for color gun tracking tests are explained on back cover of instruction manual.

Exclusive automatic controlled rejuvenation applies rejuvenation voltage for a longer period of time to guns that are lowest in emission. Merely push the rejuvenation button and the RC timer takes over to automatically rejuvenate cathodes, clear shorts or weld open cathodes. A must for equalization of beam currents in poor tracking color tubes. Once RC timer discharges, new rejuvenation voltage cannot be re-applied until button is released and depressed again. It really works; you merely push the button and the automatic circuit takes over.

New all steel portable carrying case protects meter and panel when carried in a service truck. Removable cover can be used as a handy parts tray in the home and fitted to the back while in the shop.

Let your SENCORE Distributor show you how the CR128 will pay for itself the very first month in picture tube sales.

SENCORE

426 SOUTH WESTGATE DRIVE
ADDISON, ILLINOIS

Field Effect

Transistor



Operating information on this interesting device.

by Rufus P. Turner

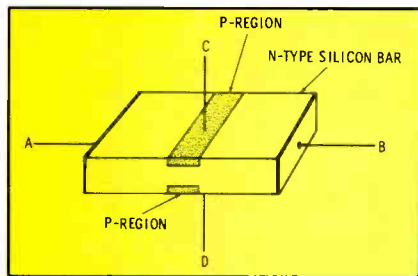

Fig. 1. Construction of a field-effect transistor.

Early searchers for a crystal-triode were frustrated in their attempt to use an electrostatic field to modulate current flow through a semiconductor diode. They had hoped in this way to imitate the vacuum tube, and studies to find out why the scheme failed to work led to invention of the transistor. The low input impedance of the transistor resulted in (1) inability to replace the tube directly in some circuits, (2) need for tapped coils and special transformers, and (3) difficulty for many persons to shift from tube-thinking to transistor-thinking.

Despite the success of the conventional transistor, work continued along the original lines. The result is the *field-effect* transistor. This device supplies the high input impedance (through electrostatic control) that was sought by the original researchers. Being more compatible

with the tube, this new transistor gives promise of eventually replacing the tube—and the conventional transistor—in transmitters, receivers, test instruments, and electronic devices.

How It Works

Fig. 1 shows the basic construction of the field-effect transistor (FET). The heart of the device is a thin bar or wafer of N-type silicon with an ohmic (nonrectifying) connection (A, B) at each end. A P-region is processed into each face of the bar in such a way that each such region extends all the way across the bar and is parallel to the other, and an ohmic connection (C, D) is made to each.

When a DC voltage is applied to A and B, the resulting current carriers (electrons in the N-type silicon) flowing through the bar must pass through the channel between the two P-regions. The bar itself has a certain resistance which is governed by its dimensions and material.

It is the nature of a PN junction that a thin depletion layer is present at the junction. In this depletion region no current carriers are available. The depletion layer for each junction is indicated in Fig. 2 as the

region within the dotted lines. A depletion layer may be thickened by applying a reverse bias to the junction, the width increasing with voltage. Such an increase in thickness narrows the channel in the silicon bar, increasing the resistance of the latter.

The two P-regions are connected together externally to form the *grid*. One end of the bar is connected to the positive terminal of the DC supply, and this end becomes the *anode*; the other end is returned to the negative terminal and becomes the *cathode*. The grid is connected to the negative terminal of a bias supply, as in a tube circuit. (Some FET manufacturers call the anode *drain*, the cathode *source*, and the grid *gate*.) The grid voltage reverse-biases the two PN junctions; and since the reverse resistance of a silicon PN junction is extremely high, the input (grid-cathode) impedance of the FET is correspondingly high.

In Fig. 2A, the grid voltage is low. Therefore, the depletion layers are thin and the channel between them is wide, permitting a larger number of electrons to flow through the bar; consequently the anode current is high. In 2B, the high grid voltage thickens the depletion layers, narrowing the channel, and reducing the anode current. Because the resistance of the silicon bar is modified in this way by effect of the grid-voltage field, this transistor has been named *field-effect*.

As you can see, this control action is quite similar to that in a triode tube. Fig. 3 shows a family of curves obtained by varying the anode-to-cathode voltage at various levels of grid voltage. These constant-current curves are seen to resemble those of a pentode tube.

It is important to note that the avalanche breakdown point of the PN junction will be reached if anode voltage is made high enough. This sudden increase of current at the avalanche point is indicated by the dotted section of each curve. The breakdown point decreases as grid potential increases, since the grid voltage acts in series with anode voltage to "break down" the junction.

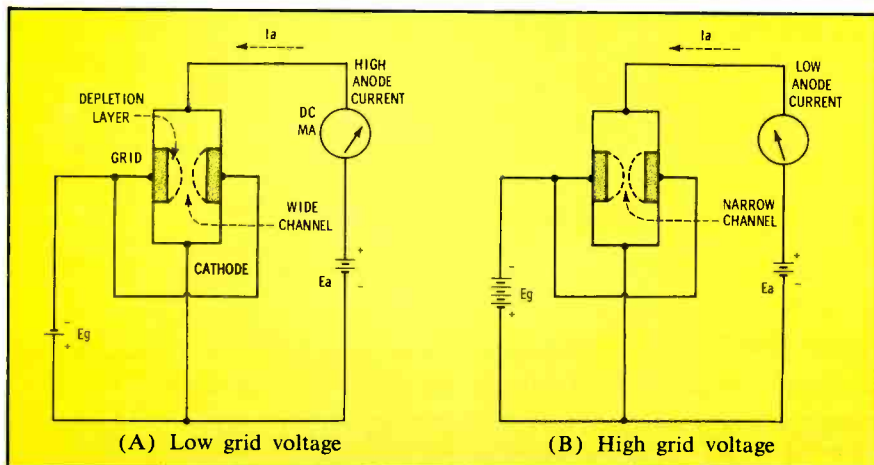

Fig. 2. The grid voltage determines depletion region in field-effect transistor.

Typical Ratings

Commercial field-effect transistors are available in many types in

FASTATCH II CONTROL SYSTEM
MORE CONVENIENT AND
VERSATILE THAN EVER!

now
Centralab
gives you

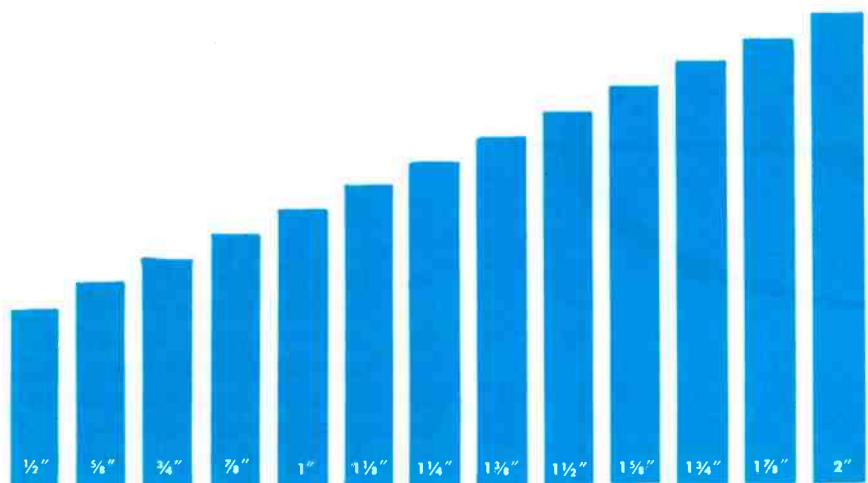

SINGLE SHAFT CONTROLS

with exact length shafts



Need a control with a flat shaft—or split knurled—or screwdriver slot?

Maybe you need it with—or without—an attached line switch.

But two things are sure: You need a certain *exact* shaft length—and your Centralab distributor can supply it!

Centralab's new exact length solid shafts provide exact replacements for ALL your single control requirements, as well as twins for stereo, triples, and quads.

If you have the FRK-100 Fastatch II Kit, you can add these exact length shafts as you need them; they snap right into place on the Fastatch II front controls. Or, you can always get the exact control you need, instantly, from your Fastatch II distributor.

For a complete catalog on the Fastatch II Control System, write to Centralab or contact your distributor.

The Electronics Division of Globe-Union Inc.
P. O. Box 591 Dept. 94F Milwaukee, Wisc. 53201
In Canada: Centralab Canada Ltd., P. O. Box 400, Ajax, Ontario

B-6420

Circle 23 on literature card

Centralab
FR

New sound symbol to think about . . .

remember . . .

look for . . .

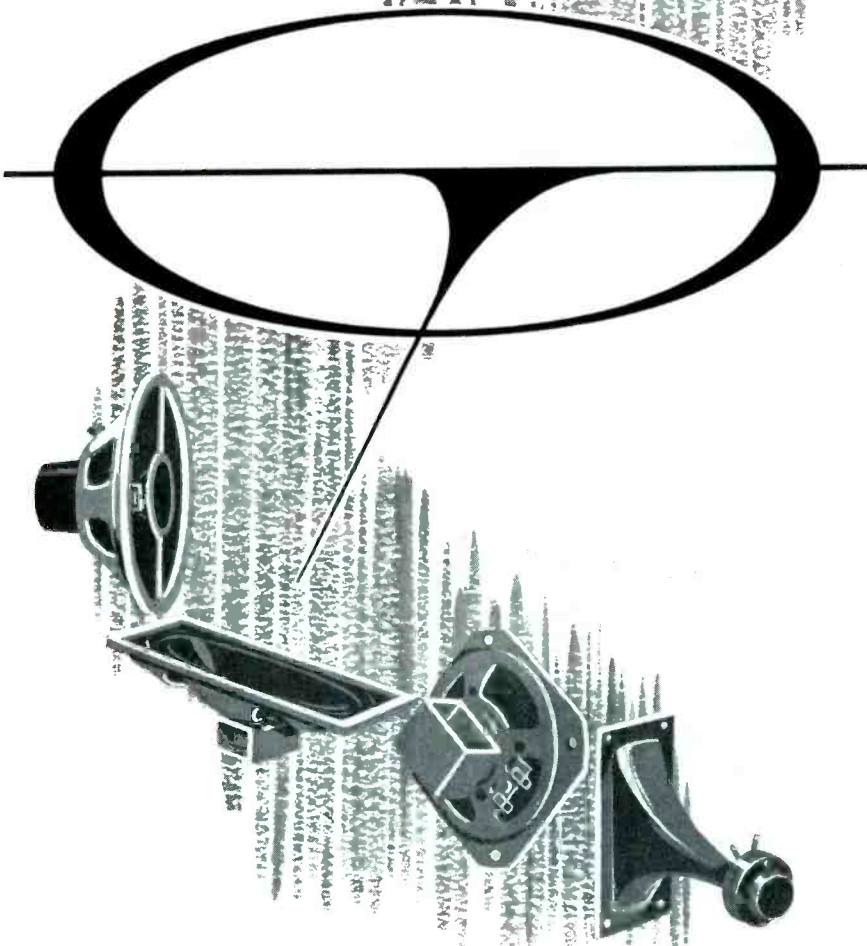

This is the symbol of the Oxford Transducer Company. It stands for quality, service and integrity . . . a good company to do business with.

It represents the time, talent, experience and devotion of an entire company whose sole objective is to build the world's finest loudspeakers. And this we have done.

The Oxford symbol means

full factory support, with a comprehensive advertising and merchandising program to insure maximum profits for you . . . prompt delivery . . . inventory protection . . . and a complete product line.

Combine these good business policies with the finest loudspeakers available, and you can see what the Oxford symbol means to you.



OXFORD / **TRANSducer CORPORATION**

Subsidiary of **OXFORD ELECTRIC CORPORATION**

2331 North Washtenaw Ave. • Chicago 47, Illinois

Circle 24 on literature card

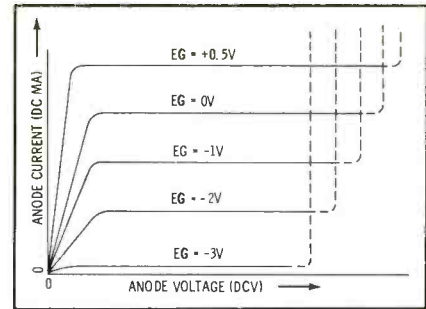

Fig. 3. Typical FET performance curve chart.

the following range of ratings: Maximum DC anode voltage, 10 to 350 volts; maximum DC anode current, .5 to 50 ma; maximum power dissipation, 250 mw to 1.5 watts; transconductance, 250 to 1200 umhos; input impedance, 1 to 1000 megohms.

Common Applications

Because of its high input impedance, the FET does not appreciably load the circuit feeding it. This transistor may therefore be operated with tube-circuit components, and many of its circuits closely resemble the equivalent tube circuits. See, for example, the RC-coupled amplifier stage in Fig. 4.

The operation of FET's has been tested extensively in AF, IF, and RF amplifiers and oscillators, DC amplifiers, operational amplifiers, flip-flops, relaxation oscillators, choppers, and voltage regulators.

In some practical respects, the field-effect transistor stands where the junction transistor was in 1952: upper frequency limit of present models is not too high (gain-bandwidth figures to 5 mc are typical) and prices are high (\$25 to \$50 each). But both increased frequency response and reduced price may be expected in comparatively short order. ▲

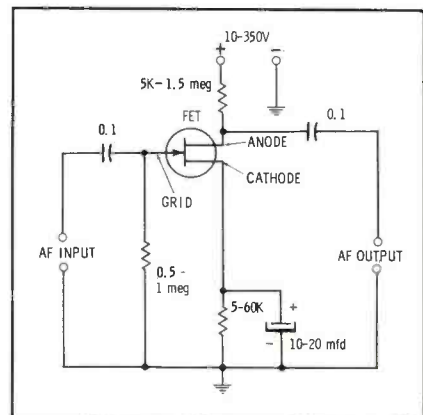

Fig. 4. Audio amplifier stage employing FET.

Qualify for the most profitable service business of all...



**FM
STEREO
SERVICE**

with the all new Sencore
**MX129 FM STEREO MULTIPLEX
GENERATOR AND ANALYZER**

\$169.50

19 TRANSISTORS
ALL CRYSTAL CONTROLLED
TRULY PORTABLE ONLY 7-1/2 LBS.

It has been established by all Radio and TV manufacturers that you must have a generator of this type to service FM stereo receivers. Here is a new field just waiting for qualified men, a field that is growing as fast as color TV. Multiplex is simple to service with this generator. If you can service an FM receiver, you can service multiplex once you have the MX129.

Look at the outstanding features of this all transistorized Sencore unit and you will see why it is the most versatile, most portable, most trouble free unit on the market. It is just like having your own FM stereo transmitter on your bench or service truck. All signals are crystal controlled and instantaneous because there are no tubes to warm up. Powered by 115 volts AC to insure top performance at all times.

The MX129 produces all signals required for trouble shooting and aligning the stereo portion of the FM multiplex receiver and can be used as a stereo demonstrator by feeding in left and right audio signals into the jacks marked LEFT and RIGHT EXT. SIG. This unique feature will allow you to demonstrate stereo to the customer even when a stereo program is not being broadcast.

The MX129 becomes a complete trouble shooting analyzer with the addition of a meter calibrated in peak to peak volts and Decibels. No other equipment is required for checking channel separation or alignment. A jack marked EXT. METER is provided for connecting the meter to the stereo speakers or at other points after detection.

Here are the signals available on the MX129 for alignment, trouble shooting and analyzing:

- FM-RF carrier with composite multiplex audio signal just like that transmitted from the FM station: 38kc suppressed carrier, 19kc pilot and 67kc SCA signal. This signal available at RF output cable.
- Multiplex signal is formed by either 60 cycle or 1000 cycle internal tones for greater flexibility in testing.
- Full control over left and right channel amplitude (and therefore modulation). Built-in meter is used to set controls for equal modulation of FM carrier. Channels can be turned completely off when desired.
- 19kc pilot calibrated directly in percentage of modulation; can be generated separately for 19kc amplifier peaking by turning down left and right channels.
- External 67kc SCA (subscription) signal available at jack marked SCA OUT (67KC) for trap adjustment. This signal, not found on some high priced multiplex generators, is very important on new stereo receivers with adjustable 67kc traps.
- Composite signals, same as described above, available on jacks marked COMP. OUT for signal injection beyond the FM detector.

SENCORE

Quality at its finest
426 SO. WESTGATE • ADDISON, ILL.

Circle 25 on literature card

June, 1964/PF REPORTER 55

Semiconductors have revolutionized industrial electronics; however, they have not and probably will not replace electron tubes in all applications. Semiconductors have expanded the applications of industrial electronics manifold because they can perform a wide range of electronic functions more economically and conveniently than tubes. In some cases, semiconductors per-

formed operations that are not economically or technically feasible with tubes.

picked up by a receiver which in turn feeds these signals to a control system. Under new FCC regulations, telemetry and alarm signals can be emitted by tiny radio transmitters for interception by fixed or mobile radio receivers on more practical frequencies than in the past. The opening of the 88-108 mc FM broadcast band to low-power, radio-

tion alarms are among the systems employing semiconductors. In addition, semiconductors are starting to play a big role in home appliances.

Semiconductors

Semiconductors generally vary the resistance they impose in a circuit, although occasionally they are designed to vary the circuit capacitance. Some of these devices have three or four terminals and alter their resistance when a specific voltage is applied to the controlling element. Moreover, a large number of semiconductors are two-terminal devices that vary their resistance or capacitance in response to a change in their physical environment.

Transistors

Most conventional transistors are three-terminal devices whose emitter-collector resistance is a function of base voltage and environment. Transistors are employed as amplifiers, oscillators, switches, and temperature-sensing devices. Some typical industrial applications of transistors are illustrated in Fig. 1.

In Fig. 1A, the transistor is acting as an electronic switch. Resistive element R1 may be a light-dependent resistor, a photodiode, a thermistor, or some other transducer. The relay is energized when the transducer resistance is reduced—by light or heat, for example—thereby causing the forward bias of the transistor to rise. In Fig 1B, the transistor itself is employed as a temperature-sensing device. Current flow through the transistor increases as its physical temperature increases. The sensitivity of this circuit can be adjusted by varying potentiometer R3, and the ammeter scale can be calibrated in terms of temperature.

Diodes

Semiconductor diodes are used by the millions as electronic switches, rectifiers, and as temperature-sensing devices. Unlike the transistor, which is a three-terminal device with a control element, the diode performs its unusual functions because its forward and backward resistance changes in proportion to voltages applied at its two terminals. There

INDUSTRIAL SEMICONDUCTORS

At Work

by Leo G. Sands

form operations that are not economically or technically feasible with tubes.

Perhaps the most important characteristic of semiconductors is the freedom they afford an industrial electronic device from commercial power mains. Since many such devices are operable from self-contained batteries, portability is achieved in a compact, lightweight package.

Systems

A semiconductor transducer can be attached inside a tank or pipe, or tossed into a chamber or duct, where it can sense and measure a liquid or gas. The transducer then modulates an RF oscillator whose output signal is picked up by a nearby radio receiver which feeds a control or computing system. Locomotives, cranes, tractors, other vehicles, and fixed machines can be controlled from remote locations without the fixed limitations of interconnecting wires. Audio tones—controlled in duration, number, amplitude, or frequency—may modulate a portable radio transmitter whose signals are

telemetry devices has suddenly expanded the scope of industrial electronics.

Semiconductors are also playing an important role in applications where abundant electric power is available and wire interconnection is feasible or preferred. Computers, machine controls, and fire and intru-

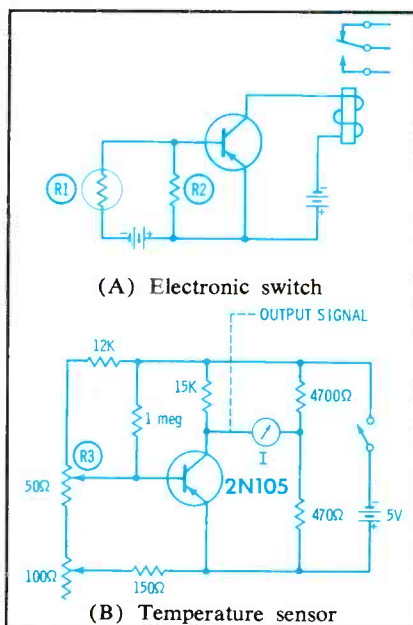
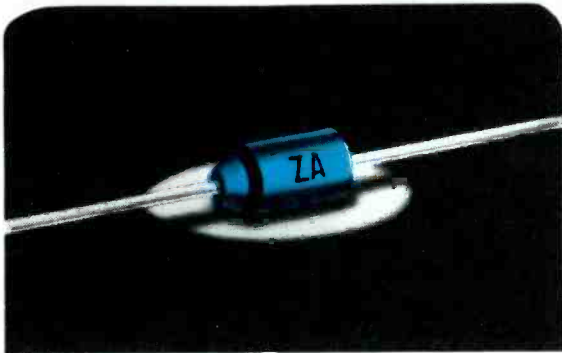

Fig. 1. Industrial applications of transistor.

New Kind of Zener Diode



A zener diode, as you're probably aware, is a special kind of semiconductor which has excellent voltage regulating characteristics. It's the solid-state successor to the gas discharge tube. It acts like a rectifier diode, blocking current in the reverse direction, until the "zener voltage" is reached—then it starts to conduct with a capital C. The zener diode can carry appreciable current continuously. So this makes it a fine regulating device. You can use it in power supplies where you need highly accurate output. Or you can use it in clipper or clamper circuits, by biasing the diode negative.

The big news in zener diodes is that you can now get them from Mallory at a price which makes them practical for service work, experimentation, or commercial circuitry. The news-maker is the new Mallory Type ZA molded-case diode. Its electrical properties and reliability record are comparable to those of military grade units. In fact, we use the same silicon cell in the ZA as in the zener diodes we make for military requirements. But the price is only about *half* that of hermetically sealed diodes.

The ZA is rated 1 watt at 25°C. If you install it in a hot spot, you can use it at ambients up to 100°C, derating linearly to 0.5 watt. Voltage ratings go from 6.8 to 200 volts, in small increments so that you can get exactly the regulating voltage you need. Standard tolerances are 20%, 10% and 5%.

You'll like the cold-case design of the ZA. No need for insulating sleeves when you squeeze it into tight layouts. It's so small—only 3/8" long by 0.220" in diameter—that it fits practically anywhere.

Your Mallory distributor has the Type ZA in a range of ratings. He also stocks Mallory silicon rectifiers . . . including handy packaged doubler, bridge and center-tap circuits. See him soon!

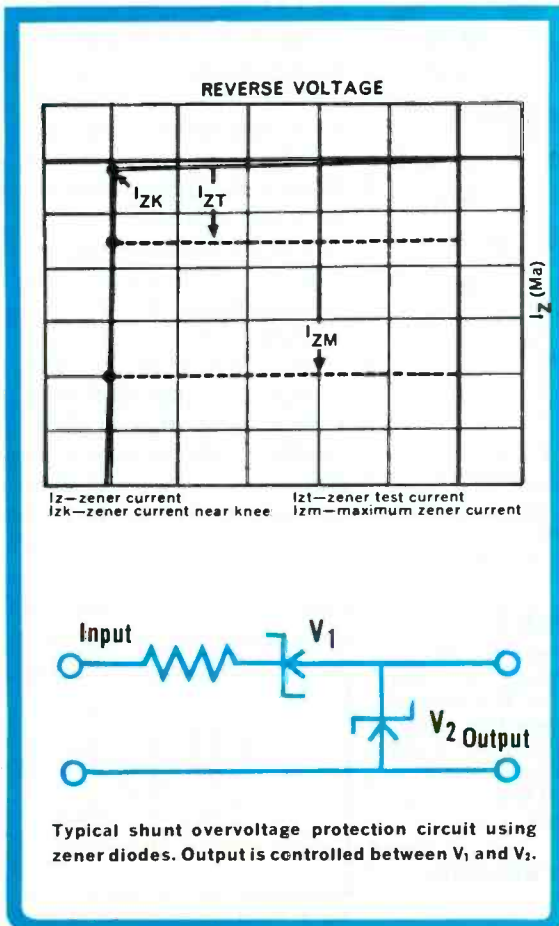

are many different types of diodes, with widely differing characteristics. Generally, a diode offers little resistance to current flow in one direction and extremely high resistance in the other. Typical industrial applications of diodes are illustrated in Fig. 2.

A diode *quad*, the series-parallel connection of four diodes, is shown in Fig. 2A; this circuit can be wired as a full-wave bridge rectifier. Fig. 2B illustrates how a diode group is utilized in a motor-speed control system. Motor speed depends on the DC armature voltage, as long as the

DC field voltage is constant. The armature voltage is obtained from the variable autotransformer, whose output voltage is rectified by full-wave bridge rectifier X1, which consists of four silicon diodes. The field voltage is derived directly from the AC line and is rectified by bridge rectifier X2, also consisting of four silicon diodes.

Varactors—One of the most interesting of semiconductor devices is the varactor diode, whose effective capacitance varies as the voltage applied across its terminals changes. One of its major applications is as

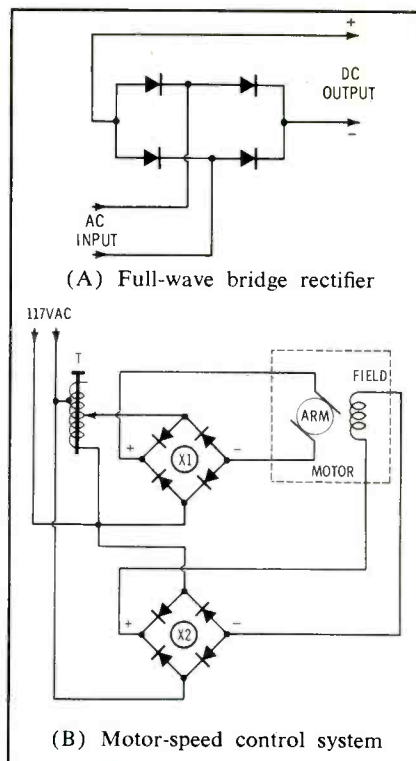

Fig. 2. Industrial applications for the diode.

a radio-frequency multiplier. They are also widely employed to vary the frequency of a crystal-controlled or self-excited oscillator. Varactors are now being used directly to frequency modulate the oscillator of an FM transmitter.

Fig. 3 illustrates a varactor diode frequency-doubling circuit. Since the varactor is a nonlinear device, the waveform of the AC input signal becomes distorted as it is passed through the device, thereby making the signal rich in harmonics. Therefore, if L1-C1 are tuned to twice the frequency of the input signal, L2-C2 can be tuned to twice the input signal frequency.

Zeners—These diodes offer a high resistance to current flow in one direction until the applied voltage becomes high enough to cause the current carriers to *avalanche*; the current through the diode then rises quickly. Zener diodes act similar to neon lamps or VR tubes; they pass little or no current until the avalanche, or firing, voltage is

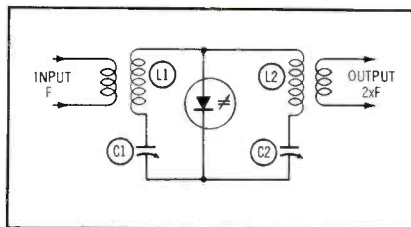

Fig. 3. Varactor diode as a frequency doubler.

look what happens when you
buy a
dozen
vu-brites...



You get the
magnifying glass free...

handy for home, shop, and service calls. Two inch diameter, handsome leatherette case. Yours free with the purchase of 12 Vu-Brites.



You get twelve
happy customers...

because 12 CRT's will be given an extra lease on life, 12 households will enjoy TV more, thanks to the brighter picture you (and Perma-Power's Vu-Brite) have provided.

what a deal!

For a limited time, Perma-Power is offering you this wonderful gift absolutely free with the purchase of 12 Vu-Brites at the regular price. Vu-Brites are the Briteners that really do a job—on parallel or series sets (Model C401 for parallel; Model C402 for series). They come colorfully packaged in individual boxes... and are priced at \$9.95 the dozen, net.

Perma-Power
COMPANY

5740 N. TRIPP AVENUE
CHICAGO, ILL. 60646

Hurry—this special gift offer will end when current stocks are gone.

Call your distributor today.

Circle 27 on literature card

QUALITY! ECONOMY! DEPENDABILITY!
RCA BATTERIES
 for all leading transistor radios



**Right now
 RCA
 BATTERIES
 are working for you on Nationwide-TV...**



Advertised on Walt Disney's "Wonderful World of Color" to over 9 MILLION HOMES*
 SUMMERTIME '64! The biggest transistor radio battery season ever. Will you be ready for it?

Get the most out of the booming radio battery business with the name people associate with radio... RCA. Put RCA's network TV advertising to work for you during the big summer selling months ahead. Stock the brand that will be seen by over 18,200,000 TV viewers. *

Call your RCA Battery Distributor today. Or contact: RCA Electronic Components and Devices, Harrison, N.J.



RCA The Most Trusted Name in Electronics

*Average viewing audience per show for the summer period based on Nielsen National Television Index.

This one is twice as safe.



When Sonotone designs a retractable cartridge, you can be sure it offers something extra. Like other retractable cartridges, the new Sonotone "21TR" withdraws into the safety of the arm to avoid bumps and bruises. Further, it has "bottoming" buttons which act as shock absorbers between the needle assembly and the record. Unlike other retractables, the "21TR" features the exclusive Sono-Flex[®] stylus, which can be dropped or mauled and still continue to provide superior performance. The high-output "21TR" is a direct replacement for the thousands of record players requiring a quality retractable cartridge.

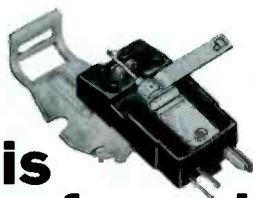

This one is twice as safe and twice as compliant.

The new Sonotone "23T" offers performance specifications never before available in a budget-priced ceramic cartridge—plus record protection. High compliance of 10; channel separation of 24 db; output voltage of 0.38; low tracking force of 2 to 4 grams make it the ideal replacement in quality stereo phonographs. Performance is only half the story of the "23T". This new cartridge features "bottoming" buttons and the flexible Sono-Flex[®] needle. Another Sonotone cartridge, the "22T," offers the high performance of the "23T" with a slightly higher output. Both feature the Sono-Flex[®], plus a unique snap-in mounting bracket, for rapid replacement without tools.

Both are direct replacements for popular makes

...and themselves.

SONOTONE
audio products

Sonotone Corp., Electronic Applications Div., Elmsford, New York
Cartridges • Speakers • Microphones • Headphones • Hearing Aids • Batteries

Circle 29 on literature card

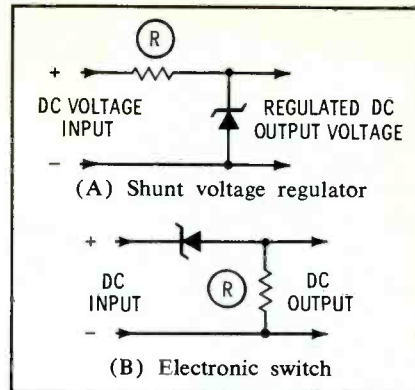

Fig. 4. Industrial applications of Zener diode.

reached. Hence, they are used widely as voltage regulators and overload protectors. Some typical applications are illustrated in Fig. 4.

Fig. 4A shows the Zener diode in use as a shunt voltage regulator. As long as the input voltage remains high enough for the Zener diode to avalanche continuously, the output voltage of the circuit will remain essentially constant. The voltage across the diode will remain steady, but the current through it will vary as the output load current increases or decreases. In Fig. 4B, the Zener diode is acting as a series switch to start or stop the output of a DC supply circuit. When the DC input voltage becomes so small the diode does not avalanche, there can be no output. When the input reaches the Zener rating, the diode avalanches and conducts, producing an output voltage across the load.

Tunnel Diodes—As their cost decreases, tunnel diodes (sometimes called Esaki diodes after the man who first explained their characteristics in 1957) are enjoying wider use. The tunnel diode is often used in computers and is popular as an oscillator or amplifier. It holds great promise in low-cost miniature communications and telemetering systems.

In Fig. 5, tunnel diode X1 is wired as a signal amplifier. The diode is biased in the forward di-

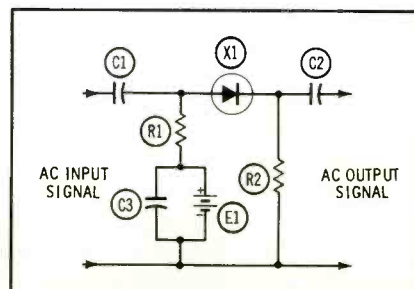

Fig. 5. Tunnel diode as a voltage amplifier.

**FINEST
MONEY-MAKER
FOR
Professional
Servicemen**

Multiple-Socket Speed with Gm Accuracy

PLUS OBSOLESCENCE PROTECTION



TESTS
All TV and Radio Tubes
—Old and New

TESTS
Nuvisitors and Novars

TESTS
European Hi-Fi Tubes,
Voltage Regulators, and
Most Industrial Types

TESTS
the New 10-Pin Tubes

TESTS
for True Dynamic
Mutual Conductance (Gm)

TESTS
New 12-Pin
Compactrons

Model 700 DYNA-QUIK DYNAMIC MUTUAL CONDUCTANCE TUBE TESTER

See your B&K Distributor
or Write for Catalog AP21-R

TESTS BOTH OLD AND NEW TUBE TYPES—SELLS MORE TUBES PER CALL

All over the nation, thousands of professional servicemen rely on the "700". Once you use it, you'll be as enthusiastic as they are. *Everyday use has proved its speed . . . its accuracy . . . its efficiency.* This up-to-date, obsolescence-proof tube tester is designed for maximum use *today and tomorrow.* Provides multiple-socket section to quick-check most of the TV and radio tube types the *true dynamic mutual conductance way—plus* simplified switch section to check new tube types in Dyna-Quik emission circuit. Also includes provision for future new sockets.

Makes test under set-operating conditions. Checks each section of multi-section tubes separately. Checks for *all* shorts, grid emission, leakage and gas. Makes quick "life" test. Exclusive *adjustable* grid emission test provides *sensitivity to over 100 megohms.*

Makes complete tube test in seconds. Checks average set in a few minutes. Discovers weak tubes that need replacement. *Satisfies more customers. Sells more tubes. Saves call-backs. Insures your reputation.* Net, \$16995

Time-Saving, Money-Making Instruments Used by Professional Servicemen Everywhere



Model 960 Transistor
Radio Analyst



Model 360 V O Matic
Automatic VOM



Model 375 Dynamatic
Automatic VTVM



Model 1076
Television Analyst



Model 445 CRT
Rejuvenator Tester

NEW TUBE INFORMATION SERVICE

Available every 3 months, on subscription,
for all B&K Dyna-Quik Tube Testers



B & K MANUFACTURING CO.

Division of DYNASCAN CORPORATION
1801 W. BELLE PLAINE AVE. • CHICAGO 13, ILL.
Canada: Atlas Radio Corp., 50 Wingold, Toronto 19, Ont.
Export: Empire Exporters, 253 Broadway, New York 7, U.S.A.

Circle 30 on literature card

CORRECT OFF-STANDARD VOLTAGE WITH

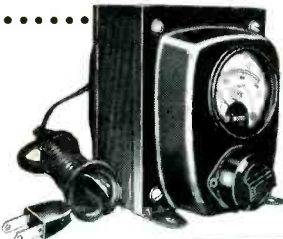

Acme  Electric

VOLTAGE ADJUSTORS

You can't get the best performance from a TV set or other electronic equipment unless it's operating on proper voltage. The Acme Electric T-8394M Voltage Adjustor corrects voltage over a range of 95 to 125 volts to normal 115/120 volts, simply by turning a regulating switch. Have a T-8394M Voltage Adjustor with you on every service call. You can use it for testing the line—and sell it on more jobs than you realize. A full 300 watts. Compact. Inexpensive. Most good supply dealers stock them. For full information write for Bulletin 161. SAA 3673-3027

ACME ELECTRIC CORPORATION

946 WATER ST. • CUBA, N. Y.

In Canada: Acme Electric Corp. Ltd., 50 Northline Rd., Toronto, Ont.

Circle 31 on literature card

Save Time on PC Board Repairs!



Melted solder disappears up hollow tip into tube

The ENDECO Desoldering Iron Removes Soldered Components in seconds... without damage!

Endeco melts solder, then removes it by vacuum • Leaves terminals and mounting holes clean • Resolders too • One-hand operation • Temperature controlled for continuous use • Ideal for use with shrinkable tubing • 4 tip sizes • Quickly pays for itself in time saved • Only \$18.75 net.

SEE YOUR DISTRIBUTOR OR WRITE



ENTERPRISE
DEVELOPMENT
CORPORATION

1102 E. 52ND • INDIANAPOLIS, IND. 46205

Circle 32 on literature card

rection by battery E1, which is bypassed with capacitor C3. When the input signal swings positive, it aids E1 and diode current decreases because of "valley" effect; the output voltage across R2 is thus reduced. As the input signal swings in the negative direction, it opposes E1 and diode current increases, thereby causing the output voltage across R2 to rise.

Varistors

A varistor is a two-terminal semiconductor that allows current to flow in either direction. Its resistance varies with the voltage applied across it, as well as with changes in temperature, but in a nonlinear manner. Varistors are widely used as voltage regulators, balanced modulators, signal-level limiters, contact protectors, and overload protectors.

A typical application is illustrated in Fig. 6. In this illustration, the varistor functions as a voltage regulator. When switch S1 (a telephone hook) is open, the DC voltage across the line is in the 40-50 volt range. When the switch is closed, the voltage drops to about 9 volts, because of resistance in the line. Of these 9 volts, about 2 volts appear across the primary of T1, and 7 volts are applied across the varistor. The resistance of the varistor changes as the applied voltage varies, and keeps the voltage across the bridge constant. This voltage is fed to the equipment through the bridge rectifier X2, whose sole function is to protect the following equipment in case the polarity of the line voltage or the connections become reversed—the bridge rectifier would hold the passage of current.

Thermistors

Thermistors are resistance elements which exhibit a high negative temperature coefficient. Their resistance is inversely proportional to temperature changes; at low temperatures, their resistance is high, and it drops as temperature increases. Their resistance can be varied by applying external heat or by passing current through them. Thermistors are used widely to sense and measure changes in temperature, as well as in time-delay devices. Their self-heating characteristics are employed in motor-starting and overload-protection applications, since their

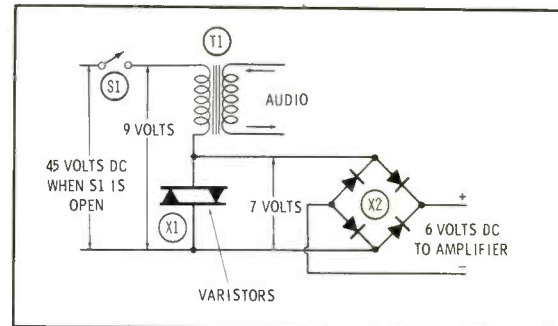

Fig. 6. Varistor as a shunt voltage regulator.

resistance is high when power is initially applied and drops as the thermistor warms up.

In the bridge circuit shown in Fig. 7, the ammeter indicates a zero reading when the ratio of R1 to R2 is equal to the ratio of the thermistor R4 to R3; variable resistor R3 can be employed for range settings. An increase in temperature causes the thermistor resistance to rise, thereby unbalancing the bridge and causing the meter to measure the resultant error voltage.

Light-Dependent Resistors

Cadmium-sulfide photocells are devices whose resistance varies with the intensity and frequency of applied light. Unlike the conventional photoelectric cells, this chemical device is often used to control a relay or other device directly, without the use of an amplifier. LDR's are used as switches and as analog-type transducers. One of the best-known uses of the LDR is as an automatic brightness and contrast control in television receivers.

Silicon-Controlled Rectifiers

An SCR (silicon-controlled rectifier) possesses characteristics similar to those of a thyatron tube. It can be used as a self-latching or nonlatching switch; by varying its one-time-per-cycle firing characteristic, the SCR can be used as an excellent regulated rectifier. This relatively new semiconductor is already playing a big role in industrial electronics.

A nonlocking electronic switch is

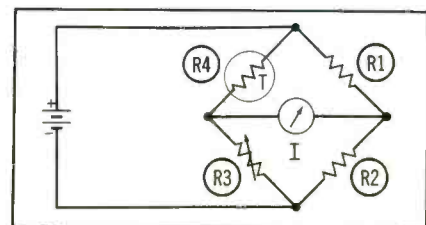
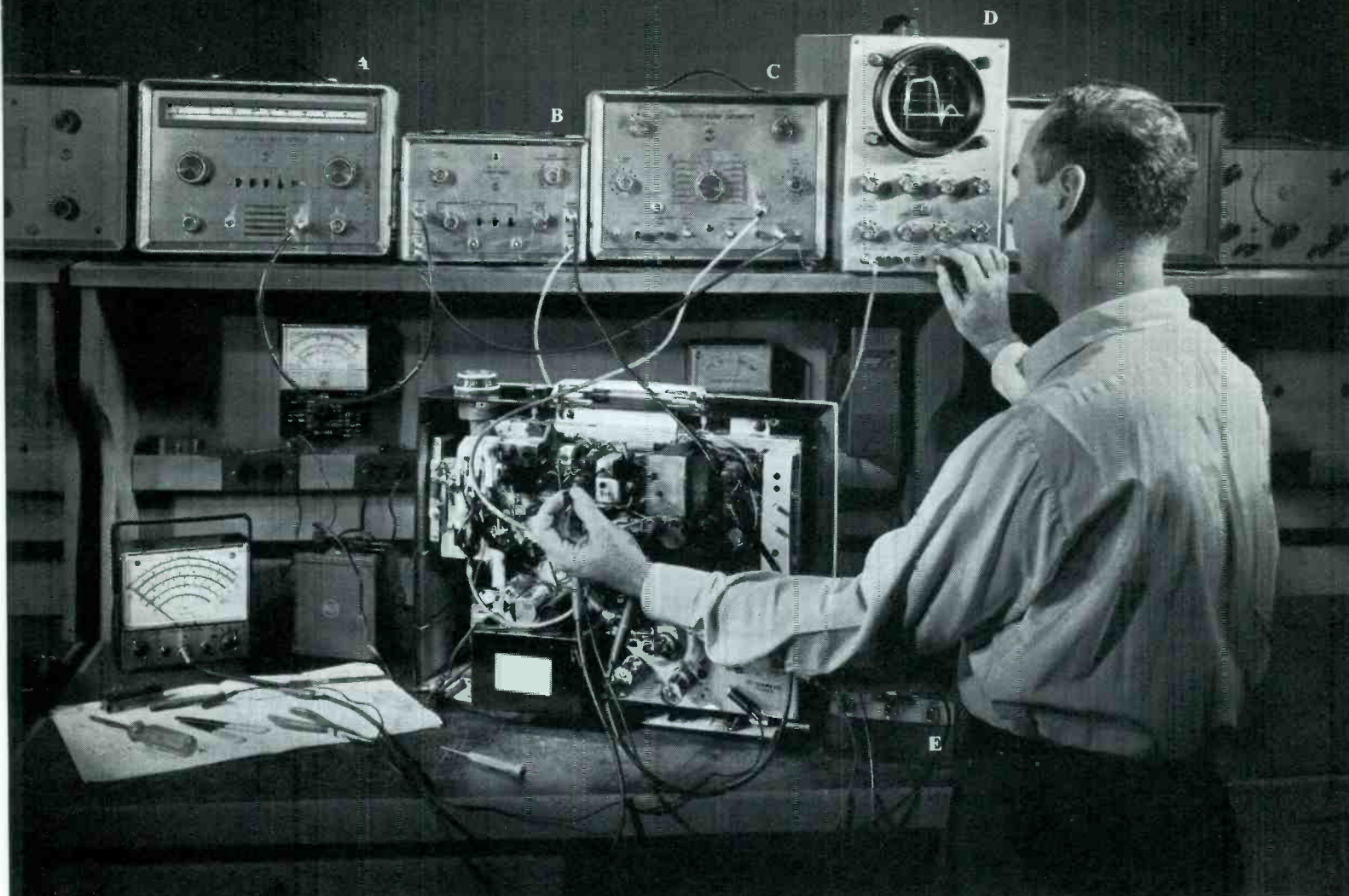

Fig. 7. Thermistor as electronic thermometer.

RCA Test Instruments...

EVERYTHING YOU NEED FOR ACCURATE TV ALIGNMENT



Checking overall frequency response (RF and IF) in a portable B&W TV receiver using the test instruments indicated in the block diagram below. Pattern on oscilloscope screen is an overall response curve with dual markers: one at picture-carrier frequency and one at sound-carrier frequency.

(A) RCA WR-99A CRYSTAL-CALIBRATED MARKER GENERATOR

Supplies a fundamental frequency RF carrier of crystal accuracy for aligning and trouble-shooting color and B&W TV receivers.

- Most-used IF and RF frequencies indicated on the dial scale
- Sound and picture carrier markers available simultaneously

\$256.50* complete with output cable.

(B) RCA WR-70A RF/VF/IF MARKER ADDER

For use with a marker generator and a sweep generator. Used for RF, IF, and VF sweep alignment color and B&W TV receivers. In visual alignment techniques, it eliminates distortion of sweep response pattern.

\$74.50* complete with four coaxial cables.

(C) RCA WR-69A TELEVISION FM SWEEP GENERATOR

For visual alignment and troubleshooting of color and B&W TV receivers, and FM receivers.

- IF/Video output frequency continuously tunable from 50 Kc to 50 Mc
- Sweep-frequency bandwidth continuously adjustable from 50 Kc to 20 Mc on IF/Video and FM; 12 Mc on TV channels

\$295.00* complete with RF output cable and IF/Video output cable.

(D) RCA WO-91A 5-INCH OSCILLOSCOPE FOR COLOR-TV

A heavy-duty, wideband precision scope, essential for TV alignment and troubleshooting.

- New 2-stage sync separator assures stable horizontal sweep lock-in on composite TV signals
- Dual bandwidth: 4.5 Mc at

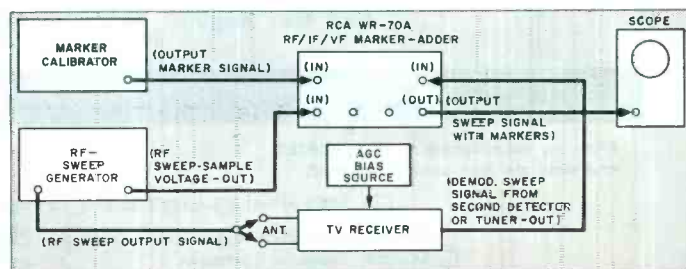

0.053 volt rms/in. sensitivity. 1.5 Mc at 0.018 volt rms/in. sensitivity

\$249.50* including direct/low capacitance probe and cable, ground cable, and insulated clip.

(E) RCA WG-307B TV BIAS SUPPLY KIT

Three separate dc output voltages each adjustable from 0 to

-15 volts provide bias voltages for aligning RF, IF and other circuits of COLOR and black and white TV receivers. **\$11.95***

See them all at your Authorized RCA Test Equipment Distributor.

**Optional Distributor Resale Price
All prices are subject to change without notice. Prices may be higher in Alaska, Hawaii and the West.*

RCA ELECTRONIC COMPONENTS AND DEVICES, HARRISON, N. J.



The Most Trusted Name in Electronics

Coming in the JULY Issue

SPECIAL COMMUNICATIONS SUPPLEMENT

- Transistorized Mikes For Mobiles
- A Clear View of Discriminators
- Removing the Mystery From Modulators
- Radio Paging

Plus



- **Heigh Ho—Come to the Fair**
... an electronics tour of the World's Fair.
- **Key to Stereo Alignment**
... quick and sure methods for accurate results.
- **Applied Reasoning for Auto Sets**
... see the advantages of systematic troubleshooting.

And Our Regular Servicing Features

Get Free Premium Books With Subscription

Enter my subscription to PF REPORTER and send me free book(s) checked.

3 Years \$10.00 2 Years \$8.00 1 Year \$5.00

- The Troubleshooter's Handbook No. 2
- Servicing Industrial Electronics
- Servicing TV from Tuner to Picture Tube

Check one for each year you subscribe

Bill Me Remittance Enclosed

Extend Present Subscription

Take this coupon to your distributor, or mail to:

Howard W. Sams & Co., Inc.

4300 W. 62nd St., Indianapolis, Ind. 46206

Name _____

Firm _____

Address _____

City _____ Zone _____ State _____

Please Check Your Business Classification

- Independent Radio, TV Serviceman
- Retailer with Service Department
- Industrial Electronics Service
- Other (Specify occupation and title)
- Owner, Mgr.
- Service Mgr.
- Employee

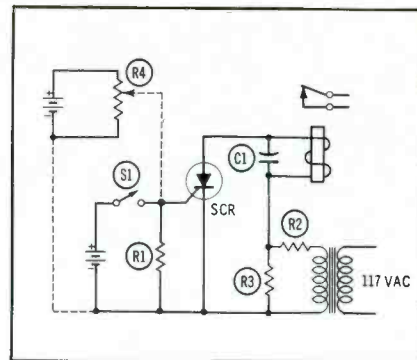

Fig. 8. Nonlocking electronic switch using SCR.

shown in Fig. 8. When switch S1 is open, the SCR does not conduct, and no current flows through the coil of K1. When S1 is closed, a positive potential is applied to the SCR "gate"; then when the AC voltage makes the anode of the SCR positive with respect to cathode, the SCR conducts. The SCR stops conducting when the AC polarity reverses just as with any rectifier, but K1 is held closed, since C1 is charged. Peak current is limited by R2, and the parallel combination of R2-R3 limits the reverse voltage on the SCR to a safe level. When S1 is opened, the SCR discontinues conduction as soon as the AC voltage swings the anode of the SCR negative with respect to cathode.

Instead of a switch, a potentiometer may be used as the control device. When the potentiometer is adjusted so the positive voltage is high enough to trigger the SCR, the relay will be energized.

Hybrid Circuits

Semiconductors are often used in so-called hybrid circuits, which also employ tubes. Transistors are current amplifiers and vacuum tubes are voltage amplifiers; hence, there are applications where both are used in combination to utilize desirable characteristics of each.

A typical hybrid circuit is illustrated in Fig. 9. To obtain a high-impedance input, a vacuum tube is used here in front of a transistor. The transistor is fed from the cathode of the tube, which functions as a cathode follower.

Semiconductor Packaging

While tube circuits are generally assembled on metal chassis, semiconductor circuits are often assembled on plug-in or wired-in cards or printed-circuit boards made of some suitable insulating material. Some-

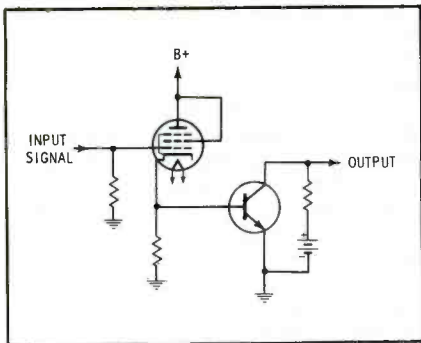

Fig. 9. Vacuum tube, transistor are a hybrid.

times the insulating material contains particles of metal, thereby enhancing its heat conduction. When a semiconductor device is employed in a circuit where it must handle a considerable amount of power, it is generally mounted on a heat sink to reduce the effects of self-heating.

Information First

There is nothing mysterious about servicing equipment that employs semiconductors. Consider them as you would resistors or capacitors whose values purposely change as a result of voltage, current, or physical environment. You are still dealing with input and output signals; either they are there or they aren't, and their character is either within limits or not within limits, in accordance with specifications. In addition to physical defects, such as broken or shorted connections, you are essentially looking for opens, shorts, or leakage, whether in semiconductors or in their associated components.

All manufacturers of industrial electronic equipment know that customer satisfaction depends on the availability and quality of maintenance service. Most are glad to have local technicians service their equipment. Complete technical information, including servicing and checkout procedure, is usually available from most industrial electronic equipment manufacturers to independent service technicians who show proof of responsibility and who definitely intend to service their equipment.

Before attacking a service problem, obtain *complete* information about the equipment to be serviced. There are so many circuit variations that rule-of-thumb procedures may lead to unhappy results and poor customer relations. ▲



THE COMPLETE TESTER

NEW SECO MODEL 88 TESTS PICTURE TUBES, TOO!

- Tests over 400 cathode ray picture tubes including 110° deflection types for
 - cathode emission
 - leaks and shorts
 - grid emission
 - gas error
 - filament continuity
 - cathode-to-heater emission
- Tests all receiving tubes including novars, nuvistors, 10 pin types, compactrons and magnovals for
 - cathode emission
 - leaks and shorts
 - grid emission
 - gas error
 - filament continuity
 - cathode-to-heater emission

Seco's patented Grid Circuit Test alone makes up to 11 simultaneous checks for tube faults. Tube Merit and Filament Continuity tests increase the test range even more—you locate those "hard to find" faults on your first try.

And now this same tester handles picture tubes, too. Merit test operates at half of rated cathode current—no possibility of damage if filament voltage is correct. Indicates leakage, gas, shorts and grid emission—tapping the tube neck shows up intermittent shorts. Even handles 110° deflection models with universal socket adaptor.

This *COMPLETE* tester saves you time and trouble—does more jobs quicker and better. New Model 88 comes to you with speed-indexed setup data, pin straighteners and 12-pin picture tube socket on a 3-foot cable. Guaranteed up-to-date—new tube data mailed periodically at no charge to all registered owners.



MODEL 88 - - - \$74.50 NET



For complete information see your distributor or write:

SECO ELECTRONICS, INC.
1221 S. CLOVER DRIVE • MINNEAPOLIS 20, MINNESOTA
A DIVISION OF DI-ACRO CORPORATION

Circle 34 on literature card



Notes on Test Equipment

analysis of test instruments . . . operation . . . applications

by Stephen Kirk

Uncomplex Multiplex



Fig. 1. Simplified unit offers complete FM stereo alignment with only one audio tone.

One of the new services that is really catching fire is FM multiplex stereo. New stations and conversions of many existing stations has put stereo FM in the reach of just about everyone. To the electronics technician, this means a new source of income; and the real kicker is that, once you look into it, stereo multiplex servicing is not at all difficult. The one extra piece of equipment you definitely need is a multiplex generator; there is no true method of aligning a multiplex receiver without one.

Zenth's Model SPTE-1 (Fig. 1) uses an ingenious approach that simplifies generator circuitry, and at the same time makes the unit easier to use. More about this later. . . .

Since stereo FM is relatively new, especially at the shop level, a brief discussion of the multiplex signal will show why a special test generator is necessary. Let's start at the source of the signal—the FM transmitter.

At the multiplex transmitter, two signals—L and R (left and right)—are fed into the transmitter through separate audio circuits. The source may be records, tapes, and—occasionally—live pickups. The simple way to broadcast

stereo would be to feed these two signals into separate transmitters and receive the signals on separate receivers; however, this obviously isn't practical. The better way is to transmit stereo from a single transmitter and have the signal heard as a monophonic signal on regular receivers and as stereo on multiplex receivers. This is called "compatibility."

Obviously then, to satisfy this requirement, we must transmit the L and R signals together so monophonic receivers will receive the program normally; then, at the same time, we must send some special signals that will let the stereo (multiplex) receiver reconstruct the original separate signals and channel them independently to left and right amplifiers. The process developed (see Fig. 2) is somewhat similar to that for sandwiching color signals into a black-and-white picture, although considerably less complex.

The answer is to send out a *difference* signal, derived from the L and R signals. Manifestly, we cannot send the difference signal along with the regular signal, using the same kind of modulation, since the signals would cancel. For example, L+R combined with L-R would produce 2L (two times the left-channel signal) since

the +R and the -R would cancel. Conversely, if an R-L difference signal were transmitted, we would obtain 2R and no L.

To overcome this possibility, a 38-kc subcarrier is superimposed (multiplexed) onto the FM carrier. This 38-kc signal is amplitude modulated with the L-R audio signal. The 38-kc "carrier" is now suppressed, leaving only the upper and lower sidebands. The upper sideband is L-R; the lower sideband, which is a mirror image of the upper sideband, is reversed in polarity and becomes -(L-R), or without parenthesis simply -L+R. The sidebands alone are sent to the FM modulator and become a part of the total modulation on the FM carrier.

These facts should be remembered since they clarify the multiplex demodulation process in the receiver which we'll discuss a little later. What we have in essence, then, is a 38-kc "switch" changing the signal from an L-R to a -L+R sample 38,000 times each second. Of course this switching action is above the audible range and, when listening, we do not realize it is taking place.

When the composite signal arrives at an FM multiplex receiver, the 38-kc "switch" signal must be reinserted into the receiver's demodulator at the correct frequency and in exact phase. To assure the proper phase relationship, the FM transmitter is modulated by a third signal, called a "pilot", of 19 kc. 19 kc is used because at low levels it is not audible and is below the range of the 38-kc sidebands. By simple doubling, the pilot signal can be amplified directly and used as the 38-kc switch in the receiver.

Fig. 3 is a simplified circuit diagram of a modern multiplex detector. Notice that the L+R signal and the L-R sidebands are coupled into the junction of two 56K resistors common to both the left and right output circuits. The transformer is tuned to 38 kc and the signal is exactly in step with the transmitter because it is developed from the 19-kc pilot signal. Without detection, the L-R and the -L+R sidebands would cancel and there would be no output to either the right or left amplifier. However, with the dual-diode detector, one half-cycle of the signal is passed on to one amplifier and the other half-cycle is coupled to the other amplifier. The L+R signal can be combined with the sidebands in this detector, to produce both right and left signals. In the process, the 38-kc component is again eliminated, and the filters finish the cleanup job. In other words, the audio product of the sidebands are "switched" in at a 38-kc rate.

Let's take an example. Say the strength of the original audio signal, at a given instant, is 3L+2R. This means we have 3L-2R in the L-R sideband and we have -3L+2R in the opposite or -L+R sideband. A monophonic receiver will receive the 3L+2R as a combined signal, since the difference sidebands would be cancelled out—even if they were audible. However, a stereo multiplex receiver will have the 3L+2R combined with 3L-2R, on one subcarrier half-cycle of 38 kc. Since the +2R and the -2R will cancel,

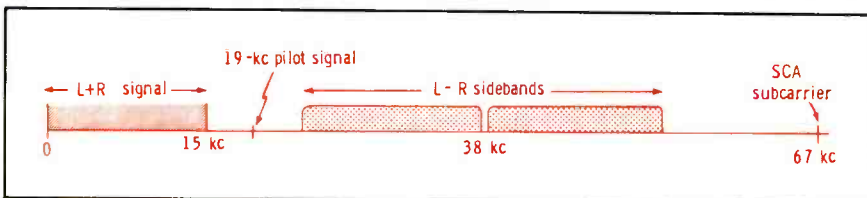

Fig. 2. Arrangement of various components of composite stereo signal utilizes subcarriers.

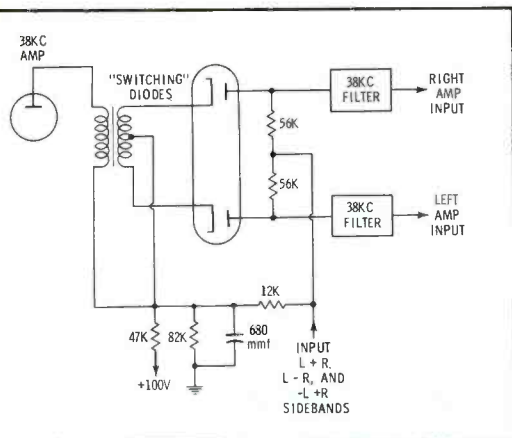

Fig. 3. A simplified stereo detector circuit.

there will remain 6L (3L+3L) going to the left channel. On the next half-cycle of 38 kc, the 3L+2R will combine with -3L+2R. Here, the +3L and the -3L will cancel, leaving 2R+2R or 4R to be channeled to the right amplifier. You can see that the same left-to-right ratio exists between the audio signal in the stereo receiver as at the transmitter (6:4 and 3:2).

A multiplex generator must pretty well simulate a stereo-FM transmitter. We mentioned earlier that Zenith has developed a simple method of generating the stereo test signal. The SPTE-1 generates only an L signal, with R at zero. For L+R, we still have a net of L, and the same applies for L-R (L-O=L). As a result, the L+R and the L-R signals cause only L to be in the receiver.

The SPTE-1 generates a 19-kc pilot signal just as does an FM transmitter. The L signal is a 1000-cps audio tone. In addition to frequency modulating an adjustable FM oscillator (88 to 108 mc), this tone is also fed to a 38-kc balanced modulator. This type of modulator produces AM sidebands above and below 38 kc but suppresses the carrier. The sidebands are in turn frequency modulated onto the main oscillator signal.

The 67-kc subcarrier oscillator in Fig. 4 can be switched in for setting the 67-kc traps in the multiplex receiver. 67 kc is the frequency used for broadcasting music to stores, buses, etc., during regular commercial programming. It must be suppressed in the home receiver, however, to prevent distortion of the stereo

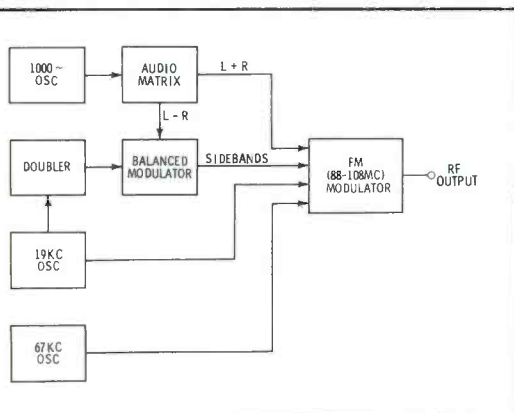

Fig. 4. Showing interrelation of the stages.

signal.

The 19-kc pilot signal must be accurate, and the SPTE-1 has provision for setting it right on the nose with a front-panel slug adjustment. A stereo receiver is needed for the adjustment. A plug-in cable, supplied with the instrument, is connected to the plate of the 38-kc amplifier in the receiver, which is tuned to a stereo station.

There are two methods of finding the zero-beat between the signal supplied by the stereo station and that of the generator: Either plug a set of earphones into a jack on the front panel and listen, or use a neon bulb and tune until it stops flickering. The unit we received from the factory was less than 1 cps off after being shipped several hundred miles.

We connected the generator to the antenna terminals of a multiplex receiver. The generator we tested was factory-set for about 100 mc, but it is a simple matter to change this frequency if you happen to live near an FM station that already occupies this frequency. Just tune the receiver to a quiet spot and then turn the slug in the SPTE-1 until you hear the 1000-cps tone modulation.

We first turned on the 67-kc subcarrier and, with a VTVM connected at the multiplex detector, tuned the 67-kc trap in the multiplex unit for minimum reading. Next, we turned up the pilot-carrier control to 10% and again using the VTVM (we could, and later did, use a scope) set the 19-kc pickoff coil and amplifier coil for maximum. We then adjusted the

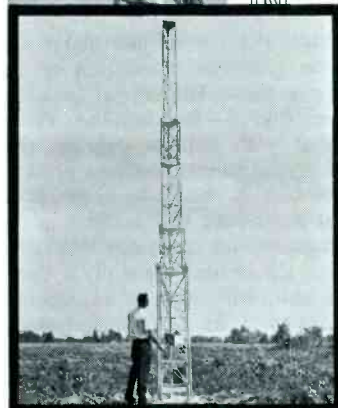
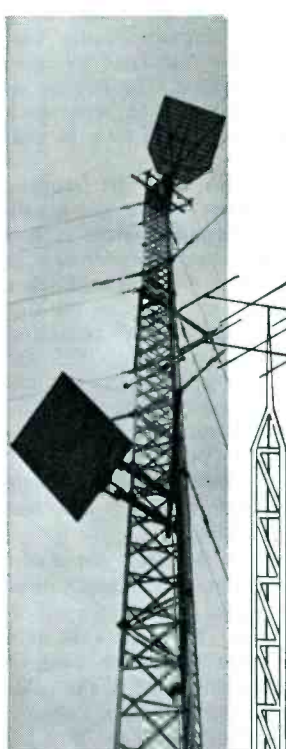

The most Famous Name in
TOWERS of ALL KINDS!

Here are the advantages you get when you insist on ROHN TOWERS

LARGEST FULL RANGE OF TOWERS—you can get anything from home TV and amateur radio towers to heavy-duty communication and micro-wave towers. Included are 500 foot self-supporting towers, 1,000 foot guyed towers, "fold-over" and crank-up towers. Regardless of your needs, ROHN can supply it.

UNQUESTIONED LEADERSHIP IN DESIGN AND MANUFACTURE—you get the latest in advanced tower engineering. All communication towers are engineered to EIA specifications, and are proved by thousands of installations. No other manufacturer can surpass the quality and fine reputation of ROHN.

QUALITY MATERIALS AND WORKMANSHIP—Only highest quality steel is used which fully meets the specifications for the job. ROHN towers are hot-dipped galvanized after fabrication—a feature ROHN pioneered!

SERVICE WHEREVER YOU WANT IT—ROHN representatives are world-wide. Complete erection service for communication systems, broadcasting, micro-wave, and other needs is available; also competent engineering service to help you.

Settle for the BEST in TOWERS—ROHN—today the world's largest, exclusive manufacturer of towers of all kinds!

Also available: Rohn Lighting Kits, Microwave Passive Reflectors, Tower Installation Service and Engineering Assistance. Representatives World-Wide to Serve You.

For your needs, contact your local ROHN salesman, distributor or dealer; or write direct for information.

SEND THE HANDY COUPON INDICATING YOUR NEEDS

ROHN
Manufacturing
Co.
BOX 2000
PEORIA, ILLINOIS

Send me complete literature on the following ROHN Products:

- | | |
|---|--|
| <input type="checkbox"/> Home TV Towers | <input type="checkbox"/> Amateur Towers |
| <input type="checkbox"/> Communication Towers | <input type="checkbox"/> AM-FM Broadcasting Towers |
| <input type="checkbox"/> Micro-Wave Towers | <input type="checkbox"/> Government |

Name

Firm

Address

City State

"World's Largest EXCLUSIVE Manufacturer of Towers; designers, engineers, and installers of complete communication tower systems."

Give your CB mobile antenna sales this PROFESSIONAL "SPRING" TUNE-UP!

Antenna Specialists does it again—with the newest, slickest "Hot Rod" in mobile CB antennas! All the high-performance, high-reliability features of the famous M-67 . . . now with a beautiful and functional stainless steel shock spring. Get up and go for more sales!



M-124 for 3/4" hole

M-125 3/4" hole, snap-in mount

M-123 Like M-125 less spring

M-126 Shock Spring Kit—converts M-67, M-73, M-74

new

M-124 "SUPER MAGGIE MOBILE"

(every high-powered combination you can think of)



the antenna specialists co.

12435 Euclid Ave., Cleveland, Ohio 44106 see your A/S rep for details!



T.M. "Stripes of Quality"

Circle 36 on literature card

38-kc coil for maximum.

The next step recommended was to turn on the L-R switch and readjust the 38-kc coil for maximum 1000-cps output to the left amplifier. The reason for this readjustment is that the phase shift inherent in the set may prevent the exact switching point between left and right channels from occurring exactly at 38 kc.

We then turned on the L+R switch,

For further information, circle 54 on literature card

Radio-Signal Generator

This model WR-50A signal generator (Fig. 5) developed by RCA is a general-purpose instrument for use in radio and TV servicing or in any other application that requires a CW or modulated-RF signal from 85 kc to 40 mc.

The RF output is modulated by an internal 400-cps sinewave audio oscillator or it may be modulated by an external signal if desired. The 400-cps signal is also available on a separate AF IN/OUT cable for making tests in audio and video circuits.

Six tuning ranges cover the frequency band outlined above. These are selected by a front-panel range switch. A large vernier tuning control dominates the front panel of the instrument. Each of the six ranges are embossed on the front panel and the "see-through" point indicates the range, "A," "B," "C," etc., making it easier to read the correct scale after setting the range switch.

A HI/LO attenuator switch (maximum output is in the HI position) and a variable attenuator control gives a wide range of output amplitude with very little leak-through at low settings.

Two cables are used with the generator, both shielded and permanently wired into the instrument: the AF cable and the RF OUTPUT cable. There is a blocking capacitor in series with each cable so that B+ voltage connected to the cables will not damage the attenuator circuit.

An additional feature of the WR-50A is the crystal socket on the front panel. This permits the use of just about any crystal for generator calibration or for receiver alignment. The crystal circuit is shown in Fig. 6—the familiar Pierce circuit that will oscillate over a wide range of crystal frequencies and produce rich harmonics. It should be noted, however, that this circuit will oscillate at the crystal *fundamental* frequency only. For example, a CB crystal, normally a third-overtone unit, will oscillate at approximately one-third its marked frequency. (Notice we say *approximately*, for the third overtone of a crystal is not always precisely the same as the third harmonic.)

To further facilitate the use of the crystal circuit, the VFO may be turned off with a panel switch so that only the crystal oscillator output is available through the RF OUTPUT cable.

One half of a 12AT7 is used as a Hartley RF oscillator, and the other half is used as a cathode follower to isolate the oscillator from the load. Modulation

and checked the voltage at the right-amplifier input with a scope. It should be, and was, less than one-tenth the amplitude of the left signal. We seemed to get equally useful results, and with less effort, by simply turning on both the L-R and L+R switches and then adjusting the 38-kc coil for *minimum* right signal. Either method produces excellent results for listening to a stereo station.



Fig. 5. Signal generator covers frequencies from ultrasonic to the high-frequency band.

voltage is shunt-fed into the plate circuit of the RF oscillator (see Fig. 7).

The audio oscillator uses transformer feedback and provides a clean 400-cps sinewave. Power is supplied by a transformer-type half-wave rectifier circuit supplying about 130 volts DC. A neon bulb across the AC input circuit is used as a pilot lamp.

We turned on the WR-50A and allowed it to warm up for 15 or 20 minutes before checking calibration. We first used selected crystals in the front panel socket and the circuit of Fig. 8 to check the accuracy of the unit. Zero-beat on the scope is indicated by a lissajous display which drops to a straight horizontal

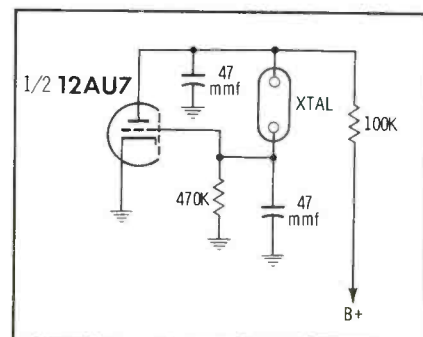

Fig. 6. Pierce oscillator used with a crystal.

THE WONDERFUL WIZARD 300*

- 1 ANTENNA + 2 WIZARDS = 2 OUTLETS
- 1 ANTENNA + 3 WIZARDS = 3 OUTLETS
- 1 ANTENNA + 4 WIZARDS = 4 OUTLETS
- 1 ANTENNA + 5 WIZARDS = 5 OUTLETS
- 1 ANTENNA + 6 WIZARDS = 6 OUTLETS
- 1 ANTENNA + 7 WIZARDS = 7 OUTLETS
- 1 ANTENNA + 8 WIZARDS = 8 OUTLETS
- 1 ANTENNA + 9 WIZARDS = 9 OUTLETS
- 1 ANTENNA + 10 WIZARDS = 10 OUTLETS
- 1 ANTENNA + 11 WIZARDS = 11 OUTLETS
- 1 ANTENNA + 12 WIZARDS = 12 OUTLETS
- 1 ANTENNA + 13 WIZARDS = 13 OUTLETS
- 1 ANTENNA + 14 WIZARDS = 14 OUTLETS
- 1 ANTENNA + 15 WIZARDS = 15 OUTLETS
- 1 ANTENNA + 16 WIZARDS = 16 OUTLETS
- 1 ANTENNA + 17 WIZARDS = 17 OUTLETS
- 1 ANTENNA + 18 WIZARDS = 18 OUTLETS
- 1 ANTENNA + 19 WIZARDS = 19 OUTLETS
- 1 ANTENNA + 20 WIZARDS = 20 OUTLETS
- 1 ANTENNA + 21 WIZARDS = 21 OUTLETS



Another Wizard 300 Master Antenna System — one antenna — 12 outlets — no amplification—done entirely in twinlead. The Towne Apartments, Downey, California.

WRITE FOR SCHEMATIC DIAGRAM & SPECIFICATIONS CHARLES ENGINEERING, INC.

3421 NORTH KNOLL DR., LOS ANGELES, CALIF. 90028
LIST \$1.95. OBTAINABLE AT YOUR DEALER OR WRITE.

*U. S. LETTERS PATENT NO. 2,913,679

Circle 37 on literature card

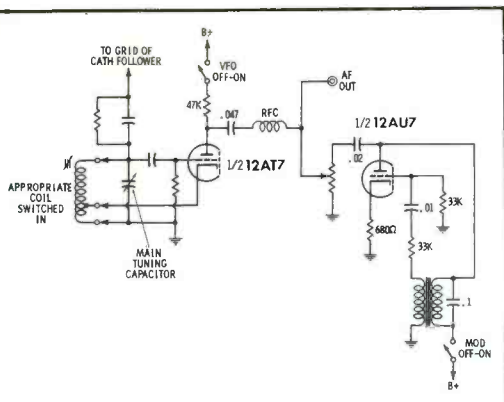

Fig. 7. Partial circuit of the RF and AF osc's.

line when the oscillator is at precisely the same frequency as the crystal (or at exact multiple).

Using this method and checking with a frequency standard, we found the calibration accuracy to be within 1% on all bands and 1/2% or better on 4 of the 6 bands. Good calibration, of course, is a prime requisite for any signal generator, since you must be able to depend upon the dial settings. Knowing that the WR-50A was okay in this respect, we tried it out in several service situations.

There is ample RF or AF output for all tube- and transistor-radio servicing. The sinewave audio signal was a valuable aid in signal tracing and even in spotting distortion using a scope as an indicator. (Tones of any sort are poor distortion indicators if you use your ear as a guide since the ear cannot very easily distinguish between a sinewave and a sawtooth when heard separately.)

The 400-cps AF signal can be used not only in audio circuits but as an ideal tracer for video stages of a TV receiver. If injected into the video circuit, the signal will cause about six horizontal bars on the CRT.

You can also use the modulated RF output for signal-tracing in the IF circuits of a TV receiver. If the TV IF is higher than 40 mc, use the 20-mc range since the generator has strong second harmonics.

The instruction booklet with this generator covers signal tracing, gain checking, alignment, calibration, and other topics. Definite procedures for finding dead stages, weak stages, and even intermittent stages, are discussed. ▲

For further information, circle 55 on literature card

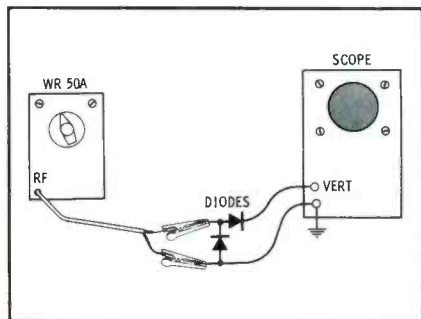
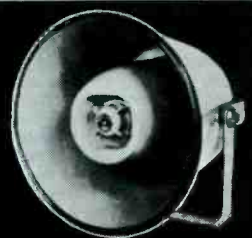

Fig. 8. Scope and diodes to check zero-beat.

YOU CAN SAFELY PUT ALL YOUR EGGS IN ONE BASKET



You profit more by using the same dependable brand of public address speakers and microphone stands for all your needs.

Your ATLAS SOUND distributor makes one-stop shopping easy with a wide selection of proven models... backed by our years of commercial sound experience... concern for product reliability... pricing for your profit.

Look for the ATLAS SOUND mark of quality on all paging and talkback speakers, trumpets, drivers, explosion-proof speakers, sound columns... floor, desk, boom stands... accessories for all. This trademark makes a world of difference. Write for catalog PF-6D

ATLAS SOUND, Division of
AMERICAN TRADING AND PRODUCTION CORPORATION
1419-51 39th Street, Brooklyn, New York 11218
Canada: Atlas Radio Corporation, Toronto



THIRTY YEARS OF LEADERSHIP IN COMMERCIAL SOUND
Circle 38 on literature card

Scoping Transistor Radios

(Continued from page 24)

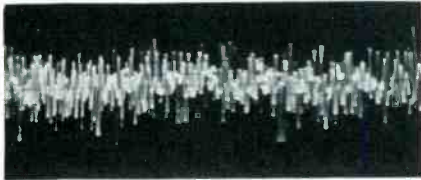

Fig. 4. Typical audio signals at RI-1 and -2.

Some commercial low-cap probes use the circuit in Fig. 5A. If yours does, change it to the circuit of Fig. 5B. R should equal seven times the scope input impedance; C can be determined experimentally to show an accurate 400-cps square wave on the scope screen. Readers of this column will remember seeing this low-cap probe in a previous column (page 89 of the December 1962 issue) concerning TV scoping. The low-cap probe I use in scoping transistor radios is the same one I use for TV troubleshooting. Let's return to the main theme of this article.

Scoping RI-2

If in tuning the radio while the scope is attached to RI-1, a signal (Fig. 4) is produced, but still no sound emanates from the speaker, the probe should be advanced to the earphone jack (RI-2). If no signal is found there, it definitely indicates trouble in the driver, the driver transformer, the output stage, or the output transformer. If all these stages and components are operating normally, RI-2 will show an audio signal like Fig. 6A with an amplitude of approximately 4

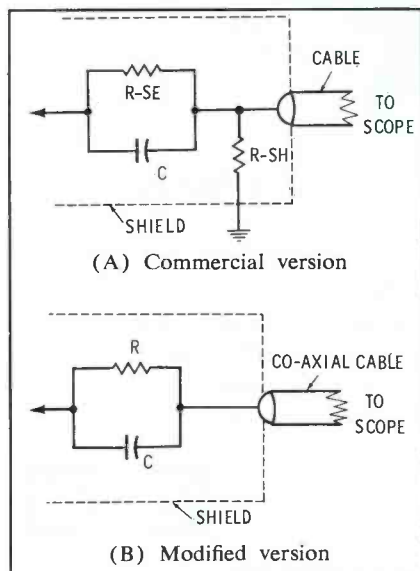

Fig. 5. Modification to low-capacitance probe.

volts. If there is still no sound, either the speaker or the jack is defective.

You can also use RI-2 to determine the approximate audio output in watts. The average transistor radio has an output power of .3 to .4 watt or approximately 350 mw. If the output transformer feeds a voice coil of 3.2 ohms, the voltage across the voice coil for 350 mw would be approximately 1.1 volt ($W = E^2/R$ or $W \times R = E^2$). Substituting .350 (watts) \times 3.2 (ohms) = 1.1² (volts) or 1.21 volt. This voltage

value is rms, while the scope reads peak-to-peak voltage—2.8 times the rms value. Thus, 3 volts on the scope, across a 3.2-ohm voice coil, will equal .3 watt—the usual value for transistor radios. It is somewhat easier merely to read the scope voltage, divide it by three, and apply it to the formula ($W = E^2/R$) to obtain the approximate audio power.

The high end of the volume control was selected and numbered RI-1 because it is profitable to determine quickly which half of the receiver is defective. The earphone

A NEW CONCEPT IN COLOR TV ANALYZING PUTS YOU IN THE PROFITABLE COLOR TV SERVICE PICTURE AT A VERY LOW COST



Checks color, video and picture tube circuits
Checks the overall performance of color TV sets
Provides for fast purity, convergence and gray scale tracking adjustments

Color TV set sales are booming all over the country! To help progressive servicemen get their share of the color service business Mercury has developed a highly efficient instrument based on an ingenious new engineering concept in color TV analyzing. The Model 900 Color TV Analyzer enables you to tackle color TV servicing in the home and in the shop with ease and confidence at a minimum cost.



FEATURES

- ✓ Makes all tests dynamically while color set is in operation
- ✓ Exclusive circuit eliminates need of range switches. Just set element selector and meter is automatically on right range
- ✓ Connects as easily as a picture tube brightener... no need to get under TV chassis
- ✓ Safety feature... circuit allows safe measurement up to 7000 volts on focus grid

See your electronics parts distributor or write for complete Mercury catalog

\$44.95 Slightly higher in the West

NEW

MAKE ANY ONE OF THESE TESTS IN MINUTES

- TEST each control grid voltage... indicates shorts or gas in each color gun
- TEST each color gun screen voltage and screen current... indicates trouble in power supply or boost circuits
- TEST focus voltage... indicates high voltage or horizontal deflection circuit trouble
- TEST each cathode voltage... indicates circuit trouble
- TEST each control grid emission current... indicates shorts or gas in each color gun
- TEST each color gun cathode emission... indicates dynamic quality of each color gun.

The Model 900 enables you to cut-out color guns in any combination and adjust for proper PURITY—CONVERGENCE—and GRAY SCALE TRACKING.

Mercury ELECTRONICS CORPORATION
manufacturers of quality electronic products

111 Roosevelt Avenue, Mineola, New York

IN CANADA: R. C. Kahnert Sales Ltd., 359 Enford Rd., Richmond Hill, Ontario

Circle 39 on literature card

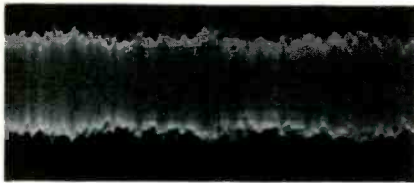

(A) Strong local-station signal

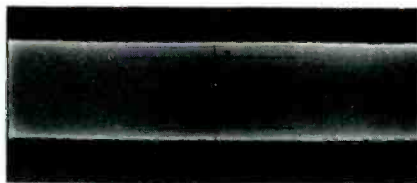

(B) Signal without modulation

Fig. 6. RF Signals found at RI-4 test point.

jack was chosen as RI-2 because faults develop in this jack or in the speaker quite frequently. The next scoping point, RI-3, is also a point where a large percentage of troubles have been quickly detected; however, because circuits involved in scoping RI-3 deserve extended discussion, I would like to shift gears temporarily and discuss RI-4 first.

Scoping RI-4

As you can see from both the receiver pictures and the schematic diagram, RI-4 is the stator connection of the tuning capacitor and the hot end of the ferrite antenna. It might be expected that at this point you would use a detector probe, but scoping is more reliable if the same modified low-cap probe is used as before; a direct probe is also suitable

at this point. If, for example, the crystal detector probe is used at this point, such a small indication is shown on the scope that it is just barely perceptible. On the other hand, using the modified low-cap or a direct probe results in a larger and more definite deflection on the scope.

The probe is attached to the stator connection of the tuning gang that tunes the antenna, the scope ground is attached to either the gang frame or the receiver common bus. Proceeding as before, the radio is oriented to obtain maximum pickup from the strongest local station. Unlike in the previous procedure, the tuning dial is not tuned through frequencies near the station; instead the dial is tuned to a point slightly above the station frequency. This is

necessary because of the added capacitance of the probe across the antenna tank. Stations up around 1200 kc will tune on the dial about 1400 kc, stations at 900 kc will tune about 1100, and lower-frequency stations will tune only slightly higher than their assigned frequencies.

The important factor of scoping RI-4 is the signal voltage presented on the scope. A small ferrite-antenna tank circuit will show a scope trace similar to Fig. 6A with a measured voltage of about .1 to .3 volt. Larger ferrite antennas will produce voltages up to about .4 or .5 volt. What might surprise you is that the signal amplitude does not shrink to zero and swell to maximum in step with modulation of the station carrier; even when the station is silent (Fig. 6B) the carrier will still present a scope signal fairly close to the amplitude of the modulated signal.

In view of the different signal strengths that prevail in different shop areas, the transistor technician will profit by developing his own standards of signal voltages obtained

MODEL NO. RK4 660-398

MINIATURE PNP TRANSISTORS

4 WILL REPLACE 1000

DIFFERENT ENTERTAINMENT TYPES

MADE IN U.S.A.

QUICK SERVICE PACK

FOR REPLACEMENT IN TIGHT PLACES.

USED IN DOMESTIC AND FOREIGN TYPE RECEIVERS.

MODEL BE6-M CONV. OSC. MIXER

MODEL BA6-M AMPLIFIER

MODEL AT6-M AUDIO DRIVER

MODEL B5-M AUDIO OUTPUT

TOP QUALITY

- PNP CONV. OSC., MIXER
- PNP I.F. AMPLIFIER
- PNP AUDIO DRIVER
- PNP AUDIO OUTPUT

WORKMAN Electronic PRODUCTS, INC.
SARASOTA, FLORIDA

FAST INVENTORY TURNOVER

4 MINIATURE PNP TRANSISTORS

4 WILL REPLACE 1000

DIFFERENT ENTERTAINMENT TYPE TRANSISTORS FOR BOTH DOMESTIC AND FOREIGN RECEIVERS

TOP QUALITY U.S.A. MADE

MODEL NO. **RK4**

4 TRANSISTORS

\$3⁹⁶ DLR. NET

COMPLETE GUIDE ON BACK OF EACH PACKAGE

WORKMAN Electronic PRODUCTS, INC.
SARASOTA, FLORIDA



service faster with Fast-Fax

Raytheon Fast-Fax puts tube data for 600 types right at your fingertips. Stays up-to-date with "pop-in" supplements (including new types in '65 sets). Operates as an interchangeability guide and inventory control. See it at your Raytheon Distributor. You'll wonder how you ever got along without it. Fast-Fax. Only \$3.95.



Circle 40 on literature card

New BERN'S Perfect Pin Crimper

Picture-Tube Repair Tool
Also for—5U4, 6SN7, 6BQ6, etc.

Eliminates that hard soldering job
only \$1.25 each



Also for color pic tubes

Fix loose pin connections in seconds. Pays for itself in time saved on first job. 3" long.

Patented

Intermittent operation of picture tubes and other tubes due to defective solder connections easily corrected. Provides solid electrical connections, can also be used as channel-selector wrench and screwdriver. Pin keeps its original form. A 3-in-1 tool.

3 MODELS ELIMINATE SOLDERING
Makes Solid Electrical Connections
Phono Pin-Plug Crimper

Slip wire in "pin plug," insert in tool, and squeeze... job is done.



C-rings 1c ea.

Use end of tool to push on C-ring for ground connection.

Ant. plugs, hi-fi, multiple plugs, public address, radio and TV tubes, radar, speakers, and loop connections. Many, many more uses.

Model LC-3 for 5/32" pin diameter
At your parts distributor or write us

BERN'S Mfg. Co.
9853 Chalmers,
Detroit 13, Mich.

Circle 42 on literature card

TV TUNERS

Rebuilt—Exchanged

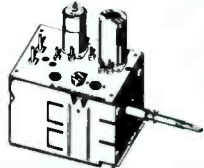

\$950*
Plus Shipping Charges

All Makes—All Models

- Includes all parts except tubes
- 90 day full warranty
- All tuners cleaned, lubed, repaired and aligned with crystal controlled factory equipment to factory specifications, by factory trained technicians.
- 1 day service

Give model number of set and complaint. Include tubes, shields, cover and all parts, broken or not.

*Practical Repairs

VALLEY TV TUNER SERVICE

5641 Cahuenga Blvd. PO 9-4730
North Hollywood, California

Circle 43 on literature card

across antenna tank circuits. This scope test will quickly show up inefficient ferrite antennas—often caused by an unsuspected crack in a ferrite core or shorted turns in the coil. A complete lack of signal at RI-4 can be traced to an open winding or shorted tuning capacitor. Sometimes, for instance, a tinkering customer will adjust the gang trimmers and in the process lose the mica insulator. This RI-4 test will show this up quicker than any technique I know of.

Scoping RI-3

Scoping at RI-3 provides a quick and positive method of determining whether the receiver oscillator is functioning. The signal at this point will normally have an amplitude between 8 and 15 volts, and will appear as in Fig. 7A. If the scope sweep rate is set at approximately one-tenth the oscillator frequency, the oscillator signal will appear as in Fig. 7B.

The converter circuit in the RCA Model 1T4 receiver (Fig. 8) is typical. The C5-R6 network is frequently deleted and the transformer winding grounded as shown by the dotted line. A defect in almost any of the components shown in Fig. 8 will prevent the oscillator from functioning. In some cases, even tolerance allowances in oscillator coil L2 and transistor X1 will result in lack of oscillation, even though these parts may not actually be defective.

In one particular radio with oscillator inoperative, an RCA Model RC-1188, replacing both X1 and L2 failed to restore oscillator operation, although all other circuit components tested perfect. By shunting



(A) Scope sweep at low frequency

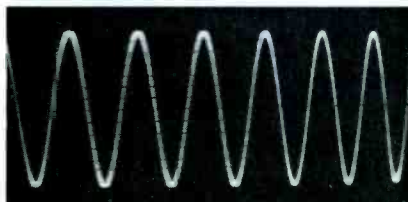

(B) Same signal swept rapidly

Fig. 7. Signals found at test point RI-3.



5-CHANNEL MIXER-PREAMP, MODEL E-5P

NEWCOMB



10 WATT E-10B

PATHFINDER P.A.



20 WATT E-20

ECONOMY LINE



40 WATT E-40

PUBLIC ADDRESS



75 WATT E-75

AMPLIFIERS

NEWCOMB AUDIO PRODUCTS CO.

Dept. PP-6 6824 Lexington Ave.
Hollywood, California 90038

Gentlemen:

Please send immediately a free copy of your Catalog No. PF-7 describing in depth your Pathfinder P.A. line.

NAME _____

ADDRESS _____

CITY _____

STATE _____ ZIP _____

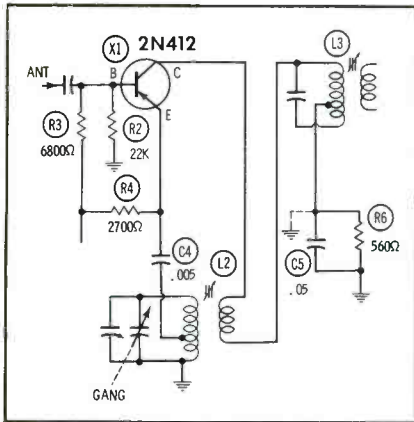

Fig. 8. Common converter circuit used by RCA.

R2 with a 100K resistor, it was found that the circuit functioned normally.

Nonfunctioning oscillators in Philco Series T-4 receivers have been traced to an open primary in the first IF transformer (L3 in Fig. 8).

Capacitor C4 in Fig. 8 is commonly referred to as an injection capacitor because it does inject a portion of the signal from the oscillator tank circuit into the emitter of the converter transistor. If C4 loses capacitance, the oscillator may stop altogether or it may function only

at the high end of the band.

One such condition involved a Motorola X19A with the slightly different oscillator circuit shown in Fig. 9. This receiver had an erratic oscillator; in cool weather it started, and in warm weather it didn't. The only components I figured would be affected by temperature were the transistor and C8, a .01-mfd ceramic capacitor. Since the transistor is more expensive than the capacitor, I tried the latter first; happily, this fixed the trouble. Measuring the old capacitor on a checker revealed a slight loss of capacitance.

The waveshape of the oscillator-tank signal is important in transistor radios. While the signal does not introduce audio distortion if it is not a pure sine wave, it will introduce chirps and parasitic oscillations between stations and immediately adjacent to stations. A "hot" replacement transistor may produce this effect; the condition can be cured by slightly reducing forward bias. In most sets, however, it is better to use an exact-duplicate replacement; this is particularly true in four-transistor sets where con-

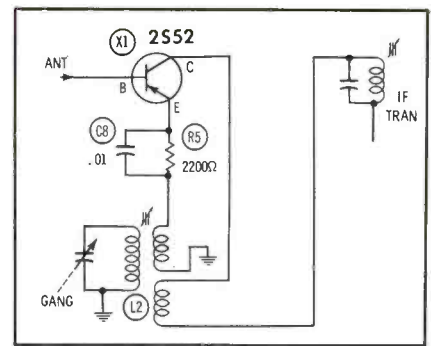

Fig. 9. Converter circuit used in a Motorola.

verter gain is important to sensitivity.

Conclusion

While scoping of signals in transistor radios was limited in this article to points easily and quickly recognized by experienced servicemen, and thus were called Rapidly-Identified (RI) points, scoping at intermediate points is also profitable. In a future *Shop Talk* feature, I will cover these intermediate points, reporting the amplitudes and gains of signals in the various stages. In addition, I'll cover distortion and other conditions—all traced easily by scoping. ▲

New coil catalog and replacement guide

No. 164

Covers the world's widest line of IF and RF coils for both service and industrial requirements

Gives exact replacements for all known TV sets, radios, car radios

Provides prices, complete specifications, more than 3000 new entries in Cross Reference Section

For your free copy, see your local distributor, or request directly from J.W. Miller Company.

J. W. MILLER COMPANY

5917 South Main Street • Los Angeles 3, California

Circle 44 on literature card

only SWITCHCRAFT offers a low-cost molded closed-circuit jack

NEW!

SWITCHCRAFT

4 LEAF CLOVER JAX* MOLDED PHONO JACK

Only Switchcraft's all-new "4 Leaf Clover" phono jack offers you a low-cost connector with closed-circuit and all these other "lucky" features:

- Exclusive! Tip spring with shunt forms DUAL contact around pin of phono plug upon insertion.

REAR VIEW PLUG IN

- Lower in cost . . . higher in reliability.
- High-impact plastic molded body for extra ruggedness.
- Special nickel silver springs for maximum life, dependability.

Available in four models: open circuit, grounded or ungrounded; closed circuit, grounded or ungrounded. Mounts on 3/4" centers.

WRITE FOR CATALOG NO. C502:

5573 N. Elston Ave., Chicago, Illinois 60630
*Patent Applied For.

Circle 45 on literature card

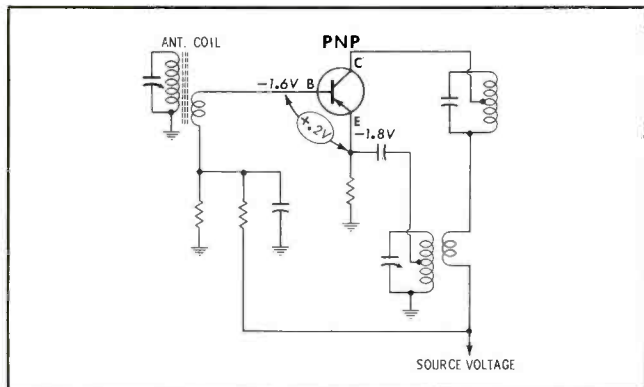

Fig. 6. Some transistor mixer-oscillators use reverse operating bias.

the oscillator circuit by touching your finger to a "hot" terminal on the oscillator coil or tuning capacitor. If the bias voltage *changes*, the circuit is oscillating; if not, you have oscillator trouble.

Transistors vs Tubes

What is the real difference between transistor and tube circuits? The main difference is one of impedances and biasing. The tube is by nature a high-impedance device (in a common-cathode circuit) at both input and output. The common-emitter transistor amplifier, on the other hand, furnishes a low-impedance input and medium- or high-impedance output. In a tube, current does not normally flow in the biasing circuit, while in a transistor current must flow.

A look at Fig. 7 reveals basic differences between tube and transistor IF circuits. The tube grid (input) circuit is tuned while the transistor base (input) circuit is untuned. The tube circuit is biased with voltage developed across a cathode resistor, but the transistor must be "started" by a fairly low-impedance base-biasing circuit (R1 and R2). The emitter resistor (R3) of the transistor cannot by itself develop bias since the transistor cannot conduct with zero bias as can a tube. In fact, a transistor with zero bias is cut off. Fig. 8 shows both tube and transistor versions of an audio driver circuit. Although the transistor circuit shown here is resistance coupled, this form of coupling is not too satisfactory for transistor circuits—for at least two reasons. First, the resistance in the output collector circuit must be kept low because the source

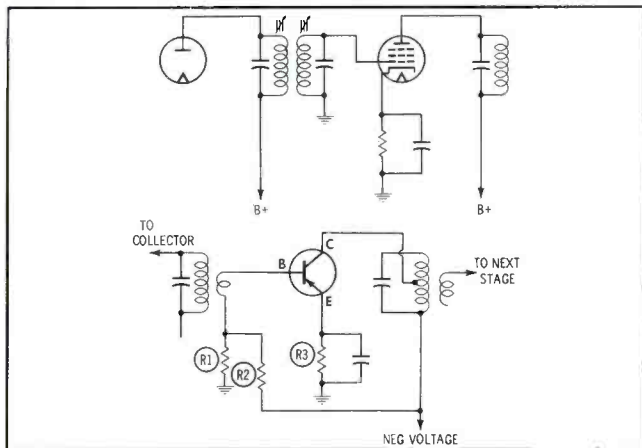
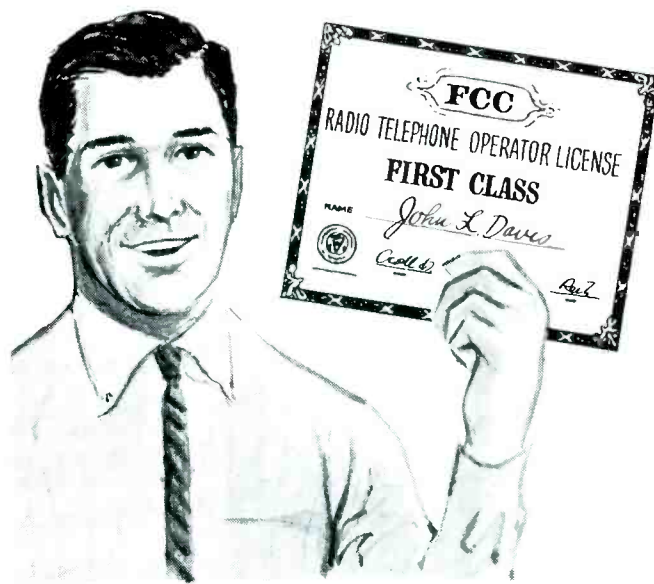

Fig. 7. Comparison circuits of tube and transistor IF amplifiers.

Communications, mobile radio...

A First Class FCC License

...or Your Money Back!



Your key to future success in electronics is a First-Class FCC License. It will permit you to operate and maintain transmitting equipment used in aviation, broadcasting, marine, microwave, mobile communications, or Citizens-Band. Cleveland Institute home study is the ideal way to get your FCC License. Here's why:

Our training programs will *quickly* prepare you for a First-Class Commercial Radio Telephone License with a Radar Endorsement. Should you fail to pass the FCC examination after completing your course, you will get a *full refund* of all tuition payments. You get an FCC License . . . or your money back!

You owe it to yourself, your family, your future to get the complete details on our "proven effective" Cleveland Institute home study. Just send the coupon below TODAY. There's no obligation.

Mail Coupon TODAY For FREE Catalog

Cleveland Institute of Electronics

1776 E. 17th St., Dept. PF 13
Cleveland, Ohio 44114

Please send FREE Career Information prepared to help me get ahead in Electronics, without further obligation.

How to Succeed in Electronics

CHECK AREA OF MOST INTEREST—

- Electronics Technology
- Industrial Electronics
- Broadcast Engineering
- First Class FCC License
- Electronic Communications
- Advanced Engineering

Your present occupation _____

Name _____ (please print) Age _____

Address _____

City _____ State _____ Zip _____

Accredited Member National Home Study Council

Winegard

Dealer of the month

No. 19 of a Series

Art Beltz Says: "The Winegard Colortron has power to spare . . . and it's built to take the roughest weather."

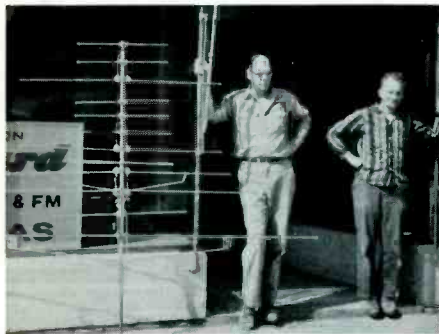

Winegard Salutes Arts Radio & Electric Co., Newman Grove, Nebraska, and their Distributor, Omaha Electronics Co., Omaha, Nebraska.

15 years of hard work have brought Art Beltz and his thriving business to their new and larger location in Newman Grove. Winegard has been proud to be associated with Art for 8 of those years, and for the last 5 years to be the only antenna sold in his store.

In Art's 150 sq. mile service area, most of his antenna installations are in rural districts where it takes plenty of power to pull in those TV signals. "That's why we went to Winegard *exclusively*," says Art, "The Winegard Colortron's got the power we need out here . . . and it's built to take the high winds that often prevail in our area."

Art is one more important dealer who knows Winegard quality first hand, one who knows it pays to give the finest products along with outstanding service to insure growth in the TV business.

Winegard Co.
ANTENNA SYSTEMS

D3009-F Kirkwood • Burlington, Iowa

Circle 47 on literature card

76 PF REPORTER/June, 1964

voltage is low. Second, the low input impedance of the following stage is shunted directly across the collector-load impedance; this further reduces the gain in the stage.

A resistance-coupled transistor stage can have gain as high or higher than a tube stage, if the collector source voltage is high and if the circuit works into a high impedance. This is often done in preamplifier circuits, especially in tape recorders, by designing the transistor stage to work into a tube (Fig. 9).

Transistorized audio-output stages are similar to transformer-coupled driver stages except that the resistance values in the emitter and base circuits are less, because of greater current flow in the output transistor. The actual bias voltage in an output stage is higher than in other stages since the collector current must develop sufficient power to drive a speaker. In addition, the increased bias allows the stage to accept a

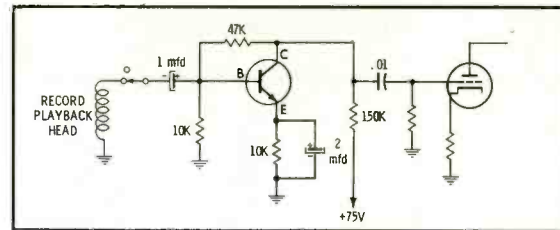

Fig. 9. Resistance-coupled transistor amplifier is working into a high-impedance output load.

larger signal and amplify it without distortion.

Summary

We have laid out some basic considerations to help you get started in transistor servicing. Just as in tube servicing, when you are familiar with the circuits you can do a much better job of servicing. Where you used your voltmeter in tube servicing, you can also use it in transistor servicing.

If you are attempting to measure some component in a transistor circuit, you should always make *two* readings. First take a reading across the component with your ohmmeter, and then reverse the test leads and take another reading. If the readings differ; the highest reading is nearest to being correct.

Transistor servicing is both interesting and fascinating. Because most transistor devices are light and easily handled, there is not too much physical labor involved. Here's a field that wide-awake technicians are finding more and more lucrative. Gonna join them?

Little Tester

The small unit you see pictured here is the new Model FC123 *Fil-check* from SENCORE. The primary purpose of the instrument is to determine continuity of heaters in octal, loktal, 7-, 9-, and 10-pin min-

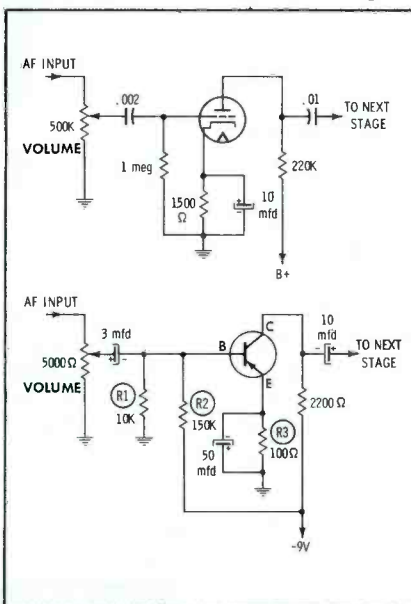

Fig. 8. Some resistance-coupled audio stages.

PRECISION TUNER SERVICE

P. O. BOX 272

1200 S. WALNUT ST.

BLOOMINGTON, IND.

EDISON 99653

7.50
V or U
COMBO PLUS
9.95 POSTAGE

6 MONTH WARRANTEE

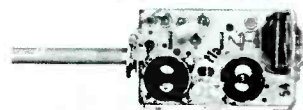

All Types T.V. Tuners Cleaned, Repaired and Aligned to Factory Specifications. Same day in shop service on most Tuners. Price Includes Minor Parts, Major Parts at Cost Price. We use Original Parts if possible. State Make Model and Enclose all Parts and Tubes. Pack Well and Insure.

ALSO HAVE LARGE STOCK OF EXCHANGE TUNERS, WRITE FOR TYPES AND PRICES.

Circle 48 on literature card

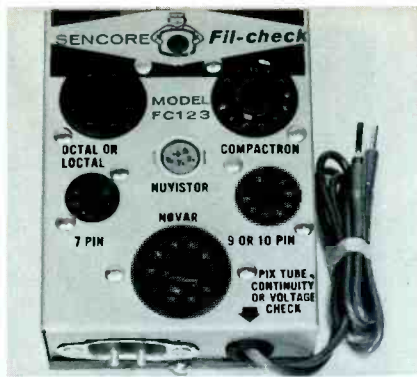

ature tubes, compactrons, *novars*, 5-pin *nuvistors*, and picture tubes. The only accessory needed with the unit is an ordinary TV-type cheater cord, which is plugged into 117 volts AC for all continuity checks.

To check heater continuity in ordinary tubes, the unit is first connected to the AC line by the cheater cord. The neon lamp recessed in a hole near the top of the unit will glow. When a tube with a normal filament is inserted into one of the sockets, the lamp will go out—this is the indication of continuity. If no continuity exists (filament open), the neon lamp will continue to glow.

Heaters of picture tubes must be tested with the test leads that extend from the bottom of the FC123, since there are no sockets to fit CRT's. 54°, 70°, and 90° tubes have their filament connections in socket pins 1 and 12; 110° and 114° CRT's use pins 1 and 8 or 3 and 4 for heater connections (the 110° 23FP4 is unusual in that pins 4 and 5 are used); color-CRT filaments are connected to pins 1 and 14 in the CRT base. In all cases, if the neon bulb is extinguished when the test leads are touched to the pins indicated, the tube filament is okay.

The Model FC123 has another use, too. It can be used directly to test for the presence of AC or DC voltages above 60 volts. To use it for this purpose, simply disconnect the cheater cord and use the test leads between any two circuit points. The neon bulb will glow if the voltage between these points exceeds 60 volts; both electrodes will glow if the voltage is AC, and only one will glow on DC.

If, in bouncing around, the neon bulbs sags away from its "window" on the panel, a drop of glue can be added to hold it in place permanently. ▲

For further information, circle 56 on literature card

"Here it is. An all channel UHF amplifier."

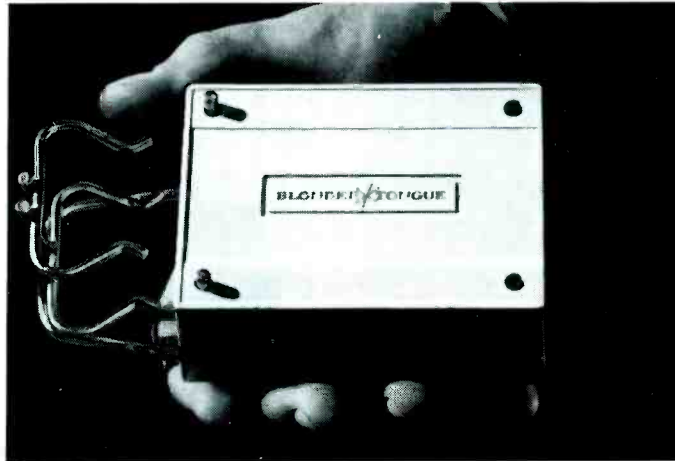

"So what?"

"So, Bob, it's the world's first two transistor UHF amplifier."

"Big deal."

"Gives twice the gain of those one transistor jobs."

"Go on, Harry. Go on."

"It's the first to deliver peak performance on all UHF channels."

"So what does it all mean to me?"

"Cleans up fuzzy pictures, brings in distant signals sharp and clear."

"Now you're really talking."

"Remote power supply, Miracle Mount for instant mounting, 300 ohm striplless screws."

"I'm sold. What's it called?"

"The Blonder-Tongue Able - U2. Only \$44.95* at your TV dealer."

"Did you say Blonder-Tongue? Great! I can use it with my Blonder-Tongue Golden Dart UHF antenna."

"Hey, Charlie! Here it is. An all-channel UHF amplifier!"

"So what?"



Blonder-Tongue Laboratories,
9 Alling St., Newark 2, New Jersey

Circle 49 on literature card



Product Report

For further information on any of the following items, circle the associated number on the Catalog & Literature Card.



Capacitor Offer (122)

Arco Electronics announces a special deal consisting of 150 Elenco dipped Mylar®-paper 600 WVDC capacitors, packaged in thirty 5-pak transparent bags, and a free Vacu-Vise valued at \$6.95. The Vacu-Vise is a portable vise which will adhere to any nonporous surface through the use of a vacuum base. The total net price of \$24.95 reflects a discount of more than 50% from list price of the capacitors.

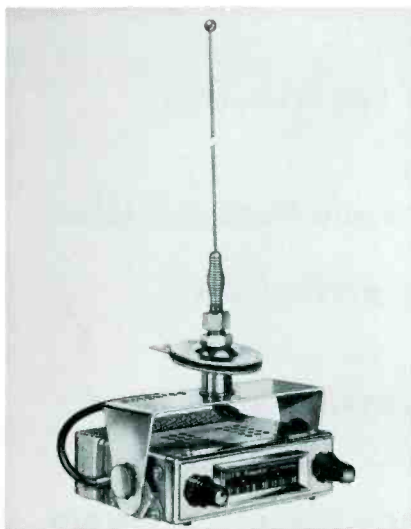

All-Transistor Truck Radio (123)

A compact, self-contained radio for trucks, featuring all-transistor construction, has been introduced by **ATR Electronics, Inc.** Named ATR Truck Karadio, this unit provides excellent tone, volume, and sensitivity, plus one-hole mounting in cab roof. Overhead mounting brings the sound source near to the ear, and the driver doesn't have to take his eyes from the road to tune and adjust set. A 5" x 3" elliptical speaker is built right into the set. Hand wiring and thorough ventilation combine to extend life of the radio. Seven tuned circuits, an RF stage, automatic volume control, and ATR's three-

section "Magna-Wave" tuner are used for sensitivity and selectivity. The 33-inch stainless steel antenna will bend in any direction without breaking. Retailing for \$44.95, this five-transistor unit comes complete with yoke-antenna assembly and interference suppression kit, and is available for 12-volt systems with either negative or positive ground.



New Color TV Analyzer (124)

A new-color TV analyzer—the Model 900 by **Mercury Electronics Corp.**—provides for testing chroma, video, and picture tube circuits, plus the convergence and screen settings of color TV sets. Troubles in these circuits can be diagnosed from the top of the chassis while the set is in operation. Tests are available for control-grid voltage, color-gun screen voltage and current, focus voltage, cathode voltage and emission, as well as control-grid emission. The meter is placed on the right range automatically, for all tests. The unit allows safe measurement of up to 7000 volts at the focus grid of the color tube. Dealer net price of the Model 900 is \$44.95.



Transistor Kit (125)

A compact transistor kit for radio-television dealers and servicemen, containing a group of "universal" transistors that can be used to replace more than 500 JEDEC and manufacturers' numbers, is now being offered by General Instrument's Distributor Division. Packaged in a small six-drawer cabinet that fits handily into a serviceman's caddy, the "Transistor Service Center" contains 22 units, covering 10 basic entertainment-transistor types. A dealer net price of \$29.76 has been set for the complete kit, including cabinet; the transistors list for \$49.59.

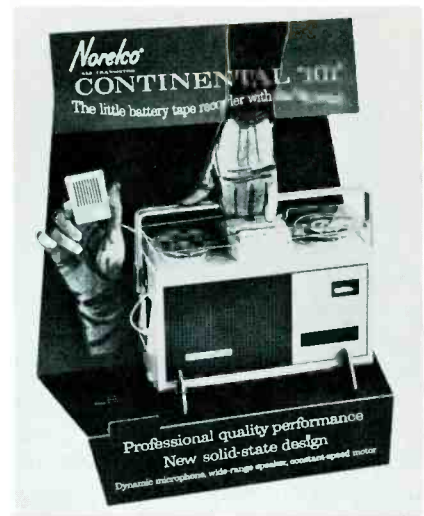

Transistor Tape Recorder (126)

As part of its merchandising program for the "Continental 101" cordless transistor tape recorder, **Norelco** has unveiled a counter display to show the machine being held by a hand. There is space next to the machine for literature and provision for unobtrusively taping the machine to the display to prevent theft. The display is built of heavy weight board, silk-screened in blue and dark brown. The background is dark brown, to show off the ivory color of the tape recorder.

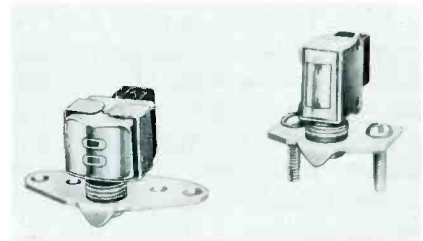

Replacement Tape Heads (127)

Owners of Sony Models 101, 262-D, and 262-SL tape decks and recorders can now replace worn tape heads with **Nortronics** laminated professional-type replacement heads which match these machines both electrically and mechanically. These heads are available in all track styles for those who wish to convert their Sony decks. A complete head kit contains the laminated head, mounting hardware, replacement pressure-pad material, and illustrated instructions.



Advance in Jack Design (128)

A new phone jack, called the "HI-D JAX," has been developed by **Switchcraft, Inc.** "HI-D" means high density

as the enclosed 1/4" jack is engineered for compact "high-density" applications. The unit is significantly smaller, taking very little depth behind a panel; it incorporates a molded thermosetting plastic housing which protect springs from being bent during mounting; silver-plated springs make for longer life and low resistance. The lightweight jacks mount on 5/8" centers in either of two planes.

New CB Transceiver (129)

This new unit, the **Hallmark 1250**, utilizes hand-wired construction in a new modular chassis. This results in small size and adds rigidity to the complete radio, while still providing the reliability and performance of an ordinary hand-wired tube unit. Sensitivity is better than .3 uv for 10 db S+N/N ratio. Adjacent channel rejection exceeds 30 db.



The twelve-channel, crystal-controlled unit uses a ferrite speaker and a silicon rectifier full-wave bridge power supply. Powered from 115 volts AC or 12 volts DC, the 1250's audio output is 3 watts; RF output is 3.2 watts. Size: 4" x 6 1/4" x 10"; weight: 11 lbs; list price: \$169.50.



Electronic Notebook (130)

This small transistorized "electronic notebook" records up to 30 minutes on one tape, rewinds in less than three minutes, and plays back through a built-in speaker. Its microphone picks up ordinary conversation as far away as 25'. Its light weight (1 1/2 lbs), and small size (2" x 3 1/2" x 5") makes it easy to carry and use for on-the-spot reports, group meetings, instructions, etc. Powered by four standard 1.5-volt penlight batteries, the unit is made by **The Hahn Co.** and sells for \$39.95 including remote control microphone, earphone, batteries, tape, extra reel, leather carrying case, and shoulder strap.



Transistor Battery Display (131)

The six most popular transistor-radio batteries and the radios they power can be displayed in a new hardwood counter display that goes to dealers free with the purchase of **Ray-O-Vac** batteries. The permanent display, called the **RB4**, measures 12 1/4" high, 15" wide, and 13 1/2" deep, and dispenses batteries from a tray that keeps batteries neat and orderly and simplifies stock control. ▲

INDEX TO ADVERTISERS

ATR Electronics, Inc.	14
Acme Electric Corp.	62
Antennacraft Co.	48
Antenna Specialists Co., The	68
Atlas Sound	69
B & K Mfg. Co.	61
Div. of Dynascan Corp.	
Belden Mfg. Co.	41
Berns Mfg. Co., Inc., The	73
Blonder-Tongue Labs	77
Bussman Mfg. Div.	18, 19
Castle TV Tuner Service	16
Centralab, Div. of Globe-Union, Inc.	53
Charles Engineering, Inc.	69
Cleveland Institute of Electronics	75
Cornell-Dubilier Electric Corp.	26
Deleo Radio Div.	49
EICO Electronics Instrument Co., Inc.	13
Enterprise Development Co.	62
Finney Co.	31
GC Electronics Co.	15
ITT Distributor Products Div.	25
Lectrotech, Inc.	14
Littelfuse, Inc.	Cover 4
Kinematix, Inc.	Cover 2
Mallory, P. R. & Co., Inc.	57
Mercury Electronics Corp.	71
Miller, J. W. Co.	74
Multicore Sales Corp.	79
Newcomb Audio Products	73
Oxford Transducer Co.	54
Perma-Power Co.	58
Philco Corp.	22, 23
Planet Sales Corp.	79
Precision Tuner Service	76
RCA Electronic Components and Devices	59, 63, Cover 3
RCA Sales Corp.	42, 43
Raytheon Co.	72
Rohn Mfg. Co.	67
Sams, Howard W. & Co., Inc.	17, 70
Sarkes Tarzian, Inc. Tuner Service	9
Seco Electronics, Inc.	65
SENCORE, Inc.	47, 51, 55
Sonotone Corp.	60
Sprague Electric Co.	11, 12
Switchcraft, Inc.	74
Sylvania Electric Products, Inc.	45
Ungar Electric Tools	46
Valley TV Tuner Service	73
Winegard Co.	20, 21, 76
Workman Electronic Products, Inc.	72
Xcelite, Inc.	50

ASK YOUR WIFE
if she could use some extra Cannon terry cloth printed dish towels. If she says "yes" then

ASK YOUR JOBBER
how you can get them for her FREE with the purchase of certain PLANET condensers.

PLANET SALES CORP.
225 Belleville Ave.
Bloomfield, New Jersey

Circle 50 on literature card

IT ONLY COSTS
1/100 OF 1¢ MORE*
PER SOLDER JOINT
TO KNOW YOU
ARE USING THE
WORLD'S FINEST
CORED SOLDER



ERSIN
Multicore
FIVE-CORE SOLDER
Sold only by Radio Parts Distributors

*Based on cost comparison in current catalogs.
MULTICORE SALES CORP., PORT WASHINGTON, N. Y.
Circle 51 on literature card



FREE Catalog and Literature Service

*Check "Index to Advertisers" for further information from these companies.

Please allow 60 to 90 days for delivery.

ANTENNAS & ACCESSORIES

57. **ALLIANCE**—Brochure describing *Tenna-Rotor* Model C-225.
58. **ANTENNACRAFT**—Catalog sheet, illustrated in color, with information on connecting a UHF and a VHF antenna together using intercoupler G1483W.*
59. **FINNEY**—Brochures showing newly introduced line of UHF antennas for channels 14 through 83.*
60. **JFD**—Specifications and operating information on *Transis-tenna* and newly designed, long-range LPV log-periodic TV antennas. Illustrated brochure showing entire line of indoor antennas and accessories for TV and FM. Data sheets on UHF antennas.*
61. **MOSLEY ELECTRONICS**—Illustrated catalog giving specifications and features on large line of antennas for Citizens band, amateur, and TV applications.
62. **SPAULDING**—Specification booklet on all types of antenna towers for TV, ham, and commercial applications.
63. **TRIO**—Brochure on installation and materials for improving UHF translator reception.
64. **ZENITH**—Informative bulletin on new line of log-periodic vee-type antennas for FM, and monochrome and color TV.

AUDIO & HI-FI

65. **ATLAS SOUND**—New 1964 catalog No. 564 contains illustrations and specifications on PA speakers, microphone stands for commercial and industrial installations, and other new products.*
66. **GIBBS SPECIAL PRODUCTS**—Folders describing principles of sound reverberation and *Stereo-Verb* reverberation units for automobiles.
67. **KINEMATIX**—Catalog sheets on *Verbatimix* auto reverberation system and wireless FM microphone.*
68. **NUTONE**—Two full-color booklets illustrating built-in stereo music systems and intercom-radio systems. Includes specifications, installation ideas, and prices.
69. **OAKTRON**—"The Blueprint to Better Sound," an 8-page catalog of loudspeakers and baffles giving detailed specifications and list prices.
70. **OXFORD TRANSDUCER**—Product information bulletins describing complete line of loudspeakers for all types of sound applications; including replacements for public address and intercom systems.*
71. **QUAM-NICHOLS**—Brochures listing speakers used in 1955 through 1963 vintage automobiles; both front and rear seat types.
72. **REK-O-KUT**—Booklet with information on line of turntables, tonearms, and accessories.
73. **SONOTONE**—Specification sheet on newly introduced speaker systems, *Beverly Hills* and *Scarsdale*.*
74. **SWITCHCRAFT**—Product bulletin No. 139 on new *Hi-D Jaz* line of phone connectors for uses with all 1/4" plugs.*
75. **UNIVERSITY**—Guide to stereo high fidelity, and catalog of speakers for PA applications.*
76. **WILDER**—Literature describing matching stereo hi-fi speaker system.

COMMUNICATIONS

77. **BROWNING**—8-page catalog on 1964 line of Citizens band equipment.
78. **CADRE**—Catalog sheet on complete line of Citizens band radios.
79. **COMMUNICATIONS CO.**—Brochure on newly introduced VHF-FM marine radio-telephone equipment.
80. **ELTEC**—Brochures on two completely transistorized FM communications receivers.

81. **NEW-TRONICS**—Literature covering several mobile and base station antennas for CB.
82. **PEARCE-SIMPSON**—Specification brochures on *Companion II* and *Escort* Citizens band transceivers.
83. **REGENCY**—Information on newly introduced Citizens band transceivers, and aircraft communications receivers.
84. **PACE**—Catalog on silicon transistor CB radio Model 5000.
85. **TEXAS-CRYSTALS**—Conversion chart for Citizens band crystals, covering over 240 different transceivers.

COMPONENTS

86. **ASTRON**—Serviceman's capacitor-replacement chart, designed to hang on the wall, gives capacitance, DCWV, size, and price.
87. **BUSSMAN**—Bulletin SBCU on Buss Fustat Box Cover Units offers simple, low-cost way to protect workbench tools, soldering irons, drills, and the like against damage and burnout. Units fit standard outlet or switch boxes; have fuseholder, plus a plug-in receptacle, switch, and pilot light.*
88. **CENTRALAB**—8-page catalog on controls, listing exact replacements and shafts for 200 types.*
89. **GC ELECTRONICS**—24-page supplement No. FR-65-S listing newly introduced products.*
90. **MILLER**—Brochures listing replacement radio-TV IF transformers and sweep circuit coils for TV's.*
91. **PERMA-POWER**—Descriptive brochure on single and multi-purpose brighteners for color and monochrome picture tubes.*
92. **SPRAGUE**—Latest catalog C-615 with complete listings of all stock parts for TV and radio replacement use, as well as *Transfarad* and *Tel-Ohmike* capacitor analyzers.*
93. **STANDARD KOLLSMAN**—Booklet on replacement tuners for RCA TV receivers, including information on special trade-in allowances.
94. **TRIAD**—Brochures on newly introduced replacement transformers for hi-fi and stereo amplifiers.

SERVICE AIDS

95. **CASTLE**—How to get fast overhaul service on all makes and models of television tuners is described in leaflet. Shipping instructions, labels, and tags are also included.*
96. **OELRICH PUBLICATIONS**—32-page catalog of TV service order forms, sales-books, file systems, message binders, job tickets, and other related business items, including marine radio service invoice forms.
97. **PRECISION TUNER**—Literature supplying information on complete, low-cost repair and alignment services for any TV tuner.*
98. **WORKMAN**—General catalog No. 102; fusible resistor and circuit breaker cross-reference guides; information on transistorized auto ignition system; and power converter sheet No. 25C.*
99. **YEATS**—The new "back-saving" appliance dolly Model 7 is featured in a four-page booklet describing feather-weight aluminum construction.

SPECIAL EQUIPMENT

100. **ACME ELECTRIC**—Complete specifications and applications for control-type magnetic amplifiers with capacities from 5-1000 watts and voltage ranges from 24-160 volts.*

101. **ATR**—Descriptive literature on selling new, all-transistor *Karadio*, Model 707, having retail price of \$29.95. Other literature on complete line of DC-AC inverters for operating 117-volt PA systems and other electronics gear.*
102. **GREYHOUND**—The complete story of the speed, convenience, and special service provided by the Greyhound Package express method of shipping, with rates and routes.
103. **MERIT**—Bulletin on transistorized power inverter; changes DC to AC with a continuous 40 watt output.
104. **STACO**—8-page catalog with general description and specifications on line of variable transformers.
105. **TERADO**—Booklet on *Trav-Electric*; a self-contained 60 cycle AC power source.
106. **VOLKSWAGEN**—Large, 60-page illustrated booklet "The Owner's Viewpoint" describes how various VW trucks can be used to save time and money in business enterprises; includes complete specifications on line of trucks.
107. **ZEUS GENERATOR**—Literature describing line of portable AC power equipment and chart giving wattage requirements.

TECHNICAL PUBLICATIONS

108. **CLEVELAND INSTITUTE OF ELECTRONICS**—"Pocket Electronics Data Guides" with handy conversion factors, formulas, tables, and color codes. Additional folder, "Choose Your Career in Electronics," describes home-study electronics training programs, including preparation for FCC-license exam.*
109. **HOWARD W. SAMS**—Literature describing popular and informative publications on radio and TV servicing, communications, audio, hi-fi, and industrial electronics; including special new 1964 catalog of technical books on every phase of electronics.*

TEST EQUIPMENT

110. **B & K**—Catalog AP-21R describing uses for and specifications of new Model 1074 Television Analyst, Model 1076 Television Analyst, Model 850 Color Generator, Model 960 Transistor Radio Analyst, new Model 445 CRT Testor-Rejuvenator, new Model 250 Substitution Master, Model 375 *Dynamatic* VTVM, Model 360 *V-O-Matic* VOM, Models 700 and 600 *Dyna-Quik* Tube Testers, and Model 1070 *Dyna-Sweep* Circuit Analyzer.*
111. **HICKOK**—Complete description and specification information on newly introduced equipment—Model 662 installer's color generator; Model 580 portable tube tester; Model 727 multiplex generator; Model 235A portable field strength meter.
112. **JACKSON**—Complete catalog describing all types of electronic test equipment for servicing and other applications.
113. **MERCURY**—Description and specification brochures on Model 900 Color TV Analyzer.*
114. **RCA COMPONENTS**—Brochure on color picture tube tester Model WT-115A.
115. **SECO**—8-page brochure giving specifications and prices for Models 88, 98, and 107-B tube testers.*
116. **SENCORE**—Question-and-answer bulletin on new Model MX-129 *Multiplex Analyzer*, and Model CR-128 *Picture Tube Tester-Rejuvenator*.*
117. **SIMPSON**—Latest series of VOM's are described in test-equipment bulletin; also information on line of automotive test equipment.

TOOLS

118. **ARROW FASTENERS**—Leaflets describing Model T-18, T-25, and T-75 tackers for speeding cable and wire installations. Illustrations show methods and models used for various wire thickness.
119. **BERNS**—Data on unique 3-in-1 picture-tube repair tools, on *Audio Pin-Plug Crimper* that enables technician to make solderless plug and ground connections, and on new-style *ION* adjustable "beam bender" for CRT's.*
120. **ENTERPRISE DEVELOPMENT**—Time saving techniques in brochure from Endeco demonstrate improved desoldering and resoldering techniques for speeding up and simplifying operations on PC boards.*

TUBES & SEMICONDUCTORS

121. **SEMITRONICS**—New updated 16" x 20" wall chart CH10 lists replacements and interchangeability for transistors and diodes.

be a
REAL PRO

the Arnold Palmer way...
 and get set for
EXTRA BUSINESS!



Golf Champ Arnold Palmer is everyone's idea of a Real Pro. In a color TV commercial currently appearing on the Walt Disney "Wonderful World of Color" TV show, this tremendously successful golf pro is telling millions of viewers to "Look for a Real Pro of a TV Serviceman."

Your potential customers are now looking for REAL PRO TV service, at Arnold Palmer's recommendation.

Here's how you can participate:



Your local RCA distributor makes available to you the following Arnold Palmer Real Pro aids:

- COLORFUL WINDOW DISPLAYS IN TWO SIZES
- AD MATS FOR LOCAL NEWSPAPER ADVERTISING
- RADIO SPOT COMMERCIALS (30 and 60 seconds)

All these aids feature Arnold Palmer's Real Pro endorsement of your services, helping to associate you in the mind of your potential customers with the unquestioned professionalism of all time golf pro, Arnold Palmer.

See your local participating RCA distributor for all Arnold Palmer Real Pro aids

Also ask about:



1A1403 — New Compact Flashlight — Remarkably handy, long lasting compact flashlight with 2 RCA alkaline batteries and unbreakable lens.



1A1001A — New RCA SUPERWELD Tube Caddy featuring the amazingly strong new vinyl covering, "Superweld", for extra durability.



1A1414 — New Heavy Duty Multiple Outlet Box — A convenient master control center with 6 sockets for your test equipment and other power requirements.

RCA ELECTRONIC COMPONENTS AND DEVICES, HARRISON, N.J.



The Most Trusted Name in Electronics



FUSE IMPULSE

**NEW FOR
QUICK PROFIT ON
YOUR COUNTER**



10 fuses
Not 5—Not 6
But 10 fuses
in this assortment
for widest coverage in fuse
replacement
in any auto!
A vital necessity
in every glove
compartment

THESE NEW "SEE-THROUGH" EMERGENCY FUSE KITS COME PACKED 24 TO A CARTON—EACH CARTON INCLUDES WALL/COUNTER DISPLAY CARD. AVAILABLE FROM YOUR LITTELFUSE DISTRIBUTOR.

LITTELFUSE

DES PLAINES, ILLINOIS

Circle 53 on literature card