

APRIL, 1964

50 CENTS



PHOTOFACT **RF REPORTER**

including **Electronic Servicing**



COMMUNICATIONS

SPECIAL SECTION

PLUS:
Symfact
Alignment Techniques
for Two-Way
Tough Dogs in
Synchroguides

1A 2L 1104 1260
W.M. M. DAVIS
RAD. & TV SERV.
118 RIVERSIDE AVE.
CANNON CITY, COLO.

WORLD'S MOST BEAUTIFUL BEST PERFORMING ALL CHANNEL UHF CONVERTER

by *standard kollsman*

World's Largest Manufacturer of Television Tuners



Inspired designer styling in beige and brown tones with "sunburst" gold knobs to harmonize with modern TV cabinet design. The new Model "A" converter takes its place tastefully and unobtrusively on TV set or close by on table or shelf and looks the fine high fidelity instrument that it is.

Tuning is simple. The Model "A" is loaded with "Fringe area" power for sharp, clear reception wherever one may be. One knob provides for complete channel coverage plus fine tuning. The second knob is for switching to UHF or VHF and turns on both converter and TV set. The built-in UHF/VHF coupler hooks up in about a minute with only a screwdriver. The Model "A" is far and away the most advanced UHF Converter money can buy.

12 GOOD REASONS WHY THE MODEL "A" IS YOUR BEST BUY

- **EARN'S YOU MORE PROFIT** because it's easier to sell.
- **MORE PICTURE POWER** by using latest nuvistor amplifier circuits for better fringe area reception.
- **EASY TUNING**—Two speed ball bearing planetary drive uses a single knob for fine tuning the picture. Not a string drive.
- **FUNCTION KNOB**—Switches VHF, UHF, and turns converter and TV set on/off at the same time. TV set on/off switch can be left in "on" position at all times.
- **RELIABILITY**—6DZ4 tube and nuvistor for longer life as well as better performance than tube types previously used in UHF converters. Sliding contacts eliminated in the main tuning circuits through use of a service free 3-gang tuning element.
- **VERY LOW DRIFT.**
- **RADIATION SPECIFICATIONS**—Complies with requirements of Federal Communications Commission for all TV sets.
- **EASY HOOK-UP**—Use only a screwdriver to connect to antenna lead, and 300 ohm antenna lead to TV set.
- **POWER RECEPTACLE**—built into back of chassis to plug in the TV power cord.
- **SAFE**—Isolation transformer provides "cold" chassis.
- **ACTIVE COMPONENTS**—6DZ4 oscillator, 1N82A mixer, 6DS4 nuvistor IF amplifier.
- **FREQUENCY RANGE**—Channels 14 through 83.

GENERAL SPECIFICATIONS

UL Approved. Line cord—a full 6 ft. Power: 110-125V AC only 50/60 cycle. 12/12 watts at nominal line voltage. Shipping weight—6 lbs. Dimensions—11 1/4" x 5 1/2" x 3".

NEW MODEL "B" UHF CONVERTER

Gives good urban reception, and it's easy on the budget. Similar to Model "A" less 6DS4 nuvistor IF amplifier circuit and AC outlet.



Circle 1 on literature card

ONE FULL YEAR WARRANTY ON MATERIAL AND WORKMANSHIP except tubes which are warranted for 6 months.



Standard Kollsman
INDUSTRIES INC.
2085 NORTH MAWTHORNE AVE., MELROSE PARK, ILLINOIS

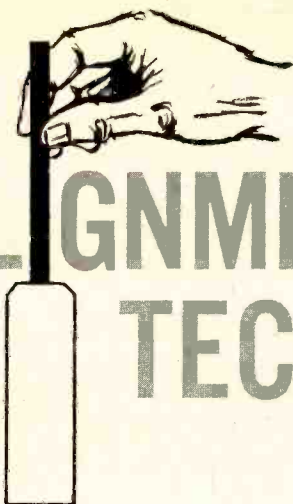

ALIGNMENT TECHNIQUES

For Two-Way

Bench servicing
transmitters and
receivers.

by Patrick M. Crane

Since indirect FM (phase modulated) transmitters and receivers are basically alike, there are very few differences in alignment procedures among the different makes. Fig. 1 shows tuned circuits in both the transmitter and receiver of a typical VHF two-way radio. In the transmitter, alignment is performed on all stages but the speech amplifiers and the modulator. In the receiver, all circuits but audio and squelch require alignment.

Some transmitters and receivers incorporate series-resonant circuits, while other tanks are parallel-resonant. No matter whether the inductor or the capacitor is adjustable, the circuits are always aligned for a peak.

Since power levels in a transmitter are much higher than in a receiver, interaction between the primary and secondary of a transmitter coupling transformer is more noticeable. It is thus desirable, and often necessary, to align first the primary and then the secondary; then repeat the primary and again touch up the secondary. In tuned stages which do not use transformer coupling, the adjustments usually consist of a slug-tuned coil in parallel with a capacitor; this type of tank circuit serves as grid or plate load.

Test Equipment

For service and maintenance of commercial two-way radio, several pieces of special test equipment are necessary. Since the FCC governs the use of radio transmitters, and thus regulates frequency and modulation, it is necessary that transmitter test equipment be precise.

If a unit is *not* checked with accurate equipment, you can't be sure it isn't in violation of FCC regulations; also, communications may suffer. With such a narrow bandwidth (± 5 kc, narrowband; ± 15 kc, wideband), even a very small frequency error can impair communications.

Frequency Meter

A frequency meter is required to insure that the transmitter is on its assigned center frequency, within the tolerance allowed by the FCC. For dependable

communications, the transmitter and receiver must both be on precisely the same frequency (netted), and a heterodyne-type frequency meter is a most accurate way of checking both.

Some frequency meters can be used as a communications receiver as well as for measuring frequency; this type generally has a phone jack or speaker for monitoring modulation. Such instruments use a receiver whose discriminator output is measured on a calibrated meter.

Modulation Meter

Without a modulation or deviation meter there is no way of determining if the frequency modulation is within legal limits, or if it is high enough to produce optimum communications.

Bandwidth of FM communications in the commercial services is limited by FCC Rule to a maximum of 20 or 40 kc, depending on the exact use. The 20-kc bandwidths do not permit the fidelity of the 40-kc units, but fidelity is not the prime consideration in these sets. For best clarity, some technicians like to maintain modulation deviation of narrowband equipment at the full 10 kc. When the modulation is set at maximum, there is little room for error or for subsequent aging of circuit components. It is thus advisable that modulation be set with the aid of an accurate deviation meter.

Should modulation exceed that allowed by the FCC, it will spill over into the guard bands on either side of the channel—see Fig. 2; if overmodulation is great enough, it can even cause interference on adjacent channels. In the wideband channels (± 15 kc), there is actually 40 kc between one center frequency and another. However, when both channels are modulated 100% to the full ± 15 kc, there is only a 10-kc guard band between. If either should overmodulate slightly, interference might result.

Normally, wideband two-way radio transmitters are not modulated 100%. Most technicians keep them set for about 85% (approximately ± 13 kc) maximum. This provides good fidelity, and yet allows a "safety

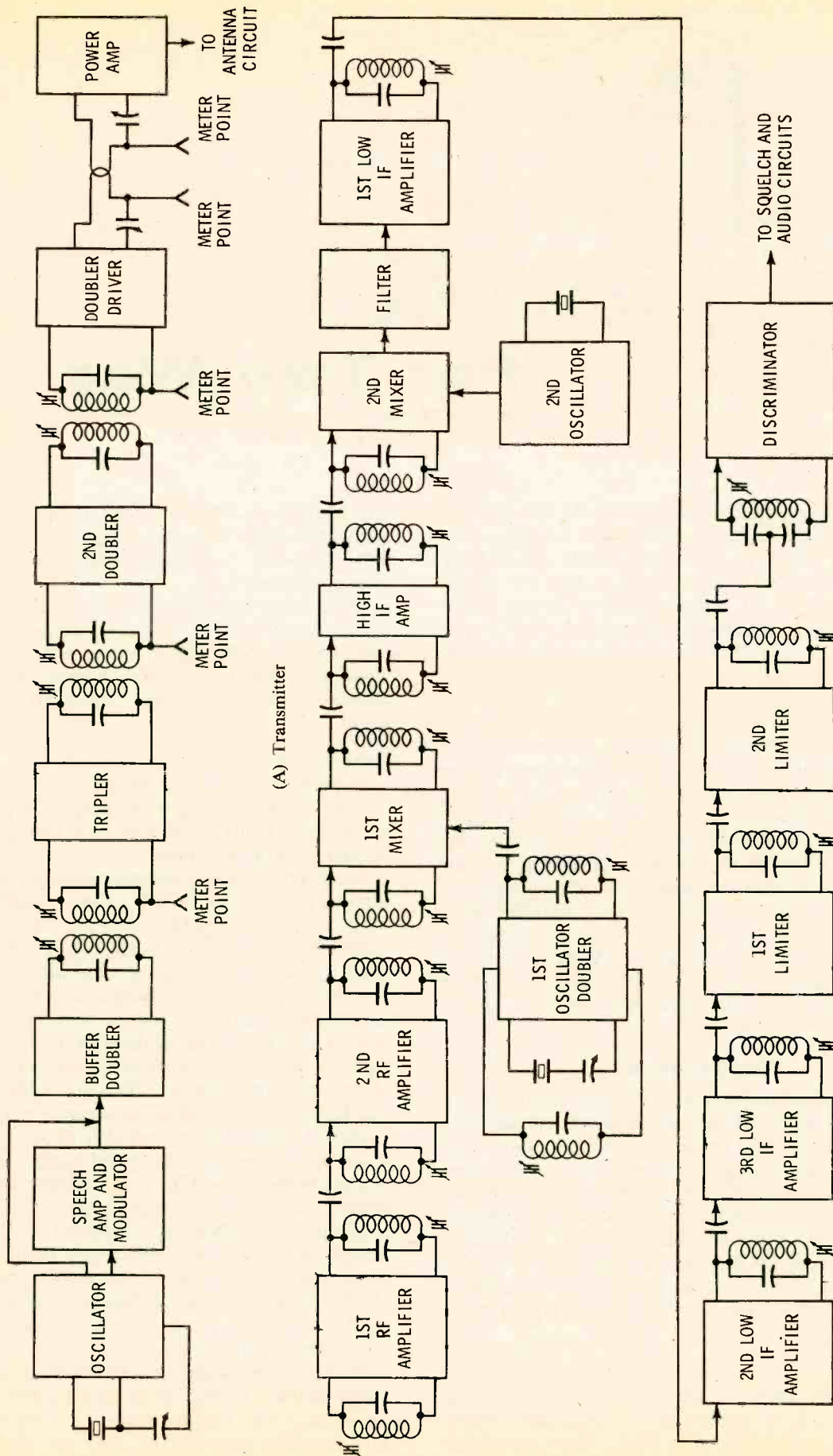

(A) Transmitter

(B) Receiver

Fig. 1. Block diagram of two-way radio transmitter and receiver showing alignment points in each.

margin" for circuit changes that might increase modulation percentage.

On narrowband channels (± 5 kc), achieving good fidelity is largely a matter of keeping the modulation level high enough that most of the voice signal is transmitted, and yet not so high as to cause overmodulation; ± 4.7 kc is a good, safe deviation figure. Besides creating interference, overmodulation can cause distortion of the recovered audio at the receiver.

RF Power Meter

For the measurement of transmitter RF power output, an in-line wattmeter like that shown in Fig. 3 is very valuable. This type of power meter not only allows you to align the final power amplifier(s) and antenna circuit for maximum efficiency and power output, but it also permits you to check the antenna and transmission line.

Some technicians use a field-strength meter in place of a wattmeter. While this method of aligning the transmitter is okay in a pinch, it is better to align with an in-line wattmeter. An FSM is broadly tuned and won't always indicate very sharply the peak power point. Most generally you will have to tune from one side of the peak to the other and then determine *approximately* where the peak is. A transmitter will probably work satisfactorily after being peaked with an FSM, but you will *know* you have correct output and tuning if you use the proper instruments.

Another method of measuring the RF power output is by use of a dummy load outfitted with some type of indicator. This can take the form of either a light bulb, which burns brightest at peak power, or a meter. Neither device, however, will show the condition of the antenna circuit, but will indicate only the power output.

The schematic of a low- and high-power dummy load is shown in Fig. 4. The input is through a coax connector to series-connected 25-ohm noninductive resistors. Since the output impedance of most two-way radio transmitters is 50 ohms, the load must also be 50 ohms for maximum transfer of power. Although the dummy load itself consists of nothing more than 50 ohms of resistance at a suitable power rating, a few additional components will enable measurement of the applied RF power.

All you need do is insert a DC voltmeter from the meter jack to ground, connect the transmitter output to the coax connector, and key the transmitter on. The RF power is sampled and rectified through M1, R3, and R1. M1 should be fairly husky—able to take repeated surges as the transmitter is keyed on and off. R1 can range from approximately 30K to 200K, depending on the meter scale you wish to use; the larger the resistance, the greater the meter readings will be. R1 through R4 need be only 2-watt resistors, as very little power is dissipated in them.

The 25-ohm resistances, however, must dissipate the total transmitter power output. If the transmitter is a 1- to 5-watt unit, it is termed "low-power." Anything above 5 watts is termed "high-power." The load-resistance wattage can be chosen to suit the highest-powered transmitter you expect to test. Allow sufficient safety margin so the load won't burn up if a surge of power higher than that normally expected should occur. Also, be sure to use hookup wire heavy enough to carry

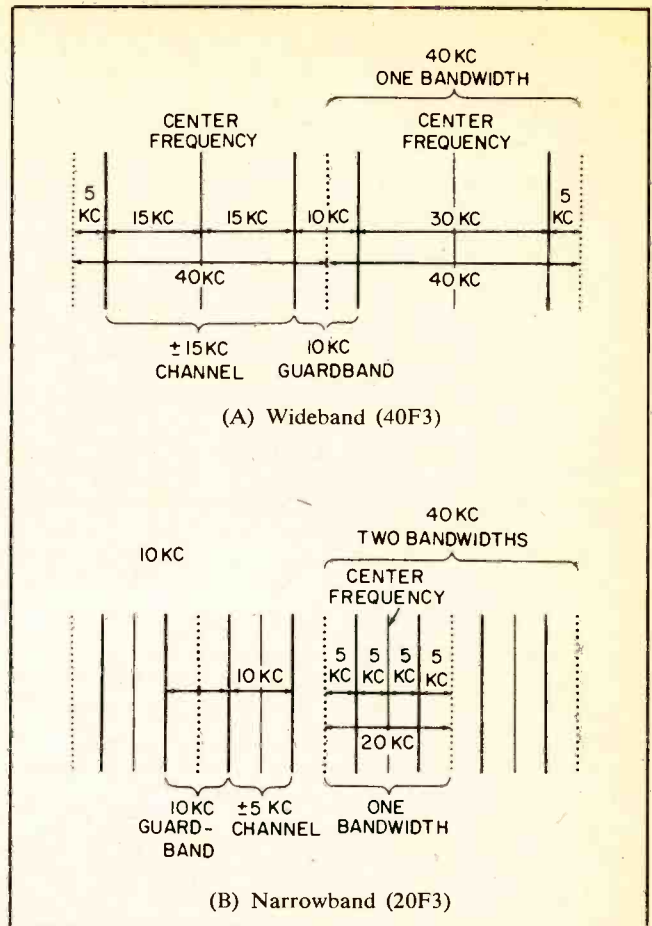

Fig. 2. Narrowband channel uses one-half the space of wideband.

the current, with insulation sufficient to withstand the voltage peaks.

Signal Generator

For maintaining and troubleshooting receivers, you will need a signal generator with at least three frequency ranges: one for alignment of the low frequency IF's, one for high IF's, and another for the front end or RF sections. The first is usually around 455 kc or less; the second ranges from 2 mc to 15 or 20 mc; the last is VHF—from 30 to 175 mc. If you encounter UHF receivers, signals up to 500 mc will be required. Frequently, two generators are required to cover the entire range—three, if UHF is needed.

The VHF or UHF generators should be equipped with an attenuator calibrated accurately in microvolts,

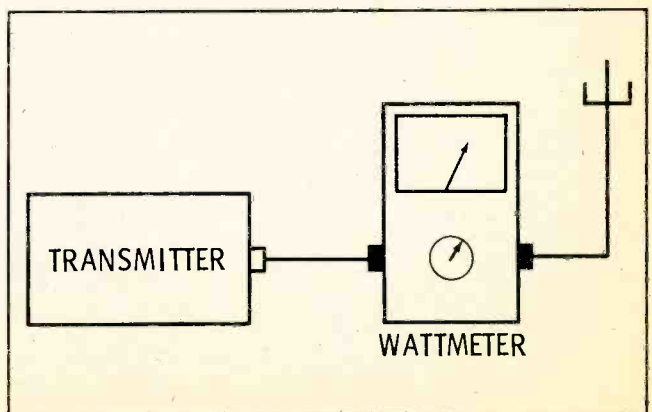

Fig. 3. An in-line wattmeter can be used to check antenna SWR.

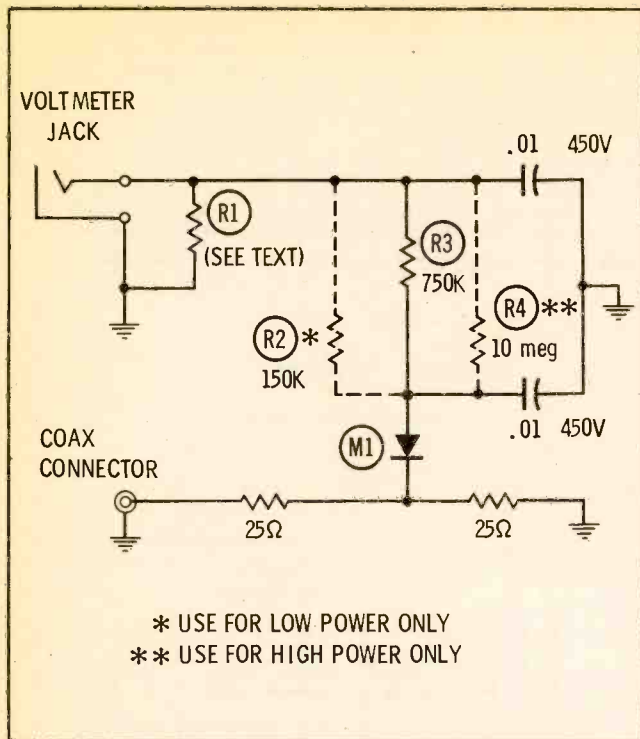

Fig. 4. Circuit dissipates and samples transmitter RF power.

for measurement of sensitivity. The attenuator shown in Fig. 5 works with a bolometer circuit and a meter to accurately control the generator output in microvolts. Signal generators ordinarily used in radio and TV shops have unmarked attenuators. Of course, you can use your servicing generator to align the FM communications receiver, but sensitivity measurements would be very inaccurate.

Transmitter Alignment

Before aligning a transmitter, measure its power output, carrier frequency, and modulation deviation. Just throwing a transmitter on the bench and beginning alignment is not the best habit to develop. First you should determine what needs improvement. These measurements will quite often give you clues to existing trouble before you even pick up your alignment tool.

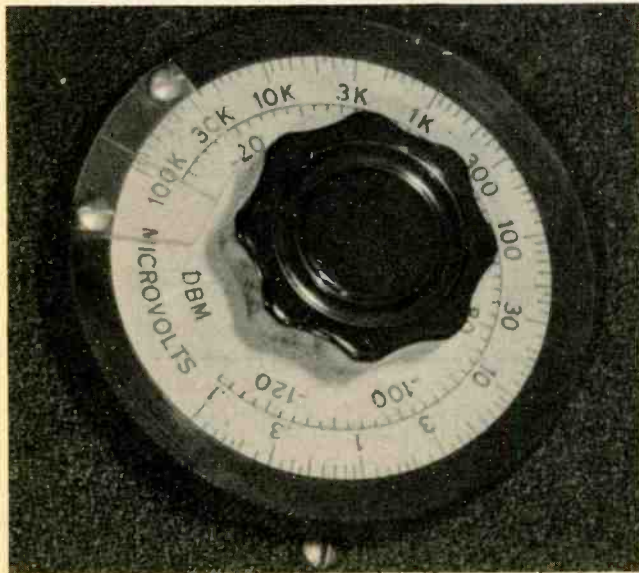

Fig. 5. Signal generator attenuator calibrated in microvolts.

Power Check

To check the power output, you can use either an in-line wattmeter, as shown in Fig. 3, or an indicating dummy load. If the output power is present, even though weak, it is an indication that all stages are working. If output is nonexistent, the fault must be found and fixed before alignment can be completed.

Make a note of the power level so you will have a reference to determine improvement, if any. If output power is less than it should be, after alignment you will have to troubleshoot the transmitter. For now, however, just measure the output power.

Frequency Check

Once you are satisfied the transmitter is okay, and have measured output power, check the center frequency with a frequency meter. While measuring the frequency have the transmitting antenna disconnected—provided you can get enough signal to the frequency meter. With the antenna connected, every time you key the transmitter you are preventing someone else from using the channel. A dummy load is best for all tests, except the final station check.

If the frequency is even slightly wrong (even though still within legal limits), carefully adjust the oscillator frequency adjustment. In some transmitters this adjustment is a trimmer, as shown in Fig. 6. In others, a coil slug is the adjustment. In either case, be sure to use a nonmetallic tuning tool. The tool in Fig. 6 consists of a metal blade set in a nylon handle.

A screwdriver used for such adjustments (even trimmers) will change the capacitance and detune the circuit, making accurate adjustment difficult. When nothing else is available, a screwdriver will have to be used. All you can do in such a case is observe how far off frequency the signal is, make a small correction with the adjustment, take the screwdriver away, and note what change was made. This adjust-and-check procedure must be repeated until the frequency-meter indicates the carrier is exactly on frequency with the screwdriver withdrawn from the adjustment.

Modulation Check

Once the carrier has been adjusted to the proper frequency, monitor the modulation deviation while injecting a 1000-cps tone into the speech-amplifier input. A shrill whistle into the mike will serve the purpose. If modulation deviation exceeds 100%, adjust the modulation limiting control (Fig. 7) for the proper level. Having set the modulation control, speak into the microphone with a normal-to-loud voice and observe deviation. If voice peaks drive the modulation over 100%, back off the control just a little. If no trouble exists in the speech or modulator circuits, this will correct any overmodulation or undermodulation.

Oscillator Peaking

Besides a frequency adjustment, some transmitter crystal oscillators have a slug-tuned coil for peaking the oscillator output. Be sure it doesn't alter frequency. If it does, you may have to reset the trimmer. Peak the oscillator output for enough power to feed the modulator and first multiplier sufficient signal for normal transmitter operation.

To know when the oscillator is producing maximum output, connect a VTVM or test set from the grid

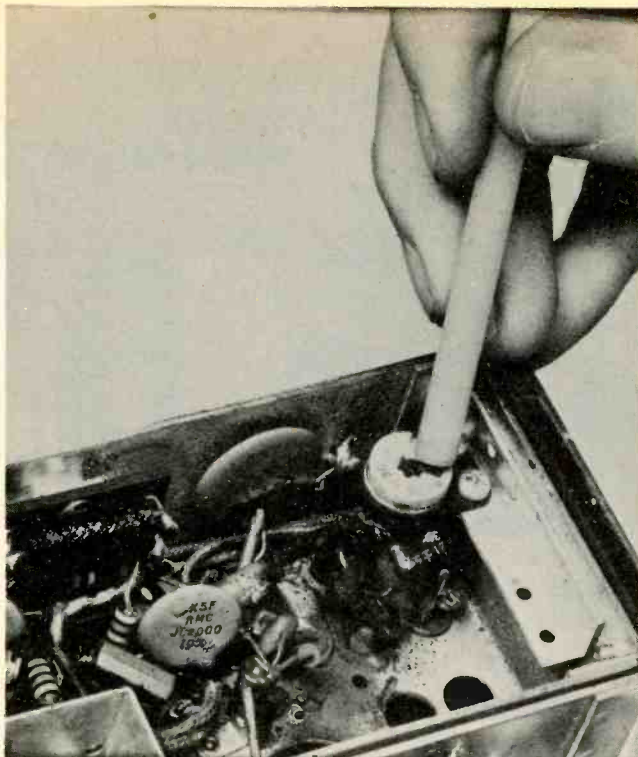

Fig. 6. A nonmetallic tool should be used to make adjustments.

circuit of the second multiplier to ground. As shown in Fig. 8, some transmitters have special connections for metering. The VTVM in Fig. 8 is connected to measure the IR drop across R1, thus indicating tripler drive. The higher the driving voltage, the larger the grid current, and the greater the meter reading.

Adjust oscillator coil L1 for a maximum meter reading. A point of interest in this circuit is that the oscillator output contains no adjustment, but is fed directly to the modulator. M1 is a low-Q phase-shift circuit that works in conjunction with the modulator.

Multiplier Alignment

The number of multipliers in a two-way radio transmitter varies from one band to another. In the low-VHF band (25-54 mc), there are usually only two doublers and one tripler. In the high band (144-174 mc), there are usually three doublers and one tripler. In the UHF band (450-470 mc), there are usually two doublers and two triplers.

No matter what the frequency range of the transmitter, tuning is the same for all multipliers (Fig. 9): tune for maximum meter reading. As shown in Fig. 10, metering of the input circuit for the doubler-driver in a low-band transmitter consists of measuring the voltage drop across the grid resistor. Both the primary and secondary of L1 are adjusted for a peak meter reading. Upon completion of the multiplier adjustments, if any one of the coils was very much out of alignment, you should go back and perform the whole procedure once again to assure optimum signal transfer.

PA Alignment

When aligning the power amplifier, you should watch both the power output indicator and the voltmeter that indicates plate current in the final stage—see Figs. 10 and 11. For these measurements, the antenna should be connected.



Fig. 7. The modulation control is usually beneath the chassis.

With the antenna coupling at minimum, adjust the PA tuning capacitor for a minimum (dip) on the voltmeter. Once a definite dip has been achieved, adjust the antenna trimmer for a maximum and then increase antenna coupling for an increased maximum output reading. Continue to alternate adjustments as follows: increase coupling for slightly greater output; dip the current reading with the PA tuning adjustment; set antenna trimmer again for maximum output; redip PA

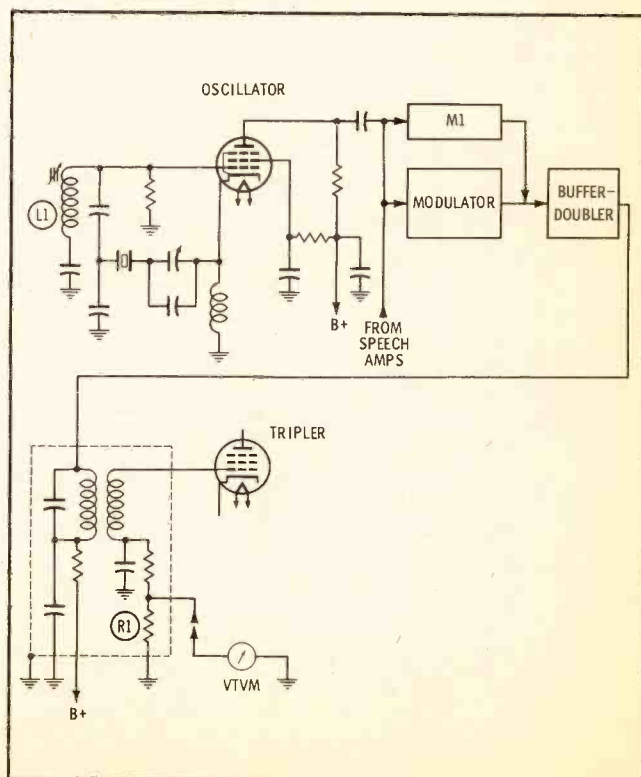

Fig. 8. Oscillator adjustment indicated on tripler circuit meter.



Fig. 9. Multiplier coils are aligned for a peak VTVM reading.

tuning adjustment. When rated output of the transmitter is reached, don't increase coupling any further. As a final adjustment, retouch PA tuning for maximum output reading, but be sure plate current rises only slightly above minimum.

If you should be caught out in the field with no output wattmeter, and you have to tune the final amplifier, leave the antenna connected, decrease the antenna coupling 50% or more, and adjust the PA tuning capacitor for minimum PA current. You can then adjust the antenna trimmer for maximum PA current. Next, in alternate steps, increase the antenna coupling slightly and then redip the PA tuning. Repeat these steps until the current reading ceases to increase with increased coupling, and the PA-current dip is very

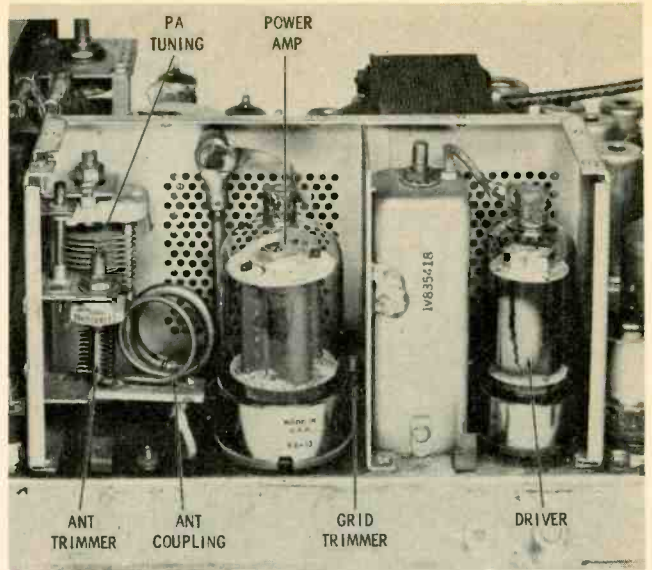

Fig. 11. Location of the driver and final and their adjustments.

indefinite (not sharp). At this point, back off the coupling just a little. You can then be sure the transmitter is pretty near optimum power output, and the final tube isn't overloaded.

Although not a part of transmitter alignment, the physical length of the antenna has a great deal to do with whether or not maximum power is radiated. If your in-line wattmeter indicates an SWR greater than 1.5:1, it is quite possible the antenna is not the correct length for the transmitter frequency. If the antenna whip is too long, careful pruning will bring it to the correct length. If too short, a longer one will have to be installed.

When pruning an antenna, take 1/4" off the top at a time, and then take a wattmeter reading. If the

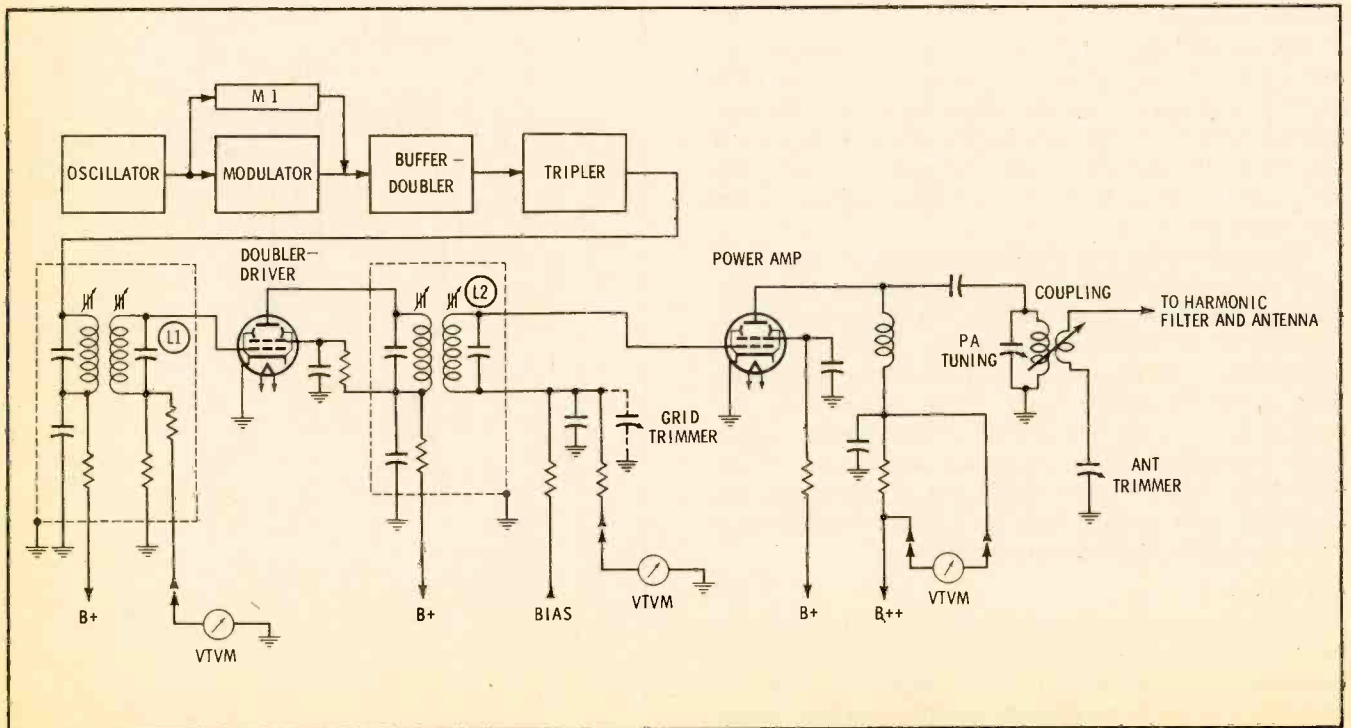

Fig. 10. Power-amp plate current measured across B++ resistor.

amount of reflected power (SWR) is reduced, but not yet acceptable, continue to prune and take readings until the SWR is acceptable. (Don't try pruning with the transmitter on, or you'll get an RF burn.) An SWR of 1.2:1 is not too bad.

Receiver Alignment

Before performing receiver alignment, it is best to determine the receiver's actual condition. Listen to the audio as messages are being received. Connect a signal generator and measure the sensitivity. Also, check the receiver's frequency; does the discriminator zero when a signal is being received?

Mushy audio indicates overmodulation at the transmitter, squelch-circuit trouble, an audio fault, poor alignment, or even an off-frequency oscillator. Sensitivity should be 1 uv or better; if not, a faulty RF or high-IF stage is indicated. Make sure all tubes are okay before starting alignment; by doing so, you partly eliminate the possibility of finding a bad tube later and having to align all over again.

Frequency Adjustment

If the receiver isn't on frequency with the transmitter, first be sure the transmitter frequency is correct. To do this, you'll have to first be sure the discriminator is set precisely for the low IF.

The discriminator can be checked by coupling a signal of the exact discriminator frequency into the grid circuit of the first low-IF amplifier, as shown in Fig. 12. If the discriminator output reading (Fig. 13) is precisely zero, and can be tuned sharply above and below zero, the discriminator transformer is correctly tuned. If not, carefully adjust the secondary (be sure you're not adjusting the primary) for a zero reading.

To set the receiver frequency accurately, couple an accurate signal (of the station frequency) into the antenna input circuit. Then, while metering the discriminator output as shown in Fig. 13, set the local-oscillator crystal adjustment to obtain a precise zero reading.

Low IF Alignment

With a loosely coupled low-IF signal injected into the grid circuit of the first low-IF amplifier, as shown in Fig. 12, meter the grid circuit of the third IF amplifier (Fig. 14). Reduce signal level until the meter reads in the lower one-third of the scale, and adjust L1 for maximum. If the reading has increased so the meter needle is in the upper portion of the scale, again reduce signal input level. Now adjust coil L2 for a peak meter reading.

For adjustment of coil L3, you will have to move the VTVM to the discriminator input meter point (Fig. 13). At this point, you will measure the drive voltage from the second limiter. Adjust L3 for a peak meter reading. Some receivers will have a limiter metering point, as well as limiter tuning adjustments. In these sets, it is best to use that metering point for all low-IF and limiter tuning.

The limiters in some sets have no adjustments; however, there is an adjustment for the discriminator input. As shown in Fig. 13, both the primary and secondary of the discriminator transformer are tunable. The secondary, of course, determines the crossover

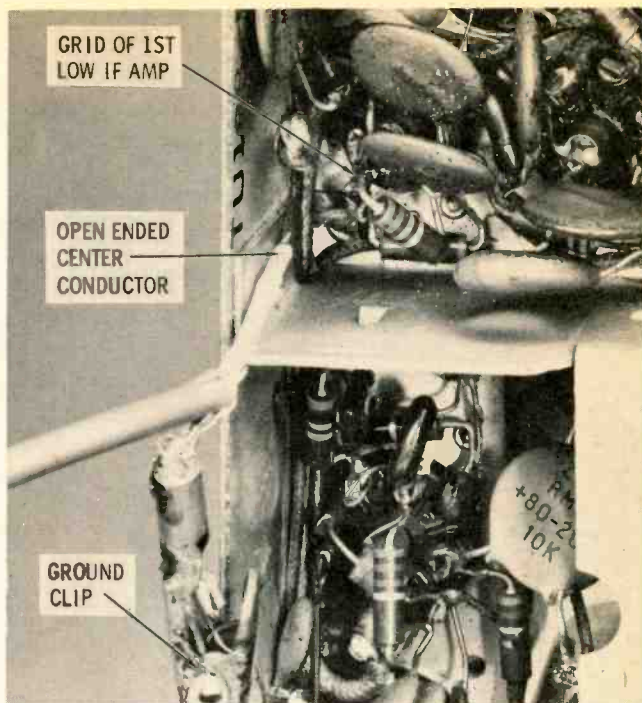

Fig. 12. Generator signal is radiated into IF amplifier circuit.

or zero point of the discriminator S-curve. The primary is tuned for maximum signal transfer. In many commercial two-way receivers, the discriminator primary has been preset at the factory and should not require adjustment. However, should you find it absolutely necessary to align the primary, it is best to short out the secondary while you align the primary.

Once you complete low-IF alignment, go back and touch up each coil to insure peak performance. You can then remove the signal source and proceed to front-end and high-IF alignment.

Front-End Alignment

Having determined that the receiver is on frequency and having properly aligned the low IF's, inject a signal of the station frequency into the antenna terminal and connect a VTVM to the meter jack of the third low-IF amplifier. Adjust the generator attenuator so the meter needle reads in the lower third of the scale.

With a nonmetallic tuning tool, as shown in Fig. 15,

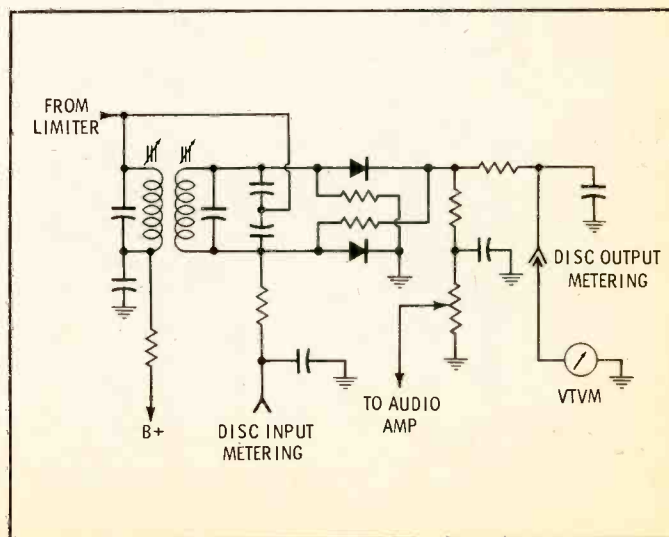

Fig. 13. Discriminator has meter jack at both input and output.

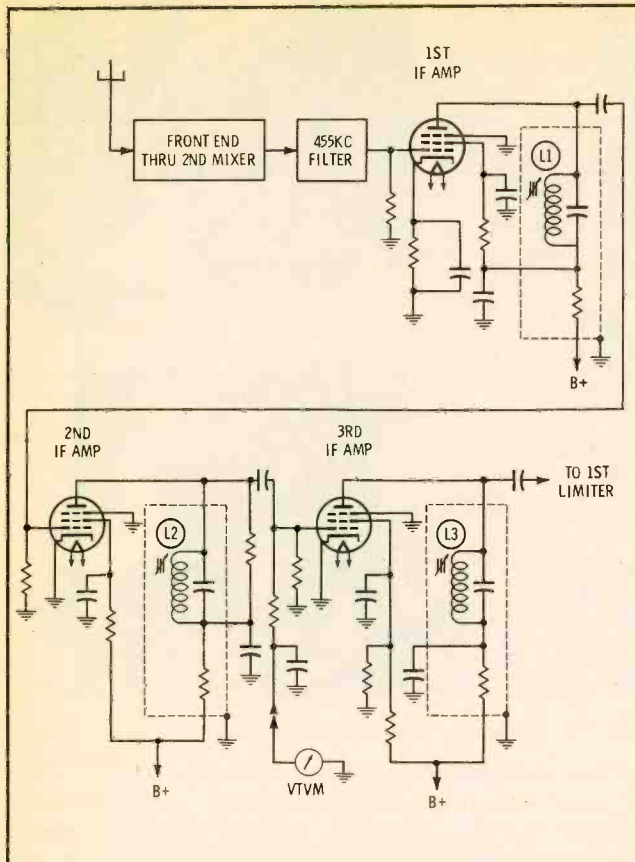

Fig. 14. To align the first two low IF amplifiers, meter the third amplifier and adjust coils L1 and L2 for a peak reading.

begin at the antenna coil (if there is one) and work towards the second mixer, peaking every coil but that of the first oscillator. If at any point the meter reading increases considerably, reduce the generator output to bring the needle back to the lower portion of the scale. If you don't have a nonmetallic tuning tool, and if the slug screws protrude from the bottom of the cans, turn the radio over and tune from the bottom.

If the first local oscillator has a multiplier stage following it, there will be provisions for alignment.

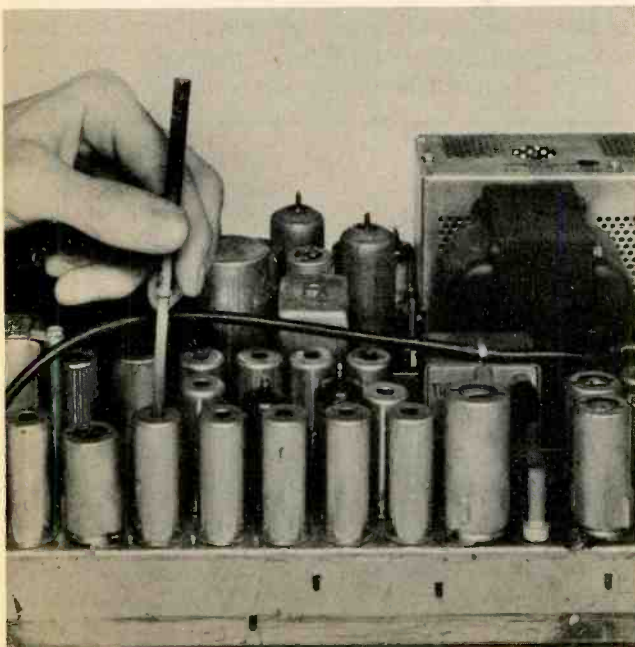

Fig. 15. Alignment of the RF and IF coils is with a plastic tool.

Adjust the multiplier or oscillator coil for a peak meter reading. Be sure to recheck the discriminator zero reading to be sure the oscillator frequency hasn't been affected.

In cases of extreme misalignment, the meter indication may be too low for easy reading. One method to achieve a larger meter reading is to bypass the selective bandpass filter located between the second mixer and first low-IF amplifier. This can be done by temporarily disconnecting the filter input and connecting a .01 mfd capacitor from the output of the second mixer to the input of the first low-IF amplifier. More signal will thus reach the IF amplifier than would be delivered through the filter.

This filter must not be left out of the circuit except during preliminary alignment. When the set is brought into some semblance of proper alignment the filter should be reinserted in the circuit, and alignment completely reperformed to insure accurate peak meter readings.

With the receiver completely aligned and on frequency, it should have a sensitivity of something less than 1 uv. Open the squelch control and slowly increase the generator signal level from zero to the point where 20 db quieting occurs. If it does not occur with 1 uv or less of signal, the receiver is still not sensitive enough. If realignment doesn't improve the overall sensitivity, try new tubes one at a time, peaking the associated coils (input and output) as you do.

To check squelch operation, turn the control just to the point where the receiver noise is squelched, and no further. Begin with no signal and increase the level to the point where you can hear the audio amplifier start conducting. Read the signal level in microvolts on the generator attenuator; this is the squelch-opening sensitivity of the receiver. Any transmitted signal whose strength at the receiver is less than this sensitivity figure will not open the squelch circuit.

When you are satisfied the receiver is aligned properly and is working satisfactorily, remove the signal generator and voltmeter, and connect the antenna. Try an on-the-air test with another two-way radio. If you can, communicate with a distant station, one that you would consider on the fringe area of communications for that particular system. If communications can be established and maintained between two sets at the fringe of their coverage, you have performed a good servicing job.

After putting the radio back in service, make another on-the-air check. Too many times, the shop bench voltage exceeds that of the auto or office where a unit will be used. If such is the case, communications may suffer; transmitter output power and receiving sensitivity may be reduced.

Customer Satisfaction

Since the commercial two-way radio customer counts on his radio to earn money, he is usually far more discriminating than the TV owner. If his radio isn't operating at maximum efficiency, he is unhappy not only over the loss of communications but also over losing money. If you as a serviceman give him the very best in service, and keep his equipment doing the job it was designed for, you will seldom lose any business. A satisfied customer is all the advertisement you'll need. ▲

Tarzian offers
**FAST, DEPENDABLE
 TUNER REPAIR
 SERVICE** (ALL
 MAKES)

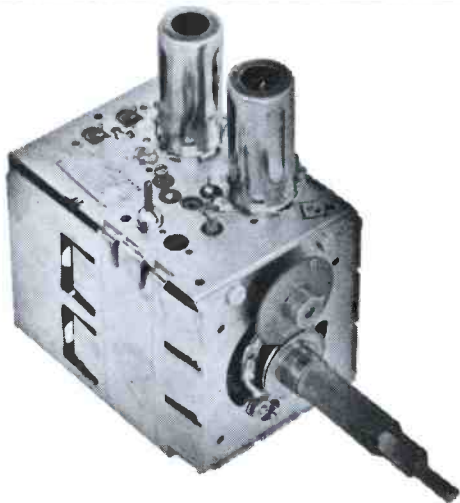

It just makes sense that a manufacturer of tuners should be better-qualified, better-equipped to offer the most dependable tuner repair and overhaul service.

Sarkes Tarzian, Inc. pioneer in the tuner business, maintains two complete, well-equipped Factory Service Centers—assisted by Engineering personnel—and staffed by specialized technicians who handle ONLY tuner repairs on ALL makes and models.

Tarzian-made tuners received one day will be repaired and shipped out the next. Allow a little more time for service on other than Tarzian-made tuners.

Tarzian offers a 12-month guarantee against defective workmanship and parts failure due to normal usage. And, compare our cost of \$9.50 and \$15 for UV combinations. There is absolutely no additional, hidden charge, for ANY parts except tubes. You pay shipping costs. Replacements on tuners beyond practical repair are available at low cost.

Ⓢ Tarzian-made tuners are identified by this stamping. When inquiring about service on other tuners, always give TV make, chassis and Model number. All tuners repaired on approved, open accounts. Check with your local distributor for Sarkes Tarzian replacement tuners, replacement parts, or repair service.

 **SARKES TARZIAN, INC.**
 Bloomington, Indiana

MANUFACTURERS OF TUNERS . . . SEMICONDUCTORS . . . AIR TRIMMERS . . . FM RADIOS . . . AM/FM RADIOS . . . AUDIO TAPE . . . BROADCAST EQUIPMENT

ONLY
\$9.50
 INCLUDING

ALL PARTS
 (except tubes)
 and **LABOR**

**24-HOUR SERVICE
 1-YEAR WARRANTY**

**TWO SERVICE CENTERS
 TO SERVE YOU BETTER**

See your distributor, or use the address nearest you for fast factory repair service

537 South Walnut St.
 Bloomington, Indiana
 Tel: 332-6055

10654 Magnolia Blvd.
 North Hollywood, Calif.
 Tel: 769-2720

Circle 2 on literature card

April, 1964/PF REPORTER 9

publisher

Howard W. Sams

executive editor

Verne M. Ray

editor

Forest H. Belt

associate editors

George F. Carne, Jr.

Patrick M. Craney

Paul Stacy

consulting editors

William E. Burke

Joe A. Groves

C. P. Oliphant

production manager

Robert N. Rippy

circulation manager

J. A. Vitt

circulation fulfillment

Pat Tidd, Mgr.

Katherine Krise, Ass't.

Cora La Von Willard, Ass't.

art directors

Gene La Rue

Robert W. Reed

advertising & editorial

assistants

Hazel Boyer

Georgeanna Caldwell

Rebecca Clingerman

photography

Paul Cornelius, Jr.

advertising sales offices

Dave Milling, advertising sales manager

midwestern

Hugh Wallace

PF REPORTER

4300 West 62nd Street,

Indianapolis 6, Ind.

AXminster 1-3100

eastern

Gregory C. Masfield

Howard W. Sams & Co., Inc.

3 West 57th Street,

New York, N. Y.

MUrray Hill 8-6350

western

The Maurice A. Kimball Co., Inc.

2550 Beverly Blvd., Los Angeles 57, Calif.

DUnkirk 8-6178; and 580 Market Street,

Room 400, San Francisco 4, Calif. EXbrook 2-3365

Address all correspondence to

PF REPORTER, 4300 W. 62nd Street,

Indianapolis 6, Indiana



Copyright © 1964 by Howard W. Sams & Co., Inc.

PF REPORTER is a trademark of Howard W. Sams

& Co., Inc. No part of PF REPORTER may be

reproduced without written permission. No patent

liability is assumed with respect to use of

information herein. Acceptance of advertising does

not in any manner signify the products, policies

and services so advertised have been approved,

endorsed or recommended by this magazine.

Subscription Prices: 1 year—\$5.00, 2 years—\$8.00,

3 years—\$10.00, in the U.S.A., its possessions and Canada.

All other foreign countries: 1 year—\$6.00, 2 years—

\$10.00, 3 years—\$13.00. Single copy 50¢; back copies 65¢.

Indexed in Lectrodex.

Printed by the Waldemar Press Div.

of Howard W. Sams & Co., Inc.



PF REPORTER

including Electronic Servicing

VOLUME 14, No. 4

APRIL, 1964

CONTENTS

Alignment Techniques for Two-Way	<i>Patrick M. Craney</i>	1
Shortcuts to troubleshooting by making circuit adjustments.		
Letters to the Editor		14
The Electronic Scanner		18
The Troubleshooter		22
Symfact: 'CS6 Sync Separator (Noise Immune)		27
See what happens to voltages and waveforms when troubles occur.		
Tough Dog Synchroguides	<i>Allan F. Kinckiner</i>	32
Shop Talk—Correct operation often depends on stages outside this circuit.		
Meet An Auto Radio Specialist		34
This man's business is installation and quick repair.		
mmf mmf mmf	<i>Rufus P. Turner</i>	36
You'll meet small-size capacitors in all types of electronic equipment. Have they changed lately?		
Cheerful Charlie Foils the DIY's	<i>Charles F. Lieder</i>	40
Our good-humor man tangles with do-it-yourselfers.		
You Can Manage For Profit—Part 2	<i>Forest H. Belt</i>	48
Dollar and Sense Servicing—Our second installment of business practices that will save you money.		
Notes on Test Equipment	<i>Stephen Kirk</i>	58
Lab reports on the B & K Model 445 CRT Tester-Rejuvenator, Delco Model P-612 Power Supply, and Electronic Measurements Corp. Model 502 Signal Generator.		
Product Report		69
Free Catalog & Literature Service		72
Monthly Index	<i>on free literature card</i>	

SPECIAL COMMUNICATIONS SUPPLEMENT

Popular demand by our readers, and the vast expansion in the field of two-way communications within the past two years, have prompted the specialized servicing articles included in this month's supplement. You'll find it starting on page 73.

ABOUT THE COVER

Two-way radio communications antennas, blossoming from atop buildings, automobiles, trucks, and other vehicles, bear evidence of the rising popularity of two-way systems. If you're servicing equipment of this type, or planning to start, don't miss the special Communications Supplement bound inside the rear cover.



WHY bother with makeshift twist-prong capacitor replacements?

When you substitute capacitor sizes and ratings, you leave yourself wide open for criticism of your work . . . you risk your reputation . . . you stand to lose customers. It just doesn't pay to use makeshifts when it's so easy to get the exact replacement from your Sprague distributor!

Get the right SIZE,
right RATING every time
with improved



**SPRAGUE
TWIST-LOK[®]
CAPACITORS!**

Over 1,690 different capacitors to choose from!

The industry's most complete selection of twist-prong capacitors, bar none. Greater reliability, too. Exclusive Sprague cover design provides a leak-proof seal which permits capacitors to withstand higher ripple currents.

GET YOUR COPY of Sprague's comprehensive Electrolytic Capacitor Replacement Manual K-106 from your Sprague Distributor, or write Sprague Products Co., 105 Marshall St., North Adams, Massachusetts.



WORLD'S LARGEST MANUFACTURER OF CAPACITORS

65-122-63

Circle 3 on literature card

April, 1964/PF REPORTER 11

For window-size blow-ups of this message, send 10¢ to Sprague Products Co., 105 Marshall St., North Adams, Mass., to cover handling and mailing costs.



You'll never see your doctor advertise a special sale on appendectomies . . .

You'll never see your lawyer announce cut-rates for divorce cases . . .

You'll never see your dentist hold a "2-for-1" sale on extractions . . .

AND You'll never see the day when you can take your TV set in for a service "bargain" and be sure you're getting a square deal!

"Bargains" in home electronic service are as scarce as the proverbial hen's teeth! Here's why—

The expert service technician, just like other professional people, must undergo years of study and apprenticeship to learn the fundamentals of his skill. And a minimum investment of from \$3000 to \$6000 per shop technician is required for the necessary equipment to test today's highly complex sets. Finally, through manufacturer's training courses and his own technical journals, he must keep up with

changes that are developing as fast as they ever did in medicine, law, or dentistry. Those best equipped to apply modern scientific methods are almost certain to be most economical for you and definitely more satisfactory in the long run.

Unfortunately, as in any business, there will always be a few fly-by-night operators. But patients, clients, and TV set owners who recognize that you get only what you pay for, will never get gypped. "There just ARE no service bargains" . . . but there is GOOD SERVICE awaiting you at FAIR PRICES!

THIS MESSAGE WAS PREPARED BY SPRAGUE PRODUCTS COMPANY,
DISTRIBUTORS' SUPPLY SUBSIDIARY OF SPRAGUE ELECTRIC COMPANY, NORTH ADAMS, MASSACHUSETTS, FOR . . .

YOUR INDEPENDENT TV-RADIO SERVICE DEALER

65-124-63

Circle 4 on literature card

In their homes, your customers are being pre-sold on **RCA Radio Batteries** over network TV ...on Walt Disney's "**Wonderful World of Color.**"

In your store, these compact counter merchandisers **continue that pre-selling** right at the point-of-purchase.



NETWORK-TV ADVERTISING

During the key summer months, network-TV commercials will be carrying RCA Battery Advertising into over NINE MILLION homes...to over 21

MILLION viewers*. Get the most out of the radio battery business with the name your customers associate with radio...RCA.

COMPACT COUNTER MERCHANDISERS

Here's the way to take a single foot of counter space and really put it to work. Any one of these attractive merchandisers effectively displays RCA Batteries while creating strong RCA brand recognition. Such a merchandiser, with pilfer-proof plastic front face, creates a real battery showcase.

For self-service operation, there's RCA's award-

winning blister-packaging. New to the battery business? Then pick an RCA pre-packed battery assortment as a start.

See your Authorized RCA Battery Distributor or write: Battery Department, RCA Electronic Components and Devices, Harrison, N. J.

*Estimate of average viewing audience per show during June, July and August based on Nielsen National Television Index.



The Most Trusted Name in Electronics



NOW...
THE FABULOUS
***G. E. COMBO**

PLAYS ANYWHERE
ON 110 AC OR 12V DC
BATTERY CURRENT

For
Auto • Boat • Plane
Camps • Picnic • Trailer

ATR MODEL 12T-RME-1 INVERTER... \$39⁹⁵
*G.E. MODEL M110Y 11" PORTABLE TV \$99⁹⁵

*Available at G.E. TV Dealers

Both Only **\$139⁹⁰** Retail
THE **ATR** MODEL 12T-RME-1 ONLY ONE
OF A FAMILY
OF FAMOUS DC-AC **INVERTERS**

Also NOW...

HAND WIRED—
NO PRINTED
CIRCUITRY

ATR ALL-TRANSISTOR
ULTRA COMPACT
UNIVERSAL MODEL 707



Karadio
IN DASH...
UNDER DASH...

Complete with variable tone control . . . R. F. stage
. . . Built-in speaker . . . and External speaker jack.

ATR MODEL 707..... \$29⁹⁵ Retail

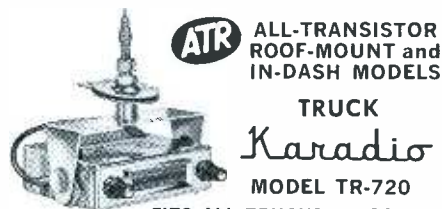

ATR ALL-TRANSISTOR
ROOF-MOUNT and
IN-DASH MODELS

TRUCK

Karadio

MODEL TR-720

FITS ALL TRUCKS • BOATS •
STATION WAGONS
INSTANT PLAY... POWERFUL

Complete with patented antenna-yoke assembly.
(U.S. Patent No. 3,087,118. Canadian Reg. 575,567)

ATR MODEL TR-720..... \$44⁹⁵ Retail



ATR "A" Battery
ELIMINATOR

For Demonstrating and
Testing Auto Radios—
TRANSISTOR or VIBRATOR
OPERATED!
Designed for testing D.C.
Electrical Apparatus on Reg-
ular A.C. Lines.

MAY ALSO BE USED AS A BATTERY CHARGER
MODEL 610C-ELIF... 6 volts at 10 amps. or 12 volts
at 6 amps. Shipping weight 22 lbs.

USER NET PRICE \$55⁰⁰

ATR AUTO RADIO and
COMMUNICATION

LONGER-LIFE
VIBRATORS

"The Best by Test!"



SEE YOUR ELECTRONIC PARTS DISTRIBUTOR OR
WRITE FACTORY FOR LITERATURE & DEALER PRICES

ATR ELECTRONICS, INC.

Quality Products Since 1931

St. Paul, Minnesota 55101—U.S.A.

Circle 6 on literature card



Letters to the Editor

Dear Editor:

A member of our association brought your October issue to a recent meeting, and we discussed the article, "Profits From PA Systems."

In the State of California, a license (C-61 classified specialist) is required for the installation of PA systems. Also, in our area, new construction installations must be done by union contractors (International Brotherhood of Electrical Workers). Thus, we feel that service shops wishing to enter the PA field should be advised of the possible need for both union agreements and contractors' licenses prior to submitting any bids.

There are other items to be considered prior to bidding work in this field:

1. Additional insurance costs.
2. Specialized tools for installation.
3. Familiarity with the contractor and lien laws.
4. Necessity for checking credit (because of larger sums involved).
5. Financial backing for larger operations.
6. Status of the competitive bid market in the area.
7. Associations that represent those specializing in this type of work.

These reminders are not intended to scare people away, but to make servicemen aware there is more to electronic specialty contracting than one might think at first.

RICHARD E. LINEBARGER
Secretary
Associated Electronics
Systems Contractors

San Carlos, Calif.

Since these conditions vary a great deal from one state or city to another, it's up to each prospective PA installer to check into the situation in his own area. A prudent businessman in any line will investigate all possible pitfalls before embarking on any new venture into a specialized field.—Ed.

Dear Editor:

Would it be possible for you to print an up-to-date listing of the EIA source code numbers for various manufacturers?

CLAYTON VOLZ

Peoria, Ill.

A regular list is issued each year as a regular feature of the PHOTOFACT Service; the next one is scheduled to appear in the first PHOTOFACT Set of the July, 1964 group. Look under "Additional PHOTOFACT Benefits" in the Master Index to determine which Set contains the current EIA list (presently Set 642).—Ed.

Dear Editor:

In your June, 1963 issue, Fig. 3 on page 50 showed a diagram of a tapped bleeder circuit to supply several different

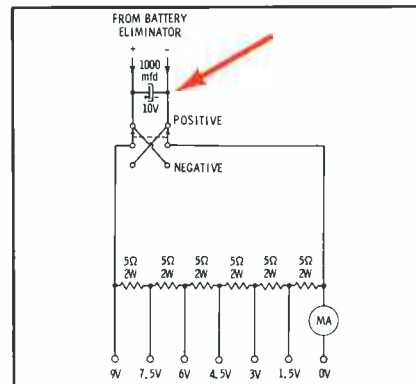

output voltages from a battery eliminator. In this hookup, what happens to the 1000 mfd electrolytic capacitor when the double-pole, double-throw switch is thrown to the position that applies negative voltage to the positive side of the capacitor?

THOMAS D. SCHNADER

Irwin, Pa.

Whatever might happen, it's not good! The capacitor should have been shown connected directly across the output of the battery eliminator—see revised schematic. In this position, it supplements the internal filter circuit of the battery eliminator, to make sure the filtering will be adequate for transistor work.—Ed.

Dear Editor:

To obtain the full benefit from your Troubleshooting column without having to cut each item out of the magazine, we make a note of each individual trouble and attach this note to the PHOTOFACT Folder for the set in question. Then, whenever we're faced with a similar trouble on that set, we can easily refer to the pertinent issue of PF REPORTER. Here's a sample note:

MOTOROLA
SAMS 579-2
SYNC TROUBLE
PER OCT '63 P. 24

Needless to say, we keep every issue stacked right on top of the Sams file cabinet for handy reference.

JOHN B. HUCKABY

Eunice, La.

Aha! This is what we had in mind when we began mentioning the appropriate PHOTOFACT Folder number for every receiver discussed. Glad to hear you're enjoying the benefits of this cross reference.—Ed.

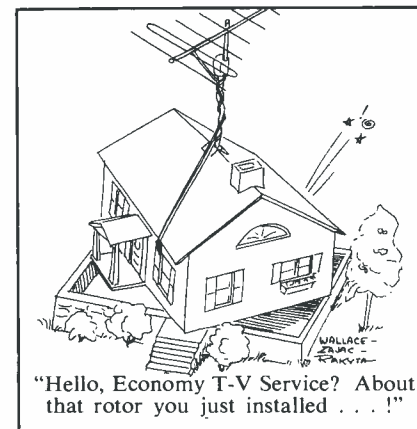

STOP!

LOOK!

SAVE!



A STANDARD COLOR BAR GENERATOR

at **1/2**
THE COST OF OTHERS

only **\$124⁵⁰**

All crystal controlled

the all new SENCORE CG126 STANDARD COLOR BAR GENERATOR

A standard color bar, white dot, crosshatch generator especially made for field service on color TV . . . and at a great savings to you.

Check these outstanding features and you will see why this generator belongs on the top of your list for color TV servicing.

All patterns crystal controlled offering "rock like" stability. You'll think the patterns are painted on the TV screen.

Simplified operation speeds up every servicing job. Just dial the standard keyed bars, white dots, crosshatch, vertical bars or horizontal bars and watch them "pop" on the screen. That's all there is to it.

Exclusive adjustable dot size. The white dots can be adjusted to the size that satisfies your needs by a screwdriver adjustment on the rear. No need to argue about dot size anymore. Just select the size that you like to work with best.

Pretuned RF output to Channel 4. Other low channels can be selected if Channel 4 is being used in your area by simple slug adjustment. Patterns are injected directly into antenna terminals, simplifying operation and saving servicing time.

Reserved output on color bars for forcing signal through defective color circuits. The color output control is calibrated at 100 percent at the center of rotation, representing normal output. A reserve up to 200 percent is available on the remainder of rotation.

Smaller and more portable. With color receivers weighing much more than black and white TV, portable equipment becomes essential for home servicing. The CG126 weighs less than 10 pounds and measures only 11" x 8" x 6".



Ten standard keyed color bars (RCA type) that automatically provide all colors at specified NTSC phases . . . but without need of interpretation when servicing.



Stable white dots with new exclusive dot size adjustment in rear.



Stabilized crosshatch pattern for simplifying convergence adjustments.



10 thin white vertical lines for horizontal dynamic convergence adjustments . . . often missing on other generators.



14 thin horizontal lines for vertical dynamic convergence. Also missing on many high priced generators.

March into your local parts distributor and demand the CG126 Sencore color generator that sells at 1/2 the price of others. Don't let him switch you.

SENCORE

426 SO. WESTGATE DRIVE • ADDISON, ILL.

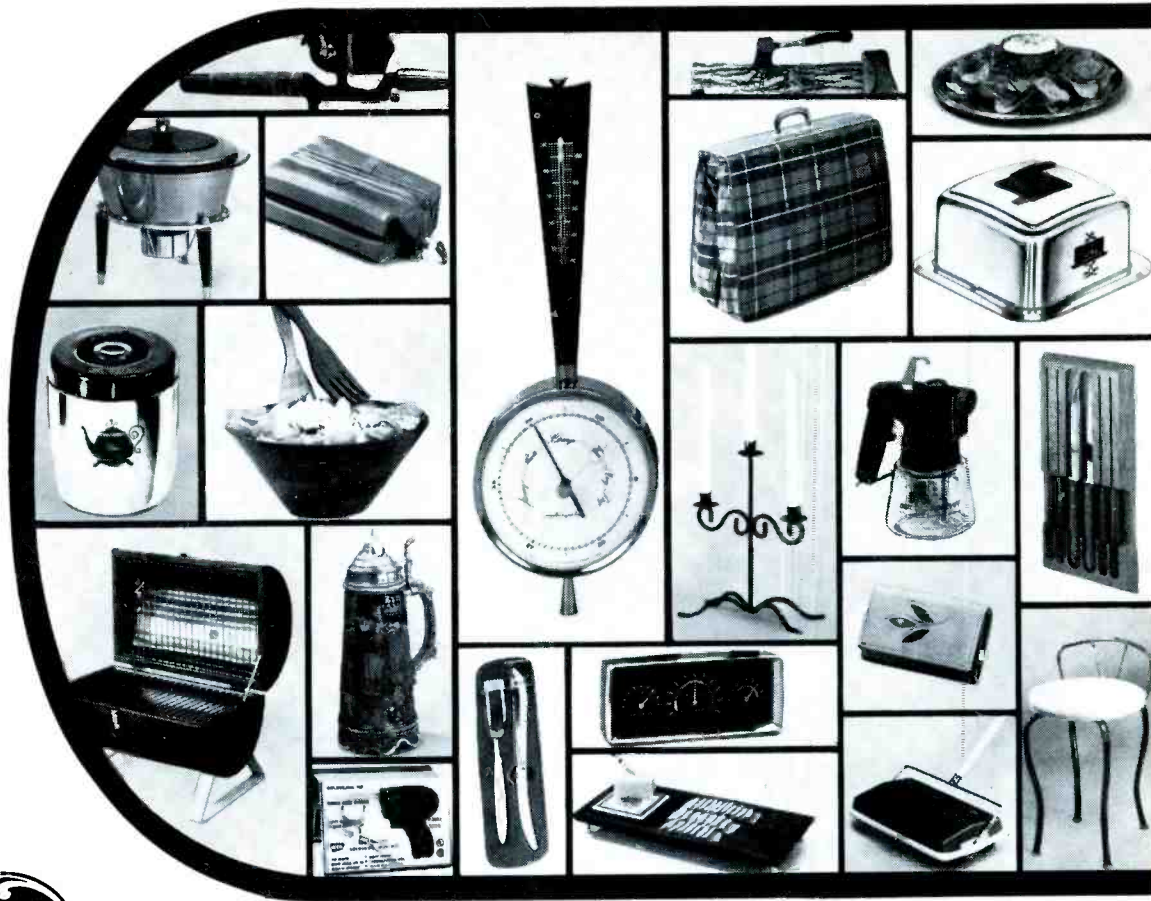

pleasure pak



**DISTRIBUTOR SALES
OWENSBORO, KENTUCKY**

Pleasure-Pak COUPON
EXPIRATION DATE: JULY 18, 1964

This Pleasure Pak coupon is valid for merchandise from this folder on the schedule outlined below when properly validated by your distributor.

3 Pleasure-Pak Coupons = 1 "B" Award
 2 Pleasure-Pak Coupons & \$3.00 = 1 "B" Award
 1 Pleasure-Pak Coupon & \$6.00 = 1 "B" Award

Keep this coupon and redeem it prior to the expiration date for your choice of Pleasure-Pak Awards.

This offer is void in any state, county or municipality where use is prohibited, taxed or otherwise restricted. Cash value is one (1) mill per certificate.



Get in on General Electric's Pleasure Pak program

The purchase of General Electric tubes makes you eligible to receive valuable merchandise during G-E's Pleasure Pak program. Imported musical steins, luggage, barbeque grills, tools, sporting equipment, carving sets and tableware and many other things can be yours at a tremendous discount or *even free*. All of these are well-known brand name products or special items that are not normally for sale.

Make your own selections from G-E Pleasure Pak books

You're not limited to just one or two items. General Electric Pleasure Pak books contain 48 handsome "prizes," accurately illustrated and described. When you buy G-E tubes, you earn one of these books. Then it's *your choice* of the merchandise inside.

Ask your G-E distributor how to earn Pleasure Pak books

Your General Electric receiving tube distributor has a supply of Pleasure Pak books. The back cover of each book is a certificate redeemable for the merchandise shown in the book. Ask your distributor how to get them. The Pleasure Pak program is limited to April and May, 1964. Better stock up on G-E tubes NOW!

Revised Nov. 7, 1963

Pleasure Pak SELECTION FORM

A. ELECTRIC Pleasure Pak Headquarters
 600 West Park Boulevard
 St. Louis, Missouri 63108

AWARD TO _____

NAME _____

ADDRESS _____

CITY _____ STATE _____ ZIP _____

DEALER'S NAME _____

DEALER'S ADDRESS _____

DEALER'S CITY _____ STATE _____ ZIP _____

DEALER'S PHONE _____

DEALER'S SIGNATURE _____

Progress Is Our Most Important Product

GENERAL  ELECTRIC

Circle 10 on literature card

GOOD NEWS FOR EASTERN TV SERVICEMEN...

CASTLE TV TUNER-EAST HAS MOVED TO NEW LOCATION WITH IMPROVED FACILITIES

In Long Island City near Postal Concentration Center to provide faster service by mail.

All other U.S. and Canadian Servicemen will get the same fast service from **CASTLE-CHICAGO** and **CASTLE-CANADA**.

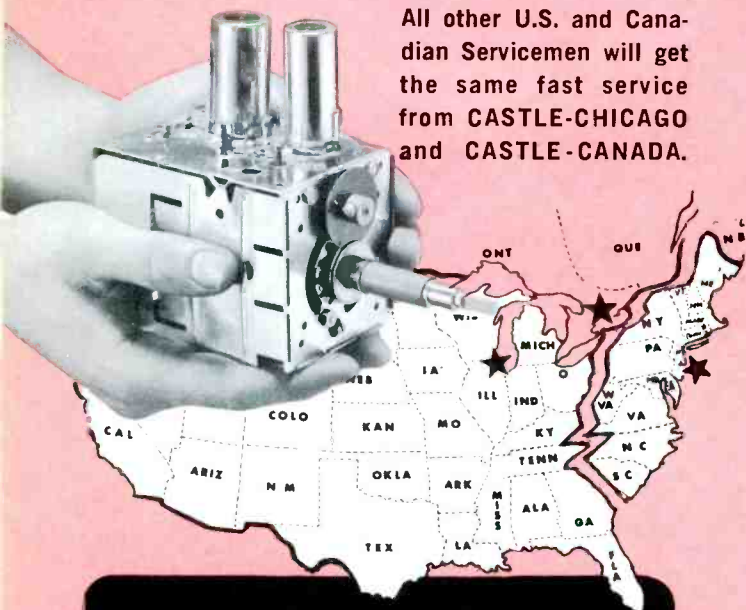

**ALL MAKES
ALL LABOR
AND PARTS
(EXCEPT TUBES)*
ONE PRICE**

995

THIS ONE LOW PRICE INCLUDES ALL UHF, VHF AND UV COMBINATION* TUNERS

Simply send us your defective tuner complete; include tubes, shield cover and any damaged parts with model number and complaint. 90 Day Warranty.

Exact Replacements are available for tuners unfit for overhaul. As low as \$12.95 exchange. (Replacements are new or rebuilt.)

*UV combination tuner must be of one piece construction. Separate UHF and VHF tuners must be dismantled and the defective unit only sent in.

Pioneers in TV



Tuner Overhauling

CASTLE

TV TUNER SERVICE, INC.

EAST: 41-90 Vernon Blvd., Long Island City 1, N. Y.

MAIN PLANT: 5701 N. Western Ave., Chicago 45, Illinois

CANADA: 136 Main Street, Toronto 13, Ontario

*Major Parts are additional in Canada

Circle 7 on literature card



The Electronic Scanner

news of the servicing industry

Service Award Presented



Howard Sams, president and chairman of the board of **Howard W. Sams & Co., Inc.**, accepts the NATESA "Friends of Service Management Award" from Larry Dorst, president of NATESA. NATESA annually presents this award to three companies chosen for their outstanding contributions to the service industry. The Sams Co. has been so honored for each of the eleven years the award has been made.

Pay TV Unscrambled



A new patent has been granted to **Teleglobe Pay-TV System, Inc.** for a pay-TV device for use with centralized metering and billing. The new system connects the home pay-TV decoder between the TV antenna and receiver, obviating removal of the back cover of the TV set, thereby reducing service costs and installation complications. The intensity of the scrambled picture received at the TV set when using Teleglobe encoding methods is shown in the left hand photograph. Teleglobe has approximately 30 patent applications for pay-TV systems granted and pending in the U.S. and foreign countries.

Reception Detection



Nine heavy-duty station wagons have been equipped by **Finco** with laboratory equipment for detecting and solving TV and FM reception problems in the field. The equipment includes an improved 60' extension tower, adjustable engineering antennas, special field meters, scopes, a VHF-UHF TV set, an FM tuner, an amplifier, and measuring instruments. Each unit of the research fleet will be under the supervision of a Finco regional manager and an engineering assistant. The mobile units will also be available for distributor open houses, service-dealer clinics, and other similar meetings.

Pioneer Cited



In recognition of his fifty years in electronics and his 64th birthday, William J. Halligan, W9AC, chairman of the board of **Hallcrafters**, was presented a wrist watch and scroll at a surprise party sponsored by amateur radio hams. Tim Coakley, W1KQP, Boston, is shown making the presentation while Garry Cole, W9MKY, Chicago, looks on.

Mr. Halligan founded The Hallcrafters Co. in 1933 when he recognized several basic needs within the then infant electronics industry.

BEST PROFESSIONAL VTVM VALUE

EICO 232 peak-to-peak VTVM featuring exclusive Uni-probe® (U.S. Pat.)

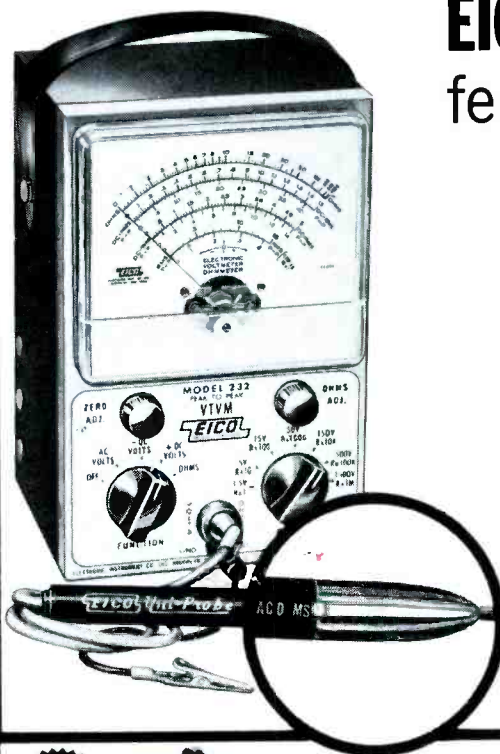

Deluxe VTVM for color & B & W

- Calibration without removing from cabinet
- Measure directly p-p voltage of complex & sine waves: 0-4, 14, 42, 140, 420, 1400, 4200
- DC/RMS sine volts; 0-1.5, 5, 15, 50, 150, 500, 1500 (up to 30,000 volts with HVP probe, & 250 mc with PRF probe)
- Resistance ranges: 0.2 ohms to 1000 megs in 7 ranges
- 7 non-skip ranges on every function
- 4 functions: + DC Volts, - DC Volts, AC Volts, Ohms.
- Uniform 3 to 1 scale ratio for extreme wide-range accuracy
- Large 4 1/2" meter in can't-burn-out circuit
- Zero center for TV-FM discriminator alignment
- Smart professional styling—new satin finish etched panel with contrasting knobs and meter and grey wrinkle steel case.

Kit \$29.95; wired \$49.95.

Exclusive UNI-PROBE: (pat. pending) Terrific timesaver, performs all functions: A half turn of probe-tip selects DC or AC-Ohms

EICO KITS FOR 1964

BEST BUY SCOPES



EICO 460 WIDEBAND 5" SCOPE For color & black-and-white TV servicing. Easily reproduces 3.58 mc color TV synchronizing burst. Vert. amp. flat from DC to 4.5 mc, usable to 10 mc; 25 mv rms/inch sensitivity. Horiz. amp. flat from 1 cps to 400 kc; 0.6 v rms/inch sensitivity. Automatic sync. Sweeps from below 10 cps to 100 kc. Kit \$89.95; Wired \$129.50.



EICO 427 ADVANCED GENERAL PURPOSE 5" SCOPE High sensitivity scope has all the facilities and quality demanded for servicing audio, communications and industrial equipment. Vert. amp. flat from DC to 500 kc, -6 db at 1 mc; 3.5 mv rms/cm sensitivity. Horiz. amp. flat from 2 cps to 450 kc; 0.18 v rms/cm sensitivity. Automatic sync. Sweeps from 10 cps to 100 kc. Kit \$69.95; Wired \$109.95.



EICO 430 PORTABLE GENERAL PURPOSE 3" SCOPE Remarkably fine compact scope. Excellent for servicing audio, communications, and industrial equipment. Ideal as a ham shack monitor. Flat-face 3" CRT with mu metal shield eliminates affects of external fields. Vert. amp. flat from 2 cps to 500 kc, -6 db at 1 mc; 25 mv rms/cm sensitivity. Horiz. amp. from 2 cps to 350 kc, 0.25 v rms/cm sensitivity. Sweeps from 10 cps to 100 kc. Kit \$69.95; Wired \$99.95.



EICO 955 IN-CIRCUIT BRIDGE-TYPE CAPACITOR TESTER Unique shunt-resistance balancing* provision, permits in-circuit short checks even in the presence of as little as 1 ohm shunt resistance. Sensitive open check down to 15 µmf normally, adjustable to as little as 5 µmf. Wien Bridge capacity measurements from 0.1 to 50 µf. Kit \$19.95; wired \$39.95 *Pat. applied for.



EICO 667 DYNAMIC CONDUCTANCE TUBE & TRANSISTOR TESTER Combines mutual conductance test with a peak emission test—gives a single reading of tube quality. Also spots bad NPN and PNP transistors by gain and leakage tests. New 1964 design has sockets and settings for the latest receiving types, including 5 and 7-pin novistors. Also tests novars, 10-pin miniatures, and compactrons, many low-power transmitting and special-purpose tubes, voltage regulators, electron-ray indicators, etc. Multi-circuit lever switch; 13 tube-element pushbutton switches. 4 1/2" meter; roll-chart in snap-in window. Kit \$79.95; wired \$129.95. **EICO CRU CRT ADAPTER**—Adapts 667 to test all color and B & W CRT's. Wired \$9.95.



EICO 369 TV/FM SWEEP GENERATOR WITH BUILT-IN POST INJECTION MARKER Feeds into the sweep signal to the circuit under test or alignment. A demodulator picks off the response signal and feeds it to a mixer stage where the markers are added before scope display. Thus, troublesome interaction effects are eliminated. Sweep generator has controllable inductor sweep circuit (all electronic) with no mechanical parts to wear and give trouble, and 5 fundamental ranges from 3.5 to 316 mc. Variable frequency marker provides output on 3 fundamental ranges from 2 to 60 mc., and 60 to 225 mc range on harmonics. 4.5 mc crystal supplied for rapid check of marker generator alignment. Kit \$89.95; wired \$139.95.

FOR COLOR AND B & W



TOP-NOTCH TRANSISTOR TESTING TEAM
EICO 1020 POWER & BIAS SUPPLY with 0.005% ripple. Continuously variable metered output voltage, 0-30 VDC at 150 to 300mA. Kit \$23.95; wired \$29.95.



EICO 680 TRANSISTOR & CIRCUIT TESTER Measures basic characteristics of signal and power transistors. Provides DC current, DC voltage (20K ohm/volt), and resistance ranges normally needed for transistor work. Kit \$25.95; wired \$39.95.

EICO Electronic Instrument Co., Inc. PF-4
131-01 39th Avenue, Flushing, N.Y. 11352

Send new 1964 catalog featuring more than 230 EICO Products.

NAME _____
ADDRESS _____
CITY _____ ZONE _____ STATE _____
Add 5% in West

WINEGARD COLORTRON.

MODEL C-44 — \$64.95
World's most powerful TV antenna

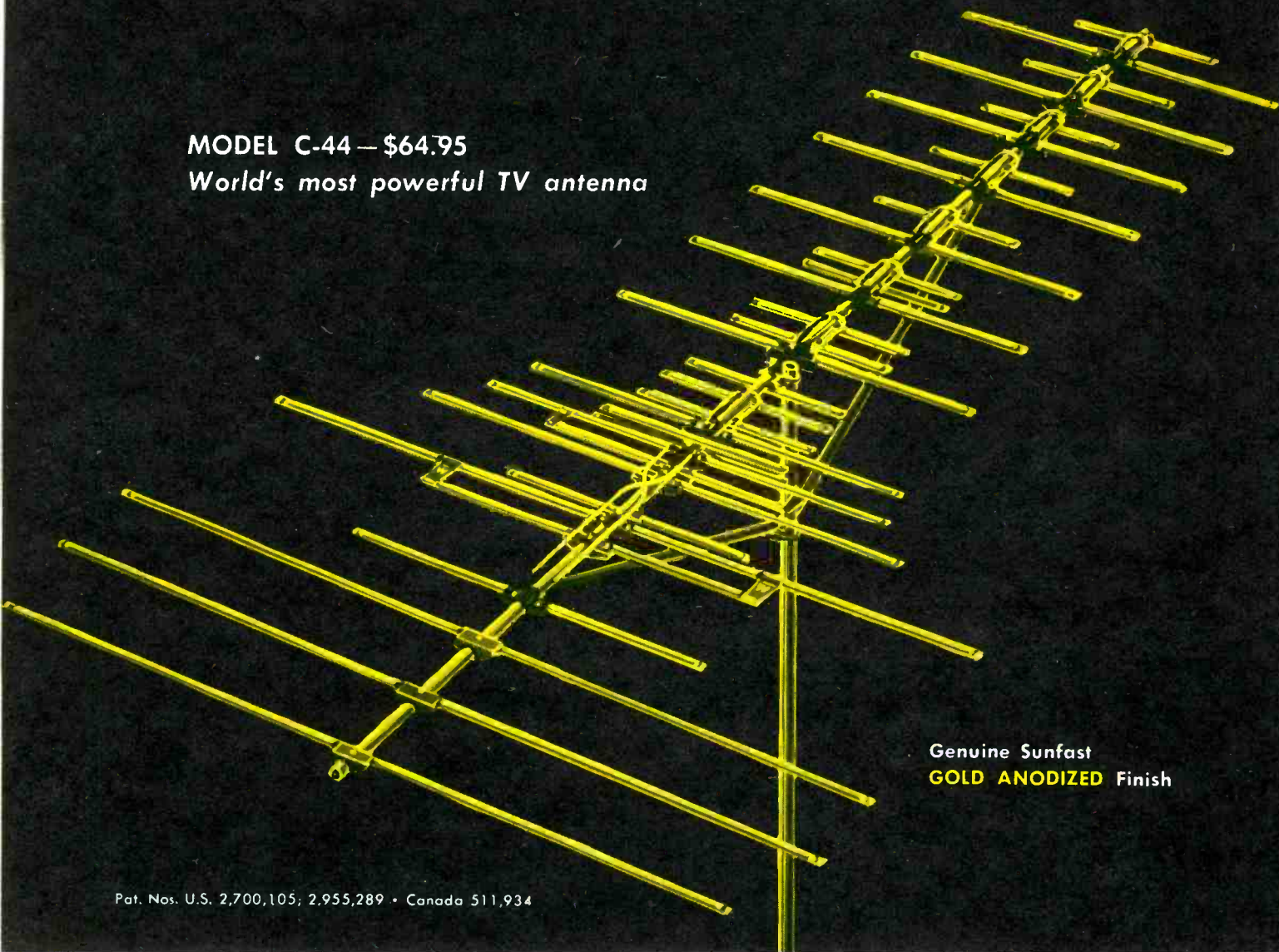

Genuine Sunfast
GOLD ANODIZED Finish

Pat. Nos. U.S. 2,700,105; 2,955,289 • Canada 511,934

FIRST IN PERFORMANCE! FIRST IN CONSTRUCTION QUALITY! FIRST IN APPEARANCE!

Antennas come. Antennas go. But Winegard's *patented* Electro-Lens all channel yagi continues to be the standard of excellence. You can see its influence in the design of every high gain antenna made today.

Because Winegard COLORTRONS *are* recognized as the standard of excellence in TV antennas, you'll find them in every state of the union and 42 foreign countries. Four models satisfy every reception requirement.

WINEGARD COLORTRONS deliver today's finest color reception, give a new picture quality to black &

white. And COLORTRONS are rugged. High tensile aluminum tubing for rigidity and stability... insulators with triple moisture barrier... GOLD ANODIZED for complete corrosion-proofing. Winegard GOLD ANODIZING is the finest in the industry —not an inexpensive stain that fades out in a few weeks, but a bright GOLD that lasts for the life of the antenna.

Try a COLORTRON. Test it against any competitive make for performance, construction, appearance. If you're not 100% convinced, we'll take it back. Your satisfaction is guaranteed.

standard of excellence in the industry



FOR
COLOR
OR
BLACK
&
WHITE



COLORTRON TWIN NUVISTOR AMPLIFIER

Has highest input — up to 400,000 microvolts
Has highest output — up to 1,200,000 microvolts
Perfect partner to the COLORTRON ANTENNA!

Winegard's revolutionary new circuit, employing 2 nuvistors, enables the Colortron to overcome the service problems and limitations of other antenna amplifiers. Colortron will not oscillate, overload or cross modulate because it takes up to 400,000 microvolts of signal input. This is 10 times better than any transistor antenna amplifier made. Has highest out-

put, too—up to 1,200,000 microvolts.

Nothing on the amplifier is exposed to the elements—even the terminals are protected. Colortron comes complete with an all AC power supply with built-in 2 set coupler. Colortron model AP-220N 300 ohm input and output \$39.95 list. Model AP-275 300 ohm input 75 ohm output \$44.95 list.

WINEGARD RESEARCH, ENGINEERING AND MANUFACTURING ARE DEVOTED EXCLUSIVELY TO PRODUCTS FOR BETTER TV-FM RECEPTION



Colortron Antenna Model C-43
Gold Anodized — \$51.90



Colortron Antenna Model C-42
Gold Anodized — \$34.95



Colortron Antenna Model C-41
Gold Anodized — \$24.95



Stereotron Antenna Model SF-8
For long distance FM reception
\$23.65



2-Set Color Coupler
Model EC-230 —
transistorized 2-set coupler
boosts signals, couples
2 sets — \$17.95



Red Head Antenna amplifier
Model RD-300—most reliable
transistor TV-FM
antenna amplifier — \$29.95

Nationally
advertised
month after
month



PLUS 3 NEW TV-FM DISTRIBUTION AMPLIFIERS



Model A-215—15 DB gain
\$44.95



Model A-430—30 DB gain
\$84.95



Model A-845—45 DB gain
\$159.95



Winegard
ANTENNA SYSTEMS
3009-D KIRKWOOD • BURLINGTON, IOWA

Circle 8 on literature card

New! BUSS SPACE SAVER PANEL MOUNTED FUSEHOLDER



Actual Size
Only 1 7/8 inches long . . .
Extends just 29/32 inch
behind front of panel

- Fuseholder takes 1/4 x 1 1/4 inch fuses. Converts to 9/32 x 1 1/4 inch fuses simply by changing screw type knob. Holder is rated at 30 ampere for any voltage up to 250.
- Also available in military type which meets all requirements of MIL-F-19207A.

BUSS

Write for BUSS
Bulletin SFH-10

BUSSMANN MFG. DIVISION, McGraw-Edison Co., St. Louis 7, Mo.

Exhaustive checks throughout the receiver failed to reveal any faulty components. After repeated searching, however, we found the following defect: The filament voltage on the horizontal oscillator tube (a 6CG7) would drop from 6.3 volts to approximately 2.5 volts, killing the oscillator. Loss of drive voltage to the horizontal-output stage caused the 6DQ5 to draw excessive current, popping the circuit breaker.

The trouble was remedied by replacing the 6CG7 socket.

MORRIS GLIKLICH

Hillside, N.J.

This was indeed an unusual fault, and I'll bet you had quite a time locating it. Evidently, the socket had developed a resistance in series with the filaments, dropping the voltage applied to this particular tube.

Touchy Radio Volume

I have a Silvertone radio, Chassis 132.40100 (PHOTOFACT Folder 347-16) that has an intermittent volume condition. The volume drops just low enough to require readjustment of the control; the sound never disappears completely.

All voltages throughout the receiver are okay. The AVC voltage drops approximately 1 volt when the volume decreases. I have monitored this set with a signal tracer and found I'm losing the signal all the way back to the antenna. I've replaced the RF transformer without curing the problem. Sometimes, just touching the antenna with my finger or connecting my meter to the chassis will return the volume to normal. Can you help?

WILLIS LONTERAT

Ville Platte, La.

The most likely causes of this trouble are a coupling capacitor, a bypass capacitor, or the volume control itself. Since the set doesn't go completely dead, I would strongly suspect a bad coupling or bypass capacitor. These capacitors may develop a faulty connection between a lead and its associated foil. When the capacitor heats up, the connection opens, due to expansion. A good way to locate one of these offenders is to tap each

BUSS: 1914-1964, Fifty years of Pioneering....



The Troubleshooter

answers your servicing problems

Lowered Filament Voltage

I would like to share a recent experience with your readers, in the hope it will prove as helpful to them, as their experiences have to me.

This problem concerned an RCA CTC11 color chassis (PHOTOFACT Folder 550-2), and the symptoms were: the circuit breaker would pop open after the set had operated for approximately two hours. After the receiver was permitted to cool, the circuit breaker could be reset, but would open again in a short time.

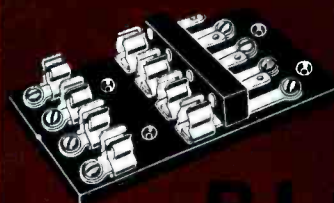
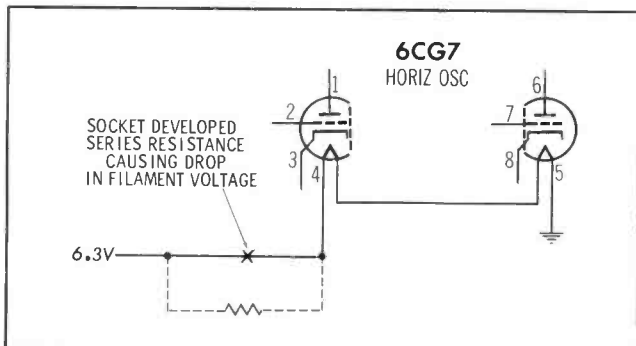

BLOCKS for BUSS FUSES

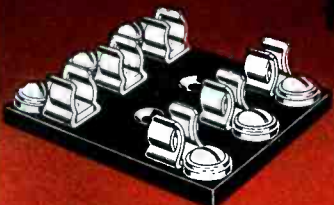

All Types Available for
Every Application . . .

Single pole, multiple pole, small base, full base, molded base, bakelite base, porcelain base for fuse from 1/4 x 3/8 inches up to 1/2 x 2 inches. Also signal fuse blocks and special blocks of all types.

Send us your requirements — we have the block you need or can engineer it for you.

BUSS

Write for BUSS
Bulletin SFB.

BUSSMANN MFG. DIVISION, McGraw-Edison Co., St. Louis 7, Mo.

Circle 9 on literature card

Save Assembly Time with Quick-Connect Terminals on BUSS Fuseholders

Eliminates soldering. Permits use of pre-assembled harness. Reduces assembly time.

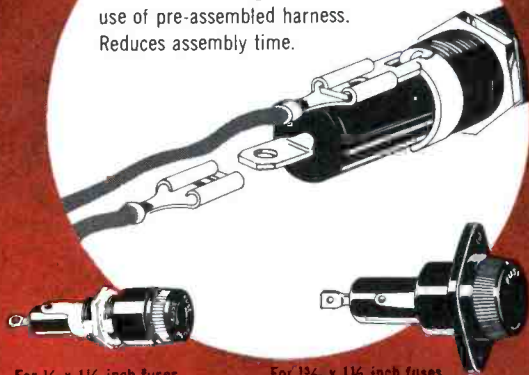

For 1/4 x 1 1/4 inch fuses Series HJ, HK, and HLD

For 1/2 x 1 1/2 inch fuses Series HPC

BUSS

Write for BUSS Bulletin SFB.

BUSSMANN MFG. DIVISION, McGraw-Edison Co., St. Louis 7, Mo.

inside the control, making smooth or stable operation impossible. These spots usually appear at the most-used positions on the control; to check for this you might try operating the radio at a much higher volume than usual and seeing what happens. Don't overlook the possibility of a bad tube socket, loose component, or faulty connection. A corroded IF transformer could also cause this type of trouble.

Tape Saturation

I would like to know how to adjust the VU or level meters on tape recorders so they will read 100% when the tape is saturated. Most of us can easily change the gain of the meter amplifier, but how can we tell when the recorder is beginning to saturate a tape—so we can make the adjustment properly?

ROBERT KINNISON

Granada Hills, Calif.

Your interest in the correlation between VU meter (relative sound volume level indicator) settings and 100% tape saturation is shared by many other technicians and recording enthusiasts.

The first step in solving your problem is to be sure that all voltage, current, and impedance settings—and mechanical adjustments relating to recording and erasing—are made according to the recommendations of the recorder manufacturer. When you are sure the unit is operating properly, put on a standard alignment tape, and adjust the meter circuit according to the instructions with the tape.

The key to success in this operation is in having and properly using a standard tape; if this is done you will have the accuracy you need for most purposes. Since tape varies from type to type, from manufacturer to manufacturer, and from reel to reel, a measure of 100% saturation is never exact—reasonably exact measurement can be made only with very specially designed equipment.

Although the method just given for establishing tape saturation is more reliable, here is another method that can be used:

• Please turn to page 68

....New Developments in Electrical Protection

capacitor with a pencil; this method works better than bending or twisting the leads.

If the tapping does not good, try applying heat to the capacitors by holding a hot soldering iron near each capacitor while listening for a change in the sound level. If this doesn't flush out the culprit, you may have to try substitution. Merely paralleling a suspected capacitor will not always work, because this may cause a surge through the bridged unit, which might effect a temporary cure.

The volume control itself may be causing the sound to fade. The carbon element may become dirty at one or more spots

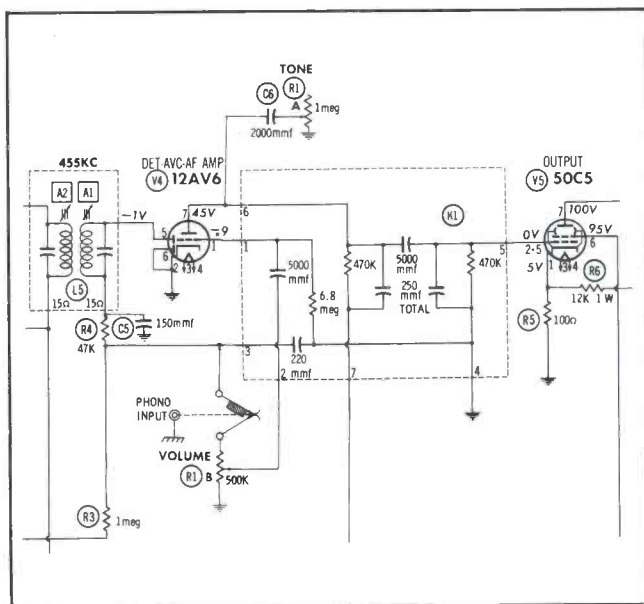

BUSS quick-acting fuses

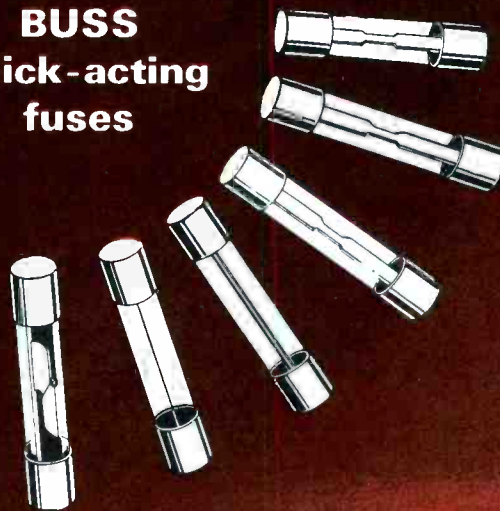

Quick Acting™ fuses for protection of sensitive instruments or delicate apparatus—or normal acting fuses for protection where circuit is not subject to starting currents or surges.

BUSS

Write for BUSS Bulletin SFB.

BUSSMANN MFG. DIVISION, McGraw-Edison Co., St. Louis 7, Mo.

Circle 9 on literature card



'JOIN THE COLOR PARADE'

Free

with your purchase
of RCA Entertainment
Receiving Tubes

Ask your participating RCA
Distributor for details

BRAND NEW!

Color TV is now a major factor in the U.S. economy. And 1964 will see more color-set sales... more color programming... and more need for color servicing... than ever before.

Are you prepared to take advantage of the swing to color? Here's the book that will help to put you and keep you in the highly profitable color-TV servicing business...

The Brand-New RCA Color-TV Troubleshooting Pict-O-Guide 1A1389

Produced under the guidance of John R. Meagher, RCA's famous color-TV servicing expert, the new PICT-O-GUIDE is your quick and easy, all-in-one aid to proper troubleshooting and adjusting of color TV receivers.



Here's why the new RCA Pict-O-Guide is so effective:

Pictures tell the story best.

Many, many full-color photos show trouble symptoms just as they appear on a color screen to help you locate troubles quickly.

Takes a new look at setup procedures.

Setup procedures have been vastly simplified. Color photos show how each setup job is done and what the results look like on the screen.

Expanded troubleshooting section.

Gives you the advantage of RCA's many years of accumulated experience in locating, diagnosing and correcting service problems in color receivers.

Helps you learn by doing.

Designed to give you practical experience...to let you follow every step of every service procedure.

**And it's Free with
your purchase of
RCA entertainment
receiving tubes!**



Also free with the purchase of RCA entertainment receiving tubes...

BULOVA WRIST WATCHES



1A1439-17 Jewel Men's Model BULOVA yellow, 10K rolled gold plate, stainless steel back, unbreakable main spring, shock resistant, good looking strap. Handsome prestige men's time piece.



1A1440-17 Jewel Ladies' Model BULOVA Yellow, 10K rolled gold plate, stainless steel back, unbreakable main spring, shock resistant, attractive cord. Beautiful prestige ladies' time piece.

CARAVELLE® WRIST WATCHES (Made by a Division of the Bulova Watch Co., Inc.)



1A1435-17 Jewel Men's Model Caravelle—Handsome 10 micron yellow gold finish case with stainless steel back. Waterproof* with unbreakable main spring, luminous hands and dial. Shock resistant; sweep second hand.



1A1436-17 Jewel Ladies' Model Caravelle—Graceful 10 micron yellow gold finish case with stainless steel back. Shock resistant with unbreakable main spring. Elegantly styled.

*Waterproof as long as case, crystal and crown remain intact

For details on how to get the new RCA Color TV Troubleshooting PICT-O-GUIDE and BULOVA or CARAVELLE® wrist watches, see your participating Authorized RCA Tube Distributor right away.

RCA ELECTRONIC COMPONENTS AND DEVICES, HARRISON, N.J.



The Most Trusted Name in Electronics

"The responsibility of leadership is to innovate, produce and deliver a reliable product."

William Dubilier, Mica Capacitor Inventor

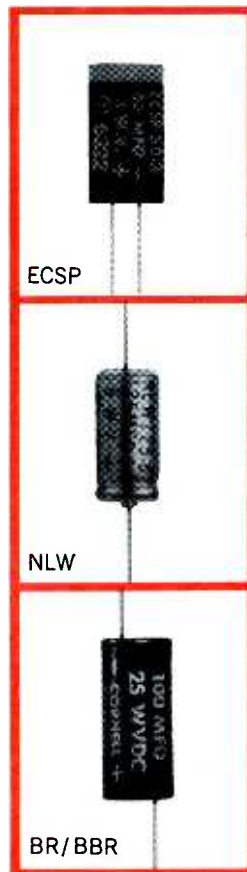

D. C. Tubular Aluminum Electrolytic Capacitors

Preferred Replacements:

Three selected types, immediately available, cover all replacement needs.

Reliability: Typically high Cornell-Dubilier quality to protect your reputation and profits.

The right replacement... when and where you want it. Immediately available from the CDE network of Authorized General Line Distributors, and especially selected to solve any under-chassis and sub-panel tubular electrolytic replacement problem. Each of the three D.C. aluminum electrolytics use highest quality materials, utilizing the latest, exclusive CDE processes—the result of CDE's 53 years of knowledge and experience in capacitors.

Type ECSP—for printed circuit and low voltage, transistorized equipment. The industry's only rectangular cased, miniature electrolytic. Pre-molded case, exclusive moisture resistant encapsulation, and guaranteed lead center dimensions. Available 3 to 75 volts DC working, 3 to 250 microfarads, operating temperature range—20 to 65C.

Type NLW—for transistorized and portable equipment, or other miniaturized applications. Ultra-miniature axial lead electrolytics,

hermetically sealed in aluminum cases, and provided with plastic insulating sleeves. Available 3 to 150 volts D.C. working, 1 to 450 microfarads, operating temperature range—40 to 85C.

Type BR/BBR—the famous CDE "Blue Beaver"®, most popular and widely used of any tubular electrolytic. Hermetically sealed in compact aluminum cases and provided with cardboard insulating sleeves. Available 3 to 700 volts D.C. working, 1 to 5000 microfarads, operating temperature range—20 up to 85C. Also available BBRD (dual), BBRT (triple), and BBRQ (four section).

Order a supply of these preferred replacements from your CDE Distributor. For more information, ask him for Section 201 of the CDE REPLACEMENT COMPONENT SELECTOR, or write: Cornell-Dubilier Electronics, Division of Federal Pacific Electric Co., 50 Paris Street, Newark 1, New Jersey.

CDE **CORNELL-DUBILIER**
INNOVATION WITH RELIABILITY

Circle 11 on literature card

Noise Immune

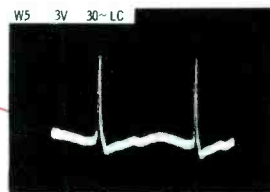
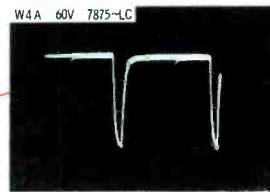
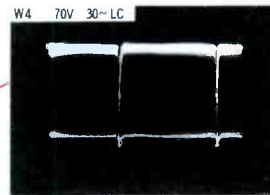
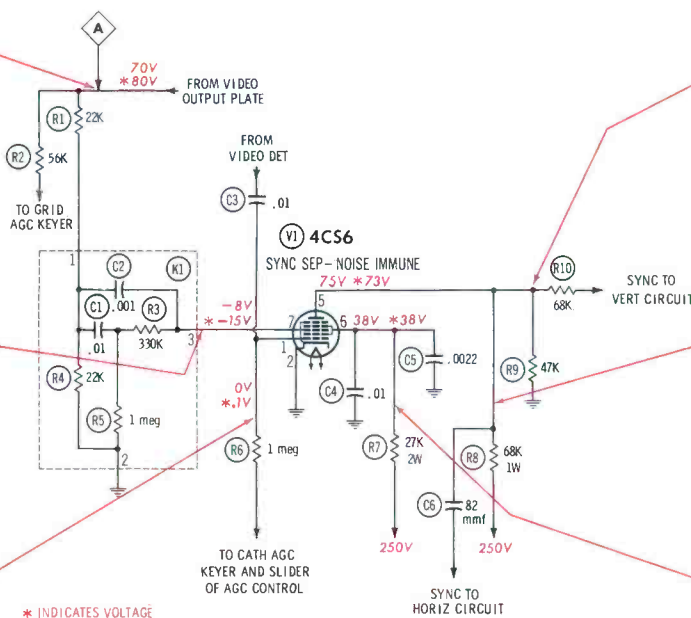
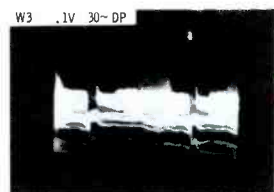
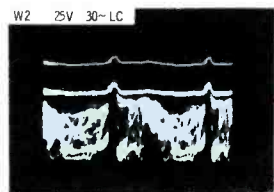
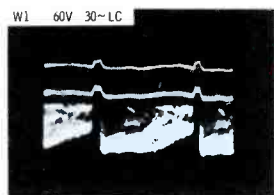

DC VOLTAGES taken with VTVM, on inactive channel; antenna terminals shorted. *Means voltage varies with signal conditions—See "Operating Variations."

WAVEFORMS taken with wideband scope; controls set for normal contrast (50 volts p-p video to CRT). Low-cap probe (LC) used where direct probe distorts.

Normal Operation

Pentagrid 4CS6 functions as combination sync separator-noise limiter in this circuit from Sylvania Chassis 571-1. High-level composite video signal (positive-going) is obtained from plate circuit of video-output tube, and coupled via R1-K1 network to grid 2 (pin 7) of V1. (Same signal is coupled to grid of AGC keyer by R2, affecting amount of AGC developed in set.) Contrast control is located in video stage after sync takeoff point, so its setting should have no effect on amplitude of W1 at Point A. W1 (60 volts) is divided by input resistor-capacitor network R1-K1, leaving 25-volt signal for input to grid of separator. Incoming signal develops grid-leak bias on V1, and tube conducts only during uppermost region of sync pulses—above blanking level. V1 is easily saturated because of low screen and plate voltages, so extreme tips of sync pulses—and any noise spikes appearing above sync tips—are clipped. Low-level negative-going video signal from detector circuit is coupled via C3 to grid 1 (pin 1) to make circuit immune to noise. If spikes of noise are present in W3, grid is driven negative for their duration, stopping conduction. Effective operating point at grid 1 of V1 is varied by small positive voltage obtained from cathode of AGC keyer; this voltage is proportional to AGC, and stabilizes noise-cancelling action. Horizontal sync pulses are fed to AFC circuit by C6; vertical sync goes via R10. Ten-volt additional amplitude of W4 (over W4A) is result of scope—at 7875 cps—not "seeing" signal being coupled back from vertical oscillator via R10.

Operating Variations

- PIN 1** No important changes in DC voltage as set is switched among local channels. However, amplitude of W3 varies widely with adjustment of AGC control; also, from minimum to maximum settings of control, DC voltage changes from 0 to 1.5 volts.
- PIN 7** Changing channels causes only 1 or 2 volt change in amplitude of W2. Rotation of AGC control, however, produces large amplitude change—maximum before *overload* is 60 volts p-p; minimum before *whiteout* is 5 volts. DC voltage stays around -15 volts with stations in local area. With fringe-area reception, voltage at this pin can drop as low as 12 volts.
- PIN 5** DC voltage is within a couple of volts with or without signal. Likewise, DC voltage is stable at all *normal* settings of AGC; however, at *whiteout* voltage drops to 25 volts, and at *overload* rises to 50 volts. Output signals undergo no significant change from one station to another.
- PIN 6** Voltage at this pin doesn't change, with or without signal. Screen is well decoupled, and W5 contains only small ripple signal and spike picked up by radiation from vertical circuit.

Horizontal Pulling

SYMPTOM 1

Vertical Jitter

C2 Open

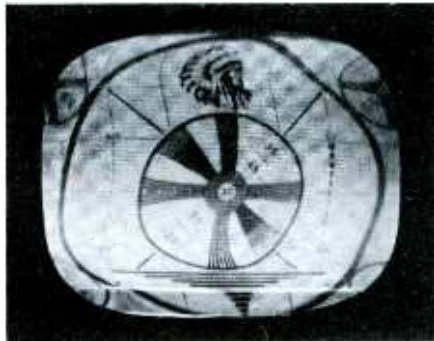

Severe pulling and intermittent vertical jitter on strong local stations; symptoms not so pronounced on fringe-area station. Looks similar to slight AGC overload, but AGC control is operative, suggesting trouble in sync stage. Vertical and horizontal controls operate normally.



Waveform Analysis

Amplitude of W1 is okay, but bent waveform suggests AGC trouble. Clamping AGC line eliminates some bending, but picture symptom is still present, pointing further to defect in sync circuit. Lack of horizontal pulses in W2 offers evidence that trouble is between Point A and grid of V1. Video contamination in W4 isn't great, indicating that DC operating conditions of V1 are not too bad—fault is definitely caused by wrong *signal* at grid.



Voltage and Component Analysis

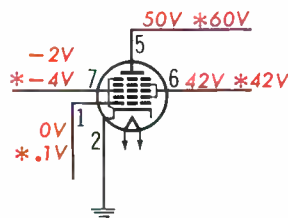

Grid bias on pin 7 has decreased somewhat—with or without signal—and may cause some concern; it has decreased 6 volts below normal. Normal -8 volts is caused by noise from high-gain front-end and video stages in absence of signal; with C2 open, noise is seriously attenuated (same as horizontal pulses), and fails to develop much grid-leak bias at pin 7. Plate voltage drops as negative grid bias is reduced. Open C2 drastically changes characteristics of network C1-R3-C2 hence higher frequencies (noise or horizontal pulses) fail to reach grid.

Best Bet: Scope will isolate this trouble quickly.

Vertical Hold Critical

SYMPTOM 2

Horizontal Affected Slightly

R8 Increased in Value

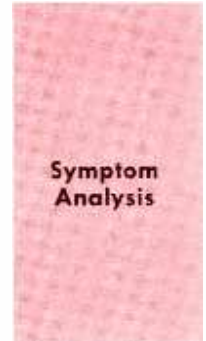
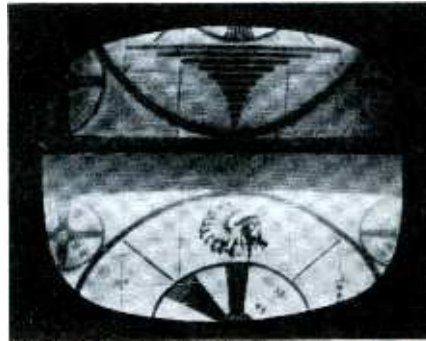

Picture rolls intermittently. Hold control is operative, but fails to give positive lock-in action. Roll can be stopped momentarily by careful adjustment. Symptom is more severe on distant stations—rolling constantly. Indications point to trouble in sync path to vertical stage.

Waveform Analysis

Normal W2 indicates everything up to this point is working normally, ruling out possibility of defects in RF-IF, video, or AGC circuits. W4, taken with vertical hold set to permit viewing sync pulse, indicates pulse at this point is low. Ten-volt *sync* signal here is greatly attenuated from that of normal operation. 40-volt spike is coupled back from vertical oscillator. Viewing sync signal at 7875 cps (W4A) will confirm low 10-volt sync pulse from V1.

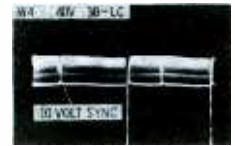

Voltage and Component Analysis

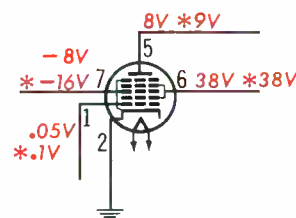

Best voltage clue is extremely low plate voltage. Voltages on both grids of V1 are within limits—with or without signal—dismissing possibility of overconduction through tube. B+ source is normal, so trouble is isolated to one or more components in plate circuit of V1, best suspects being R8 and R9. In this instance, R8 had increased to nearly 1 meg; further increase in value would cause loss of both vertical and horizontal sync. Separating ability of 'CS6 is not altered greatly, since grid-leak bias is maintained by good input signal to grid.

Best Bet: Isolate with scope; pinpoint with VTVM.

Vertical Roll

SYMPTOM 3

Horizontal Stable

R7 Increased in Value

Symptom Analysis

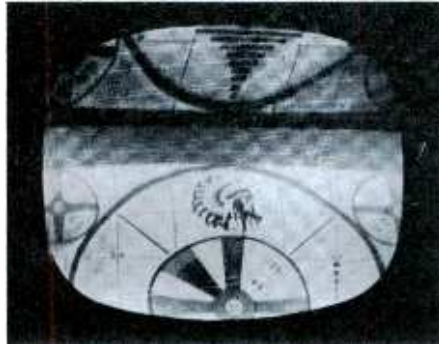

Vertical rolls slowly; may lock in at times, but jitters or bounces under most conditions. Symptoms are same on local and fringe stations. Height and linearity are good, and vertical hold control is operative. Trouble likely caused by weak or distorted sync to vertical oscillator.

Waveform Analysis

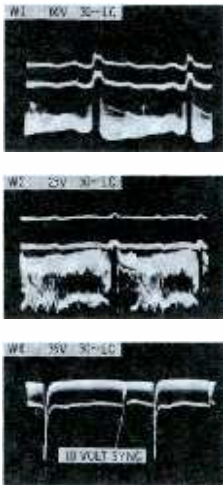

Scoping W1 shows good composite signal, removing all suspicion that poor vertical sync is caused by front-end or video stages. W2 has normal amplitude of 25 volts, and vertical sync pulse is clearly defined. W4 offers conclusive indication that trouble is in sync stage: vertical sync pulse at this point is only 10 volts. As in Symptom 2, horizontal is fairly stable, although overall sync amplitude is reduced; AFC discriminator still controls horizontal.

Voltage and Component Analysis

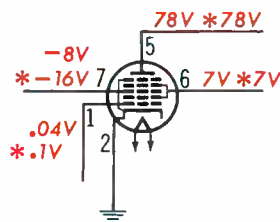

All voltages on V1, with exception of screen voltage, are within normal range—with or without signal. Screen voltage, however, is only 7 volts; trouble is probably faulty tube, shorted C4 or C5, or defective R7. Here, value of R7 has increased to around 250K, considerably lowering gain of V1 (note plate voltage is slightly higher from reduced conduction). Attenuated sync pulse in output of separator is not sufficient to lock in vertical oscillator. It's a good idea to check C4 and C5 for possible leakage when R7 is found damaged.

Best Bet: Scope to isolate; VTVM to pinpoint.

Horizontal Bending and Pulling

SYMPTOM 4

Intermittent Vertical Roll

K1 Ground Return Open

Symptom Analysis



Entire CRT screen is affected and pulling is most pronounced at top of raster. Trouble remains on all stations—local and fringe—and AGC control is operative; almost rules out fault in AGC circuit. Vertical holds fairly well, rolling only a few frames occasionally.

Waveform Analysis

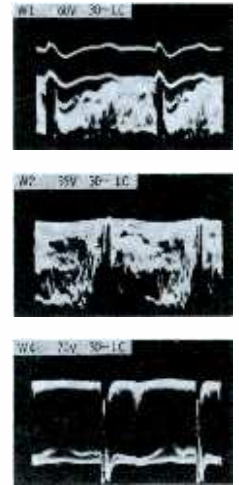

W1 is good, disregarding slight distortion caused by feedback loop of keyed AGC action. Clamping AGC does little to improve picture condition, and thus definitely eliminates AGC trouble. Distorted W2 is good evidence that defect follows Point A, probably in some component associated with printed couplate K1. Sync pulses actually appear in waveform, but they're swamped by video information—much like overload from AGC.

Voltage and Component Analysis

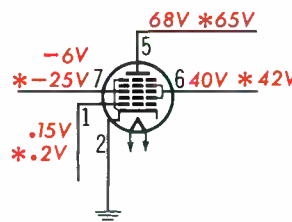

Voltages on V1 without signal are normal. However, with signal, bias on pin 7 goes rather high, averaging -25 volts and fluctuating from -5 to -45 volts with video content of incoming picture. Wild variations such as these give hint that grid circuit is "floating" and check on grid-to-ground path of V1 is in order. Ohmmeter connected from pin 7 to chassis gives infinite resistance reading. Open connection could be inside K1, making replacement necessary. Open connection external to couplate (poor solder joint) can be corrected easily.

Best Bet: Scope isolates; VTVM pinpoints.

Horizontal Pulling

SYMPTOM 5

Slight Vertical Jitter

C1 Leaky

Symptom Analysis

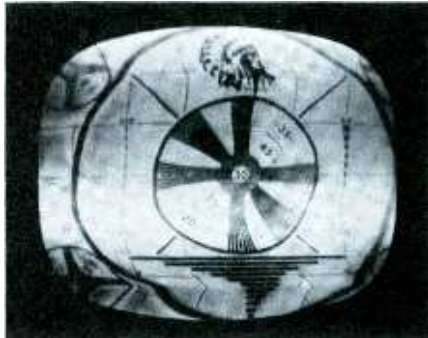

Pulling at top of raster on all channels, and degree of pulling varies with picture content. Jitter is also noticeable—not pronounced, but still unpleasing to the eye. Both horizontal and vertical remain in sync; adjusting either hold control gives good lock-in action.

Waveform Analysis

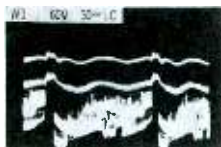

Clamping AGC first rules out trouble in AGC circuit—symptoms remain. 70-volt amplitude of W4 at output of separator is okay, but contamination is evident. Checking input to V1 (W2) is next logical step; 20-volt amplitude is acceptable, but sync pulses are highly compressed. Theory of possible trouble in video stage is disproved by normal W1. Only three waveform checks are necessary to pinpoint troubled area: Fault must be in K1.

Voltage and Component Analysis

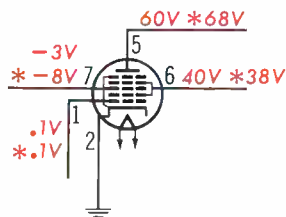

Voltages on plate, screen, and noise grid are within normal limits. Vague voltage clue is reduced bias on pin 7, with or without signal. Leaky C1 provides path for positive voltage to reach grid of V1; grid bias is lowered, and normal operating mode of separator is changed. Time constant of K1 is also affected, and sync pulses at pin 7 are compressed. When grid bias is lowered in this and similar circuits, coupling capacitor(s) in grid circuit should become prime suspects. Dynamic leakage check at terminal 3 of K1 can be made by slicing of PC board.

Best Bet: Scope and VTVM will pinpoint this defect.

Vertical Hold Critical

SYMPTOM 6

Horizontal Not Affected

R8 Decreased in Value

Symptom Analysis

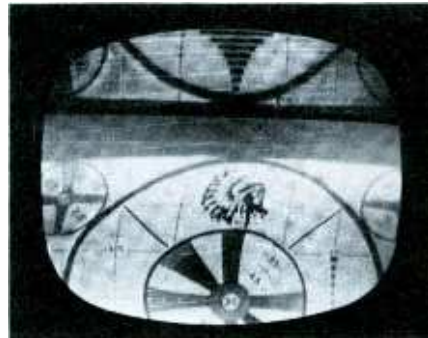

Picture has tendency to roll a few frames, then lock in. Condition is aggravated on fringe-area station, and rolling occurs more often. Vertical hold control does not give positive snap-in action, probably indicating distorted or weak sync reaching oscillator stage.

Waveform Analysis



When vertical seems to “float-by” as hold control is adjusted, best procedure to isolate trouble is by taking waveform samples at input and output of separator. Normal W2 at grid of V1 holds no clue to fault, but does eliminate K1 and front-end stages. Abnormal W4 clears oscillator of suspicion and suggests trouble in plate or screen circuit of V1—normal 70-volt W4 is down to 30 volts. W4A (7875 cps) is likewise attenuated, but still controls horizontal.

Voltage and Component Analysis

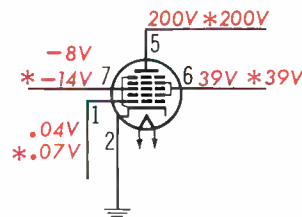

Big voltage clue—200 volts on plate accompanied by normal screen voltage—is conclusive proof that defect in plate circuit is causing this trouble. Voltages on other elements of V1 are normal, with or without a signal; tube obviously isn't cut off, and this further narrows fault to shorted R8 or open R9. In this instance, R8 decreased to 6800 ohms, increasing plate voltage close to B+ source value. Under these conditions, little gain is developed by V1, and weak sync pulses appear in output. Resistor usually shows signs of overheating.

Best Bet: VTVM for voltage and resistance measurements.

WIN

THE FABULOUS INTERNATIONAL RECTIFIER 1964 'ROUND THE WORLD CONTEST!



**CONTEST OPEN TO ALL ELECTRONIC
TECHNICIANS AND ENGINEERS
Enter As Often As You Wish!**

MEET THE FAMOUS GEISHA GIRLS OF TOKYO! SEE THE SINOUS TEMPLE DANCERS OF BANGKOK! ENJOY THE EXOTIC NIGHT LIFE OF NEW DELHI, INDIA! You are on your fun packed way around the world by Trans World Airlines, free for 28 days to enjoy the pleasures of 9 countries on 3 continents. ■ As you mingle with the friendly beauties of modern Rome, watch the Folies Bergere in Paris, and become acquainted with the legendary English Bar Maid in London, you will know that your life is richer by far for the never-to-be forgotten memories of your trip around the world. ■ So act today! Complete the entry form below and send it to International Rectifier Corporation. You may be the lucky winner who can choose between a 28 day trip around the world for 1, or a 15 day trip to Europe for 2, with full world wide accident insurance protection provided for duration of trip through Beneficial Insurance Group.



INTERNATIONAL RECTIFIER 1964 'ROUND THE WORLD CONTEST RULES:

1. Add a fourth line to the limerick: (judging will be based on pertinence of your words, rather than their literary quality)
2. Answer all questions on form and sign it.
3. Remove label or box end from any boxed I.R. product, or draw a free-hand facsimile of the I.R. trademark.
4. Send completed entry form and I.R. label, box end, or trademark facsimile to INTERNATIONAL RECTIFIER CORP., 233 Kansas Street, El Segundo, Calif.
5. Answer as often as you wish. All entries must be postmarked on or before April 30, 1964. Winner will be selected and announced by International Rectifier Corporation on May 18, 1964. All entries become the property of International Rectifier Corporation.

ACT TODAY!

1964 'ROUND THE WORLD CONTEST

INTERNATIONAL RECTIFIER CORP. / 233 Kansas Street, El Segundo, California

Add a 4th line to this limerick:

OF ALL THE REPLACEMENTS
I'VE PUT TO THE TEST,
INTERNATIONAL RECTIFIER

Date _____

(Please Print All Answers)

Name of my I.R. distributor: _____

Distributor's address: _____

City _____ State _____

My distributor salesman: _____

My name: _____

My address: _____

City _____ State _____

Additional entry forms available from all electronic distributors.



INTERNATIONAL RECTIFIER



SYNCHROGUIDES

by Allan F. Kinckiner

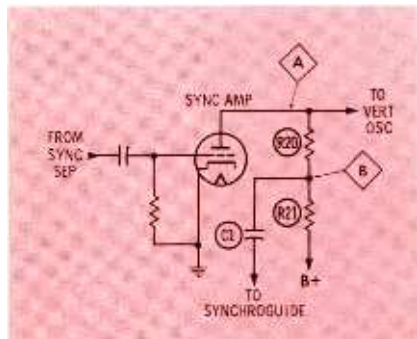

Fig. 1. Point B is waveform-divider point for checking sync amplitude for Synchroguide.

There are a number of *Synchroguide* troubles that can be classified as "tough dogs." They affect reception in various ways. In some cases, horizontal sync is intermittently lost; in between these periods, operation is just about perfect. Every serviceman has house-checked a poor-sync complaint only to find the receiver operating properly. The receiver may continue to work normally for days and sometimes weeks before the customer calls again with the same complaint. Checking these sets when they are working right will often produce no clues even though sync operation is subjected to the closest scrutiny.

In other cases horizontal sync is poor only on one of several stations. Here again, a house-check procedure, including changing of suspect tubes, will fail to reveal the cause of the trouble. In addition to sets that act up only on widely separated days, or only on certain stations, there are those sets with horizontal sync so sensitive that poor sync occurs only on certain programs.



(A) Contaminated sync



(B) Ripple didn't affect sync

Fig. 2. Scope displays of abnormal sync at output of sync separator circuit in Fig. 1.

While these conditions cannot be corrected during home service calls, the cause of the trouble can often be readily determined by scope checks. So a shop troubleshooting session using scope traces is frequently the best way to handle "tough-dog" *Synchroguide* troubles.

Sync-Signal Defects

Because many of these troubles result from defective sync signals rather than *Synchroguide*-circuit defects, the best place to start is often at the output of the sync section. In addition, it is easier to identify sync-signal distortions than it is to recognize abnormalities in the combined signal applied to the AFC-stage grid, inasmuch as this combined signal is subject to normal variations in different receivers.

For efficient operation, the *Synchroguide* requires that sync signals have the following characteristics: (1) Amplitude—ranging between 15 and 25 volts, (2) Shape—narrow pulse with steep leading edge, (3) Polarity—pulse must be positive-going. All of these requirements are easily obtained from a two-stage sync section, and the majority of receivers using *Synchroguide* contain at least two stages of sync. Since two-stage sync sections usually supply 30 or more volts of sync amplitude, a voltage divider is generally incorporated at the output to reduce the sync to 15 volts or so. The circuit in Fig. 1 is typical of final sync stages in *Synchroguide* receivers. The voltage divider consists of R20 and R21, and C1 couples sync pulses to the *Synchroguide*.

For examining the sync signal, it is recommended that the first scope observation be made at the plate of the sync output (point A of Fig. 1), since any distortion is more obvious here than at the takeoff point (point B of Fig. 1). It is also recommended that the scope sweep be set at one-half the vertical frequency rather than the horizontal frequency. There are two reasons for these recom-

mendations: First, the amplitude at point A is often supplied on schematics, while that at point B is not. Second, any video contamination of the sync signal (as shown in Fig. 2A), becomes obvious when such a signal is displayed at a vertical-frequency sweep. Not only is the same distortion harder to see if the signal is displayed at a horizontal rate, but video contamination in the sync brings about another problem. If a defect is present that is capable of producing video signals in the sync, the front pedestal preceding the horizontal sync pulse will ride up in the sync. This front pedestal distorts the leading edge of the horizontal sync pulse. Since scope sweep locks on leading edges of viewed signals, the distorted sync pulses cause jitter in the scope trace.

Unlike some other horizontal AFC circuits, the *Synchroguide* is not critically affected by amplitude



(A) Symptom appearance



(B) Vertical sync signal



(C) Horizontal sync signal



(D) Waveform B after servicing



(E) Waveform C after servicing

Fig. 3. Picture instability resulting from modification when changing to a larger CRT.

variations between adjacent horizontal sync pulses. In one Philco using *Synchroguide* AFC, a defective filter resulted in the ripple on the sync output shown in Fig. 2B. Strangely enough, this large ripple did not affect horizontal deflection or synchronization in any way. If, however, the low-amplitude points in the ripple had dipped below a critical value, jitter and poor sync would have resulted. The distortion so apparent in Fig. 2B could not be detected when the same signal was displayed at a horizontal viewing rate.

The Third Signal

The picture presented in Fig. 3A was taken from one of the first Muntz receivers using a rectangular picture tube. The set had a peculiar horizontal jitter and irregular twists to vertical lines (the picture is shown deliberately out of phase so you can see the raggedness of the raster edges). Because the condition looked like a contaminated-sync defect, I checked the sync at point A in Fig. 1 and was surprised to find the signal there was perfectly normal. Next, I checked at point B of Fig. 1 and got the trace shown in Fig. 3B. The amplitude was slightly less than it should have been, but the hash in the horizontal portions between the vertical sync pulses was the most disconcerting factor. Viewing this same signal at a sweep rate of 7875 cps revealed the badly distorted horizontal sync pulses shown in Fig. 3C.

Checking the schematic revealed

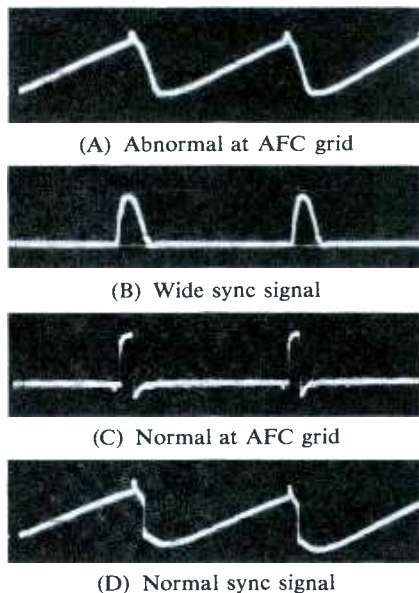

Fig. 5. Waveforms in circuit with defective resistor in the horizontal separator.

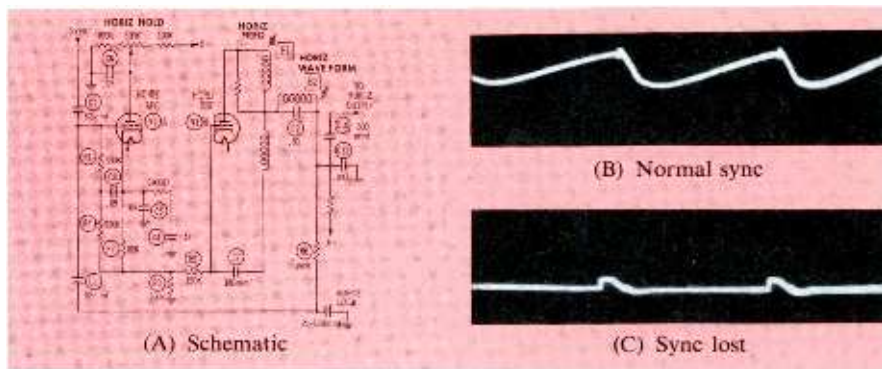

Fig. 4. Combined sync-sample signal in receiver with very erratic horizontal sync.

that the *Synchroguide* in this set used three signals instead of two on the AFC grid. Disconnecting the third signal (a sawtooth obtained by integrating a negative pulse from the flyback-yoke circuit) removed the raster defects and also resulted in more normal traces. The trace in Fig. 3B became the one shown in Fig. 3D, and the trace in Fig. 3C became the one in Fig. 3E.

The conditions shown in Fig. 3 have been encountered numerous times in receivers converted for the use of larger picture tubes, but not very often in sets conforming to the manufacturer's original design. Any time a serviceman is confronted with horizontal jitter that defies correction, he should check to see if the design uses a third AFC signal. When it does, temporarily remove this third signal. Quite often in such cases better horizontal stability will result.

Checking the Combined Signal

Troubleshooting by observing the combined sync and sample signal at the AFC grid with an oscilloscope is frequently the quickest way to pinpoint specific defects. In one Tele-tone receiver—Fig. 4A—horizontal sync was erratic and intermittent. With the scope lead attached to the AFC grid, it was noted that every time trouble occurred, the waveform in Fig. 4B changed to the one shown in Fig. 4C. The loss of sample signal in Fig. 4C could only result from two possible causes: opening of the sample-signal resistor or capacitor or shorting of the locking-range trimmer. The latter was proved to be the case, and replacement of the locking trimmer restored normal operation.

In sets where a locking-range trimmer is used, the scope can be used to set the trimmer for best

operation. First, observe the sync at the input end of the coupling capacitor (C1 in Fig. 4A), and note the amplitude. Next, attach the scope to the AFC grid and adjust the locking-range trimmer so that the combined waveform has twice the amplitude of the trace previously observed. This should result in *Synchroguide* operation compatible with standards prescribed in service literature.

Less apparent defects can also be picked out easily by checking the combined signal with a scope, but only if the technician is familiar with normal waveform departures among different receivers. For example, the sync pulse retains its shape in the combined signal in many sets. In other receivers, the shape of the sync pulse is lost, and the only indication of its presence in the waveform is the slight pip seen atop the sawtooth in Fig. 4B.

In an RCA KCS81 with extremely critical horizontal hold, the combined sync and sample signal appeared as in Fig. 5A. Note the long fall time or slope of the retrace. The scope probe was next applied at the takeoff point in the horizontal sync-amplifier circuit, resulting in the trace of Fig. 5B; this trace shows an excessively wide horizontal sync

• Please turn to page 66

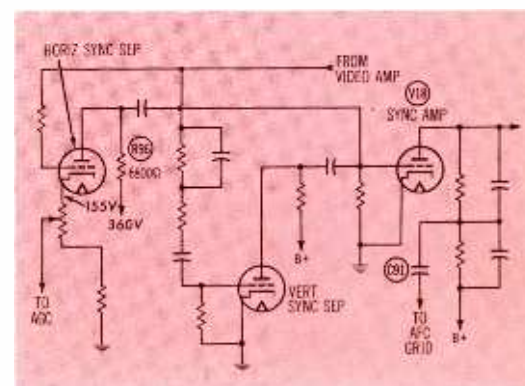

Fig. 6. Portion of sync circuits in receiver from which waveforms in Fig. 5 were taken.



The large garage area depicted in this photo facilitates the booming volume of drive-in repairs. This garage area will hold as many as six cars, and a rear lot accommodates six others. Gene mentioned that quite often all twelve spots are full.

Meet Gene Fortune, working owner of Skinner Radio and Television Inc. in Indianapolis, Indiana. Gene has been in the auto-radio repair business since his discharge from the Navy in 1945. Skinner Radio first opened its doors in 1934; and Gene purchased and incorporated the business in 1956. From the onset, auto radio has been the company's prime target.



meet an

Being an auto radio specialist involves more than generally meets the eye! We found this to be very true when we visited the owner of a thriving auto-



Here's the other end of the equipment Bob was using in the trunk. Similar power-extension setups are located at convenient points throughout the garage. The handle of the trouble light also has AC receptacles for quick power-tool connections. Equipment such as this must be right at hand for this type of service operation. Speed is important!



Talk about warranty work—take a look at this stack of radios in for repair! Gene does repair work for at least 43 new-car dealerships. We wondered where he found time to repair so many of these carried-in sets, when he averages 35 to 40 drive-in jobs every day. The answer: two nights a week they work till nine, and they make good use of any other time when drive-in business slacks.

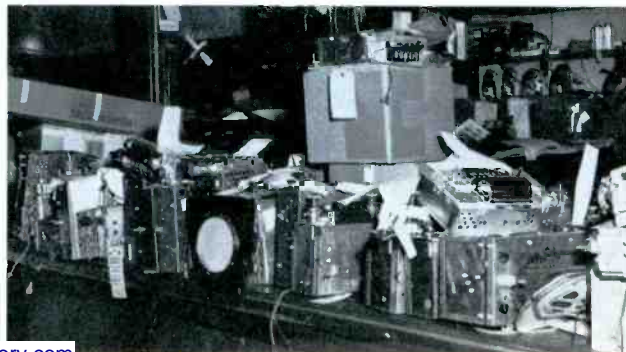



The technician in this photo is preparing to mount a reverberation unit in the trunk compartment of a new car. Notice the drill and trouble light; they are always within easy reach, as you'll see presently. Asked how reverberation-unit sales were going, Gene informed us requests came in groups—several in one day, then maybe a week until the next one.



Shown at this special auto-radio repair bench is Bob Shepherd, one of three full-time technicians in addition to the owner (who also does servicing on a full-time basis). The bench has all of the test equipment needed to troubleshoot auto radios.

Auto-Radio Specialist

radio repair business and asked him several questions: How many auto radios does an expert repair in a day? What about warranty work? We found

answers to these and other questions as we talked with this specialist, and saw how he handles his fast-growing service business.



This is one of the two stock rooms, where new radios are waiting for installation. Skinner's is the central warehouse in this area for auto radios manufactured by Automatic. In addition, Gene is an authorized dealer for Motorola and several other auto-radio manufacturers. Gene also repairs other auto accessories, such as alternators, electronic light dimmers, etc.



A special area is set aside for television, radio, and phonograph servicing. Two additional technicians are employed in this activity, and one of them specializes in the installation and repair of garage-door openers. The office personnel consist of Gene's wife—Jean Fortune—and one other employee.

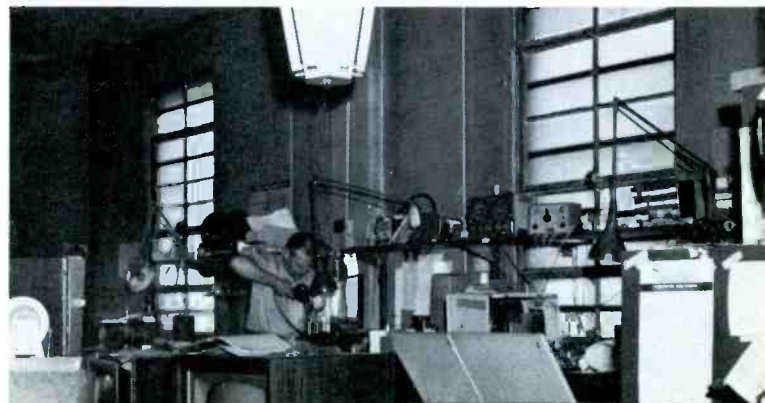

Fixed capacitors are used in large numbers in modern electronic equipment, and often outlast the equipment unless something goes wrong in the circuit. They play an essential role in spite of their basic simplicity.

Much has been written about high-capacitance units, both large- and small-sized, used principally in power supply filters. But relatively little attention is paid to the more numerous capacitors of the so-called "micromike" variety, having capacitance between .5 mmf and .01 mfd.

You may occasionally see the term picofarad (pf) in electronic literature and schematics; it is equiv-

SIZES, FUNCTIONS, AND FACTS

ABOUT SMALL-VALUE CAPACITORS

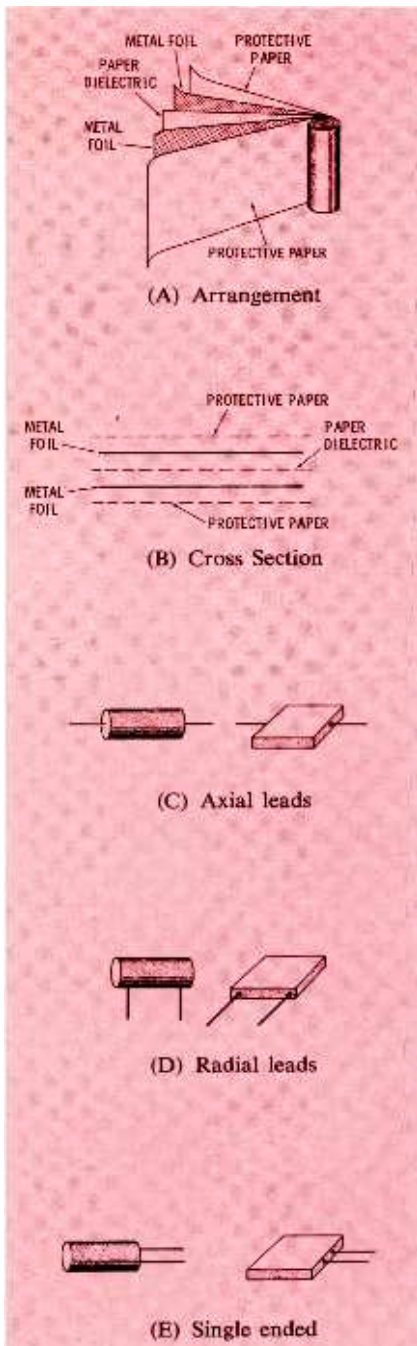

Fig. 1. Paper capacitors are made in tubular shape but can be potted in rectangular case.

alent to micromicrofarad (mmf). This expression is gradually being adopted as the preferred term for most military and industrial electronics, and will soon be commonly used in TV schematic notation.

These capacitors are used for AF and RF bypass and coupling, tank circuit tuning, oscillator padding, audio tone control, industrial timing, flip-flop speedup, high-frequency filtering, vibrator buffering, and in countless other applications. Common capacitor types are paper, metallized paper, plastic film, foil-type mica, silvered mica, glass, and ceramic.

Paper Tubular

Tubular configuration is one of the oldest arrangements employed in capacitor construction. Fig. 1 shows the essential details. The capacitor is made from two strips of aluminum foil separated by a strip of paper (Figs. 1A and 1B). For protection, an additional strip of paper is placed over the outside of each foil. This sandwich is rolled up and a pigtail attached to each foil. The completed capacitor assembly is enclosed in a cylinder or tube of paper, plastic, or metal, or is pressed flat and enclosed in a rectangular case and impregnated with wax or oil (Figs. 1C, 1D, 1E).

A few low-capacitance units of this type are obtainable, but typically their values are close to .1 mfd. Capacitance tolerance is usually $\pm 10\%$ or $\pm 20\%$. Temperature characteristics are poor, compared to those of other capacitors, since heating can cause a shift in the

separation between foils. (Paper tubulars in TV sets often leak their wax coating.) Common DC voltage ratings are obtainable (with still lower values). Power factor is comparatively high; Q is low. Because this capacitor is rolled, it has higher inductance than other types; therefore it has a lower self-resonant frequency, but special noninductive types are available in some values.

The foil-type paper tubular is used only for noncritical coupling and bypassing, where temperature variations and size is inconsequential and low cost is important. Because of its low Q and erratic temperature characteristics, the foil-paper type is not used in tuned circuits where selectivity and frequency stability are major factors.

Metallized Paper

The metallized paper capacitor is similar to the paper tubular just described, except that its plates are made by depositing a metal film in a special pattern on each side of the thin paper strip used as a dielectric. In this way, the plates are tightly bonded to the dielectric to a degree not possible with foil plates. The resulting metal-paper-metal sandwich is provided with pigtails, insulated, rolled up, and encased like the tubular in Fig. 1.

This type of capacitor is supplied over a wide capacitance range. Microminiature units in the low-capacitance range (500 mmf to .01 mfd at $\pm 25\%$) are available, rated at DC working voltages of 200, 400, and 600 volts. Power factor is less than 1% at 1000 cps, and the oper-

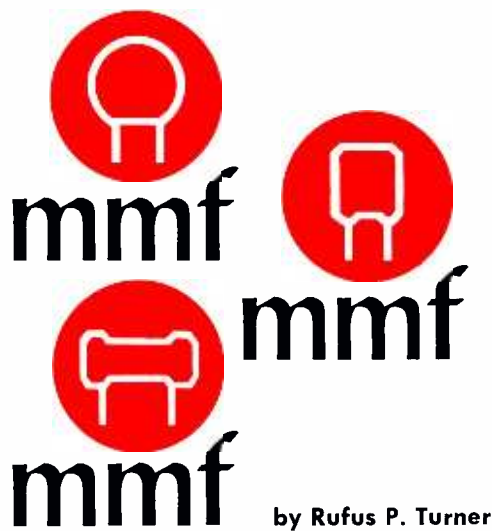

ating temperature range is -55°C to $+100^{\circ}\text{C}$.

The metallized paper tubular is smaller in size than a foil-type unit of the same capacitance and voltage rating. It is used in coupling and bypassing where important considerations are reduced size, improved temperature characteristics, long-term capacitance stability, and ability to heal itself after momentary breakdowns. This type is useful also in wavefilters (high-pass, low-pass, bandpass, and band rejection). Its Q is not high enough, however, to recommend its use in highly selective tank circuits.

Plastic Film

If a metal film is deposited on each side of a plastic film dielectric and this combination is finished and packaged like one of the metallized paper types, the result is called a plastic film capacitor. Various plastic materials are used for the dielectric, some of them being polystyrene, Mylar, Teflon, and Cellophane.

Mylar, Cellophane, and Teflon types are found almost totally in the high-capacitance range, hence will be ignored here. However, there is at least one example of a low-capacitance series of polystyrene capacitor; the range is 20 mmf to .01 mfd at $\pm 5\%$ tolerance (special tolerances of $\pm 2\%$, $\pm 1\%$, $\pm \frac{1}{2}\%$, and $\pm \frac{1}{4}\%$ are obtainable). Rated DC operating voltage is 500 volts; minimum Q is 2000 at 1 mc; power factor is .02% at 1000 cps; and negative temperature coefficient approaches 200 parts per million per $^{\circ}\text{C}$.

The polystyrene capacitor is used in critical applications, where size is unimportant, but wide operating temperature range, good temperature coefficient, high leakage resistance, and high Q are essential. Such applications include computer circuit coupling, commutation, and bypassing; RF tank circuit tuning; wavefilter frequency setting; industrial timing; and laboratory capacitance standards.

Foil-type Mica

The mica capacitor is the oldest of the high-performance types. In its simplest form, it consists of two aluminum foil plates separated by a thin wafer of mica (see Fig. 2A), but this simple arrangement is used only in very-low-capacitance units. In order to obtain higher capacitance, most of these capacitors contain several alternate layers of foil and mica (with the foil connected to pigtails), stacked as shown in Fig. 2B. This is equivalent to connecting several simple two-plate units in parallel. Pigtails are attached to the capacitor assembly and the latter is molded in plastic or enclosed in a container (Fig. 2C, 2D). In some commonly used styles, the capacitor element is simply dipped in a protective plastic. In most cases, the mica capacitor is smaller-sized than an equivalent paper or plastic type (the dielectric constant of mica is more than three times that of paper).

Mica capacitors are supplied in the capacitance range of 1 mmf to .01 mfd at $\pm 5\%$ tolerance for 10 mmf and higher and $\pm 10\%$ below 10 mmf. Special units are available with closer tolerances. Receiver-type units are rated at 500 volts DC; transmitter types are rated up to several kilovolts. Minimum Q varies from 150 at 5 mmf to more than 1500 at 500 mmf.

The electrical, temperature, and size characteristics of the mica capacitor suit it to many applications. Because it is not rolled, the mica capacitor has low internal inductance and therefore a very high self-resonant frequency. It has the disadvantage that, in its higher values, it costs more than other capacitors of similar ratings.

Silvered Mica

Just as the paper capacitor may

be improved by metallizing a paper film instead of using foil plates, the mica capacitor may be improved by metallizing the mica wafer and discarding the foil plates. In this way, variations in plate spacing from temperature or aging are minimized, because the plate is tightly bonded to the mica. The metallizing process consists of painting and firing a silver paste on the mica face, or electrodepositing the silver. A single silvered-mica wafer provides a simple two-plate capacitor similar to Fig. 2A, but for higher capacitance several silvered wafers may be stacked and alternately connected to pigtails, as in Fig. 2B. For very low internal inductance (to use in UHF circuits), some silvered-mica capacitors employ round discs of mica and are assembled in small metal

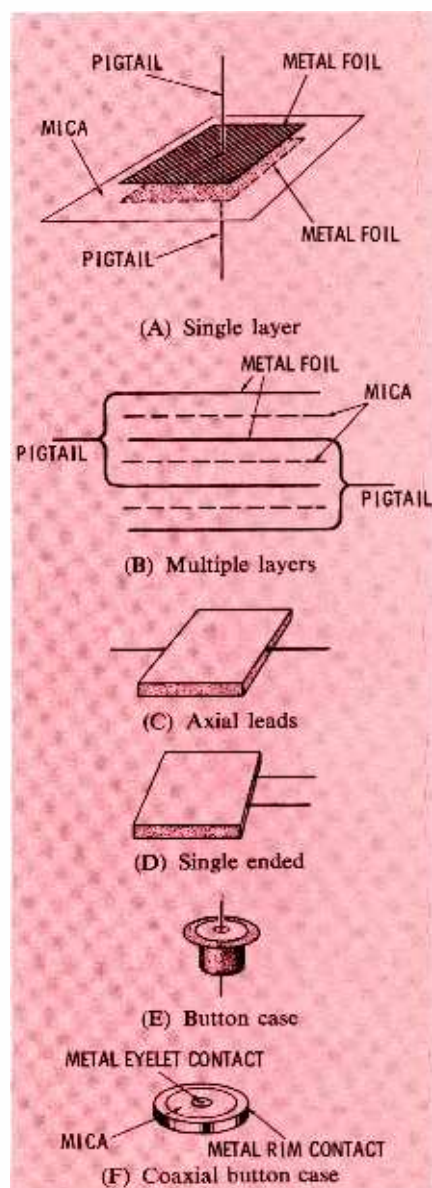

Fig. 2. The high-performance mica capacitor is available in a variety of configurations.

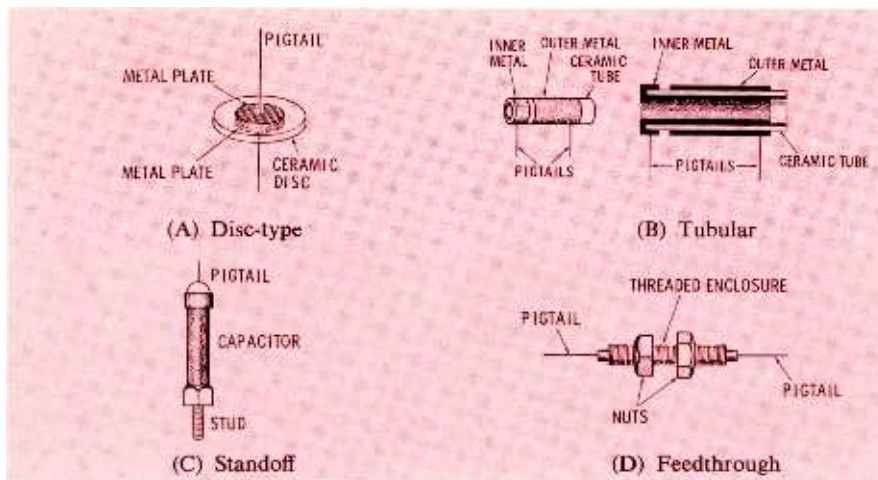

Fig. 3. Its high dielectric constant makes the ceramic capacitor a good space saver.

cases (Fig. 2E) or as "coaxial" buttons (Fig. 2F).

The major ratings of silvered-mica capacitors are similar to those of foil-type micas. However, temperature coefficient is greatly improved, ranging from -20 to $+100$ parts per million per $^{\circ}\text{C}$, depending upon type and capacitance. Receiver types are commonly rated at DC operating voltages of 300 or 500 volts, but they are available up to several thousand volts. The Q may be several thousand.

Silvered-mica capacitors are used in very critical circuits, especially at high radio frequencies, where important considerations are low inductance, high leakage resistance, high Q, capacitance stability with temperature and aging, and small size. In receivers, transmitters, and test instruments, special close-tolerance silvered-mica capacitors are employed in stable oscillators. Close-tolerance units are used also as laboratory standards and are found in capacitance, inductance, and impedance bridges.

Glass

The glass capacitor is similar in construction to the silvered-mica capacitor, the difference being that the dielectric is a thin glass wafer, each face of which is metallized to form the electrode plates, and the capacitor assembly is molded in glass to provide a fused, completely sealed structure.

Capacitances are supplied in the range .5 mmf to .01 mfd at $\pm 5\%$ tolerances. DC working voltage is 300 or 500 volts, and power factor is .1% at 1000 cps.

The glass capacitor is the only type made entirely of inorganic materials.

Because of its high Q, extremely high leakage resistance, and good temperature characteristics, it may be used in all critical applications where its capacitance and voltage ratings are adequate. Possible disadvantages are the high cost of this capacitor and its susceptibility to breakage.

Ceramic

Ceramic provides the highest capacitor values—size-for-size—of the low-capacitance types. This capacitance-to-size ratio results from the high dielectric constant (K) of the ceramic material (commonly titanium dioxide or barium titanate). It is not unusual to find a 1000-mmf ceramic capacitor no larger than a 2-mmf unit of some other type.

The principal configurations of the ceramic capacitor are shown in Fig. 3. In the disc type (Fig. 3A), a metal plate is deposited on each face of a thin ceramic disc by painting and firing or by electro-deposition, and a pigtail is attached to each plate. In a similar construction (flat-plate type), a thin rectangular ceramic wafer is used. In the tubular type (Fig. 3B), the inside and outside of a thin ceramic cylinder or tube is metallized to form an inner and outer plate, and a pigtail is attached to each. The capacitor structure is completed by protective painting, dipping, molding, or encapsulating.

Sometimes, to insure low inductance and to provide a straight conduction path, the capacitor is enclosed in a special housing, such as the standoff type (Fig. 3C) or feedthrough type (Fig. 3D). Dual assemblies are available containing two capacitor elements.

Depending upon type and voltage rating, capacitances are supplied from .5 mmf to .05 mfd. Common DC working voltages are: 500, 600, and 1000 volts for general-purpose ceramics; 3000 volts or more for high-voltage units; and 3, 10, 20, 30, 50, 75, 100, and 150 volts for low-voltage types, such as those intended for transistor circuits.

One special ceramic capacitor is the temperature-compensating type. This type may be obtained with either positive or negative temperature coefficient. The drift of a conventional capacitor may be reduced to zero by operating it in a circuit with a temperature-compensating unit having the same drift in the opposite direction. Or, the drift may be set at any desired specific amount by proper selection of a compensating capacitor. Zero-temperature-coefficient ceramics also are available and are replacing silvered micas in critical applications.

Because of their small size for a given capacitance, ceramic capacitors often replace all other low-capacitance types in miniature equipment. An important disadvantage is the readiness with which the brittle ceramic material may be chipped or broken if the capacitor is of the uncased type.

Selecting the Correct Unit

It is often said that a defective capacitor should be replaced with one of the same type or better. Often, however, the cost and size of a better replacement must govern whether or not it is chosen. With this in mind, it is interesting to note the difference in price of capacitors of various types.

It is difficult to compare prices meaningfully "across the board," since price differences between types vary in different capacitance groups and between various capacitor styles. Nevertheless, some notion may be gained from the following comparison of prices of a .005-mfd, 500-volt capacitor in various types:

TYPE	COST (\$)
Paper	.15
Metallized Paper	.27
Polystyrene	.21
Mylar	.15
Mica	.42
Silvered Mica	.99
Glass	2.89
Ceramic Disc	.15

CTC 15 Color TV Chassis gives brighter, sharper picture; has greater reliability; is easier to service... than any previous RCA Victor Color TV Chassis!

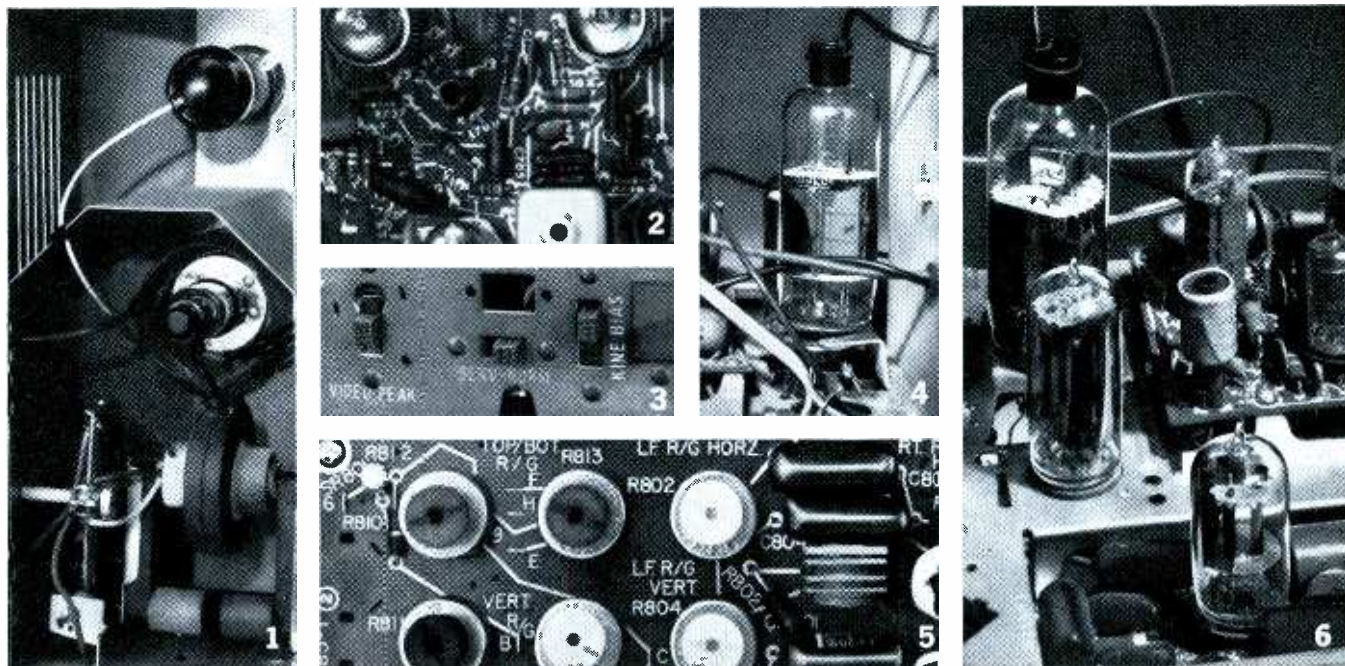

RCA Victor's new CTC 15 chassis keeps all the performance-proved virtues of the CTC 12 . . . but adds these engineering improvements that should please both you and your customers:

The picture is brighter, better. It's brighter because a new design in the high voltage section (1) gives 30% more current output at the same voltage. The picture tube circuits are designed for effective use of this higher power.

It's sharper because the picture tube screen voltages have been boosted . . . giving a smaller, sharper dot pattern with less blooming. The video amplifier has better phase response.

It's steadier because of substantially improved vertical hold circuits.

A new picture "tone control" . . . it's a video peaking switch (3) . . . offers three choices of picture quality: soft, normal and sharp. When snow and ghosts are your problem, use the soft setting for a smoother, more pleasing picture. When the signal is better, make the most of it with the normal or sharp setting.

Less color fringing results from a new clamp diode in the convergence circuit and rearranged controls are easier to use.

And UHF reception is improved by new circuitry that reduces snivets . . . those black vertical lines near the center of the picture.

Greater reliability . . . longer component life. Heat buildup has been reduced by housing the flyback transformer and the regulator tube in separate compartments.

The horizontal output tube (4) is placed on a raised "cooling shelf" outside the H.V. compartment. Its position allows free flow of air around its base. Three conventional tubes have been replaced by novars (6). They run cooler and last longer. One of them is the hardest working tube in the set—the horizontal output tube.

And dark heater tubes are used in all high-performance circuits.

To further increase life, the focus rectifier is now specially designed for additional life expectancy.

Easier servicing. Circuit tracing is easier and faster . . . the new schematic solid-line roadmaps (2) go point-to-point, and component labels are larger.

It's easier to service the high voltage

compartment . . . it has a hinged cover and better arrangement.

Color setup has been simplified by the addition of a conveniently placed 3-position bias switch (3) which accommodates wide variations of picture-tube characteristics.

RG controls (5) on the convergence board have also been rearranged for your convenience. Now you use the entire top row to make adjustments according to the horizontal lines in a crosshatch pattern; the entire second row is for the vertical lines.

Color TV is the technician's big bread and butter business . . . for years to come. We stand ready to help in every possible way to make this fast-growing business a profitable one for technicians—and for dealers as well.

See Walt Disney's "Wonderful World of Color," Sundays, NBC-TV Network.



The Most Trusted Name
in Television

Tmk(s)©

Cheerful Charlie

foils the DIY'S

Service-Shop humor . . . with a wise moral

by Charles F. Lieder



I've noticed that many servicemen have a cynical attitude toward the ambitious "do-it-yourselfers" (DIY's) who attempt to repair their own television sets. For my part, I rather like them; particularly the ones who manage to damage a few parts and put a little more cash in my register.

I suppose, too, I can understand their motives as I happen to be a DIY from 'way back, myself. When a board comes off the house I built, I nail it back on. If the faucet leaks, I repair it. When it still leaks, then I call a plumber. The only thing I'm reluctant to work on is my own TV, but my wife insists.

I usually encourage people to tell me their TV troubles and ask my advice. I inform them about such things as being sure the set is plugged in, power cord is not broken, antenna lead is not pulled loose, how to adjust controls, etc.

Some people know very little about these things. One of them phoned my home late the other evening. It seemed the switch on his set had jammed and he couldn't shut it off. He got excited and phoned for me. Since I wasn't home, my wife had taken the call.

"Tell Charlie to come as soon as he gets home!" the man implored her. "I can't leave it run and I want to go to bed!"

"Can't you pull the plug from the wall outlet and stop it?" my wife asked.

"No, no! I tried that and it still runs!" he answered.

"It has to stop," my wife insisted.

"It just doesn't!" he exclaimed.

My wife was very puzzled. She knew that television sets had to be connected to the line in order to operate. But she'd begun to wonder if I'd been keeping something from her.

A little later, another phone call erased her doubts. The man explained balefully that he had pulled the antenna lead loose instead of the power cord. After talking with her, he'd looked again and seen his mistake. He had the set stopped.

Leave the Back On?

I do warn the DIY's against tampering with the "innards" of their TV's. But if I warn a DIY not to poke his fingers around the high voltage section while the set is running, and he does it anyhow—well, after all, it's his TV!

Many DIY's have learned to read the tube charts on their TV sets. They can take the tubes out and put them back in the right sockets most of the time; but that's all they know about it. They're all eager to get advice and this is where I beat the self-service tester in the drug store. I give advice besides selling tubes—something the tester can't do. As a result, I even sell tubes to the druggist.

Generally my pet DIY's will come in time and again, with a couple of tubes for me to test. This is always their first step. The tubes will have been pulled at random from the set with no regard of trouble symptoms. Only a few tubes will be brought in at a time. I'm told this is done to avoid getting them mixed up. If the tubes they've pulled test good (as they usually do) the DIY will bring a couple more. After a few trips he gives up, and does what I suggest; he brings the set in.

Dean was a hard man to convince on this score. He had a good general ability to do things for himself and a great belief that he could fix anything.

He came into the shop one morning, held out a dark-looking 6BN6

and announced, "I need a new tube like this. I've got good sound, but the picture is blacked out. The little light comes on in the back of the picture tube so that's okay, but this tube is burned out."

"Perhaps I'd better test it," I suggested.

"No, just give me a new one. I know this one is shot."

I sold him a new tube and he left. He lived some distance from town, so I turned my attention to another job while I waited for him to come back.

This time he brought in several tubes. I could see they were from the tuner and IF stages.

"Better test these," he said. "that one didn't make any difference."

I don't know how, but I kept quiet and just tested the tubes. The 6BK7 was quite weak, so he bought a new one and departed. A short time later he was back again.

"I need a 6U8 and 12AX7," he said.

"Didn't you bring the old ones?" I asked.

"Well, when I was putting the tubes back, one of them popped out of my fingers, hit another one, and they both broke," he confessed.

I got him two more tubes, but I was getting writer's cramp from making out sales slips.

"This time you may be able to zero in on the neck of the picture tube," I told him, "and it's fairly fragile. When you break it, jump back quickly because that glass can really fly!"

Dean looked startled, but left without a word. In a little longer than his average time, he was back again. His TV was in the car.

We carried it in. When I found the burned out fuse and replaced it, the set was back in action. No other trouble showed up. Dean was quite

SENCORE

SIMPLIFIES COLOR SERVICING

NEW! CA122

COLOR CIRCUIT ANALYZER

A simple approach to a complex problem

Here is an instrument that is designed to eliminate the guesswork in color TV servicing. A complete analyzer that provides all required test patterns and signals for testing from the tuner to the tri-color tube. Additional analyzing signals for injection at each stage including audio, video and sync, brings to life a truly portable and practical TV analyzer for on the spot service; virtually obsoleting other analyzers with the advent of color. Sencore's simplified approach requires no knowledge of I, Q, R-Y, B-Y, G-Y or other hard to remember formulas. The CA122 generates every signal normally received from the TV station plus convergence and color test patterns.

The CA122 offers more for less money:

TEN STANDARD COLOR BARS: The type and phase that is fast becoming the standard of the industry. Crystal controlled keyed bars, (RCA type) as explained in most service literature, offer a complete gamut of colors for every color circuit test.

WHITE DOTS: New stabilized dots, a must for convergence, are created by new Sencore counting circuits.

CROSS HATCH PATTERN: A basic requirement for fast CRT convergence.

VERTICAL AND HORIZONTAL BARS: An added feature to speed up convergence, not found on many other color generators.

SHADING BARS: Determines the ability of the video amplifier to produce shades (Y Signal) and to make color temperature adjustments. An important feature missing on other generators.

COLOR GUN INTERRUPTOR: For fast purity and convergence checks without upsetting color controls. Insures proper operation of tri-color guns, preventing wasted time in trouble shooting circuits when CRT is at fault.



A must for color . . .

a money maker for black and white TV servicing

ANALYZING SIGNALS: RF and IF signals modulated with any of the above patterns for injection into grid circuits from antenna to detector. IF attenuator is pre-set for minimum signal for each IF stage to produce pattern on CRT thus providing a check on individual stage gain. Sync and video, plus or minus from 0 to 30 volts peak to peak, have separate peak to peak calibrated controls for quick checks on all video and sync circuits. Crystal controlled 4.5 mc and 900 cycles audio simplify trouble shooting of audio circuits.

NEW ILLUMINATED PATTERN INDICATOR: A Sencore first, offering a rotating color film that exhibits the actual color patterns as they appear on color TV receivers. Locks in with pattern selector control.

You'll pay more for other color generators only.

Dealer Net. 187.50

NEW! PS120 PROFESSIONAL WIDE BAND OSCILLOSCOPE

A portable wide band 3 inch oscilloscope for fast, on-the-spot testing. An all new simplified design brings new meaning to the word portability . . . it's as easy to operate and carry as a VTVM. Though compact in size, the PS120 is powerful in performance: Vertical amplifier frequency response of 4 MC flat, only 3 DB down at 7.5 MC and usable to 12 MC, equips the technician for every color servicing job and the engineer with a scope for field and production line testing. AC coupled, with a low frequency response of 20 cycles insure accurate low frequency measurements without vertical bounce. Sensitive single band vertical amplifier; sensitivity of .035 volts RMS for one inch deflection saves band switching and guessing. Horizontal sweep frequency range of 15 cycles to 150 KC and sync range from 15 cycles to 8 MC (usable to 12 MC) results in positive "locking" on all signals. New exclusive Sencore features are direct reading peak-to-peak volts —no interpretation; dual controls to simplify tuning; lead compartment to conceal test leads, jacks and seldom used switches. Rear tilt adjustment angles scope "just right" for easy viewing on bench or production line.

Size: 7" w x 9" h x 11 1/4" d. Weight: 12 lbs.

Dealer Net. 124.50
(with low cap. probe)

Kit. 74.50



A must for servicing color TV in the home . . . lowest priced broad band scope. All hand wired — all American made

disgusted, but he was finally convinced that TV repair was out of his line.

DIY Symptoms

There are also times when DIY's can do things to a TV to create symptoms that no self-respecting TV would have of its own accord. These are probably very rare symptoms, taking almost sheer genius to accomplish, but to a genuine DIY nothing is impossible.

For an ordinary technician to undo what the successful DIY has

managed to do can cause plenty of headaches. The bald spot on *my* head was not caused by dandruff.

In one particular case I found a set on the bench when I came back from a round of service calls. No complaint was listed and my wife informed me that the gent who left it just said it didn't work as it should. He was so right!

When I turned it on, it had lovely symptoms. One was a loud buzz that changed in pitch when I rotated the vertical hold. The picture had good contrast, and was stable

and well defined, but bright vertical retrace lines were superimposed on it. Adjusting the contrast control changed the lines very little, but did affect the contrast normally. I could black the lines out only by turning the brightness down.

At first, I suspected the CRT. This checked good. The next culprit could possibly be a filter capacitor. The vertical buzz in the sound seemed to indicate this. I checked the tubes in the vertical circuit first though, just in case; they tested all right.

The next thing I did was get into the set with my scope. I found no unusual waveforms at the terminals of the electrolytic capacitors. I checked the blanking signal at the grid of the CRT; it was there and in good shape.

I had noticed that several of the molded capacitors and several resistors were new. Many of the solder joints were new and shiny. It was evident that this set had been worked over already. The work seemed to be done well, so I suspected it had been in a shop very recently. I began to think perhaps this was one of those sets with fleas.

The vertical circuit was checked out next. The waveforms at key points looked normal. I checked further. At the plate of the video amplifier the vertical pulses showed up. Tracing backward, I found them also at the grid and at the detector output. Evidently they were getting into some IF stage. Checking through these to the AGC circuit disclosed a prominent vertical pulse which didn't belong there. Still, a voltage check of the AGC showed normal action. Whew!

The signs indicating that the set had just been worked on led me to start a terminal-to-terminal check

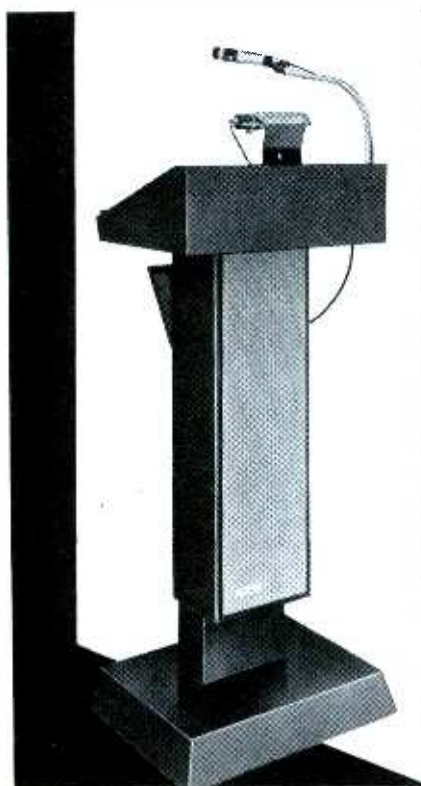

**why
compromise?
the AMPLI-VOX
sound
column
lectern
meets all
your needs!**

You don't have to weigh sound system features vs. lectern features vs. budget—and end up with a compromise.

Here's a deluxe lectern which includes a complete high volume sound system—available for only \$299! It's powerful enough for enormous auditoriums, versatile enough for every public address requirement, and it's battery operated, so *anyone* can use it *anywhere*. Check the features; compare them with any other equipment at any price; then write for complete data, source information, and/or a no-obligation demonstration.

Lectern Features

- Fingertip height adjustment over 10 inch range
- Instant set-up, immediate performance
- Sturdily constructed of heavy-duty wood covered with scuff-proof Texolite in rich looking black ostrich grain
- Retractable wheels let you *roll it* from place to place
- Weighs only 40 pounds
- Completely self-contained

Sound System Features

- 25 watt all-transistor amplifier (40 watt peak)
- Six built-in speakers in integrated sound column, for wide penetrating coverage
- Powered by flashlight batteries! No plug-in; no engineer or maintenance man required. AC adapter available
- High quality cardioid microphone
- 2 inputs, 2 outputs
- Adapts for audience participation

AMPLI-VOX AUDIO PRODUCTS

Manufactured in USA by

PERMA-POWER COMPANY

Circle 14 on literature card

5740 NORTH TRIPP AVENUE

CHICAGO, ILLINOIS 60646

PHONE: 539-7171 (AREA CODE 312)

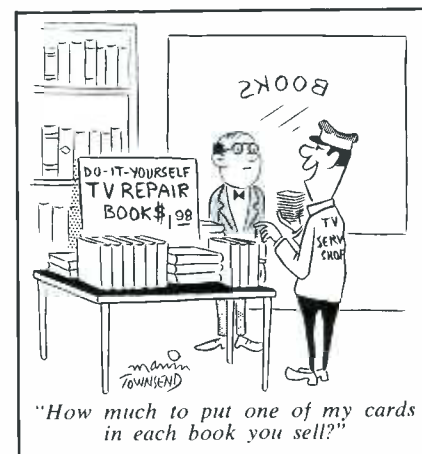

Can you afford to guess

AT SWEEP, SYNC OR HIGH VOLTAGE TROUBLES?

WHEN IT'S SO EASY TO WALK THE TROUBLE RIGHT OUT OF THESE TIME CONSUMING CIRCUITS..... STEP BY STEP.....



SYNC. CIR. & H. SYNC. DISCRIM.

VERT. OSC.

VERT. OUTPUT

VERT. OUTPUT XFORMER

VERT. DEFLEC. YOKE

HORIZ. OSC.

HORIZ. OUTPUT

HORIZ. FLYBACK XFORMER

2nd ANODE VOLTAGE CIRCUIT

HORIZ. DEFLEC. YOKE



NEW, IMPROVED SENCORE SWEEP CIRCUIT ANALYZER MODEL SS117

How many times do you ask, "Why do I take so long finding that sweep trouble?" How often have you wondered whether weak horizontal sync was caused by defective sync circuit, horizontal oscillator, or sync discriminator? Can you quickly isolate inadequate width or low 2nd anode voltage to the oscillator, output, flyback transformer, or yoke? How many times have you changed a good yoke by mistake?

The SS117 will pinpoint troubles like these in minutes with tried and proven signal injection, plus yoke substitution for dynamic in-circuit tests. Error proof push button testing enables you to make all tests from the top of the chassis without removal from cabinet for maximum speed and profit on every job.

Here are the checks the SS117 makes . . .

- Horizontal Oscillator: Checked by substituting 15,750 variable output universal oscillator from SS117. Signal can be injected at any spot from horizontal output grid to horizontal oscillator to determine defective component.
- Horizontal Output Stage: Checked by reliable cathode current and screen voltage checks made with adapter socket and two push buttons.
- Horizontal Output Transformer: Checked for power transfer in circuit and read as good or bad on meter.
- Horizontal Deflection Yoke: Checked by direct substitution with adjustable universal yoke on SS117.

- Vertical Oscillator: Checked by substituting 60 cycle synchronized oscillator.
- Vertical Output Transformer: By simple signal injection for full height on picture tube.
- Vertical Deflection Yoke: By signal substitution for full height on picture tube.
- Sync Stages: Checked by synchronizing triggered horizontal SS117 oscillator from any stage. If oscillator synchronizes, sync is O.K.
- 2nd Anode Voltage: A new dynamic check using simulated picture tube load. C.R.T. does not need to be operating for current tests. No interpretations—read direct from 0 to 30 KV.
- External Circuit Measurements: By applying from 0 to 1000 volts AC or DC to external meter jacks. Meter will read DC or peak-to-peak volts. 0 to 300 milliamp scale also provided for measuring horizontal fuse current.
- New features include: Large 0 to 300 microamp meter for minimum circuit loading; all-steel carrying case with full mirror in adjustable cover; two 115 volt AC outlets in cable compartment.

Size: 10¼" x 9¼" x 3½". Wt. 10 lbs.

Model SS117

Dealer Net **\$89⁵⁰**

SEE YOUR AUTHORIZED SENCORE DISTRIBUTOR
Circle 13 on literature card

SENCORE
ADDISON, ILLINOIS



Sencore Sam says . . . How can you miss . . .

EACH PACKAGED UNIT CONTAINS:

- An Easy to Follow Instruction Book Especially Prepared and Edited by H. W. Sams.
- A complete 33 RPM, 10 inch Permanent Record on "How to Simplify Sweep Circuit Trouble Shooting."

CORRECT OFF-STANDARD VOLTAGE WITH

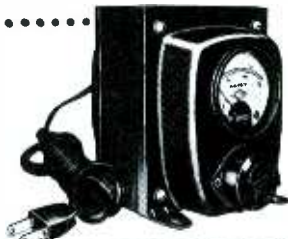

Acme Electric

VOLTAGE ADJUSTORS

You can't get the best performance from a TV set or other electronic equipment unless it's operating on proper voltage. The Acme Electric T-8394M Voltage Adjustor corrects voltage over a range of 95 to 125 volts to normal 115/120 volts, simply by turning a regulating switch. Have a T-8394M Voltage Adjustor with you on every service call. You can use it for testing the line—and sell it on more jobs than you realize. A full 300 watts. Compact. Inexpensive. Most good supply dealers stock them. For full information write for Bulletin 161. SAA 3673-3027

ACME ELECTRIC CORPORATION

944 WATER ST. • CUBA, N. Y.

In Canada: Acme Electric Corp. Ltd., 50 Northline Rd., Toronto, Ont.

Circle 16 on literature card

Save Time on PC Board Repairs!



The ENDECO Desoldering Iron Removes Soldered Components in seconds... without damage!

Endeco melts solder, then removes it by vacuum • Leaves terminals and mounting holes clean • Resolders too • One-hand operation • Temperature controlled for continuous use • Ideal for use with shrinkable tubing • 4 tip sizes • Quickly pays for itself in time saved • Only \$18.75 net.

SEE YOUR DISTRIBUTOR OR WRITE



ENTERPRISE
DEVELOPMENT
CORPORATION

1102 E. 52ND • INDIANAPOLIS, IND. 46205

Circle 17 on literature card

44 PF REPORTER/April, 1964

of each component in the AGC circuit. I looked for unsoldered or incorrect connections and touching leads. I compared each connection with the schematic and the location of each component with the pictorial section of the PHOTOFACT folder.

Finally, I found that one of the two AGC filter capacitors in this set had been connected to the junction of two series-connected capacitors in the vertical waveshaping network instead of ground.

When the owner came for his television, I showed him that it was working good. Then I asked, point blank, who had worked on it before.

"Oh, my nephew did," he told me. "The boy is smart. He even built himself a radio with one of those kits." The man admired the picture on his TV. "My nephew knows how to fix TV's, too," he added.

"He sure does!" I agreed, and handed him my bill.

I try to coax people to admit if they have attempted to fix a set themselves. Some are proud of their efforts. If I also point out that knowing what they have done will help me fix the receiver more quickly, they will explain just what happened. Others will not admit that they touched the set, although the evidence is apparent.

DIY Fingerprints

Signs of tampering are usually easy to see. I generally examine a set for misadjusted controls. I've also found that the DIY will often leave the back off or will just put it on loosely, not bothering to tighten the screws. As a coating of dust soon accumulates on a TV chassis, a quick look will tell if it has been disturbed recently.

One general habit of the DIY is to misplace tubes. Suspecting that this may have happened to a receiver I'm about to work on can save me a lot of needless troubleshooting.

I received a call from a farmer's wife. I knew that Mrs. Joe was one of those few women who will try to fix anything themselves, so I wasn't surprised to find the back off of her TV. She readily told me that a friend had informed her that merely changing the tubes around in a receiver will often cure some trouble it might have.

(Incidentally, I don't start rumors

like this. Business has been good enough without using such tactics.)

Mrs. Joe's set wouldn't stay in sync anymore and she had tried the tube changing scheme. She had broken a tube in the process so I was called.

I decided to test the tubes as I rearranged them into their proper sockets. I noticed that the high voltage cage had been opened and the damper tube was missing. I assumed it was the broken tube.

As I set up equipment to start work, I had an audience of one little girl. "Mama was fixing the TV herself," she said. "Then she jumped up quickly, fell over the flower stand, and said a lot of words she won't let me say!"

Mrs. Joe came from the kitchen, grinning shamefacedly.

"Blabbermouth!" she exclaimed to her daughter. Then she asked me, "Why did I get a shock from that little tube? I thought it was the picture tube that shocked you."

"It so happens that this metal cage contains the parts that produce high voltage. The cage has two purposes. One is to prevent radiation from affecting other circuits; the other is to stop people from poking their fingers among the parts," I answered cheerfully. "You probably touched the metal terminal of this 1B3 socket which has a direct connection to the picture tube anode."

"I'll keep my fingers out of it after this," she promised.

"When you get hurt by a TV," the youngster asked, "do you say naughty words too?"

I didn't dare answer that.

I settled down to fix the set. It wasn't too difficult; checking the tubes showed up a bad sync amplifier. I replaced this and the damper tube. With all the tubes restored to their proper sockets, the set worked fine.

Another little trick DIY's can play on a serviceman is the simple act of pulling wires loose. A yoke lead pulled loose from the pin of the yoke connecting plug, then carefully pushed back in but not soldered, once created a very nice intermittent B-boost failure that took me some time to locate.

After a few such experiences I've learned to be on the lookout for loose wires. Any lead that is exposed is vulnerable. Sometimes they

QUALIFY NOW FOR

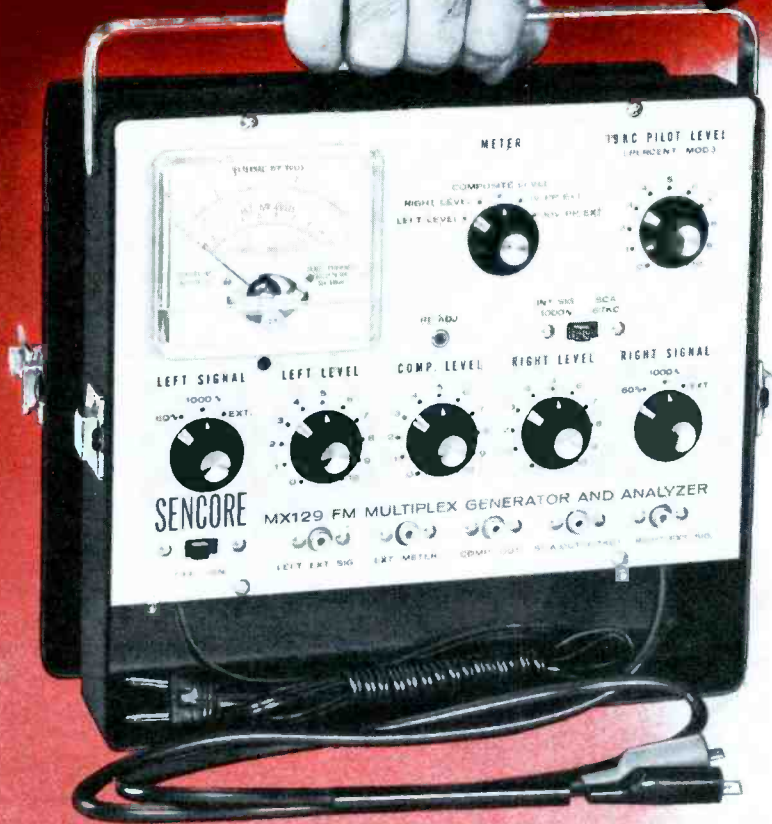

FM STEREO SERVICE

19 TRANSISTORS
ALL CRYSTAL CONTROLLED
TRULY PORTABLE ONLY 7½ LBS.

\$169⁵⁰

SAVE HUNDREDS
OF DOLLARS

... with the ALL NEW **SENCORE** MX129 FM STEREO MULTIPLEX GENERATOR AND ANALYZER

It has been established by all Radio and TV manufacturers that you must have a generator of this type to service FM stereo receivers. Here is a new field just waiting for qualified men, a field that is growing as fast as color TV. Multiplex is simple to service with this generator. If you can service an FM receiver, you can service multiplex once you have the MX129.

Look at the outstanding features of this all transistorized Sencore unit and you will see why it is the most versatile, most portable, most trouble free unit on the market. It is just like having your own FM stereo transmitter on your bench or service truck. All signals are crystal controlled and instantaneous because there are no tubes to warm up. Powered by 115 volts AC to insure top performance at all times.

The MX129 produces all signals required for trouble shooting and aligning the stereo portion of the FM multiplex receiver and can be used as a stereo demonstrator by feeding in left and right audio signals into the jacks marked LEFT and RIGHT EXT. SIG. This unique feature will allow you to demonstrate stereo to the customer even when a stereo program is not being broadcast.

The MX129 becomes a complete trouble shooting analyzer with the addition of a meter calibrated in peak to peak volts and Decibels. No other equipment is required for checking channel separation or alignment. A jack marked EXT. METER is provided for connecting the meter to the stereo speakers or at other points after detection.

Here are the signals available on the MX129 for alignment, trouble shooting and analyzing:

- FM-RF carrier with composite multiplex audio signal just like that transmitted from the FM station: 38kc suppressed carrier, 19kc pilot and 67kc SCA signal. This signal available at RF output cable.
- Multiplex signal is formed by either 60 cycle or 1000 cycle internal tones for greater flexibility in testing.
- Full control over left and right channel amplitude (and therefore modulation). Built-in meter is used to set controls for equal modulation of FM carrier. Channels can be turned completely off when desired.
- 19kc pilot calibrated directly in percentage of modulation; can be generated separately for 19kc amplifier peaking by turning down left and right channels.
- External 67kc SCA (subscription) signal available at jack marked SCA OUT (67KC) for trap adjustment. This signal, not found on some high priced multiplex generators, is very important on new stereo receivers with adjustable 67kc traps.
- Composite signals, same as described above, available on jacks marked COMP. OUT for signal injection beyond the FM detector.

SENCORE

426 SO. WESTGATE • ADDISON, ILL.

Circle 18 on literature card

April, 1964/PF REPORTER 45

have been carefully reconnected—to the wrong terminal.

CAUTION . . . Children at Work

I have also learned that the small fry who intently watch a serviceman at work in their home are the DIY's of the future.

I serviced for a family, none of whom (that I knew of) would do more than turn their television on. I had, at one time, been called just to adjust the vertical hold.

This time, I was informed that the sound had quit. I tested tubes routinely and found the audio out-

put tube defective. Putting in a new one did not bring the sound back. As I listened and considered other possible failures, I realized that even the normal hiss and hum were absent. I expected to find a bad audio output transformer or speaker.

The speaker was mounted in the bottom of the console cabinet. When I looked at it, I saw that the leads had been cut off and neatly twisted together.

I asked the lady, "Has the household handyman tried to work on this set?"

"Oh no," she quickly answered.

"I never touched it, and I'm sure Jim didn't."

"Look!" I pulled the wires out so she could see the handiwork.

"Well! I wonder . . . ?"

She called Dick, the thirteen year old. When he came in, his mother asked, "Did you do this to the TV?"

"Sure. I saw Charlie twist the wires together that time the switch wouldn't work. That made the set go till he got a new switch. I thought I could get it talking for a while by twisting the speaker wires."

"What can I do with a boy like that?" the mother asked.

"I suspect some manufacturers would give a great deal to be able to reproduce sound without some form of speaker," I replied. "See that he gets an education. He might be the man they're waiting for."

Costly Experience

Some DIY's may sorrowfully learn that "fixing" their own TV is an expensive way to save money. But I haven't learned to accept at face value everything they tell me and act accordingly.

If, for example, I would install a new CRT for each customer who thought he needed one, I'd get a note of thanks from the government when my income tax return went in.

But humane impulses, and a strong desire to avoid being considered a cheat, lead me to argue (even with DIY's) against putting unnecessary parts in their TV sets.

Still, I haven't always been right.

One DIY came in and said, "I think I need a new picture tube."

I've heard this so much I'm always skeptical (but hopeful).

"You can't really tell about that unless you test the old one," I told him.

"Isn't there any other way of being sure?" he asked.

"No."

"Well, what is this?" he opened up a paper sack he had in his hand, and I looked in.

"It's the broken neck of a picture tube," I answered.

"My set quit; and when I removed the back, it slipped out of my hand and broke this off. Doggonit! I know I need a new picture tube!"

When a DIY is sure he's right, I won't argue with him. And you shouldn't either. Just accept his money meekly. ▲

THIS SPEAKER HAS SOMETHING TO SAY



A true breakthrough in product design, ATLAS SOUND's EC-10 is an all-American value in performance and price. Outstanding in established applications, it opens up brand-new uses for horn speakers—in intercoms, low-power paging and talkback systems, mobile and Citizens Band transceivers. Use instead of cones. Install these extras:

Performance—Crisp, efficient, big-speaker sound from 6 watts or less . . . clean response from 400-13,000 cps.

Construction—All-weather design . . . high-impact plastic horn with permanent, molded-in color . . . die-cast metal parts for extra strength . . . tough, easily adjustable, steel mounting bracket . . . high-efficiency, ceramic magnet and reinforced phenolic diaphragm.

Utility—Compact (6³/₈" long, 6¹/₄" diameter), fits anywhere . . . available in 8 or 45 ohms . . . also specially designed T-3 (25-volt) and T-4 (70-volt) line matching transformers.

Speaker Price: \$14.25 net

For more on the EC-10 and all your needs in public address speakers and microphone stands, write for catalog PF-F14



ATLAS SOUND, Division of
AMERICAN TRADING AND PRODUCTION CORPORATION
1419-51 39th Street, Brooklyn, New York 11218
Canada: Atlas Radio Corporation, Toronto

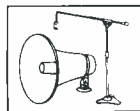

THIRTY YEARS OF LEADERSHIP IN COMMERCIAL SOUND

Circle 19 on literature card

PRECISION TUNER SERVICE

P. O. BOX 272

1200 S. WALNUT ST.

BLOOMINGTON, IND.

EDISON 99653

7.50
V or U

COMBO PLUS
9.95 POSTAGE

6 MONTH WARRANTY



All Types T.V. Tuners Cleaned, Repaired and Aligned to Factory Specifications. Same day in shop service on most Tuners. Price Includes Minor Parts, Major Parts at Cost Price. We use Original Parts if possible. State Make Model and Enclose all Parts and Tubes. Pack Well and Insure.

ALSO HAVE LARGE STOCK OF EXCHANGE TUNERS, WRITE FOR TYPES AND PRICES.

Circle 20 on literature card

Now! Without any help from a rotator...

GET MORE SOUND

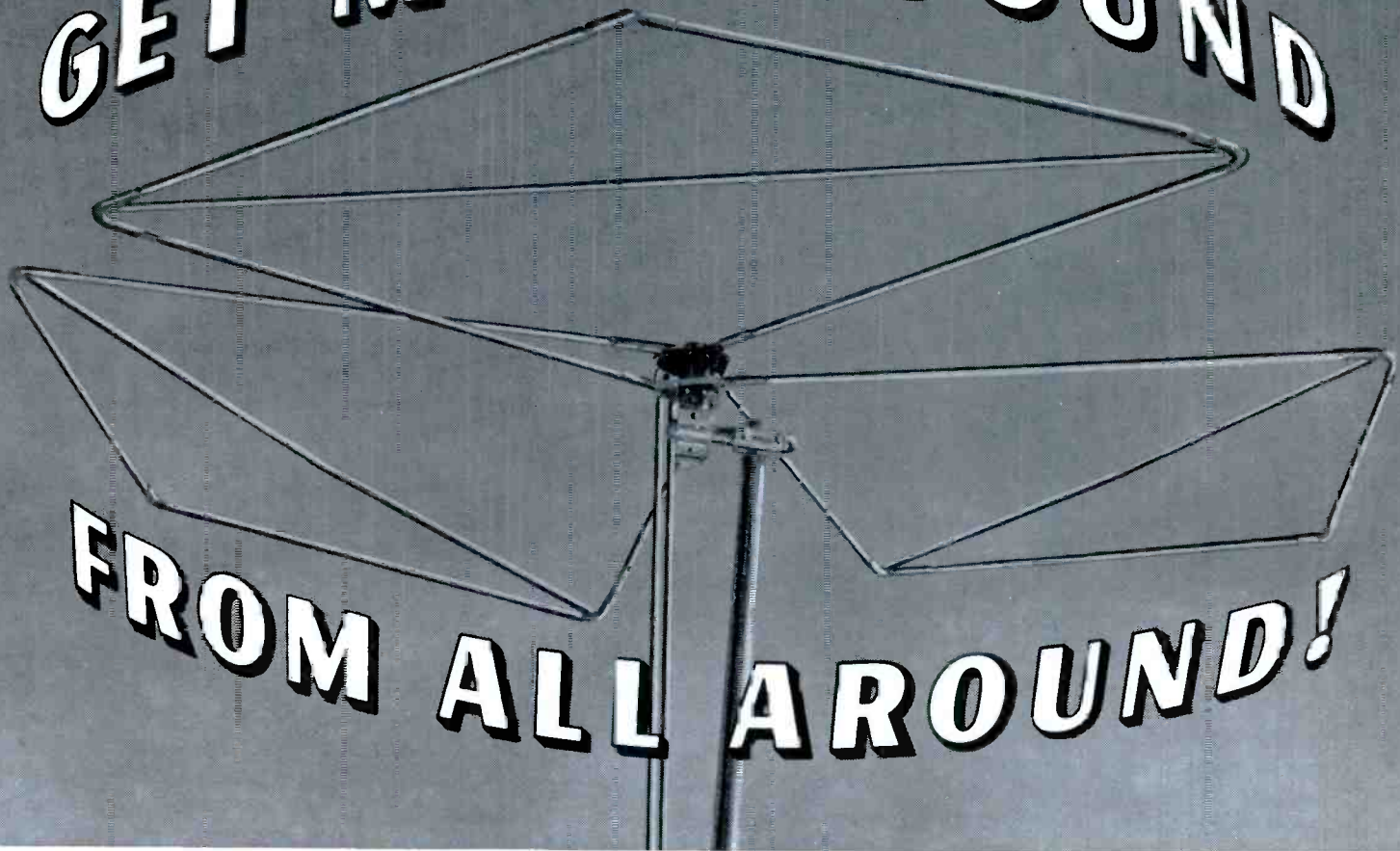

FROM ALL AROUND!

Model 4407G

CHANNEL MASTER **FM RONDO** STEREO

WORLD'S FIRST TRULY OMNI-DIRECTIONAL ANTENNA! There's a real need for an FM antenna that receives stations strongly from all directions—without a rotator. Turnstiles are supposed to do the job—but they do not! They have weak sides that drop off up to 8 DB.

The FM Rondo is a spectacular breakthrough in FM antennas. It has no weak sides. It picks up strongly from all directions. Thanks to its unique "Tri-Di" dipole design, the Rondo has a roughly circular reception pattern which remains constant on all FM frequencies; provides up to 7.4 db more gain than turnstiles; gets more stations.

The Proof is in the Polar Pattern!

Rondo has true Omni-directivity with up to 7.4 DB more gain.

Compare Rondo (solid line) with turnstile (dotted line). Turnstile patterns are "peanut-shaped". Drop-offs are high as 8 DB. A single bay Rondo is as good as a single bay turnstile on its strongest sides—but up to 7.4 DB better than turnstile on its weak sides.

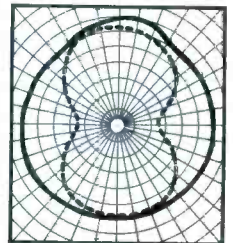

CHANNEL MASTER
ELLENVILLE, N. Y.

TRY THIS
for Maximum
Omni-Directional
Performance in
Fringe Areas...
at Lowest Cost:

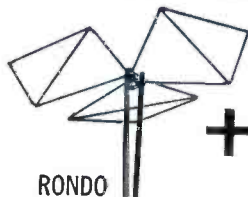

RONDO

+



TELSTAR FMX BOOSTER

=

GREATER
POWER
THAN A
5-ELEMENT
YAGI ON A
ROTATOR



you can
MANAGE
for
profit

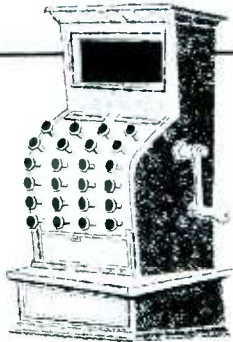

Two months ago, the first part of this article began the discussion of how an ordinary service technician could develop skill in *managing* his business, and thus increase his profits. A few who tried the steps we suggested have taken the trouble to tell us that these ideas really work. The odd thing was—they were *surprised* that they worked!

Certainly, they work! They are procedures that all successful businesses—from the smallest to the largest—use in one form or another every day of their existence. In presenting them in one form, we hope to encourage every shop owner and technician to increase his ability to manage a business.

In the first installment, we repeatedly pointed out that “to earn a profit, you must take in more money than you spend.” We didn’t say how much profit you should make, for that is a matter of your own choice. We also suggested that, if you are making a profit that satisfied you, there is little need to read what follows; obviously, you are already a good manager. However, if you’d like to increase your profits, there are a number of ways you can do so.

If our proverb of profit—earn more, spend less—is correct, the ways to improve profit fall into two

categories—*income* and *expense*. Last time, we discussed a method of analyzing your business records and developing ways to *increase income*; this time, we will discuss how you can take clues from your profit-loss statement to help you *reduce expenses*. If you can cut expenses, at no sacrifice in income or business relations, you will increase the money you can put into your pocket each month.

The “Feel” of Expense

By now, I’m sure you’re convinced that you will need a profit-loss statement if you are to manage a business of any kind. No matter how simple or how complicated your statement, you must know how to get the information you want from it. Exactly what information you get, and what you do with this information, will determine your success or failure.

First, let’s get the “feel” of what we’re talking about. What is expense? It’s what you pay out for supplies. It buys the time of your employees. It pays the rent on your shop. It gets you a service vehicle, and keeps it running. It pays the phone bill. It buys the parts you put in sets, it pays for sets you sell, and it fills the inventory you keep on your shelves (whether catching dust or moving freely). Advertising and promotion, which makes your shop what it is and helps you to increase your income, is an expense. In other words, from a standpoint of analysis, you can consider any expenditure of your money as expense.

Expense is classified into several categories, however, and you must learn to distinguish one from the other. There is *current expense*, which usually can be considered as those bills which you pay monthly. There is *cost of merchandise*, a different kind of expense which you pay out for items which you will subsequently resell; money spent for parts, accessories, and sets would fall into this classification. Lastly, there is *long-term expense* such as money you borrowed to go into business, the mortgage on your building, or the money it takes to keep your test equipment up-to-date and modern. All of these represent money you have to pay out in one way or another if you are to stay in business.

What To Do About Expense

It is absolutely necessary to know which expenses you can do something about, and which you can’t. While we won’t go into every type of expense you will encounter in the electronics servicing business, we are going to show you examples of the type of *thinking* and analysis you are going to have to do, using the expense and cost-of-sales figures of your profit-loss statement. Learn how to apply this type of thinking, and do it a little more each month; you’ll soon find yourself classed as a true businessman, instead of a struggling technician.

Cost of Sales

Take a look at the profit-loss statement shown in Table 1. Gross sales are broken down into two categories—Sets, and Parts and Accessories. Beneath, the Cost of Merchandise is also divided into the same categories. We can use these figures to decide if there is anything we can do to lower the expense of buying the merchandise we sell—parts, sets, or accessories.

Here’s one line of thought our analysis might take: Are we paying too much for our parts and the accessories we sell? In this month, their cost was slightly more than 61%. Turning this around, we can figure that our gross profit from parts and accessories was 39%—

**Table 1—P-L Statement
Month of March 1962**

Gross Sales:		
Set Sales	\$2759.55	
Parts and Accessories	958.67	
Service Labor	1438.76	
		\$5156.98
Cost of Merchandise		
Sets	\$1942.87	
Parts and Accessories	587.30	
		\$2530.17
		Profit on Sales \$2626.81
EXPENSES:		
Service Salaries (excluding owner)	\$ 680.00	
Outside Labor (ant. work)	85.00	
Rent	150.00	
Supplies—Ofc. & Shop	27.35	
Utilities	73.79	
Phone	37.69	
Vehicle Expense	177.65	
Insurance	77.50	
Taxes, Licenses (prorated)	27.54	
Repairs and Maintenance	18.76	
Acctg., Banking, Legal	26.75	
Depreciation	42.00	
Advertising and Promotion	93.85	
Interest on Loans	26.87	
Miscellaneous	173.67	1718.42
Net Income		\$ 908.39
Owner's Withdrawal		600.00
		Net Profit: \$ 308.39

Featuring Automatic Controlled Rejuvenation

CHECKS AND REJUVENATES ALL PICTURE TUBES WITHOUT ADAPTORS OR ACCIDENTAL TUBE DAMAGE

The All New SENCORE CR125 CATHODE RAY TUBE TESTER

An all new method of testing and rejuvenating picture tubes. Although the method is new, the tests performed are standard, correlating directly with set-up information from the RCA and GE picture tube manuals.

Check these outstanding features and you will see why this money making instrument belongs on top of your purchasing list for both monochrome and color TV testing.

Checks all picture tubes thoroughly and carefully; checks for inter-element shorts, cathode emission, control grid cut-off capabilities, gas, and life test. Checks all picture tubes with well filtered DC just like they are operated in the TV set.

Automatic controlled rejuvenation. A Sencore first, preventing the operator from over-rejuvenating or damaging a tube. An RC timing circuit controls the rejuvenation time thus applying just the right amount of voltage for a regulated interval. With the flick of a switch, the RC timer converts to a capacity type welder for welding open cathodes. New rejuvenation or welding voltage can be re-applied only when the rejuvenate button is released and depressed again.

Uses DC on all tests. Unlike other CRT testers that use straight AC, the CR125 uses well filtered DC on all tests. This enables Sencore to use standard recommended checks and to provide a more accurate check on control grid capabilities. This is very important in color.

No adaptor sockets. One neat test cable with all six



All six sockets, including latest color socket, on one neat cable.



Checks each gun individually in color tubes

sockets for testing any CRT. No messy adaptors, reference charts or up-dating is required. The Sencore CR125 is the only tester with both color sockets. (Some have no color sockets, others have only the older type color socket.)

No draggy leads. A neat, oversized compartment, in the lower portion of the CR125 allows you to neatly "tuck away" the cable and line cord after each check in the home.



MODEL CR128
For the man on the go. Same as above but in all steel carrying case . . . \$69.95

Model CR125 \$69.95

PS127 DELUXE WIDE BAND OSCILLOSCOPE AT A SURPRISINGLY LOW PRICE

This all new 5 inch oscilloscope offers the finest in performance, portability and appearance. Vertical amplifier frequency response, flat within 1 DB from 10 CPS to 4.5 mc and only 3 DB down at 5.2 mc insures true waveform reproduction. Vertical amplifier sensitivity of .017 volts RMS for one inch deflection on wide band (without band switching) is found only on scopes costing hundreds of dollars more. High input impedance of 2.7 megohms shunted by 99 mmfd (or 27 megohms with 9 mmfd with built-in low capacity probe), insures minimum circuit loading. For the first time, waveforms can be viewed in TV horizontal and vertical output circuits with the low capacity probe that will withstand up to 5000 volts peak to peak. To top that, the vertical amplifier attenuator controls are calibrated directly in peak to peak volts for fast direct reading of all peak to peak voltages.

Horizontal amplifier extended sweep range from 5 to 500 kc in five overlapping steps and frequency response from 10 CPS to 1 mc within 3 DB insures linear sweep and positive sync. External inputs for horizontal sweep and sync, intensity modulation, and smart two-toned case and "designer" styled controls brands the PS127 a truly professional oscilloscope.



PS127 \$169.50

Circle 22 on literature card

**"all you
could ask for"***

TV - FM - AM
AUDIO - ELECTRONIC
EQUIPMENT



**MODEL 202
SIGNAL TRACER**

* "... *"Its sensitivity and frequency response impose little or no limitations on the types of signals it can handle, and it has about all you could ask for in the way of indicating devices."*

Check complete stages or individual components either aurally (5" speaker) or visually (indicator eye with remote monitor scope outlet) with the Model 202 Signal Tracer.

Testing Facilities — include RF Probe (to 300 mc); AF Probe (2 cps to 300 kc); special noise test with break down voltage; and watt-meter circuit to check power consumption.

Substitution Unit — May be used as audio test amplifier and speaker; transformer substituted in single end and push-pull applications.

Power Specifications: 110/120v AC, 60cps; power consumption 40 watts. Model 202 with AF Probe only — \$59.95. Model A Probe (Signal Tracer RF Demodulator Probe) — \$4.50. Model B Probe (Signal Tracer RF Demodulator Amplifier Probe)—\$7.50.

* As reported by national Service Magazine. Name on request.

PRECISION ELECTRONICS, INC.
9101 King St., Franklin Park, Ill.

Circle 23 on literature card

which isn't bad, at all. Therefore, it would little behoove us to spend great lengths of time and effort trying to squeeze this percentage of cost downward, for—at best—we could only hope to gain 1% or 2%.

Next, we'd wonder about the cost of sets we sell. They cost us, this month, 74% of what we sold them for. If we want a better margin, we'd better find a way to get them at less cost, or quit selling them at less-than-normal prices. However, our gross profit margin is 26%—again, not too bad for the type of merchandise. At least we know what we'll have to do if we want to improve the margin.

This kind of analysis could work the other way, too. Suppose our cost-of-sales analysis shows we were making a 34% profit on sets. Knowing this is out of line, our managerial minds would wonder why. Checking, we also note that total sales are dwindling from month to month—a sure sign that our selling prices are too high, or that our set cost us so little we must be selling shoddy merchandise (people are bound to find out).

The point, then, is to keep your eye on these cost (expense) ratios, and be ready to analyze any notable deviation from normal. Once the problem is found and evaluated, remedying it is much easier; unless it is found, no action is possible.

Current Expense

It is in the area of current expenses that the cost-analyst can usually have a field day. There are so many ways hidden expenses can get into the profit-loss statement that it takes years of experience to be able

to sit down and pick them all out.

Years of experience, we said. And what is it that you're developing as you sail along through month after month of operating your own business? Why, of course, you're accumulating those years of experience. And if you will concentrate your attention on the problem of cost-cutting just once a month, you can eventually have your ship sailing as trimly as that of any large corporation.

Let's take a closer look at the comparative expense sheet shown in Table 2. In the column naming the expense categories, are "ideal" percentage figures that relate expense to gross sales—a generally accepted measure of whether expenses are too high or too low. Each expense figure is also accompanied by its percentage of gross sales. Three major columns are provided for comparisons: Last Month, which is taken from the profit-loss statement shown in Table 1; This Month, which we'll discuss; and Month Last Year, for comparison only, which we won't use in our discussion.

Let's assume that we examined our profit-loss statement last month, made some calculations and decided that we needed to improve our expense record—indeed, it represented 18.3% of our gross sales, quite a bit above the 16% we had set for our goal.

Next, we went down the list of expense items, thinking something like: Rent—that's fixed and we're stuck with it, unless we change buildings; besides, it doesn't exceed our "ideal." Supplies—a bit high, and perhaps we can reduce it by minding our

Table 2—Comparative Expense Sheet

Expenses	This Month	Last Month		Mo. Last Year			
		\$	%	\$	%	\$	%
<i>* Figures Show Ideal Percentage of Sales</i>							
Rent	3.0	150.00	2.9	150.00	2.9		
Supplies	.3	18.65	.4	27.35	.5		
Utilities	.7	65.85	1.3	73.79	1.4		
Phone	.5	21.55	.4	37.69	.7		
Vehicle Exp.	3.0	139.65	2.8	177.65	3.4		
Insurance	1.4	77.50	1.5	77.50	1.5		
Taxes, Licenses	.5	27.54	.5	27.54	.5		
Repairs, Maint.	.2		0	18.76	.4		
Acctg., Bank, Legal	.7	24.45	.5	26.75	.5		
Depreciation	1.0	42.00	.8	42.00	.8		
Advertising	2.0	85.55	1.1	93.85	1.8		
Interest	.3	26.87	.5	26.87	.5		
Miscellaneous	2.4	139.45	2.8	173.67	3.4		
Total	16	819.06	15.5	953.42	18.3		
Sales		5063.65		5156.98			

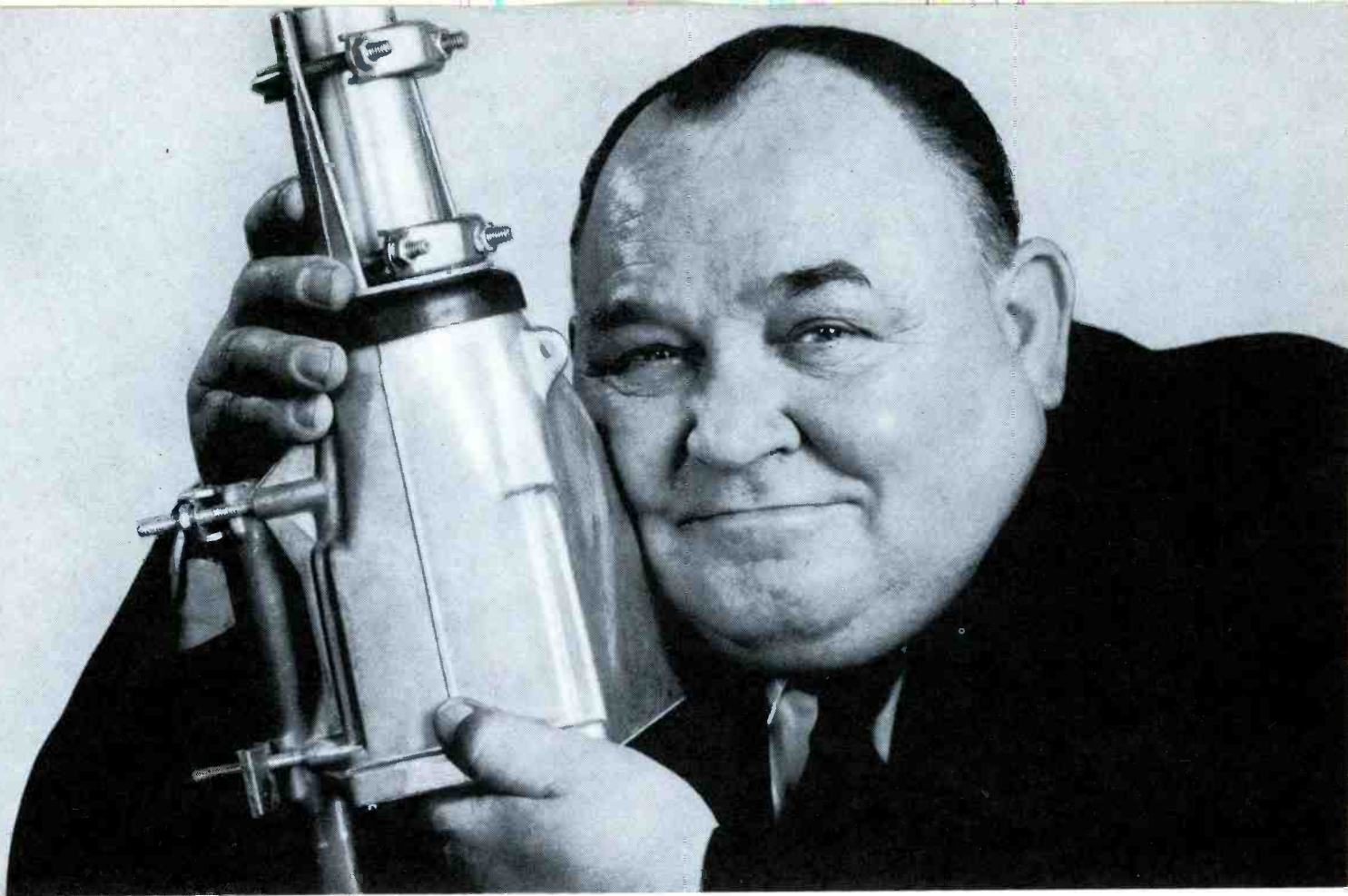

Here's the only excuse you may have for not installing the world's best manual rotator at our **REDUCED PRICES...**

...you just don't use manual rotators in your area!

Say, on the other hand, you *do* sell them. And believe with all your heart in selling the very best. What else can you do then but go with Channel Master rotators? Especially when you can now get our manual model at reduced prices.

This is the one rotator, remember, that makes all others look like also-rans; because it alone has the high torque to turn the heaviest antenna array easily—plus the ruggedness to keep it on course in foulest weather.

For instance: In addition to simplest fingertip control, accurate repeatability, continuous instant direction indication, (and lots of other good features), only Tenn-A-Liners give you:

- Built-in hard-steel thrust bearings (not soft aluminum parts). So friction-free the Tenn-A-Liner will turn ice-loaded installations as heavy as 330 lbs.
- Hard-steel precision-machined gears (not stamped). So rugged that they won't strip or bind. Will continue to operate even in 70 mile gale winds.
- Pushbutton "On-Off" Switch (brand-new) that prevents reception interference caused by wind vibration.



model 9520

... now what's your excuse for not calling your nearest Channel Master distributor?

NEW! Unique Gemini Rotator/Amplifier.
... for fast, neat 2-in-1 installations that save you money 4 ways.

(A simple explanation of what the Gemini is—for those dealers who have heard about this product's terrific profit success story.)

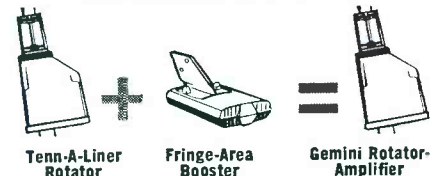

(Where's the booster? It's hidden in the rotator.)

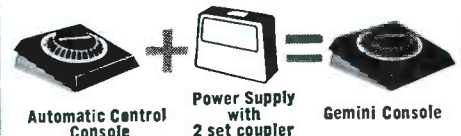

World's first all-in-one rotator-amplifier combination! Only 1 unit on mast—1 housing on set—1 transmission line.
Choice of 2 Models:
NEW! TV/FM Gemini, Model 9518.
"TV ONLY" Gemini, Model 9527
(includes Built-in FM Trap).

Tried our superb Automatic Rotators? There's nothing better. They're available at our regular prices.

CHANNEL MASTER ROTATORS

Circle 24 on literature card

ELLENVILLE, NEW YORK

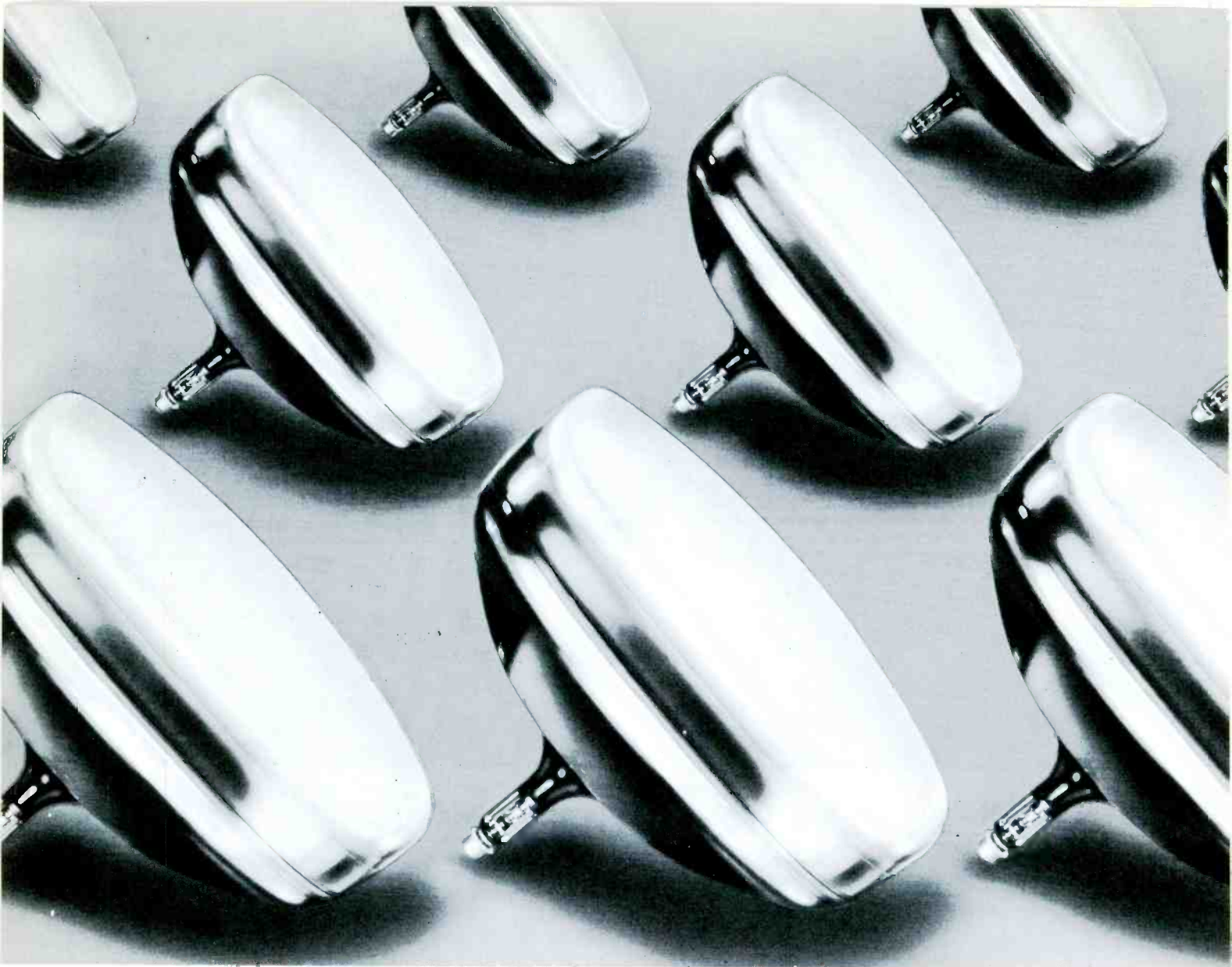

THE QUALITY OF YOUR SERVICE DEPENDS ON THE PARTS YOU USE... DEPEND

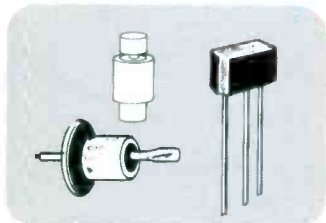

Diodes, Rectifiers, Condensers and Resistors

Complete variety for all makes and models.



Universal Controls

With or without on-off switch. Standard taper, 3 inch shaft, half flat. 1 meg, 2 meg, 500 K. Complete selection. Fit Philco and other makes.

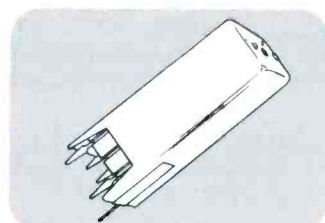

I.F. Transformers

For printed circuits, 4 lug, 5 lug or 6 lug types . . . to fit Philco or other makes. Dependable Philco Quality.

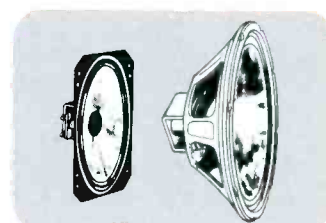

Replacement Speakers

All sizes, round, oval or rectangular types. 3.2, 8, 16, 20 ohms. From tiny 1 3/4" to giant 15" sizes.



Philco Receiving Tubes

To fit any make, any model TV or radio, manufactured to exact Philco standards, thoroughly inspected. Original factory cartons.



Rotary Switch Antenna

High gain type with 6 position switch for best possible signal selectivity. 3 section brass dipoles. Padded cast iron base.



Contact Cleaner

Philco TV and Radio Contact and Control Cleaner, Lubricant in self spray can, complete with protective cap and spray nozzle.



Philco TV Yoke

Genuine Philco TV yokes, made to original factory specifications. Accurately wound and inspected. Packed in individual boxes, ready to install.

There's a Philco Fully Stocked Parts Center Near You!

IF YOU NEED A PHILCO PART...YOU CAN GET IT FAST...HERE'S WHY

1. Philco has a nationwide network of Parts distributors—THERE'S one in your area.
2. Philco distributors are backed up by Parts Warehouses with millions of dollars in Parts inventory.
3. NEW Parts for NEW Philco models are shipped automatically along with the NEW products.
4. All Parts orders are handled by experienced Parts specialists.
5. ALL EMERGENCY orders are transmitted over the nation's largest industrial communications system and processed within 24 hours.

Whatever you need—whenever you need it—if it's a Philco Part just dial your Philco distributor. He has thousands of Philco Parts right now on his shelves. If the item you need is temporarily out of stock—he can get it for you FAST. You may DEPEND on your Philco Parts distributor.

Customer Confidence Begins When You Use Genuine Philco Star Bright 20/20 Picture Tubes

Every CR Tube you replace represents a high-dollar service sale for you . . . and your customer. Play it safe with a brand that's known for Quality . . . PHILCO. All material and parts used in the manufacture of Philco Star Bright 20/20 Picture Tubes are new except for the envelope, which prior to reuse, has been inspected and tested to the same standards as new envelopes.

ON YOUR PHILCO DISTRIBUTOR FOR ALL YOUR PARTS AND ACCESSORIES

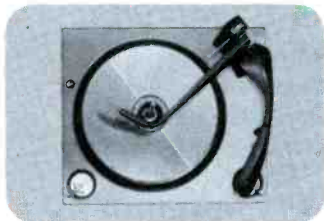

M62A 4-speed Record Changer
Intermixes all size records. Lightweight tone arm with retractable scratch protection assembly and famous Euphonics U8 cartridge. Changer ideal for built-in installations or "modernizing" record playing equipment. Template and instructions included.

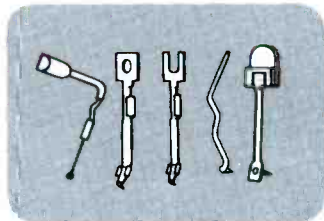

Philco Phono Needles
A complete selection of types and numbers for Philco and most all other makes. Carefully made, attractively-packaged. ALL TIP TYPES and sizes, including Diamond. Special now available—"THE BIG 18 KIT." This attractive compact metal case contains 18 of the industry's fastest selling needles.

Your Philco Distributor Features These Famous Makes

PHILCO • PHILCO-Bendix • CROSLEY • EVEREADY Batteries and Flashlights • CAROL Cables • GOODRICH V-Belts • GC Products • AUDIOTEX • WALSCO Products • COLORMAGIC Antennas • PRECISION Test Equipment • SPRAGUE Capacitors

Philco Parts are Available Through a nationwide network of Parts Distributors. Mail the Coupon Today for the Name of the One Nearest You.



PARTS AND SERVICE OPERATIONS

PHILCO®

A SUBSIDIARY OF *Ford Motor Company*

Philco Parts & Service Operations
C & Tioga Streets, Phila. 34, Pa.

I am interested in receiving information about special Philco Parts offers, prices and facts. Please send me the name of the nearest Parts distributor.

Name _____

Address _____

City _____ Zone _____ State _____

buying carefully; of course, it may be high because of some large purchase (such as stationery) that will be used over an extended period. Utilities—very high, but that's because of winter heat; the average will probably be okay, although it would bear watching.

And so we continued down the list, reasoning about this, questioning that, until we'd decided on a couple of categories that might definitely need checking into—vehicle expense and that catch-all, Miscellaneous. We found several items of the Miscellaneous category that we

could reduce a bit. We also found that we'd not been routing service calls very efficiently, so we started working on that problem.

The results of our actions can be seen in the This Month column of Table 2. We managed to cut vehicle expense to less than 3% of gross sales, resulting in a tidy savings of \$38. The miscellaneous category reflected a saving of \$34.22. The telephone charge was lowered when we took out some extensions we'd been letting collect dust. We also began watching long-distance calls, using letters when time would permit.

The saving this month was \$16.14.

Other slight reductions appeared, too, but not as a result of our expense-checking program. Repairs and maintenance showed a reduction to zero; this was coincidental, as no equipment happened to fail during this month. The bank charge was slightly less, and its category showed the saving.

All in all, we effected a savings of \$88.36 as the direct result of our investigation into expenses. The remaining \$46.00 reduction just happened. Sales were down slightly this month, but our savings almost offset the entire amount.

Salaries

There is only one way to save money on salaries—get more for your money. Naturally, this doesn't mean that you shouldn't lay off help if business is bad, but you'll never gain anything by reducing anyone's salary. So calculate your salaries carefully, and be sure you get your money's worth from your employees. Hire capable, trustworthy technicians, pay them well, and expect good work.

Your total service payroll, when added to any outside service labor charges you pay, should never exceed 55% of your service income. If it does, better look at service procedures and charges, and improve your profit picture. (In the example shown in Table 1, a portion of the service payroll can be attributed to delivery of sets sold; in more elaborate bookkeeping systems, this would be charged to the Cost of Sales.)

The Method

These examples naturally sound easy, and it would be fine if every technician could put all these steps to work tomorrow. However, let's be practical; every little bit of improvement is going to help, so let's take on these improved management practices a little at a time.

Start this month. Pick one item on your expense sheet, preferably something like that hazy "Miscellaneous" category, and calculate exactly what percentage of your gross sales is required to pay that portion of your overhead. Then decide what a fair and proper percentage should be, and figure out some steps you might take to reduce your expenditures to meet the new standard. Then get to work on it.

More useful than ever!

ALL
New!
COMPLETELY
INTEGRATED



CRT 445

Checks and Corrects
B & W and COLOR
Picture Tube Troubles



THE INDUSTRY'S STANDARD

*Most Widely Used Today
by Professional Servicemen*

Includes all desired features. Does the job in a few minutes right in the home without removing tube from TV set.

**SAVES CUSTOMERS—ADDS SERVICE INCOME
MAKES NEW TUBE SALES EASIER**

Gives new life to weak or inoperative tubes. Checks for leakage, shorts, open circuits and emission. Removes inter-element shorts and leakage. Repairs open circuits and low emission. Restores emission and brightness. Life Test checks gas content and predicts remaining useful life of picture tube. Quickly pays for itself. **Net, \$74.95**

TESTS AND REJUVENATES

all picture tubes at correct filament voltage from 1 to 12 volts.

TESTS AND REJUVENATES

all Hi G-2 and Lo G-2 picture tubes, including tubes that require as low a G-2 voltage as 30 volts. Supplies all three necessary voltages: Hi G-2, Low-1 G-2, and Lo-2 G-2.

TESTS AND REJUVENATES

110° tubes and the new 19° and 23° tubes.

TESTS AND REJUVENATES

color picture tubes, including the new 90° 23° 23BG22. Checks and corrects each gun of color tube separately.

Subscribe to
New
Picture Tube
Information
Service

UP-DATE YOUR B&K CRT WITH THESE ACCESSORIES

Model C40 Adapter. For use with previous Models 400 and 350 CRT's— to test and rejuvenate TV color picture tubes and 6.3 volt 110° picture tubes. **Net, \$9.95**

Model CR48 Adapter. For use with previous Models 400 and 350 CRT's— to test and rejuvenate 110° picture tubes with 2.34, 2.68, and 8.4 volt filaments. **Net, \$4.95**

See Your B&K
Distributor,
or Write for
Catalog
AP21-R

B&K MANUFACTURING CO.

DIVISION OF DYNASCAN CORPORATION

1801 W. BELLE PLAINE AVE. • CHICAGO 13, ILL.
Canada: Atlas Radio Corp., 50 Wingold, Toronto 19, Ont.
Export: Empire Exporters, 253 Broadway, New York 7, U.S.A.



Circle 26 on literature card

Find it and Fix it in 1/2 the time!

EASILY SOLVES "TOUGH DOGS"... INTERMITTENTS... ANY TV TROUBLE



MODEL
1076

TELEVISION ANALYST
BLACK & WHITE AND COLOR

ANALYST

NOW WITH KEYED RAINBOW COLOR DISPLAY

By Easy Point-to-Point Signal Injection, You see the Trouble on the TV Screen and Correct it—Twice as Fast and Easy!

Simplified technique stops lost hours never recovered on "tough dogs", intermittents, and general TV troubleshooting. This one instrument, with its complete, accurate diagnosis, enables any serviceman to cut servicing time in half... service more TV sets in less time... satisfy more customers... and make more money.

With the Analyst, you inject your own TV signals at any time, at any point, while you watch the generated test pattern on the picture tube of the television set itself. This makes it quick and easy to isolate, pinpoint, and correct TV trouble in any stage throughout the video, audio, r.f., i.f., sync and sweep sections of black & white and color television sets—including intermittents. No external scope or waveform interpretation is needed. Checks any and all circuits—solves any performance problem. Gives you today's most valuable instrument in TV servicing—proved by thousands of professional servicemen everywhere.

Available on Budget Terms. As low as \$30.00 down.

Net, \$329.95

SIMPLIFIES COLOR TV SERVICING, TOO

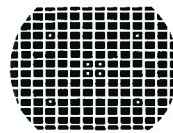

Enables you to troubleshoot and signal trace color circuits in color TV sets, or facilitate installation.

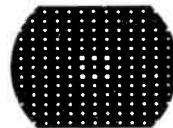

Generates white dot, crosshatch and color bar patterns on the TV screen for color TV convergence adjustments.



Generates full color rainbow display and color bar pattern to test color sync circuits, check range of hue control, align color demodulators. Demonstrates to customers correct color values.

Time-Saving, Money-Making Instruments Used by Professional Servicemen Everywhere



Model 960 Transistor Radio Analyst



Model 360 V O Matic Automatic VOM



Model 375 Dynamatic Automatic VTVM



Model 700 Dyna-Quik Tube Tester



Model 445 CRT Rejuvenator Tester

See Your B&K Distributor
or Write for Catalog AP21-R



B & K MANUFACTURING CO.

Division of DYNASCAN CORPORATION

1801 W. BELLE PLAINE AVE. • CHICAGO 13, ILL.

Canada: Atlas Radio Corp., 50 Wingold, Toronto 19, Ont.

Export: Empire Exporters, 253 Broadway, New York 7, U.S.A.



18 WAYS TO MAKE TESTING A LOT EASIER... SIMPSON MICRO-TESTERS



If you run tests on communication systems, motors, wiring, appliances, tubes, components, batteries, or coolers, one or more of these nifty little testers may be just what you've been looking for. Micro-Testers measure only 3" x 5 7/8" x 2 1/2"—Simpson quality in a tester that is compact in size and price. Pick a couple from below, then call your distributor for immediate delivery.

AC/DC VOLT-OHM-MILLIAMMETER, Model 230: 12 ranges.....	\$30.95
AC/DC VOLT-OHM-MILLIAMMETER, Model 240: 14 ranges.....	31.95
OHMMETER, Model 372: 6 ranges, 0 ohms to 50 meg.....	29.95
LOW-OHMMETER, Model 362: 0-5, 0-25 ohms.....	24.95
AC AMMETER, Model 370: 0-1, 2.5, 5, 10, 25 amp. ±5% FS.....	22.95
DC AMMETER, Model 375: 0-1, 2.5, 5, 10, 25 amp. ± 3% FS.....	21.95
AC MILLIAMMETER, Model 378: 0-5, 25, 100, 250, 1000 ma, ± 5% FS.....	24.95
DC MILLIAMMETER, Model 373: 0-1, 5, 10, 25, 50, 100, 250, 1000 ma, ± 3% FS.....	21.95
DC MICROAMMETER, Model 374: 0-50, 100, 250, 500, 1000, ua ± 3% FS.....	24.95
AC VOLTMETER, Model 376: 0-5, 10, 25, 50, 100, 250, 500, 1000 v, ± 5% FS.....	21.95
AC VOLTMETER, Model 371: 0-150, 300, 600 v, ± 3% FS.....	22.95
DC VOLTMETER, Model 377: 10 ranges, 0 to 1000 v, ± 3% FS.....	22.95
DC MILLIVOLTMETER, Model 387: 0-10, 30, 100, 300, 1000 mv, ± 3% FS.....	29.95
AC VOLT-AMP-WATTMETER, Model 390: 8 ranges (300 v, 15 a, 3000 w. max) ± 5% FS.....	48.95
AC/DC VOLT-WATTMETER, Model 391: 4 ranges (260 v, 3000 w, max) ± 5% FS.....	43.95
AC/DC VOLT-WATTMETER, Model 392: 4 ranges (260 v, 5000 w, max) ± 5% FS.....	43.95
BATTERY TESTER, Model 379: for radios, flashlights, hearing aids.....	29.95
TEMPERATURE METER, Model 385-3L: -50° to +70°F (up to 3 temp. one time).....	33.95

All 18 Micro-Testers are in stock for immediate delivery... call your Electronics Distributor or the factory for Bulletin 2064A

Simpson

Representatives in Principal Cities
... See Telephone Yellow Pages

SIMPSON ELECTRIC COMPANY, 5209 W. Kinzie St., Chicago, Ill. 60644 Phone: (312) ESTebrook 9-1121
In Canada: Bach-Simpson Ltd., London, Ontario

Circle 28 on literature card

Next month, see how much improvement you've made. Then pick another item for evaluation. Figure out what you can do about it. If you're absolutely sure you can do nothing, move on to another category and save the tough ones for after you have more experience. Don't try to cut in categories that will result in reduced income. For example, you could cut advertising and promotion to the bone, but you'd only lower your income and that would reduce profit. Concentrate your energies on items that will not reduce income in any way. As your skill grows, you'll figure out ways to work at reducing the other expense categories, too, and you'll find a way to do it without losing any income. That will come when you master this technique of being a manager.

Each month, take on a new expense item; but don't forget the old ones. Once you get them down, keep them down. You'll find it easier and easier as you go along. Work on lowering expenses, and on boosting income, and you may be startled by the sudden improvement in your profits.

And That's It

Now take a little glimpse into the future, and imagine yourself sitting at your desk over the few months that will have just passed. You've improved your income slightly each month, as we outlined in the February part of this article; and you've reduced your expenses slightly each month, as pointed out in this section. If you weren't making money before, you certainly will be. And if you are now, you should be able to sit back and take a deep breath of satisfaction at the additional growth your business has shown since you actually became a MANAGER. ▲



for every
**High Quality
Speaker
need...**

**LOOK
IN THE NEW
JENSEN
GUIDE TO
LOUDSPEAKERS**



We'd like you to have a copy of our new 1090 speaker guide describing the new Concert, Viking and Weather Master Series loudspeakers. It's the largest catalog of its kind, fully illustrated with complete descriptions and easy-to-read specification tables.

Included to name only a few are: a new group of Electronic Musical Instrument speakers; a new complete range of circular and oval general purpose units; Miniatures; special Automotive types; an augmented Viking series for inexpensive replacements; Weather Master outdoor speakers; Hi-Fi replacements; Concert Fidelity speakers and components; Intercom and Communication/Aircraft types. And there is an interesting discussion of magnetic materials.

*Write for your free copy of
CATALOG 1090 today!*



JENSEN MANUFACTURING COMPANY / DIVISION OF THE MUTER COMPANY / 6601 SOUTH LARAMIE AVENUE, CHICAGO 38, ILLINOIS
Canada: Radio Speakers of Canada, Ltd., Toronto • Argentina: Ucoa Radio, S. A., Buenos Aires • Mexico: Fapartel, S. A., Naucalpan, Mex.
Circle 29 on literature card



Notes on Test Equipment

analysis of test instruments . . . operation . . . applications

by Stephen Kirk

Low-Cost Signals

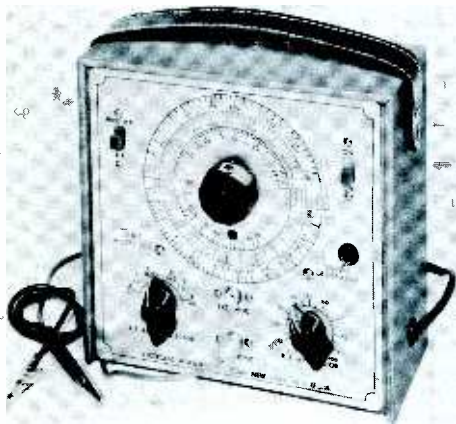

Fig. 1. This simple, uncluttered generator gives complete FM and TV signal coverage.

A small, compact AM signal generator is a desirable piece of test equipment in any radio or TV shop. The Electronic Measurements Corp. Model 502 shown in Fig. 1 is a simple, uncluttered generator which completely covers FM and TV frequencies. Its frequency range is 115 kc to 108 mc on fundamentals, and it produces good second harmonic signals up to 216 mc. The size of the cabinet, excluding the carrying handle, is just 7" x 7" x 3". The output cable is terminated in a phono plug at the generator end and two alligator clips at the output end.

The frequency ranges are selected in six steps by the front panel RF RANGE SELECTOR. Also on the front panel are:

the ON-OFF switch, the MOD RF-RF switch, the RF ATTENUATOR, the RF OUTPUT jack the EXT MOD input jack, the frequency-setting dial with vernier control, and a neon panel lamp.

The circuitry is fairly standard, as you can see by the schematic in Fig. 2. A 12AT7 twin triode tube is used as a combination modulator and Colpitts RF oscillator. Internal modulation of 400 cps is generated by a neon bulb and an RC time-constant circuit that gives a sawtooth output waveform. This sawtooth voltage is coupled to the grid of the modulator tube. For external modulation, or when no modulation is desired, the neon circuit is disconnected with the MOD RF-RF switch.

As you can see by the circuit diagram, different plate voltages are supplied to the 12AT7 RF oscillator for each band change. This tends to keep the generator output constant for all frequency ranges.

We checked the 502 against our frequency standard and found the calibration was good, even on the high frequency bands. This was encouraging, since many inexpensive signal generators have poor calibration, with no easy way of recalibrating. The 502 uses slug-tuned coils that should make recalibration easier if it ever becomes necessary.

We used the 502 to check and align both an AM and an FM receiver and had no problems. The attenuator, as with all signal generators, should be kept at the lowest level that will produce a reasonable signal, especially when using internal

modulation. This prevents receiver overloading that may cause the signal to "ride through" the circuit and give a false indication of circuit sensitivity.

We connected an FM tuner output into the external modulation jack and used the generator as a converter to listen to the FM signal on an AM radio. It worked out well. Modulation fidelity, if our ear was a good guide, was excellent.

This instrument should make a useful addition to most any shop's test equipment inventory. It is easy to operate, stays on frequency well (after a five-minute warmup), and doesn't take up a lot of room on the bench.

For further information, circle 66 on literature card.

Updated CRT Checker

The new Model 445 B & K picture tube rejuvenator-tester pictured in Fig. 3 is an updated and refined version of the Model 440.

Three neon lamps are used, as in the 440, to determine discontinuity in, or shorts between, elements. This is done by placing an AC voltage between the picture tube elements and a neon bulb circuit, as shown in Fig. 4. Since G1 and G2 go positive with respect to the cathode on one half of the AC waveform, they will draw current if the cathode is emitting properly. This will cause only one side of each neon bulb to light. However, if a short or leakage is present, the neon will "see" AC and both sides will glow.

Fig. 5 is a somewhat simplified schematic of the test circuit used in the 445. The effective cathode emission is read as the first-anode current of the zero-biased picture tube. Note that a three-position switch, labelled HI-LO1-LO2, determines the amount of test voltage placed on G2. Since there is a possibility of damaging the CRT if the wrong G2 voltage is used, a chart is supplied listing the G2 and heater voltage settings for all picture tubes.

The rejuvenation circuit is virtually the same as used in other B & K models. When the DYNAMIC INTENSIFIER button is depressed (see Fig. 6), a high positive voltage is placed on G1 of the picture tube. This creates a high surge of cathode current and tends to break up any "crust" that may have formed on the cathode. The 445 has three rejuvenation positions—LOW, MED, and HI. They are the same except that on MED and HI positions the heater voltage is increased by 35% and 85% respectively. Emission should be checked after each rejuvenation attempt; no attempt should be made to rejuvenate a tube that has satisfactory emission, or the tube may be damaged. If emission goes up temporarily in the MED and HI position, but falls off to below normal on the regular emission check, a CRT brightener may be the answer.

The same circuit used for rejuvenation is also used in the REMOVE SHORTS position, except here the heater voltage to the picture tube is turned off so the cathode will not be damaged by prolonged high current. This circuit is also used to make cathode welds by depressing the DYNAMIC

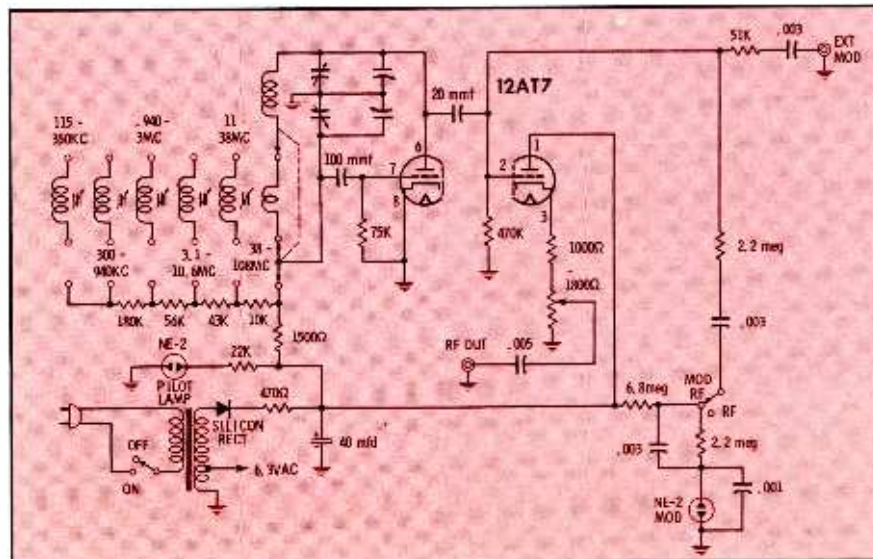

Fig. 2. This Colpitts oscillator schematic shows plate-voltage compensation circuit.

you get **PRODUCT PLUS** *from your Sylvania Distributor*



Must-Reading since 1930—Sylvania News

Sylvania and its distributors have long known that it pays to keep their customers informed. That's why 35,000 dealers today receive, read and depend on Sylvania News for useful information. Now in its 35th year of continuous publication, the News is still one of the most important dealer publications in the industry. ■ Dealers aren't the only ones who read Sylvania News — it also serves some 70,000 distributors, engineers and technical service men. Are you getting your copy? It's free. You can request it by asking your Sylvania distributor or dropping a line to: Editor, Sylvania News, 1100 Main Street, Buffalo, N. Y. 14209.

SYLVANIA
SUBSIDIARY OF
GENERAL TELEPHONE & ELECTRONICS **GTE**

Circle 5 on literature card

April, 1964/PF REPORTER 59

NEW SECO MODEL 107B TUBE TESTER

SPEEDS REPAIRS, DETECTS SLEEPERS

● 8 sockets wired to 14 lever-type pin selectors for testing tubes circuit by circuit!

● 40 prewired sockets accommodating 63 basic arrangements for testing thousands of popular tube types with no set-up data required!



FOOLPROOF READINGS—all test information reads on *one meter and one scale!* Eliminates errors that can be made reading off closely packed multiple scales. Wide sweep increases accuracy of readings.

3 COMPREHENSIVE TESTS find tube faults that slip by other testers that cost much more. Pull out more "sleepers" on your first try—save time and call-backs.

- **GRID CIRCUIT TEST** makes up to 11 simultaneous checks for leaks, shorts and grid emission—indicates "hard to find faults" that conventional short tests pass by.

- **DYNAMIC MUTUAL CONDUCTANCE TEST** indicates relative transconductance—incorporates gas error test.

- **CATHODE EMISSION TEST** provides the best method for testing pulse amplifier, power output and damper type tubes.

Readings can be made for element identification and analysis of elements for shorts. A "life" test checks for allowable drop in mutual conductance or emission current under reduced heater supply conditions. The exclusive Grid Circuit Test above is a test originated and patented by Seco.



PLUG-IN-SOCKET CHASSIS is easily replaced or interchanged to accommodate the widest possible range of tubes. In addition to 8 sockets, panel has 3 pin straighteners for 4 most popular types. Inexpensive and easy to keep up to date as new tubes appear. Plug in chassis can be customized at low cost to fit your needs.

WIDE RANGE of tube types tested includes all modern TV, radio, industrial and foreign tubes using the following sockets—seven pin, nine pin, octal, loctal, novar, nuvistor, compactron, magnoval and ten pin.. Special circuit for low voltage hybrid types. Complete set-up data book is included—pages covering new tubes that appear are mailed periodically to all registered owners at no charge.

ALWAYS UP TO DATE



Model 107B **\$189.50** NET



For complete information see your distributor or write:

SECO ELECTRONICS, INC.

1221 S. Clover Drive, Minneapolis 20, Minnesota

A DIVISION OF DI-ACRO CORPORATION

Circle 38 on literature card



Fig. 3. Modern CRT tester supply adequate heater power to properly check color tubes.

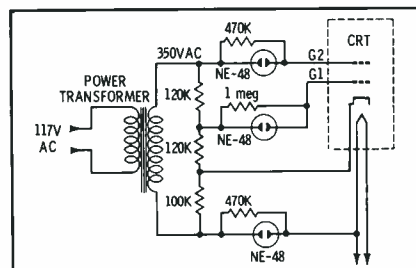

Fig. 4. Neon lamp for each element—G1, G2, filament—checks for shorts or continuity.

INTENSIFIER button and gently tapping the neck of the picture tube, with the function switch in the DYN-HI position. You should see an arc inside the tube neck if the weld takes place. Cathode welds are not always permanent and should not be trusted until the set has been turned off and on several times, allowing time for the cathode to completely cool. This will expand and contract the joint, and if the weld is not solid it will almost invariably open up again.

Color tubes are checked with a separate two-socket cable on the 445. A switch on the front panel selects any one of the three color guns for testing or rejuvenating. Relative emission among the guns is often more important in color-tube checking than the actual emission; that is, each gun should show approximately the same emission. If one gun is excessively higher or lower than the others, it almost surely indicates that the picture (especially the black-and-white picture) will be difficult to set up properly. Rejuvenation of the color picture tube is sometimes successful, but it should not be attempted if you are not

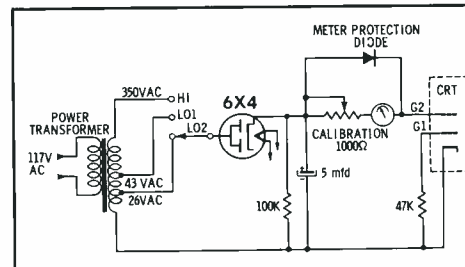

Fig. 5. Simplified schematic of the circuit used to measure effective cathode emission.



PROOF OF 119 SUCCESS STORIES!

119 INDEPENDENT SERVICEMEN ASSURED THEIR LIFE'S FUTURE with the LAFAYETTE ASSOCIATE STORE PROGRAM

What Are You Waiting For--

You're in business for yourself, probably an independent serviceman like those other 119 businessmen. You have a basic knowledge of radio, television or electronics, and most of all you have ambitions to become a true success story—with your own profitable business, a respected place in your community, and security for your family.

You owe it to yourself, and your family, to investigate the Lafayette Associate Store Program.

This Is What We Offer You:

1. **Business Stability**—Lafayette Radio Electronics has been in business for 43 years. You'll cash in on this established reputation.
2. **Product Diversification**—You can sell the tremendous variety of products that Lafayette offers—hi-fi stereo, citizens band, tape recorders, radios, tools, radio and T.V. parts, hobby supplies, and much more. You'll attract more customers than you ever thought possible.
3. **Advertising Support**—Year 'round advertising, publicity, public relations and promotional campaigns have established Lafayette and its franchised dealers as America's primary source for hi-fi and electronics.
4. **Protected Territory**—Yours will be the ONLY franchised Lafayette Radio Electronics Associate Store in your marketing area.
5. **Marketing Guidance**—Our program helps you set up a complete operation. We'll help you select the right location, or evaluate your present one, design your store for maximum profit and assist in selecting your inventory. We'll show you how to deal with customers, how to hold a loyal following, how to build a successful business and maintain it. We will always be available to help you in any way possible. In short, we want you to be a Lafayette Success Story.

We are looking for a limited number of men who want to become part of America's largest and most successful Electronics Associate Store program, who are willing to invest \$10,000 to \$30,000 to make a new business career for themselves.

Mail the coupon for complete information without obligation. What are YOU waiting for!

Lafayette Radio Electronics Corporation
 Dept. PFD-4
 111 Jericho Turnpike, Syosset, L. I., New York
 Mr. Robert Laub
 Please send me full information on how I can own my own profitable business. I understand there is no obligation.

Name

Address

City Zone State

MR. ANTENNA INSTALLER:

Inside this colorful box is one of 7 TRIO Golden Zephyr VHF Antenna Models. In similar boxes are the new TRIO Color-Site UHF Antennas and 5 models of popular TRIO Golden FM Antennas. Each is GUARANTEED IN WRITING to offer Better Performance, Better Construction and Better Appearance. This is important to you! Equally important... in the envelope on the end of each these TRIO antenna boxes is a coupon to be redeemed BY YOU for a generous number of 3 & H Green Stamps or TRIO Premium Points. YOU BUILD CUSTOMER GOOD WILL AND YOU EARN VALUABLE PREMIUMS FAST WHEN YOU INSTALL TRIO.

See your TRIO Distributor or write us for details.

TRIO MANUFACTURING COMPANY
GRIGGSVILLE, ILLINOIS



Circle 30 on literature card

absolutely sure the picture tube is at fault. Some slight difference always exists in the color guns and may be considered normal.

Some testers in the past have failed to check color CRT's properly because of inadequate heater current from the tester transformer (a color tube requires three times that of a normal black-and-white CRT). This has been solved in the 445 by providing a special color tap on the transformer, selected by the front panel switch.

We checked several good monochrome tubes and one new color tube to get a feel for the tester. Operation was easy and all readings seemed to be accurate.

A set came in that had been running with a brightener for almost six months and was now so dim it could hardly be seen in daytime. This was one of those "impossible" rejuvenation jobs and we didn't expect much. But it did respond to rejuvenation by the 445 in the MED position; and—with the brightener still on it—was considerably brighter, without any of the telltale milkiness that indicates over-rejuvenation.

Another tube was made considerably

For further information, circle 67 on literature card.

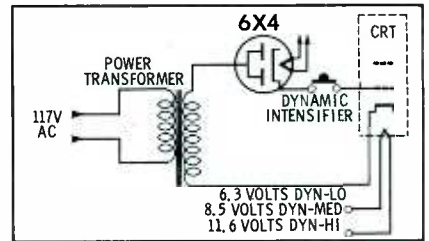

Fig. 6. Rejuvenation circuit, with a choice of filament voltages, also removes shorts.

brighter and came on more quickly with a fast rejuvenation in the LO position.

Tester-rejuvenators can help you sell picture tubes. They let the customer see the condition of his tube; and if a rejuvenation attempt is made and is not successful, the customer is in a more receptive mood to purchase a new CRT. Rejuvenation should not be sold as a "sure cure," but as a stopgap measure until the customer is ready to purchase a picture tube. Sometimes rejuvenation may last for many months, and some technicians offer the customer a refund of the rejuvenation fee if a picture tube is needed within a specified time—such as thirty days.

Constant Power

This Model P-612 power supply (Fig. 7) was developed by Delco Radio especially for servicing "Wonder Bar" signal-seeking radios, both tube and transistor types. It is suitable for servicing all kinds of car radios or for use anywhere a low-voltage high-current highly filtered DC supply is needed. It will supply up to 8 amps at 8 volts and up to 5 amps at 16 volts, with output filtering equal to 1,500,000 mfd. The resultant low ripple is accomplished by a transistorized electronic filter circuit.

The special problem of testing and repairing the signal-seeking radio (especially those with solenoid tuner return) is the need for an instantaneous current of about 16 amps at the end of each dial sweep. With a regular power supply, having pi-network filtering, the added



Fig. 7. Transistor-regulated power supply is capable of unusual performance under load.

current requirement usually drops the output voltage drastically and the mechanism "hangs up," not returning far

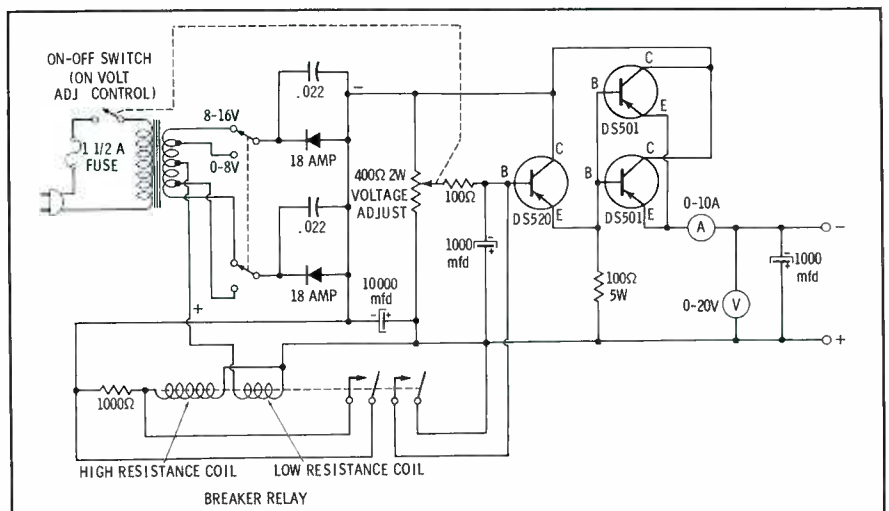

Fig. 8. Special overload circuit uses a relay that has two separate actuating coils.

you profit 4 ways

- 1— Test tubes faster, more accurately
- 2— Sell more tubes per customer
- 3— Save call-backs
- 4— Satisfy more customers



basic for the professional service shop



**Model 700
DYNA-QUIK**

Dynamic Mutual Conductance Tube Tester

Multiple-Socket Speed with Gm Accuracy plus obsolescence protection

TESTS All TV and Radio Tubes, Old and New

TESTS Nuvistors and Novars

TESTS 10-Pin Tubes

TESTS 12-Pin Compactrons

TESTS European Hi-Fi Tubes, Voltage Regulators, and Most Industrial Types

Everyday use by thousands of professional servicemen has proved its speed . . . its accuracy . . . its efficiency.

You can quickly check all the tubes in the set, detect hard-to-locate weak tubes that need replacement . . . and sell more tubes. Provides multiple-socket section to quick-check most of the TV and radio tube types the *true dynamic mutual conductance way*—plus simplified switch section to check new tube types in Dyna-Quik emission circuit. Also includes provision for future new sockets.

Makes test under set-operating conditions. Checks each section of multi-section tubes separately. Checks for *all* shorts, grid emission, leakage, and gas. Makes quick "life" test. Exclusive adjustable grid emission test provides sensitivity to over 100 megohms. *Insures your reputation. Quickly pays for itself.*

See your B&K Distributor or Write for Catalog AP21-R

Time-Saving, Money-Making Instruments Used by Professional Servicemen Everywhere



Model 960 Transistor Radio Analyst



Model 1074 Television Analyst

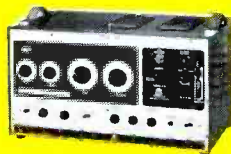

Model 1076 Television Analyst



Model 850 Color Generator



Model 445 CRT Rejuvenator Tester

NEW TUBE INFORMATION SERVICE

Available every 3 months, on subscription, for all B&K Dyna-Quik Tube Testers



B&K MANUFACTURING CO.

DIVISION OF DYNASCAN CORPORATION

1801 W. BELLE PLAINE AVE. • CHICAGO 13, ILL.

Canada: Atlas Radio Corp., 50 Wingold, Toronto 19, Ont.

Export: Empire Exporters, 253 Broadway, New York 7, U.S.A.

Circle 31 on literature card

Oxford...

THE SYMBOL OF BETTER SOUND

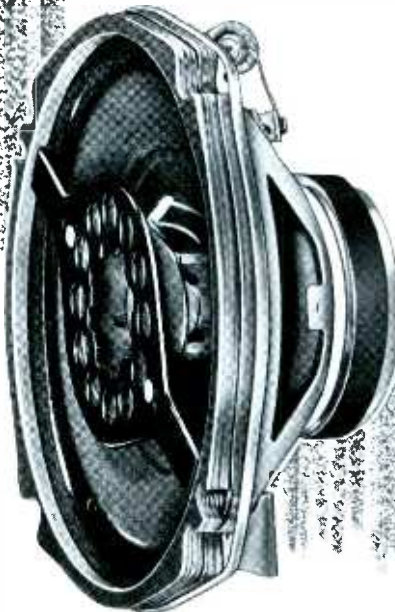

MODEL C8T

INTRODUCES AN ENTIRELY NEW LOUDSPEAKER FOR COMMERCIAL SOUND APPLICATIONS

Here is a full-range speaker that will satisfy the requirements of even the most critical audio engineers.

Designed for varied commercial sound uses, including background music, paging and intercom, the new Oxford C8T features an unusually wide distribution pattern (110°) combined with superb high fidelity sound reproduction. The C8T is a true coaxial type speaker with dual cone and magnet construction and built-in crossover. Frequency response is from 45 to 15,000 CPS and is one of the most

efficient 8-inch speakers available today.

It's priced right, too, providing an edge in today's competitive market. Oxford "know-how" and volume makes it possible to peg the price of the C8T under many single cone 8's in use today.

The C8T is representative of Oxford's *advanced* commercial sound line, where quality and price are perfectly blended to give you the world's greatest speaker values.

Write today for complete information on the new C8T speaker. Ask for Bulletin No. C-102.



OXFORD TRANSDUCER COMPANY

Division of OXFORD ELECTRIC CORPORATION

2331 North Washtenaw Ave. • Chicago 47, Illinois

Circle 32 on literature card

enough to open the return switch; as a result, the solenoid overheats. Increasing the power supply voltage to around 16 volts (for a 12 volt radio) will return the solenoid but this leaves excessive voltage on the radio for making other service checks and adjustments.

To overcome this regulation problem, this supply uses transistor control of the output voltage. The complete circuit is shown in Fig. 8. A tapped transformer supplies low voltage AC to full-wave silicon rectifiers. A switch selects either of two voltage ranges: 0-8 or 8-16 volts.

The P-612 output circuit differs considerably from the conventional choke and capacitor filter circuit of Fig. 9A. Here, all current must pass through a fixed-resistance filter choke. And even though the resistance of the choke is only ½ ohm, there is still a drop of 5 volts in the output voltage if the output current is increased to 10 amps. This kind of circuit presents no problems when current drawn is constant, since the DC voltage to the filter input can merely be stepped up to overcome the loss in the choke. The problem arises when recurring surges of high current are required—such as during the returning of the signal-seeking tuner solenoid.

Fig. 9B shows a simplified version of the transistor-controlled circuit used in the P-612. The voltage reaching the circuit from the rectifiers is filtered first by 10,000 mfd capacitor C1. A 400 ohm pot, R1, is shunted across the rectified voltage. Adjusting the arm of R1 varies the base voltage of the transistor and so, effectively alters the emitter-collector resistance of the transistor. Since this resistance is in series with the negative side of the output line, it controls the output voltage.

This takes care of the voltage control but has no effect on regulation or filtering of the output voltage. The latter is done by C2 which is tied directly from the positive side of the line to the base of the transistor. Any sudden change in output voltage is immediately impressed on the base to counteract the change. For example, if the voltage instantaneously goes down (as a result of ripple or of increased output current), the voltage on the base of the transistor also lowers (becomes more negative); this causes the transistor to conduct more, providing greater negative output voltage and counteracting the initial loss. This may mean that, as more output current is drawn, the resistance in series with the output voltage is reduced automatically to provide less voltage *drop* and thus more output voltage.

We connected the P-612 in the lab, first to a 6 volt radio having a vibrator power supply. We connected a scope directly across the power supply terminals to check the ripple. With the radio off, there was no discernible ripple with the scope at full gain. With the radio drawing 6.5 amps at 8 volts, the total ripple voltage was just .08 volt peak to peak, including the considerable hash from a rather reluctant vibrator.

We then connected the supply to a transistor signal-seeking Delco radio (12

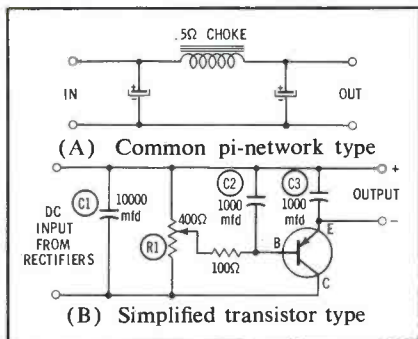

Fig. 9. Old versus new, in filter circuits.

volt). With the radio on and drawing slightly under 2 amps, there was only about .01 volt ripple. With the P-612 voltmeter set at 11.5 volts we started the radio seeking. When the pointer had scanned across the dial, the solenoid flipped it back without a hitch.

Realizing that this low ripple and extremely good regulation would be useful for checking transistor radios with class-B output stages, we connected the P-612 to a portable transistor radio. There was absolutely no discernible hum in the radio output, nor was there any change in output voltage (using a sensitive DC scope as the monitor) as the radio was played at full volume.

The P-612 has two built-in protective devices to prevent damage should the load become excessive. The first is a 1½ amp line fuse. The other is a quick-acting circuit breaker that disconnects the output transistors should the output leads be accidentally (or purposely) shorted.

The circuit breaker relay has both high resistance (voltage operated) and low resistance (current operated) coil windings. In normal operation, the points on the relay are open. All output current passes through the current coil on the relay, but with normal loads there is not enough pull to close the contacts. The voltage is connected through a 1000 ohm resistor to the negative side of the line and the other end connects to the positive side. The resistor reduces the current through the coil enough that the relay points will not close, but the relay is kept "ready" so excessive current through the current coil will close the points.

When the points close, due to an overload, the voltage-coil resistor is bypassed, and the voltage will hold the relay in. The second set of points shorts the base of the DS520 transistor to its emitter; this cuts off the control transistor and, since it is DC coupled to the output transistors, also cuts them off—removing the output voltage and protecting the transistors against damage.

The breaker stays closed until the power supply is turned off, and the output voltage will not return. Even after the unit is off, the charge on the 10,000 mfd capacitor holds the relay closed for an additional 8 to 10 seconds; then the relay will open up and the output voltage will return if the supply is turned back on. ▲

For further information, circle 68 on literature card.

FREE!

2 EASY-TO-USE DE-SOLDERING TIPS FROM



Ungar

when you
buy the #270

Ungar® de-soldering kit

Buy this kit, and mail the coupon inside for Ungar's #861 Triangle Tip and #863 Cube Tip. A \$1.20 value absolutely free!

Ungar's #270 De-Soldering Kit contains a lightweight pencil Handle with full length, extra flexible insulated cord. Plus the #4045 Super Hi-Heat Unit with special 3/16" tap. Also five special shaped de-

soldering tips: #857 Slotted Tip, #856 ¼" Cup Tip, #855 ⅜" Cup Tip, #854 1" Cup Tip and #858 Bar Tip.

These tips remove components 70% faster, because they desolder all terminals simultaneously. Correct heat is delivered exactly where needed to prevent lug breaking, shorting and printed board rupturing. Only \$5.83 ea

BONUS OFFER

FREE DE-SOLDERING BOOKLET

For Just Visiting Your Ungar Distributor! Get It Now!

**UNGAR ELECTRIC
TOOLS** ELECTRONIC DIVISION OF ELDON INDUSTRIES, INC.
Hawthorne, California 90252

Circle 33 on literature card

Tough Dog

(Continued from page 33)

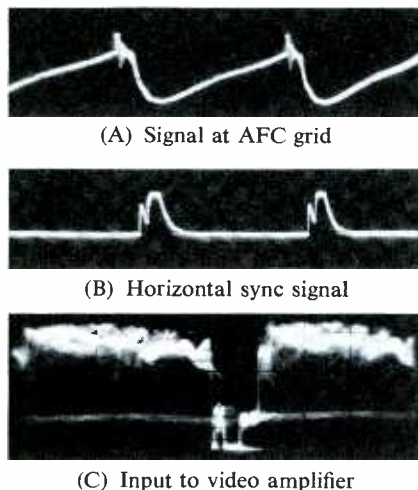

Fig. 7. Waveforms in receiver with critical horizontal sync; traced to defective balun. pulse. Further checking in the horizontal sync-separator circuit revealed that R96 (Fig. 6) had dropped from 6800 ohms to less than 500 ohms. Replacing this resistor with a 6800-ohm unit cured the critical hold. The horizontal sync signal then appeared as in Fig. 5C, and the combined waveform looked like Fig. 5D.

A study of Fig. 6 will show why some horizontal locking action is possible despite the defect in R96. The sync section contains separate vertical and horizontal sync separators. The vertical sync separator is fed from the video amplifier through an RC network with time constants favoring the vertical. The horizontal sync is fed through networks favorable to horizontal pulses. The outputs of both separators are fed to the same sync amplifier (V18), and the horizontal pulse is coupled from the plate through C91 to the *Synchroguide*. Thus the trace in Fig. 5B is the horizontal pulse coming through the vertical separator. Since time constants in this stage are not correct for a sharp horizontal sync pulse, the broad integrated pulses result. The same symptoms have been encountered in other RCA models.

In the case of another older model RCA, the cause of critical horizontal

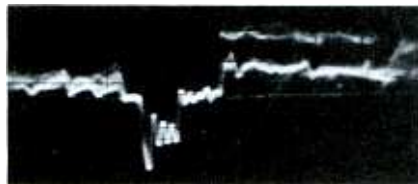

Fig. 8. Waveforms distorted similar to those in Fig. 7; caused by open video peaking coil.

sync was as unusual as the combined signal observed on the AFC grid. The odd waveform is shown in Fig. 7A. It resulted in my checking next the sync output. This gave the trace in Fig. 7B. Scoping further back to the video amplifier revealed the trace in Fig. 7C, which was present at the video-amplifier input. Since this last waveform indicated trouble in the video signal circuits, I took a more critical look at the picture, which I had previously accepted as pretty good, considering the age of the receiver. A more critical examination of the picture revealed a grainy appearance in the background. Grain is a distant cousin of snow, and since snow relates to trouble in the RF stage my troubleshooting was directed to that stage. There I found the culprit which, unlikely as it may seem, was an unravelling balun.

About a month after my bout with this RCA, I worked on an old Crosley with critical horizontal sync. Using the scope to examine the combined sync and sample signal on the *Synchroguide* showed a trace identical to Fig. 7A. The sync pulse looked identical to that shown in Fig. 7B. I thought, "Obviously another bad balun." One more look at the set changed my mind—the Crosley didn't use a balun; instead it used a continuous tuner similar to those used in older model DuMonts. This discovery led me to grab the scope probe to again check the video amplifier. The trace shown in Fig. 8 was obtained at the video-amplifier plate. The waveform at the video detector was not as distorted. Checking the video-amplifier components brought to light a defective peaking coil. That's a *long* way from the tuner.

Oscillator Coils

So far, no mention has been made of the adjustment of the ringing (phasing) coil, because most servicemen are familiar with this adjustment. This is not to de-emphasize the importance of correct adjustment. Some technicians are in the habit of adjusting the phasing coil in every *Synchroguide*-equipped receiver. Others seldom adjust the coil if the set has a hold control as part of the oscillator-coil core.

However, in some more recent *Synchroguide* circuits, the oscillator core is fixed. A portion of this cir-

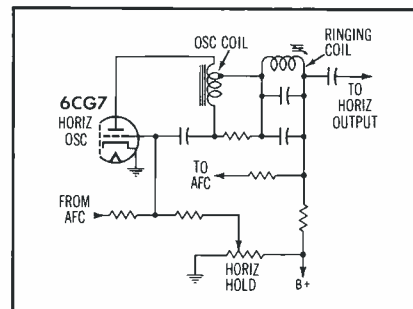

Fig. 9. A modernized form of *Synchroguide*.

cuit is shown in Fig. 9. One such receiver I recently serviced seemed extremely sensitive to ignition noise from passing cars. It was impossible to correct the trouble by adjusting the phasing coil to produce a correct scope trace of the sine-and-sawtooth combination waveform. With the horizontal in best sync, the sine-and-sawtooth signal appeared as in Fig. 10. Adjusting the ringing coil to raise the level of the sine wave only led to a loss of horizontal sync.

After considerable troubleshooting failed to locate a faulty component, I decided to reposition the core in the oscillator coil. These cores are positioned at the factory and locked in place with wax. I heated the core and removed it entirely. Next I adjusted the hold-control potentiometer to midrange. Then the core was slid into the coil until horizontal synchronization was obtained with a correct sine-and-sawtooth-signal present on the scope. Some additional wax was melted into the coil to hold the core in this new position, and the repair was complete.

Conclusion

While this article has been concerned chiefly with the most common type of *Synchroguide*, the servicing procedures apply to any of the variations. By applying this knowledge of unusual circumstances, the serviceman should be able to solve tough-dog *Synchroguide* problems with little trouble. ▲

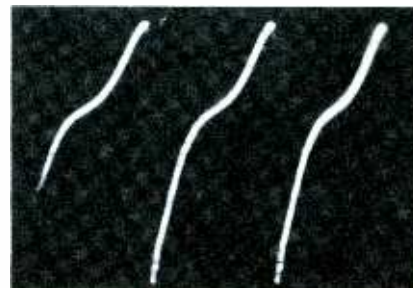

Fig. 10. Abnormal waveform resulting from improper placement of slug in oscillator coil.

Any type of TV lead-in...

BELDEN makes it!

Your **BELDEN** distributor has it!



PERMOHM* 8285 . . . excellent for color TV. Gives stronger, clearer UHF and VHF signals under conditions of extreme salt spray, industrial contamination, rain, and snow. 300 Ohm.



STANDARD 300 OHM LINE 8225 . . . low losses at high frequencies. Well suited for use with FM receiving antennas.



CELLULINE* 8275 . . . installs easily . . . no end sealing necessary. Has excellent resistance to sun, abrasion, and wind. Delivers strong UHF and VHF signals. 300 Ohm.



WELDOHM 8230 . . . resists pulling, whipping, twisting. Weldohm has two and a half times the flexing life, and one and a half times the breaking strength of ordinary 300 ohm lead-in.



DECORATOR CABLE 8226 . . . for interiors . . . neutral color blends into decor of any room. No dark brown color to contrast with light carpets or walls. 300 Ohm.



COAXIAL TRANSMISSION LINES—RG/U AND FOAM RG/U TYPES . . . low-loss signal transmission for multiple TV installations such as motels.

Your Belden distributor has a complete line of Belden TV lead-in cable . . . in standard lengths for easy handling. He also carries microphone and shielded power supply cables; hi-fi, stereo, and phonograph cables; power supply cords; multi-conductor portable cordage; antenna rotor cables; hook-up wire; TV and cheater cords; aluminum ground wire . . . plus many other related items.



Better Built . . . Better Buy . . .



WELDOHM, PERMOHM, CELLULINE are Belden Trademarks
Reg. U.S. Pat. Off. *Belden Patents U.S. 2,782,251 and 2,814,666

8-9-3

cord sets and portable cables • electrical household cords • magnet wire • lead wire • automotive wire and cable • welding cable

Circle 34 on literature card

Troubleshooter

(Continued from page 23)

Record a tape at several levels, playing each recording back, with a distortion analyzer connected to the output of the recorder. Increase the recording level until the reading on the analyzer increases rapidly. This point is, for practical purposes, 100% tape saturation.

This Is A Sawtooth?

An Airline Model 35WG-3060B (PHOTOFACT Folder 212-2) has given me a lot of trouble. After replacing a bad

flyback transformer, I still had no high voltage or raster, until I applied a drive signal from an outside source to the grid of the horizontal output tube. Since this test resulted in a normal raster, I knew I had horizontal-oscillator trouble; yet I can't pin down the kind of trouble I'm facing.

The oscillator is not dead, but does not seem to put out enough drive or the right kind of signal. Replacing all resistors, and substituting silver mica units for all capacitors, has not helped. All voltages on the oscillator tube seem to be okay, but there is only a volt and a half of negative bias on the grid of the

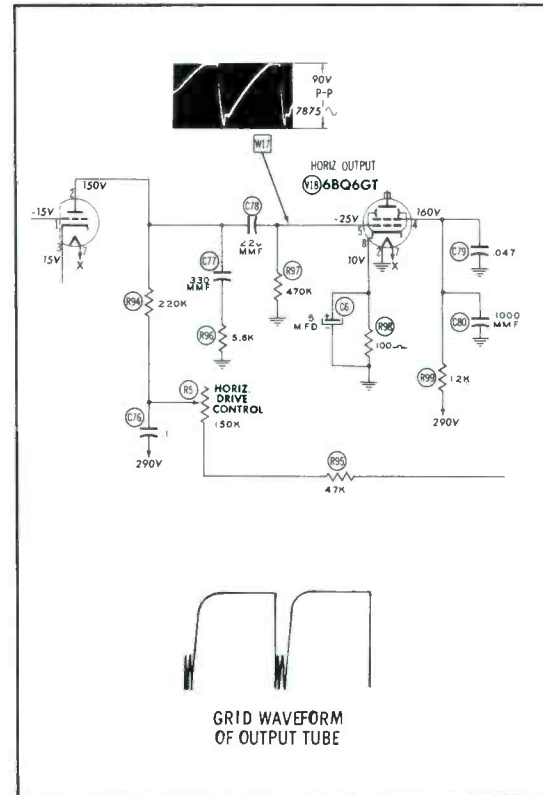

output tube. The peak-to-peak voltages at the grid measures 120 volts with either a scope or an AC VTVM. It has the odd shape shown in the attached sketch when the oscillator is driving the sweep circuit, but the substitute signal appears to have a normal sawtooth waveshape.

R. SHEARER

Albuquerque, N. Mex.

The strangely shaped drive waveform is most probably due to a greatly shortened RC time constant in the sawtooth-forming network between the oscillator and output tube. I strongly suspect an open C77 or R96, or a faulty connection to one of these components. Removal of this network causes the oscillator to put out a virtual square wave, like the one you have sketched. Since the grid of the output tube is held at the positive peak value of the signal voltage through most of each cycle, the tube cannot drive the flyback circuit in proper fashion, and flyback current will be excessive. The long duration of the positive peak also explains the lack of bias on the output tube. ▲

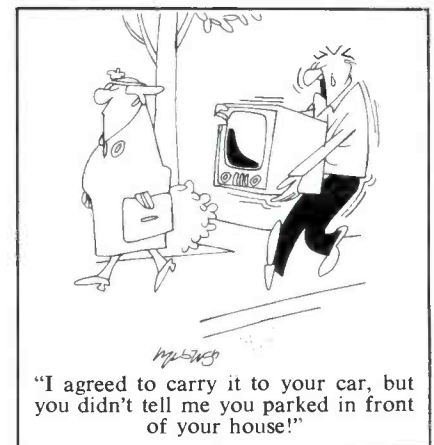

Model 801 CRT TESTER-REACTIVATOR

TESTS REPAIRS REACTIVATES

BLACK/WHITE
PICTURE TUBES

COLOR
PICTURE TUBES



Take the guesswork out of testing, repairing and reactivating both black/white and color picture tubes. The Model 801 helps increase picture tube sales, satisfy customers and boost service income. Does the job in the set or in the carton.

EXCLUSIVE FEATURES

- ✓ "Watch-it-reactivate" feature... see and control the reactivation process on the meter as it takes place.
- ✓ No adapters required... exclusive Multi-Head enables you to test all picture tubes with a single cable and test head.
- ✓ Provides new 12v filament voltage as well as 2v, 6v, and 8v voltages.
- ✓ Filament burn-out protection.

TESTS: all black/white and all color picture tubes for cathode emission, inter-element shorts, screen grid continuity and life expectancy • Accommodates picture tubes from 3" to 30", 15° to 115°, 12-pin base, 8-pin base, 14-pin base or the very latest 7-pin base. This includes the new picture tubes with low screen voltages and the new "SF" types • The red, green and blue color guns of color picture tubes are handled separately • Separate short test provided for each picture tube element • Special visual life-expectancy test estimates the remaining life of the picture tube

REPAIRS: will eliminate inter-element shorts and weld open elements with complete safety to the picture tube

REACTIVATES: A specially designed controlled high voltage pulse is employed. An exclusive "watch-it-reactivate" feature enables you to see and control the reactivation process directly on the meter as it takes place. This eliminates the danger of over-reactivation • Quick reference pictorial guide on panel • Housed in handsome sturdy leatherette carrying case • Size 11 1/8" x 9 1/2" x 4 1/2"

See your electronics parts distributor or write for complete literature

Mercury ELECTRONICS CORPORATION
manufacturers of quality electronic products

111 Roosevelt Avenue, Mineola, New York

Circle 35 on literature card



Product Report

For further information on any of the following items, circle the associated number on the Catalog & Literature Card.

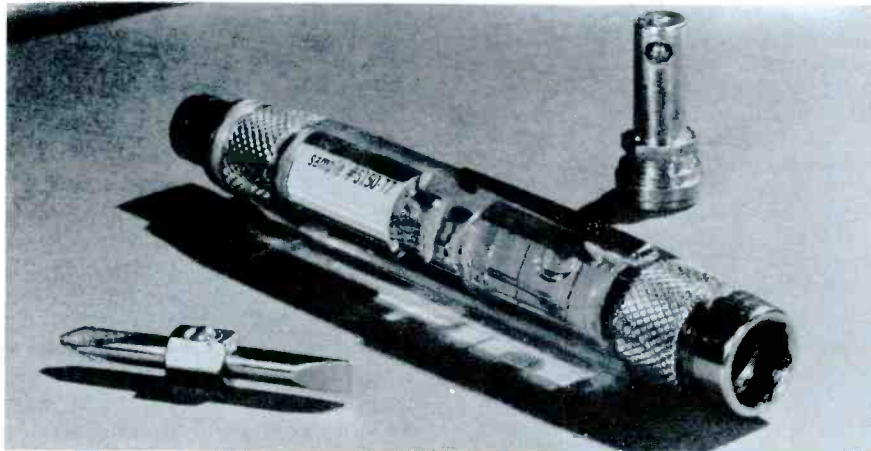

Pocket Tool (135)

A service tool that clips to the pocket is the new compact "7 in 1" by **Exclusive Products Co.** In addition to containing a high voltage tester, the tough "Tenite" butyrate handle also houses an accurate 1" spirit level, a 3/8", 1/4", and 5/16" hex socket, a standard screwdriver, and a Phillips attachment. All tool parts are hardened tool steel, nickel plated.



Chassis on High (136)

A versatile fixture that situates a chassis at any desired height for assembly, test, and service work has been developed by **Matrix Engineering Corp.** The Model 701 features a worm gear transmission that assures the simplest and most practical arrangement to safely lock the chassis in any desired position within the unit's 360° rotation range.

Log-Periodic UHF Antennas (137)

A new series of UHF antennas based on the log-periodic concept is being produced by **JFD Electronics Corp.** The new units are available in four models to suit

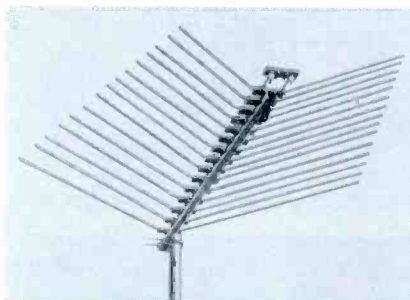

local, suburban, fringe, and deep-fringe areas. V-dipoles in the 3/2-wavelength mode achieve horizontal-plane half-power beamwidths between 28° and 35°. This narrow beam improves rejection of multi-path signals and interferences. For deep fringe and special problem areas, phasing bars are available for stacking the antennas. These same bars can be used to couple several antennas beamed toward different directions.



Mono Speaker for Stereo (138)

A monophonic extension speaker system can be used with stereo sets using an

HM-90 matching transformer developed by the **Microtran Co.** This new transformer is designed to take both left- and right-channel signals and mix them together to provide one balanced "center" channel. Net price is \$6.33.



Marine and CB (139)

The "Escort" is one of a line of **Pearce-Simpson** radiotelephone units introduced at a recent boat show in Florida. This particular unit is a Citizens-band transceiver, with 8 fixed channels and a receiver tunable for all 23 CB channels. The set can be used on 117 volts AC or 12 volts DC, and features squelch control, output metering, signal-strength meter, 1/2-uv sensitivity for squelch opening, and complete hand wiring. With 5 watts input, the "Escort" delivers 3 watts of RF power into a 52-ohm load. The transceiver, complete with two crystals, microphone, power cables, and mounting cradle, sells for \$229.95. The company also builds a variety of marine radiotelephone equipment.



Rechargeable Battery (140)

A rapid-charge battery which holds promise both for space uses and for powering portable tools and appliances is a new development at **General Electric.** Although conventional sealed batteries require about 15 hours to recharge, this sealed cadmium cell may be recharged in less than an hour, actual time depending on battery size. Ratings now available are: 3, 6, 12, 20, and 40 ampere-hours.

Adapter for Keyed Rainbow Display (141)

A new Model A-106 Adapter to provide crystal-controlled keyed rainbow color display and more accurate horizontal synchronization for Model 1076 Television Analysts is announced by **B & K Mfg., Division of Dynascan Corp.,**

a tool chest
in your
pocket

for electronic assembly
and service work

Shockproof (UL), breakproof,
plastic handles with clips

ROUND-BLADE SCREWDRIVERS

$\frac{3}{32}$ " and $\frac{1}{8}$ " x 2", 3", and
4" blades

PHILLIPS SCREWDRIVER

Point size #0, 2" blade

BERYLLIUM-COPPER SCREWDRIVER

Non-magnetic, non-sparking
 $\frac{1}{8}$ " x 2" blade

NUTDRIVERS

10 Hex sizes from $\frac{3}{32}$ " to $\frac{3}{8}$ "
 $1\frac{1}{4}$ " blades
Color coded handles

TERMINAL WRENCHES

Fit $\frac{1}{4}$ " and $\frac{3}{16}$ " O.D. spanner nuts
on external antenna and phone
jacks of transistor radios

WRITE FOR LITERATURE

XCELITE

**PROFESSIONAL
POCKET TOOLS**

XCELITE, INC., 18 Bank St., Orchard Park, N.Y.
Canada: Charles W. Pointon, Ltd., Toronto, Ont.
Circle 59 on literature card

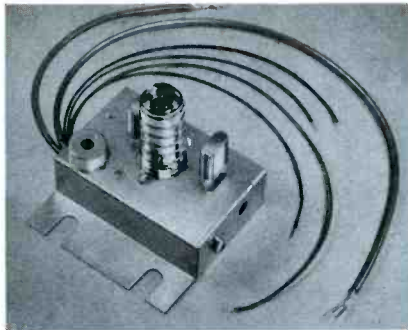

Chicago, Illinois. This crystal-controlled circuit is already being incorporated in the current Model 1076 Television Analyst. The new adapter provides a crystal-controlled keyed-rainbow display for better definition of each color bar in the pattern. The adapter also improves horizontal stability. Net price is \$35.95.

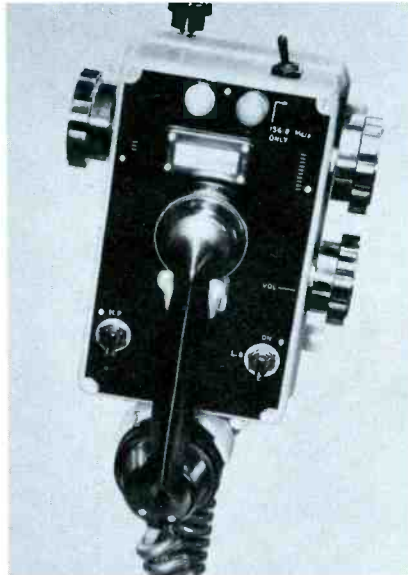

CB Frequency Meter (143)

The Budelman Type 17A4 frequency meter can be used as a field-strength meter or for measuring Citizens-band frequencies in the 27-mc band. Rated accuracy is .001%. It operates from self-contained batteries, making it useful in the field as well as on the bench.

The instrument indicates frequency difference directly in kilocycles per second on a calibrated meter. It can be equipped with up to four crystals for measuring up to 12 Citizens band frequencies. Each crystal permits measurement of three channels—the one for which the crystal serves as a zero reference, the channel 10 kc below, and the channel 10 kc higher.

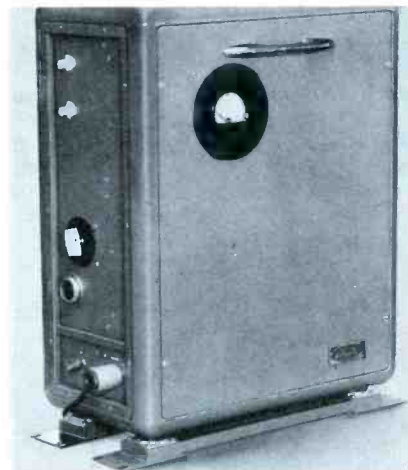

Marine VHF Sets (142)

VHF-FM two-way radios for marine use have been added to Raytheon Company's line of electronic communication and navigation aids. The sets cover the band from 156 to 162 mc and have an override selector for Channel 16, the international VHF safety-and-calling frequency. Covering all 28 international VHF channels, the new Model RAY-124ME28 consists of a transmitter-

receiver with built-in power supply, and a control unit, loudspeaker, and antenna. Remote operation at one or two locations is optional. Cabinets are made of aluminum. The single-chassis unit hinges outward for maintenance.



Record Duster (144)

The "Changer Dust Bug," made to fit any changer arm, removes static and dust while it protects the record surface. This \$5.00 tone arm attachment is manufactured by Elpa Marketing Industries, Inc., and has a plush-pile cleaning head with added antistatic agent to eliminate dust and microscopic dirt ahead of the stylus.

Extends Tube Life (145)

A new fin-type heat-dissipating tube shield is now being marketed by Cool-Fin Electronics Corp. Called the CFT-16ELDS, the new tube shield reduces



Tools. The A150 features a steel insert along the cutting edge to lengthen service life, increase the tool's hardness and cutting abilities, and insure more precise cutting. An exclusive feature of the Hunter A150 is the method of attaching the steel tip. The cutter is designed so the tip is exposed along the cutting edge but is protected by the body of the plier on all other surfaces, thus reducing chances of the insert breaking away.

temperature up to 60° below bare-bulb temperature, and increases the life of KT88, 6336, and tubes with similar envelopes.



Wire Cutter (146)

A wire cutter specifically designed for cutting the nickel leads used in welded modules is a new product of **Hunter**

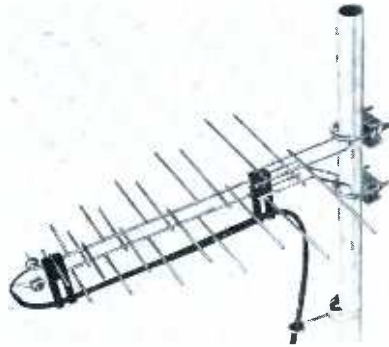

New UHF Antenna (147)

A new UHF television antenna, based on principles used in the U.S. satellite program, has been announced by **Blonder-Tongue Laboratories, Inc.** The "Golden Dart" rounds out a line of UHF products which includes converters, boosters, amplifiers, and couplers. List price of the antenna is \$5.95.



Replacement Transformers (148)

Merit Coil & Transformer Corp. has added several new replacement transformers to their existing line. Among these is the HVO-225, a horizontal fly-back transformer designed to replace several Setchell-Carlson types. This transformer nets for \$8.78.

New Paging Equipment (149)

A line of transistorized encoders for use with pocket paging equipment has been announced by **Multitone Electronics, Ltd.** The new encoders are preset for automatic coding and call duration, and have provision for connecting a speech unit, remote control units, or remote triggering. They are serviced with interchangeable circuit boards. Two codes permit identification of urgent



messages or speech calls. Speech can be transmitted by plugging in a new noise-cancelling dynamic microphone that has a built-in preamplifier. The Type EA4 transistorized desk model provides 70 individual paging channels. Receivers with the new encoders weigh only 5 oz. and are 1/2" thick. ▲

INDEX TO ADVERTISERS

ATR Electronics, Inc.	14
Acme Electric Corp.	44
Antennacraft Co.	88, 89
Atlas Sound	46
B & K Mfg. Co.	54, 55, 63
Div. of Dynasean Corp.	
Belden Mfg. Co.	67
Berns Mfg. Co., Inc.	101
Blonder-Tongue Labs	85
Bussmann Mfg. Div.	22, 23
Cadre Industries	101, 103
Castle TV Tuner Service	18
Channel Master Corp.	47, 51
Cleveland Institute of Electronics	90
Communications Co., Inc.	104
Cornell-Dubilier Electric Corp.	26
Delco Radio Div.	93
EICO Electronic Instrument Co., Inc.	19
Electronic Communications, Inc.	97
Enterprise Development Co.	44
Finney Co.	95
GC Electronics Co.	81
General Electric Co.	16, 17
General Radiotelephone Co.	80
Hallmark Instruments	100
Heath Co.	82, 84
International Rectifier Corp.	31
Jensen Mfg. Co.	57
E. F. Johnson Co.	96
Lafayette Radio Electronics Corp.	61
Littelfuse, Inc.	Cover 4
Mallory, P. R. & Co., Inc.	91
Mercury Electronics Corp.	68
Mosley Electronics, Inc.	98
Multicore Sales Corp.	100
Oxford Transducer Co.	64
Perma-Power Co.	42
Philco Corp.	52, 53, 87
Planet Sales Corp.	101
Precision Electronics, Inc.	50
Precision Tuner Service	46
RCA Electronic Components and Devices	13, 24, 25, 79, 92
RCA Parts and Accessories	Cover 3
RCA Sales Corp.	39
Sams, Howard W. & Co., Inc.	99, 102
Sarkes Tarzian, Inc. Tuner Service	9
Seco Electronics, Inc.	60
SENCORE, Inc.	15, 41, 43, 45, 49, 75
Simpson Electric Co.	56
Sonotone Corp.	94
Sprague Electric Co.	11, 12
Standard Kollsman Industries, Inc.	Cover 2
Switchcraft, Inc.	71
Sylvania Electric Products, Inc.	59
Texas Crystals	100
Trio Mfg. Co.	62
Unger Electric Tools	65
University Loudspeakers, Inc.	83
Winegard Co.	20, 21, 102
Xcelite, Inc.	70
Yeats Appliance Dolly Sales Co., Inc.	96

**FOR TECHNICIANS, SERVICE MEN,
HI-FI, STEREO HOBBYISTS**

SWITCHCRAFT
Everyday Necessities

2 NEW PHONO JAX

- Eliminate rivet mounting.
- Convenient replacement for old style Jacks.

No. 3501FP—Lock Nut back of panel, requires only 1/4" hole.



No. 3501FR—For front of panel mounting, where necessary to assemble Jack through the panel from the back due to lack of space.



NEW PHONO PLUG

No. 3502—Removable handle—exposed terminals. Nickel plated brass body and handle. Can be used in multiples even where Jacks are on 3/16" centers.



NEW PHONO EXTENSION JAX

No. 3503—Removable handle. Cable clamp. Shielded. Nickel plated brass.



SWITCHCRAFT®

5573 N. Elston Avenue, Chicago, Illinois 60630
Canada: Atlas Radio Corp., Ltd.
50 Wingold Ave., Toronto, Canada
Circle 65 on literature card



FREE Catalog and Literature Service

*Check "Index to Advertisers" for further information from these companies.

Please allow 60 to 90 days for delivery.

ice provided by the Greyhound Package Express method of shipping, with rates and routes.

115. **TERADO**—Literature on Models 50-202 and 50-191 power inverters, designed for operating 110-volt equipment from automobiles, boats, and other low-voltage power sources.
116. **VOLKSWAGEN**—Large, 60-page illustrated booklet "The Owner's Viewpoint" describes how various VW trucks can be used to save time and money in business enterprises; includes complete specifications on line of trucks.

TECHNICAL PUBLICATIONS

117. **CLEVELAND INSTITUTE OF ELECTRONICS**— "Pocket Electronics Data Guides" with handy conversion factors, formulas, tables, and color codes. Additional folder, "Choose Your Career in Electronics," describes home-study electronics training programs, including preparation for FCC-license exam.*
118. **HOWARD W. SAMS**—Literature describing popular and informative publications on radio and TV servicing, communications, audio, hi-fi, and industrial electronics; including special new 1964 catalog of technical books on every phase of electronics.*
119. **MOTOROLA**—Brochure describing home-study course on servicing FM two-way radio; includes section on transistors and transistorized equipment.

TEST EQUIPMENT

120. **B & K**—Catalog AP-21R describing uses for and specifications of new Model 1074 Television Analyst, Model 1076 Television Analyst, Model 850 Color Generator, Model 960 Transistor Radio Analyst, new Model 445 CRT Tester-Rejuvenator, new Model 250 Substitution Master, Model 375 *Dynamatic* VTVM, Model 360 *V-O-Matic* VOM, Models 700 and 600 *Dyna-Quik* Tube Testers, and Model 1070 *Dyna-Sweep* Circuit Analyzer.*
121. **EICO**—New 32-page, 1964 catalog of test instruments, hi-fi components, tape recorders, Citizens band, and amateur radio equipment.*
122. **HICKOK**—Complete descriptive and specification information on newly introduced equipment—Model 662 installer's color generator; Model 580 portable tube tester; Model 727 multiplex generator; Model 235A portable field strength meter.
123. **JACKSON**—Complete catalog describing all types of electronic test equipment for servicing and other applications.
124. **LAMPKIN LABORATORIES**—Informative booklet tells "How to Make Money in Mobile Radio Maintenance."
125. **MERCURY**—Literature describing line of test equipment, including self-service tube testers.*
126. **SECO**—Product sheet describing Model 88TC *caddy pack* tube tester; a tube caddy with built-in tester.*
127. **SENCORE**—Question-and-answer bulletin on requirements of color TV and FM multiplex test equipment.*
128. **SIMPSON**—Latest series of VOM's are described in test-equipment bulletin; also information on line of automotive test equipment.*
129. **TRIPLETT**—Brand new test equipment catalog No. 45-T, listing complete line of testers and accessories.

TOOLS

130. **BERNS**—Data on unique 3-in-1 picture-tube repair tools, on *Audio Pin-Plug Crimper* that enables technician to make solderless plug and ground connections, and on new-style *ION* adjustable "beam bender" for CRT's.*
131. **ENTERPRISE DEVELOPMENT**—Time saving techniques in brochure from Endeco demonstrate improved desoldering and resoldering techniques for speeding up and simplifying operations on PC boards.*
132. **KESTER SOLDER**—Informative "Soldering Simplified" booklet gives valuable tips on the art of soldering.

TUBES & SEMICONDUCTORS

133. **SEMITRONICS**—New updated 16" x 20" wall chart CH10 lists replacements and interchangeability for transistors and diodes.
134. **AMERICAN ELITE**—48-page semiconductor catalog and technical notes on AEG selenium rectifiers, including bridge and voltage-doubler circuits.

ANTENNAS AND ACCESSORIES

69. **ALLIANCE**—Brochure describing *Tenna-Rotor* Model C-225.
70. **ANTENNACRAFT**—Catalog sheet, illustrated in color, with information on connecting a UHF and a VHF antenna together using intercoupler G1483W.*
71. **CORNELL-DUBILIER**—Copy of informative booklet titled "Improved TV and FM Reception."*
72. **FINNEY CO.**—Brochure describing newly introduced duo-twin driven antenna, *The Explorer*, especially designed for fringe-area reception.*
73. **GC ELECTRONICS**—Specification sheet No. FR-542-G on *Colormagic* fringe-area antenna, and exact replacement cross reference guide for indoor TV antennas.*
74. **JERROLD**—"J-Jacks at the U.S. Office of Education" brochure describing distribution system for off-the-air and closed-circuit television.
75. **JFD**—Specifications and operating information on *Transis-tenna* and newly designed, long-range LPV log-periodic TV antennas. Illustrated brochure showing entire line of indoor antennas and accessories for TV and FM. Data sheets on UHF antennas.
76. **KRECKMAN CO.**—Catalog No. H64, listing complete line of communications antennas.
77. **MOSLEY ELECTRONICS**—Illustrated catalog giving specifications and features on large line of antennas for Citizens band and amateur applications.*
78. **TRIO**—Illustrated sheets showing line of antennas for TV and FM reception; also includes information on *Color-Brite* line of UHF antennas for color reception.*
79. **ZENITH**—Informative bulletin on new line of log-periodic vee-type antennas for FM, and monochrome and color TV.

AUDIO & HI-FI

80. **ATLAS SOUND**—Specification sheets describing new economy Model EC-10 paging and talkback speaker for intercoms, low power paging systems, and Citizens band transceivers.*
81. **FANON-MASCO**—Five catalog brochures describing intercoms for industrial, home entertainment, and other applications.
82. **GIBBS SPECIAL PRODUCTS**—Folders describing principles of sound reverberation and *Stereo-Verb* reverberation units for automobiles.
83. **OAKTRON**—"The Blueprint to Better Sound," an 8-page catalog of loudspeakers and baffles giving detailed specifications and list prices.
84. **OXFORD TRANSDUCER**—Product information bulletins describing complete line of loudspeakers for all types of sound applications; including replacements for public address and intercom systems.*
85. **QUAM-NICHOLS**—New hi-fi catalog listing specifications and response limits for coaxial, extended-range, low-frequency woofer, and tweeter speakers, in addition to other components.
86. **SHURE**—New catalog covering microphones, cartridges, and tone arms.
87. **SONOTONE**—Product brochure on ceramic microphone, Model CM-10A-39.*
88. **SWITCHCRAFT**—Bulletin No. 137 describing stereo-headphone adapter that permits operation of two headphones from single output.

COMMUNICATIONS

89. **AMECO**—Catalog No. G4 listing large line of RF equipment for amateurs, servicemen, laboratories, and industry; also includes list of technical books.
90. **CADRE**—Catalog sheet on complete line of Citizens band radios.
91. **E. F. JOHNSON**—4-page, full-color brochure on new all-transistor *Messenger III* Citizens band transceiver.*

92. **PEARCE-SIMPSON**—Booklet on how to choose and use marine radio telephones; brochures on complete line of two-way communications equipment, including the *Companion* and *Escort* line.
93. **COMMUNICATIONS CO.**—Specifications brochure describing *Comco* Model 684 UHF-FM two-way radio.

COMPONENTS

94. **ASTRON**—Serviceman's capacitor-replacement chart, designed to hang on the wall, gives capacitance, DCWV, size, and price.
95. **BUSSMANN**—Bulletin, SFH-10 on new compact fuseholder 1½" long, and completely water-proof; takes ¼" x 1¼" fuse; easily converts to 9/32" x 1¼" fuse by changing screw type knob.*
96. **CLAROSTAT**—1964 service components catalog.
97. **COMPONENTS SPECIALTIES**—Catalog listing line of *Speco* electronic replacement components.
98. **E-Z-HOOK**—Product sheet describing all types of clips, adapters, test leads, and probes for servicing applications.
99. **OHMITE**—Bulletin No. 105 describing new 3 and 5¼ watt *Brown Devil* wire-wound resistors; explains increased wattage rating of present sizes.
100. **PERMACEL**—16-page condensed data book describing line of pressure-sensitive tapes; includes specifications, features, and uses.
101. **RCA BATTERIES**—Brochure No. 1P1162, illustrating various selection of counter merchandiser display racks and promotional items on radio batteries.*
102. **RAWN CO.**—Product sheet and instruction bulletin gives description and uses for *Plus-T-Pair* kit; permits quick, sure repair of all types of plastic material—knobs, cabinets, etc.
103. **SPRAGUE**—Chart C-457 (designed to hang on wall) showing all popular TV, radio, and hi-fi replacement components.*
104. **TRIAD**—Technical data sheet on newly introduced color TV deflection yoke, YC-300-1.
105. **WUERTH**—Brochures describing *Surgistor* and other protective devices for electronic equipment.

SERVICE AIDS

106. **CASTLE**—How to get fast overhaul service on all makes and models of television tuners is described in leaflet. Shipping instructions, labels, and tags are also included.*
107. **PRECISION TUNER**—Literature supplying information on complete, low-cost repair and alignment services for any TV tuner.*
108. **ELECTRONIC CHEMICAL**—Product sheet on *No-Noise* line of chemical aerosols.
109. **STANDARD KOLLSMAN**—Catalog page and installation instructions for built-in UHF converter kit.*
110. **WORKMAN**—General catalog No. 102; fusible resistor and circuit breaker cross-reference guides; information on transistorized auto ignition system; and power converter sheet No. 25C.
111. **YEATS**—The new "back-saving" appliance dolly Model 7 is featured in a four-page booklet describing feather-weight aluminum construction.*

SPECIAL EQUIPMENT

112. **ACME ELECTRIC**—Complete specifications and applications for control-type magnetic amplifiers with capacities from 5-1000 watts and voltage ranges from 24-160 volts.*
113. **AMPROBE**—Descriptive literature explaining company's trade-in program on chart recorders.
114. **GREYHOUND**—The complete story of the speed, convenience, and special serv-



SPECIAL
COMMUNICATIONS
SUPPLEMENT

CONTENTS

Guide to Communications Antennas Here's a chart to help plan your antenna sales.		76
The Misaligned RF Stage This "dog" was a soft and elusive barker. The dog catcher should be so lucky. . . .	Richard Martin	78
Frequency Synthesizers Special circuits that form many frequencies from a few.	Keith Bose	86
Modulation Limiters For Two-Way Circuits that prevent transmitter overmodulation.	Edward M. Noll	92
CB For Industrial Communications It takes all kinds to handle the many jobs.	Leo G. Sands	98

For the Reader

One of our continuing aims is to bring you—our reader—bigger and better issues, jam-packed with articles on subjects that make you a better technician and build up your income and profits. Your needs and interests take precedence over any other consideration in planning the features that appear regularly in PF REPORTER.

Certain subjects obviously command more interest than others, and satisfy needs that are more widespread. Your expressed needs and wants have resulted in our regular special issues—on color TV, transistors, test equipment, and other important and popular subjects.

One field of specialization is emerging rapidly as worthy of *special* consideration—the business of two-way radio communications. Few fields are growing as rapidly as this one. There are more than 300,000 two-way radio systems in operation (not counting CB or amateur stations), and two-way sets number above 2,000,000. Many of you have expressed your need

for strong, informative articles and accurate servicing information for this type of equipment. This Communications Supplement is our answer to your demand.

Study this supplement carefully. We are considering adding it to PF REPORTER every quarter-year—in January, April, July, and October. You can help us decide. Our wish is to supply this quarterly Supplement only for those who really need it and who want to increase their knowledge and technical ability in the field of communications servicing.

A portion of this page is a questionnaire. You can do us a great favor if you'd take a moment to answer the six questions and mail the questionnaire to my attention. Here's your chance to let us know easily and directly what you want or don't want. May we hear from you?

Sincerely,

The Editor

1. Do you like this quarterly Supplement idea?
2. What article in this one do you like most? Why?

3. Which do you like least? Why?

Other Comments:

4. What subjects do you consider of most importance to the communications service technicians?

5. Is four times a year often enough?
More often? How many times?

6. Would you pay \$2.00 per year to have the Supplement bound into your copy of PF REPORTER every third month? (PLEASE DO NOT SEND ANY MONEY at this time!)

Name.....

Address.....

City & State..... Zipcode.....

Do you receive your
PF REPORTER by:

Subscription

Distributor

NEW

IMPROVED

**MIGHTY
MITE!**

NEW

Lower voltage checks for Nuvistors and all new frame grid tubes, as demanded by tube manufacturers, but not found on other tube checkers.

NEW

Speedy indexed set-up cards to reduce "look-up" time. No more cumbersome booklets, or incomplete charts.

NEW

Simplified panel layout reduces set-up time — prevents set-up errors.

NEW

Streamline styling with rounded corners and rubber feet, prevents marring Furniture — presents that "Professional look".

fast, accurate, never lets you down . . .

*New Burn-out,
stick proof meter!*



NEW TC 130

Checks them all . . .

including Novars, Compactrons,
Nuvistors, 10 pin tubes — plus
Picture Tubes!

only
\$7450

Only 7 Lbs. . .
Smaller Than A Portable Typewriter

Here's the famous MIGHTY MITE, America's fastest selling tube checker, with an all-new look and many new exclusive features. MIGHTY MITE III brings you even greater portability, versatility and operating simplicity beyond comparison. Controls are set as fast and simply as A-B-C right from the speedy set-up cards in the cover. The new functional cover can be quickly removed and placed in a spot with more light for faster reading of the set-up data or "cradled" in the specially designed handle as a space saver as shown above. New unique design also prevents cover from shutting on fingers or cutting of line cords as in older models.

In a nut shell . . . the MIGHTY MITE III is so very popular because it checks for control grid contamination and gas just like the earlier "eye tube" gas checkers (100 megohm sensitivity) and then with a flick of a switch, checks the tube for inter-element shorts and cathode emission at full operating levels. Sencore calls this "the stethoscope approach" . . . as each element is checked individually to be sure that the tube is operating like new. User after user has helped coin the phrase "this checker won't lie to me". Most claim that it will outperform large mutual conductance testers costing hundreds of dollars more and is a real winner in finding those "tough dogs" in critical circuits such as color TV and FM stereo.

*See Your Parts Distributor-- And See
The Mighty Mite III For Yourself!*

SENCORE

426 SOUTH WESTGATE DRIVE
ADDISON, ILLINOIS

Circle 39 on literature card



GUIDE TO

Communications Antennas

There is considerable choice of base station antennas available for communications equipment. Some are general purpose and others are specialized. Here is a brief description of the characteristics and use of each type classified in a recent survey. From the accompanying charts you can decide which antenna type suits the coverage needs of your customer, pick the frequency range, and find the names of the manufacturers who offer this type.



Of the omnidirectional types, the *dipole* antenna's pattern is the most "donut" shaped. It is the most simple, and usually the least expensive.

A *ground-plane* antenna consists of a quarter-wave vertical radiator and an artificial ground. It is omnidirectional horizontally, but the vertical pattern is narrower than that of the dipole.

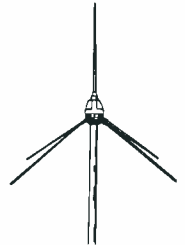

The *duo-ground-plane* type (sometimes called an "isoplan") has an extra ground plane which, because of its position and shape, lowers the radiation angle.

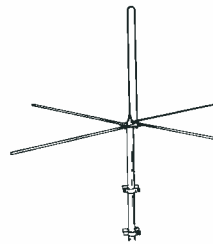
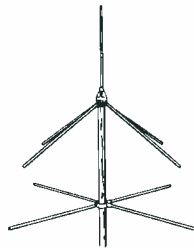

The grounded end of the radiating element of the *unipole* (folded ground plane) antenna provides a path for corona discharge and minimizes lightning hazards. Gain is similar to a ground-plane type.

Cardioid is the term applied to a unipole type that includes a grounded reflector to give a horizontally cardioid pattern (with gain of more than unity).

The *coaxial* antenna has a quarter-wave vertical radiator with a quarter-wave "skirt" below it. The skirt takes the functional place of the ground plane. Gain is higher than with the ordinary ground-plane antenna.



A lower vertical radiation angle is achieved by using a ground plane below the skirt of a coaxial type. This is called a *co-plane* antenna.

Extreme gain and directivity are possible with the *yagi* antenna—a combination of dipole radiator with reflectors and directors.

High gain can be combined with omnidirectivity by stacking dipoles vertically. Such a combination is called a *collinear* antenna.

For a high front-to-back ratio, a single *corner-reflector* type of antenna or an array of several units may be used.

The term *bidirectional unipole* is very descriptive of this dual unit that provides a "figure-eight" pattern to reduce side interference.

The *stacked unipole* configuration maintains the advantages of the unipole and adds the capability of increasing gain and arranging for desired directivity.

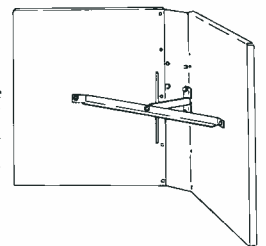
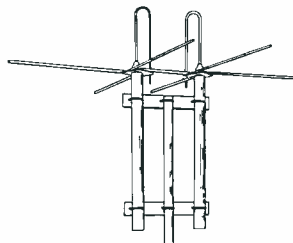
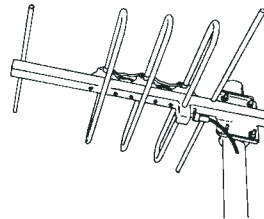
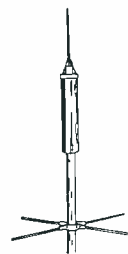

As more skirts are added below the radiator on the coaxial antenna its vertical pattern narrows, and gain increases significantly. This type can be considered a *stacked coaxial*. With three, the term "triple-skirt" is often used.



Replace the projecting rods of the typical unipole antenna with a coaxial skirt section and you have a *folded coaxial* design. This type has the advantages of the unipole in a simple unit with a low radiation angle.



Special Antenna Types	Bidirectional Unipole	Stacked Unipole	Stacked Coaxial	Folded Coaxial	Cardioid Coaxial	Screen-Reflector Yagi	all for high band VHF
Manufacturer							
Andrew Corp.	×						
Hy-Gain Antenna Prod.		×					
Herb Kreckman Co.			×				
Motorola				×	×		
Taco						×	

A grounded element added to the folded coaxial type as a reflector gives it the added characteristic of directivity. Because of its design and the resulting pattern, this is called a *cardioid coaxial* antenna.

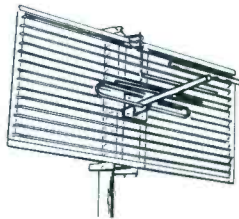

If the reflector section of a conventional yagi antenna is replaced by a screen, the resulting type is a *screen-reflector yagi*, which has greatly increased gain and front-to-back ratio. ▲

Antenna Type	Dipole	Ground-plane	Duo-Ground-plane	Unipole	Cardioid	Coaxial	Co-plane	Yagi	Collinear	Corner Reflector	freq range
Manufacturer											▼
Andrew Corp.	×	×		×	×						low band VHF
Herb Kreckman Co.		×	×	×		×	×				
Mark Products	×										
Motorola		×		×	×	×					
Taco								×			
Andrew Corp.				×	×	×			×	×	high band VHF
Cush Craft								×			
Hy-Gain Antenna Prod.		×				×					
Herb Kreckman Co.		×	×	×		×	×				
Mark Products	×								×		
Motorola									×		
Regency Electronics, Inc.						×					
Taco								×			
Andrew Corp.								×	×	×	UHF
Cush Craft								×			
Hy-Gain Antenna Prod.		×									
Herb Kreckman Co.		×	×			×	×				
Mark Products	×								×		
Motorola									×		
Taco								×			

the MISALIGNED RF Stage

Sensitivity was good on the bench, but . . .

by Richard Martin

It was just before closing time when an oil truck drove into the shop garage and blew those malicious air horns. The shock wave rattled the windows.

"Got a bad one here, boy!" the driver shouted as he cut the motor.

Being in the middle of dipping a final amplifier on a 10-watt transmitter (which demanded my full attention), I ignored him for the moment. Besides, I had intended to lock up after I got rid of this taxicab radio. "Maybe he'll go away if I don't answer him," I thought to myself.

When I heard the truck door slam, I knew I was wrong. As he was marching up to the bench, I finished peaking the output and turned to meet him. "What can I do for you?" I asked.

"I can't get the dispatcher on that thing you call a radio," he grated, jerking his thumb over his shoulder.

Musing over this statement, I turned back and tightened the high-voltage cage over the final. He might mean that he can't hear the dispatcher's messages; or he could mean the dispatcher can't hear him.

"Dispatcher can't hear you, huh?"

"I dunno, mac, I can't hear *him*; so how would I know if he can hear me?"

So! He's got receiver trouble. Now why didn't he just tell me that instead of making me play this guessing game?

"Have a seat; be with you in a minute," I said patiently.

"Well, make it snappy, buddy. I've still got five more deliveries to make before I quit; and I'm in a *big* hurry. The old lady's got a bug about going to a drive-in tonight, and she'll clobber me if I'm not home for supper."

"*She'll* clobber you? You may not have to wait . . ." I thought as I disconnected the dummy load and connected the antenna. I keyed the mike and called the taxi dispatcher for an on-the-air check. Everything okay; so I put the radio back in the cab; and the driver took off, leaving me alone with my last customer of the day—or so I hoped. Just to be

sure, I let down the garage door, drew the shades on the shop door, and locked the door.

After I finished this nightly ritual, the truck driver growled, "*Now* are you going to take care of me, pal?"

Since I didn't feel very much like a pal to him, I just said, "Yep." I hopped into the cab of his truck, turned on the ignition and radio, and waited for the radio to warm up. It was one of those new transistorized jobs. "Sure hope I can fix it quick," I thought.

Just then "squelch" noise emitted from the speaker. I waited for another half-minute to be sure the transmitter tubes were warm, and then keyed the mike. "Unit 17 at radio shop to dispatcher," I called into the mike.

No answer; in fact no traffic at all. I couldn't even hear other trucks in the system; and they were undoubtedly calling in for any final deliveries of the day.

"Radio shop to dispatcher," I said once again. Still nothing.

"Radio shop to any unit," I tried as a last resort. Again nothing.

Switching off the radio and ignition, I told the driver I'd have to put the set on the bench. I unlocked the case, disconnected the cables, and removed the radio from its case. It was mounted upside down on the ceiling of the cab—on the passenger's side where no one ever sits. Quite a tight fit, too. When I finally got it loose, it came tumbling down on me, almost knocking me out of the cab.

I placed the radio on the bench, connected the power and control cables, and checked the receiver metering points with the test set. The oscillator checked okay; limiters, too. Injecting a strong signal into the receiver, I noted that the limiter reading didn't increase as much as it should.

"Losing too much signal in the front end, I'll bet," I said, unintentionally, just loud enough for the truck driver to overhear.

"Don't much care where you're losing your signal, mac; find it and get that set working. Like I told you, I'm in a hurry."

From experience with this particular model of radio, I suspected that the protective diode across the antenna input (Fig. 1) was either partially or completely shorted out. I turned the radio over and removed the protective cover from the RF amplifier strip. With a pair of small sidecutters, I carefully reached in and clipped loose the ground side of the diode. Instantly, the limiter reading shot upscale and the low-IF reading rose considerably—indicating normal operation.

I reduced the signal-generator output and noted the attenuator indicated .5 uv at full quieting. "Not good enough for this particular radio," I thought to myself,

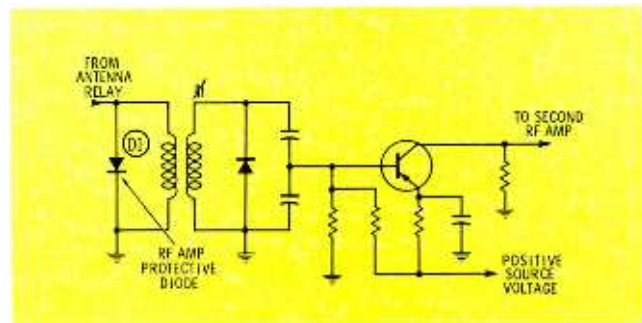

Fig. 1. Diode D1 keeps static discharge from reaching RF amplifier.

You probably thought top quality electronic test instruments were too expensive...*didn't you?*

Well, they're not when you build them with money-saving RCA kits

You've known right along that you can save money on electronic test instruments by building from kits.

But you may have shied away from kits because you thought they involved complicated calibration or adjustment problems. Forget it!

RCA kits are inexpensive, of course, but they're also easy to build. Build them right and they'll give you the best performance you can buy in their price range.

What's better about RCA test instrument kits?

Ease of assembly is one thing. Parts are clearly identified. Each assembly diagram appears on the same page as the step-by-step instructions for that section of assembly. There's no need to refer back constantly to other pages, which consumes time and increases the chance of error.

Ease of alignment is another thing. Each kit contains complete instructions for accurate calibration or alignment of the instrument. Where necessary, precision calibrating resistors are provided for this purpose.

What does it mean? It means that with RCA kits you can get a professional V-O-M or VTVM for as little as \$29.95*. Or you can get a good oscilloscope (one of the most useful—but normally one of the most expensive—test instruments) for only \$79.50*

Specialized instruments such as an AC VTVM or an RF Signal Generator are also available as kits for far less than they would cost otherwise. In every case, RCA kits, when completed, are identical with RCA factory assembled instruments.

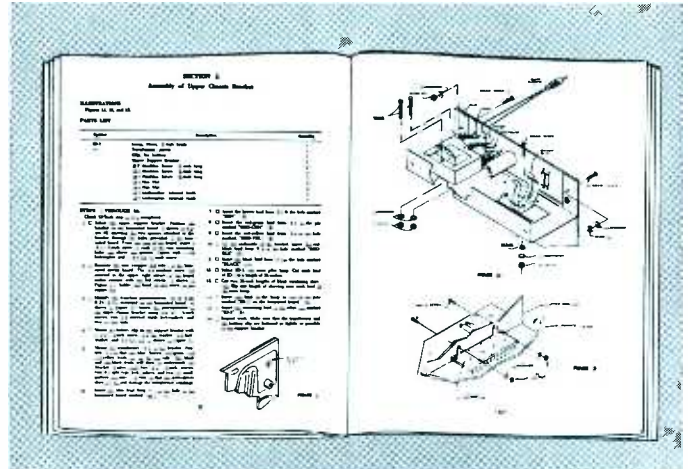

Each sub-assembly is described in a separate section with illustrations applying to that sub-assembly available at a glance. No cross referencing necessary.

LOOK WHAT'S AVAILABLE TO YOU IN KIT FORM:



RCA VOLT-OHM-MILLIAMMETER. The most popular VTVM on the market. WV-77E(K). Kit price: \$29.95*



RCA SENIOR VOLT-OHM-MILLIAMMETER. A professional VTVM. WV-98C(K). Kit price: \$57.95*



RCA VOLT-OHM-MILLIAMMETER. One of most useful instruments. WV-38A(K). Kit price: \$29.95*



RCA 3-INCH OSCILLOSCOPE. Compact, lightweight, portable. WO-33A(K). Kit price: \$79.95*

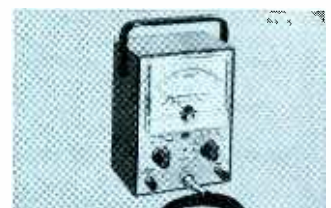

RCA HIGH-SENSITIVITY AC VTVM. Doubles as audio pre-amplifier. WV-76A(K). Kit price: \$57.95*

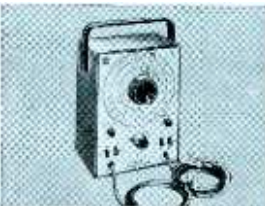

RCA RF SIGNAL GENERATOR. For audio and TV servicing. WR-50A(K). Kit price: \$39.95*

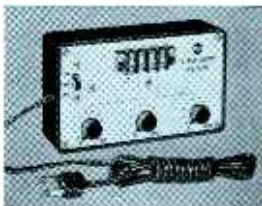

RCA TV BIAS SUPPLY. For RF, IF alignment in TV sets. WG-307B(K). Kit price: \$11.95*

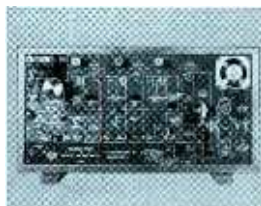

RCA TRANSISTOR-RADIO DYNAMIC DEMONSTRATOR. For schools. WE-93A(K). Kit price: \$39.95*

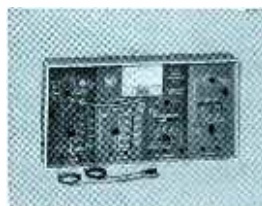

RCA V-O-M DYNAMIC DEMONSTRATOR. A working V-O-M. WE-95A(K). Kit price: \$37.95*

See them all—and get full technical specifications for each—at your local Authorized RCA Test Equipment Distributor. Or write for information to: Commercial Engineering, Sec. D-33-W, RCA ELECTRONIC COMPONENTS AND DEVICES, HARRISON, N. J.

*User price (optional)

RCA ELECTRONIC COMPONENTS AND DEVICES, HARRISON, N. J.



The Most Trusted Name in Electronics

GENERAL '64

America's Number 1 Dealer Line

maximum sales . minimum service



MC-6 — The World's most advanced mobile or base Citizens Band 2-way radio. 6V, 12V, 115V operation—\$199.95.

25 Watt Construction *



VS-4 — Industrial 11 meter, 2-way, 5 channel radio. Built for continuous heavy duty. Transistor powered. \$149.95 VS-5 (6 volt model). \$149.95

25 Watt Construction *



BB-10 — 18 watt input industrial AM unit. 27.235 to 27.490 MC. 180' antenna permissible! See FCC Form 400. \$189.95.



SBT-4 Sideband Generator. Simply plug the SBT-4 into any CB transmitter. Automatically generates double sideband suppressed carrier signal or 25 watt AM linear amplifier on 10 meters. \$99.95.



615-B Multifunction Bridge A precision instrument that measures true power, standing wave ratio, and relative field strength . . . \$39.95. A must for every service technician!



FM-120 — 60 watt input FM mobile unit, 150-174 MC . . . \$399.95. Also available: **FM-60** — 30 watt input FM mobile unit, 150-174 MC . . . \$349.95.

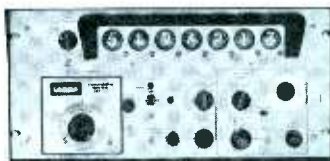

CG-2 Counter-Generator. Frequency measurement equipment. Range: DC to 512 MC (with converters) . . . from \$1485.00.

YOUR 1964 MONEY-MAKING LINE!

Write for General's Dealer and Consumer
10% DOWN Financing Program TODAY.

GENERAL RADIOTELEPHONE COMPANY

3501 West Burbank Boulevard, Burbank, California

Telephone: 849-6891, Area Code: 213

*Under Present Rules Part 19.32 The FCC Does Not Provide For More Than Five (5) Watt Input In The Citizens Radio Service (26.965-27.285 Mc Band).

Circle 41 on literature card

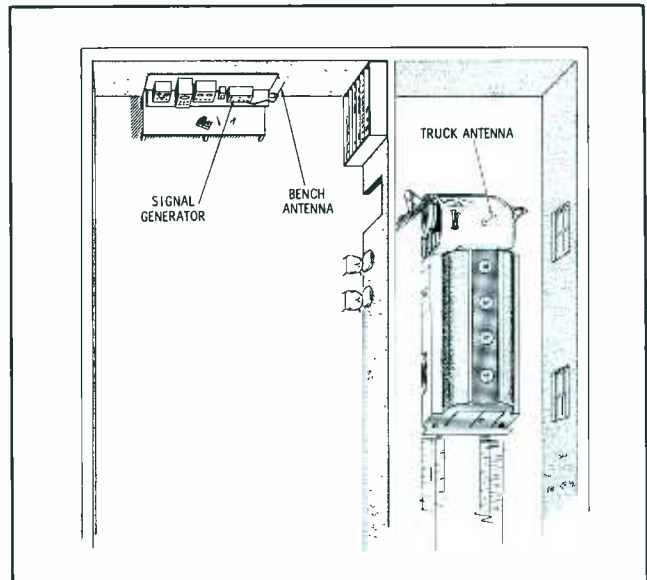

Fig. 2. Receiver checked by radiating signal from generator.

"but I'd better not touch alignment with this guy in such a hurry."

I removed the diode from the circuit and inserted a new one. Once again I checked sensitivity; still okay. I disconnected the generator and connected the RF wattmeter to the antenna receptacle. Quickly setting the frequency and deviation meter to the proper frequency, I spoke into the mike and checked the power output, frequency, and modulation deviation all at once. Everything okay here, too.

When I made an on-the-air check with the bench antenna connected to the radio, the dispatcher's reply was loud and clear—full quieting.

"Well, now, that only took a few minutes," I said to the driver as I disconnected the antenna, lifted the radio off the bench, and headed for the truck.

"Yeah, that's all right!" he said, "Now I can get outta here."

I climbed into the cab and swung the radio up into its case and placed the lid on. After locking the unit in place, I connected the cables, slid down in the seat, and turned the ignition on.

After the transmitter warmed up, I called the dispatcher. In waiting for a reply, all I heard was the squelch circuit trying to open the audio amplifier—just an intermittent popping and crackling for about three seconds. "Certainly this can't be the dispatcher transmitting," I thought. "His transmission would be loud and clear. Must be another mobile unit operating out in the county."

"He probably stepped out of the office for a minute," the driver suggested. "The radio's all right. Climb down outta there and I'll take off."

"No. Let's wait a minute," I replied. I hopped down from the cab, went over to the bench, and turned the modulation meter towards the truck. Getting back into the cab, I called the dispatcher again. Still no answer. However, the transmitter was working; I could tell from the modulation meter.

I went for the signal generator. Since it would be awkward getting the instrument into the truck cab, I connected it to the bench antenna (Fig. 2), set it on the correct frequency once more, and cranked the

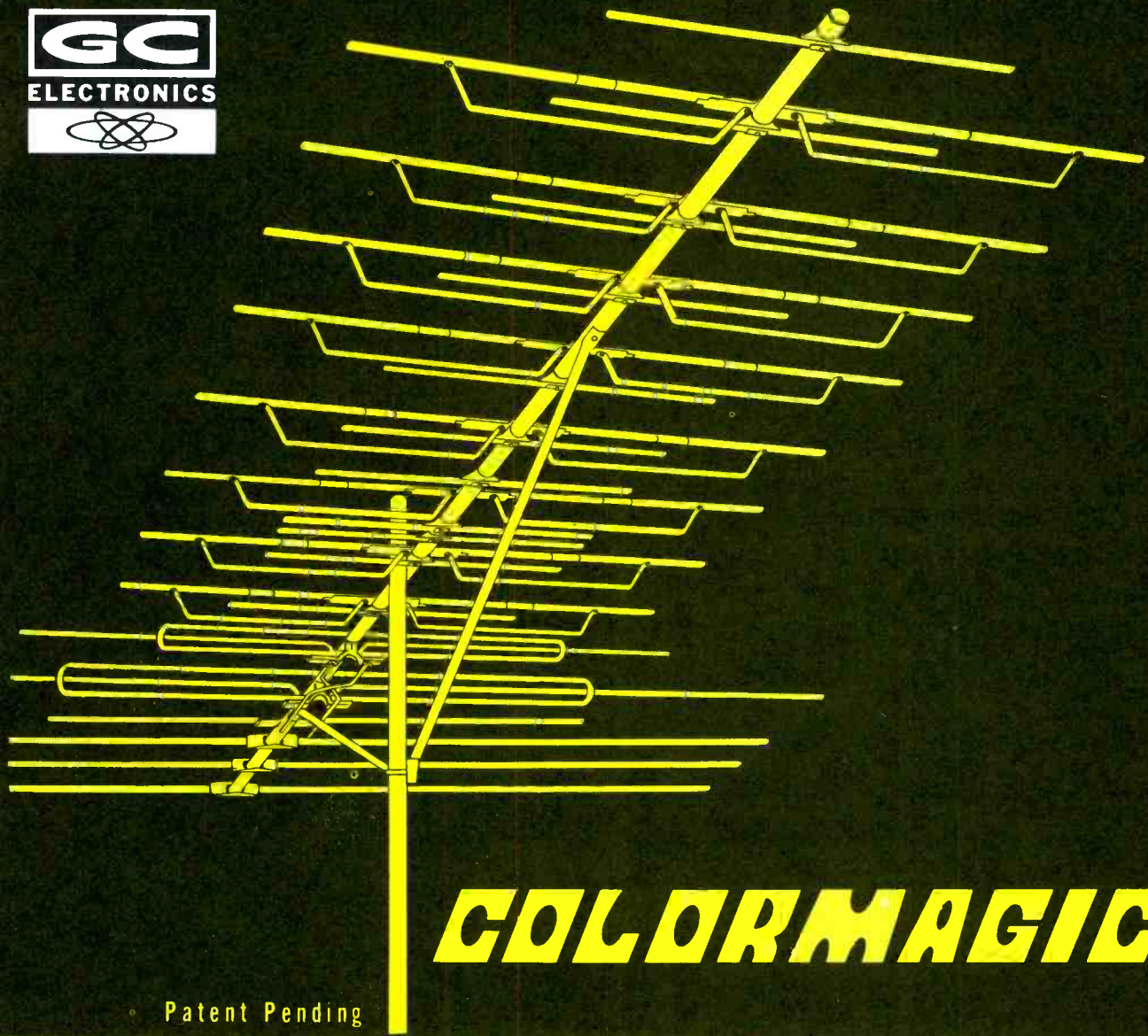

COLORMAGIC

Patent Pending

FHR **FUNDAMENTAL HARMONIC RESONANCE...GC'S EXCLUSIVE DESIGN PROCESS!**
 Colormagic elements resonate on the fundamental harmonics within both the high and low bands. Colormagic FHR outperforms the average second harmonic TV element by producing a tight, laser-linked directivity of signal...higher gain! It's in the elements!

GC "GOLD-GUARD" anodizing process guards against pitting, chipping, rust and corrosion...makes the Colormagic series the best protected, all-weather line available!

GC "SOLID-SEMBLED" construction insures quick, easy installation...rigid-lock elements snap securely into place!

Compare! Colormagic Antenna Systems offer pencil-point polar patterns...laser-linked directivity...flat plateau response curve...no traps or peaks...excellent for color or black & white TV reception.

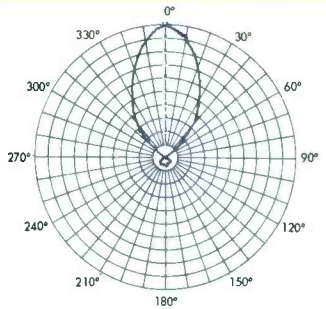

15 All-New Colormagic Combo-Couplers permit cross-direction reception of UHF-VHF-FM antenna combinations...each unit encased in high-impact polystyrene case...supplied with stainless Steel mounting strap. Complete sales program available.



See your GC Distributor! He'll fill you in on this "prestige" package. *CONSIDER THE ELEMENTS INVOLVED!* ...then GO COLORMAGIC! If not stocked locally, write us for name of Distributor nearest you.

GC ELECTRONICS CO.
 Division of Textron Electronics, Inc. | Western Plant: 3225 Exposition Place, Los Angeles 18, Calif.
MAIN PLANT: 400 S. Wyman St., Rockford, Ill., U.S.A.

Circle 40 on literature card

signal level to full output. With a normal receiver this near the generator, full quieting should occur. However, in this case, it didn't. Opening the squelch control in the truck produced only the hiss normally heard in two-way receivers; no signal coming through at all.

"Now what the devil . . . !" I muttered to myself. "I know the receiver works; I just fixed it. Maybe the signal generator isn't set properly."

Just then the shop phone rang. It was the oil company dispatcher. He said he had answered me both times I had called, but that apparently I hadn't heard him. I thanked him and asked if he wanted the driver to leave his radio so he could finish his deliveries. We would work on the radio the next morning, and have it ready by noon. (It was now well past closing.)

"It's up to the driver," the dispatcher decided.

I asked him to hold on a second, and asked the driver what he wanted to do. He said that, as much as he didn't want to, he'd wait, because he needed his radio in the morning as much as he did now. I told this to the dispatcher, and he just grunted, "Okay, but he isn't getting overtime while he's hanging around there."

Figuring I better not mention this to the driver, I said goodbye and hung up.

So! Still got receiver troubles, huh? What could it be? It worked okay on the bench. "Maybe I knocked something loose or put the circuit board in a twist when I put the radio back in the case," I thought, remembering a similar case last week. I took the radio out of the cab and set it on the bench once

again. After connecting the power and control cables, I checked sensitivity; still .5 uv, and right on frequency.

"Now what could be causing a loss of sensitivity in the cab, but not on the bench?" I wondered. "Well, let's see: The antenna must be okay since the dispatcher can hear my transmissions. Perhaps the trouble is a voltage-sensitive transistor."

I reduced the battery eliminator output from 12.1 volts to 11.5 volts and again checked sensitivity. No change. "So it isn't a voltage-sensitive transistor," I mused. "Maybe something will show up if I inject more A-voltage than normal." I reached over to the eliminator and turned it up to 13 volts, but the only change was from .5 uv to .3 uv. I ruled out heat troubles in the practically airtight case because the set hadn't worked the instant I turned it on.

I injected 10 uv of signal into the receiver and tapped and pried components and the PC boards all along the signal path from antenna relay to speaker plug. Defiantly, the limiter and low-IF meter readings stayed the same—no reduction to indicate a signal loss.

"Couldn't be in the power supply, 'cause there's no circuit there that serves the receiver alone," I said to myself, "and the transmitter works fine."

At a loss to explain the trouble, I took the radio back to the truck. I loosened the power and control cable clamps above the windshield and let the cables drop to the seat. Connecting the cables to the radio, I tried another check with the dispatcher, hoping I would learn something about the trouble. No such

Big in Power and Popularity Little in Size and Cost



Heathkit Single Band SSB Transceivers... \$119.95

It's easy to see why the new Heathkit SSB Single Band Transceivers are heard so often on the air today—in both fixed and mobile operation! They are compact (less than 1/2 cubic foot), lightweight (only 12 lbs.), loaded with versatile features and pack more input power-per-ounce than any other comparable unit (200 watts PEP). And best of all you save two thirds the cost of three band units by buying only the band you need. Assembly is a marvel of simplicity (only 15 hours) with over 90% of the components mounted on a heavy-duty circuit board. The rugged one-piece steel chassis is welded and braced to withstand plenty of abuse . . . dependable operation with maximum stability. Choose 80, 40, or 20 meter models, or all three, now and enjoy versatile, power-packed performance at lowest cost!

Check These Features!

- True Transceiver for one-band, one sideband operation
- 200 watts PEP RF input
- Crystal filter type SSB generation
- Automatic level control
- PTT and VOX circuits built-in
- Low frequency VFO (1.5-1.7 mv) for greater stability
- 2 kc dial calibration
- 6" of bandspread
- Vernier tuning
- Provision for operation with Linear Amplifier
- Fast, easy, circuit board assembly
- Complete with one-piece steel cabinet and "gimbal" mounting bracket.

- Kit HW-12, 80-meter (LSB) . . . 15 lbs. \$119.95
- Kit HW-22, 40-meter (LSB) . . . 15 lbs. \$119.95
- Kit HW-32, 20-meter (USB) . . . 15 lbs. \$119.95
- Kit HW-42 (all 3 models) 45 lbs. Save \$39.85. \$320.00
- Kit HP-13, DC power supply . . . 7 lbs. \$59.95
- Kit HP-23, AC power supply . . . 18 lbs. \$39.95
- GH-12: Push-to-talk microphone . . . 2 lbs. \$6.95
- Kit HR-10A: Plug-in 100 kc crystal calibrator. 1 lb. \$8.95

SPECIFICATIONS—RF Input: 200 watts PEP. **Sideband generation:** Crystal lattice bandpass filter method. **Stability:** 200 cps per hour after warm-up. **Carrier & unwanted sideband suppression:** 45 db. **Frequency coverage:** HW-12, 3.8-4.0 mc, HW-22, 7.2-7.3 mc; HW-32, 14.2-24.35 mc. **Receiver sensitivity:** 1 uv for 15 db S + N/N ratio. **Receiver selectivity:** 2.7 kc @ 6 db, 6.0 kc @ 50 db. **Output:** 50 ohm fixed (unbalanced). **Operation:** HW-12 & HW-22, LSB; HW-32, USB. **Audio output:** 1 watt @ 8 ohms. **Mike Input:** Hi-Z. **Panel controls:** Frequency, final tune, function (OFF-PTT-VOX-TUNE), RF gain, AF gain, (gull for crystal calibrator), VOX gain, meter. Front panel screwdriver adjust for S-meter and VOX delay. **Rear panel controls:** Mike gain, tune level, final bias. **Tube complement:** Fourteen tube heterodyne circuit, (3) 6EAB 5 mc amp., VOX relay amp., IF amp., RF amp., Rcvr. mixer, (5) 6AU6's, VFO, VOX amp., IF amp., Xmtr. mixer, (1) 6BE6, VFO isolator (HW-12), Het., Osc. and mixer (HW-22 & HW-32); (1) 12BY7, Driver; (1) 12AU7, Xtal osc. product det., (1) 6EB8, Audio amp. and output; (2) 6GE5 RF output. **Power requirements:** 800 VDC @ 250 MA peak, 250 VDC @ 100 MA, -125 VDC @ 5 MA, 12 VAC or VDC @ 3.75 amperes. **Cabinet dimensions:** 6 1/2" H x 12" W x 9 1/2" D.

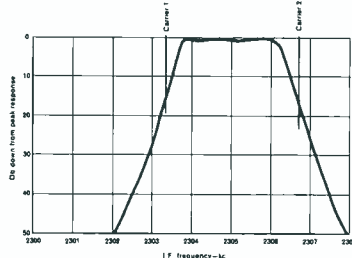

A "pre-designed" full lattice crystal filter provides selectivity and unwanted sideband suppression comparable to the most expensive transceivers. Note the narrow bandpass (2.7 kc at 6 db), steep skirts (6.0 kc at 50 db), and low passband ripple (less than 1 db).



HEATH COMPANY, Dept. 25-4-1
Benton Harbor, Michigan 49023
In Canada: Daystrom, Ltd., Cooksville, Ont.

Enclosed is \$_____ plus postage. Please send model(s) _____.

Please send my Free 1964 Heathkit Catalog.

Name _____

Address _____

City _____ State _____ Zip _____

Prices & specifications subject to change without notice. AM-145



FREE CATALOG

Send for your free copy today! Fully illustrates over 250 exciting Heathkits at savings of 30% or more! Choose from the world's largest selection of quality Test, Amateur Radio, Marine, Hi-Fi, Educational and General Hobby kits.



**INTRODUCING THE WORLD'S NEWEST MICROPHONES...
GUARANTEED FOR FIVE YEARS!**

ALL NEW DESIGN...ALL NEW PERFORMANCE—Today... from the laboratories of University... an advanced technology has produced a great new breed of microphones for broadcasting, TV, professional and home recording, P.A., ham and CB applications. Each one represents a clean and dramatic break with tradition...with outmoded notions. Each one is far superior to any other microphone in its class. Let other microphone manufacturers offer the usual two to three-year warranty. Every University microphone—whether designed for the professional studio or the home recordist—is sold with a five-year warranty. For complete specifications, write: Desk PR-4, LTV/University, 9500 West Reno, Oklahoma City, Oklahoma.

EXAMPLES OF THIS GREAT NEW LINE!

MODEL 8000—A high performance dynamic cardioid for only \$29.95 net! Response: 70-13,000 cps. Sensitivity: -148 db (EIA). Output Level: -55 db/1mw/10 dynes/cm². Includes 18 ft. cable with Cannon plug and receptacle, and desk stand adaptor.

MODEL 2040—VOICE REALISM AT ITS BEST! New omnidirectional dynamic microphone that has astounded hams in initial trials! Modulation free of the harshness and muddy effect common to most microphones in this class. Ideal for upgrading P.A. and home tape recording performance as well.

MODEL 1000—CARDIOID DYNAMIC. Unique directional characteristics provide unexcelled discrimination against unwanted sounds—assure superior results even in noisy or reverberant locations. Internally shock-mounted—sensitive elements float, vibration-free, on polystyrene ribs! For any application requiring a truly discrete sound source.

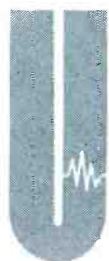

**LTV
UNIVERSITY**

A DIVISION OF LING-TEMCO-VOUGHT, INC.

Circle 44 on literature card

luck; he answered. I heard him okay, and I was more baffled than ever.

I slipped the radio back into its case and tightened it down without the cover. Again I called the dispatcher. This time I heard the popping squelch again.

"Now, we're getting warm!" I thought. "It positively has something to do with the radio being in the case. I'll bet if I remove all external grounds I'll get a signal." I went back to the service bench and made sure the signal generator

hadn't changed frequency. I gingerly slipped the radio out of its case, upside down, and held it clear. No change; the set was still dead. Holding the radio near my head, I turned it over quickly to see if anything would happen. Instantly, the signal came through. At last! Whatever is wrong with this little "jewel" occurred only with the set upside down.

As I slowly turned the set over several times with my ear near the chassis, I became aware of a faint "clunk," like something falling

against metal. I took the radio back to the bench and took the RF amplifier cover off again.

Carefully, I poked among the RF components. Nothing loose; so I turned the radio upside down. "Plunk!" Something fell out and bounced behind a parts can. I moved the can, and there lay a coil slug.

"Well, well," I said, "what have we here?"

"Beats me, doc, what *have* you got there?" a voice said from over my shoulder.

"This, my good friend," holding up the slug for him to see, "may well be the cause of your trouble," I said.

"Okay, so fix it!" he said.

"Okay, so I will," I smiled at him.

Slipping the slug back into the form, I screwed it down a couple of turns and turned the radio over again. The slug stayed in place.

I connected the generator and checked the sensitivity. It was about .6 uv; so I adjusted the other coil slugs in the front end of the receiver for a peak meter reading. The meter reading at the low-IF amplifier increased about 50%. The generator attenuator indicated that sensitivity was now .4 uv—even with the radio upside down.

Jubilantly, I disconnected all cables, took the radio back to the truck, fastened it into its case, and checked with the dispatcher. This time he came through fine. I reached over and turned the volume down and asked him for a ten-count. As he complied, I hit the radio several times with my fist to see if the slug would come loose. It didn't.

With the driver standing just outside the open cab door, I told the dispatcher the radio would be all right now, but that it had a broken part which would need attention when the driver had an hour to spare.

"Whoops, wait a minute," I said.

I went around to the passenger's side and climbed in once more. With my nut driver I quickly refastened the cables over the windshield.

I climbed down and went over to the overhead door controls. With the door raised, the driver backed out, turned around, and was gone with a blast of air horns and a cloud of parking-lot dust. I punched the "down" button, went over to the file box, and pulled the card on his radio. . . . ▲

Heathkit's great base station deserves



an equally fine working partner!



In a two-way radio communications system, overall performance is only as good as it's weakest link. The deluxe Heathkit GW-42 "Master Station" CB Transceiver teamed up with the powerful GW-52 1-watt "Walkie-Talkie" brings you Citizen's Band radio facilities of outstanding capability with complete freedom and mobility of operations. Check and compare the many features offered in Heathkit equipment with any other...see why Heathkit is your best buy in CB!

"Master Station" CB Transceiver

- 5 Crystal-controlled transmit & receive channels • Built-in 3-way power supply • Built-in 4-tone selective call circuitry • All-channel receiver tuning • Built-in tuning meter • Adjustable squelch control • Switchable automatic noise limiter • Push-to-talk microphone • Beautifully styled • Easy-to-build.

Kit GW-42...23 lbs.....\$119.95
Assembled GWW-42...22 lbs.....\$189.95

1 Watt Walkie-Talkie

- Rugged 10-transistor, 2-diode circuit • Long-range transmitter—1-watt input • Sensitive superheterodyne receiver with RF stage • Adjustable squelch control • Automatic noise limiter • Crystal-controlled transmit & receive channels • \$20 rechargeable battery included

- Built-in 117 v. AC battery charger • Built-in battery condition meter • Easy circuit board assembly.

Kit GW-52...4 lbs.....\$ 74.95
Assembled GWW-52...4 lbs.....\$124.95



FREE 1964 HEATHKIT CATALOG
See these and over 250 other exciting Heathkits available in easy-to-build kit form. Save 50% or more by doing the easy assembly yourself! Send for your free catalog today!

HEATHKIT

HEATH COMPANY, Dept. 25-4-2
Benton Harbor, Michigan 49023

Enclosed is \$_____, plus postage. Please send model (s)_____.

Please send my Free 1964 Heathkit Catalog.

Name _____

Address _____

City _____ State _____ Zip _____ GX-124R



Gas Stations do a \$500,000,000 business by promoting spring tune-ups...

?

TV service dealers can do a multi-million dollar business by promoting **SPRING TV Tune-ups**. It's logical. Damaged antennas, worn twinlead, aging TV sets can use a freshening up after the long, hard winter. What better time than in the spring for the TV service dealer to promote a "Spring TV Tune-up" special. Blonder-Tongue gives you a complete, straightforward promotion that means extra sales in antennas, twinlead, and profitable TV signal amplifiers. **It starts with a plan.** Sales aids, window streamer, local ad mats and business producing postcard for use by TV service dealers. **Then comes the most complete product line** in the

field; indoor and outdoor signal amplifiers—VHF, UHF and FM. For example, there's the new 2-transistor mast mounted UHF amplifiers (Able-U2) that really brings in all UHF channels. The lowest cost, full power two set TV signal amplifier for indoor installation (B-42) and the well-known outdoor transistor models (Able-2 and Able-1).

Add to this a bit of your own energy, and you can rack up extra "Spring TV Tune-up" profits. Get details today from your Blonder-Tongue distributor or, write, wire, phone

BLONDER-TONGUE 9 Alling St., Newark, New Jersey 07102
Canadian Div. Benco TV Assoc., Ltd., Toronto, Ont.
home tv accessories/closed circuit/community tv/uhf converters/master tv

Circle 42 on literature card

FREQUENCY SYNTHESIS

Multichannel transmitters with few crystals . . . by Keith Bose

In modern electronic equipment, there are applications in which each individual frequency must be accurately controlled within limits so close that crystal oscillators must be used. Crystals are expensive, and in many cases it is physically difficult to mount a crystal for each desired frequency in the allotted space.

What It Is

Frequency synthesis is the process in which a large number of stable frequencies may be obtained with comparatively few crystals. It is based on the double-superheterodyne process. When two signals of differing frequencies are combined in a *nonlinear* impedance, other frequency components will be created. These other frequencies are mathematically related to the two original frequencies. Of most interest in frequency synthesis are the components equal to the sum and the difference of the two original frequencies.

In an ordinary superheterodyne receiver, for example, the frequency difference between the local oscillator and the incoming signal forms the IF. The mixer tube acts as the nonlinear impedance necessary to create the intermediate frequency. It is apparent that some combination of oscillators and nonlinear impedances

can be devised to create many discrete frequencies from a series of accurate signals.

Applications

Crystal-controlled signal generators which produce signals from frequency synthesis are available for laboratory use when such accuracy is required. The greatest use of frequency synthesis is in the field of aviation communications, but some CB makers are developing 23-channel transceivers that don't necessarily need 46 crystals.

The frequency of aircraft transmitters must be maintained within $\pm 0.01\%$. Such stability is most conveniently obtained with crystals. Aircraft operating under all weather conditions must employ transmitters capable of operating from 118 to 135 mc in increments of 50 or 100 kc. Rather than a separate crystal for each channel, frequency synthesis is used in these transmitters to provide up to 360 channels with relatively few crystals.

Frequency synthesis is also used in aircraft receivers to generate accurate local oscillator signals. The reason for this is that a pilot must be able to tune at once to a specified channel without the inconvenience of tuning a dial. Obviously, dial settings vary with temperature and humidity or as tubes and other components age. If a pilot is required to dial to a station, a crucial part of a message can be lost. The better aircraft receivers, therefore, employ frequency synthesis.

The technique of frequency synthesis is the same regardless of the application in which it is used. For purposes of illustration, several examples of frequency synthesis in aircraft equipment will now be described.

It is possible to arrange a system so that frequencies may be generated in increments by switching crystals. Aircraft systems are arranged so that they may be "tuned" digitally; that is, frequencies may be changed in digital increments.

An example of a receiver using digital tuning is shown in the block diagram of Fig. 1. Twenty-nine crystals cover the band from 108 to 126.9 mc in 100-kc steps. The first IF in this double-conversion set is obtained by doubling the frequency of a third-harmonic crystal

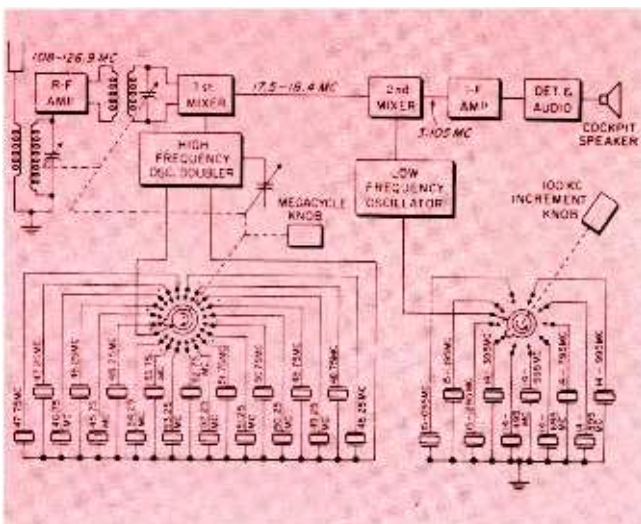

Fig. 1. Diagram of dual-conversion receiver using frequency synthesis.

work smarter



not harder



Subscribe to PHILCO® TECH DATA the smart way to servicing profits

If you are working as hard as you can, it's time to switch to working smarter, with the most up-to-date, factory accurate, complete source of Philco Technical Information right at your fingertips. Philco's new TECH DATA Subscription is an invaluable source of servicing knowledge and technical data . . . faster, more accurate and at lower cost than from any other source. You get the complete, full year's supply of Philco Technical Information; service manuals, specifications, schematics, wiring diagrams, parts lists and production change bulletins promptly and direct . . . to give you the right servicing information when you need it, to help you make your business hours more productive, more profitable.

Subscribe now to PHILCO TECH DATA
(Electronics, Appliances or Laundry) Single Data Subscription \$7.50

Special 1/2 Price Offer PHILCO SERVICE BUSINESSMAN
(with subscription to Philco Tech Data) Only \$1 per yr.

The serviceman's most reliable, progressive magazine for helpful business information, servicing management articles as well as technical and servicing articles.

PARTS AND SERVICE OPERATIONS

PHILCO®

A SUBSIDIARY OF *Ford Motor Company*

MAIL THIS COUPON TODAY!

To: Philco Parts and Service Operations—C & Tioga Sts., Phila. 36, Pa.

CHECK SUBSCRIPTION DESIRED

- ELECTRONICS @ \$7.50 APPLIANCE @ \$7.50 LAUNDRY @ \$7.50

(Single subscription, \$7.50, two categories; \$13.50; three categories \$18.50)
 PHILCO Service Businessman Magazine, Special Subscription Rate \$1.00 (with Tech Data Subscription)

TOTAL _____

Make check or money order payable to
PHILCO Parts & Service Operations, for
processing through your local distributor.

SUBSCRIPTION ORDER—PHILCO TECH DATA

1964 (Jan. 1 to Dec. 31)

Firm Name _____

Your Name _____

Address _____

City _____ State _____ Zip Code _____

UHF ANTENNAS

G 1483 OR G 1483K

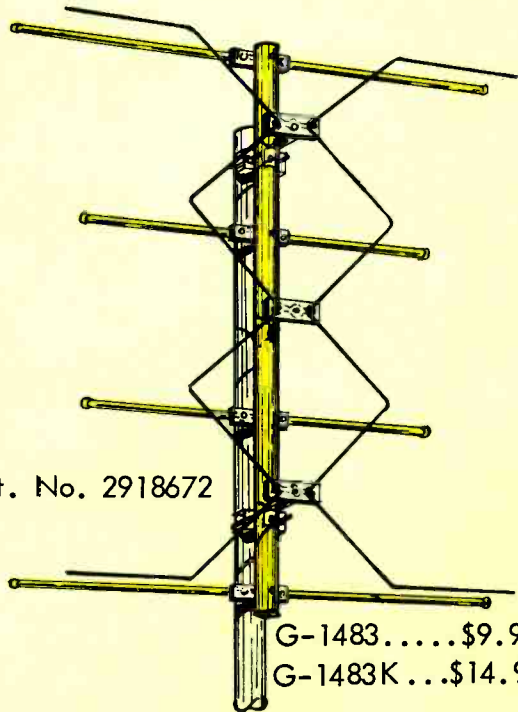

Pat. No. 2918672

G-1483.....\$9.95
G-1483K...\$14.95

ANTENNACRAFT'S new G-1483 antenna for channels 14 to 83. All aluminum, diamond phased construction with aluminum lead-in terminals and Dura-Gold finish. Completely pre-assembled. Also available in kit form (G-1483-K) with mast, lead-in and all installation hardware. The finest UHF antenna you can buy.

The SUPER G-1483 is one antenna built to perform with all the power of two G-1483 antennas connected together. No stacking harness is required. This antenna is also available in kit form, (SUPER G-1483 K).

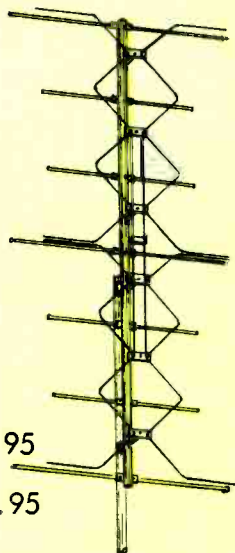

SUPER G-1483.....\$14.95
SUPER G-1483K\$19.95

ANTENNACRAFT
BETTER BUILT FOR BETTER PERFORMANCE
Automatic Channel Selector
TV ANTENNAS
BURLINGTON, IOWA

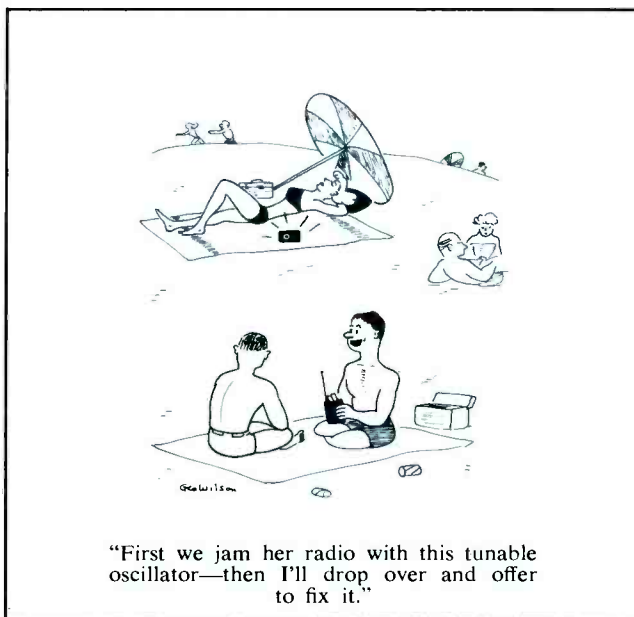

Fig. 2. Tuning controls for a communications set.

and then combining with the incoming signal in the first mixer. The frequency from the high-frequency oscillator-doubler is chosen to be between 17.5 and 18.4 mc (.9-mc spread) below the incoming signal, and this difference-frequency (IF) is coupled to the second mixer. The low-frequency oscillator is switched in 100-kc increments. This oscillator operates about 3.105 mc below the output frequency of the first mixer.

The control dials of this receiver are arranged as in Fig. 2. The frequency selector consists of two selector switches—the center control for 1-mc increments and the peripheral control for 100- or 50-kc increments. The megacycle knob selects the crystal for the input to the first mixer. A 100-kc (.1-mc) knob allows selection of the crystal for the low-frequency input to the second mixer.

Another application of frequency synthesis is in a VHF transmitter, part of which is shown in Fig. 3. This unit employs 19 crystals to cover the range from 118 to 126.9 mc. One section of the dual triode (V101B) acts as a low-frequency oscillator; the other section (V101A) forms a high-frequency oscillator. Together, these oscillators provide a total of 90 possible



frequency combinations. The high-frequency oscillator is controlled by the megacycle switch (S101), and the .1-mc switch (S102) selects crystals for the low-frequency oscillator. The output of the high-frequency oscillator is fed to the control grid of mixer V102, and the output of the low-frequency oscillator is fed to the mixer cathode from the oscillator cathode. The mixer output is tuned to the sum of the two oscillator frequencies, and the sum frequency is doubled twice in the stages that follow the mixer. The transmitter output frequency, therefore, is:

$$\text{Output} = 4(F_h + F_l)$$

where

F_h is the high-frequency oscillator frequency,

F_l is the low-frequency oscillator frequency.

The megacycle control switch (S101) is ganged with C109A in the plate circuit of the mixer. As the megacycle switch is rotated through its range, the tuned plate circuit of the mixer passes the sum frequencies in a band from 29.5 to 31.725 mc. The first and second doubler stages which follow (not shown in the schematic) also have trimmers which are ganged to the megacycle switch. This tunes the respective output circuits within a range that will generate the desired harmonics.

Another interesting system of frequency synthesis is contained in the transceiver, shown in Fig. 4. This system generates frequencies in 50-kc (.05-mc) increments. The first injector supplies frequencies in 1-mc increments from 130.485 to 147.485 mc. The output of the first injector is fed to both the first mixer of the receiver section and the mixer of the transmitter section. The output of the first mixer in the receiver will be 11.535 to 12.485 mc throughout the band. The first IF stage tunes broadly and passes these frequencies to the second mixer. The second-injector frequencies

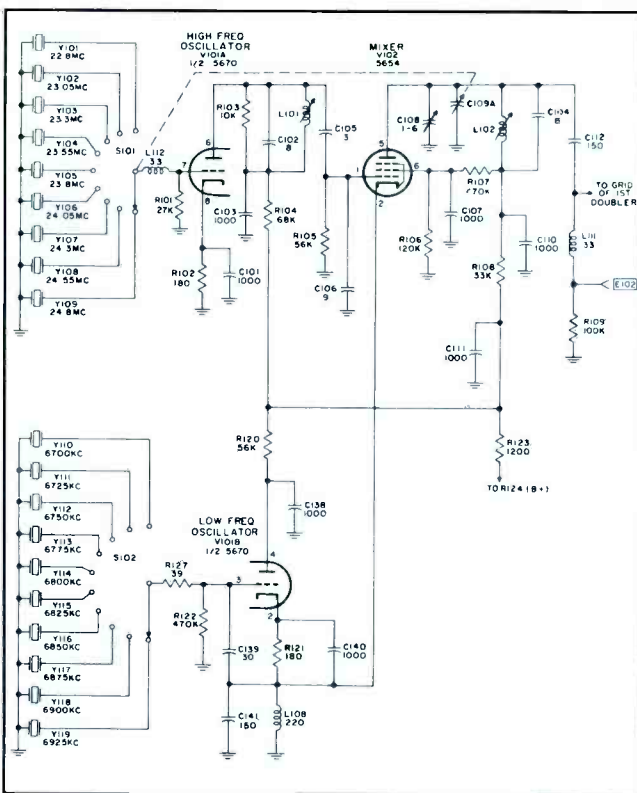
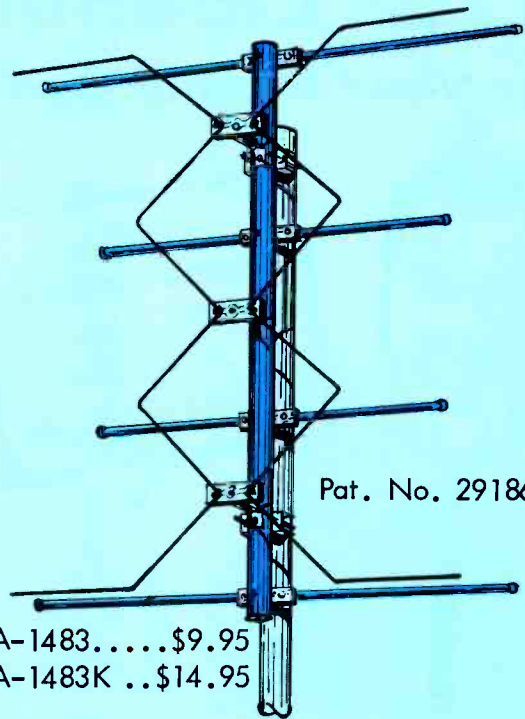

Fig. 3. Frequency synthesizing arrangements in a VHF transmitter.

UHF ANTENNAS SA1483 OR SA1483K



SA-1483.....\$9.95
SA-1483K ..\$14.95

ANTENNACRAFT'S new SA-1483 antenna for channels 14 to 83, with all aluminum diamond phased construction, aluminum lead-in terminals and Sapphire Blue Anodizing. Completely pre-assembled. Also available in kit form (SA-1483K) with mast, lead-in and all installation hardware. The finest UHF antenna you can buy.



The SUPER SA-1483 is one antenna built to perform with all the power of two SA-1483 antennas connected together. No stacking harness is required. The SUPER SA-1483 is also available in kit form, (SUPER SA-1483 K).

SUPER SA-1483.....\$14.95
SUPER SA-1483K....\$19.95



BETTER BUILT FOR BETTER PERFORMANCE

ANTENNACRAFT

Automatic Channel Selector
TV ANTENNAS
BURLINGTON, IOWA

Circle 46 on literature card

Communications, mobile radio...

A First Class FCC License

...or Your Money Back!

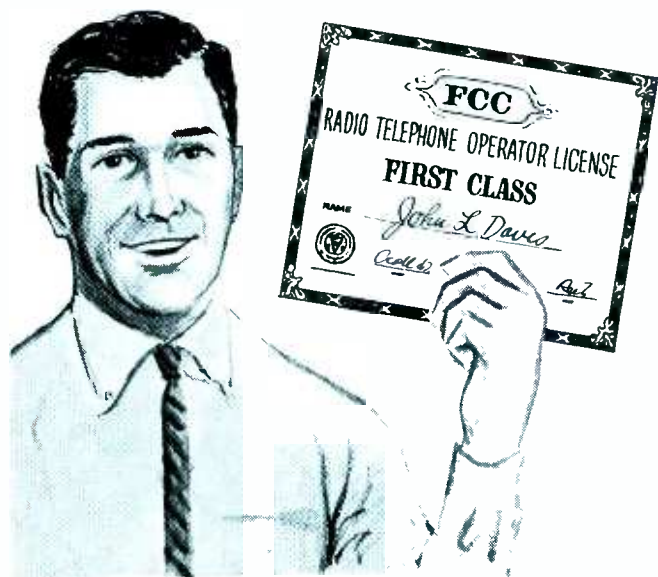

Your key to future success in electronics is a First-Class FCC License. It will permit you to operate and maintain transmitting equipment used in aviation, broadcasting, marine, microwave, mobile communications, or Citizens-Band. Cleveland Institute home study is the ideal way to get your FCC License. Here's why:

Our training programs will *quickly* prepare you for a First-Class Commercial Radio Telephone License with a Radar Endorsement. Should you fail to pass the FCC examination after completing your course, you will get a *full refund* of all tuition payments. You get an FCC License . . . or your money back!

You owe it to yourself, your family, your future to get the complete details on our "proven effective" Cleveland Institute home study. Just send the coupon below TODAY. There's no obligation.

MAIL COUPON TODAY FOR FREE CATALOG

Cleveland Institute of Electronics

1776 E. 17th St., Dept. PF-11
Cleveland 14, Ohio

Please send FREE Career Information prepared to help me get ahead in Electronics, without further obligation.

CHECK AREA OF MOST INTEREST -

- | | |
|---|--|
| <input type="checkbox"/> Electronics Technology | <input type="checkbox"/> First-Class FCC License |
| <input type="checkbox"/> Industrial Electronics | <input type="checkbox"/> Electronic Communications |
| <input type="checkbox"/> Broadcast Engineering | <input type="checkbox"/> _____ other _____ |

Your present occupation _____

Name _____ (please print) Age _____

Address _____

City _____ Zone _____ State _____

Accredited Member National Home Study Council

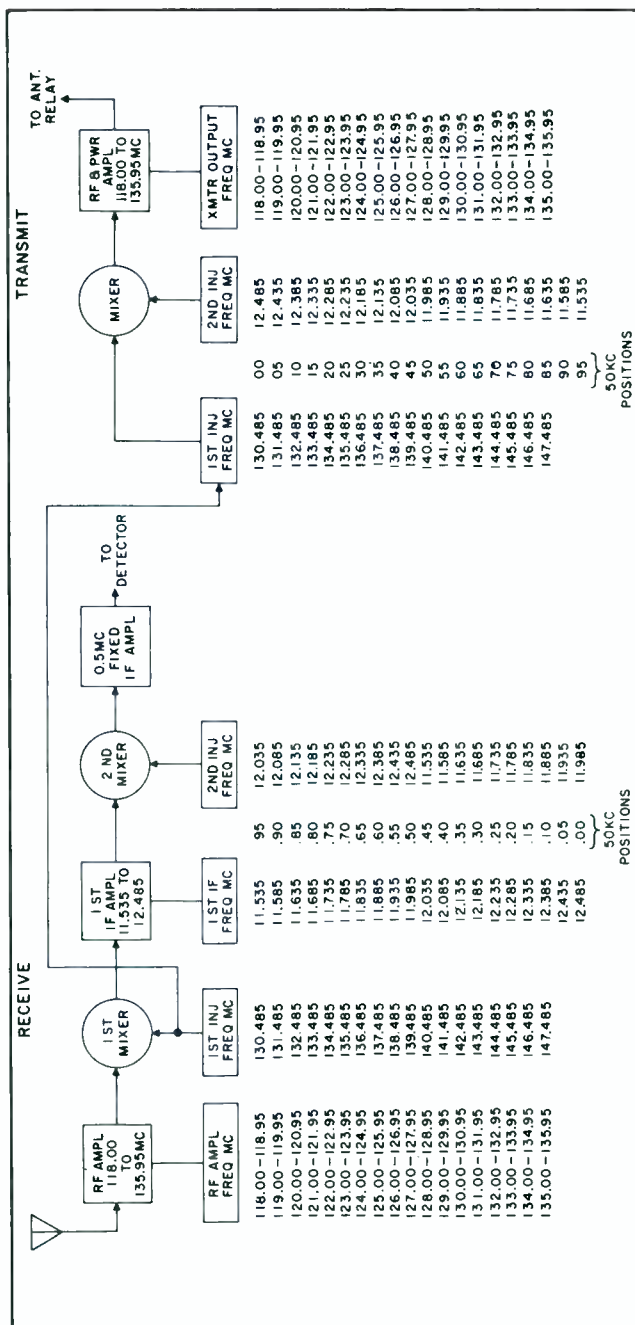
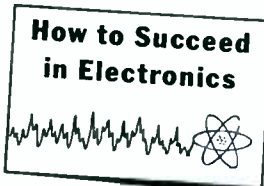

Fig. 4. Synthesizing circuits for both transmitting and receiving.

range from 12.035 to 11.985 mc in .05-mc increments. When these components are mixed with the first IF, a constant .5-mc IF results. In the transmitting mode, the output frequency is synthesized by injecting frequencies from 12.485 to 11.535 mc in .05-mc (50-kc) increments into the transmitter mixer.

Conclusion

Each year more equipment utilizing frequency synthesis is being produced. Solid-state circuitry is becoming commonplace. There is continuous research directed toward finding methods of producing more frequencies with equipment of minimum weight and physical size. Although frequency synthesis is most widely used in aircraft electronics, this technique is also used in missile work for generating timing signals and in other advanced applications. You'll see it in CB equipment, too. ▲



Tips for Technicians

Mallory Distributor Products Company
 P.O. Box 1558, Indianapolis 6, Indiana
 a division of P. R. Mallory & Co. Inc.

Why Mallory Mercury Batteries work better in transistor radios

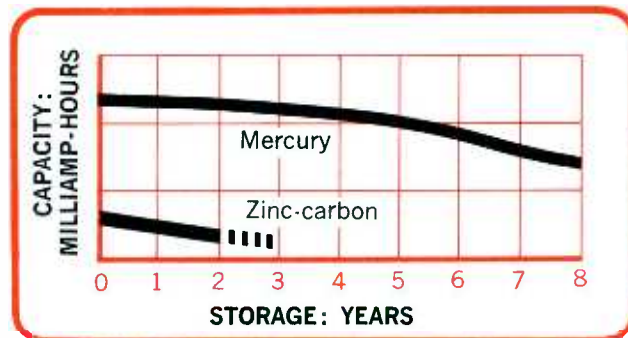
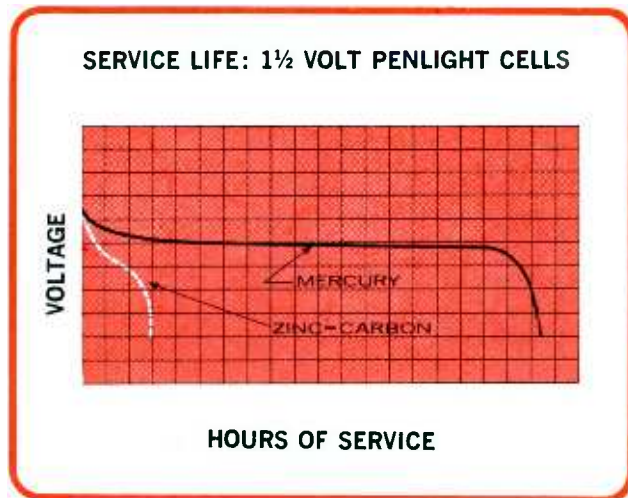
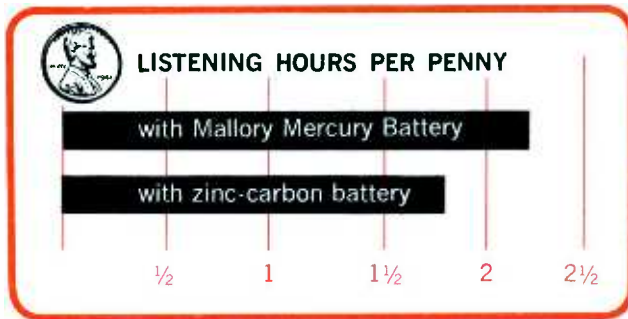

There are a lot of good reasons why more and more people are using mercury batteries in their transistor radios. And the reasons boil down to this—they're a better value, and they give better performance.

To get a comparison between mercury batteries and ordinary zinc-carbon batteries, let's look at a typical transistor radio. This radio uses size "AA" penlight batteries and has a current drain of 15 milliamperes. The Mallory Mercury Battery is the ZM9 and the zinc-carbon type would be the NEDA type 815. The ZM9 retails for 75¢ versus 20¢ for the 815. Got the picture?

Here's where the fun begins. The ZM9 will operate the radio for 165 hours versus only 35 hours for the zinc-carbon battery. This means that for one penny you'll get 2.2 hours of listening pleasure using the ZM9 versus 1.75 hours for the zinc-carbon battery. In other words, it costs you 0.57 cents per hour to use the zinc-carbon compared to only 0.45 cents for the mercury battery.

We're not through yet. Let's get back to *listening pleasure*. The mercury battery has essentially a flat discharge curve. This means that it presents a more constant voltage to the transistors. Result: you don't have to keep turning the volume control up while you're listening AND the radio *sounds* better because there's far less distortion.

Had enough? There's one more important point. Suppose you put the batteries in the radio and use it only slightly. Those 20¢ zinc-carbon batteries go "dead" in a few months whether you use them or not. But the mercury batteries can be stored 2 to 3 years and still deliver dependable power. Plus the fact that Mallory Mercury Batteries are guaranteed* against leakage in your transistor radio.

We've used this "Tip" to illustrate the superiority of Mallory Mercury Batteries in transistor radios. But this superiority extends to *thousands* of other applications. So whether you're building test equipment, heart-pacers, or satellites, see your Mallory Distributor. He has a Mallory Mercury Battery that will do exactly the job you want done.

*We guarantee to repair the radio and replace the batteries, free of charge, if Mallory Mercury Batteries should ever leak and damage a radio set. Send radio with batteries to Mallory Battery Company, Tarrytown, New York.

At \$114⁷⁵*

**YOUR BEST BUY
IN C-B RADIO**

**THE FAMOUS RCA
MARK VIII**

27-Mc Citizens Band Radio-Phone



Here's the LOW-COST C-B radio-phone for car, boat, home, office, or shop. High sensitivity receiver pulls in weak signals. 2½ watt speaker output delivers ample volume to overcome engine noise. Automatic noise suppressor minimizes ignition interference. Light and compact—only 3½ inches high, weight only 9 pounds; fits easily under the dashboard of even compact cars.

**PLUS THESE PREMIUM FEATURES—
RCA MARK VIII RADIO-PHONE**

- 9 crystal-controlled transmit and receive channels
- Tunable receiver permits reception of all 23 C-B channels; dial marked in both channel numbers and frequency
- Exceptionally good voice reproduction—high intelligibility
- Excellent modulation characteristics
- Operates from standard 117-volt AC; separate 6- and 12-volt DC power supplies (optional) for mobile installations
- Electronic switching—no relay noise or chatter
- Illuminated "working channel" feature plus many more features to increase usefulness and efficiency.

NEW LOW PRICE: \$114⁷⁵* AC Unit
Optional DC Power Supply \$19⁹⁵*
 (6- or 12-volt)
 *Optional List Price



**The Most Trusted Name
in Electronics**

MAIL COUPON FOR MORE INFORMATION

RCA Electronic Components and Devices
 Commercial Engineering Dept. D-33-R
 415 South Fifth Street, Harrison, N. J.

Please send more information on the RCA
 Mark VIII 27-Mc 2-Way Radio-Phone.

Name _____
 Address _____
 City _____ Zone _____ State _____

MODULATION LIMITERS FOR TWO-WAY

Learn your way around
in clipper circuits.

by Edward M. Noll

Some months ago (October 1963), we discussed the operation and troubleshooting of audio clippers in receivers for communications. There are many basic similarities between those clippers and the limiters used to prevent overmodulation in transmitters.

As was pointed out in the first article, the purpose of a modulation limiter is to clip off voice-signal peaks so a higher average level of modulation can be maintained. This increases the average level of demodulated audio at the receiver, raises the intelligibility of the signal, and increases the reliable transmission range. In this article, we are going to analyze these noise-limiting circuits in communications transmitters.

Limiter Action

The communications technician adjusts the signal level in the audio section of a transmitter with gain or deviation controls. Their purpose is to set a level of voice-peak clipping that doesn't introduce distortion or reduce the average modulation percentage. Speech is a very irregular waveform and occasional peaks are much greater in amplitude than the average level of the voice signal. It is these voice peaks that are clipped off by the modulation limiter in the same manner that high-amplitude



Fig. 1. Most effective power is below line.

noise pulses are removed by a clipper in the receiver.

Fig. 1 shows how clipping off voice peaks above a certain amplitude level leaves most of the audio waveform energy below the limiting level. The portion below the limiting line can be amplified considerably and fed to the modulator; the result will be greater efficiency in the modulator, since there will be no high peaks to drive the modulator into distortion or overmodulation.

A quick review of limiting or clipping action could be helpful in understanding modulation limiters. Although the basic audio-clipper circuit (Fig. 2) looks like a half-wave rectifier, it must respond to the modulation peaks rather than the average level of the signal.

This can be accomplished by the use of either self-bias or external bias. The effect of biasing the "rectifier" circuit is shown in Fig. 2B. The anode of the diode is positive with respect to its cathode, so the diode normally conducts. When an

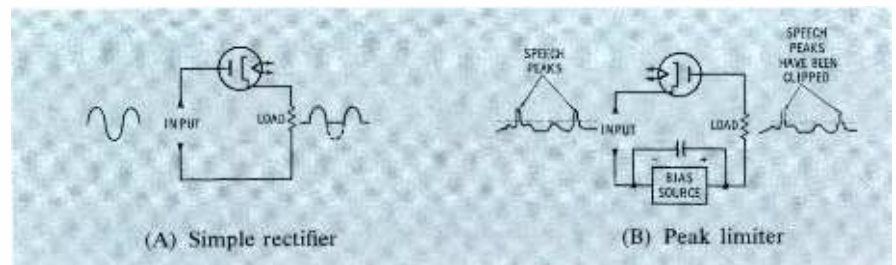

Fig. 2. Noise limiter circuits bear a strong resemblance to ordinary diode rectifiers.



**ALL THE INVENTORY YOU NEED
TO SERVICE ALMOST ANY TRANSISTOR CAR RADIO ON THE ROAD!**

simply say **Delco**

6 is the magic number! That's all it takes to replace millions of transistors in car radios today! One of these Delco numbers will fit exactly the requirements of most of your customers!

- DS-25 and DS-26 cover small signal needs in Delco and other auto radios. They also replace practically every PNP transistor used in portable radios.
- DS-501 and DS-503 restore the full audio power to Delco Radios.

- DS-520 and DS-525 can be used in all non-Delco radios and in place of DS-501 and DS-503 in older cars where low cost is a factor.

Full instructions, application and cross reference charts come with your order. Call your United Delco supplier today.

Delco Radio Automotive Radio Service Parts and Electro-Mechanical devices are distributed nationally through **United Delco**.

DELCO RADIO, Division of General Motors, Kokomo, Indiana



Circle 50 on literature card

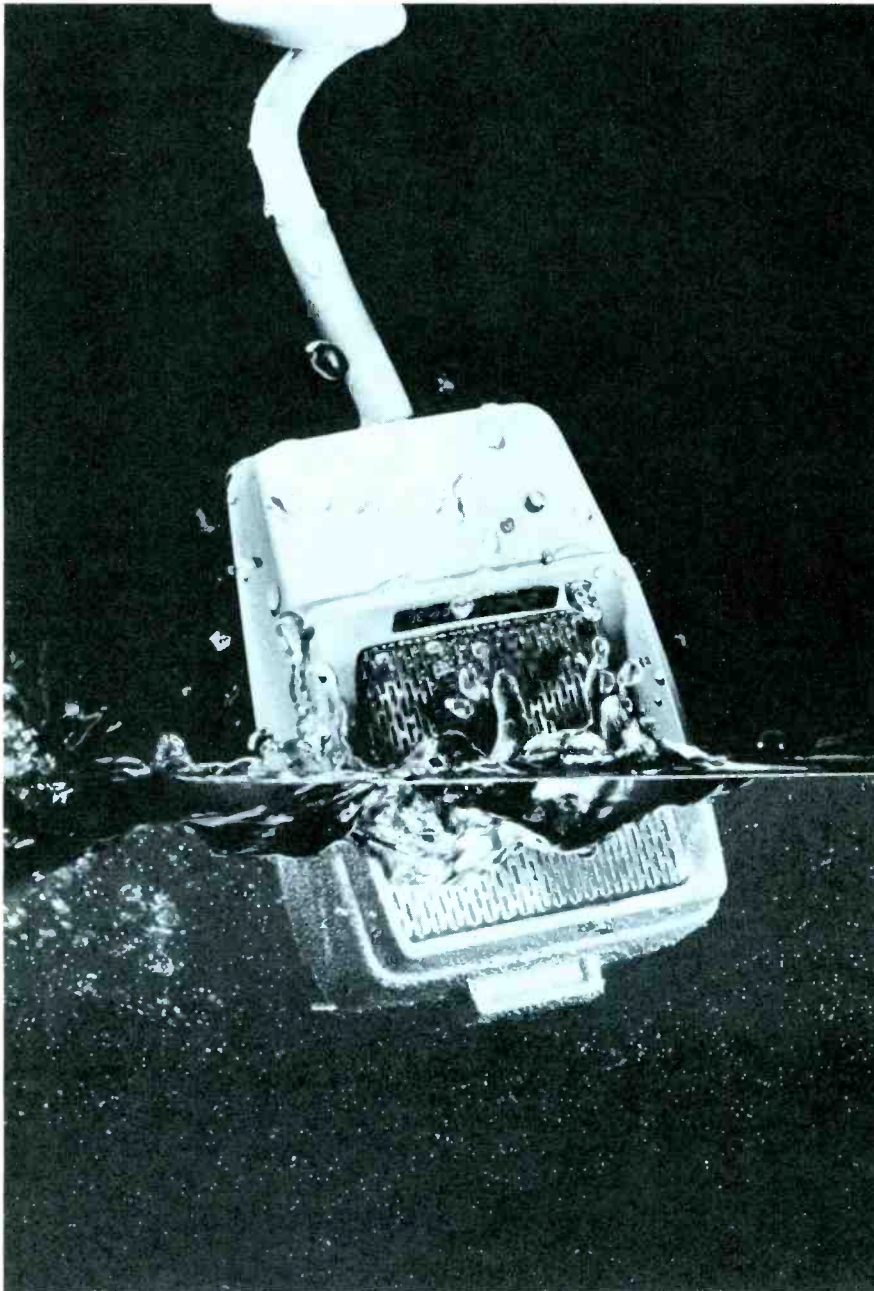

DUNK IT!

CERAMIKES STILL GIVE TOP FLIGHT PERFORMANCE

Anything can happen to a CB mike—and generally does. That's why the Sonotone Ceramike CM-30 is built to take such terrific punishment. Its heart—a rugged ceramic element—is mounted in a sturdy but pliant neoprene suspension, and is immune to shock, vibration, and moisture. Its operation is unaffected by even extreme humidity. Its light, short-travel switch will make over 100,000 clean, sharp contacts.

The CM-30M comes in a "shatter-proof" plastic case with a "push-to-talk" switch at the top and a 6-foot retractable cord.

For long life, ruggedness and outstanding performance, make your next CB mike a Sonotone Ceramike. Model CM-30, \$14.00. CM-30M (with convenient dashboard 'Magnet Mount'), \$16.50. CM-31 (same as CM-30 less switch), \$13.50.

Sonotone Sonotone Corp., Electronic Applications Div., Elmsford, New York
Cartridges • Speakers • Microphones • Headphones • Hearing Aids • Batteries
Circle 51 on literature card

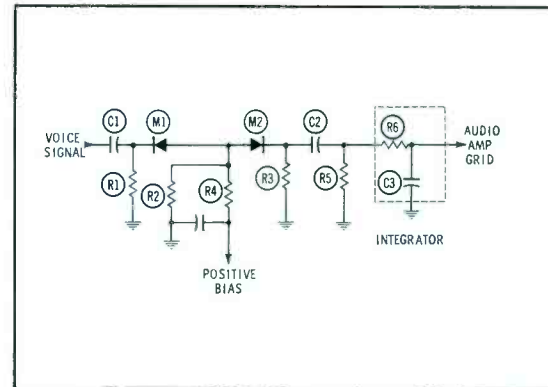

Fig. 3. Series-diode circuit is most common.

audio signal is applied to the cathode, the diode current tends to follow the signal excursions, developing the signal across the load resistor. The level of input signal is insufficient to swing the cathode positive at any time; thus, the signal is not rectified but merely coupled through the diode.

However, a very strong voice peak will have an amplitude greater than the diode bias. When such a pulse occurs, the cathode will be driven positive with respect to the plate, and the diode will not conduct. As a result, the voice peak will not be developed across the output resistor, and is thus clipped from the output signal.

It is significant that the simple diode circuit of Fig. 2B can limit only the positive excursions of the complex voice waveform. In most transmitters, there are also negative peaks that should be removed. Just as two diodes can be made to rectify both positive and negative portions of a sine wave in the secondary of a power transformer (full-wave rectifier), an arrangement of two diodes can be used to limit both positive and negative peaks in a speech amplifier.

A Practical Limiter

One simple type of modulation limiter is shown in Fig. 3. Either tube or semiconductor diodes can be used, although the trend is to semiconductors. In a two-way transmitter, the limiting stage is often positioned between the first and second speech amplifiers. The level at which limiting occurs depends on the positive bias applied to the anodes of the two diodes by divider network R2-R4.

The first series-connected diode (M1) clips off positive voice peaks. Positive peaks on the cathode that

exceed the bias voltage applied to the anode cut the diode off.

Negative peaks are conducted by the first diode and appear across resistor R2. They are thus applied to the plate of second diode M2. If their amplitude is above the limiting level set by the bias network, they will cause the second diode to cut off. Thus, both positive and negative voice peaks are removed and do not appear across output resistor R3.

Spurious signal components are generated by any clipping action. They can produce distortion, increase bandwidth, or in other ways adversely affect modulation. Fortunately, these frequency components are usually above the desired voice frequencies. Consequently, a resistor-capacitor integrating combination or a low-pass filter often follows the modulation limiter. The integrator blocks the transfer of high-frequency components and helps restore the smooth shape of the original waveform.

In many communications transmitters, it is customary to include a simple RC integrator plus a low-pass filter. The low-pass filter provides additional attenuation of unwanted harmonics because the audio high-frequency limit of most communications systems is around 3000 cps.

The audio amplifiers of a communications transmitter must provide enough audio gain ahead of the modulation limiter to keep normal speech levels near the point of limiting. In addition, the stages that follow must have enough gain to permit a high average modulation percentage. Of course, too much clipping can distort the speech, so the preamplification mustn't overdrive the limiter. Too much gain following the limiter will cause overmodulation of the transmitter. The

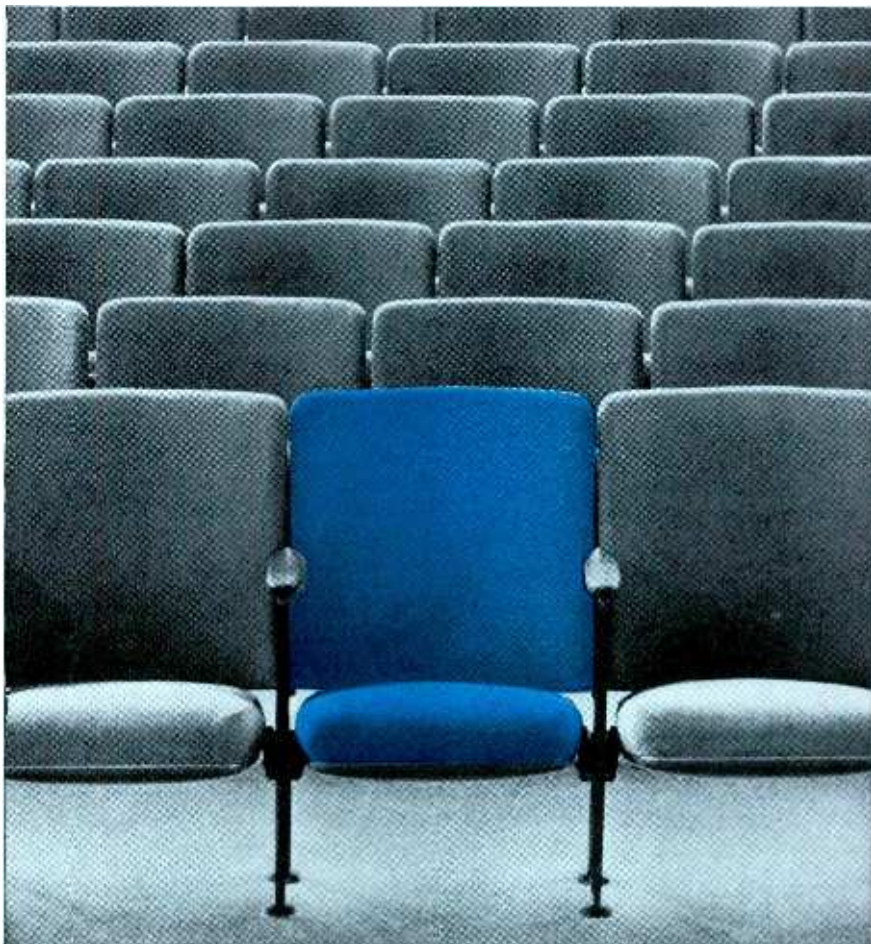

the best seat in the house...

... and it's right in every living room if the FM is equipped with a

FINCO® AWARD WINNING FM ANTENNA

Broadcasting authorities agree that an outdoor antenna is absolutely essential for the reception of full quality monaural and multiplex FM sound.

A *FINCO* FM antenna will deliver a clean undistorted signal and bring in more stations, regardless of location.

Guarantee the best seat in the house for tonight's FM concert . . . install a fidelity-phased *FINCO* FM antenna.

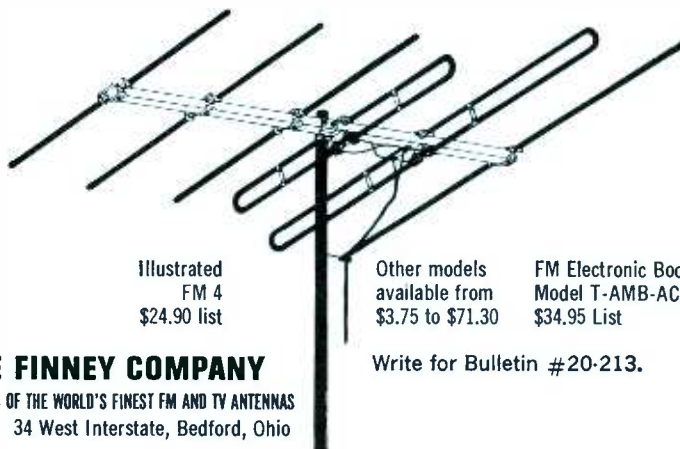

Illustrated
FM 4
\$24.90 list

Other models
available from
\$3.75 to \$71.30

FM Electronic Booster
Model T-AMB-AC
\$34.95 List

THE FINNEY COMPANY

PRODUCERS OF THE WORLD'S FINEST FM AND TV ANTENNAS
34 West Interstate, Bedford, Ohio

Write for Bulletin #20-213.

Circle 52 on literature card

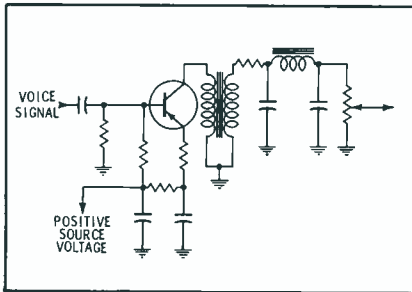

Fig. 4. Single transistor clips both peaks. modulation level control usually follows the limiter.

Whether the transmitter is amplitude or frequency modulated, proper adjustment is best obtained by using a modulation meter at the transmitter output. Checks with an oscilloscope can help locate adjustment or circuit defects when there is modulation distortion.

A Transistor Unit

A transistor modulation clipper is shown in Fig. 4. A low-level signal can drive a transistor stage from cutoff to saturation with ease. At the same time, the transistor will still operate with full gain and low distortion for any signal amplitude that falls between the limits of satu-

ration and cutoff. Thus a transistor amplifier very early in the speech system can provide effective voice-peak clipping. Here's how it works:

When the base-emitter junction of a transistor is reverse-biased, no emitter-base current flows. As a result, the collector current is cut off. For a PNP transistor it is the positive voice peaks that swing toward cutoff. If an NPN transistor is being used, it is the negative voice peaks at the base that are clipped off by cutoff action.

As transistor forward bias is increased, a point is reached at which there is no further increase in base current with rising signal amplitude. Thus, collector current is also limited. For a PNP transistor, this limiting action removes negative modulation peaks. Oppositely, positive modulation peaks are removed by saturation in an NPN circuit.

Actually, in a transistor circuit, saturation can also be the result of collector-base current flow. If the voice peaks on the base exceed a certain level, it places a forward bias on the base-collector junction. This results in collector-base current flow

to the input circuit, which limits any further increase in base-emitter bias current. This action is comparable to the flow of grid current in a vacuum-tube stage that employs grid limiting.

As with the diode-type limiter, the transistor limiter must be followed by suitable integrating components and an additional low-pass filter. Again, the modulation level control follows the modulation limiter circuit.

Checking Limiters

Testing the action of modulation limiters is not at all difficult. An audio generator and oscilloscope (or an AC VTVM) are all that is necessary for troubleshooting. Here is a test procedure that will work with almost any type of limiter, and will check the system from mike input right up to the modulator.

Use just enough signal output from the generator—1000 cps is a good test frequency—to be visible on the scope. Make sure the modulation control is set for maximum modulation. It is important in this first step that the limiter not be

Make BIG PROFITS with CB or 25 to 50 Mc. Industrial 2-WAY RADIO



"Messengers" rated "best" by Distributor Salesmen! Dealer program puts you into this profitable field!

Priced within easy reach of any business—"Messenger" Citizens radio or 25 to 50 Mc. Industrial Radio equipment can be your key to a bigger more profitable 1964!

CITIZENS RADIO—Compact, hand-held 100 milliwatt and 1½ watt "Personal Messengers" . . . performance-proved base station and mobile "Messenger" and "Messenger Two" . . . new, all-transistor "Messenger III" for base station, mobile, portable field pack or public address use! High efficiency design makes full use of maximum allowable legal power—all units offer excellent receiver sensitivity, selectivity and automatic "squelch" control. 5 crystal controlled channels on the "Messenger"—10 plus tunable receiver on "Messenger Two"—11 on "Messenger III".

INDUSTRIAL RADIO (25 to 50 Mcs.)—F.C.C. type accepted for use in the Industrial, Public Safety and Land Transportation services, the "Messenger 202" and the 25 to 50 Mc. "Personal Messenger" are finding ready acceptance in thousands of business, industrial and municipal applications! Plenty of pep, power and performance for solid communications—designed for easy operation and simplified maintenance.

"Messenger" equipment is available nationally from E. F. Johnson Company distributors. Powerful dealer ad program shows you how to make big money in sales and service in this profitable field!

CONTACT YOUR DISTRIBUTOR or write today for full details



E. F. JOHNSON CO.
8220 Tenth Ave. S.W. • Waseca, Minn.

Manufacturers of World's Most Widely Used Personal Communications Transmitters

Circle 53 on literature card

SAVES
your back...
SAVES
your time...

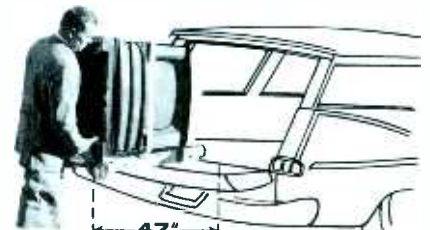

YEATS SHORTY DOLLY for RADIO and TV

just 47 inches high for STATION WAGONS and PANEL PICK-UPS



FOLDING PLATFORM
15¼" x 24½" top.
Snaps on or off.
(Platform only)
\$11.95

Designed for TV, radio and appliance men who make deliveries by station wagon or panel truck . . . the short 47 inch length saves detaching the set for loading into the "wagon" or pick up. Tough, yet featherlight aluminum alloy frame has padded felt front, fast (30 second) web strap ratchet fastener and two endless rubber belt step glides. New folding platform attachment, at left, saves your back handling large TV chassis or table models. Call your YEATS dealer or write direct today!



YEATS
Model No. 5
Height 47"
Weight 32 lbs.



FURNITURE PAD

"Everlast" COVER AND PADS

YEATS semi fitted covers are made of tough water repellent fabric with adjustable web straps and soft, scratchless white flannel liners. All shapes and sizes — Write



TV COVER



APPLIANCE DOLLY SALES COMPANY

1307 W. Fond du Lac Ave. • Milwaukee, Wisconsin

Circle 54 on literature card

driven to the point where it begins limiting.

Apply the signal to the mike input point, and trace it through each stage of the speech amplifier. You should find gain across the speech amplifier stages. There should be a slight loss in the limiter section, and a loss across the RC networks following. If there is a stage of amplification between the limiter and the modulator, make sure the signal actually is amplified.

Next, set the modulation control at its half-way point. Connect the scope or VTVM at the output of the first speech amplifier, and see if raising the generator output level causes an increase in signal output. Do the same for the second speech amplifier, or whatever other stages precede the limiter section. All of these stages should show an increase in output whenever the generator output is increased; they should accept increased signal right up to their point of overloading—signified by severe distortion, which points up the advantage of using a scope.

Then connect the scope or VTVM at the output of the integrator network. Turn the generator output control up and down, and note the signal level at which the scope or VTVM indicator ceases to increase. This proves that the limiter is working.

Set the generator output just below the point of limiting. Try resetting the modulation control of the transmitter to see if it will control limiting below the half-way point. It should reduce the signal at the scope or VTVM as it is turned for less modulation. Return the control to midrange.

Set the generator output level just above the point of limiting. Try setting the modulation control for

higher modulation. The scope indication should rise correspondingly. Set the generator a little higher; again, moving the modulation control should result in a higher indication on the scope or VTVM.

Finally, make the last two tests with the indicator connected right at the input to the modulator. If all is well, the results will be the same as with the scope or VTVM connected at the output of the limiter.

Conclusion

Obviously, the important ingredients for servicing transmitter modu-

lation limiters are an understanding of the circuits, a knowledge of servicing techniques, and the test instruments we've described. The stages shown are the common ones, but most others are based on some slight variation of these two basic types. Careful maintenance of the modulator and its associated circuits can result in better than average communications for your customer than would be possible if you didn't understand how to check these stages. Become familiar with them and you can do the job your two-way customers deserve. ▲

new! Courier 23



**23 CHANNELS
23 FEATURES
DUAL CONVERSION**

TRANSISTOR POWER SUPPLY

\$189⁵⁰ including all crystals, mounting brackets, power cords and noise-cancelling microphone

slightly higher west of Rockies

Send for details . . . dealer inquiries invited

e.c.i. electronics communications, inc. dept. B
325 no. macquisten pkwy., mt. vernon, n. y.

Gentlemen: Please send all information concerning the COURIER 23.

name

address

city Zone State



electronics communications, inc. 325 no. macquisten pkwy., mt. vernon, n. y.



Mosley UNI-LINEAR

**SERVING BUSINESS
THROUGH
DEPENDABLE
COMMUNICATIONS!**

AS YOUR BUSINESS GROWS, SO DOES YOUR NEED FOR DEPENDABLE 2-WAY COMMUNICATIONS. HERE IS THE ANTENNA THAT WILL MEET THOSE GROWING DEMANDS.

THE MOSLEY UNI-LINEAR BUSINESS BAND ANTENNA IS AVAILABLE IN TWO MODELS:

ULBB-27 (27.2 to 27.5 MCS)
ULBB-35 (36 MCS)

AND ARE COMPATIBLE WITH ANY TRANSMITTER, RECEIVER OR TRANSCEIVER YOU CHOOSE.

THE (ULBB) ANTENNA IS AN OMNI-DIRECTIONAL VERTICAL GROUND PLANE, DESIGNED AND MANUFACTURED TO FULFILL THE MOST EXACTING REQUIREMENTS DEMANDED BY 2-WAY COMMUNICATION USERS.

MOSLEY (ULBB) INCORPORATES A SHUNT MATCH FEED WITH 50 OHM IMPEDANCE, RATED TO 1000 WATTS WITH A NOMINAL 1.5 OR LESS VSWR AT RESONANT FREQUENCY. MOSLEY UNI-LINEAR OFFERS A BIG 3.4 DB GAIN OVER A STANDARD GROUND PLANE AND DIRECT GROUND LIGHTNING PROTECTION.

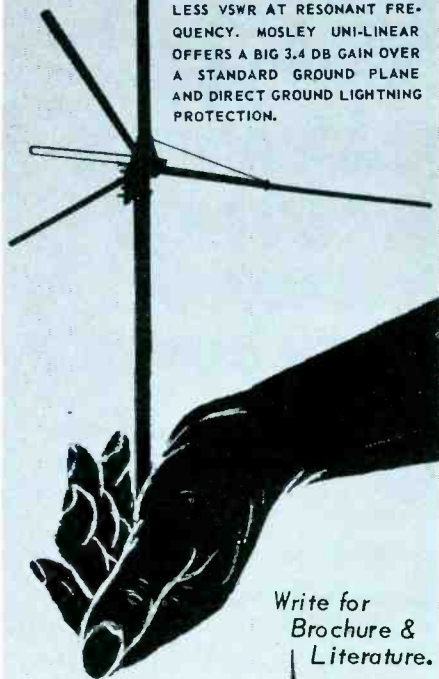

Write for
Brochure &
Literature.

Mosley Electronics, Inc.

4610 LINDBERGH BLVD. BRIDGETON, MO. 63044.

Circle 55 on literature card

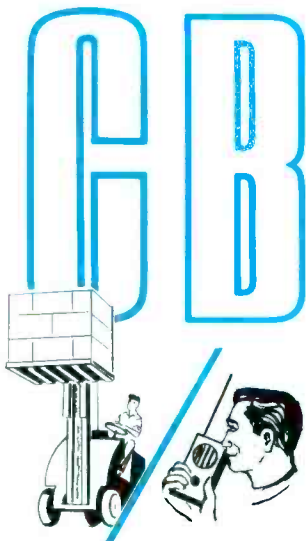

FOR INDUSTRIAL COMMUNICATIONS

by Leo G. Sands

Industry is making wide use of Citizens-band radio for short-range communications because it costs less than FM two-way radio—and in many cases does the job as well. CB is used in industry for several different applications: expediting the operation of material-handling vehicles, paging personnel, and other interoffice and interplant communications; some units are used for remote control of cranes, gates, and other mechanical devices.

Most CB *hobbyists* operate class D Citizens-band stations in the 27-mc band. But, industry is using all four types of CB radio: class A and class

B in the 460-470 mc band, class C and class D in the 27 mc band (see Table 1).

Uses for Class D

The use of class D (27 mc band) CB radios in industry is restricted to the few localities where the band is not congested by hobbyists. A major railroad, for example, is using CB radio for point-to-point communication from a main-line point to a branch-line office. In order to achieve the required range and reliability, large rhombic antennas are used. The system is in an area far removed from populous areas and very little interference from hobbyists is experienced.

In one large industrial plant, 23-channel sets are used for office and plant intercommunication. Each set is normally left tuned to a channel assigned its particular office. Anyone wanting to call that office switches his set to their channel. Hence, it is possible for 23 conversations to take place at the same time, without interference; each is on a different channel. Since the range between offices and buildings is short, plug-in antennas suffice and reduce possible interference from hobbyists in the vicinity.

The interference problem is minimized with CB sets equipped with tone squelch. Some units that will operate on any of the 23 available channels, have a built-in tone squelch that can be used for ringing a bell to alert the called party.

In a paper-container plant, fork-lift trucks are equipped with radio which enables a supervisor to contact his driver at any time. A loud-

Table 1
Citizens Band Station Classes and Channels

Station class	Max. Power (watts)	Number of channels	Band (mc)	Functions
A	60	48	460-470	Voice communications
B	5	1	465	Voice communications Radio control Multi-channel
		49*	460-470	Voice communications Radio control
C	5	6	26.96-27.26	Radio control
	30	1	27.255	Radio control
D	5	23	26.96-27.26	Voice communications

*Only when transmitter is type-accepted for class A and operated at 5 watts or less.

Now...**MORE TV THAN EVER** in **PHOTOFACT**[®]

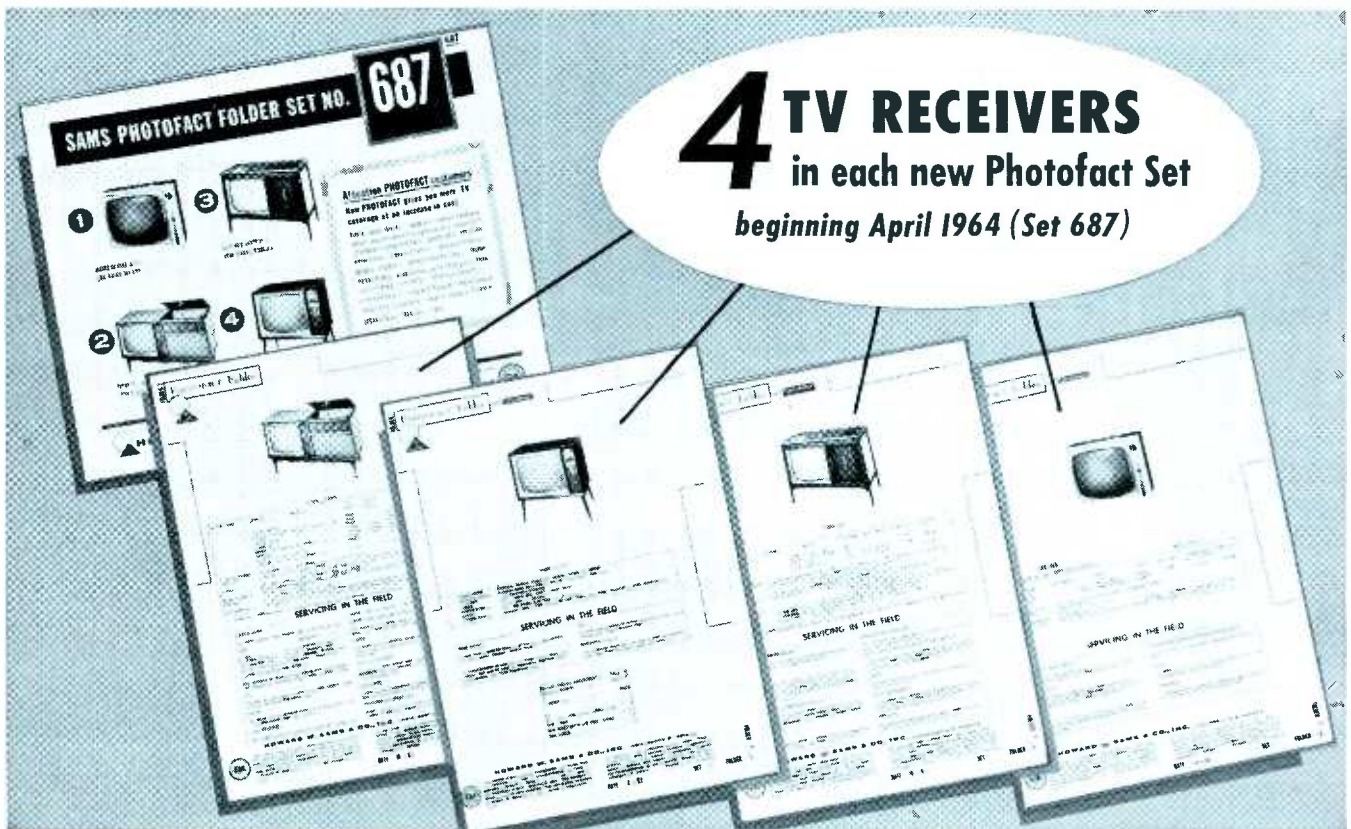

keep up-to-the-minute—at no increase in cost!

Now—PHOTOFACT gives you MORE and quicker-than-ever TV service data coverage (*plus* coverage of the kind of equipment you most frequently repair—AM, FM, Phono, Hi-Fi and Stereo). It's a bigger value than ever!

You get these famous PHOTOFACT time-saving, troubleshooting aids to help you earn more daily: Exclusive Standard Notation Schematics, packed with the service details you need; full photo coverage

of all chassis views; *complete* replacement parts lists; tube placement diagrams; actual waveform photos; CircuiTrace[®] for printed boards; alternate tuner data; disassembly instructions; field servicing tips—dozens of other great time-saving features.

Take the *right* step to fast, money-making service work—be sure you have PHOTOFACT at your fingertips when you need it. Sign up now for a money-saving Standing Order Subscription!

SEE YOUR SAMS DISTRIBUTOR AND SUBSCRIBE TODAY—OR SEND ORDER FORM BELOW

**LIMITED
INTRODUCTORY OFFER
FOR NEW
SUBSCRIBERS**



HALF-PRICE CABINET OFFER EXPIRES JUNE 30, 1964

Sign up for a PHOTOFACT Subscription for at least six months, and get this all-steel file cabinet valued at \$9.95 for only \$5.00! Remember, too, with a Standing Order Subscription you pay only \$1.95 per Set instead of the regular \$2.25 price. You save 30¢ per Set!

HOWARD W. SAMS & CO., INC.

HOWARD W. SAMS & CO., INC., Dept. PFF-4
4300 W. 62nd St., Indianapolis 6, Indiana

- Enter my subscription to PHOTOFACT effective with Set No. _____ Month _____
- I enclose \$5 for the single-drawer cabinet at half price. I agree to keep this subscription for at least six months. Place my subscription with my Sams Distributor, who is:

(Distributor must be specified)

Name _____

Address _____

City _____ Zone _____ State _____

Signature _____

Unexcelled Performance!



Suggested List: \$149.50

Hallmark 512

SMART STYLING! RUGGED RELIABILITY!

The Hallmark 512 has been designed and manufactured to give consistent unexcelled performance even under the most severe conditions. It features dual-power, 12 channel crystal-controlled, push-to-talk operation. Sensitivity better than $0.3\mu\text{V}$ for 10 db S/N ratio. Selectivity better than 30 db. RF power over 3.2 watts. Audio power 3 watts. Top quality components in rugged hand-wired chassis. 26.965 to 27.255 mc. High-level modulation, improved low-noise front end. "S" meter and neon modulation indicator standard.

Now! from Hallmark

Most advanced transceiver tester available!



only \$49.50

Here is the most versatile and reliable test instrument of its kind—a crystal-controlled signal generator for low power transceivers. It was specifically designed to assist the technician in installation and servicing of low power transceiver. Measures: RF power (absolute) 0—5 w.; 0—120% amplitude modulation; VSWR. Produces a 100 mw carrier (with or without amplitude modulation of a 1000 cps tone) for checking receivers. Use as a field strength meter.



HALLMARK INSTRUMENTS
6612 Denton Drive, Dallas 35, Texas
Circle 56 on literature card



Dial used with class A Citizens band radio lets driver dial desired station or number.

speaker connected to the supervisor's base station and placed outside his office enables him to receive calls from drivers when he's on the loading platform.

At a large electrical equipment plant, fork-lift trucks and a small locomotive are radio equipped, enabling the supervisor to contact his drivers and expedite the flow of materials. A similar system is in use at one large grocery warehouse.

Plant security officers have CB sets in their cars, and those on foot carry CB walkie-talkies for communicating with their supervisor at alarm headquarters. Since the walkie-talkies are used for communicating with licensed CB sets—even if they qualify for unlicensed operation—they must meet FCC technical standards for class D stations.

Walkie-talkies are often used at construction sites by personnel on foot (and riding construction elevators), for communicating with a supervisor equipped with a fixed CB set. They are also used in large parking lots, garages, and apartment



Metal box contains resistors to drop voltage to 12 volts on electrically-propelled vehicle.

IT ONLY COSTS
1/100 OF 1¢ MORE*
PER SOLDER JOINT
TO KNOW YOU
ARE USING THE
WORLD'S FINEST
CORED SOLDER



ERSIN
Multicore
FIVE-CORE SOLDER
Sold only by Radio Parts Distributors

*Based on cost comparison in current catalogs.
MULTICORE SALES CORP., PORT WASHINGTON, N. Y.

Circle 57 on literature card



send for NEW FREE
CRYSTAL CATALOG
with NEW TRANSISTOR
OSCILLATOR CIRCUITS

3 PLANTS TO SERVE YOU BETTER
HERMETICALLY SEALED
PRECISION GROUND
CUSTOM-MADE
NON-OVEN CRYSTALS

Gold or silver plated, spring mounted, vacuum sealed or inert gas, high freq. stability, 10 milliwatt max. current cap. Meet mil. specs.
1000KC to 1600KC (Fund. Freq.)
1601KC to 2000KC (Fund. Freq.) \$5.00 ea.
2001KC to 2500KC (Fund. Freq.) 4.00 ea.
2501KC to 5000KC (Fund. Freq.) 3.50 ea.
5001KC to 7000KC (Fund. Freq.) 3.90 ea.
7001KC to 10,000KC (Fund. Freq.) 3.25 ea.
10,001KC to 15,000KC (Fund. Freq.) 3.75 ea.
15MC to 20MC (Fund. Freq.) 5.00 ea.

OVERTONE CRYSTALS

15MC to 30MC Third Overtone \$3.85 ea.
30MC to 40MC Third Overtone 4.10 ea.
40MC to 65MC Third or Fifth Overtone 4.50 ea.
65MC to 100MC Fifth Overtone 6.00 ea.
DRAKE 2-B Receiver Crystals \$4.00

(All Channels—Order by Freq.)

OVEN-TYPE CRYSTALS

For Motorola, GE, Gonset, Bendix, etc.
Add \$2.00 per crystal to above prices
SUB-MINIATURE PRICES slightly higher

ORDER FROM CLOSER PLANT
TEXAS CRYSTALS

DEPT. PF
1000 Crystal Drive
FORT MYERS, FLORIDA
Phone 813 WE 6-2109
TWX 813-334-2830

Division of



AND
4117 W. Jefferson Blvd.
LOS ANGELES, CALIF.
Phone 213-731-2258
TWX 213-737-1315

Circle 58 on literature card



TYPE IL . . . why use old fashioned wax end-filled cardboard capacitors in radio repairs? Avoid call-backs with Planet type IL dual section tubular electrolytics . . . hermetically sealed in aluminum tubes with wax impregnated insulating jacket. Planet IL's are also available in 450 volts for TV servicing. Ask for them by type number at your distributor.

PLANET SALES CORP.

225 Belleville Ave.
Bloomfield, New Jersey

Circle 36 on literature card

New **BERNS** Perfect Pin Crimper

Picture-Tube Repair Tool

Also for—5U4, 65N7, 6BQ6, etc.

Eliminates that hard soldering job
only \$1.25 each

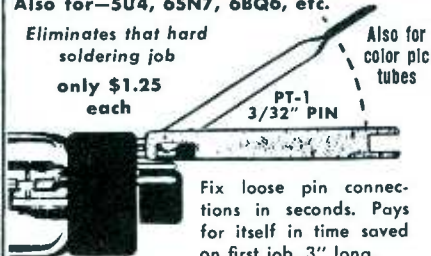

Fix loose pin connections in seconds. Pays for itself in time saved on first job. 3" long.

Patented

Intermittent operation of picture tubes and other tubes due to defective solder connections easily corrected. Provides solid electrical connections, can also be used as channel-selector wrench and screwdriver. Pin keeps its original form. A 3-in-1 tool.

3 MODELS ELIMINATE SOLDERING

Makes Solid Electrical Connections Phono Pin-Plug Crimper

Slip wire in "pin plug," insert in tool, and squeeze . . . job is done.



C-rings 1c ea.

Use end of tool to push on C-ring for ground connection.

Ant. plugs, hi-fi, multiple plugs, public address, radio and TV tubes, radar, speakers, and loop connections. Many, many more uses.

Model LC-3 for 5/32" pin diameter

At your parts distributor or write us

BERNS

Mfg. Co.
9853 Chalmers,
Detroit 13, Mich.

Circle 37 on literature card



This tiny locomotive is radio-equipped, as are fork-lift trucks used at this same plant.

houses for communicating with maintenance personnel.

The foregoing are typical industrial applications of class D Citizens-band radios. Equipment cost is quite low, ranging from around \$70 to as much as \$350. Most sets are in the under-\$200 class. Power input to the final RF power amplifier is limited to 5 watts and antenna height to 20' above the structure on which the antenna is mounted.

Class A Stations

Industrial CB radio systems also operate in the 460-470 mc UHF band. Class A stations employ FM sets similar to those used in the Business and Manufacturing radio services. Power input to the final stage is limited to 60 watts, but there is no restriction on antenna height. Communication from a base station to a mobile unit 20 miles distant is not uncommon when the base station antenna is effectively located. Class A stations may operate on only one of 48 channels; which one is specified in the station license. Class A stations, while intended primarily for voice communications, can be used for facsimile transmission and other purposes when special permission is granted by the FCC.

Requirements for Class B

Class B stations have 49 channels available to them in the 460-470 mc UHF band—the same 48 channels allocated to class A stations plus one wideband channel on 465 mc. Class B stations can use any channel without special permission, but they must use equipment that has been type-accepted by the FCC and operate the transmitter with no more than 5 watts input. Antenna height

solid
state
reliability...

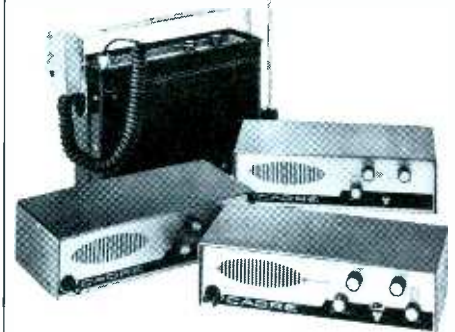

Cadre (CB Transceivers)

Solid state circuitry means that Cadre CB receivers can be bounced over rough roads in mobile installations; and can take plenty of rough use at base stations and in portable field use.

Solid state circuitry means that Cadre transceivers draw about as much power as an electric clock. Not only do auto or marine batteries last longer, but when batteries get low, Cadre solid state transceivers operate where others might not.

Reliability is only one reason why Cadre solid state CB transceivers are your best buy. Performance is another part of the story—plenty of transmission punch on 5 crystal-controlled channels—long distance reception with the dual conversion superhet receiver. And unwanted noise and adjacent channels are effectively suppressed.

FOUR POWERFUL SOLID STATE 5-WATT, 5 CHANNEL MODELS for every possible application—base station, mobile, field. New Cadre 510-A—AC/DC 23 channel manual tuning \$199.95. Cadre 515 same as 510-A less manual tuning \$185.00. Cadre 520 DC only with battery cable and mounting kit. For mobile and portable use from 12 volt batteries \$169.95. Cadre 525, model 520 in portable pack carrying case with built-in battery/power supply, recharger, AC cord and telescoping antenna for complete field portability. \$249.95.

FULL POWER, 1.5 WATT HAND HELD RECEIVER CADRE C-75 Solid state throughout. Two crystal-controlled channels. Sensitive receiver, powerful transmitter with one watt output to the antenna. \$99.95. Recharger and set of (2) nickel-cadmium batteries. \$28.05. Cartridge for (9) penlite cells. \$2.55.

CADRE INDUSTRIES CORP.
COMMERCIAL PRODUCT DIVISION □ ENDICOTT, NEW YORK □ AREA CODE 607, 748-3373. Canada: Tri-Tel Assoc., Ltd., 81 Sheppard Ave. W., Willowdale, Ont. Export: Morhan Export, 458 B'way, N. Y. 13, N. Y.

Circle 60 on literature card

SAMS Best Sellers

LATEST EDITIONS OF TWO FAMOUS
HOWARD W. SAMS HANDBOOKS!

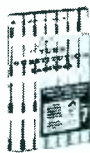

Tube Substitution Handbook
still the Leading Reference—lists
10,000 Tube Substitutions
Absolutely indispensable! 7 Sec-
tions cover: Cross-reference of
American Receiving Tubes; Cross-
reference of Subminiature Tubes;
Industrial Substitutes for Receiv-
ing Tubes; Communications and
Special-Purpose Tubes; Foreign Substitutes
for American Types; American Substitutes
for Foreign Types; Picture Tube Substitu-
tions. 128 pages; 5 1/2 x 8 1/2". **\$150**
Order **TUB-7**, still only.....



Transistor Substitution Handbook
Computer-Selected Substitutes for
Over 5,000 Transistors—Updated!
Lists over 40,000 direct substitu-
tions, including all popular types
used in transistor radios and sim-
ilar equipment. Shows biasing dia-
grams, polarity identification and
manufacturers for over 5,000 types.
Special section lists more than
15,000 American replacements for foreign
transistors—plus a semiconductor and diode
guide containing 800 substitutions. 128
pages, 5 1/2 x 8 1/2". Order **SSH-5**, still only **\$150**

Transistor Ignition Systems Handbook

by **Brice Ward**. Transistor ignition systems are revo-
lutionizing the auto industry. This new book clearly
explains the principles of these highly efficient sys-
tems—how they work, how to install them, how to
tune them up. Describes typical systems now in use;
provides complete data on installation. **\$250**
128 pages; 5 1/2 x 8 1/2". Order **IGS-1**, only....

Color TV Servicing Made Easy

by **Wayne Lemons**. Written in "make easy" style.
Takes the mystery out of color TV servicing. Intro-
duces you to color principles and setup adjustments;
thoroughly covers color circuitry, adjustments, and
servicing of all color TV sets produced to date. This
book will help to put you into this fast-growing,
profitable service work. 128 pages, 5 1/2 x 8 1/2". **\$295**
Order **CSL-1**, only.....

PHOTOFAC Guide to TV Troubles

by **Herrington & Oliphant**. Contains over 240 photos
of actual TV picture troubles, keyed to defective
components in typical circuits. Shows exactly what
happens to picture tube display when any compo-
nent becomes defective. By making the quick checks
recommended in special charts, troubleshooting is
reduced to minutes. 160 pages, 5 1/2 x 8 1/2". **\$295**
Order **PFG-1**, only.....

Troubleshooting with the Oscilloscope

by **Bob Middleton**. Explains how you can best use
the scope to actually view and analyze electronic
circuit actions, and apply what you see to more
effective TV and radio troubleshooting. Practical
chapters on scope operation, use of probes, signal-
tracing, visual alignment, signal testing, circuit
analysis, and troubleshooting TV, Radio, and
Hi-Fi. 128 pages; 5 1/2 x 8 1/2". Order **TOS-1**, only **\$250**

Troubleshooting with the VOM-VTVM

by **Bob Middleton**. Shows how to use these instru-
ments for troubleshooting TV circuits. Tells how to
check and interpret voltages; gives step-by-step pro-
cedures for analyzing every type of TV circuit. Also
describes measurement and analysis of both AC and
DC voltages, resistance, capacitance, and RF sig-
nals. 160 pages; 5 1/2 x 8 1/2". **\$250**
Order **TWV-1**, only.....

Phonograph Cartridge & Needle Replacement Guide

by the **Howard W. Sams Technical Staff**. Most com-
prehensive guide available to replacement cartridges
and needles. Listed by original parts numbers and
by equipment manufacturers' model and part num-
bers. Fully cross-referenced. 96 pages, 5 1/2 x
8 1/2". Order **RCN-1**, only..... **\$195**

HOWARD W. SAMS & CO., INC.

Order from your Sams Distributor today, or mail
to Howard W. Sams & Co., Inc., Dept. PF-4
4300 W. 62nd Street, Indianapolis 6, Ind.

Send me the following books:

- TUB-7 IGS-1 PFG-1 TWV-1
 SSH-5 CSL-1 TOS-1 RCN-1

\$_____ enclosed. Send FREE Booklist

Name _____

Address _____

City _____ Zone _____ State _____

My Distributor is _____

IN CANADA: A. C. Simmonds & Sons, Ltd., Toronto 7

is restricted since the center of the radiating portion of the antenna must be within 25 feet of the control point. Class B stations can be used for voice communication, radio control, and other types of emission, as long as channel-occupancy limits are not exceeded.

For point-to-point communication, class B stations can use microwave-type equipment, with carefully aimed beams. Since a class B station operating on 465 mc can occupy up to 4.95 mc of band space, it is possible to employ multiplex equipment to provide a large number of voice and control channels.

There is also another kind of class B station—a low-cost transceiver which has a self-excited transmitter and a superregenerative receiver. When properly installed and used, sets of this type provide short-range communications and are free of skip interference from distant stations because of the high operating frequency. Sets of this type are still being produced, although they have been largely superseded by class A and class D type sets.

Class C for Control

Portable transmitters that transmit tone signals for control of cranes and other machines are licensed as class C stations in the 27 mc Citizens band. There are six channels available for this purpose. On five of the channels, transmitter power input is limited to 5 watts; on one channel, 27.255 mc, up to 30 watts of transmitter power may be used.

Another industrial application for class C stations is the opening and closing of gates and doors by personnel in vehicles. A push button causes a tone-coded radio signal to be transmitted; this signal actuates



Citizens band radio has many uses around aircraft depots. Here's one mounted on tractor.

Winegard

Dealer of the month

M. B. Mac Donald says, "From the first demonstration, our sales of Winegard Colortrons rose over the two bay, modified yagi until we now install Winegard Colortrons three to one!"



Winegard salutes Mac Donald's Radio Company of Los Gatos, California

Mac Donald's sell radios, television sets, records and appliances besides providing complete service. M. B. Mac Donald, owner of the business which he started in March of 1925, says that Los Gatos, 55 miles from San Francisco, is a real fringe area. He installed his first Winegard on his own rooftop and has never had any failure with Winegard antennas.

He states, "From the first demonstration our sales of Winegard Colortrons rose over the two bay modified yagi until we now install Winegard Colortrons three to one. Los Gatos is in a fringe area on the highway to the Santa Cruz Mountains so we have a problem."

In the photograph above are, left to right, William Anthes (technician), Mary Jane Olson (records), and Jim Proctor (helper). Other members of the organization not shown here are technician Irv McVea, owner Mac Donald and Neva Johannes.

During the World Series approximately 24 Winegard antennas were installed in one week by Mac Donald's.

Winegard Co.

Antenna Systems

D3009-D Kirkwood • Burlington, Iowa

Circle 61 on literature card



Extension loudspeaker at base station permits more flexibility of personnel in charge.

the door or gate control mechanism through a fixed radio receiver. In some cases, the vehicle is equipped with a telephone dial. The driver dials a prescribed number to open a specific door or gate, another to turn lights on and off, etc. The dial keys an audio oscillator that modulates the class C transmitter. At each point where some apparatus is to be controlled, there is a radio receiver equipped with a dial-pulse decoder.

While most remote control systems operate as class C stations, some are authorized in the 460-470 mc UHF band. They use either a low-cost class B transmitter operating on 465 mc, or a class A transmitter operating on one of the 49 specific channels under a class B license and with transmitter power limited to 5 watts input.

When the control signal is less than 1 second in duration, and does not recur more than once every 30 seconds, the control transmitter may operate on any frequency above 70 mc and no station license is required. However, the transmitter must conform to the requirements of Part 15 of FCC Rules and Regulations.



Both class A and D are used on material vehicles. Unit here is class A (460-470 mc).



Bread & Butter

Betacom solid-state intercoms are the profitable way to tackle the common 'bread and butter' intercom jobs. Reasons: installation ease saves time; solid-state circuitry spells maintenance-free, economical operation, and low power drain, no profit robbing callbacks.

Newest additions to the Betacom line are high level 6 and 11-station AC systems. Masters BI-606 (6-station) \$59.95; BI-611 (11-station) \$64.95. Relay-activated remote BI-602-S (private non-selective 1-station and private selective, 5-station) \$49.95.

MASTERS • high audio output for natural, intelligible voice quality without crosstalk. • operate from central AC power source, wired through a central distribution box. • privacy switch at master allows hands-free operation for answering calls

when not near the Master. • automatic volume compression circuit sets level regardless of loudness of calling message. • push-to-talk lever has hold-down facility. • telephone type junction box factory-wired to master for easy installation.

REMOTES • matching remotes powered from a central supply feature volume control, push-to-talk button with matching facility and selective calling up to 5 different masters.

If you're ready to increase your "bread and butter" communication profits, write for Betacom literature describing a complete line of solid-state battery and AC operated intercoms: popularly priced two-station systems; battery-powered 6-station systems plus accessories that speed installation and make expansion of existing systems easy.

BETACOM
Division of Cadre Industries Corp., Endicott, N. Y.

Circle 62 on literature card

Selling to Industry

Industry is a good market for the independent service shop operator selling CB equipment. Each prospective customer is generally interested in several CB sets, not just one or two (as is the case with hobbyists). Furthermore, industry wants equipment to operate with a minimum of down-time and is therefore an excellent service prospect. Almost every plant of reasonable size has several materials-handling vehicles. And many have vehicles that operate out of the plant area,

but well within the 5-10 mile reliable range of CB sets.

Since down-time is often costly, it is a good idea to have spare sets available when servicing industrial CB installations. The 23-channel types are best for this purpose when the customers use class D equipment, since they are suitable for use in any system.

Installation sometimes poses some problems. At most base-station sites, AC power is usually available and most vehicles operated on roads are equipped with 12-volt storage bat-

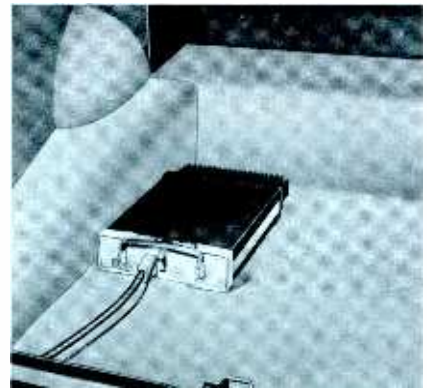

Some class A radiotelephones are designed for installation in trunk of the automobile.

COMCO

Dealerships

FOR
2-WAY RADIO SALES AND SERVICE
NOW AVAILABLE IN MANY AREAS



PRODUCTS

HF-SSB (1.6-16 Mc/s.)

- Point-to-point
- Marine, ship and shore stations
- Military

VHF-AM (108-156 Mc/s.)

- Aeronautical ground stations
- Airport vehicles
- Point-to-point
- Military

UHF-AM (220-400 Mc/s-)

- Ground-to-Air
- Airport vehicles
- Military

VHF-FM (25-54, 144-174 Mc/s.)

- Mobile
- Base
- Repeater
- Marine
- Portable
- Military
- Military
- Point-to-point

UHF-FM (400-420, 450-482 Mc/s.)

- Mobile
- Base
- Repeater
- Portable
- Military
- Point-to-point
- Voice
- RTTY
- Data

- Antennas
- Transmission line
- Remote controls
- Line termination panels
- Tone control and signaling

COMCO offers dealers reliable, high performance two-radio equipment, backed by 25 years of engineering and production experience.

A complete line of two-way equipment is sold —

Directly to the U.S. Military Agencies, to other two-way radio manufacturers, by dealers throughout the world.

You can qualify for a dealership if you have —

✓ An FCC second-class radiotelephone license.

✓ A shop with necessary test equipment for installation and maintenance of VHF-FM equipment.

✓ An established business with good credit rating.

✓ Enthusiasm to promote sales of COMCO radios.

If you meet our requirements, we will be pleased to give you complete information. Write or telephone Frederick R. Macklin, Sales Manager

COMMUNICATIONS COMPANY

Post Office Box 520
Coral Gables, Florida 33134
Telephone (Area 305) 445-2671

teries. But, materials-handling vehicles are apt to have a battery rated at 24, 32, 64 volts, or higher. Since no standard CB sets are designed to operate from these voltages, it is necessary to provide means for reducing or converting the voltage. An AC type CB set can be used with a DC-to-AC inverter to convert the DC battery voltage to 115 volts AC. Some makers build rotating-type inverters and motor generators for providing AC from almost any DC voltage.

On a materials-handling vehicle, a plug-in base-loaded antenna may be attached directly to the CB set's antenna receptacle. Or, one of the short, loaded CB antennas can be installed on the vehicle body; the whip on these is only a little more than a yard long.

Class D Citizen-band radio equipment is available direct from manufacturers and through many distributors at discounts that allow the seller to compete with other CB dealers. Class A equipment is also available directly from some manufacturers at dealer discounts. Class C equipment is generally sold at radio parts distributors and hobby shops, but should be available on a direct basis from some manufacturers.

There are no figures on what percentage of the CB sets now in use are used by industry. Applications for CB station licenses from both hobbyists and industry are running at a rate of more than 20,000 per month. It is estimated that the average CB licensee buys three sets. This indicates that some 60,000 CB sets are being sold each month, representing annual business volume of \$72,000,000 per year. Obviously, CB is well worth investigating as an added source of income. ▲

Circle 63 on literature card

New from RCA!

5 TV ALIGNMENT PROBES

*...for consistently accurate
bandpass circuitry
checks*

At last . . . RCA puts into your hands complete equipment for overall alignment checks that pinpoint a faulty circuit accurately and rapidly in RCA Victor black-and-white or color receivers.

You no longer need to construct temporary circuits or bypass their use altogether because of inadequate equipment. Now you can use bandpass analysis easily on every job. You'll eliminate wasted time on component checks that are unnecessary.

RCA provides you with five new clearly labeled alignment probes:

- Video Detector Test Block—8B105
- IF Test Block—8B106
- Sound Detector Test Block—8B107
- Mixer Grid Matching Pad—8B108
- Tuner IF Input Head—8B109

All have "E-Z" Hook tips that practically eliminate accidental shorting of circuitry and greatly simplify test instrument hook-up and disconnection. Each special circuit is of single unit construction, enclosed in a plastic case. All leads are shielded and cable connections accommodate the specified test equipment.

RCA Alignment Probes . . . the essential service equipment for all RCA Victor TV receivers and most other makes of color TV receivers. From your authorized RCA Parts and Accessories Distributor, or write RCA Parts and Accessories, P.O. Box 654, Camden 1, N. J.



The Most Trusted Name in Electronics



FUSE IMPULSE

**NEW FOR
QUICK PROFIT ON
YOUR COUNTER**



10 fuses
Not 5—Not 6
But 10 fuses
in this assortment
for widest coverage in fuse
replacement
in any auto!
A vital necessity
in every glove
compartment

THESE NEW "SEE-THROUGH" EMERGENCY FUSE KITS COME PACKED 24 TO A CARTON—EACH CARTON INCLUDES WALL/COUNTER DISPLAY CARD. AVAILABLE FROM YOUR LITTELFUSE DISTRIBUTOR.

LITTELFUSE

DES PLAINES, ILLINOIS

Circle 64 on literature card

www.americanradiohistory.com