

SEPTEMBER, 1963

50 CENTS



PHOTOFACT REPORTER

Including **Electronic Servicing**



Transistors
in HI-FI

When Replacement
Parts Don't Quite Fit

A New Look in
Printed Components

Know Your
'63 Color Circuits

Chasing
Intermittent
Sweep

**5 BIG
FEATURES
IN THIS ISSUE**

IA 2L 104 1200
WM. L. DAVIS
RAD. & TV SERV.
118 RIVERSIDE AVE.
GANNON CITY, COLO.

NEW TWIN-TRANSISTOR SUPER POWERMATE

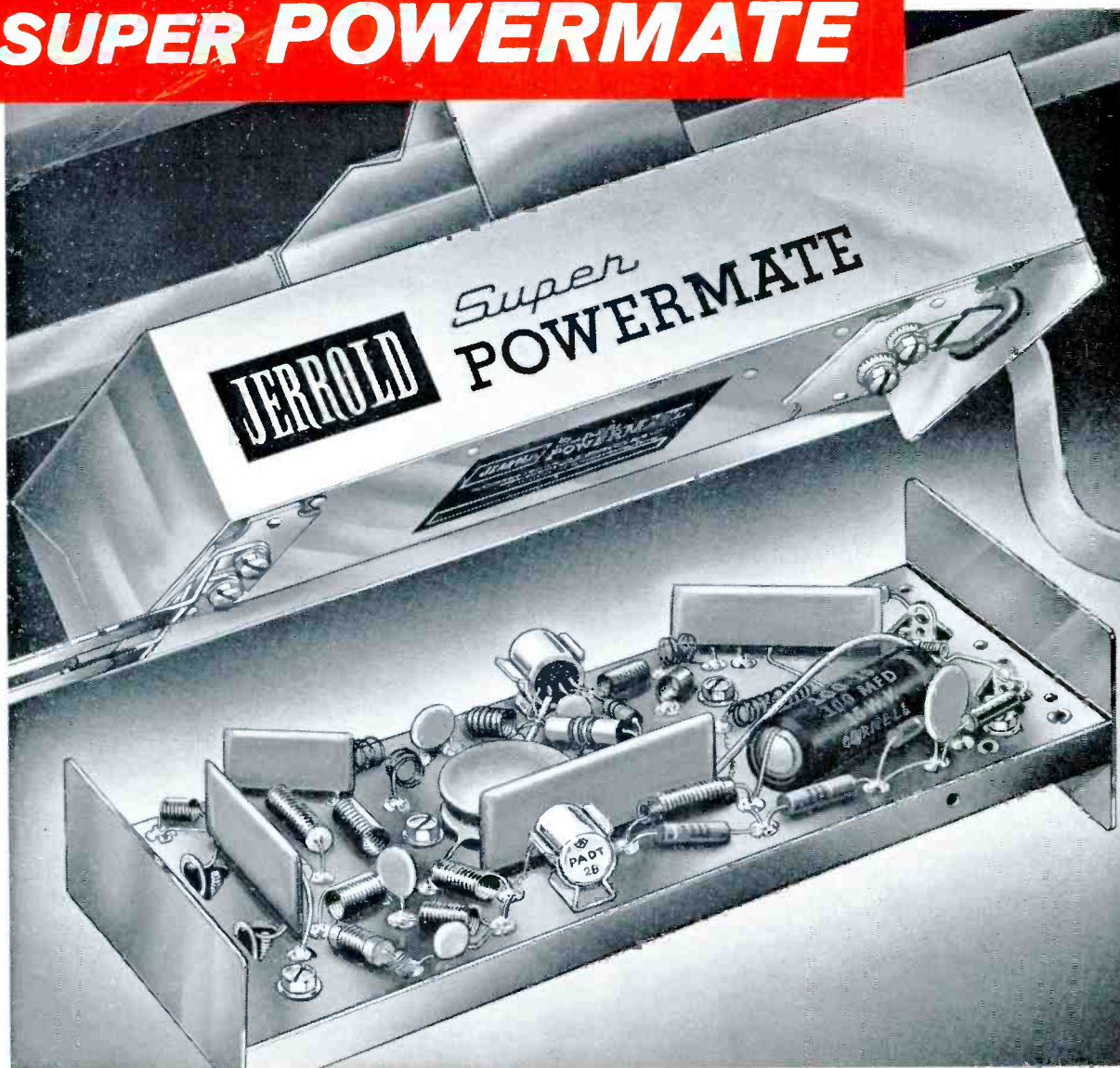

BREAKS THE GAIN/OVERLOAD BARRIER

Servicemen and the public long wanted it, but were told they couldn't have it—a transistorized TV antenna preamplifier with the overload capacity to handle local signals without sacrificing the gain that brings in distant stations.

But Jerrold did what couldn't be done. With the new twin-transistor SUPER POWERMATE, you have, for the first time, a transistor preamplifier with the high gain and low noise figure that made the original Jerrold Powermate famous—plus an unprecedented overload capability for local-signal situations. SUPER POWERMATE offers a gain range from 15.5db with 700,000 μ v max. output at Channel 2, to 11.3db with 200,000 μ v max. output at Channel 13. There are no tubes or nuvistors to replace. And frequency response is fantastically flat—a boon to color TV.

Sell new SUPER POWERMATE, the all-channel antenna preamplifier with G/O—the industry's best Gain/Overload capability. List \$44.95. See your Jerrold distributor or write Jerrold Electronics, Philadelphia 32, Pa.

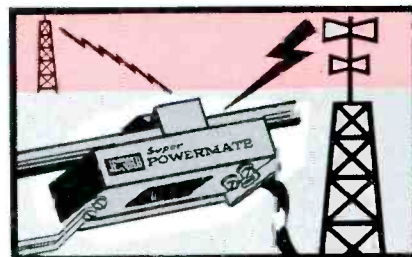

GAIN to reach far-distant stations, OVERLOAD capability to prevent local-signal interference.

SUPER POWERMATE **G/O**
HAS
GAIN / OVERLOAD

JERROLD
ELECTRONICS

A subsidiary of The Jerrold Corporation

Circle 1 on literature card

FM-AM RADIO CHASSIS

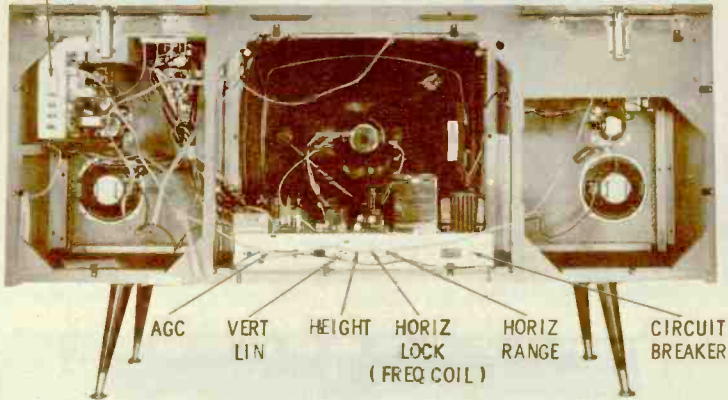

**Admiral
Model STF33X11
TV Chassis 21X3U**

The combination model shown here includes a four-speed stereo phonograph, an FM-AM tuner chassis, and a 23" television chassis. The audio circuit, located on the TV chassis, contains two EL86/6CW5 output tubes; one amplifies either the TV sound or the right-channel stereo signal, while the other is used only for the left stereo channel. The TV-sound tube is also used as the voltage divider in a "stacked" B+ circuit. The TV tuner, sound IF, audio detector, and AGC circuits all receive operating voltage from this secondary B+ supply.

The AM-FM tuner chassis has no separate power supply; it obtains its B+ and filament voltages directly from the transformer-5U4GB supply in the TV chassis. Protective devices include a circuit breaker in the center tap of the power-transformer and a #26 wire-link fuse in the filament circuit.

The VHF tuner is a turret type, with individual oscillator slugs. These adjustments are made accessible by removing the channel-selector and fine-tuning knobs. The RF amplifier is a 6DS4 nuvistor; the mixer-oscillator is a 6CG8A. The tube complement of the IF strip includes 6BZ6's in the first two stages and a 6DK6 in the third stage. You'll find a 1N87 or 1N87A diode serving as the video detector; if you replace it, use only the same type as the original. The location of the diode is marked on one of the photos; it's reached by removing a snap-on shield from the IF can.

Admiral is again using a 6BU8 as a combination sync separator-noise limiter-AGC keying tube. (Some recent chassis used a 6K11 compactron for this purpose.) Other tubes in this chassis are: 6EW7 vertical multivibrator-output, 6DQ6A horizontal output, 6AX3 compactron damper, and 1G3GT HV rectifier. The horizontal oscillator is a 6FQ7 (alternate 6CG7); AFC for this stage is provided by a plug-in dual diode of the common-cathode type.

The vertical hold, contrast, brightness, channel selector, fine tuning, on-off-volume, and function selector (a switch, to select TV or radio/phonograph operation) are all controlled from the front of the cabinet. Mounted on the rear apron of the chassis are the AGC, vertical linearity, height, horizontal lock, and horizontal range controls.



WITH TUNER DRUM REMOVED, COMPONENTS ARE FAIRLY ACCESSIBLE

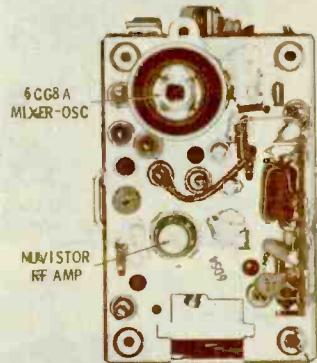

6CG8A MIXER-OSC

NUVISTOR RF AMP

VERT HOLD CONTRAST BRIGHTNESS TV-RADIO-PHONO SELECTOR SWITCH ON-OFF-VOLUME

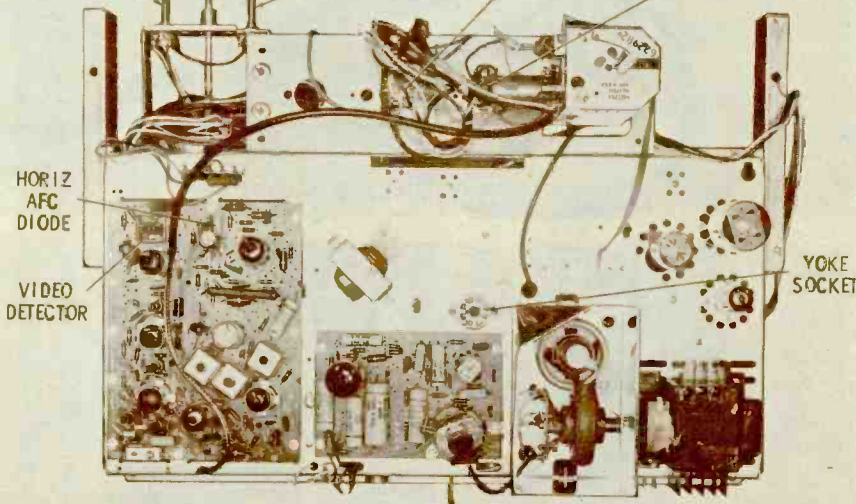



**Clairtone
Model ST-801
TV Chassis S-2
FM-AM-Stereo Amplifier
Chassis C-401**

One of the most recent imports from Canada is the combination model shown here. It features, in addition to a 23" TV chassis, a separate FM-AM-stereo amplifier chassis and a four-speed phonograph. This radio-phono chassis is self-powered, having its own B+ power supply and filament source. You'll notice from the photo that the mode of operation is selected by merely depressing the desired push button. All of the input and output jacks on this unit are clearly marked with their appropriate connections.

The TV chassis features a 114° bonded 23CP4 CRT, and a new type of "drum" tuner. The channel strips (see example pictured) utilize printed coils on a wafer form; each strip can be removed individually, in much the same manner as the more familiar turret-tuner strips. A 4ES8 RF amplifier and a 5U8 mixer-oscillator are the tubes used in this tuner. One overall trimmer for all channels, located at the front of the tuner, is used for oscillator adjustment.

A half-wave voltage doubler, using two silicon rectifiers, supplies the B+ for this receiver. This circuit has for its protection a 2.5-amp slow-blow line fuse and a 7.5-ohm, 10-watt surge-limiting resistor. The series filament string includes a series dropping resistor—a 22-ohm, 15-watt unit.

Three stages of IF amplification are used. The first and second IF tubes are 3BZ6's, and the third is a 3CB6. The video detector is a 1N87 crystal diode (see photo), and the video output tube is a 8DX8 (XCL84 alternate). Some of the other tubes used in the TV chassis include: 8B8 (XCL82 alternate) audio output-sync inverter, 5U8 AGC keying-noise amplifier, and 3AJ8 (ECH81 alternate) AGC clamper-sync separator. Those you'll find in the horizontal circuits are: 3AL5 phase detector, 6CG7 multivibrator, 13CM5 (XL36 alternate) output, 16AQ3 (XY88 alternate) damper, and 1G3GT/1B3GT HV rectifier.

Operating controls at the front of the cabinet are the channel selector, fine tuning, on-off-volume, brightness, vertical hold, and contrast. Controls mounted at the rear are for horizontal hold, vertical size, and vertical linearity.

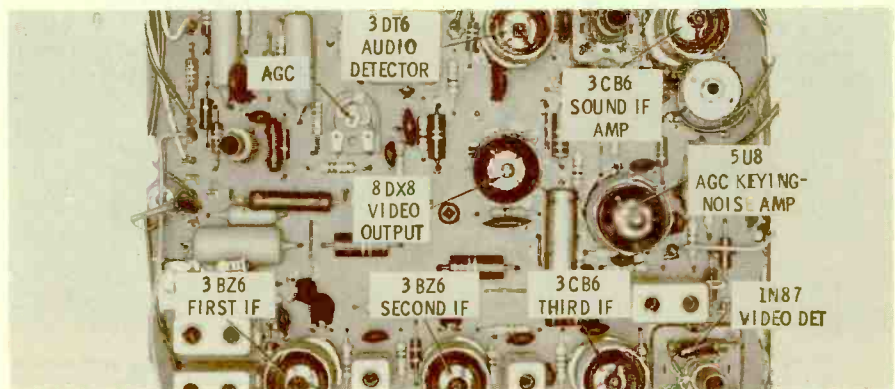
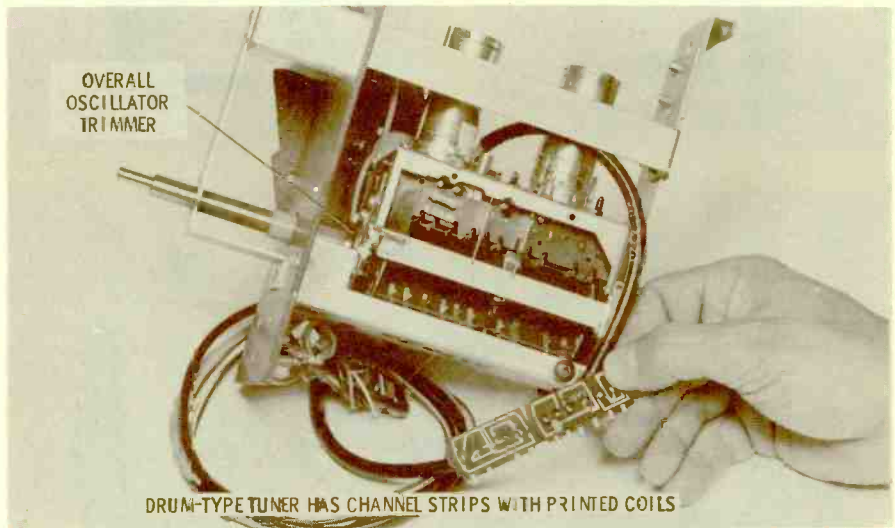
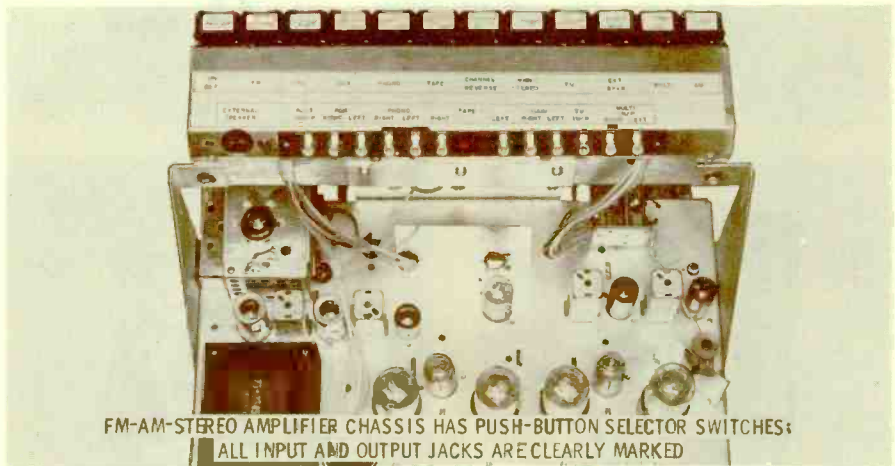
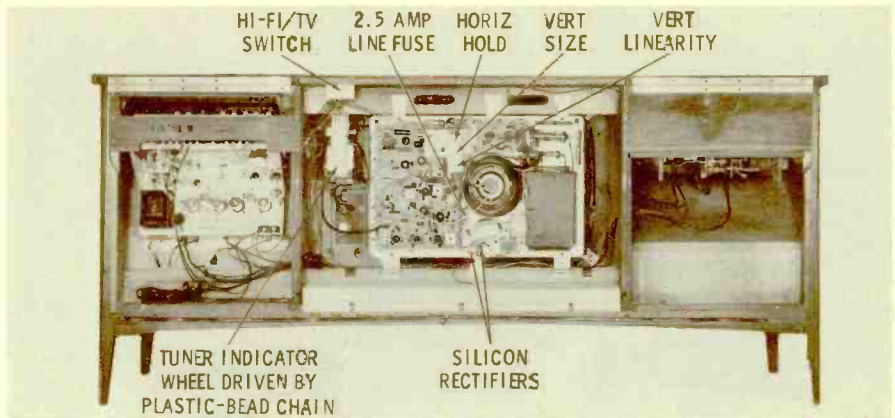

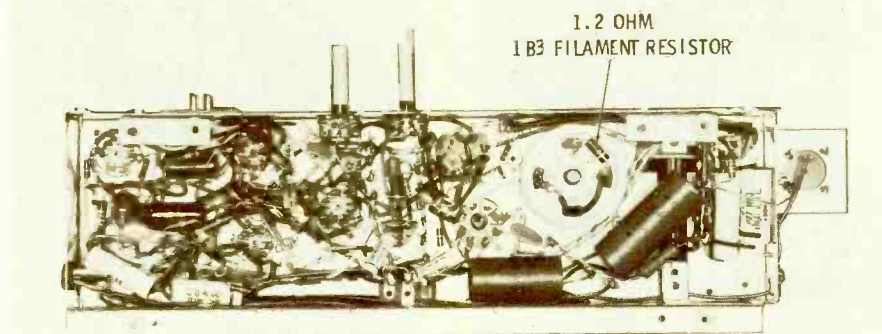
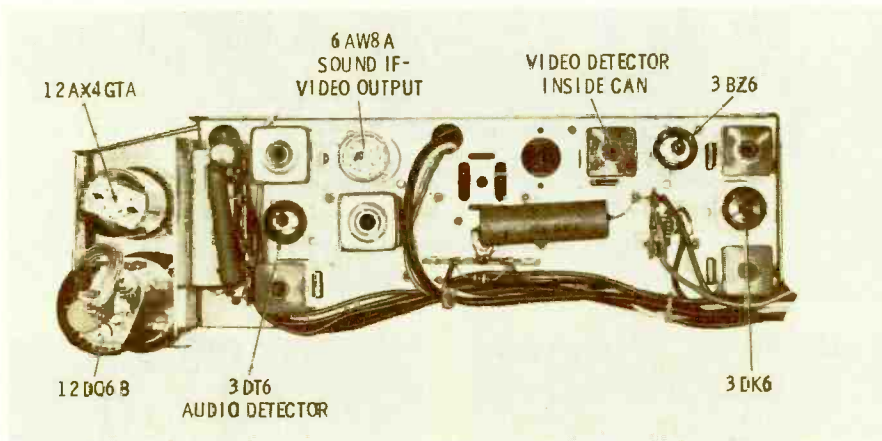
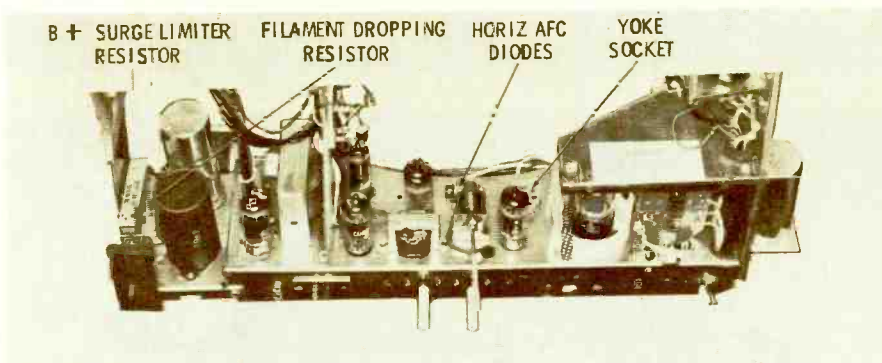
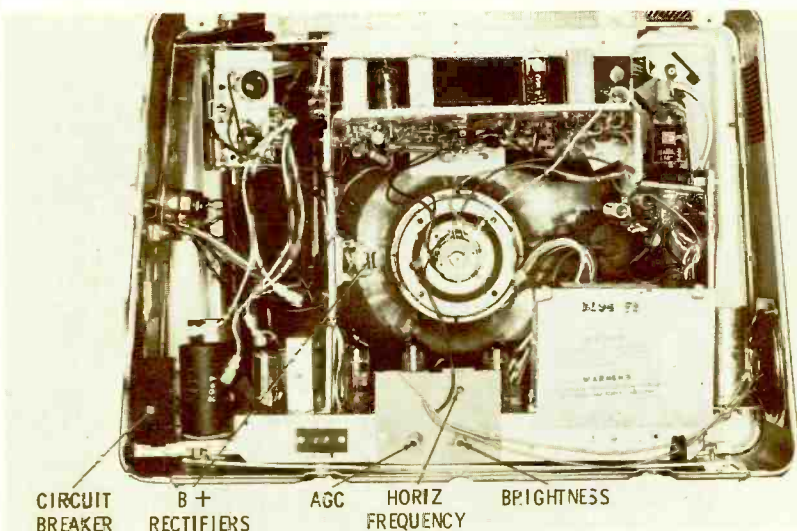

HAND WIRING IS USED THROUGHOUT RECEIVER



Coronado
Model TV17-9444A
Chassis 1194-72

This Coronado portable television comes equipped with a retractable monopole antenna and a 114° 19XP4 CRT. The turret-type tuner uses a 2GK5 as the RF amplifier, and a 5CG8 as the mixer-oscillator. The individual oscillator slugs can be reached by removing the channel-selector and fine-tuning knobs at the top of the cabinet.

The filament string has a 35-ohm, 15-watt series resistor; its location is marked on one of the photos. Two protective devices are used in the B+ circuit of this receiver—a thermal circuit breaker and an 8-ohm, 20-watt surge-limiting resistor. Two silicon rectifiers, wired as a half-wave voltage doubler, develop the 270-volt B+. As shown in the photo, the rectifiers can be replaced quite easily without removing the chassis.

The 12CU5 audio output tube also functions as a voltage divider in a "stacked B+" circuit; the 270 volts is dropped to 130 volts, producing a secondary B+ source. The tuner, sound IF, audio detector, and video output tubes are all supplied from this secondary B+ line. The two IF stages use a 3DK6 and a 3BZ6, in that order. The video detector is a crystal diode, located inside the second IF can.

Another semiconductor in this chassis is a series-connected dual diode, used for horizontal AFC—not the usual common-cathode type. It plugs into a socket atop the chassis, as shown in the photo.

Operating controls for contrast (vertical linearity inside), vertical hold (vertical size inside), and on-off-volume are located on the side of the cabinet. Adjustments on the rear apron include the AGC and brightness controls, in addition to a horizontal frequency coil that serves as a hold control.

The tubes used in the horizontal circuit are familiar: 6CG7 horizontal oscillator, 12DQ6B horizontal output, 12AX4GTA damper, and 1B3/1G3 high-voltage rectifier. If a new picture tube is installed, it may be necessary to change the focus connection (pin 4 of the CRT). A lead from the CRT socket, terminating in a female connector, connects to one of three voltage terminals on the chassis; these terminals are pointed out in one of the photos. One side of this chassis connects to the AC line, so be sure you observe normal "hot-chassis" precautions when servicing it.



**Philco
Model L2602BR
Chassis 13G20**

Pictured here is the 16" *Courier* television recently introduced by Philco. This receiver has many new features, among which is a 114° bonded 16ASP4 CRT. Nine different models use this same chassis. The switch-type tuner, shown in one of the photos, uses a frame-grid 3GK5 RF amplifier and a 6BL8/ECF80 mixer-oscillator.

A single silicon rectifier develops the 140 volts of B+ in this chassis. Protection for this circuit is provided by a 5.6-ohm fusible resistor of the plug-in type; it's placed in a convenient location, making its replacement fairly simple. The series filament string in this transformerless chassis includes a 12-ohm, 7-watt dropping resistor.

Two high-gain frame-grid 4EH7's are used for IF amplification. The video detector is a diode, located under the shield covering the last IF transformer; the shield snaps on, and can be easily removed to replace the diode.

A 10JY8 functions as the video output-AGC keying tube. The AGC keying circuit doesn't have an adjustable level control; this level is preset by the circuit design. DC coupling is used from the video stage to the CRT to establish a DC reference level for the CRT cathode.

One of the two compactrons used in this chassis—a 17JZ8—fills the vertical multivibrator-output function. This circuit has a number of new features; the most interesting is the *varistor* used in the plate circuit of the output section to control the amplitude of the vertical pulse fed to the output transformer. The varistor decreases in resistance as the voltage across it decreases—and vice versa—maintaining the peak level at a safe, constant level. This component also prevents vertical-sweep variations during warmup time.

You'll notice in the photo that the chassis has a compact horizontal layout. The cabinet is designed so that it's possible to remove the chassis for servicing without disconnecting any leads. The majority of components are mounted on the large printed-circuit board; only the tuner and high-voltage cage extend above the board.

The tube complement of the horizontal sweep circuits is as follows: 8FQ7 multivibrator, 21GY5 output, 1G3 HV rectifier, and a 17BE3 (the other compactron) as the damper.

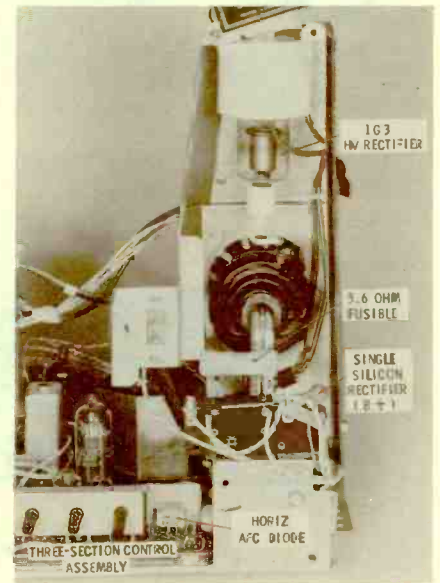
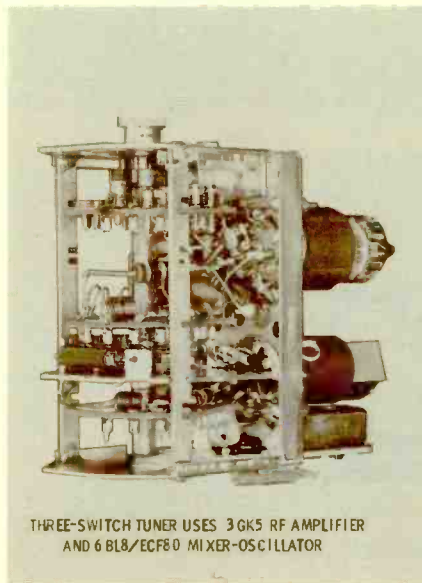
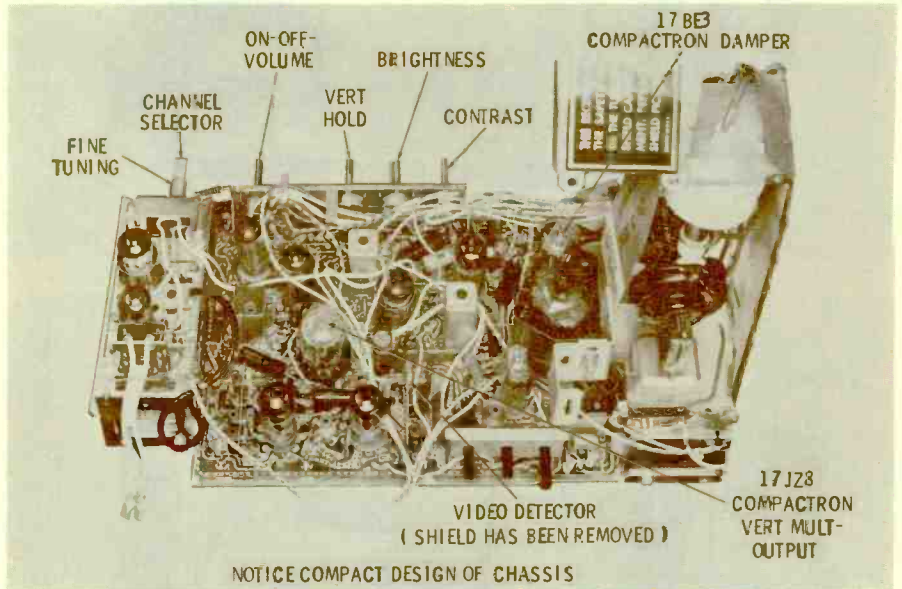
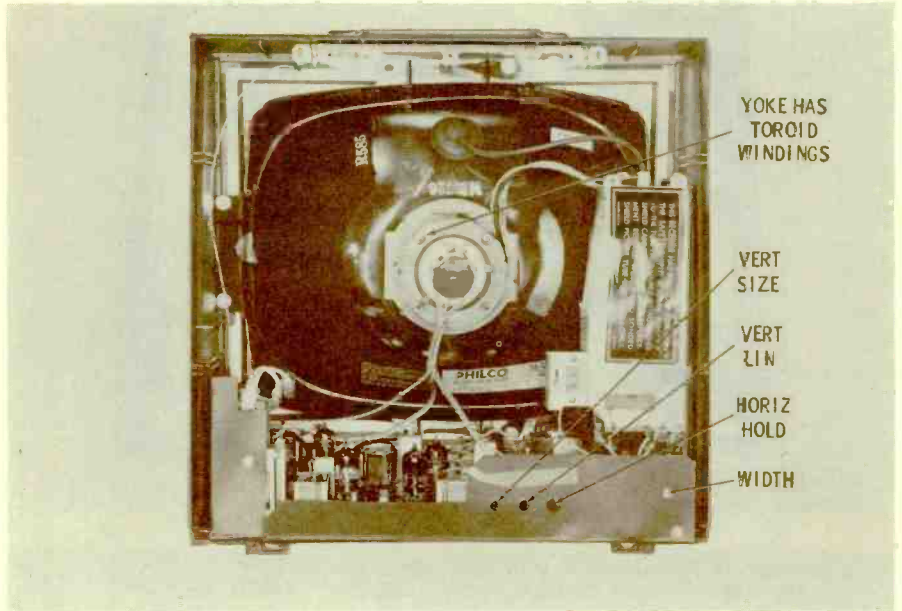

See PHOTOFACT Set 543, Folder 1

Mfr: General Electric Chassis No. LW

Card No: GE LW-1

Section Affected: Sync.

Symptoms: Horizontal hold erratic. Low voltage at plate (pin 3) of V4B (6CX8).

Cause: Leaky coupling capacitor between sync separator and horizontal AFC phase detector.

What To Do: Replace C48 (39 mmf—N750, 10%).

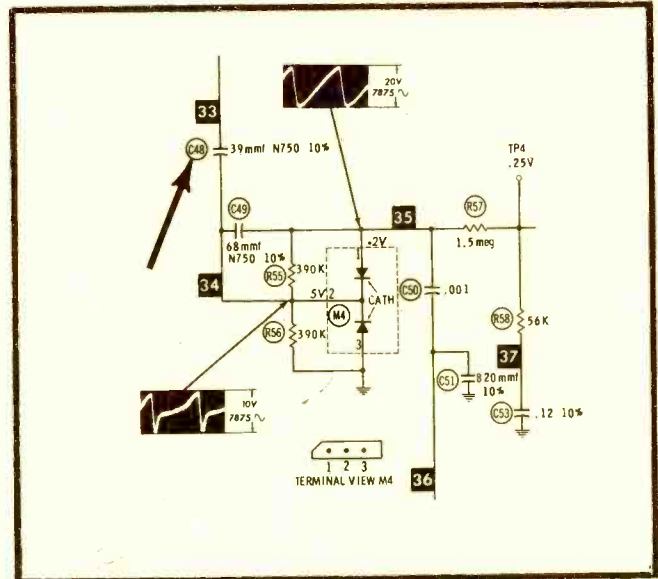

Mfr: General Electric Chassis No. LW

Card No: GE LW-2

Section Affected: Raster.

Symptoms: No raster; low voltage at control grid (pin 6) of CRT.

Cause: Shorted capacitor in retrace-blanking circuit.

What To Do: Replace C27 (.01 mfd).

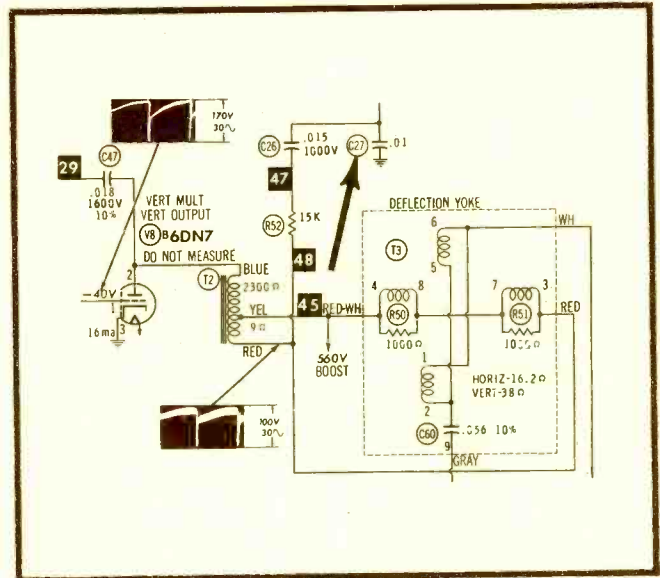

Mfr: General Electric Chassis No. LW

Card No: GE LW-3

Section Affected: Sound.

Symptoms: Sound intermittently drops in volume. Tapping sound IF transformer may bring back normal volume.

Cause: Defective sound IF transformer.

What To Do: Replace L15.

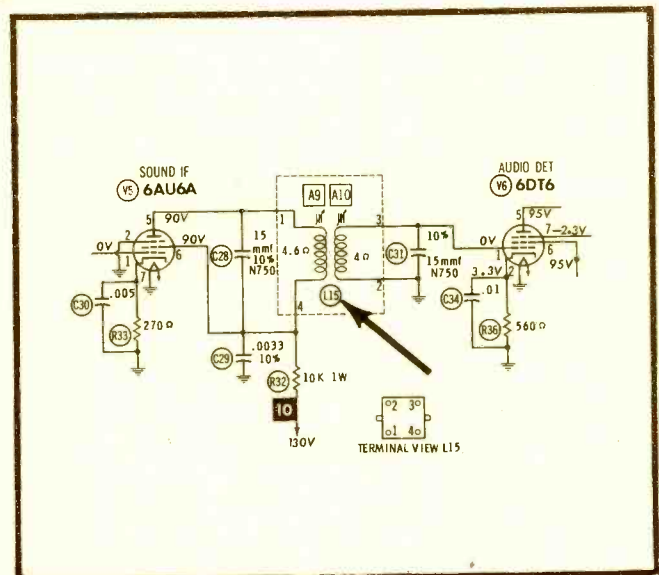

See PHOTOFACT Set 543, Folder 1

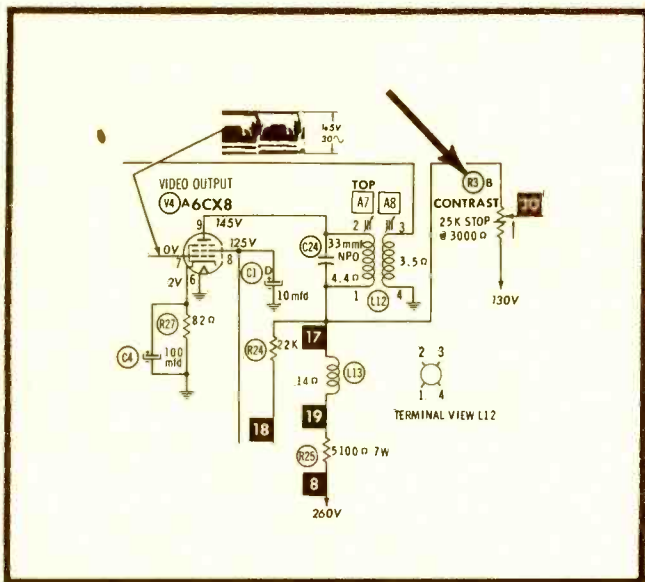

See PHOTOFACT Set 543, Folder 1

Mfr: General Electric Chassis No. LW

Card No: GE LW-4

Section Affected: Pix.

Symptoms: Streaks in picture; voltage fluctuates at plate (pin 9) of V4A (6CX8).

Cause: Defective contrast control.

What To Do: Replace R3B (25K with stop at 3K).

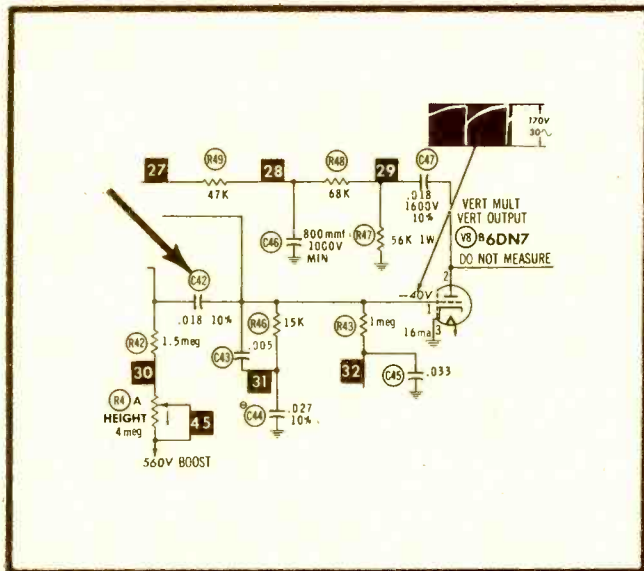

Mfr: General Electric Chassis No. LW

Card No: GE LW-5

Section Affected: Raster.

Symptoms: Vertical foldover at bottom of raster as receiver warms up.

Cause: Leaky coupling capacitor in vertical multivibrator.

What To Do: Replace C42 (.018 mfd — 600V, 10%).

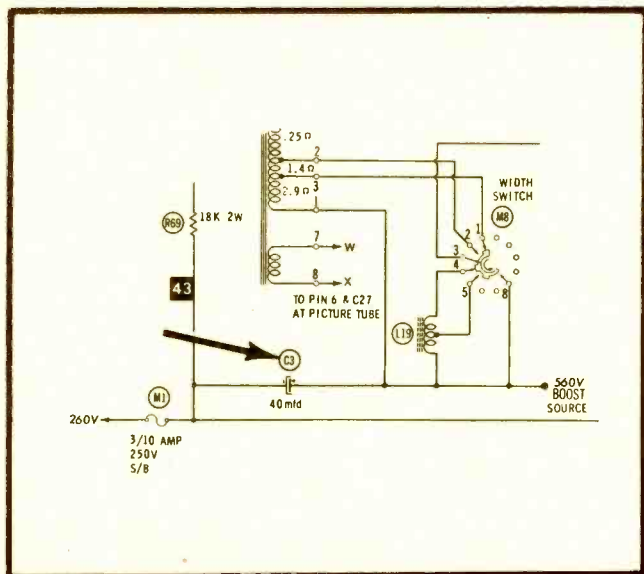

Mfr: General Electric Chassis No. LW

Card No: GE LW-6

Section Affected: Raster.

Symptoms: No raster; weak or no high voltage; boost voltage is low.

Cause: Open boost capacitor.

What To Do: Replace C3 (40 mfd—400V).

TUNER REPAIRS

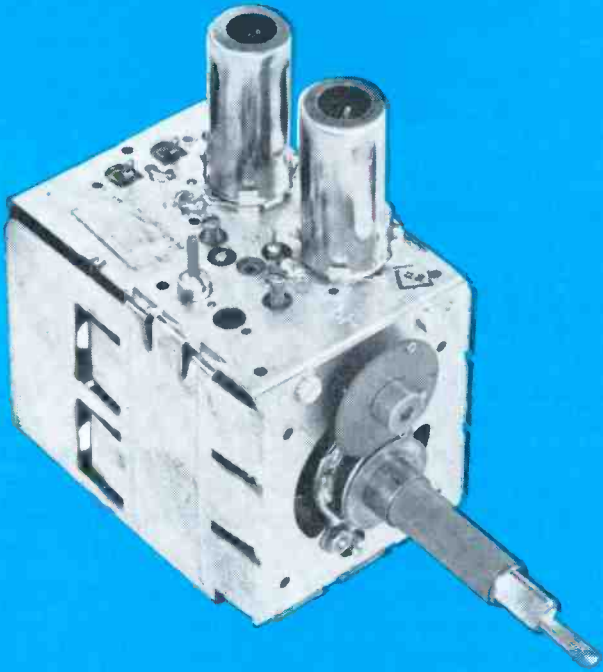

\$9.50

FOR COMPLETE OVERHAUL

Includes ALL parts (except tubes)
ALL labor on ALL makes

24-HOUR SERVICE with FULL YEAR WARRANTY

Sarkes Tarzian, Inc., largest manufacturer of TV and FM tuners, maintains two completely-equipped Service Centers to serve YOU. Both centers are staffed by well-trained technicians in this specialized field and are assisted by engineering personnel to assure you of FAST, DEPENDABLE service.

Ⓢ Tarzian-made tuners—identified by this stamping—received one day will be repaired and shipped out the next. A little more time may be required on other makes. Every channel is checked and re-aligned per manufacturer's specifications, not just the channels which might exist in any given area.

You get a 12-month guarantee against defective workmanship and parts failure due to normal usage. Cost to you is only \$9.50 and \$15 for UV combinations, including all labor and parts except tubes. No additional costs. No hidden charges. All tuners repaired on approved, open accounts. You pay shipping. Replacements on tuners beyond practical repair are available at low cost.

When inquiring about service on other than Tarzian-made tuners, always send TV make, chassis and Model number. Check with your local distributor for Sarkes Tarzian replacement tuners, parts, or repair service. Or, use the address nearest you for fast factory repair service.



SARKES TARZIAN, INC.

TUNER SERVICE DIVISION

See your distributor, or use the address nearest you

537 South Walnut St.,
Bloomington, Indiana
Tel: 332-6055

10654 Magnolia Blvd.,
North Hollywood, Calif.
Tel: 769-2720

Manufacturers of Tuners . . . Semiconductors . . . Air Trimmers . . . FM Radios . . . AM-FM Radios . . . Audio Tape . . . Broadcast Equipment

Circle 2 on literature card

September, 1963/PF REPORTER 9

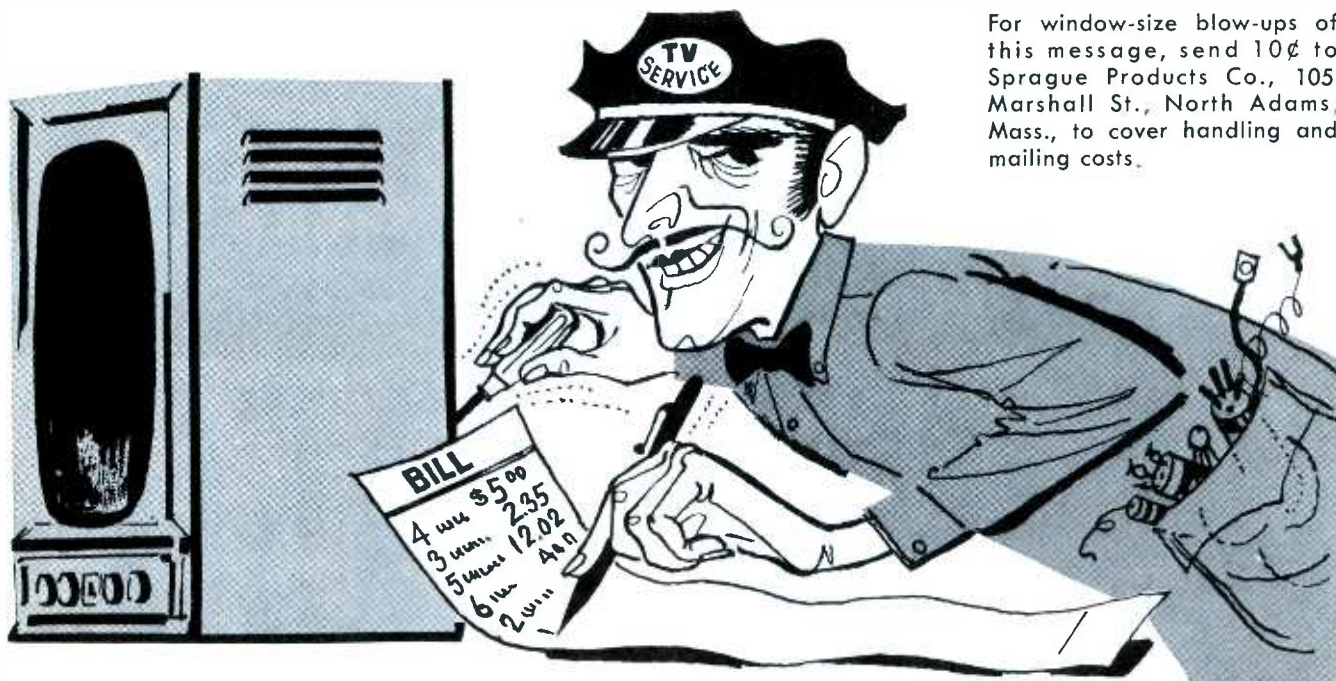

For window-size blow-ups of this message, send 10¢ to Sprague Products Co., 105 Marshall St., North Adams, Mass., to cover handling and mailing costs.

ARE TV SERVICE DEALERS GYPS?

Every so often, some magazine or newspaper sounds off about TV-radio service shops.

"Service technicians are a bunch of gyps," is the general theme. "They'll clip you if you don't watch out."

They might just as well write the same thing about doctors, lawyers, storekeepers, auto mechanics—or anyone else. There are gyps in every line of business. Actually the percentage in TV-radio is lower than in most.

The average service technician is a hard-working, straight-shooting individual. Rather than gyp customers, he is far more likely to spend more time on a job than he knows he will be paid for—simply as a matter of personal pride in doing things right.

We recently heard about someone's TV set going bad. A service technician called for it with his truck and returned it in good working condition within 48 hours. His bill came to \$10 for service plus \$2.68 for replacement parts.

The set owner argued that this was too much—yet he would never dream of complaining to the medical specialist who charged him \$10 for a 15-minute office visit; the lawyer whose bill for writing a simple will was \$75; or the garage man who laughingly admits that he charges \$5 for "just raising the hood" of a car.

In one of our very large cities, the Better Business Bureau received fewer than 500 complaints about serv-

ice in a year. Most of the complaints came from folks who expected first-class reception in doubtful fringe areas; who tried to operate their sets without suitable antennas; or who had bought sets "wholesale" at ridiculously low prices from cut-rate dealers who could offer little or no service.

Actually, it takes almost as long to become a good service technician as it does to train for any other profession. Beyond this, it calls for regular study to keep up with the constant stream of new developments. Also, it requires a surprisingly big investment in test instruments, manuals, and other shop equipment. The modern TV or radio receiver is by far the most intricate piece of equipment the average person ever owns or uses.

Service technicians are not fly-by-night businessmen—99 out of 100 run their businesses properly. The other one per cent—the gyps—can usually be spotted a mile away. Nine times out of ten, they are the shops that feature "bargain" prices and ridiculously liberal service contracts. And their victims are generally set owners who expect to beat the game by "getting something for nothing."

Good television sets or good TV service are not things to be bought on a "bargain counter" basis. Set owners who recognize this aren't likely to get gyped.

Instead, they'll find that they get more real value for their television entertainment dollars than for any other dollars they spend!

THIS MESSAGE WAS PREPARED BY SPRAGUE PRODUCTS COMPANY,
DISTRIBUTORS' SUPPLY SUBSIDIARY OF SPRAGUE ELECTRIC COMPANY, NORTH ADAMS, MASSACHUSETTS, FOR . . .

YOUR INDEPENDENT TV-RADIO SERVICE DEALER

65-123-63

Circle 3 on literature card

publisher

Howard W. Sams

general manager

Mal Parks, Jr.

executive editor

Verne M. Ray

editor

Forest H. Belt

assistant editor

Thomas A. Lesh

associate editors

George F. Corne, Jr.

Patrick M. Craney

consulting editors

William E. Burke

Joe A. Groves

C. P. Oliphant

production manager

Robert N. Rippy

circulation manager

J. A. Vitt

circulation fulfillment

Pat Tidd, Mgr.

Katherine Krise, Ass't.

Cora La Von Willard, Ass't.

art directors

Dick Lovell

Robert W. Reed

advertising & editorial

assistants

Gladys Bauer

Georgeanna Caldwell

Clare Hult

Ellie Rother

photography

Paul Cornelius, Jr.

advertising sales offices

Dave Milling, advertising sales manager

midwestern

Hugh Wallace

PF REPORTER

4300 West 62nd Street,

Indianapolis 6, Ind.

AXminster 1-3100

eastern

Charles Horner

Howard W. Sams & Co., Inc.

3 West 57th Street,

New York, N. Y.

MUrray Hill 8-6350

western

The Maurice A. Kimball Co., Inc.

2550 Beverly Blvd., Los Angeles 57, Calif.

DUnkirk 8-6178; and 580 Market Street,

Room 400, San Francisco 4, Calif. EXbrook 2-3365

Address all correspondence to

PF REPORTER, 4300 W. 62nd Street,

Indianapolis 6, Indiana



Copyright © 1963 by Howard W. Sams & Co., Inc.

PF REPORTER is a trademark of Howard W. Sams

& Co., Inc. No part of PF REPORTER may be

reproduced without written permission. No patent

liability is assumed with respect to use of

information herein. Acceptance of advertising does

not in any manner signify the products, policies

and services so advertised have been approved,

endorsed or recommended by this magazine.

Subscription Prices: 1 year—\$5.00, 2 years—\$8.00,

3 years—\$10.00, in the U.S.A., its possessions and Canada.

All other foreign countries: 1 year—\$6.00, 2 years—

\$10.00, 3 years—\$13.00. Single copy 50¢; back copies 65¢.

Indexed in Lectrodex.

Printed by the Waldemar Press Div.

of Howard W. Sams & Co., Inc.



PF REPORTER

including **Electronic Servicing**

VOLUME 13, No. 9

SEPTEMBER, 1963

CONTENTS

Previews of New Sets	1
Admiral Model STF33X11 (Chassis 21X3U)	
Clairtone Model ST-801 (Chassis S-2)	
Coronado Model TV17-9444A (Chassis 1194-72)	
Philco Model L2602BR (Chassis 13G20)	
Video Speed Servicing	5
Service hints on Admiral Chassis 15E1 and General Electric Chassis LW	
Letters to the Editor	12
The Electronic Scanner	18
The Troubleshooter	25
Symfact: Vertical Oscillator (Modified Hartley Type)	27
See what happens to voltages and waveforms when troubles occur.	
Transistors in Hi-Fi Edward M. Noll	32
Audio Facts—Solid-state circuits are attracting more attention this Fall.	
When Replacement Parts Don't Quite Fit	34
Often it's no trick at all to solve installation problems.	
The Audio Circuit—Simple? Art H. Meyerson	36
Servicemen tend to be complacent about TV sound problems, until a tough dog comes along.	
Know Your '63 Color Circuits: The Color Sync Section George F. Corne, Jr.	38
How the 3.58-mc oscillator is locked in by the color burst.	
Chasing Intermittent Sweep Stu Hoberman	42
Quicker Servicing—Certain components are habitual offenders.	
A Sensible Parts Stock for Transistor Radios	52
Notes on Test Equipment Patrick M. Craney	54
Lab reports on the Triplett Model 630-L VOM and Precision Apparatus Model E-490 Stereo Generator.	
How to Find a Serviceman Wayne Lemons	64
Dollar and Sense Servicing—Could you use some help in hiring a good technician?	
A New Look in Printed Components Rufus P. Turner	72
Advanced techniques produce single units that function as complete resistance-capacitance networks.	
Product Report	85
Free Catalog & Literature Service	88
Monthly Index on free literature card	

ABOUT THE COVER

In this month's issue you'll find a generous handful of useful features on diverse subjects, all of which will help you to broaden your understanding of new electronic developments and work out better solutions to familiar TV-service problems.



NEW FROM ATR

ATR

ALL-TRANSISTOR MODEL 707 Karadio®

"the oldest name in radio"



Suggested \$
Retail Price **29.95**

... for those who want the finest! Check the features of this all-new, all-transistor Model 707 Karadio by ATR ... features galore that make sales easier, keep users happier! Compare ... and without hesitation place your order NOW for the new all-transistor ATR Karadio.

- Large easy-to-read illuminated dial
- Finger-tip tone control to adjust tone as you desire.
- 7-tuned circuits including RF stage to provide maximum sensitivity and selectivity.
- Automatic volume control to keep signals strong and steady.
- Utilizes "solid state" construction employing 7 semiconductor (5 transistors and 2 diodes).
- Superheterodyne circuit.
- 3-Section Super "Magna-Wave" tuner.
- Hand wired No printed circuitry.
- Has one-piece self-contained chassis for easy installation.
- "Fits-All" universal construction. For use with practically all import and American cars and trucks.
- Fits under-dash or in-dash utilizing standard trim plate kits.
- Comes complete with built-in speaker.
- External speaker jack provided.
- Available for 12-volt negative ground installations only.
- Low battery drain.

Neutral Gray-Tan baked enamel finish. Overall size approximately 5½" deep x 6½" wide x 2" high. Shipping Weight 5 lbs.

SEE YOUR ELECTRONIC PARTS DISTRIBUTOR
WRITE FACTORY FOR FREE LITERATURE ...
ATR ELECTRONICS, INC.
Formerly, American Television & Radio Co.
Quality Products Since 1931
ST. PAUL 1, MINNESOTA—U.S.A.

Circle 4 on literature card



LETTERS TO THE EDITOR

Dear Editor:

The June issue of PF REPORTER arrived last week, and it couldn't have been timed better. For the last two months, most of the TV technicians in Sydney have been attending an evening course on transistors, so I took the magazine along and showed it to some of the boys. They were very enthusiastic about it, and I expect you will be hearing from a few more "down-under" technicians keen on getting your magazine.

Speaking of "down under," I noticed in the March *Letters* column that you wonder how we keep the valves from falling out of the sets. Well—there are several ways: Clips over valves, jam the valves against the top of the cabinet, glue, bend the pins over, etc. But the easiest way is to turn the chassis upside down and invert the yoke. Yoga enthusiasts don't even turn the yoke around.

CHRIS KNIGHT

Waverley, N.S.W.
Australia

Good thing the AC cord is there to anchor the set so it doesn't fall off the floor!—Ed.

Dear Editor:

In the schematic labeled Fig. 12A on page 8 of your June issue, you show a transistor with an arrow pointing outward, and refer to it in the text as a PNP type. Is this an error, or have I learned the symbols wrong?

FREDERICK J. SEIDEL

Freddy's Electronics Service
Hamburg, Pa.

Dear Editor:

I've been studying "Transistor Oscillators from A to Z" in the June PF REPORTER, and it's been very helpful. However, I've had some trouble understanding the last paragraph on page 5, especially the reference to two taps on the primary winding of the oscillator transformer.

STEWART HINDS

Bronx, N.Y.

Our score: One hit, two errors. The A and B sections of Fig. 12 were inadvertently switched; the second schematic containing the PNP transistor, should have been positioned over the caption "Feedback to Emitter," and the schematic with the NPN transistor should have been labeled "Feedback to Base." On page 5, the figure reference in the last paragraph should have been to Fig. 9 instead of Fig. 10; this change should quickly clear up the meaning of the text.—Ed.

Heat absorbing "THIRD HAND"

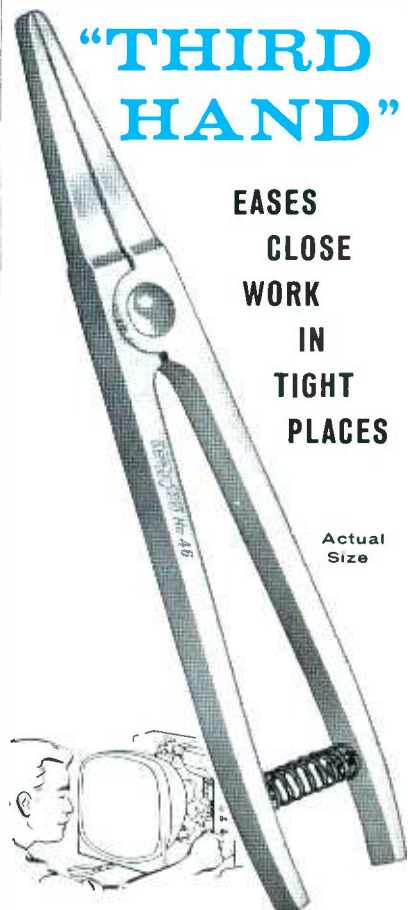

EASES
CLOSE
WORK
IN
TIGHT
PLACES

Actual
Size

SELF-GRIPPING

CHAN NEL LOCK

No. 46

HEATSORB CLAMP

(HEAT SINK)

A specially designed "heat sink" that prevents heat damage to electronic components during soldering operations. Also serves as handy, self-gripping "third hand" that holds and retrieves small parts in close work. Precision-made of light weight aluminum ... easy to handle ... cannot rust ... Best of all, it's reasonably priced. Be sure it's a genuine Channel-lock. Look for the trademark on the handle. Write for catalog showing complete line of pliers. Made Only By Champion DeArment Tool Company, Meadville, Pennsylvania.

Circle 5 on literature card

FREE!

Your Own AMF Bowling Ball ...
or any of over 30 Wonderful Gifts in

PHILCO'S

Fall Fiesta

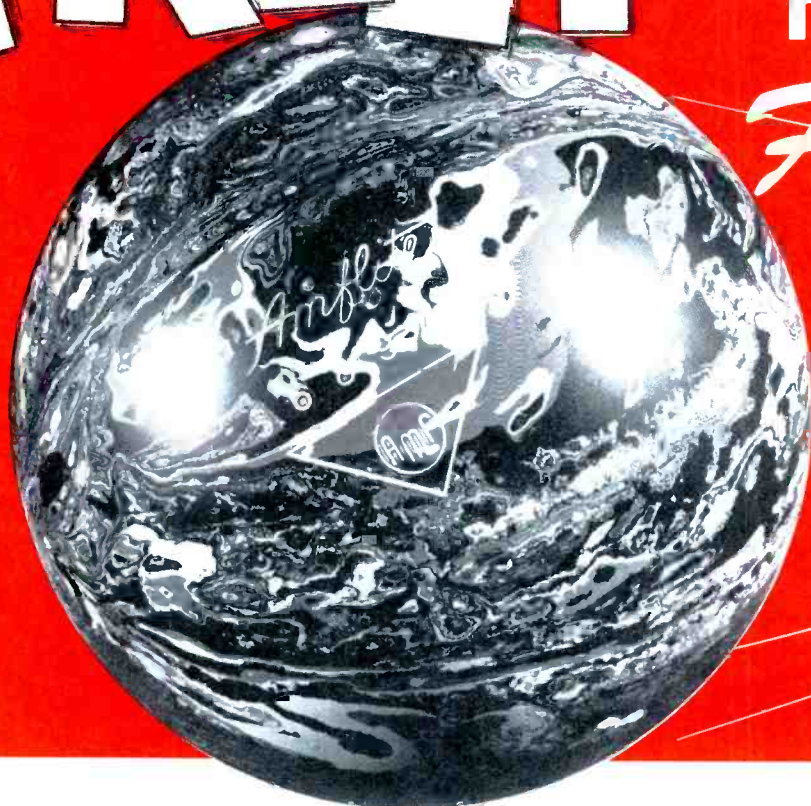

AMFLITE Bowling Ball ... for men, women or youngsters. **YOURS FREE** with purchases of only \$375!

Your choice of scores of wonderful gifts FREE with your purchases of Philco Parts, Accessories and Tubes included in Philco's Fall Fiesta Catalog! Big savings ... as well as wonderful gifts, just in time for Fall and Christmas. Get Your Philco Fall Fiesta Catalog NOW ... see your Philco distributor ... stock up on parts and accessories you need ... **AND GET THE GIFTS YOU WANT, TOO!**

**ALL THESE
OTHER WONDERFUL GIFTS ... YOURS FREE**
with your purchases of
Philco Fall Fiesta Catalog Merchandise

	FREE with your purchases of merchandise worth
AMF Rigger Bowling Bag	\$125
Daisy CO ₂ Gas Operated Pistol	\$225
AMF Roadmaster Hawk Bicycle	\$700
Bridal-Trousseau Doll Set	\$110
Famous Lionel Train Set	\$200
Daisy Thundercap Tank	\$ 55
Men's Million Miler Luggage	
One Suiter	\$400
Two Suiter	\$450
Three Suiter	\$500
Attache Case	\$275
Ladies' Million Miler Luggage	
16" Hat Box	\$250
21" Overnighter	\$275
26" Pullman Case	\$450
Ladies' Orlon Sweater	\$135
Ladies' Antron Cardigan Sweater	\$175
Ladies' Suburban Coat	\$350
Men's Melton Loden Coat	\$350
Men's Imported Rain Coat	\$350
Men's OuterJac	\$175
Men's Lambs Wool Cardigan	\$175
Men's Runabout Nylon Coat	\$350
Weather Trio (Instruments)	\$130
Outdoor Thermometer	\$ 15
Stanley Ratchet Driver Set	\$ 65
Oneida Dinner Ware	\$350
Oneida Stainless Flatware	\$450
8 Piece Cutlery Set	\$130
Hamilton Cosco Table and Chair Set	\$550



Luxurious
**MINK and Cashmere Ladies'
Sweater by Dalton**

YOURS FREE with purchases of only
\$1300 of Philco Fall Fiesta Catalog
merchandise.



Famous
SCHICK TRAVEL-ALL
(Shaver, pre-shave, after-shave and
grooming kit in handsome travel case.)

YOURS FREE with purchases of only
\$225 of Philco Fall Fiesta Catalog
merchandise.

GET YOUR FREE Fall Fiesta Gifts NOW ... See Your PHILCO Distributor Today



PARTS & SERVICE OPERATIONS

PHILCO

A SUBSIDIARY OF *Ford Motor Company*

SENCORE

SIMPLIFIES COLOR SERVICING

NEW! CA122

COLOR CIRCUIT ANALYZER

A simple approach to a complex problem

Here is an instrument that is designed to eliminate the guesswork in color TV servicing. A complete analyzer that provides all required test patterns and signals for testing from the tuner to the tri-color tube. Additional analyzing signals for injection at each stage including audio, video and sync, brings to life a truly portable and practical TV analyzer for on the spot service; virtually obsoleting other analyzers with the advent of color. Sencore's simplified approach requires no knowledge of I, Q, R-Y, B-Y, G-Y or other hard to remember formulas. The CA122 generates every signal normally received from the TV station plus convergence and color test patterns.

The CA122 offers more for less money:

TEN STANDARD COLOR BARS: The type and phase that is fast becoming the standard of the industry. Crystal controlled keyed bars, (RCA type) as explained in most service literature, offer a complete gamut of colors for every color circuit test.

WHITE DOTS: New stabilized dots, a must for convergence, are created by new Sencore counting circuits.

CROSS HATCH PATTERN: A basic requirement for fast CRT convergence.

VERTICAL AND HORIZONTAL BARS: An added feature to speed up convergence, not found on many other color generators.

SHADING BARS: Determines the ability of the video amplifier to produce shades (Y Signal) and to make color temperature adjustments. An important feature missing on other generators.

COLOR GUN INTERRUPTOR: For fast purity and convergence checks without upsetting color controls. Insures proper operation of tri-color guns, preventing wasted time in trouble shooting circuits when CRT is at fault.



A must for color . . .

a money maker for black and white TV servicing

ANALYZING SIGNALS: RF and IF signals modulated with any of the above patterns for injection into grid circuits from antenna to detector. IF attenuator is pre-set for minimum signal for each IF stage to produce pattern on CRT thus providing a check on individual stage gain. Sync and video, plus or minus from 0 to 30 volts peak to peak, have separate peak to peak calibrated controls for quick checks on all video and sync circuits. Crystal controlled 4.5 mc and 900 cycles audio simplify trouble shooting of audio circuits.

NEW ILLUMINATED PATTERN INDICATOR: A Sencore first, offering a rotating color film that exhibits the actual color patterns as they appear on color TV receivers. Locks in with pattern selector control.

You'll pay more for other color generators only.

Dealer Net 187.50

NEW! PS120 PROFESSIONAL WIDE BAND OSCILLOSCOPE

A portable wide band 3 inch oscilloscope for fast, on-the-spot testing. An all new simplified design brings new meaning to the word portability . . . it's as easy to operate and carry as a VTVM. Though compact in size, the PS120 is powerful in performance: Vertical amplifier frequency response of 4 MC flat, only 3 DB down at 7.5 MC and usable to 12 MC, equips the technician for every color servicing job and the engineer with a scope for field and production line testing. AC coupled, with a low frequency response of 20 cycles insure accurate low frequency measurements without vertical bounce. Sensitive single band vertical amplifier; sensitivity of .035 volts RMS for one inch deflection saves band switching and guessing. Horizontal sweep frequency range of 15 cycles to 150 KC and sync range from 15 cycles to 8 MC (usable to 12 MC) results in positive "locking" on all signals. New exclusive Sencore features are direct reading peak-to-peak volts — no interpretation; dual controls to simplify tuning; lead compartment to conceal test leads, jacks and seldom used switches. Rear tilt adjustment angles scope "just right" for easy viewing on bench or production line.

Size: 7" w x 9" h x 11 1/4" d. Weight: 12 lbs.

Dealer Net 124.50
(with low cap. probe)

Kit 74.50

Circle 16 on literature card



A must for servicing color TV in the home . . . lowest priced broad band scope. All hand wired — all American made

SENCORE

SIMPLIFIES SWEEP CIRCUIT TROUBLE SHOOTING

SS117 SWEEP CIRCUIT ANALYZER

For Color and Monochrome Testing

A professional trouble shooter that helps you methodically walk the trouble out of "tough-dog" sweep circuits in monochrome and color receivers. The SS117 provides a positive but simple push button test on all circuits indicated in the block diagrams. These time-consuming circuits are checked step-by-step with tried and proven signal injection and substitution methods. All checks can be made from the top of the chassis or from under the chassis when it is removed from the cabinet.

TV horizontal oscillator check is made by substituting a universal oscillator known to be good. Horizontal output check consists of a cathode current and screen voltage test. The TV horizontal yoke is checked by substituting a universal yoke from the SS117 and viewing brightness or restoration of 2nd anode voltage. Horizontal flyback is checked dynamically in circuit by measuring the power transfer to the yoke when TV is turned on. TV horizontal sync can be used to control the SS117 horizontal oscillator, providing a positive check on sync from the video amplifier to the TV oscillator. Vertical circuits are tested by simple signal injection from vertical yoke to oscillator for full height on CRT. The SS117 with the CA122 Color Analyzer provides a complete TV analyzer for virtually every stage in monochrome or color receivers.

External checks for AC, DC, peak to peak voltage readings and DC current in the upper right hand corner save using a separate VTVM. Accurate 2nd anode measurements up to 30,000 volts are made with a sensitive 300 microamp meter and the attached high voltage probe. AC outlets, all steel construction and mirror in the cover makes every servicing job easier.

Size: 10 1/4" x 9 1/4" x 3 1/2". Wt. 10 lbs.

Dealer Net..... 89.50



The SS117 checks them all



FREE—A 33 RPM half hour permanent record packed with every unit explains each test.

FOR FASTER MORE ACCURATE TUBE TESTING TC114 MIGHTY MITE TUBE CHECKER

This is the famous Mighty Mite, acclaimed by over 25,000 servicemen, maintenance men and engineers as "the best they've ever used." A complete tube tester that is smaller than a portable typewriter yet finds tubes that testers costing hundreds of dollars miss, thus selling more tubes and reducing call backs. A real money maker for the serviceman and a trusty companion for engineers, maintenance men and experimenters. The Mighty Mite has been acclaimed from coast to coast as the real answer for the man on the go. Even though the Mighty Mite weighs less than 8 pounds, new circuitry by Sencore enables you to use a meter to check grid leakage as high as 100 megohms and gas conditions that cause as little as one half microamp of grid current to flow. Thus, too, it checks for cathode current at operating levels and shorts or leakage up to 120,000 ohms between all elements. And it does all this by merely setting four controls labeled A, B, C, & D with new type easy grip knobs. Check these plus Sencore features... Meter glows in dark for easy reading behind TV set... The new Mighty Mite has large size Speedy-Setup Tube Chart inside of cover—cuts setup time for even faster servicing. New stick proof D' Arsonval meter will not burn out even with shorted tube... Rugged, all steel carrying case and easy grip handle.

The improved Mighty Mite will test virtually every radio and TV tube that you encounter, nearly 2000 in all, including foreign, five star, auto radio tubes plus the new Compactrons, Novars, Nuvistors and 10 pin tubes. Has larger, easy-to-read type set-up booklet for faster testing.

Size: 10 1/4" x 9 1/4" x 3 1/2". Weight: 8 lbs.

Dealer Net..... 74.50

TM116 TUBE TESTER MODERNIZING PANEL

New tube adapter for testing Compactrons, Novars, Nuvistors and 10 pin tubes in any tube tester except cardomatic types. Plugs into octal socket of your tube tester enabling you to test these new tubes in the same manner



Fast, Accurate . . .
never lets
you down



A must for color



that your tester checks conventional tubes. Tube set-up chart included with each adapter.

Dealer Net..... 24.95

Circle 7 on literature card

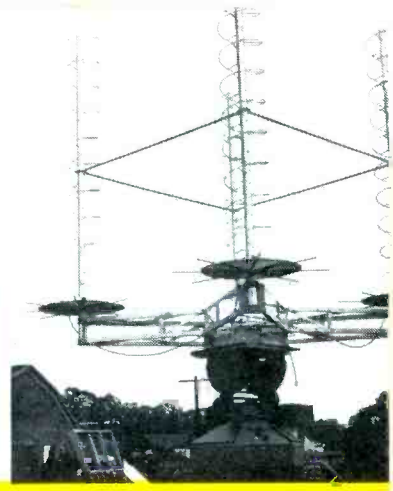
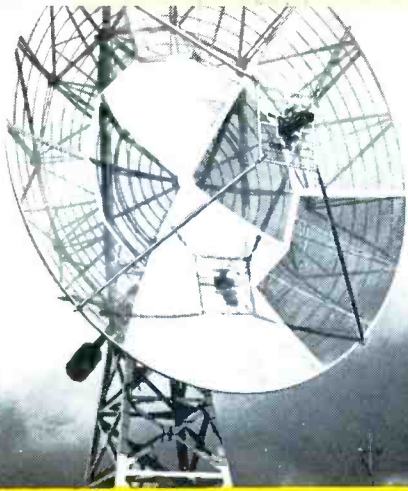

**THE SAME ENGINEERING, SAME PLANT THAT
PRODUCES AMERICA'S GREATEST SATELLITE-
TRACKING AND TELEMETRY STATIONS, HAS CREATED**

the revolutionary new

PARALOG

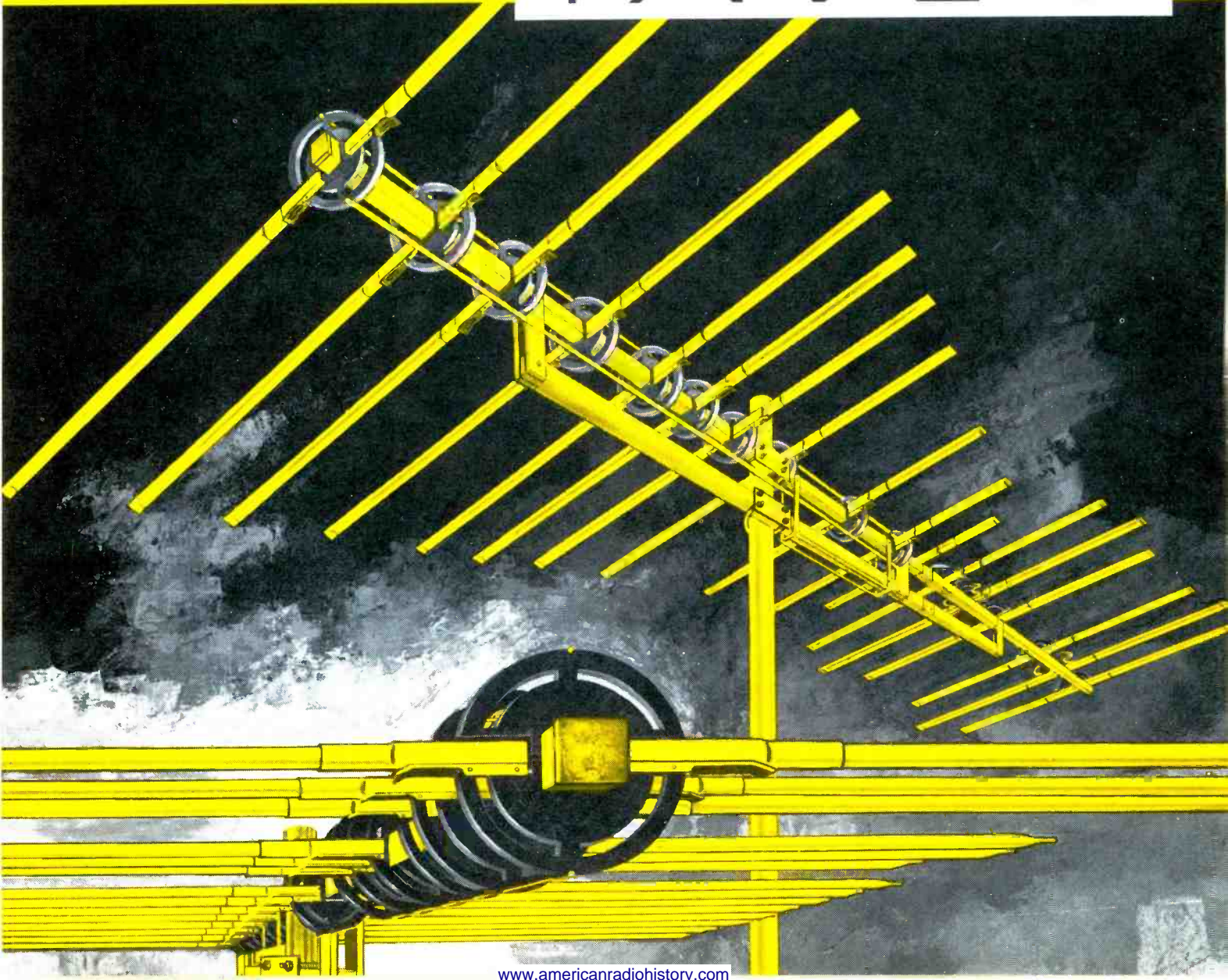



PARALOG

TV/FM ANTENNA

... Unparalleled performance because it has **ALL 4**:

- **HIGH GAIN**
- **EXTREMELY LOW VSWR**
- **HIGH FRONT-TO-BACK RATIO**
- **RUGGED CONSTRUCTION**

HERE IT IS—the space-age TV/FM antenna from the only manufacturer with actual space-age experience!

From the laboratories of Jerrold-TACO, designers of powerful satellite-tracking and space-telemetry antenna arrays for the U. S. Government, comes the all-new PARALOG, first home TV/FM antenna truly based on the log-periodic principle with a unique parasitic-element system for maximum all-channel gain.

Exclusive Cylolac insulating mounts on PARALOG antennas assure constant impedance under all weather conditions, and eliminate the troublesome and unsatisfactory cross-feed systems of other antennas. Cylolac, tough enough to be used for timber-splitting wedges and golf-club heads, makes each insulating mount a *strong point* on the PARALOG. Look at all these features:

- **HIGHEST GAIN, SHARPEST DIRECTIVITY** for snow-free pictures
- **BEST FRONT-TO-BACK RATIO** eliminates ghosts and unwanted signals
- **LOWEST VSWR** prevents line ghosting and smearing
- **DUAL SQUARE-BOOM CONSTRUCTION** gives great strength, long life
- **FLATTEST RESPONSE** assures best color reception on all channels
- **GOLDEN ARMOR COATING**—a superior corrosion-resistant finish
- **ONE-PIECE INSTALLATION**—no time wasted on dangling braces
- **ANTENNA WEIGHT BALANCED** for perfect equilibrium

PARALOG FEED SYSTEM



OTHER FEED SYSTEMS

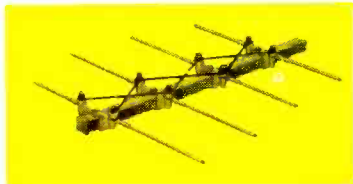

SELF-CLEANING WEDGE-SNAP LOCKS

eliminate dipole-join noise, can't loosen to cause vibration snow. Wind vibration merely serves to tighten wedge further into dipole.

CYCOLAC INSULATORS and radically-new impedance-stabilizing phase correctors eliminate the poor criss-cross transmission-line characteristics of other antennas.

UNIFORM STRONG FORWARD LOBE

is maintained throughout high and low bands. Left: 69 mc (mid-channel 4); right: 195 mc (mid-channel 10). Lobe patterns for each channel equal or surpass these.

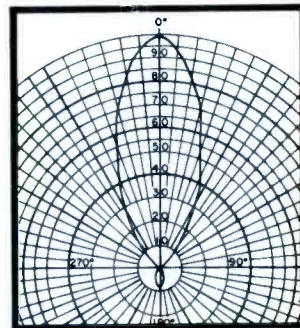
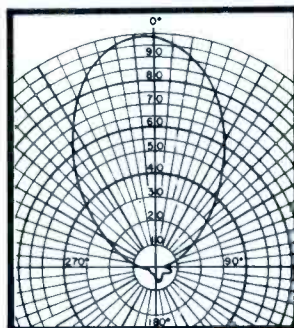

4 Electronic Models feature NEW TWIN-TRANSISTOR SUPER POWERMATE

Best gain/overload capability in the industry—brings in distant stations without overloading from nearby signals.



14 MODELS, UNSURPASSED FOR EVERY RECEPTION NEED

Seven non-amplified and four electronic PARALOGs for TV and FM, plus three special FM-stereo models, give you a line prepared to meet any reception condition at distances up to 200 miles.

ELECTRONIC MODELS

JTP-130S—List \$94.95 JTP-190S—List \$114.95
JTP-160S—List \$104.95 JTP-220S—List \$124.95

FM STEREO MODELS

FMJTP-8—List \$29.95 FMJTP-10—List \$39.95
FMJTP-16—List \$59.95

See your Jerrold-TACO distributor now, or write Jerrold Electronics, Philadelphia 32, Pa.

Circle 8 on literature card

JTP-60—List \$29.95

JTP-40—List \$19.95

JTP-100—List \$39.95

JTP-130—List \$49.95

JTP-220—List \$79.95

JTP-160—List \$59.95

JTP-190—List \$69.95

PARALOG

NOW! CASTLE OFFERS YOU THE BIGGEST BARGAIN IN TV TUNER OVERHAULING!

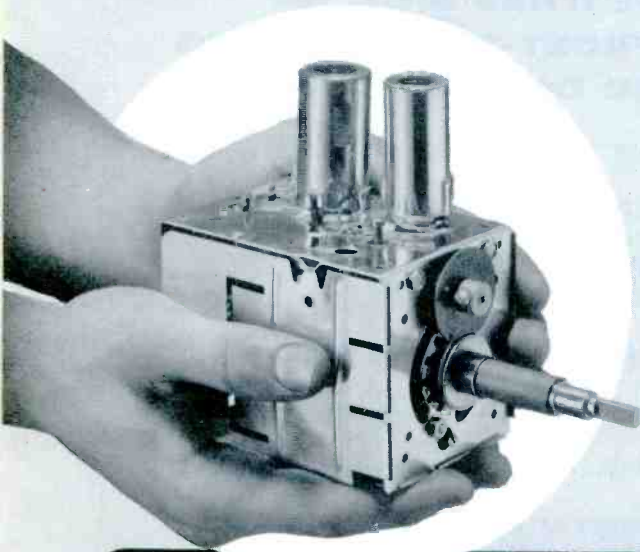

**ALL MAKES
ALL LABOR
AND PARTS
(EXCEPT TUBES)***

9.95

ONE PRICE

THIS ONE LOW PRICE INCLUDES ALL UHF, VHF
AND UV COMBINATION* TUNERS

In a decade of experience overhauling TV Tuners of ALL MAKES, Castle has developed new handling and overhauling techniques which give you . . .

Fast Service

A recent study at our Chicago Plant revealed that of all tuners accepted for overhauling, over 30% were completed and shipped within . . . **Seven Hours** . . . all others within 24 Hours.

Simply send us your defective tuner complete; include tubes, shield cover and any damaged parts with model number and complaint. 90 Day Warranty.

Exact Replacements are available for tuners unfit for overhaul. As low as \$12.95 exchange. (Replacements are new or rebuilt.)

*UV combination tuner must be of one piece construction. Separate UHF and VHF tuners must be dismantled and the defective unit only sent in.

Pioneers in TV  Tuner Overhauling

CASTLE

TV TUNER SERVICE, INC.

5701 N. Western Ave., Chicago 45, Illinois
653 S. Palisade Ave., Cliffside Park, New Jersey
Canada: 136 Main St., Toronto 13, Ontario

*Major Parts are additional in Canada
Circle 9 on literature card

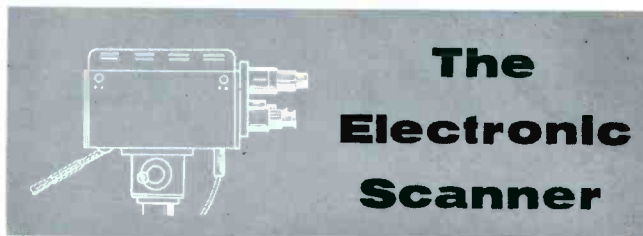

The Electronic Scanner

Timely Award



R. L. Triplett, senior family member and founder of the **Triplett Electrical Instrument Co.**, is shown presenting President W. R. Triplett his traditional 25-year service award—a gold watch. The elder Mr. Triplett will soon be performing a similar ceremony for another son, M. M. Triplett, who will pass his 25th anniversary with the firm later this year.

UHF Converter Promotion



The merchandising impact of new all-channel UHF converters from **Standard Kollsman Industries, Inc.** is heightened by a one-piece display that holds a converter prominently in sight. Specially highlighted panels on the face of the displays can be filled in by the dealer with the channel numbers of local UHF stations and the prices of the Model A and Model B converters. Made of cardboard, the blue, brown, and yellow display piece is easily assembled and placed on top of a counter or TV set in the showroom.

Company Move



The new, larger home of **Polytronics Laboratories, Inc.** is located at 88 Clinton Road, West Caldwell, New Jersey. The 13,000-square-foot structure will house, in a single integrated facility, the research, manufacturing, testing, marketing, and general offices for the makers of "Poly-Comm" communications equipment. According to President John A. Doremus, it will be outfitted with a unique in-plant material and equipment transport system, designed by the firm's engineers to expedite production and effect operating economies. One factor in the selection of the new site was the availability of air transportation facilities close at hand.

New Hybrid Microcircuit



First prize for microminiature packaging has been awarded to **International Resistance Co.** for its "Hybrid Microcircuit" in a packaging-design contest at the recent National Electronic Packaging and Production Conference in New York. IRC's prize-winning entry consists of complete electronic circuits packaged in a tiny container. The unit consists of stacked ceramic wafers—each containing a section of the circuit—within the popular TO-5 package. Leads, rising from the header and passing through peripheral holes in the wafer, support and interconnect the wafers.

In making the award, Mr. Wilson Hannahs, Chairman of the Panel of Judges, commented, "An excellent design for what the trade needs while integrated circuits are getting ready." IRC also sees a permanent and important market for these products.

From RCA Victor—another big advance in Space-Age Sealed Circuitry

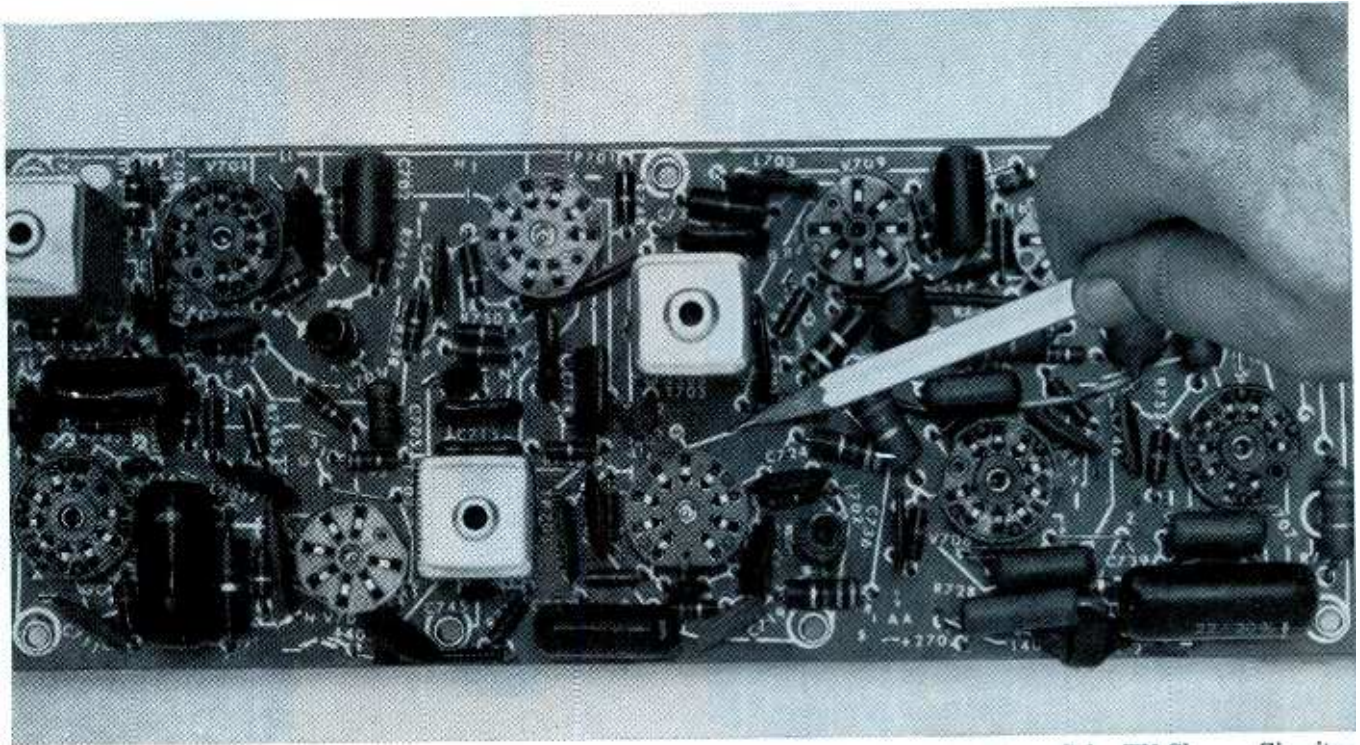

RCA Victor Color TV Chroma Circuitry

You can see at a glance how new streamlined “road-mapping” makes servicing faster, easier, surer than ever before

Pictured above is the “new look” in RCA Space Age Sealed Circuitry . . . the new precision-crafted boards that you’ll see in *all* 1964 New Vista Color and in most RCA Victor black-and-white television sets for 1964.

This new schematic diagram “road-mapping” consists of *straight white lines* that run *directly* from *point-to-point*. No confusion, no difficult paths. And the extra space gained has been used

to make the label markings larger. You can see and trace the circuits at a glance.

Here again RCA Victor has made a vitally important contribution to easier, faster and more accurate servicing. It is part of our continuing research program to offer the utmost in reliability with Space Age Sealed Circuitry.

See Walt Disney’s “Wonderful World of Color,”
Sundays, NBC-TV Network



The Most Trusted Name in Electronics

Tmk(s)®

Circle 10 on literature card

September, 1963/PF REPORTER 19

Only Sylvania receiving tubes

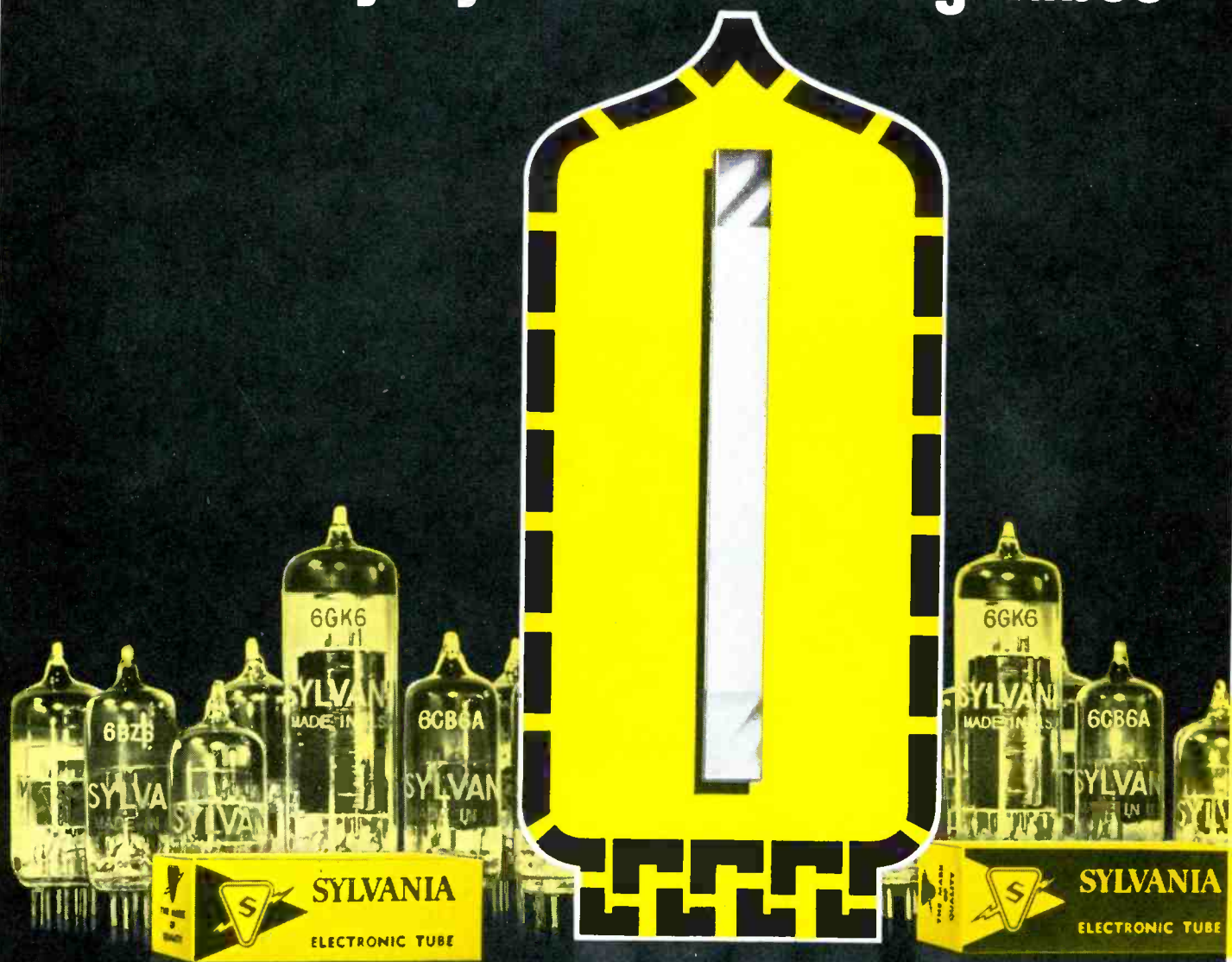

LIFE-BOOST* CATHODE...a big bonus in tube quality

Sylvania's exclusive LIFE-BOOST Cathode is putting new life into tubes—and sales. This latest evidence of Sylvania leadership in tube technology offers benefits you can really sell: it virtually eliminates performance slump, a major cause of profit-stealing callbacks. Besides stability, it produces significantly better tube life and uniformity. 90 types already have LIFE-BOOST, with more on the way...and it's being heavily promoted in national magazines and by mail. *Trademark

New edition of Sylvania Technical Manual. Valuable 632-page dealer reference lists data on over 2,000 tube types, is fully indexed and tabbed for quick reference. Free supplementary data service to keep your manual current. Price \$3.00 through your Sylvania Distributor.



give you these 2 big bonuses:

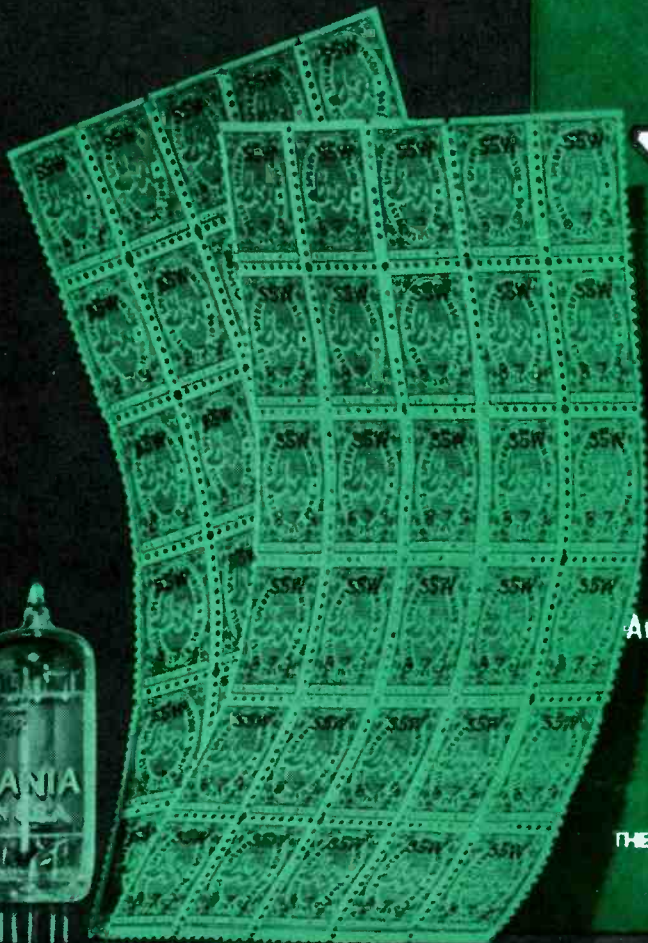

America's Most Valuable Stamps

THE SPERRY AND HUTCHINSON COMPANY
ESTABLISHED 1896



S&H GREEN STAMPS...with the Service 'n Save Plan

Here's another big reason to go with Sylvania. S&H Green Stamps, exclusive with participating Sylvania Distributors, are given free to dealers with the purchase of Sylvania receiving tubes. They add up fast, especially when they're combined with stamps from the grocer and other merchants who give S&H Green Stamps. And the family can select gifts from a 144-page S&H Catalog full of everything from home furnishings to furs.

GO WITH SYLVANIA—TO PROFIT!

SYLVANIA

SUBSIDIARY OF
GENERAL TELEPHONE & ELECTRONICS



Circle 11 on literature card

September, 1963/PF REPORTER 21

AT THE MOMENT OF TRUTH -- THE PICTURE IS THE PROOF!

THE JFD LOG-PERIODIC LPV IS BEST FOR COLOR, BLACK AND WHITE TV, AND FM STEREO.

Model LPV11 (illustrated)



$\frac{L(n+1)}{L_n} = \tau$ - the reason why the JFD LOG-PERIODIC LPV has **obsoleted** all other TV antenna designs overnight!

Performance has made the LPV first in antenna sales--not claims or words. JFD will gladly abide by that moment of truth that proves the true caliber of any antenna's performance- THE PICTURE IS THE PROOF!







Copyright JFD Electronics Corp. 1963

LICENSED UNDER ONE OR MORE OF U.S. PATENTS 2,958,081; 2,985,879; 3,011,168 AND ADDITIONAL PATENTS PENDING IN U.S.A. AND CANADA. PRODUCED BY JFD ELECTRONICS CORPORATION UNDER EXCLUSIVE LICENSE FROM THE UNIVERSITY OF ILLINOIS FOUNDATION.

THE FIRST TV/FM ANTENNA BASED ON THE GEOMETRICALLY-DERIVED LOGARITHMIC-PERIODIC SCALE DEVELOPED BY THE ANTENNA RESEARCH LABORATORIES OF THE UNIVERSITY OF ILLINOIS FOR SATELLITE TELEMETRY.

No longer must you sacrifice directivity or gain to obtain broader bandwidth, as with single-channel Yagis and "all-channel" Yagi types. Now the new JFD Log-Periodic LPV breaks through the bandwidth barrier to put an end to cumbersome antenna compro-

mises. The reason?...The patented geometric concept - $\frac{L(n+1)}{L_n} = \tau$ that scientifically formulates individual cells (dipole lengths and spacings) to bring you performance that's **frequency independent** for:

	Model LPV17: 18 Active Cells and Director System for areas up to 175 miles distant. \$59.95 list.
	Model LPV14: 15 Active Cells and Director System for areas up to 150 miles distant. \$49.95 list.
	Model LPV11: 11 Active Cells and Director System for areas up to 125 miles distant. \$39.95 list.
	Model LPV8: 8 Active Cells and Director System for areas up to 100 miles distant. \$29.95 list.
	Model LPV6: 6 Active Cells for areas up to 75 miles distant. \$21.95 list.
	Model LPV4: 4 Active Cells for areas up to 50 miles distant. \$14.95 list.

- **HIGHER FORWARD GAIN** Element for element you get two to three times more gain than with similar-priced competitive makes. Flat gain across each channel, too, for vivid color rendition. (More driven elements do it.)
- **SHARPER DIRECTIVITY** Because the LPV has bandwidth to spare. Its narrow unidirectional beam **does not change with frequency**—does not intercept the ghosts and interference picked up by other broad main-lobed competitive makes.
- **LOWER VSWR** Down to 1.2 to 1—derived from optimum impedance match across the VHF and FM Stereo bands.
- **GOLD ALODIZED** Electrically conductive golden alodizing that is part of the aluminum—assures continuous signal transfer—does not insulate contact points like competitive anodizing.
- **HIGHER FRONT-TO-BACK RATIOS** All elements are fed in phase opposition to reinforce signals arriving from the front end. The crossed harness creates a 180 degree phase shift in the signal path from rear—effectively cancelling out rear pick-up of unwanted signals. (e.g., the LPV11 maintains a front-to-back ratio of 35 db on each VHF channel).



Harmonically Resonant V-Elements, Operating on the Patented Log-Periodic Cellular Formula, in the Fundamental and Third Harmonic Modes, Provide Flawless COLOR... Black and White TV... FM Stereo!



The technical press... the news press... the consumer press... the trade press—never before have so many so acclaimed a new TV antenna!

ADVERTISED IN LOOK

One of America's most vital and widely read magazines—now alerting millions to the new Log-Periodic antenna concept.

ADVERTISED IN SUNSET

The favorite "home" magazine of millions.



Professor Paul Mayes of the Antenna Research Laboratories of the University of Illinois, originator of the log-periodic V-dipole antenna concept.

ORDER NOW FROM YOUR JFD LPV DISTRIBUTOR AND STEP UP INTO THE MODERN LOG-PERIODIC ANTENNA ERA OF PERFORMANCE AND PROFITS!

JFD

THE BRAND THAT PUTS YOU IN COMMAND OF THE MARKET

JFD ELECTRONICS CORPORATION

15th Avenue at 62nd Street, Brooklyn 19, N.Y.

JFD Electronics-Southern Inc., Oxford, North Carolina

JFD International, 15 Moore Street, New York, N.Y.

JFD Canada, Ltd., 51 McCormack Street, Toronto, Ontario, Canada

401-144 W. Hastings Street, Vancouver 3, B.C.

Circle 12 on literature card

TO HELP MAKE FUSE HANDLING MORE PROFITABLE.

BUSS VISUAL-PAK

ANOTHER BUSS FIRST



CLEAR PLASTIC BOX,
THERE'S NO NEED
TO OPEN
TO SEE HOW MANY
FUSES ARE
IN IT

- BUSS fuse 5-in clear plastic box—let's you check fuses in each box at a glance... guards against running short on needed fuses.
- Size and style of fuses printed in large type on lid of box makes it easier to pick out fuses you want.
- Box fits all fuse display stands and channels.

BUSS

PIONEERING NEW
DEVELOPMENTS IN
ELECTRICAL PROTECTION
SINCE 1914

BUSSMANN MFG. DIVISION, McGraw-Edison Co., St. Louis 7, Mo.

Circle 13 on literature card

BUSS: the complete line of fuses...

THE TROUBLESHOOTER

answers your service problems

Refereeing

A discussion has arisen between myself and a friend in which I contend that low line voltage over a period of time will help to break down a power transformer used with a 5U4 rectifier. He maintains that it will not. Will you please tell us which theory is correct?

P. J. KINGSTON

Newcastle, N. B., Canada

I rather doubt that low line voltage would cause breakdown of either the power transformer or the tube—even over an extended period of time. Perhaps you are assuming that, with lowered voltage, the same wattage would necessarily mean increased current. However, in most cases, the load remains the same on this type of power-supply circuitry. This, of course, merely means that reduced voltage only causes reduced current.

Floating Up and Down

I'm stuck on a service problem with a Silvertone Model 2100A (PHOTOFACT Folder 217-15) that suffers from loss of vertical sync. When the set is cold, the sync is fine; after five to ten minutes, though, the picture starts to float. It can be kept fairly stable by adjusting the vertical hold control, but there is no "snap" to the control action—that is, the picture doesn't seem to lock in firmly. After much checking of com-

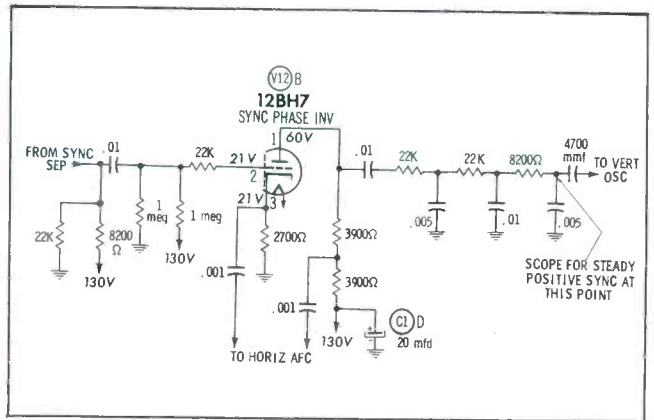

ponents, I found that by momentarily shorting out C1D, the 20-mfd filter on the 130-volt line, I can restore good vertical sync for a few minutes.

WAYNE SCHAFFTER

Mount Eaton, Ohio

Filter capacitor C1 may have some defect such as leakage between sections, and it would be wise to eliminate this possibility by promptly replacing the entire unit. However, I wouldn't be surprised if additional trouble were found elsewhere.

The powerful voltage surges that occur when you short across the 130-volt line may be causing temporary healing of some component defect in the sync section, since all the sync stages are fed from the 130-volt source. You can check this diagnosis by temporarily grounding the plate of the vertical oscillator (to disable this stage) and scoping the sync signal entering the oscillator from the vertical integrator network. With the scope sweep set at 30 cps, you should find positive pips of steady amplitude. If this signal fades away when the set warms up, but reappears after you short across C1D, scope back through the sync stages in search of the trouble.

FUSETRON dual-element fuses time-delay type

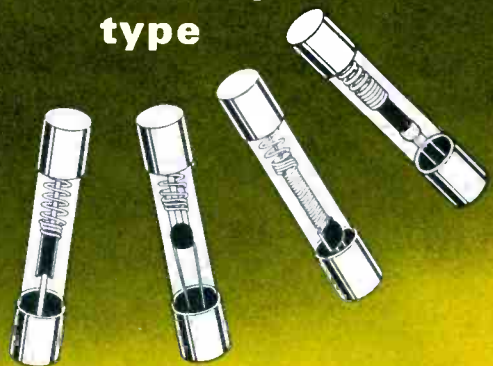

"Slow blowing" fuses for circuits where harmless surges occur. These fuses prevent needless outages by safely holding starting currents or surges, — yet they provide safe, positive protection against short-circuits or continued overloads.

BUSS

Write for BUSS
Bulletin SFB.

BUSSMANN MFG. DIVISION, McGraw-Edison Co., St. Louis 7, Mo.

Circle 13 on literature card

TO HELP MAKE FUSE HANDLING MORE PROFITABLE...



BUSS VISUAL-PAK

**CLEAR PLASTIC BOX,
THERE'S NO NEED
TO OPEN
TO SEE HOW MANY
FUSES ARE
IN IT**

- BUSS fuse 5-in clear plastic box—let's you check fuses in each box at a glance... guards against running short on needed fuses.
- Size and style of fuses printed in large type or lid of box makes it easier to pick out fuses you want.
- Box fits all fuse display stands and channels.

BUSS

PIONEERING NEW DEVELOPMENTS IN ELECTRICAL PROTECTION SINCE 1914

BUSSMANN MFG. DIVISION, McGraw-Edison Co., St. Louis 7, Mo.

eliminate the problem. If this is impractical, a trap can be installed at the tuner input to help eliminate the 39.5-mc signal. In extreme cases, it might be necessary to shield the TV chassis—especially if it is located in an area close to the offending transmitter.

Erratic Sound

I have a Zenith Model 16E21Q (PHOTOFACT Folder 496-2) with a peculiar intermittent trouble that causes the sound to increase and decrease erratically. It sometimes takes five or six hours for this defect to appear; when it does, any attempt to measure voltages, check waveforms, or inject a signal restores normal operation. New tubes have been tried without success.

The voltages measured on the 6EB8 sound IF amplifier and 6BN6 sound detector are all 10% lower than those on the schematic, but I consider this an acceptable variation.

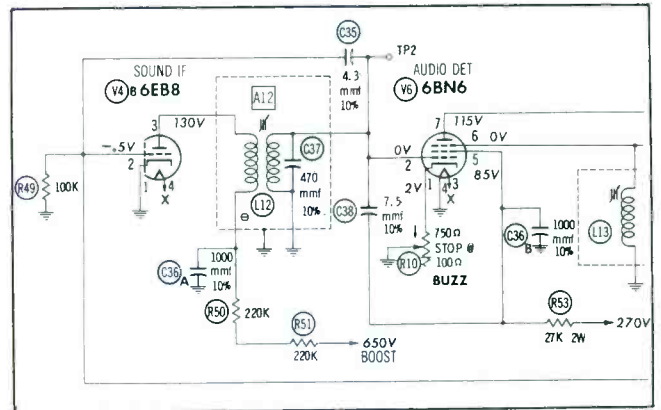

• Please turn to page 77

Circle 13 on literature card
... of unquestioned high quality

Spots Before Your Eyes

I have an Admiral Model P17E35 (PHOTOFACT Folder 424-1) that has what appears to be a burnt spot on the face of the picture tube. The spot is round (approximately 3" in diameter), and a little to the right and down from center. Can you tell me what might cause this and how to get rid of it?

H. L. SMITH

El Paso, Texas

It sounds as if the tube has an accumulation of dirt at one spot on the face. During some manufacturing processes, a suction cup is attached to the face of the CRT; this cup may leave a slight film that is prone to catch dirt and show up as a round spot the size you mention. The remedy is to clean the tube face thoroughly with a detergent, following up with a volatile glass cleaner.

If a dirty face is not the problem, the CRT may have an ion burn. However, this defect is rarely seen in the 110° tubes used with this chassis, even though the tubes are designed to operate without an ion trap.

Sheriff Static

Our county sheriff's two-way radios are causing interference to local TV sets on channels 5, 6, 10, and 11. Apparently the sheriff's antenna is improperly filtered and harmonics are causing the interference. Can you help me correct the trouble?

HIBBS RADIO & TV

Beaver, Okla.

More than likely, the interference is the result of the radios' fundamental frequency (generally 39.5 mc) entering the IF's of the TV set. One step that might be taken to correct the trouble is to make sure the sheriff's transmitters are properly tuned—that is, not exceeding their rated output power, and not over-coupled to the antenna circuits. A careful check by a qualified and licensed communications technician should get rid of any spurious radiation.

Occasionally, it is possible to shift the TV IF's slightly to

Let BUSS Fuses Help Protect Your PROFITS

To make sure BUSS fuses will operate as intended under all service conditions, each and every BUSS fuse is individually tested in a sensitive electronic device.

This is your assurance that when you sell or install BUSS fuses, you are safeguarded against complaints, call-backs and adjustments that might result from faulty fuses and eat away your profit.

It is just good business to sell fuses the BUSS way.

BUSS

Write for BUSS Bulletin SFB.

BUSSMANN MFG. DIVISION, McGraw-Edison Co., St. Louis 7, Mo.

Circle 13 on literature card

Tips for Technicians

Mallory Distributor Products Company
P.O. Box 1558, Indianapolis 6, Indiana
a division of P. R. Mallory & Co. Inc.

Choosing and using audio attenuators

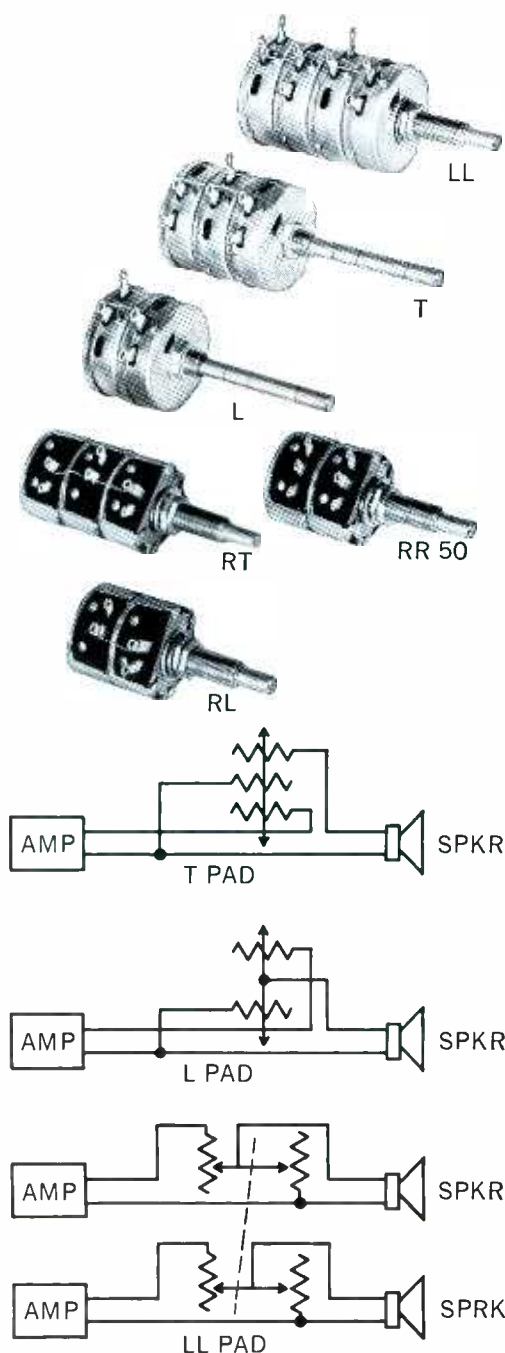

Ever notice that a hi-fi rig sounds *best* about mid-range on the level (volume) control? Man, those drums, fifes, bugles and train whistles sound GREAT! But, oh, those grouchy neighbors. Somehow they fail to appreciate three or four solid hours of this "pure" sound.

Fear not! There's a simple way to keep true hi-fi sound as well as your neighbors. All you need is an audio attenuator (a fancy name for audio control). There are two basic types of audio attenuators: T pads and L pads.

If yours is the *ultimate* in hi-fi rigs you need a T pad. It maintains a constant impedance between the amplifier and the speaker. You simply turn the amplifier up to optimum performance (somewhere around mid-range) (pretty doggone loud) and control *listening* level with the T pad. The "fi" is very "hi" but the level is reasonable and so are the neighbors.

Not all of us can afford the "ultimate". Budgets being what they are, we make a few compromises. Not that our hi-fi doesn't sound great—it does. It's just that it won't break the picture window. We may be able to get by with an L pad. This presents a constant impedance only to the amplifier. Strangely enough, an L pad often seems to *improve* the performance of an inexpensive speaker. Try it—you'll see!

If you have stereo, try an LL pad. That's a pair of L pads with a common shaft. You can balance your rig at the amplifiers and control level at the speakers with only one knob.

How about money? Mallory T, L, and LL pads will handle an "ear-busting" 15 watts of audio power! But if yours is the usual 10 watt system you'll need only an RT or RL pad... same extreme quality—only smaller and more economical.

Speaking of economy, try the new Mallory RR 50 Stereo Control. It does a terrific job on most popular stereo outfits. Just what you need for the recreation room or patio.

The whole point of this "tip" is to let you know that your Mallory Distributor has exactly the audio attenuator you need. All kinds of values and several price ranges. He's your "one stop" source for *all* of your electronic requirements. Stop in soon.

Circle 14 on literature card



Modified Hartley Type

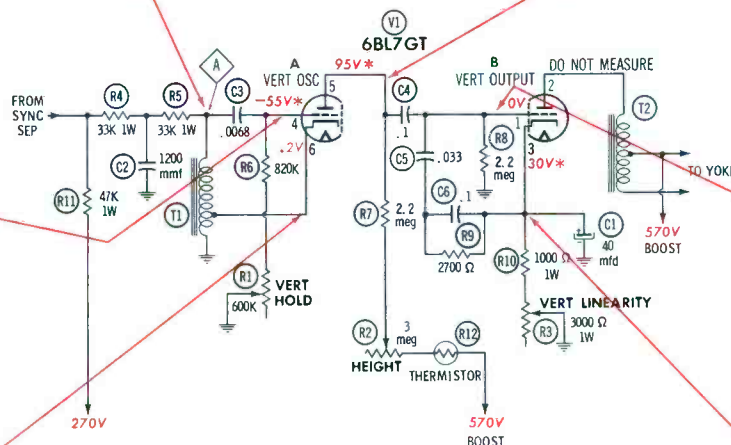
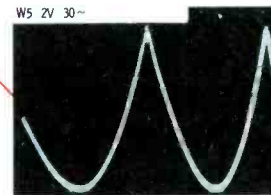
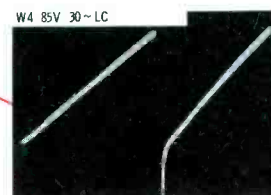
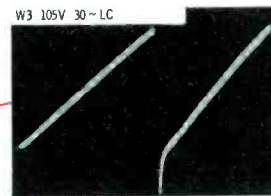
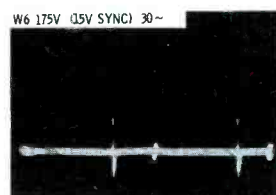
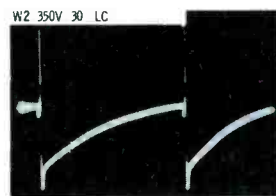
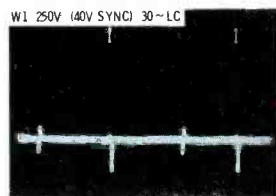

DC VOLTAGES taken with VTVM. * Means voltage varies with operating conditions—see "Variations."

WAVEFORMS taken with wideband scope; low-cap probe (LC) used where direct probe distorts signals.

Normal Operation

Self-contained vertical oscillator stages, not requiring feedback from output stage, are headed for extinction; but they were quite common a few years ago. Circuit shown here (from 1957 General Electric "U" chassis) has same layout as conventional Hartley oscillator; however, it operates like a blocking oscillator: conduction period of V1A lasts for only about 5% of each cycle. When V1A begins to conduct, strong positive pulse is induced in T1 and applied to grid (see W2). This regenerative effect soon reaches saturation point; then, grid current rapidly charges C3, biasing grid deep into cutoff. V1A cannot conduct again until C3 has almost completely discharged through R6 and hold control R1. Varying R1 changes length of each discharge period, thus controlling oscillator frequency. Waveforms in grid circuit contain small sync pulse and much larger pulse due to conduction of oscillator. These pulses normally coincide, but can be separated for inspection (as in W1) by throwing oscillator out of sync. Although input to V1A from sync separator is negative pulse, its leading and trailing edges respectively induce negative and positive spikes across T1; oscillator synchronizes on the latter. During interval while C3 is discharging, C5 and associated capacitors charge from boost source through R7, height control R2, and thermistor R12. R2 sets charging rate to produce desired amplitude of drive waveform W4 at output-tube grid; shaping network C6-R9 modifies W4 from pure sawtooth wave by adding negative spike.

Operating Variations

- PIN 3** DC voltage varies from 22 to 37 volts as R3 is turned from minimum resistance (top of raster stretched) to maximum resistance (top of raster compressed). R3 normally affects top more than bottom. W5 remains constant.
- PIN 5** As R2 is rotated from minimum to maximum, DC voltage rises from 75 to 130, and amplitude of W3 expands from 80 to 150 volts peak to peak. Out-of-sync condition affects both DC and AC readings; DC voltage varies ± 20 to 25 volts from normal over full range of R1, and W3 may reach 150 volts when oscillator is slow.
- PIN 1** AC voltage drop across C4 causes W4 to have slightly lower amplitude than W3, varying from 70 to 120 volts through range of R2. DC voltage reading is always zero except when R2 and R3 are close to minimum-resistance position; then V1B draws grid current on positive peaks of W4, causing as much as -15 volts of grid-leak bias.
- PIN 4** Rotating R1 causes DC voltage to change as much as 15 volts above or below nominal value. In addition, grid voltage is 15 volts less negative with R2 at minimum, and 25 volts more negative with R2 at maximum. Peaks in W2 vary from 300 to 500 volts, according to R1 and R2 adjustments. All voltage readings in vertical sections are practically unchanged by applying signal to receiver.

Top of Raster Spread

SYMPTOM 1

Linearity Nearly
Normal at Bottom

C4 Leaky

Symptom
Analysis

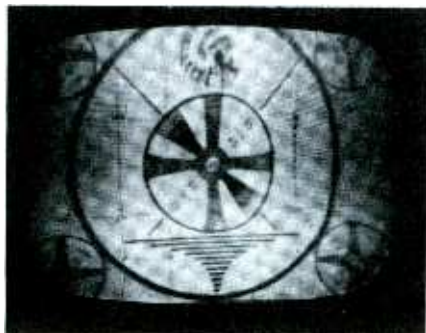

Symptom was photographed while R3 was in full clockwise position (maximum resistance in circuit). Turning control counterclockwise exaggerates stretching at top of raster and causes foldover at bottom. R2 acts normally. Symptoms suggest bias upset on V1B.

Waveform Analysis



W4 has amplitude of 75 volts—slightly below normal. Amplitude of W3 is also deficient, but still in proper proportion to W4. There is no waveshape distortion that could account for nonlinearity of raster. Since slightly weak drive signal is able to produce full sweep of CRT, and nonlinearity cannot be corrected, V1B probably has slightly low bias between grid and cathode.



Voltage and Component Analysis

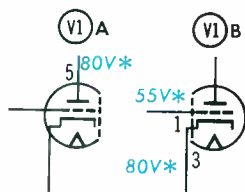

Grid and cathode voltages of V1B are positive 55 and 80 volts, respectively. Bias between these two elements is still near normal (25 volts), explaining why raster is only slightly distorted. If R3 is reset, grid-cathode bias decreases, and visible distortion becomes worse. High cathode voltage is sign of heavy current through R3 and R10. Primary cause appears to be high positive voltage on grid, and technician should immediately suspect DC leakage through C4 from oscillator plate supply. Suspicion is fortified by low plate voltage on V1A (60 to 105 volts over range of R2). VTVM reading on unsoldered grid end of C4 is 20 volts.

Best Bet: Voltage tests in area of V1B grid and cathode.

Nonlinear Sweep

Stretched at Top,
Compressed at Bottom

SYMPTOM 2

C5 Leaky

Symptom
Analysis

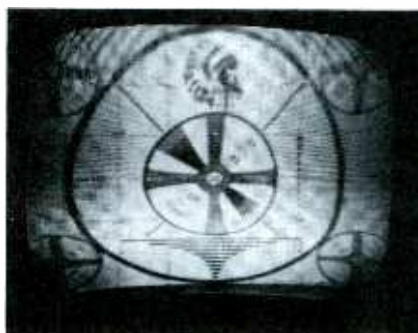

Only way to fill screen is to advance R2 to maximum, adjust R3 to spread raster lines at top, and reset centering rings to close gap at bottom. Linear sweep can be obtained only by reducing height to two-thirds of normal. Again, fault could be low bias on V1B.

Waveform Analysis

With controls adjusted to fill screen, W4 has normal amplitude, but distorted shape; note large negative spike and rounded shoulder of sawtooth slope (cause of stretched top in raster). W3 looks similar, and is larger than normal. These two clues point to something wrong in sawtooth-shaping and coupling circuit between plate of V1A and grid of V1B.



Voltage and Component Analysis

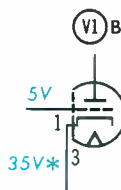

Grid of V1B measures positive 5 volts. Cathode voltage is also several volts above normal (range, 26 to 40 volts); therefore, raster distortion is not due to bias error, but rather to misshapen drive signal. Then why is grid positive? Slight leakage in C4 is ruled out by substitution. However, DC voltage could also reach high grid from cathode of V1B via leaky C5; and since this component is a critical part of drive-signal network, its failure would have relatively great effect on W4's waveshape. Disconnecting one end of C5 for voltage-leakage test is impractical (causes squegging of oscillator), but capacitor tester or substitution check spots fault.

Best Bet: Analyze drive waveform, voltages and schematic.

No Vertical Hold

SYMPTOM 3

Oscillator Too Slow

R6 Increased in Value

Symptom Analysis

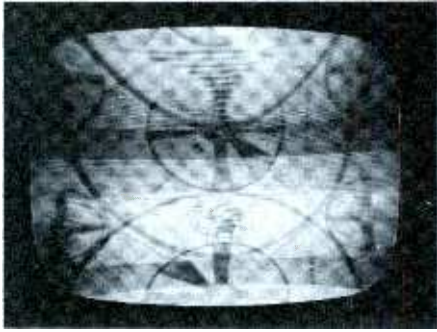

Picture breaks up into jumping, flickering images that give effect of rapid rolling in upward direction. R1, at one point in its range, locks in two pictures stacked one on top of the other—indicating 30-cps oscillation. Loss of sync may be intermittent.

Waveform Analysis

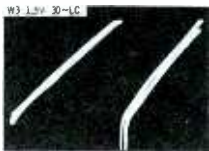
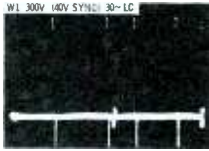

W1 can be synchronized at normal 30-cps scope-sweep frequency, with two sync pulses locked in. Multiple feedback spikes indicate irregular triggering of oscillator, explaining jumbled pattern on CRT. Both sets of pulses in W1 have normal amplitude. W3 almost locks in when sweep frequency of scope is reduced; its shape and amplitude are nearly normal.

Voltage and Component Analysis

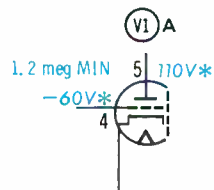

Touching VTVM probe to grid of V1A may pull picture into sync, if R1 is at minimum-resistance position. Reading is -60 volts at this end of range; up to -85 volts at other R1 settings. Unusually negative readings simply confirm slow operation of oscillator. So does high plate voltage: 110 to 140 volts DC at normal height, depending on how R1 is set. Since RC time constant of grid circuit is important in determining oscillator frequency, resistance check at grid is in order. After allowing a minute for V1A to cool, reading stabilizes at 1.2 meg when R1 is set for minimum resistance. 50% increase in value of R6 has detuned oscillator.

Best Bet: Visual clue suggests prompt resistance test.

No Vertical Hold

Trouble Appears Only After Warmup

SYMPTOM 4

C3 Leaky

Symptom Analysis

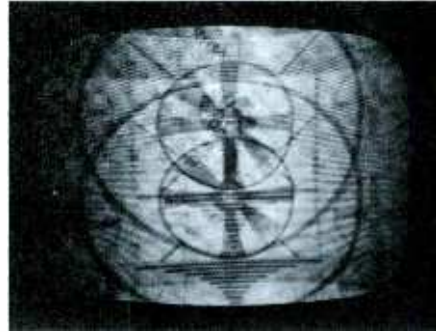

When chassis is on bench, picture may lock in at one end of hold-control range, with normal height and linearity. However, if chassis is placed in cabinet, or heat is directed on vertical circuit, picture soon begins flipping in manner described under symptom 3.

Waveform Analysis

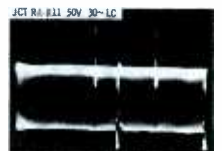
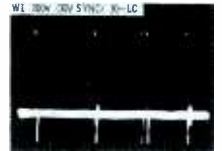

W1 and W2 appear normal in shape, but amplitude of both waveforms is seen to decrease as trouble develops. Even then, signal at junction R4-R11 contains clean sync pulses of normal 50-volt amplitude. (Also notice presence of vertical sweep pulses fed back through R5 and R4). W3 changes in frequency and slightly rises in amplitude when sync is lost.

Voltage and Component Analysis

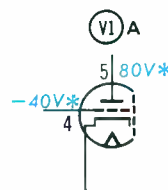

Grid bias of only -40 volts on V1A comes as surprise; with oscillator running slow, each cycle should be long enough to develop more than usual bias—as in symptom 3. When R1 is adjusted to add resistance in circuit, negative grid voltage increases. Low plate voltage on V1A (nominal value 80 volts) can be attributed to increased plate current due to partial loss of grid bias. Odd combination of clues can be explained by leakage in C3. It makes grid unable to maintain sufficient bias, but has paradoxical effect of increasing apparent RC time constant in grid circuit—thus slowing oscillator. Substitution is most effective check of C3.

Best Bet: Combination of visual, scope, and VTVM tests.

Sweep Nearly Lost

SYMPTOM 5

Raster 2" High
on 21" Screen

T1 Open (Grid Winding)

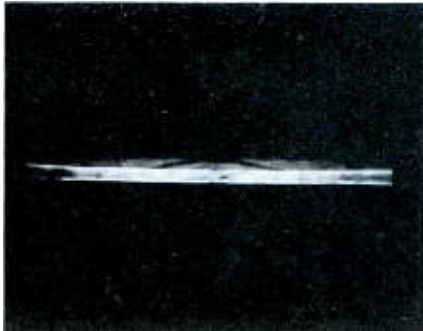

On certain vacant channels, jittery and nonlinear raster fills about half the height of screen. This pattern gives reassurance that yoke and vertical output stage are functioning. Hold control has some slight effect, so continuity must exist through oscillator tube.

Waveform Analysis

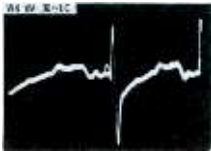

W4 is very weak, and has strange shape. Squirming line between pulses is video; on some "adjacent" channels, much stronger noise signal takes its place. W4 is being amplified by V1B and is feebly driving yoke. W3 is similar to W4. Both W1 and W2 consist of vertical sync signal with video along base line. This is getting through V1A, but oscillator is inoperative.

Voltage and Component Analysis

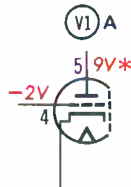

Grid of V1A has only -2 volts, and plate voltage varies from 8 to 11 volts as R2 is turned. Substantial voltage drops across R7, R2, and R12 indicate heavy plate current. All voltages on V1B are normal. Point A measures positive 130 volts, and same voltage is found at both ends of R4; so low-resistance path to ground through T1 is evidently broken. There must still be continuity from ground to cathode of V1A, because cathode voltage is zero and tube is conducting. When resistance from point A to ground is measured, ohmmeter shows characteristic effect of charging B+ filters. Out-of-circuit resistance check indicates open T1.

Best Bet: Localize with scope; pinpoint with meter.

No Vertical Sweep

Momentary Deflection
Under Certain Conditions

SYMPTOM 6

R3 Open

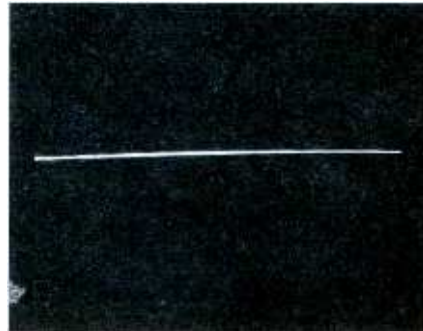

CRT trace bounces—briefly producing few inches of sweep—if height or hold control is rapidly turned counterclockwise. Linearity control does not induce this effect. Small amount of sweep also appears when set is first turned on, but vanishes after a minute of warmup.

Waveform Analysis

W4 is normal in all respects but one: At maximum height, a small portion of positive peak of sawtooth should normally be clipped off, because grid of V1B should be driven positive enough to draw grid current. With this symptom present, no flat spot appears. Furthermore, usual parabolic waveform is missing at cathode. These clues add up to prove V1B is not conducting.



Voltage and Component Analysis

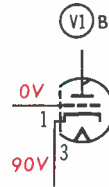

Grid of V1B measures normal zero volts, but when R1 or R2 is operated to cause momentary sweep, meter needle flicks up to positive 10 volts. Cathode measures 90 volts, and this reading is not affected by adjusting R3. Same voltage is present on other side of R10; absence of voltage drop across this resistor shows there is practically no cathode current, and implies that R3 must be open. High-resistance input circuit of VTVM is only DC connection from cathode to ground, and small trickle of current through meter is sufficient to develop high apparent cathode voltage. Fault in R3 sometimes gives itself away if slider makes intermittent contact.

Best Bet: Voltage readings alone are sufficient.

**Behind Every
PHILCO Tube,
Part or Product**



**stands the one
Important common
denominator that
is your positive
guarantee of
Satisfaction--**

“Quality!”



PARTS AND SERVICE OPERATIONS

PHILCO

A SUBSIDIARY OF *Ford Motor Company*,
Circle 15 on literature card

Transistors in

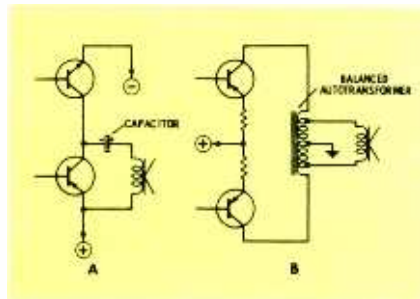

Fig. 1. Two different ways of eliminating conventional output transformer.



Fig. 2. Modular construction is sometimes used in transistorized preamps.

The increasing popularity of transistors in high-powered high-fidelity amplifiers has not been unexpected. The development of stable, low-distortion transistor power amplifiers was the final step in making all-transistor units feasible.

The all-transistor hi-fi amplifier has a number of attractive features:

Heat-producing devices are few because there are no tubes. A low power demand is made on the power transformer, especially when there is no applied signal or the audio is at a low level. Small cabinets are possible, and ventilation problems are less critical for a given audio output than with equivalent tube-operated equipment.

Transistor circuits are readily adaptable to direct coupling; hence, the number of coupling capacitors and transformers is reduced. Their

absence circumvents feedback problems that might result from phase shift introduced by reactive circuit elements. Consequently, a very high order of feedback is possible in transistor amplifiers (70 db of feedback is not uncommon), and distortion can be reduced to an extremely low value—often a small fractional part of one percent.

The absence of filament circuits and high DC supply voltages removes two of the most troublesome sources of hum in tube amplifiers. Transistor circuits operate at a low impedance, and are not as subject to the influence of hum fields as high-impedance tube circuits.

The low impedance of audio output transistors even permits loudspeaker systems to be connected directly. Although audio output transformers are still used in some

units, transformerless power amplifier stages have become increasingly common and popular; they eliminate costly and critical audio transformers. In the transformerless arrangement shown in Fig. 1A, a capacitor is used to couple the output of the transistor to the loudspeaker.

Even when a transformer is used, it can be an autotransformer, as shown in Fig. 1B. This is often less costly and less bulky than those output transformers required by tube output stages.

There are some all-transistor amplifiers, while others are hybrids—part tube and part transistor. In some hybrid amplifiers the first input stages use transistors, as does the output stage; the intermediate stages are tube circuits.

Transistors have given further impetus to the development of completely integrated systems, such as units that include AM and FM tuner, multiplex adapter, tape-and-phono preamplifier, and main amplifier, all on one chassis. In many of these, only the loudspeaker is external. Accessory items such as the record changer, tape deck, and microphone plug into this single unit.

Preamplifier Circuits

Transistor preamplifier stages perform the same functions as those using tubes. The input circuit must present the proper loading to the program-source accessories. Equalization is needed, as well as bass and treble tone-control circuits. A volume control is necessary, and loudness compensation is often provided. Stereo balance and separation adjustments may be used. Modular construction can be incorporated in these key circuits; an example is shown in Fig. 2.

The layout of the left channel of a typical transistor preamp is shown in Fig. 3. Phono or tape-head signals are fed to the first stage. Some equalization is inserted for use with a ceramic phono cartridge.

A feedback loop, inserted from the base circuit of the high-level driver to the emitter circuit of the first preamplifier, provides equalization similar to that used in tube-type units. A network is provided for overall low-frequency equalization; another provides high-frequency tape-head compensation,

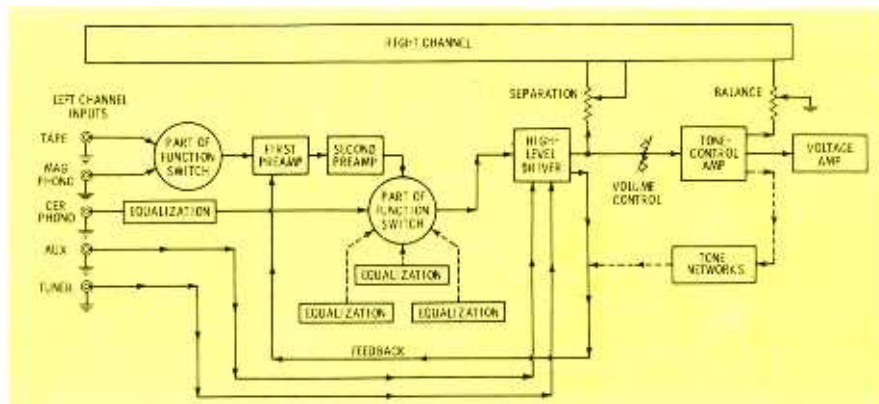

Fig. 3. Left channel of transistorized stereo preamp accepts five inputs.

while a third serves the same purpose with the phono input.

The output of the second pre-amplifier is coupled through the selector switch to the base of high-level driver X5. This switch is open when either the auxiliary input or the tuner input is used. Auxiliary and tuner signals are generally of a higher level and impedance, so they are connected directly to the high-level driver.

The high-level driver operates as an emitter follower, whose low-impedance signal is fed to the tone-control amplifier through the volume control. A feedback type of tone-control circuit is used.

Stereo separation and balance controls are provided. The separation control is in the emitter circuit of the high-level driver. As the separation control is advanced, progressively greater mixing of signals takes place between the left and right channels, and this blending effect can be used to eliminate the exaggerated "ping-pong" effect in some stereo program material.

The balance potentiometer, in the output of the tone-control amplifier, is a linear control with equal resistances from its mid-position to ground—so no loss is inserted into either channel. As the control is rotated, more resistance is inserted into one channel and less into the other; in this way, right and left channel signals can be regulated to obtain the proper volume relationship.

Power Amplifiers

A transistor power stage using an output autotransformer is shown in Fig. 4. A push-pull signal is applied from base to base of the driver transistors by the input transformer. The drivers are operated as emitter followers and are DC-coupled to the bases of the output transistors. The autotransformer is connected between the collectors; taps provide loudspeaker matching. The output circuit is stabilized by emitter resistors and a thermistor in the supply-voltage line. A fuse in the supply line to the emitters protects the transistors from excessive current that might be caused by an improper loading or some other fault.

The use of complementary transistor pairs in output stages — as shown in Fig. 5 — eliminates the need for a push-pull transformer.

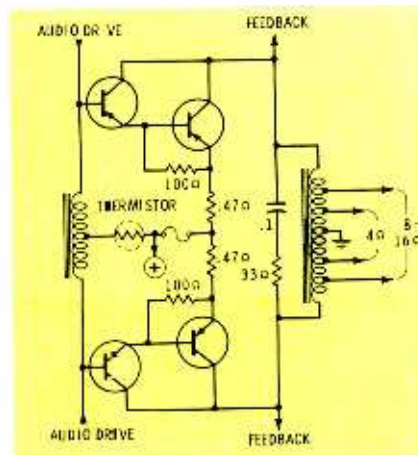

Fig. 4. Complete push-pull power output stage with DC-coupled drivers.

The output transistors operate in push-pull, so if the load is connected in their collector circuits, it is driven single-ended. The coupling capacitor prevents DC from entering the speaker coils.

A different output arrangement is shown in Fig. 6. Both transistors are connected in common-emitter circuits; the load for transistor X4 is connected between the collector and ground, while that for the other transistor is connected between emitter and ground. This arrangement provides an essentially single-ended output, even though the transistors operate in push-pull fashion. The bases are driven in a push-pull manner using the specially-phased secondaries of the driver transformer. However, the two transistors are connected in series across the power supply, which consists of two voltages—one positive and the other negative with respect to ground.

Transistor X3 has a negative collector voltage with respect to its base and emitter, the emitter being held at DC ground potential by the path through the speaker voice coil. The emitter of transistor X4 is con-

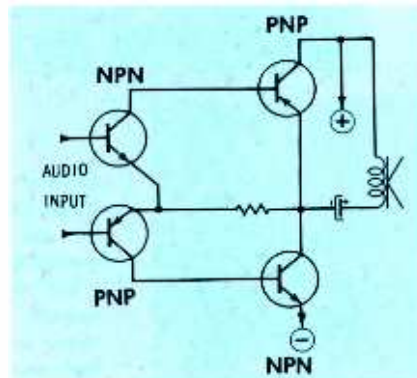

Fig. 5. Complementary PNP and NPN transistors simplify amplifier design.

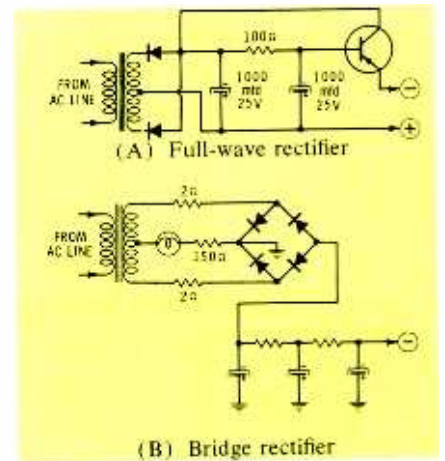

Fig. 7. Two types of power-supply circuits for transistorized amplifiers.

ected to the positive voltage of the power supply, making its collector also negative with respect to its base and emitter. Thus, X3 is an emitter follower, while X4 operates with the collector as the output element. Because of the phasing of the input-transformer secondaries, the two outputs are developed in push-pull fashion. Their signal voltages are in phase at the connection between the X3 emitter and the X4 collector, providing "single-ended" drive for the loudspeaker — and without a heavy, expensive output transformer.

The lamps located in the emitter circuits, because of their positive temperature coefficient, help prevent thermal runaway. Thus, if the collector current rises (either as a result of heating, or because the speaker load is too heavy), the filament resistances increase, and the lamps provide additional safety bias. They also protect in another way: Excessive emitter current will cause the lamps to burn out, opening the supply circuits. Therefore, if one of the transistors shorts, the open lamp will prevent the supply

• Please turn to page 83

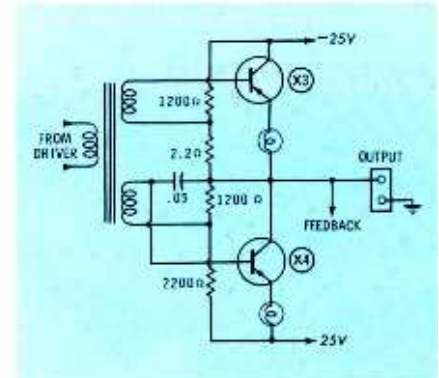
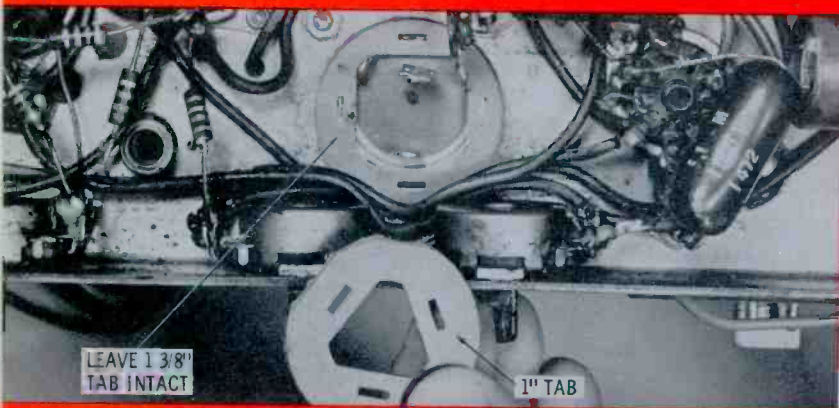

Fig. 6. Transistors in series across voltage source, driven in push-pull.

When Replacement Parts



Often when we order an electrolytic capacitor and indicate the value needed, our distributor doesn't have one of the same physical size—even though the electrical specifications are acceptable. Fortunately, there's a quick and easy way to replace a 1 3/8" electrolytic with a 1" unit—without drilling new holes in the chassis to install a different-sized mounting plate. First, remove the old electrolytic, leaving the original mounting plate in place.

Some major components used in television receivers often have externally mounted accessories—such as the horizontal linearity magnet on the original yoke shown in this group of photos. If you order a replacement for this yoke, chances are it will not come equipped with the linearity magnet. However, you can remove the yoke-core clamp and linearity magnet assembly from the defective yoke



Guilty of replacing selenium rectifiers with silicons in the manner shown here? Most of us have been, at one time or another, although we know what will happen if one of the old rectifiers happens to short or become leaky. When making a replacement of this type, you'll be safer to install the silicon units on a terminal board as shown here. Use a four-lug terminal strip for mounting the new rectifiers, find or drill a mounting hole in the chassis (usually, you can find one

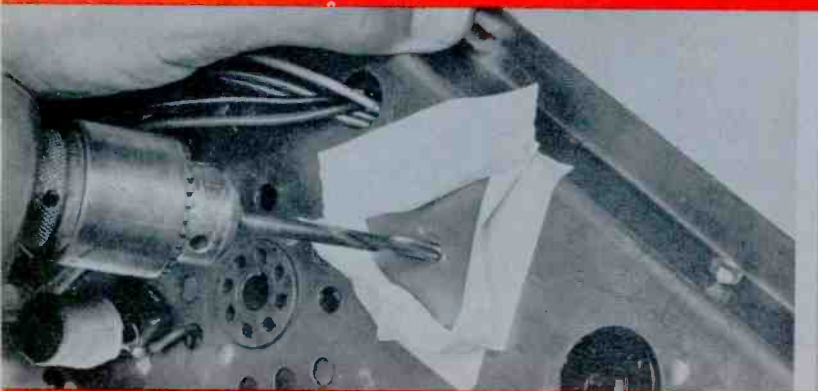
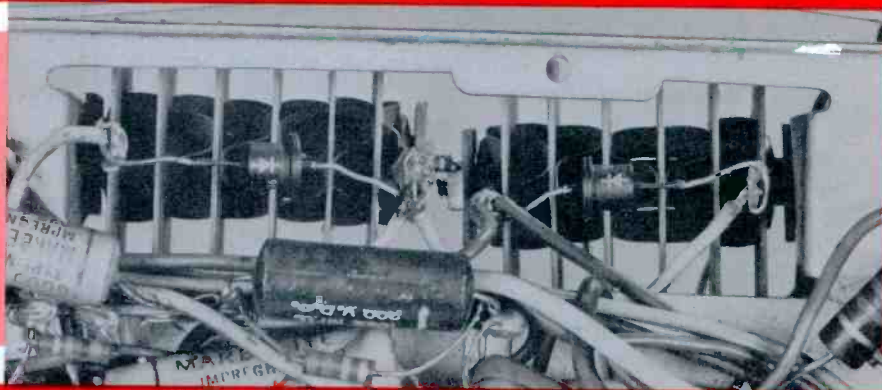

Drilling new mounting holes for transformers and other major components is something you do almost every day. But do you know all the handy little techniques that make for easier and safer drilling in electronic apparatus? Especially in equipment using printed circuit boards, metal shavings thrown from the drill bit can lodge among components and cause considerable damage—shorts, for instance. To catch these troublesome shavings, try placing a few strips of masking tape

DON'T

QUITE

FIT

Procurring an exact replacement component for use in electronic gear is, in some areas of the country, next to impossible—unless you wish to sideline a set for two or three weeks. (We all know our customers' feelings about this idea!) Usually, however, you can obtain a suitable substitute from the distributor in your area, and with a little ingenuity, even a part that "doesn't quite fit" can be simple to install. Here are some helpful modification techniques for particular replacement applications.

Trim the insulating plate supplied with the 1" can into a circular shape, to fit the chassis cutout (as shown in the photo). Next, poke the terminals and tabs of the new filter through the mounting plate left on the chassis; then place the newly trimmed 1" plate over the protruding tabs. To finish the job, simply twist all three tabs for a snug fit, and resolder the lead connections. This method is fast, simple, and neat.

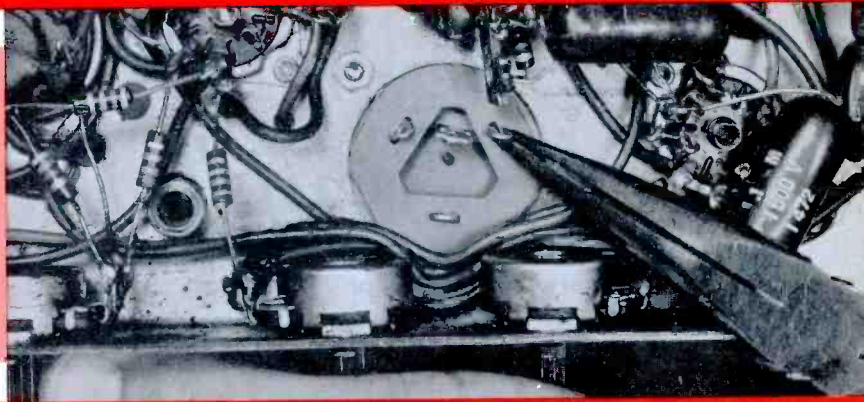

ANTI-PINCUSHION
MAGNETS

EMPTY MAGNET
SLOTS

YOKE-CORE CLAMP AND
LINEARITY MAGNET ASSEMBLY

and install it on the new yoke. One other tip on the replacement of yokes has to do with the anti-pincushioning magnets (see second photo). If the new yoke causes the set you're repairing to develop an excessive pincushion effect, remove the small magnets from the old yoke, position them on the new yoke for the best raster, and glue them in place. A thorough job allays callbacks.

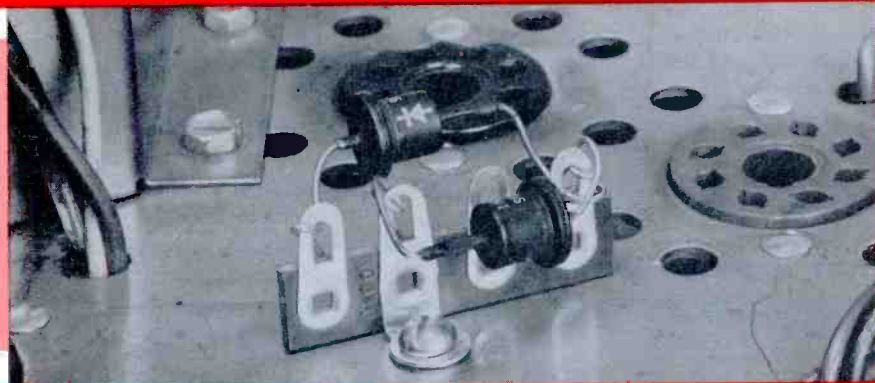

in a convenient spot), and install the terminal strip with a metal screw. The grounded lug can serve as the chassis connection for one of the rectifiers, unless the circuit is designed to be isolated from chassis ground. In some sets, it may be more convenient to merely solder the ground lug to the chassis. Why not carry a couple of these silicon assemblies, already mounted on terminal strips, in your tube caddy? They could save you quite a bit of time.

around the drill area—as shown here. Another handy technique to prevent damage to components and circuits on the underside of the chassis is depicted in the second photo. Use a metal or plastic sleeve (hollow tubing, for example) over the end of the drill bit, and adjust the bit in the chuck so it will just clear the depth of the chassis metal. The sleeve will stop the bit from penetrating too far below the chassis. The sleeve shown was made from the plastic cover of a ballpoint pen.



The Audio Circuit

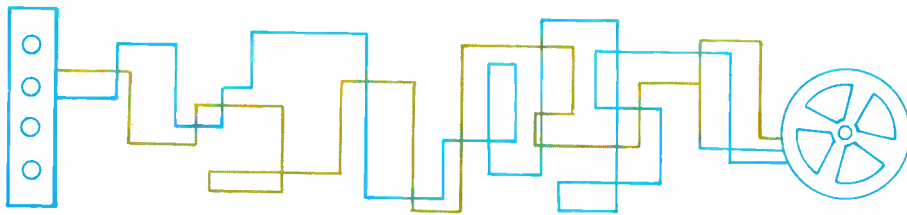

— Simple ?

Service hints for the most neglected part of a TV set — by Art H. Meyerson

Audio repair does not give such dramatic results as the correction of picture defects, but is just as essential to proper maintenance of a TV receiver. Many an unsatisfactory repair job can be ascribed to a perfunctory check of the audio system, which causes a good video repair to be downgraded because of hum, buzz, or distortion in the sound. Even though the customer's original complaint may not have mentioned the sound, he's likely to be listening for trouble after the chassis is back in the cabinet. Many TV owners apparently expect marginal sound defects to go away automatically when picture troubles are cleared up. This quirk of customers can be very discouraging, if not downright aggravating.

The very simplicity of the audio circuit can be the serviceman's undoing. Too many times, it is acci-

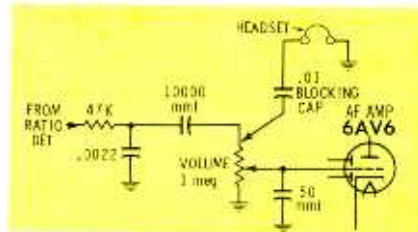

Fig. 1. Low-impedance headphones are helpful in localizing sound troubles.

dentally disabled by circumstances so elementary they are easily overlooked. Perhaps the housewife, while cleaning under the set, has pulled out a speaker lead; or one of the children might have left a TV-phono switch in the wrong position; or maybe the man of the house has tried to fix the set, and has mixed up the tubes a little. The result can be no sound, no picture, no raster, or almost anything—depending on the circuitry.

Whether simple or not, audio

problems should be attacked logically, so that they will not be time-consuming beyond the point of profitable return. Most servicemen know and use several basic techniques for analyzing complaints of no sound. These tests give most effective results when applied in the following sequence: First, see if the audio tubes are lit. Then try signal injection in its simplest form: If the set has a phono jack, inserting a thin screwdriver should set up a characteristic hum. If the volume control is accessible (as it is in many late-model sets), the same check can be made at the high side of the control. Another possible way to introduce a hum signal is via a tube-socket adapter to the grid of the audio amplifier. If there is no hum, the next step is to pull the audio power tube in and out of its socket, listening for the characteristic "thump" or "click." No sound calls for a check of the speaker. An ohmmeter, or the battery from your flashlight, can be used for this test. If the speaker cone jumps when the test leads are touched to the voice-coil terminals, the speaker is functioning.

Incidentally, don't pass over the speaker as a possible suspect when the set has intermittent sound, or distortion. A rubbing voice coil or damaged cone can create all sorts of difficulties, particularly in those TV's where the speaker faces up. Kids love to poke things into the speaker grille, and often spill liquids onto the cone.

To help test audio circuits in the home, a low-impedance headset or single earphone is a handy item to have in the service case for speaker substitution or progressive checking of the audio system. Fig. 1

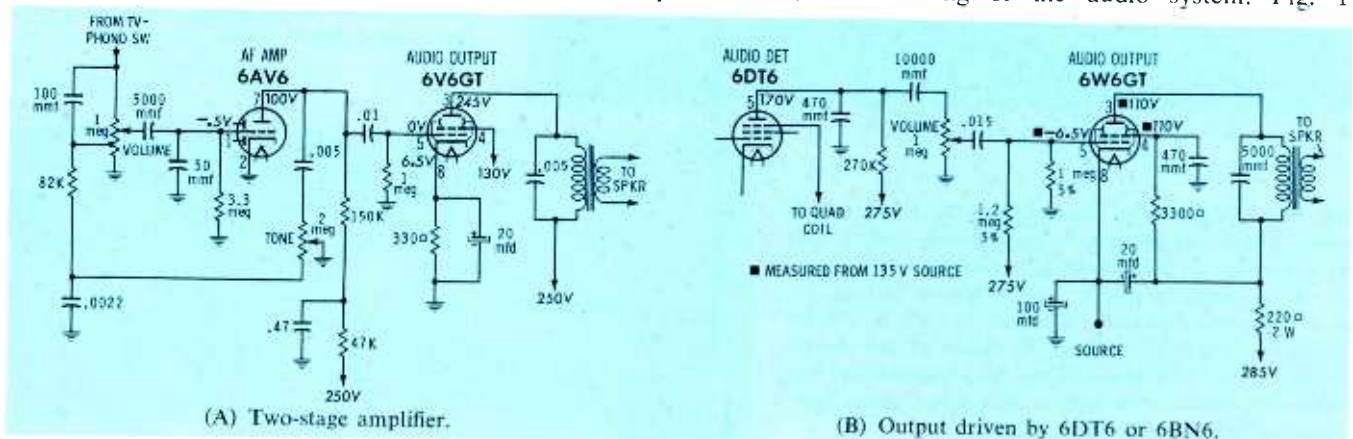

Fig. 2. These two configurations are typical of most TV audio circuits.

shows how headphones can be connected across the volume control to see if the audio section is receiving a satisfactory input from the sound detector. The .01-mfd blocking capacitor serves to protect the low-impedance earphone winding from damage during tests in audio circuits that also contain DC voltages. To make further dynamic checks of the audio system without removing the chassis, socket adapters are useful.

Bench Checks

If you must pull the chassis to pinpoint audio troubles, here are some tips to speed up the process of finding the defect:

Intermittent faults are often caused by bad paper and mica capacitors. Instead of wasting time checking these parts, why not replace them all? Even with tone-control circuits included, no more than six or seven capacitors are involved, at a total cost of less than a dollar, and fifteen minutes of time. Remember that service is a commercial operation, and you mustn't sell your time short.

Hum problems in audio circuits are fairly easy to trace. Quick isolation of the hum source can be achieved by using a 40-mfd, 450-volt capacitor to bypass first the plate and then the grid of each audio tube. Working back from the speaker, note the point where the hum can no longer be blocked—and you'll find it entering the audio circuit near that point. Be sure to discharge the capacitor after touching each point.

Once you have some idea of where the hum is entering, check wire positions in this vicinity—particularly control-grid wires, shielded wires, and their associated grounds. (Check ground connections by re-flowing the solder.) The position of coupling capacitors is also critical for avoiding hum pickup. The oscilloscope is an invaluable aid in tracing hum. It can show you whether the hum frequency is 60 or 120 cps; in sets using full-wave rectifiers, this immediately isolates the source to either the filament circuit or the B+ line.

One other point to remember is that the vertical oscillator may be responsible for 60-cycle hum. This is easily checked by turning the vertical hold control and listening

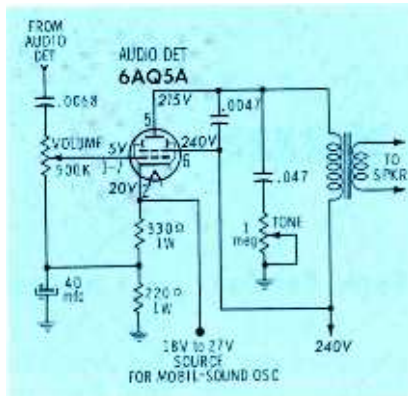
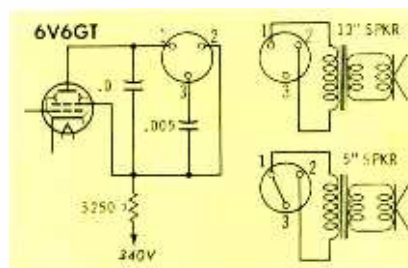

Fig. 3. B+ for Mobile-sound oscillator is taken from audio-output cathode.

for a change in the sound of the hum. In one stubborn case, vertical-sweep hum in the audio was eliminated only by adding an RC filter consisting of a 5000-ohm resistor and a 40-mfd capacitor in the B+ feed line to the plate of the first audio amplifier.

Localizing the cause of weak or distorted sound is not always easy. First, you need to find out whether the trouble is before or after the volume control. If a good signal is present at this key check point, you can go on to signal-trace the audio section. One method is to inject a sine-wave audio signal at various points, listening for evidence of distortion or low gain. Or you can scope these points; the waveforms will give a good indication of stage gain, and will reveal hum or buzz. Some other troubleshooting ideas are to trace through the audio circuits using headphones, or to tap in at points ahead of the output stage and feed the signal to an external audio amplifier. In the latter two tests, any distortion you hear is known to be produced ahead of the takeoff point.

These isolation tests can bring you very close to the exact trouble spot. You can speedily close in on the culprit if you're familiar with the different audio-circuit arrangements used in TV receivers.



(A) In CBS-Columbia Chassis 817

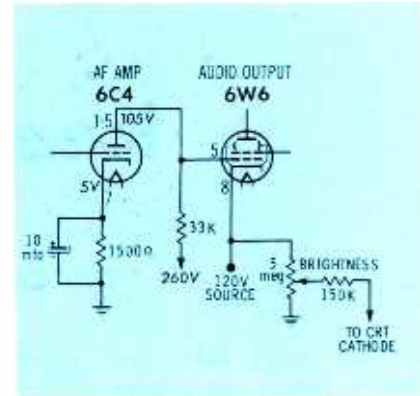

Fig. 5. Hoffman Chassis 213 uses direct coupling between audio stages.

Many of the older sets use the "classic" circuit shown in Fig. 2A, consisting of a voltage amplifier driving a power stage. Nearly all recent models, on the other hand, have a simplified circuit incorporating a 6BN6 or 6DT6 quadrature detector (Fig. 2B). Since this type of detector includes the equivalent of an audio voltage amplifier in its circuitry, it is capable of driving the power output stage directly. This development has simplified the audio problem without greatly increasing the complexity of the detector stage.

Either of the basic configurations shown in Fig. 2 may utilize the output tube as part of a "stacked" B+ system. As illustrated in Fig. 2B, the cathode of this tube is connected to a low B+ source point instead of ground, and all the current from this B+ branch passes through the audio stage to reach the main B+ source. This circuit is popular for several reasons. It utilizes current that normally would be dissipated as heat in a dropping resistor; it reduces the filtering problem; and it permits reducing the size of power transformers and filter chokes.

Basically, the audio output tube serves also as a voltage-dropping resistor. Since the cathode of this

• Please turn to page 80

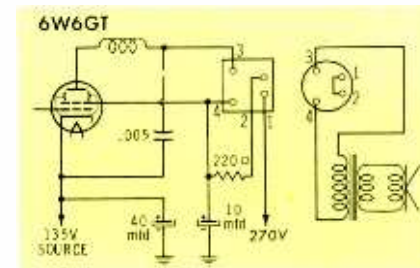

(B) In DuMont Chassis RA-305

Fig. 4. Speaker-plant connections.

know your '63 COLOR CIRCUITS

The Color Sync Section . . . by George F. Corne, Jr.

This year's color sync circuits follow closely the pattern of those used in last year's chassis. A few new tube types have been introduced—such as the 6JU8 quadruple diode—and minor variations have been made in certain circuits. RCA's CTC12 chassis uses one 'JU8 in two phase-detector circuits; two diodes function as the chroma sync phase detector, while the other two form a killer phase detector—a stage new to RCA chassis.

However, in Zenith's *spring '63* chassis, the 26KC20, you'll find the new 6JU8 seeing duty as the sync

phase detector and the ACC-killer detector. Another new tube that makes its debut in the 26KC20 is a 6KT8—whose triode section is in the color killer stage, while the pentode section serves as the second chroma bandpass amplifier. Many component values and circuit arrangements have been revamped in this new chassis, but the color sync circuits remain fairly similar in basic operation to those of the 27KC20 series.

Let's look more closely at the color sync circuits in both the RCA and Zenith, and see what's new in

each. The schematics (Figs. 1 and 2) show voltages on the tube elements (taken with and without a color signal), and peak-to-peak waveforms obtained with a keyed-rainbow color-bar generator. All waveforms were taken with a wide-band oscilloscope, using a low-capacitance (LC) probe.

RCA's Circuit

The color sync section of the CTC12 chassis (Fig. 1) includes the burst amplifier, chroma sync phase detector, chroma reference oscillator and its control circuit, and

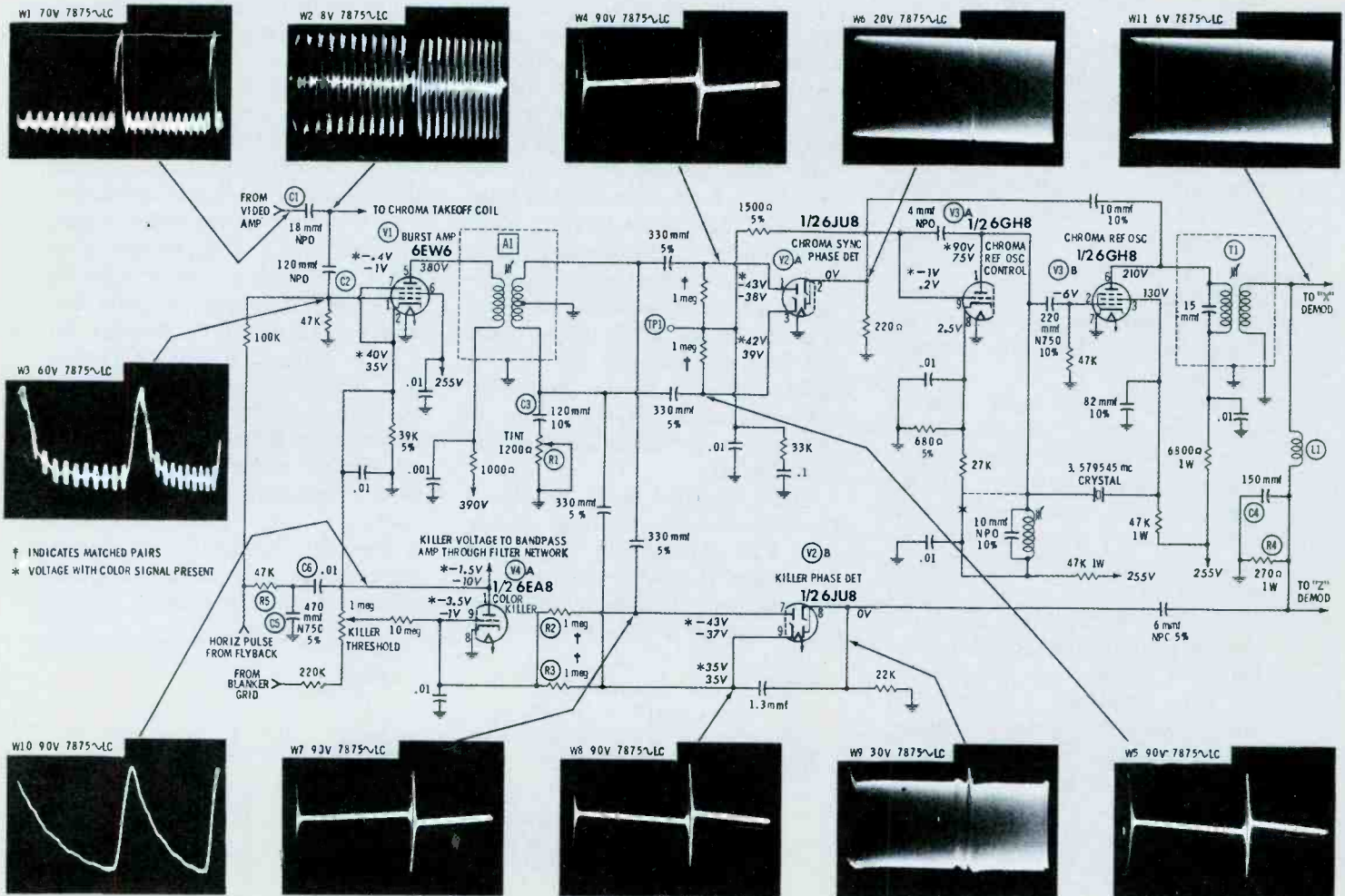

Fig. 1. RCA's CTC12 color chassis uses one-half 6JU8 in new killer detector stage this year.

the color killer and its phase detector. An easy way to analyze the circuit is to trace the color-bar signal through each stage, observing the signal that should be present at certain key points. This will serve as a review of the operational features of each circuit, and pinpoint what's been changed since last year.

W1 represents the composite color-bar signal after it passes the first video amplifier; this signal contains the horizontal sync pulse, plus eleven pulses of chroma information. (The first pulse serves as the reference burst, leaving only ten to produce color bars on the screen of the CRT.)

W2 shows the signal that's fed to the grid of the chroma bandpass amplifier. The low value of coupling capacitor C1 causes the horizontal sync pulse to be removed, leaving only the eleven "bars" of chroma information.

Chroma Sync Phase Detector

Although a 6JU8 takes the place of the 6AL5 used last year, the components and circuit configuration are very similar to those in the CTC11 chassis.

W4 and W5 represent the separated burst signal as it is fed to the phase-detector plate and cathode. W6 shows the CW reference signal (from the 3.58-mc oscillator) fed to the opposite side of the phase detector for comparison with the incoming burst signal. During the time when no color burst is present in the secondary winding of the burst transformer, both of the diodes conduct an equal amount; therefore, no voltage is present at test point TP-1. When a color burst is present in the transformer, the diodes compare its phase with that of the reference oscillator; if the 3.58-mc oscillator is not exactly in step with the burst signal, one of the diode sections will conduct more than the other, producing a proportionate voltage at TP-1. Any correction voltage developed in the phase detector is impressed on the grid of oscillator-control tube V3A, which in turn pulls the reference oscillator (V3B) back into step with the incoming burst.

Capacitor C3 and TINT control R1 form a phase-shifting network to adjust the phase of the burst signal fed to the phase-detector diodes; the visual effect of varying

R1 is a change in color hues on the CRT screen. Transformer adjustment A1, in the plate circuit of the burst amplifier, also affects the phase and amplitude of the burst signal. Normally, A1 will be adjusted only during bench alignment of the color sync circuits, although an occasional in-the-field touchup may be necessary (possibly in new receiver installations) to provide the proper range of the TINT (hue) control.

Killer Phase Detector

The purpose of this newly added stage is to detect the presence of a color burst signal, and to supply this information—as a negative cutoff voltage—to the grid of the color killer stage. (In last year's chassis, this cutoff voltage was obtained through a divider network in the color sync phase detector.) The operation of the killer-detector circuit is very much like the sync-phase circuit we just discussed. Input burst signals W7 and W8 are identical to W4 and W5, and are obtained from the same point—the secondary of the burst transformer. The comparison signal—shown in W9—is taken from the Z-demodulator tap in the demodulator phase-shift network.

Under no-burst conditions, conduction is equal in the V2B diodes, and no cutoff voltage is fed to the grid of color killer V4A. The phase of the comparison signal is always such that, when a burst signal is present in W7 and W8, diode conduction is unbalanced in the direction necessary to develop a negative voltage at the junction of R2 and R3. During color reception the grid of V4A receives -3.5 volts. This bias is sufficient to cut off the killer, and the -10 volts normally developed at the plate (used to keep the bandpass amplifier disabled) drops to -1.5 volts, allowing the bandpass amplifier to operate.

Chroma Reference Oscillator and Control

One new feature this year is the location of the 3.58-mc crystal; it's now connected from the plate of control tube V3A to the screen grid of oscillator V3B. In the CTC11 chassis, the crystal was wired directly between the control and screen grids of V3B.

Waveform W11 is the CW reference signal fed to the X demodu-

lator. The same signal, shifted in phase by the L1-C4-R4 network, is also fed to the Z demodulator.

Points to Remember

Keep these facts in mind when you're working with the color sync circuits in the CTC12 chassis:

1. The color-signal takeoff point—at the plate of the first video amplifier—is a good point to start signal-tracing.
2. Waveform W3 at the grid of the burst amplifier should contain the color bars, burst signal, and horizontal keying pulse.
3. The killer phase detector circuit is new; it supplies a negative voltage to block the color killer stage when chroma signals are being received.
4. A clean burst signal—no color-bar information—should be present at the color sync phase detector, and at the killer detector.

Zenith's Circuit

The color sync stages of the 27KC20 chassis are shown in Fig. 2. Let's analyze the way these circuits handle the signal from the color-bar generator. The operation of each circuit is similar to its corresponding RCA circuit; so, to avoid repetition, we'll simply trace the progress of the color signal through each stage.

W12 shows the eleven color "bars" at the chroma takeoff point, following the first bandpass amplifier. You'll notice the horizontal sync pulse has already been removed, making this waveform identical to W2 in Fig. 1. Waveform W13 contains the same chroma components as W12, plus a positive keying pulse from the flyback circuit. The latter pulse keys the burst amplifier during retrace time.

The HUE control (a coil, like last year) is located in the tuned plate circuit of V5 and controls the phase of the burst signal fed to the phase detectors. The circuit of the burst amplifier stage is exactly the same as in last year's 29JC20 chassis.

The chroma sync phase detector is also similar to Zenith's previous circuit. A 6AL5 functions as the detector, and the burst signals fed to its input plate and cathode are depicted by W14 and W15. The signal at this point should contain

no chroma information—only burst signal. W16 shows the 3.58-mc reference signal.

In the 3.58-mc oscillator and control stage, the crystal has been relocated; it's now connected from the plate of V7A to the screen grid of V7B, as in the RCA chassis. In the 29JC20 chassis, the crystal was connected from the control grid to the screen grid of V7B.

A combination ACC-killer phase detector is again included, using the dual-diode section of a 6BN8 as the detector. W17 and W18 show the burst signals fed to this stage; W19 is the sample signal from the oscillator. This circuit works in the same manner as the color killer stage we discussed earlier. In this chassis, however, two bandpass amplifiers are used, and the killer controls only the second one.

The first bandpass stage is also affected by this phase detector, in that a portion of the negative voltage is fed to its grid via R10. The

amount of this voltage depends on the amplitude of the burst signal, and therefore controls the gain of the first bandpass amplifier—a sort of AGC action. The term used in this case is ACC—for *automatic color control*.

In previous Zenith color chassis, the conduction point of the killer was preset, with no means to vary it. However, in this chassis series, and in the newer 26KC series, a control is inserted in the cathode circuit of V8A as a killer adjustment. A "color-off" switch, the same as in last year's set, is used in the grid circuit.

Waveforms W20 and W21 are the 3.58-mc CW reference signals fed to R-Y and B-Y demodulators, also very similar to last year's.

Points To Remember

Here are some important facts about Zenith's color sync circuits:

1. The color signal (with burst) must pass through the first band-

pass amplifier before it can reach the grid of the burst amplifier. The grid of the burst amplifier also needs a horizontal keying pulse.

2. There should be a clean burst signal at the input of both phase detectors; no chroma information is permissible here.
3. The color killer stage has a color-off switch located in its grid circuit; check this switch first if a loss of color occurs (customers sometimes forget).

Summary

The color sync stages in the 1963 color chassis do have a few important changes — new circuits, tubes, etc. However, their basic operation is about the same as in earlier models. And the troubleshooting technique of using a color-bar generator and scope (equipped with LC probe) to signal-trace the color information remains the quickest way to isolate a defective stage. ▲

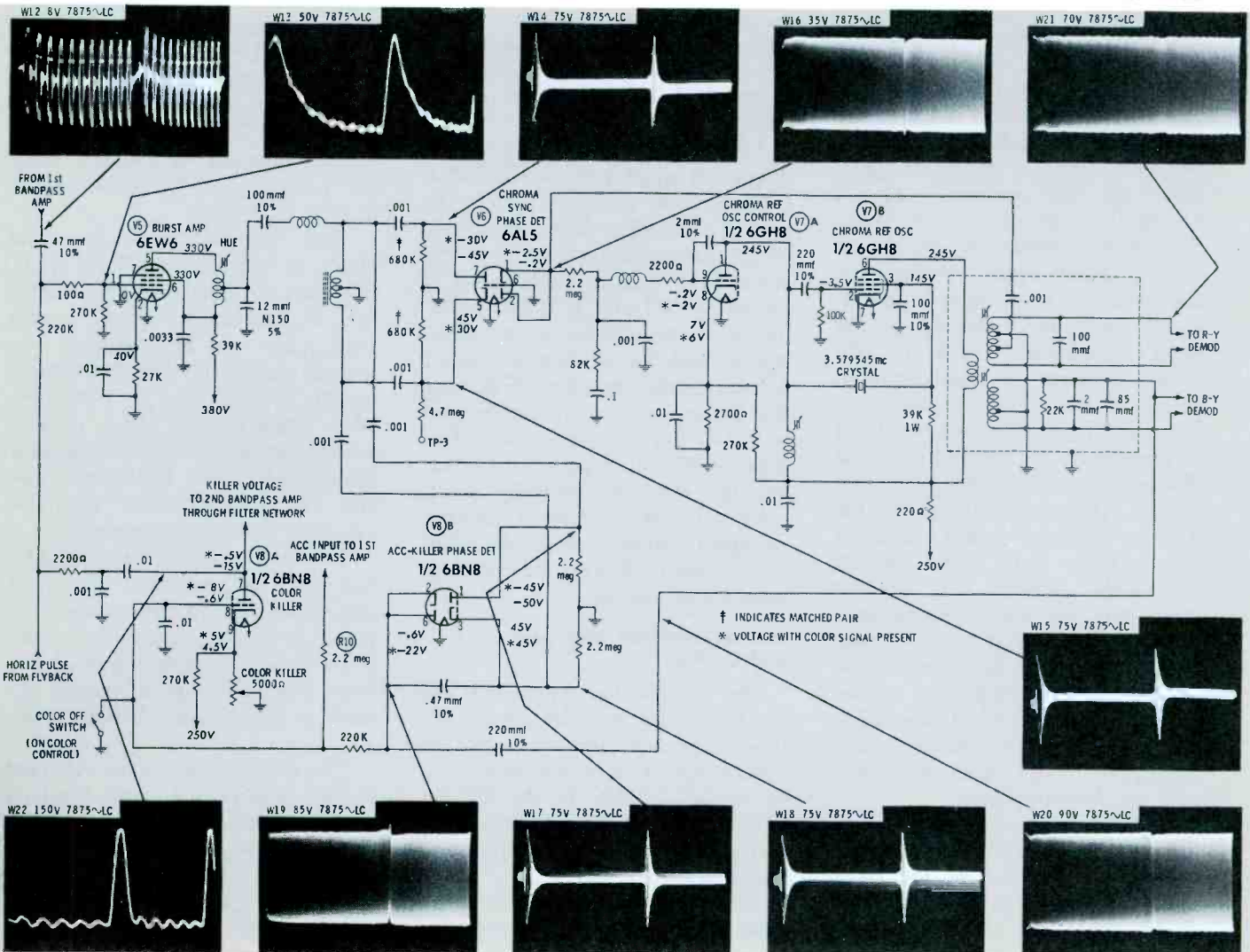

Fig. 2. Color sync circuits used in Zenith's 27KC20 chassis are very similar to last year's.



6 NTSC
Standard Colors

Standard
Alignment Signals

Horizontal Bars

Vertical Bars

Crosshatch

White Dots

COLOR-APPROVED and NTSC for \$200 less!

Model 661-NTSC Bar-Dot Generator-\$349.50

Based on the same designs as Hickok's famous Model 656XC NTSC color bar generator, the NEW Model 661 is literally the answer for progressive service technicians who recognize the opportunities in color TV service but have been stopped by the cost of equipment. *The 661 is not a compromise—there are no short cuts—it's not "NTSC-like"; it is a complete instrument generating correct, 100% saturated, NTSC color signals complete with sync, blanking and burst at the right pedestal position and of the correct amplitude and phase, as well as demodulator alignment signals (R-Y, B-Y, —G-Y, G-Y 90°), plus dots and crosshatch.* In short, you

can expect the same kind of performance standards from the new 661 that have established Hickok's reputation with leading Color TV manufacturers as COLOR-APPROVED.

Compact, weighing just nine pounds, ideal for installation, convergence and in-the-home servicing, the new Model 661 provides everything needed for complete color service.

Ask your Hickok distributor to demonstrate the Model 661 for you . . . Write for our free booklet, "Why NTSC?" which explains why the NTSC standard tests are important. There is no obligation.

Equip your shop with these other Hickok Color-Approved instruments to provide your customers with complete color TV service:

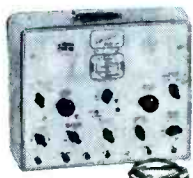

615
Sweep &
Marker
Generator



CR33
Color
Picture Tube
Tester

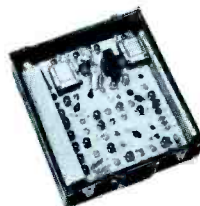

656XC
NTSC Color
Bar Generator

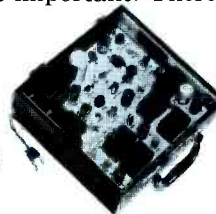

660
White Dot-
Bar Generator

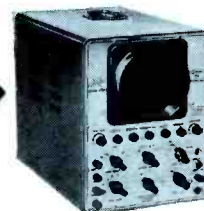

675A
Wide-Band
Oscilloscope



691
Marker
Adder

THE **HICKOK** ELECTRICAL INSTRUMENT CO.

10566 Dupont Avenue • Cleveland 8, Ohio

Circle 13 on literature card

September, 1963/PF REPORTER 41

are you replacing
top quality tubes
with identical
top quality tubes
?

Now you can carry the identical tubes that you find designed into most of the quality TV sets you service. Chances are, you were not aware that these TV sets were designed around special Frame Grid tubes originated by Amperex and that even more tube types originated by Amperex are being designed into the sets you'll be handling in the future. Amperex frame grid tubes provide 55% higher gain-bandwidth, increase TV set reliability by simplifying circuits and speed up your servicing because their extraordinary uniformity virtually eliminates need for re-alignment when you replace tubes.

Tubes introduced by Amperex, currently used by major TV set makers include:

Frame Grid				Others	
2GK5	4GK5	6GK5	6EH7	6AL3	9A8
2ER5	4EH7	6ES8	6EJ7	6BL8	15CW5
3GK5	4EJ7	6ER5	6HG8	6BQ5	16AQ3
3EH7	4ES8	6FY5	7HG8	12AX7	27GB5

For optimum satisfaction for your customers and a better profit operation for yourself, make room in your caddy now for these matchless-quality tubes. Next time you visit your distributor, look for the green-and-yellow boxes and enjoy confidence in your work such as you never have before. Amperex Electronic Corporation, Hicksville, L. I., New York.



where the plate glows red. If this happens, current through the flyback increases dangerously, and damage can easily follow.

Coupling capacitor C3, from the oscillator plate to the output grid, is a common troublemaker. Many sweep troubles start with this unit, and replacement is usually advisable merely on general principles.

Flyback transformer T1 develops high-amplitude pulses for the high-voltage rectifier. Damper V3 damps out secondary oscillations in the flyback and, in conjunction with C2, develops the boost voltage. C2 usually has a high breakdown rating, but also has a tendency to be intermittent. The symptoms caused by a defective C2 can appear as intermittent width reduction, linearity changes, or no raster at all.

In analyzing symptoms, don't overlook the flyback transformer; this is one component in which almost anything can happen. High-voltage corona, caused by high humidity or worn insulation on outer windings, can give intermittent symptoms ranging from Barkhausen oscillations to picture blooming. Also, shorted turns on the flyback

windings can cause intermittent sweep, poor linearity or blooming.

Why Intermittent?

Most intermittents are caused by thermal breakdown of components or connections, undesirable value changes in parts that have become temperature-sensitive, or component breakdown brought on by voltage transients. Components in sweep circuits are more prone to change value than those in other circuits, because peak (transient) waveform amplitudes often considerably exceed average or effective values; this constantly changing stress (especially in the horizontal stages) places a terrific strain on the dielectric of capacitors and on the carbon structure of resistors.

Voltage Transients

Voltage transients are most likely to damage components which are underrated, especially if they are filters or coupling capacitors. An example is filter capacitor C8 in Fig. 1, which is connected between the B+ line (280 volts) and the boost voltage (590 volts). Before the oscillator and output sections start

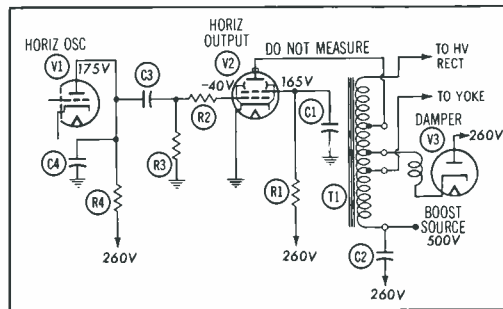

Fig. 2. Horizontal sweep circuit is a common trouble spot in TV receivers.

operating, the voltage across the filter is greater than 300 volts; under some conditions, the applied voltage can even exceed 400 volts. Even though the 450-volt filter may seem properly rated, aging or deterioration of the electrolytic—considering the large pulse voltage it must bypass—may eventually result in a shorted, leaky, or intermittent filter. A defect of this type can lower the plate voltage of both tubes enough to cause poor linearity, intermittent vertical deflection, or no vertical deflection at all.

You might find the same thing in a horizontal sweep circuit; for example, screen bypass C1 or boost capacitor C2 in Fig. 2 might become

Trust your **24 HR SERVICE**
VHF or UHF-All Makes
TV TUNER REPAIR and ALIGNMENT to **JW**

Personal Service
EACH TUNER COMPLETELY SERVICED BY AN EXPERIENCED TECHNICIAN

VHF TUNERS \$9.50
UHF TUNERS NET
UHF CONVERTERS \$17.95
UHF-VHF COMBINATIONS NET

Prices are for service and unmutated units. Missing, broken and damaged parts, defective tubes charged extra at LOW net prices. We ship C.O.D.

OUR GUARANTEED SERVICE INCLUDES:

1. All tuners mechanically and electronically inspected.
2. All necessary parts replaced.
3. Contact surfaces correctly cleaned and lubricated.
4. First test run for intermittents and drift indication.
5. Fine tuning range checked on all channels.
6. Local osc aligned to correct frequency all channels—XTAL controlled.
7. RF alignment—all channels—XTAL controlled.
8. AGC check, all channels—cut off of RF amp checked.
9. Overall response all channels, shield covers in position.
10. Quality control FINAL CHECK ALL UNITS, UHF-VHF.

IMPORTANT:

Ship complete. Include all broken parts. State model and complaint. Package well to avoid transit damage.

JW ELECTRONICS Phone: EDison 2-0665
P.O. BOX 511 • BLOOMINGTON, INDIANA

Circle 18 on literature card

SAVES
your back...
SAVES
your time...

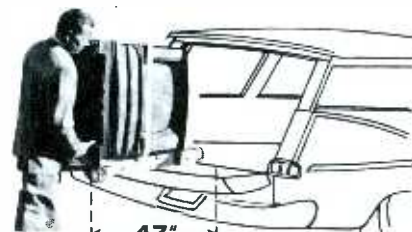

YEATS SHORTY DOLLY
for RADIO and TV

just 47 inches high for STATION WAGONS and PANEL PICK-UPS



FOLDING PLATFORM
15 1/4" x 24 1/2" top.
Snaps on or off.
(Platform only)
\$11.95

Designed for TV, radio and appliance men who make deliveries by station wagon or panel truck... the short 47 inch length saves detaching the set for loading into the "wagon" or pick up. Tough, yet featherlight aluminum alloy frame has padded felt front, fast (30 second) web strap ratchet fastener and two endless rubber belt step glides. New folding platform attachment, at left, saves your back handling large TV chassis or table models. Call your YEATS dealer or write direct today!



YEATS
Model No. 5
Height 47"
Weight 32 lbs.



FURNITURE PAD

"Everlast" COVER AND PADS

YEATS semi fitted covers are made of tough water repellent fabric with adjustable web straps and soft, scratchless white flannel liners. All shapes and sizes — Write



TV COVER

YEATS

APPLIANCE DOLLY SALES COMPANY

2103 N. 12th STREET MILWAUKEE, WISCONSIN

Circle 19 on literature card

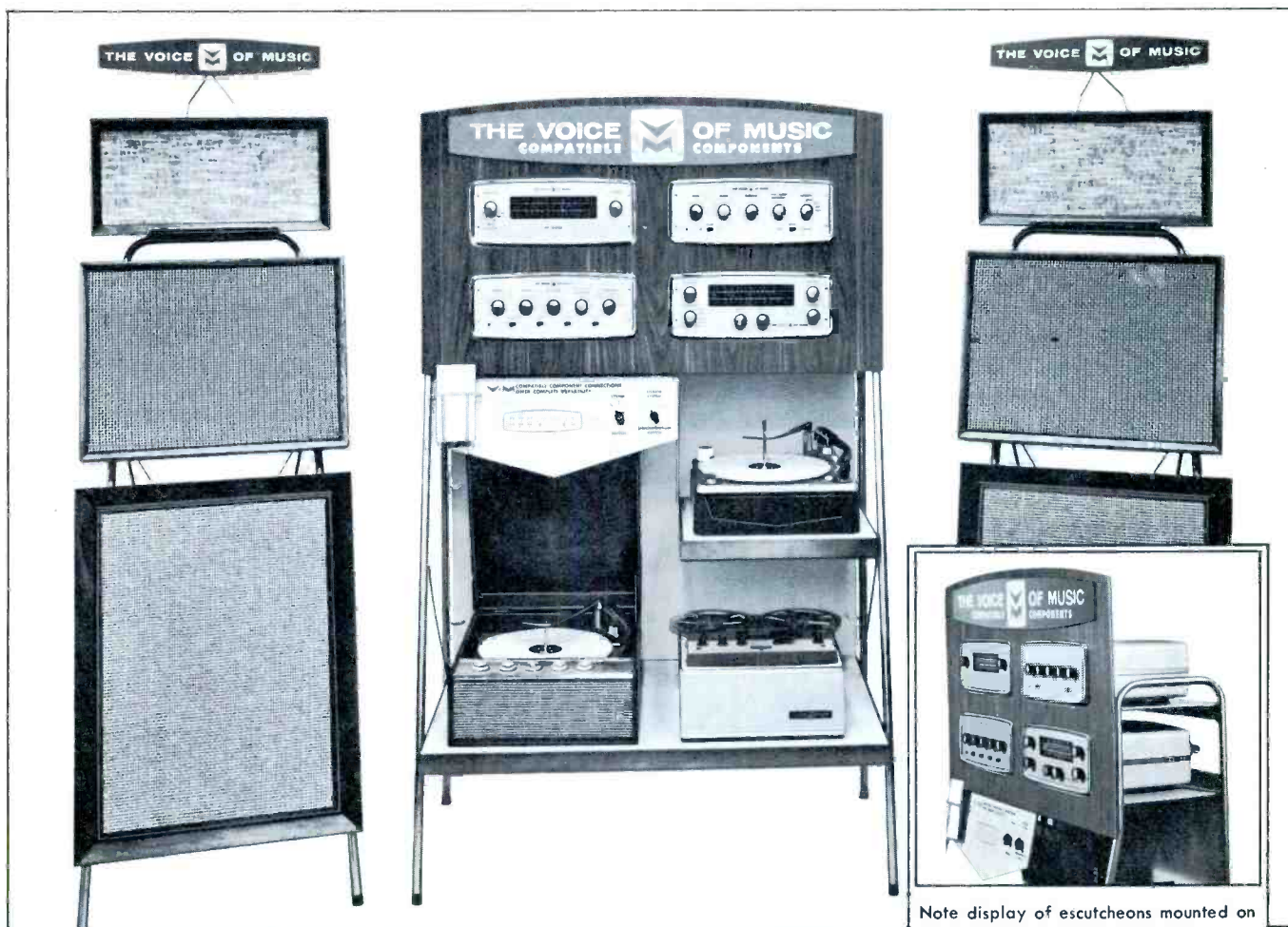

Note display of escutcheons mounted on walnut facing, with control switches below

COMPATIBLE COMPONENTS DISPLAY DEMONSTRATION CENTER OFFERS MORE WAYS TO Make MORE Sales... BIGGER Sales

While almost everybody else **promises** more profits with their line, V·M *delivers the special tools you need* to build better profits.

FOR EXAMPLE: this new display-demonstrator contains 15 separate V·M high-fidelity compatible components, has a big, bright header to gain attention, yet fits conveniently in minimum store space. Complete connections provided so you can demonstrate three complete VOICE OF MUSIC component hook-ups, and play each component series through any of three separate dual speaker systems.

All you or your salesman does is turn a switch to select component combinations. The sound does the selling! Prospects *hear* the difference in systems, realize at once why a few extra dollars more in an

amplifier or speaker or radio tuner is money well spent! By assisting selling people to trade up, their personal effectiveness is increased.

The new V·M display-demonstrator is available when you order components to stock it. Included in this component selection are the following items: Model 1428 amplifier; 1465-2 radio tuner; 1448 amplifier; 1467 tuner-amplifier combination; 1470 tape recorder deck; 1475 base; 1573 record changer; 1438 base; 1466 changer-amplifier combination; 2 Model "32" speakers; 2 Model "42" speakers; 2 Model "62" speakers.

ORDER TODAY!
 Your V·M distributor can provide full details.

THE VOICE  OF MUSIC®

leaky. In a case of narrowed width, both of these capacitors should be considered.

Troubleshooting for intermittents such as those just described is fairly simple. In some cases, you can listen closely as the intermittent occurs and hear a "crack" as the filter shorts and recharges. In others, a careful voltage check will be needed to isolate the defective component. The best method, although perhaps not the fastest, is to temporarily replace the suspected component and see if the condition is remedied. An effective way of checking compon-

ents which are suspected of being temperature-sensitive is to hold a heat lamp or hot iron near the suspected components and watch the raster for possible changes, thereby pinpointing the defective part.

Common Thermal Problems

Heat-induced conditions affect resistors primarily, although some capacitors can become quite temperature-sensitive. In one set I serviced, coupling capacitor C3 (Fig. 1) developed slight leakage as the set heated up. After a short while, the

picture would come up from the bottom and shrink from the top. As the leakage increased, the vertical output grid became more positive, the drive decreased, and the picture shrank. A voltmeter connected to the vertical output grid showed the positive bias, indicating that the coupling capacitor needed replacement.

In most sets, however, it is usually a resistor that becomes temperature sensitive and causes intermittents. One prime example I've run into on many older sets (and in some newer ones) is the resistor between the vertical hold control and the vertical oscillator grid—R1 in Fig. 1. This particular resistor, as it ages, often becomes so sensitive to temperature changes that frequent adjustment of the vertical hold control is required as the set warms up. What happens is that the resistance of R1 increases with the set temperature, requiring less series resistance from the hold control. Usually, replacement of R1 clears up the problem; use a higher wattage rating, and if possible choose a location with better ventilation.

I've had several sets in which the vertical height would decrease as the set warmed up. The most common cause turned out to be series resistor R4 between the height control and the oscillator plate. It would increase in resistance, as the temperature rose; the increased resistance lowered the plate voltage, diminishing the drive-signal amplitude.

Some models compensate for normal temperature variations by using a thermistor in critical circuits. Due to the design of a thermistor, its resistance varies inversely with temperature changes. Its cold resistance might be 1 meg; as the temperature increases, the resistance may drop to 500K or lower, keeping the plate voltage of the oscillator more or less constant.

In horizontal sweep circuits, one resistor is likely to give the most trouble—the output screen resistor, R1 in Fig. 2. Check the value of this resistor both cold and hot; and check the voltage drop across it during both temperature extremes. Whenever space permits, always replace this resistor with one having a heavier wattage rating; this will save you many future callbacks.

Another unusually sensitive com-

More useful than ever!

ALL
New!
COMPLETELY
INTEGRATED

B&K

CRT 445

Checks and Corrects
B & W and COLOR
Picture Tube Troubles



THE INDUSTRY'S STANDARD

*Most Widely Used Today
by Professional Servicemen*

Includes all desired features. Does the job in a few minutes right in the home without removing tube from TV set.

**SAVES CUSTOMERS—ADDS SERVICE INCOME
MAKES NEW TUBE SALES EASIER**

Gives new life to weak or inoperative tubes. Checks for leakage, shorts, open circuits and emission. Removes inter-element shorts and leakage. Repairs open circuits and low emission. Restores emission and brightness. Life Test checks gas content and predicts remaining useful life of picture tube. Quickly pays for itself. Net, **\$74.95**

TESTS AND REJUVENATES

all picture tubes at correct filament voltage from 1 to 12 volts.

TESTS AND REJUVENATES

all Hi G-2 and Lo G-2 picture tubes, including tubes that require as low a G-2 voltage as 30 volts. Supplies all three necessary voltages: Hi G-2, Low-1 G-2, and Lo-2 G-2.

TESTS AND REJUVENATES

110° tubes and the new 19" and 23" tubes.

TESTS AND REJUVENATES

color picture tubes, including the new 90° 23" 23BG22. Checks and corrects each gun of color tube separately.

Subscribe to
New
Picture Tube
Information
Service

UP-DATE YOUR B&K CRT WITH THESE ACCESSORIES

Model C40 Adapter. For use with previous Models 400 and 350 CRT's—to test and rejuvenate TV color picture tubes and 6.3 volt 110° picture tubes. Net, **\$9.95**

Model CR48 Adapter. For use with previous Models 400 and 350 CRT's—to test and rejuvenate 110° picture tubes with 2.34, 2.68, and 8.4 volt filaments. Net, **\$4.95**

See Your B&K
Distributor,
or Write for
Catalog
AP21-R

B&K MANUFACTURING CO.
DIVISION OF DYNASCAN CORPORATION
1801 W. BELLE PLAINE AVE. • CHICAGO 13, ILL.
Canada: Atlas Radio Corp., 50 Wingold, Toronto 19, Ont.
Export: Empire Exporters, 253 Broadway, New York 7, U.S.A.



Circle 21 on literature card

**FINEST
MONEY-MAKER
FOR
Professional
Servicemen**

Multiple-Socket Speed with Gm Accuracy

PLUS OBSOLESCENCE PROTECTION

TESTS
All TV and Radio Tubes
—Old and New

TESTS
Nuvistors and Novars

TESTS
European Hi-Fi Tubes,
Voltage Regulators, and
Most Industrial Types

TESTS
the New 10-Pin Tubes

TESTS
for True Dynamic
Mutual Conductance (Gm)

TESTS
New 12-Pin
Compactrons



Model 700 DYNA-QUIK DYNAMIC MUTUAL CONDUCTANCE TUBE TESTER

See your B&K Distributor
or Write for Catalog AP21-R

TESTS BOTH OLD AND NEW TUBE TYPES—SELLS MORE TUBES PER CALL

All over the nation, thousands of professional servicemen rely on the "700". Once you use it, you'll be as enthusiastic as they are. *Everyday use has proved its speed . . . its accuracy . . . its efficiency.* This up-to-date, obsolescence-proof tube tester is designed for maximum use *today and tomorrow.* Provides multiple-socket section to quick-check most of the TV and radio tube types the *true dynamic mutual conductance way*—plus simplified switch section to check new tube types in Dyna-Quik emission circuit. Also includes provision for future new sockets.

Makes test under set-operating conditions. Checks each section of multi-section tubes separately. Checks for *all* shorts, grid emission, leakage and gas. Makes quick "life" test. Exclusive *adjustable* grid emission test provides *sensitivity to over 100 megohms.*

Makes complete tube test in seconds. Checks average set in a few minutes. Discovers weak tubes that need replacement. *Satisfies more customers. Sells more tubes. Saves call-backs. Insures your reputation. Pays for itself over and over again.* Net, \$169⁹⁵

Time-Saving, Money-Making Instruments Used by Professional Servicemen Everywhere



Model 960 Transistor
Radio Analyst



Model 360 V O Matic
Automatic VOM



Model 375 Dynamatic
Automatic VTVM



Model 1076
Television Analyst



Model 445 CRT
Rejuvenator Tester

NEW TUBE INFORMATION SERVICE

Available every 3 months, on subscription,
for all B&K Dyna-Quik Tube Testers



B & K MANUFACTURING CO.

Division of DYNASCAN CORPORATION

1801 W. BELLE PLAINE AVE. • CHICAGO 13, ILL.

Canada: Atlas Radio Corp., 50 Wingold, Toronto 19, Ont.

Export: Empire Exporters, 253 Broadway, New York 7, U.S.A.

Circle 22 on literature card

September, 1963/PF REPORTER 47

IT'S A FIRST!

Gator-Probe

a new development in test leads

- Adjustable Length Probe
- Swivel Jawed Clips
- Probe-to-Tip Insulation
- No Moving Parts in Circuit
- Changeable Thread-in Tips
- ONE Pair for ALL Jobs

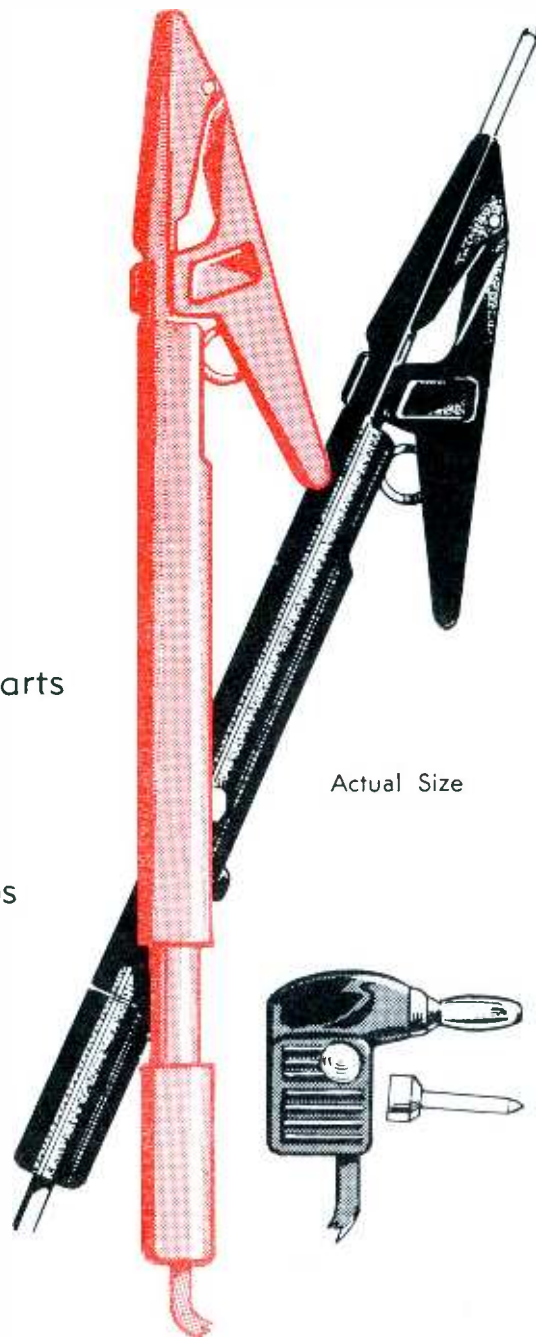

**SEE YOUR
DISTRIBUTOR**

Gator-Probe Corporation
HOLLISTER, CALIFORNIA
A Subsidiary of HOLEX Incorporated

ponent in horizontal sweep circuits is the capacitor used with the oscillator frequency or waveform coil. Because of the unusual stresses mentioned earlier, this component is especially prone to trouble, and accounts for most oscillator-drift problems. When replacing this part, use a type that is not sensitive to temperature changes.

Width problems frequently develop from leakage in the coupling capacitor between the oscillator plate and the output grid. The easiest way to check this failure, which results in reduced horizontal drive and consequent overheating of the tube and flyback, is to disconnect the capacitor at the grid and check the free end for even a slight positive voltage. Also, with the capacitor reconnected, use your VTVM to make sure a heavy negative bias (at least -30 volts) is present. If the bias voltage is correct, look for an off-value screen resistor or leaky cathode-bypass capacitor (if used).

Troubleshooting for temperature dependent intermittents is probably one of the more aggravating aspects of a bench technician's work. The most effective system is a careful check of all operating voltages in the suspected circuit both before and during the trouble. If you can't get readings before the set cuts out, try comparing each of the circuit voltages (while the trouble is occurring) against those shown on the schematic diagram.

Lastly, check especially the following clues:

1. Are any components obviously overheating or showing signs of previous damage?
2. Is the negative drive voltage at the oscillator grid high enough?
3. Will a hot iron held adjacent to suspected components cause any change in circuit measurements?
4. If a printed circuit board is involved, will probing the board with an insulated tool correct the condition or change any circuit measurement?
5. Is the intermittent more likely to occur with the chassis positioned in one way than in another? If so, has the printed board (or chassis wiring) been thoroughly checked for poor terminal connections?

One last word on troubleshooting and repairing intermittents — don't lose your temper! Cool, calm rea-

Circle 23 on literature card

NEW RCA-6146A WITH "DARK HEATER"



Lets You Forget Heater Voltage Variations

New! RCA-6146A, a Beam Power Tube with "Dark Heater", joins the outstanding RCA-6146 family. With RCA-6146A in the circuit, you can be sure that drop in power output will be negligible — even when the heater voltage is reduced to 5 volts!

When you replace with RCA-6146A "Dark Heater," you get the latest in electron tube technology: lower internal stresses for longer heater life; cooler operation to reduce possible heater damage; and stable heater-current characteristics.

This small, sturdily-built tube provides the same high efficiency and power output capabilities as its prototypes—35 watts CW (ICAS) at 175 Mc.; 70 watts CW (ICAS) at 60 Mc. RCA-6146A, as well as the entire 6146 family, is available everywhere through RCA INDUSTRIAL TUBE DISTRIBUTORS.

RCA Electronic Components and Devices, Harrison, N.J.



The Most Trusted Name in Electronics

Circle 24 on literature card

www.americanradiohistory.com

RCA FAMILY OF 6146 TUBE DESIGNS All feature the Dark Heater except 4604.

6.3-V	Quick Heating Filament; RF Amplifier & Osc. Service RF Amplifier & Osc. Service RF Amplifier & Osc. Service Pulse Modulator Service Ruggedized; RF Amplifier & Osc. Service	RCA-4604 RCA-6146 RCA-6146A RCA-6293 RCA-6146W/7212
12.6-V	RF Amplifier & Osc. Service	RCA-6883
13.5-V	RF Amplifier & Osc. Service	RCA-8032
26.5-V	RF Amplifier & Osc. Service Ruggedized; RF Amplifier & Osc. Service	RCA-6159 RCA-6159W/7357

For name and address of your local distributor, call or write your nearest RCA Distributor Products Sales Office: New York, N.Y.: 36 W. 49th St., Murray Hill 9-7200; Needham Heights 94, Mass.: 80 "A" St., Hillcrest 4-8480; Washington 6, D.C.: 1725 "K" St., S.W., Federal 7-8500; Atlanta, Ga.: 134 Peachtree St., N.W., Jackson 4-7703; Cleveland, Ohio: 1621 Euclid Ave., Cherry 1-3450; Chicago, Ill.: Merchandise Mart, 467-5900; Dallas 7, Texas: 7901 Carpenter Freeway, Melrose 1-3050; Kansas City 14, Mo.: 7711 State Line, Emerson 1-6462; Los Angeles 22, Cal.: 6801 E. Washington Blvd., Raymond 3-8361.

over 100,000,000
already sold!



MINIATURIZED

ELMENCO

Dipped Mylar* Paper Capacitors

first choice with service technicians!

Now being used in millions of television sets, radios, phonographs, electronic circuitry and military applications. ■ Operates at 125° C without derating. ■ Standard Tolerance ±10% ■ Missile Reliability ■ Completely moisture proof ■ Up to 50% smaller than other types.

NOW AT NEW LOW PRICES

DON'T ACCEPT SUBSTITUTES OR IMITATIONS!

Available at all authorized ARCO distributors in U.S.A.

ARCO
electronics inc.

Community Drive
Great Neck, New York
Branches:
Dallas 7, Los Angeles 35



Circle 25 on literature card

soning and observation will solve even the most exasperating troubles.

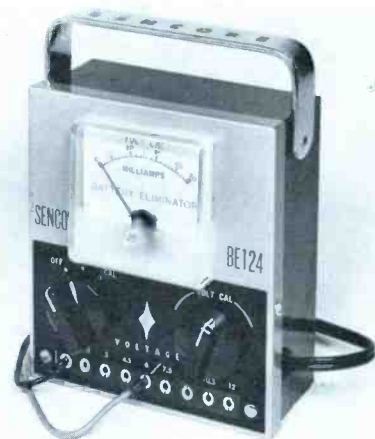

Handy Battery Eliminator

Capable of supplying eight different DC voltages from 1.5 to 12 volts, the SENCORE Model BE124 battery eliminator affords the serviceman a known standard from which to work in localizing transistor-radio troubles. A faulty radio battery can be spotted immediately by removing it and substituting the correct supply voltage from the eliminator. If trouble symptoms persist when a radio is powered by the BE124, the 0-50 ma meter built into the instrument can be put to good use for checking and monitoring the current drawn by the radio. "Troubleshoot Transistors by Current Drain!" (June PF REPORTER) describes in detail how the milliammeter readings can be interpreted to pinpoint disabled stages and short circuits.

AC-powered and isolated from the AC line, the BE124 can supply a maximum continuous current of 50 ma, and a peak current as high as 200 ma. Ripple in the DC output does not exceed 0.9%.

Just prior to each use of the eliminator, the switch at the left side of the panel is flipped to the CAL position, and the VOLT CAL control at the right is adjusted to bring the meter pointer exactly to center scale. This calibration simultaneously adjusts all output voltages to the correct values. Two or more different voltages may be fed to a radio that requires a tapped battery supply. Furnished with the BE124 are three color-coded output leads that plug into pin jacks on the instrument and terminate in miniature clips. ▲

For further information, Circle 70 on literature card.

NOW *EVERYONE* CAN QUICKLY Set up and Service Color TV



1 PATTERN DISPLAY STANDARD
Shows correct pattern in window viewer for visual guide

2 PATTERN SELECTOR
Produces each pattern individually for quick, easy convergence

3 AUTOMATIC DECONVERGENCE
Simplifies static and dynamic convergence. No digging into set

4 COLOR SELECTOR
Produces each color one at a time for accurate color set-up

5 COLOR GUN KILLER
Automatically enables the technician to actuate any combination of the 3 guns

6 DEMODULATOR ALIGNMENT
Makes alignment extremely simple, without going into the color set

New! **B&K** Model 850 **COLOR GENERATOR**

*Most Complete, Most Versatile, Portable Instrument for Use in the Home and in the Shop
Makes Color TV Set-up and Service Easier, Faster than ever!*

Now every service technician can be ready to set-up and service color TV with amazing new ease and speed! New advanced design simplifies the entire operation, saves time and work in every installation. Eliminates difficult steps in digging into the color TV set. Gives you new confidence in handling color.

Produces Patterns, Burst, and Colors Individually—Provides dot pattern, crosshatch, vertical lines, horizontal lines, burst signal, and individual colors—one at a time—on the TV color set—for fastest, easiest check. Unique window-viewer on front of the instrument panel shows you each pattern as it should be—gives you an exclusive display standard to use as a sure guide for quick, visual comparison.

Provides Accurate, Individual Color Display—Produces Green, Cyan, Blue, B—Y, Q, Magenta, R—Y, Red, I, Yellow, and Burst—one at a time. All colors are crystal-controlled and are produced by a precision delay-line for maximum accuracy. Each color is individually switch-selected—no chance of error.

Provides Accurate NTSC-Type Signal—Color phase angles are maintained in accordance with NTSC specifications.

Makes Convergence and Linearity Adjustments Easy—Highly stable crystal-controlled system with

vertical and horizontal sync pulses, assures the ultimate in line and dot stability.

Simplifies Demodulator Alignment—The type of color display produced by this instrument provides the ultimate in simplicity for precise demodulator alignment.

Provides Automatic Deconvergence—Eliminates the necessity for continual static convergence adjustments. The instrument automatically deconverges a white into a color dot trio without digging into the color set to mis-adjust the convergence magnets. It also deconverges a white horizontal or vertical line into red, green and blue parallel lines. This greatly simplifies dynamic convergence adjustments.

Provides Exclusive Color Gun Killer—Front-panel switch control makes it easy to disable any combination of the three color guns. Eliminates continuous adjustment of the background or screen controls, or connection of a shorting clip inside the receiver. The switch also selects the individual grids of the color tube and connects to a front-panel jack to simplify demodulator alignment.

Provides Switch-Selected R.F. Signals—Factory-tuned, for channels 3, 4, and 5—for open channel use in your area.

Model 850 also includes other features that make it invaluable for home and shop use. Net, \$199⁹⁵

See Your B&K Distributor
or Write for Catalog AP21-R



B & K MANUFACTURING CO.

Division of DYNASCAN CORPORATION

1801 W. BELLE PLAINE AVE. • CHICAGO 13, ILL.

Canada: Atlas Radio Corp., 50 Wingold, Toronto 19, Ont.

Export: Empire Exporters, 253 Broadway, New York 7, U.S.A.

Circle 26 on literature card

September, 1963/PF REPORTER 51

A sensible parts stock for Transistor Radios

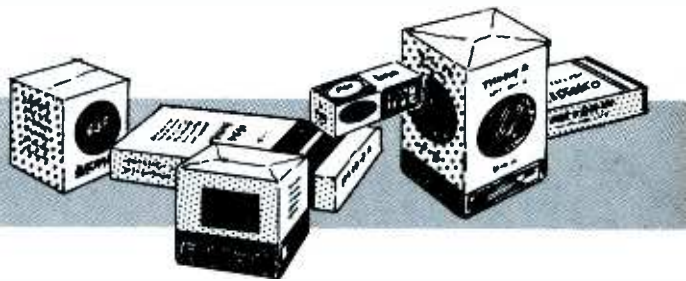

A considerable number of radio-television shops are waking up to the potentialities in the rapidly expanding field of transistor-receiver servicing. Even though many of the sets are tiny, and it's sometimes difficult to find exact-replacement parts for them, there is a regular and significant profit in store for those who service these sets.

Many service technicians who plan to expand their transistor operations have written us asking what to stock in the way of replacement parts. It is rather difficult to provide specific information, for much depends on what types of sets are being serviced in greatest volume.

In this chart, we've compiled a check list of the most common parts needs. The listing is by no means all-inclusive, for it is impossible to tabulate in this space the countless parts variations in the innumerable brands found on the market today. However, long experience has confirmed that certain parts are needed more often than others in transistor servicing.

As in all servicing, it is sometimes desirable to replace a defective part with one of a higher rating—for example, a 1/2-watt resistor in place of a faulty 1/4-watt unit. However, in transistor sets, space is generally at a premium, and such a substitution may not always be practical.

A 10-mfd bypass electrolytic can be replaced with a 25-mfd unit—often with a significant improvement in performance. On the other hand, increasing the value of an electrolytic used for coupling may cause trouble; so, it isn't wise to substitute electrolytic values indiscriminately in just any circuit. Using a replacement with a higher working-voltage rating is feasible, within limits; doubling the rating (where space permits) will seldom introduce any difficulties. The advantage of all such substitutions lies primarily in the reduced chance for callbacks or repeats of the same trouble.

In the case of small audio transformers, a little ingenuity will pay off in reduced inventory needs. There are a wide variety of small audio transformers. We suggest stocking only a few of these units; by adapting the mounting arrangements, you can substitute among them

quite consistently. By carefully checking the resistance of the original windings, a similar replacement can be chosen easily.

Transistor IF transformers fall mostly into two categories: miniature and subminiature. Some sets use round-can types; these can be replaced with the more common square types, if an exact replacement isn't available.

Oscillator coils for inexpensive transistor sets are remarkably alike; a couple of types will make 75% of the replacements. Don't be fooled by unusual-looking circuits; most of them are very similar (see "Transistor Oscillators From A to Z" in the June issue). The occasional other types you need will have to be ordered—unless you service a particular brand in volume, in which case it is wise to stock a couple of spare oscillator coils.

A few transistor sets use dual ceramic capacitors—two capacitors in one case. None of these are mentioned in the chart, because either or both sections can easily be replaced by single units.

Transistors are in a class by themselves, when it comes to inventory requirements. Many manufacturers now offer "kits" that contain "universal" substitutes which will solve a large percentage of transistor replacement problems. A substitution guide such as the Howard W. Sams "Transistor Substitution Handbook," which is updated regularly to include the newest transistors and their equivalents, can be used to help plan a sensible transistor stock.

Quantities of items to be kept in your own stock depend mostly on the number of transistor sets you service. Remember, there is little reason to keep on hand more than a week's supply of any one item, unless it takes longer to get one from the supplier. Money tied up in slow-moving items isn't making you a fair profit. Keep enough parts for an average week's work, and no more. For a start, we suggest no more than a couple of each item. Keep a careful record of the parts you use, and you'll soon see which items are fast movers. Then you can tailor your sensible parts stock to the sets that are more popular in your area. ▲

Resistors	Assortment of 1/2-watt values Assortment of 1/4-watt values	IF Transformers	2 each input IF's: 1/4" type, 3/8" type 2 each output IF's: 1/4" type, 3/8" type 2 each round type
Capacitors	Assortment of 50-volt ceramic disc types from 100 mmf through .05 mfd Assortment of ceramic tubulars from 2 mmf through 500 mmf 3-volt electrolytics: 3, 5, 6, 10, 12, 15, 25, and 100 mfd 6-volt electrolytics: 3, 5, 6, 10, 12, 15, 25, and 100 mfd 25-volt electrolytics: 10, 25, 50, and 100 mfd 50-volt electrolytics: 10, 25, and 50 mfd 200-volt paper or Mylar tubulars: .001 through .1 mfd	Oscillator Coils	2 each of three most popular types: Shielded 1/4" and 3/8" form Unshielded 1/4" and 3/8" form "E" form (unshielded, circular) Any special types regularly encountered
		Antenna Coils	1 each of two common types, both for use with 365-mmf tuning capacitor
		Tuning Capacitors	One or two "universal" types available for inexpensive sets; for others, best to order as needed unless volume is great

Hum-m-m-m
BOOM! BOOM

**stops
noise!**

CLATTER!

murmur
murmur
murmur
murmur
murmur
murmur

BANG!

k! Honk! Honk!

THUMP!

POP! POP! POP!



Electro-Voice Model 717 Noise-Cancelling Microphone \$19.50 List (Less normal trade discounts)

E-V Plug a new E-V 717 into your transceiver and get up to 15 db more protection against noise pickup. Not just big noise, but every sound that reduces the effectiveness of your signal. Even the effect of poor acoustics is reduced by the 717.

How does the 717 cut down on lost messages, repeated calls and wasted time and money? It has a sound-cancelling port on the back that rejects sound arriving at the rear of the microphone. Random noise pickup is reduced up to 67%.

The advantages of the E-V 717 don't stop with noise rejection. The new high-output

ceramic element withstands extremes of heat and humidity. It's built into a tough Cyclac* high-impact plastic case that's comfortable in any weather. And the push-to-talk switch has been tested to operate a million times or more, easily and dependably.

How does the 717 sound? Crisp, smooth and peak-free for highest efficiency and articulation. There's plenty of output for any transceiver on the market. And *no noise!* But don't take our word for it. Test the new E-V 717 on your rig today. We guarantee you'll like how you're heard. **ELECTRO-VOICE, INC.**, Dept. 932R, Buchanan, Michigan

* T. M. Borg-Warner

HERE'S HOW THE 717 STOPS NOISE

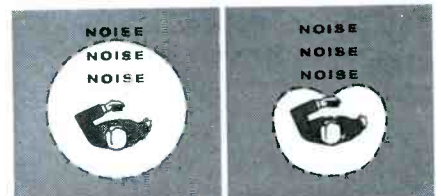

Ordinary Microphone Pickup Pattern

E-V 717 Noise-Cancelling Pickup Pattern

Electro-Voice
SETTING NEW STANDARDS IN SOUND

Circle 27 on literature card

FOR SHARP, CLEAR 2-WAY COMMUNICATION

Fixed or mobile,
business or pleasure
Get the new, low-cost

RCA MARK VIII

27-Mc Citizens Band Radio-Phone

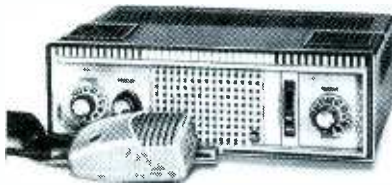

Here's the LOW-COST C-B radio-phone for car, boat, home, office, or shop. High sensitivity receiver pulls in weak signals. 2½ watt speaker output delivers ample volume to overcome engine noise. Automatic noise suppressor minimizes ignition interference. Light and compact—only 3½ inches high, weight only 9 pounds; fits easily under the dashboard of even compact cars.

PLUS THESE PREMIUM FEATURES— RCA MARK VIII RADIO-PHONE

- 9 crystal-controlled transmit and receive channels
- Tunable receiver permits reception of all 23 C-B channels; dial marked in both channel numbers and frequency
- Exceptionally good voice reproduction—high intelligibility
- Excellent modulation characteristics
- Operates from standard 117-volt AC; separate 6- and 12-volt DC power supplies (optional) for mobile installations
- Electronic switching—no relay noise or chatter
- Illuminated "working channel" feature plus many more features to increase usefulness and efficiency.

AC Unit only **\$149.50***

DC Power Supplies, Where Needed, \$19.95*

*Optional list price



The Most Trusted Name
in Electronics

MAIL COUPON FOR MORE INFORMATION

RCA Electronic Components & Devices
Commercial Engineering Dept. I-33-R
415 South Fifth Street, Harrison, N. J.
Please send more information on the RCA
Mark VIII 27-Mc 2-Way Radio-phone.

Name _____

Address _____

City _____ Zone _____ State _____

Circle 28 on literature card

NOTES ON TEST EQUIPMENT

by Patrick M. Craney

Transistor-Checking VOM

In addition to the regular functions of measuring db levels, DC resistance and current, and AC and DC voltages, the Triplett Model 630-L VOM (shown in Fig. 1) provides for safe testing of semiconductor devices on special ohmmeter ranges that apply exceptionally low voltages and currents from the instrument's batteries.

Specifications are:

1. *Power Required*—30-volt battery; 1.35-volt mercury battery.
2. *DC Voltmeter*—Measures from 0 to 2.5, 10, 50, 250, and 1000 volts, at 20,000 ohms per volt, with accuracy of 3%; by connecting test lead to special jack, highest range is extended to 5000 volts, with 5% accuracy.
3. *AC Voltmeter*—Measures from 0 to 3, 10, 50, 250, and 1000 volts, at 5000 ohms per volt, with accuracy of 4%; special jack extends highest range to 5000 volts, with 5% accuracy.
4. *DC Ammeter*—Measures from 0 to 100 μ a; from 0 to 10, 100, and 1000 ma; and from 0 to 10 amps.
5. *Ohmmeter*—Measures from 0 to 1000 and 10K ohms on two "Low Ohms" ranges, $\Omega \times 1$ and $\Omega \times 10$; measures from 0 to 1 and 100 megohms on two "High Ohms" ranges, $\Omega \times 1K$ and $\Omega \times 100K$.
6. *Output Volts AC*—Measures from 0 to 3, 10, 50, 350, and 1000 volts at 5000 ohms per volt; DC-blocking capacitor in series with OUTPUT jack protects meter circuitry.
7. *Decibels*—Measures from -20 to +11, +21, +35, +49, +61, and +75 db (0 db reference is 1 mw on 600-ohm line).
8. *Panel Meter*—5" face size; 40- μ a, 120-mv movement.
9. *Controls and Terminals*—Rotary function-selector switch; polarity-selector switch with two positions: DC $\pm/\Omega/ACV$, and DC; recessed thumb-wheel-type Ω ADJ control; COM- pin jack for black test lead; V- Ω -A, OUTPUT, 5000 DC V, and 5000 AC V pin jacks for red test lead, used on different functions.
10. *Case*—Black molded plastic, fully insulated.
11. *Size, Weight, Price*—7½" x 5½" x



Fig. 1. Triplett 630-L has low-current ranges for transistor servicing.

3 11/32"; 5 lbs. (with batteries); \$54.50 net.

The Model 630-L has six scales for indicating voltage, current, resistance, and output measurements. The top scale (black) is used for indicating high values of resistance on the $\Omega \times 1K$ and $\Omega \times 100K$ ranges, and the second from the top (red) is for measuring low values of resistance on the $\Omega \times 1$ and $\Omega \times 10$ ranges. The third scale (black) is for indicating all DC voltages and currents; the fourth scale (red) indicates all AC voltages except those on the 3-volt range, for which the fifth scale (also red) is used. The sixth scale (black) is used for all db measurements; direct readings from -20 to +11 db are obtained when the function selector is on the 3-volt AC range, and a chart at the lower right corner of the meter face gives the factors to be added for deriving db readings at higher AC-voltage settings. For example, when measurements are made with the switch set on the 10-volt AC range, 10 db is added to the needle indication; for measurements on the 50-volt range, 50 db is added. In this manner, the db scale is able to indicate as high as 75 db.

The $\Omega \times 1$ and $\Omega \times 10$ ranges constitute



...leave sooner—get there faster!



It's there in hours...and costs you less!

	Buses Daily	Running Time	15 Lbs.	25 Lbs.	35 Lbs.*
BOSTON— NEW YORK	18	5 hrs. — min.	\$1.80	\$2.10	\$2.35
PITTSBURGH— CLEVELAND	14	2 hrs. 55 min.	1.60	1.85	2.15
CHICAGO— ST. LOUIS	8	6 hrs. 10 min.	1.90	2.15	2.45
LOS ANGELES— SAN DIEGO	38	2 hrs. 30 min.	1.25	1.45	1.70
CINCINNATI— LOUISVILLE	15	2 hrs. 40 min.	1.50	1.70	1.95

* Other low rates up to 100 lbs

Save time! Save money! Ease those inventory control problems too! Ship via Greyhound Package Express! Packages go everywhere Greyhound goes, on regular Greyhound buses. Very often they arrive the same day shipped. Ship nationwide, anytime... twenty-four hours a day, seven days a week, weekends and holidays. Ship C.O.D., Collect, Prepaid, or open a charge account. Insist on Greyhound Package Express. **It's there in hours... and costs you less.**

Circle 29 on literature card

GREYHOUND PACKAGE EXPRESS, Dept. 52-V.
140 S. Dearborn St., Chicago 3, Illinois

Please send, without cost or obligation, complete information on Greyhound Package Express service... including rates and routes.

NAME _____ TITLE _____

COMPANY _____

ADDRESS _____

CITY _____ STATE _____ PHONE _____

**CALL YOUR LOCAL GREYHOUND BUS TERMINAL
OR MAIL THIS CONVENIENT COUPON TODAY**

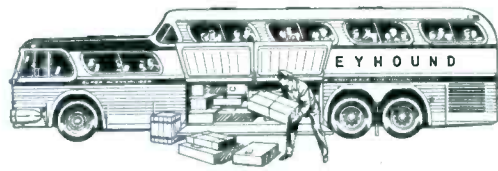



ELECTRONICS' FAMOUS TRADEMARK

means . . .

THE PRESTIGE LINE

THE PROFIT LINE

THE ACCEPTED LINE

transformers

flybacks

yokes

coils

Merit Plaza

Hollywood, Florida

MERIT
COIL and TRANSFORMER CORPORATION

Circle 30 on literature card

a low-power ohmmeter circuit designed primarily for safe measurement of transistors and their associated circuits. On both of these ranges, the value of the measuring voltage (even with an open circuit across the test prods) is limited to 140 mv; the maximum current, with test prods shorted, is limited to 12 ma on the x1 range and 1.2 ma on the x10 range. With the polarity switch in its DC+ position, the negative side of the ohmmeter battery is returned to the panel com jack.

Transistor tests with the 630-L are based on the fact that a transistor essentially consists of two fused junction diodes (emitter-base and base-collector). Each diode can be checked by placing the ohmmeter probes across it in first one direction and then in the other, and looking for a considerable difference between the two readings. This test readily detects open or shorted junctions, or excessive leakage across a junction in the reverse (normally high-resistance) direction.

Using these ohmmeter tests, it is also rather easy to identify an unknown transistor as either a PNP or an NPN type. Since several measurements are involved, it is advisable to keep track of the results by writing them down. For this purpose, sketches of the transistor's basing diagram (like those in Fig. 2) are convenient. The resistance readings shown in this figure were obtained on a small-signal transistor in our lab with the 630-L.

The first step in identifying the transistor was to connect the negative (black) meter probe to lead 1 of the transistor, and touch the positive (red) probe to the other two leads, one at a time. The respective readings at leads 2 and 3 were 800 and 2500 ohms, as noted in Fig. 2A.

Next, the negative probe was moved to lead 2. When the positive probe was touched to pin 1 and then to pin 3, the readings were 2500 and 20K ohms (see Fig. 2B). Finally, with the negative probe on pin 3, readings of 5000 and 850 ohms were noted when the positive probe was placed on leads 1 and 2 in turn (Fig. 2C).

Now, to analyze the results: The lower of the two readings taken between leads 1 and 2 was obtained when the negative meter probe was on lead 1 and the positive probe on pin 2. This indication would be expected if lead 1 were connected to the N side of a PN semiconductor junction, and if lead 2 were connected to the P side. Between leads 2 and 3, a much lower reading was obtained with the negative probe on lead 3 than with the positive probe on this lead; thus, it could be assumed that leads 2 and 3 are respectively attached to the P and N sides of a diode junction. The lower of the two resistance readings between leads 1 and 3 was still quite high, and changing the meter connections made a comparatively small difference in the reading; therefore, these two leads seem least likely to be connected to the opposite sides of a single junction.

Lead 2, common to the other two pairs of measurements, is presumably the base lead. Since two tests have tentative-

Blonder-Tongue increases the UHF profit zone

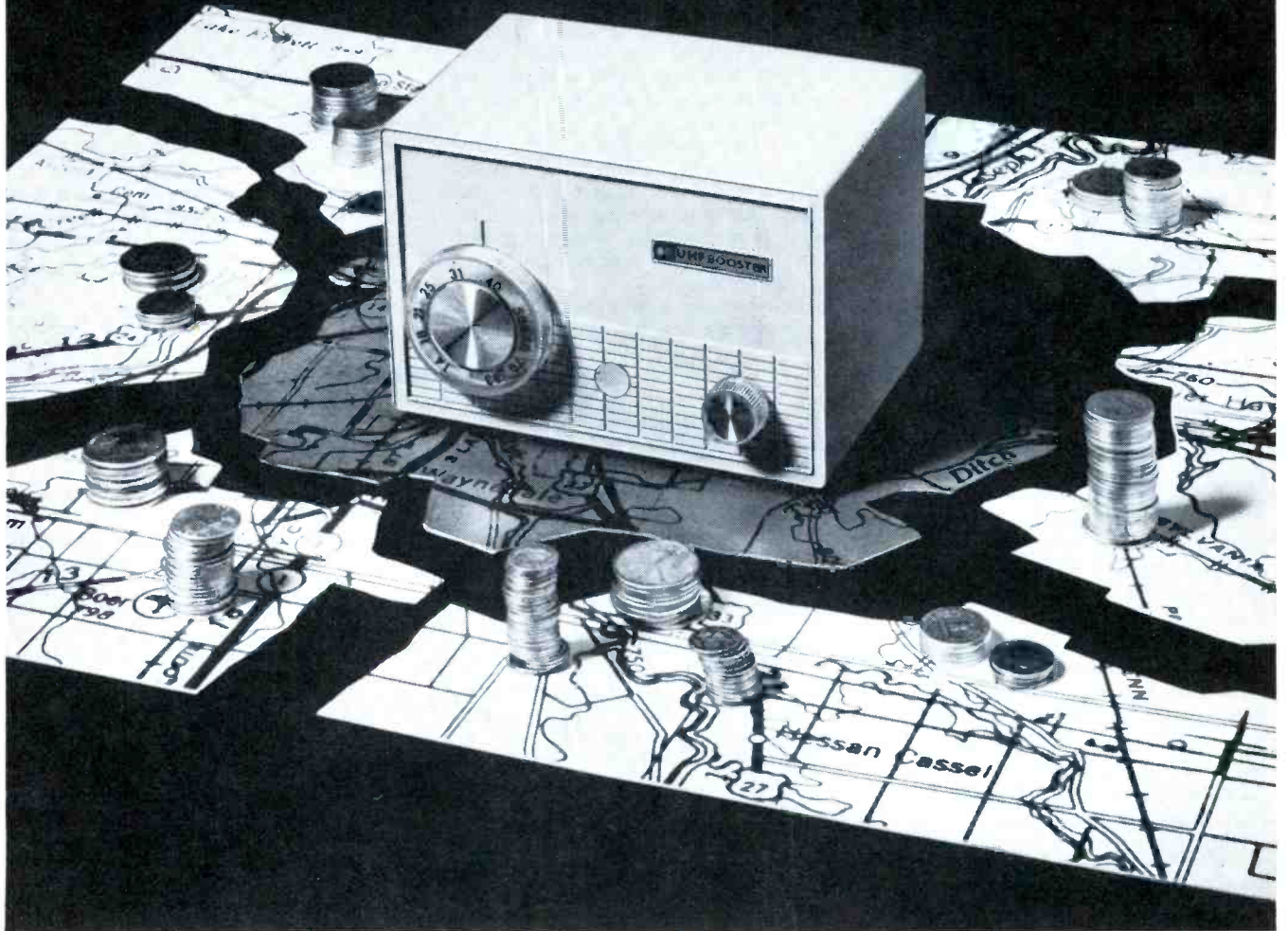

First all-channel UHF Booster—the U-BOOST

The fabulous new Blonder-Tongue can add up to 15 miles to your city's UHF reception range. It turns TV viewers formerly beyond the range of UHF into profitable UHF customers—prospects for UHF converters, UHF antennas, all-channel TV receivers and the U-Boost itself. The U-Boost will also clean up and improve reception for viewers in poor signal areas—More money in your pocket!

The U-Boost (gain 10 db)—triples the antenna signal voltage. Teamed up with a UHF converter, or added to an all-channel receiver, the U-Boost improves picture contrast on all but the "hottest" TV sets or with deluxe converters. Just a turn of the dial pinpoints any desired channel from 14 to 83 and brings it in sharp and clear. TV picture quality is always excellent with the U-Boost because it has a lower noise figure than most existing TV sets or UHF converters. This means a better signal-to-noise ratio, resulting in less snow

The U-Boost is easy to install: convenience AC receptacle;

patented 300 ohm stripless twinlead terminals. And finally, the modern U-Boost styling matches the new Blonder-Tongue UHF converters — making combination sales easy. Sell a Blonder-Tongue converter and a U-Boost together. They're "profit-mates".

U-Boost, List \$34.95.

BLONDER-TONGUE TOTAL SALES POWER SPELLS BIGGEST UHF PROFITS
1. World's finest UHF converters performance tested in 2,000,000 homes.

Model 99-S for prime signal areas. List \$27.95.

BTU-2T for weak signal areas. List \$41.35.

2. New U-Boost to increase your UHF profit zone.

3. Powerful merchandising program backing up every Blonder-Tongue product.

Look to the leader in UHF.

Contact the Blonder-Tongue distributor in your area now.



engineered and manufactured by

BLONDER-TONGUE

9 Alling St., Newark, 2 N. J.

Canadian Div.: Benco Television Assoc., Ltd., Toronto, Ont./home TV accessories • closed circuit TV • community TV • UHF converters • master TV

Circle 31 on literature card

September, 1963/PF REPORTER 57

**Anyone
can install
a MOSLEY
Ty-FM Antenna
System !!**



Mosley FG-1PK

Here is a TV/FM receptacle designed to make every room a family room. Mosley engineered to fit popular interchangeable type electrical plates and straps. Now the AC and TV/FM outlets can be matched to fit any room decor. Convenient - Set can easily be moved for enjoyment in other rooms. Mosley FG-1PK combines efficiency with neatness and ease of installation in one compact outlet. Comes complete with mating polarized 303 plug. Available in brown and ivory to match interchangeable plates.

MOSLEY FG-1PK

List \$.99

MOSLEY HAS A COMPLETE LINE
OF TV/FM ACCESSORIES
DESIGNED AND ENGINEERED TO
PROVIDE BETTER TV/FM
RECEPTION THROUGH A BETTER
INSTALLATION!

FREE  **FREE**

Please send me your catalog containing the complete line of TV/FM installation accessories.

Name

Address

City/State

Mosley
Electronics Inc.
4610 N. Lindbergh Bridgeton Mo.
Circle 32 on literature card

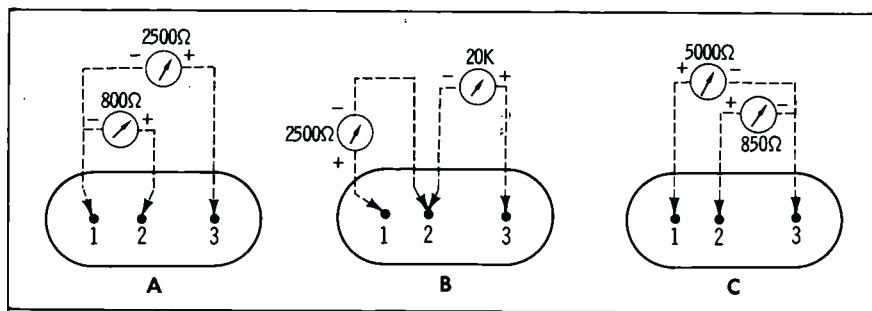

Fig. 2. Resistance checks can identify unknown transistor as PNP or NPN.

ly identified this lead as going to the P side of a junction, the transistor is evidently an NPN type, with a P-type base sandwiched between an N-type emitter and collector.

The reverse resistance is quite a bit higher between leads 3 and 2 (20K ohms) than between leads 1 and 2 (2500 ohms); this information is evidence that lead 3 is the collector. Identifying leads 2 and 3 as the base and collector leaves 1 as the emitter.

The resistance measurements obtained in this sample test are typical of those

for small-signal transistors; some power transistors yield slightly lower readings. Therefore, the usable range of the "Low Ohms" scale (0 to 10K) is adequate for most transistor work. If the need arises to measure higher resistances, the x100K range should be avoided, because the maximum voltage supplied by the battery on this range is 32 volts. However, the x1K range operates with no more than 1.5 volts, and is safe to use for checking most transistors.

For further information, circle 68 on the literature card.

Stereo Signal Generator

For testing and alignment of multiplex circuitry in all stereo FM receivers and adapters, Precision Apparatus Co. has developed the Model E-490 Multiplex Stereo Generator shown in Fig. 3.

Specifications are:

1. Power Required—117 volts AC, 50-60 cps, 50 watts.
2. RF Carrier—None.
3. Operating Modes — L = -R (difference or subcarrier signal only); L = R (sum or monophonic signal only); L OR R (left-channel or right channel output only).
4. Pilot Signal—19 kc \pm 2 cps, crystal-controlled; phase adjustable with respect to stereo subcarrier, and amplitude adjustable from 0 to 15% of maximum composite-signal amplitude; can be switched off.
5. Synchronizing Signals—Used in setting up oscilloscope for measurements: Pilot sync of constant amplitude (independent of PILOT AMPLITUDE control), available whether pilot component of composite signal is turned on or off; audio sync, obtained from right-channel audio signal.
6. Internal Modulation Generator—Supplies sine wave at approximately 1 kc.
7. External Audio—Can be used instead of internal modulation; required amplitude 7 volts rms per channel for maximum composite-signal output (12 volts peak to peak); input impedance in each channel 10K ohms.
8. Channel Separation—40 db minimum from 50 cps to 5 kc, and 30 db minimum from 30 cps to 15 kc.
9. Subcarrier Suppression—40 db minimum, with respect to maximum composite-signal output.
10. Controls and Terminals — POWER slide switch; rotary MODE switch to select either L = -R, L = R, or L OR R; CHANNEL switch (operative only with MODE switch in L OR R position), to select either left- or right-channel output; MODULATION switch, to select either internal 1-kc audio signal or any signal connected to EXT. MODULATION INPUT jacks; OUTPUT LEVEL control, continuously variable from 0 to 12 volts peak to peak (varying the pilot and composite signals together, thus maintaining constant ratio between them); CARRIER BAL. control, to obtain maximum suppression of subcarrier in absence of stereo modulation; PILOT AMPLITUDE control, to adjust pilot-signal level to proper percentage of composite-signal level; PILOT PHASE control, to adjust phase of pilot signal to precisely that of stereo subcarrier.
11. Frequency Response—40 to 15,000 cps, \pm 1 db at less than 1% distortion.
12. Size, Weight, Price—6" x 17½" x 6", 14 lbs, \$229.00.

The Model E-490 delivers basically the same signals to the multiplex circuitry as those normally received from the detector of the FM receiver. The amplitude is variable over a wide range to match the varying requirements of different multiplex units. The three test signals selected by the MODE switch are sufficient for all alignment and signal-tracing operations except adjustment of the 67-kc



Fig. 3. Precision E-490 furnishes signals for checking multiplex circuits.

PHOTOFACT[®] gives you maximum, current coverage in the new SPECIALIZED SERVICE DATA SERIES



Transistor Radio Series

Now available in handy volumes, twelve to fifteen issued each year—to keep you up-to-the-minute on new Transistor Radio production. Each covers 40 to 50 popular late models. Regular price per volume, \$2.95—only \$2.65 when purchased on a Standing Order Subscription—you save 30¢ per volume!

TYPICAL COVERAGE IN VOL. 24 JUNE 1963: 33 SEPARATE CHASSIS, 52 POPULAR MODELS COVERED

Here's a wealth of complete, uniform, authoritative PHOTOFACT service data on current Transistor Radio models. Includes Standard Notation Schematics[®], CircuiTrace[®], chassis photos, complete replacement parts lists, alignment instructions—everything you want for time-saving, profitable repair work!



Auto Radio Series

Available to you in convenient volumes, issued six to eight times yearly. Gives you timely, complete PHOTOFACT service data on current Auto Radio output. Each volume covers 40 to 60 popular late models. Regular price per volume, \$2.95—only \$2.65 when purchased on a Standing Order Subscription—you save 30¢ per volume!

TYPICAL COVERAGE IN VOL. 19, JUNE 1963: 32 SEPARATE CHASSIS, 60 POPULAR MODELS COVERED

You get famous PHOTOFACT coverage on current Auto Radio models—complete, uniform, authoritative. Includes full alignment details, Standard Notation Schematics[®], CircuiTrace[®] for printed circuits, chassis photos, dial cord stringing, complete replacement parts lists—every detail for more profitable servicing!



Tape Recorder Series

Two volumes issued yearly, to bring you complete PHOTOFACT coverage of all important, late model Tape Recorders. Regular price per volume, \$4.95—only \$4.65 when purchased on a Standing Order Subscription—you save 30¢ per volume!



CB Radio Series

Two to three volumes issued yearly—complete PHOTOFACT coverage of all popular CB Radio models. Regular price per volume, \$2.95—only \$2.65 when purchased on a Standing Order Subscription—you save 30¢ per volume!



SAVE 30¢ PER VOLUME

SIGN UP TODAY FOR A MONEY-SAVING STANDING ORDER SUBSCRIPTION

With a Standing Order Subscription to receive PHOTOFACT Specialized Series of your choice as issued, you pay only \$2.65 for the Transistor, Auto Radio and CB Radio Series, instead of the regular \$2.95 price; only \$4.65 for the Tape Recorder Series, instead of the regular \$4.95 price. You save 30¢ per volume and you keep right up with current model output. Get the world's finest specialized servicing data regularly, and enjoy extra savings with a Standing Order Subscription. Sign up with your Sams Distributor, or send coupon today.

SAVE WITH A STANDING ORDER SUBSCRIPTION!

HOWARD W. SAMS & CO., INC.

Howard W. Sams & Co., Inc., Dept. 7-J3
4300 W. 62nd St., Indianapolis 6, Indiana

- Enter my Photofact Standing Order Subscription
 Send full information on money-saving Easy-Buy Plan

My Distributor is: _____

Shop Name _____

Attn. _____

Address _____

City _____ Zone _____ State _____

Circle 33 on literature card

September, 1963/PF REPORTER 59

AEROVOX MYLAR* BYPASS CAPACITORS PROVIDE SUPERIOR PROTECTION FOR EVERY SERVICE JOB!

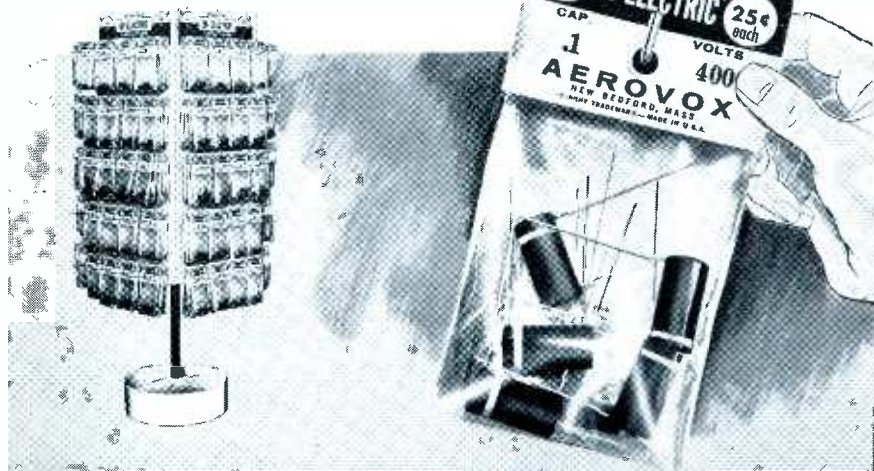

*Registered DuPont trademark

Aerovox Bi-Electric Capacitors are packaged in handy see-thru plastic bags for your convenience... sealed for your protection. Look for the famous Bi-Electric stand at your distributor's store.

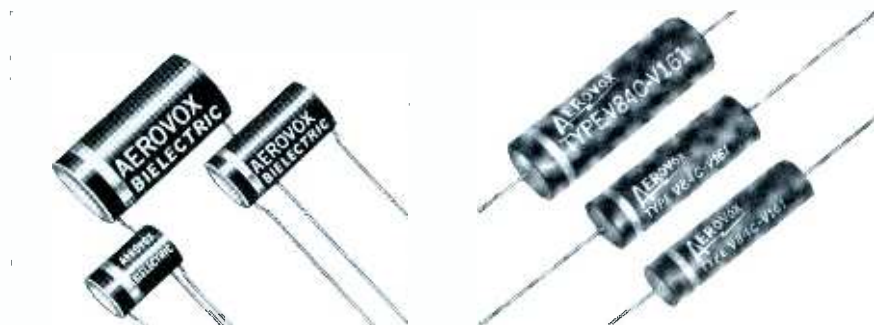

Aerovox Type BE Bi-Electric® Mylar Paper Bypass Capacitors combine the advantages of an exclusive Polycap® case from end-to-end, and process controlled end-fills to provide complete sealed protection for every service job! Over and over again, actual tests prove that this superior, uniform construction eliminates the cracking and chipping problems common with conventional dipped bypass capacitors—even when the Bi-Electric units are used for axial lead installations.

It's no wonder that Aerovox Mylar Paper Bypass Capacitors, featuring the Polycap case, are becoming more popular every day. Protect your reputation and your profits by asking your Aerovox distributor salesman or counterperson for Aerovox Type BE or Type V84C-V161 Bypass Capacitors.

Aerovox Type V84C-V161 Aerofilm® Mylar Capacitors are extremely stable axial lead units offering the exceptional protection of the Polycap® case and epoxy end-seals which will not flow, soften or melt at any operating temperature! These high-quality capacitors have high insulation resistance and low dielectric absorption and power factor.

Aerovox Bypass Kits AK-100 and AK-101HS provide you with a ready supply of the most popular V84C-V161 units in a practical metal cabinet. Eliminate costly delays and increase your profits with these money-saving kits now available from your Aerovox distributor.



SCA trap in the multiplex receiver; this infrequently needed adjustment requires the use of an external audio generator.

The 19-kc pilot carrier is available at all times (unless switched off) for servicing the circuits that reconstruct the 38-kc subcarrier needed for demodulation of the L - R stereo-difference signal.

Internal modulation of the generator consists of a 1000-cps tone developed in a transformer-coupled phase-shift oscillator and supplied to the L and R channels at the EXT. MODULATION switch. As shown in Fig. 4, this switch can select either this constant-amplitude audio tone or any signals connected to the EXT. MODULATION INPUT jacks.

The signals are capacitively coupled (out of phase with each other) to cathode followers which act as impedance-matching devices between the signal source and the balanced modulator. Notice that the takeoff for the AUDIO SYNC signal is from the output side of the right-channel cathode follower.

The MODE and CHANNEL switches determine whether the left only, right only, L - R, or L + R signal is to be sent to the modulator. In the L OR R position, one or the other of the cathode-follower outputs is open-circuited, depending on the setting of the CHANNEL switch. When the L - R signal is selected, both cathode followers feed their output to different sections of the modulator; when the L + R signal is selected, only the signal from the right-channel cathode follower is coupled to both modulator stacks.

The balanced modulator consists of two stacks of diodes (four in either stack). Each section of the modulator is arranged to sample an incoming audio signal at a 38-kc rate. To accomplish this action, a signal is developed in a 19-kc crystal-controlled, transformer-coupled oscillator, doubled in frequency to 38 kc, and injected into the modulator.

In the absence of an audio signal, the modulator stacks are conducting at a 38-kc rate. However, since the output waveforms of the two stacks are of equal amplitude and opposite polarity, cancellation occurs—and there is no signal output. The CARRIER BAL. control, a variable resistance in series with the two bridge circuits, is used to effect precise balance of the 38-kc signal for maximum subcarrier suppression. When audio is impressed on either or both sections of the modulator, the conduction of the diodes is altered in such a way that the net output of the modulator will consist of amplitude-modulated 38-kc sidebands.

The outputs of both modulator stacks are tied together and injected into a cathode follower. Here, they are mixed with a pilot signal taken from the 19-kc oscillator. The composite output is passed through a filter network containing a SEPARATION adjustment that sets the relative amplitudes of L + R and L - R information in the L OR R signal. The desired amount of composite signal is then tapped off by the OUTPUT LEVEL control and fed to the output jack.

The instrument has no provisions for an RF carrier and consequently cannot check the operation of the RF-IF stages in a stereo FM tuner. However, its facilities for thorough testing of multiplex



Remember—it pays to use Aerovox!

AEROVOX CORPORATION
DISTRIBUTOR DIVISION NEW BEDFORD, MASS.

Technical Leadership - Manufacturing Excellence
Circle 34 on literature card

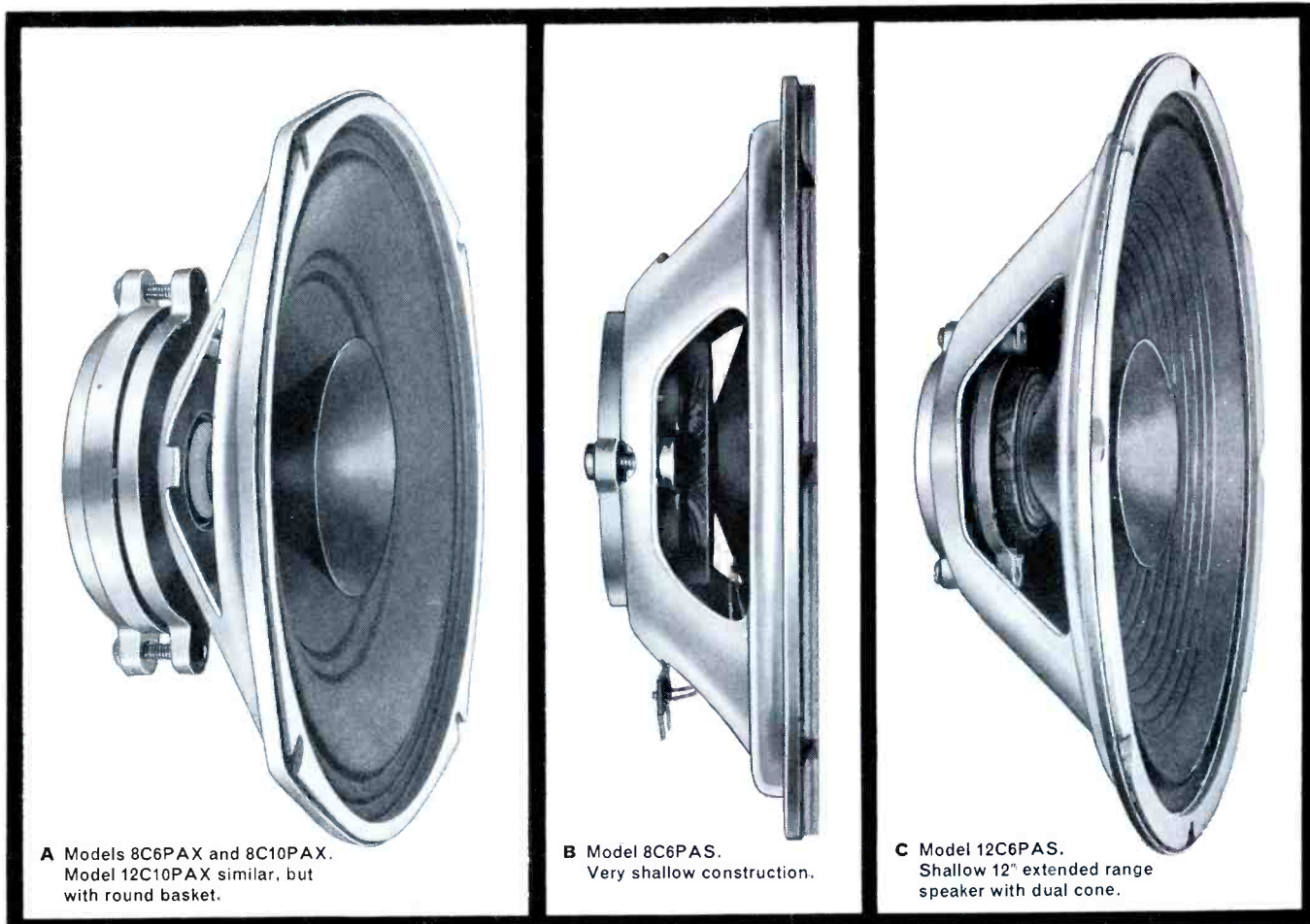

For your background music installations

5 new Quam speakers

Over the hubbub of other sounds, background music has to be audible without being obtrusive. Ordinary public address speakers, designed for capturing the primary attention of the audience, are *not* the answer. These new Quam Speakers—especially designed to handle background music—are.

Quam offers you five background music speakers,

three eight-inch models and two twelve-inch. All have ceramic magnets; four of these new units are extended range units with dual cones; two of the new speakers offer very shallow construction. (Complete specifications are given in the new Quam Catalog 63 . . . now available on request.) They meet the traditional Quam standards of utmost quality and performance satisfaction.

Remember Quam—for forty years the Quality Line for all your speaker needs.

QUAM

**QUAM-
NICHOLS
COMPANY**

234G East Marquette Road
Chicago 37, Illinois

Circle 35 on literature card

NOW! A 2-Set Coupler
for fringe areas...

Winegard's

**NEW Transistorized TV-FM
2-Set Color-Coupler has no
signal loss... (Actually gives a
signal boost of over 7 DB)**

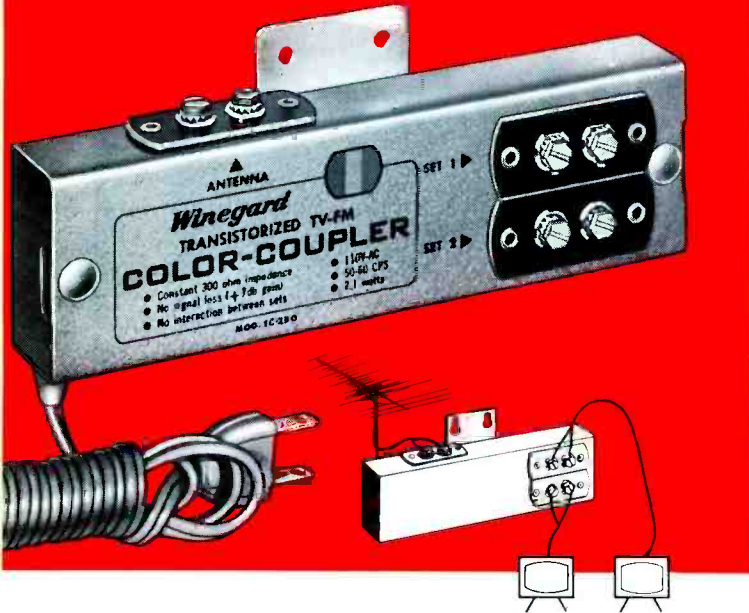

Now even in fringe and weak signal areas, you can run two sets from one antenna without loss or any interference between sets!

The Winegard Transistor Color-Coupler (Model EC-230) has linear frequency response across both TV and FM bands. Isolation between sets 15 DB, with exact match into 300 ohms. This means *No Smear, No line ghosts, No picture degradation, No interference between sets!* Works perfectly with Color and FM as well as black and white. Works with signals from 25 microvolts to 45,000 microvolts. 300 ohm input, two 300 ohm outputs—no-strip terminals. \$17.95 list.



Write for complete specifications or ask your distributor.

Winegard

ANTENNA SYSTEMS

3009-9 Kirkwood, Burlington, Iowa
Circle 36 on literature card

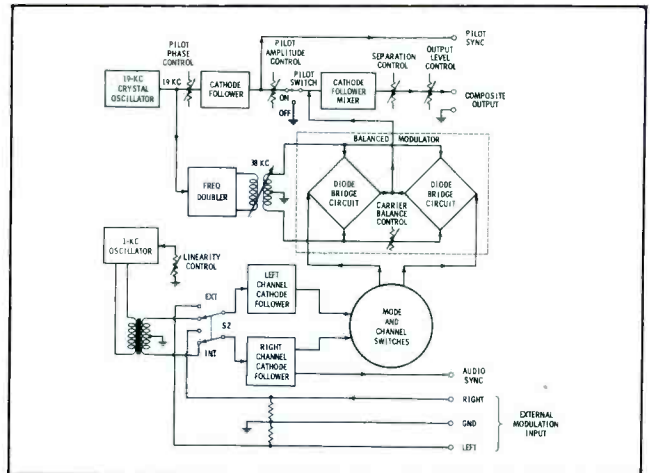

Fig. 4. Stereo signals are produced in balanced modulator.

circuitry make it possible to isolate a defect quite conclusively to either the front end of the tuner or the stereo-processing circuits themselves.

In the lab, we found channel-separation tests—with the generator operating in the LORR mode—most widely useful in diagnosing the condition of multiplex equipment. The setup is as shown in Fig. 5. Most FM-tuner manufacturers specify using "left channel only" modulation for the basic test, and switching to a height-channel signal as a secondary check. A scope is used as an output indicator, and is first connected to the left audio terminal. If the multiplex circuits are operating properly, the scope should display a 1-ke signal of sufficient amplitude to drive the left channel of the audio system to normal output. When the scope probe is transferred to the right-channel terminal of the multiplex unit, a much smaller signal should be noted. The right channel is never completely free of output when a "left-only" signal is present, because practical multiplex circuits do not give perfect channel separation; however, the left-channel output should be at least 10 times (20 db above) the peak-to-peak voltage amplitude of the observed right-channel output. When the CHANNEL switch on the generator is changed to the R position, the signal-voltage conditions in the two channels should be almost exactly reversed.

Initial tests may reveal a need for alignment; if so, the E-490 can furnish the proper input signals.

We've found that most multiplex alignment procedures boil down to two basic phases:

1. All the 19 and 38 kc tuned circuits in the pilot-amplifier and subcarrier-generator stages are peaked, using the pilot signal from the test equipment. Some manufacturers recommend disabling the L + R and L - R signal path for this operation, and various points are suggested for connecting the scope or VTVM indicator; so it's important to follow the instructions for the particular equipment involved.
2. The channel-separation test is set up, as in Fig. 5, and certain of the 19 and 38 kc adjustments are critically retouched for maximum separation and minimum audio distortion.

For a really thorough check of a multiplex unit, a tunable audio generator can be hooked up to the left or right EXT. MODULATION INPUT jack of the E-490, and the channel separation checked at different audio frequencies. You can even feed in music from a stereo tape or phono source and check the sound from a multiplex receiver without waiting for a stereo broadcast.

For further information, circle 69 on the literature card.

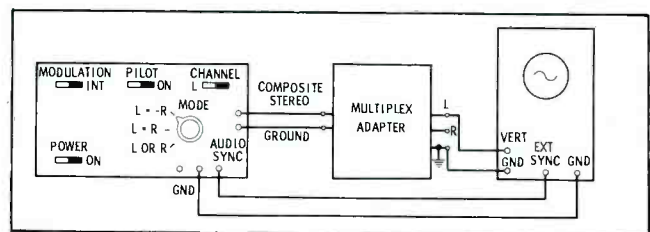

Fig. 5. Setup used to check multiplex unit for separation.

ANOTHER GREAT ADDITION TO THE
FAMOUS SERIES OF B&K ANALYSTS

SIMPLIFIES AND SPEEDS TV SERVICING

NEW!

B&K

Compact Model 1074 TELEVISION ANALYST FOR BLACK & WHITE and COLOR



Dot Pattern

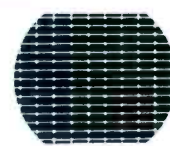

Crosshatch

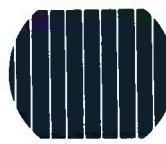

Vertical Lines

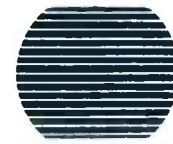

Horizontal Lines



Color Pattern

Here is an exciting new addition to the famous B&K series of Television Analysts—*designed to give every service technician a faster, easier way to service more TV sets!*

The compact "1074" gives you a complete TV signal generating source of your own. Using the B&K *point-to-point signal injection technique*, you can isolate and pinpoint any performance problem for quick correction.

By injecting your own signals, with a visual check on the TV screen, *you can easily signal-trace and troubleshoot any stage* throughout the video, audio, r.f., i.f., sync and sweep sections of black & white and color television sets.

It becomes much easier to find and fix "tough dogs," and troublesome intermittents, as well as to solve other general TV set troubles—to the satisfaction of your customer, and to your own profit. Net, \$24995

Supplies complete r.f. and i.f. signals, with pattern video and tone audio. Video signals are switch selected for fast, visual troubleshooting. Provides FM modulated 4.5 mc sound channel, with built-in 900 cycle tone generator. Provides composite synchronizing signals. Provides separate vertical and horizontal plate and grid driving signals to check complete output circuit and interrelated components. Many other features.

Makes it Easy to Set-up and Service Color TV

Provides dot pattern, crosshatch, vertical lines, horizontal lines, burst signal and individual colors (Green, Blue, B-Y, R-Y, Red, I, and Q) one at a time on the TV set—all crystal controlled for maximum accuracy. Color phase angles are maintained in accordance with NTSC specifications. Thin lines and high stability assure fastest, easiest convergence and linearity adjustments. Color display makes demodulator alignment extremely simple.

Time-Saving, Money-Making Instruments Used and Preferred by Professional Servicemen Everywhere.



Model 375 Dynamic Automatic VTVM



Model 360 V O Matic Automatic VOM



Model 700 Dyna-Quik Tube Tester



Model 850 Color Generator



Model 445 CRT Tester Rejuvenator

See Your B&K Distributor
or Write for Catalog AP21-R



B&K MANUFACTURING CO.
DIVISION OF DYNASCAN CORPORATION
1801 W. BELLE PLAINE AVE. • CHICAGO 13, ILL.
Canada: Atlas Radio Corp., 50 Wingold, Toronto 19, Ont.
Export: Empire Exporters, 253 Broadway, New York 7, U.S.A.

Circle 37 on literature card

How to find a

SERVICEMAN



Company expansion, the loss of a serviceman to other employment, or any number of other reasons may start you considering how to hire a new man. What problems are involved, and how do you go about the serious business of adding new personnel? These questions can be answered best after considering certain important factors: Just what kind of serviceman do you want? Will he be used primarily for home calls or shop service, or for both? Will he be expected to meet and please the public? Do you want a hotshot serviceman who can demand and get an excellent salary, or can you get by with someone less capable who will work for less money and will condescend to sweep the floor occasionally?

The answers to these last questions depend a great deal on your particular operation. Every organization must have at least one hotshot technician, or the dogs will start to pile up. But if you already have that man, or can do this work yourself, perhaps a less experienced man will be just the ticket for you.

If the new man is to do home service primarily, or must meet the public, his personality is more important than his ability; improving ability is nearly always easier than building personality. Complaints from customers can often be avoided by a simple explanation or some show of concern from a friendly employee; few people can resist the charm of a gracious person.

This is not to say that just any flunky with a dazzling personality is the answer to your problem, but personality considerations should be high on your list. In shop servicing it may be possible to hide away an experienced but moody serviceman, and keep his contact with the public to a minimum. Here he may be able to do an excellent servicing job and be happy in his own private world; but in general the likable fellow will be more suitable as an all-around employee.

Traveling in many parts of the country, I am frequently amazed to find so many classified ads pleading for electronics servicemen. This is especially true in larger cities where employment in kindred electronic fields is plentiful. Many good servicemen apparently have been lured away from the service bench into industry. Competition from industry and the government makes finding an experienced technician increasingly difficult. If you do find one, and he is competent, you will likely have to offer benefits and salary to rival those of the larger companies. This is why many serv-

ice organizations today are contenting themselves with hiring men of little or no shop experience and training them from scratch—or through an electronics school—into able technicians.

Every service shop has many jobs that do not call for skilled help. Pulling and replacing chassis, cleaning faceplates and picture tubes, checking tubes, installing parts after diagnosis, even replacing picture tubes—all these chores can be handled by people with a minimum of training, freeing a good technician for diagnosis, alignment, and other jobs that require special skills. Actually, one really sharp technician can keep two or three nonskilled men busy. TV sets are built with semi-skilled labor, so it seems feasible that some phases of repair work can be done this way, too.

Don't overlook the possibility that a man who lacks actual experience, but who has a deep interest in electronics service and is willing to learn, may make the most loyal employee. He "grows up" with the company and becomes an important part of it.

Where To Look

There are several sources you may explore for the person you need. Your ingenuity will help in this area and, with some luck, you can find just the man you want. Here are some places to start:

Students, just out of electronics school or soon to be, usually make good "trainees"; the very fact that a student is attending electronics school is a good indication of his interest. Schools are more than happy to recommend their students; when you're searching for a new man, give them a call.

Distributor personnel are fertile sources of leads concerning who is available in the area. Often they also have a fair idea of the prospect's qualifications. They can sometimes point to a man who is looking for a job and who might fit your operation perfectly.

Service associations often compile information on technicians looking for work. Call the secretary of the association—whether you are a member or not; he is almost sure to offer you friendly help in locating a technician.

Newspaper ads get wide exposure; and if you are looking for the outstanding technician, you may just find him with a classified ad. Don't skimp on the ad cost; you needn't include a life story, but don't just



There's more profit in your hands with ITT tubes

Yes, you can pocket extra profit when you stock ITT receiving tubes . . . with full confidence that you are giving your customers the finest replacement tubes money can buy.

Your customers will appreciate it, too, because they know ITT's international

reputation for quality and leadership in electronics.

ITT can provide this "extra value" of finest quality at higher profit margins because ITT products are available from 154 factories and laboratories in 24 countries. Brands without these world-

wide resources cannot offer you these advantages.

Ask your local distributor about ITT tubes. He'll give you *extra profit* details.

ITT Distributor Products Division, International Telephone and Telegraph Corporation, Box 99, Lodi, New Jersey.

Circle 38 on literature card

ITT



**HIDDEN*
QUALITY**

MODEL 630 V-O-M



**Standard
Of the
Industry**

**PRICE†
\$49.50**

EXCLUSIVE TRIPLET BAR RING SHIELDED MOVEMENT

EASY TO CHANGE STANDARD BATTERIES

FUSED

HIGH FLUX MAGNET, SPRING BACKED JEWELS—FOR RUGGEDNESS

SIMPLE TO REPLACE MULTIPLIERS OR SHUNTS

HEAVY INSULATED CASE

SPARE FUSE

COMPLETELY WIRED CIRCUIT

FACTS MAKE FEATURES:

- 1 Popular streamlined tester with long meter scales arranged for easy reading. Fuse protected.
- 2 Single control knob selects any of 32 ranges—less chance of incorrect settings and burnouts.
- 3 Four resistance ranges—from .1 ohm reads direct; 4½ ohm center scale; high 100 megohms.

Attention to detail makes the Triplet Model 630 V-O-M a life-time investment. It has an outstanding ohm scale; four ranges—low readings .1 ohm, high 100 megs. Fuse affords extra protection to the resistors in the ohmmeter circuit, especially the X1 setting, should too high a voltage be applied. Accuracy 3% DC to 1200V. Heavy molded case for high impact, fully insulated.

† 630A same as 630 plus 1½% accuracy and mirror scale only \$59.50

TRIPLET ELECTRICAL INSTRUMENT COMPANY, BLUFFTON, OHIO

Circle 39 on literature card

say: "Man wanted for service department." Put in an extra teaser or two. Get a little "sizzle" into your ad—like: "Man wanted to head TV service department. Good salary and working conditions. Paid vacation; free hand." Put your best foot forward; you're more apt to find the kind of fellow you have in mind. Whatever particular benefits you can offer that will be appealing, try to get them in the ad—the slight extra cost is worth it. But don't offer benefits that are non-existent! Newspaper ads for less skilled persons to pull chassis and do other incidental jobs should also list benefits and kind of work. One might read: "Man wanted for electronics service department. Some experience preferable but not absolutely necessary. Chance to train and advance in electronics service."

State and private employment agencies can sometimes supply good leads when you're trying to find new help. This service in most cases is free to the employer.

Don't overlook your own personal acquaintances, especially if you are looking for someone to fill a semi-skilled position. The grocery clerk or the personable young man at the laundry may be just the man who can do a bang-up job. One fellow working in a filling station impressed a shop owner with his friendliness. The shop owner approached him and found that he had a definite interest in electronics servicing; he was even willing to take a small cut in salary to start. Today he is making three times his old salary, is service manager, and is still with the *same* shop.

In another instance, a student just out of electronics school got a job in industry, but was not happy with the regimentation. He was hired by a progressive service company and trained under the supervision of good technicians. Today, just six years later, he's a partner in the company.

The moral of these stories is: If you keep your eyes open for the young man with that particular gleam in his eye and an agreeable personality, you may be looking at your next employee.

Prospectives

When your endeavors produce bonafide applicants, you are faced with separating the wheat from the chaff. This involves determining if the applicant suits the job you are trying to fill, and if he is the type of person you'd want working for you. This screening process is usually a two-step procedure—the application blank and the interview. In some shops, a written or practical working test is used; whether the job test comes before or after the interview is strictly a matter of personal choice for the employer.

The Good From the Bad

The practice of having a prospective employee fill out an application form serves several purposes. It gives you information which you can digest and check prior to talking at any length with the prospective employee; it compiles data which will be necessary for employment records should you hire him; it allows you to screen out any applicants who are obviously unsuited for the job, without wasting precious time in an interview.

Check the application carefully for flaws. A gap in his employment record may indicate he is withholding

2 GREAT BELDEN CABLES FOR **COLOR** TV RECEPTION

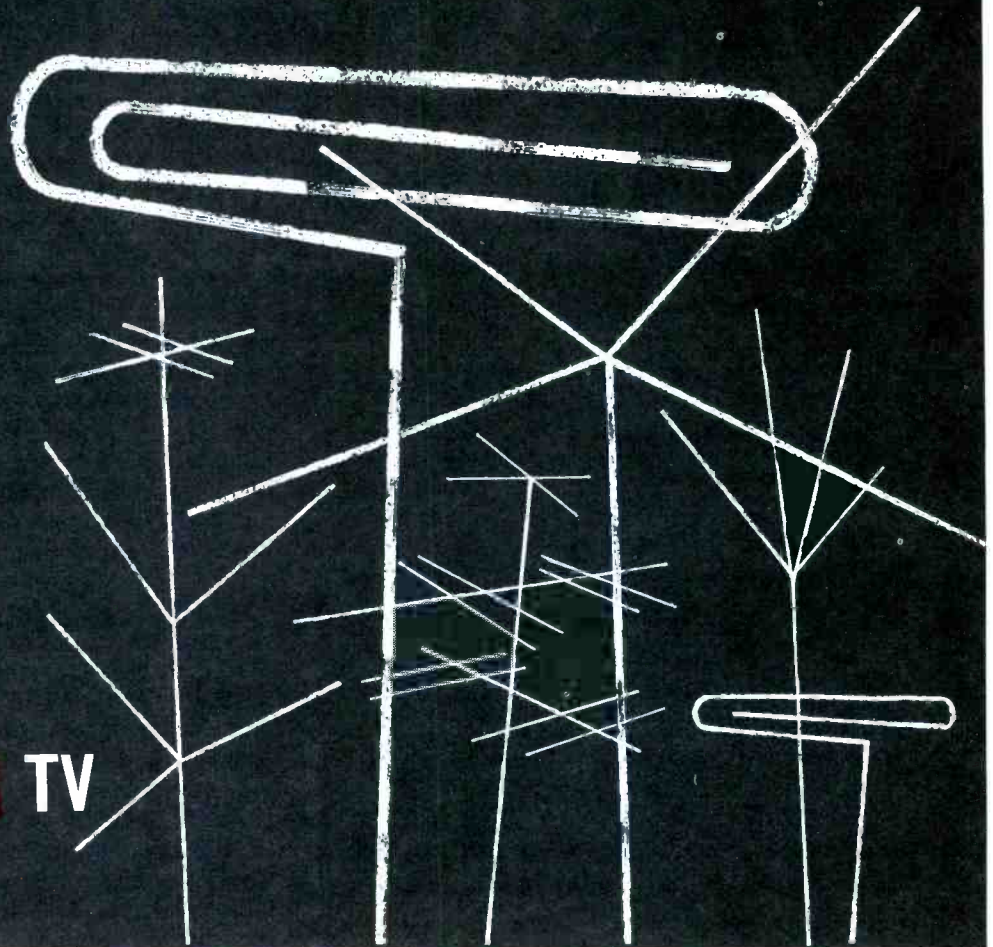

CELLULINE 8275

* Maintains uniform electrical characteristics by eliminating all possible moisture between conductors. The thick outer wall of polyethylene protects the cable from abrasion and sun damage, and the round shape offers less resistance to wind. The result is a long lasting, efficient transmission line for clearer color and black and white TV reception.



AWG & (Stranding)	Color	Nom. O.D. (Inch)	Nom. Velocity of Propagation	Nom. Capacitance (mmf/ft)	Nom. Attenuation per 100' mc db		Standard Package Lengths in ft
20 (7x28)	Brown	.300 x .400	80%	4.6	100	1.05	50' coils 75' coils 100' coils 500' spools 1000' spools
					200	1.64	
					300	2.12	
					400	2.5	
					500	2.98	
					700	3.62	
900	4.3						

PERMOHM 8285

* Conductors are encapsulated in cellular polyethylene. This exclusive design provides clearer TV pictures in all areas including areas where conditions of salt spray, industrial contamination, ice, rain, or snow exist. It further improves fringe area reception as well as strengthens UHF and color TV reception.



AWG & (Stranding)	Color	Nom. O.D. (Inch)	Nom. Velocity of Propagation	Nom. Capacitance (mmf/ft)	Nom. Attenuation per 100' mc db		Standard Package Lengths in ft
22 (7x30)	Brown	.255 x .468	73.3%	5.3	100	1.4	50' coils 75' coils 100' coils 500' spools 1000' spools
					300	2.8	
					500	3.8	
					700	4.8	
					800	5.6	
					900	5.6	

Belden

WIREMAKER FOR INDUSTRY
SINCE 1902 - CHICAGO

Belden Cable is Packaged in Standard Lengths for Display and Handling

Power Supply Cords • Cord Sets • Portable Cordage • Electrical Household Cords • Magnet Wire • Lead Wire • Automotive Wire and Cable • Welding Cable

*Belden Trademark—Reg. U. S. Pat. Off.

8-5-2

Circle 40 on literature card

September, 1963/PF REPORTER 67

**"Don't tell me
all power supplies are the same
... I've used Electro for 10 years
and I know better!"**



(... quote from a user who refused to be sold a substitute)



**30 ADC output
at 1% AC ripple**

... up to 50 ADC
for short periods

"PS-30" 12 VDC Power Supply offers many performance/operating advantages of high-priced brands.

Broad application ... service all communication equipment; use as power source for base station operation, quality control, varied industrial and laboratory needs.

Variable voltage ... 8-position selector switch gives wide range of voltage adjustment.

Low DC impedance ... 0.27 ohms, no load to full load.

Guaranteed 1 year ... many years of satisfactory service assured with special circuitry, patented conduction cooling and top quality components.

Stocked at Your Electronic Distributor

18 OTHERS FROM 6 TO 125V ... \$19.95 TO \$195.00
FREE SELECTION GUIDE PS-562R ON COMPLETE LINE



**ELECTRO PRODUCTS
LABORATORIES**

6125-T Howard, Chicago 48 (Niles), Ill.
Phone: 647-6125

Canada: Atlas Radio Ltd., Toronto

Since 1936 ... Pioneers in Low Voltage DC Power Supplies
Circle 41 on literature card

information; you can ask for a complete explanation during the interview. Be sure to check references. While they may be inconclusive (no one in his right mind would name as a reference someone who will give him a poor recommendation), the persons named are a clue to the type of people with whom the applicant associates.

Similarly, letters of recommendation won't tell you too much, since it is highly unlikely that anyone will produce a letter with unfavorable comments. However, letters written by important members of the community can usually be relied upon to vouch for the reputation of the applicant.

A properly completed application form should list past jobs, giving a clue to the nature of experience. You can also tell if the prospect is a "job hopper." Don't hesitate to call past employers to learn their impressions of the applicant's work habits. Again, these facts are inconclusive in themselves, but they can be woven together into a reasonable picture of what kind of person you're dealing with.

At this point, some employers like the applicant to take a technical test so any serious inadequacies in the prospect's training will be brought to light. Others prefer to postpone any technical questions until during or following the interview. Indeed, if you have a good technical background yourself, it shouldn't take long to separate the doer from the talker. Just lead him into a discussion of a few case histories of jobs he has done; let him explain how and why he came to the source of trouble in the manner he did. However, don't make the mistake of insisting that his way be yours—his might be better. In any case, if he has a good servicing background, he can be trained to service your way.

The Interview

When your screening reaches the interviewing stage, proceed on a businesslike basis. Be courteous and concerned when a prospective employee turns up; his first impression of the company is an important one. Go out of your way to set him at ease; you may have to turn him down, but he and his relatives may be or may become your customers.

Find a *private* place to conduct the interview and seat the prospect in a comfortable chair. Let him do most of the talking. Remember, he can tell you more about himself than anyone else can. Concern yourself with getting him to "open up" so you are better able to judge his "normal" personality.

Make notes as the interview progresses. Note the condition of his health, his personal habits, his appearance. Put yourself in your customer's place and consider how you would feel about this man coming into your home. See how well he "wears" during the interview. Is your first impression the correct one?

If you use a technical test after the interview, it may be difficult or simple. Some employers use two (I won't argue the ethics): One is extremely difficult and is used when the prospect hasn't passed the employer's other criteria; thus an excuse is gained for refusing to hire. A simpler test is used for the man he would like to employ, if his technical ability is acceptable.

If you are interviewing the "trainee," you will likely be more interested in his personality, intelligence, manner, and appearance than in his technical skills. Any



MR. SERVICE DEALER: MAKE AN EXTRA 12½% ON YOUR REPLACEMENT SPEAKER PURCHASES!

12½% EXTRA is a big deal! It's three times savings account interest . . . twice the yield of good bonds . . . more than the final net profit of many a business enterprise.

Worth while? You bet! And it's easy. Every time you install a JENSEN Viking replacement speaker you make not 40%, but 45% profit plus your labor charge. There's no extra cost to the customer—official list prices are very competitive . . . you benefit from a built-in better profit structure.

Quality? Of course. You and your customer know that the JENSEN label is synonymous with the best in hi-fi . . . with equipment on every fighting ship . . . major commercial aircraft . . . wherever the finest is important.

Can you afford not to use JENSEN Viking replacement speakers? Better see your distributor soon!

*Write for Data Sheet 170.

NOW NEW OVALS!

All the popular oval sizes and impedances are now available in the new JENSEN Viking series of replacement and general purpose loudspeakers. You get them at the right prices . . . and best profit margin!



Nom. Size	Model No.	Magnet Wt. Oz.	Imped. Ohms	List Price
3	3K7	.68	3.2	\$ 3.80
3½	35K7	.68	3.2	3.80
4	4K5	.53	3.2	2.90
4	4K7	.68	3.2	3.55
5	5K5	.53	3.2	3.25
5	5K7	.68	3.2	3.85
5¼	525K7	.68	3.2	4.35
6	6K7	.68	3.2	4.35
7	7W3	1.00	3.2	6.55
7	7J9	1.47	3.2	6.65
8	EW3	1.00	3.2	5.85
8	EJ9	1.47	3.2	6.90
10	10J1C	1.73	3.2	9.00
12	12J1C	1.73	3.2	10.50
3x5	3X5K5	.53	3.2	4.10
4x6	4X6K7	.68	3.2	4.80
4x8	4X8W9	1.00	8-10	6.00
4x10	4X10W9	1.00	8-10	6.50
5x7	5X7W3	1.00	3.2	5.35
5x7	5X7W9	1.00	8-10	5.35
5x7	57J9	1.47	3.2	5.40
6x9	6X9W3	1.00	3.2	5.95
6x9	6X9W9	1.00	8-10	5.95
6x9	69J9	1.47	3.2	6.40

JENSEN MANUFACTURING COMPANY, DIVISION OF THE NUTEC COMPANY/6601 SOUTH LARAMIE AVENUE, CHICAGO 28, ILL. 60638
Canada: Radio Speakers of Canada, Ltd., Toronto • Argentina: UODA, S.A., Buenos Aires • Mexico: Fapartel, S.A., Naucalpan, Mex.

Circle 42 on literature card

Communications, mobile radio...

A First Class FCC License

...or Your Money Back!

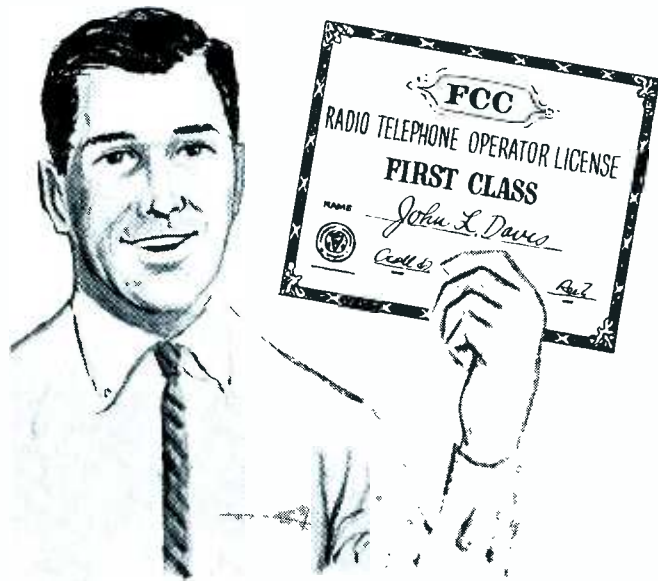

Your key to future success in electronics is a First-Class FCC License. It will permit you to operate and maintain transmitting equipment used in aviation, broadcasting, marine, microwave, mobile communications, or Citizens-Band. Cleveland Institute home study is the ideal way to get your FCC License. Here's why:

Our training programs will *quickly* prepare you for a First-Class Commercial Radio Telephone License with a Radar Endorsement. Should you fail to pass the FCC examination after completing your course, you will get a *full refund* of all tuition payments. You get an FCC License . . . or your money back!

You owe it to yourself, your family, your future to get the complete details on our "proven effective" Cleveland Institute home study. Just send the coupon below TODAY. There's no obligation.

MAIL COUPON TODAY FOR FREE CATALOG

Cleveland Institute of Electronics

1776 E. 17th St., Dept. PF-6
Cleveland 14, Ohio

Please send FREE Career Information prepared to help me get ahead in Electronics, without further obligation.

CHECK AREA OF MOST INTEREST -

- | | |
|---|--|
| <input type="checkbox"/> Electronics Technology | <input type="checkbox"/> First-Class FCC License |
| <input type="checkbox"/> Industrial Electronics | <input type="checkbox"/> Electronic Communications |
| <input type="checkbox"/> Broadcast Engineering | <input type="checkbox"/> _____
other |

Your present occupation _____

Name _____ Age _____

(please print)

Address _____

City _____ Zone _____ State _____

Accredited Member National Home Study Council

Circle 43 on literature card

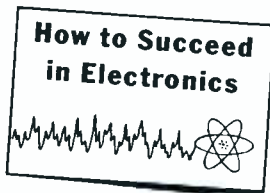

indication that he has mechanical aptitude along with an interest in mathematics is usually a favorable recommendation.

Closing The Deal

Once you find the man you want, you may discover that now *he* is the one who must be sold. You should have a plan ready to convince him that employment with your company is what he really wants. Restate the benefits he will have. If the salary is not as much as he expects, point out chances for advancement. But *don't* consider the man who is willing to work for considerably less than he is obviously worth; he is apt to be using the position with you as a temporary stopover while he fishes for a more lucrative job. If you can't pay a man near what he expects, you're usually better off to turn down his application and explain the reason. Of course, don't overlook circumstances that could make a man content with a lower salary, such as the location of his home or a desire to keep his children in a particular school or church.

If the job is accepted, explain his duties, what time to start and quit, payment for overtime, to whom he will be responsible, and any special instructions necessary to the smooth operation of your particular business. This will get you off on the right foot and may easily prevent serious misunderstandings later on. Too many men are hired and never told what is expected of them until they make a mistake; this is too late. Any company worth its salt must have a fixed policy, and this policy should be made clear to the employee at the outset.

Saying No

There will always be several applicants whom you will have to turn down. This is such a painful operation for some people that they resort to an unfair deception that might be called the "dangling hope."

"You seem to have most of the qualifications we are looking for; we'll let you know just as soon as we make our decision." An indefinite statement such as this can easily be misconstrued by an eager prospect as tantamount to early employment when it really means just the opposite. Out of common decency, don't leave a man hanging in the air. If he doesn't meet your qualifications—tell him so in a courteous, friendly way, but make it definite. If you can, add a personal compliment, such as: "You seem to have wonderful mechanical ability, but we are looking for someone with more experience in the electronics field." Or, "Actually, we are interested in paying a smaller salary than someone with your ability can afford to work for."

Sometimes, of course, you may want to prolong your decision about hiring. If so, tell the prospect and also give him a definite date when the decision will be reached. If feasible, tell him why the delay. If a good prospect is reluctant to wait, you likely have not sold him on the importance of going to work for you. Sometimes, a little reselling job may be in order, but do not be panicked into making an immature decision to hire. The next fellow you interview may be far and away the better man.

If you feel unsure about what to tell an applicant at any stage in the hiring procedure, simply treat him the way you'd want to be treated if you were in his shoes. ▲

TOP PERFORMANCE AT ROCK-BOTTOM COST

With money-saving RCA Electronic Instrument Kits

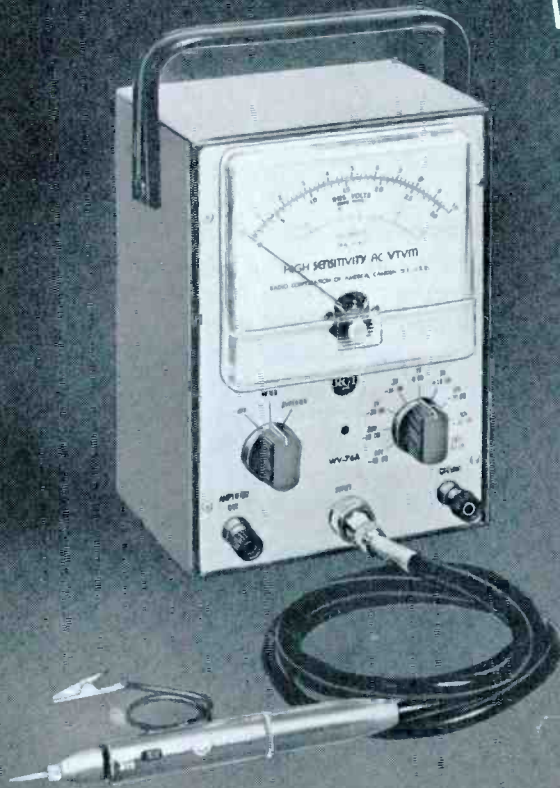

RCA WV-76A (K) HIGH SENSITIVITY AC VTVM KIT

Measures AC Voltages .0002-Volt to 500 Volts
Doubles as a Preamplifier

An exceptional two-way kit value! As a high sensitivity AC VTVM the new RCA WV-76A measures AC voltages from 10 mv to 100 v full-scale in nine overlapping ranges; special "low-cap" switch on probe extends upper range limit to 500 v. As a flat-response preamp fifier, it provides a 38 db maximum gain on the .10 mv range.

- Flat frequency response ± 1 db from 15 cps to 1.5 Mc with probe on "direct"; and from 10 cps to 500 kc with probe switched to "low-cap."
- High input impedance for accurate measurements in circuits sensitive to loading.
- Easy-to-use, direct-reading decibel scales
- Pre-assembled shielded probe and cable, all-metal case eliminate stray pickup.
- Large power-supply filter minimizes hum.
- Compact, lightweight, portable.

Kit price: only \$57.95* • Factory-wired and calibrated: \$79.95*

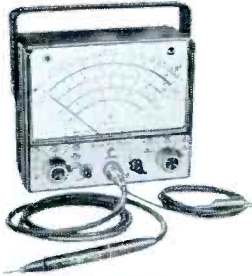

RCA WV-99C (K) SENIOR VOLT-OHM-MYST® KIT

Special 0.5-volt DC range for transistor circuits. Measures: AC voltages 0.2 to 4200 peak to peak—including complex waves—and 0.1 to 1500 rms; DC voltages 0.01 to 1500; Resistances 0.2 ohm to 1,000 megohms. Pre-assembled, AC/DC-OHMS probe. Big 6½" meter. AC, DC accuracy: $\pm 3\%$ FS.

Kit: \$57.95* Factory Wired: \$79.50*



RCA WV-77E (K) VOLT-OHM-MYST® KIT

Separate 1.5-volt rms and 4-volt peak-to-peak scales for accurate low AC measurements. Measures AC and DC voltages to 1500 volts, resistances from 0.2 ohm to 1,000 megohms. Ultra-slim probes, long flexible leads.

Kit: \$29.95* Factory Wired: \$43.95*



RCA WV-38A (K) VOLT-OHM-MILLIAMMETER KIT

Accurately measures AC and DC volts, ohms, DC current, and decibels. Special 0.25-volt and 1.0-volt DC ranges. 5¼" meter in plastic case—no glass to crack or shatter. Jacks located below switches to keep leads out of the way. Spring clips on handle to hold leads.

Kit: \$29.95* Factory Wired: \$43.95*



RCA WO-33A (K) PORTABLE 'SCOPE KIT

For trouble-shooting B&W and color TV, radio, hi-fi, tape recorders. Exceptional gain and bandwidth (response to 5.5 Mc) for toughest jobs. Scaled graph screen and internal calibrating voltage source for direct reading of peak-to-peak voltage. Supplied with direct/low-cap shielded cable.

Kit: \$79.95* Factory Wired: \$129.95*

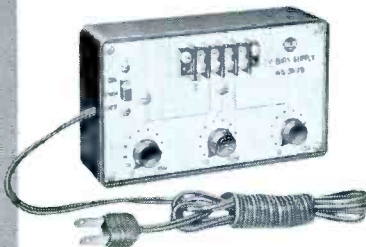

RCA WG-307B (K) TV BIAS SUPPLY KIT

Three separate DC output voltages each adjustable from 0 to 15 volts provide bias voltages for aligning RF, IF and other circuits of color and black-and-white TV receivers. Kit: \$11.95*

See them all at your Authorized RCA Electronic Instrument Distributor

For specifications and technical data on individual kits, write Commercial Engineering, Section 1-33-W, RCA Electronic Components and Devices, Harrison, N. J.

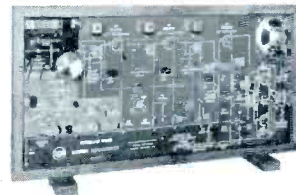

RCA WE-93A (K) TRANSISTOR-RADIO DYNAMIC DEMONSTRATOR KIT

Working six-transistor radio on color-coded panel board for instructional and demonstration purposes. Removable components. Includes 304-page RCA transistor manual containing detailed data on 373 semiconductor devices, representative transistor circuits, basic theory. Kit: \$39.95*

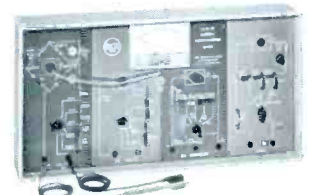

RCA WE-95A (K) VOLT-OHM-MILLIAMMETER DYNAMIC DEMONSTRATOR KIT

A functional, accurate V-O-M laid out on panel board for instruction and demonstration. Each basic circuit separately color coded. Measures AC volts, DC volts, DC current and ohms. One of the most useful test instruments in electronics. Kit: \$37.95*

*User price (optional)



The Most Trusted Name in Electronics

Circle 44 on literature card

A NEW LOOK IN PRINTED COMPONENTS

The really important changes are inside . . . by Rufus P. Turner

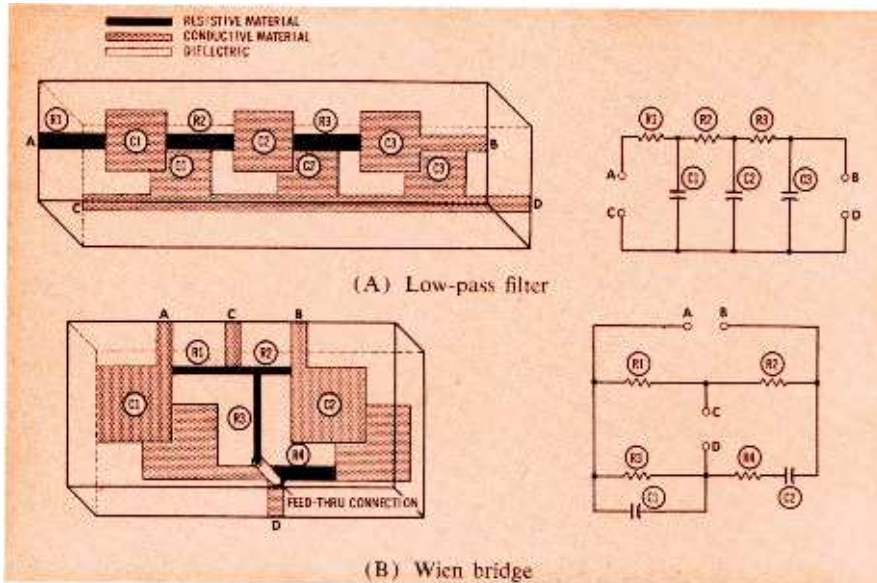

Fig. 1. Two examples of RC configurations printed on thin dielectric wafers.

Resistance-capacitance (RC) circuits suit a variety of applications in electronics because of their sensitivity to frequency and phase. Some well known configurations are wave filters (low-pass, high-pass, band-pass, and band-rejection), Wien bridge, parallel-T null network, bridged-T null network, differentiator, and integrator. Several of these circuits are now appearing in new forms, in which they are sometimes scarcely recognizable

Printed Components

The scheme of printing circuit elements on mica or high-K ceramic has brought important reductions in the size of RC circuits, simplifying them into slim wafers, thin films, or tiny slabs which are readily incorporated into subminiature equipment. This technique has changed the face of many RC circuits.

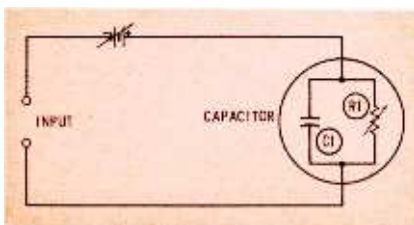

Fig. 2. Leakage resistance of ceramic capacitor varies with applied voltage.

Fig. 1 shows two possible configurations for printed RC sections: a low-pass filter in Fig. 1A and a Wien bridge in Fig. 1B. The capacitors and leads are formed by rectangles or discs of conductive material, such as silver or copper, plated or evaporated on opposite faces of a thin dielectric wafer. The resistors are formed by painting on or evaporating resistive material. Use of a thin, high-dielectric wafer and a highly resistive material accounts for the extremely small size of the completed unit.

By this same means, an audio-frequency parallel-T null network which requires three capacitors and three resistors may be produced, in final thin-film form, in a size much smaller than *one* ordinary capacitor. (A 100-cps network about one-fourth the size of a postage stamp is presently available.) Such printed-

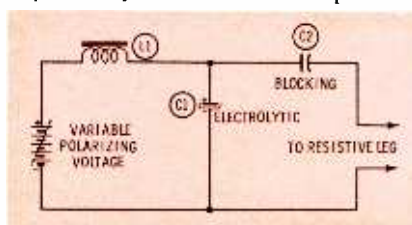

Fig. 3. Voltage changes can be used to vary capacitance of electrolytic.

component circuits may be adjusted to an exact frequency or a precise phase angle by either "brushing on" additional material or shaving away a small portion of that which is already deposited.

Such printed components are commercially available both as independent units and in potted assemblies along with transistors.

Secondary Parameters

A secondary parameter (extra characteristic) in a component often is useful in making an RC circuit from what appears to be a single component. If this parameter is reliably controllable by either voltage or current, then the network may be adjusted — or tuned — by varying voltage or current in the associated circuit.

Such a controllable parameter is the leakage resistance of certain low-voltage ceramic capacitors. In a typical 1-mfd capacitor of this kind, the leakage resistance may be 300K at .5 volts DC, and 1500 ohms at 3 volts—a resistance change of 200:1 for a voltage change of only 10:1. The capacitance, on the other hand, remains substantially constant with voltage. This controllable leakage is represented in Fig. 2 as a voltage-variable shunt resistance.

Thus, what appears to be only a capacitor is actually a parallel RC circuit, the resistive leg of which may be varied over a considerable range by means of a variable DC voltage. Such a component is useful as a tiny adjustable RC combination which can be part of a frequency-selective network or used by itself as an impedance element.

Another extra characteristic which has not been extensively exploited is the leakage resistance of an electrolytic capacitor and the fact that its capacitance depends heavily upon the DC polarizing voltage. (If you have checked an electrolytic with a bridge, you have noticed the difference in capacitance readings with and without DC.)

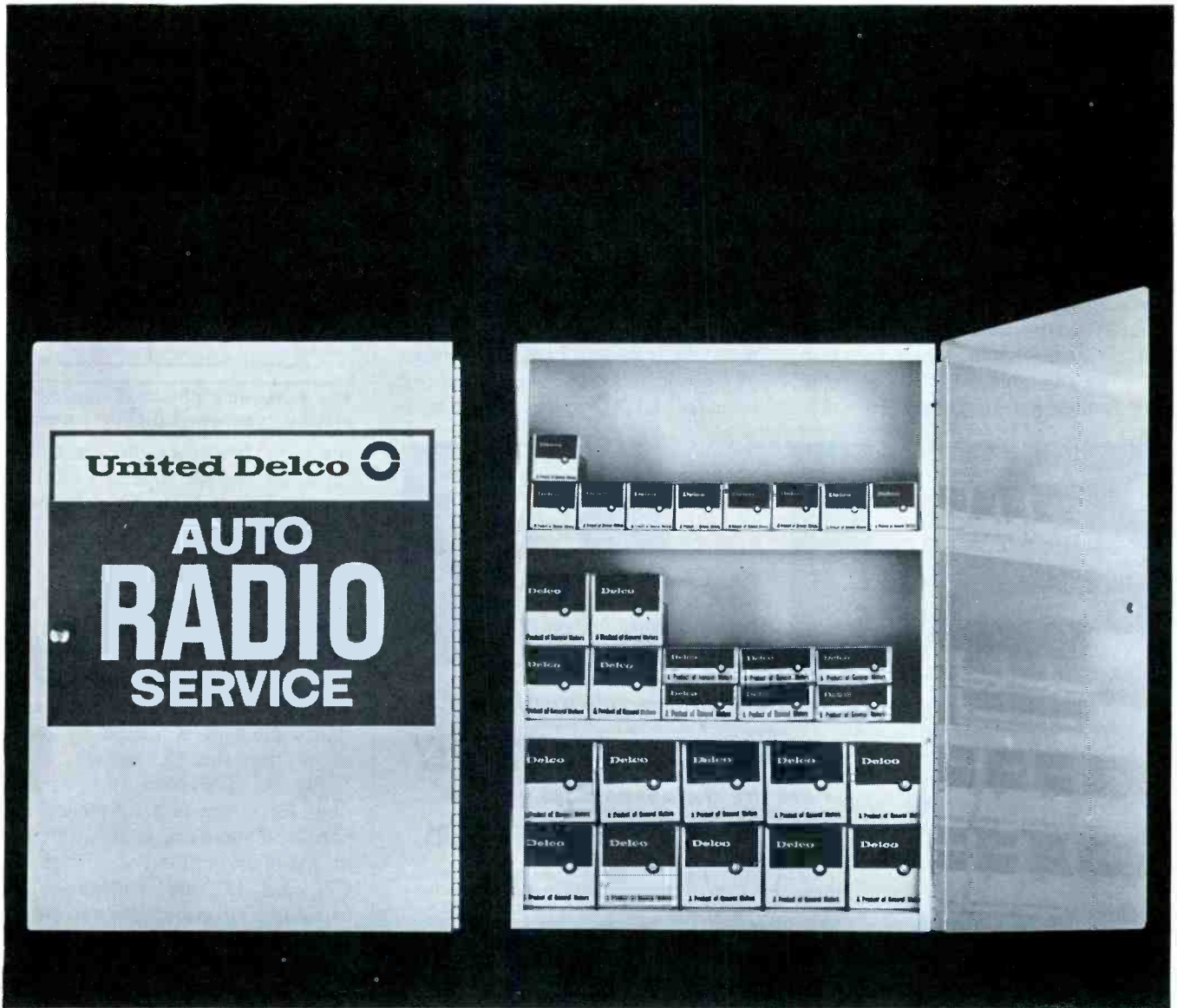

This cabinet is yours free ... when you order these 1964 radio parts

Order the parts you need to service the Delco radios in all the 1964 General Motors cars—and get a good looking cabinet to boot. Plan on using this cabinet often because the parts you get with this package are the fastest movers. And to help make sure you never run out of them, you'll also get a handy inventory control card. All this is yours

when you order Part No. 1964 from your United Delco representative. Supply of cabinets is limited, so call him today!

Delco Radio automotive radio service parts are distributed nationally through **United Delco**.

DELCO RADIO, Division of General Motors, Kokomo, Indiana.

simply say **Delco**



Circle 45 on literature card

Fig. 3 shows one type of circuit in which this effect has been used. In this arrangement, electrolytic C1 is the capacitive element of a shunt RC circuit. High-capacitance non-electrolytic capacitor C2 blocks the DC control voltage from the external circuit, whereas inductor L1 keeps any AC from the external circuit out of the DC source.

As the control voltage approaches the DC working voltage of C1, the effective capacitance decreases. By this means, a capacitance variation may be obtained which is suitable for tuning low-frequency RC net-

works, at a capacitance value much higher than that obtainable with ordinary variable units. The magnitude of change depends upon the type of capacitor, its nominal capacitance, and the working voltage.

One disadvantage of this circuit is its low Q, which unsuits it for applications in which high selectivity is important. An additional feature, which may or may not be a shortcoming, is the comparatively long time constant in the control circuit resulting from the high capacitance of C1 and the internal resistance of inductor L1. Despite these short-

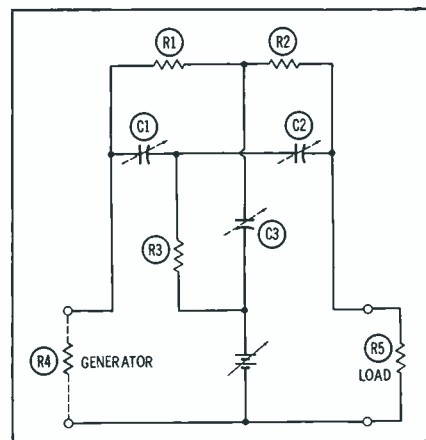

Fig. 4. Tunable parallel-T network employing voltage-variable capacitors.

comings, however, the electrolytic capacitor can provide a useful adjustable parallel-RC circuit at audio and power-line frequencies.

Varactors

Varactors (semiconductor voltage-variable capacitors) and ceramic nonlinear capacitors have been tested extensively in tunable RC networks in which the capacitance element is varied by means of an adjustable DC voltage.

Fig. 4 shows one such application. Here, the null frequency of a parallel-T network is controlled by means of a variable DC voltage. C1, C2, and C3 are voltage-variable capacitors of either the varactor or ceramic type. The DC control voltage is applied to C1 through resistor R3 and generator internal resistance R4; to C2 through R3 and load resistor R5; and to C3 through R4 and R1 in parallel with R5 and R2. The variable capacitors have virtually no leakage, so there is no DC voltage drop across these resistances. By this method, all three capacitances are varied simultaneously—the requirement for tuning a parallel-T circuit.

Semiconductor varactors offer the advantage of good temperature stability and low DC control voltage (0.1 - 20 volts), but do not afford very high capacitance (1800 mmf is the highest nominal value offered commercially at this writing); consequently, they are suitable only for higher frequencies. Certain ceramic voltage-variable capacitors offer higher capacitance values (up to several tenths of a microfarad), but they suffer severely from temperature drift and also require high DC control voltages.

Varactors are tiny in size and,



The most Famous Name in
TOWERS of ALL KINDS!

Here are the advantages you get when you insist on ROHN TOWERS

LARGEST FULL RANGE OF TOWERS—you can get anything from home TV and amateur radio towers to heavy-duty communication and micro-wave towers. Included are 170 foot self-supporting towers, 1,000 foot guyed towers, and "fold-over" towers. Regardless of your needs, ROHN can supply it.

UNQUESTIONED LEADERSHIP IN DESIGN AND MANUFACTURE—you get the latest in advanced tower engineering. All communication towers are engineered to EIA specifications, and are proved by thousands of installations. No other manufacturer can surpass the quality and fine reputation of ROHN.

QUALITY MATERIALS AND WORKMANSHIP—Only highest quality steel is used which fully meets the specifications for the job. ROHN towers are hot-dipped galvanized **after fabrication**—a feature ROHN pioneered!

SERVICE WHEREVER YOU WANT IT—ROHN representatives are world-wide. Complete erection service for communication systems, broadcasting, micro-wave, and other needs is available; also competent engineering service to help you.

Settle for the BEST in TOWERS—ROHN—today the world's largest, exclusive manufacturer of towers of all kinds!

For your needs, contact your local ROHN salesman, distributor or dealer; or write direct for information.



SEND THE HANDY COUPON INDICATING YOUR NEEDS

ROHN
Manufacturing
Company
BOX 2000
PEORIA, ILLINOIS

ROHN Manufacturing Company
Box 3000
Peoria, Illinois

Send me complete literature on the following ROHN Products:

- | | |
|---|--|
| <input type="checkbox"/> Home TV Towers | <input type="checkbox"/> Amateur Towers |
| <input type="checkbox"/> Communication Towers | <input type="checkbox"/> AM-FM Broadcasting Towers |
| <input type="checkbox"/> Micro-Wave Towers | <input type="checkbox"/> Government |

Name _____

Firm _____

Address _____

City _____ State _____

Circle 46 on literature card

when combined with miniature resistors, form adjustable RC circuits of subminiature dimensions.

Varistors

In any RC network, the resistance—instead of capacitance—may be varied to tune the network. For this purpose, there are several types of varistor (voltage-variable resistor): silicon carbide (*Thyrite*) resistors, thermistors, and semiconductor diodes.

Fig. 5A shows a simple RC circuit with varistor control. Here, the DC source supplies a bias current in series with varistor R1 and load resistor R2. A resistance change of several decades can be produced by a single decade of DC voltage change. The nonlinear resistance may be either a *Thyrite* resistor, a thermistor, or a germanium or silicon diode.

Fig. 5B shows a three-section low-pass filter circuit in which the DC control voltage forces a current through varistors R1, R2, and R3, generator resistance R4, and load resistance R5. The input signal voltage is superimposed upon the DC control bias. Similar circuits have been worked out for null networks (parallel-T, Wien bridge, bridged-T, Hall circuit) and phase-shift networks.

Distributed Circuits

The *distributed RC circuit* is a quite new concept. In this arrangement, the resistance and capacitance components are—as the name implies—distributed rather than

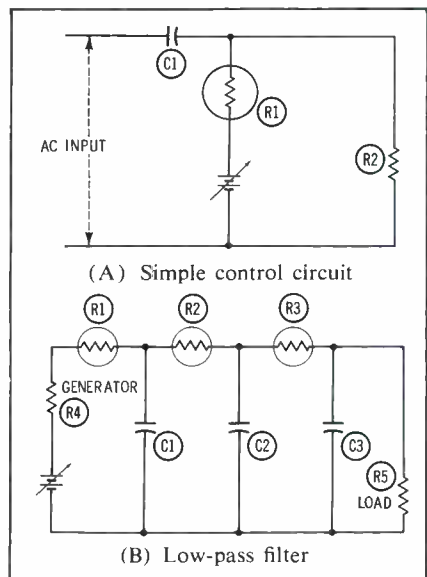

Fig. 5. RC networks using varistors.

make extra dollars with your scope

An oscilloscope gives a visual picture of what is happening in a circuit, something no other test instrument can do. This very feature makes a good scope a money maker for your shop. It saves you time, analyzes those intermittent faults, and makes routine servicing easier than ever. Once you start using a scope regularly you'll never be without one.

You've pulled a set with a buzz in the sound. Is it 60-cycle hum or 60-cycle buzz? A quick look with the scope and you'll know. You'll either see a 60-cycle sine wave caused by heater-cathode leakage or there'll be a vertical deflection sawtooth probably resulting from a defective bypass capacitor.

I.f. alignment required? A scope is a must. Set it up along with your EICO post injection sweep generator, and you have only to adjust transformer and sound trap slugs to finish the job. Same thing for setting up the 4.5-mc sound takeoff network.

Losing the signal somewhere in the video circuits? Hook up the scope and see where it's going astray. There's a good chance you'll spot the bad component at the same time.

But when you go to buy a scope, what do you look for? Large screen, high sensitivity, frequency response, attenuators, synchronization, calibrator? All of these are important and are included in the design of any professional scope intended for the service technician.

Large screen: You can get by with 3 inches, but take the 5-inch screen of the EICO 460. Get a close look at what's happening. It's got an edge lit calibrated bezel too. **High sensitivity:** The 460's vertical amplifier delivers 25 mv per cm. All you'll ever need and more. **Frequency response:** EICO makes it flat from dc to 4.5 mc

in the 460. Ideal for color and black and white as well as industrial production and research, audio testing and experimenting. **Attenuators:** The vertical attenuator in the EICO 460 is a 4-step frequency compensated network. Can't beat this kind of design. **Sync:** Any signal reaching the screen is fully synced—automatically. And for special purposes you can inject your own external sync signal. **Calibration:** Accurate peak-to-peak voltage calibrator is built right into the 460.

All this adds up to the top scope for TV service. You can get it as a kit for \$89.95 or completely wired for \$129.50.

If you don't need so elaborate an instrument, take a careful look at the 427 dc to 1 mc scope or the new 3" General Purpose scope, the EICO 430 (kit, \$65.95; wired, \$99.95). The new 430 does everything bigger and more expensive scopes do. Vert amp/flat from 2 c to 500 kc, —6 db at 1mc. Sensitivity 25 mv/cm. Horiz amp. flat from 2 c to 300 kc. Sensitivity .25 V/cm. Flat face 3" tube; mu-metal shield eliminates effects of external fields.

There are plenty of accessories for EICO scopes too. An Electronic Switch to put two different signals on the scope screen at the same time (EICO 488; kit, \$23.95; wired, \$39.95). Voltage Calibrator for the less expensive 427 and 430 (EICO 495; kit, \$12.95; wired, \$17.95). Three accessory probes-demodulator, direct and low capacitance types.

Whether it's scopes, tube testers or VTVM's you get the best for less with EICO. Save money by building your instruments from kits, or buy them factory-wired at a substantial savings. See your distributor. Write for complete 28 page catalog. Dept. PF-9 Add 5% in west



EICO ELECTRONIC INSTRUMENT CO. INC., 3300 Northern Blvd., L. I. C. 1, N. Y.
EXPORT: ROBURN AGENCIES INC., 431 GREENWICH ST., N. Y. 13, N. Y.

Circle 47 on literature card

lumped.

The circuit in Fig. 6A shows one such arrangement. This one consists of a sandwich; one face of a dielectric wafer is coated with resistive material, and the other with a good conductor. The corresponding conventional "lumped" bridged-T network is shown in 6B. R1 in Fig. 6A corresponds to R2 in 6B and is the balancing resistor of the network.

The equivalent circuit of the distributed bridged-T, shown in Fig. 6C, consists of an infinite number of C's and R's. The distributed unit

has a sharper null than the conventional circuit employing lumped R and C components, and is easily constructed by making a capacitor with one resistive plate and one metallic plate.

A semiconductor PN junction can be employed for the same purpose (see Fig. 6D). In this arrangement, the P-layer is lightly doped and supplies the distributed resistance; the N-layer is highly doped and supplies the "conductive" plate of the capacitor. In this unit, capacitance is a result of the depletion layer always found between P and N layers, and

NEW DEEP FRINGE TV ANTENNAS

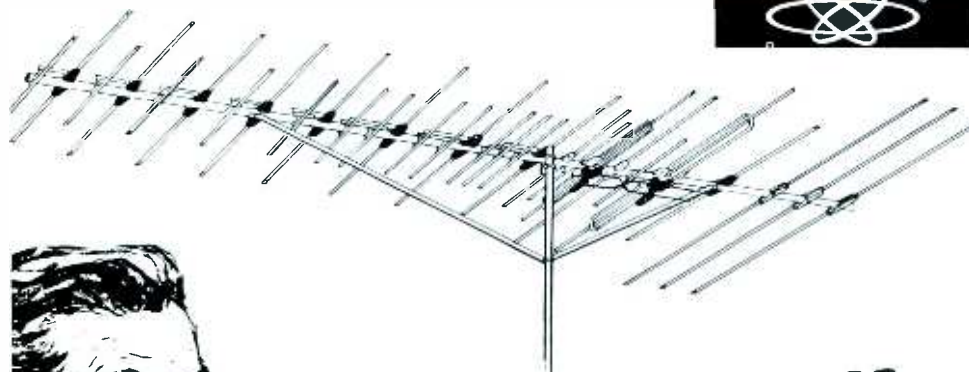

FOR OUTSTANDING COLOR OR BLACK and WHITE TV RECEPTION!

GC COLORMAGIC line

NOW—GC Electronics enables you to offer your customers the finest in long range color and black and white TV reception! COLORMAGIC—the new Leader in the field; the televiewing series designed for the customer who expects and deserves the finest in color and black and white TV viewing!

IT ALL ADDS UP:

The Colormagic series insures brighter, clearer viewing on more channels over a larger reception area. GC's engineering research developments have created an almost perfect 300 ohm impedance match—VSWR 1.5 to 1 maximum.

Installation is a "snap". GC's solid-sembled construction permits quick, easy installation—rigid-lock elements snap securely into place. The entire series is built for long-life, trouble-free service. GC's exclusive Gold-Guard anodizing process also makes the Colormagic series the best protected all-weather line available.

COLORMAGIC—GC's all-new "prestige line"—the ultimate in purer color and black and white TV reception . . . Ask your distributor about this new profit package today!

Write for full particulars today to:

GC ELECTRONICS Division of Textron Electronics, Inc.
400 S. Wyman St., Rockford, Ill., U.S.A.

Circle 48 on literature card

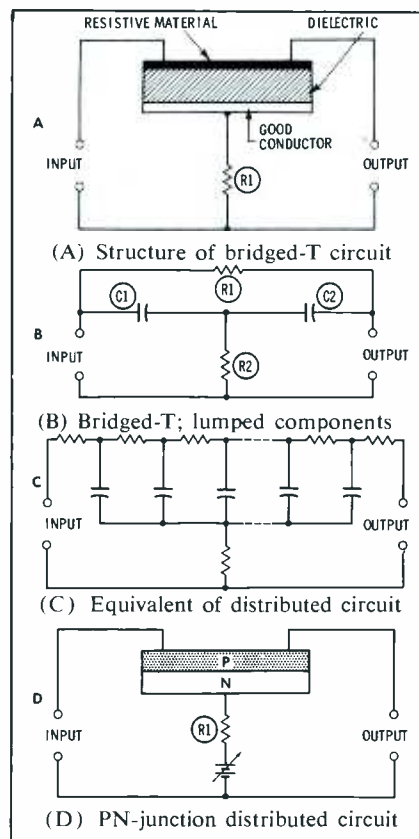

Fig. 6. Distributed RC circuits have combined resistive-capacitive effect.

may be varied by adjusting the DC reverse bias—as in a varactor.

For high-frequency applications, a distributed network of the semiconductor type may be as small as a transistor. For low frequencies—where high capacitance is necessary—the network may be fabricated on a slab or wafer of high-dielectric ceramic, and will be proportionately larger in size.

Prospects

The use of lumped resistance and capacitance (ordinary resistors and capacitors) in RC circuits will likely continue in applications where size is not a consideration and available components must be used. But because miniaturization daily becomes more imperative in equipment design, it is likely that the number of special-form circuits such as printed-component types will continue to grow. Besides their obvious applications in satellites, missiles, computers, and microminiature instrumentation, there are increasing opportunities for using them in pocket-size communications equipment and personal radio or TV receivers. Therefore, as a service technician, you must keep abreast of developments in this field. ▲

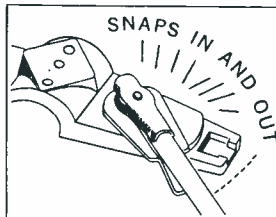

Quick assembly components—dependable, long lasting, all rigid-lock elements snap securely into place.

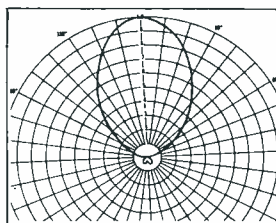

Extremely excellent front-to-back ratio. Pencil-point directivity drives out co channel interference.

Troubleshooter

(Continued from page 25)

The sound immediately returns to normal when I touch a soldering aid to TP-2 at the grid of the 6BN6. The trouble can also be stopped by bridging a resistor of any value across sound-IF plate resistor R50. I also understand that the owner has tried kicking the set; this offers a remedy, but not a cure!

RICHARD S. HOWISON

Arnold, Md.

Your description of the trouble sounds as if it might be due to intermittent spurious oscillation of the sound IF or detector. Such a problem could easily be caused by either a poor ground connection or leakage between sections in dual capacitor C36; of course, there are also other possible causes such as an open C35 or C38.

On the other hand, the trouble could be merely a fluctuation in the gain of the sound IF or detector; if so, the cause could probably be localized by voltage measurements, if these could be obtained! Sometimes, in troubleshooting intermittents of this nature, it is necessary to connect test equipment to the set before turning it on, and then leave it connected until the trouble finally shows up. This technique is time-consuming, but it is sometimes the only way—short of rebuilding the entire circuit.

Drift Not Quite Cured

A General Electric Model 14T012 (PHOTOFACT Folder 310-4), when I first started working on it, drifted out of horizontal sync every 5 to 15 minutes. Changing the ringing coil and its parallel capacitor C67 resulted in a considerable improvement, but not a complete cure. The coil (which is the hold control) now has to be adjusted two or three times during the first half hour after the set is turned on; then it needs no further adjustment as long as the set plays. If the power is switched off and the set is allowed to cool down for an hour or so, the horizontal sync again needs adjusting when operation is resumed.

I've tried the usual component checks in the oscillator and AFC circuits, with no luck. Voltages and waveforms all

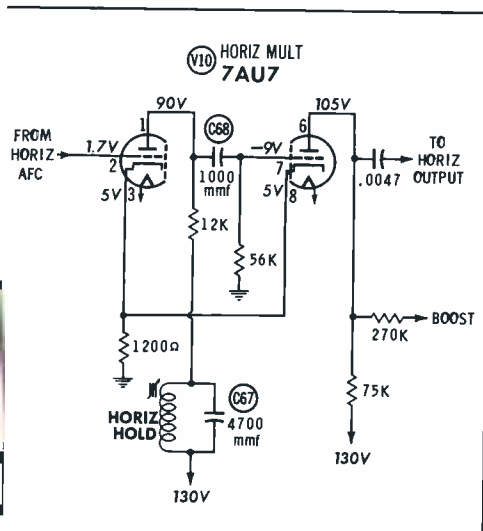

Heavy Duty... Dual Heat

Weller
PROFESSIONAL
240/325 WATTS
SOLDERING KIT
Mod. D-550-PK
TWIN SPOTLIGHTS

Weller
SOLDERING KIT
with 240/325 watt gun

Professional, heavy-duty gun has two trigger positions—lets you switch instantly to the heat best suited for the job. Use of low heat prevents damage when soldering near heat-sensitive components and prolongs tip life. Heat comes on instantly when trigger is pulled—goes off when trigger is released. Spotlight illuminates work. Kit also includes break-proof metal-tone plastic utility case—smoothing tip—cutting tip—tip-changing wrench—and solder. MODEL D550PK.

Light...Efficient...Rugged



Weller "Pencil" SOLDERING IRON

A low cost 25 watt, 115 volt iron that's ideal for miniature-type soldering. Use it as easily as a pencil. High efficiency and rapid recovery enable this Weller model to do the work of irons with much higher wattage ratings. Rugged heating element for extra durability and long service. Lightweight design reduces user fatigue, provides more accurate control. Complete with tip and cord set. Screwdriver-shaped tips available in three sizes. MODEL LW-P.

Buy Weller Soldering Tools at your Electronic Parts Distributor

WELLER ELECTRIC CORP., 601 Stone's Crossing Rd., Easton, Pa.

Circle 49 on literature card

waveform. Next, measure the screen voltage of V20 to be sure it does not exceed 80 volts. In any case, it's a good idea to try substituting for screen- and cathode-bypass capacitors C101 and C102. Lastly, with a voltmeter across cathode resistor R139, adjust the horizontal linearity coil for a minimum voltage reading. If the indication isn't sharp enough, connect a milliammeter in the cathode circuit of the 6CD6; you should be able to reduce the current in the output tube to less than 125 ma. If these adjustments don't succeed in cooling off the flyback, RCA recommends adding a small capacitor (18 to 33 mmf, rated at 1600 volts) across the yoke and flyback circuit—between points A and B on the schematic shown here.

Mournful Monochrome

I'm having my headaches with an RCA CTC5 color set (PHOTOFACT Folder 353-11). Turning the contrast control down only 15° or 20° from the maximum position extinguishes the raster instead of just washing out the picture. To get a half-decent picture, I have to turn the brightness and contrast controls all the way up. The grid voltage of the 12BY7 video output tube is too high (positive 3 volts instead of negative .7 volts); accordingly, the plate and screen voltages on this tube are too low (240 and 170 volts, respectively).

WILLIAM GULKEWICZ

Allentown, Pa.

The positive grid voltage on the 12BY7 may mean trouble in the network consisting of R142 and C119, which supplies a fixed negative bias voltage to the bottom of the brightness control from the grid of the horizontal output tube. Leakage in C64 or C65B could also account for the grid-voltage error.

Whether or not you find trouble in this grid circuit, I think you'll need to reset the gray-scale tracking adjustments to obtain normal operation of the brightness and contrast controls. Improper settings of the background and screen controls can result in exactly the symptoms you have described, and there's a chance that someone has misadjusted them to compensate for a defect in the video output circuit. ▲

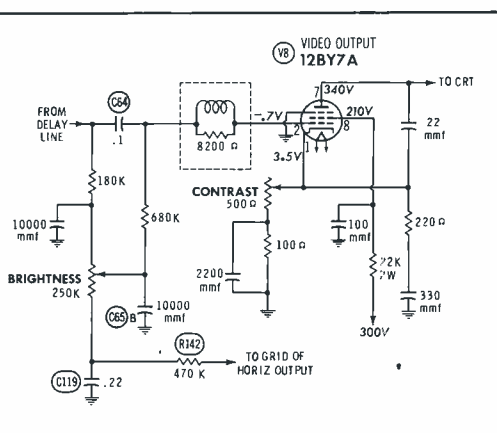

Goodbye to flashlight fumbling...

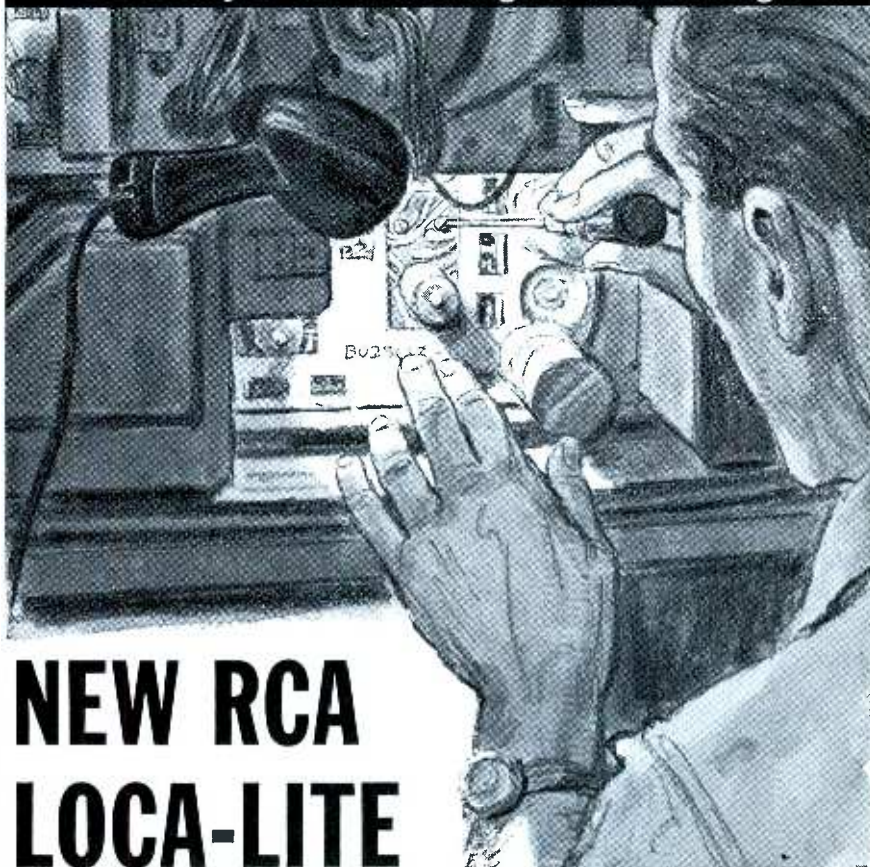

NEW RCA LOCA-LITE

spotlights your work—frees both hands!

This big-power little lamp—developed by RCA especially for TV and radio service technicians—hangs its light to shine right where you're working! Just attach Loca-Lite's swivel hook to a lead wire or component and Loca-Lite stays horizontal, leaving both your hands free as long as you work. No more flashlight fumbling!

A limiting resistor guards against short circuits and limits secondary voltage to prolong bulb life. Transformer construction prevents both 110-volt and AC hum in chassis vicinity, eliminating interference with critical adjustments in chassis circuits. Practical Loca-Lite has a practical transformer, too, that plugs into standard 110-volt outlets without interference with other caps in duplicate receptacles.

Ten-foot plastic Loca-Lite cable allows complete freedom of movement. Loca-Lite's high-impac plastic lamp housing has a mirror-finish reflector and a deep-seated bulb that spot and magnify the beam right on your work area.



See your Authorized RCA Parts and Accessories Distributor for safe, practical Loca-Lite... or write...

RCA PARTS AND ACCESSORIES, P.O. BOX 654, CAMDEN 1, N.J.



THE MOST TRUSTED NAME IN ELECTRONICS

Circle 52 on literature card

IT'S

HERE

NOW

PHILCO®
FALL
FIESTA

SEE THE
PARTS
MANAGER
AT YOUR
PHILCO
DISTRIBUTOR

Circle 53 on literature card

80 PF REPORTER/September, 1963

Audio Circuit

(Continued from page 37)

tube is at a high potential above ground, the control grid must be returned to the same point, or supplied with a similar potential. In Fig. 2B, the proper control-grid voltage is obtained from a voltage divider across the B+ supply. Note that the 1-meg and 1.2-meg resistors in the divider are both rated at 5%. This is necessary because any greater variations in these values might bias the audio power tube incorrectly, unbalancing the circuit, and possibly avalanching the plate current. When a defective output tube is replaced, it is good practice to check the grid-cathode voltage to make sure the bias is correct.

Since the RF, IF, brightness, and similar circuits obtain operating voltages from the output-tube cathode, a defect here can cause many misleading visual symptoms. Frequently, the complaint is that the picture and sound die out after the set has been on awhile. When the audio output tube is the culprit, it can sometimes be spotted by its glowing red plate. In the stacked circuit, more than in any other, a defective cathode or screen-grid filter can be the cause of 120-cps hum or audio bars in the picture.

Unusual Design Features

Fig. 3 shows an interesting adaptation of the stacked B+ principle in the Westinghouse Chassis V-2417. A low DC supply voltage, needed for the *Mobil-Sound* oscillator, was obtained by making the 6AQ5 cathode resistor large enough to develop the required voltage, and then returning the control grid to an appropriate tap for correct biasing of the 6AQ5.

Fig. 4A shows the speaker connections for the CBS-Columbia 817 chassis. A universal output plug permits the attachment of either a 5" or a 10" speaker. Note that a higher shunt capacitance is placed across the transformer primary in order to cut down the high-frequency response and achieve a better balance between highs and lows.

Fig. 4B shows an interlock included in the speaker connections for the DuMont RA-306. If the speaker plug is accidentally pulled out while the set is running, the

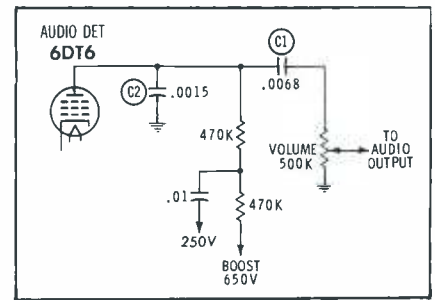

Fig. 6. Boost is sometimes used as plate voltage for quadrature detector.

B+ supply to the output tube is removed, and, in turn, so is the voltage supply to the IF and other circuits fed by the 135-volt line.

An unorthodox circuit from the Hoffman Model 213 is shown in Fig. 5. The plate of the 6C4 first audio tube is direct-coupled to the control grid of the 6W6 audio output. Should the 6C4 burn out, or be removed while the set is on, the control-grid voltage of the 6W6 will rise to 260 volts, but not for long. Since the cathode of the same tube remains at 150 volts, the highly positive control grid starts to draw heavy current, and something's going to give.

By no means rare, but still a source of some confusion in troubleshooting, is the use of boost as a plate-voltage source for the quadrature sound detector. (See Fig. 6.) This practice is especially common in sets which have a regular B+ of only 130 to 140 volts. Naturally, any significant decrease in boost voltage will weaken and distort the audio signal; so, the conventional symptom of flyback trouble (raster defective — sound normal) won't hold true here.

There is an additional problem in the use of boost voltage. Should the 6DT6 burn out or be removed while the set is operating, the full boost voltage will be applied to the .0068 and .0015 capacitors. Therefore, if either capacitor requires replacing, it would be wise to use 1000-volt types.

The service notes of many manufacturers refer to resistors changing value in the plate and screen-grid circuits of the 6DT6 and similar tube types, apparently because of the relatively high IR drop across these resistors. The usual symptoms are weak or distorted sound, hum, or increased buzz. (For additional details, see *Symfact* in the January, 1963 PF REPORTER.)

NEW SECO MODEL 107B TUBE TESTER SPEEDS REPAIRS, DETECTS SLEEPERS

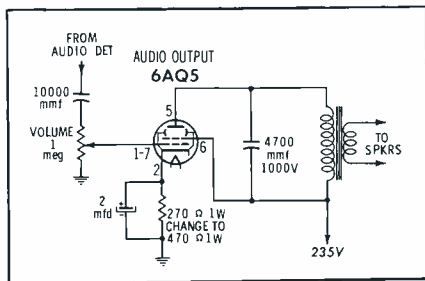

Fig. 7. Changing value of audio cathode resistor cures picture pulsations.

Effects Outside Audio Section

Here are several examples of how far audio trouble can go in affecting other circuits. As in the Magnavox Chassis 32 (Fig. 2B), a shorted coupling capacitor between the volume control and the grid of the output tube would allow changes in the volume-control setting to vary the DC voltage on the 6W6 control grid. This, in turn, would change the voltage at the cathode, thereby altering the plate voltage on the video IF's and varying the contrast.

Another visual symptom is sometimes caused by the final audio stage of the Emerson 120407S (Fig. 7) at high sound-input levels. Positive peaks of the input signal can initiate short bursts of grid current that cause momentary high values of plate current. These surges affect the entire power supply and cause pulsations in the picture. A service note from Emerson recommends changing the cathode-resistor value from 270 to 470 ohms to remedy this condition.

Fig. 8 shows the output circuit of the General Electric Q2 chassis. Certainly this circuit looks straightforward, with no evidence of any potential problems; yet a service note instructs technicians to add a 22-ohm resistor between the audio output stage and the low B+ source to prevent Barkhausen oscillations.

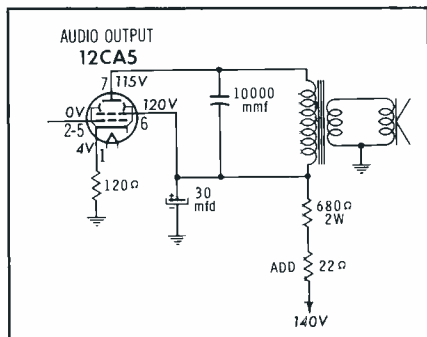

Fig. 8. Small added resistor stops Barkhausen oscillations in G-E Q2.

● 8 sockets wired to 14 lever type pin selectors for testing tubes circuit by circuit!

● 40 prewired sockets accommodating 63 basic arrangements for testing thousands of popular tube types with no set-up data required!



FOOLPROOF READINGS—all test information reads on one meter and one scale! Eliminates errors that can be made reading off closely packed multiple scales. Wide sweep increases accuracy of readings.

3 COMPREHENSIVE TESTS find tube faults that slip by other testers that cost much more. Pull out more "sleepers" on your first try—save time and call-backs.

● **GRID CIRCUIT TEST** makes up to 11 simultaneous checks for leaks, shorts and grid emission—indicates "hard to find faults" that conventional short tests pass by.

● **DYNAMIC MUTUAL CONDUCTANCE TEST** indicates relative transconductance—incorporates gas error test.

● **CATHODE EMISSION TEST** provides the best method for testing pulse amplifier, power output and damper type tubes.

Readings can be made for element identification and analysis of elements for shorts. A "life" test checks for allowable drop in mutual conductance or emission current under reduced heater supply conditions. The exclusive Grid Circuit Test above is a test originated and patented by Seco.



PLUG-IN-SOCKET CHASSIS is easily replaced or interchanged to accommodate the widest possible range of tubes. In addition to 8 sockets, panel has 3 pin straighteners for 4 most popular types. Inexpensive and easy to keep up to date as new tubes appear. Plug in chassis can be customized at low cost to fit your needs.

WIDE RANGE of tube types tested includes all modern TV, radio, industrial and foreign tubes using the following sockets—seven pin, nine pin, octal, loctal, novar, nuvistor, compactron, magnoval and ten pin. Special circuit for low voltage hybrid types. Complete set-up data book is included—pages covering new tubes that appear are mailed periodically to all registered owners at no charge.

ALWAYS UP TO DATE



Model 107B \$169.50 NET

For complete information see your distributor or write:

SECO ELECTRONICS, INC.

1221 S. Clover Drive, Minneapolis 20, Minnesota
A DIVISION OF DI-ACRO CORPORATION

Circle 54 on literature card

NEW SAMS BOOKS

Know Your VOM-VTVM

by Joseph H. Risse. A new one-source guide explaining the operating principles and applications of the two most widely used test instruments. Each potential application for these instruments is thoroughly explained; shows how to perform the tests for most meaningful results. Fully illustrated. A most valuable reference book and an effective self-study guide. 128 pages; 5½ x 8½". Order KVM-1, only. \$250

TV Servicing Methods Guidebook

by Robert Middleton. The outstanding authority on TV servicing presents an entirely new and different approach to efficient, rapid TV repairs. Special check charts, schematics, and unique step-by-step procedures are presented in place of the usual study text. An unusual "self-check" system shows you how to utilize one section of a receiver to test another. Every progressive TV technician will want to own this practical book. 160 pages; 5½ x 8½". Order TSG-1, only. \$295

ABC's of Modern Radio

by Walter G. Salm. Anyone can easily understand this explanation of the basic principles of radio transmission and reception. Simplified block diagrams take you along the entire path of the radio wave, from its origin at the station to its reception in the home. Elements of an AM radio are analyzed to fully explain the operation of the entire receiver. Covers FM transmission and reception, and the differences between AM and FM and Stereo broadcasting. An ideal introduction to all the facts about modern radio. 128 pages; 5½ x 8½". Order ARS-1, only. \$195

Outboard Motor Service Manual

New second edition of this popular manual now covers more than 900 models in over 20 popular makes, from tiny trollers to 100-horsepower giants. Provides step-by-step service procedure and tuneup data for each model. Includes sections on lubrication, ignition, carburetion, power heads, lower units, and electrical systems for each model. Special section on fundamentals explains operating theory simply and understandably. Over 725 illustrations. 320 pages; 8½ x 11". Order OUM-2, only. \$495

Hi-Fi Projects for the Hobbyist

by Leonard Feldman. Here's the book that tells you how to improve your present hi-fi or stereo system at minimum cost. Shows you how to construct valuable attachments and improvements for your equipment (record player, tape recorder, FM tuner, etc.). No prior knowledge or special skill required—you get easy-to-follow instructions, clear schematic diagrams, and photos. Easy-to-build projects include: Rumble filter; noise filter (to reduce record scratch); hi-gain antenna (for better FM stereo reception); transistorized microphone preamp (for improved tape recordings), etc. Also shows you how to check out system without costly test instruments. 128 p.; 5½ x 8½". Order HFF-1, only. \$250

Science Projects in Electronics

by Edward M. Noll. Learn the basic principles of electronics by actually building fascinating projects. Simplified text and clear illustrations for each of the numerous projects demonstrates basic principles and leads to an understanding of modern electronics systems. You begin with a demonstration of how to use the VOM (volt-ohm-milliammeter), and progress to more advanced projects. Ideal for self-instruction or for use as a science class project guide. 128 p.; 5½ x 8½". Order SPJ-1, only. \$295

ABC's of Boolean Algebra

by Allan Lytel. Now—a sound introduction to the special language of computers—all the phases of Boolean algebra presented in an easily understandable way. Clearly explains the intricacies of the mathematical logic which forms the basis for all digital systems and their operation. The text is down-to-earth, supported by profuse illustrations. An important book for students, experimenters, technicians, and engineers. 96 pages; 5½ x 8½". Order BAB-1, only. \$195

HOWARD W. SAMS & CO., INC.

Order from your Sams Distributor today, or mail to Howard W. Sams & Co., Inc., Dept. J-33, 4300 W. 62nd Street, Indianapolis 6, Ind.

Send me the following books:

KVM-1 ARS-1 HFF-1 BAB-1
 TSG-1 OUM-2 SPJ-1

\$_____ enclosed. Send FREE Booklist

Name _____

Address _____

City _____ Zone _____ State _____

IN CANADA: A. C. Simmonds & Sons, Ltd., Toronto 7

Circle 55 on literature card

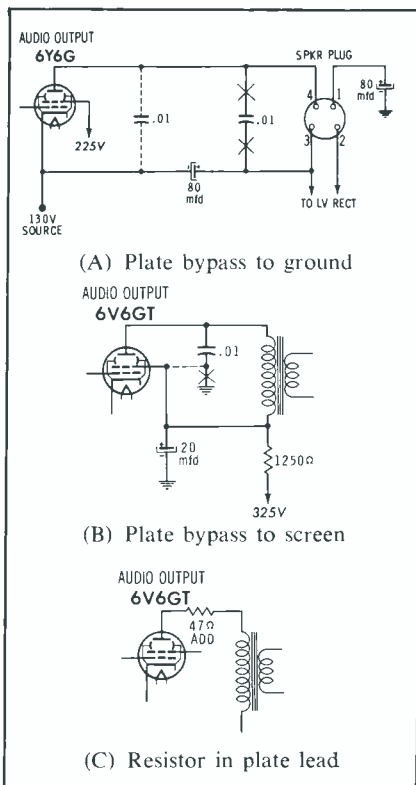

Fig. 9. Cures for parasitics.

lations on channel 5!

Parasitic oscillations in the audio amplifier (such as the Barkhausen described above) can be very troublesome, and difficult to track down, since the frequency can be as high as several hundred megacycles. Fig. 9A is a case in point. The .01 plate-bypass capacitor was originally tied between points 3 and 4 on the speaker plug. Connecting it to cathode or ground cleared up the oscillation. (The addition of a 150-ohm resistor in the control-grid circuit also helped cure the trouble.) Fig. 9B shows just the opposite solution. Here, transferring the return lead of the .01 plate-bypass capacitor from ground to the screen grid killed a 180-mc parasitic oscillation. Fig. 9C shows Sylvania's answer to the parasitic-oscillation problem. They insert a 47-ohm resistor in the plate lead, right at the socket. Sometimes parasitics are due to poor grounds around the audio tube sockets, and can be stopped by simply resoldering all the ground connections.

The circuits shown in this article are representative of what you'll find in the audio section of any TV, and many more could be described. The seemingly infinite variety of circuit arrangements only goes to prove that the "simple" audio circuit is anything but . . . ▲

ON OFF
Turn ON the QUIET
Turn OFF the NOISE
with QUIETROLE . . .

The quality, proved lubricant for effective silencing of noisy controls and switches on TV, radio and electronics instruments. And the FREE EXTENDER TUBE makes those once pesky places easy to reach. Put quality QUIETROLE in your repair kit and see how quickly and easily you satisfy more of your customers.



6 Oz. SPRAY PACK CAN
(with FREE Extender Tube)

2, 4, 8 oz. Bottles
(with Dropper)

Product of
QUIETROLE COMPANY
Spartanburg, South Carolina
in Canada: CROSS CANADA ELECTRONICS
12 Laurel Street, Waterloo, Ontario

Circle 56 on literature card



WINEGARD COLOR-COUPLER
DESIGNED FOR COLOR TV SETS

Winegard's new Color-Coupler, Model CC-23, is the most perfect 2-set coupler ever made. Because it has a perfect impedance match, it works perfectly for both color and black and white TV. Will not cause smear, line ghosts, or change in picture quality. Has flat frequency response across VHF TV and FM bands. Ultra low signal loss, yet has inter-set isolation of 20 DB . . . eliminates interference between sets! Input and output impedance 300 ohms. (VSWR—better than 1.25 to 1.) List only 3.95. Write for spec. sheets.

Winegard
ANTENNA SYSTEMS

3009-9A Scotten, Burlington, Iowa
Circle 57 on literature card

Transistors in Hi-Fi

(Continued from page 33)

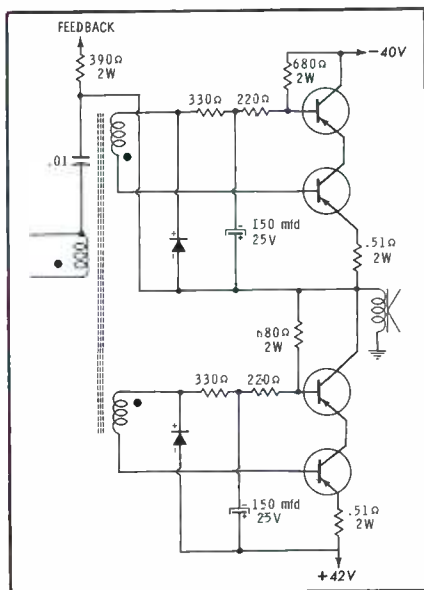

Fig. 8. Output-transformerless circuit utilizing two pairs of transistors.

voltage from reaching the loud-speaker voice coil.

Power Supplies

Silicon rectifiers are common in transistor hi-fi equipment. Usually they are connected in full-wave

(Fig. 7A) or bridge (Fig. 7B) rectifier circuits. A series regulator, employing a transistor, may be included—like the one in Fig. 7A. Such a regulator also functions as a filter and reduces power-supply ripple to an insignificant value. The DC power-supply path through the regulator transistor is across the base-emitter junction. If any voltage variation occurs at the base, an out-of-phase component will be developed in the collector circuit, which is returned to the input side of the filter network. Thus, it will have a canceling effect on the ripple, resulting in a substantial overall reduction in ripple.

High-Power Amplifiers

A schematic diagram of one output stage from a 100-watt all-transistor stereo amplifier is shown in Fig. 8. The top pair of transistors are driven in push-pull, while their outputs add in series. The lower pair are connected in a similar arrangement. The two pairs then operate in the push-pull manner that was shown in Fig. 6. The final output is also "single-ended," the speaker load being connected be-



Fig. 9. Eight output transistors of 100-watt amplifier require heat sinks.

tween ground and the junction of the top and bottom pairs.

The power developed in these transistors generates considerable heat; Fig. 9 shows the eight power transistors (outputs for both channels) mounted in their heat sinks. The amplifier is equipped with a thermal protector that will open the power circuit if the operating temperature becomes too high.

Another transformerless high-power output stage is shown in Fig. 10, using four high-power transistors connected in a bridgelike arrangement. They develop a maximum peak-to-peak output voltage that approaches twice the DC power supply potential, operating on alternate cycles of the audio input volt-



SELF-SERVICE TUBE TESTERS are BIG INCOME PRODUCERS



Model 202-LB
(Lo-Boy Floor Model)
Dealer Net **\$184.50**

Model 202-C
(Counter Model)
Dealer Net **\$129.95**

NEW MODERN EYE-STOPPING TESTERS... TOPS in PERFORMANCE... QUALITY... and VALUE

Here is everything you want in self-service tube testers at down-to-earth prices. **MORE VERSATILITY**—Tests emission, shorts and gas of over 1200 tube types including the very latest NUVIDATORS, NOVARS, COMPACTRONS, etc... Also tests fuses, pilot lights, 6 and 12 volt auto radio vibrators, all type batteries under load. **SMARTER LOOKING**—Modern cabinet design finished in a rich green and white color combination with gold trim... Eye-stoppers in any location—will attract do-it-yourself customers as never before and sell tubes in a big way. **MORE QUALITY FEATURES**—Completely self-service... Only two easy-to-use controls are required to test any tube... Easy-to-read quick flip tube charts list over 1200 tube types... Engineered to accommodate new tube types as they are introduced... Etched aluminum panel always retains its handsome appearance... 63 phosphor-bronze beryllium tube sockets assure positive contacts and long life.

Replace old self-service tube testers with Mercury testers and spark-up your present locations... place them in new locations and be assured of the greatest profit results.

Slightly higher in the West



Model 203-LB
(Deluxe Lo-Boy Floor Model)
Dealer Net **\$254.50**

Model 203-C
(Deluxe Counter Model)
Dealer Net **\$166.95**

MERCURY ELECTRONICS CORPORATION, 111 ROOSEVELT AVENUE, MINEOLA, NEW YORK

Circle 58 on literature card

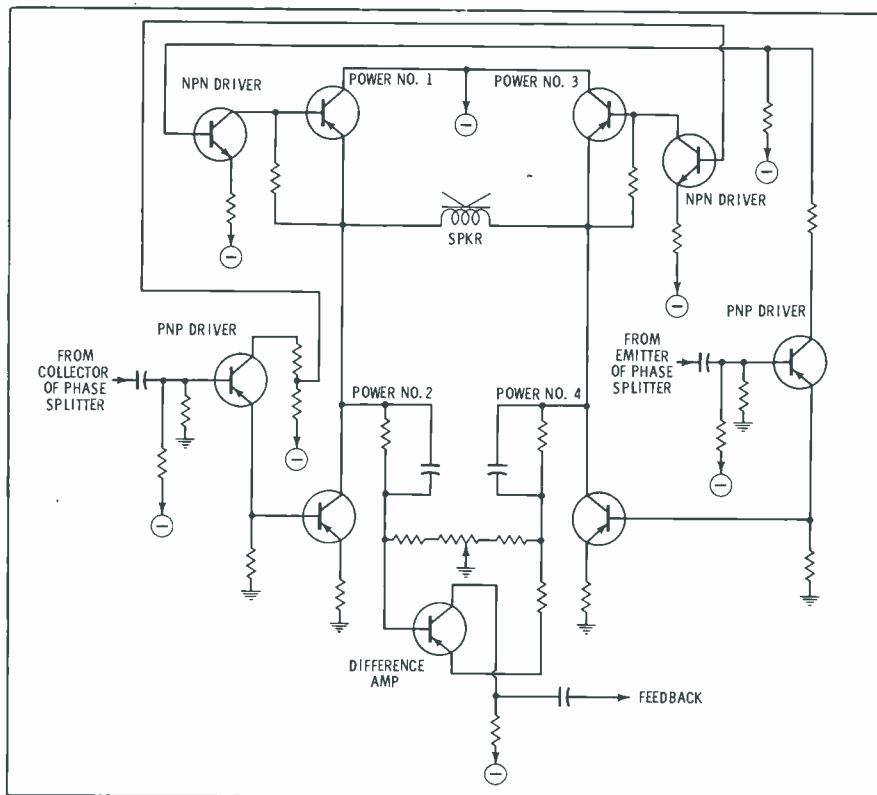

Fig. 10. Different type of high-power amplifier resembles bridge circuit.

age. When power transistors X1 and X4 are conducting, power transistors X2 and X3 are cut off, and vice versa. Each output transistor

has its own DC-coupled driver transistor.

A phase splitter changes the input signal to the push-pull drive

needed in the power stages. The PNP drivers are fed directly from the phase splitter, while the NPN drivers receive their signal from the collectors of the PNP drivers.

The speaker load is connected into the bridge between the "legs" formed by the power transistors; consequently, no DC current flows in the load. Feedback is by way of a difference amplifier that is connected like the speaker and which is very sensitive to any unbalance in the output signals. Any signal unbalance is fed back to an earlier stage of the amplifier to correct the condition. The elimination of phase shift from transformers permits using considerable feedback, with an accompanying extension of the low- and high-frequency response.

Summary

Transistor high-fidelity amplifiers are smaller and weigh less than their vacuum-tube counterparts. Power-circuit problems are less prevalent, and there are fewer critical components to go bad. These and other advantages promise to increase the future popularity of transistors in hi-fi. ▲

Fingers Too Big?

... Use Beau-Tech stainless steel probes to get into those impossible places.

Handy tools for checking loose connections in confined areas where your fingers just won't fit. Made of tough stainless steel, heat-treated for extra strength. Ideal for probing or scraping. Three different tip styles available. Probers come with vinyl hang-up pouch for easy storage. Buy now from your electronics distributor. He has a Beau-Tech Tool for most every soldering need.

98¢ Each

BEAU-TECH TOOLS
BEAUCHAINE
Laconia, New Hampshire

Sales

CORP.

PROFESSIONAL technicians use *Dave Rice's* OFFICIAL ORDER BOOKS for every TV-RADIO service call

This is the businesslike approach to service record keeping. TriPLICATE forms serve as order form, invoice and office record, with spaces for complete information on every job. Separate listings for receiving tubes, pix tube, parts, serial numbers, labor and tax charges, signatures, etc. 75c a book, \$6.50 for dust-proof box of 10. In stock at your distributor.

* * * *

FREE

Write for your free folder describing Dave Rice's OFFICIAL ORDER BOOKS, including an actual size sample copy of the handy order form.

ELECTRONIC PUBLISHING CO., INC.
133 N. JEFFERSON ST.
CHICAGO 6, ILLINOIS

Circle 60 on literature card

PRODUCT report

For further information on any of the following items, circle the associated number on the Catalog & Literature Card.



Record Cushion (138)

A new record cushion from **Oneida Electronic Mfg. Co.** has a built-in stroboscope. Made of slip-proof plastic, this cushion absorbs vibration and shock that might otherwise harm the record or needle. A brass center eyelet prevents fraying or tearing of material or stroboscope. Two sizes are available: the 10" (PR-10) cushion priced at \$1.00, and the 12" (PR-12) at \$1.25.

Cavity-Generator Speaker (139)

An "all-direction" speaker system manufactured by the **Murray-Carlson Corp.** embodies a unique principle in audio reproduction. The unit, marketed under the trade name Murray-Tone "CG", contains a single source of energy nested within a cavity, and produces the full range of audible sound. The instrument is also self-limiting—it is designed to bring forth the weaker portions of the program material and subdue the stronger ones. The most distinctive part of the "CG" system is the fact that it radiates sound in a full 360° sphere. This char-

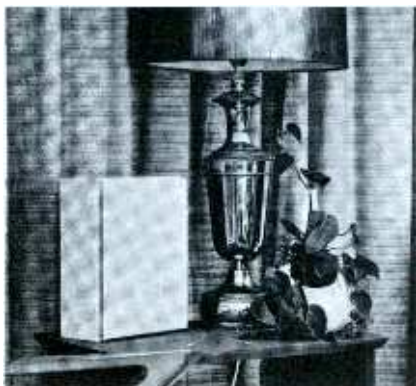

acteristic allows it to be placed behind or beneath furniture; its sound reaches out with a high degree of penetration. The system has a frequency response of from 30 to 17,000 cps and an input impedance of 8 ohms. It will deliver up to 8 watts of power output. Priced at \$39.95, the unit measures 11" x 8" x 4½", weight 5 lbs, and come in a variety of finishes.

Log-Periodic Antennas (140)

The addition of modular parasitic elements to a log-periodic antenna produces an unamplified TV antenna gain of up to 16 db in the **Jerrold-Taco "Paralog"** (JTP series) VHF antennas. Of eleven available models, seven are nonampli-

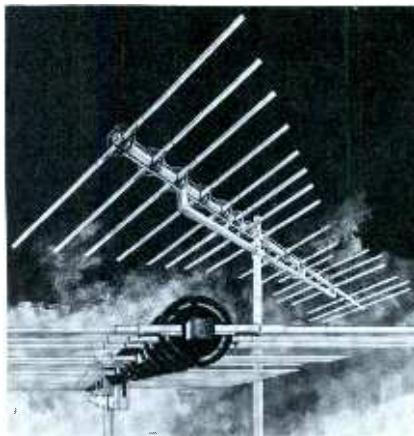

fied (gain to 16 db), and four are electronically amplified for gains up to 28 db. Also available are three "Paralog" FM antennas—each featuring a gain figure of up to 12 db. Through the use of special plastic insulating mounts, line losses due to reflections are reduced to a negligible figure. Featuring dual square-boom construction for high strength and long service life, these antennas are priced from \$19.95 to \$124.95.

Tunnel-Diode Manual (141)

Many of the latest uses for tunnel diodes and tunnel rectifiers are spelled out in the **RCA "Tunnel Diode Manual"** (TD-30). With more than 150 pages, the TD-30 explains the concept of "tunneling," and uses simplified energy-band diagrams to illustrate tunneling as compared to electron flow in conventional semiconductor diodes. A chapter devoted to characteristics presents a thorough dis-

FREE WIRE STRIPPER



AT YOUR FAVORITE
ELECTRONIC PARTS JOBBER

WITH **BRITENER 10 PAK**
FOR ALL TYPES OF PICTURE TUBES



10 Universal Britener Pak \$13.40 Value

PLUS FREE
WIRE STRIPPER... **Only \$11.95**



ANTRONIC CORPORATION

2712 W. Montrose Ave., Chicago, Ill.

Circle 61 on literature card

September, 1963/PF REPORTER 85

SHOP TALK

by DICK PAVEK

• Antenna coil filter assemblies can be adjusted by spreading or squeezing the coils with a bone fibre tool. Most filters should be nulled at 44 mc.

• A machinists drill press vise is very handy in holding P.C. boards when replacing components.

C. Madison, Lake Worth, Fla.

• You can now replace almost any TV, Radio or Hi Fi knob with the Colman Universal 2 Part Knob System. We have added set screw stems to fit 1/4, 3/8, and 1/2 inch round shafts.

• A jewelers loupe, or photographers magnifier, is very helpful in checking tracking of variable condensers and in finding cracks in printed wiring.

J. Fowler, Tuscaloosa, Ala.

• Ever have trouble with clock radio knob shafts breaking off? We have replacement Shaft Tips available that are easy to use and inexpensive. Colman numbers 1246, 1246X, and 1246Y. (Three lengths).

Special kit of Colman Service Aids given for any tip we publish. (Worth \$10). Write to me care of:

COLMAN ELECTRONIC PRODUCTS
P. O. Box 2965 Amarillo, Texas

Circle 62 on literature card

Now you can correct off-standard voltage

with a

terado

**VOLTAGE
ADJUSTER**



Electronic equipment operates best at the 115-120 volts for which it was designed! No longer do you have to make-do with high or low voltage, which affect the performance and operating life of tubes and other components. Use a Terado Voltage Adjuster, which will correct any voltage within a 95 to 135 range, to a normal 115-120. Great for TV, hi-fi, and universal A.C., motors in low or high voltage areas.

TWO MODELS:

Planet (up to 300 Watt) Dealer Net.\$7.80
Polaris (up to 500 Watt) Dealer Net.\$9.20

See your electronics parts jobber, or write:

terado CORPORATION
1073 Raymond Ave.
St. Paul 8, Minnesota
In Canada, Atlas Radio Corp., Ltd., Toronto, Ont.

Circle 63 on literature card



discussion on tunnel-diode circuit behavior, as well as the effects of temperature, radiation, and aging. The manual also includes more than 30 practical circuits ranging from a basic tunnel-diode switching configuration to a complete computer memory circuit using both tunnel diodes and tunnel rectifiers. The interesting "tunnel resistor" is covered, and there is a complete discussion of how to measure tunnel-diode parameters. A concise, seven-page technical data section lists ratings and characteristics for more than 40 RCA germanium and gallium arsenide tunnel diodes and rectifiers—including several newly announced types. Price of the book is \$1.50.

Retracting Phono Cartridge (142)

"Soft Touch," the name for a new phono cartridge recently announced by Euphonics Corp., refers to the protection afforded both the stylus and record. The instant excessive pressure is ap-

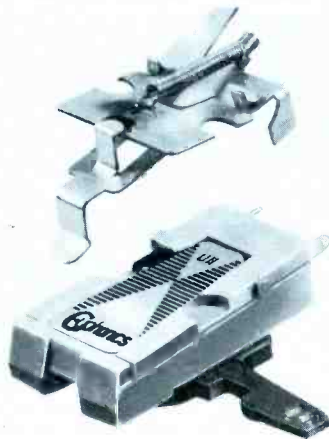

plied to the tone arm, the stylus retracts automatically and a soft plastic guard at the rear of the cartridge contacts the record. The cartridge is attached to a pivotal plate: as the front of the plate containing the needle is pushed up into the tone arm, the rear end (with the guard nib) swings down. Upon removal of the pressure, the needle returns to its original position as the guard nib retracts.

Electrical-Tape Dispenser (143)

A small, refillable, pocket-size dispenser that affords ease and convenience in applying plastic electrical tape is now available from the Johns-Manville Co. This compact unit offers all the advantages of larger dispensers, keeping the



tape safe from dirt and small foreign particles. It holds 20' of 3/4" plastic tape. Although there are no moving parts, the dispenser allows cutting the tape with one hand.



Recording Millivoltmeters (144)

A series of new strip-chart millivoltmeters, made by Amprobe Instrument Corp., are designed for use with external, 50-mv DC shunts, and are available in

PRECISION TUNER SERVICE

P. O. BOX 272

1200 S. WALNUT ST.

BLOOMINGTON, IND.

EDISON 99653

7.50
V or U
COMBO PLUS
9.95 POSTAGE

6 MONTH WARRANTY



All Types T.V. Tuners Cleaned, Repaired and Aligned to Factory Specifications. Same day in shop service on most Tuners. Price Includes Minor Parts, Major Parts at Cost Price. We use Original Parts if possible. State Make Model and Enclose all Parts and Tubes. Pack Well and Insure.

ALSO HAVE LARGE STOCK OF EXCHANGE TUNERS, WRITE FOR TYPES AND PRICES.

Circle 64 on literature card

INDEX TO ADVERTISERS

Aerovox Corp.	60
Amperex Corp.	43
Antronic Corp.	85
Arco Electronics, Inc.	50
ATR Electronics, Inc.	12
B & K Mfg. Co.	
Div. of Dynascan Corp.	46, 47, 51, 63
Beauchaine & Sons, Inc.	84
Belden Mfg. Co.	67
Berns Mfg. Co., Inc., The	78
Blonder-Tongue Labs	57
Bussmann Mfg. Div.	24-25
Castle TV Tuner Service	18
Champion DeArment Tool Co.	12
Cleveland Institute of Electronics	70
Colman Electronic Products	86
Delco Radio Div. (GMC)	73
EICO Electronic Instrument Co., Inc.	75
Electronic Publishing Co., Inc.	84
Electro Products Labs	68
Electro-Voice, Inc.	53
Gator-Probe Corp.	48
GC Electronics Co.	76
Greyhound Corp.	55
Hickok Electrical Instrument Co.	41
ITT Distributor Products Div.	65
Jensen Mfg. Co.	69
Jerrold Electronics	16-17, 2nd Cover
JFD Electronics Corp.	22-23
J. W. Electronics	44
Littelfuse, Inc.	4th Cover
Mallory, P. R. & Co., Inc.	26
Mercury Electronics Corp.	83
Merit Coil & Transformer Corp.	56
Mosley Electronics, Inc.	58
Philco Corp.	
Parts and Service Operations	13, 31, 80
Planet Sales Corp.	78
Precision Tuner Service	86
Quam-Nichols Co.	61
Quietrole Co.	82
RCA Electronic Components and Devices	49, 71, 3rd Cover
Commercial Engineering Dept.	54
RCA Parts and Accessories	79
RCA Sales Corp.	19
Rohn Mfg. Co.	74
Sams, Howard W. & Co., Inc.	59, 82
Sarkes Tarzian, Inc.	
Tuner Div.	9
Seco Electronics, Inc.	81
SENCORE, Inc.	14-15
Sprague Products Co.	10
Sylvania Electric Products, Inc.	20-21
Terado Corp.	86
Triplet Electrical Instrument Co.	66
V-M Corp.	45
Weller Electronic Corp.	77
Winegard Co.	62, 82, 87
Yeats Appliance Dolly Sales Co., Inc.	44

three models: LDM830 (0-30 amps DC), LDM840 (0-40 amps DC), and LDM850 (0-50 amps DC). Additional portable shunts allow the instruments to measure up to 500 amps. Although normally supplied in a leather case for added portability and protection, these units are also available as flush-mounting types for panel installations. Price is \$79.85.



Improved VOM (145)

The Simpson Electric Co. has again improved its well-known Model 260 VOM. The 260 Series 4 and 4M still have all of the features of previous series, plus improved accuracy and a new annular, self-shielded meter movement which is not influenced by external magnetic fields. Greater ruggedness is obtained by using spring-backed jewels that withstand more shock and vibration without increasing frictional error.

These new versions of the 260, having an accuracy of $\pm 2\%$ on DC and $\pm 3\%$ on AC, list for \$48.95 with a standard scale (Series 4) and for \$50.95 with a mirror scale (Series 4M).



Plastic Polishing Cloth (146)

A plastic polishing cloth, dubbed the "Ruby Cloth," is listed as GC Electronics part number 912. Impregnated with polish, the cloth is ideal for cleaning picture tubes, and is handy to cover glass (keeping dirt and smudges off) during servicing operations. As a plastic cleaner and polisher, the cloth can be used on plastic TV cabinets, knobs, converter cabinets, or any plastic surfaces. The "Ruby Cloth" can even help disguise minor scratches.

Winegard Dealer of the month



Pacific Antenna Service El Cajon, California

Winegard Congratulates Pacific Antenna Service on their 15th year of continual growth and their distributor, Radio Parts Company, San Diego, Calif.

How would you like to have a rig like L. G. Schlick, owner of Pacific Antenna Service? One of the largest antenna specialists in the country, Pacific Antenna Service sells and installs hundreds of antennas every month.

An exclusive Winegard dealer, Pacific constantly tests antennas both Winegard and competitive makes. Mr. L. G. Schlick recently wrote John Winegard as follows:

"Six years ago, after going from one antenna to another, we finally settled down with WINEGARD. Since that time we have never had a complaint against a WINEGARD antenna, and WINEGARD has doubled our business year after year.

"We have just completed tests with WINEGARDS against the new V type antennas, and also against a new \$79.00 antenna that was supposed to out-perform the new WINEGARD (Colortron model C44). We made the tests without amplifier and there was NO comparison. WINEGARD was out in front in every way—directivity, DB gain, front-to-back ratio, ease of assembly, and durability."



D3009-9 Kirkwood • Burlington, Iowa

Circle 65 on literature card

September, 1963/PF REPORTER 87

CATALOG AND LITERATURE SERVICE

ANTENNAS & ACCESSORIES

72. **ANTENNACRAFT**—Catalog sheet, illustrated in color, with complete performance and pricing information on new *Gold UHF* antennas — single, stacked, or in kits.
73. **ANTENNA SPECIALISTS** — Complete set of catalog pages listing outstanding features of both amateur and Citizens-band beam antennas.
74. **BLONDER-TONGUE**—Illustrated brochure showing complete line of indoor TV-FM signal boosters for use with one to four different receivers. Tube and transistor types available.*
75. **CHANNEL MASTER** — Brochure describing *Super-Crossfire* high-gain antenna, designed for both stereo-FM and TV reception.
76. **CUSH CRAFT**—Illustrated brochure on complete line of Citizens-band antennas and accessories, including *Blitz Bug* coaxial lightning arrester.
77. **GALLO**—Descriptive brochure on FMS-101, an FM antenna system with transistorized preamplifier, entirely contained within decorative 6 1/2" x 3 3/4" x 1-3/16" case.
78. **JERROLD ELECTRONICS** — 6-page, color-illustrated catalog on *Paralog*, new line of log-periodic antennas with modular parasitic elements, for VHF TV and FM installations.*
79. **JFD**—Specifications and operating information on *Transis-tenna* and newly designed, long-range LPV log-periodic TV antennas. Illustrated brochure showing entire line of indoor antennas and accessories for TV and FM.*
80. **MOSLEY ELECTRONICS**—Illustrated catalog giving specifications and features on large line of antennas for Citizens band and amateur applications.*
81. **WINEGARD**—New Fact-Finder booklets on line taps, "K" series antennas, FM antennas, multiset couplers, and UHF-110 transistor antenna amplifier.*
82. **ZENITH**—Informative bulletin on new line of log-periodic vee-tube antennas for FM, and for monochrome and color TV.*

AUDIO & HI-FI

83. **ATLAS SOUND, Div. of American Trading and Production Corp.**—New illustrated catalog number 563, containing specifications of microphone stands and loudspeakers for use in public address, commercial, or industrial installations.
84. **ELECTRO-VOICE**—High-Fidelity catalog No. 159 is a buyer's guide to component loudspeakers, accessories, and kits.*
85. **EUPHONICS** — Four informative brochures illustrating ceramic phono cartridges and microphones; cartridge cross-reference index is included.
86. **MINNEAPOLIS SPEAKER** — Descriptive catalog with illustrations of new weatherproof *Music Mini-Speaker* for indoor or outdoor high-fidelity reproduction.
87. **OAKTRON**—"The Blueprint to Better Sound" an 8-page catalog of loudspeakers and baffles giving detailed specifications and list prices.
88. **PERMA-POWER** — Descriptive literature on battery-operated, portable sound systems: *Roving Rostrum and Diplomat*.
89. **PRECISION ELECTRONICS** — Bulletin 101 describing popular Model 502M stereo tuner-amplifier, now offered at new lower price.
90. **QUALITONE** — Wall chart, with needles pictured, for cross-reference of all popular needle replacement needs.
91. **QUAM-NICHOLS** — *Speaker Replacement Guide* listing the speakers used in all automobiles from 1955 through 1962.*
92. **ROBINS**—Special catalog No. 17XL provides technical specifications of Cannon XL series of plugs and connectors for electronic equipment.
93. **SONOTONE**—Four-page technical article "Cordless Power Story" gives construction features and applications for nickel-cadmium battery cells.
94. **SWITCHCRAFT**—Bulletin No. 129 describing new series 3508 color-coded phono plugs, with snap-on colored handles and positive-grip cable clamp; simplified stereo, hi-fi, and test equipment hookups.
95. **UTAH**—Catalog listing complete line of speakers and accessories for high-fidelity and public-address equipment. Also contains speaker replacement data.

COMMUNICATIONS

96. **CADRE INDUSTRIES** — Detailed information on 5-watt Citizens-band units,

and on new 1.5-watt hand-held transceiver.

97. **ELECTRONIC COMMUNICATIONS, INC.** — Illustrated leaflets describing line of communications gear, including CB transceiver and 30-watt linear amplifier.
98. **MICROWAVE SERVICES INTERNATIONAL** — Comprehensive 12-page brochure describing services, capabilities and experience in telecommunications systems engineering. Included is discussion of techniques used in conducting communications systems analyses and designs.
99. **RAYTHEON** — Descriptive sheet on *Ray-Tel* CB communications system, using solid-state frequency synthesizer.

COMPONENTS

100. **BUSSMANN**—Bulletin SBCU on Buss Fustat Box Cover Units offers simple, low-cost way to protect workbench tools, soldering irons, drills, and the like against damage and burnout. Units fit standard outlet or switch boxes; have fuseholder, plus a plug-in receptacle, switch, and pilot light.*
101. **COLUMBIA WIRE** — Comprehensive catalog 110 describing many service-dealer wire needs plus an array of multicolor coax cables.
102. **LITTELFUSE** — Form L-562 showing prices and specifications on complete line of fuses, fuse holders, and merchandising aids.*
103. **SPRAGUE**—Latest catalog C-615 with complete listings of all stock parts for TV and radio replacement use, as well as *Transfarad* and *Tel-Ohmike* capacitor analyzers.*
104. **STANCOR ELECTRONICS** — Durable wall-card tabulating proper output transformer to use with each of 260 different audio output tubes; includes specifications for each transformer recommended.
105. **TRIAD**—New catalog TV-63/64 lists many replacement items for radio, TV, and hi-fi.
106. **WALDOM**—New catalog PMR-3 gives complete list of packaged electronic and electrical products "for prototype, maintenance and repair." Includes such items as solderless terminals and connectors, hardware, tube sockets, and terminal strips. Comprehensive list of speakers for foreign-made transistor radios helps technician to select proper replacement types.

SERVICE AIDS

107. **CASTLE**—How to get fast overhaul service on all makes and models of television tuners is described in leaflet, which also contains a comprehensive list of universal and original-equipment tuners.*
108. **CHEMTRONICS**—Brochures illustrating dozens of chemical products for TV and radio use. Includes information on new *Jet Spare* aerosol-spray compound that seals tire punctures and re-inflates tire in one operation.
109. **COLMAN** — New 1963-64 catalog of radio-TV replacement components and service aids.*
110. **ELECTRONIC CHEMICAL CORP.** — Catalog listing chemical sprays for cleaning and lubrication in all types of electronic equipment.
111. **INJECTORALL** — New 1963 catalog showing complete line of chemicals used in electronics.*
112. **PRECISION TUNER**—Literature supplying information on complete, low-cost repair and alignment services for any TV tuner.
113. **STANDARD KOLLSMAN** — Tuner replacement guide, covering all TV sets from 1947 through 1962, with replacement parts listings.
114. **WORKMAN** — General catalog CAF-102, fusible resistor and circuit breaker cross-reference guides, information on transistorized auto ignition system, and power converter sheet 25C.
115. **YEATS**—The new "back-saving" appliance dolly Model 7 is featured in a four-page booklet describing feather-weight aluminum construction.*

SPECIAL EQUIPMENT

116. **ATR**—Descriptive literature on selling new, all-transistor *Karadio*, Model 707, having retail price of \$29.95. Other literature on complete line of DC-AC inverters for operating 117-volt PA systems and other electronic gear.*
117. **GC ELECTRONICS**—Giant-sized catalog FR-65 contains 330 pages, forming the most complete listing yet published of new products and equipment offered by all company divisions.*
118. **GREYHOUND**—The complete story of

the speed, convenience, and special service provided by the Greyhound Package Express method of shipping, with rates and routes.*

119. **SIMPSON**—Latest series of VOM's are described in test-equipment bulletin; also information on line of automotive test equipment.
120. **TERADO**—Sheet depicting wide line of 60-cps mobile power inverters and several types of battery chargers.*
121. **VOLKSWAGEN**—Large, 60-page illustrated booklet "The Owner's Viewpoint" describes how various VW trucks can be used to save time and money in business enterprises; includes complete specifications on line of trucks.*

TECHNICAL PUBLICATIONS

122. **CLEVELAND INSTITUTE OF ELECTRONICS** — "Pocket Electronics Data Guides" with handy conversion factors, formulas, tables, and color codes. Additional folder, "Choose Your Career in Electronics," describes home-study electronics training programs, including preparation for FCC-license exam.*
123. **HOWARD W. SAMS**—Literature describing popular and informative publications on radio and TV servicing, communications, audio, hi-fi, and industrial electronics; including special new 1963 catalog of technical books on every phase of electronics.*

TEST EQUIPMENT

124. **ANTRONICS**—General catalog describing Anchor Model T-475 *Reacto-Tester*, which repairs, analyzes, and tests every type of picture tube.*
125. **B & K**—Catalog AP-21R describing uses for and specifications of new Model 1074 Television Analyst, Model 1076 Television Analyst, Model 850 Color Generator, Model 960 Transistor Radio Analyst, new Model 445 CRT Tester-Rejuvenator, new Model 230 Substitution Master, Model 375 *Dynamatic* VTVM, Model 360 *V-O-Matic* VOM, Models 700 and 600 *Dyna-Quik* Tube Testers, and Model 1070 *Dyna-Sweep* Circuit Analyzer.*
126. **EICO**—Catalog sheets on new Model 430 small general-purpose oscilloscope with 3" screen, and on Model 902 IM-Harmonic Distortion Meter and AC VTVM. Booklet "Short Course For Novice License" is also available.*
127. **HICKOK**—Complete descriptive and operating information on Model 661 *Chrom-Aligner* standard NTSC color-bar generator.*
128. **MERCURY**—Catalog giving full information on Models 1000, 1100, and 1200 Tube Testers, Models 202 and 203 Self-Service Tube Testers, new Model 301 Combination Tester, new Model 501 Component Substitutor, and Model 800 CRT Tester-Reactivator.*
129. **SECO**—New four-page catalog describes *Vari-Volt* units for controlling lighting, heating elements, or AC-DC motors up to 15 amps.*
130. **SENCOKE** — Special, newly released data on color test equipment, including the entirely new, low cost CG126 Color Generator, CA122 *Color Circuit Analyzer*, and PS120 *Wide-Band Scope*.*
131. **TRIPLETT**—Catalogs displaying complete line of test equipment for servicing, and industrial meters for all purposes.*

TOOLS

132. **BERNS**—Data on unique 3-in-1 picture-tube repair tools, on *Audio Pin-Plug Crimper* that enables technician to make solderless plug and ground connections, and on new-style *ION* adjustable "beam bender" for CRT's.*
133. **ENTERPRISE DEVELOPMENT** — Time-saving techniques in brochure from Endeco demonstrate improved desoldering and resoldering techniques for speeding up and simplifying operations on PC boards.
134. **EVERSOLE** — Sheets describing and listing prices of *DeSod* desoldering tools for removing and replacing parts on printed circuit boards, including new tip for miniature IF transformers.

TUBES AND TRANSISTORS

135. **AMPEREX** — Catalog specifically devoted to extensive line of silicon planar epitaxial transistors. Describes applications for different types, with their basic specifications.*
136. **SEMITRONICS**—New updated 16" x 20" wall chart CH7 lists replacements, with substitution data, for 2000 U.S. and foreign transistors.
137. **GRODEN INC.**—New, condensed semi-conductor catalog listing complete line of components.

*Check "Index to Advertisers" for further information from this company.

Service Technicians ahoy!

RCA to the rescue!

In electronic servicing, it's the little things that count . . . the minor problems that add up to a major loss of time. Now RCA answers the S-O-S of busy servicemen with 5 new service aids:

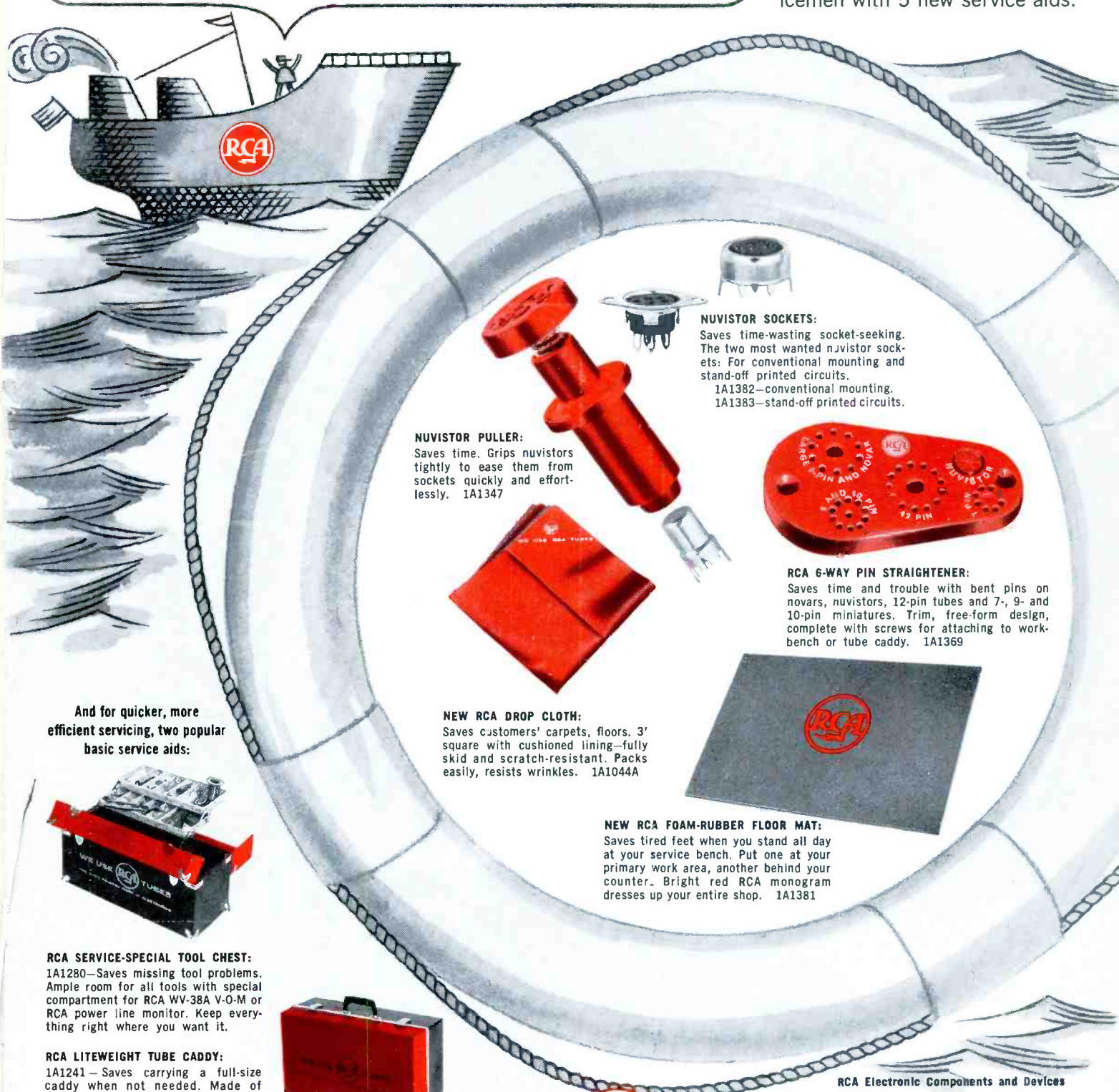

NUVISTOR PULLER:
Saves time. Grips nuvistors tightly to ease them from sockets quickly and effortlessly. 1A1347

NUVISTOR SOCKETS:
Saves time-wasting socket-seeking. The two most wanted nuvistor sockets: For conventional mounting and stand-off printed circuits.
1A1382—conventional mounting.
1A1383—stand-off printed circuits.

RCA 6-WAY PIN STRAIGHTENER:
Saves time and trouble with bent pins on novars, nuvistors, 12-pin tubes and 7-, 9- and 10-pin miniatures. Trim, free-form design, complete with screws for attaching to workbench or tube caddy. 1A1369

NEW RCA DROP CLOTH:
Saves customers' carpets, floors. 3' square with cushioned lining—fully skid and scratch-resistant. Packs easily, resists wrinkles. 1A1044A

NEW RCA FOAM-RUBBER FLOOR MAT:
Saves tired feet when you stand all day at your service bench. Put one at your primary work area, another behind your counter. Bright red RCA monogram dresses up your entire shop. 1A1381

And for quicker, more efficient servicing, two popular basic service aids:

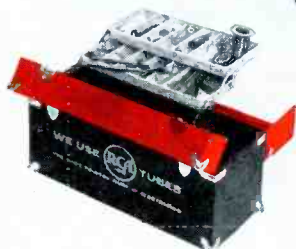

RCA SERVICE-SPECIAL TOOL CHEST:
1A1280—Saves missing tool problems. Ample room for all tools with special compartment for RCA WV-38A V-O-M or RCA power line monitor. Keep everything right where you want it.

RCA LITEWEIGHT TUBE CADDY:
1A1241—Saves carrying a full-size caddy when not needed. Made of sturdy, stain-resistant lightweight molded plastic. And it can hold up to 210 receiving tubes at one time.



RCA Electronic Components and Devices



The Most Trusted Name in Electronics

Circle 66 on literature card

SEE YOUR PARTICIPATING RCA TUBE DISTRIBUTOR FOR ALL THESE RCA SERVICE AIDS.

www.americanradiohistory.com

See the caddy



See the fuse box
through the caddy



See the fuses
through the
fuse box
through the caddy



See more profits through

LITTELFUSE

DES PLAINES, ILLINOIS

Circle 67 on literature card

www.americanradiohistory.com