

APRIL, 1962

35 CENTS



# PHOTOFACT REPORTER

including **Electronic Servicing**

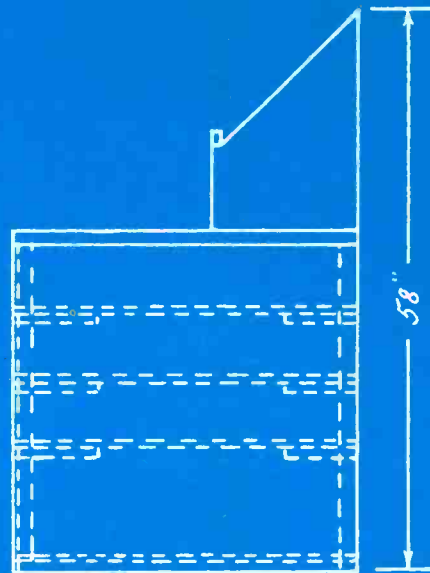
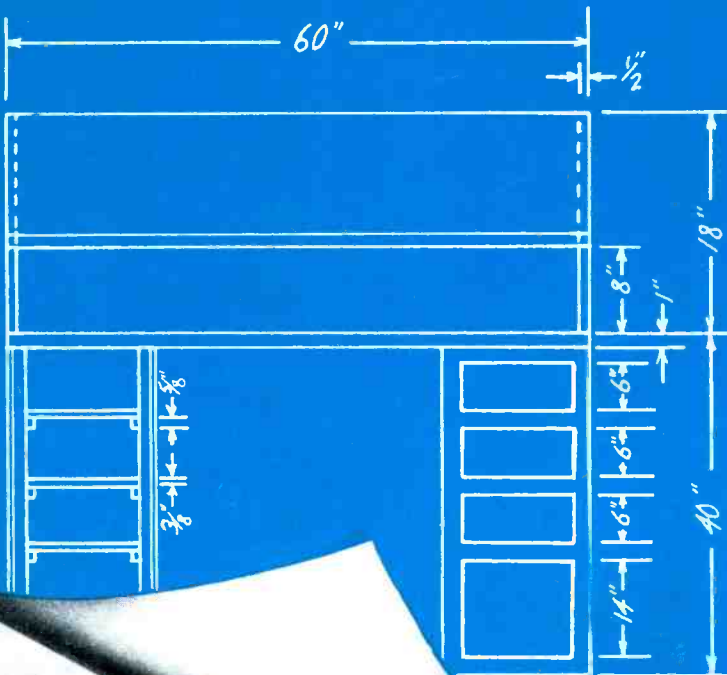
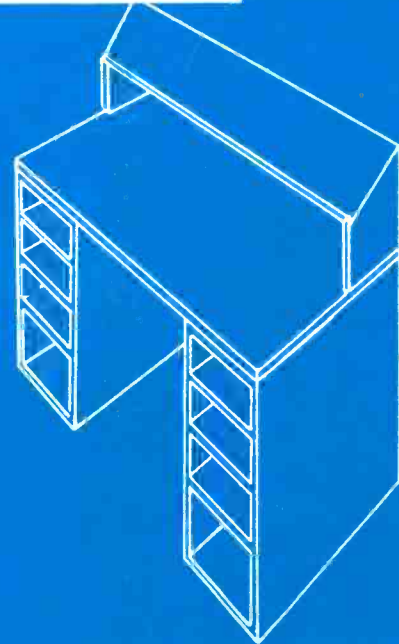
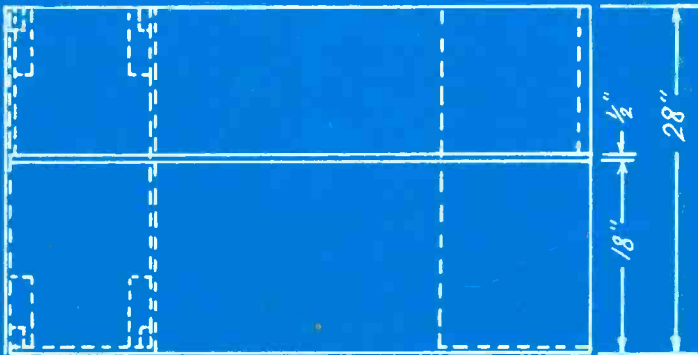

## Blueprints for Service Benches

**Automatic Brightness and Contrast Control**

**Let's Have a Look at Antenna Preamps**

**Develop Your Own Tube-Test Data**

**Freak Rasters and Their Causes**

**Coping With Callbacks**

JAN. 27 1962  
JAMES M. DAVIS  
RADIO TV SERV.  
118 RIVERSIDE AVE.  
CANNON CITY, COLO.

# TOP

**Higher Gain**

**Lower Noise**

# OF THE HEAP

85% of all TV servicemen prefer Standard turret type replacement TV tuners.

1 year guarantee backed by the world's largest TV tuner manufacturer.

Trade-in allowance for the defective tuner being replaced.

**In TV It's Standard**

See your local authorized Standard Coil Distributor

## **standard kollsmann**

**INDUSTRIES INC.**

FORMERLY STANDARD COIL PRODUCTS CO., INC., MELROSE PARK, ILLINOIS

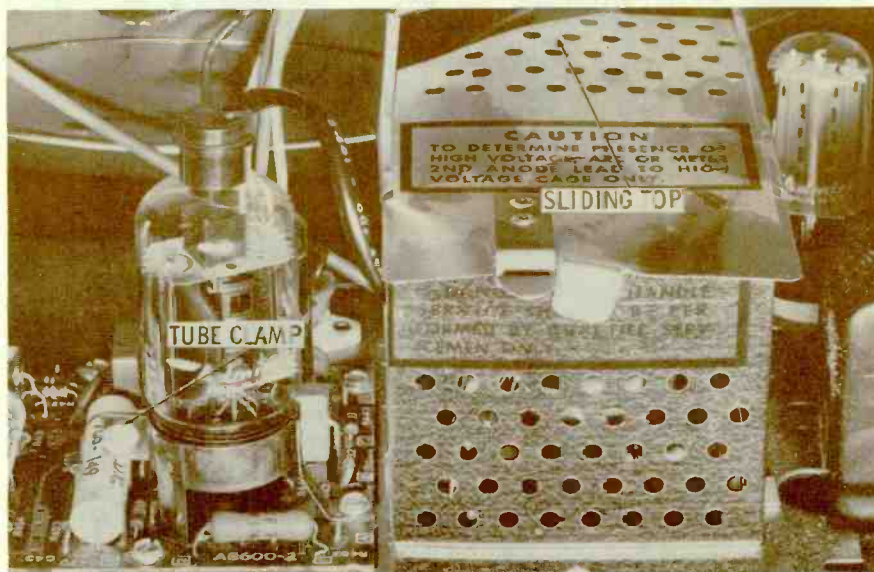
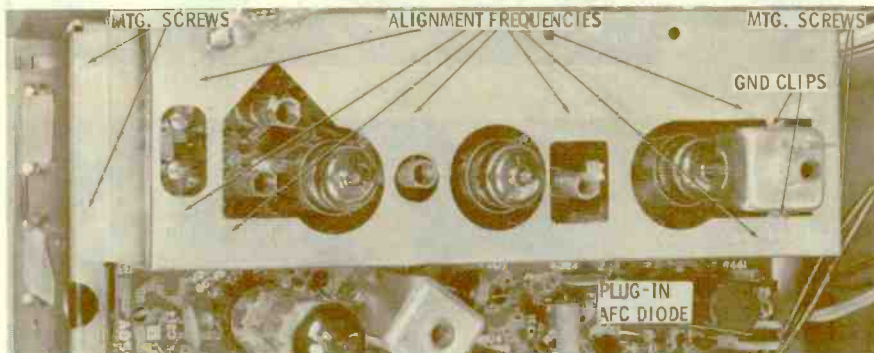
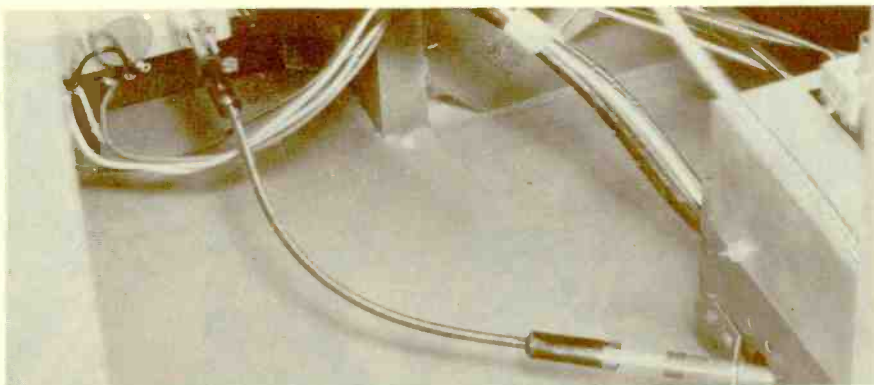
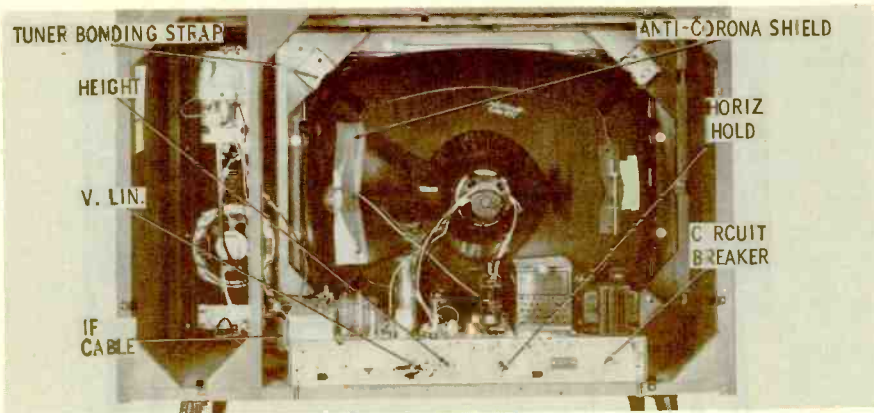

### Admiral Model 2711 Chassis 20L8

The Model 2711 uses a chassis which is very similar in many respects to other chassis of Admiral's 1962 line, but incorporates certain changes which adapt it to the 92° short-neck 27YP4 CRT. For example, the yoke is different from that used in 23" models. All 27" sets use the more efficient 1K3 high-voltage rectifier instead of the 1G3 found in some 23" chassis, and the 6DE4 damper is used in place of the more conventional 6AX4GTB. As in other chassis, a 6K11 *compacron* is used as a gated AGC-sync separator-noise inverter, and a 6EW7 serves as a vertical oscillator-output stage.

Among other changes are: Different peaking coils are used in the video amplifiers, some component values are altered in the CRT cathode and grid circuits, the horizontal-output screen resistor is reduced from 18K to 10K, the boost capacitor is increased from .027 mfd to .1 mfd, and a capacitor is added across part of the yoke winding to increase the width.

The rear cover is held in place by clip retainers, simplifying access to the inside. The chassis must be removed from the rear of the cabinet, since the CRT and chassis are separate assemblies.

On the rear chassis apron, certain of the service controls are covered with paper stickers to prevent tampering. The close-up photo shows the sliding top used on the high-voltage cage, the support clamp for the horizontal output tube, and a plastic sleeve projecting from the rear of the chassis (the horizontal hold control).

Width is controlled by a width sleeve placed around the neck of the CRT, under the deflection yoke. The *picture guard* serves as a sync-stabilizing control, adjusting the bias on the noise-inverter section of the 6K11.

The cover shield of the video-IF section can be removed, if necessary to service the printed board, by removing four screws (see photo). Access to all IF adjustments is from the top, and the alignment frequency for each coil is stamped on the shield. The video-detector can, near the right end in the photo, is grounded to the shield by spring clips.

The contrast control is connected to its knob by a flexible drive shaft, as seen in the close-up photo. The shaft can be removed from the control by pushing forward on the coupling near the chassis.



**Emerson Model 1554  
Chassis 120572-C**

This model combines an AM-FM-stereo combination with a 19" television set. The TV section utilizes a 114° aluminized 19YP4 CRT and a glare-free safety glass. The AM-FM-stereo and television sections can be used independently, although the speaker system is common to both.

The TV is divided into two chassis, one containing the power supply and parts of the deflection circuits, and the other — a printed-board chassis — containing the remainder of the circuits. The power supply is a half-wave doubler which makes use of a tapped selenium rectifier. The power-supply circuits are protected by a 1.6-amp slow-blow fuse, and the filament circuit is protected by a 1-ohm fusible resistor.

An 8EB8 tube serves as video output and vertical oscillator, and an 8EM5 is used in the vertical output stage. AGC voltage is developed in the video detector, and controlled by a switch. With the switch in NORMAL position, two 680-ohm resistors are in series with the tuner input leads. In the DISTANCE position, the switch bypasses these two resistors and also shunts a part of the AGC voltage to ground.

The stereo record changer is a four-speed type, and shuts itself off after playing the last record in the stack. It does not, however, turn off the amplifier. The stereo amplifier on-off switch, mounted with the treble control, is a three-pole type. When the stereo amplifier is turned off, two switch contacts connect the speaker system to the TV audio-output transformer. Thus, if the stereo-section switch is left "on," the TV sound cannot be heard.

The FM receiver is separate from the AM-radio RF-IF section, and both can be tuned independently for simulcast stereo presentations. The B+ and filament supplies for the AM section are separate from those of the FM tuner. The AM power supply (which also supplies the audio amplifiers) is a small silicon rectifier, protected by a 22-ohm fusible resistor. The FM tuner receives B+ from a selenium rectifier, protected by a 220-ohm fusible resistor. Filaments of the three 12-volt tubes in the FM tuner receive current from the AC line through a 530-ohm resistor.

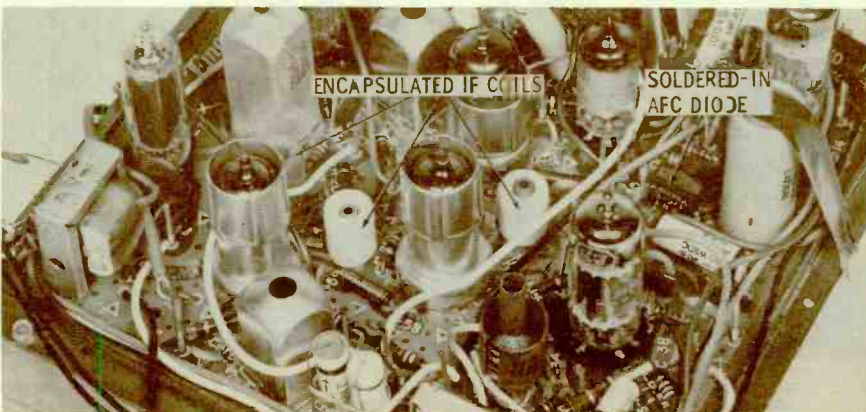
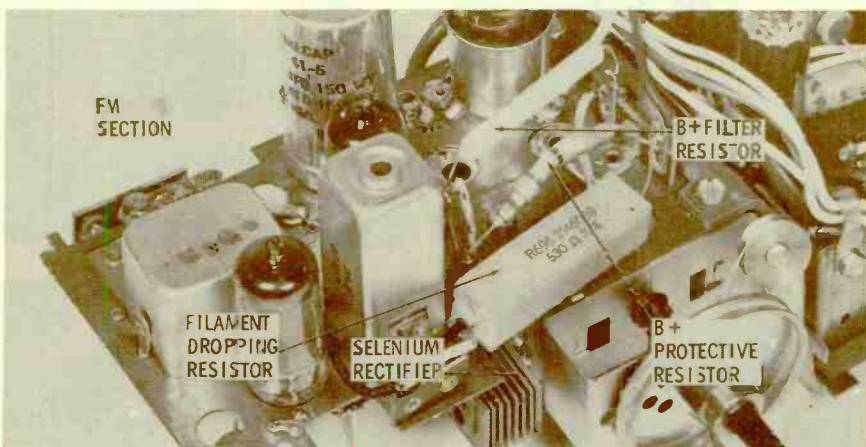
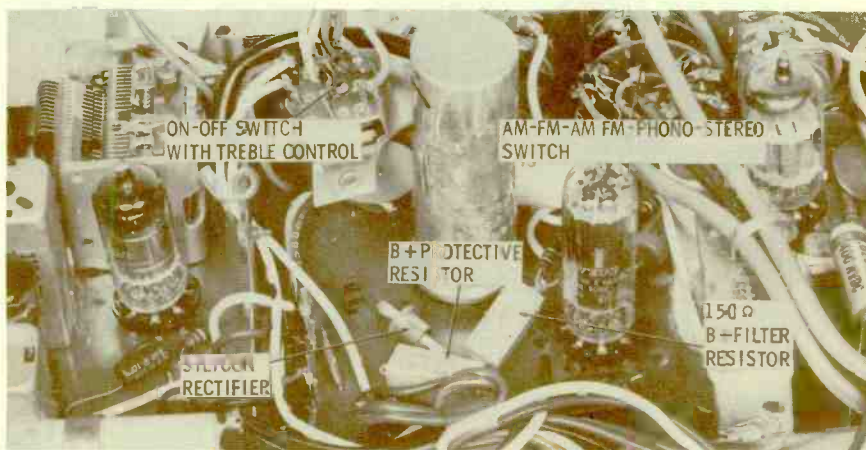
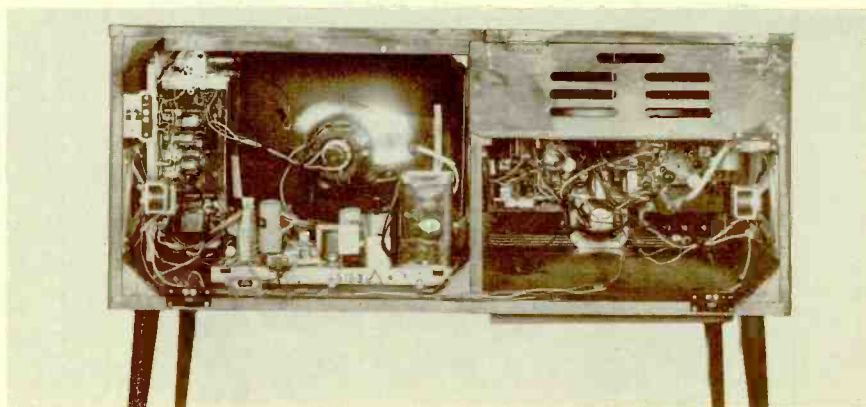

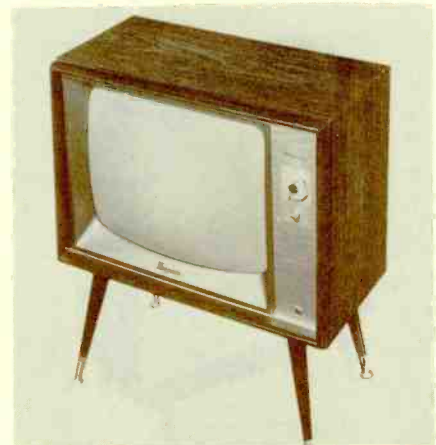
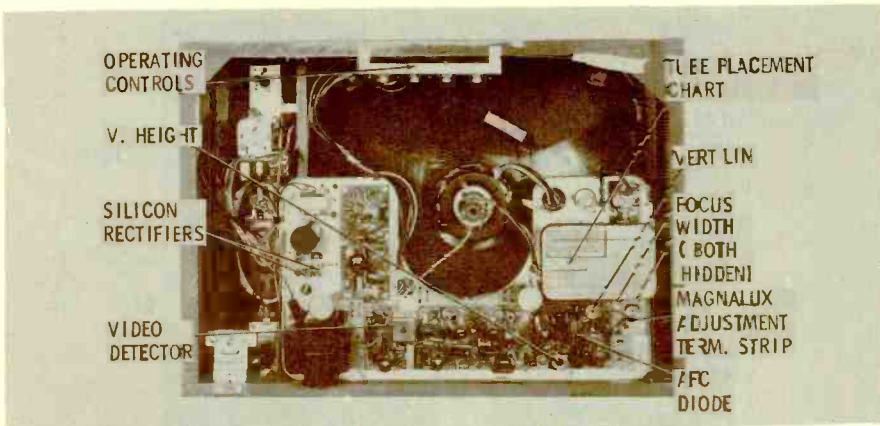

**Magnavox  
Model 2MV360M  
Chassis 36-03**

The 19" sets in this series use a 114° aluminized 19BTP4 CRT, while 23" sets use a 114° aluminized 23MP4. The chassis in both model sizes are similar. The short vertically-mounted printed-circuit chassis is typical of the most recent Magnavox sets. Operating controls are mounted on a subassembly seen at the top center of the rear-view photo; the viewer reaches over the top of the set to control brightness, contrast, vertical hold, and horizontal hold.

The horizontal output tube is a newer type, a 6GW6 which operates at increased efficiency with a lower-than-usual screen voltage. The 6GC5 audio output tube is one of the new 9-pin tubes which has a large envelope (known as a T9), and runs at higher power than its smaller counterpart (the standard 9-pin miniature).

Four printed boards—video-IF, video, audio, and sweep-oscillator—are mounted on the main chassis, which contains the conventionally-wired horizontal output circuits and power supply. The B+ supply is a transformer-isolated voltage doubler using silicon rectifiers and protected by a 5-ohm, 10-watt fusible resistor. Also shown is the terminal strip used when the set is equipped with remote control. In addition to the fusible resistor, the power supply of the set is protected by a circuit breaker in the primary circuit of the power transformer.

The tuner is one of the small CK-type "compact" units recently introduced by Standard Kollsman, and uses a 6GK5 low-noise RF amplifier and a 6CG8 mixer-oscillator. In the photo, note the plastic parts used in the fine-tuning control. The on-off switch and volume control are mounted on the tuner bracket.

The *Magnalux* circuit automatically compensates for changes in room lighting. This circuit is a bit more than just an automatic brightness control. The cadmium-sulfide cell (seen atop the chassis in the photo) affects the voltage at the brightness control, and governs to some degree the voltage on the screen of the video amplifier. In this manner, it automatically adjusts both the brightness and the contrast levels on the CRT. A three-terminal board on the main chassis permits adjustment of the range of the *Magnalux* controlling voltages, to suit varying conditions.

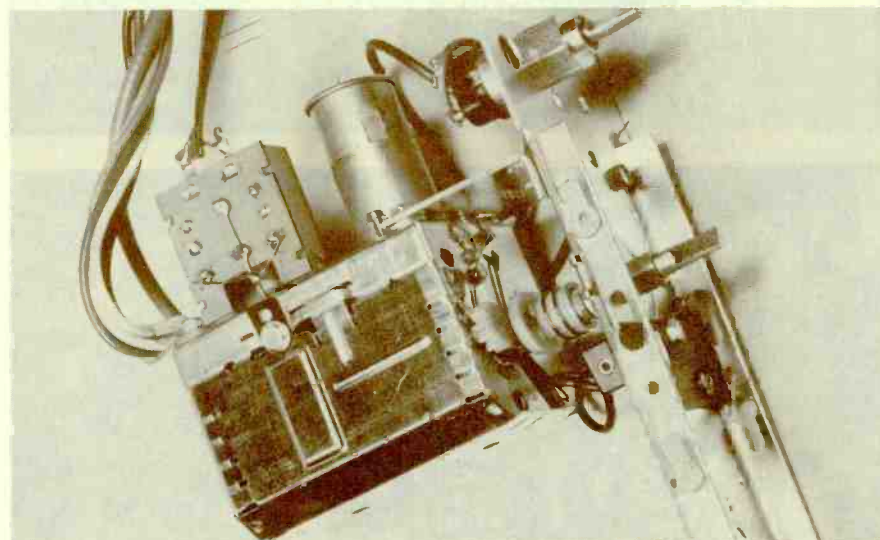
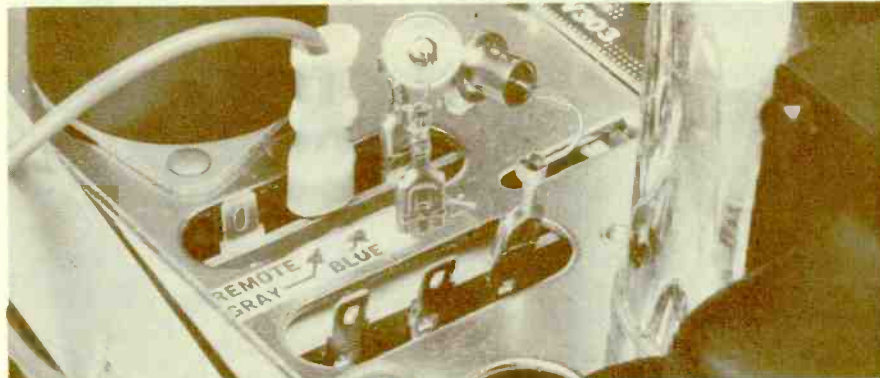



**Silvertone Model 21-461  
Chassis 528.51894**

This chassis is available in both 19" and 23" models, incorporating a 19AY-P4, 19AXP4, or a 23ALP4 CRT (all 114° aluminized types).

This model features the usual "swing-out" chassis mounting, released by removing three screws. With some of the sets, in order to swing the chassis out far enough to permit access to the entire chassis, it is necessary to snap out a small plastic mounting clip (see photo).

The silicon rectifier voltage-doubler power supply is protected by both a circuit-breaker and a 4.5-ohm, 10-watt fusible resistor. The 450-ma controlled warm-up heater string is protected by a 22-ohm, 7-watt resistor.

No new or unusual tube types are found in this model. A 22DE4 damper is used, along with a 1G3GT high-voltage rectifier. In the vertical sweep circuit, a 13EM7 functions as a multivibrator-output stage.

The VHF tuner is a turret type, using a 3GK5 RF amplifier and a 6FG7 oscillator-mixer. A UHF tuner can be used with this set, incorporating a 3AF4 UHF oscillator tube. A special UHF position of the VHF tuner disables the VHF oscillator and connects the RF amplifier and the mixer to act as IF amplifiers for the converted UHF signal. Since the UHF tuner converts the signal directly to the 40-mc IF range, no further conversion is needed.

Following the shunt-type video-detector diode (part of a 6AM8 tube) is a coil called the "tweet" coil. This coil is broadly self-resonant at 4.5 mc, and serves to reduce the amount of sound-IF signal at the AGC take-off point. AGC is sent from the picture detector to the first video IF and the RF amplifier, without benefit of control or clamp, only the usual AGC filtering.

The audio-circuit components are contained in a module or "pack" which can be seen in the photo. Components used in the sync separator are also grouped in one of these modules. The printed-circuit boards are stamped in usual Silvertone fashion to simplify circuit-tracing and component identification. Two of these printed-circuit boards contain all the stages except the horizontal-deflection and high-voltage circuits, which are conventionally wired on the main chassis.

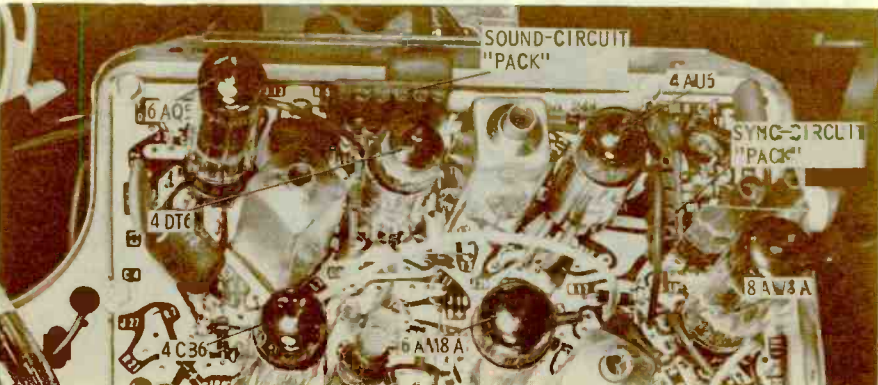
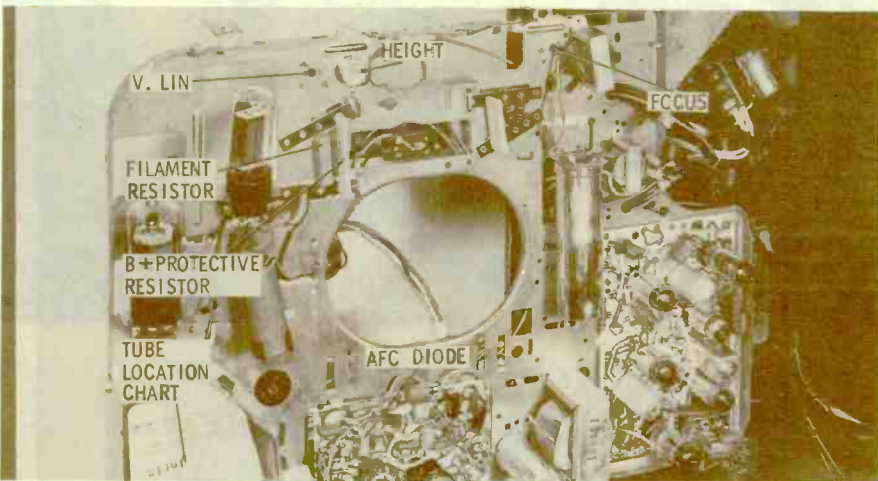
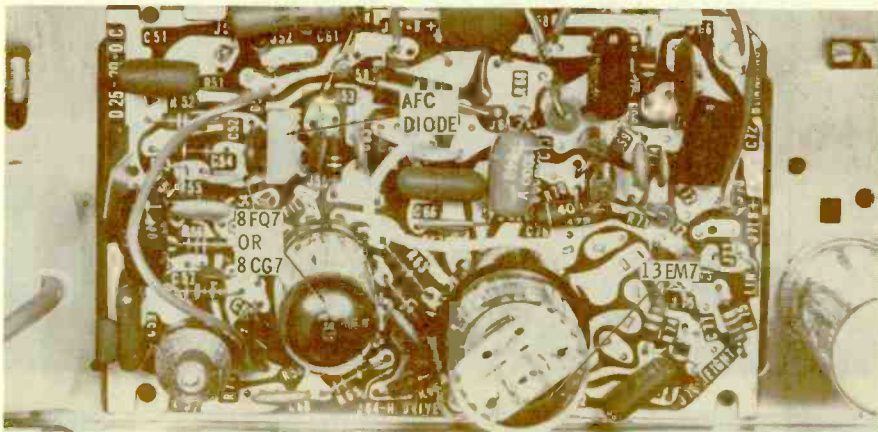
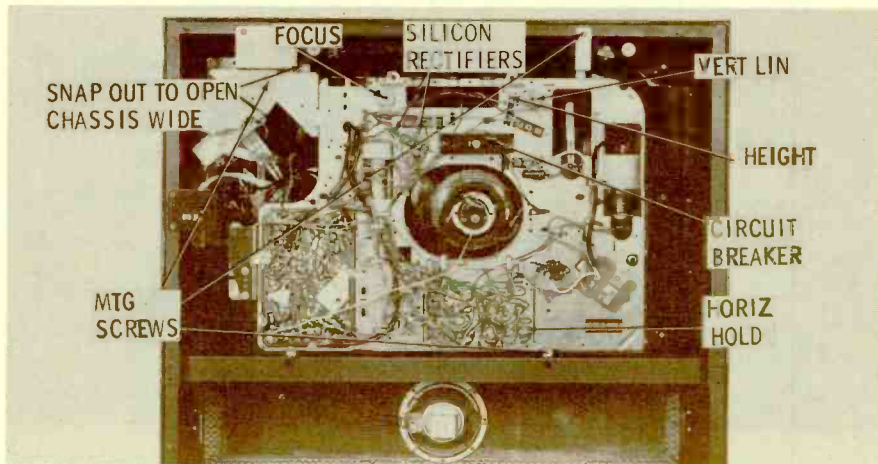

See PHOTOFACT Set 524, Folder 1

Mfr: Hoffman Chassis No. 356

Card No: HO 356-1

Section Affected: Raster.

**Symptoms:** No vertical sweep. Incorrect voltage and waveform on grid (pins 3 and 6) of V10.

**Cause:** Shorted feedback capacitor in vertical multivibrator.

**What To Do:** Replace C64 (10000 mmf - 2000V).

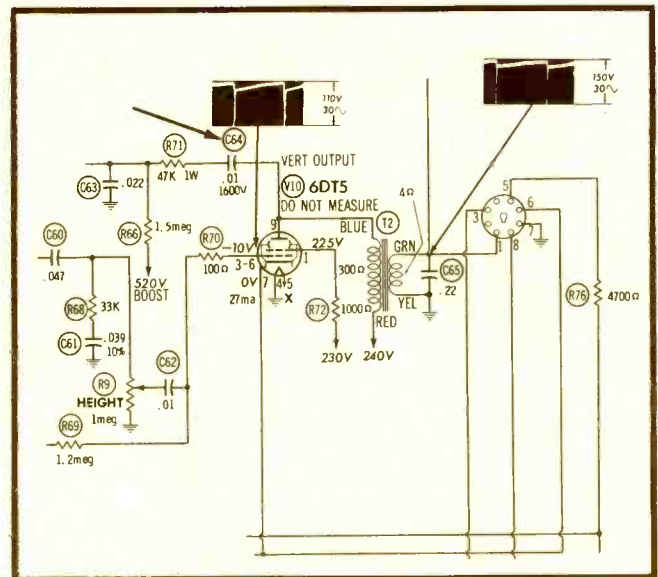

Mfr: Hoffman Chassis No. 356

Card No: HO 356-2

Section Affected: Sync.

**Symptoms:** Unstable horizontal and vertical hold. Voltage on plate (pin 1) of V5B may be too high.

**Cause:** Leaky plate-bypass capacitor in sync separator.

**What To Do:** Replace C51 (100 mmf).

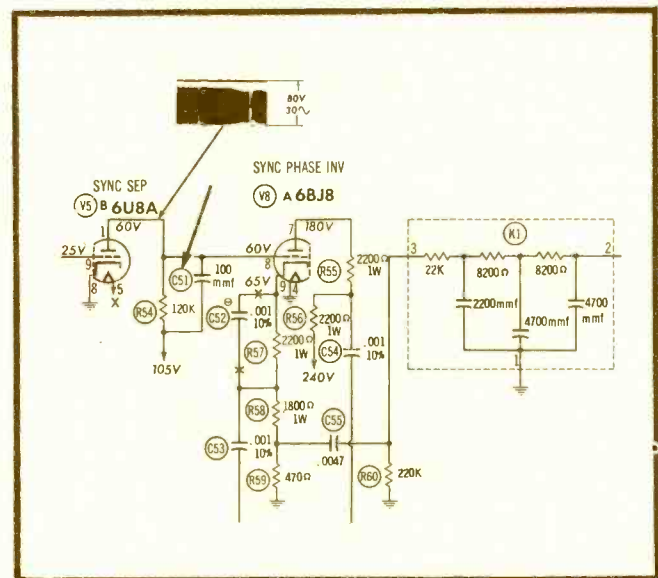

Mfr: Hoffman Chassis No. 356

Card No: HO 356-3

Section Affected: Sync.

**Symptoms:** No vertical or horizontal hold. Incorrect waveform at grid (pin 9) of V5A.

**Cause:** Open coupling capacitor between video output and sync separator.

**What To Do:** Replace C49 (.0022 mfd).

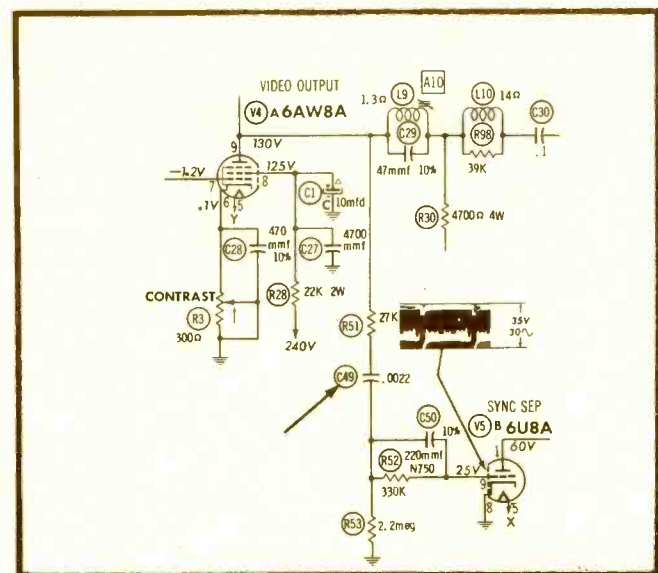

See PHOTOFACT Set 524, Folder 1

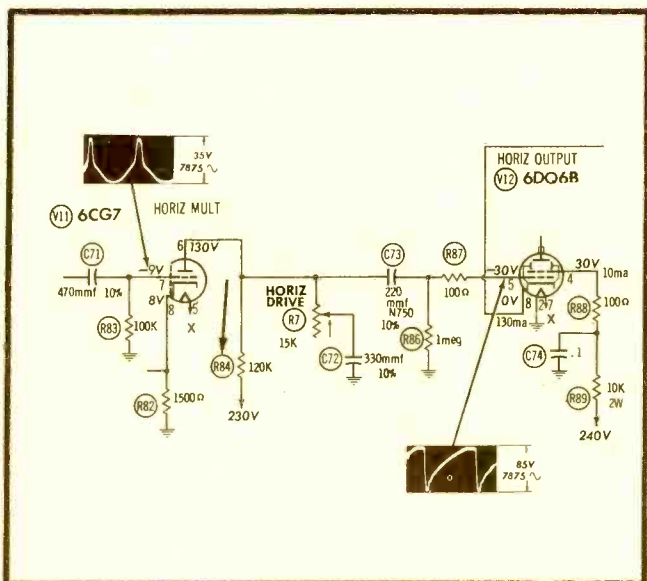

See PHOTOFACT Set 524, Folder 1

Mfr: Hoffman Chassis No. 356

Card No: HO 356-4

Section Affected: Raster.

Symptoms: Insufficient width. Low voltage at plate (pin 6) of V11. Incorrect waveform at grid (pin 5) of V12.

Cause: Plate-load resistor of horizontal multi-vibrator has increased in value.

What To Do: Replace R84 (120K).

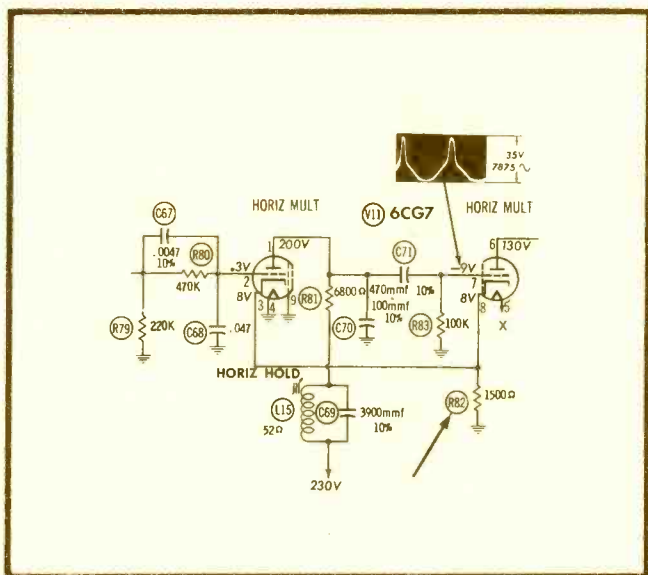

Mfr: Hoffman Chassis No. 356

Card No: HO 356-5

Section Affected: Sync.

Symptoms: Horizontal-multivibrator frequency drifts out of lock-in range. Voltage too high on cathodes (pins 3 and 8) of V11; incorrect waveform amplitude at grid (pin 7) of V11.

Cause: Cathode resistor of horizontal multi-vibrator increases in value.

What To Do: Replace R82 (1500 ohms).

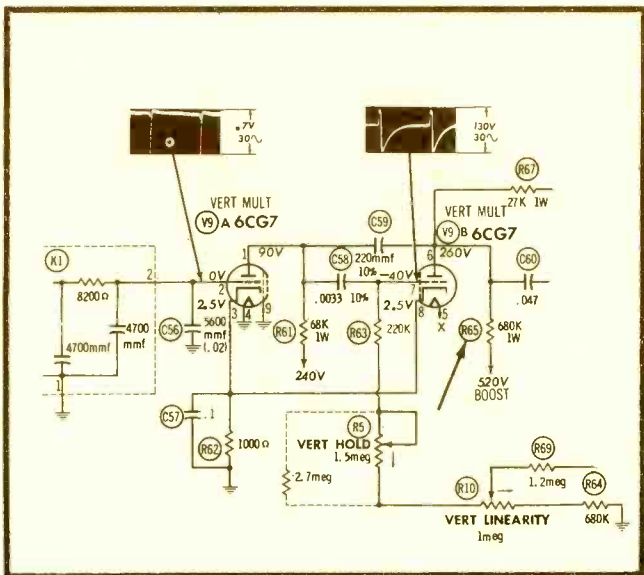

Mfr: Hoffman Chassis No. 356

Card No: HO 356-6

Section Affected: Raster.

Symptoms: Insufficient vertical sweep. Low voltage on plate (pin 6) of V9B; incorrect waveform at cathodes (pins 3 and 6) of V10.

Cause: Plate-load resistor of vertical multi-vibrator has increased in value.

What To Do: Replace R65 (680K).



See PHOTOFACT Set 496, Folder 2

Mfr: Zenith Chassis No. 16E21

Card No: ZE-16E21-1

Section Affected: Sync.

Symptoms: Picture drifts out of horizontal sync.

Cause: Grid resistor of horizontal oscillator increases in value, reducing the negative bias on grid of horizontal oscillator.

What To Do: Replace R78 (6.8 meg).

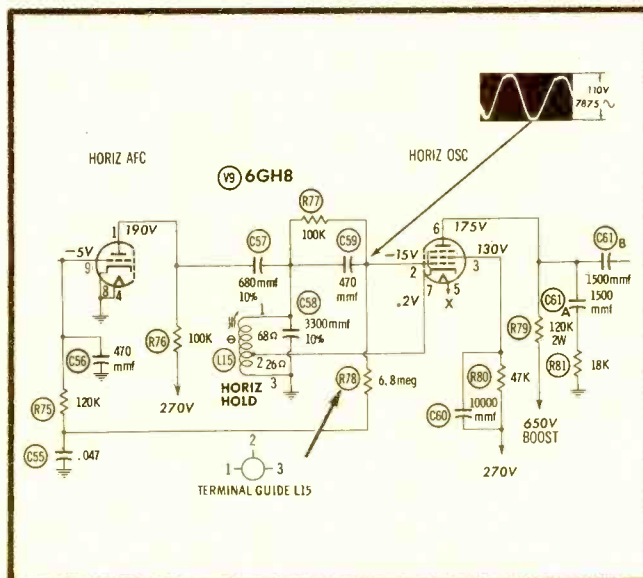

Mfr: Zenith Chassis No. 16E21

Card No: ZE-16E21-2

Section Affected: Sync.

Symptoms: No horizontal or vertical hold.

Cause: Resistor in sync-separator input circuit has increased in value. Voltage at sync-input grid (pin 9) of V5 is lower than normal.

What To Do: Replace R46 (8.2 meg).

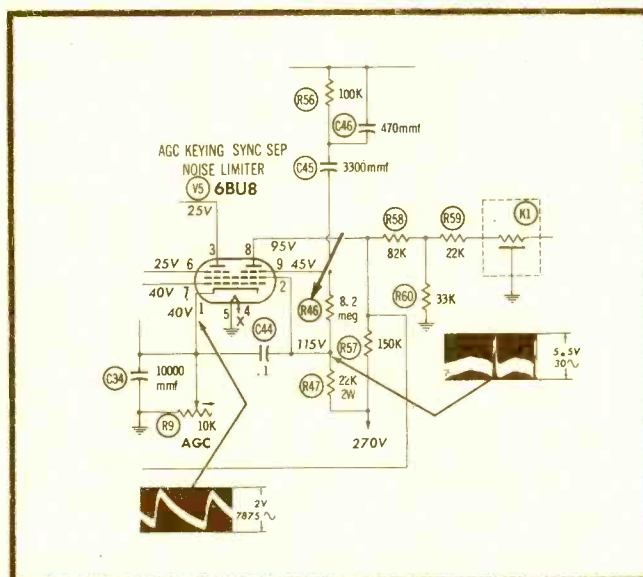

Mfr: Zenith Chassis No. 16E21

Card No: ZE-16E21-3

Section Affected: Raster.

Symptoms: Distorted vertical sweep; vertical-linearity control has no effect.

Cause: Shorted cathode-bypass capacitor in vertical output stage.

What To Do: Replace C1 (40-80-100 mfd - 400-400-50V).

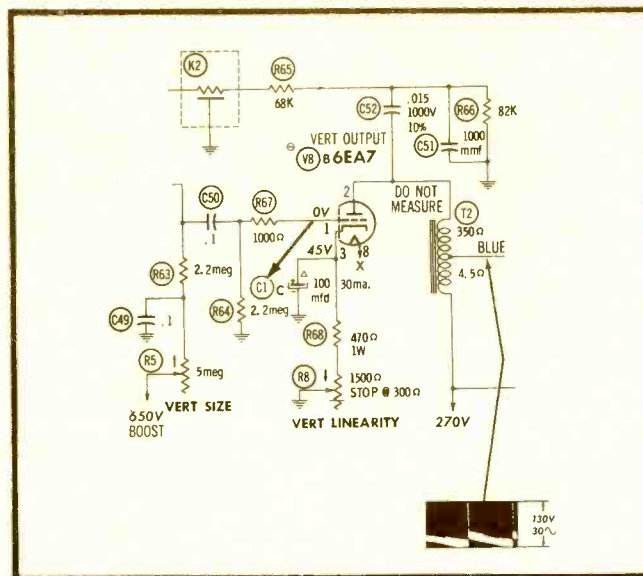

See PHOTOFACT Set 496, Folder 2

See PHOTOFACT Set 496, Folder 2

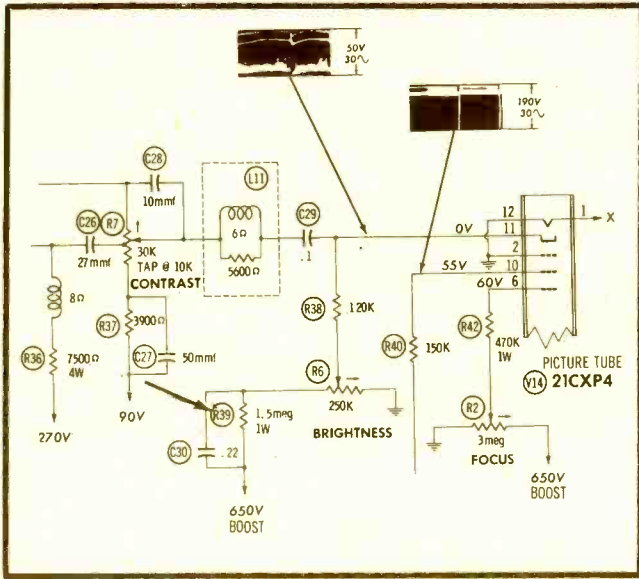

See PHOTOFACT Set 496, Folder 2

Mfr: Zenith Chassis No. 16E21

Card No: ZE-16E21-4

Section Affected: Pix.

Symptoms: Brightness always at maximum; control has no effect. Voltage at cathode (pin 1) of picture tube remains at zero.

Cause: Open resistor in series with brightness control across boost source.

What To Do: Replace R39 (1.5 meg - 1W).

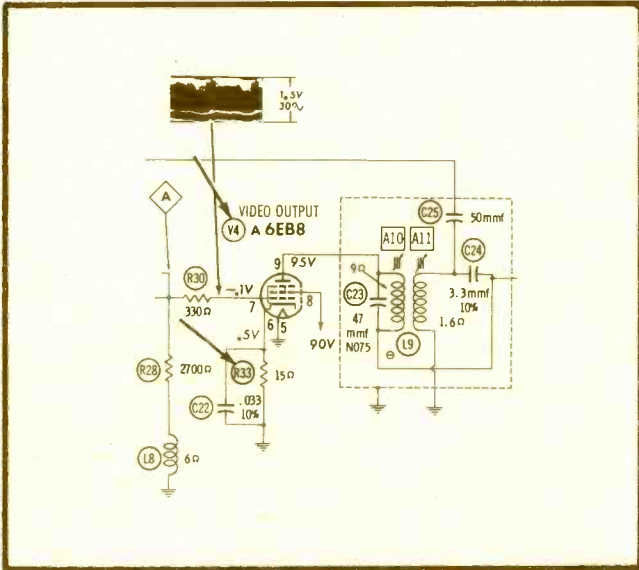

Mfr: Zenith Chassis No. 16E21

Card No: ZE-16E21-5

Section Affected: Pix.

Symptoms: Picture flashes off and on. Abnormally high voltage at cathode (pin 6) of V4A.

Cause: Cathode resistor has burned open, possibly because of a short or arc in video output tube.

What To Do: Replace R33 (15 ohms) and check for shorts and arcing in V4 (6EB8).

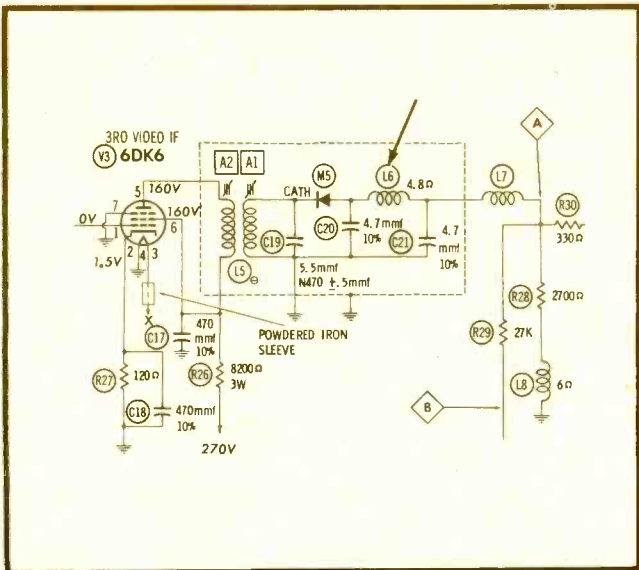

Mfr: Zenith Chassis No. 16E21

Card No: ZE-16E21-6

Section Affected: Pix.

Symptoms: Smeared, negative picture.

Cause: Open video-detector choke.

What To Do: Resolder leads of L6, or replace.

# Argos

**tube caddy**\*

---



THE ELECTRONIC TECHNICIAN'S  
MOST WIDELY USED SERVICE TOOL...  
NOW WITH NEW **VINYL** COVERING

\* REG. TM

Four models...all with new vinyl

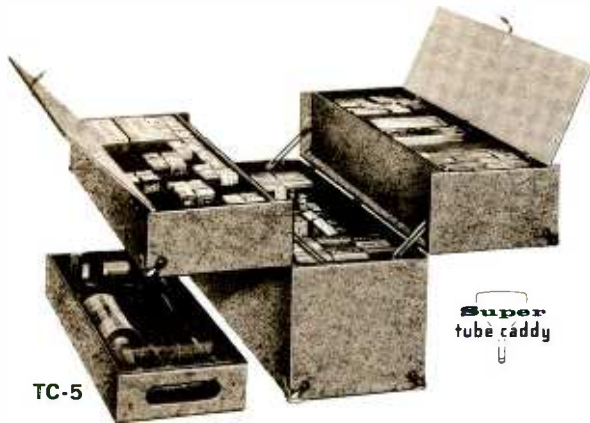

Super  
tube caddy

TC-5

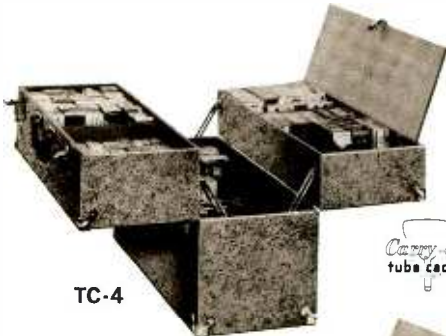

Carry-all  
tube caddy

TC-4

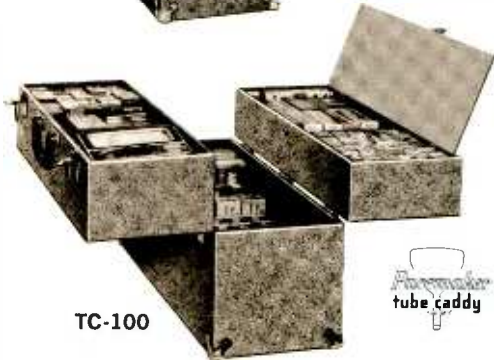

Pacemaker  
tube caddy

TC-100



Pacemaker Jr.  
tube caddy

TC-201

## NEW VINYL FOR THE ARGOS tube caddy\* IS THE TOUGHEST, LONGEST-LASTING, MOST ABRASION-RESISTANT COVERING WE'VE EVER USED!

Vinyl has long been famous for its super toughness and good looks. Now—after six years of research—Argos has perfected a method of applying a long-life vinyl covering to the Argos Tube Caddy® . . . and the technician's handiest helper now takes on a new value.

Argos Tube Caddies count, carry and "sort" tubes automatically. Missing tubes are easily spotted . . . you always have the right tube with you. And there's room for tools and meter. Shop owners say a Tube Caddy pays for itself in three weeks.

**TC-5 \$21.95 Super Tube Caddy.** Our largest Tube Caddy . . . a real man-size case with space for everything. Has over 3300 cu. in. volume, roughly  $\frac{1}{3}$  larger than TC-4. Designed for the man who believes in carrying a full load to save extra trips. Holds countless tubes and tools, soldering gun, meter, accessories. Tool tray clearance  $2\frac{3}{4}$  in. Handsome, new, brown vinyl covering. Size 24" W x  $16\frac{1}{2}$ " H x  $8\frac{1}{2}$ " D. Ship. wt. 19 lbs.

**TC-4 \$15.95 Carry-All Tube Caddy**—most popular Tube Caddy ever made. Gives quick availability to all sections. Holds up to 262 tubes . . . less with tools and meter. Durable, new, brown vinyl covering. Size 21" W x 15" H x 8" D. Ship. wt. 12 lbs.

**TC-100 \$12.75 The Pacemaker Tube Caddy.** Same size as TC-4, but built for the thrifty buyer. Popular break-away design gives quick access to all sections. Holds up to 262 tubes . . . less with tools and meter. Durable, new, brown vinyl covering. Size 21" W x 15" H x 8" D. Ship. wt.  $11\frac{1}{2}$  lbs.

**TC-201 \$9.95 The Pacemaker Junior.** Smaller, easy-to-carry size for quick trips or as a matched companion to other Argos Tube Caddies. Holds up to 143 tubes . . . less with tools and meter. Durable, new, brown vinyl covering. Size  $15\frac{3}{4}$ " W x  $12\frac{1}{2}$ " H x 8" D. Ship. wt. 9 lbs.

\* REG. TM

YOUR LOCAL PARTS JOBBER HAS THEM!

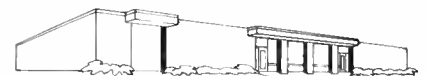

**Argos**  
PRODUCTS COMPANY

GENOA, ILLINOIS

*Craftsmanship in Cabinets*

Tarzian offers

# FAST, DEPENDABLE TUNER REPAIR SERVICE

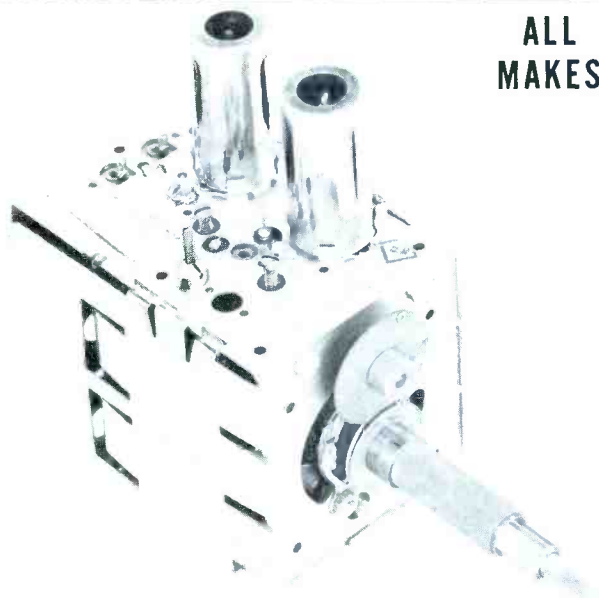

ALL  
MAKES

ONLY

# \$850

INCLUDING

## ALL PARTS and LABOR

## 24-HOUR SERVICE 6-MONTH WARRANTY

## Tuners Repaired on Approved, Open Accounts

See your distributor, or  
use this address for fast,  
factory repair service

It just makes sense that a manufacturer of tuners should be better-qualified, better-equipped to offer the most dependable tuner repair and overhaul service.

Sarkes Tarzian, Inc., pioneer in the tuner business, maintains a complete, well-equipped Factory Service Dept.—assisted by Engineering personnel—and staffed by specialized technicians who handle ONLY tuner repairs . . . on ALL makes and models.

Tarzian-made tuners received one day will be fixed and shipped out the next. Cost is only \$8.50 and \$15 for UV combinations. That includes ALL parts (except tubes which are furnished at our cost) and labor, and a 6-month guarantee against defective workmanship and parts failure due to normal usage. Replacements available at low cost on tuners beyond practical repair.

Ⓢ Tarzian-made tuners are identified by this stamping. When inquiring about service on other tuners, always give tube complement . . . shaft length . . . filament . . . voltage . . . series or shunt heater . . . IF frequency . . . chassis identification. All tuners repaired on approved, open accounts. Check with your local distributor for Sarkes Tarzian replacement tuners, replacement parts, or repair service.

SERVICE MANAGER • TUNER DIVISION • DEPT. 3A



### SARKES TARZIAN INC

east hillside drive • bloomington, indiana  
edison 2-7251

MANUFACTURERS OF TUNERS . . . SEMICONDUCTORS . . . AIR TRIMMERS . . . FM RADIOS . . . AM-FM RADIOS . . . AUDIO TAPE . . . BROADCAST EQUIPMENT and SHISH-KABOB GRILLES

**publisher**  
Howard W. Sams

**general manager**  
Mal Parks, Jr.

**editor**  
Verne M. Ray

**associate editors**  
Forest H. Belt  
James F. Galloway  
Thomas A. Lesh  
George F. Corne

**consulting editors**  
Willicm E. Burke  
Robert B. Dunham  
Joe A. Groves  
George B. Mann  
C. P. Oliphant  
Paul C. Smith

**art director**  
Anthony M. Andreone

**advertising & editorial assistants**  
Georgeanna Caldwell  
Paula Haffner  
Ruth E. Bastin

**production manager**  
Robert N. Rippey

**circulation fulfillment**  
Pat Tidd, Mgr.  
Constance Bland, Ass't.  
Katherine Smith, Ass't.

**photography**  
Robert W. Reed

**advertising sales offices**

**mid-western**

John Groce, advertising sales manager  
PF REPORTER  
2201 East 46th Street, Indianapolis 6, Ind.  
Clifford 3-6441

**eastern**

Charles Horner  
Howard W. Sams & Co., Inc.  
3 West 57th Street,  
New York, N. Y.  
Murray Hill 8-6350

**western**

The Maurice A. Kimball Co., Inc.  
2550 Beverly Blvd., Los Angeles 57, Calif.  
Dunkirk 8-6178; and 580 Market Street,  
Room 400, San Francisco 4, Calif. Exbrook 2-3365

Address all correspondence to  
PF REPORTER, 2201 East 46th Street,  
Indianapolis 6, Indiana



Copyright © 1962 by Howard W. Sams & Co., Inc. PF REPORTER is a trademark of Howard W. Sams & Co., Inc. No part of PF Reporter may be reproduced without written permission. No patent liability is assumed with respect to use of information herein. Acceptance of advertising does not in any manner signify the products, policies and services so advertised have been approved, endorsed or recommended by this magazine.

Indexed in *Lectrodex*.

Printed by the Waldemar Press Div.  
of Howard W. Sams & Co., Inc.



# PF REPORTER

including **Electronic Servicing**  
VOLUME 11, No. 4

APRIL, 1962

## CONTENTS

<b>Previews of New Sets</b>	3
Admiral Model L2711 (Chassis 20L8), Emerson Model 1554 (Chassis 120572C), Magnavox Model 2MV360M (Chassis 36-03), Silvertone Model 21461 (Chassis 528.51894).	
<b>Video Speed Servicing</b>	7
Service hints on Hoffman Chassis 356 and Zenith Chassis 16E21.	
<b>Letters to the Editor</b>	18
<b>The Electronic Scanner</b>	22
<b>SfocK Guide for TV Tubes</b>	28
<b>Freak Rasters and Their Causes</b>	32
Shop Talk—Explanations for rare visual symptoms you won't find in the "book."	
<b>Let's Have a Look at Antenna Preamps</b>	34
Reports on all available units, explaining what the specifications mean.	
<b>Automatic Brightness and Contrast Control</b>	36
Light-sensitive resistors are the "brain" of self-regulating video circuits in new TV sets.	
<b>Howell Co.'s All Taped Up</b>	38
Audio Facts—This Texas firm makes profits from tape recorders in several ways.	
<b>Blueprints for Service Benches</b>	40
Part 1—Detailed plans for a general-purpose, one-man bench setup.	
<b>Coping With Callbacks</b>	52
Quicker Servicing—Give the customer and the set a chance to tip you off to future troubles!	
<b>Curbing TV Radiation</b>	58
Do the sets leaving your shop comply with FCC regulations on suppression of stray RF?	
<b>Cost of Doing Business</b>	66
Dollar and Sense Servicing—A profit-and-loss statement tells you if costs are getting out of line.	
<b>Putting "Silent Sound" to Work</b>	74
Servicing Industrial Electronics—Ultrasonic devices can't be beat for cleaning parts.	
<b>Develop Your Own Tube-Test Data</b>	82
How to check tubes not listed on your tester's roll chart.	
<b>The Troubleshooter</b>	94
<b>Product Report</b>	106
<b>Free Catalog &amp; Literature Service</b>	108
<b>Monthly Index</b>	on free literature card

### ABOUT THE COVER

A well-arranged service bench is indispensable in helping you turn out more work with less fatigue. For complete scale drawings of an expertly-designed bench you can build, turn to page 40.





## CAN YOU SOLVE THIS MYSTERY?

(Using the clues below, identify the Company that offers you the industry's best service)

Service technicians—and set manufacturers, as well—use this company's capacitors oftener than any other brand.

Providing the right sizes, styles, ratings, mountings, this company offers the industry's most complete capacitor line.

Replacements for new capacitors in latest model sets are promptly made available to the service technician.

A continuous research program, employing a staff of over 500 scientists, engineers and technicians, assures our ability to keep up with new capacitor needs.

Guaranteed for performance and dependability, every type of capacitor we make is double-checked by our rigid quality control program.

Unequaled service aids include replacement guides, wall charts, service manuals, capacitor calculators, and other technical helps which simplify your job of correct capacitor selection and replacement.

Effective posters and advertising mats are available to you as part of our customer relations program for dealers.

**WHO ARE WE?** If you still don't know the answer, read the initial letter of each of the sentences above. This is the name that stands for the most complete and best quality line of capacitors, unsurpassed service help, continued technical assistance—and less call-backs for our friends, the service technicians.



### TVL TWIST-LOK® CAPACITORS

These 'lytics take on the toughest TV and radio duty, give maximum trouble-free service, *without HUMMM!* They are dependable at extremely high and low temperatures. Cathodes are etched to meet the needs of high ripple currents, high surge voltages.

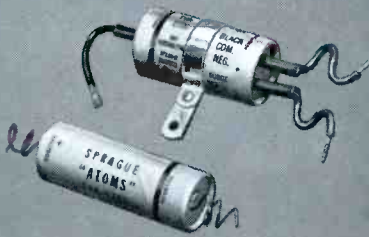

### TVA ATOM® CAPACITORS

Atom tubulars are service favorites because they fit anywhere, work anywhere. They're the *only* small size 85 C (185 F) capacitors in ratings up to 450 WVDC. They have low leakage current, long shelf life, and withstand high ripple currents, high surge voltages.



### TE LITTL-LYTIC® CAPACITORS

The very best ultra-miniature replacements for transistor circuits, offering unusual reliability through all-welded construction. No pressure joints to cause "open" or intermittent circuits. Long shelf life—extremely important in sets used only part of the year.

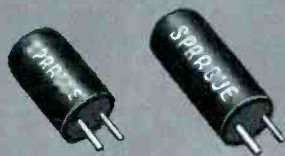

### VL VERTI-LYTIC\* CAPACITORS

These single-ended molded tubulars are the ideal replacement for units of this type found on printed wiring boards. Keyed terminals assure fast manual mounting and correct polarity. Resin end fill protects against drying of electrolyte or entrance of external moisture.



### PCL PRINT-LOK® CAPACITORS

The printed circuit version of the Twist-Lok. Universal base replaces any of the printed circuit 'lytics in use today. No makeshift mounting adapters to damage capacitor or add extra height . . . no possibility of high resistance contacts.

## EVERY 'LYTIC YOU NEED . . .

- every value
- every rating
- every style

Shown here are the more popular of Sprague's big family of Electrolytic Capacitors, the broadest in the industry. Other types include Metal-encased Screwbase; Plastic-encased High-MF; Metal-encased Octal-base; Ultra-low leakage Photoflash. All are listed and described in Sprague's NEW Catalog C-614. Get your copy from any Sprague distributor, or write Sprague Products Company, 105 Marshall Street, North Adams, Massachusetts.

\*TRADEMARK

# SPRAGUE®

THE MARK OF RELIABILITY

WORLD'S LARGEST CAPACITOR MANUFACTURER



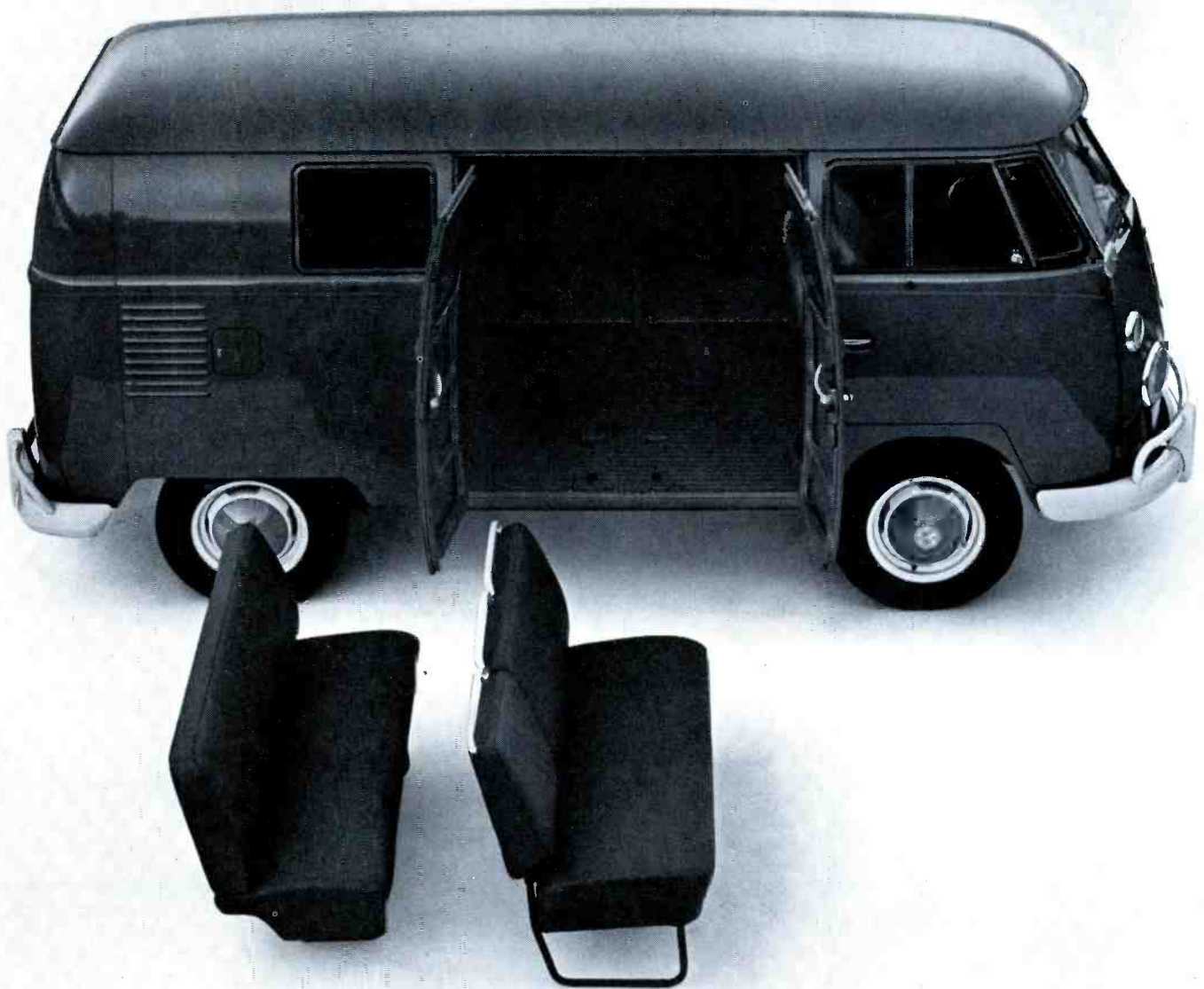

©1962 VOLKSWAGEN OF AMERICA, INC. \*SUGGESTED RETAIL PRICE, EAST COAST, P.O.E.; \$2,115 WEST COAST.

## The truck that thinks it's a station wagon.

We made it with seats and windows. But a truck is what it is.

Take out the seats and you can put in 1,786 pounds of anything.

In just about any size or shape. The doorway's almost 4 feet wide.

For business deliveries, this Volkswagen costs so little to run that you can make a profit even on dinky orders.

2½¢ a mile seems to be average for most owners. For gas, tires, everything.

(Almost all our trucks get over 20 miles a gallon. Some even get 30.)

For weekends, you can take 8 relatives anywhere you might want to take 8 relatives.

(If you're just taking them away, there's room for their luggage on the rear shelf.

All their luggage.)

We call this the Volkswagen Kombi.

All the usual VW virtues go with it. Rear-engine traction in snow and sand. The air-cooled engine that can't freeze up or boil over. And the price, another interesting VW virtue.

\$2,095.\*

New.



**a tool chest  
in your  
pocket**

**for electronic assembly  
and service work**

Shockproof (UL), breakproof,  
plastic handles with clips

**ROUND BLADE SCREWDRIVERS**  
3/32" and 1/8" x 2", 3", and  
4" blades

**PHILLIPS SCREWDRIVER**  
Point size #0, 2" blade

**BERYLLIUM-COPPER SCREWDRIVER**  
Non-magnetic, non-sparking  
1/4" x 2" blade

**NUTDRIVERS**  
10 Hex sizes from 3/32" to 3/8"  
1 1/4" blades  
Color coded handles

**TERMINAL WRENCHES**  
Fit 1/4" and 3/16" O.D. spanner nuts  
on external antenna and phone  
jacks of transistor radios

WRITE FOR LITERATURE

**XCELITE**®

**PROFESSIONAL  
POCKET TOOLS**

XCELITE, INC. • ORCHARD PARK, N. Y.  
Canada: Charles W. Pointon, Ltd., Toronto, Ont.



## LETTERS TO THE EDITOR

Dear Editor:

In "Getting Into the Background Music Business" (February issue), I note that no reference was made to ASCAP or BMI royalty fees for the use of background music in commercial establishments.

I believe you will find that these fees, which are based on the size and type of business using the service and the number of speakers involved, must be paid somehow on a regular basis in order to use practically any tape recorder, off-the-air programs, or even records. I can cite instances in my own area where small stores or restaurants who attempted to use a home tape recorder or hi-fi set for background-music purposes have been forced to pay these license fees.

I would appreciate a complete explanation of these royalties in a future issue. Since my company has been eyeing this field, I personally would like to know the requirements for licensing under BMI and ASCAP.

IRVING J. TONER

Toner Radio & Television  
East Aurora, N. Y.

Dear Editor:

Mr. Len Buckwalter's article in your February issue covers some of the steps a TV or hi-fi service shop proprietor must take to enter the background-music business. If any of your readers were encouraged to try, we suggest that a few details be added.

Mr. Buckwalter neglected to mention the 8% Federal excise tax on all air and wire transmission. Also missing were the monthly payments to ASCAP and BMI for permission to use their copyright music, either by wire, air, or on-premise recordings. In addition, the problem of assembling a suitable music library isn't as simple as described. Proper programming, the crux of a successful operation, is a field for experts.

STANLEY WARREN

Director of Public Relations  
Muzak Corporation  
New York, N. Y.

Dear Editor:

I read with interest, and quite frankly a little dismay, the February *Audio Facts* column. Under "Tape" on page 29, it stated,

"Music reproduced on tape is least practical for local systems. Reels have to be loaded or reversed every hour and a half, the selection of prerecorded tapes is limited, and building a library is expensive."

Our company manufactures a self-re-

versing tape player with 10 1/2" reels, the Crown *Mus-O-Matic*, which will give six hours of continuous play at 3 3/4 ips without repetition. Also, I believe you will find that good quarter-track and half-track tapes are available at prices comparable to LP discs.

The cost of owning a self-reversing automatic tape player, plus even a rental background-music program, would be less expensive in the long run than to use the telephone lines as recommended by the writer of the article.

JOHN ANDREWS

Sales Manager  
Crown International  
Elkhart, Ind.

*Thanks to all of you for contributing more information to help the prospective background-music installer decide what type of system will best suit his customers' needs.*

*Mr. Toner, your suggestion that we supply specific information on BMI-ASCAP licensing is an excellent one and will be acted upon.—Ed.*

Dear Editor:

I wonder if I can receive information about the basing of the new tubes such as *Compactrons* and *novars* which have recently come out. What I would like to do is design a socket box that would allow me to check all these tubes on my emission-type tube tester. I know that adapters are on the market, but am informed that they are for testers of the Gm type.

O. A. KINCH

Battle Creek, Mich.

*Adapters which can be used with any emission tester are now becoming available. A couple of examples are the Sen-core Model TM116 (page 40, February issue) and the Walsco "Nuvisor Socket Adapter" covered in our November Product Report column.—Ed.*

Dear Editor:

We believe that the listing of Nichimen Co. as an importer or manufacturer of transistor radios under the name "Olimpic" (page 25, January issue) was in error.

We have been informed by Nichimen Co., Inc., that they have never imported or distributed any radios with the brand name "Olympic" (which is a registered trademark of ours) except on our behalf.

Most likely the spelling of the name "Olimpic" resulted from a typographical error; but, in any event, we would appreciate your informing your readers that replacement parts for Olympic radios may be ordered only from Olympic Radio and Television Division of The Siegler Corporation, or its authorized distributors.

FRANKLYN P. ROSENFELD

Assistant Counsel  
Olympic Radio & Television  
Division of the Siegler Corp.  
Long Island City, N. Y.

*The information on "Olimpic" was obtained originally from a list of importers furnished by the Japan Trade Center; this was the source of the misspelling. The*

**TESTS**  
All TV and Radio  
Tubes—Old and New

**TESTS**  
the Nuvistors  
and Novars

**TESTS**  
the New 12-Pin  
Compactrons

**TESTS**  
the New 10-Pin Tubes

**TESTS**  
for True Dynamic  
Mutual Conductance (Gm)

**TESTS**  
European Hi-Fi Tubes,  
Voltage Regulators, and  
Most Industrial Types

**OBSOLESCENCE  
PROOF**  
Designed for Maximum  
Use Today and  
Tomorrow



**NEWEST  
FINEST  
MONEY-MAKER**  
*for Professional  
Servicemen*

# Multiple-Socket Speed with Gm Accuracy PLUS OBSOLESCENCE PROTECTION

**Model 700  
DYNA-QUIK**  
*Fastest, Most Complete  
Most Up-to-Date*  
**DYNAMIC  
MUTUAL CONDUCTANCE  
TUBE TESTER**

**TESTS BOTH OLD AND NEW TUBE TYPES—SELLS MORE TUBES PER CALL**

*Again you benefit from proved B&K techniques! This up-to-date, obsolescence-proof, professional instrument is designed for maximum use today and tomorrow. Provides multiple-socket section to quick-check most of the TV and radio tube types the true dynamic mutual conductance way—plus simplified switch section to check new tube types in Dyna-Quik emission circuit. Also includes provision for future new sockets.*

*Makes test under set-operating conditions. Checks each section of multi-section tubes separately. Checks for all shorts, grid emission, leakage and gas. Makes quick "life" test. Exclusive adjustable grid emission test provides sensitivity to over 100 megohms.*

*Makes complete tube test in seconds. Checks average set in a few minutes. Discovers weak tubes that need replacement. Satisfies more customers. Sells more tubes. Saves call-backs. Insures your reputation.*

*Patented automatic compensation for line voltage variation. Large 4½" plastic meter with easy-to-read "Replace-Good" scale. Lists most commonly used tube types with settings directly on socket panel for fastest operation. Complete listing in reference chart in cover. Phosphor-bronze contacts for long life. 7, 9, and 10-pin straighteners on panel. Operates on 117 volts 50-60 cycle a.c. Hand-some leatherette-covered carrying case.*

Size: 16½" x 15¼" x 5⅞" deep. Net wt: 15½ lbs.

Net, **\$169<sup>95</sup>**

*See your B&K Distributor,  
or Write for Catalog AP18-R*

**NEW TUBE INFORMATION SERVICE**  
Available every 3 months, on subscription,  
for all B&K Dyna-Quik Tube Testers



**B & K MANUFACTURING CO.**  
1801 W. BELLE PLAINE AVE • CHICAGO 13, ILL.  
Canada: Atlas Radio Corp., 50 Wingold, Toronto 19, Ont.  
Export: Empire Exporters, 277 Broadway, New York 7, U.S.A.



**STOCK**—Hang it on the wall, stand it on a shelf, slip it into your caddy. Cartridge model number is always visible for quick identification.

**SAVE**—Save money on purchase of any 6 SONOTONE cartridges—save time by always having the right replacements.

**SERVICE**—You always have the right replacement to service virtually every record player on the market.

**SELL**—In your shop, an eye-compelling display (unique bonnet fits over 6-Pak to remind your walk-in customers to modernize their record players). In your caddy—a variety of cartridges for nearly every replacement.

Every time you buy 6 SONOTONE cartridges from your distributor, they come in the new attractive 6-Pak cartridge sleeve. You can select any 6 SONOTONE cartridges, or one of three pre-selected 6-Paks which include the most needed cartridges for the most often faced replacement situations.

- **STEREO 6-PAK**—covers nearly every stereo replacement or conversion. Six stereo cartridges from the audiophile's favorite, the 9T, to the budget-priced stereo crystal cartridge, the 12T. Consists of models: 9T, 8T-A, 16T, 18T, 10T and 12T.
- **STEREO/MONO 6-PAK**—covers most stereo or mono replacement needs. Consists of 3 stereo ceramics models 8T-A, 9T, 16T; and 3 mono ceramics: 1P, 2T, 3T.
- **MONOPHONIC 6-PAK**—covers virtually all most called for monophonic replacements. "LB" denotes "less bracket" for slim tonearms. Consists of models; 1P, two 2T's, 2T-LB, 3T-LB.

The 6-Pak is just another way that SONOTONE simplifies your inventory and makes it easier to sell cartridges. Order a SONOTONE 6-Pak today at your parts distributor.

**FREE:** The new SONOTONE cartridge cross-reference chart catalog is available at your distributor, or write: Dept. PF-4

**SONOTONE® CORPORATION** ELMSFORD, NEW YORK  
ELECTRONIC APPLICATIONS DIVISION In Canada: Atlas Radio Corp., Ltd. Toronto  
Cartridges • Speakers • Tape Heads • Mikes • Electronic Tubes • Batteries • Hearing Aids

way the chart was set up also gave the erroneous impression that Nichimen makes parts available for Olympic radios. We appreciate the opportunity to straighten out this matter.—Ed.

Dear Editor:

"The Right Way to Install Antennas" (pages 30-31, February issue) uses 13 photographs to prove that a technician should strive to obtain the best picture possible. Being a master electrician as well as an electronics technician, I am disappointed that the article did not follow all the provisions of Article 810, National Electrical Code.

For instance, a ground conductor is shown connected to a driven ground rod. If an underground water piping system is present anywhere in the building, it is mandatory that the TV grounding conductor be properly connected to the water pipe instead. The N.E. Code also requires that all metal masts be grounded, but when driven rods are used, it is illegal to use the electric service ground rod for this purpose. A separate rod should be provided at least 6' from the electrical ground rod.

In the picture at the top of page 31, it must have been difficult to bring the antenna lead-in down the outside of the building between the electrical service attachment and the telephone cable and still maintain the proper clearances as given in the N.E. Code.

The location shown for the drip loop is the very spot where a lightning arrester should have been installed.

Another picture gives advice to utilize the holes already drilled for electrical cables, to save effort and time in fishing the TV antenna lead through the floor. The N.E. Code prohibits use of these holes unless armored cables are used, or the TV wires are covered with enough extra flexible tubing. A separate non-metallic box 16" away from the lighting receptacle will look just as nice without disturbing the wiring installed by the electrician.

Further reprinting of the N.E. Code would require permission from the National Fire Protection Association, but it should be possible to purchase a copy of this code at the Building Inspector's office in your city hall.

WALTER S. HINCKLEY

Springfield, Mass.

*As we hang from the antenna mast, we want to tell all readers, "Don't get in this fix—check the code!"—Ed.*

Dear Editor:

The first thing I noticed in the January PF REPORTER was the article on troubleshooting vertical sweep circuits from A to Z. Hurray for us — I hope you continue to produce these articles, as they are what some of us need. There are lots of articles of this nature that could be written. Such interesting items mean much to the serviceman, because they bring back things that tend to slip his mind. Keep up the good work and articles, please!

HENRY L. MARPLE

Buckhannon, W. Va.

*We will — it's our bread and butter!*  
—Ed.

# DOUBLES YOUR EFFECTIVE MANPOWER



Fix "Tough Dogs" Fast!

Save Half Your Time!

Step Up Your Profit!

**B&K** NEW  
MODEL 1076

## TELEVISION ANALYST

for Black & White and Color



Check all circuits—Pinpoint any TV trouble...in minutes

**By Easy Point-to-Point Signal Injection,  
You See the Trouble on the TV Screen and  
Correct it—Twice as Fast and Easy!**

There's no longer any need to "lose your shirt" (and customers)—and worry about the lost hours you never recover—on "tough dogs" or even intermittents. The remarkable B&K Analyst enables you to inject your own TV signal at any point and watch the resulting test pattern on the picture tube itself. Makes it quick and easy to isolate, pinpoint, and correct TV trouble in any stage throughout the video, audio, r.f., i.f., sync, and sweep sections of black & white and color television sets—including intermittents. Makes external scope or wave-form interpretation unnecessary. Most useful instrument in TV servicing! Its basic technique has been proved by thousands of successful servicemen the world over.

The Analyst enables any serviceman to cut servicing time in half, service more TV sets in less time, really satisfy more customers, and make more money.

Model 1076. Net, \$29995

Available on Budget Terms. As low as \$30.00 down.

Combines all the features of both  
the Model 1075 and Model A107

COMPLETE R.F. and I.F.

VIDEO TEST PATTERN

COMPOSITE SYNC

FM MODULATED AUDIO

COLOR PATTERNS

HORIZONTAL and VERTICAL  
PLATE and GRID DRIVE

B+ BOOST INDICATOR

HI-VOLT INDICATOR

YOKE and HI-VOLTAGE  
TRANSFORMER TEST

**Also Now Provides:**

SWITCH-TYPE TUNER

NEGATIVE BIAS SUPPLY

AGC KEYING PULSE

PICTURE TUBE MODULATION

**B&K**

**B & K MANUFACTURING CO.**  
1801 W. BELLE PLAINE AVE • CHICAGO 13, ILL.  
Canada: Atlas Radio Corp., 50 Wingold, Toronto 19, Ont.  
Export: Empire Exporters, 277 Broadway, New York 7, U.S.A.

See Your B&K Distributor or Write for Bulletin AP18-R

## ADD A NEW SIGN TO YOUR DOOR

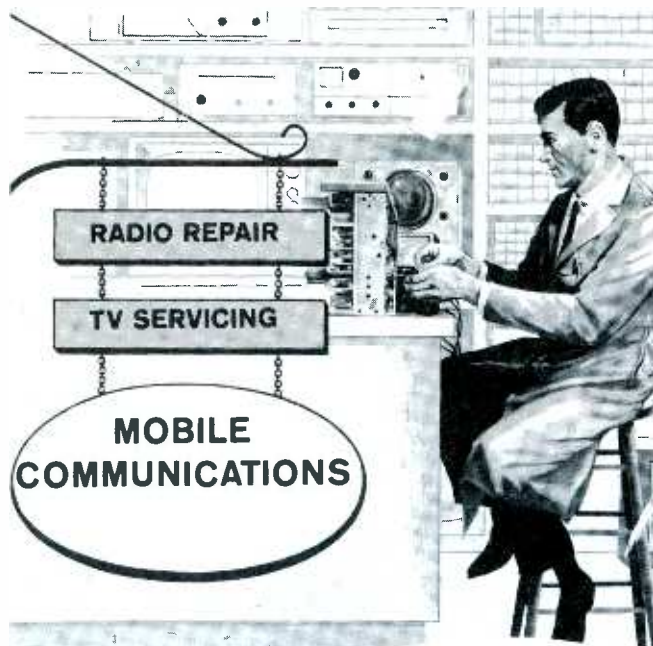

## Let RCA Train You at Home in COMMUNICATIONS

A completely new RCA Institutes course with brand new opportunities for electronic technicians . . . COMMUNICATIONS ELECTRONICS.

1962 starts a new era in mobile communications when you get your FCC License. Under the skilled direction of RCA Institutes experts, you can obtain at home the technical qualifications for employment in the Communications Industry. In addition to preparing you for an FCC license, you are supplied with the training needed to service and maintain 2-way radio communications for truck and taxi fleets, police, fire, bus, railroad and other public service vehicles. You also get the technical foundation for advancement in space and aviation communication electronics. This is *not* a cram course . . . *not* a rehash of old radio lessons. Learn from RCA what it takes to get ahead in the ever-expanding field of communications.

With RCA Institutes home training in Communications Electronics, you set the pace that suits your ability, finances and time. RCA's liberal Voluntary Tuition Plan is the most economical home study method, because you pay for lessons only if you order them . . . one study group at a time! If you drop out at any time, for any reason, you do not owe RCA one penny! No other obligations! Licensed by New York State Education Department. Approved for Veterans.

**Prepares You for an FCC License**

### RCA INSTITUTES, INC.

A Service of Radio Corporation of America  
350 West Fourth Street, New York 14, N. Y.

#### Other home study courses available:

Electronics Fundamentals  
Black & White and Color TV  
Automation Electronics  
Computer Programming  
Transistors



The Most Trusted Name  
in Electronics

RCA INSTITUTES, INC. Home Study School, Dept. PF-42  
350 West Fourth Street, N. Y. 14, N. Y.

Without obligation, rush me the FREE 64-page illustrated booklet "Your Career in Electronics" describing your electronic home study training program. No salesman will call.

Name.....Age.....

Address.....

City.....Zone.....State.....

CANADIANS—Take advantage of these same RCA courses at no additional cost. No postage, no customs, no delay. Send coupon to: RCA Victor Company, Ltd., 5581 Royalmount Ave., Montreal 9, Quebec.

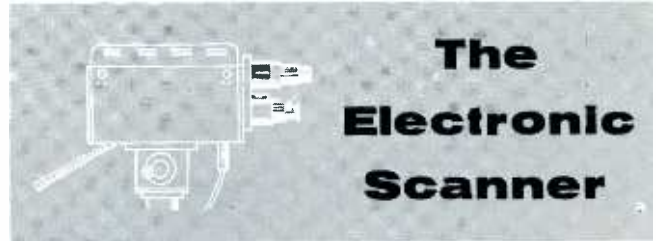

#### Free Window Poster

A series of shop-window posters is now available from Sprague Products Co. or their distributors. The latest 17" by 22" sheet displays five points consumers should consider in having their TV sets repaired.

#### Novel Dealer Sales Promotion

Wayne Collins, owner of Lectra Home, El Segundo, Calif., recently gave away a Sylvania portable TV, a stereo hi-fi phonograph, and a radio to customers who came closest to estimating how long a TV set would run without requiring service. A Sylvania Model 23C20 placed in his show window operated a total of 15 months and 15 days—equivalent to six years of normal playing time—before requiring service.

#### A Look at the Future



Mr. R. H. (Herb) Bowden, President of Sencore, Inc., was guest speaker at the recent 1962 Annual Banquet of the California State Electronics Association. His speech, "The Importance of the Independent Serviceman—Today and Tomorrow," conveyed his conviction that the future is bright for servicemen who keep abreast of new developments in testing methods, and who practice sound business principles.

#### Littelfuse Vice-President Honored



Walter A. Clements, Vice President—Distributor Division of Littelfuse, Inc., received the industry award presented annually by the Electronics Representatives Association for "Excellence in Sales Management" at the association's recent annual convention. Littelfuse has been a major supplier of fuses to the service industry for over 25 years.

#### New Corporate Name

Stockholders of Electronic Instrument Co., Inc., voted for approval to change the company name to EICO Electronic Instrument Co., Inc., at the annual meeting held January 31.

#### Expanding Market

Mr. Irving I. Schachtel, President of Sonotone Corp., recently predicted an increase in the use of sintered-plate, nickel-cadmium sealed battery cells. He cited the expanded usage of these cells in such products as portable communications transceivers, paging devices, cordless electric shavers, etc. Mr. Schachtel announced that his company manufactured and distributed a total of one million such batteries during 1961. Seems like a good time for progressive dealers to look into the replacement-sales potential of these items.

#### Guarantee Against Obsolescence

Seco Electronics, Inc., unconditionally guarantees that their Models 88, 107A, and 350 tube testers will be kept up to date for receiving-tube testing for a period of one year after purchase date. Adapter kits or setup data will be furnished at no cost to owners during the first year.

#### The "New Look" in Westinghouse Tubes

"There's NEW POWER in Westinghouse Tubes" is the theme of a dealer profit-sharing program being announced this month by Westinghouse. Replacement receiving and picture tubes are now undergoing a more rigid quality-control check than ever before, and will appear in new gold and black cartons. To introduce the new tube program to service dealers, the cartons are designed with tear-off "Golden Profitabs" which are redeemable for premium merchandise. The program is being announced this month in a special "kick-off" ad containing a "Bonus Profitab" worth 100 points.

# New TRANSISTOR RADIO ANALYST

makes it Easy and Profitable to Service all Transistor Radios



**B&K** Model 960  
**TRANSISTOR RADIO ANALYST**  
 with Exclusive **DYNA-TRACE**  
 Single-Point Probe—and Built-in  
 Metered Power Supply and VTVM

**Complete Transistor Radio  
 Service Shop in One Instrument**

Signal-Generator, Power Supply,  
 Milliammeter, VTVM,  
 Ohmmeter, and Both In-Circuit and  
 Out-of-Circuit Transistor Tester—  
 All in One

Check all circuits - Pinpoint any trouble ... in minutes

Now you can profit from transistor radio servicing! This amazing new B&K "960" ANALYST gives you *everything* in one complete easy-to-use instrument. Makes transistor radio servicing *quick and easy*. Nothing else is needed except the transistor radios themselves waiting to be serviced. Brings you new customers for service, parts, and batteries. Makes this new business *yours*.

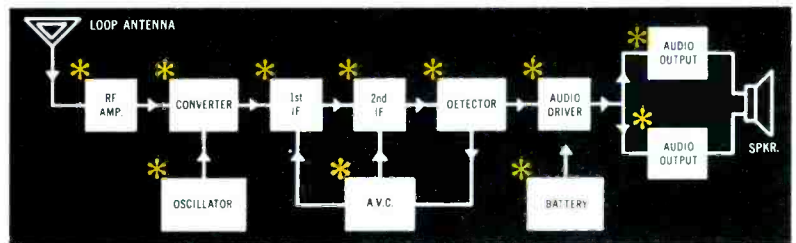

**EASILY TROUBLE-SHOOT ANY STAGE  
 BY UNIQUE POINT-TO-POINT SIGNAL INJECTION**

The ANALYST gives you a complete signal-generating source for point-to-point signal injection. Easily enables you to trouble-shoot any transistor radio—check all circuits stage-by-stage—isolate and pinpoint the exact trouble in minutes.

Supplies modulated signals, with adjustable control, to check r.f., i.f., converter, and detector. Supplies audio signal to check audio driver and audio output. Provides unmodulated signal to test local oscillator. Provides separate audio low-impedance output for signal injection into loudspeaker voice coils to check speaker performance.

**BUILT-IN METERED POWER SUPPLY FOR EASY SERVICING**

Makes it easy to operate radio under test, while you inject your own signals. Provides from 1 to 12 volts in 1½ volt steps. Supplies all bias taps that may be required.

**SIMPLIFIES IN-CIRCUIT TRANSISTOR TEST  
 WITH NEW DYNA-TRACE SINGLE-POINT PROBE**

Unique single-point probe needs only the one contact to transistor under test. No longer are three wires required to connect to emitter, base, and collector. Gives fast, positive meter indication. Saves time. Makes trouble-shooting simple and easy.

**BUILT-IN VTVM**

Includes high-input-impedance vacuum-tube voltmeter, which is so necessary for transistor radio servicing.

**TESTS ALL TRANSISTORS OUT-OF-CIRCUIT**

Meter has "Good-Bad" scale for *both* leakage and beta. Also has direct-reading Beta scale, calibrated 0-150. Assures quick, accurate test. Also automatically determines whether transistor is NPN or PNP. Meter is protected against accidental overload and burn-out.

Model 960. Net, \$99<sup>95</sup>

Solve Every Service Problem and Profit  
 with a Modern B&K Service Shop. See Your  
 B&K Distributor or Write for Catalog AP18-R



**B & K MANUFACTURING CO.**  
 1801 W. BELLE PLAINE AVE • CHICAGO 13, ILL.  
 Canada: Atlas Radio Corp., 50 Wingold, Toronto 19, Ont.  
 Export: Empire Exporters, 277 Broadway, New York 7, U.S.A.



1. **ANNOUNCER:** Why do many TV servicemen buy RCA Victor New Vista Television for their own homes? Let's visit one . . .



2. **JOHN HALVERSON (Meriden Conn.):** "I work with many kinds of TV sets . . . that's why I picked RCA Victor for my home."



4. . . . gives you an amazingly clear, steady picture.

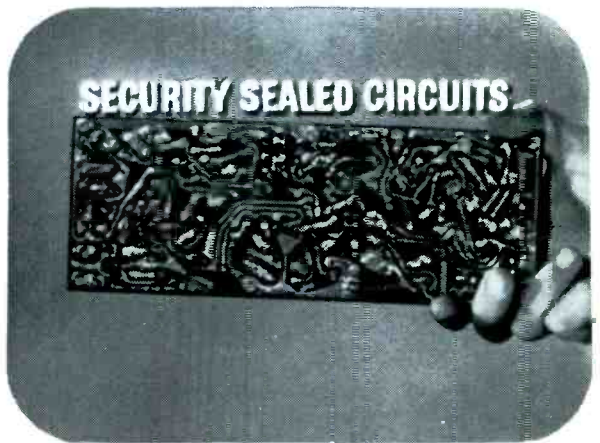

5. Second—RCA Victor has Security Sealed Circuit Boards. And John knows they're precision-crafted, and far more dependable . . .



7. And third, he prefers RCA Victor TV because it's so reliable.

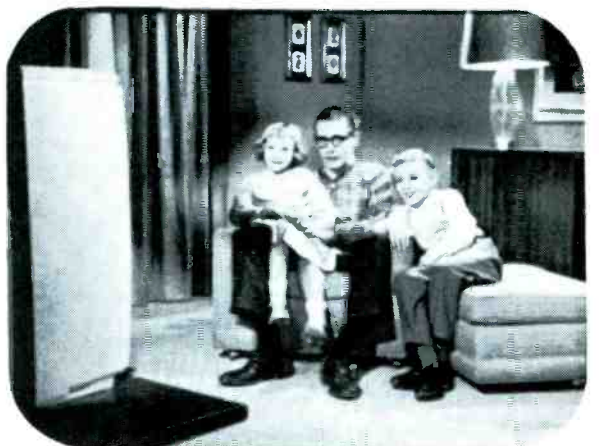

8. **JOHN HALVERSON:** That's right. I spend much of my time fixing other people's sets. When I get home I like to relax!





3. **ANNOUNCER:** John Halverson gives three reasons: First, RCA Victor with its powerful New Vista Tuner . . .

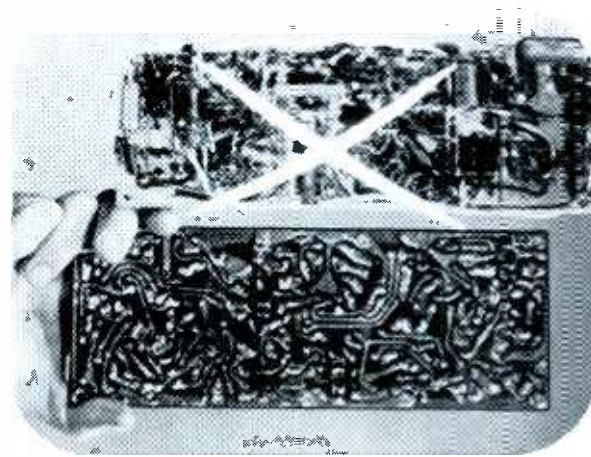

6. With no old-fashioned hand-wiring to come loose or short-circuit.



9. **ANNOUNCER:** See RCA Victor New Vista Television at your dealer's this week!

This TV commercial is telling the story of RCA VICTOR performance to millions of people on the hit TV show, Walt Disney's "Wonderful World of Color" on the NBC-TV network . . . it builds public awareness of the role you play in providing dependable TV entertainment. 



The Most Trusted Name in Television

Tmk(s)®

See Walt Disney's Wonderful World of Color every Sunday, NBC-TV Network.

# Sylvania

...completeness that assures  
...quality that



Never say "Tubes"—say "Sylvania"!

# Tubes

delivery!  
assures profits!

## SILVER SCREEN 85 PICTURE TUBES

Sylvania was a pioneer in the manufacture of commercially produced picture tubes. That kind of experience builds profit protection into every 1962 SILVER SCREEN 85—top performance, maximum assurance against callback. And, when you specify Sylvania for that replacement job, you are sure to get delivery...because SYLVANIA has the *comprehensive* line... SYLVANIA DISTRIBUTORS are wherever there is TV!

Bonded Shield • anti-reflection Bonded Shield • non-Bonded Shield • single and multiple branded • long and short necks • metal and glass envelopes • 50° to 114° deflection • magnetic and electrostatic focus • ion trap and non-ion trap types • rectangular and round faceplates • 2.35-v to 6.3-v and 450-mA to 600-mA heaters • 5" (50°-70°) and 8" (90°-114°) universal bench-test tubes.

Plus "universal" 17-, 21- and 24-inch picture tubes!

Plus color TV picture tubes!

## SYLVANIA RECEIVING TUBES

...for Color TV... Sylvania continues to prove its capabilities... in the production of tubes especially for color TV replacement. Since your customers are buying "performance"—not technical data—tubes at SYLVANIA are performance-tested continuously in actual color TV sets. Go with quality—go with Sylvania tubes for color TV: 6BK4 • IV2 • 3A3 • 6DQ5 • 6CB5A • 6AU4GTA • 6CG7 • 6AW8 • 12BY7 • 6AQ5 • 6AV5 • 6EM7.

...for Black & White TV... Sophisticated manufacturing techniques and processes have made Sylvania a preferred supplier of tubes for TV. Developments such as Sarong Cathode and Strap Frame Grid *plus* extensive automation in production assure that replacement tubes are... in every way... as good as the original.

...for TV Tuners... Sylvania-originated, the 6GK5 brings new advances to the state of the electron tube art. This new tube type, as manufactured by Sylvania, features Strap Frame Grid constructions and high Gm, provides high gain and low noise in rf amplifier-service in TV front-ends. When replacing a 6GK5, specify *Sylvania*—universally accepted by manufacturers of TV sets. Sylvania 6GK5 also replaces the popular 6FQ5, 6FQ5A and the 6FY5.

...for AM-FM Radio... Whether servicing an AC-DC table radio, a fine Hi-Fi tuner or one of the latest Multiplex units, make Sylvania your number one choice. Take, for examples of outstanding quality, the new 17C9 and 6JK8. Both are Sylvania-originated and provide superior performance in standard tuner and in multiplex circuitry.

...for Hi-Fi and Phono... One of the pioneers in tubes for audio amplifier service, Sylvania has led with old faithfuls like the 6L6, 6V6 and 6AQ5 and the new high-performance Sylvania 6GM5 and Sylvania 7591. Automated production techniques and final test procedures maintain precision, assure high quality. A Sylvania replacement tube is the best way to make old equipment perform like new again. Electronic Tubes Division, Sylvania Electric Products Inc., 1740 Broadway, New York 19, N. Y.

Sylvania Tubes—available wherever there is TV!

# SYLVANIA

SUBSIDIARY OF

GENERAL TELEPHONE & ELECTRONICS



# STOCK GUIDE

## FOR TV TUBES...

This list omits over 50 of the rarest TV tube types, which many shops do not find it practical to keep in stock. To simplify the chart as much as possible, common radio and hi-fi tube types used in TV combinations are omitted; so are UHF types. Tubes marked\* are primarily used in color sets.

The figures on a gray background suggest a stock of 350 tubes which should account for over 90% of your replacement needs, and should minimize your risk of being "caught short" even if you travel all day without refilling your tube caddy. However, if you prefer a more

limited caddy stock, the other set of figures (on white background) will help you decide which types to cull out. These figures indicate the number of tubes of each type you could expect to find in a random sample of 1000 tubes taken from all TV sets now in service. Where the usage is well below 1 per 1000, a dash is shown. To scale down your stock, you can omit many "dashed" types, and also reduce quantities of other types. In so doing, keep in mind three other factors besides usage rates which influence the demand for various tubes:

1. Relatively high failure rate of power

output and similar types.

2. Your specialization in certain makes of sets.

3. Average age of sets containing a particular tube type.

Temporary substitution of available types for rare types, as outlined in the Howard W. Sams book, **Tube Substitution Handbook, Vol. 4**, can also help you reduce stock requirements.

Another way to ease tube-stock headaches is to use only the latest -A or -B versions of various tubes. Types in common use are listed in the chart.

PER CADDY TUBE	PER CADDY TUBE	PER CADDY TUBE	PER CADDY TUBE	PER CADDY TUBE	PER CADDY TUBE
1000 STOCK	1000 STOCK	1000 STOCK	1000 STOCK	1000 STOCK	1000 STOCK
TUBE TYPE	TUBE TYPE	TUBE TYPE	TUBE TYPE	TUBE TYPE	TUBE TYPE
27	2	1B3GT	5	2	5AQ5
12	2	1G3GT	—	1	5AS4
5	1	1J3	—	1	5AS8
3	1	1K3	1	1	5AT8
—	1	1S2A	—	1	5AV8
—	1	1V2*	—	1	5AU4
6	2	1X2B	1	1	5B8
2	2	2BN4	—	1	5BE8
—	1	2CW4	1	1	5BK7A
3	2	2CY5	1	1	5BR8
1	1	2FH5	—	1	5BW8
—	1	2FS5	4	2	5CG8
—	1	2GK5	2	1	5CL8A
3	1	3A3	—	1	5CZ5
1	1	3AL5	1	1	5EA8
3	2	3AU6	—	1	5EU8
—	1	3AV6	—	1	5EW6
—	1	3BC5	—	1	5GH8
3	2	3BN6	—	1	5GM6
3	2	3BU8	—	1	5J6
19	2	3BZ6	2	1	5T8
9	2	3CB6	34	3	5U4GB
2	1	3CS6	5	2	5U8
1	1	3CY5	2	2	5V3
1	1	3DG4	—	1	5X8
2	1	3DK6	2	2	5Y3GT
7	2	3DT6	—	1	6AB4
—	1	3GK5	2	1	6AC7
—	1	3GS8	1	1	6AF3
—	1	4AU6	3	1	6AG5
—	1	4AV6	—	1	6AG7
1	1	4BC8	2	1	6AH4GT
—	1	4BN6	3	2	6AH6
1	1	4BQ7A	1	1	6AK5
—	1	4BU8	—	1	6AL3
3	2	4BZ6	33	2	6AL5
1	1	4CB6	4	2	6AM8A
1	1	4CS6	4	2	6AN8A
—	1	4DE6	19	2	6AQ5A
1	1	4DT6	2	2	6AS5
—	1	4ES8	1	1	6AS8
—	1	4EW6	2	1	6AT6
—	1	4GS8	1	1	6AT8A
2	1	5AM8	5	2	6AU4GTA
1	1	5AN8	59	2	6AU6A
3	2	6AU8A	2	1	6AV5GTA
1	1	6AV6	9	2	6AV6
13	2	6AW8A	2	1	6CU5
24	3	6AX4GTB	1	1	6CU8
4	1	6BA6	1	1	6CW4
1	1	6BA8A	—	1	6CW5
3	2	6BC5	2	1	6CX8
2	1	6BC8	2	1	6CY5
3	1	6BE6	1	1	6CY7
—	1	6BF6	1	1	6CZ5
2	2	6BG6GA	2	1	6DA4
2	1	6BH8	—	1	6DB5
—	1	6BJ8	5	2	6DE4
—	1	6BK4*	4	2	6DE6
1	1	6BK5	1	1	6DE7
5	2	6BK7B	1	1	6DG6GT
3	2	6BL7GT	4	1	6DK6
1	1	6BL8	2	1	6DN7
2	2	6BN4	—	1	6DQ5*
8	2	6BN6	19	3	6DQ6B
3	1	6BN8	2	1	6DR7
6	2	6BQ5	—	1	6DS5
11	3	6BQ6GTB	—	1	6DT5
9	2	6BQ7A	10	2	6DT6
1	1	6BR8A	1	1	6EA7
—	1	6BS8	8	2	6EA8
6	2	6BU8	5	1	6EB8
—	1	6BW8	—	1	6EH7
—	1	6BX7GT	—	1	6EJ7
2	1	6BY6	1	1	6EM5
1	1	6BY8	4	2	6EM7
32	3	6BZ6	2	1	6ER5
2	1	6BZ7	2	1	6ES8
3	2	6C4	—	1	6ET7
69	3	6CB6A	—	1	6EU8
2	2	6CD6GA	4	1	6EW6
2	1	6CF6	—	1	6EZ5
33	3	6CG7	2	1	6FG7
9	2	6CG8A	—	1	6FG7
1	1	6CL6	—	1	6FM8
1	1	6CL8A	—	1	6FQ7
—	1	6CM6	—	1	6FS5
6	2	6CM7	—	1	6FV6
2	1	6CN7	—	1	6FV8
1	1	6CQ3	1	1	6FW5
3	1	6CS6	—	1	6FY5
—	1	6CS7	—	1	6GC5
4	1	6CU5	4	1	6GH8
1	1	6CU8	1	1	6GK5
1	1	6CW4	1	1	6GK6
2	1	6CW5	2	1	6GM6
2	1	6CX8	2	1	6GN8
—	1	6CY5	—	1	6GW6
—	1	6CY7	—	1	6GX6
—	1	6CZ5	—	1	6GY6
—	1	6DA4	—	1	6HJ8
1	1	6DB5	1	1	6HS8
1	1	6DE4	1	1	6J5
11	2	6DE6	3	2	6J6
3	2	6DE7	—	1	6K6GT
—	1	6DG6GT	—	1	6K11
1	1	6DK6	1	1	6S4A
—	1	6DN7	—	1	6SL7GT
33	3	6DQ5*	8	2	6SN7GTB
1	1	6DQ6B	1	1	6SQ7
8	2	6DR7	8	2	6T8
12	2	6DS5	—	1	6U8A
1	1	6DT5	1	1	6V3A
8	2	6DT6	8	2	6V6GT
5	2	6EA7	5	2	6W6GT
5	2	6EA8	2	1	6X8A
2	1	6EB8	—	1	7AU7
—	1	6EH7	—	1	7EY6
1	1	6EJ7	1	1	8AW8A
—	1	6EM5	—	1	8BA8A
2	1	6EM7	1	1	8BQ5
1	1	6ER5	1	1	8CG7
—	1	6ES8	—	1	8CS7
—	1	6ET7	—	1	8CX8
—	1	6EU8	—	1	8EB8
—	1	6EW6	—	1	8EM5
—	1	6EZ5	—	1	8ET7
—	1	6FG7	—	1	8FQ7
—	1	6FG7	—	1	8GN8
1	1	6FM8	1	1	9AU7
—	1	6FQ7	—	1	9BR7
2	1	6FS5	—	1	10DE7
—	1	6FV6	—	1	10EG7
—	1	6FV8	—	1	10EM7
—	1	10HF8	1	1	12AF3
5	2	12AT7	18	3	12AU7
1	1	12AV5GA	1	1	12AV7
1	1	12AV7	8	2	12AX4GTB
4	2	12AX7	—	1	12AZ7A*
1	1	12B4A	1	1	12B7A
7	2	12BH7A	1	1	12BQ6GTB
—	1	12BR7	—	1	12BR7
—	1	12BV7	9	3	12BY7A
3	2	12C/-CU5	3	2	12C/-CU5
1	1	12CA5	2	1	12D4
1	1	12D5	1	1	12D85
8	2	12DQ6B	—	1	12DQ7
—	1	12DQ7	—	1	12DT5
—	1	12ED5	—	1	12EN6GT
—	1	12EN6GT	—	1	12GC6
—	1	12GC6	2	1	12L6GT
2	1	12SN7GTA	2	1	12W6GT
1	1	12W6GT	—	1	13DE7
—	1	13DR7	1	1	13EM7
1	1	17AX4GT	1	1	17D4A
1	1	17D4A	—	1	17DE4
—	1	17DM4	2	1	17DQ6B
—	1	17GW6	—	1	17GU6
2	2	19AU4GTA	2	2	19DE4
—	1	22DE4	—	1	25AX4GT
—	1	25BK5	—	1	25BQ6GTB
—	1	25CD6GB	—	1	25DN6
2	1	25L6GT	2	1	25L6GT

# What Does F.C.C. Mean To You?

## What Can an F.C.C. License Do for You?

What do you need in order to achieve greater success? You need some symbol of achievement which will prove to others that you have accomplished a specific goal in self improvement. This is why most schools award diplomas to their graduates.

Some diplomas are worth a great deal more than others, and this makes it difficult to be sure just how valuable a certain diploma will be. However, in electronics there is a reliable standard... the F.C.C. license. Your F.C.C. license is like a "diploma in electronics" granted by the U.S. Government. It is recognized as such by employers. Your F.C.C. license means a great deal more than an "ordinary diploma."

## What are the Different Types of Operator Licenses?

The F.C.C. grants three different types (or groups) of operator licenses—commercial radiotelePHONE, commercial radioteleGRAPH, and amateur.

**COMMERCIAL RADIOTELEPHONE** operator licenses are those required of technicians and engineers responsible for the proper operation of electronic equipment involved in the transmission of voice, music, or pictures. For example, a person who installs or maintains two-way mobile radio systems or radio and television broadcast equipment must hold a radiotelePHONE license. (A knowledge of Morse code is NOT required to obtain such a license.)

**COMMERCIAL RADIOTELEGRAPH** operator licenses are those required of the operators and maintenance men working with communications equipment which involves the use of Morse code. For example, a radio operator on board a merchant ship must hold a radioteleGRAPH license. (The ability to send and receive Morse is required to obtain such a license.)

**AMATEUR** operator licenses are those required of radio "hams"—people who are radio hobbyists and experimenters. (A knowledge of Morse code is necessary to be a "ham".)

## What are the Different Classes of RadiotelePHONE licenses?

Each type (or group) of license is divided into different classes. There are three classes of radiotelePHONE licenses, as follows:

(1) Third Class RadiotelePHONE License. No previous license or on-the-job experience is required to qualify for the examination for this license. The examination consists of F.C.C. Elements I and II covering radio laws, F.C.C. regulations, and basic operating practices.

(2) Second Class RadiotelePHONE License. No on-the-job experience is required for this examination. However, the applicant must have already passed examination Elements I and II. The second class radiotelePHONE examination consists of F.C.C. Element III. It is mostly technical and covers basic radiotelePHONE theory (including electrical calculations), vacuum tubes, transistors, amplifiers, oscillators, power supplies, amplitude modulation, frequency modulation, measuring instruments, transmitters, receivers, antennas and transmission lines, etc.

(3) First Class RadiotelePHONE License. No on-the-job experience is required to qualify for this examination. However, the applicant must have already passed examination Elements I, II, and III. (If the applicant wishes, he may take all four elements at the same sitting, but this is

not the general practice.) The first class radiotelePHONE examination consists of F.C.C. Element IV. It is mostly technical covering advanced radiotelePHONE theory and basic television theory. This examination covers generally the same subject matter as the second class examination, but the questions are more difficult and involve more mathematics.

## Which License Qualifies for Which Jobs?

The THIRD CLASS radiotelePHONE license is of value primarily in that it qualifies you to take the second class examination. The scope of authority covered by a third class license is extremely limited.

The SECOND CLASS radiotelePHONE license qualifies you to install, maintain, and operate most all radiotelePHONE equipment except commercial broadcast station equipment.

The FIRST CLASS radiotelePHONE license qualifies you to install, maintain, and operate every type of radiotelePHONE equipment (except amateur, of course) including all radio and television stations in the United States, and in its Territories and Possessions. This is the highest class of radiotelePHONE license available.

## How Long Does it Take to Prepare for F.C.C. Exams?

The time required to prepare for FCC examinations naturally varies with the individual, depending on his background and aptitude. Grantham training prepares the student to pass FCC exams in a minimum of time.

In the Grantham correspondence course, the average beginner should prepare for his second class radiotelePHONE license after from 300 to 350 hours of study. This same student should then prepare for his first class license in approximately 75 additional hours of study.

In the Grantham resident course, the time normally required to complete the course and get your license is as follows:

In the DAY course (5 days a week) you should get your second class license at the end of the first 9 weeks of classes, and your first class license at the end of 3 additional weeks of classes. This makes a total of 12 weeks (just a little less than 3 months) required to cover the whole course, from "scratch" through first class.

In the EVENING course (3 nights a week) you should get your second class license at the end of the 15th week of classes and your first class license at the end of 5 additional weeks of classes. This makes a total of less than 5 months required to cover the whole course, from "scratch" through first class, in the evening course.

**HERE'S PROOF** that Grantham Students prepare for F.C.C. examinations in a minimum of time. Here is a list of a few of our recent graduates, the class of license they got, and how long it took them:

Name	License	Weeks
James C. Bailey, 217 Behrends Ave., Juneau, Alaska	1st	12
Edward R. Barber, 907 S. Winnifred, Tacoma, Wash.	1st	20
M. A. Dill, Jr., 20 Cherry St., Gardiner, Maine	1st	12
Bernhard G. Fokken, Route 2, Canby, Minn.	1st	12
Thomas J. Hoof, 216 S. Franklin St., Allentown, Pa.	1st	22
Clyde C. Morse, 5755 Sharronlee Dr., Mentor, Ohio	1st	12
Louis W. Pavak, 838 Page St., Berkeley 10, Calif.	1st	16
Wayne Winsauer, 2009 B St., Bellingham, Wash.	1st	12

**OUR GUARANTEE:** If you should fail the F.C.C. exam after finishing our course, we guarantee to give you additional training at NO ADDITIONAL COST. Read details in our free booklet.

## Accredited by the National Home Study Council

For further details concerning F.C.C. licenses and our training, send for our FREE booklet, "Careers in Electronics". Clip the coupon below and mail it to the School nearest you.

Get your First Class Commercial F.C.C. License Quickly by training at



## GRANTHAM SCHOOL OF ELECTRONICS

1505 N. Western Ave.      408 Marion Street      3123 Gillham Road      821 - 19th Street, N.W.  
Los Angeles 27, Calif.      Seattle 4, Wash.      Kansas City 9, Mo.      Washington 6, D. C.  
(Phone: HO 7-7727)      (Phone: MA 2-7227)      (Phone: JE 1-6320)      (Phone: ST 3-3614)

MAIL COUPON NOW — NO SALESMAN WILL CALL →

The Grantham course is designed specifically to prepare you to pass FCC examinations. All the instruction is presented with the FCC examinations in mind. In every lesson test and pre-examination you are given constant practice in answering FCC-type questions, presented in the same manner as the questions you will have to answer on your FCC examinations.

## Why Choose Grantham Training?

The Grantham Communications Electronics Course is planned primarily to lead to an F.C.C. license, but it does this by TEACHING electronics. This course can prepare you quickly to pass F.C.C. examinations because it presents the necessary principles of electronics in a simple "easy to grasp" manner. Each new idea is tied in with familiar ideas. Each new principle is presented first in simple, everyday language. Then after you understand the "what and why" of a certain principle, you are taught the technical language associated with that principle. You learn more electronics in less time, because we make the subject easy and interesting.

## Is the Grantham Course a "Memory Course"?

No doubt you've heard rumors about "memory courses" or "cram courses" offering "all the exact FCC questions". Ask anyone who has an FCC license if the necessary material can be memorized. Even if you had the exact exam questions and answers, it would be much more difficult to memorize this "meaningless" material than to learn to understand the subject. Choose the school that teaches you to thoroughly understand—choose Grantham School of Electronics.

## Is the Grantham Course Merely a "Coaching Service"?

Some schools and individuals offer a "coaching service" in FCC license preparation. The weakness of the "coaching service" method is that it presumes the student already has a knowledge of technical radio and approaches the subject on a "question and answer" basis. On the other hand, the Grantham course "begins at the beginning" and progresses in logical order from one point to another. Every subject is covered simply and in detail. The emphasis is on making the subject easy to understand. With each lesson, you receive an FCC-type test so you can discover daily just which points you do not understand and clear them up as you go along.

## MAIL TO SCHOOL NEAREST YOU

(Mail in envelope or paste on postal card)

To: GRANTHAM SCHOOL OF ELECTRONICS

1505 N. Western • 408 Marion • 3123 Gillham Rd. • 821-19th, NW  
Los Angeles • Seattle • Kansas City • Washington

Please send me your free booklet telling how I can get my commercial F.C.C. license quickly. I understand there is no obligation and no salesman will call.

29-D

Name \_\_\_\_\_ Age \_\_\_\_\_

Address \_\_\_\_\_

City \_\_\_\_\_ State \_\_\_\_\_

I am interested in:  Home Study,  Resident Classes

## RCA COLOR PARTS AND DISPLAY RACK STOCK No. 11A1014

• Convenient • Compact

Because of the ideal size of this rack, it lends itself very well to mounting on the wall or on the service work bench.

**126 ESSENTIAL COLOR PARTS FOR SERVICING RCA COLOR CHASSIS TYPES CTC 10 & CTC 11**

A complete color service center.

**SEE YOUR  
RCA DISTRIBUTOR NOW!**



**PARTS &  
ACCESSORIES**

# new

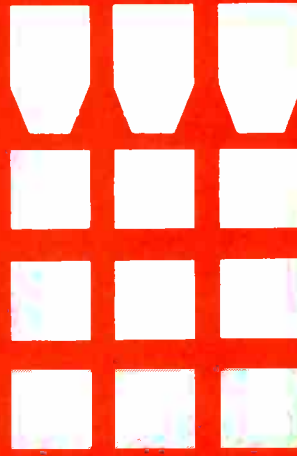

## RCA COLOR TEST JIG

#11A1015

A **must** for any serviceman now servicing or planning to service Color TV receivers ■ Make a one man service call out of a costly two man cabinet pulling job ■ Eliminate possibility of damage to the customer's set when transporting to and from his home ■ Eliminate the need to reconverge the customer's set when the chassis is returned ■ Professional Appearance—Finish matches that of RCA Test Equipment ■ Partial Assembly—Safety glass and kine mask assembled at factory ■ Components Kit furnished with Test Jig includes all necessary components, hardware and Instructions for installation of an RCA Tri-Color Kinescope ■ Convergence control panel supplied provides dynamic as well as static convergence for the CTC-10 and CTC-11 chassis ■ Instructions included with test jig provides data for utilization with CTC-4, 5, 7 and 9 chassis and lists extension cables required ■



### CONTENTS OF PARTS KIT SUPPLIED WITH TEST JIG

Description	Quantity	Stock No.
Cushion—Plastic, for kinescope mounting.....	2	105033
Shield—Plastic, for anode contact.....	1	105034
Lead—Anode lead.....	1	105539
Resistor—Fixed Comp. 56K± 10%, 2W.....	1	—
Spring—For anode resistor.....	1	105028
Yoke—Deflection yoke.....	1	109457
Convergence assembly.....	1	—
Ring—Purity magnet.....	1	79604
Magnet—Blue beam lateral.....	1	103172
Clamp—For convergence cable.....	1	—
Screw—For mounting convergence assem.....	3	—
Lead—Ground lead.....	1	—
Clip—For ground lead.....	1	—
Tool kaddy.....	1	—

see your RCA distributor for details

*RCA parts & accessories/camden, n. j.*

## act now for the color season



**RCA The Most Trusted Name in Color Television**  
**RADIO CORPORATION OF AMERICA**

# FREAK

# RASTERS



Fig. 1. Scallop (*vola jacobaea*) is a bivalve. Habitat: Shallow sea bottoms.

Most visual symptoms of TV trouble are familiar to servicemen through repeated encounters, and are also well catalogued in technical books and magazines (see Chart I). Thus, their most common causes are well established, and experienced servicemen know what troubleshooting strategy to employ for quickest results.

But every now and then, some unusual defect, a peculiar combination of troubles, or an interaction between circuits, will produce a symptom the average technician has never seen before. He may be baffled, with scarcely any idea of where to begin troubleshooting, unless he is able to reason out the possible causes of a set's oddball behavior. The following actual cases will give some idea of how to proceed when



Fig. 3. Not a luminous funnel cloud, but struggling attempt at TV sweep.

a freak raster makes its appearance.

## Sea Shell

The dim raster on a Hallicrafters Chassis C1850D resembled, more than anything else, a picture that might be found in the crustacean section of a natural-history encyclopedia. Because of its keystone shape, I first suspected a yoke defect; but resistance and inductance checking gave that item an AOK. So, I removed the cage cover to look at the flyback, which I considered the next most probable offender. The first thing I noticed was that R82 (Fig. 2), mounted on the flyback, was running hot. On checking, I found that it measured half its original resistance. Replacing this part did not correct the raster shape, although it did make the raster somewhat brighter. A closer study of the circuit suggested a defective C78. When I replaced this capacitor, the raster resumed its full size and normal shape. A capacitance check revealed that C78 was practically open.

## Tornado

Fig. 3, which looks somewhat like a Kansas twister, was the very dim pattern found on the screen of a General Electric Chassis U3. While

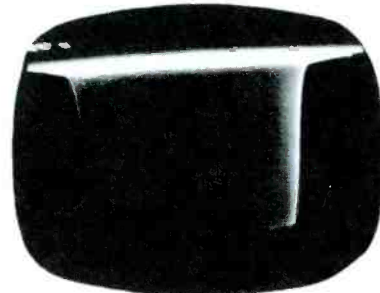

Fig. 5. Cup-shaped raster was sign of abnormal loading on sweep circuits.

I had never before seen a raster affected as severely as this one, I had seen misshapen rasters in other sets of this same series — and they had all been due to a defective boost capacitor (C4 in Fig. 4). The U3's use of an unusually large electrolytic unit for this function may have something to do with the relatively frequent failures, as well as the odd symptoms observed. In the present case, a scope check of C4 proved beyond doubt it was open, and installation of a replacement resulted in a normally-deflected raster of acceptable brightness.

In Fig. 3, as well as in Fig. 1,

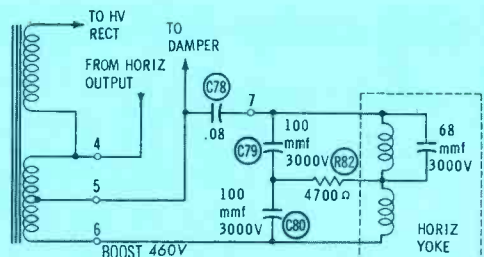

Fig. 2. Faulty components in yoke circuit caused a keystone-shaped raster.

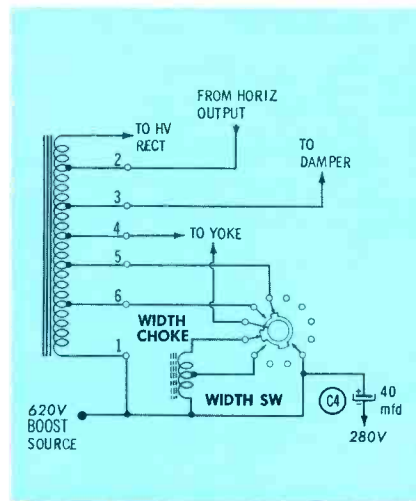
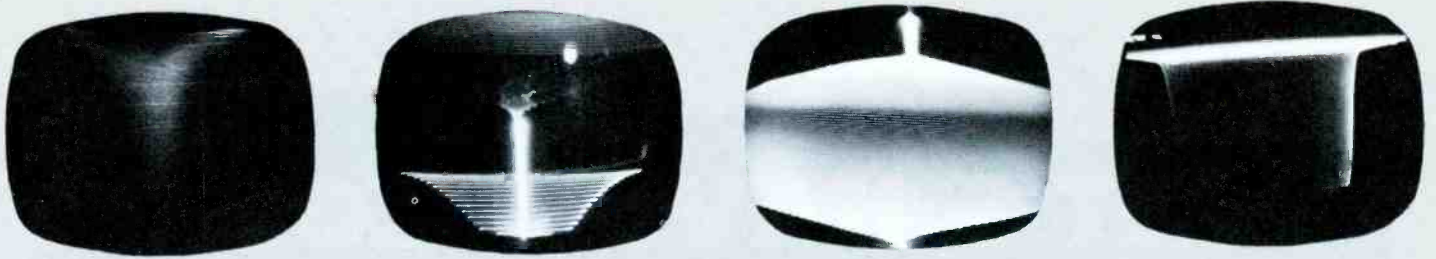

Fig. 4. Extra-large boost capacitor C4 had practically ceased functioning.





# ... AND THEIR CAUSES!

the light on the screen was so feeble as to be barely perceptible under normal room lighting. This dimness was a by-product of the inefficient flyback-circuit operation, and was automatically corrected when the primary trouble was cured.

## Cup o' Trouble

The cup-shaped raster shown in Fig. 5 was photographed from the screen of a Zenith Chassis 16D21. Soon after I fired up this set on the bench, I noted that R59 (Fig. 6) was running excessively hot. This reinforced my initial suspicion that a faulty filter capacitor was causing the raster distortion, although I wasn't immediately sure which filter was to blame. Scoping the power-supply circuit, I found horizontal flyback pulses on the 270-volt B+ line. Obviously, C1B was not properly filtering the plate voltage of the damper tube. Replacing C1 restored a full raster, and I then concerned myself with determining why R59 had been overheating. DC voltage checks at both ends of the resistor had indicated no reason why it should run hot. However, since the series combination of R59 and C2A had presented the lowest-impedance path to ground for the damper-plate pulses, the strength of the pulses developed across R59 was undoubtedly great enough to account for its feverish temperature.

Although the resistance of R59 had not shifted too far from its original value, I nonetheless replaced it, because a resistor subjected to excessive current is likely to become "noisy" at a later date and result in some pretty hard-to-pin-down troubles.

• Please turn to page 101

Chart 1—Recent PF REPORTER Articles on Common Visual Symptoms

CONDITION	USUAL CAUSES	ARTICLE AND ISSUE
<b>AFFECTS RASTER WITH OR WITHOUT PICTURE</b>		
Blank screen	No high voltage  CRT burned out or biased to cutoff	Restoring Horizontal Sweep Feb 62 Where'd the Boost Go? Aug 61 Pinpointing Yoke and Flyback Troubles May 61 Have HV—No Raster May 60
Raster reduced to thin horizontal line Raster rectangular, but not high enough or distorted vertically	Failure of vertical sweep circuit or yoke Weak or nonlinear vertical sweep	Vertical Sweep Troubleshooting from A to Z Jan 62 Operation Vertical Jan-Feb 61
Raster rectangular, but not wide enough or distorted horizontally	Weak or nonlinear horizontal sweep	That's the Way the Horizontal Sweeps May 60
Raster not rectangular Poor focus, with blooming	Defect in yoke or associated component Insufficient high voltage	Pinpointing Yoke and Flyback Troubles May 60
Poor focus of scanning lines; no blooming	Misadjusted or faulty focusing system	Selecting a CRT Replacement May 61
Irregular flashing	High-voltage arcing  Regeneration	Pinpointing Yoke and Flyback Troubles May 60 Regeneration in Picture - Signal Circuits Dec 60
Background shading or bars in raster	Hum or ripple entering picture circuits	Track Down That Visible Hum Sep 61
<b>AFFECTS PICTURE ONLY</b>		
Raster, but no picture	Broken RF-IF-video signal path	Have Raster—No Pix Jan 61
Weak, snowy picture	Low gain in tuner	TV Tuners—Repair or Replace? Sep 61
Weak picture—no snow	Low IF or video gain Excessive AGC bias	Scoping Video and Vertical Troubles Jan 60
High contrast, but gray-scale distortion	Insufficient AGC bias  RF-IF-video defect	Causes and Cures for Negative Picture Oct 60 Servicing the Big Loop Jul 60
Scanning lines sharp, but picture smeared or blurred	Misaligned or defective RF-IF-video section	Painless-TV Alignment Oct 61  Checking Up on Video Amplifiers Jan 62
Picture tearing and/or rolling (flipping)	Loss of sync; defect in sync, sweep, video, AGC, IF, or tuner	Wanted: Pix—Must Be Steady Feb 61 Servicing Sync and Sound Sep 60 Tough-Dog Sync Troubles Feb-Apr 60
Bars or lines in picture	RF interference	Eliminating TVI Jan 62
Copies of all back numbers listed in this chart, except January and May 1960, are still available. To obtain any of these issues, use the convenient coupon on page 104.		

# LET'S HAVE A LOOK

New "top-end" circuits are further expanding the limits of TV fringe areas.

... by Jim Galloway



The advent of high-frequency transistors and stable, ultra-high-gain RF tubes has brought about a resurgence of interest in TV preamplifiers, especially among consumers. Of course, preamps have long been available, but newer units can claim much better performance characteristics than the early-model "boosters."

The original boosters sat on top of the TV receiver and acted as an extra stage of RF amplification, increasing the sensitivity of the set—not only to television signals, but to line noises as well. The next logical step was to place the preamp nearer to the antenna. By locating the unit closer to the signal-pickup point, the line loss between the antenna and preamp is reduced. Thus, noise generated within the preamp, as well as that picked up by the antenna and line, have less of a deteriorating effect on the signal. Mast-mounted preamps are still being used today with a great deal of success.

The small physical size and low power requirements of transistorized units made it possible to locate the

preamp right at the antenna terminals. This almost completely eliminated the transmission line between the antenna and preamp, simplifying the problem of achieving a good impedance match and thus a better transfer of signal energy. Recently, manufacturers have been selling antennas and preamps as single units—calling them, quite logically, "transistorized antennas."

## Characteristics

There are two important specifications—*gain* and *noise figure*—which can be used to indicate the performance of any preamplifier. When you buy a preamp, it is a good idea to know how to interpret these terms, so that you will be in a better position to select the unit which will fulfill the needs of a specific application.

### Gain

Most gain figures are given in decibels; however, a single gain figure is not adequate to describe the over-all performance of a preamp. Since the bandpass of the unit must be of sufficient width to amplify at

least all the VHF television signals (and perhaps FM signals as well), gain is not usually the same across the entire amplifier range. Therefore, at least two gain figures are often given—one for the high range (Channels 7 through 13), and another for the low range (Channels 2 through 6 plus the FM band). Each of these figures usually represents the average gain over the particular ranges they cover. Many manufacturers include gain curves in their specifications; these are helpful in determining the relative gain of the unit for each particular channel.

It is not unusual for the purchaser of a preamp to be swayed into selecting a unit with the highest gain characteristics, consistent with a price considered reasonable for the application. As mentioned above, however, noise is also a factor in determining the suitability of a given preamplifier for a specific requirement.

### Noise Figure

In considering the use of a preamplifier, we must realize that its sole purpose is to increase desired signals to a usable level, and this level must be sufficient to overcome the noise generated in the front-end circuits of the receiver. In other words, depending on the receiver used, a certain amount of signal must be delivered to its antenna terminals to provide satisfactory performance. Since the preamplifier itself is basically an "addition" to the front-end of the receiver, and contains RF circuits which also generate noise, its *noise figure* must be considered in conjunction with its gain figure.

For example, suppose the gain figure for one preamplifier is specified as 10 db, and its noise figure

AVAILABLE MODELS OF ANTENNA AND MAST-MOUNTED PREAMPS AND ELECTRONIC ANTENNAS

MANUFACTURER	MODEL #	TRADE NAME	DESCRIPTION	TYPE	IMPED- ANCE	LIST PRICE
BLONDER-TONGUE	AB-2		Mast-Mounted Amp	Tube	300 $\Omega$	\$53.95
	AB-4	Signal Master	Mast-Mounted Amp	Xstr	300 $\Omega$	\$29.95
CHANNEL-MASTER	0020	Jetron	Antenna-Mounted Amp	Xstr	300 $\Omega$	\$44.95
FINNEY	T-AMB	Nova-Tron	Antenna-Mounted Amp	Xstr	300 $\Omega$	\$29.95
JERROLD	APM-101	Powermate	Antenna-Mounted Amp	Xstr	300 $\Omega$	\$39.95
	DSA-132	De-Snower	Mast-Mounted Amp	Tube	75 or 300 $\Omega$	\$119.50
	DSA-202	De-Snower	Mast-Mounted Amp	Tube	75 or 300 $\Omega$	\$89.95
JFD	TNT-100	Transis-tenna	Antenna-Mounted Amp	Xstr	300 $\Omega$	\$34.95
	TNT-103AC	Transis-tenna	Antenna-Mounted Amp	Xstr	300 $\Omega$	\$36.95
TACO	*	Electra	Electronic Antenna	Xstr	75 or 300 $\Omega$	78.80-\$107.20
WINEGARD	MA-300	Tenna-Boost	Antenna-Mounted Amp	Xstr	300 $\Omega$	\$34.95
	*	Powertron	Electronic Antenna	Xstr	75 or 300 $\Omega$	74.95-\$104.95

\* SEVERAL MODELS AVAILABLE



# AUTOMATIC

## BRIGHTNESS

PF

## CONTRAST

# CONTROL!

For years, television viewers have had to adjust brightness and contrast levels to compensate for room lighting. On bright, sunny days, a higher brightness and video level is required from the TV than on a dark, dull day, or even when the curtains are closed. At night, with incandescent lighting (or with very little light at all, as some viewers prefer), it is necessary to change the controls again. To relieve this "drudgery," some set manufacturers are including automatic controls which compensate for changes in room-lighting levels. Some of these circuits alter the brightness, and some the contrast, but most circuits vary them both. Whatever the method, their common function is to relieve the viewer of the need for changing the manual controls himself.

As every good technician knows, the basic method of controlling CRT brightness is by adjusting the grid-cathode bias voltage. Brightness can be reduced by making the cathode more positive, or by causing the grid to become more negative (less positive). Either method reduces the intensity of the electron beam striking the CRT phosphor, with a re-

sulting decrease in image brightness. If some manner of controlling this bias by a light-sensing device is introduced, the brightness can be altered automatically in accordance with the ambient light in the viewing area.

The simplified diagram in Fig. 1 shows one way this can be done. Voltage divider R2-R3-R4 determines the amount of positive voltage applied to the cathode of the CRT. If the slider of brightness control R2 is moved toward R3, less voltage is dropped across R2, and more voltage is present at the junction of R3 and R4 (point A). R1 applies this voltage to the cathode of the CRT, reducing the beam intensity.

If divider resistor R4 is paralleled by another resistor — R5 — which is sensitive to changes in light, the voltage at point A becomes greater or lesser according to the amount of light striking R5. This causes the CRT beam current to be automatically changed. If the resistance of R5 decreases as more light strikes it, the bias voltage at the CRT cathode becomes less; as a result, the CRT image becomes brighter, overcoming the glare of

In many '62 TV sets, cadmium sulfide cells are a new factor in video troubleshooting . . .

by Forest H. Belt

room light.

A change in CRT brightness should be accompanied by a corresponding change in the video level; otherwise, the gray-scale balance of the picture will be upset, resulting in a "washed-out" picture. A method of increasing the video automatically is shown in Fig. 2. Video gain in this circuit is normally controlled by R4, which is part of the video-amplifier plate load. Automatic contrast compensation is accomplished when series resistor R3 changes in value, causing more or less video signal to develop across R4.

If an increase in room lighting causes the resistance of R3 to decrease, the signal voltage at point A increases because of divider action in R3-R4. Note that C1 keeps the lower end of R4 at signal ground. The increase in video signal at point A causes a greater signal voltage to be fed through C2 to the CRT. Thus, light-sensitive element R3 can cause an increase in contrast which compensates for increased room lighting; if the room becomes darker, R3 increases in value and the contrast is reduced accordingly.

The resistive device which is re-

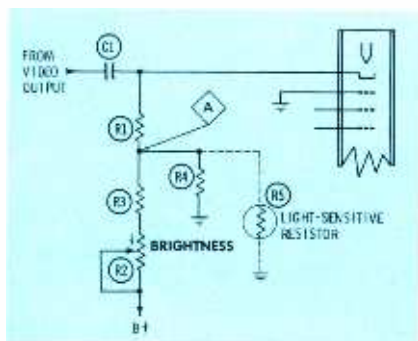

Fig. 1. A light-sensitive resistance controls bias and brightness of CRT.

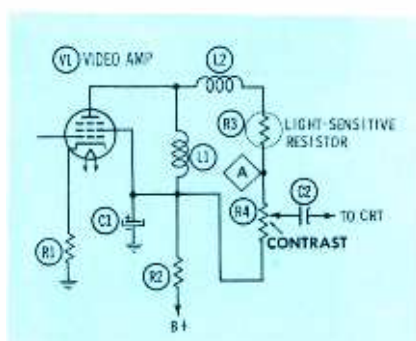

Fig. 2. A method of contrast control.



Fig. 3. Cadmium sulfide photoconductor changes resistance with light.

sponsible for this unusual action is known as a *cadmium sulfide photoconductor cell* — see Fig. 3. A thin layer of cadmium sulfide, when deposited as shown in the photo, reduces its resistance in the presence of light. This is a negative characteristic, which means that more light causes less resistance. The *dark* resistance (no light) of these cells can range from 100K ohms to several megohms, depending on the design. Under high-intensity light, their resistance ranges from 200 ohms to as much as 10K ohms. Those used in TV automatic brightness and contrast circuits usually have a *dark* resistance of a few megohms and a *bright* resistance of 200 or 300 ohms.

### A Practical Circuit

The *Magnalux* circuit used in Magnavox receivers is shown in Fig. 4. The key element in the circuit is the light-sensitive cadmium sulfide cell R12. The element has a dark resistance of nearly 5 megohms. In semi-darkened surroundings, its resistance falls to around 50K ohms, and in very bright light the resistance is about 300 ohms. Thus, under normal circumstances, the cell resistance will vary from 50K to 300 ohms, according to the amount of light present.

Manual control of CRT brightness is accomplished by R14 in Fig. 4. This brightness control varies the amount of voltage applied to the CRT grid. Divider R6-R7 holds the cathode at a fixed DC potential. The video level is set by contrast control R4, which adjusts the cathode bias of V1, the video output tube.

In a semi-darkened room, such as a living room at night with only one lamp burning, the resistance of R12 is approximately 50K ohms. In this condition, it exerts very little influence on the divider networks, which consist of R10-R11-R12, CRT voltage divider R13-R14, and screen voltage divider R8-R9. As increased illumination (more lamps, or daylight) lowers the resistance of the cell, the total value of the parallel combination R10-R11-R12 decreases, causing more voltage from the 280-volt line to be available at point A. R13 and R14 apply this voltage increase (point B) to the grid of the CRT through R15.

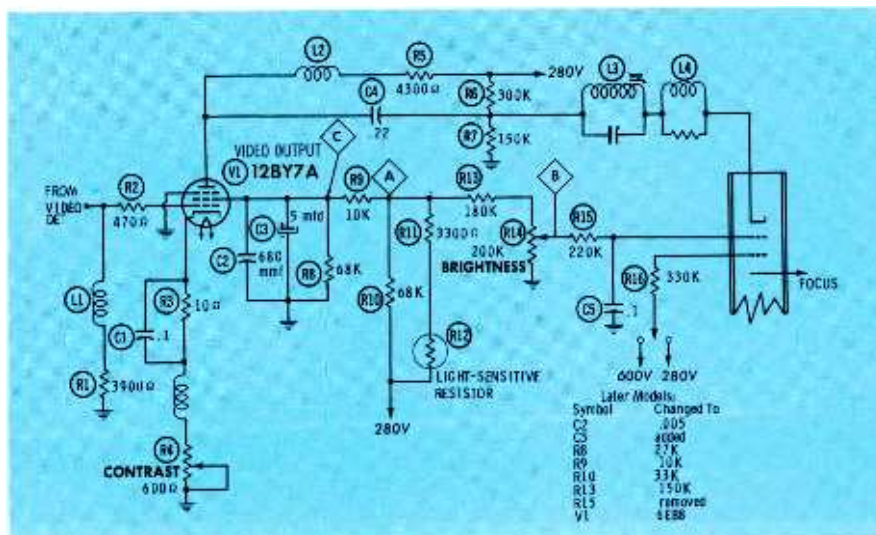

Fig. 4. Magnavox automatic brightness circuit has no switch for disabling.

The beam current in the CRT becomes more intense, and the raster brightens.

At the same time, R8 and R9 apply the voltage increase (point A) to the screen (point C) of video amplifier V1, raising its gain and increasing the contrast. This greater video signal is applied to the cathode of the CRT and the contrast change corresponds with the increased brightness.

### A Complex Circuit

An automatic brightness circuit called *Magic Eye* is used in certain RCA chassis. A simplified schematic of this arrangement is shown in Fig. 5. This circuit is primarily a complex voltage divider arrangement, and Fig. 5 is drawn in such a way as to aid in tracing the DC and signal paths.

First, let's analyze the circuit with the automatic brightness switch in the *off* position. The voltage divider consisting of R13, R15, and both sections of R14 controls the first-

anode voltage and the grid bias of the CRT. R14B chooses the grid bias, and R14A acts in conjunction with R15 to keep the first-anode voltage fixed with respect to the grid. This improves the operation of the CRT at any brightness level which may be manually selected by R14, the brightness control.

Contrast control R5 is effectively in parallel with the plate load of V1, the video output tube, since ABC switch S1 bypasses R4 and R5 — see Fig. 6. R7 determines the minimum contrast level obtainable with R6. C5 couples the video signal to the cathode of the CRT across resistor R12. R8, R10, R11, and R12 (Fig. 5) form a voltage divider which maintains the DC level at the cathode of the CRT, improving the video presentation.

When ABC switch S1 is placed in the *on* position, as it is shown in Fig. 5, the short across cadmium sulfide cell R4 is removed by one set of contacts, and another set changes

• Please turn to page 42

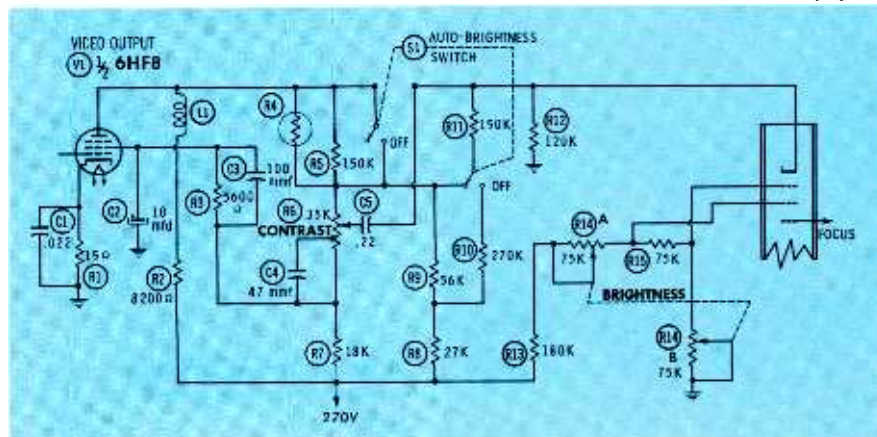

Fig. 5. Simplified layout of *Magic Eye* circuits clarifies explanations.

AUDIO FACTS by C. THOMAS



# HOWELL CO.'S ALL TAPED UP!

The Howell Company of El Paso, Texas, established in 1950 as a general TV-radio repair shop, began easing away from TV into hi-fi about 1954. By 1957, when they dropped TV entirely, they'd already spent a full year on their present job—selling and servicing tape recorders.

"By the nature of the tape-recorder business, we also include phonograph sales and service," says owner Tom Howell. "We service 6,000 phonos a year. But tape is our main business."

Howell's sales run right at \$100,000 a year. The service department, with five full-time technicians, grosses \$50,000 a year. Parts inventory averages between \$6000 and \$7500, including parts for all popular foreign makes.

When a service job hits the bench, the technician studies the complaint carefully. If he thinks the job is going to cost the customer in excess of \$12.50, he drops it and telephones the customer. Some instruct him to go ahead; others consider trading in the equipment, and ask him to hold off until they can come to Howell's. Names in this second group are relayed to Fred Willems, sales manager, who handles the situation personally after being briefed by the technician.

"We trade for anything electronic," says Willems. "If we can gross \$10 on a trade-in, we are satisfied. We prefer to move our stock fast, rather than to hold out for a larger profit margin."

Most equipment is purchased on time payments, with credit handled by finance companies. Delinquent accounts are few, and repossessions are almost unknown.

### Service Routines

Recorders and changers being bench-serviced are stripped down for a complete cleaning and lubrication, if they are more than about a year old. Dry motor bearings, and deteriorated drive belts or idler wheels—both sources of objectionable noise—are often found.

"We always clean and demagnetize the tape heads as a free service, even if the repair is only a tube replacement," says W. D. "Scotty" Scott, service manager. "On professional or semiprofessional units, the bench serviceman also checks the bias on the record head and its azimuth alignment."

### Custom Sound Recording

A little over a year ago, Howell's ventured into the commercial recording field, seeing unlimited possi-



Customer listens in sales room while Tom Howell plays tape recording of daughter's part in school performance.

Bench technicians handle a recording session at a local high school.





Several bench technicians are kept busy servicing recorders and phonographs.

Simple AM tuner—just an RF tank circuit and crystal detector—supplies amplifier-test signal.

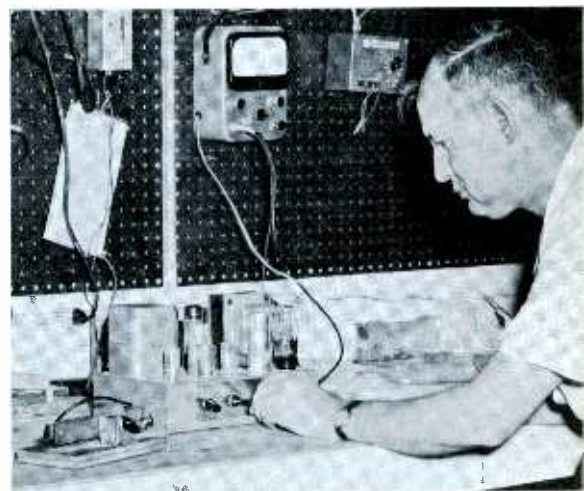

bilities for making contacts to boost the sale of equipment and increase the service department's volume—“... besides picking up the additional profit from the sale of tapes and platters as we go along,” says Howell.

The company is franchised by Century Records, a West Coast disc-pressing firm, which works from master tapes recorded by local high school bands, college bands and orchestras, choral groups at both schools and churches, and other instrumental and vocal groups. The musical programs are recorded during a performance, as a rule—rarely at a rehearsal. Whenever possible, Howell's has a prominent display of music systems, tapes, and records at the entrance to the auditorium, with Tom alongside to answer all questions.

Requests to play back the recordings immediately after the performance are squelched, since both the participants and the recording technicians are usually ready to call it a day. Tom explains, “We return at a prearranged time, when the performers are convened, and play back the tape via one of our professional or semiprofessional units.” Later, performers or parents

often come back to Howell's to hear the recordings again and buy copies on discs or tape.

Tom says, “It's seldom we gross less than \$300 on a session.” At the high school in Deming, New Mexico (population 5,000), he sold \$880 worth of tapes and platters on one job. A session with two churches at Albuquerque brought in \$1210. Another time, he worked out a program with Austin High School in El Paso to sell a thousand records at \$1 each, with \$550 going to the school for a fund-raising project. This record contained highlights of the school year, as taped by a journalism student. There were school yells, famous sayings of class members, a few bars of a popular song rendered by “the girl most unlikely to become a vocalist,” the school orchestra tuning up, the band making a few off-key sounds, and a few characteristic remarks of faculty members. This was all edited down to 12 minutes with Howell's help, put on both sides of a 45-rpm disc by Century, and included with the school's annual.

“It was a lot of fun, and it meant \$450 for us,” says Tom Howell. “There's no end to the possibilities tape offers a dealer.” ▲



Stereo speakers like these are being installed over all bench positions.

Foreign brands account for a considerable portion of Howell's tape-recorder service business.

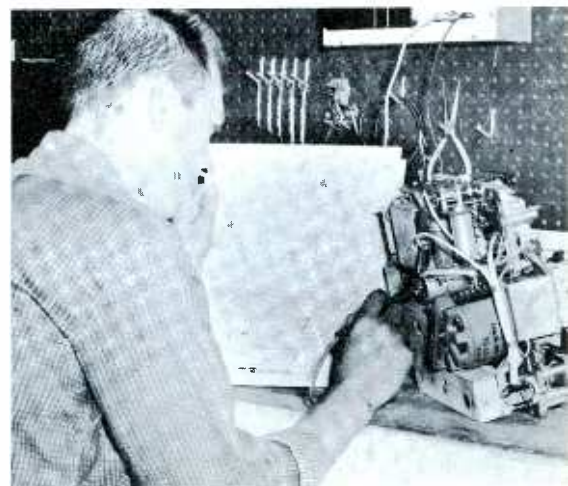

# Blueprints for Service Benches

*part 1*

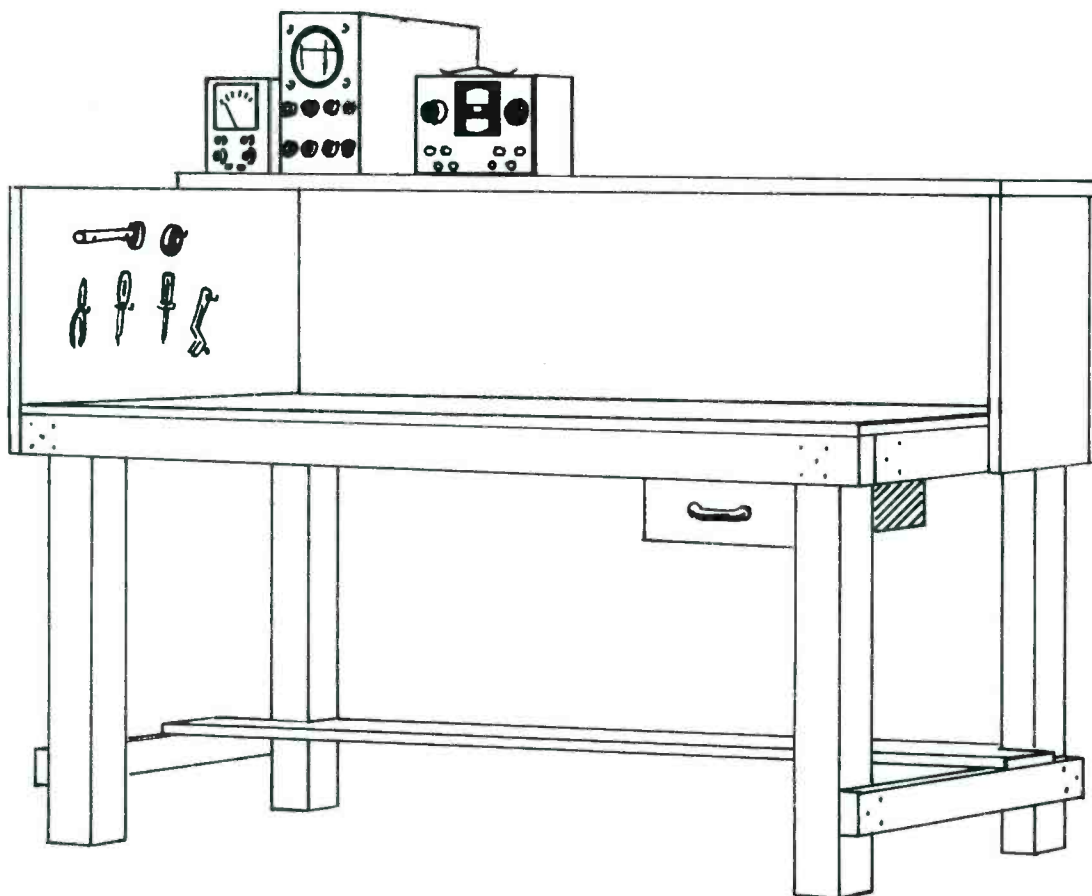

You can build this one-man bench with a minimum of effort and materials. It has a rugged surface that can take a lot of punishment, and it is designed to let you work with maximum efficiency. Either screws or nails can be used to assemble the work. Screws provide a somewhat stronger construction, but involve considerably more work. On the other hand, nails will do the job adequately if driven in the proper pattern (see corner-detail drawing on next page).

A row of AC outlets along the back of the shelf is definitely recommended, so that the line cords of the

test instruments can be kept out of the way. You may prefer to install additional outlets along the front edge for powering sets and soldering irons. In this case, the top covering should be extended about two inches beyond the front edge of the bench frame, to "roof over" the outlets so that the plugs will not be inadvertently pulled.

The shelf near the floor can be as wide as desired, depending on whether you have a greater need for leg room or for storage space. This shelf should be fastened securely to the end braces, because it is an integral part of the bracing structure of the bench.





# NOW-FIRST TIME EVER! The exact or equivalent replacement for nearly every record player made since 1930 MASTER CARTRIDGE SUBSTITUTION GUIDEBOOK

by Jack Strong

For everyone who services or sells record players this guidebook will pay for itself over and over again by:

1. saving time in locating the right replacement quickly.
2. saving money by cutting down on the number of cartridges you need to stock.

This cross reference guide book will help you locate the exact replacement or equivalent cartridge (mono or stereo) for virtually every record player made since 1930. Even the old record players can be serviced through the use of universal replacement types. The book consists of two parts. In Part I, substantially all cartridges made since 1930 are listed, first by numerical order, and then in alphabetical order. This listing also shows one or more equivalent cartridge types and its manufacturer. Part II, lists (60) record player manufacturers, and the model numbers of their players, and the part number of the original cartridge used. #288, \$2.00.



(Direct Receiving Tube Substitutions Only... plus added new feature—1300 direct CRT substitutions)

This direct substitution guide, designed to be carried in the tube caddy, contains only direct receiving tube substitutions—which can be made without modification of the wiring.

This guidebook will—

- save you time
- eliminate carrying needless tube types
- enable you to select the best substitution
- minimize sales losses because you don't have the right tube

It will pay for itself on the first service call!

It contains substitutions for: • Receiving tubes • Ruggedized tubes • European-to-American tubes • American-to-European tubes • Cathode-Ray Picture tubes.

Cat. #299... still only 90c

CAUTION—You can't afford to be without this book!

**HOW TO AVOID LAWSUITS IN TV-RADIO-APPLIANCE SALES & SERVICE** by Leo Parker, Jr. . . . A valuable manual for the technician . . . —ELECTRONICS WORLD.

• When can a serviceman collect for repairs? • When is a service guarantee enforceable? • When can a serviceman demand cash payment? • When does a lien protect a serviceman? • How can a knowledge of contract law earn profits? • How valid are written contracts? • What are the insurance laws? • These are just a few of the vital questions that are answered in this book written by an experienced lawyer. It covers many situations that you may face if you sell equipment, enter a home to service it or receive equipment for servicing in your shop. #283, \$1.00.

You can depend upon any of the direct substitutions in

**INTERNATIONAL TRANSISTOR SUBSTITUTION GUIDE-BOOK** by Keats A. Pullen, Jr. Eng. D. (Scientific Staff, Ballistics Research Labs., Aberdeen Proving Grounds) direct substitutions only "possible substitutions deemed doubtful", that is they work only in some cases, were omitted . . . thus, substitution guide is a 'safe' guide." —INDUSTRIAL ELECTRONIC ENGINEERING AND MAINTENANCE. It's complete and comprehensive — lists 4500 direct substitutions comprised of American, Japanese, British, French, German, Dutch and Italian transistor types. Includes both triodes and tetodes. Not only are the direct electrical substitution shown, but case styles, dimensions and basing diagrams for the original and substitute also are given. #276—\$1.50.

At your Electronic Parts Distributor, or order direct from publisher.

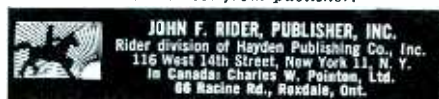

## Automatic Brightness Control

(Continued from page 37)

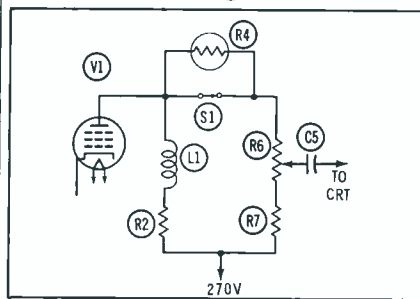

Fig. 6. Video circuit when S1 is off.

the voltage divider from R8 through R12 to place less resistive isolation between the cell and the CRT cathode. Now the light-sensitive cell can affect the cathode voltage on the CRT, as you will presently see.

In Fig. 7, the resistive networks of Fig. 5 have been combined and simplified to show how they affect the CRT cathode when the automatic brightness circuits are in operation. The B+ supply voltage is dropped across the R8-R9 resistance, and then applied to a series-parallel arrangement. One parallel leg consists of the cadmium sulfide cell R4 and the plate resistance of V1; the other is made up of R11 and R12. The CRT cathode is connected directly to the junction of R11 and R12.

The operation of this brightness-control circuit is relatively simple. When light strikes the element of cell R4, the resistance drops in proportion to the amount of light. This lowers the resistance of the entire parallel network, causing the voltage at point A to diminish. Consequently, the voltage at point B (and the CRT cathode) decreases, making the cathode less positive and increasing the CRT beam current. Thus, a change in light on the cell causes a corresponding change in CRT brightness.

The circuit of Fig. 5 exerts two forms of control over the contrast. Fig. 8A shows how the cadmium sulfide cell operates with the contrast control to alter the video-signal level. When light is falling on the element, the resistance of the cell R4 is low enough that its parallel resistor (R5 in Fig. 5) can be overlooked. R4, R6 (the contrast control) and R7 form a voltage divider across the video load L1-R2. As the light on the cell increases, its resistance decreases and permits more of the signal voltage from the

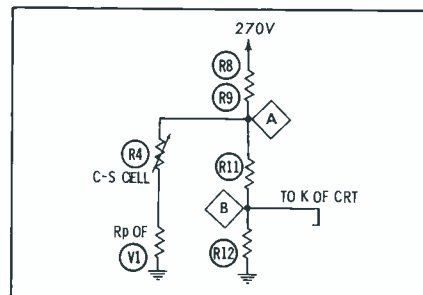

Fig. 7. Automatic brightness control.

video amplifier to be developed across contrast control R6. This increases the video coupled by C5 to the CRT, and adds more contrast to the picture.

In order to effect a more linear change of the picture contrast, a second form of automatic video control is provided. Fig. 8B shows a simplified layout of the secondary control arrangement. This arrangement controls the screen voltage of V1 and, as a result, the video gain in V1.

When the controlling resistance Rc lowers in value (due to light on the cell) more plate voltage is applied to the video amplifier V1, and the tube might add some distortion to the video signal. However, the voltage at point A and the screen also decreases because of voltage-divider action, and the amplifying characteristic of V1 is altered slightly. This compensates for any non-linearity introduced by the increased plate voltage, and assures a proper balance between contrast and brightness during *Magic Eye* operation.

### More Voltage Dividers

DuMont provides automatic brightness and contrast control in a circuit arrangement shown in the simplified schematic of Fig. 9. When ABC switch S1 is off, R5 and R6 (point A) set the normal screen voltage for V1, and the light-sensitive cell circuit is disabled. For manual control of brightness, the cathode of the CRT is connected through R17 to the slider of R16, the brightness control. R16 chooses the cathode voltage for the CRT, setting the brightness level of the raster. Normal video is chosen by the slider of contrast control R9, which couples the video signal to the CRT cathode via C3.

The automatic action is the result of voltage dividers in the supply

**BUY  
"ET"**



**THE TRANSISTOR LINE THAT TUNG-SOL TAILORED TO YOUR NEEDS**

- LOW INVENTORY ■ HIGH TURNOVER
- RELIABILITY ■ PROFIT
- CUSTOMER SATISFACTION

"ET" is your guide to the compact transistor line engineered and packaged specifically for entertainment replacement. You can make just about every radio and TV replacement from only a handful-size inventory. Eleven PNP and NPN types replace hundreds of older numbers.

Each package is plainly marked with the type of service as well as the part number to save you time in selecting the units you need. Every Tung-Sol

transistor is fully warranted. Tung-Sol takes *your* responsibility seriously and spares no effort to provide the very highest in transistor performance. So make your transistor purchases with an eye to convenience, profit and customer satisfaction. Tell your supplier you'd rather have Tung-Sol "ET" transistors. Write for the Tung-Sol Transistor Interchangeability Guide. Tung-Sol Electric Inc., Newark 4, New Jersey

 **TUNG-SOL®**

**A TYPE FOR EVERY JOB**

**PNP TYPES**

**Low power**

- ET1 Mixer/oscillator/converter
- ET2 IF amplifier
- ET3 AF amplifier 6v.
- ET4 AF amplifier 12v.
- ET5 AF amplifier 9v.

**Medium power**

- ET6 AF power amplifier

**High power**

- ET7 AF high power amplifier

**NPN TYPES**

**Low power**

- ET8 Mixer/oscillator/converter
- ET9 IF amplifier
- ET10 AF amplifier 9v.
- ET11 AF amplifier 12v.



FOR **BETTER** PROTECTION  
 FOR **BETTER** INSULATION  
 FOR **BETTER** WATERPROOFING  
 FOR **BETTER** RESULTS...



Net Wt. 16 oz.

- A truly clear acrylic protective finish that will not become cloudy
- Has 33% more acrylic for greater insulating properties
- Will dry within minutes
- Will not "run"
- Manufactured in accordance with MIL Specs MIL-C-12599
- Moisture resistant

**\$1.39**

Dealer Net

**CHEMTRONICS Inc.**

871 East 52nd Street, Brooklyn 3, New York

circuits. When switch S1 is open, or *on*, the voltage at point A is divided across R4, R2-R3, R12, and R13. If increased room lighting strikes the cadmium sulfide cell R2, the resistance of R2-R3 decreases and applies more voltage to point B; as a result, more voltage is developed at point C, also. The increase at point C raises the positive grid voltage and causes the CRT beam to increase and make the raster brighter. At the same time, the increase in screen voltage at point B raises the gain of V1 so that more video signal is sent to the contrast control and to the CRT. Thus, light-sensitive cell R2 controls both brightness and contrast in a comparatively simple manner.

In order to assure that the CRT operates over a proper brightness range, R11 applies a small amount of the voltage change from point D to the CRT cathode. This prevents the cathode and grid voltages from becoming too nearly the same and causing improper CRT operation.

#### Troubleshooting

Troubleshooting these systems shouldn't be difficult if you understand the circuits. A step-by-step technique can be developed which will apply to these and any other automatic brightness and contrast circuits which may crop up. The steps in locating trouble in one of these circuits are as follows:

(1) Switch the ABC circuit *off* and adjust the manual controls for normal contrast and brightness. Where an ABC switch is provided, it includes some method of removing the effect of the light-sensitive cell from the circuit; be sure the

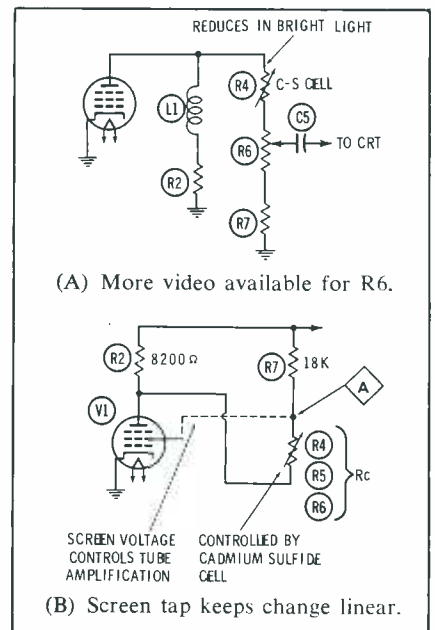

Fig. 8. Automatic contrast control is affected in two ways by cadmium cell.

switch is doing this. Putting your hand temporarily over the cell will block enough light to cause a noticeable change if the cell is still in the circuit. If the manual controls can be set normally, the brightness and contrast circuits are okay, and you can proceed to the next step. If not, the trouble has nothing to do with the automatic control action, and should be serviced the same as in any manually-controlled receiver.

(2) Switch the automatic brightness control circuit *on* and note the effect on the picture. You must keep in mind that the levels are set primarily by the manual controls, and the automatic circuits merely vary this original level to suit room conditions. For this reason, there should be little change from one setting of the switch to the other. If a wide

• Please turn to page 49

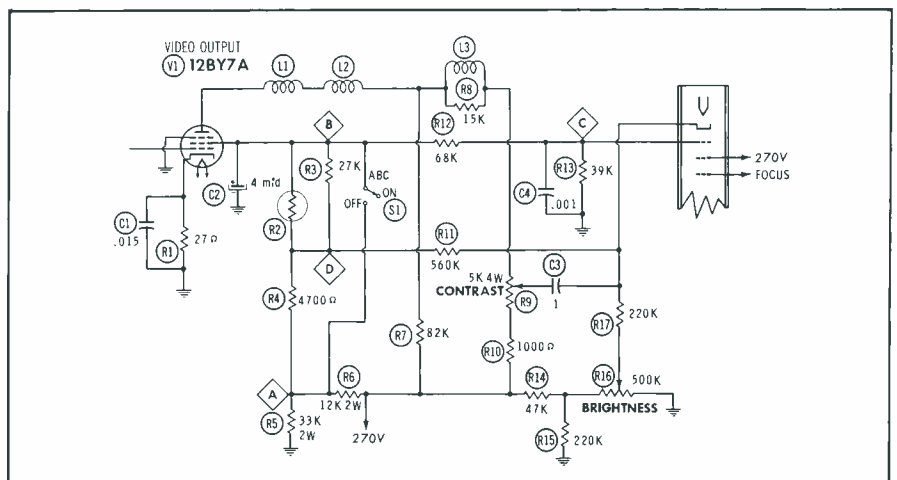
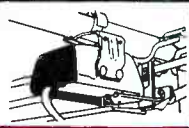
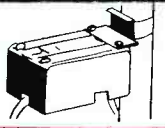
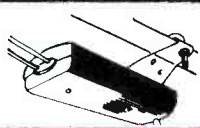



Fig. 9. DuMont's automatic brightness- and contrast-controlling circuits.

# HERE IS THE ANTENNA AMPLIFIER COMPARISON CHART

...WITH THE JFD SPECIFICATIONS THAT COMPETITION FORGOT (?)

ANTENNA AMPLIFIER COMPARISON CHART	THIS IS THE ANTENNA AMPLIFIER MANUFACTURER WHO MADE THIS TEST	COMPETITOR A List \$29.95 plus Batt.	COMPETITOR B List \$44.95	COMPETITOR C List \$39.95	JFD TRANSIS-TENNA \$36.95-AC and \$34.95-DC List
<b>PERFORMANCE FEATURES</b>					
1. Average gain, low band	18 db	13 db	4 db	17.2 db	18 db
2. Average gain, high band	14 db	7 db	9.5 db	13.5 db	15 db
3. Average VSWR, input	1:1.5	1:2	1:2.5	1:2	1:1.4
4. Average VSWR, output	1:1.5	1:2	1:3	1:2.5	1:1.4
5. Balanced input & output ferrite transformer	YES	NO (INPUT ONLY)	NO (INPUT ONLY)	YES	NO
6. High pass input filter	YES	NO	NO	NO	YES
7. Channels where amplifier phase shift hurts picture quality	NONE	CH. 2, 3, 4	Ch. 2, 3	CH. 2, 6	NONE
8. Uses MADT 4-lead (VHF) transistor with high gain, low noise figure	YES	NO	NO	NO	NO
9. Designed with enough power to drive up to 6 TV or FM sets	YES	NO	NO	YES	YES
10. Two section power supply filter	YES	NO	YES	NO	NO
11. Circuit stability (won't oscillate)	EXCELLENT	FAIR	POOR	GOOD	EXCELLENT
<b>CONVENIENCE &amp; SERVICE FEATURES</b>					
1. AC receptacle on Power Supply for plugging in TV	YES	NO	NO	NO	NO
2. Polarity and Gain Control switch	YES	NO	NO	NO	NO
3. 3-way amplifier mounting bracket that is easily mounted anyplace from antenna boom to TV set	YES	NO	YES (NOT EASILY INSTALLED WHEN AMPLIFIER IS REMOVED FROM ANTENNA)	YES	NO
4. Rectifier, filter condenser and power transformer in power unit instead of up on antenna amplifier	YES	BATTERY TYPE POWER SUPPLY	YES	NO	YES
5. Electric Power Supply with AC isolation transformer	YES	NO	YES	YES	YES
6. No-strip terminals on both input and output of amplifier and power supply	YES	YES	OUTPUT OF AMPLIFIER ONLY	YES	NO
7. Number of set outputs on power supply	2	4	4	2	4
<b>SELLING FEATURES</b>					
1. List price	34.95	29.95 + BATT.	44.95	39.95	\$36.95-AC and \$34.95-DC List
2. Dealer net price	20.97	19.00 + BATT.	28.77	26.63	As low as \$22.70 for AC. As low as \$21.47 for DC.
3. Compact, set-up display carton	YES	NO	NO	NO	YES
4. Nationally advertised to your customers	YES	NO	NO	NO	YES
5. Cost per year to operate	27¢	AT LEAST \$2.00 BATT. REPLACEM.	27¢	27¢	27¢

## JFD transis- tenna AMPLIFIER

Ferrite transformer is used in JFD amplifier input only. Not needed in output because the output circuit has been designed for 300 ohm balanced operation.

MADT denotes "micro-alloy diffusion transistor" production technique. JFD uses PADT denoting "post-alloy diffusion transistor" production technique. Both types are 4-lead VHF transistors with high gain, low noise figures.

JFD power supply is designed to provide more than adequate filtering under standard load. Why use two filters when one better filter will do as well? With the bonus of fewer parts that minimize servicing needs.

Why add something not really needed? Almost all AC outlets are duplex types nowadays. Besides, power supply and amplifier will always remain "on" if TV set is plugged into built-in AC receptacle. JFD "sensible" engineering provides you with "on-off" switch so amplifier can be turned off when TV is not being used.

No gain control is needed in JFD amplifier since it is designed and tuned for maximum gain on all channels at all times. Moreover, if a local signal is strong enough to require attenuation, why penalize all the other channels by turning down the gain control? Instead, JFD engineers recommend that the serviceman pad the offending channel only, leaving all the others to come in with maximum gain.

Neither is a polarity switch needed. Polarity is set at time of installation. Why offer the TV viewer a useless polarity switch? If he or one of the family should accidentally reset the switch, it means a needless callback at the serviceman's time and expense.

It's common sense to provide a minimum of necessary operating controls for the use of the consumer. The fewer the controls the smaller is the possibility of trouble with consumer handling of unit. This is part of JFD engineering philosophy.

Because the best place for the amplifier is at the antenna terminals. Why defeat the very purpose of an amplifier by attaching it any place but the right place? — at the point of highest signal-to-noise ratio — the antenna's take-off points. Be it single-driven, twin-driven, stacked-conical, Yagi or any other antenna design, that's where the JFD amplifier goes.

No-strip terminals are used only on output of JFD amplifier and JFD power supply. The input to JFD amplifier is effected through indestructible heavy gauge solid aluminum busbars which attach directly to antenna terminals. (One less potentially troublesome twin lead connection.)

Reprints of the above chart are available on request. JFD will be pleased to send you also its Transis-tenna brochure which shows you how to convert its many consumer benefits into profits.

## Automatic Brightness Control (Continued from page 44)

change occurs, it is likely there is some defect in the ABC system.

(3) In a semi-darkened room, or with a shade over the light-sensitive cell, adjust the manual controls for proper viewing. Be sure the contrast and brightness have a normal gray-scale relationship; use a test pattern if one is available. A piece of white double-weight cleansing tissue makes an excellent shade during initial adjustments in a very bright room; this allows the cell resistance to remain about 40K or 50K, and results in more accurate adjustments. However, be sure you allow for the fact that room light can cast a glare on the CRT screen, causing a properly-adjusted picture to appear slightly faded under these conditions. When you remove the paper shade, the picture should increase markedly in both brightness and contrast.

(4) If no change is noted in the picture from a bright room to a darkened one (or a shaded cell), you must look for trouble in the automatic circuits. The light-sensitive cell is the most likely suspect, so check its operation first. It usually has a long set of leads which plug into the chassis at some point; these leads can be unplugged and the cell removed for tests. Or, if you prefer, just unplug the leads and take measurements across the ends of the leads, with the cell in its mounting.

An ohmmeter provides the easiest way to check these units. Those cells most commonly used will show a resistance of several megohms in completely dark surroundings (hide it in your coat pocket). In ordinary room lighting, the resistance drops to a few thousand ohms, or perhaps 10K. In bright lighting, or with a flashlight shining directly on the element, the cell drops to a value of 200 or 300 ohms. If these light changes result in the proper resistance variation, the cell can be considered okay.

(5) Checking voltages in the DC divider arrangements of the automatic circuits is the next step. In the circuit of Fig. 4, for instance, points A, B and C each develop certain voltages during "bright" operation, which change during "dark" operation. If one of these voltages does not change, or is very far from its

usual level, you can assume some trouble exists in the associated divider network.

In Fig. 4, you will notice two possible connections to the CRT first anode—one to B+ and another to the boost voltage. This is because CRT's have varied characteristics, and to obtain a suitable brightness change, either voltage may be chosen. If this circuit fails to produce a change in brightness or contrast with a variation in cell illumination, try moving the tap to the other voltage; in many instances, this will solve the problem.

The circuits of Fig. 5 include a complicated network of voltage dividers, but Figs. 7 and 8 will enable you to find the most important voltage points. Point A is the junction of R9 and R11, which you will note from Fig. 5 is at switch S1. Point B is the CRT cathode.

The same voltage-analysis techniques apply to the circuits of Fig. 9. The key test points are A, B, C, and D. Of course, the manual brightness control and contrast circuits are more or less conventional, and need no further explanation.

(6) In connection with voltage checks, don't overlook the fact that improper voltages can result from defective capacitors in a circuit, as well as resistors which have changed value or become otherwise defective. For instance, in Fig. 9, C2 or C4 could drastically alter the CRT grid bias if either capacitor were to become leaky or shorted. This, of course, would alter the brightness, possibly even making the CRT completely black. A leaky C3 would apply too much positive voltage to the cathode, with similar results. In Fig. 4, C4 or C5 could cause trouble with the brightness levels, if either became defective.

### Summarizing

When you learn to consider automatic brightness and contrast controls as variable divider networks, their mystery is gone and they suddenly become very simple to service. If you learn these basic circuits, and the function of each divider network in the over-all action, you will have little trouble diagnosing the cause of failures in these circuits or in similar circuits which you may encounter in the future. ▲

## TV TIPS FROM TRIAD

NO. 16 IN A SERIES

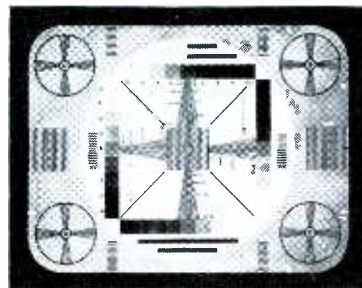

"Where's Joe?" asked parts salesman Al.

"Reading up on electrolytics, I suppose," smiled Bill, the Senior PTM.

"How's that?"

"Well, Joe got this 19-inch portable job that was keystoneing. Right away, he says to himself it's got to be the yoke. But it wasn't, and he fooled with that thing for the longest time. He'd still be at it if I hadn't pointed out that a lot of new 19- and 23-inchers use the B+ boost voltage for the vertical output stage rather than the B+ source."

"Has to do with giving you enough vertical scan on the big CRT's, doesn't it?" said Al.

"Right. In a lashup like that, they've got a filtering capacitor, usually an electrolytic, to take care of the horizontal spike coming from the B+ boost voltage source. When this capacitor opens the filtering action drops. This causes the spike to show up at the plate of the vertical output stage and in the vertical yoke coils. The rest is simple. You lose some in the vertical and horizontal sweeps and it's just like a keystone from a flubbed out yoke."

"Hmm," said Al slyly, "I guess Joe will make a better Keystone cop from now on!"

MORAL: Don't knock the Triad Y-66-1 until you've checked out the filtering capacitor. In the meantime, get on Triad's permanent mailing list and receive the new catalog TV-62 as well as other helpful literature. Write *Triad Distributor Division*, 305 No. Briant St., Huntington, Indiana.

A DIVISION OF LITTON INDUSTRIES 

# LET'S GET THE RECORD STRAIGHT

A JFD competitor is currently circulating the "unbiased" antenna amplifier comparison chart shown on the right. This enlightening analysis (not surprisingly) claims the competitor's amplifier superior in every respect.

However, my competitor overlooked (?) one important detail.

### HE CONVENIENTLY OMITTED THE JFD TRANSIS-TENNA AMPLIFIER.

I am not surprised, but I am disappointed at my competitor's oversight.

Just for the record, only the JFD transistorized amplifier has the unique and desirable feature of mounting directly on the dipole terminals at the point of lowest noise level. It is available as a built-in part of 16 JFD Transis-tenna antennas. It is also used as an "add-on" amplifier that is universally adaptable to any other antenna be it inline Yagi, conical or otherwise. In my opinion, this versatility makes the Transis-tenna the best of the "add-on" amplifiers.

I had believed that the members of the antenna industry had outgrown the need for such so-called "authentic" comparison charts. At this point, however, I feel that every distributor and dealer is entitled to know the complete story. So with apologies to our competitors, we are reproducing the data from his chart with the JFD features added.

I invite your review of the now complete analysis. Judge for yourself which is truly the best "add-on" antenna amplifier in value and performance.

JFD ELECTRONICS CORPORATION

*Edward Finkel*

Edward Finkel,  
Vice President — Sales

Open this flap for the complete  
"add-on" amplifier story... 

...AND HERE ARE SOME MORE EXCLUSIVE **transis-tenna** REGISTERED TRADE MARK AMPLIFIER FEATURES OUR COMPETITION NEGLECTED TO MENTION!

**1** JFD supplies 300 ohm male and female twin lead connectors for 4-set operation or to provide four different locations where set(s) can be used.

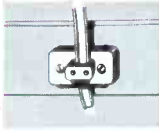

**2** JFD power supply employs on-off switch for viewer's convenience and use when set is shut off. (Also used by competitor A.)



**3** JFD multi-set distribution system uses low-loss ferrite core transformer circuit... not lossy resistor design such as that of our competitor's.



**4** JFD amplifier is corrosion-resistant. It is constructed of aluminum busbars, butyrate housing and an irridited steel terminal plate.



**5** Only JFD offers choice of AC or DC operated amplifier (excellent for accessible attic installations).



**6** Only JFD provides you with the widest selection of electronic Transis-tenna antenna-amplifier-distribution systems that helps you make every antenna sale a profitable Transis-tenna sale.



Only the **JFD** REGISTERED TRADE MARK transis-tenna amplifier *integrates* itself into your antenna system

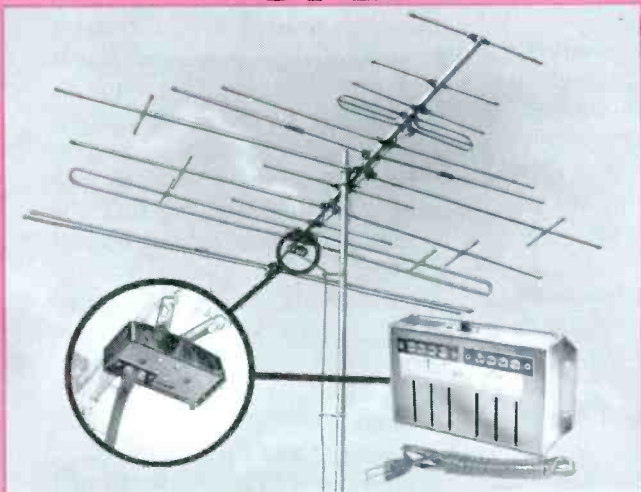

The Transis-tenna is the only amplifier designed to be an electrical and mechanical built-in part of the antenna.

JFD mounts its amplifier at the point of highest signal-to-noise ratio. You do not attach it to the mast, or the crossarm, or at the set—but at only one place, the right place—directly to the antenna take-off points. That is why you get no makeshift straps, clamps or brackets with the Transis-tenna. And for all-new antenna installations, JFD offers you the choice of 16 different Transis-tenna systems complete with integrated amplifier, antenna, power supply and set-coupling units. You pick the right electronic antenna package, perfectly matched to the location.

Only the **transis-tenna** REGISTERED TRADE MARK amplifier converts *any* antenna type into a truly *electronic* antenna system!

The Transis-tenna amplifier mounts directly to the take-off points of any antenna in 30 seconds.

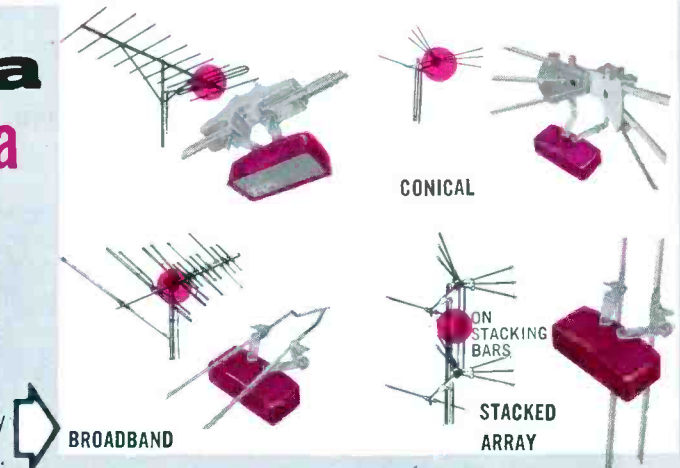

NOW . . . PROVE THE TRANSIS-TENNA'S SUPERIOR PERFORMANCE TO YOURSELF!

JFD invites your on-the-job comparison of the design and performance advantages of the Transis-tenna. See for yourself why more quality-conscious, performance-conscious, profit-conscious service-dealers are switching to the JFD Transis-tenna amplifier.

Call YOUR JFD DISTRIBUTOR TODAY FOR transis-tenna

**JFD**

THE BRAND THAT PUTS YOU IN COMMAND OF THE MARKET

**JFD ELECTRONICS CORPORATION**

6101 Sixteenth Avenue, Brooklyn 4, N. Y.  
 JFD Electronics-Southern, Inc., Oxford, North Carolina  
 JFD International, 15 Moore Street, New York, N. Y.  
 JFD Canada, Ltd., 51 McCormack Street, Toronto, Ontario, Canada



# COPING WITH CALLBACKS

In its simplest terms, a *Service Call Repeat Law* might be stated, "Callbacks are inversely proportional to your skill as a TV technician." Such a rule is true as far as it goes, but it doesn't give the entire picture — not by a long shot. For it is also true that most TV's you accept for repairs have more than a single obvious trouble. More often than not, a receiver that has been in use for a few years has developed many worn spots. Weak tubes, leaky capacitors, changed-value resistors, and assorted other faults in addition to the primary trouble are likely to be found on almost every repair. You are not usually summoned till the TV has its proverbial tongue hanging limp.

No matter how much the set own-

er may have neglected his receiver, he isn't inclined to tolerate neglect on your part. To protect yourself against callbacks, you must not only repair the primary trouble, but root out all the secondary ailments as well. If you do not, you increase the probability of callbacks — it's as simple as that. Our outfit has been doing its best to eliminate these money-losers, and we have been able to reduce our callback percentage to a practical minimum. I'll describe our technique in some detail, so you'll be able to glean some information that you can use to your advantage.

## Passing the Time of Day

With the pressure of a busy

schedule constantly prodding you along, you probably feel you can't afford to dawdle on house calls. However, a little "passing the time of day" doesn't hurt; in fact, it will pay off in reducing your callback percentage.

For instance, one day I was out examining a Silvertone console with doors. The set owner — a genial, unkempt woman — greeted me at the door and immediately began a rapid stream of talk. By the time I arrived at the TV and leaned over to open the doors, I knew that her daughter had three geniuses for children and an Army sergeant for a husband.

I asked her what was wrong with the television. Then she took many more words to explain that it was a little slow in coming on, and that it had horizontal-frequency trouble when the picture finally did appear.

I pulled open the doors, and to my surprise, the TV was playing merrily. She informed me that she had turned it on in anticipation of my arrival.

I removed the back and installed my cheater cord. As the picture returned, it did take awhile to pull in horizontally. I rapped the 6CG7 horizontal oscillator with the eraser of my pencil. The lines went wild.

I tapped the 12DQ6 horizontal output, too, as a matter of course. The picture flattened into a vertical line, disappeared, and then snapped back. I replaced both tubes, and horizontal sync was much firmer.

She said, "Every time I change the channel the TV squeaks." I clicked the channel selector and recognized a microphonic noise. The 12W6 audio output tube was the culprit. When I replaced it, the squeak was gone, and I felt the repair was complete.

As I wrote up the bill, I casually asked, "Think, now — is there anything else about the TV that disturbs you?"

She said, "Only the squeak," but then continued in a matter-of-fact tone with this astounding statement: "I'm so glad I won't have to turn on the TV the night before to watch it in the morning!"

I shook my head. "Would you repeat that?"

She repeated, "It takes a little long for the TV to come on—about

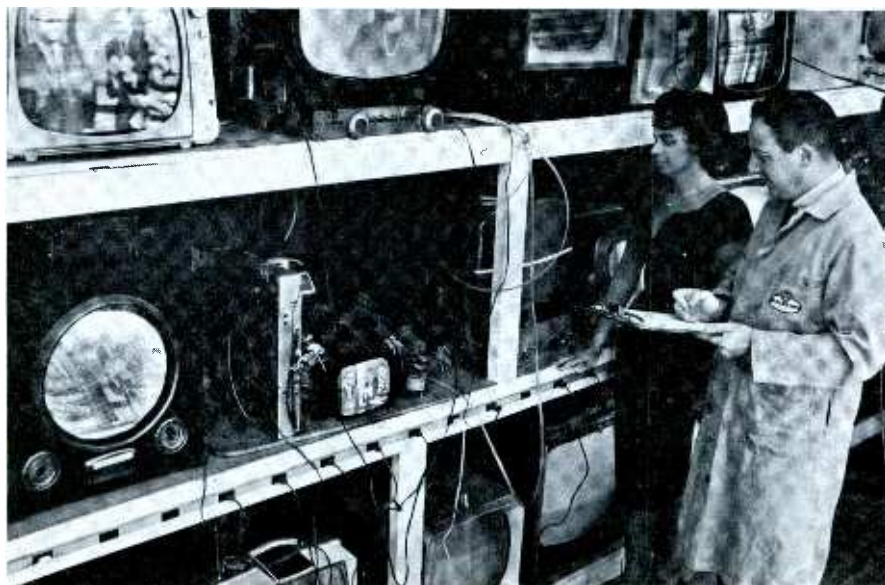
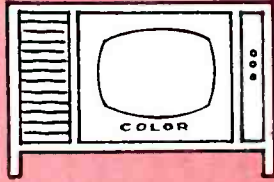

Fig. 1. Repaired sets are given six-hour "air check" to reduce callbacks.





# FIX OVER 90% OF ALL TV COLOR TROUBLES WITH THIS SENSITIVE TUBE TESTER



## THE NEW SENCORE MIGHTY MITE II

Thinking of buying equipment for color TV servicing? Here is the tester that you should place number one on your list. Why? Because this tester alone will help you repair over 90% of all color TV receivers. Faulty tubes cause over 90% of all color TV troubles because the majority of color tubes have high impedance grid circuits. To detect faults in these critical tubes, sensitive grid circuit checks are essential. The Mighty Mite checks for grid leakage as high as 100 megohms or as little as .5 microamps of current. Large expensive testers and the drug store type offering only 2 or 5 megohm leakage checks will pass these critical tubes as good. You can find these tubes in a jiffy with the famous Mighty Mite . . . give real service to your new customers with color receivers . . . and make more money too.

MODEL TC114  
**67<sup>50</sup>**

*Typical high impedance circuits like these, need the Mighty Mite for accurate checks*

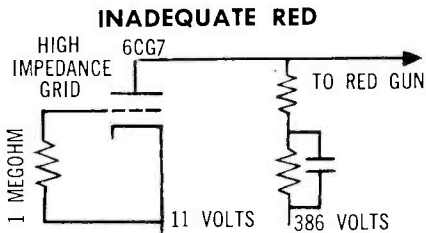

**RCA & ADMIRAL R-Y AMPLIFIER**

If this tube draws as little as 2 microamps of grid current, the bias is upset 2 volts causing reduced red signal. To correct this, you may go to all the trouble of readjusting the red gun when the Mighty Mite, with its high sensitivity grid check, would have indicated the tube bad, saving you this trouble.

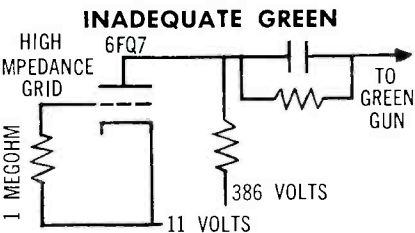

**RCA & ADMIRAL G-Y AMPLIFIER**

If this 6FQ7 tube starts to draw only 2 microamps of grid current, the tube bias will be upset 2 volts because of the high impedance one megohm grid resistor. An old fashioned tube tester, or drug store type that requires 25 microamps of current to indicate the tube as bad, would pass the troublesome tube as good.

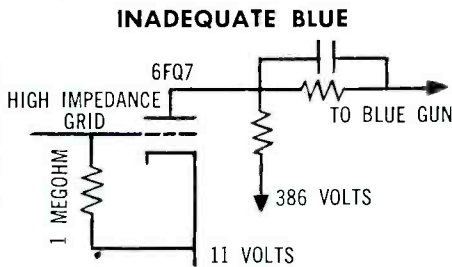

**RCA & ADMIRAL G-Y AMPLIFIER**

Conventional tube testers will not show this tube bad until it develops a change of 25 volts positive bias in circuit. The Mighty Mite will find it as soon as it starts to cause poor color mixing.

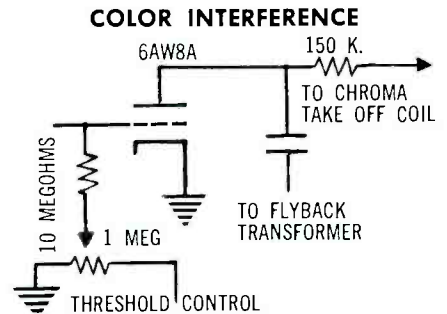

**RCA & ADMIRAL COLOR KILLER**

If the tube draws only 1 microamp of current through this 10 megohm grid resistor the bias will be upset 10 volts restricting operation of the color killer. Color signal will interfere with black and white programs. The Mighty Mite will locate this faulty tube in a hurry while old fashioned testers will pass it as good.

Checks them all, including the New RCA Novars, Nuvistors, Sylvania 10 Pin, GE Compactrons, and picture tubes too. A real money maker for servicing color, black and white, radio, Hi-Fi.

Available at Electronic Parts Distributors • Manufactured by Sencore, Inc., Addison, Ill.

# NEW SAMS BOOKS

BRAND-NEW! 4th Edition of  
the Famous Howard W. Sams

## Tube Substitution Handbook

Still Only \$1.50

- ★ Includes Over 1400 New Substitutions
- ★ Brand-New Section on Subminiature Tubes



This newest edition is more valuable than ever! Now lists more than 6,600 DIRECT substitutes (1400 more than in prior volume), including new section showing substitutes for over 250 subminiature types, 3050 substitutes for 1758 receiving tube types, 242 industrial and 622 European substitutes for American receiving types; 530 American substitutes for European types. Picture-tube substitutions now include 43 new types (508 total) and over 1900 DIRECT substitutions. A "must" for every tube caddy and service bench. 112 pages; 5 1/2 x 8 1/2". Still only..... \$1.50



### Transistor Radio Servicing Made Easy

Wayne Lemons has written the first completely practical book on the subject—based on nearly a year of his own experience in perfecting a technique to insure profitable repairs. You get the benefit of his experience—no "hole and electron" theory—but solid, practical circuit explanations and servicing procedures that will help you repair almost any transistor radio in minutes. The final chapter alone, on parts procurement and substitution, is well worth the book cost. 128 p.; 5 1/2 x 8 1/2". Only ... \$1.95

### FM Multiplexing for Stereo

The most up-to-date volume on this brand-new broadcasting technique. Leonard Feldman expertly describes the new receiver and adapter designs, as well as the problems of converting existing sets and developing new servicing and alignment methods. 8 fact-packed chapters cover the FCC-approved system, converting present sets, servicing multiplex circuits, adapter alignment, typical circuits, etc. 128 pages; 5 1/2 x 8 1/2". Only..... \$2.50

### Basic Electronics Series: Transistor Circuits

Capt. T. M. Adams completely explains basic transistor circuits. As in his previous 3 volumes, 4-COLOR circuit diagrams show you exactly what actions take place during every moment of operation. Each and every electron current is unmistakably identified, as are the changes each undergoes in actual operation. Covers: Transistor Physics Simplified; Special Techniques & Definitions; Oscillator Circuits; Amplifier Circuits; Detector Circuits. 128 p.; 5 1/2 x 8 1/2". Only..... \$2.95

### Single-Sideband Communications Handbook

Only book of its kind. Harry D. Hooton presents much previously unavailable data on this important subject—invaluable to anyone in communications, including engineers, hams, and technicians. Describes single-sideband development, carrier suppression, carrier generators, speech amplifiers and filters, balanced mixers and converters, linear power amplifiers, SSB receivers, tests, measurements, etc. 320 p.; hardbound; 5 1/2 x 8 1/2". Only..... \$6.95

## HOWARD W. SAMS & CO., INC.

Order from your Sams Distributor today, or mail to Howard W. Sams & Co., Inc., Dept. D-32, 1720 E. 38th St., Indianapolis 6, Ind.

Send me the following books:

- Tube Substitution Handbook, Vol. 4 (TUB-4)
- Transistor Radio Servicing Made Easy (TRE-1)
- FM Multiplexing for Stereo (FMS-1)
- Basic Electronics Series: Transistor Cir. (BET-1)
- Single-Sideband Communications (SIH-1)

\$.....enclosed.  Send Free Book List

Name.....

Address.....

City..... Zone..... State.....

IN CANADA: A. C. Simmonds & Sons, Ltd., Toronto 7

(outside U.S.A. priced slightly higher)

eight hours. I turned it on last night so you could fix it this morning." I sighed and removed the back once more.

While later I was done. A 200-mfd power-supply filter capacitor was in bad shape — apparently so bad that it took eight hours to build up a full charge. I replaced this part, and sidestepped a recall — thanks to dawdling and talking.

### Check-Out in Shop

Another callback-cutter is a good check-out on all bench jobs. Our procedure is simple and effective: We let the repaired sets play continually for about six hours on the rack shown in Fig. 1. At the end of about three hours, we test the operation of all the controls and test the tubes for defects. At the end of six hours, we check the controls once again. If everything is AOK, we turn the set off and deliver it.

I'd say that at least 50% of the TV's on checkout require some type of alignment, adjustment, or tube replacement during the air check. Also, at least 10% require an additional component replacement or more bench analysis — like the 21" G-E 21C102 that appeared in the shop with a tag labeled, "No vertical sweep, check lin pot." When it first arrived, I followed the message from the outside man and checked the vertical-linearity control. It was one of these little screwdriver-slotted affairs similar to a buzz control. The customer had been in there with a screwdriver; the wiper arm was turning but not making contact with the resistive element.

I quickly installed a new pot and turned on the TV. There was no more trouble with vertical collapse;

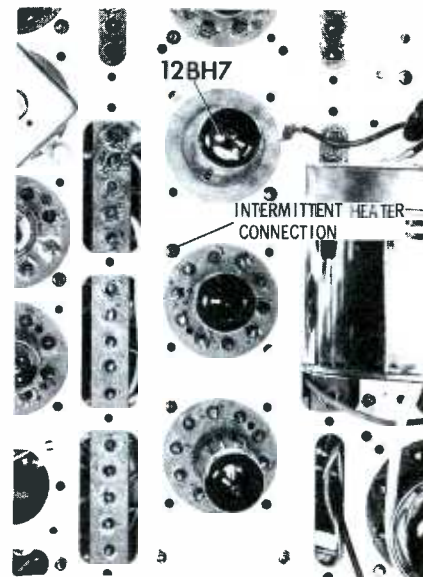

Fig. 2. High-resistance solder joint here caused vertical-linearity problem.

the picture spread out fine. When I checked out the rest of the TV, it looked good, so I put it on the check-out rack.

At the end of three hours, I routinely examined the set. The raster had shrunk some on the top and bottom. I restored the full sweep by tenderly adjusting the new linearity pot. A few minutes later, I glanced over at the G-E and saw a headless man on the screen. The scanning lines near the top were wide enough to put a finger through. I readjusted the pot and all was well once more, for about five minutes—then the top and bottom came in toward each other again.

Since I wasn't about to gouge out the new pot as the set owner had done before, I put the chassis back on the bench.

I stared at the vertical oscillator-output tube, a 12BH7. It seemed to be a bit dim for awhile, and then brightened up to normal. I replaced

# TV TUNERS

\* REBUILT OR EXCHANGED

ALL TYPES



**\$9.95** Including all parts and labor (except broken wafers—billed at cost)

- Normally shipped same day received
- 90 day full guarantee
- U/V combinations \$17.95

FREE—If Mailing carton sent to you on request

Phone REpublic 3-9189

L. A. TUNER EXCHANGE

4611 West Jefferson Blvd.  
Los Angeles 16, California

# Wake Up

A new day is dawning in electronics.



Transistors are here to stay... they are now being used everywhere; in radio, television, Hi-Fi, intercom, and in nearly all new electronic equipment...

Why put off transistor circuit servicing any longer... there's gold in them thar hills. But you must be equipped to do the job fast and efficiently. Here are the tools that you will need.



## NEW SENCORE TRANSI-MASTER

This Tester will analyze the entire circuit in minutes and test transistors in-circuit or out of circuit. Here is how you can pin point troubles step by step with the TR110.

First, check the batteries with the 0 to 12 volt meter. If the batteries are O.K., check the current drain with the 0 to 50 milliamp meter. A special probe is provided so that you do not need to break the circuit. Excessive current indicates a short; low current indicates an open stage or cracked board. All PF schematics indicate average current.

If trouble is not located by now, isolate the trouble to a specific stage by touching the output of the harmonic generator to the base of each transistor and note spot where sound from speaker (or scope where no speaker is used) stops or becomes weak. The generator becomes a sine wave generator for audio stages to help find distortion.

If trouble points to a transistor, check it in a jiffy with the exclusive in-circuit power oscillator check provided by the TR110. A special probe is also provided for this.

If the transistor checks bad in-circuit, remove it and give it an out of circuit check with the oscillator check or the more accurate DC check.

The DC check is provided for comparison reasons, experimental or engineering work and to match transistors in audio output stages. Beta (current gain) is read direct or on a good-bad scale for service work.

DEALER NET. ONLY **\$4950**



Tests all transistors in-circuit or out-of-circuit

### Model TR110

It's a COMPLETE TRANSISTOR TESTER

- SIGNAL TRACER • VOLTMETER
- BATTERY TESTER • MILLIAMMETER



## NEW SENCORE TRANSISTOR AND DIODE CHECKER

Here is a low cost tester that has become America's favorite. The TR115 provides the same DC out of circuit checks as the TR110; leakage and current gain. Beta (circuit gain) can also be read direct or as good or bad. Opens or shorts in the transistor are spotted in a minute. The TR115 checks them all from power transistors to the small hearing aid type. Japanese equivalents are listed also. This famous tester is used by such companies as Sears Roebuck, Bell Telephone and Commonwealth Edison. New circuits enable you to make service checks without set-up charts even though charts are provided for critical checks.



Model TR115  
Dealer Net  
**\$1995**

TR115K Available in Kit Form. Dealer Net \$13.95.



## SENCORE BATTERY ELIMINATOR AND TROUBLE SHOOTER

For replacing batteries during repair.

Many servicemen say that they wouldn't service transistor circuits without this power supply. The tried and proven PS103 is a sure fire answer. It can be used to charge the nickel cadmium batteries as well. Dial the desired output from 0 to 24 volts DC and read on meter. Low ripple insures no hum or feedback. Total current drawn can also be read on the PS103 by merely flicking the function switch to milliamps. The PS103 is the only supply that will operate radios with tapped battery supplies such as Philco, Sylvania and Motorola. No other supply has a third lead.



Model PS103  
Dealer Net  
**\$1995**

Now in stock at your Authorized Sencore Distributor



# SENCORE

ADDISON, ILLINOIS

General Electric reporter,  
 Roland Kempton, makes the rounds with  
 the independent service dealers . . .

Don Ellis saved  
 30 minutes  
 and \$3.75  
 because  
 one G-E  
*SERVICE-DESIGNED*  
 capacitor takes  
 the place of 4  
 ordinary types

In minutes and money, Don Ellis and George Bentley, owners of QUALITY TV, Kansas City, Mo., measure some of the advantages of stocking G-E Service-Designed capacitors. Don (shown here) put it this way, "We didn't stock can-type capacitors before because we never knew what types we'd need. Now, with just 25 or 30 capacitors in stock we meet most of our requirements, and we don't have to make special trips to pick up exact replacements. I figure this saves 30 minutes and \$3.75 per trip."

And according to George, "There have been many occasions, especially on Saturdays, when we've been able to get the set out because we've had G-E capacitors in stock. Our customers really appreciate it, and we haven't had a single call back."

Yes, it pays to stock General Electric Service-Designed capacitors. Get full details from your G-E capacitor distributor. General Electric Company, Electronic Components Division, Room 1719, Owensboro, Kentucky.

*Progress Is Our Most Important Product*

**GENERAL ELECTRIC**

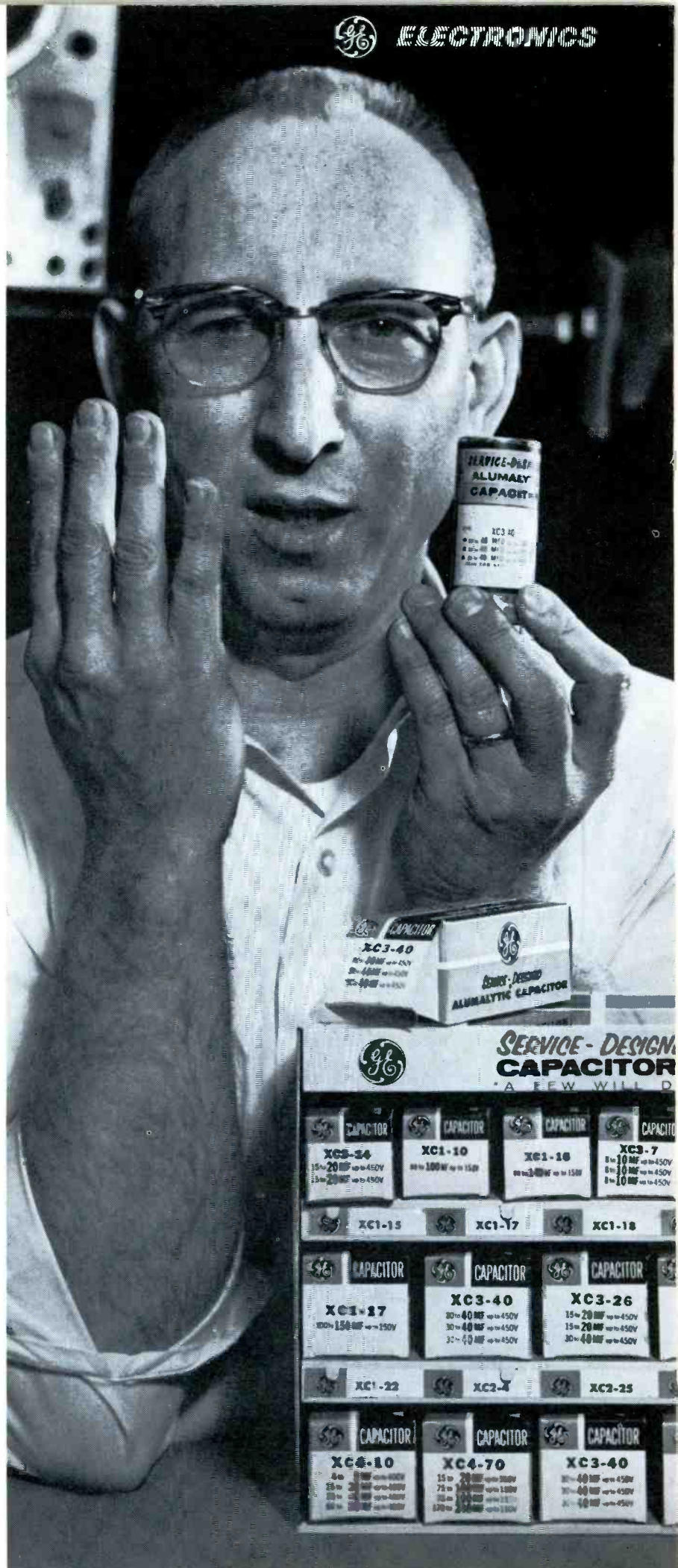

**ELECTRONICS**

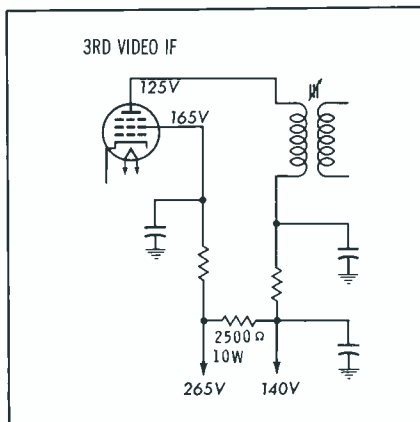

Fig. 3. Faulty resistor lowered voltage on 140-volt line; killed picture.

the tube, but the new one reacted in the same way.

With the power off, I began checking the heater line and discovered the trouble when I grasped the heater-ground wire coming out of the 12BH7 socket. It was hot! I noticed a discoloration where the wire went into a cone-type terminal—one of those connection points that stick up like little spikes on top of the chassis (Fig. 2). I pulled on the wire, and found that it was firmly soldered. I turned on the TV and continued pulling as the wire got hotter. Suddenly it pulled loose. The heat caused by a high-resistance joint was doing the unsoldering. To cure the trouble, I resoldered the wire to the chassis itself. Can you imagine completing this repair without an adequate check-out?

### Psychological Approach

Some callbacks have psychosomatic overtones. People somehow feel that if you repair their TV, it should play perfect from then on. If the set should develop any kind of trouble within a few months' time, it is your fault. A psychological approach is needed to quell this type of callback. You have to destroy this laymen's notion that the TV will continue to play forever, and instill the idea that sets are going to need periodic maintenance.

I have in mind one set owner who gets special treatment. A finicky matron who is head bookkeeper in a large firm, she's the type that sends a restaurant meal back three times no matter how delicious the food. The last job we did on her 17" RCA was a "raster only" trouble — not a peep from the speaker, and zero

contrast. Tubes didn't help, so I hauled the chassis into the shop.

I began checking voltages. When I arrived at the plate of the third IF, I found only 30 volts instead of the prescribed 125. I tested the screen grid and saw that the required 165 volts was present. Strange.

Perusal of the schematic (Fig. 3) showed that the screen was connected to the 265-volt source in the power supply, but that the plate voltage had a different origin—the 140-volt line. The rest was easy. A 2500-ohm, 10-watt resistor between the two B+ source points had increased in value to 100K.

I replaced the defective resistor with a new one, and the TV once more played well. It went through the final checkout without a hitch, so I loaded it aboard a truck and drove to the customer's home. From past experience I knew that delivery was not going to be easy, but I had my plans.

She greeted me warmly, and I carried the chassis in. As I installed it, I turned the vertical linearity pot all the way up. As the raster came on, she began to complain. I smiled, "I haven't made the final adjustment yet. You watch and tell me when I have it right."

The picture was 'way too high. As she watched, I gradually drew the linearity back down. She snapped, "Hold it, right there! It's fine!"

Then I prepared for the coup de grace. I placed my hand in the chassis area and said solemnly, "Now I'm going to make the final adjustments for focus and straightening."

I clenched my fist, not touching anything, and grimaced. She said "That looks a little better — now a little bit more." I grimaced mightily in great effort. She shouted, "That's it, hold it; don't touch it again."

I buttoned up the back of the TV and left her pleased. I knew I wouldn't have a callback there unless it was a legitimate case.

That's about all there is to our callback story. Any more attention to detail involves unwarranted expense. All you have to do to reduce your callback percentage is dawdle profitably on house calls, air-check every chassis for a few hours after bench servicing, and use a little sensible showmanship. ▲

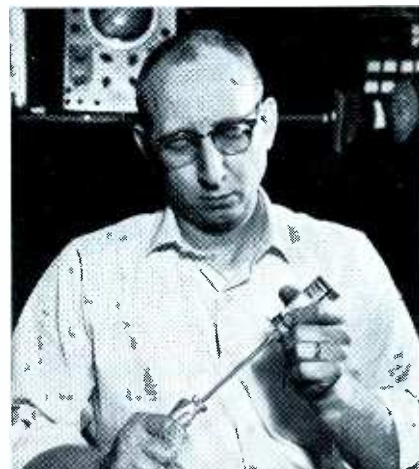

Another New Service Aid From General Electric

### SERVICE-DESIGNED

## Capacitor Tab Adjuster saves time—easier to use than pliers

"How soon can I get a couple of them?"

That was Don Ellis' first comment after he tried out this new tab adjuster. This handy Service Aid from General Electric is easier to use than needle-nose pliers—saves time on service calls and at the bench. The slotted end fits over capacitor tabs; won't slip off. A quick twist locks or unlocks the tabs. 8 inches long; plastic handle. Here's one of the most useful Service-Designed tools for the bench and in your service case. Order now from your G-E capacitor distributor or mail coupon to Chicago warehouse address shown.



Progress Is Our Most Important Product

**GENERAL ELECTRIC**

General Electric Company, Dept. 1719A  
3800 N. Milwaukee Ave., Chicago 41, Ill.  
Please ship prepaid:

..... ETR-2968 Capacitor Tab Adjuster, \$1 each.

My check or money order is enclosed for the required amount plus any sales or use tax applicable in my area.

Name.....

Address.....

City..... Zone..... State.....

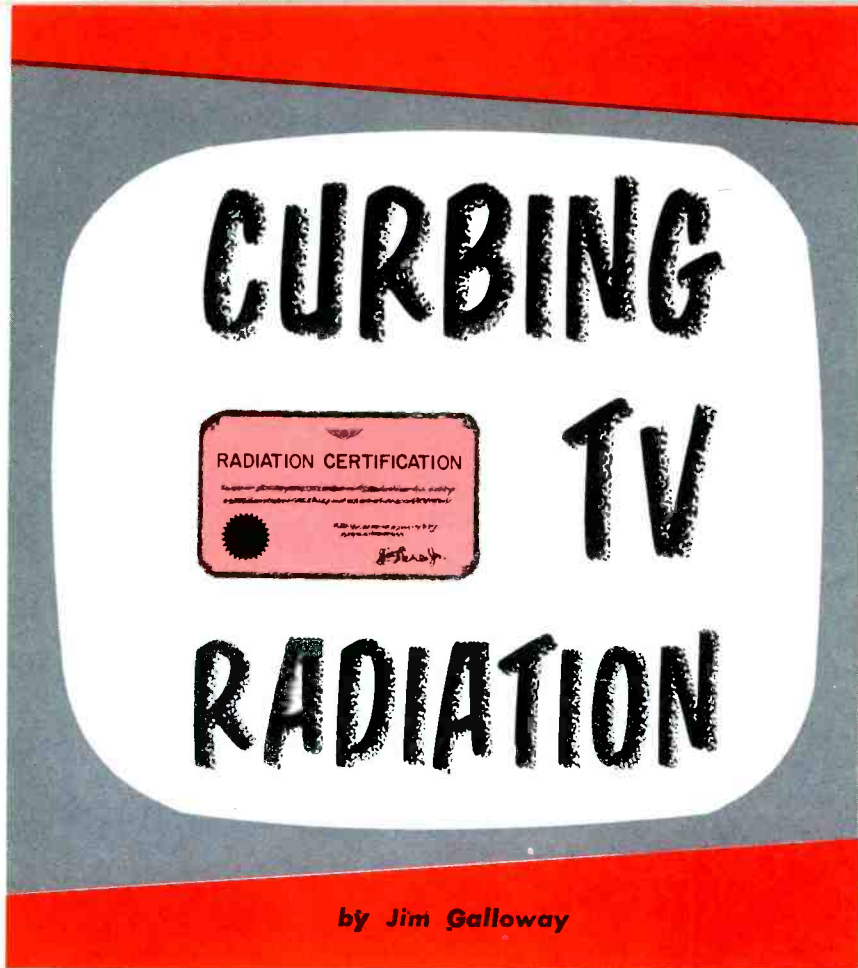

by Jim Galloway

Have you ever noticed a label, worded as shown in Fig. 1, on the rear cover of a new TV set? This label certifies that the receiver, when it left the factory, was not radiating RF energy in excess of the amount specified in the following excerpt from current FCC regulations:

**15.62 Radiation Interference Limits.**

(a) The radiation from all radio receivers that operate (tune) in the range 30 to 890 mc, including frequency modulation broadcast receivers and television broadcast receivers manufactured after the effective date specified in 15.68, shall not exceed the following field strength limits at a distance of 100 feet or more from the receiver:

Frequency of radiation (mc)	Field strength (uv/m)
0.45 up to and including 25	See paragraph b
Over 25 up to and including 70	32

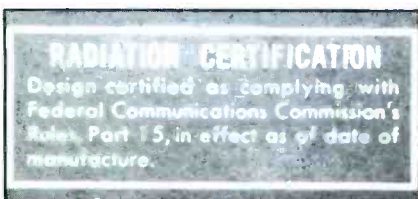

Fig. 1. This label on new TV set certifies it does not radiate excessively.

Over 70 up to and including 130	50
130-174	50-150 (linear interpolation)
174-260	150
260-470	150-500 (linear interpolation)
470-1000	500

(b) Pending the development of suitable measurement techniques for measuring the actual radiation in the band 0.45 to 25 mc, the interference capabilities of a receiver in this band will be determined by the measurement of radio frequency voltage between each power line and ground at the power terminals of the receiver. This requirement applies only to radio receivers intended to be connected to power lines of public utility systems. For television broadcast receivers the voltage so measured shall not exceed 100 uv at any frequency between 450 kc and 25 mc inclusive. For all other receivers the voltage shall not exceed 100 uv at any frequency between 450 kc and 9 mc inclusive, 1000 uv for frequencies between 10 mc and 25 mc and linear increases from 100 uv to 1000 uv for frequencies between 9 mc and 10 mc.

Since 1956, manufacturers have been required to comply with these rules in the design of their new sets,

except where allowable deviations are specifically stated by the FCC. However, as a receiver ages, and various technicians work on it, the radiation level sometimes increases to the point where interference to other electronic equipment may occur. Who is then responsible for bringing the radiation within bounds? Part 15 of FCC regulations supplies the answer:

**15.69 Interference From a Radio Receiver.**

The operator of a radio receiver, regardless of tuning range, date of manufacture, or of certification, which causes harmful interference shall promptly take steps to eliminate the harmful interference.

The definition of "radio receivers" under these rules includes TV sets. Since it is the set owner's responsibility to cure radiation problems, you might be called on to repair a TV that is causing interference. It is wise, then, to know about different types of radiation and how they can be controlled.

**Local Oscillator and IF Amplifier**

Interference resulting from local-oscillator radiation was one of many factors that had to be considered in the selection of the intermediate frequency used in TV receivers. (Among the other considerations were image-frequency rejection, IF-amplifier stability, and IF gain.) Before the intermediate frequency could be chosen, it was necessary to decide whether the local oscillator was to operate above or below the incoming signal frequency. The former choice was decided upon because it resulted in better rejection of image-frequency interference from high-power communications equipment in certain frequency bands. Originally, 21-27 mc was chosen for the IF because amplifiers operating at these frequencies provided high gain, and did not have as strong a tendency to oscillate as those tuned to higher frequencies. The introduction of UHF telecasting, and the appearance of new tube designs, later encouraged the adoption of higher IF frequencies; today, almost all sets use 41-47 mc. The use of this higher intermediate-frequency range creates new problems, especially concerning radiation interference. For example, assume that a receiver is

# Can you afford to guess

AT SWEEP, SYNC OR HIGH VOLTAGE TROUBLES?

WHEN IT'S SO EASY TO WALK THE TROUBLE RIGHT OUT OF THESE TIME CONSUMING CIRCUITS ..... STEP BY STEP.....



SYNC. CIR. & H. SYNC. DISCRIM.	VERT. OSC.	VERT. OUTPUT	VERT. OUTPUT XFORMER	VERT. DEFLEC. YOKE
HORIZ. OSC.	HORIZ. OUTPUT	HORIZ. FLYBACK XFORMER	2nd ANODE VOLTAGE CIRCUIT	HORIZ. DEFLEC. YOKE

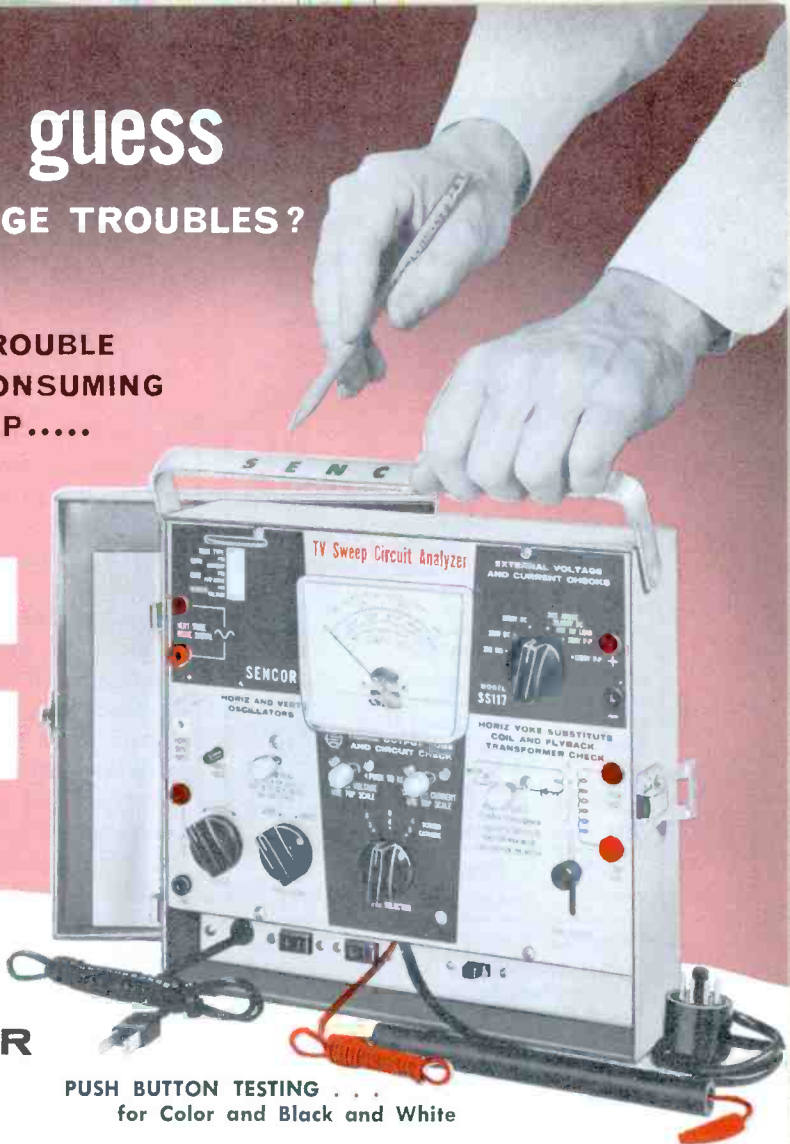

## NEW, IMPROVED SENCORE SWEEP CIRCUIT ANALYZER MODEL SS117

How many times do you ask, "Why do I take so long finding that sweep trouble?" How often have you wondered whether weak horizontal sync was caused by defective sync circuit, horizontal oscillator, or sync discriminator? Can you quickly isolate inadequate width or low 2nd anode voltage to the oscillator, output, flyback transformer, or yoke? How many times have you changed a good yoke by mistake?

The SS117 will pinpoint troubles like these in minutes with tried and proven signal injection, plus yoke substitution for dynamic in-circuit tests. Error proof push button testing enables you to make all tests from the top of the chassis without removal from cabinet for maximum speed and profit on every job.

Here are the checks the SS117 makes . . .

- Horizontal Oscillator: Checked by substituting 15,750 variable output universal oscillator from SS117. Signal can be injected at any spot from horizontal output grid to horizontal oscillator to determine defective component.
- Horizontal Output Stage: Checked by reliable cathode current and screen voltage checks made with adapter socket and two push buttons.
- Horizontal Output Transformer: Checked for power transfer in circuit and read as good or bad on meter.
- Horizontal Deflection Yoke: Checked by direct substitution with adjustable universal yoke on SS117.
- Vertical Oscillator: Checked by substituting 60 cycle synchronized oscillator.
- Vertical Output Transformer: By simple signal injection for full height on picture tube.
- Vertical Deflection Yoke: By signal substitution for full height on picture tube.
- Sync Stages: Checked by synchronizing triggered horizontal SS117 oscillator from any stage. If oscillator synchronizes, sync is O.K.
- 2nd Anode Voltage: A new dynamic check using simulated picture tube load. C.R.T. does not need to be operating for current tests. No interpretations—read direct from 0 to 30 KV.
- External Circuit Measurements: By applying from 0 to 1000 volts AC or DC to external meter jacks. Meter will read DC or peak-to-peak volts. 0 to 300 milliamp scale also provided for measuring horizontal fuse current.
- New features include: Large 0 to 300 microamp meter for minimum circuit loading; all-steel carrying case with full mirror in adjustable cover; two 115 volt AC outlets in cable compartment.

Size: 10 1/4" x 9 1/4" x 3 1/2". Wt. 10 lbs.

Model SS117

Dealer Net **\$89<sup>50</sup>**

SEE YOUR AUTHORIZED SENCORE DISTRIBUTOR

**SENCORE**  
ADDISON, ILLINOIS



Sencore Sam says . . . How can you miss . . .

EACH PACKAGED UNIT CONTAINS:

- An Easy to Follow Instruction Book Especially Prepared and Edited by H. W. Sams.
- A complete 33 RPM, 10 inch Permanent Record an "How to Simplify Sweep Circuit Trouble Shooting."

## Exact Replacements for Original Equipment



The following special parts have been manufactured as exact replacements for the set manufacturers shown, so as to assure top performance.

Cat. No.	Use	O.E.M. Part No.
<b>Admiral</b>		
1471-A	Sound Take-Off	72B185-2
1472-A	Sound Take-Off	72C132-19
6332	Horiz. Osc.	94C17-4
7701	455 KC I.F.	72 B 31,2
<b>Bendix</b>		
6501	Auto Radio I.F.	2090237-1
6502	Auto Radio I.F.	2090237-2
6503	Auto Radio I.F.	2090237-3
6504	Auto Radio I.F.	2090237-4
6505	Auto Radio I.F.	2090237-5
6506	Auto Radio I.F.	2090239-1
6507	Auto Radio I.F.	2090239-2
6508	Auto Radio I.F.	2090239-3
<b>Crosley</b>		
7101	2nd Sound I.F.	157856-1
<b>General Electric and Hotpoint</b>		
12-C11	Home Radio	RTL-143 and 163
12-C13	Home Radio	RTL-172
6206-PC	TV Ratio Det.	RTD-026 (WT56X38)
6207-PC	TV Ratio Det.	RTD-025 (WT56X37)
6208-PC	TV Ratio Det.	RTD-020
6209-G1	TV Ratio Det.	RTD-024 (WT 56X36)
<b>Hallierafter</b>		
1482 IFT	Sound I.F. and Trap	51B1996
7101	2nd Sound I.F.	51A1859
<b>Philco</b>		
6209-P1	TV Disc.	32-4721
6209-P2	TV Disc.	32-4689-1, 2
6209-P3	TV Disc.	32-4735-1, 2
<b>R.C.A.</b>		
1483 IF	Sound I.F.	76437
1484 RD	Sound Ratio Detector	102692
1485 RD	Sound Ratio Detector	102644
1486 RD	Sound Ratio Detector	102253
1487 RD	Sound Ratio Detector	100364
1488 RD	Sound Ratio Detector	79141
1489 RD	Sound Ratio Detector	101219
6333	Horiz. Osc.	103103
<b>Westinghouse</b>		
12-C14	Home Radio I.F.	235V025H-11,2 (V157661)
68 Osc	Home Radio Osc.	230V039H-01 (V15764-1)
6204-W3	TV I.F.	V12128-1, 2, 3



**J. W. MILLER CO.**  
5917 S. Main Street  
Los Angeles 3, California

EXPORT REPRESENTATIVE:  
Roburn Agencies, Inc., N.Y. 13, N.Y.

CANADIAN REPRESENTATIVE:  
Atlas Radio Corp., Ltd., Toronto 19, Ont.

operating on channel 2 (54-60 mc) and its IF picture-carrier frequency is 45.75 mc. Since the local oscillator operates above the incoming carrier, and the video-carrier frequency on channel 2 is 55.25 mc, the oscillator will be tuned to 45.75 plus 55.25, or 101 mc. If the local oscillator were not properly shielded, it could radiate a 101-mc carrier which would be picked up by any FM tuner in the immediate vicinity. In most cases, the only result would be a dead spot at 101 mc; however, the signal received from an FM station operating at a frequency adjacent to 101 mc would suffer from interference. In the case of the local oscillator, radiation is practically eliminated by shielding the tuner tubes and the entire tuner chassis. (See Fig. 2.) Shields used at radio frequencies are made of a material (such as copper or aluminum) which is a good conductor. When a magnetic field penetrates a shield, it induces eddy currents which tend to oppose the field and prevent it from passing through the shield. Good electrical contact should be maintained at all edges, corners, and seems in order to present the least possible resistance to these eddy currents. Tuner shields which meet the necessary electrical requirements are sometimes difficult to remove and replace, but the fact is that they do serve a worthwhile purpose and should be replaced by the technician after any repair job done in the tuner. Tube shields should be securely grounded when replaced.

The grid and plate tanks in IF amplifiers are also likely to radiate unless shielded. The 45-75-mc IF picture carrier itself would not usually cause any problem to other equipment found in the home; however, its second harmonic (at 91.5 mc) could conceivably affect FM reception. Unlike the radiated local-oscillator carrier, the IF radiation contains modulation which could cause quite a bit of interference to an FM radio signal on an adjacent frequency. Sync buzz would be one indication that FM radio interference is due to a radiating TV receiver. IF circuits can also radiate energy within the television set itself, sometimes causing inverted (negative) video and herringbone effects in the picture.

IF strips, especially in late-model receivers, are generally enclosed in some sort of shield which is securely grounded to the chassis. (See Fig. 3.) When a repair job is completed in the IF section of a receiver, all mounting screws or solder lugs should be refastened to the shield—not only to prevent radiation from the IF amplifier, but also to keep outside radiation from entering these high-gain stages.

### Horizontal and High Voltage

The horizontal flyback pulses of a TV receiver are radiated in two ways. Mechanical vibration of components is the explanation for the 15,750-cps note heard in the vicinity of the set. A vibrating part operates on the same principle as a speaker, in that the air is disturbed and sound is transmitted by longitudinal waves. Although not likely to produce interference in other electronic equipment, this sound radiation is sometimes annoying to people who are able to hear 15,750 cps. Fortunately, it can usually be reduced in intensity.

The usual source of mechanical vibrations is the horizontal output transformer. Since this unit is not hermetically sealed, vibration between the core and the windings is set up in almost all parts of the transformer. If the mounting screws become loosened, the intensity of the note increases. Thus, tightening these screws may be the only cure that is needed. If the screws seem tight, and the transformer is still loose enough to cause objectionable "singing," a wedge of wood can be driven between the transformer mounting and the chassis. The wedge places additional pressure on the transformer and often reduces

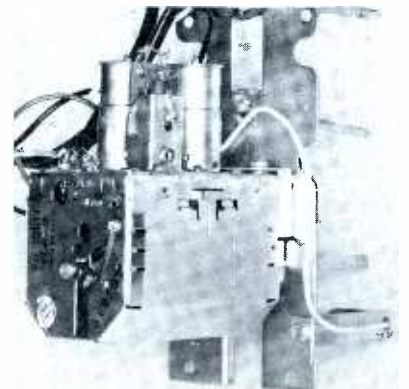
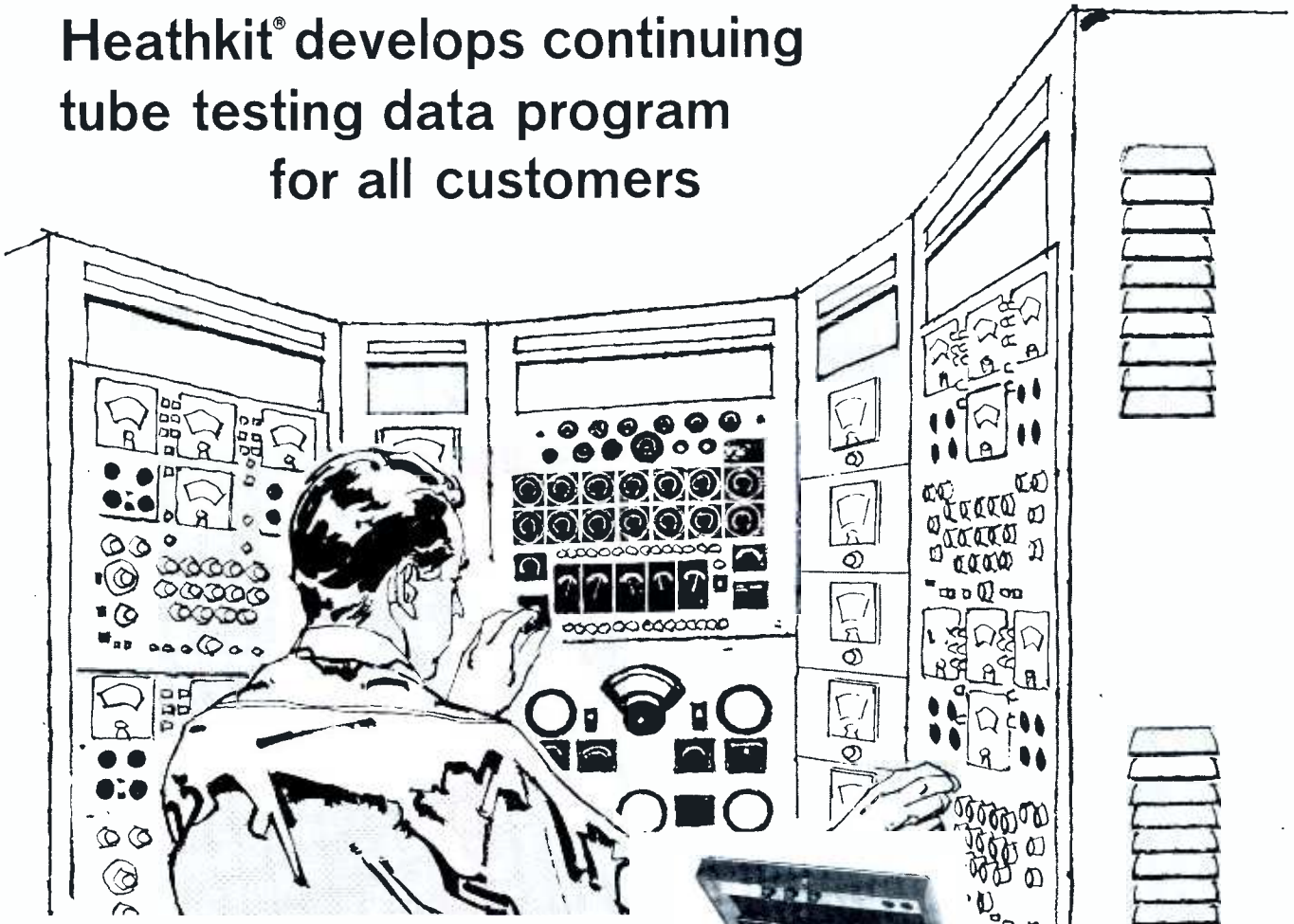

Fig. 2. Tuners are completely shielded to avoid local-oscillator radiation.



# Heathkit® develops continuing tube testing data program for all customers



## SMALL ANNUAL FEE PROVIDES ROLL CHART DATA FOR ALL NEW TUBES

The unique tube test data console shown above was developed by Heath engineers for the express purpose of providing accurate, up-to-date roll-chart information on all new tube types as they are developed. With this new service all Heathkit tube checker owners can receive, automatically, latest test data on new tube types . . . eliminating obsolescence . . . assuring latest test facilities for all service operations. Arrangements have been made with tube manufacturers for necessary samples and data on new tube types which will then be compiled and transferred to roll-chart information for all Heathkit tube checkers. Subscribers will receive a supplement every three months and a new roll-chart incorporating this data at the end of the year. Availability of this service is another of the many advantages you enjoy with dependable Heathkit test instruments!

## ANY TUBE CHECKER OWNER IS ELIGIBLE TO SUBSCRIBE TO THIS SERVICE

Subscription rates are \$2.50 per year on TT-1A type testers, \$1.50 per year for IT-21 and TC type checkers. If you own a Heathkit tube checker, send model no. of your checker along with your remittance . . . proper supplements and roll-chart will be sent automatically.

## TWO NEW IMPROVED HEATHKIT MODELS OFFER FIRST YEAR'S DATA FREE

### Heathkit IT-21 TUBE CHECKER

—Tests all tube types including new compactron, nuvistor, novar and 10-pin miniatures. Tests tubes for quality, shorts, leakage, open elements, and continuity. Individual tube element switches. "Bad-?-Good" meter scale. 11 lbs.

No money down, \$5 mo. . . \$44.95



**Heathkit TT-1A Gm TUBE TESTER**—Professional quality throughout! Indicates Gm to 24,000; micromhos. Constant-current heater supplies. Ultra-sensitive grid current test. Direct reading ohmmeter leakage test. Built-in adapter for testing new compactron, nuvistor, novar & 10-pin miniatures. Built-in switch operated calibration circuit. 32 lbs. No money down, \$14 mo. **\$149.95**

**ADAPTER KIT TTA-1-1:** converts earlier model TT-1 to TT-1A. Includes new cabinet, sockets, selector switches, and necessary tube test data. 13 lbs. . . . **\$19.95**



**HEATH COMPANY**  
Benton Harbor 68, Michigan

- Please Send My Free Copy of the 1962 Heathkit Catalog
- Enclosed is \$\_\_\_\_ for \_\_\_\_ subscriptions to tube data service for Heathkit Model \_\_\_\_ tube checkers.
- Enclosed is \$\_\_\_\_ (including postage) for \_\_\_\_ (no.) Heathkit IT-21 Tube Checkers.
- Enclosed is \$\_\_\_\_ (including postage) for \_\_\_\_ (no.) Heathkit TT-1A Tube Testers.
- Enclosed is \$\_\_\_\_ (including postage) for \_\_\_\_ (no.) Heathkit TTA-1-1 Adapters.

NAME \_\_\_\_\_  
ADDRESS \_\_\_\_\_  
CITY \_\_\_\_\_ ZONE \_\_\_\_\_ STATE \_\_\_\_\_

**ALSO AVAILABLE AT YOUR NEAREST HEATHKIT DEALER OR DISTRIBUTOR**

mechanical vibrations.

Because the pulses are large in amplitude in many parts of the horizontal circuit, they are able to be radiated electromagnetically by components and leads acting as antennas. It is this type of radiation that causes headaches for servicemen. As with the IF signal, the actual 15,750-cps pulse will not usually interfere with other home electronic equipment. However, since the pulse is sometimes almost square in shape and contains many high-order harmonics, interference to the

AM broadcast band is quite possible. Besides causing interference outside the set, horizontal-frequency radiation will feed into different portions of the circuitry inside the set. Various distortions of the video signal can result from horizontal pulses being coupled into the IF and video amplifiers.

Unfiltered high voltage is a common cause of horizontal radiation. Because the peak voltage of rectified HV pulses is so great, the level of radiation from a poorly-filtered HV supply can become high enough



Fig. 3. Shield over IF strip prevents radiation and pickup of stray signals.

to block the broadcast band over a large area. A common practice in TV manufacture is to use the aquadag coatings on the inside and outside of the picture tube as a filter capacitor for the high voltage. Consequently, if the outer coating should become ungrounded, the high voltage will be unfiltered and objectionable radiation may result.

### Locating Outside Sources of Interference

In most instances, even when a TV set is inadequately shielded, it will not radiate with enough power to cause interference outside of the home in which it is located. However, a customer will sometimes complain of TV, FM-radio, or AM-broadcast interference that does not originate in his own TV set. The problem of locating the source of such radiation can become difficult. The easiest method involves requesting the customer to call some of the neighbors and have them turn off their sets. As various receivers are turned off, the customer or serviceman should watch the interference and note when it disappears. Should this method fail, the trouble can sometimes be located by using a portable radio or TV (depending on what type of equipment is being bothered by interference).

The portable is carried around the neighborhood and used to pinpoint the area of strongest interference. Should the interfering source appear to be very far away (over a block or two), the chances are the trouble comes from a source other than a TV set, such as a radio transmitter. However, if an interfering set can be located, the owner should be notified, and steps taken to cure the trouble.

When interference is picked up at a considerable distance from the offending set, it is either being radiated from the antenna or being conducted via the AC power lines. Horizontal-sweep radiation, as well as local-oscillator or IF signals, can travel by both routes. An accept-

Perma-Power puts you in the P. A. picture

## with the **ROVING ROSTRUM**

a complete high-volume  
sound system in a single case



- Use it anywhere—  
INDOORS OR OUT—  
It's Battery-Powered!
- Perfect for CLUBS,  
SCHOOLS, CHURCHES,  
MEETING ROOMS,  
RENTALS, ETC.



**T**HE Perma-Power Roving Rostrum is as simple to use as one-two-three. You open the case, plug in the microphone, turn on and talk! It reproduces voice or music clearly, distinctly, and naturally—and covers audiences of over 500! No electrical outlets are needed: The Roving Rostrum is powered by 2 standard lantern batteries that will last more than a year with moderately heavy use.

The Roving Rostrum includes a 10 watt transistor amplifier, Astatic microphone and accessories, 2 full fidelity Quam speakers with special anti-feedback housings, an extra input for phono or radio, and outputs for auxiliary speaker and tape recorder. Even the reading desk is part of this compact self-contained system! Yet it weighs under 30 lbs. for easy portability—and is priced at only \$124.50 user net (\$175 less than you'd expect!)

**Perma-Power**

COMPANY

3102 North Elston Ave.  
Chicago 18, Ill.

Ask your distributor for a demonstration—or write to Perma-Power for detailed literature.

# SPRINGTIME IS VALUETIME

## - WITH RCA!!!

That's right! Spring's here at last...and RCA's "garden" of exciting new premiums is in full bloom! See for yourself...



**RADIO TV HI-FI**

**SERVICE**

with RCA tubes  

### DISPLAY MATERIAL

Outdoor and indoor signs that advertise your services to the public.

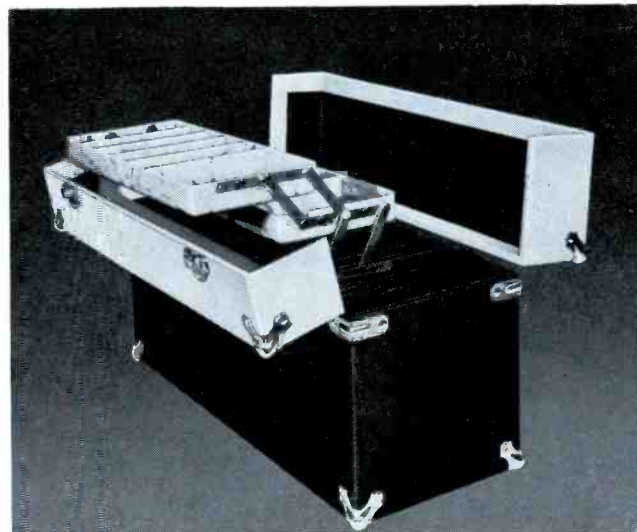

### SERVICE AIDS FOR YOUR WORK

*Service-Special Tool Chest.* A newly designed mate for your RCA Tube Caddy.

**PLUS**... The famous RCA TV Toter Table...and other helpful items to make your job easier and faster.



### ACCESSORIES FOR OUTDOOR LIVING



Skotch Portable Charcoal Grill



Handsome, durable, lightweight *HAMPDEN OUTDOOR FURNITURE* including lawn chair and chaise lounge.

RCA ELECTRON TUBE DIVISION, HARRISON, N.J.

All these values can be yours by ordering the world's finest entertainment receiving tubes! For full details on how you can get your VALUETIME premiums, see your participating RCA Tube Distributor right away.



The Most Trusted Name in Electronics

# PRACTICAL INGENUITY IN ELECTRONICS

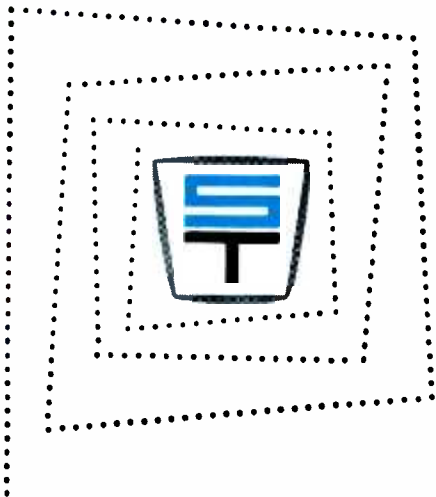

What is it? You might call it a philosophy . . . an idea . . . a principle.

What does it mean? Technical excellence, reliability, performance—combined with sensible pricing. On this philosophy rests the enviable Tarzian reputation for customer satisfaction. Too, it has earned for Sarkes Tarzian, Inc. recognition as the producer of "the world's finest tuner for the world's finest sets". You'll also find this same practical ingenuity in all of these electronic products from Tarzian:

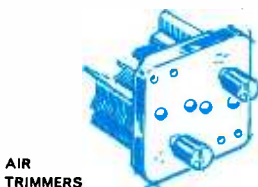
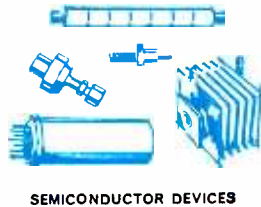
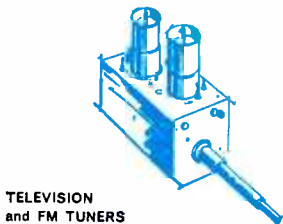

Electronic Products of Tomorrow . . . TODAY



## SARKES TARZIAN INC

east hillside drive • bloomington, indiana • edison 2-7251

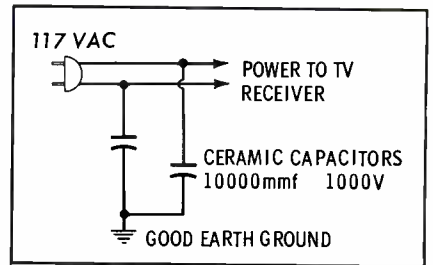

Fig. 4. Filter prevents coupling of interference from set into power line.

able solution to this problem can often be accomplished by installing filters in the power-line and antenna circuits of the set causing the interference.

Radiated signals can be kept off the power line by means of a commercially-available line filter, or with the simple circuit shown in Fig. 4. Horizontal-sweep interference can be prevented from entering the antenna circuit if a commercial high-pass filter is placed in series with the antenna lead. (It should be installed on the rear cover of the set rather than at the tuner, since the sweep radiation is often picked up on the lead between these two points.) Such a filter is not effective in preventing local-oscillator radiation into the antenna—which can be remedied only by proper shielding or thorough realignment of the tuner.

### Repairing and Maintaining Receivers

Filtering may also be of some help in reducing interference to receivers within approximately 20' of the radiating set, but more satisfactory results can be obtained by finding and eliminating the cause of excessive radiation. As has been stated previously, the usual cause of radiation is lack of shielding. The first step to take, after the type of radiation has been determined, is to check all shields for poor grounds and connections.

If the set was designed in compliance with the FCC regulations stated in this article, it should not be necessary to redesign the shields or devise additional methods of compensating for radiation. However, replacement of all shields and all grounding screws is a *must* after every service call. Remember, it's up to service technicians to maintain TV sets in such a manner that radiation is held within FCC-specified limits. ▲

**RCA**  
**BATTERY CENTER**

Booming sales of transistor radios and battery-operated toys make today's battery market bigger than ever. Let your RCA Distributor put into your hands the tools to capture a bigger share of this business.

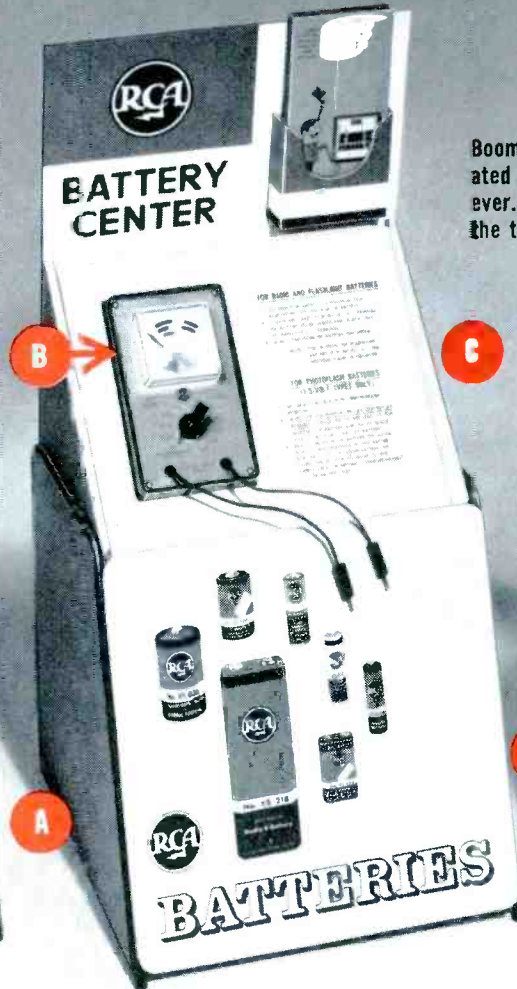

## Capture a Bigger Share Of Today's Bigger Battery Market

Here are the new RCA dealer aids to help you increase your battery business.

### RCA COUNTER MERCHANDISER (A)

Sturdy steel and masonite construction. Rubber tipped legs. Permits you to stock a complete line of transistor radio batteries in one square foot of counter space. Top shelf offers ideal spot to display your inexpensive flashlight or photo-flash batteries.

### RCA BATTERY TESTER (B)

Checks eleven ranges of radio battery voltages from 1.5 volts to 90 volts, plus separate 1.5 volt range for the round-cell photoflash types.

### TESTER DISPLAY (C)

Sits atop battery merchandiser to create an RCA Battery Center where you have all your battery needs in organized fashion: stock, display, testing facilities and customer literature.

If desired, holes in the top shelf of the merchandiser permit you to secure tester directly to your merchandiser (D) for either customer or sales clerk use.

Contact your Authorized RCA Distributor today. Find out how you can put these effective sales tools to work creating more sales and more profits for you throughout 1962.

### Plus Colorful, Attention-Getting Sales Promotional Aids...



**Battery-Powered Motion Window Display (E).** Novel flip-flop motion makes it a perfect show piece for store window.

**Good-will Giveaways (F).** Neat, compact litterbags for customers' cars... with large space for your store imprint.

**Literature and Technical Help (G).** Battery Identifier Chart, Door or Window Decals, pocket-size Interchangeability Guides, Window Streamers, Price Sheets—everything you need to bring in more traffic and convert it to dollars in the cash register.

RCA ELECTRON TUBE DIVISION, HARRISON, N.J.



The Most Trusted Name in Electronics

by Forest H. Belt

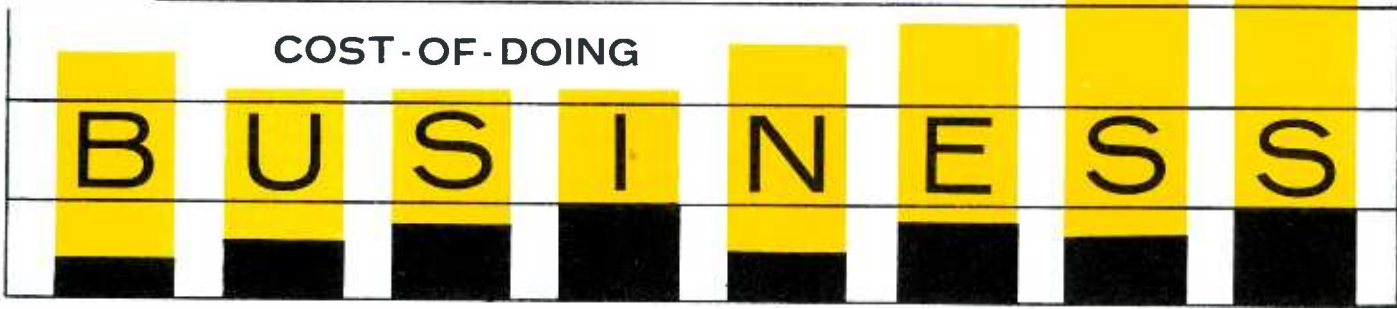

John Smith TV - Year ending Dec. 31, 1961	
Service and Parts Sales	\$ 8670
Cost of Parts Sold	2125
Gross Profit	6555
Business Expenses	4947
Net Income	1608
Owner's Withdrawal	3000
Net Business loss	\$ 1392

Fig. 1. Simplified statement shows how capital can be lost.

We recently undertook a survey of electronics service companies across the country to determine how much it costs them to run their businesses. The result disclosed that many of them are operating with little or no profit margin. Several of these shop owners are taking home far more money than the business nets in a year's time and, in some cases, this is no great amount.

How can a man pay himself more than the business nets? Usually, without realizing it, he dips into his operating

capital. Eventually, this will dwindle into nothing, and he'll be out of business. One respondent, realizing his plight, stated, "I'm living off my capital, and can't make enough profit to replenish it. Can you tell me how I am going to survive as a businessman?" At least this shop owner knows where he stands. His problem can be solved by increasing the ratio of income to outgo. In other words, he must take in more money without spending more—or he must reduce the amount he spends to bring in the same gross earnings. The amount he spends is referred to as the *cost of doing business*.

Anyone who is responsible for the operation of a business should realize these facts—yet, from the results of our survey, it is obvious that too many self-employed servicemen just don't know how to determine where they stand.

A large number of these businessmen keep inadequate records, while others have almost no accounting system at all. Certainly one of the most important facts about a business is profit—or lack of it! But how can a shop owner tell whether he is making a profit or not, if he fails to keep adequate books?

For example, more than one shop had a record sheet which read something like the example of John Smith TV in Fig. 1. His last year's *gross income* was \$8670, and the cost of his *merchandise sold* came to \$2125, leaving a *gross profit* of \$6555. From this he had to subtract his business expenses, which came to \$4947, leaving a net business income of \$1608. This might sound fine, but don't forget, John Smith has not received any salary yet!

Now, as to his salary—he shows that he withdrew \$3000 from the company funds—the minimum he could live on. The business income was only \$1608, leaving \$1392 to come from . . . who knows where? The almost \$1400 deficit must necessarily reflect as a drain on the operating capital of the business, and represents a genuine business loss. The sad thing is: If John Smith doesn't take the time or trouble to prepare an analysis like that of Fig. 1 (or have his accountant do it), he has no way of knowing that he is undermining his own security.

Many factors enter into the art of making a profit. The service shop must sell a certain quantity of parts, and perform service for a definite number of customers, or on a certain volume of sets. On the other hand, service performed entails certain costs—servicemen's wages, shop rent, telephone, test equipment,

lights, and many other seemingly "unseen" costs which are called *overhead*. The shop owner must advertise; he must have insurance; he needs the services of a bookkeeper to help keep track of all this; and by no means last, he needs *operating capital*—money to keep the business going through all these operations.

He uses operating capital to pay for the expenses of overhead and wages, and if he fails to get a sufficient return for his services—one which will replace this operating capital and repay him for its use—he cannot make a profit.

### The Need for Records

Our survey disclosed that few servicemen keep records in a form which readily enables them to determine what it costs them to run a business. As a result, they have no idea how much it actually costs them to stay open for an extra eight hours, or to make a given number of service calls. It would be difficult for them to find what return, if any, they are getting on the capital they have invested in test equipment, tools, and shop fixtures. Many do not actually know *what* salary they can pay themselves without taking a part of their operating capital.

What type of information would help the serviceman recognize any deficiency in his business activity? A *profit-loss statement*, such as shown in Fig. 2, is probably the most useful. This can be prepared weekly, monthly, quarterly, or on any basis which will provide a regular analysis of costs. From the statement, he can glean figures which will tell him the facts of business life for his shop.

He can use these figures to help him decide if it would be profitable to add another serviceman or a part-time helper. Certain income or expense categories can be itemized in a way which permits checking to see if carrying a certain line is advisable, or if providing a certain service is profitable.

### Developing the P/L Statement

A profit-loss statement can be set up in many ways, and your accountant can help you arrange the form which will most benefit your business. Fig. 2 illustrates a simple statement, and shows the important figures from which you can calculate your progress. Such a monthly statement might show a profit; some months it might reveal a loss. Careful analysis will often indicate the reason

P/L Statement Month of March 1962	
GROSS SALES:	
Set Sales	\$ 2759.55
Parts and Accessories	958.67
Service Labor	1438.76
	\$ 5156.98
COST OF MERCHANDISE:	
Sets	\$ 1942.87
Parts and Accessories	587.30
	\$ 2530.17
PROFIT ON SALES:	\$ 2626.81
EXPENSES:	
Service Salaries (excluding owner)	\$ 680.00
Outside Labor (ant. work)	85.00
Rent	150.00
Supplies - Off. & Shop	27.35
Utilities	73.79
Phone	37.69
Vehicle Expense	177.65
Insurance	77.50
Taxes, Licenses (prorated)	27.54
Repairs and Maintenance	18.76
Accounting, Banking, Legal	26.75
Depreciation	42.00
Advertising and Promotion	93.85
Interest on Loans	26.87
Miscellaneous	173.67
	3718.42
Net Income	\$ 908.39
Owner's Withdrawal	600.00
Net Profit:	\$ 308.39

Fig. 2. Profit-loss statement indicates progress of business.

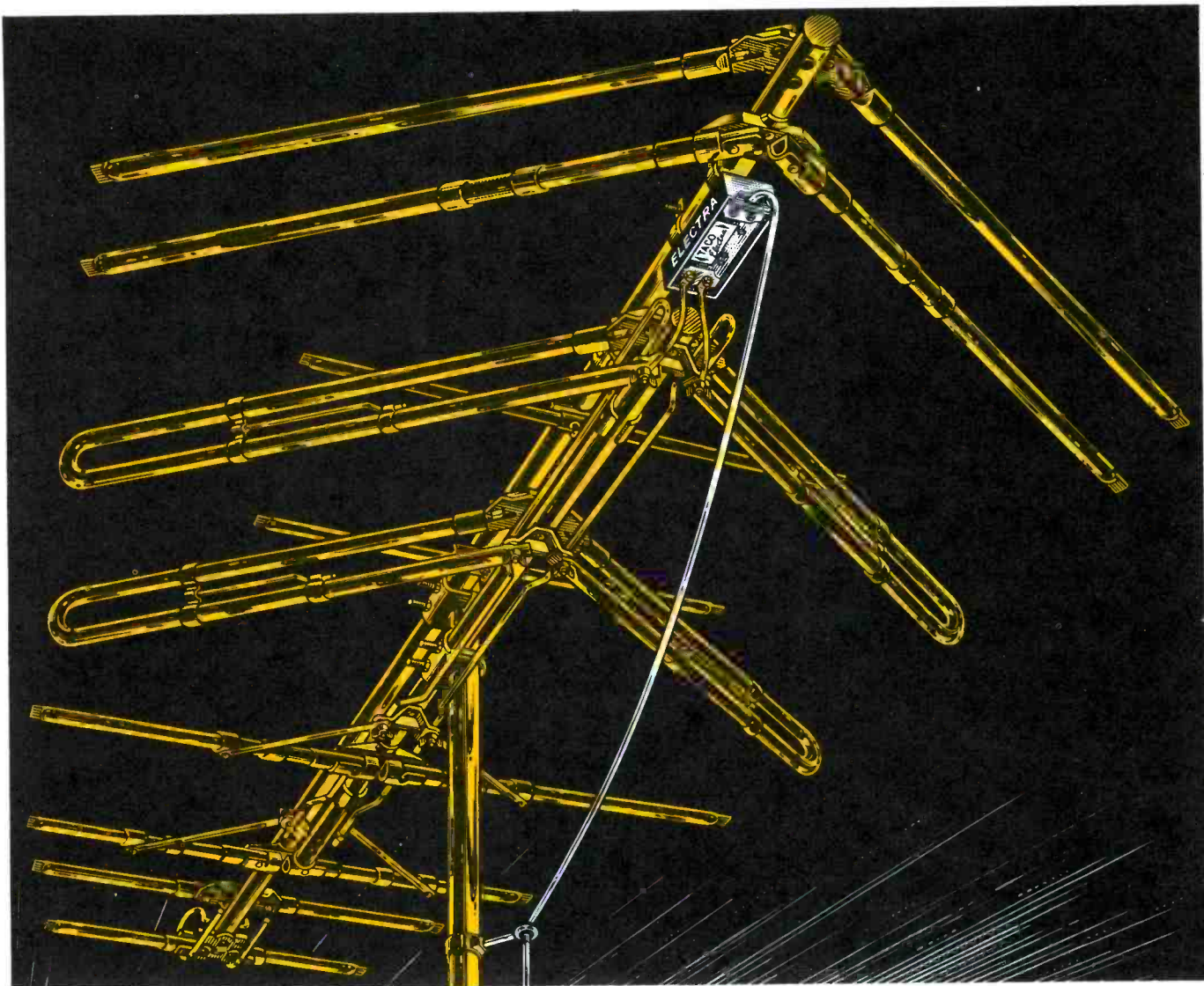

## HOTTEST

Servicemen and distributors everywhere are talking about the hottest-performing electronic antenna around—the TACO T-BIRD ELECTRA.

And you know what started them talking ... color TV. Color reception is the ultimate test of an antenna today, and here the T-BIRD ELECTRA's superior design separates the men from the boys. No friction noise, no signal flutter, a rifle-sharp forward lobe, flat response on all channels—and the best transistor preamplifier in the business (Jerrold-designed) . . . a few of the reasons why T-BIRD ELECTRAS (model for model) are *the world's most powerful electronic antennas*. Every element is extra rugged and put there to *work*, not just look pretty.

Only TACO, of all leading TV antenna manufacturers, has deep experience in designing satellite-tracking and defense antennas, as well as the best electronic know-how in the business. It's this combination that's making T-BIRD ELECTRA the hottest antenna news today. Add to this the new promotional concept that TACO offers you, and you have a line that can't be beat. Hot tip: GO TACO.

Shown above: T-BIRD ELECTRA Model G-990-8, list price \$107.20. Other T-BIRD ELECTRAS as low as \$78.80. Unpowered T-BIRD antennas list from \$28.30 to \$65.05.



# TACO T-BIRD ELECTRA

WORLD'S MOST POWERFUL ELECTRONIC TV/FM ANTENNA

TECHNICAL APPLIANCE CORPORATION, Dept. JTD-35, Sherburne, N.Y.

*A Subsidiary of Jerrold Electronics Corporation*

In Canada: Jerrold Electronics (Canada) Ltd., 50 Wingold Ave., Toronto • Export: Joseph Plasencia, Inc., 401 Broadway, New York 13, N.Y.

# NEW

ONLY  
PUBLICATION  
OF ITS KIND!

Howard W. Sams 1962

# Test Equipment Annual

the most complete,  
authoritative guide ever  
published on the practical  
application of test equipment



Only  
**\$1.50**

132 Pages  
Over 100 Illustrations  
the most useful, practical, time-saving information on test equipment ever to appear in a single volume!

## UNIQUE BUSINESS SECTION

Here's the money-saving information you need to help you buy and use test equipment to best advantage:

- Prorating Your Equipment for Tax Deductions
- When Should You Buy New Equipment
- Kit or Factory-Wired—How to Decide
- He Owns a TV Shop—On Wheels!

### SPECIAL! TEST EQUIPMENT BUYER'S GUIDE

Lists complete specifications for virtually every instrument available through parts distributors—especially planned to help you choose just the instruments you need in your work. Instruments are listed by category with informative tips preceding each group.

HERE'S YOUR TEST EQUIPMENT  
BUYING GUIDE IN ONE  
CONVENIENT VOLUME!

## FACT-PACKED FEATURES!

So easy to understand—here's the help you need to increase your servicing know-how... here are the latest techniques developed by the experts for your benefit.

### Partial List of Contents:

- How to Get More Mileage From Your VOM and VTVM
- How to Interpret Tube Tester Readings
- Using a Scope Effectively
- Circuit Analyzers Cut Troubleshooting Time
- Choosing Your Color TV Equipment
- Making Two-Way Transmitter Measurements
- Using Component Testers and Substitutors to Advantage
- The Versatility of Pulse Generators
- Using and Understanding Probes
- Radiation Detection and Measurements
- Transistor Testers—What They Do and How They Do It.

**DON'T MISS THE 1962 TEST EQUIPMENT ANNUAL**—it's packed with lab-proved test equipment information and latest servicing techniques to make your work easier, more profitable!

**ORDER YOUR COPY TODAY**

HOWARD W. SAMS & CO., INC.

ONLY  
**\$1.50**

Order from your local parts distributor, or mail to Howard W. Sams & Co., Inc. Dept. 7-CC-3 1720 E. 38th St., Indianapolis 6, Ind.

Please send me \_\_\_\_\_ copy(ies) of "Test Equipment Annual"  
My (check) (money-order) for \$\_\_\_\_\_ enclosed.

Name \_\_\_\_\_

Address \_\_\_\_\_

City \_\_\_\_\_ Zone \_\_\_\_\_ State \_\_\_\_\_

(outside U.S.A. priced slightly higher)

	Parts	Service	Both
GROSS SALES:			
Radio - TV	\$ 675.85	947.50	1623.35
Two-Way Radio	586.90	1312.80	1899.70
Appliances	873.00	757.60	1630.60
TOTALS:	\$2135.75	3017.90	5153.65

Fig. 3. Sales breakdown into departments aids cost analysis.

for any loss, and perhaps suggest a remedy. If losses continue over an extended period, it is time to change something about your way of doing business.

Gross sales represents the business income from all sources. If your shop does not sell sets, you would omit that category from the sheet. One business, which specializes in several types of service, prefers to divide the sales figures among various departments, as in Fig. 3. From this, the manager can see what portion of gross sales is derived from each. His overhead expenses can be divided proportionately to show whether or not a department is carrying its own weight.

Returning to Fig. 1, the *Cost of Merchandise* can be determined in either of two ways. The actual cost of each item sold can be listed on the shop copy of the customer invoice and the totals of these figures combined in the P/L statement. This method, however, can become very time-consuming.

The alternate method consists of applying a cost factor to the merchandise sales figures. This factor is derived from the average cost of items held in inventory. To illustrate, suppose the inventory contains \$2000 worth of items which were purchased at 60% of list price, \$3000 worth of goods at a 50% discount, and \$1000 worth of merchandise which was discounted to 70%. The average factor is computed by adding the factors in proportion (per \$1000) and dividing by the total of proportionate factors— $.6(2) + .5(3) + .7(1) = 3.4$ , divided by 6 =  $.567$ . This factor, when applied to the gross merchandise sales, will indicate the *approximate* cost. Thus, the *cost of merchandise* for \$1500 worth of parts and accessories would be about \$850.50 ( $\$1500 \times .567$ ).

*Expenses* can be computed from monthly bills as they are paid, or from check stubs. The totals can be added and entered on the profit-loss statement as the monthly expense for each category.

*Service salaries* should exclude the owner's salary if the business is a proprietorship or a partnership. If the business is a corporation the manager's salary must be included. The reason for this differentiation is because net taxable income of a proprietorship must be figured before the owner(s) withdraws any money from the business. In a corporation, the taxable corporate profits are computed only after all personnel and officers are paid. Clerical or office help can be included with service salaries or else placed in a separate category with other nonproductive salaries.

## Bonus 16-PAGE BOOK SECTION

Gives you all the facts you need to take the guesswork out of using signal generators—written by Bob Middleton, the dean of test equipment authorities.

**YOU GET ALL THE FACTS!**



# What's the difference in loudspeakers that makes Quam so special?

All loudspeakers look pretty much alike, and may even sound pretty much alike—yet Quam speakers are different—in a way that's very important to you who use them!

the  
difference  
lies  
in  
**PERFORMANCE  
RELIABILITY**

When it's a Quam speaker—you install it and forget it. Quam speakers are built to give long, trouble-free performance.

Quam's factory is a manufacturing plant, not merely an assembly shop. By making our own speaker parts, we can guarantee the quality of the materials that go into them. Our voice coils are centered precisely; each and every speaker is thoroughly tested; the product you get meets the standards we have insisted on for almost forty years.

Quam Quality Line speakers are enameled in gold—and while the color has no effect on performance characteristics, it symbolizes the quality and reliability that's built into every Quam speaker.

ASK FOR

# QUAM

**THE QUALITY LINE—  
for all your speaker needs**

QUAM-  
NICHOLS  
COMPANY

234 East Marquette Road  
Chicago 37, Illinois

# LIMITED OFFER

## for unlimited servicing profit

### TRUE SQUARE WAVE OUTPUT FROM YOUR PRESENT OSCILLATOR AND SCOPE

Reduce amplifier analysis time to one minute with a simple high and low range frequency response reading. The 606 gives true square waves coupled with your present sine wave generator. Square wave shape is independent of the driving source wave shape, and covers the full frequency range provided by your present driving generator.

JACKSON 606 SQUARE WAYER ~~\$34.95~~  
SPECIAL OFFER—\$29.95

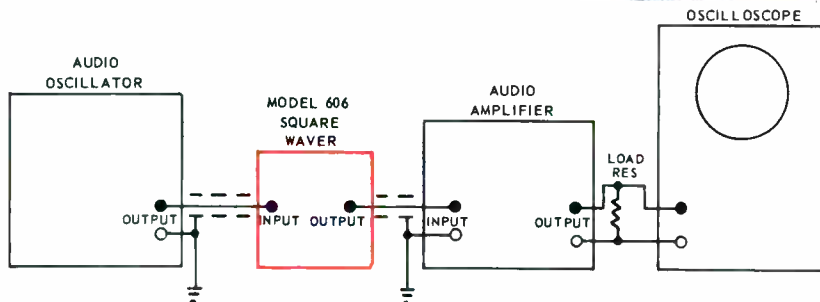
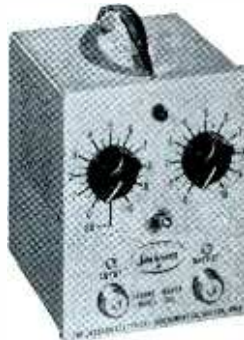

For a full service, ultra reliable yet compact wave generating source, the Jackson Model 605 Audio Sine/Square Wave Oscillator is your best answer. Provides both sine and square wave output for accurate checking of distortion, voltage, gain and frequency response of amplifier circuits. Range 20 to 200,000 cycles in four push button selected ranges. Continuously variable output. A Professional Quality instrument. \$129.95.



ELECTRICAL INSTRUMENT COMPANY

124 McDonough St., Dayton, Ohio

### \$5.00 SAVINGS COUPON

This coupon and \$29.95 will add the Jackson 606 Square Waver to your service profit potential.

Take this coupon to your Jackson Instruments dealer, or mail direct to Jackson Electrical Instrument Company, 124 McDonough Street, Dayton 2, Ohio.

NAME \_\_\_\_\_  
FIRM \_\_\_\_\_  
ADDRESS \_\_\_\_\_  
DEALER \_\_\_\_\_  
DEALER ADDRESS \_\_\_\_\_

THIS OFFER GOOD THROUGH JUNE 15, 1962



606

Service-Call Income - 180 calls @ \$4.00  
720.00 or approx 1/7 of gross

EXPENSES ( p means prorated)	
Serviceman Salary	\$ 420.00
Rent ( p )	21.00
Supplies	5.00
Utilities & Phone ( p )	16.00
Vehicle Expenses ( one truck )	75.00
Taxes & Licenses ( p )	4.00
Repairs & Maintenance ( p )	3.00
Acct., Bank, and Legal ( p )	4.00
Depreciation ( p )	6.00
Adv. & Promotion ( p )	14.00
Interest & Misc. ( p )	29.00
	<b>\$ 597.00</b>
180 calls	\$ 3.32 cost per call

Fig. 4. Service-call costs are determined from P/L statement.

*Outside labor* includes money paid to another company for services rendered, for which a customer was charged. Antenna work often falls into this category, since many shops "farm out" this work to specialists. Sometimes an electrical contractor is hired to pull wiring for an intercom system; this would be outside labor.

*Office and shop supplies* can be grouped together. *Shop supplies* include items such as solder, tape, hookup wire, or any material for which the customer is not charged directly. *Office supplies* normally means stationery, pencils, postage, paper clips, and similar material.

*Vehicle expense* covers gas, oil, tires, and normal service expense connected with the company vehicles. The vehicle insurance and major repairs are usually placed in the *insurance* and *repairs and maintenance* categories.

*Insurance* includes any coverage of risks entailed in normal business operation. The premium is usually billed on a per-year basis, and you must divide this figure by 12 to arrive at your monthly insurance cost.

*Taxes and licenses* are always on a yearly basis, and the monthly amount can be computed as described for insurance premiums. Licenses include any city, county, state, or federal permits or fees. Taxes include federal excise taxes on purchases, sales tax on items bought for business use, corporate taxes and fees, and payroll taxes.

*Repair and maintenance* costs, whether for test equipment, buildings, vehicles or shop and office furniture, are listed in this category.

The *accounting, banking, legal* category is self-explanatory. Fees of the agency who collects your delinquent charge accounts are included.

*Depreciation* is that allowance which permits you to set aside a part of your capital assets each month as "used up." As a piece of test equipment (or a truck) is used and grows older, it becomes less valuable to the business. This depreciation of value can be claimed as a business expense, and must be included in the profit-loss statement.

If you borrow money, the *interest* you



# STA-LOC® Control Kits

now more versatile than ever

Here's the new Mallory STA-LOC Control Kit. It's better than ever now. All we did was shuffle a few parts around to really bring it up-to-date. Now you can make exact replacements for hundreds of jobs . . . TV, Hi-Fi, stereo, home and auto radio . . . singles, duals, tandems . . . even clutch controls . . . all with or without a line switch.

STA-LOC controls snap together . . . and *stay* together. Best of all, you can snap a rear section on in any of three positions . . . so you can fit those tough auto radio jobs. The whole STA-LOC system is slick. It's designed for you . . . the service technician.

There are two STA-LOC kits. The small SLD-1A covers

over 200 dual combinations, 300 tandems, and scores of singles. The big SLD-2A handles over twice as many jobs. Both kits come complete with cross reference guides and instructions. And they're inexpensive.

You'll save time, phone calls, and extra trips to your distributor. Here's a real plus . . . Your Mallory distributor has *complete* back-up stock for your STA-LOC kit . . . you can even switch it around to fit your needs exactly. Give your Mallory Distributor a call . . . let him give you the details on the best doggone control system ever made for service technicians.

STA-LOC. U.S. Patent 2,958,838.



Distributor Division, Indianapolis 6, Indiana



# SAMS BOOKS

## INTRODUCE YOU TO NEW FIELDS

(available from your Sams Distributor)



**ABC's of Computers.** Tells what computers do and how they operate. Explains analog and digital types, binary numbers, circuitry, memory devices, arithmetic functions, symbolic logic, input-output devices, programming, etc. 128 p., 5 1/2 x 8 1/2". **\$1.95**  
No. ABC-1, Only.....

**ABC's of Radar.** Comprehensive, easy-to-understand explanation of radar: principles; how it works; uses; types of radar systems; microwave; antenna systems; receivers; indicating systems; timers and modulators, etc. 112 p., 5 1/2 x 8 1/2". **\$1.95**  
No. ABR-1, Only.....

**ABC's of Mobile Radio.** Basic introduction to systems and equipment used in today's booming field of 2-way mobile communications. Provides a clear understanding of the principles and equipment used. 96 p., **\$1.95**  
5 1/2 x 8 1/2". No. AMR-1, Only.....

**ABC's of Ultrasonics.** The fascinating story of how sound waves above the normal audible range are being used to perform jobs ranging from cleaning tiny watch movements to huge missile cases, homogenizing milk, measuring thickness and depth, locating schools of fish, etc. Describes theory and equipment used. 96 p., 5 1/2 x 8 1/2". **\$1.95**  
No. ULT-1, Only.....

**ABC's of Missile Guidance.** Easily understandable book on the principles used to guide today's missiles and rockets. Covers development, propulsion techniques, guidance fundamentals and systems, etc. 96 p., **\$1.95**  
5 1/2 x 8 1/2". No. GMS-1, Only.....



**ABC's of Electronic Organs.** Explains theory, development, features, and operation of electronic organs, circuitry used, how to maintain and troubleshoot these instruments. 96 p., 5 1/2 x 8 1/2". **\$1.95**  
No. ECO-1, Only.....

**ABC's of Model Radio Control.** Gives you an understanding of this popular hobbyist interest—the radio control of model planes, cars, boats, etc. Explains radio control principles; describes equipment; how to build, install, and use it. 96 p., **\$1.95**  
5 1/2 x 8 1/2". No. MOR-1, Only.....

**ABC's of Ham Radio.** All you need to know to qualify for the ham novice license. 10 chapters include typical exam questions; the radio code; the transmitter; radio power supplies; measurements; regulations; exam procedures—right down to "You're On the Air!" 112 p., 5 1/2 x 8 1/2". **\$1.50**  
No. HAP-1, Only.....

**ABC's of Tape Recording.** Provides a clear understanding of how tape recorders work and how to use them to best advantage for pleasure or business. Includes many unique tape recorder uses. 96 p., 5 1/2 x 8 1/2". **\$1.50**  
No. TAP-1, Only.....

**ABC's of Transistors.** Tells in practical language the function of the transistor in today's commercial circuits. Covers transistor fundamentals, physical construction, basic circuits, transistor amplifiers and oscillators, temperature considerations, testing and servicing facts. 96 p., 5 1/2 x 8 1/2". **\$1.25**  
No. TRA-1, Only.....

**FREE** New Sams Booklist describing over 150 important books. Available from your Distributor or write us direct.

**HOWARD W. SAMS & CO., INC.**  
1720 E. 38th St., Indianapolis 6, Ind.  
In Canada: A. C. Simmonds & Sons, Ltd., Toronto 7

ESTIMATED MONTHLY ADD'L COST (four extra days)		SUMMARY
Utilities	12.00	To make 17% profit - \$310.00 additional business.
Supplies	1.50	78 service calls - impossible
Vehicle Expense	35.00	- or -
Miscellaneous	35.00	\$1000 worth of extra sets - possible
R & M, A-B-L, Depreciation	17.00	- or -
Additional Promotion	30.00	30 service calls and \$650 worth
Salary & Payroll Tax	125.00	of extra sets - possible
	<u>255.50</u>	

Fig. 5. Using profit-loss figures to evaluate future plans.

pay on the loan can be considered as a business expense, and is listed as such. Your banker or your accountant can give you specific details on how to compute this interest, since this is a highly specialized field and sometimes loan charges are difficult to analyze.

The *miscellaneous* category is a "catch-all" under which you can list any item not covered in a regular account. Such things as travel expenses to and from a service meeting, a magazine subscription, or membership dues in the local servicemen's organization are expenses which logically fall into this category.

### Using the Information

Now you can use all this information to compute various cost factors of your business. For example, suppose you are interested in how much it costs you to make a home service call. The costs include salaries, service vehicle expense, and proportionate parts of all overhead expenses. Fig. 4 shows a tabulation of these various expenses, some of them prorated.

The relationship for prorating is established by comparing the income from service calls with the total income. Since over-all income (in Fig. 2) was around \$5000, and service-call income for the month was slightly over \$700, about 1/7 of overhead should be charged to service calls.

To develop the analysis shown in Fig. 4, each expense item must be considered. Only one serviceman makes outside calls, so his is the only salary applied. Certain expenses are peculiar only to service calls, such as truck expense. As you can see, certain expenses remain fixed, while others fluctuate with the overhead of the business. The point is, your service-call charge should be sufficient to cover expenses and leave a reasonable profit for the business.

In the example of Fig. 4, the profit is 68¢ per \$4.00 service call, or 17% of gross; 15% is usually acceptable. If no profit is evident, it is up to you to decide if your service charges are wrong, the volume of calls being handled is too small, or if expenses are too great. In this way, the P/L statement both helps you find a fault and assists in planning a way to eliminate it.

### Stay Open More?

Suppose you wondered if it would be

wise to keep the store open an extra day each week, and perhaps handle extra service calls. Things to consider would be: added utility expense, extra advertising, and additional salaries. Salaries might involve overtime pay, or maybe just adding a part-time man; in both cases, additional payroll taxes will be involved. If service calls will be made, vehicle expense is added.

To offset this additional expense and provide a profit, you must know just how much extra business you need. So you consult your P/L statement (Fig. 2) again. Let's examine *utilities*—they have been costing about \$3.00 per working day, so this figure can be used as a basis for preparing the *estimated cost* sheet in Fig. 5. Similar proportions are used in the estimates of other current expenses. All expenses which would increase must be included if the shop were kept open four extra days each month.

A fair profit must be added to the total-expense figure. (What reason is there to stay open, if not for a profit?) The summary in Fig. 5 demonstrates that it would be a losing proposition to stay open for service calls only, but it might be possible to sell enough sets to make it worthwhile. Don't forget, when figuring the profit on sets, to subtract the *cost of merchandise* from the sale price; then you can figure your profit by deducting *expenses* from *profit on sales*. If a normal quota of service calls can be obtained, it is easy to see that nominal set sales will make staying open profitable. This is a break-even point; additional service calls or more set sales will simply add to the profit percentage, provided no further expenses are entailed.

Of course, the owner can now have an additional withdrawal for "keeping the store," and this is included in the 17% profit; in fact, about 11% is the owner's normal withdrawal. So, in the example of Fig. 5, the owner could add approximately \$35 extra to his monthly withdrawal. In all of this planning, the P/L statement is his guide.

From these examples, you see by now that you can use your profit-loss statement to chart your progress or your decline. If you are faced with the latter, it is time to analyze the business and make some changes. If you are *aware* of your *cost of doing business*, you are in an excellent position to do something about your fate as a businessman, and you can find ways to pay yourself a better wage. ▲

**ALL-NEW**

**ATR**<sup>®</sup>

**TUBE-TYPE and TRANSISTOR-POWERED**

**Karadio**<sup>®</sup>

*"the oldest name in auto radio"*

*with Excellent Tone, Sensitivity, and Volume!*

- HAND WIRED – NO PRINTED CIRCUITRY
- FINGER-TIP TONE CONTROL
- EQUIVALENT 8 TUBE PERFORMANCE
- AUTOMATIC VOLUME CONTROL

**TUBE-OPERATED**



UNIVERSAL Karadio

**\$ 39.95**  
LIST PRICE

MODEL 600 SERIES. Easily installed in-dash or under-dash. Amplifier/power supply chassis may be separated from tuner chassis for installation flexibility and easy servicing. Utilizes 6-tube superheterodyne circuit (two dual purpose tubes) with 8-tube performance... pulls in those distant stations with good tone and volume. Supplied with separate 5" x 7" speaker.



TRUCK Karadio

**\$ 59.95**  
LIST PRICE

MODEL TR-1279. Easily installed in cab of truck or boat by simply drilling one (1) hole. Overhead mounting adds extra safety to driving. Has built in speaker and utilizes 6-tube circuit as above. Perfect for all trucks.



JUST THE THING FOR BOATS



PERFECT FOR TRUCKS

UNIVERSAL Karadio

**\$ 44.95**  
LIST PRICE

MODEL TR/K-1279 SERIES. Easily installed in-dash or under-dash. Has self-container speaker and 6-tube superheterodyne circuit with 8-tube performance... pulls in those distant stations with good tone and volume.

**TRANSISTOR-POWERED**



UNIVERSAL Karadio

**\$ 39.95**  
LIST PRICE

MODEL 400 SERIES. Easily installed in-dash or under-dash. Superheterodyne circuit utilizing 4 tubes (two dual purpose tubes) together with two transistors... pulls in those distant stations with good tone and volume. Supplied with separate 5" x 7" speaker.



FULL CUSTOM Karadio

**\$ 49.95**  
LIST PRICE

UTILIZES MODEL 400 SERIES designed specifically for 1960-61-62 Ford and Falcon cars. Blends perfectly with dashboard same as original equipment. Supplied with 6" x 9" speaker.



FULL CUSTOM Karadio

**\$ 49.95**  
LIST PRICE

UTILIZES MODEL 400 SERIES designed specifically for 1961 and 1962 Chevrolet. Blends perfectly with dashboard same as original equipment. Supplied with 6" x 9" speaker.

Customized Karadio



Illustrates ATR CUSTOMIZED Karadio utilizing Model 600 Series and deluxe trim plate mounting for Falcon. Many model CUSTOMIZED Karadios are available in Model 600 series, 400 series, or TR/K-1279 series permitting maximum installation flexibility.

as low as **\$45.95** Complete  
LIST PRICE

to fit most **Import Cars \ Compact U.S. Cars and Standard U.S. Cars & Trucks**

**READ and COMPARE!**

Read why ATR KARADIOS provide the highest value and performance at the lowest cost, giving utmost customer satisfaction



QUALITY PRODUCTS SINCE 1931  
**ATR ELECTRONICS, INC.**

©Trademarks of ATR Electronics, Inc. Registered in the U.S. Patent Office.

300 E. 4th St.  
St. Paul 1, Minn.

SEE YOUR ATR KARADIO DISTRIBUTOR OR WRITE FACTORY FOR COMPLETE INFORMATION. FRANCHISE TERRITORIES AVAILABLE FOR AUTO RADIO SPECIALISTS. ACT NOW!

ATR UNIVERSAL Karadio 400 SERIES. Transistor-Powered	4 Tubes	2 Transistors	RF Stage	Tone Control
Brand A Transistor-Powered	2 Tubes	2 Transistors	None	None
Brand B Transistor-Powered	3 Tubes	2 Transistors	None	None
Brand C Transistor-Powered	3 Tubes	2 Transistors	None	None

The above UNIVERSAL type sets being compared are all Transistor-Powered types having suggested selling price \$39.95. Note the extra value of the ATR KARADIO providing extra RF stage and variable tone control providing top performance, and maximum distance reception. In addition ATR KARADIO is supplied with a separate 5" x 7" speaker giving high fidelity tone, and maximum volume.

# PUTTING "SILENT SOUND" TO WORK

Sound waves are produced by mechanical vibrations over a frequency range that extends far beyond the limits of our hearing. The inaudible sounds in the *ultrasonic* region, above 20 kc, are put to good use in industry.

Ultrasonic cleaning is one of the best known applications of ultrasonics. This method of cleaning is used in almost every kind of manufacturing, and has proved successful in cleaning grease, oil films, metal chips, and corrosion from intricate mechanisms. It is ideally suited for irregular shapes and forms that are hard to clean by other methods.

The output of an oscillator unit is applied to a transducer which converts it into mechanical vibrations of the same frequency.

These vibrations--ultrasonic energy--are then transmitted into the cleaning liquid.

This results in cavitation, the formation and collapse of millions of microscopic bubbles in the liquid.

The collapse of these bubbles results in a powerful scrubbing action.

Ultrasonic vibrations remove contaminants from cracks, undercuts, and blind holes inaccessible by any other means. In many cases, complex assemblies need not be disassembled before cleaning, thus reducing labor costs and time by making it possible to use automatic cleaning methods.

This cleaning action of ultrasonics works on the erosion principle. The cleaning liquid is placed in motion by a transducer, resulting in a scrubbing action. However, the mere presence of high-frequency energy does not necessarily produce cleaning. This action results from "cavita-

tion" of the cleaning liquid. Cavitation is the rapid formation and sudden collapse of countless thousands of microscopic bubbles in a liquid, generated by transmitting ultrasonic vibrations through the liquid (Fig. 1). The implosion or collapse of these bubbles during the pressure-reduction part of the cycle pulls dirt and other contaminants free from the parts immersed in the liquid. A solvent dissolves grease and soluble oil, while a detergent holds in suspension the dirt torn free by the ultrasonically-generated cavitation.

### The Ultrasonic Generator

The generator used in ultrasonic cleaning draws power from the 60-cps power line and converts it to useful output at the resonant frequency of the transducer. The generator is basically an oscillator; for a typical circuit, see Fig. 2. The output-power ratings of generators cover a range from about 60 watts in the small sizes used in laboratories (Fig. 3) to many kilowatts in sizes used for cleaning large parts in volume. These generators are usually rated at both average power output and pulsed power output (four times average). The output of the generator excites the transducer, which expands and contracts at the same frequency to generate the ultrasonic vibrations and thereby couple the ultrasonic energy into the liquid.

Another measure of energy is in terms of watts per gallon. 25-30 watts per gallon represents about the minimum requirement for ultrasonic cleaning.

In most cleaning applications, 40 kc is an optimum operating frequency. Adequate power levels, a

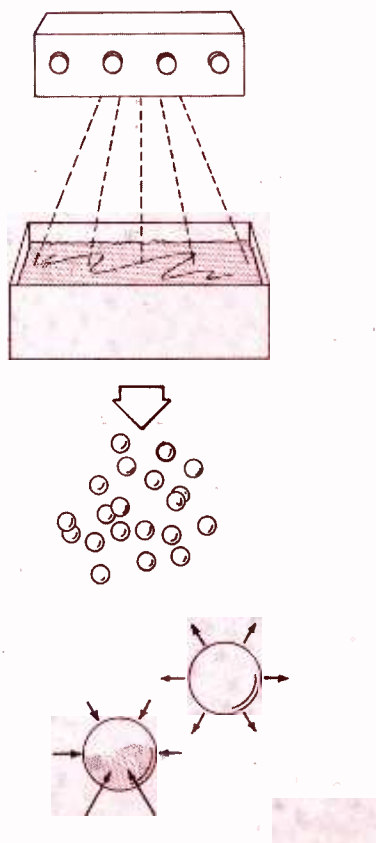

Fig. 1. An ultrasonic cleaner loosens dirt by means of cavitation in liquid.

# BETTER THAN EVER IN ITS 32<sup>nd</sup> YEAR



## THE PHILCO PLEDGE OF QUALITY TO THE SERVICE-DEALER

When you insist on a Philco STAR BRIGHT 20/20 Picture Tube or Philco Receiving Tube, you're sure of unbeatably high quality. There are many technical reasons why—but the most fundamental reason behind the Philco Pledge of Quality is Philco's own reputation—and the fact that we consider the service technician as our most important tube customer.

Everything that Philco makes or sells reflects on the proud reputation that we have tried to build throughout the years. Your customer makes no distinction between the

Philco part or tube that you install and the original Philco instrument that she purchased. To us, the most important fact is that your customer . . . and ours . . . is satisfied.

That is why we refuse to relax the quality standards for every product, every tube, every part sold by Philco. That is one reason we believe every replacement part should meet original factory specifications. Your Philco Distributor makes it especially easy for you to use and order the right tube or part, by offering a service data program and maintaining complete stocks of Philco tubes and parts.

See Your Philco Distributor . . . He's the Best Friend and Partner Any Serviceman Could Have!

### Double Protection—both Bond and Warranty

Every Philco STAR BRIGHT 20/20 Picture Tube is Bonded to be made only from new parts and materials except for the envelope which, prior to

re-use, is inspected and tested to the same standards as a new envelope. Plus the standard Philco full year Warranty on picture tubes.

PARTS & SERVICE OPERATIONS

# PHILCO®

A SUBSIDIARY OF *Ford Motor Company*

Want  
Additional  
Service  
Information?

MAIL  
THIS COUPON  
TODAY

Philco Parts & Service Operations, Dept. C-4  
2nd and Westmoreland Sts., Phila. 40, Pa.

Please send me the latest Free technical information and my complimentary copy of the Philco Service-Businessman magazine.

Name .....

Address .....

City ..... State .....

Service Only       Retailer with Service Dept.

Just Off the Press! New Philco Electronic Parts Catalog! Ask Your Philco Distributor for Your Copy Today!

# Miniature I. F. TRANSFORMERS OSCILLATOR COILS and LOOP ANTENNAS for Transistor Sets

GENERAL REPLACEMENTS FOR  
IMPORTED and DOMESTIC SETS

Size  $\frac{3}{8}$ " x  $\frac{3}{8}$ "  
PART NO. OPERATION  
455-A1 INPUT  
455-A2 INTERSTAGE  
455-A3 OUTPUT  
455-OA OSCILLATOR

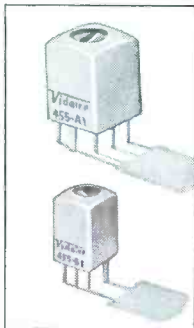

Size  $\frac{1}{4}$ " x  $\frac{1}{4}$ "  
PART NO. OPERATION  
455-B1 INPUT  
455-B2 INTERSTAGE  
455-B3 OUTPUT  
455-OB OSCILLATOR

Packaged in Plastic See-  
Thru box in display car-  
ton with instruction.

## MODEL LA-14

FOR USE WITH  
148 MMFD.  
TUNING  
CONDENSER



SIZE  
 $1\frac{1}{16}$ " x  $1\frac{1}{16}$ "

## MODEL LA-21

FOR USE WITH 211 MMFD.  
TUNING CONDENSER —  
SIZE 2-5/16 x 11/16

## MODEL LA-36

FOR USE WITH 365 MMFD.  
TUNING CONDENSER —  
SIZE 2-13/16 x 11/16

Packaged in plastic bag on display card

**Vidair** ELECTRONICS MFG. CORP.  
365 BABYLON TPKE. — ROOSEVELT, N. Y.

## New **BERNS** Perfect Pin Crimper

### Picture-Tube Repair Tool

Also for—5U4, 6SN7, 6BQ6, etc.

Eliminates that hard  
soldering job

only \$1.25  
each



Patented

Intermittent operation of picture tubes due to defective solder connections easily corrected. Provides solid electrical connections, can also be used as channel-selector wrench and screwdriver. Pin keeps its original form. A 3-in-1 tool.

### 3 MODELS ELIMINATE SOLDERING

#### Makes Solid Electrical Connections Phono Pin-Plug Crimper

Slip wire in "pin  
plug," insert  
in tool, and  
squeeze . . .  
job is done.

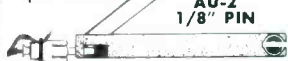

AU-2  
1/8" PIN

C-rings 1c ea.

Use end of  
tool to push  
on C-ring for  
ground con-  
nection.

Ant. plugs, hi-fi, multiple plugs, public  
address, radio and TV tubes, radar, speakers,  
and loop connections. Many, many more uses.

Model LC-3 for 5/32" pin diameter

At your parts distributor or write us

**BERNS**

Mfg. Co.  
9853 Chalmers,  
Detroit 13, Mich.

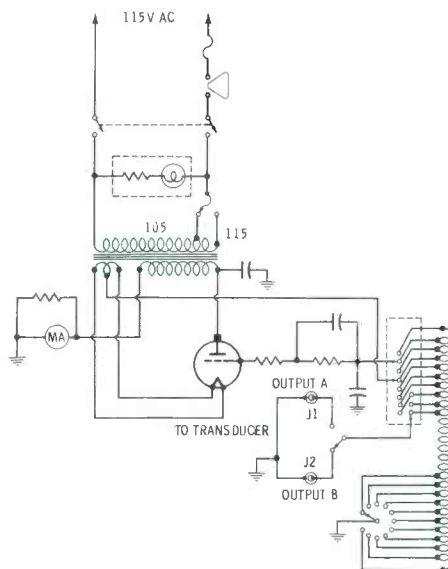

Fig. 2. An oscillator circuit typical of those used in ultrasonic cleaners.

high percentage coverage of the tank, and low noise levels can be achieved at minimum cost. For certain applications in which higher power is desired, especially in cleaning parts of large mass, and where a higher noise level is not objectionable, 20 kc is a recommended frequency.

### Transducers

There are two basic methods of converting electrical power to mechanical power in an ultrasonic cleaner. The *piezoelectric* method utilizes the property of certain crystals and ceramics to change shape when an electrical potential is applied to them, and the *magnetostrictive* method depends on the ability of certain metals, such as nickel, to change dimensions when magnetized.

### Piezoelectric Generator

The piezoelectric effect is prob-

ably the most frequently-used method for generating ultrasonic energy and offers a means for generating the highest frequencies.

The brothers Curie discovered in 1880 that many crystals, when sub-



Fig. 3. Sonogen laboratory-type ultrasonic unit used to clean small parts.

## Western T.V. Tuner Rebuilders

VHF or UHF ALL MAKES

**\$9.95** Including all parts  
and labor

major parts extra at (low) net price.

UHF-VHF COMB. \$17.50

90 Days Guarantee — 24 Hour Service

All tuners are thoroughly cleaned, mechanically and electrically overhauled, aligned with crystal-controlled equipment, and finally given air check for sensitivity with TV transmitters located in Los Angeles at 5,000 feet height and 120 mile distance from us.

### TRANSISTOR RADIOS REPAIRED

Standard—\$4.75 plus parts  
Shortwave—\$6.75 plus parts  
A.M. & F.M.—\$7.50 plus parts

### WESTERN TUNER REBUILDERS

4030 W. Sunset Blvd., Los Angeles, Calif., NO 2-1397  
4130 El Cajon Blvd., San Diego 5, Calif., AT 4-2733

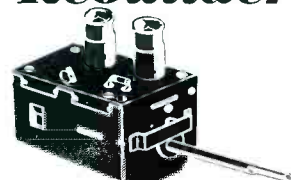





For stronger... clearer  
TV reception

**Belden**  
**PERMOHM\***  
TV Lead-in Cable

100 FEET  
8285  
Belden  
PERMOHM

There's a Belden Lead-in Cable  
for every requirement



**8225**  
STANDARD 300-OHM LINE—  
Offers low losses at high frequencies. For use with TV and FM receiving antennas.



**8275**  
CELLULINE † 300-OHM LINE—  
Resists abrasion, sun, and wind. Provides strong UHF and VHF TV pictures.



**8222**  
STANDARD 72-OHM LINE—  
Can be used with all types of receiving antennas at high frequencies.



**8230**  
WELDOHM † 300-OHM LINE—  
Provides 2½ times the breaking strength of ordinary lead-in cable.



**8226**  
DECORATOR LEAD-IN 300-OHM LINE—For interiors only. Replaces unsightly cables. Neutral color blends into room's decor.



**8224**  
STANDARD 150-OHM LINE—  
For receiving antennas, matching transformers, and experimental applications.

Permohm conductors are encapsulated in cellular polyethylene. This exclusive 300-ohm line design provides clearer TV reception in all areas, including areas where conditions of extreme salt spray, industrial contamination, ice, rain, or snow are experienced. It further improves fringe area pictures on all channels, as well as strengthening UHF and color TV transmission. Ask your Belden Distributor about this improved 300-ohm cable. Permohm is available in packaged lengths of 50, 75, and 100 feet, and in 500- and 1000-foot spools.

\*Belden Trademark and Patent . . . U.S. Patent No. 2782251



- Power Supply Cords • Cord Sets •
- Portable Cordage • Electrical Household Cords • Magnet Wire •
- Lead Wire • Automotive Wire and Cable • Aircraft Wires •
- Welding Cable



Belden Cable is Packaged  
in Standard Lengths for  
Display and Handling.

† Belden Trademark—Reg. U.S. Pat. Off.

6-5-1

jected to pressure or tension in certain directions, developed electric charges on definite surfaces. Conversely, applying electricity to a crystal through driving electrodes causes distortion of the crystal. (Further details are presented in Fig. 4.) This piezoelectric effect is observed in such crystals as tourmaline, quartz, zinc blend, sodium chlorate, tartaric acid, cane sugar, and Rochelle salt.

If a piezoelectric quartz plate is placed in an alternating electric field in such a manner that the direction of the field corresponds to the direction of the piezoelectric

axis, the quartz will be compressed during one half-cycle of the field, and expanded the same amount during the other half-cycle. It will thereby be set into elastic oscillations of the same frequency as the field. The resulting amplitudes will be at a maximum when there is resonance between the applied field and the natural mechanical frequency of the crystal plate. The resonant frequencies of the crystals can be tuned very sharply.

Although the most widely-used crystal for utilizing the piezoelectric effect has been the quartz crystal, artificially-produced ceramics are

replacing natural crystals because they can be manufactured to provide specific characteristics and in any practical size.

Crystals composed of ceramics are generally used for transducers in ultrasonic cleaning. This has proven to be one of the most economical and satisfactory means of activating the cleaning liquid. Synthetically produced of barium titanate, the material is easily formed during manufacture into the most efficient shapes to provide the relatively large radiating areas required. Barium titanate transducers, when operated in the 40-kc range, also

**NEXT BEST THING TO THE  
WINEGARD ELECTRONIC  
POWERTRON TV ANTENNA**

**NEW TRANSISTOR TV-FM  
WINEGARD  
TENNA-  
BOOST**

**MOUNTS ON ANY ANTENNA**

**MOUNTS ON  
ANTENNA**



Model  
MA-300

**\$34<sup>95</sup>**  
only LIST

**INSTALL IT... FORGET IT!**

**ALL ELECTRIC, ALL-AC POWER  
SUPPLY** costs less than 27c a  
year to operate. Many exclusive  
features.

No costly, nuisance batteries!



Built-in two set  
coupler.

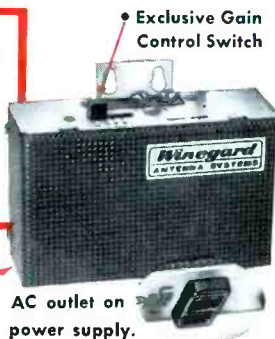

**19 DB GAIN! CUTS SNOW...BOOSTS SIGNAL!**

Now you can make any TV or FM antenna work better by magnifying signals with the new Winegard transistor Tenna-Boost.

Tenna-Boost has up to 19 DB gain, no peaks and valleys. Ultra low noise. Linear frequency response. VSWR input better than 1.5:1 across all frequencies. Output VSWR 1.8:1 or better. This fine frequency response plus the very low VSWR make Tenna-Boost excellent for color.

Winegard's *exclusive* input band-pass filter eliminates interference from citizen's band, Hams, garage door openers, etc. Only TV and FM signals are amplified.

All metal parts are anodized, irridized or stainless steel. Completely weather-proof, trouble-free. Install it... forget it.

There's a big difference in antenna amplifiers! Ask your distributor or write for technical bulletin.

**FOR THE ULTIMATE IN  
TV RECEPTION**

Winegard Transistorized Electronic  
Powertron TV Antennas. 3 Models  
to Choose From.



**Winegard**

**ANTENNA SYSTEMS**  
3009-4B Kirkwood • Burlington, Iowa

# For the Ultimate in FM and FM Stereo Reception...

## Winegard

### FM ANTENNAS

No matter how sensitive an FM tuner or set is, it's no better than the antenna to which it is connected.

With a good FM antenna, you can receive both nearby stations as well as stations up to 200 miles away. Add a Winegard FM antenna to your receiver for the finest high fidelity sound modern electronics can provide. Choose from the complete Winegard line of GOLD ANODIZED and aluminum FM antennas.

## NEW ELECTRONIC FM ANTENNAS FOR FRINGE AREAS— Most Powerful FM Antennas You Can Own



### Guaranteed 200 Mile Reception With STEREO-TRON

This is the finest constructed, most sensitive FM antenna made—carries written guarantee that you will receive 85% of all FM stations within 200 miles over normal terrain when used with rotator.

Only recommended for fringe areas (locations where closest FM station is 30 or more miles away). Stereo-tron has a total gain of 26 DB over a folded dipole with a flat frequency response of  $\pm 1/4$  DB from 88 to 108 mc.

Model PF 8 (300 ohm) \$64.25  
Model PF 8C (75 ohm) \$64.25

### ELECTRONIC "TURNSTILE" ANTENNA

Model PF 4 (300 ohm) \$55.80

Non-directional, has 16 DB gain, receives in all directions to 125 miles. Both electronic antennas have built-in amplifiers and come with power supply. Both are GOLD ANODIZED.

### FOR MIXED FM RECEPTION AREAS (locations where one or more FM stations are within 30 miles and other FM stations are located beyond that distance.)

#### FM-8 DIRECTIONAL YAGI

For long distance reception in "mixed" areas. Same design as "Stereo-tron" but without amplifier. Will easily pull in signal from 175 miles. GOLD ANODIZED.

#### FM 3T "TURNSTILE"

Popular for close-in reception—non-directional. Has offset mount for easy installation on same mast as TV antenna. GOLD ANODIZED. Model FM 3T \$12.50

#### FM 3A "TURNSTILE"

Same as model FM 3T, but includes complete installation: antenna, mast, universal roof mount, lead-in wire. Install it yourself in minutes. GOLD ANODIZED. FM 3A \$18.95

#### ECONOMY MODELS

K 2 FM—5 element, K 2 FM—For strong directional yagi for signal areas. Compact "pearl ring" area, best, sturdy. \$5.05 \$13.80

For free technical bulletins, write today

# Winegard

ANTENNA SYSTEMS

3009-4F Kirkwood St., Burlington, Iowa

Originators of GOLD ANODIZED TV and FM antennas  
Makers of the World Famous Color-Captor TV antenna

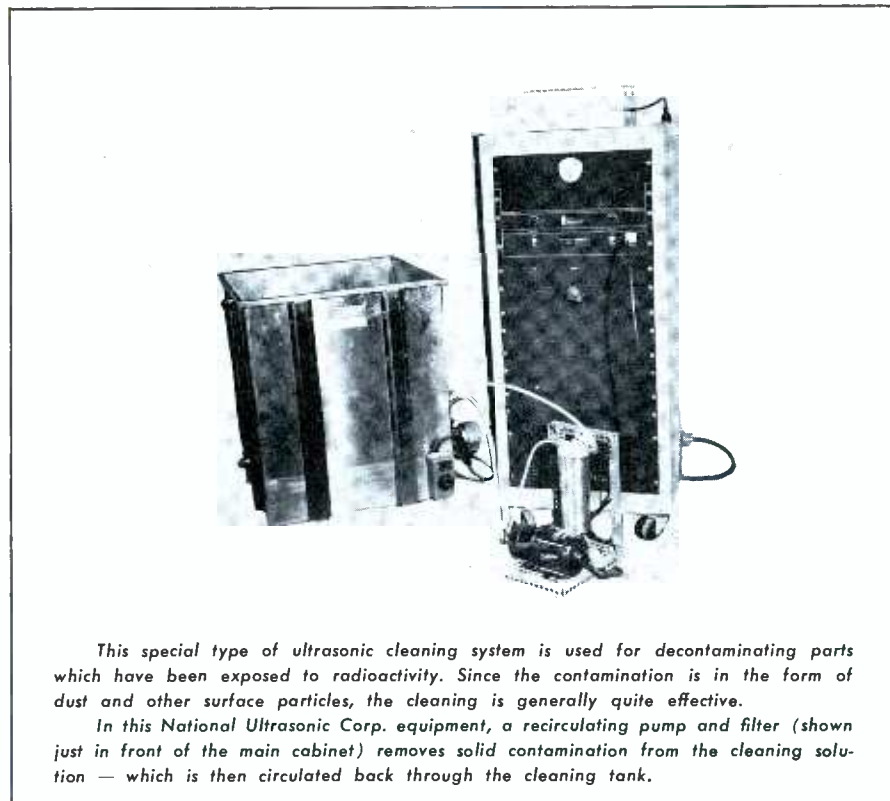

This special type of ultrasonic cleaning system is used for decontaminating parts which have been exposed to radioactivity. Since the contamination is in the form of dust and other surface particles, the cleaning is generally quite effective.

In this National Ultrasonic Corp. equipment, a recirculating pump and filter (shown just in front of the main cabinet) removes solid contamination from the cleaning solution — which is then circulated back through the cleaning tank.

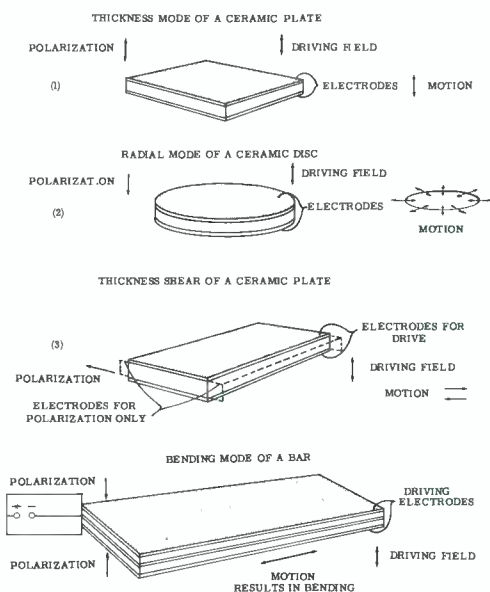

Fig. 4. Piezoelectric effect in several differently shaped ceramic plates.

provide uniform intensity throughout the liquid.

Hermetically sealed cans, with barium titanate ceramic transducers permanently mounted inside, are placed at the bottom or mounted on the sides of the tank used for cleaning. For high-power cleaning units, the transducers are usually used in multiples to cover large areas.

#### Magnetostrictive Generator

When a rod or piece of tubing made of a magnetostrictive material is brought into a magnetic field which is parallel to its length, this length is changed slightly. The change is independent of the direction of the magnetic field and may be either an increase or decrease, depending upon the nature of the material, its previous treatment, the degree to which it was previously magnetized, and the temperature (Fig. 5).

The Joule effect (magnetostriction) can be illustrated by this simple experiment. If an unmagnetized steel bar is inserted into the coil when switch S is closed, wattmeter W will indicate the power applied to the electromagnet. The power input can be increased by adjusting R to place less resistance in the circuit, and vice versa. If the length of the bar is measured with a micrometer, it will be found to be shortest when maximum power is applied.

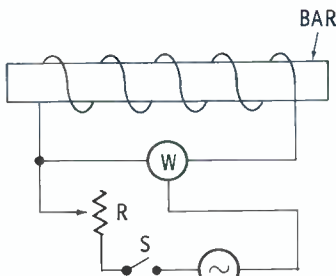



**NEED A 110 V.  
A. C. OUTLET?**

**IN CAR, BOAT OR TRUCK,  
YOU HAVE IT WITH A**

## terado POWER CONVERTER

Actually gives you 110 volt, 60 cycle A.C. from your 6 or 12 volt D.C. battery! Plug converter into cigarette lighter, and operate lights, electric shavers, record players, electric tools, portable TV, radios, testing equipment etc.

Models from 15 to 300 watts, priced as low as **\$12.95** LIST

See Your Electronics Parts Jobber, or Write:

**terado COMPANY**  
1073 RAYMOND AVE  
ST. PAUL 8, MINN  
In Canada, ATLAS RADIO CORP. LTD. — Toronto, Ont.

**Ask By Name For  
GENUINE**

your assurance of brand name quality

### "NO NOISE" PRODUCTS

No-Noise **VOLUME CONTROL** and Contact Restorer  
• Cleans • Lubricates • Protects  
Not a Carbon Test Solution  
2 Oz. Bottle **\$1.00** Net to Servicemen  
6 Oz. Spray Can **\$2.25** Net to Servicemen



No-Noise **TUNER-TONIC**  
with PERMA-FILM  
• Cleans, lubricates, restores all tuners, including wafer type  
• Non-toxic, non-inflammable  
• For TV, radio and FM use  
• Economical—a little does a lot.  
6 oz. Aerosol **\$3.25** Net to Servicemen

**FREE**

with each can of **ELECTRONIC CHEMICAL** products—**5" PLASTIC EXTENDER**

Push Button Assembly For Pin Point Applications—Does Not Cause Shorts



Electronic Chemical new formula **EC-44** Lubricates, conditions, cleans all electrical contacts. Economical—a little does a lot! 6 oz. spray can **\$3.50**

**ELECTRONIC CHEMICAL CORP.**  
813 Communipaw Avenue Jersey City 4, N. J.

This phenomenon of magnetostriction is also known as the "Joule effect," after its discoverer, J. P. Joule. The change in length of the material is relatively small—on the order of one part in a million.

When a magnetostrictive material such as nickel is introduced into an alternating magnetic field, it is periodically shortened and lengthened by the magnetostrictive effect. Since this change in length is independent of the direction of the magnetic field (if the rod has not been previously magnetized), it will vibrate at double the frequency of the alternating magnetic field. However, if it has been premagnetized, the mechanical change in length will be in phase with the frequency of the magnetizing current. The amplitude of oscillation will be maximum whenever there is resonance between the natural frequency of the rod and the frequency of the magnetizing current. Sound waves of the

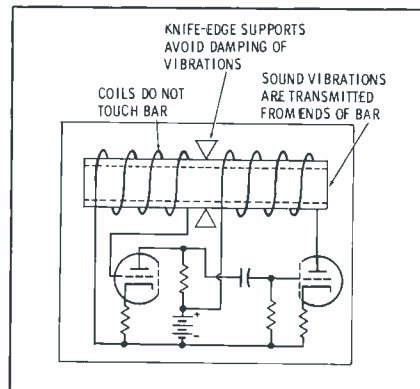

Fig. 6. Basic Pierce oscillator circuit with a magnetostrictive transducer.

same frequency will then be transmitted from the end of the rod.

The Pierce oscillator shown in Fig. 6 can be used to generate ultrasonic frequencies. Pure nickel and various nickel alloys give good results when used in rods and tubes.

This apparatus is considerably different from a piezoelectric transducer, and yet the end product is the same—"clean sound." ▲

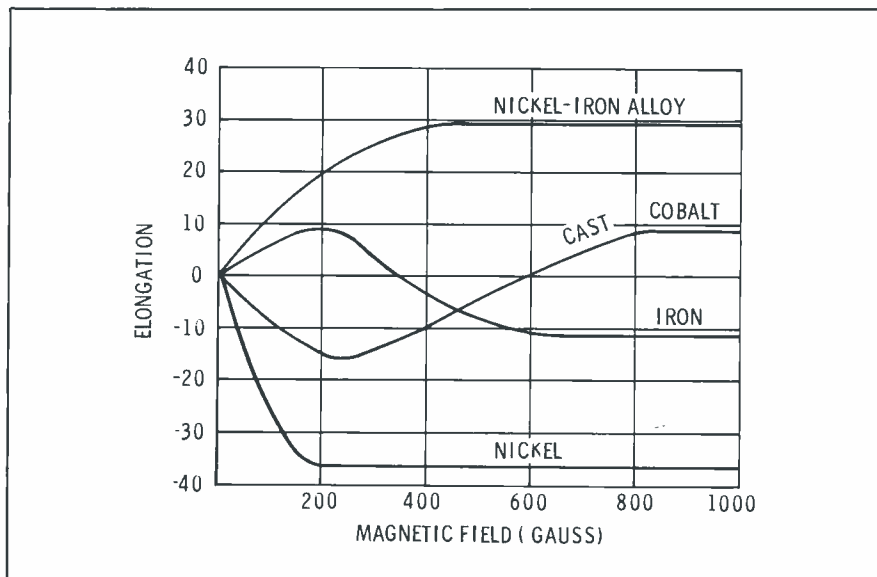

Fig. 5. Magnetostrictive changes in rod length with increased flux density.

## PRECISION TUNER SERVICE

P. O. BOX 272  
1200 S. WALNUT ST.  
BLOOMINGTON, IND. EDISON 99653

**7.50**  
V or U  
**COMBO PLUS**  
**9.95 POSTAGE**

6 MONTH WARRANTY



All Types T.V. Tuners Cleaned, Repaired and Aligned to Factory Specifications. Same day in shop service on most Tuners. Price Includes Minor Parts, Major Parts at Cost Price. We use Original Parts if possible. State Make Model and Enclose all Parts and Tubes. Pack Well and Insure.

ALSO HAVE LARGE STOCK OF EXCHANGE TUNERS, WRITE FOR TYPES AND PRICES.

NOW! ONE SOURCE TO BUY FROM... ONE NAME

TO SELL — ELECTRO-VOICE!

**300**  
**EXACT**  
**REPLACEMENT**  
**NEEDLES**

Complete line  
to fill every need

**150**  
**EXACT**  
**REPLACEMENT**  
**CARTRIDGES**

for every modern type,  
every major brand

90 replaceable-needle  
cartridges

60 plug-in, permanent-  
needle cartridges

**THE**  
**INDUSTRY'S**  
**ONLY COMPLETE**  
**"LOOK-ALIKE" LINE**  
**OF BOTH**  
**NEEDLES AND**  
**CARTRIDGES!**



Here, at last! The industry's first complete line of both needles and cartridges of every type! Not just a few general-purpose models, but exact type-for-type, model-for-model, "look-alike" replacements for every modern type, every major brand!

It's the greatest merchandising break-through since needles and cartridges became "big business." And only Electro-Voice, with over 35 years experience in electro-acoustics exclusively, could accomplish it.

What an opportunity for you to consolidate your inventory! . . . to step-up sales through instant, convenient service! . . . and enjoy complete coverage of your entire cartridge and replacement-needle requirements from one source. Saves time, money . . . simplifies inventory . . . and speeds your ordering. And complete cross-reference catalogs, wall charts and guides make needle or cartridge selection quick and positive!

 Your E-V distributor is now stocking the complete E-V needle and cartridge line. Ask him for your FREE cross-reference guides or write today for literature.

**ELECTRO-VOICE, INC..**  
Needles & Cartridge Div., Dept. 427-R  
Buchanan, Michigan

**Electro-Voice®**

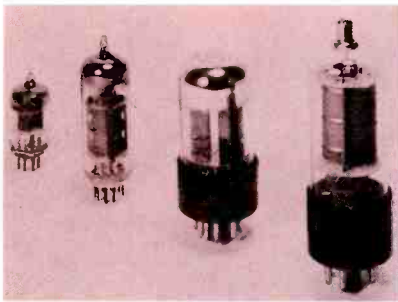

# DEVELOP YOUR OWN TUBE-TEST DATA

by  
W. E. Burke

The ingredients: Basing diagrams, a few key tube specifications, and knowledge of tester-control functions.

Don't sit there and just wish you could test that new tube type—do it! A reliable system can be developed for almost any tester.

With the multitude of new tubes being developed almost daily, you're bound to run across a type you don't have setup data for, no matter how new your tester is. Although

some tester manufacturers make new setup data available as often as every month, there are still times when the information you need is not immediately at hand. The problem can be minimized if you know your tester and how to figure out appropriate test settings.

Even in equipment so new that

regular service information is not yet available, a good serviceman can determine circuit connections by checking under the chassis and, by measuring voltages and resistances, determine approximately where a trouble exists. If a tube is suspect and your tester does not have settings for that tube, what do you do?

**Table I—Voltage and Current Ratings of Tube Heaters**

Prefix	V/MA	Prefix	V/MA	Prefix	V/MA	Prefix	V/MA	Prefix	V/MA		
1	1.2	5	4.7/600	11	10.9/450	19	18.9/150	32	32.0/100		
	1.25		5.0		11.0/450		18.9/300		34	34.0	
	1.4		5.2/600	12	11.6/450		18.9/600	35		35.0	
	1.5		5.6/450		12.6		19.0/100		36	36.0	
	2.0				13		12.8/600			19.0/300	38
2	1.75	6	6.3	14		14.0/100	20	20.0/100	40	40.0/100	
	2.0		6.3		14.0/150	21.5		45		45.0	
	2.1/450	7	6.3	15	14.8/450	21	25.0		50	50.0	
	2.3/600		7.0/300		15.0/150		22	22.4/450		55	55.0
	2.35/600		7.2/300		15.0/300			25.0			25
2.4/600	7.3/600	15.0/600	16	16.0/300	26	26.5	70	70.0			
2.5	7.3/300	16.4/600		16.5/300		17		16.8/150	27	27.0	117
3	2.8	8	7.9/600	18	18.0/100		30	30.0/150			
	2.8/450		8.0/300		18.0/300	30.0/300					
	2.9/450		8.0/600	17.0/100	31	31.0/100					
	3.0/450		8.2/600	17.0/300		31.5/300					
	3.1/450		8.4/300	17.0/600							
3.15	8.4/450	17.5/150									
3.15/600	8.4/600										
3.2/450	9	9.0/300	17	16.8/450	30	30.0/150					
3.3		9.0/600		17.0/100		31	31.0/100				
3.4/600		9.4	17.0/300	31.5/300							
3.6/600		9.4/300	17.0/600								
4		3.8/300	9.4/600	18	18.0/100						
	4.0	9.45/300	18.0/300								
	4.0/300	9.5/300	18.5/300								
	4.0/600	10	9.7/600								
	4.2/300		10.5/300								
4.2/450	10.5/450										
4.2/600	10.5/600										
4.4/450	10.6/450										
4.5/300											
4.5/600											
4.6/600											

NOTE: "Prefix" denotes digits ahead of letters in tube type number. Current ratings are given only for tubes specially designed for series-string operation.

# exclusive in PHOTOFACT the world's finest electronic service data

**famous Howard W. Sams CIRCUITRACE® and SERVICING AIDS!**

handiest, most-complete data ever published to speed and simplify servicing—  
equally useful for troubleshooting in the home or on the bench...

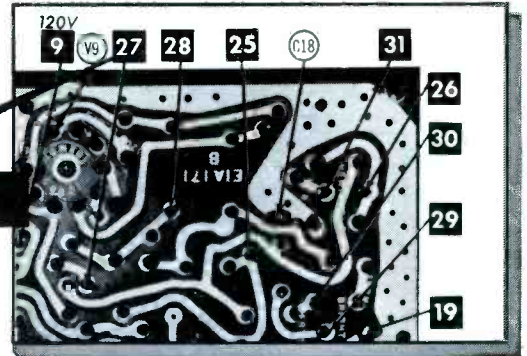
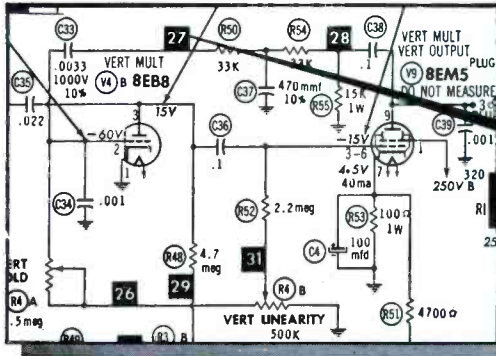

## CIRCUITRACE®

exclusive Sams standardized, uniform system for fastest, easiest printed board troubleshooting...

**Here's how CircuitTrace works:** All test points are clearly shown on the schematic and each is plainly coded (see illustration at left). The same test points are similarly coded on the printed board photo (see illustration at right) so you instantly know where to make your

measurement! No more costly hunting for test points... no more guesswork... no need to look at both sides of the board—identifies tubes, transistors, and foil connections of parts throughout circuits. CircuitTrace makes printed board servicing a breeze!

## TIME-SAVING SERVICE AIDS for field or shop

### FIELD SERVICING NOTES

#### SAFETY GLASS REMOVAL (MODEL KC366)

Remove 4 screws holding the trim strip at the top of the safety glass. Tilt glass out and remove.

#### FUSE AND FUSE DEVICE

TV: Sweep - 1/2 Amp. (M1)  
LV Supply - Fuse Wire (M2)  
Filament - Fuse Wire (M3)  
See "Tube..."

Radial

Valuable instructions for making all necessary adjustments in the home, locating fuses, removing safety glass, etc.

### TUBE PLACEMENT CHARTS

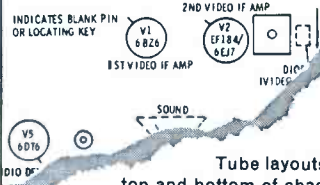

Tube layouts of top and bottom of chassis show sync and sound paths, tube keyways, fuses, rectifiers, etc. Helps you trace signal path to localize the trouble.

### TUBE FAILURE CHECK CHART

**POWER SUPPLY FAILURE**  
No raster, no sound Fuse Wire (LV Power), Fuse Wire (M2)

**SWEEP FAILURE**  
No raster, has sound Fuse (Sweep), V8, V9, V10, No vertical deflection V7  
Poor vert. linearity or foldover V7  
Poor horiz. linearity or foldover V8, V9, V10  
Narrow picture V8, V9, V10  
Vert. sync failure V8, V9, V10

Points out probable causes of common troubles, tells you which tubes to replace to correct the symptom. Also shows series-string filament connections.

### DISASSEMBLY INSTRUCTIONS

#### TV CHASSIS REMOVAL

1. Remove 10 push-on type knobs
2. Remove 12 wood screws in

You get step-by-step procedure for removing chassis, CRT, speakers, knobs, hidden bolts and connections. Avoids parts damage—saves valuable time.

### HORIZONTAL SWEEP CIRCUIT ADJUSTMENTS

Set the Horizontal Hold Control to Horizontal Frequency Slug (B1) tally. Keep turning B1 in the out of sync. Reverse the

Detailed instructions help you solve the troublesome problem of adjusting the horizontal circuits (oscillator, linearity, and width)—avoids guesswork!

These are just a few of the dozens of great features in PHOTOFACT for fastest, easiest, most profitable servicing. See your Sams Distributor for full details on an Easy Buy Library or Standing Order subscription!

## Are You Enjoying the Benefits of Membership in "PEET"?

Join the thousands who have qualified and profited by membership in the "PEET" Program. If you now own a PHOTOFACT Library or plan to own one, you can apply for membership. It's the *only* program designed to build powerful public acceptance for you, which means increased business and profits. You get dozens of free promotional aids. Benefits cost you absolutely nothing if you qualify. Ask your Sams Distributor for the "PEET" details or mail coupon today.



Powerful national advertising monthly in TV Guide now carries the "PEET" message to over 8,000,000 TV families, building dynamic support and demand for the services of "PEET" members. Now more than ever it pays to qualify as a "PEET" member!

## HOWARD W. SAMS & CO., INC.

Howard W. Sams & Co., Inc., Dept. 7-D2  
1724 E. 38th St., Indianapolis 6, Ind.

- Send me full details on how I can qualify as a member in the "PEET" Program.
- Send Free Photofact Cumulative Index

Shop Name \_\_\_\_\_

Attn.: \_\_\_\_\_

Address: \_\_\_\_\_

City \_\_\_\_\_ Zone \_\_\_\_\_ State \_\_\_\_\_

**Mr. Service Dealer....**

**the "MERIT" Line is**

**Your Line.....**

**and we constantly strive to keep it up to date. Any suggestions will be welcome. Drop us a line and we'll mail you a new MERIT PENCIL HOLDER with our compliments.**

**COIL & TRANSFORMER CORPORATION**

MERIT PLAZA - HOLLYWOOD, FLORIDA

You might run to the distributor and ask for a tube of that type. But suppose the tube is too new and he doesn't have it in stock—what do you do next?

If you do have service information on the chassis you are servicing, consult the schematic to see if there are any alternate tubes listed. Also check to see if the tube is listed in one of the available tube-substitution handbooks. If no substitute can be found, you have to start determining how to test the tube in your tester. Some of the requirements for this are several good, complete tube manuals, up-to-date tube-information releases, and the instruction manual for your tester.

Start by comparing the suspect tube with some of the older types used in the same stage or circuit in older equipment. Suppose the trouble lies in a video IF stage. Now, the major improvements in IF amplifiers over the years have been in lowered interelectrode capacitances and increased transconductance. Since capacitances aren't measured on a service-type tube tester, the change in transconductance and a possible change of basing connections are all you really have to consider. The basing can be determined by inspection of the under-chassis wiring. If yours is an emission-type tester, the changed transconductance doesn't matter. An emission tester checks all tubes as diodes, so if you test the suspect tube with settings for an older but similar tube type, a fair test can be made. If you have a transconductance tester, you will have to determine new settings for the tube; we will soon see how this can be done.

If your suspect is a vertical or horizontal output tube, just remember that improvements in these tubes haven't been drastic as far as tube testers are concerned. The major improvements in these pulse amplifiers have been an increase in the peak positive plate voltage the tube can tolerate, an increase in maximum pulse cathode current, and an increase in the plate-to-screen current ratio.

With tubes for other circuits in entertainment-type equipment, the principal new improvements have been increased heater-to-cathode voltages, changes in filament voltage



ANOTHER **PRECISION**  
SERVICE TIP FOR YOU.

# PRECISION PETE

"A CASE OF  
DOUBLE TROUBLE!"

WELL, JUST ONE MORE CALL TO MAKE TONIGHT. HOPE MY PORTABLE **PRECISION CR-60** CRT PICTURE TUBE TESTER AND REJUVENATOR CUTS THIS ONE SHORT.

EVENING, MISS DORA. HELLO, MISS FLORA. WHAT SEEMS TO BE THE TROUBLE?

THE PICTURE ON MY PORTABLE IS SO DARK, I CAN'T TELL THE COWBOYS FROM THE INDIANS!

AND ON MY COLOR SET, THE PICTURE IS DIM, TOO.

MMM...THE METER ON THE **CR-60** READS BAD. A BOOSTER MAY HELP. WITH THE **CR-60**, I CAN INCREASE AC HEATER VOLTAGE TO SIMULATE A BOOSTER

I'M SORRY, THE METER STILL READS "BAD" AND EVEN TRYING TO REJUVENATE DOESN'T HELP. YOU'LL NEED A NEW PICTURE TUBE.

OH, DEAR! ARE YOU SURE?

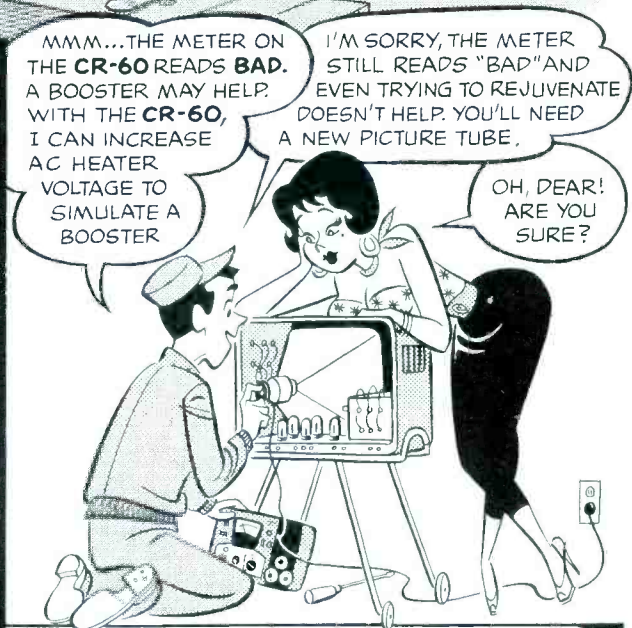

YES, YOU SEE, THE **PRECISION CR-60** IS THE ONLY TESTER OF ITS KIND TODAY THAT NOT ONLY TELLS ME IF A "BOOSTER" WILL SOLVE THE PROBLEM, BUT ALSO LETS ME CHECK FOR TUBE BRIGHTNESS UNDER HIGH OR LOW LINE-VOLTAGE CONDITIONS.

PETE, WHAT ABOUT THE DIM PICTURE ON MY COLOR SET?

WELL, THE PICTURE TUBE IS FINE, SO THIS DIMNESS MUST BE DUE TO SOME OTHER CONDITION. PROBABLY IN THE CHASSIS. WHEN I COME BACK TOMORROW WITH YOUR NEW TUBE, DORA, I'LL BRING MY **PRECISION** COLOR TEST EQUIPMENT TO FIND THE TROUBLE.

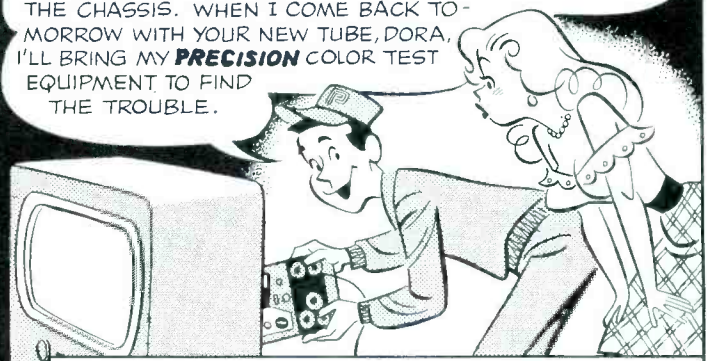
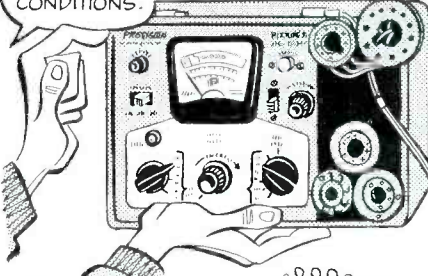

OH, PETE! YOU'RE WONDERFUL! WE'LL SEE YOU TOMORROW.

THAT'S ONE CALL-BACK I'M GOING TO ENJOY, THANKS TO **PRECISION'S CR-60** CRT TESTER AND REJUVENATOR.

**SERVICEMEN:** QUICKER SERVICE WITH THE **CR-60** ELIMINATES MANY CALL-BACKS, SAVES TIME AND EARNS YOU MORE PROFIT. FOR MORE SERVICE TIPS WITH THE **CR-60** (DEALER NET \$64.95), WRITE FOR BULLETIN #100. **IT'S FREE!**

## PRECISION APPARATUS CO., INC.

70-31 84th STREET—GLENDALE 27, N.Y.

ALL PRECISION TEST EQUIPMENT IS GUARANTEED FOR ONE FULL YEAR AND BACKED BY OVER 30 YEARS OF ELECTRONIC EXPERIENCE.





**PLANET**

SIZE:  
1/4" x 7/8"

PLANET  
CAPACITORS  
"Engineered for Quality"

## TRANSISTOR LYTICAPS

### TYPE "TL"

**TYPE "TL"** . . . Sub-miniature aluminum foil capacitors . . . hermetically sealed in aluminum tubes . . . clear plastic outer insulating sleeves . . . all mechanical internal connections . . . no "cold weld" nor "pressure" connections . . . engineered for quality for replacement in all transistorized circuits.

Write today for complete information.

## PLANET SALES CORPORATION

225 Belleville Avenue      Bloomfield, New Jersey

and/or current characteristics for use in series filament strings, combinations of two or more tubes in one envelope, and changes of base-pin arrangements for circuit convenience.

There once was a day when tubes had either a 2.5-, 5-, or 6-3-volt heater. Those days are gone forever! Now heater voltages range from .625 volts to 117 volts, with a total of 89 different voltages. Table I shows how many different voltage-current combinations are represented by the prefix (first one or two digits) in the type numbers of existing tubes. The filament-voltage selector on your tester may not provide all of the needed voltages, but will come close enough in most cases.

An additional hint for determining filament voltages is to check the other tubes in series strings. They may be older tubes, and you can look them up in a tube manual and find the filament current. This same current rating will apply to the unknown tube, and you can use this information to help locate the exact filament voltage in Table I. Also check to see if the tube in question is on your tester's chart under a different filament voltage. For instance, the 6EH7 is also manufactured as a 3EH7 and a 4EH7. Every control setting, except for the filament voltage, is the same for all tubes of this group.

Tube designers have been going all out to help the equipment designer in his fight to reduce the total number of tubes in a receiver. Combinations of tubes in one envelope such as triode-pentodes, twin pentodes, triode-tetrodes, and triple triodes are becoming more numerous. One tube manufacturer has even announced a tube including both the horizontal output amplifier and the damper in one envelope. This tube, the 6JF8 by Raytheon, would be fairly easy to set up in your tester because the output section is the exact equivalent of the 6DQ6B and the damper section is the exact equivalent of the 6AX4GTB. If you determine the base connections and transpose these to your tester's settings for the 6DQ6B and the 6AX4GTB, the hard work is done.

The rearrangement of base pins of an older tube to produce a new tube requires that a new type num-

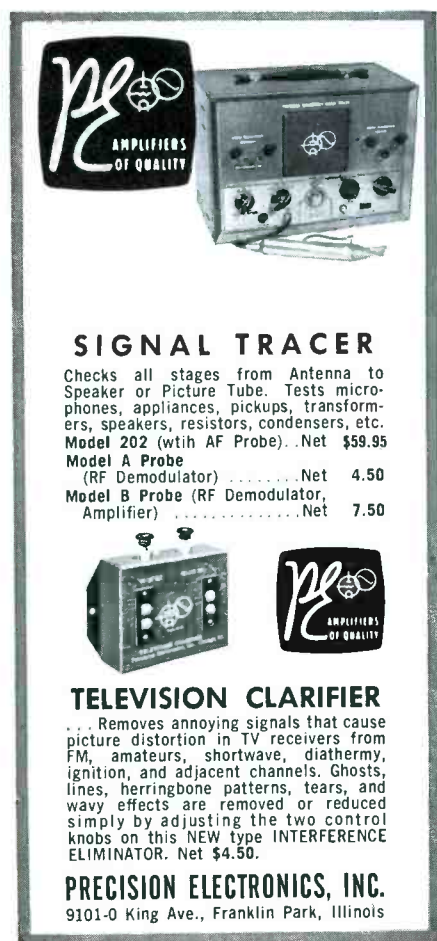

**pe**  
AMPLIFIERS OF QUALITY

### SIGNAL TRACER

Checks all stages from Antenna to Speaker or Picture Tube. Tests microphones, appliances, pickups, transformers, speakers, resistors, condensers, etc. Model 202 (with AF Probe). Net \$59.95

Model A Probe (RF Demodulator) . . . . . Net 4.50  
Model B Probe (RF Demodulator, Amplifier) . . . . . Net 7.50

### TELEVISION CLARIFIER

. . . Removes annoying signals that cause picture distortion in TV receivers from FM, amateurs, shortwave, diathermy, ignition, and adjacent channels. Ghosts, lines, herringbone patterns, tears, and wavy effects are removed or reduced simply by adjusting the two control knobs on this NEW type INTERFERENCE ELIMINATOR. Net \$4.50.

**PRECISION ELECTRONICS, INC.**  
9101-0 King Ave., Franklin Park, Illinois



ON OFF

Turn ON the QUIET  
Turn OFF the NOISE

with **QUIETROLE** . . .

The quality, proved lubricant for effective silencing of noisy controls and switches on TV, radio and electronics instruments. And the FREE EXTENDER TUBE makes those once pesky places easy to reach. Put quality QUIETROLE in your repair kit and see how quickly and easily you satisfy more of your customers.

6 Oz. SPRAY PACK CAN (with FREE Extender Tube)

2, 4, 8 oz. Bottles (with Dropper)

Product of **QUIETROLE** COMPANY  
Spartanburg, South Carolina  
in Canada: CROSS CANADA ELECTRONICS  
12 Laurel Street, Waterloo, Ontario

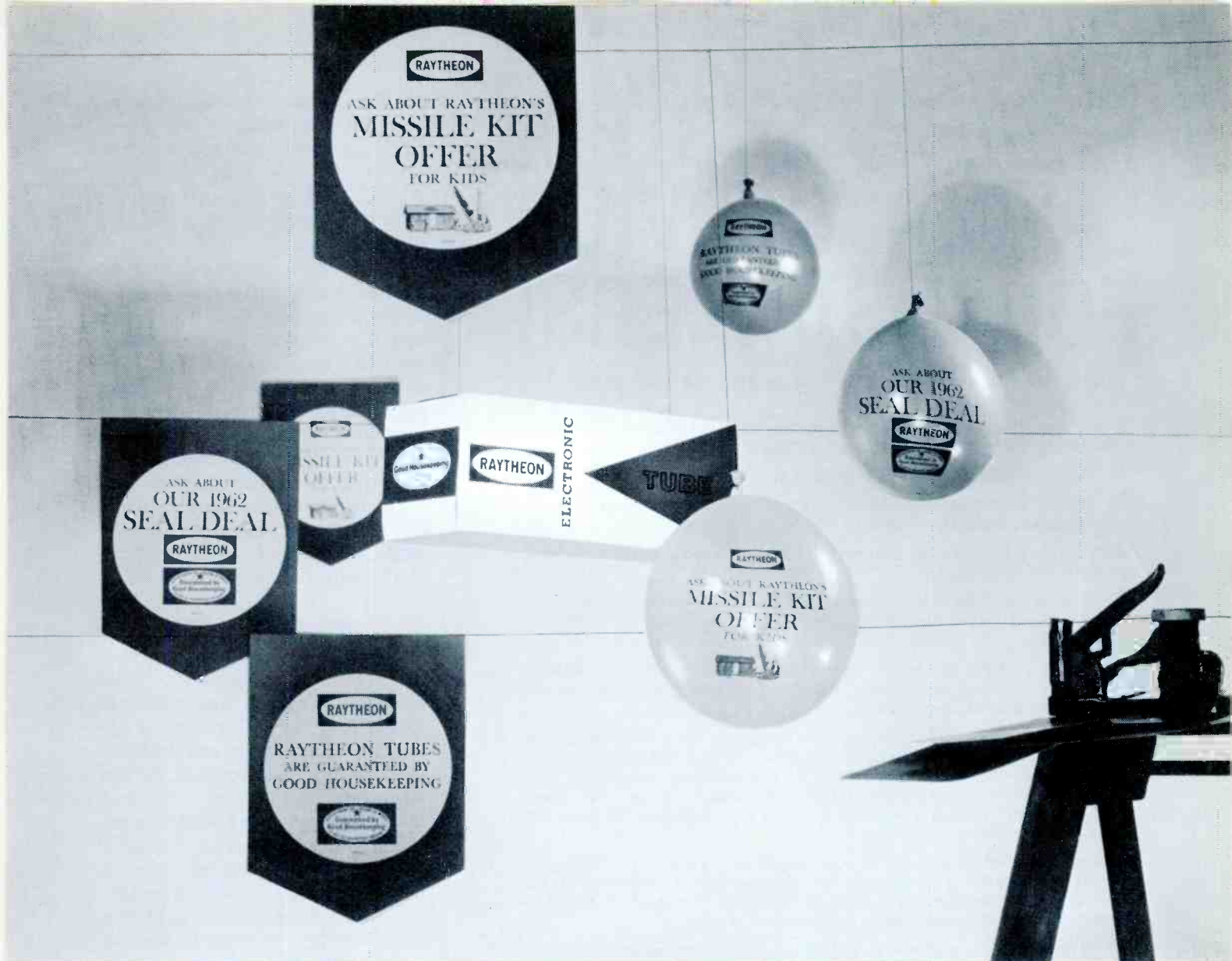

## "Dress Up" and Cash in on Raytheon's Good Housekeeping Seal Promotion

Good Housekeeping's famous Guaranty Seal — trusted buy-sign with families all over America — is now carried on every Raytheon receiving and picture tube. And families have extra faith in the service dealer who uses Good Housekeeping-backed Raytheon tubes.

We're advertising continuously — with full-page ads — to more than 5 million Good Housekeeping readers. So get set to boost your own prestige and profits . . . by telling your customers you give them this extra protection provided by the Good Housekeeping Seal.

We've prepared a colorful, hard-hitting promotional program to help you. Wire hangers, balloons, to dress up your place of business . . . repair labels and many other eye-catching items. A complete, business building promotion! Sound good? See your Raytheon Distributor Salesman, or mail this coupon with your name and address today.

**RAYTHEON, Box 666**  
Distributor Products Division  
Westwood, Massachusetts

*Send Me Details On How I Can Profitably Tie In with Raytheon's Seal Deal Promotion.*

Name \_\_\_\_\_

Store Name \_\_\_\_\_

Address \_\_\_\_\_

City \_\_\_\_\_ Zone \_\_\_\_\_ State \_\_\_\_\_

DISTRIBUTOR PRODUCTS DIVISION

Westwood, Massachusetts



# FREE TV SYSTEM LAYOUT SERVICE FOR INSTALLERS!

(Another Blonder-Tongue Service to increase your profits.)

If you are now enjoying profits from the lucrative Master TV system installation field, this *free* Blonder-Tongue service will help you:

1. Provide the system that is best for a specific installation.
2. Provide a system that combines top performance with sensible price so that you can bid competitively.
3. Provide a system with provision for future expansion for additional profits in the future.
4. Provide a system that is most practical and easy to install by taking into consideration the type of construction and conditions under which it will operate.

If you're a qualified technician who is not participating in the profitable master TV installation business, Blonder-Tongue's free layout service can get you off to a successful start.

What's more, Blonder-Tongue not only helps you with technical assistance, but also provides you with the world's only matched and integrated line of master TV, CCTV, CATV, and ETV Equipment (amplifiers, converters, CCTV cameras and monitors, distribution accessories). Each product is designed to do a specific job — yet each is matched to bring out the best in the others.

Motels, hotels, schools, trailer courts, hospitals — even private homes — represent big master TV business. Get your share. Take advantage of this Blonder-Tongue service — Free System layout. And remember, Blonder-Tongue does not compete with its customers.

For information on our Free System Layout service and free 28-page installation planning manual write: Dept. PF-4

engineered and manufactured by

**BLONDER-TONGUE**  
9 Alling St., Newark, N. J.

Canadian Div.: Benco Television Assoc., Toronto  
Export: Rocke Int'l. Corp., N. Y. 16, N. Y.—CABLES: ARLAB



ber be assigned. This has been occurring with some of the newer tubes and poses only one problem. Which old tube was revamped? Again, compare the new tube to older tubes used in the same type of circuit.

For instance, the 18FW6 is new enough that it may not be on your tester chart. It is also old enough that it is in many tube manuals. If you were to compare the specifications of the 18FW6 with those of the 12BA6, you would find that they are identical with the exception of the filament voltage and current. Likewise, the 18FX6 and the 18FY6 are identical to the 12BE6 and the 12AV6 other than the filaments. Many other tubes that are related in this way can be found.

## Types of Tube Testers

The most basic of all tube testers is the emission type. All electrodes except the cathode are connected to the plate, an AC voltage is applied between plate and cathode, and the resultant rectified current is measured by a meter. The main difference in settings (other than pin connections and filament voltages), between two different tube types is the adjustment of what is usually called a LOAD, SHUNT, or PLATE CONTROL. This is a variable resistor, in series with the applied voltage, which limits the current and calibrates the meter.

When attempting to calibrate a new tube on such a tester, you must determine where to set this LOAD control. The appropriate procedure is to compare the settings for several tubes of the same general type and obtain an average setting of this control. For instance, several different types of horizontal output tubes may require LOAD settings that vary between 81 and 96 on your tester. If you make your new setting about 89, you will be very close. Several different IF amplifiers may require settings between 28 and 46, and a setting of 37 should do the job. Remember, of course, that you will have to judge the resultant meter reading on this basis. It may be slightly lower or higher than the nominal 100% value, depending on the LOAD control setting.

In a transconductance tester, appropriate AC and DC voltages are

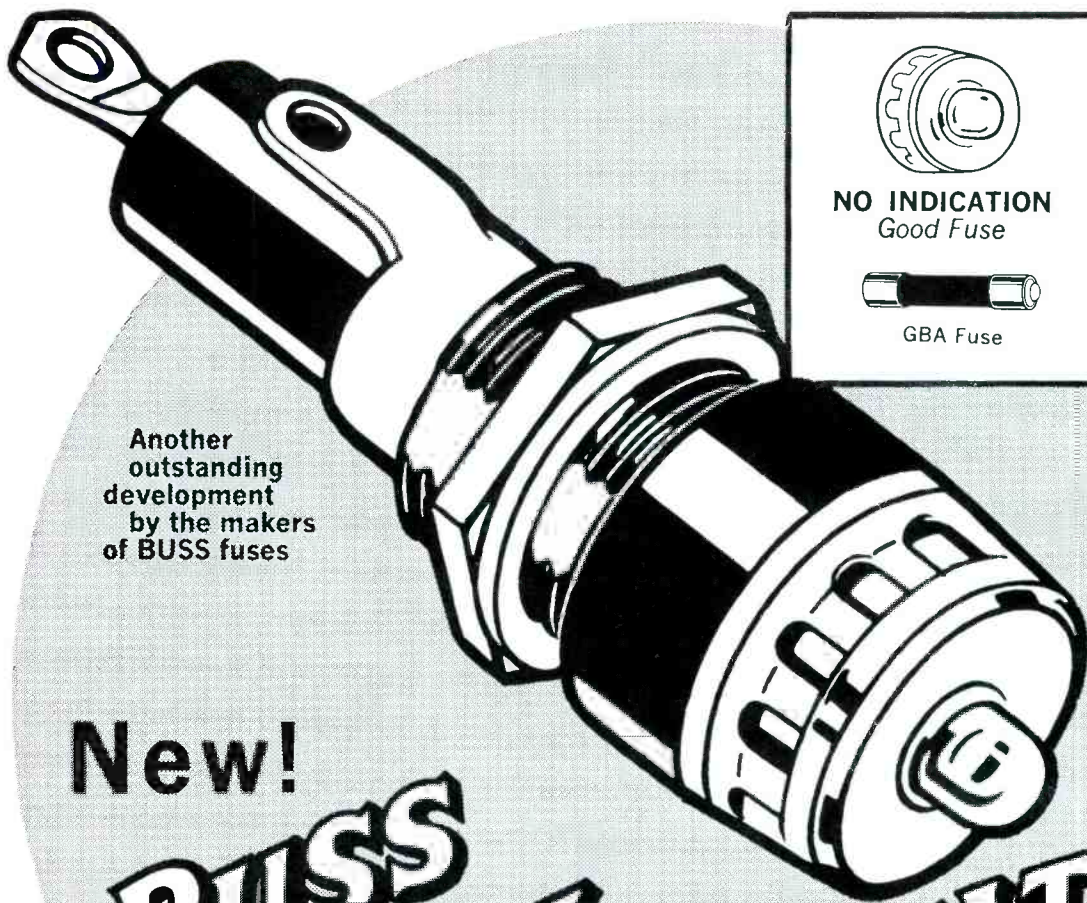

Another outstanding development by the makers of BUSS fuses

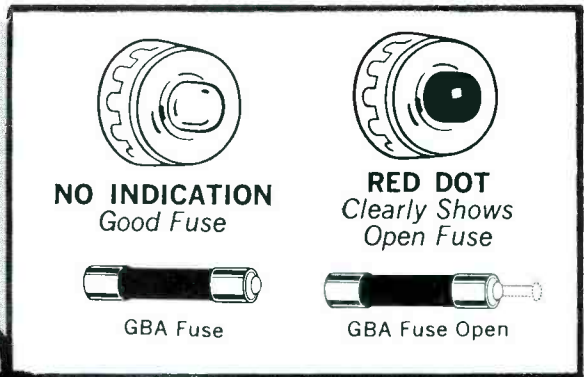

# New! BUSS VISUAL INDICATING

## HLD Fuseholders and GBA Fuses...

*for all types of electrical and electronic equipment*

New BUSS fuse and holder combination provides quick, positive, visual identification of faulted circuit.

When the fuse opens, an indicating pin pops out of fuse into transparent knob of holder. Head of pin is red. It is clearly visible and makes it easy to spot open circuit, even after power is off.

BUSS HLD fuseholders are for panel mounting in circuits of 125 volts or less. They take 1/4 x 1 1/4 inch BUSS

GBA fuses. Knob of holder grips fuse tightly and pulls fuse from holder when knob is removed.

Side terminal is held mechanically as well as by solder. Heat of soldering cannot cause it to loosen or come off.

Vibration will not cause failure of terminals as they are designed to withstand severe service.

Get the full story, write for **BUSS Bulletin SFH-9.**

**BUSS: The complete line of fuses and fuse mountings of unquestioned high quality.**

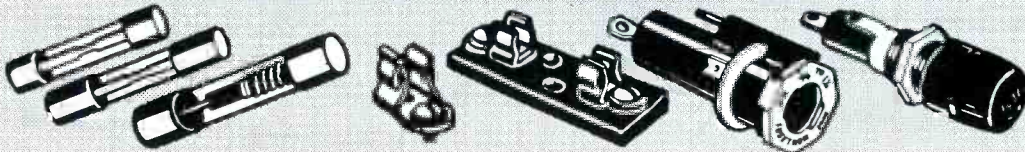

**BUSSMANN MFG. DIVISION**  
McGraw-Edison Co.  
St. Louis 7, Mo.



Fig. 1. Rotary switches for setting up elements on transconductance tester.

applied to all elements, and the AC plate current resulting from an applied AC grid voltage is measured. More controls and switches must be properly positioned to obtain an accurate reading with this type of tester. The majority of transconductance testers provide a plate-voltage switch, a variable meter-shunt control, and a grid-voltage control. Studying the tube manual data and tester instruction book will enable you to determine what plate voltage to apply, the setting of the meter-shunt control, and the proper grid voltage.

#### Types of Switching for Various Pin Connections

The types of switching used in service-type tube testers include ro-

tary switches as in Fig. 1, lever switches as in Fig. 2, and push-button switches as in Fig. 3.

Rotary switches, when used, are inserted into the circuit function to be switched, and each switch position corresponds to a certain socket pin. The tester panel shown in Fig. 1 has seven rotary switches—one for each side of the filament and one each for the control grid, plate, screen-grid, cathode, and suppressor circuits. Switches of this type are usually interlocked so that one socket pin cannot be connected to more than one circuit. For example, if the grid switch is set at pin 5, this pin is disconnected from all the other switches. Accidental shorts that might damage the tube tester are thereby prevented.

When lever switches are used, one switch is provided for each socket pin, and the different switch positions correspond to the circuit function. The tester panel in Fig. 2A has twelve lever switches, each of which can be set in five positions labeled W, X, Y, Z and NORMAL. As explained in the in-

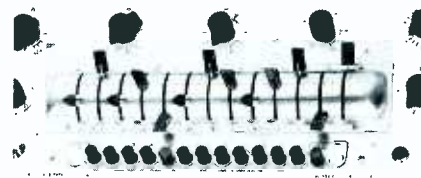

(A) With five positions.

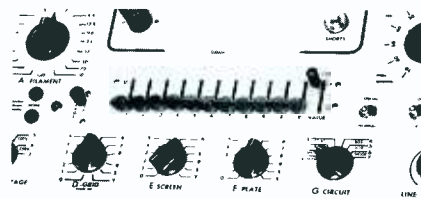

(B) With three positions.

Fig. 2. Tube-element lever switches.

struction manual accompanying this particular tester, these positions correspond respectively to open, screen-grid, plate, control-grid, and cathode connections.

Emission testers having lever switches will usually have only three positions for each lever switch. These are: one position for all elements other than the filament and cathode, one position for the high or "hot" side of the filament, and one position for the cathode and

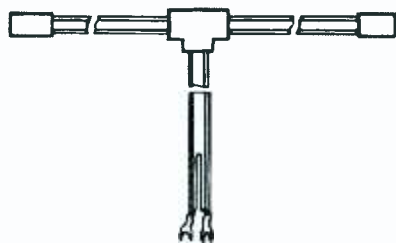

this...

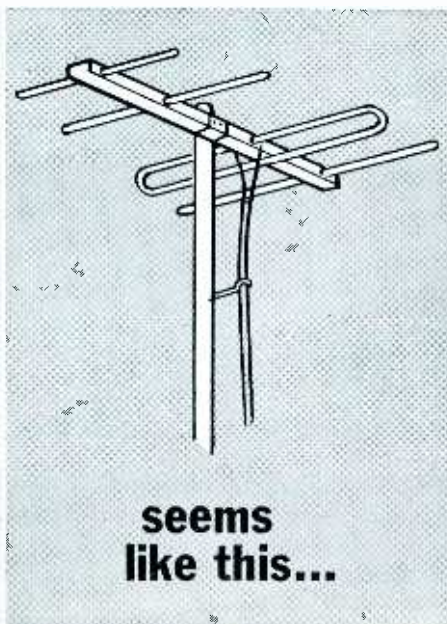

seems like this...



when you use this!

## Fisher FM tuners are the world's most sensitive.

A simple under-the-rug dipole will seem to perform like a multi-element Yagi when there's a Fisher tuner at the end of the lead-in. Even the least sensitive of the new Fisher FM Stereo tuners with built-in Multiplex needs no more than 0.7 microvolts for 20 db quieting (2.2 microvolts IHFM); the most sensitive breaks all records with a 20 db quieting sensitivity of 0.45 microvolts (1.5 microvolts IHFM)! This kind of sensitivity can laugh at weak-signal areas...and makes up the important difference between mono and stereo FM sensitivity requirements with margin to spare. Explain Fisher tuner performance to your next customer with FM reception problems.

— USE THIS COUPON FOR DETAILED INFORMATION —

Fisher Radio Corporation  
21-24 44th Drive, Long Island City 1, N. Y.

Please rush free literature and complete specifications on all Fisher FM Tuners and Receivers.

NAME \_\_\_\_\_

ADDRESS \_\_\_\_\_

CITY \_\_\_\_\_ ZONE \_\_\_\_\_ STATE \_\_\_\_\_

PF-401

the "cold" side of the filament. The tester arrangement shown in Fig. 2B has these three positions—the top for all elements which are tied to the plate, the center for the hot filament pin, and the bottom for the cathode. It is important to note that the levers on this tester are identified by the letters A through K, but that these letters correspond respectively to pin numbers 1 through 9.

The tester shown in Fig. 3 is an example of noncorresponding push buttons. You will notice that the top row of buttons set up the filament and cathode connections. For a 6J5, the chart specifies that buttons 1, 2, and 3 in the top row should be depressed. Now, you know that the filaments of a 6J5 are pins 2 and 7, and that the cathode is pin 8. Obviously, the buttons do not correspond to the pin numbers. Luckily, the instruction book for this model of tester includes a chart showing which pin numbers correspond to which button numbers. For other pushbutton testers which pose this problem, you can make your own chart.

### Limitations in Number of Pins Accommodated

The number of socket pins which a particular tester can accommodate is determined by the number of switches of the lever or push-button type or by the number of positions on switches of the rotary type. Naturally, this is of concern only if you wish to modernize an older tester by adding the newer types of sockets such as the 5- and 7-pin *Nuvistor*, the *Novar*, the 10-pin *noval*, and the 12-pin *Compactron*. If you don't want to redesign your tester, but wish to test these new types of tubes, adapters are available to fit almost every tester having an octal socket.

### Setting Up a New Tube

Instead of supposing an imaginary new tube, let us consider an actual tube—one that is too new to be on your tube-tester chart. A good example is the 16AQ3, a diode intended for damper service. It is being used in a portable receiver with a 114° picture tube. For the last year or so, this set manufacturer has been partial to using the



Fig. 3. Push-button numbers do not correspond to actual pin numbers of tubes. 6AF3 and 12AF3 in portables with 114° sweep circuits. Thus, we are going to compare the new 16AQ3 to the 'AF3 in our testing procedure. One requirement for this is that the 'AF3 must be included on your tester chart. We know that the 16AQ3 must equal or exceed the maximum ratings of the 'AF3, but that the filament and possibly the basing are different. The filament must be in the range between 16.0 and 16.5 volts as indicated in Table I. If 17 volts is the closest setting available on the filament selector on your tester, this should be satisfactory. The basing can be determined by inspection of the socket wiring in the receiver.

The filament leads will be easy to find, since this is a series-filament chassis. Each filament lead must go to a filament pin on another tube socket, or to a resistor or choke in

**ALL NEW  
SENCORE  
component  
substitutor**



## All your favorite Sencore Substitution Time-Savers in One Compact Unit

A complete range of carbon resistors, wire wound power resistors, capacitors, electrolytics, and universal selenium and silicon rectifiers.

Imagine, all of these hard to locate parts at your finger tips for on the spot substitution. Say goodbye to messy, crumpled parts, unnecessary unsoldering and soldering of components for testing purposes only. Save valuable servicing time and be sure, by substituting.

NEW . . . each section operates independently with a value close enough for every substitution need. Components in each section are isolated from chassis and from the other sections. For example, a complete power supply can be constructed using the RC121 Components only.

NEW . . . dual electrolytics provided. A new circuit enables you to substitute up to 25 single electrolytic values or 9 duals. Exclusive surge protector provides protection on both singles and duals for both you and the circuit.

You save space and money. Equivalent Sencore substitution pieces purchased individually (H36, PR111, RS106, ES102) cost you \$54.00

**RC121 (all hand wired, all American made) only 3995**  
**RC121K (Kit) . . . . . 27.95**

Now in stock at your Sencore Distributor. See him today!

**SENCORE**  
 ADDISON 2, ILLINOIS

the filament string. Since this is a 9-pin miniature tube, the odds are that the filament pins are 4 and 5. Inspection proves this to be true.

The cathode of a modern damper tube receives the high-voltage negative pulses from the horizontal circuit, so this terminal on the tube must be better insulated than the plate terminal. Accordingly, all damper tubes of miniature construction have the cathode connected to the top cap. Inspection of the circuit proves this to be true for the 16AQ3.

The plate pin of the tube is the

only other one to be determined. A look at the socket shows that pin 9 is the only pin with connections; therefore, this must be the plate pin.

The switch or push-button settings for the 'AF3 can also be used for the 16AQ3, with one exception strictly for safety's sake. If yours is a lever-type tester with an "open" position for the levers, position all the levers for unused pins in this open position. Most damper tubes have some of the unused pins reserved for internal connections, and if these pins were not opened by the levers, a short could exist and dam-

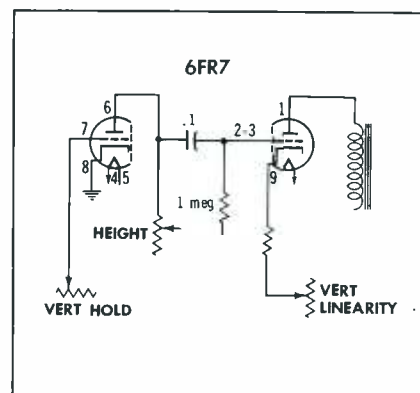

Fig. 4. Pin connections of 6FR7 tube in vertical oscillator-output circuit.

age the tester. If your lever-type tester does not have this open position, you can exercise the same caution by checking with an ohmmeter for continuity from the plate (pin 9) to all unused pins. The levers for any pins that show continuity to the plate pin should be moved to the same position as the plate pin. If the new tube you are checking has active elements other than the plate, use the same method to identify internally-connected pins.

You are now ready to set up the tester and test your suspect tube. Set the filament voltage selector to approximately 16 volts. Set the other controls, switches, push buttons, etc., to the settings given for the 'AF3 tube type. Push the test button and observe the meter indication. A good tube will come close to or exceed the expected reading for the 'AF3, and a bad tube will fall far short. Shorts and gas tests will be the same as for the 'AF3.

### Multi-Function Types

A diode is the simplest tube to set up. Let's now consider a multi-element tube such as the 9A8 triode-pentode in the same receiver. This is a foreign tube registered with EIA by Rogers Electronic Corp. of Canada in 1956. This is the first time it has been used in an American receiver, but the tube is old enough to be in several different tube manuals—which all state that the specifications of the 9A8 are identical to those of the 6BL8 with the exception of the filaments. Use the 6BL8 settings with a 9-volt filament voltage, and you can test the 9A8.

For a more difficult example of a dual-purpose tube, let us consider

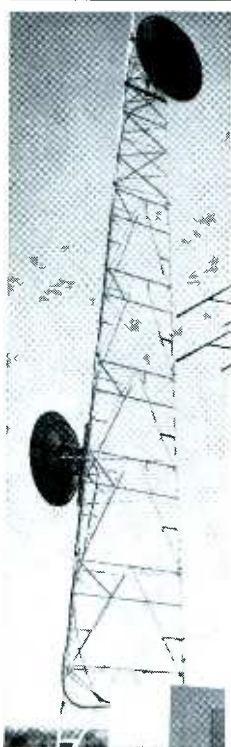

*The most Famous Name in*  
**TOWERS of ALL KINDS!**

Here are the advantages you get  
when you insist on **ROHN TOWERS**

**LARGEST FULL RANGE OF TOWERS**—you can get anything from home TV and amateur radio towers to heavy-duty communication and micro-wave towers. Included are 170 foot self-supporting towers, 1,000 foot guyed towers, and "fold-over" towers. Regardless of your needs, ROHN can supply it.

**UNQUESTIONED LEADERSHIP IN DESIGN AND MANUFACTURE**—you get the latest in advanced tower engineering. All communication towers are engineered to EIA specifications, and are proved by thousands of installations. No other manufacturer can surpass the quality and fine reputation of ROHN.

**QUALITY MATERIALS AND WORKMANSHIP**—Only highest quality steel is used which fully meets the specifications for the job. ROHN towers are hot-dipped galvanized **after fabrication**—a feature ROHN pioneered!

**SERVICE WHEREVER YOU WANT IT**—ROHN representatives are world-wide. Complete erection service for communication systems, broadcasting, micro-wave, and other needs is available; also competent engineering service to help you.

**Settle for the BEST in TOWERS**—ROHN—today the world's largest, exclusive manufacturer of towers of all kinds!

*For your needs, contact your local ROHN salesman, distributor or dealer; or write direct for information.*

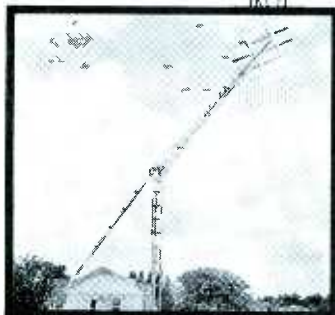

SEND THE HANDY COUPON INDICATING YOUR NEEDS

**ROHN**  
Manufacturing  
Company  
BOX 2000  
PEORIA, ILLINOIS

ROHN Manufacturing Company  
Box 2000  
Peoria, Illinois

Send me complete literature on the following ROHN Products:

- |   |  |
|---|--|
| <input type="checkbox"/> Home TV Towers       | <input type="checkbox"/> Amateur Towers            |
| <input type="checkbox"/> Communication Towers | <input type="checkbox"/> AM-FM Broadcasting Towers |
| <input type="checkbox"/> Micro-Wave Towers    | <input type="checkbox"/> Government                |

Name \_\_\_\_\_  
Firm \_\_\_\_\_  
Address \_\_\_\_\_  
City \_\_\_\_\_ State \_\_\_\_\_



the 6FR7, which is fairly new and may not be covered by the chart for your tester. This tube contains two triode sections. The low-power section is intended for service as a vertical oscillator, and the high-power section is intended as a vertical output amplifier. One of the most popular dual triodes for vertical oscillator-vertical output use has been the 6EM7, so let us compare our new tube to this type.

The 6FR7 has a 9-pin miniature base, while the 6EM7 has an octal base. We will have to develop new settings for the switches, levers or push buttons which set up the pin connections. Turn the receiver chassis up so that the 6FR7 socket is visible, and start tracing connections.

Pin 1 has a blue lead which goes to the vertical output transformer. Thus, pin 1 has to be the plate of the output section. Pins 2 and 3 are connected together, and the components tied to these pins include a .1-mfd capacitor and a 1-megohm resistor. Either one or both of these pins must be the grid of the output section. To play safe, assume that both pins connect to the grid, and set them both together on the tester. Pins 4 and 5 have a pair of twisted brown wires connected to them, so these must be the filament connections. Pin 6 has a lead going to the height control and also is connected to the capacitor going to pins 2 and 3. Thus, pin 6 has to be the plate of the oscillator section. Pin 7 is connected to the vertical hold control and appears to be the grid of the oscillator section. Pin 8 goes to ground, and the only tube element this could connect to is the cathode of the oscillator section. Pin 9 connects through a resistor to the vertical linearity control and is almost certain to be the output cathode terminal. All of the pins are now identified (Fig. 4), so let's set up the tester.

The filament connections in the tester should be set to pins 4 and 5. We will arbitrarily test the oscillator section first; to do so, the plate circuit should be set to pin 6, the cathode circuit should be set to pin 8, and the grid circuit should be set to pin 7. Since these tubes have two sections, we need to identify the oscillator section of the 6EM7. A look at a tube manual tells us pins

4, 5, and 6 connect to the oscillator section; therefore, the other controls on the tester should be positioned as the chart specifies for the 6EM7 test which includes pins 4, 5, and 6.

In the second test, for the output section, we should set the plate circuit to pin 1, the cathode circuit to pin 9, and the grid circuit to pin 2 or 3. (If the grid connects to only one of these and you pick the wrong one, the tube will test bad. If it does, be sure to try the other pin and retest the tube.) The other controls should be positioned as the chart

specifies for the other test of the 6EM7.

You can see that many of the new tubes are minor improvements on old tubes. Start now and make a file of all of the tube manuals and manufacturers' specification sheets that are available from your distributor. Some of the trade magazines publish specs on new tubes as they are released—clip these and add to your file. Keep yourself and your tube tester up to date, and you'll save time when you find it necessary to check a suspect tube for which you have no setup data. ▲

*a simple solution*

OVERHAULED BY  
**CASTLE**  
TV TUNER SERVICE, INC.  
Pioneers in TV Tuner Overhaul

## THAT SOLVES ALL YOUR TV TUNER PROBLEMS

*Ask yourself*

... do you have the time to fool around drilling, sawing, filing ... trying to make a "Universal" replacement tuner fit in place of the original?

... do you have all the expensive instruments and equipment to complete the alignment so essential after each tuner repair or replacement?

... can you spare the time repairing and adjusting your own TV tuners and can you charge enough to justify the time spent?

**A Castle Overhaul eliminates every one of these problems.**

Castle replaces all defective parts, (tubes and major parts are extra at net prices) and then aligns your tuner to the exact, original specifications.

Simply send us your defective tuner complete; include tubes, shield cover and any damaged parts with model number and complaint.

Send for **FREE Mailing Kit** and complete details.

ONE PRICE

**9<sup>95</sup>**

ALL MAKES

VHF TUNERS  
UHF TUNERS  
UV COMBINATIONS\*

\*UV combination tuner must be of one piece construction. Separate UHF and VHF tuners with cord or gear drives must be dismantled and the defective unit sent in.

90 Day Warranty

**CASTLE**  
TV TUNER SERVICE, INC.



Pioneers in

TV Tuner Overhauling

5701 N. Western Ave., Chicago 45, Illinois • 653 S. Palisade Ave., Cliffside Park, New Jersey  
In Canada: 136 Main St., Toronto 13, Ontario

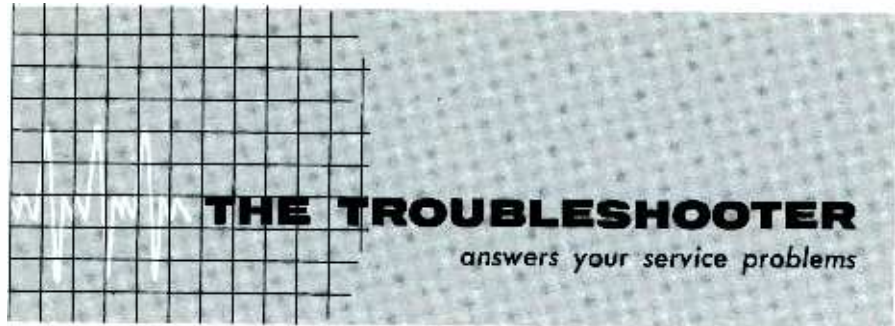

### Horizontal Alignment

In reading over your February issue, I noted Mr. Edwin H. Robac's problem concerning waviness in the raster on a General Electric Model 21C242.

This condition can occur through improper setup of the horizontal hold control and horizontal stabilizer coil. Therefore, the following procedure should be tried before any components are tested:

1. Tune in a weak signal and set all controls for a normal picture.
  2. Short the arm of the horizontal hold control to the junction of the 3000-ohm and 680K-ohm resistors in the horizontal AFC circuit (R89 and R96).
  3. Connect a 1000-ohm resistor across the horizontal stabilizer coil.
  4. Adjust the horizontal hold control until the picture just "floats" back and forth across the screen.
  5. Remove the resistor from across the stabilizer coil, and adjust this coil until the picture again floats across the screen.
  6. Remove the AFC jumper. The picture should lock in properly, and slight adjustment of the hold control should be sufficient to compensate for future aging of tubes. No further adjustment of the stabilizer coil should be made, once the alignment is completed.
- If the picture cannot be made to "float" in step 4, the free-running speed of the horizontal multivibrator is incorrect

—probably because of off-value components. Unless this condition is remedied, horizontal stability will be poor.

Should the problem persist, it may be due to 60-cps hum fed in through a poor ground connection. Ground returns in this chassis are made by soldering component leads into hollow metal pins which are riveted to the chassis. Some grid returns are made to the same pins which carry tube-filament grounds. If corrosion develops between these pins and the chassis, enough filament voltage may be picked up on grid leads to induce bending in the picture. Thus, all grounds in the sync amplifier, clipper, phase splitter, AFC, horizontal oscillator, and horizontal output should be checked. This is easily done by shorting the pins to chassis while watching for the picture to straighten out.

A poor connection can be corrected by soldering the pin to chassis, using a heavy iron, or by bolting in a solder lug to carry the component leads.

R. C. HANNUM

Supervisor—Technical Service  
General Electric Co.  
Syracuse, N.Y.

*This is a revised alignment procedure which replaces the instructions originally given in manufacturer's data and in PHOTOFAC Folder 264-7. Filing this information with the 21C242 schematic would be a good way to avoid future sync headaches.*

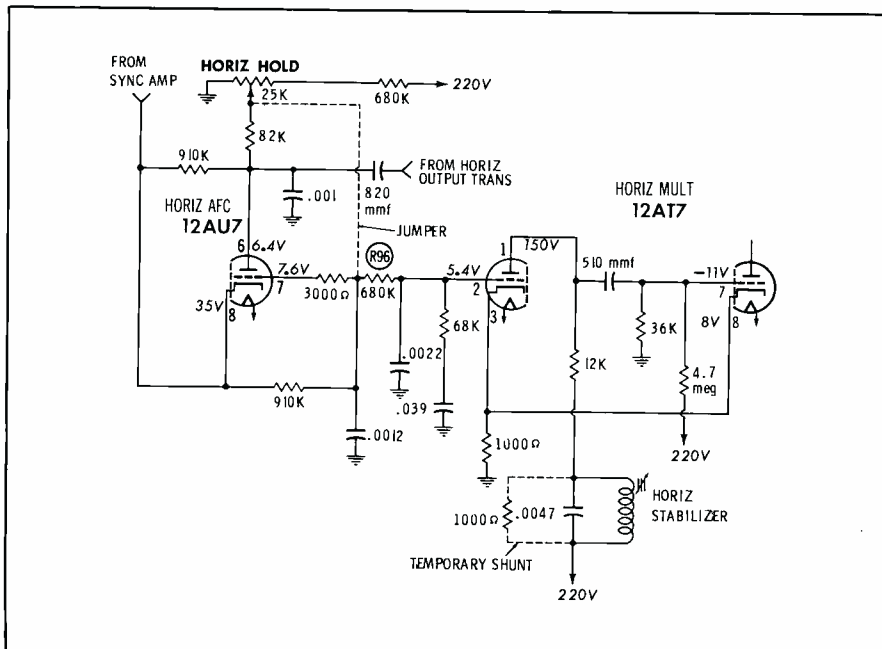

### Pop Goes the . . .

I have a hard time locating TV trouble which cause the fusible resistor to pop as soon as the set is turned on. What are the main causes of high initial surge currents in sets which show no apparent B+ shorts?

KENNETH PIERCE

Kansas City, Mo.

*A defective input filter capacitor in the B+ circuit, or rectifiers with lower-than-normal reverse resistance, could be at fault. The best way to check this possibility is to substitute new parts, being careful not to use an input filter with much higher capacitance than the original (If you did so, it would increase the initial surge current.)*

*Another important factor is the value of the fusible resistor itself; if this is higher than the resistance called for in the design of the set, the resistor will dissipate too much power and will be prone to burn out.*

*About the only remaining suspect would be an elusive short—perhaps intermittent—somewhere in the B+ network.*

### Where's the Oscillator?

I'd like some help with a Silvertone Model 4118 (covered in PHOTOFAC Folder 227-12). After the set has been on for about an hour, a number of thin horizontal bars appear in the picture, and a slight tone or whistle can be heard from the speaker. The bars are five or six scanning lines in thickness, and are evenly spaced by this same interval. The picture is still visible through the bars.

The trouble appears on either VHF or UHF. It can be made to disappear for awhile if the tuner is switched off channel and back again, if any tube is pulled and reinserted, or if any point in the IF or audio section is touched with a test probe.

I have checked the filters in the audio circuit, and have even tried substituting a different tuner, with no luck. All tubes in the suspected sections have been replaced. I'm having trouble getting anywhere with voltage and resistance checks because, as I mentioned, any circuit disturbance clears up the condition for awhile.

A. L. ORTMAN

Decatur, Ill.

*Our first thought was that you might have a microphonic condition in the tuner, but you've already ruled this out by tuner substitution. We've also seen similar symptoms caused by open bypass or decoupling capacitors in the picture-signal stages, and even one case of horizontal bars due to internal arcing in the picture tube!*

*The bars and the whistle are signs of audio oscillation, likely in some stage common to the picture and sound signals. Thus, the trouble could be originating at any point from the IF input to the sound take-off circuit at the plate of the video amplifier. It's also possible that an audio-circuit defect could be causing feed-*

back into the video section through the 130-volt B+ line, which has the cathode circuit of the audio output tube as its source.

Since the condition is so sensitive to probing, it's very difficult to isolate by the usual voltage-checking or signal-tracing methods. I'd suggest starting at the CRT and working back through the video and IF sections, looking for such things as faulty bypass capacitors and poor solder joints.

You also might be able to narrow down the trouble area by connecting a VTVM or scope to a major test point (such as the video-detector output) before turning the set on. This would avoid the transient surges that result from touching a probe to a "live" circuit, and might allow you to see what happens to key voltages and waveforms when the trouble first appears.

### Fill Out the Corners

I would like to use an RCA Chassis KCS83 to drive a bonded-shield 23" picture tube in a custom installation. Does this sound feasible? If it does, what modifications would have to be made to the chassis, and which type of 23" tube would be best suited to this job?

RICHARD CIESIELSKI

Dick's TV and Radio  
Lisle, Ill.

The success of this project depends on whether or not this chassis has enough reserve sweep power to increase the CRT deflection from 70° to 92°—the smallest sweep angle available in a 23" tube. You could get a rough idea of the results by making a preliminary check with an 8", 90° check tube. If you can obtain ample sweep by advancing the width and height controls, this is a good sign; otherwise, you'll have to modify or rebuild the sweep circuits. Width is more likely to be a problem than height, but you may be able to increase the width slightly by connecting a small capacitor (50 to 100 mmf) across the horizontal windings of the yoke. If you do this, be sure to check the resulting increase in horizontal-output cathode current, and make sure it isn't excessive.

The most suitable CRT for your purpose would probably be the 23XP4, a 92° tube which is designed to operate with somewhat less high voltage than many other new square-cornered tubes. You should not expect as much "sparkle" and contrast as in a new set with 20-kv anode voltage and 150-volt video drive, but the 13 or 14 kv in the KCS83 should be adequate for a good picture.

The 23" tube will be electrostatically focused, so you can simply eliminate the old focus magnet—and the ion trap, too. You'll need to add a pin-6 connection to the CRT socket and apply a focusing potential to this pin. You can tap in anywhere in the B+ or boost system for focus voltage, choosing any value which gives acceptable results.

# Now with New Features For Added Versatility

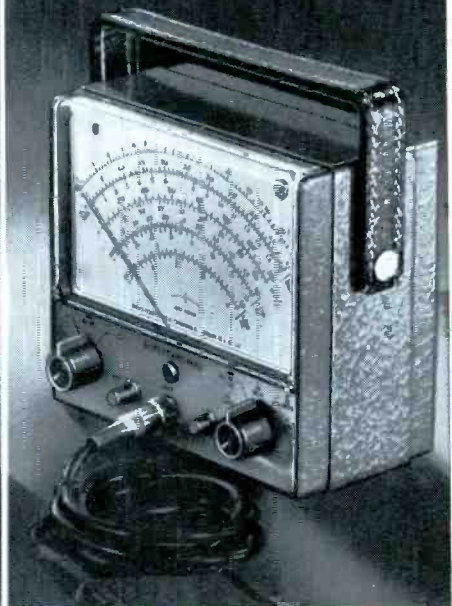

## RCA WO-91A 5-INCH OSCILLOSCOPE

**New 2-Stage Sync Separator Simplifies Checking TV Horizontal and Vertical Sweep Synchronization**

This popular RCA 5-inch scope now at your distributor's includes a new feature to simplify TV servicing: a built-in two-stage sync separator. This circuit, connected in the pre-set TV "H" and "V" positions, provides exceptionally solid lock-in action on composite TV signals.

### Other "PLUS" Features:

- 5-inch screen with high resolution
- Dual bandwidth (4.5 Mc with 0.053 volt rms/in. sensitivity; 1.5 Mc with 0.018 volt rms/in. sensitivity)
- Internal calibrating voltage and calibrated graph screen
- Includes special direct/low capacitance shielded probe and cable

**\$249<sup>50\*</sup>**  
factory-wired and calibrated

**SEE THEM BOTH AT YOUR AUTHORIZED  
RCA TEST EQUIPMENT DISTRIBUTOR.**

\*User Price (Optional)

## RCA WV-98C SENIOR VOLTOHMYST®

**New 0.5 Volt Full-Scale DC Range for Testing Transistor Circuits**

Now you can check the low voltages used in transistor circuits even more accurately with the latest model of the famous RCA Senior VoltOhmyst.

The new "C" version of this time-tested instrument includes a high-sensitivity range that provides full-scale deflection at only one-half volt DC.

### Other "PLUS" Features:

- Easy-to-read 6½" meter face
- 200-µa meter movement with less than 1% tracking error
- Precision multiplier resistors accurate to 1%
- Meter electronically protected against burnout
- Separate color-coded peak-to-peak and rms voltage scales
- Die-cast aluminum case with leather carrying handle

### MEASURES:

DC volts, 0.02 to 1500 volts  
AC volts, 0.1 to 1500 volts rms; 0.2 to 4200 volts peak-to-peak  
Resistance, 0.2 ohm to 1000 megohms

**\$79<sup>50\*</sup>**  
factory-wired and calibrated

RCA ELECTRON TUBE DIVISION, HARRISON, N. J.



The Most Trusted Name in Electronics



Duotone needles, of course . . . tipped with genuine diamonds, sapphires or osmium. Most people forget to change their styli or don't know how to change them. Why not suggest a Duotone diamond needle replacement for every phonograph that comes into your shop? It's the stylus with the whole diamond tip that's handset and hand polished. Your customers will appreciate the service and you'll appreciate the increase in business.

Write for Free 1962 Duotone Needle Wall Chart and see DUOTONE Distributor.  
"Chicago Parts Show—Rooms 609A and 611A"

**DUOTONE**  
COMPANY INC. KEYPORT, N. J.



## CITIZEN BAND CLASS "D" CRYSTALS



3rd Overtone: Hermetically Sealed .005% tolerance—Meet F C C requirements. 1/2" pin spacing—.050 pin diameter. (.093 pins available, add 15¢ per crystal.)  
**\$2.95 EACH**  
ALL 22 Frequencies In Stock!  
(add 5¢ per crystal for postage and handling)

The following Class "D" Citizen Band frequencies in stock (frequencies listed in megacycles): 26.965, 26.975, 26.985, 27.005, 27.015, 27.025, 27.035, 27.055, 27.065, 27.075, 27.085, 27.105, 27.115, 27.125, 27.135, 27.155, 27.165, 27.175, 27.185, 27.205, 27.215, 27.225.

Matched crystal sets for all CB units . . . \$5.90 per set. Specify make and model numbers.

### RADIO CONTROL CRYSTALS

In HC6/U HOLDERS—SIX FREQUENCIES  
In stock for immediate delivery (frequencies listed in megacycles); tolerance .005%. 1/2" pin spacing. .050 pin diameter. (.093 pins available, add 15¢ per crystal.) Specify frequency desired.  
26.995, 27.045, 27.095, 27.145, 27.195, 27.255 . . . . .  
**\$2.95 EACH**  
(add 5¢ per crystal for postage-handling)

NOW! Engineering samples and small quantities for prototypes now made either at Chicago or at Ft. Myers Plant. 24 Hour Service!  
IN CHICAGO, PHONE GLadstone 3-3555

Send for **FREE CRYSTAL CATALOG #961 WITH OSCILLATOR CIRCUITS**

ASK YOUR PARTS DEALER FOR TEXAS CRYSTALS  
See big red display . . . If he doesn't stock them, send us his name and order direct from factory.

RUSH YOUR ORDER NOW TO  
**TEXAS CRYSTALS**  
1000 Crystal Drive, Fort Myers, Florida  
Dept. (pf-4) Phone WE 6-2100

FOR SHIPMENT VIA FIRST CLASS MAIL AT NO EXTRA COST ATTACH THIS ADVT. TO YOUR ORDER!

## Antenna Preamps (Continued from page 35)

considered as ideal or "perfect" for the type of unit in question. (Obviously, a figure of "zero" cannot be used, so something approaching zero must be chosen as a reference.) The resultant noise figure is thus a ratio, which can be expressed in db. Another way of arriving at a noise figure is to compare the noise output obtained when no signal is applied at the input, to the output obtained with a specified noise-signal input.

As you can see, there are various methods of arriving at a noise figure, and the result will vary in accordance with the reference levels and types of measurements used. Thus, a simple comparison of the gain and noise figures of different units is not necessarily indicative of their relative performance capabilities — unless the specifications were derived by using exactly the same set of measurement standards.

### Typical Preamps

Now that you have some idea of how antenna-preamplifier performance is defined, let's examine several units, all representative of those currently in production, and learn what they have to offer.

#### Blonder-Tongue Model AB-4

The *Signal-Master* Model AB-4 (Fig. 1) uses a PNP transistor in a common-emitter circuit. The unit provides facilities for operating four different sets, through the use of a signal-splitter network built into the power supply. The amplifier is mast-mounted, while the power supply is normally fastened to the rear of the TV receiver.

Two different power supplies are available; the RP-4 operates on four

ordinary flashlight batteries, while the RP4-AC is powered from 115 volts AC.

Published figures specify that gain ranges from 13 db on Channel 2 to 10.5 db on the higher channels (7-13). At FM frequencies, the gain is 11 db. The noise figure varies from 5 db on the low band to 6.5 db on the high band.

Also available from Blonder-Tongue is the AB-2 (Fig. 2), a vacuum-tube unit which provides an average gain of 10 db across the TV band.

#### Channel Master Model 0020

Channel Master has just developed a new version of their *Jetron*, an antenna-mounted preamp employing a triode-connected PADT transistor in a common-base configuration (see Fig. 4). Like the earlier

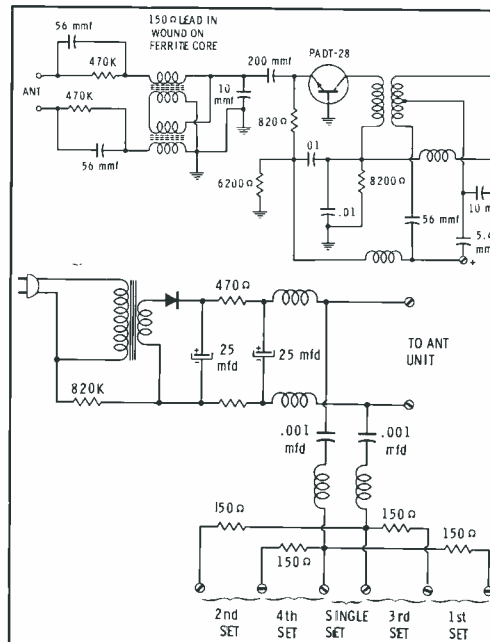

Fig. 4. Schematic of Channel Master Model 0020 preamplifier and supply.

# MERCURY TUNER SERVICE, INC.

890-1 River Ave., Bronx 51, N.Y.  
"Largest in the East"

## VHF-UHF TUNERS

7 Months Warranty  
Price Includes Labor & Minor Parts  
TUBES & MAJOR PARTS AT NET PRICES

ALL MAKES ONE PRICE!  
**\$9.50**

When Shipping Tuner: Include Tubes, Shields and Damaged Parts.  
Give Model Number and State Complaint  
PACK WELL AND INSURE  
24 HOURS ON POPULAR TYPES

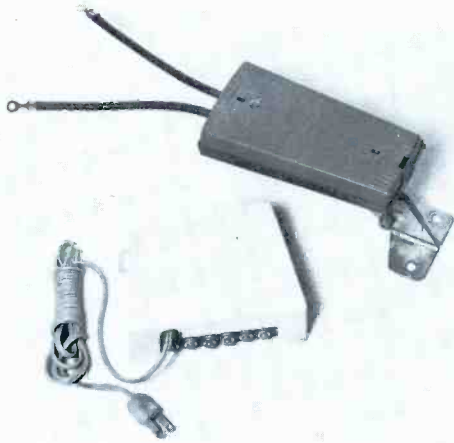

Fig. 5. Channel Master Model 0020 pre-amp and AC-operated power supply.

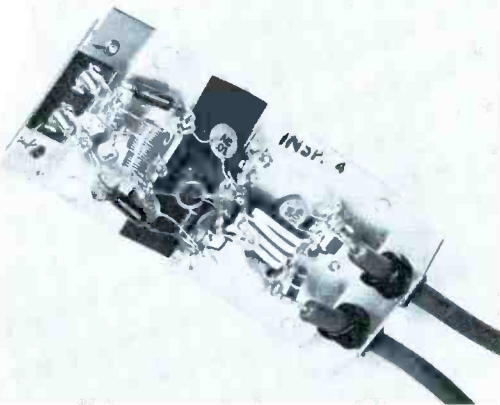

Fig. 6. Channel Master 0020 with cover removed to show internal view.

model, this unit is unique in that it provides more gain on the upper channels than on the low end of the band. Furthermore, the manufacturer indicates that the new model has a higher average gain than its predecessor; however, the unit is just coming out of the "pilot" run stages, and no specific gain and noise figures have as yet been released. The new design is pictured in Figs. 5 and 6.

The power supply is fed from 115 volts AC, and contains a built-in four-set coupler. The amplifier measures 1¼" x 3⅛" x 6⅛" and weighs 12 ounces, while the power supply is 5" x 3¾" x 1¾".

#### Jerrold Model APM-101

The *Powermate* (Fig. 7) is an antenna-mounted unit which uses a PNP transistor as a common-emitter amplifier (Fig. 8). The preamp is housed in an aluminum case and is connected through solid-bar conductors to the antenna terminals, assuring a constant impedance match regardless of frequency.

The manufacturers' specifications

## Now in breakproof plastic utility case!

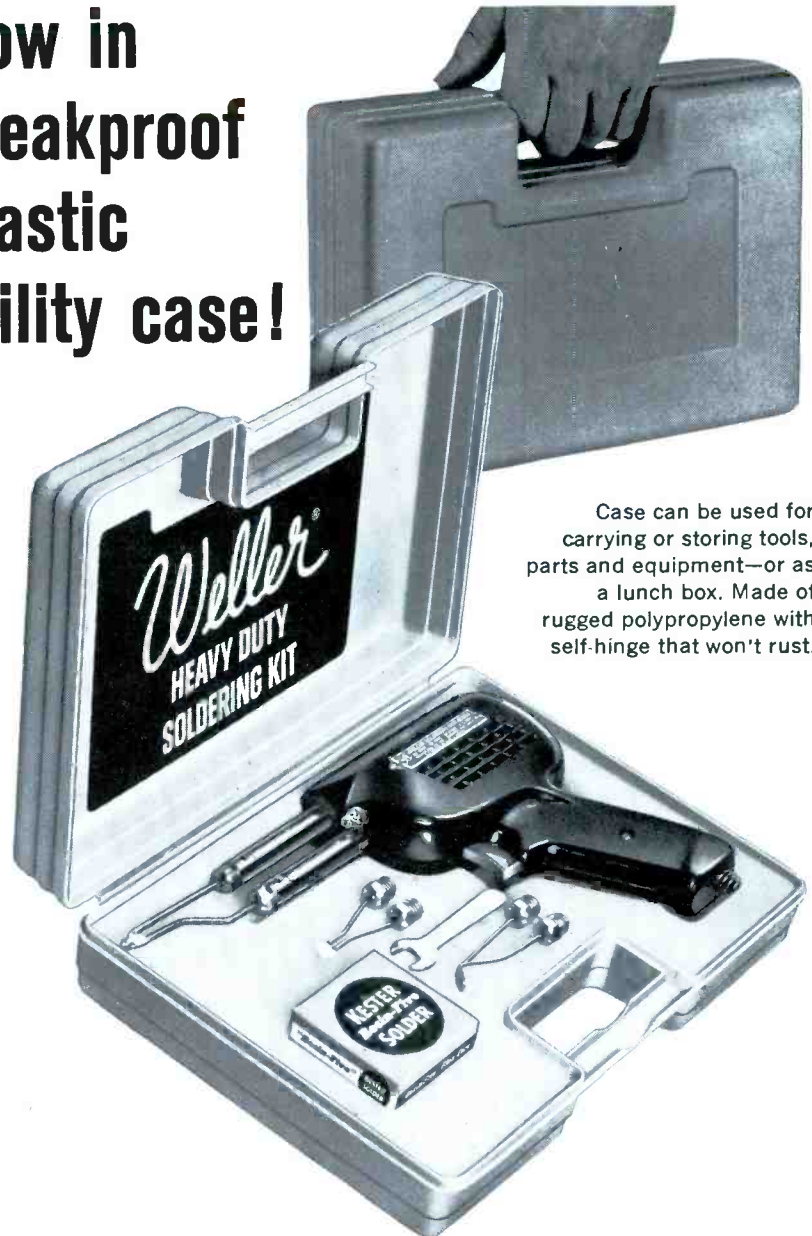

Case can be used for carrying or storing tools, parts and equipment—or as a lunch box. Made of rugged polypropylene with self-hinge that won't rust.

Weller adds greater value to the Heavy Duty Soldering Kit with a new utility case of miracle plastic that won't break. Kit features the Weller 250-watt Soldering Gun used by electronic service technicians the world over. Instant heat. Twin spot-lights. Long life, long reach tip—made of copper for superior heat transfer and iron plated for long life. Also included in this kit are smoothing tip, cutting tip, tip interchange wrench and supply of solder. Model 8250AK.

**\$14.95** list

#### 100 Watt Gun and Solder Dispenser

A combination for faster, easier, better soldered connections—particularly in difficult-to-reach spots. 100-watt Weller Gun heats instantly. Weller-Kormat Dispenser feeds and supports the solder, prevents hand contamination that causes faulty connections, prevents finger burns. Model WK81 set.

**\$9.95** list



On sale at your Electronic Parts Distributor

**WELLER ELECTRIC CORP. • EASTON, PA.**

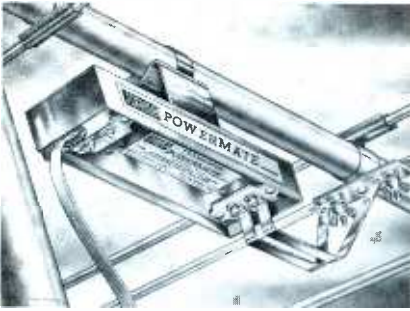

Fig. 7. Jerrold Model APM-101 "Powermate" preamp and AC power supply.

show the gain to be 18.25 db for Channel 2 and 13.9 db for Channel 13. The gain varies from 12 db to 18.2 db over the FM band. Noise

figures vary from 4.1 to 5.5 db across the low band, and from 5.4 to 7.0 db over the high band.

Jerrold also makes the Model DSA-12 *De-Snowder* — a tube-type preamp for use in distribution systems. The unit has an average gain of 25 db across the band and its noise figure varies from 6 to 7.5 db.

**JFD Model TNT100**

The antenna-mounted *Transistenna* shown in Figs. 9 and 10 employs a PADT transistor in a common-base amplifier circuit (see Fig. 11). The power supply utilizes four flashlight batteries to provide 6 volts

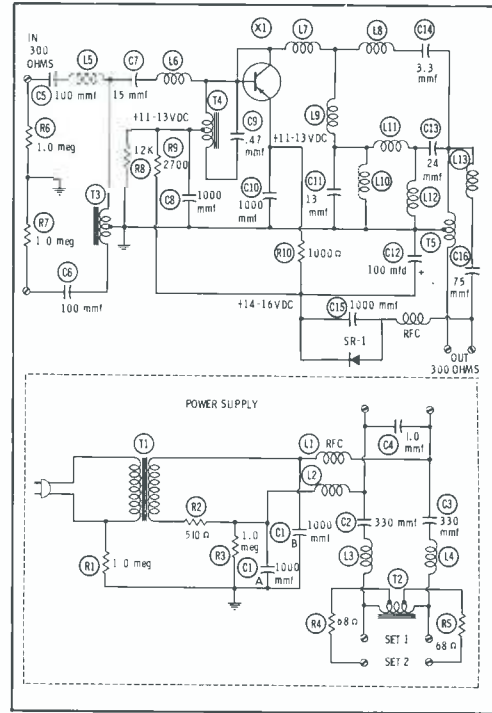

Fig. 8. Schematic of the Jerrold Model APM-101 amplifier and power supply.

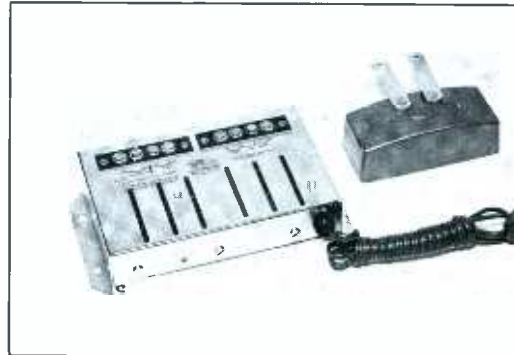

Fig. 9. JFD Model TNT-103 remote preamp and AC-operated power supply.

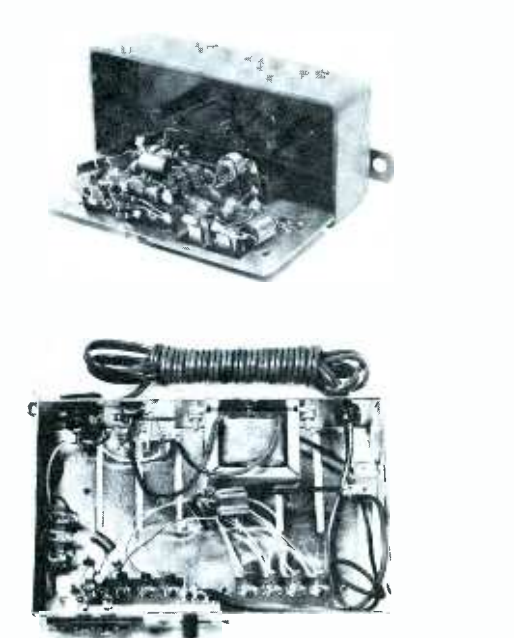

Fig. 10. JFD Model TNT-103 with amplifier and power-supply covers removed.



Model 1571 Shown with Accessory 45 rpm Spindle in Base Plate Spindle Well

**V-M Deluxe 'Stere-O-Matic'® 4-Speed Automatic Record Changer with Stereo Cartridge and Diamond Needle**

*The Sales Pace Setter For ALL Custom and Replacement Hi-Fi and Stereo Installations!* Sell customers a combination of true transcription-turntable fidelity and automatic record changer convenience . . . all in *ONE* unit with this functional V-M 'Stere-O-Matic'®! The eleven-inch turntable, scientifically balanced, assures minimum rumble and wow! V-M Automatic Manual-Play function saves possible needle damage by returning the extra-long, dynamically balanced tone arm to the rest post *AUTOMATICALLY* after single record play! *V-M Model 1571* . . . \$50.00\* LIST Available with 4-pole motor and plug-in tone arm head for magnetic cartridges as *Model 1572* . . . \$50.00\* LIST

\*Slightly Higher West.



Attractive, functional Base or pre-cut mounting board available for mounting all V-M record changers in any kind of Hi-Fi Installation. Model 1438 . . . \$5.95 LIST.

**GET THE SELLING FACTS ON THIS COMPATIBLE V-M DELUXE 'STERE-O-MATIC'® —YOU'LL PROFIT!**



V-M CORPORATION • BENTON HARBOR, MICHIGAN • KNOWN FOR THE FINEST IN RECORD CHANGERS, PHONOGRAPHS AND TAPE RECORDERS

# Outperforms them all! Outsells them all!

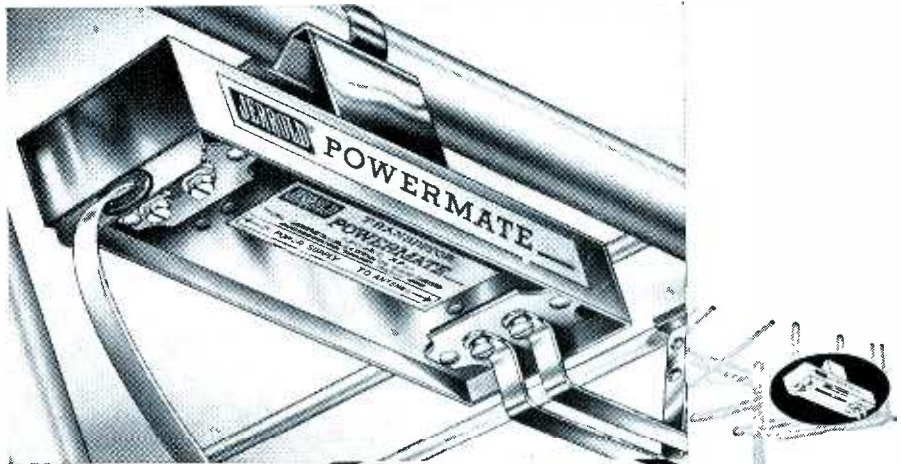

**JERROLD**®

## TRANSISTOR POWERMATE PREAMPLIFIER

BY FAR THE BEST antenna preamplifier in the business—that's POWERMATE! On black-and-white, and where it *really counts*—on color TV—POWERMATE's superiority shows up across the country.

The better VSWR (impedance match), flat response, ultra-high gain, special broad-band neutralizing transformer, and better power-supply filtering—all add up to an outstanding product. No polarity problems . . . no call-backs . . . transistor protected from lightning-coupled surges . . . remote a-c power supply feeds 2 sets.

Step up to POWERMATE, and step up to a tremendous new profit opportunity. See your Jerrold distributor now.

Model APM-101 \$39.95 *list, complete*

**JERROLD ELECTRONICS CORPORATION**

Distributor Sales Division, Dept. IDS-222, Philadelphia 32, Pa.  
Jerrold Electronics (Canada) Ltd., Toronto • Export: CBS International, New York 22, N.Y.

April, 1962/PF REPORTER 99

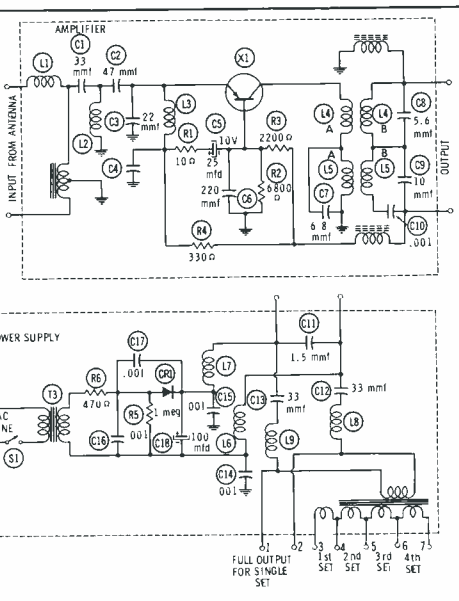

Fig. 11. Schematic of the JFD Model TNT-103 amplifier and power supply.

for the remote amplifier. A multiple-secondary transformer is used to provide impedance matching, so that four sets may be operated simultaneously.

According to JFD specifications, the amplifier gain varies from 18 db on the low channels to 10 db on the high channels. The same amplifier is also available with an AC supply, designated as Model TNT103-AC.

### Winegard Model MA-300

The *Tenna-Boost* amplifier (Fig.

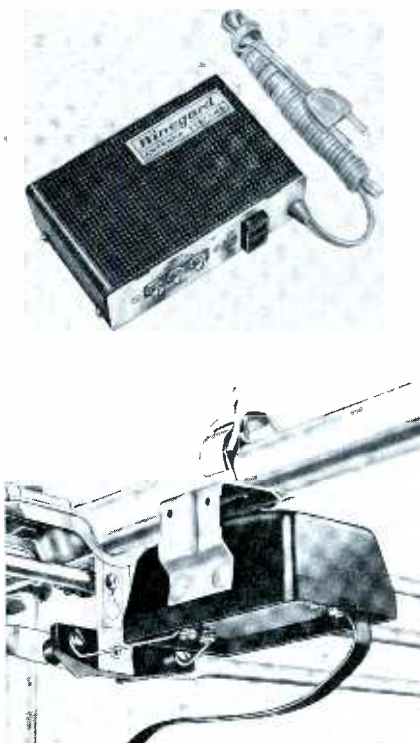

Fig. 12. Winegard MA-300 antenna-mounted amplifier and power supply.

# IN THE MAY PF REPORTER



... with a cross-reference chart of all types on the market.

## EFFECTIVE USE OF SERVICE CHEMICALS

### REPORT ON THE



### NEW YORK UHF TEST

The story behind the FCC's \$2 million experiment with a channel 31 station, being operated for comparison with New York City's seven VHF's.

### TV TUNER

### TROUBLESHOOTING TECHNIQUES

... will show you how to take care of most tuner defects right in your own shop.

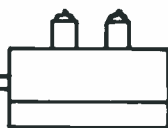

### NOTES ON TEST EQUIPMENT

Evaluating B & K 375 VTVM — EICO 680 Transistor Tester — Mercury 1100 Tube Tester

### HOW TO EXTEND CREDIT WITHOUT GOING BROKE

... will tell you where to turn for outside sources of customer credit.

### SURE CURES FOR REPEAT TUBE BURNOUT

... will shed light on abnormal circuit conditions that carry tubes to an early grave.

### RADIO-TV SUBSTITUTION STOCK GUIDE

... a suggested inventory of transformers, filters, and other major parts to keep on hand in the shop.

## Free Premium Books With New or Renewal Subscriptions

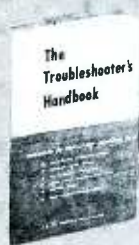

Enter my subscription to PF REPORTER and send me free book(s) checked.

3 Years \$9.00     2 Years \$7.00     1 Year \$4.00

The Troubleshooter's Handbook  
 Servicing Industrial Electronics  
 Servicing TV from Tuner to Picture Tube } Check one for each year you subscribe

Bill Me     Remittance Enclosed     Extend Present Subscription

Take this coupon to your distributor, or mail to:  
**Howard W. Sams & Co., Inc.**  
 2201 E. 46th St., Indianapolis 6, Ind.

Name \_\_\_\_\_  
 Firm \_\_\_\_\_  
 Address \_\_\_\_\_  
 City \_\_\_\_\_ Zone \_\_\_\_\_ State \_\_\_\_\_

Please Check Your Business Classification

Independent Radio, TV Serviceman     Owner, Mgr.  
 Retailer with Service Department     Service Mgr.  
 Industrial Electronics Service     Employee  
 Other (Specify occupation and title)



Fig. 13. Cutaway view of Winegard MA-300 showing internal construction.

12) is antenna-mounted and employs an MADT transistor as a common-emitter preamplifier (see Figs. 13 and 14). The manufacturer's specifications show an average gain of 18 db on the low band and 14 db for the high band. The noise figure varies from 3.8 db on Channel 2 to 4.9 db on Channel 13. A high-pass filter circuit is provided at the input to reduce interference from Citizens band transmitters.

The system is AC-powered and has provisions for feeding two receivers, either TV or FM. This pre-amp, and others of similar design, are supplied as part of especially-designed "electronic" antennas.

### Conclusion

The units described are typical of those available on the market at this time. Further details on these and other preamplifiers are contained in the chart at the beginning of this article. ▲

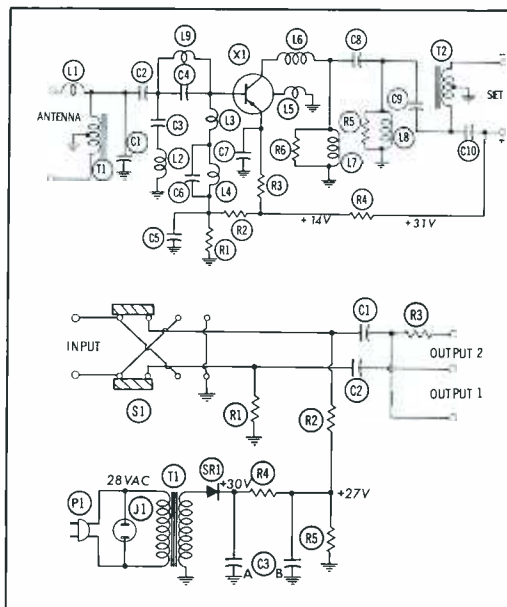

Fig. 14. Schematic diagram of Winegard MA-300 preamplifier and supply.



## Freak Rasters

(Continued from page 33)

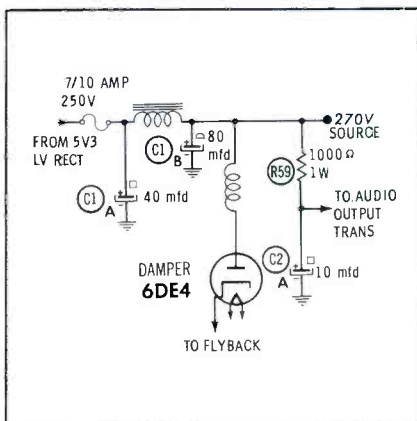

Fig. 6. Flyback pulses were present on 270-volt line because C1B was open.

### The Artistic Etching

The pattern in Fig. 7, which reminded me of a white-on-black etching of a candle and candle holder, remained fairly steady on the screen of a Motorola Chassis TS-533. I was reasonably sure it was due to filter trouble of some sort, so I proceeded to scope the electrolytics throughout the set. To my surprise, there was not just one bad filter; the ripple waveforms on all three sections of C1 (for circuit locations, see Fig. 8) were several times their normal amplitudes. Apparently, the common connection inside the can was open. As I shunted each individual section with a good unit, the raster presentation changed; at one time, it became very similar to Fig. 5. Replacing the entire can restored completely normal operation.

### Musical Top

The raster in Fig. 9, the most unusual I have yet encountered, was found on the screen of a G-E Model 17T101. Scope checks of the filters in this set were unproductive, so I proceeded to check another likely suspect — the horizontal output cir-



"I'll match your radio phono repair job & raise you one color-TV service call!"

# MAKING ROOM AT THE TOP

## AC VTVM & AMPLIFIER #250

**NEW** EICO ENGINEERING ACHIEVEMENT Kit \$49.95 Wired \$79.95



Phenomenally good AC VTVM, bound to make room for itself at the top of the professional market. 12 ranges from 1 mv to 300 V full-scale, 10c-600kc  $\pm 0$  db response, 10 megohms input impedance,  $\pm 3\%$  of full scale accuracy. At the flick of a switch, the internal wide-band amplifier is available for external use. Provides 8c-800kc  $\pm 0$  db response, 5 VRMS output, 5 kilohm output impedance, gain control, noise  $-40$  db. Regulated power supply, frame grid tubes.

**AC VTVM #255** Kit \$44.95 Wired \$72.95

All the precision VTVM facilities of the #250, less the external use of the wide-band amplifier.

## ARMED TO THE TEST LEADS FOR THE TRANSISTOR GAME



## TRANSISTOR AND CIRCUIT TESTER #680

Kit \$25.95 Wired \$39.95

Measure  $ICEO$ ,  $ICBO$  &  $dc\beta$  directly,  $ac\beta$  indirectly, without charts or special settings—plus all dc volts, currents, and resistances needed to service transistor equipment. 50  $\mu A$ , 3 1/2" face meter movement provides sensitivity and scale length necessary for accurate measurements. Built-in 20,000 ohms/volt VOM facilities let you work on transistor equipment with minimum equipment tie-up.

## SITTING DUCKS FOR THIS SNOOPER



## IN-CIRCUIT CAPACITOR TESTER #955

Kit \$19.95 Wired \$39.95

Leave those capacitors where they are! Without unsoldering:

- check for shorts (even in the presence of as little as 1 ohm shunt resistance)
- check for opens (determine the presence of as little as 5mmf in the circuit), and to confirm open indication . . .
- measure capacitance with  $\pm 10\%$  accuracy between 0.1 mf and 50 mf
- measure RC product, convertible into dissipation or power factor.

### Also New From EICO:



**Battery Eliminator and Charger #1064**  
Kit \$43.95  
Wired \$52.95



**AC Bench Supplies: Model 1073—**  
Kit \$35.95  
Wired \$47.95  
**Model 1078—**  
Kit \$42.95  
Wired \$54.95



**AC Volt-Watt Meter #260**  
Kit \$49.95  
Wired \$79.95



For complete catalog of over 106 EICO kits and wired units—hi-fi, test equipment, citizens radio, ham gear—plus name of nearest distributor, write to dept. PF-4

ELECTRONIC INSTRUMENT CO., INC., 3300 N. BLVD., L. I. C. 1, N. Y.

Add 5% in the West

Export Dept: Roburn Agencies, Inc. 431 Greenwich St., N. Y. 13, N. Y.



Tarzian 400 and 600 volt F and H series units are available in handy Ten-Paks, in Doubler Replacement Kits, and in bulk; M150 and M500 units are available in Conversion Kits and in bulk. Nine standard tube replacement rectifiers replace over 95% of all popular

vacuum tube rectifiers; S5347 replaces 6BW4 or 12BW4 in Citizen's Band radios; your 50 to 500 ma requirements are covered by four "condensed stack" selenium rectifiers, which Sarkes Tarzian has made more efficient—and smaller—than before.

## Sarkes Tarzian

*...the preferred silicon rectifiers that mean fewer call-backs*

■ Tarzian silicon rectifier dependability virtually eliminates call-backs that waste your time and profits. Units are available immediately from distributors throughout the country... in the shapes, sizes, and specifications you need to do your work quickly and easily.

Tarzian's industry-wide reputation for high quality at a pace-setting low price is a basic reason why more technicians like yourself prefer Sarkes Tarzian rectifiers than the next two most popular makes combined.

That statement is firmly based on the results of a 1961 mailing by Brand Name Survey, an independent research organization, to 23,000 service technicians in all major market areas of the United States, covering 36 states. You're in good company—and lots of it—when you make Tarzian rectifiers your first choice for replacement applications.

Free Tarzian "Distributor Line" catalog is available now as your guide to replacement rectifier quality. Ask your nearest Tarzian distributor for your copy.



### SARKES TARZIAN, INC.

World's Leading Manufacturers of TV and FM Tuners • Closed Circuit TV Systems • Broadcast Equipment • Air Trimmers • FM Radios • Magnetic Recording Tape • Semiconductor Devices

SEMICONDUCTOR DIVISION • BLOOMINGTON, INDIANA  
In Canada: 700 Weston Rd., Toronto 9 • Export: Ad Aurilema, Inc., New York



Fig. 7. Electron-beam artistry on the screen of a Motorola Chassis TS-533.

cuit. The sawtooth trace at the control grid of the 25BQ6 output tube was thoroughly normal; but my next check, at the screen grid, produced the abnormal trace shown in Fig. 10. The frequency of this pulse signal was 60 cps, and its peak-to-peak amplitude was approximately 100 volts.

The B+ line on the other side of the screen resistor was clean, so the waveform was obviously originating in the output stage itself. But what could produce 60-cycle interference at this point? The most probable answer was a short or leakage between the filament and screen circuits — either inside the tube (not too likely) or in the external circuit wiring. Opening the high-voltage cage to get at the 25BQ6, I found the solution to this puzzler. At some previous time, the dropping resistor in the series filament circuit and the horizontal-output screen resistor had both been replaced — the former with its correct replacement, and the latter with several units in parallel. As pointed out in Fig. 11, a short had developed between the leads of the filament and screen resistors. Removing this short did not restore a normal raster; in fact, it resulted in no raster at all. This condition was easy to cure, though; after finding an extremely low voltage on the

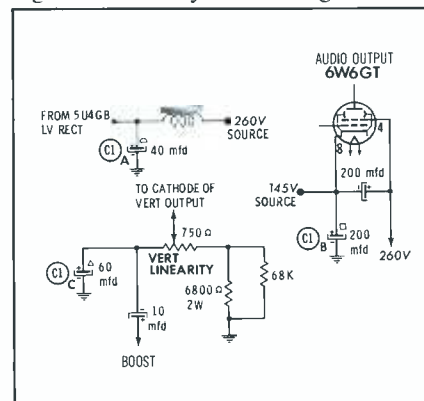

Fig. 8. All three sections of electrolytic capacitor C1 were inoperative

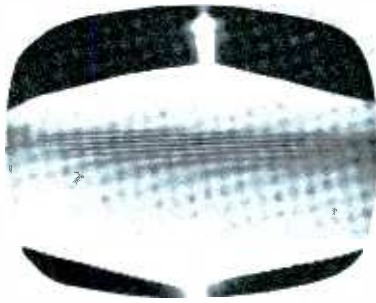

Fig. 9. Raster on an old General Electric set looked like a spinning top.

screen, I soon discovered that the wire-wound screen resistor was open and that the other resistors had kited to very high values. Replacing all these resistors with the recommended types put the set back in business.

#### Partial Blackout

Troubleshooting the causes of unusual rasters is often difficult and time-consuming. It is even more so when the unusual raster condition is not steady but intermittent, as in a Philco Model 50T1600 I once serviced. An inky-black shadow would cover the right half of the screen, as shown in Fig. 12, after about ten minutes of normal playing. The defect would remain for about one minute, and then, *zing!* — back to normal. Ten minutes later, the condition would repeat itself.

My first inclination was to blame the damper circuit, but I dropped this thought when I remembered that damper-circuit defects darken the left half of a raster more seriously than the right half. Then I recalled a circuit peculiarity of this model, not found in any other receiver to the best of my knowledge: The B+ line to the sweep circuits has its own filter choke and capacitor (L2 and C3 in Fig. 13). Hook-

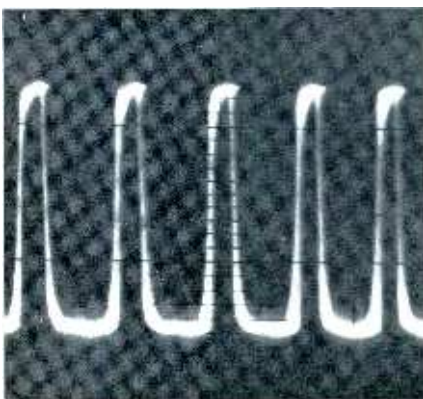

Fig. 10. These 60-cps pulses appeared on screen of horizontal output tube.



## I'm out of **Centralab**<sup>®</sup> Ceramic Capacitors!



There's no need to fly off the handle when you need a ceramic capacitor. Just taxi down the field to your nearest CENTRALAB distributor. He has the unit you need—whether it's plane or fancy.

CENTRALAB piloted the ceramic capacitor to its present importance in electronics, and today is flying high with the most complete line of discs, tubulars, buffers, trimmers, feed-thrus—for every standard or special application . . . and if you use CENTRALAB's handy capacitor kits you'll never be grounded by lack of parts.

You'll not only like CENTRALAB's complete selection of ceramic capacitors. You'll like the product quality—and you'll like the brand-new plastic box. Travel first class with CENTRALAB ceramic capacitors—in stock at your distributor.

### Centralab<sup>®</sup>

THE ELECTRONICS DIVISION OF GLOBE-UNION INC.  
942D EAST KEEFE AVENUE • MILWAUKEE 1, WISCONSIN  
In Canada: Centralab Canada Ltd., P.O. Box 400, Ajax, Ontario  
D-6211S

ELECTRONIC SWITCHES • VARIABLE RESISTORS • CERAMIC CAPACITORS  
PACKAGED ELECTRONIC CIRCUITS • ENGINEERED CERAMICS



Fig. 11. Short between screen and filament resistors (arrow) was the culprit.

ing the scope probe across this capacitor, I sat back to watch and await the partial blackout. When it did take place, I was happy to note that the scope trace changed from a perfectly normal ripple waveform to the 40-volt wave shown in Fig. 14. C3 was definitely the culprit.

### Why Such Strange Symptoms?

It's interesting (and educational) to analyze the reasons why rasters assume such unusual shapes as a result of defective filter capacitors. One factor is the changing current drain in the circuit containing the filter. For instance, the boost capacitor in the G-E circuit of Fig. 4 is



Fig. 12. In an old Philco, right half of screen intermittently blacked out.

rather heavily loaded by the vertical output circuit. Since the current drain of this stage is least when the CRT beam is at the top of the screen, the raster in Fig. 3 is most nearly normal at this point. As vertical sweep proceeds downward, the current drain on the crippled boost circuit increases, and the raster tapers off because the vertical circuit robs current from the horizontal circuit.

Another factor in some odd troubles is the mismatch between the horizontal output tube and its plate load. For instance, in the Zenith set of Fig. 5, R59 and other components in the B+ circuit were added

to the AC plate load of the horizontal output tube when C1B lost its ability to bypass these components.

One other factor helps in shaping unusual rasters: A B+ or boost line with defective filters may feed back unbypassed signals to other circuits in the set, where they can modulate the beam of the picture tube. Such beam modulation is not necessarily confined to the control grid or cathode of the picture tube, but can result from the unbypassed signals being fed to the focusing and accelerating grids as well.

### Testing Electrolytics

Since so many freak raster conditions are traceable to bad filter capacitors, you may wonder, "Why not just shunt suspected filters with good ones?" I have a very good reason for replying, "Don't." When the new capacitor comes into contact with the circuit, it may cause the defective electrolytic to heal temporarily, and the trouble to disappear—also temporarily. When this happens, you may feel pretty sure that the shunted capacitor was defective,

## A Virtual Encyclopedia On Servicing

... available to you in back issues of PF REPORTER

... and they're yours for just 50c a copy

<b>1956</b> all except Jan-Oct	<b>1958</b> all except Jan, Feb, Mar, Apr, and June	<b>1960</b> all except Jan and May
<b>1957</b> all except Mar, Aug, Oct, Nov, and Dec	<b>1959</b> all except Nov and Dec	<b>1961</b> all except Apr

Just place an "X" in the appropriate boxes for each issue ordered. Enclose check or money order—sorry, no C.O.D.'s.

Special!!! Order 6 issues or more and save 10c a copy.

	JAN.	FEB.	MAR.	APR.	MAY	JUNE	JULY	AUG.	SEPT.	OCT.	NOV.	DEC.
1956												
1957												
1958												
1959												
1960												
1961												

Enclosed please find \$\_\_\_\_\_ for back issues checked above.

Mail to: Circulation Dept., PF REPORTER  
2201 E. 46th St., Indianapolis 6, Ind.

NAME \_\_\_\_\_

STREET \_\_\_\_\_

CITY \_\_\_\_\_ ZONE \_\_\_\_\_ STATE \_\_\_\_\_

## NEW KRYLON CLEANER LUBRICANT SPRAY

To service  
volume controls,  
tuners,  
switches

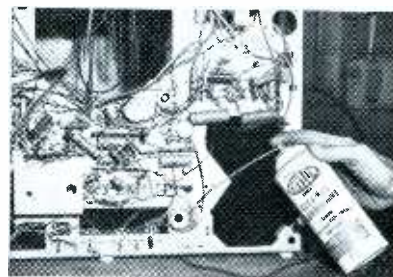

Cleans away dirt and gummy deposits. Provides a nondrying lubricating film on contact surfaces. Gives long-lasting protection against corrosion. Comes with 5-in. flexible plastic hose for controlled spraying in hard-to-reach places.

### KRYLON CRYSTAL-CLEAR ACRYLIC SPRAY



Protects electronic parts. Use on TV, radio, hi-fi, transmitting or test equipment. Protects against humidity, dust, corrosion and leakage currents. Long lasting. High dielectric strength.

### KRYLON SPRAY PAINTS



Choice of 24 standard colors and 7 glowing fluorescent spray paints. Use for touchup, color coding, safety, or repainting cabinets and enclosures. DRY IN MINUTES.

If you prize it . . . KRYLON-ize it!

Contact your Radio-TV jobber or write for Krylon's new industrial products catalog

KRYLON, INC., NORRISTOWN, PA.



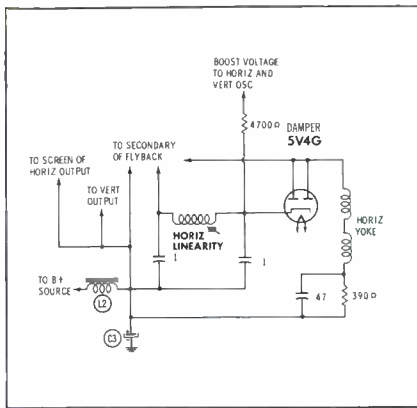
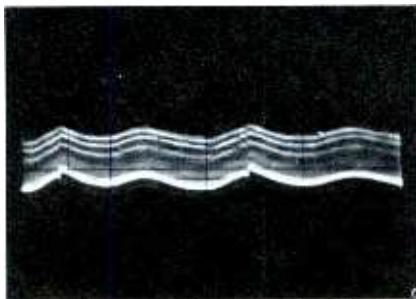

**Fig. 13.** How B+ is supplied to sweep circuits of the Philco Model 50T1600.

and proceed to install a replacement. If you do this, you're overlooking something. The initial current surge was not confined to the capacitor shunted, but extended to any others in parallel with it or in associated circuits. Borderline defects in these other capacitors could also be healed. For example, shunting a capacitor on the 150-volt line might easily create a surge that would heal a defective unit on the 250-volt line. The effect of this surge might last for days, but it will invariably wear off. If the set has been returned in the meantime, a callback will most surely result.

Such confusion can be avoided by using a capacitor-substitution box with a surge-preventing feature, or by checking ripple waveforms with a scope (as I do) to locate a filter that is not doing its job.

Although checking electrolytic capacitors is usually a good place to start analyzing an odd raster trouble you've never encountered before, I don't mean to leave the impression that filters are practically the only source of such trouble. TV sets have many other ways of trying to outwit servicemen with freak symptoms. However, they're no match for the professional technician who knows how to think his way out of a tough problem. ▲



**Fig. 14.** When C3 opened intermittently, this 40-volt ripple was on B+ line.

**ONLY \$69.50 net**

**GUARANTEE**

Each Seco Model 88 is unconditionally guaranteed to be up-to-date for the testing of receiving type tubes. Adaptor kits or set-up data will be furnished without cost to keep your tester current for one year from date of purchase.

**A SECO PLUS!**

© SEI 1962

New Seco Model 88 Tube Tester is guaranteed against obsolescence. Gives you patented Seco GRID CIRCUIT, also CATHODE EMISSION tests—tests over 2,200 tube types including Nuvistors, Novars, Compactrons, new 10-pin types and battery types. You also get:

- A check for troublesome grid emission and all common leakage and short faults in one operation. READ ON METER.
- A cathode emission test in special low impedance circuit.
- A burnout-proof meter employing a VTVM amplifying circuit.
- Few controls—simple operation—compact, lightweight size.
- Convenient fast-find setup information in cover.
- A check for filament continuity and open elements.

For full information write or send coupon below to Seco, originator of the famous Grid Circuit Test.



**SECO ELECTRONICS, INC.**

5031 Penn Ave. So., Minneapolis 19, Minn.

Please send free  Model 88 information  "How to Test Tubes"

NAME \_\_\_\_\_

ADDRESS \_\_\_\_\_

CITY \_\_\_\_\_ STATE \_\_\_\_\_

# PRODUCT report

For further information on any of the following items, circle the associated number on the Catalog & Literature Card.

## Tube Caddies (39M)



A new line of tube caddies, with a vinyl covering, is now available from **Argos Products Co.** The largest model (TC-5) has a volume of 3300 cu. in. and contains a tool tray with 2 $\frac{3}{4}$ " clearance. Other models include the TC-4, the TC-100, and the TC-201. Prices range from \$21.95 for the TC-5 to \$9.95 for the small TC-201.

## VHF/UHF Antenna (40M)



360° horizontal dispersion characterizes the "Big Wheel," a clover-leaf antenna by **Cush Craft**. The unit mounts on a  $\frac{3}{4}$ " to 1 $\frac{1}{2}$ " pipe and can be used for either amateur or commercial service. A single bay has approximately 5 db gain over a halo type, while a two-bay unit gives 5.5 db over the

single bay. If more gain is desired, a four-bay arrangement will give a 7.5 db over the two-bay. Bandwidth is over 4 mc with an SWR of 1:1.2 or less.

## Replacement Pressure Pads (41M)

A package of felt pads designed to replace worn tape-recorder pressure pads is available from **Robins**. The pads, which come in packages of 40, are intended to eliminate troubles that occur when old pads wear through or become hardened with age. Virtually any model of recorder available today can be serviced from the assortment, which lists at \$1.00 for a package.



## "Protecto-Com" Display (42M)

The door-answering and fire-detection features of the **Progress Webster "Protecto-Com"** are emphasized in a dealer's display. Mounted in the display intended for use on a counter, shelf, or in a window are an IR-6 and OR-1 Remote Station and an FB2 Thermo Button. The display measures 15" x 22" x 4", and is priced at \$14.45 including equipment.



## Antenna Coil Assembly (43M)

A high-efficiency balun coil and a three-section IF trap designed to eliminate interference between TV sets are contained in the **Colman** antenna-coil assembly replacement for RCA and Admiral tuners. Mounted on a phenolic-board and metal-plate assembly, the No. 1359A will simplify the replacement of defective antenna coils in these TV sets.



## JUST WHAT YOU NEED FOR TESTING TRANSISTORS



**AC to DC  
POWER  
SUPPLY**

Plug this instrument into any 60 cps, 95/130 volt circuit and get a stabilized source of direct current, adjustable over a range from 0 to 45 volts DC, with current output 0/2.5 amperes. Filtered direct current output range 0/45 volts, 0/2.5 amperes is continuously adjustable and stabilized  $\pm 1\%$  at any setting regardless of alternating current fluctuation. Voltage regulation is approximately 5% between full load and no load at full voltage setting.

This DC Power Supply instrument is ideal for use in transistor testing, circuit testing, to provide regulated voltage for light testing, eliminates the need of batteries by supplying exact DC voltage required.

Write for Bulletin 17-BLO1 which gives full details and models available.

**ACME ELECTRIC CORPORATION**

944 Water St.

SAA3499/1952

Cuba, N. Y.

**Acme Electric**

## NEW! SARGENT ELECTRONIC CHEMICALS and FINISHES

### SARGENT TUNER CLEANER

Thoroughly cleans tuners and controls. Protects against future corrosion, oxidation and contact wear. Non-flammable.

Giant 16.4 Ounce Can **\$1.47** Dealer Net

Includes plastic extension tube.

### SARGENT GEAR AND PARTS CLEANER

Instant cleaning power for turntables, tape recorders, business machines and electronic devices. Flushes away dirt, oil and grease in gears and parts. Non-flammable.

Giant 16.4 Ounce Can **\$1.29** Dealer Net

Includes plastic extension tube.

### OTHER PRODUCTS IN THE SARGENT ELECTRONICS LINE

Red Insulator, Degreaser, Clear Acrylic Plastic, Penetrating Oil, Squeak Stopper, Enamels, Lacquers, Metallics, Engine Enamels, Stop Rust, and other Specialties.

For Free Literature and Prices, Check Your Electronics Parts Distributor, or write... **ELECTRONICS DIVISION**

**THE Sargent-Gerke Co. ©**

Producer of Paints and Chemicals for Over 60 Years

P. O. Box 729 • INDIANAPOLIS 6, INDIANA



### DC-AC Converter (44M)



275 watts of 60-cycle power is available from the **Terado** Model 50-191 "Continental" converter. The unit converts a 12-volt DC battery potential into 115 volts AC which can be used to power such appliances as shavers, dictating machines, tape recorders, and portable TV's. The 60-cycle frequency is maintained within 1 cycle regardless of changing load or input voltage. Dealer net is \$116.34.

### Citizens Band Transceiver (45M)



The transmitter and receiver sections of the **E. F. Johnson** "Personal Messenger" are crystal-controlled, and the superhet receiver has a tuned RF amplifier. This two-way radio is intended primarily for limited-range CB operation requiring no FCC license. The standard model is powered by eight "penlite" cells mounted inside the case; however, a rechargeable nickel-cadmium battery or a cigarette-lighter plug for tapping an auto-battery source can be obtained as an accessory. Also available is a leather case with shoulder strap.

### Flybacks (46M)

Three replacement flyback transformers have been added to the **Stancor** line. Intended as exact replacements for Motorola parts, these units are available for immediate delivery. HO-342 replaces Motorola 24C740969 and 24C742676; HO-343 replaces 24C744042; and HO-344 replaces 24K748397 and 24K754273-Z.

### UHF Antenna (47M)



Featuring a wire-grid reflector that concentrates the received signals on its two-bay solid dipoles, the "Sonata" Model TA-149 by **JFD**, is merchandised in a 3-color protective package. This antenna has sharp directivity, high gain, high front-to-back ratio, and plastic-tipped legs for increased mechanical stability. The TA-149 carries a list price of \$8.95.

### RF Paging System (48M)



A staff-locating system using radio frequencies is available from **Multitone Electronics**. The system solves problems encountered in installation of "Personal Call" induction-loop systems in large areas where a wired loop is impractical. When a key is pressed on the encoder, a "beep" signal is heard by the person being paged. The receiver requires one battery and is constructed of aluminum and plastic.

### Replacement Picture Tubes (49M)

Three new "universal" picture-tube types are available from **Sylvania**. The 21CBP4A, 24AEP4, and 17DKP4 will replace 20 popular types now in use, and do not require use of an ion trap. When substituted for an original type which incorporated an ion trap, the magnet assembly should be discarded. Almost one-fourth of the service shop's replacement picture-tube needs can be handled with these three types.

# GENERAL ELECTRIC TRANSISTOR MANUAL

NEW SIXTH EDITION

NOW OVER 400 PAGES OF CIRCUITS, APPLICATIONS, THEORY

- **New Experimenter's chapter** . . . 17 circuits you can use to build audio amplifiers, simple or complex receivers, a transistor tester, an audible automobile signal minder (you hear your turn indicator), code practice oscillators, a tachometer, and many more
- **Expanded Hi-Fi chapter** . . . information on stereo, hi-fi, amplifiers, preamplifiers, including circuits for very versatile 12 watt transistorized stereo amplifiers, matched preamps with base and treble controls, for use with ceramic or magnetic cartridge or tape deck
- **Expanded Radio Receiver chapter** . . . with circuits for AM and FM receivers and tuners
- **How to use a Transistor Spec Sheet** . . . complete explanation of how to interpret a spec sheet, most important characteristics, parameters

PLUS an expanded "Reader's List" of basic reference works on transistor theory and application, a new chapter explaining transistor reliability, expanded and updated comparison charts, outline drawings, over 1200 JEDEC types. This is the kind of reference information you just *have to have* . . . at home or on the job. See your G-E Semiconductor Products Distributor for your copy of the sixth edition of this industry classic, or send \$2.00 with the coupon.

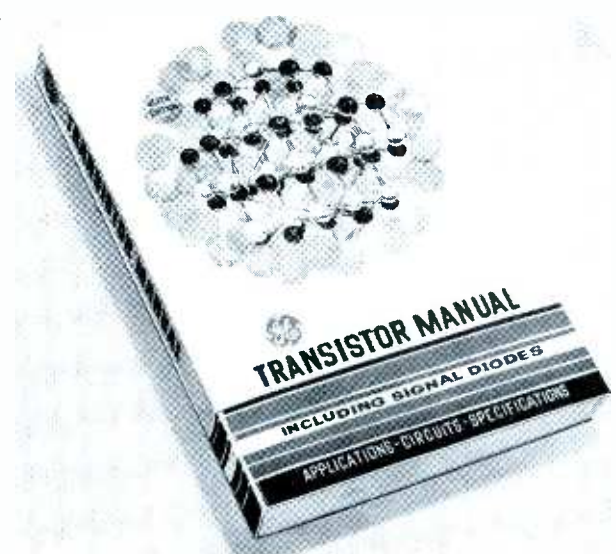

General Electric Company, Semiconductor Products Department  
Section 324128, Electronics Park, Syracuse, New York

Please send me the new 420 page 6th Edition of the General Electric Transistor Manual. I enclose \$2.00. (No stamps, please.)

Name \_\_\_\_\_

Address \_\_\_\_\_

City \_\_\_\_\_ Zone \_\_\_\_\_ State \_\_\_\_\_

GENERAL  ELECTRIC





# This One Picture Tube...



## Replaces 19 Types

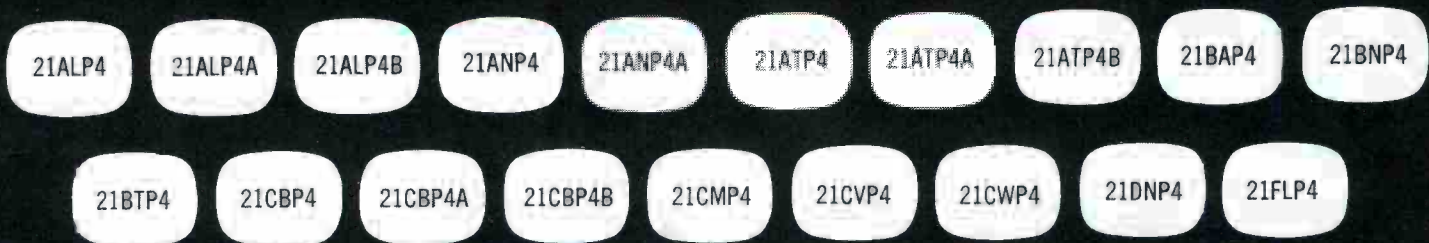

## RCA-21CBP4A UNIVERSAL SILVERAMA® PICTURE TUBE

may be installed in place of any of the above types, regardless of manufacturer.

Think of the simplicity, economy and efficiency of having just one picture tube type to take care of OVER 25% of your replacement needs. That's exactly what you get with the RCA-21CBP4A, one of a growing family of universal Silverama picture tubes designed to help you cover the maximum number of sockets with the minimum number of types. Other universal types are listed on the chart, below left.

RCA Silverama "Universal" Type	Replacing	
17BJP4	17ATP4 17ATP4A 17AVP4 17AVP4A	17BJP4 17BUP4 17CBP4 17CLP4
21AMP4A	21ACP4 21ACP4A 21AMP4 21AMP4A	21AQP4 21AQP4A 21BSP4 21CUP4
21DEP4A	21DAP4 21DEP4	21DEP4A 21CZP4
24CP4A	24ADP4 24CP4 24CP4A 24QP4	24TP4 24VP4 24VP4A 24XP4

Like all Silverama picture tubes, these universal types are made with all-new electron gun, finest parts and materials, and a high-quality glass envelope that has been thoroughly inspected, cleaned and rescreened prior to reuse.

Start simplifying picture tube replacement problems now. See your Authorized RCA Distributor this week about the new line of universal Silverama picture tubes.

**Silverama Picture Tubes are advertised nationally over NBC-TV**

RCA Electron Tube Division, Harrison, N. J.



The Most Trusted Name in Television

# WHAT'S IN A FUSE?

Only a fuse element, glass & caps?

No! Every fuse carries  
with it the skill and quality of its manufacturer.

You can't reach out and touch or taste this,  
you can't even be sure it will do  
its job when needed except  
by purchasing from a company  
that has the know how of 30 years  
of manufacturing fine fuses.

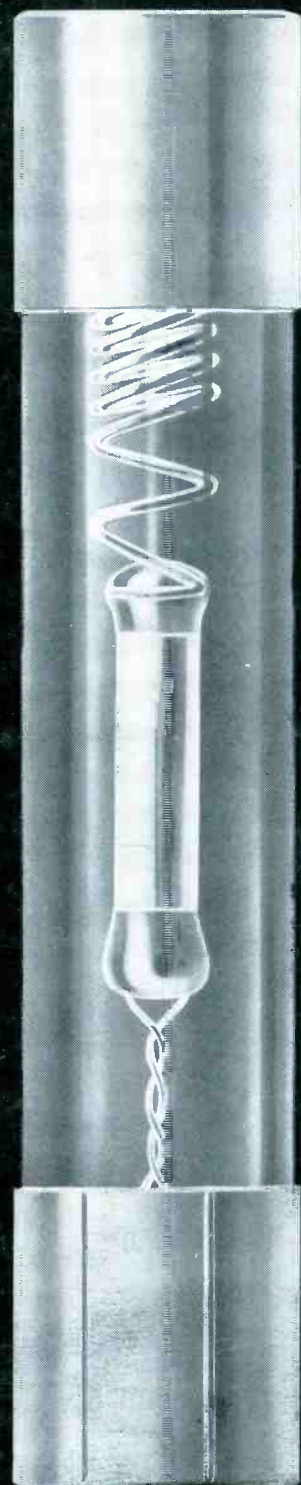
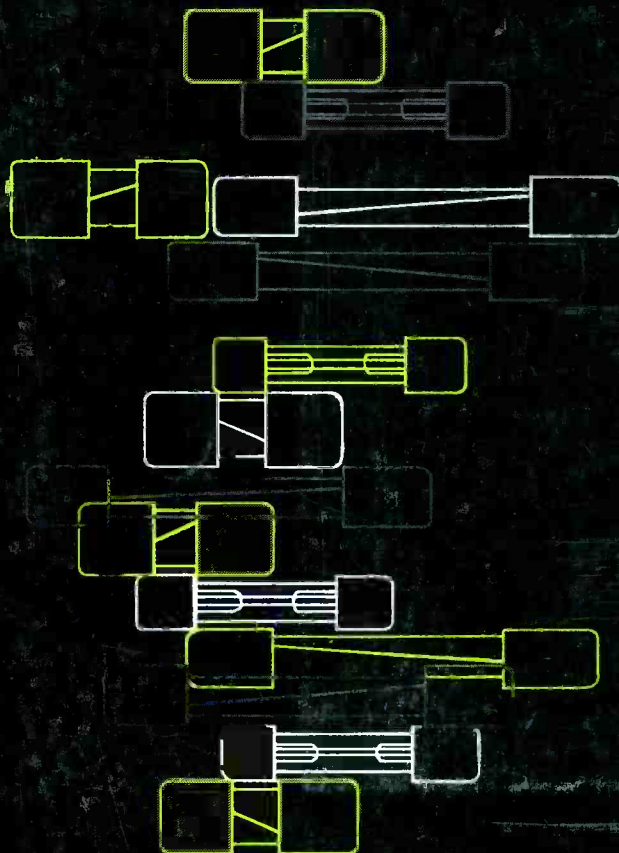

BURTON BROWNE ADVERTISING

## LITTELFUSE

1865 Miner Street - Des Plaines, Illinois