

FEBRUARY, 1962

35 CENTS



# PHOTOFACT REPORTER

including **Electronic Servicing**



GETTING  
INTO THE  
*Background Music  
Business*

Restoring Horizontal Sweep  
Selective Calling Ends Hubbub in  
Mobile Radio

What's Different About FM  
Radio Servicing?

ROBERT G. KATRAVEN  
803 HEUSS AVE.  
SCHOFFIELD, WISCONSIN

# TOP

**Higher Gain**

**Lower Noise**

# OF THE HEAP

85% of all TV servicemen prefer Standard turret type replacement TV tuners.

1 year guarantee backed by the world's largest TV tuner manufacturer.

Trade-in allowance for the defective tuner being replaced.

**In TV It's Standard**

See your local authorized Standard Coil Distributor

## **standard kollisman**

**INDUSTRIES INC.**

FORMERLY STANDARD COIL PRODUCTS CO., INC., MELROSE PARK, ILLINOIS

# TRIPLETT

## HAND SIZE

### USES UNLIMITED:

Field Engineers  
Application  
Engineers

Electrical,  
Radio, TV,  
and Appliance  
Servicemen

Electrical  
Contractors

Factory  
Maintenance  
Men

Industrial  
Electronic  
Maintenance  
Technicians

Home Owners,  
Hobbyists



MODEL

## 310 VOLT-OHM-MILLIAMMETER

# World's Largest Selling POCKET SIZE V-O-M

### FACTS MAKE FEATURES:

- 1** Hand size and lightweight, but with the features of a full-size V-O-M.
- 2** 20,000 ohms per volt DC; 5,000 AC.
- 3** EXCLUSIVE SINGLE SELECTOR SWITCH speeds circuit and range settings. The first miniature V-O-M with this exclusive feature for quick, fool-proof selection of all ranges.

SELF-SHIELDED Bar-Ring instrument; permits checking in strong magnetic fields • Fitting interchangeable test prod tip into top of tester makes it the common probe, thereby freeing one hand • UNBREAKABLE plastic meter window • BANANA-TYPE JACKS—positive connection and long life.

■ Price—only \$37.50; leather case \$3.20.

Available For Immediate Delivery From Your Triplett Distributor's Stock

THE TRIPLETT ELECTRICAL INSTRUMENT COMPANY, BLUFFTON, OHIO

FOR EVERY PURPOSE—THE WORLD'S  
MOST COMPLETE LINE OF V-O-M'S

**NEW  
AND MOST  
VERSATILE**

**TRIPLET**



**MODEL  
850  
\$79.50**

## **MODEL 850 ELECTRONIC VOLT-OHMMETER IS BEST FOR YOU**

### **FACTS MAKE FEATURES:**

- 1** Long 7" easy-to-read scale.
- 2** .5 D.C. volt range for transistor circuits.
- 3** HIGH STABILITY. Meter connected in cathode circuit of 12AU7.

High Input Impedance (11 MEGOHMS) and wide Frequency Ranges give this extremely versatile Electronic Volt-Ohmmeter considerable advantage in the measurement of DC voltages, AC RMS and Peak-to-Peak voltages. It measures directly the Peak-to-Peak values of high-frequency complex wave forms and RMS values of sine waves on separate scales.

**ADDED PROTECTION.** Meter is shorted out in OFF position for greater damping, meter safety during transit, electrically protected against accidental overload. ZERO CENTER mark for FM discriminator alignment, plus other galvanometer measurements.

New pencil thin test probe used for all functions: DC, AC, and ohms. No need to change cables. Beautifully styled case for professional appearance and functional utility, 7 $\frac{5}{8}$ " x 6 $\frac{1}{16}$ " x 3 $\frac{3}{4}$ ".

Carrying handle can be used as a tester stand to place the tester at 25° angle for ease in reading.

Frequencies to 250 MC may be measured with auxiliary Diode Probe, \$7.50 extra. DC voltages to 50 KV may be measured with auxiliary High Voltage Probe. \$20.50 extra.

**TRIPLET ELECTRICAL INSTRUMENT COMPANY, BLUFFTON, OHIO**

**THE WORLD'S MOST COMPLETE LINE OF V-O-Ms. AVAILABLE FROM  
YOUR TRIPLET DISTRIBUTOR'S STOCK**

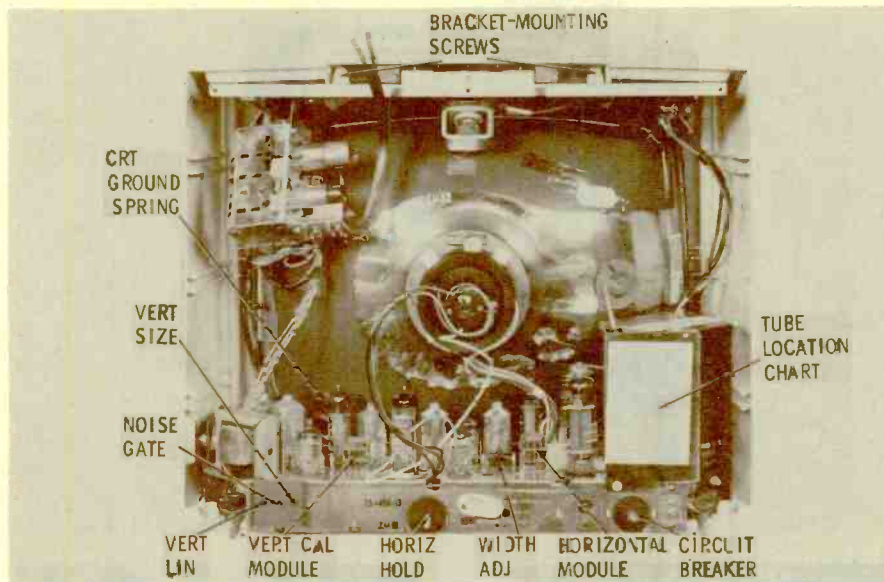

### Motorola Model 19P15BEH Chassis TS-449A-03

The Model 19P15 is one example of Motorola's new line of low-priced portable TV sets, using 110° deflection and a 19CHP4 self-focusing CRT.

The big news in this series is the introduction of a whole lineup of new tube types. A group of 300-ma tubes are used in two parallel filament strings which are, in turn, wired in series with the damper, RF amplifier, and mixer-oscillator tube heaters — all three of which are 600-ma types. Among the new tubes are: 7HG8/PCF86 mixer-oscillator, 6EH7/EF183 first video IF, 6EJ7/EF184 second video IF, 15HB6 video output, 27GB5/PL500 horizontal output, and 16AQ3/XY88 damper. In addition, 15CW5/PL84's are used in the vertical-output and audio-output stages, and 9A8/PCF80's serve in the AGC, vertical oscillator-sound IF, and horizontal oscillator-sync amplifier circuits. Conventional tube types include a 6DT6 sound detector, a 4GK5 low-noise RF amplifier, and a 3A3 or 3AW3 high-voltage rectifier.

The 27GB5/PL500 horizontal output tube is a *novar* type, located next to the high-voltage cage. It is shown with the damper and the HV rectifier.

Under-chassis components can be reached by removing the rear cover, extracting four chassis screws, and sliding the chassis partly out of the cabinet. To take the chassis from the cabinet, the handle and the tuner-and-control bracket must be removed. The handle is secured by two pins which can be pushed out with a small screwdriver; the control bracket is held in place by four screws.

The B+ circuit uses a single silicon rectifier in a half-wave circuit, producing 145 volts DC. It is protected by a thermal-overload circuit-breaker, and by a 7.5-ohm, 10-watt fusible resistor. Each of the 300-ma filament strings contains a protective wirewound resistor.

The vertical adjustments and the noise-gate control are combined in a printed-circuit module. The noise-gate control adjusts the bias in the noise inverter; this stage, using part of a 9A8/PCF80, controls the amount of degenerative feedback in the video amplifier. Horizontal size can be adjusted by changing a jumper connection (covered with tape in the photo). AGC is keyed, and no control is provided. Most of the components in the horizontal and vertical oscillators are contained in two plug-in modules, shown in the rear-view picture.

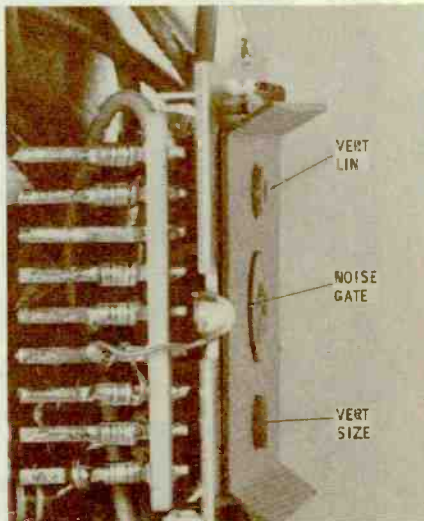
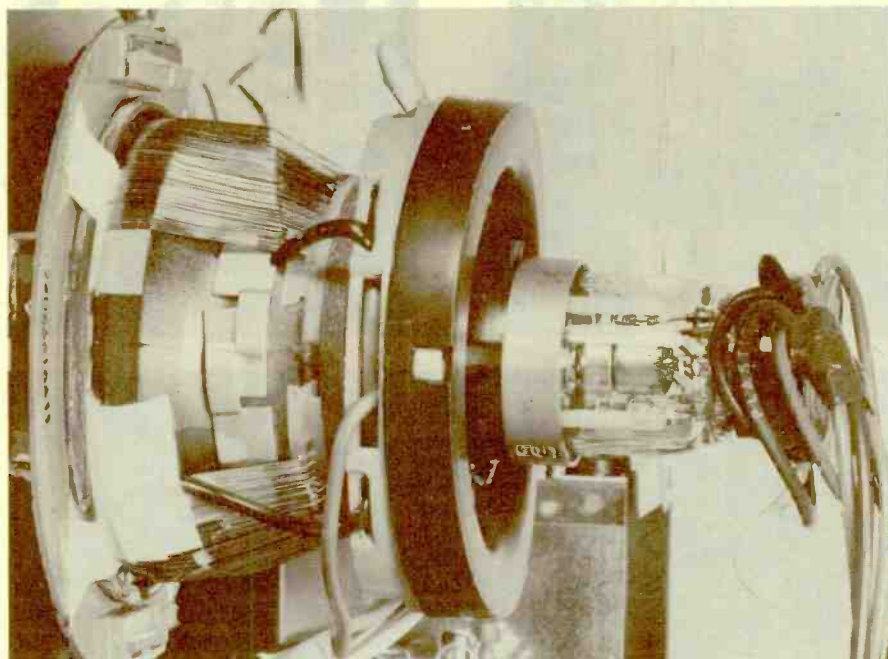

PF REPORTER for February, 1962, Vol. 12 No. 2. PF REPORTER is published monthly by Howard W. Sams & Co., Inc., 2201 E. 46th St., Indianapolis 6, Indiana. Second-class postage paid at Indianapolis, Indiana. 1, 2 & 3 year subscription prices: U.S.A., its possessions, and Canada \$4.00, \$7.00, \$9.00. All other countries: \$5.00, \$9.00, \$12.00. Current single issues 35c each; back issues 50c each.



**Packard-Bell  
Model 2MN360M  
Chassis 98D14**

This chassis is one of Packard-Bell's Award (98) series. The 27" models use a 90° 27VP4 aluminized CRT, while the 23" sets use a 114° aluminized 23MP4. In the 27" models, the horizontal output circuit is altered to increase the ability of the stage to provide adequate sweep for the larger CRT, and to accommodate the yoke characteristics.

Circuits in the set include: A noise-cancelling arrangement known as ANI or automatic noise inverter, with a control to set the bias on the tube (one-half of a 12AX7) for optimum results; a DC restorer which can be activated by pulling outward on the brightness-control knob, and which assists in maintaining a constant "black level" of the picture; AGC, which is developed in a keyed-type circuit, and can be adjusted to suit signal conditions; a picture-fidelity control which adjusts the amount of video signal applied to the video output stage; and a separate horizontal-blanking amplifier. Some models include, in addition, an automatic brightness control. This consists of a light-sensitive resistor connected to control the voltage on the cathode of the CRT; any change in room lighting results in an automatic compensation in the CRT beam intensity.

Removing the back cover from the cabinet is a simple operation; turning a locking device (see photo) and pressing a few clips (one of these is also shown) releases the entire cover board. The inside of the cabinet is covered with foil, providing an effective shield from external radiations, and confining the set's own radiations. Once exposed, the chassis can be pivoted outward, after removing two screws — indicated at the lower right in the rear-view photo — and disconnecting the high-voltage lead.

These chassis can be equipped with either of two types of remote control. One type provides for two control functions and an on-off function, while the other permits four control functions in addition to the on-off action. The remote-control units can be installed in the field by simply removing the jumpers from the remote-control sockets and inserting the plugs from the remote chassis.

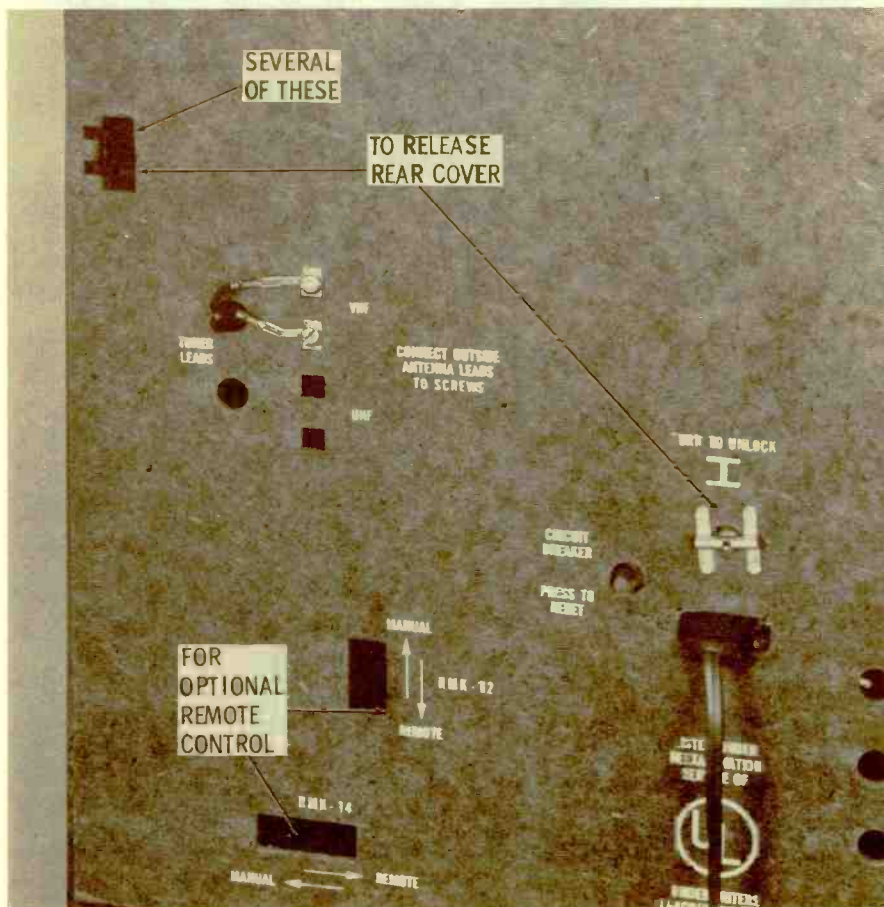
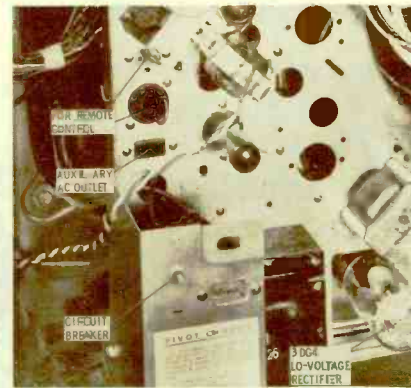
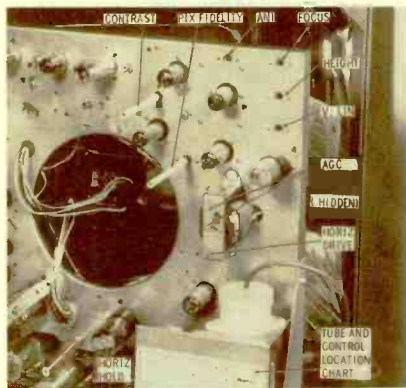
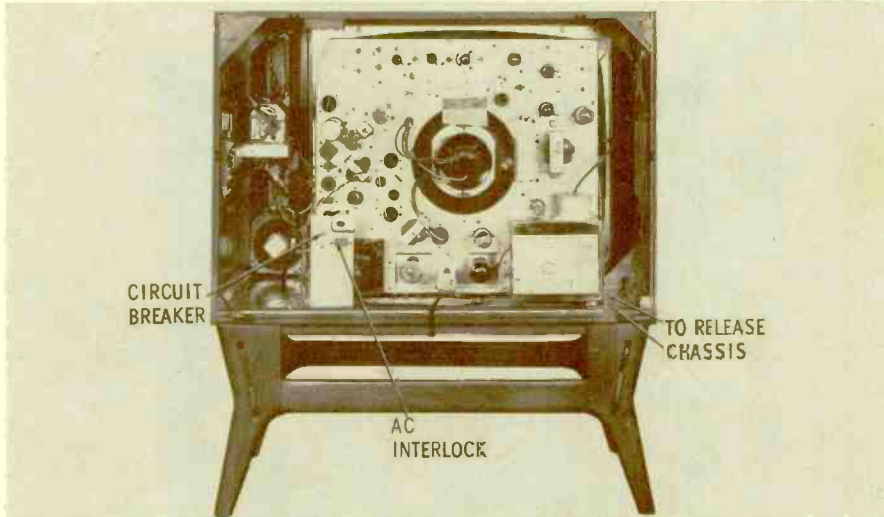

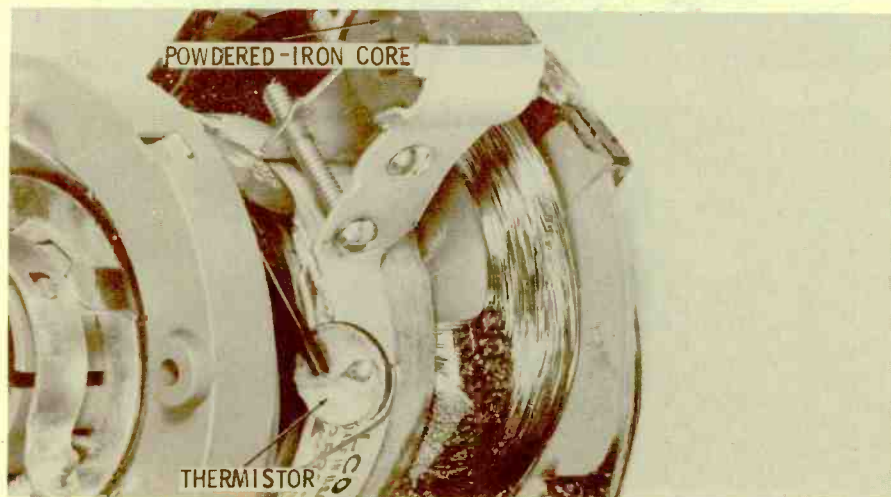
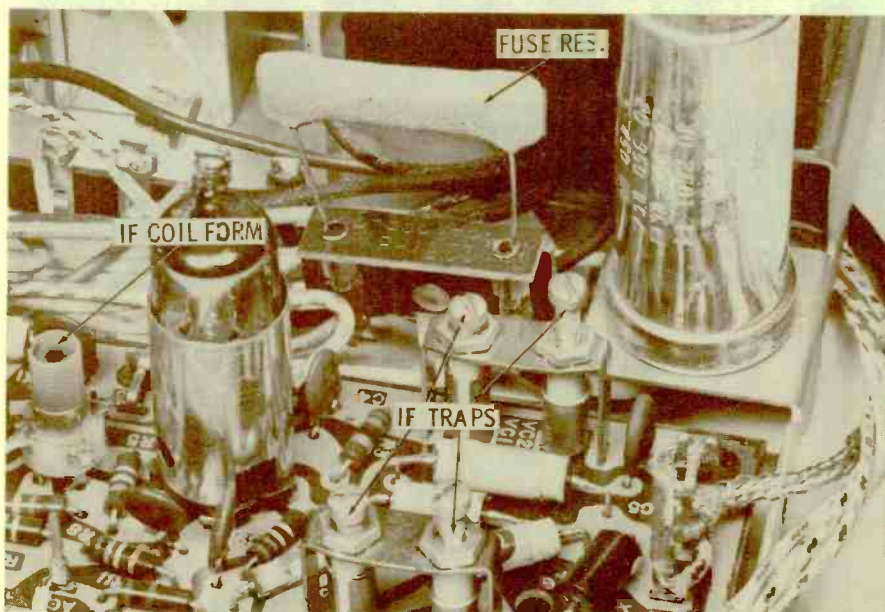
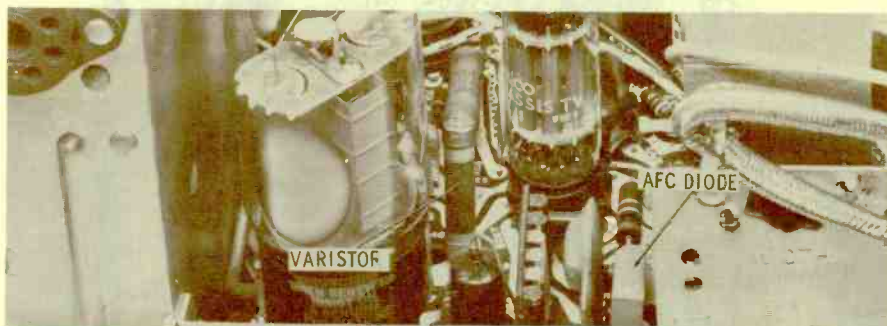
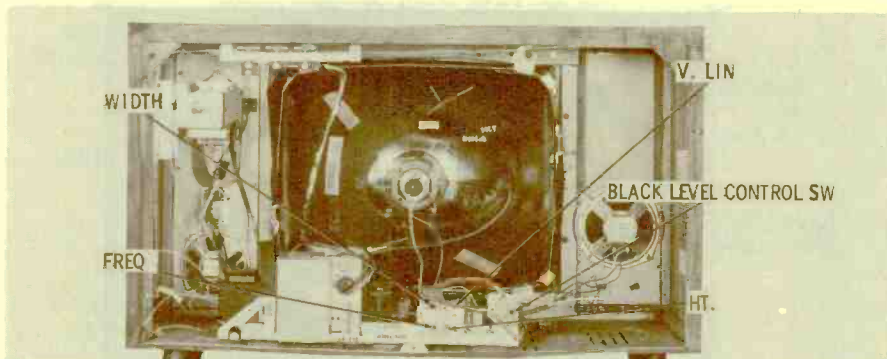

## Philco Model K4850WA Chassis 12N53

This chassis is a member of the Philco "Custom" line of TV receivers. It uses a 110° aluminized 23BNP4 bonded CRT in most models, although a 23CP4 is used in some. When a 23CP4 is used, a 120K-ohm resistor, which is mounted on a terminal board, must be added across the brightness control.

A few unusual tube types are found in this series, among them a 6HJ8 third video IF and video detector, a 6HZ8 video output and sync separator, and a 6FD7 vertical oscillator-output.

The power supply features an isolation transformer and a conventional silicon-rectifier doubler circuit. The rectifiers are protected by the usual 5.6-ohm fusible resistor, visible in the close-up photo of the IF traps.

The ganged IF traps are somewhat standard with Philco, but deserve some mention. They provide highly-efficient filters for adjacent-channel and/or other unwanted interference signals. They are located at the input to the first video-IF amplifier, trapping out undesirable frequencies before they can be amplified by the IF stages.

A varistor — a voltage-sensitive resistor — is shown beside the 6DQ6B horizontal-output tube. This component reacts to pulses supplied by the flyback transformer, altering the drive to the grid of the horizontal output tube; it functions somewhat like a regulator, maintaining a more constant level of grid drive. The AFC dual diode, a plug-in type, is visible in the same photo.

A control called *horizontal centering* will be seen on these chassis; the function of this adjustment is to center the range of the horizontal hold control, *not* to center the picture as might be anticipated. An *auxiliary brightness control* sets the effective range of the main brightness control, by changing the amount of voltage which reaches the main control. A *DC-AC Black-Level control switch* (at the lower right corner in the rear-view photo) permits a choice of AC or DC coupling to the CRT cathode. This switch is also referred to as the "picture switch."

The close-up view of the deflection yoke reveals a ferrite linearity magnet, which affects the horizontal linearity. The *thermistor* used in series with the vertical coils is also visible.

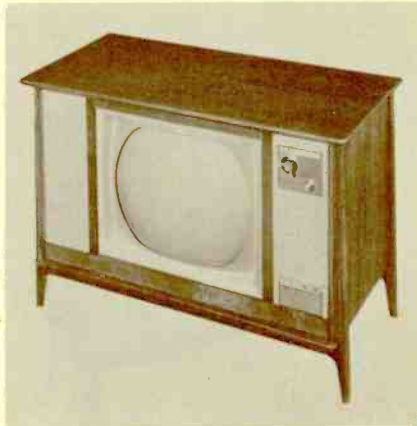

**Zenith Model 5040W  
Color TV  
Chassis 29JC20**

Zenith's entry into the color-TV field is represented by this model. The CRT, a 21FBP22 glass type, has a bonded safety plate.

Featuring hand-wired design (using solder-cone terminals for connecting small parts), the chassis incorporates a few new tube types. A 6HS8 is used as a gated AGC-sync separator, a 6HB6 serves as a luminance (video) amplifier, and two 6JH8's are incorporated as the B-Y and R-Y demodulators. Modern 6EH7 and 6EJ7 frame-grid tubes are found in the video-IF stages, and a pair of 3DG4 rectifiers are in a transformer power supply.

Separate diodes are provided as detectors for the video and for the 4.5-mc sound-IF and sync signals. The sound-IF signal, instead of going directly to the sound detector stage, is preamplified, limited (to improve the noise-rejection characteristics), and then applied to the 6BN6 gated-beam detector. The preamplifier stage also amplifies the sync signals, which are separated from the sound-IF signals in the output.

The crystal-controlled 3.58-mc reference oscillator is a modified form of the Pierce circuit — shown in the schematic. Color-burst and reference-oscillator signals are compared in a phase detector, and the resultant correction voltage governs the bias of a reactance stage which controls the phase of the 3.58-mc oscillator signal.

The operating controls are in a covered escutcheon panel, plainly labeled for the viewer's convenience, as the photo shows. The AGC and vertical-linearity adjustments are recessed behind the control panel.

Many of the service adjustments are mounted, for easy access, on the rear apron of the chassis. Certain test points are available at a terminal strip near the rear of the chassis. The *horizontal efficiency* control is similar to what is usually known as the horizontal linearity control. The delay-line termination adjustment controls the delay of the luminance channel (video) signal so it will reach the CRT in proper phase with the chrominance channel (color) information.

Convergence adjustments are simplified by the labeling arrangement on the convergence panel. Each control is plainly marked, according to the section of the raster affected when it is adjusted.

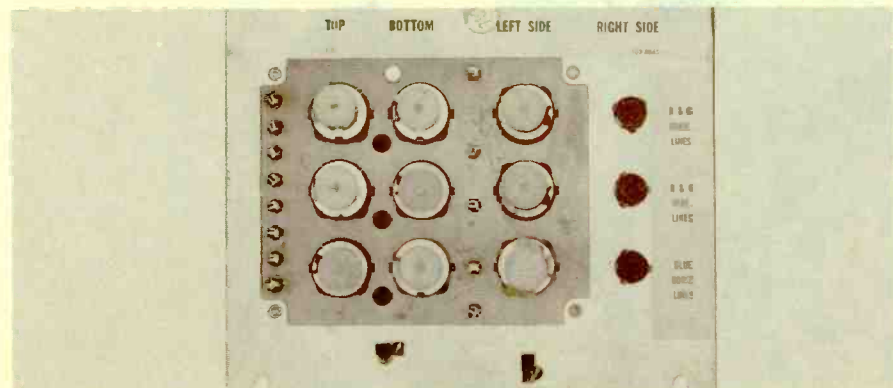
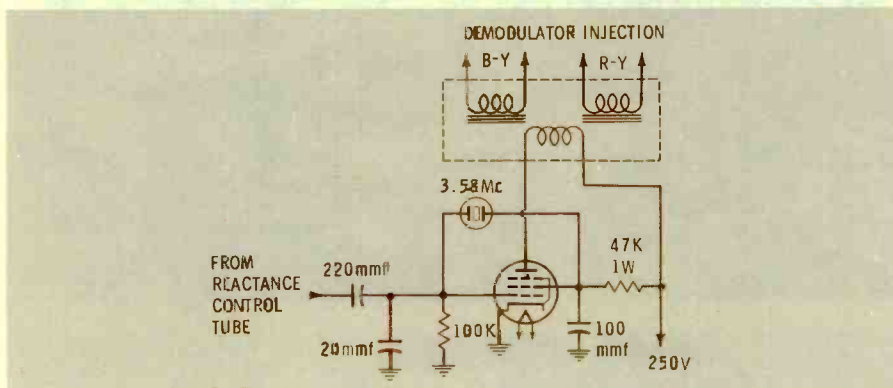
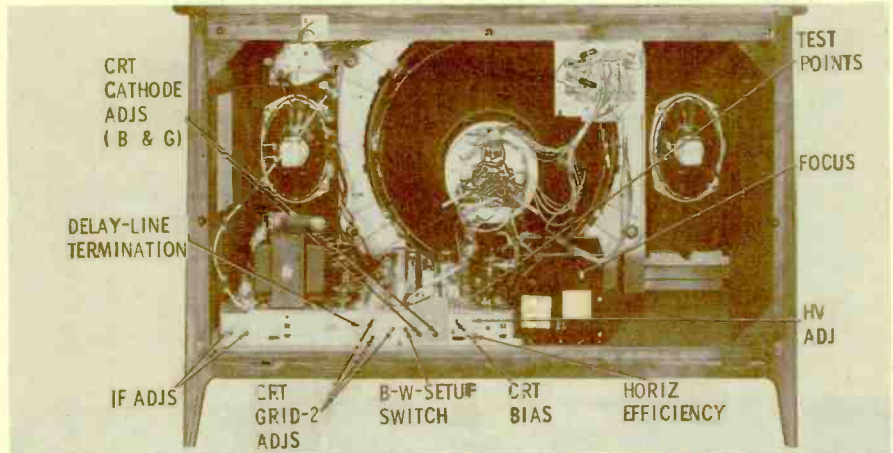



See PHOTOFAC Set 512, Folder 2

Mfr: General Electric Chassis No. M6

Card No: GE M6-1

Section Affected: Raster.

Symptoms: No raster; no boost B+.

Cause: Vertical output transformer shorted to ground.

What To Do: Replace T2.

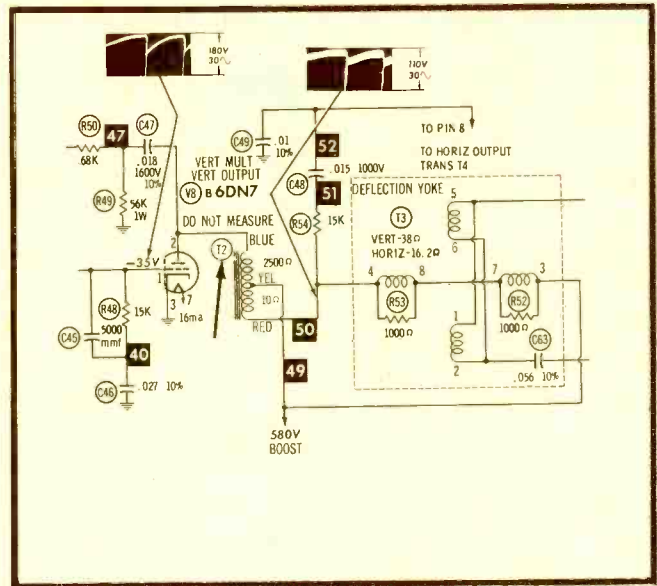

See PHOTOFAC Set 512, Folder 2

Mfr: General Electric Chassis No. M6

Card No: GE M6-2

Section Affected: Pix.

Symptoms: Erratic video (sudden change in contrast); or inability to vary contrast, accompanied by smearing which increases as contrast control is turned counterclockwise.

Cause: Defective contrast control.

What To Do: Replace R4B.

Note: Contrast-control damage may be caused by removal of audio output tube V7 (6CU5), an open video output tube V4A (6CX8), an open R25, or a short to ground from the 120-volt line.

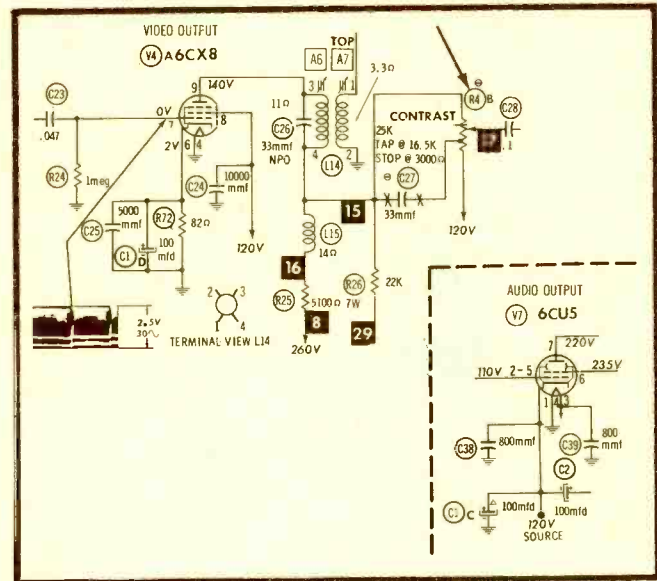

Mfr: General Electric Chassis No. M6

Card No: GE M6-3

Section Affected: Raster.

Symptoms: Insufficient vertical sweep. Low voltage at pin 5 of V8.

Cause: Plate resistor of vertical multivibrator has increased in value.

What To Do: Replace R44 (1.5 meg).

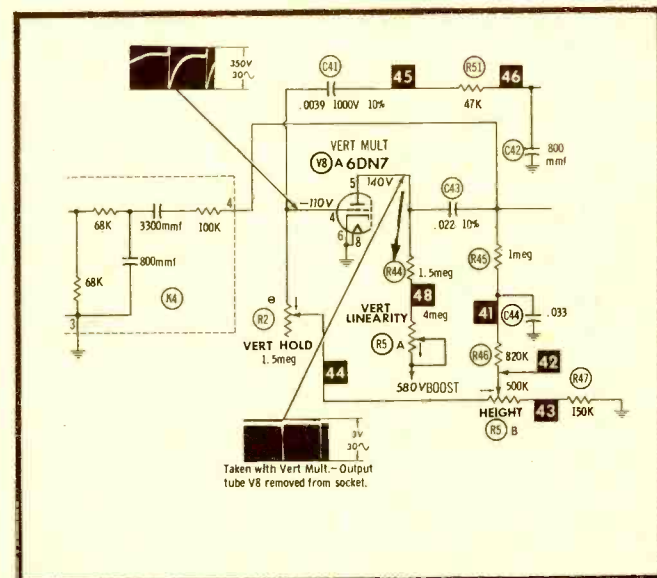

See PHOTOFACT Set 512, Folder 2

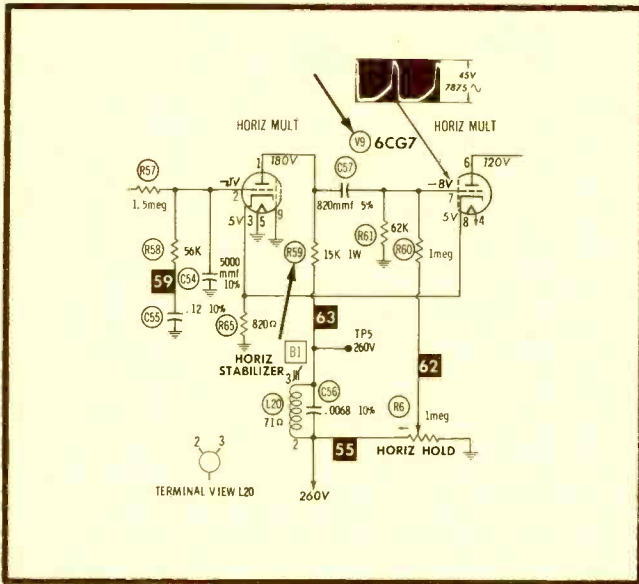

See PHOTOFACT Set 512, Folder 2

Mfr: General Electric Chassis No. M6

Card No: GE M6-4

Section Affected: Raster.

Symptoms: No raster; no high voltage. Low plate voltage at pin 1 of V9.

Cause: Open plate resistor in horizontal multi-vibrator.

What To Do: Replace R59 (15K) and check V9 (6CG7).

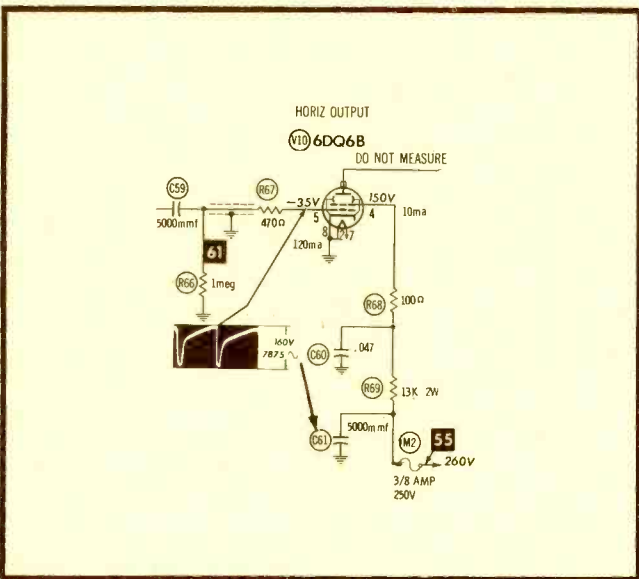

Mfr: General Electric Chassis No. M6

Card No: GE M6-5

Section Affected: Raster.

Symptoms: No raster; no high voltage. Fuse M2 blown.

Cause: Shorted screen bypass capacitor in horizontal output stage.

What To Do: Replace C61 (5000 mmf).

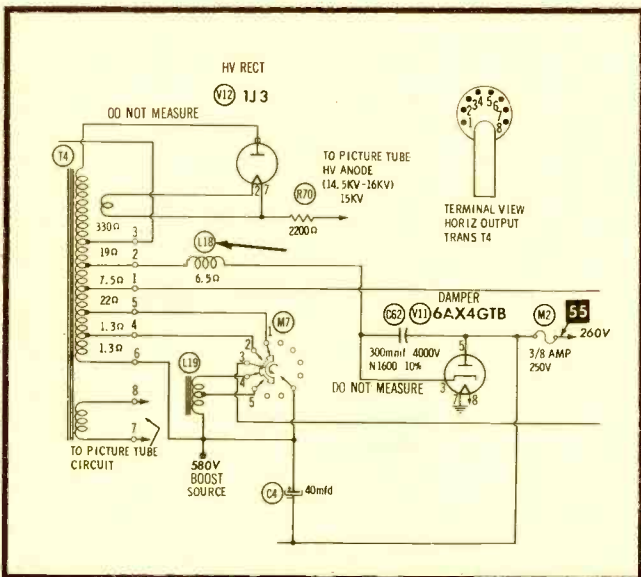

Mfr: General Electric Chassis No. M6

Card No: GE M6-6

Section Affected: Raster.

Symptoms: Raster flashes off and on.

Cause: Damper choke opens intermittently.

What To Do: Replace L18 (10-microhenry RF choke).

See PHOTOFACT Set 501, Folder 2

Mfr: Trav-Ler Chassis No. 1150-59

Card No: TR 1150-59-1

Section Affected: Raster.

Symptoms: Insufficient width.

Cause: Resistor in horizontal yoke circuit has decreased in value.

What To Do: Replace R57 (6800 ohms).

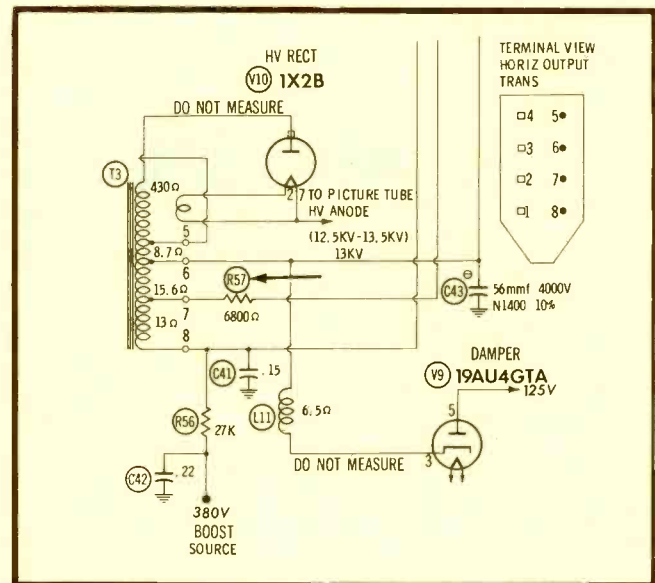

See PHOTOFACT Set 501, Folder 2

Mfr: Trav-Ler Chassis No. 1150-59

Card No: TR 1150-59-2

Section Affected: Raster.

Symptoms: Vertical foldover at bottom of raster. Insufficient negative voltage on control grid (pin 5) of V6.

Cause: Leaky coupling capacitor in vertical multivibrator.

What To Do: Replace C27 (.082 mfd).

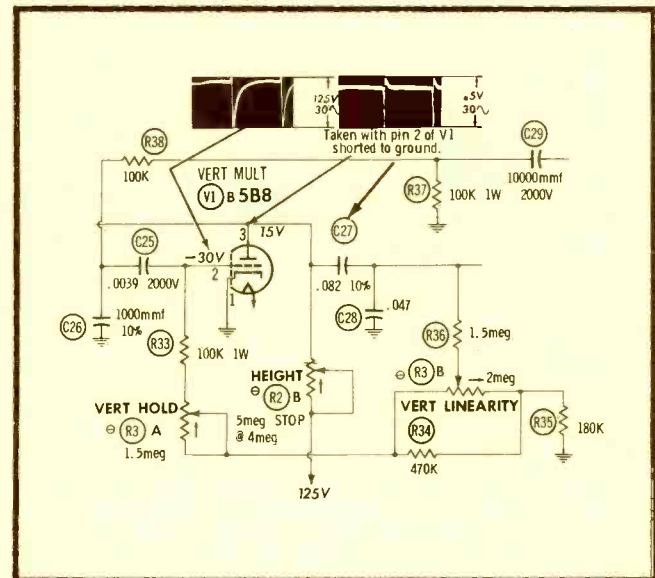

Mfr: Trav-Ler Chassis No. 1150-59

Card No: TR 1150-59-3

Section Affected: Sync.

Symptoms: Picture drifts out of horizontal sync. Incorrect voltage on cathodes (pins 3 and 8) of V7.

Cause: Cathode resistor of horizontal multivibrator changes value.

What To Do: Replace R48 (1200 ohms).

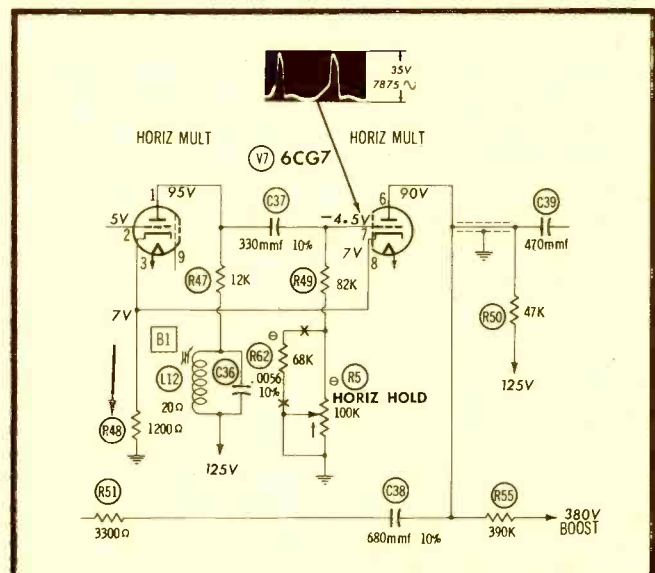

See PHOTOFACT Set 501, Folder 2

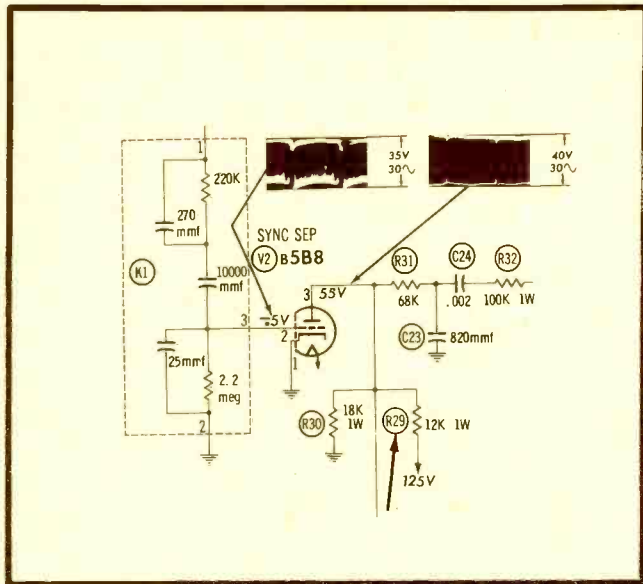

See PHOTOFACT Set 501, Folder 2

Mfr: Trav-Ler Chassis No. 1150-59

Card No: TR 1150-59-4

Section Affected: Sync.

Symptoms: Poor horizontal hold. Incorrect voltage on plate (pin 3) of V2B.

Cause: Voltage-divider resistor in plate circuit of V2B has overheated and changed value because of defect in V2B.

What To Do: Replace R29 (12K - 1W) and V2 (5B8).

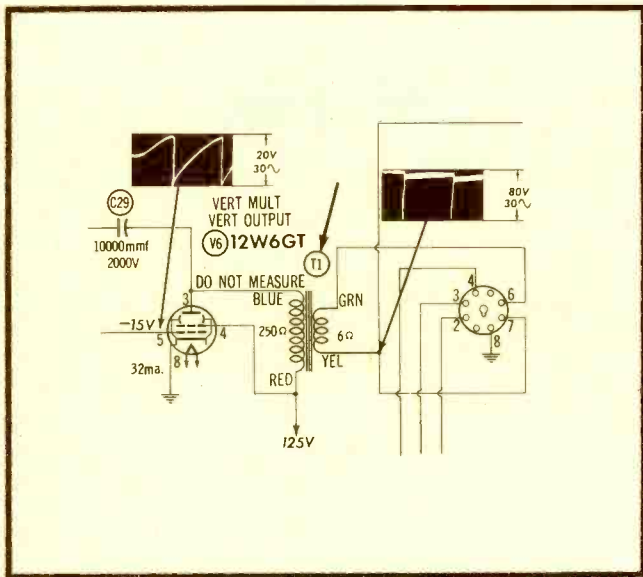

Mfr: Trav-Ler Chassis No. 1150-59

Card No: TR 1150-59-5

Section Affected: Raster.

Symptoms: Insufficient vertical sweep. Amplitude of output waveform (at yellow lead of T1) is low. Otherwise, circuit voltage and resistance values check OK.

Cause: Defective vertical output transformer.

What To Do: Replace T1.

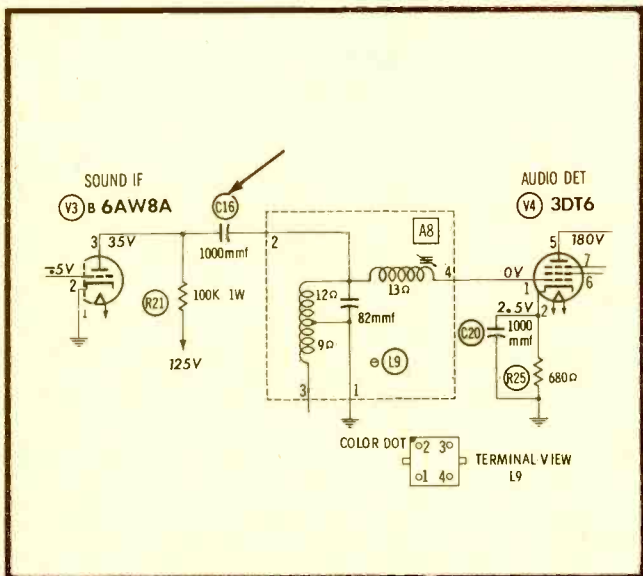

Mfr: Trav-Ler Chassis No. 1150-59

Card No: TR 1150-59-6

Section Affected: Sound.

Symptoms: Weak and distorted sound. Positive voltage on grid (pin 1) of V4.

Cause: Leaky coupling capacitor between sound IF and audio detector.

What To Do: Replace C16 (1000 mmf).

Tarzian offers

# FAST, DEPENDABLE TUNER REPAIR SERVICE

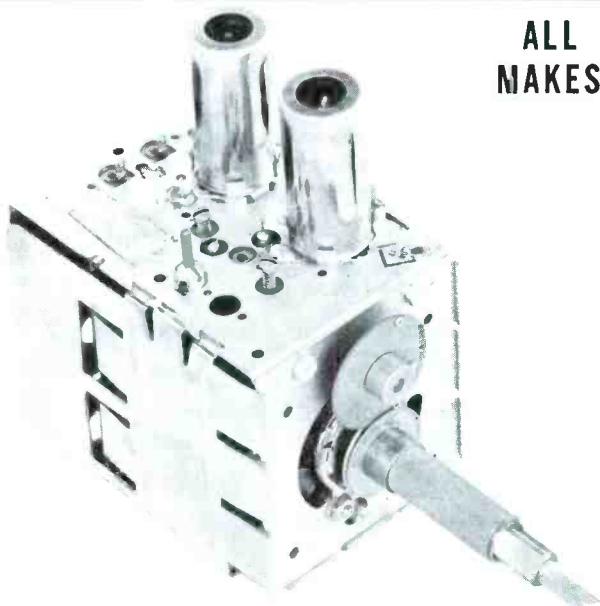

ALL  
MAKES

ONLY  
**\$850**  
INCLUDING

**ALL PARTS  
and LABOR**

**24-HOUR SERVICE  
6-MONTH WARRANTY**

**Tuners Repaired on  
Approved, Open Accounts**

**See your distributor, or  
use this address for fast,  
factory repair service**

It just makes sense that a manufacturer of tuners should be better-qualified, better-equipped to offer the most dependable tuner repair and overhaul service.

Sarkes Tarzian, Inc., pioneer in the tuner business, maintains a complete, well-equipped Factory Service Dept.—assisted by Engineering personnel—and staffed by specialized technicians who handle **ONLY** tuner repairs . . . on **ALL** makes and models.

Tarzian-made tuners received one day will be fixed and shipped out the next. Cost is only \$8.50 and \$15 for UV combinations. That includes **ALL** parts (except tubes which are furnished at our cost) and labor, and a 6-month guarantee against defective workmanship and parts failure due to normal usage. Replacements available at low cost on tuners beyond practical repair.

Ⓜ Tarzian-made tuners are identified by this stamping. When inquiring about service on other tuners, always give tube complement . . . shaft length . . . filament . . . voltage . . . series or shunt heater . . . IF frequency . . . chassis identification. All tuners repaired on approved, open accounts. Check with your local distributor for Sarkes Tarzian replacement tuners, replacement parts, or repair service.

SERVICE MANAGER • TUNER DIVISION • DEPT. 3A



**SARKES TARZIAN INC**

*east hillside drive • bloomington, indiana  
edison 2-7251*

MANUFACTURERS OF TUNERS . . . SEMICONDUCTORS . . . AIR TRIMMERS . . . FM RADIOS . . . AM-FM RADIOS . . . AUDIO TAPE . . . BROADCAST EQUIPMENT and SHISH-KABOB GRILLES

**publisher**  
Howard W. Sams

**general manager**  
Mal Parks, Jr.

**editor**  
Verne M. Ray

**associate editors**  
Forest H. Belt  
James F. Galloway  
Thomas A. Lesh

**consulting editors**  
William E. Burke  
Robert B. Dunham  
Joe A. Groves  
George B. Mann  
C. P. Oliphant  
Paul C. Smith

**art director**  
Anthony M. Andreone

**advertising & editorial assistants**  
Georgeanna Caldwell  
Paula Haffner  
Ruth E. Bastin

**production manager**  
Robert N. Rippey

**circulation fulfillment**  
Pat Tidd, Mgr.  
Constance Bland, Ass't.  
Katherine Smith, Ass't.

**photography**  
Robert W. Reed

**advertising sales offices**  
**midwestern**

John Groce, advertising sales manager  
PF REPORTER  
2201 East 46th Street, Indianapolis 6, Ind.  
CLifford 3-6441

**eastern**

Charles Horner  
Howard W. Sams & Co., Inc.  
3 West 57th Street,  
New York, N. Y.  
MURray Hill 8-6350

**western**

The Maurice A. Kimball Co., Inc.  
2550 Beverly Blvd., Los Angeles 57, Calif.  
Dunkirk 8-6178; and 681 Market Street,  
San Francisco 5, Calif. EXbrook 2-3365

Address all correspondence to  
PF REPORTER, 2201 East 46th Street,  
Indianapolis 6, Indiana



Copyright © 1962 by Howard W. Sams & Co., Inc. PF REPORTER is a trademark of Howard W. Sams & Co., Inc. No part of PF REPORTER may be reproduced without written permission. No patent liability is assumed with respect to use of information herein. Acceptance of advertising does not in any manner signify the products, policies and services so advertised have been approved, endorsed or recommended by this magazine.

Indexed in *Lectrodex*.  
Printed by the Waldemar Press Div.  
of Howard W. Sams & Co., Inc.



# PF REPORTER

including **Electronic Servicing**

VOLUME 12, No. 2      **CONTENTS**      FEBRUARY, 1962

<b>Previews of New Sets</b>	<b>3</b>
<small>Motorola Model 19P15 (Chassis TS-449A), Packard-Bell Model 23DC10M (Chassis 98D14), Philco Model K-4850WA (Chassis 12N53), Zenith Model 5040W (Chassis 29JC20).</small>	
<b>Video Speed Servicing</b>	<b>7</b>
<b>Letters to the Editor</b>	<b>16</b>
<b>The Electronic Scanner</b>	<b>26</b>
<b>Getting Into the Background Music Business</b>	<b>28</b>
<small>Len Buckwalter Audio Facts—This sideline can make "sweet music" on the cash register.</small>	
<b>The Right Way to Install Antennas</b>	<b>30</b>
<small>Watch us turn a horrible example into a professional job.</small>	
<b>Speedier Servicing With a Scope</b>	<b>32</b>
<small>Allan F. Kinckiner Shop Talk—It may not solve all your problems by itself, but it's often a big help.</small>	
<b>Selective Calling Ends Hubbub in Mobile Radio</b>	<b>34</b>
<small>Allan Lytel Stations need not receive messages that don't concern them.</small>	
<b>Restoring Horizontal Sweep</b>	<b>36</b>
<small>Mike Martynec Quicker Servicing—Basic test procedures for bringing back a lost raster.</small>	
<b>How to Save \$ on Your Federal Income Tax</b>	<b>42</b>
<small>Art Margolis Dollar and Sense Servicing—Careful accounting will more than repay you for the time spent.</small>	
<b>What's Different About FM Radio Servicing?</b>	<b>48</b>
<small>Leonard Feldman For one thing, this activity is enjoying healthy growth.</small>	
<b>Stock Guide of Communications Tubes</b>	<b>60</b>
<b>Notes on Test Equipment</b>	<b>62</b>
<small>Forest H. Belt Lab reports on the RCA Model WG-360A Phase Checker and EICO Model 250 AC VTVM.</small>	
<b>The Troubleshooter</b>	<b>69</b>
<b>Product Report</b>	<b>86</b>
<b>Free Catalog &amp; Literature Service</b>	<b>90</b>
<b>Monthly Index</b>	<b>on free literature card</b>

## ABOUT THE COVER

If you find the background on this month's cover soothing and relaxing, our artist has succeeded in conveying a visual impression of background music. To learn more about the service dealer's place in the rapidly expanding market for background-music systems, see the article beginning on page 28.



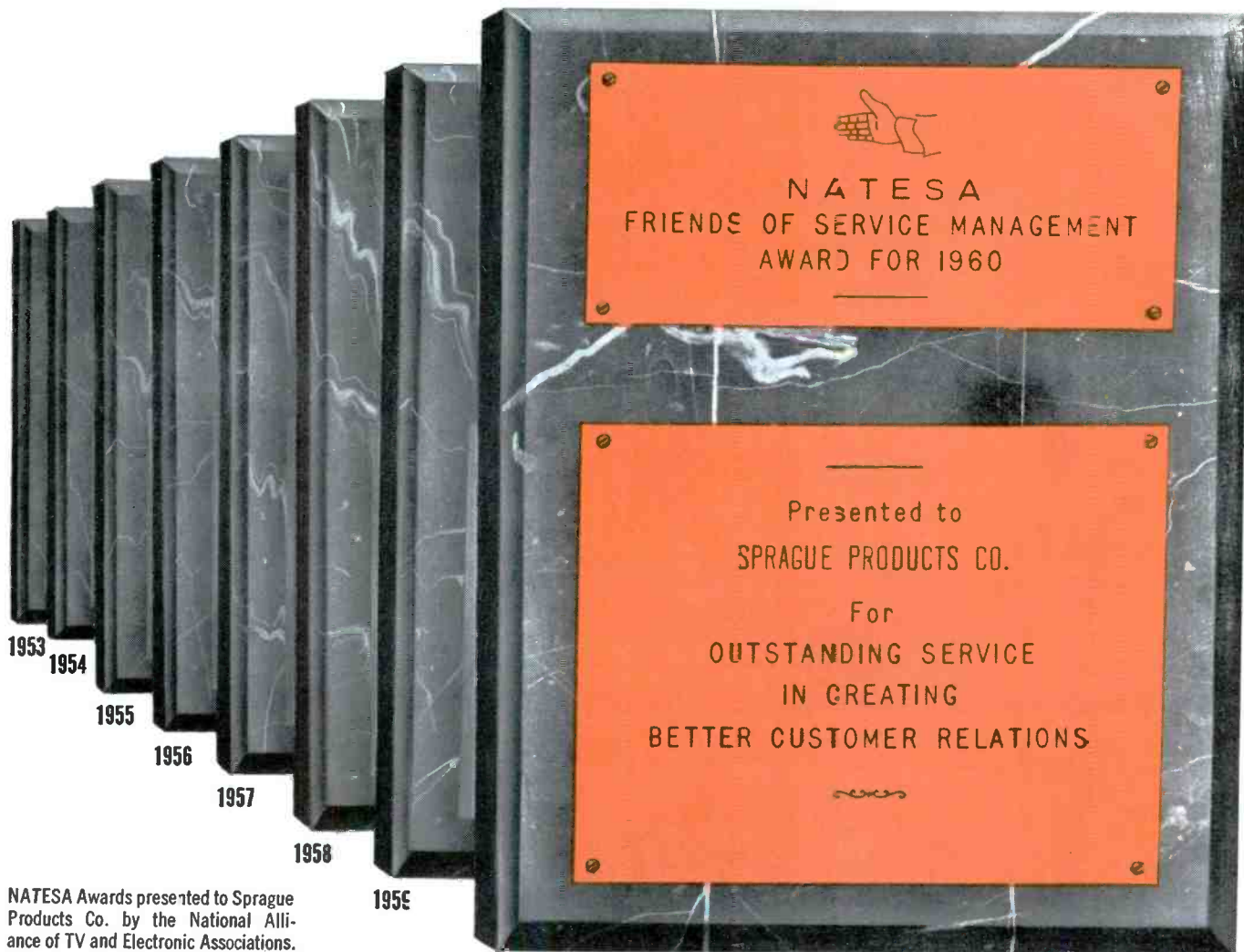

NATESA Awards presented to Sprague Products Co. by the National Alliance of TV and Electronic Associations.

# THANK YOU, NATESA

## for your latest "Friends of Service" Award

Winning the NATESA "Friends of Service" Award for the eighth consecutive year makes us more than ordinarily proud.

We're even more gratified because it was awarded in recognition of our cooperation with service dealers and technicians throughout the country.

But even without awards, it has always been the policy of Sprague Products Company to provide the independent dealer or technician with products and technical aids that simplify his job of servicing—and with sales promotion materials that help him maintain good customer relations.

As always, Sprague will continue to provide to the service technician the cooperation needed for continued growth.

WORLD'S LARGEST CAPACITOR MANUFACTURER





**1**

**DON'T BE A "SCREWDRIVER MECHANIC."**

Every year, hundreds of "do-it-yourself-ers" damage or ruin their sets, pile up needless expense, and endanger their safety by trying to make their own TV repairs. Your TV is the most intricate piece of equipment you've ever owned—far more complicated than your car! If you're tempted to tinker with it, DON'T! Guesswork is much too costly.

**2**

**LEAVE YOUR TV REPAIRS TO A "PRO."**

Years of training and experience make the TV technician an expert. He has repaired hundreds—perhaps thousands—of TV sets. He spends countless hours and hundreds of dollars on manuals, keeping up-to-the-minute on new developments, circuits, trouble-shooting techniques. He is qualified in every way to diagnose TV trouble accurately—cure it quickly and safely.

**3**

**DON'T LOOK FOR SERVICE "BARGAINS."**

There aren't any! Cut-rate prices mean cut-rate methods and cut-rate parts in your TV set. And these lead to unsatisfactory set performance, probable damage, and additional costly repairs. The expert TV technician charges a fair price for honest service. He can't afford special deals and service "bargains" any more than you can!

**4**

**CALL YOUR TV EXPERT AT THE FIRST SIGN OF TROUBLE.**

Don't wait for your set to go completely dead. Failure of one TV part sets up a chain reaction—other parts are damaged and repair costs pile up. Early attention prevents this and also makes it easier—and less expensive—to find and cure the trouble. To keep your repair costs low, call your TV technician when trouble *starts!*

**5**

**TRUST YOUR INDEPENDENT TV TECHNICIAN.**

As a member of your community, he stakes his reputation on your continued satisfaction. His years of study and experience, his large investment in equipment, and the fact that *he's in business for himself* are your assurances of good work and honest prices. His first loyalty is to *you*—his customer.

**THIS MESSAGE WAS PREPARED BY SPRAGUE PRODUCTS COMPANY,  
DISTRIBUTORS' SUPPLY SUBSIDIARY OF SPRAGUE ELECTRIC COMPANY, NORTH ADAMS, MASSACHUSETTS FOR . . .**

**YOUR NEIGHBORHOOD TV-RADIO TECHNICIAN**



**NEW**

**JERROLD**<sup>®</sup>

# TRANSISTOR POWERMATE

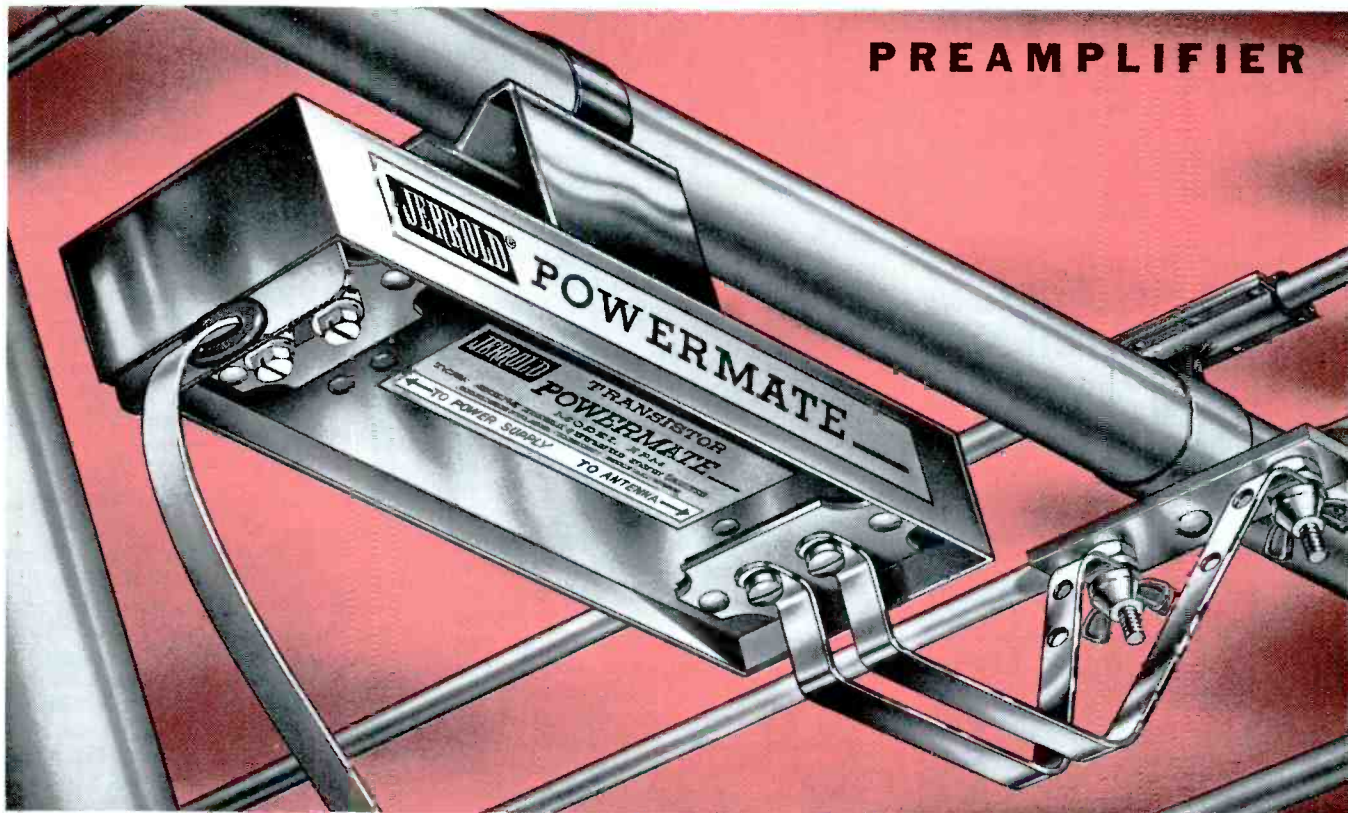

**PREAMPLIFIER**

*Servicemen everywhere are saying . . .*

## **OUTPERFORMS THEM ALL— OUTSELLS THEM ALL!**

In fringe areas all across America, TV servicemen are saying the new JERROLD Transistor POWERMATE outperforms all other antenna-mounted preamplifiers—and it's a *must* for color TV!

Such thorough acceptance makes POWERMATE the unit to recommend. And the acceptance is certainly well earned. Highest gain in the business, (an average of 13.9db at Channel 13 and 18.25 db at Channel 2), lowest System Noise Figure, most rugged and easily installed preamplifier you can recommend. So get on the POWERMATE bandwagon to make '62 your big *SELL* year. See your distributor today, or write for special bulletin describing *System Noise Figure*.

*Model APM-101—\$39.95 list complete with power supply*

**JERROLD**<sup>®</sup> **ELECTRONICS CORPORATION**  
Distributor Sales Division, Dept. IDS-209,  
The Jerrold Building, Philadelphia 32, Pa.

Jerrold Electronics (Canada) Ltd., Toronto, Ontario  
Export Representative: CBS International, New York 22, N.Y.

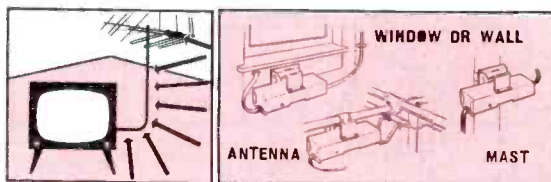

**NO TUBES, NO BATTERIES,  
NO OSCILLATION, NO FEEDBACK**  
Mount it on the boom or anywhere along the down-lead. Thoroughly neutralized against oscillation; output impedance balanced to prevent radiation back to antenna. Same 300-ohm lead that carries signal also carries 15 volts ac to POWERMATE. No tubes or batteries to replace.

**REMOTE AC POWER SUPPLY  
OPERATES 1 OR 2 TV OR FM SETS**

installs on or near receiver, draws less current than an electric clock. No polarity nuisance when attaching to lead, no danger of transistor damage.



AMERICA'S LEADING MANUFACTURER OF TV-FM RECEPTION AIDS AND MASTER-ANTENNA-SYSTEM PRODUCTS

# ATR

## PRODUCTS FOR MODERN LIVING



### ATR PLUG-IN TYPE PORTABLE INVERTERS\*

A.C. HOUSEHOLD ELECTRICITY Anywhere  
... in your own car, boat or plane

- Operates Standard A.C.
  - Record Players
  - Dictating Machines
  - Small Radios
  - Electric Shavers
  - Heating Pads, etc.
- In your own car or boat!

**MODELS**  
6-RMF (6 volts) 60 to 80 watts. Shipping weight 12 lbs. DEALER NET PRICE \$33.00  
12T-RME (12 volts) 90 to 125 watts. Shipping weight 12 lbs. DEALER NET PRICE \$33.00  
\*Additional Models Available

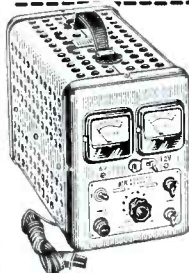

### ATR "A" Battery ELIMINATOR

For Demonstrating and Testing Auto Radios—TRANSISTOR or VIBRATOR OPERATED!

Designed for testing D.C. Electrical Apparatus on Regular A.C. Lines—Equipped with Full-Wave Dry Disc-Type Rectifier, assuring noiseless, interference-free operation and extreme long life and reliability.

MAY ALSO BE USED AS A BATTERY CHARGER  
MODEL 610C-ELIF... 6 volts at 10 amps. or 12 volts at 6 amps. Shipping weight 22 lbs. DEALER NET PRICE \$49.95  
MODEL 620C-ELIT... 6 volts at 20 amps. or 12 volts at 10 amps. Shipping weight 33 lbs. DEALER NET PRICE \$66.95

### AUTO-RADIO VIBRATORS



By every test ATR Auto-Radio Vibrators are best! ... and feature Ceramic Stack Spacers, Instant Starting, Large Oversized Tungsten Contacts, Perforated Reed, plus Highest Precision Construction and Workmanship and Quiet Operation!

There is an ATR VIBRATOR for every make of car!

Ask your distributor for ATR's Low Priced type 1400, 6 volt 4-prong Vibrator; and 1843, 12 volt 3-prong, or 1840, 12 volt 4-prong Vibrator. THE WORLD'S FINEST!

There is a trim plate kit for YOUR CAR!



### ATR CUSTOMIZED KARADIO

Vibrator-Operated with Tone Control

ATR KARADIO... is ideal for small import cars, or compact American cars! Unit is completely self-contained—extremely compact! Powerful 8-tube performance provides remarkable freedom from engine, static, and road noises. The ATR Customized Karadio comes complete with speaker and ready to install. Can be mounted in-dash or under-dash—wherever space permits! No polarity problem. Neutral Gray-Tan, baked enamel finish. Overall size, 7" deep, 4" high, and 6 1/2" wide. Shipping weight, radio set, 7 lbs. Model K-1279—12 for 12V Dealer Net Price \$33.57  
Model K-1279—6 for 6V Dealer Net Price \$33.57

Airplane Style Overhead Mounting under Cab Roof

NO PRINTED CIRCUITRY

### ATR TRUCK KARADIO

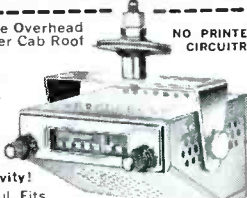

Excellent Tone, Volume, and Sensitivity!

Compact, yet powerful. Fits all trucks, station wagons,

most cars and boats. Just drill a 3/8 inch hole in roof and suspend the one-piece unit (serial, chassis and speaker) in minutes. Watertight mounting assembly holds antenna upright. Yoke-type bracket lets you tilt radio to any angle.

Extra-sensitive radio has 6 tubes (2 double-purpose), over-size Alnico 5 PM speaker for full, rich tone. Big, easy-to-read illuminated dial. Fingertip tuning control. Volume and tone controls. 33-in. stainless steel antenna. Neutral gray-tan enameled metal cabinet, 7 x 6 1/2 x 4 in. high over-all. Shipping weight 10 1/2 lbs. Model TR-1279—12 for 12V Dealer Net Price \$41.96  
Model TR-1279—6A for 6V Dealer Net Price \$41.96

See Your Electronic Parts Distributor Write Factory For Free Literature

## ATR ELECTRONICS, INC.

Formerly: American Television & Radio Co.



Quality Products Since 1931  
ST. PAUL 1, MINNESOTA—U.S.A.

# LETTERS TO THE EDITOR



Dear Editor:

In answer to Joseph Brucculeiri's letter in the December issue, I think it would be unwise to print articles in your magazine on building electronic gadgets. There are a number of other magazines on the market which have such articles. Your magazine is devoted to service; let's keep it that way.

STAN CMIELEWSKI

Stan's Radio & TV  
Newark, N. J.

Dear Editor:

I fully agreed with the remarks by George Karmas (November Letters) about the size of schematics accompanying your articles. Before I could get around to saying, "second the motion," here came the December issue with another letter on the same subject from A. Taylor, along with your very terse editorial note pointing out the "new deal." Yeah, man, this is better. I can add only one suggestion, considering that some of us may be even older than Mr. Taylor: The schematics printed on a dark gray background are much harder to read than those backed up with lighter colors or white, particularly under not-so-good artificial light—for example, when I take PF REPORTER home to study under the bulbs my wife prefers in her lamps.

I'm glad you asked for comments on Mr. Brucculeiri's letter (December Letters). There was also another letter a month or so ago on something completely outside the radio-TV field—I believe it was automobile ignition or something. There are plenty of magazines who devote most of their space to gadgets, gimmicks, gimcracks, and what have you. Some of these should be ideal for Mr. B's purpose, and I guarantee he can accumulate enough in two or three months to last—well, a long time.

LEO FRUIT

Macks Creek, Mo.

Okay, Leo, no more "gray" schematics. As for gadgets, etc., we agree—but don't forget that TV was once considered a gadget in some circles!—Ed.

Dear Editor:

Suppose that the "few pages" wanted by Joseph J. Brucculeiri are published in the space you now use for Video Speed Servicing! The results might be a perfect home, but poorer service.

Personally, I prefer to have better service aids in my shop, and a home equipped with standard doors and windows, a regular non-disappearing bar, and a good operating TV set. The rest is vanity.

RAF. FEBRES ORTIN

Febres TV-Radio Servicio  
Caracas, Venezuela

Aw, c'mon now. Who ever heard of a TV serviceman owning a set that operates properly?—Ed.

Dear Editor:

May I extend my congratulations for your color TV issue? I'll bet it becomes a collector's item. With the impetus being given color-set sales by several manufacturers, I hope you will devote more space in your magazine to color.

ELLIOTT J. DULLEA

Maple Shade TV Service  
Maple Shade, N. J.

Can do! Anything in particular?—Ed.

Dear Editor:

A salute to you for your November color issue! If we had had editions like this earlier, color would not have been set back ten years. The industry needs these articles very badly to bolster their courage and come up from the dark. With articles like these, your magazine can be nothing else but a success.

ALBERT MALINICK

Maintenance Dept.  
National Broadcasting Company  
New York, N. Y.

The November issue was actually a "booster shot"—we injected a massive dose of color-TV service information (our 16-part Color TV Training Series) when color first appeared in 1954-55, but the first "vaccination" didn't cure the service industry of its timidity in approaching color. A greater spirit of cooperation in all parts of the industry is the answer to making a success of color TV.—Ed.

Dear Editor:

I have been trying to round up the material needed for building the two-way radio test set you describe on page 42 of the December issue, and have run into a snag. Where can I obtain the diodes listed as "HD2149 or equivalent"?

AMOS J. THRASHER

Ottumwa, Iowa

Dear Editor:

I have built the two-way test set according to the information given in your December issue. Had a hard time cross-

• Please turn to page 22

### EDITOR'S NOTE:

Two changes should be made in the list of transistor-radio manufacturers and importers which appeared on page 25 of the January issue. Excel Corp. of New York City, former importer of Excel and Trancel brands, has recently gone out of business and should be dropped from the list. In addition, the address opposite RCA Victor should be changed to the following: RCA Victor Home Instrument Div., Indianapolis 1, Ind.

# GET THE FACTS



## BEFORE

### You Buy Color TV Test Equipment!

You can't look for a rainbow to answer the question of what color test equipment to buy. Don't be misled... you need equipment that meets the standards set up by set manufacturers and broadcasters...*NTSC* standards. Insist on your equipment meeting these standards... insist on *HICKOK Color Approved* test equipment.

## WHY NTSC ?

Send For This  
**FREE  
FOLDER!**

It explains *NTSC* and how *HICKOK Color Approved* equipment fits into the picture.

Plain Facts  
About Color  
Test Equipment

The Hickok  
Electrical Instrument Co.  
10514 Dupont Avenue • Cleveland 8, Ohio

LOOK FOR THIS LABEL  
On The Color Test  
Equipment You Buy.



These are some of the  
manufacturers who are making  
color television sets now:

DUMONT

ADMIRAL



ZENITH

Emerson

Magnavox

Olympic.

PHILCO.

# The **HICKOK**

## Electrical Instrument Co.

10566 Dupont Avenue • Cleveland 8, Ohio

# Sylvania

...completeness that assures  
...quality that



Never say "Tubes"—say "Sylvania"!

# Tubes

delivery!  
assures profits!

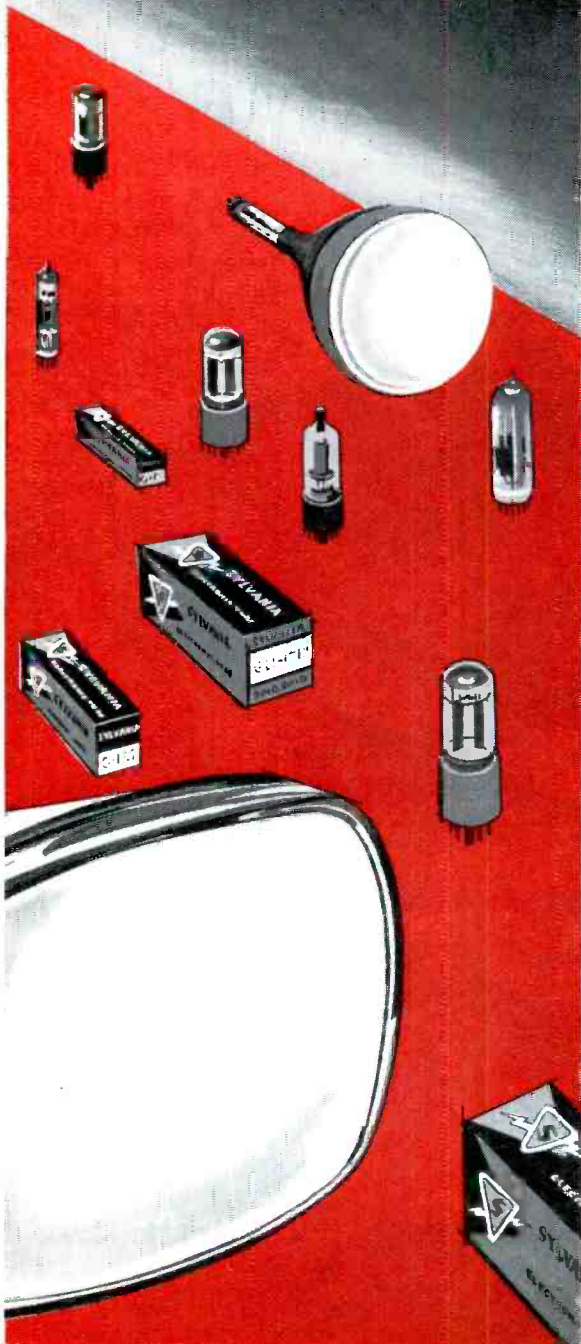

## SILVER SCREEN 85 PICTURE TUBES

Sylvania was a pioneer in the manufacture of commercially produced picture tubes. That kind of experience builds profit protection into every 1962 SILVER SCREEN 85—top performance, maximum assurance against callback. And, when you specify Sylvania for that replacement job, you are sure to get delivery...because SYLVANIA has the *comprehensive* line...SYLVANIA DISTRIBUTORS are wherever there is TV!

Bonded Shield • anti-reflection Bonded Shield • non-Bonded Shield • single and multiple branded • long and short necks • metal and glass envelopes • 50° to 114° deflection • magnetic and electrostatic focus • ion trap and non-ion trap types • rectangular and round faceplates • 2.35-v to 6.3-v and 450-mA to 600-mA heaters • 5" (50°-70°) and 8" (90°-114°) universal bench-test tubes.

Plus "universal" 17-, 21- and 24-inch picture tubes!

Plus color TV picture tubes!

## SYLVANIA RECEIVING TUBES

**...for Color TV...**Sylvania continues to prove its capabilities...in the production of tubes especially for color TV replacement. Since your customers are buying "performance"—not technical data—tubes at SYLVANIA are performance-tested continuously in actual color TV sets. Go with quality—go with Sylvania tubes for color TV: 6BK4 • IV2 • 3A3 • 6DQ5 • 6CB5A • 6AU4GTA • 6CG7 • 6AW8 • 12BY7 • 6AQ5 • 6AV5 • 6EM7.

**...for Black & White TV...**Sophisticated manufacturing techniques and processes have made Sylvania a preferred supplier of tubes for TV. Developments such as Sarong Cathode and Strap Frame Grid *plus* extensive automation in production assure that replacement tubes are...in every way...as good as the original.

**...for TV Tuners...**Sylvania-originated, the 6GK5 brings new advances to the state of the electron tube art. This new tube type, as manufactured by Sylvania, features Strap Frame Grid constructions and high Gm, provides high gain and low noise in rf amplifier-service in TV front-ends. When replacing a 6GK5, specify *Sylvania*—universally accepted by manufacturers of TV sets. Sylvania 6GK5 also replaces the popular 6FQ5, 6FQ5A and the 6FY5.

**...for AM-FM Radio...**Whether servicing an AC-DC table radio, a fine Hi-Fi tuner or one of the latest Multiplex units, make Sylvania your number one choice. Take, for examples of outstanding quality, the new 17C9 and 6JK8. Both are Sylvania-originated and provide superior performance in standard tuner and in multiplex circuitry.

**...for Hi-Fi and Phono...**One of the pioneers in tubes for audio amplifier service, Sylvania has led with old faithfuls like the 6L6, 6V6 and 6AQ5 and the new high-performance Sylvania 6GM5 and Sylvania 7591. Automated production techniques and final test procedures maintain precision, assure high quality. A Sylvania replacement tube is the best way to make old equipment perform like new again. Electronic Tubes Division, Sylvania Electric Products Inc., 1740 Broadway, New York 19, N. Y.

Sylvania Tubes—available wherever there is TV!

# SYLVANIA

SUBSIDIARY OF

GENERAL TELEPHONE & ELECTRONICS



Spring Comes Early...

in the wonderful

PHILCO

World of

FREE

GIFTS

## Redwood and Aluminum Foam Cushion CHAISE

1" tubular aluminum, weatherproof redwood back, seat and arms. 6" rubber tired wheels, plastic covered 2" thick soft poly-foam cushion. 3 positions. Folds compactly for storage. Ideal for indoors or outdoors, porch, patio or sunroom.



AD 3993



AD 3989

### Folding Arm Chair

Redwood and aluminum, 1" tubular frame. Folds flat to 6" for storage. Weatherproof.

FREE with \$130 worth of purchases



AD 3967

### Fitted Travel Case

For the ladies. Scuff resistant vinyl covering, fitted with Jewelite Nylon brush, comb and mirror set.

FREE with \$125 worth of purchases



AD 3965

### Nylon Bag, Gloves

Clutch style purse with gold finished chain. Nylon palm stretch gloves to match. Black only.

FREE with \$60 worth of purchases



AD 3982

### Ronson CFL Shaver

1962 Mark II Electric Shaver. \$23.50 value. Multi-blade miracle cutter gives quickest shaves.

FREE with \$250 worth of purchases

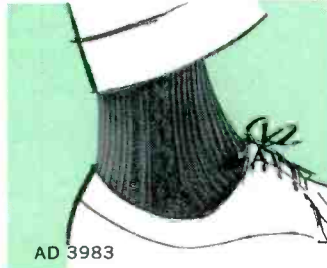

AD 3983

### Men's Ban-Lon Sox

First quality, 100% Ban-Lon yarn, reinforced top and heel. Stretch type, fits sizes 10 to 13.

FREE with \$12 worth of purchases



AD 3986

### 3/8" Electric Drill

3/8" electric drill with new "Speedsight" for easier drilling at any angle. "Speedway" brand.

FREE with \$225 worth of purchases

FREE WITH \$415 WORTH  
OF PURCHASES...

\$25 LESS WITH BONUS CHECK

MANY OTHER OFFERS NOT SHOWN!

SEE YOUR PHILCO DISTRIBUTOR TODAY

# FREE \$75 WORTH OF PHILCO BONUS CHECKS FOR YOU

I understand that by mailing this coupon to you today I will receive a colorful brochure featuring the Wonderful Philco World of FREE Gifts and my \$75 worth of FREE Philco Bonus Checks. My name and address is:

Name .....

Address .....

(Please Print)

City .....

MAIL TODAY TO: PHILCO ACCESSORY-SERVICE  
BOX NO. 3635, Philadelphia 34, Penna.

Offer Expires  
April 30, 1962

All your purchases of PHILCO branded tubes, PHILCO parts, PHILCO accessories can be credited toward the gifts you want. Choose your Gifts . . . accumulate your purchases for Total Credit toward the gift. All your PHILCO purchases are included, all count toward FREE GIFTS. FREE Philco Bonus Checks save you up to \$75 on some items. Get your FREE Bonus Checks today.

## Famous Wilson SAM SNEAD BLUE RIDGE Matched Golf Clubs

Set of 5 Irons . . . or Set of 2 Woods

Chrome plated matched irons with Aer-Flo steel shaft, calfskin Reminder Grip, famous Dynamic Balance. #3, #5, #7, #9 irons and putter. Strata-Bloc woods, matched Driver (#1) and Spoon (#3) in Walnut tone.

SET OF 5 IRONS FREE WITH \$600 WORTH OF PURCHASES . . . \$50 LESS WITH BONUS CHECK

Set of 2 MATCHED WOODS FREE with \$295 worth of purchases



AD 3973



AD 3995



### Chino Work Shirts

Sanforized, vat dyed for lasting color. Full cut, two pockets. Unconditionally guaranteed. Gray.

FREE with \$45 worth of purchases



AD 3991

### 30" Coffee Table

Weather resistant, 1" tubular aluminum legs, stained redwood top. Folds flat for storage.

FREE with \$130 worth of purchases



AD 3981

### Bowling Game

Ten unbreakable 9" plastic pins on automatic resetting mechanism. Two 3½" bowling balls.

FREE with \$100 worth of purchases



AD 3977

### Classic Golf Cart

All steel, opens automatically. 12" wheels. Wilson Make.

FREE with \$325 worth of purchases  
\$25 LESS with Bonus Check



AD 3862

### Metal Desk, File

Index folders, storage compartment with lock. File, 30" x 12½" x 15", opens to 40" desk.

FREE with \$250 worth of purchases



AD 3703

### Magnifier Lamp

Illuminates and magnifies, cool Circuline Fluorescent tube, spring balanced bracket. LUXO Make.

FREE with \$550 worth of purchases



AD 3978

### Wilson Golf Balls

Package of 3. K-28 white-for-life finish golf balls. Tough balata cover. Best for distance.

FREE with \$50 worth of purchases



AD 3969

### Flower Plantarama

Washable permanent plastic flower arrangement in aluminum planter. For home or shop!

FREE with \$40 worth of purchases

TAKE ADVANTAGE OF THESE PHILCO FREE GIFTS

## Letters

(Continued from page 16)

referencing diodes, but figured some out for myself, and the set works like a charm on Motorola equipment. (It hasn't yet been tried on RCA.) In place of the 1N1224 (high-voltage) diodes, I substituted Raytheon 1N1096's; for the HD2149's, I used 1N34A's.

There's just one question for which I still need an answer: How can I measure oscillator drive for RCA sets? The metering connection is pin 8 on P1, but in RCVR position, your schematic shows this circuit coming to a dead end on S3A. Should the cathode lead of M5 be attached to pin 8 instead of pin 7 on P1?

W. H. CLARKSON

Kansas City, Mo.

As Mr. Clarkson has discovered, 1N34A's can be substituted for the hard-to-find HD2149's; so can various other general-purpose diodes such as the 1N70A or 1N52A.

One important correction needs to be made on the test-set schematic (page 43 of the December issue): M7 should be a 1N1224 or a similar diode with a higher voltage rating than a general-purpose type.

The RCA oscillator drive can be metered by adding a connection from position 1 of S3A to the lower lefthand terminal of S1 (as shown on schematic) via a SPST toggle switch. Or, as an alternative, a 10-position switch could be used for S4A in place of the 9-position switch originally shown; in this case, the tenth position of the switch would be connected to position 1 of S3A.—Ed.

Dear Editor:

Mr. Paul Goldberg's article, "Circuit Voltages Tell the Story" (page 32, December issue) teaches a lot about servicing. I would like to see some more articles on the order of this one; in particular, I'd like to read something on the subject of resistance measurements.

PEDRO GAMARGO

Caracas, Venezuela

Good point! Resistance readings must be interpreted correctly if they are to be of any help in servicing. There's a knack to this, too — as we'll explain in a future issue.—Ed.

Dear Editor:

Since a good tube tester represents a sizable investment, I want to be sure before I buy. Thus, I would like to see some unbiased comparative information on different types of testers.

ARTHUR LADD

LaGrande, Ore.

The Howard W. Sams 1962 Test Equipment Annual, available later this month, will include a "Test Equipment Buyer's Guide" listing specifications and prices for all the service-type equipment now on the market. To get the most out of this information, study it in combination with articles such as "Using a Tube Tester to Advantage" (September, 1961 PF REPORTER) which discuss and compare the different basic types of tube testers.—Ed.

**GUARANTEED FM AND  
FM STEREO RECEPTION  
FROM 200 MILES!**

# Winegard STEREO-TRON

World's Most Powerful FM Antenna!

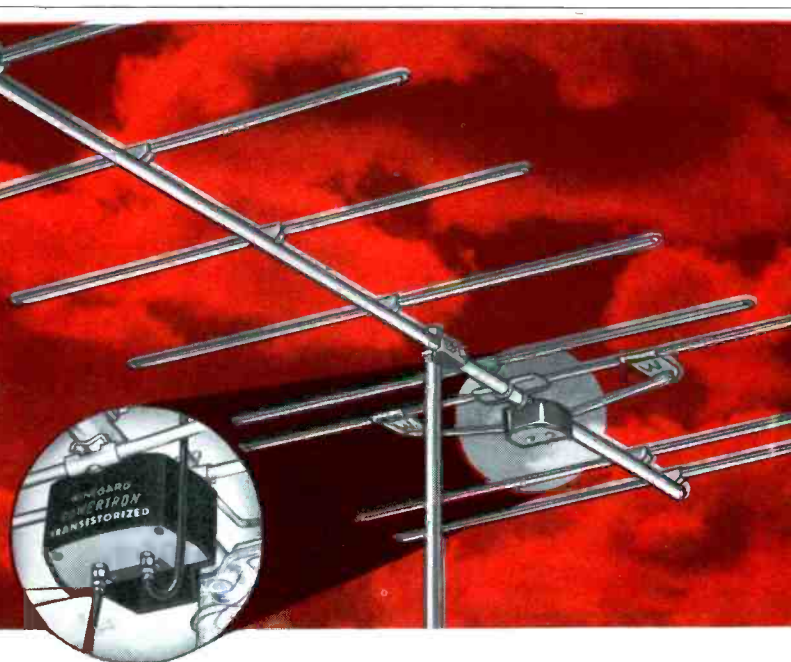

**NEW ELECTRONIC FM ANTENNA FOR LONG DISTANCE FM AND STEREO!** Now Winegard Guarantees unexcelled FM performance with the new Winegard electronic Stereo-Tron. Actually **GUARANTEES** your customer will receive 85% of all FM stations in a 200 miles radius over normal terrain with a rotor. Built in transistor amplifies signals, really gets L-O-N-G distance reception. Opens a new field of opportunity in the fast growing FM and FM stereo market.

**MODEL PF-8 FM STEREO-TRON YAGI—Gold Anodized!** This is the world's most powerful FM antenna. Because Multiplex requires an antenna with greater sensitivity and gain to offset the power loss of the carrier and subcarrier, Winegard's PF-8 is the best antenna you can install for Multiplex. When you hook up a PF-8, weak signals come in like "locals." Recommended for use where signals are under 10,000 microvolts. For strong signal areas, same antenna without amplifier, Model FM-8, is recommended.

The PF-8 has a minimum gain of 26 DB over a folded dipole with a flat frequency response of  $\pm 1/4$  DB from 88 to 108 m.c. It features a built-in TV-FM coupler and has eight elements with **EXCLUSIVE "TAPERED T"** driven element engineered

to perfectly match the powerful transistor, direct coupled, built-in amplifier. It is available two ways—Model PF-8 for 300 ohm twin lead or Model PF-8C for 75 ohm coax.

### Important Features of Winegard Electronic FM Antennas

1. Transistor amplifier is designed as part of the "Tapered T" driven element (model PF-8) for unprecedented efficiency and signal-to-noise ratio.
2. At no extra charge, built-in FM-TV coupler allows you to use one power supply and down lead when used with a WINEGARD POWERTRON TV antenna.
3. Beautiful gold anodized permanent finish—100% corrosion proofed—all hardware irridized. This is the finest finish of any antenna—has richest appearance—meets U.S. Navy specifications.
4. The quality of craftsmanship and fine materials in these antennas tell their own story—perfect mechanical balance—100 m.p.h. wind tested.

Winegard makes a complete line of FM antennas. Write for information and spec. sheets. Also get **FREE**, Station Log and FM map of U.S.

**MODEL PF-4 FM ELECTRONIC TURNSTILE**  
Gold Anodized! Non-directional FM antenna with 16 DB gain in all directions over a folded dipole. Has Winegard offset mount and transistor amplifier with TV-FM coupler. Also available without amplifier, Model FM-3T.



# Winegard

ANTENNA SYSTEMS

1009-2D Kirkwood Avenue, Burlington, Iowa



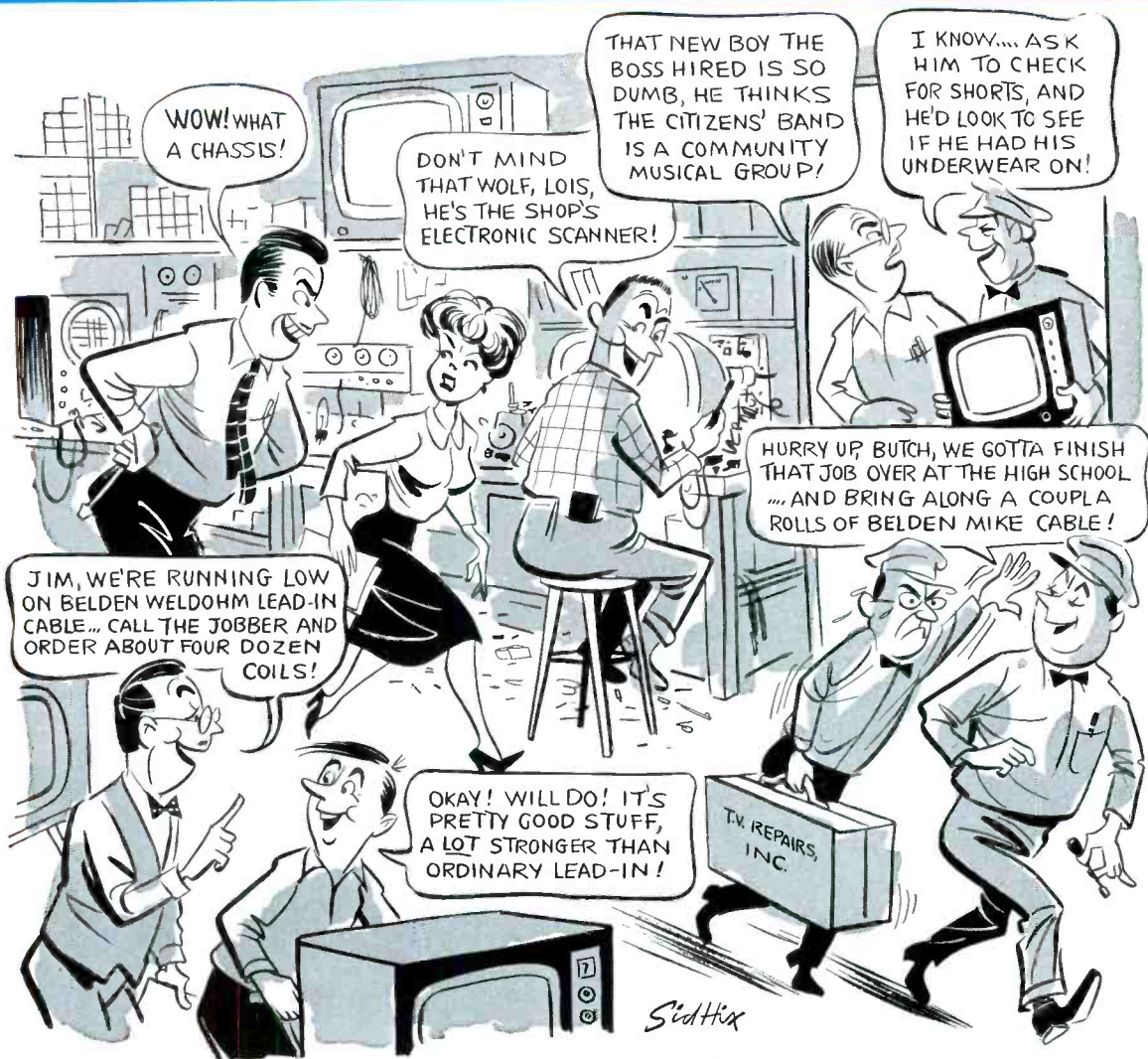

## This is the 300 ohm Belden Weldohm they're ordering...

... Yes, it is strong ... it has one and a half times the breaking strength and two and a half times the flexing life of ordinary lead-in. Order No. 8230.

Here's the Belden microphone cable Butch is going to take along for the high school job ... No. 8410. It's abrasion and impact resistant. It's limp ... lies flat on the floor. It has long flex-life and high tensile strength.

Call your Belden jobber. He carries a complete line of lead-in cable ... also microphone and shielded power supply cables; hi-fi, stereo and phonograph cables; power supply cords; rubber-vinyl, multi-conductor portable cordage; antenna rotor cables; hook-up wire; TV and cheater cords; aluminum ground wire ... and related items. He has it all ... in stock.



power supply cords • cord sets and portable cordage • electrical household cords • magnet wire • lead wire

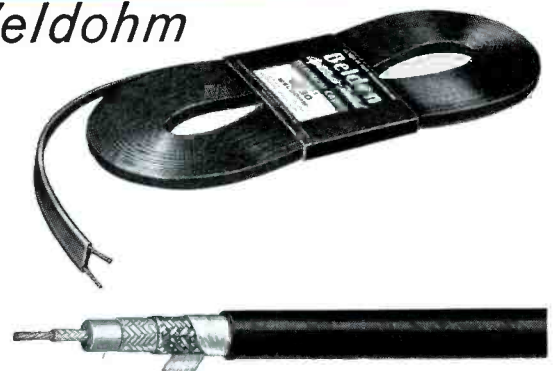

### Be a Cartoon Gag Writer!

Win a \$25.00 Savings Bond

Send us your gag ideas for future cartoons. For each of your gag ideas our advertising manager uses, he'll send you a \$25.00 Savings Bond ... plus a Belden Gag Writer's Certificate. Write Belden Manufacturing Company, Att: Mrs. Madelsa Allison, 415 South Kilpatrick Avenue, Chicago 80, Illinois.



Only **ZENITH**

EXCLUSIVE

HANDCRAFTED

NO PRINTED  
CIRCUITS

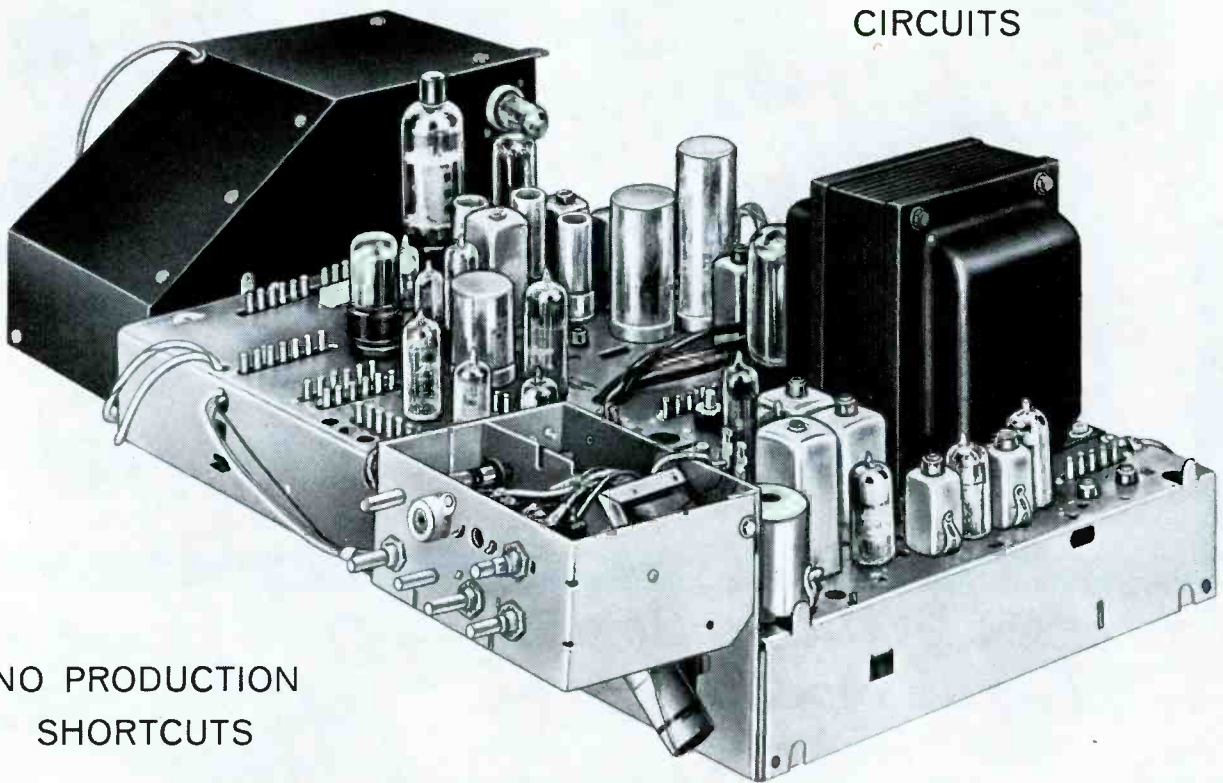

NO PRODUCTION  
SHORTCUTS

**There are only two kinds of color TV made in America—  
ZENITH AND ALL OTHERS!**

Now Zenith brings you the easiest-to-service color TV ever made, with the only handcrafted horizontal Service Saver color TV chassis in the industry. No printed circuits! No production shortcuts!

Every connection is hand wired and hand soldered! Mechanical design is simplified—electrical circuitry is straight-forward for greater dependability and easier, faster servicing.

*EVERY ZENITH COLOR TV IS EXCLUSIVELY DESIGNED,  
DEVELOPED AND MANUFACTURED BY ZENITH!*

has it!

# COLOR TV CHASSIS!

**For greater dependability... simplified servicing  
90% OF CHASSIS ACCESSIBLE FOR SERVICING  
without removing it from the cabinet!**

**ONLY HANDCRAFTED ZENITH  
has the "easy service" bottom plate!**

When this plate is removed, 90% of the chassis is accessible for servicing without taking it out of the cabinet. Saves time and effort! Even the back of the cabinet is specially designed to come off in seconds with just 5 easy-turn clips—no screws!

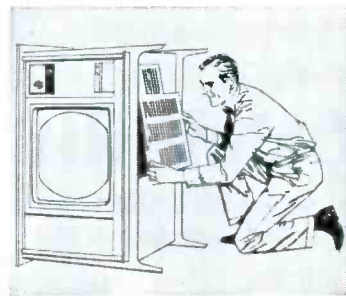

**ONLY HANDCRAFTED ZENITH  
has metal cone circuitry check points!**

Metal cone circuitry on the new Zenith Color TV chassis makes a majority of test points accessible on top of the chassis. You do not have to remove the chassis from the cabinet. Makes servicing easier, faster, less costly!

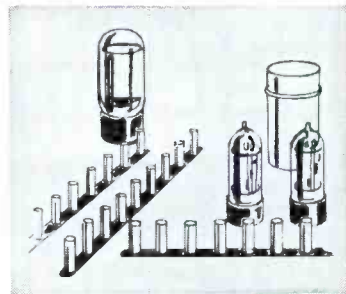

**Zenith's Special Training Program assures you an  
important role in the future of color television!**

Zenith Distributors are conducting special color TV training programs now, and will continue these programs in the future. For complete information, see your Zenith Distributor.



ZENITH RADIO CORPORATION,  
CHICAGO 39,  
ILLINOIS, IN CAN.  
ZENITH RADIO CORPORATION OF  
CANADA, LTD., TORONTO, ONTARIO.  
The Royalty of television, stereophonic  
high fidelity instruments, phonographs,  
radios and hearing aids. 43 years of lead-  
ership in radionics exclusively.  
*Specifications subject to change without notice*

# ZENITH®

*The quality goes in  
before the name goes on*

# ADD A NEW SIGN TO YOUR DOOR

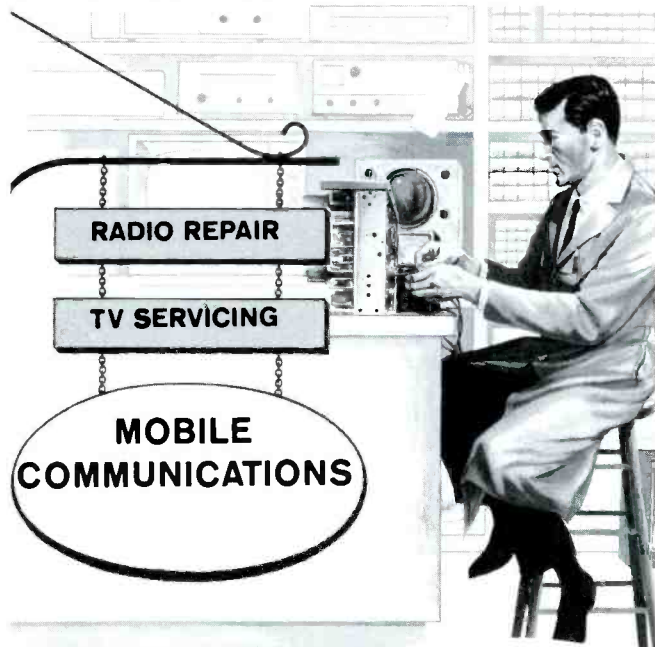

## Let RCA Train You at Home in COMMUNICATIONS

A completely new RCA Institutes course with brand new opportunities for electronic technicians . . . COMMUNICATIONS ELECTRONICS.

1962 starts a new era in mobile communications when you get your FCC License. Under the skilled direction of RCA Institutes experts, you can obtain at home the technical qualifications for employment in the Communications Industry. In addition to preparing you for an FCC license, you are supplied with the training needed to service and maintain 2-way radio communications for truck and taxi fleets, police, fire, bus, railroad and other public service vehicles. You also get the technical foundation for advancement in space and aviation communication electronics. This is *not* a cram course . . . *not* a rehash of old radio lessons. Learn from RCA what it takes to get ahead in the ever-expanding field of communications.

With RCA Institutes home training in Communications Electronics, you set the pace that suits your ability, finances and time. RCA's liberal Voluntary Tuition Plan is the most economical home study method, because you pay for lessons only if you order them . . . one study group at a time! If you drop out at any time, for any reason, you do not owe RCA one penny! No other obligations! Licensed by New York State Education Department. Approved for Veterans.

**Prepares You for an FCC License**

### RCA INSTITUTES, INC.

A Service of Radio Corporation of America  
350 West Fourth Street, New York 14, N. Y.

#### Other home study courses available:

Electronics Fundamentals  
Black & White and Color TV  
Automation Electronics  
Computer Programming  
Transistors



The Most Trusted Name  
in Electronics

RCA INSTITUTES, INC. Home Study School, Dept. PF-22  
350 West Fourth Street, N. Y. 14, N. Y.

Without obligation, rush me the FREE 64-page illustrated booklet "Your Career in Electronics" describing your electronic home study training program. No salesman will call.

Name..... Age.....

Address.....

City..... Zone..... State.....

**CANADIANS**—Take advantage of these same RCA courses at no additional cost. No postage, no customs, no delay. Send coupon to: RCA Victor Company, Ltd., 5581 Royalmount Ave., Montreal 9, Quebec.

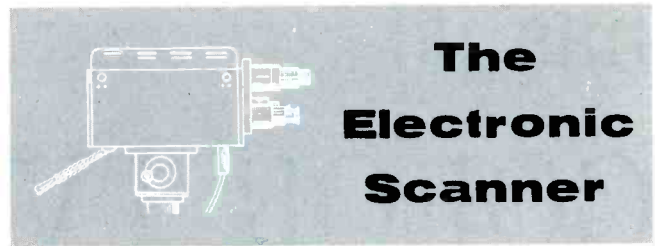

## The Electronic Scanner

### Volkswagen Sales Up From '61

Sales of Volkswagen cars, trucks, and station wagons totalled 17,777 vehicles during October, bringing total sales for the first ten months of 1961 to 172,333 compared to 157,156 during the comparable period of 1960, a gain of 9.7 per cent. According to G. C. Hahn, general manager of Volkswagen of America, current delivery rates indicate that 1962 will be the first 200,000-unit year for the car in this country. The U.S. is second only to West Germany in Volkswagen sales.

### Cartridges in 6-Paks



Jobbers and dealers can now take advantage of a new Sonotone cartridge packaging program designed to save time, reduce stocking requirements, and boost cartridge sales. The 6-Pak will hold either a balanced or mixed assortment of cartridges, and has a tab which permits it to be hung on a wall with the product in clear view.

### Color TV Seminar

New York City is to be the scene of a color seminar, to be presented on February 14 by Precision Apparatus Co. in cooperation with General Electric and Voorhees Technical Institute. The agenda includes such topics as how and why a color TV receiver works, the installer's major adjustments, and the most frequent service alignments requiring the use of color TV test equipment. Moderators for the program will be Mr. Bill Hatters and Mr. Ed Tillen, training specialists from GE. The seminar will be held at the Voorhees Institute.

### New Tool Displays



Two new display stands offering Vaco screwdriver and nut driver assortments at discount prices are now available. The stands, which are designed to promote impulse purchasing, contain complete information enabling the customer to make his own selection without having to question the salesman. The screwdrivers are 69¢ each, and nut drivers are 75¢.

### Increase Predicted in Multiplex Broadcast

A recent survey has revealed that 288 of the country's FM stations expect to begin broadcasting stereo during the next year. At present, about 40 stations are using the new method of broadcasting approved by the FCC last April. According to Sidney Harman, president of Jerrold Electronics, the anticipated addition of the new stations should increase sales and service of the component high fidelity industry. Harman-Kardon (division of Jerrold) expects to surpass the previous year's sales by almost 50%.

### New Needle Dispenser



A dispenser which hangs on a wall, stands on a counter, or lies flat in a display case is free from Duotone with the purchase of a diamond-needle assortment. The attractive black and gold dispenser, together with 32 needles, simplifies inventory-taking and encourages impulse buying.

### Tube Brightener Suit Settled

The tube brightener suit between Perma-Power Co. vs. Antronic Corp. has been settled in U.S. District Court, Chicago. Under the terms of the settlement, Perma-Power has dropped all claims of infringement of tube brightener patent no. 2,757,316, and Antronic Corp. has dropped its counter-claim.



©1962 VOLKSWAGEN OF AMERICA, INC.

# Ain't ours.

Volkswagen owners don't dig this stuff. Not when it's only this deep.

For one thing, our engine's in the rear. The weight sits on our drive wheels.

It's like putting concrete blocks in your trunk.

For another, most trucks only clear about 7 inches, but the VW clears 9½.

Our bottom doesn't drag.

Even our air-cooling helps. The Volkswagen engine does not use water. There's nothing to freeze up. You always go.

(New VW owners sometimes feel uneasy about not buying anti-freeze. But there's no place to put it.)

All this, however, doesn't mean our

trucks never get stuck. A drift's a drift.

That's why we ask owners to use chains or snow tires. Just to be sure.

Would you like to know who has a Volkswagen Truck in your neighborhood? Wait until you get about 6 inches of snow. Then look to see who isn't shoveling.

**AUDIO FACTS**  
by  
**Len Buckwalter**

# Getting into the Background Music Business

The newly-ripe plum of background music is within the grasp of any service shop. This field has fairly burst from its traditional place in the plush restaurant into an incredible number of other applications. Several systems have evolved, each with something special to offer the customer in terms of price and performance. For the alert service

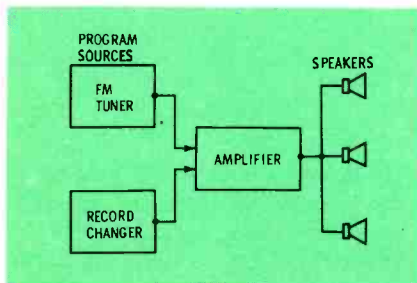

Fig. 1. Simplest form of background-music system — standard components.

shop proprietor, background music can mean new sources of revenue and diversification. And since the circuits are not markedly different from those used in home-entertainment equipment, branching into the business is largely a matter of becoming familiar with the various systems and lining up customers.

## Applications

Once considered a costly extra, background music has become a basic fixture in countless retail stores, industrial plants, and business offices. Consider a 35-mile radius around your shop and you'll probably discover a dozen or more likely prospects. Entire supermarket chains have had music systems installed. Savings banks, who former-

ly played music only during holiday seasons, now use it on a full-time basis. Factories, where work is dull and repetitive, have discovered that background music will more than repay its cost by improving employee morale and reducing absenteeism. You'll find it at swimming pools, aboard commercial airliners, and even at the gas pumps of filling stations.

Where *won't* it work? Places where people must concentrate deeply are not likely locations for background music. Thus, an attorney's waiting room would be suitable, but not his office. Users of heavy industrial machinery which operates at high noise levels are usually poor customers for this service.

Background music systems fall into either of two broad categories — *local* or *central*. In local systems (see Fig. 1), the music is provided by a tuner or other device at the subscriber's location. Customarily, this represents a one-time sale of equipment. There is, of course, some service work, but the local system offers no other continuing source of revenue.

Central systems, on the other hand, are secured by contract and provide the background music operator with a monthly fee for supplying a complete music service. This is popularly known as "canned" music. Originating at a central point, the program is transmitted via air or wire to the premises of an account, or subscriber. The advantages of each approach will become apparent in the following descriptions.

## Local Systems

The chief attraction of FM radio as a background music source, for small businesses, is price appeal. Often, they do not wish to assume the burden of monthly rental fees.

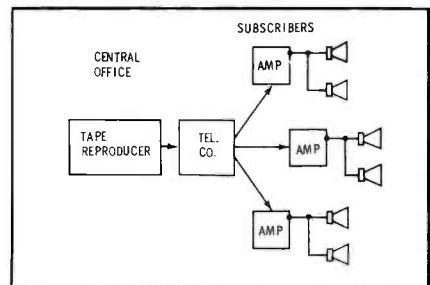

Fig. 2. Central music system service uses lines leased from phone company.

To the service shop, FM represents an inexpensive entry into the field.

In selling a system which uses FM music, one is apt to encounter the common misconception that there are no commercials on FM. This is not true of all stations. The number of FM stations is nearing 1,000 and, except for educational outlets, most are increasing their number of paid announcements. Yet, FM is practical, especially if there are one or two stations which specialize in music, within approximately 50 miles of the customer. Serving a customer beyond this distance may not be economically feasible.

## Record Changer

The problem of commercial announcements is completely eliminated by using a record changer. A great deal of excellent recorded music is available and works in favor of this program source. But, building a record library can be a disadvantage to the customer; an 8-hour day of recorded music requires about twelve long-play records. The cost for these will be approximately \$35, and for a music library which will not be overly repetitious, several hundred dollars.

A record system also needs periodic attention. Records must be either reloaded or flipped every few hours. Yet, there are numerous locations where this requirement is not a disadvantage. The responsibility for changing records is most often delegated to a switchboard operator, information-desk attendant, or receptionist.

## Tape

Music reproduced on tape is least practical for local systems. Reels have to be loaded or reversed every hour and a half, the selection of pre-recorded tapes is limited, and building a library is expensive.

In suggesting such a system, the serviceman often encounters the hi-fi enthusiast who thinks the problem of cost can be solved by recording music at home from an FM tuner. Factors against this approach are: the cost of raw tape (almost as expensive as recorded discs) and the inordinate amount of time needed to make the recordings. Editing out voice announcements is also a time-consuming job. Besides, if an FM

## FM Tuners

Sensitivity requirements depend on the available signal at the subscriber's location. In most instances, a sensitivity of 10 uv (for 20 db quieting) is sufficient. Some tuners offer a sensitivity as great as 1 microvolt.

The tuner should provide at least 1 volt of audio signal. Its output impedance should be 47,000 ohms or higher, to match the tuner input of most amplifiers. Some tuners include additional amplification and, when used in conjunction with a booster-type audio amplifier, are suitable for high-power applications.

Installation of the tuner should include the necessary antenna facilities. In most cases, a simple omnidirectional dipole is sufficient; in others, a sharply-directional antenna is necessary. If only one station is to be received, the directional antenna is usually more satisfactory. If the station is nearby, a simple power-cord or internal antenna (furnished with most tuners) may be all that is required.

## Multiplex Receivers

These are usually fixed-tuned sets designed to receive only one station. The multiplex circuitry is tuned to the subcarrier, and demodulates the program information. The audio output should be approximately 1 volt. Audio-frequency response is limited because of noise considerations. These receivers generally have a sensitivity of about 10 microvolts.

Adapters can be used with conventional FM tuners to receive multiplex transmissions. In these instances, the subcarrier output must be tapped off at a point preceding the tuner's de-emphasis network.

## Record Changers

A good-quality 33 $\frac{1}{3}$ -rpm changer is best. 16 $\frac{2}{3}$ -rpm records play longer, but are not recommended for music. 33 $\frac{1}{3}$ -rpm records are readily available, and provide a wide selection of program material. A 4-pole motor is preferable; hysteresis synchronous types are more expensive, and the added quality is not necessary for this purpose.

A cartridge which has a light tracking pressure (less than 5 grams) and a frequency response of 50 to 10,000 cps is preferable. Its output should be sufficient to drive the amplifier which the system will use; otherwise a preamplifier will be necessary. A diamond needle will wear much longer than a sapphire type, and for continuous use is the better choice of the two. Regardless of the stylus used, however, it should be inspected periodically to guard against excessive record wear.

tuner is to be used, why not in the system itself? The tape approach, however, does play a key role in central systems.

You may feel that FM and records are not new, and certainly they are not. But, promoted on business cards and other sales literature as "background music systems," they are removed from the category of home entertainment. They form the heart of systems which make background music feasible for the smallest customer — and the service shop with limited financial resources can sell and install them.

## Central Systems

A more ideal approach is pos-

## Microphones

A simple crystal-type microphone is sufficient. For most amplifiers it should have an output of about -50 db or 100 millivolts. Frequency response need be only 300 to 3000 cps, for voice announcements. If used in high-noise areas, noise-cancelling or close-talk microphones add to the clarity of spoken messages.

## Amplifiers

A conventional all-purpose audio amplifier can be used. It should have an input sensitivity of 100 millivolts for a microphone, the same for a record changer, and 1 volt for the tuner. The input volume for each should be separately controllable.

Output requirements vary widely with application. Some generalities are:

In quiet areas—	2 watts for	10,000 cu. ft.
	10 watts for	100,000 cu. ft.
	40 watts for	1,000,000 cu. ft.
In busy areas—	4 watts for	10,000 cu. ft.
	30 watts for	100,000 cu. ft.
	100 watts for	1,000,000 cu. ft.

In areas requiring high-power amplifiers, the booster-type amplifier can be used. This is driven by a small amplifier which raises the program or paging levels to between 1 and 5 volts. Booster amplifiers which furnish power outputs of up to 500 watts are available.

## Speakers

In small, quiet areas the usual 8-inch speaker mounted in either a ceiling, wall, or corner baffle will suffice. In larger areas, or where the noise level is higher, several of these units may be used. One speaker should be provided for each 10,000 cu. ft. of room size, and the necessary driving power (from the amplifier) distributed to each of them. In case one area is noisier than another, more speakers can be used, or more power can be supplied to one speaker.

In high-noise areas—and outdoors—trumpets are sometimes necessary to provide a sufficient power level. These are usually of the 15-watt variety, and each is fed enough of the amplifier power output to cover its designated area.

The frequency response of the speakers and trumpets need not be great—70-7000 cps will do for most applications. If too wide a range of frequencies is covered, the background effect of the music is often lost, and the program material becomes obtrusive.

sible with the central-office system. A single program is fed to any number of subscriber locations. There are no announcements, and the musical material is specially chosen to be functional — that is, suited to the time of day or mood of work. The system operates on a rental basis, with all or most of the equipment being owned by the central operator.

The two central systems now in use, wired and radio, may sound like sizable financial undertakings for the average service shop. However, it is possible to begin on a modest basis and expand if conditions warrant.

Each subscriber installation requires a capital outlay which the operator may not recover for six

• Please turn to page 81

# THE RIGHT WAY TO INSTALL ANTENNAS

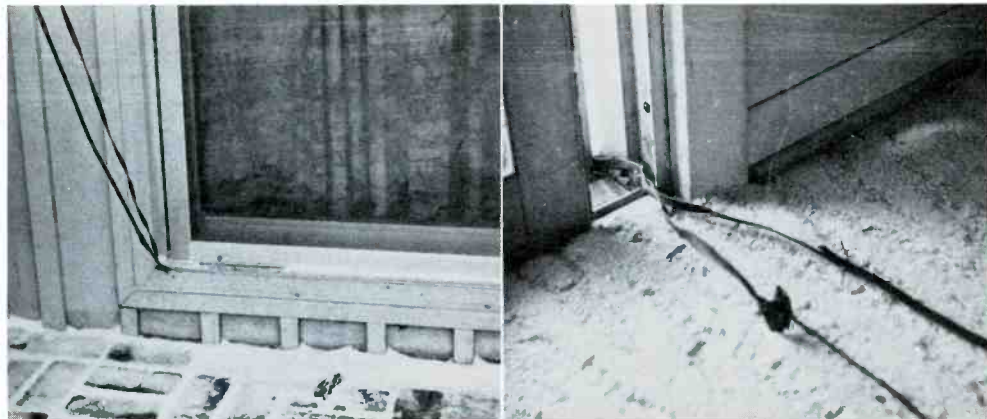

It wasn't necessary to look far to find what was causing the main difficulty. Notice how both the twin-lead and the rotator-control cable had been routed through a sliding glass door that crushed them each time it was closed. A careful inspection revealed that leads in both of the cables had been broken; but before doing anything we decided to look outside.

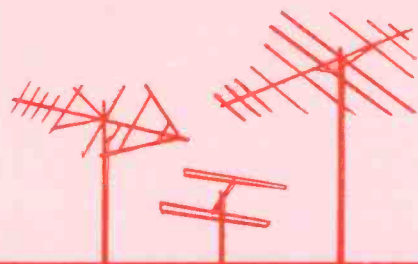

There is a right and a wrong way to do almost everything, including the installation of antennas and lead-ins. We decided to see what improvement could be gained by using approved installation methods on a system which had been in use for some time. The system chosen included a complete collection of poor techniques. We gained the owner's permission to "operate" when we informed him that we would guarantee a noticeable improvement in the appearance of both the TV picture and the physical installation.

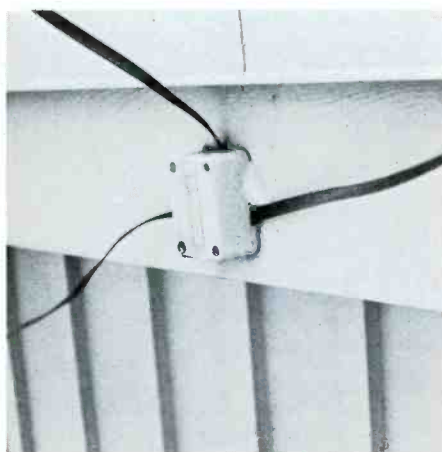

The lead-in from the mast led directly to this two-set coupler, which obviously was not in a very protected location. The coupler is an outdoor type, but even so, it should have been installed under the overhang of the roof edge. At this point we decided to look further and trace the two lead-in wires to the sets.

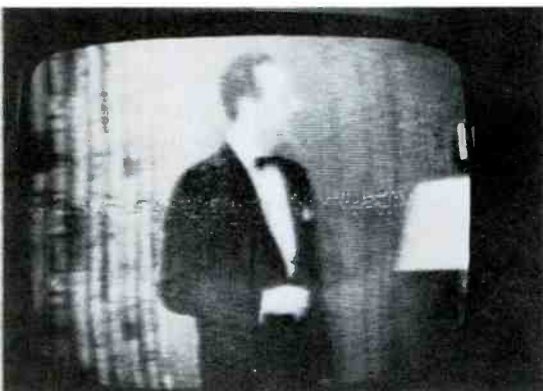

Turning on the set, we were rewarded with this picture, which immediately suggested that something was drastically wrong with the present system. Disconnecting the antenna lead-in wires from the set did not change the picture appreciably, indicating that the lead-in was open somewhere.



One line led across a gravelled roof (pictured on the left), and it would be difficult to estimate the signal losses in this short run. Even if the lead had been properly run, there would still be objectionable losses due to the way the lead is touching the metal gutter. The other line, although protected from the weather, was sagging from its own weight as it traversed a 50' horizontal run on only three standoffs.





At this point, we decided that a complete rerouting job was in order. After determining that the house was built over a crawl space, we installed a feedthrough entry as shown in this picture. Notice how the standoff below the fitting allows a drip loop to be formed. This type of entry also permitted a straight run down the mast.



After connecting a piece of lead-in to the set and installing the plug supplied by the wall-plate manufacturer on the other end, we turned on the set and received this signal. Ghosts were present because we had not yet had an opportunity to reroute and repair the rotator leads, or to turn the antenna for the best picture.

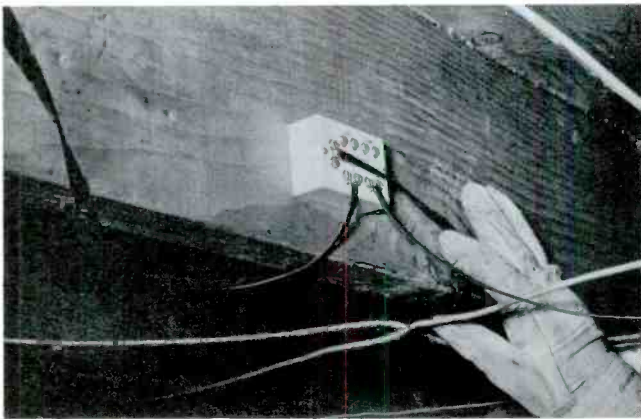

A floor joist provided the ideal spot for mounting a four-set coupler. An inside location serves to shelter the coupler from the weather, and, keep the twin-lead from being subjected to movement which could cause a connection to break. Also, by locating the coupler as far as possible from the antenna, the signal will be at its highest amplitude over the major portion of the transmission line. Therefore, any noise picked up on this section of the line will be comparatively weak.

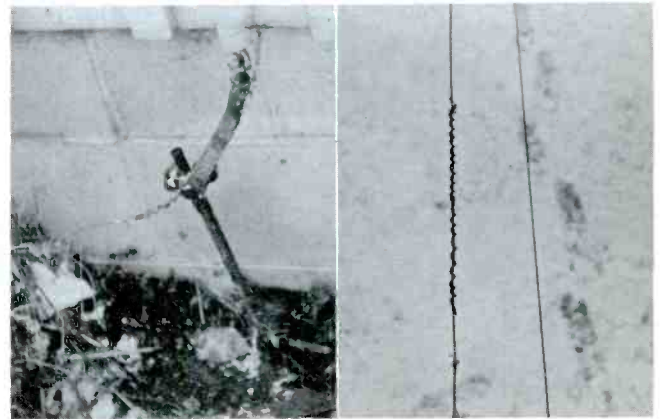

All we had left to do were a few outdoor "mopping-up" operations. First we inspected the guy wires supporting the mast. While several had been spliced in the original installation, we didn't attempt to replace them because they seemed strong enough to hold. However, if we had made the original installation, we would have used only continuous lengths of wire (even if this meant wasting several feet of wire) rather than to use splices.

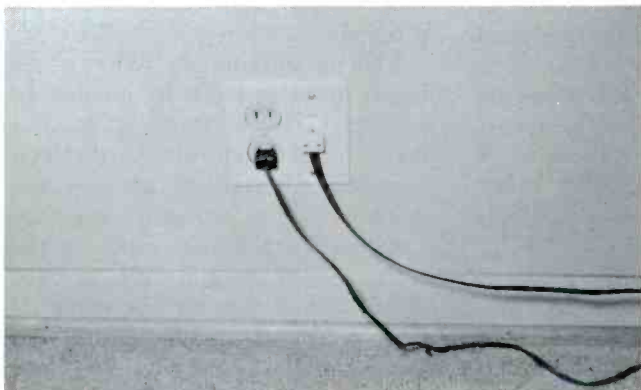

With a minimum amount of effort, we were able to install wall plates which provide a jack for plugging the TV into both the antenna system and the power line. Besides allowing the TV set to be moved easily from room to room, this type of entry keeps the lead-in short and away from the floor. Utilizing the holes already drilled for the electrical cable saves effort and time in fishing the lead-in through the floor.

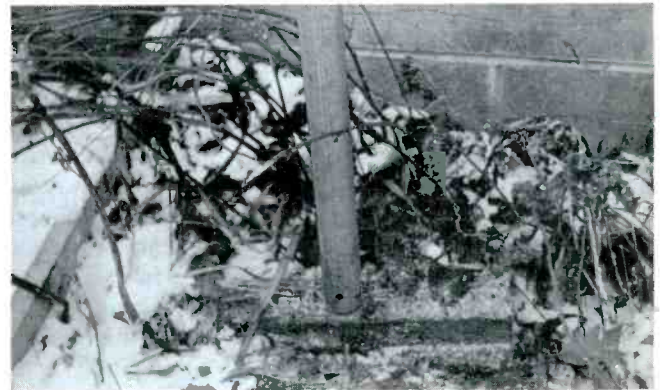

One final error in the original installation — the absence of provisions for grounding the antenna system — still had to be corrected. We had noticed that the mast did not have a ground lead, and that the base was resting on a block of wood (presumably to keep it from sinking into the ground). We installed a ground wire to the electrical ground rod (shown on the right) and secured the other end to the base of the mast.

by Allan F. Kinckiner

The repair of any piece of electronic equipment consists of two operations — first an analytical troubleshooting procedure to determine the cause of an abnormal condition, and then the actual replacement of defective components. Since replacing parts is usually the easier and less time-consuming of the two operations, the most effective method of cutting over-all repair time is to find ways of reducing troubleshooting time.

Troubleshooting is itself a combination of two basic functions—localizing a fault to one particular section of the equipment, and pinpointing the defective component in

of the strong points each offers without being hampered by the limitations of any unit.

Especially in TV servicing, the most effective blend of troubleshooting techniques is accomplished by using a scope along with other instruments. Although no claim is made for the scope as a “cure-all,” it does provide a great deal of useful information not obtainable with other types of test equipment. Besides its well-known value in dealing with “tough-dog” troubles, it is excellent for speeding up the completion of many simpler jobs.

Whenever there is any doubt as to the significance or accuracy of results obtained with other test methods, scope checks can make it easier to interpret these results. For example, in troubles involving inter-

frequency of 60 or 120 cps, but may do an inadequate job at higher frequencies. This is not to say that component tests are useless; the point is simply that waveforms can frequently give added evidence needed for properly interpreting the results of such tests.

If scope servicing is “all it is cracked up to be,” why isn’t it more universally employed? This is not an easy question to answer, but here’s a try: Beginners or infrequent scope users naturally have some difficulty in recognizing and interpreting abnormal features in waveforms. Too many of these men allow themselves to become discouraged, and give up too easily. Possibly they expect too much from the instrument. If a technician doesn’t resort to a scope until the set he is working on

# SPEEDIER SERVICING WITH A SCOPE

that section. The first function is sometimes so easily accomplished that it is done without conscious effort; for instance, it is often possible to narrow a TV-receiver defect down to one or two stages by merely analyzing the picture and/or listening to the sound. On the other hand, some troubles (unstable sync is a prime example) are not readily isolated without the use of test equipment.

Various instruments are available to help servicemen localize and pinpoint defects. Some popular types used since the early days of radio servicing are voltmeters, component testers, and signal-substitution units. Seldom does a serviceman depend on one of these instruments by itself. Instead, he uses them in combinations, so he can take full advantage

action between circuits, inspection of a few waveforms will enable the serviceman to avoid wasting a great deal of time measuring voltages in the wrong stages. And even when a defective stage has been found, can the trouble always be cured just by correcting a voltage that is apparently abnormal? Definitely not! A quicker way of pinpointing many defects is to relate voltage readings to abnormal scope traces.

In component checking, the most common pitfall is the often-encountered difference between test conditions and actual operating conditions. Sync and sweep tubes, when checked for transconductance in a tube tester, may pass with flying colors—and still fail to function in the circuits. Also, filter capacitors may seem normal at the usual test

has already taxed his composure, he is apt to find fault with scope troubleshooting because it doesn’t immediately help him solve the problem.

Skill in interpreting scope traces is not developed just by reading an instruction book; it takes practice and is aided by knowledge of circuit operation. Waveform analysis becomes easier as the scope user accumulates experience with the peculiarities of various TV models, differences in signals according to local reception conditions, and distortions that appear as sets age. Anyone can develop the ability to analyze important factors such as amplitude, sync-to-picture ratio (in composite video signals), noise, and hum, often without finding it necessary to check waveforms in service



Fig. 1. Top of picture flapped back and forth like a flag in a stiff breeze.

data. Then, by using his scope in conjunction with other test instruments, he can do a more complete job of troubleshooting, and do it in less time—as the following specific examples will illustrate.

### Scope First—VTVM Later

A DuMont RA-112 could be locked in horizontally by only a very critical setting of the hold control, and even then the picture would flap sideways and curl slightly as shown in Fig. 1. Since this condition could result from many things (video-contaminated or insufficient sync, horizontal AFC-oscillator defects, a distorted or weak sweep signal fed back to the AFC stage, or some other less likely cause), I decided to use the scope for initial troubleshooting. The very first waveform I checked, at the grid of the AFC tube (Fig. 2), gave a prime clue to the trouble. At this point I found only the horizontal sync pulse shown in Fig. 3A—not the normal trace I expected to find (Fig. 3B).

Because of the absence of any sawtooth component in the waveform, I suspected that feedback resistor R123 was open. I could have checked for this condition by turn-

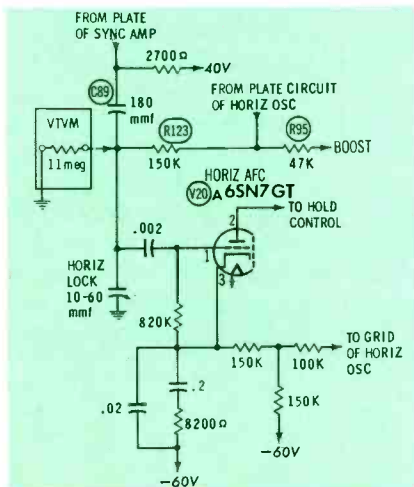

Fig. 2. Fault in the AFC grid circuit caused the loss of horizontal hold.



(A) Pulses only, indicating defect.



(B) Normal pulse-sawtooth combination. Fig. 3. Horizontal-AFC grid signals.

ing the set off and measuring the resistance of R123, but in this case it was quicker to check for DC voltage at the AFC end of the resistor. With a DC circuit completed across the boost source through R95, R123, and the input circuit of the VTVM, a high voltage would be indicated at the AFC end of R123 if this resistor were good; however, an open R123 would prevent a DC indication. A voltage actually was present, but it measured only 50 volts. This might have pointed to an extreme increase in the value of R123, but before jumping to this conclusion, I took one more voltage reading—at the sync-amplifier side of C89. This also turned out to be 50 volts, suggesting that C89 might be shorted. This supposition was confirmed when I changed C89 and found that horizontal sync was restored to normal. The VTVM provided the final solution to this problem, but the scope showed me where to look first.

### Scope Absolves Suspected Part

A fellow serviceman had on his bench a General Electric table model using the M3 chassis. When first turned on, the receiver operated

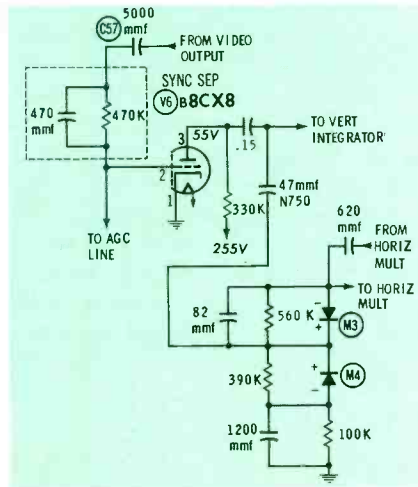

Fig. 5. Trouble was not in horizontal AFC, but at input of sync separator.

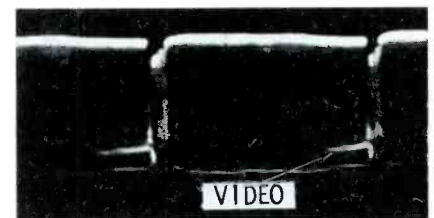

Fig. 4. In second case of horizontal bends, raster had billowed appearance.

perfectly; but after five minutes, vertical lines in the picture took on a twist that gave the picture a billowy appearance (Fig. 4). As the set continued to warm up, the twist became more severe, and horizontal sync would tear out at every signal interruption resulting from camera or channel changes. My friend was pretty sure the trouble was caused by AFC diodes M3 and M4 (Fig. 5), but before changing them, he accepted my advice and scoped the output of the one-stage sync circuit. The waveform at the plate of the 8CX8 triode sync separator (Fig. 6A) showed evidence of video contamination. Further checking in this stage turned up a leaky input coupling capacitor C57, which incidentally turned out to be a Wedgecap used only by G-E. This capacitor, designed for insertion in printed circuits, is shown in Fig. 7. Replacing C57 with a standard .005-mfd tubular unit resulted in normal sync output (Fig. 6B), and everything was hunky-dory — everything but my friend's puzzlement, that is.

"Why," he wanted to know, "didn't the sync condition upset vertical locking? Also, how come the

• Please turn to page 73



(A) Contaminated with video.

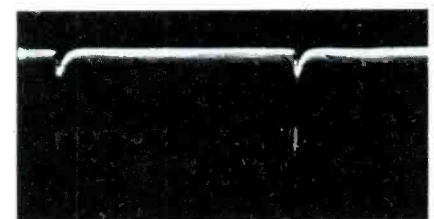

(B) Normal pulses.

Fig. 6. Sync-separator output (30 cps).

# SELECTIVE CALLING

## ENDS HUBBUB IN MOBILE RADIO

Tone-coding systems make it possible to "dial" individual stations in a radio net without disturbing others . . . . . by Allan Lytel

In a two-way communications system equipped for selective calling, the various stations hear only those messages intended specifically for them. Mobile units are contacted by the base transmitter either individually, in groups, or all at once, in response to different codes created by the operation of a telephone dial or push buttons. When the correct code is received at a particular mobile station, a decoding device either activates a normally-muted loudspeaker, turns on a light, or sounds an alarm to notify the operator of a call. Different electrical devices may also be remote-controlled by selective calling.

When mobile units and base stations are both equipped with code senders and decoder units, any radio station can dial any other station in the same system without alerting the others—just as if all stations were connected by a dial telephone system. However, the stations in such systems cannot be interconnected with a conventional dial telephone system.

The mobile-radio serviceman will run across two basic types of selective-calling equipment. One is a



(A) Secode digital code sender.

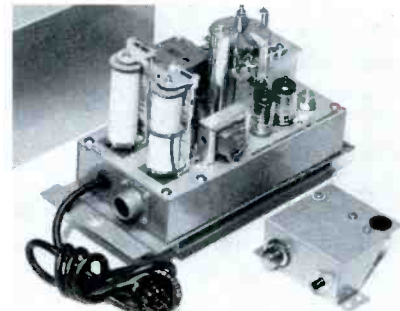

(B) Decoder and call head.

Fig. 1. Selective-calling components.

digital type which transmits pulse trains consisting of dual or single tones. In the other type, a single tone or group of tones is transmitted, but not in pulse form.

### Digital Pulses by Dialing

The pulse type of selective-calling system typically utilizes an audio oscillator and telephone dial at the transmitter. A code number, comprising one or more digits, is dialed to call another station. Each time a digit is dialed, a series of tone pulses are transmitted—for example, six pulses to indicate the number 6. Each pulse represents the presence of tone modulation (when a single tone is used) or a change from one

tone to another (when two are used).

Besides the code sender at the transmitter, the selective-calling equipment includes two units at the receiver—a decoder, and an indicating device known as a *call head*. Representative pieces of equipment are pictured in Fig. 1.

When a station operator dials the appropriate code to contact a certain other station, the pulse train produced by his code sender is transmitted to all units in the system. However, only the decoder of the called station responds by activating its associated call head to signal an incoming message.

Some systems use a two-contact

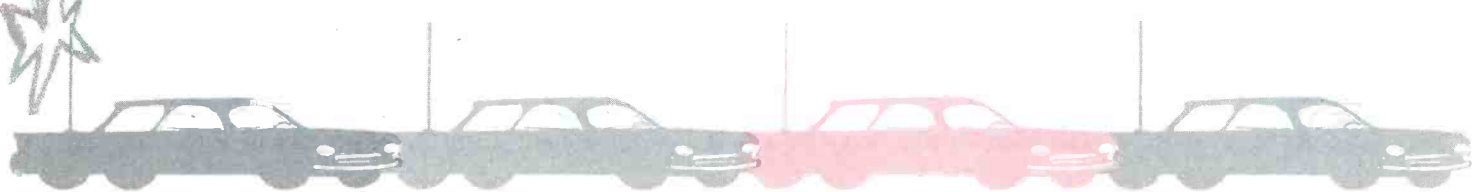

decoder that enables the dispatcher to sound a vehicle's horn or turn on its lights to indicate a call. This feature is especially desirable on utility or construction trucks whose crews may be working at some distance from the vehicle. Two code numbers may be assigned to each mobile unit. The first code actuates the dash indicator light. If there is no response, the dispatcher dials the next code, which closes the second contact and turns on the lights or horn for about four seconds.

**Code Sender**

A code sender of the type used in many base-station transmitters is shown schematically in Fig. 2. This device is connected in parallel with the microphone so that either the code unit or the mike can modulate the transmitter.

Tube V1 operates as a push-pull oscillator. The plate circuits of the two triode sections are connected to opposite ends of the resonant tank circuit, and each plate is also capacitively coupled to the grid of the opposite tube section. The two halves of the tube produce voltages 180° out of phase, thereby sustaining oscillation.

When the dial is turned, contacts M2A close, completing the circuit through relay M1 to ground. This relay then operates, and plate voltage is applied to the tone generator through contacts M1A. At the same time, the relay keys the transmitter on through contacts M1B, and also sends the tone signal to the transmitter via contacts M1C.

When the dial is released and allowed to return to the resting position, dial-pulsing contacts M2B alternately open and close the oscil-

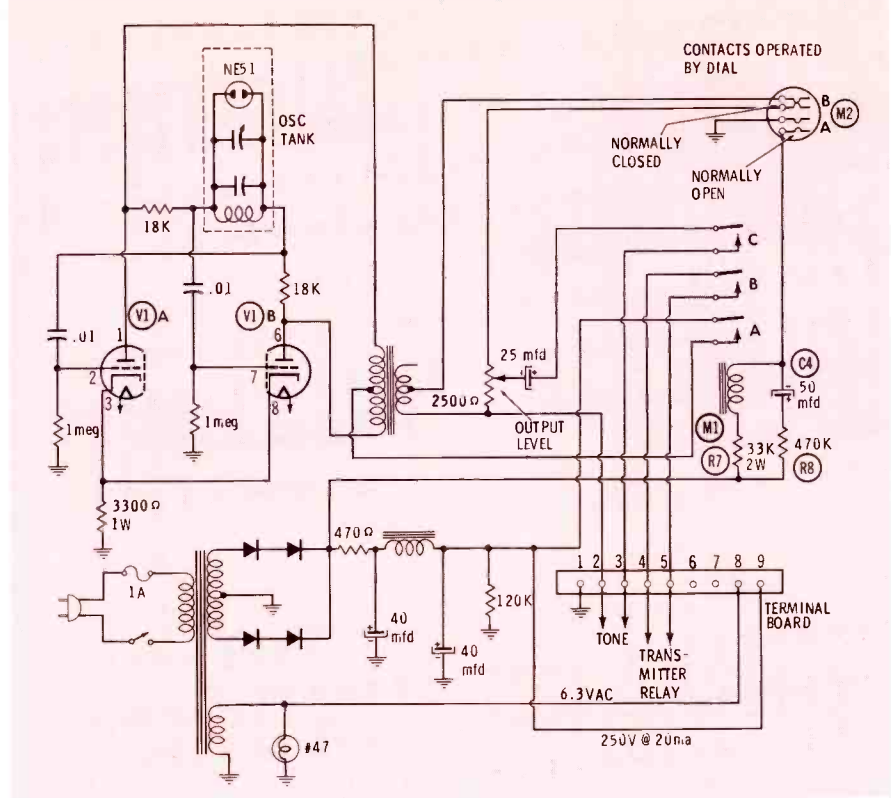

Fig. 2. Dial contacts interrupt oscillator signal, forming digital code pulses.

lator-output circuit, thereby interrupting the tone signal. This causes the code sender to produce "break" pulses or "holes" in the tone, the number of "holes" equaling the digit dialed. A chief advantage of this negative keying system is high noise rejection. Selective signaling operates even when the amplitude of noise on the circuit is as much as five times that of the signal.

The standard operating frequency of this tone generator is 2805 cps, but the unit can be changed over to any single frequency in the range from 600 to 3145 cps. The OUTPUT LEVEL control serves as an adjustment to provide sufficient signal for modulating the transmitter. A time-delay circuit consisting of resistors R7 and R8, together with capacitor

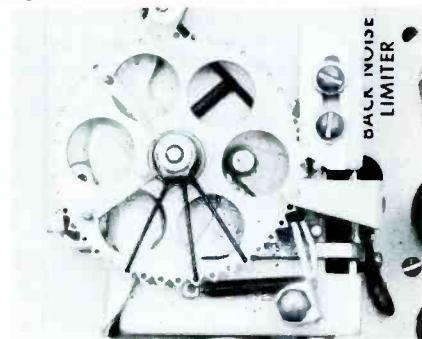

Fig. 3. Selector wheel is electromagnetically driven by pulses from decoder.

C4, keeps relay M1 energized for about four seconds after the dialing operation is completed. When this RC network has discharged through the relay coil, the contacts of M1 open and extinguish the tone signal.

As illustrated in Fig. 2, this code

• Please turn to page 78

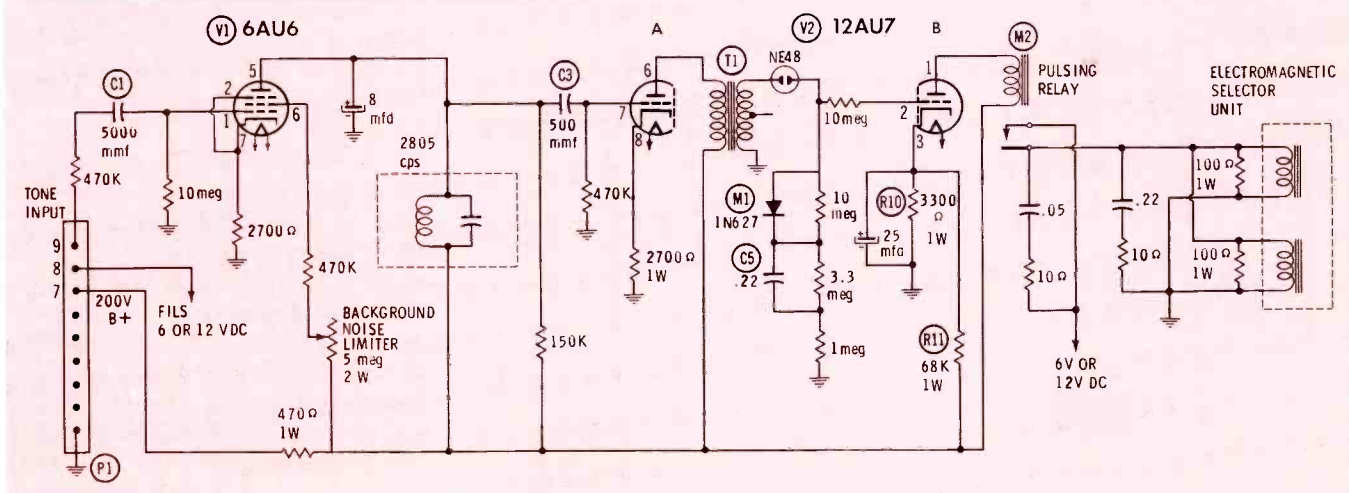

Fig. 4. Relay M2 closes each time the signal fed to decoder is interrupted.



by Mike Martynec

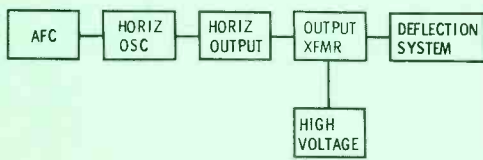

Fig. 1. Any of these stages may be involved in "sound-no raster" troubles.

The phone rings loudly, and you lift the receiver to hear, "This is Mrs. Jones. My TV set has lost its picture, and the kids are about to drive me crazy. Can you come right out?" Naturally, such a distressed plea cannot be ignored, so you climb into your truck and drive over to the Jones' house.

At setside, you quickly note the set has a very common fault—sound but no raster. After checking the front controls (just to be sure one of the little Joneses hasn't tampered), you slip the back off and install your

cheater cord. First, you look for the reassuring glow of the CRT heater, and are relieved to find it normal. Next, you check the sweep fuse, which you find is okay. Using a screwdriver, you attempt to draw a fuzzy arc from the cap of the high-voltage rectifier, but cannot.

At this point, you decide to try tube substitution, so you replace the horizontal oscillator, output, damper, and high-voltage rectifier, all to no avail. The CRT remains dark, and the Jones kids are climbing all over your tube caddy, so you decide that this is a job for the bench. An immediate outburst of small voices persuades you to leave a portable loaner until you can complete the repair job and return the Jones' set.

In the shop, you brush away the dust and cobwebs from the chassis and out of the high-voltage cage. Now you can make a quick visual check for discolored resistors or

other signs of overheating. Seeing none, you decide to sit down and analyze the horizontal and high-voltage sections of the receiver before proceeding further.

Your interest is primarily in the circuits represented in Fig. 1. The horizontal oscillator, whose frequency is controlled by the AFC circuit, supplies a sawtooth wave to the horizontal output stage. The highly-amplified sawtooth is fed into the output transformer; here, a portion of its energy is used to develop high voltage for the CRT, while the remainder is fed to the deflection system.

Fig. 2 and Fig. 3 show the circuits schematically. Horizontal oscillator V8, in Fig. 2, generates pulses which are fed to shaping network K3 in Fig. 3. The output of this network (W14) is coupled to the horizontal-output grid. V9 provides sufficient power amplification to drive output transformer T4 and the deflection coils. V10 damps the flyback-circuit oscillations caused by the large pulses in T4, and also develops a boost B+ voltage for application to circuits which need more voltage than the regular B+ source provides.

In addition, T4 steps up the voltage of the flyback pulses and applies them to high-voltage rectifier V11. Here, they are rectified and applied to the HV anode of the CRT.

A good way to start troubleshooting the circuits in Figs. 2 and 3 is by isolating the trouble to one stage. Your scope can be valuable to you for this operation. By using it to measure waveforms W13 and W14, you can discover three things about them: their existence, their ampli-

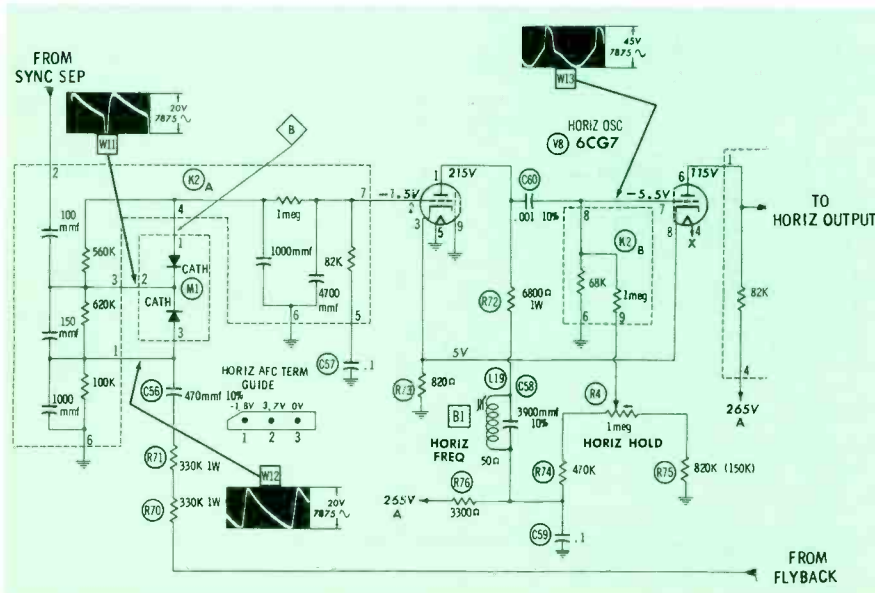

Fig. 2. Cathode-coupled multivibrator — a typical horizontal sweep generator.

tude, and their shape. For example, if W13 is missing or very low in amplitude, there is no need to measure W14 at all; the trouble lies in the oscillator circuit. On the other hand, if both waveshapes are normal, look for trouble somewhere in the output stage or in the circuits that follow.

If the trouble is traced to the oscillator section, careful voltage and resistance tests will often pinpoint a defective or off-value component. If plate voltage is missing from the first part of the multivibrator, R72 or L19 could be open. If the voltage is there, but is lower than normal, R72 may have changed value — or C60 may possibly be leaky. In the latter case, you will also find an incorrect grid voltage in the second section.

Take careful note of capacitors such as C60, making sure that their value has not changed. Certain types of capacitors in horizontal circuits tend to change value, perhaps because of the high-energy pulses to which they are continually subjected. When you are in doubt about such components, substitute a known good one of the proper value. This takes much less time than just wondering about it. Also be certain to replace any defective temperature-compensating capacitor (used in some sets) with another of the same characteristics — this is important to the frequency stability of the oscillator.

If waveform W13 is normal, look at W14 (Fig. 3). The amplitude is important; but if waveform W13 was okay, you will usually find W14 also sufficient. To calibrate your scope quickly and easily, touch the probe to the heater terminal of any tube. The 6.3-volt AC waveform found here has a peak-to-peak value of about 17.5 volts. If you adjust the scope's vertical gain so as to have about  $\frac{7}{8}$ " deflection, your scope will then be calibrated for 20 peak-to-peak volts per inch. However, the shape of W14 is also important; if it is found to vary from the correct waveform, try substituting the waveshaping components. (In the circuit of Fig. 3, replace K3.)

If your scope happens to be out of commission, or you don't have one yet, a fairly good test of the

oscillator and waveshaping network can be made with a voltmeter. If either the amplitude or shape of W14 is incorrect, there will be a change in the DC grid bias developed by the output stage (a class-C amplifier). If voltages were normal in the oscillator section, you are justified in suspecting the waveshaping network.

There are a few considerations to watch out for, when you use this method of troubleshooting. First, the type of voltmeter used will affect your readings. A VTVM will not appreciably load the circuit, and the measured voltage will practically equal the DC level which actually exists at the grid. However, some service literature (especially for older receivers) gives measurements taken with a 20,000-ohms-per-volt meter, and the resulting readings are somewhat lower than those obtained with a VTVM.

Another consideration is the setting of C61 (Fig. 3), which is labelled SIZE CONTROL in this particular receiver, but which is more commonly called a drive control. If this control is set for minimum drive, the grid-signal amplitude will be low, resulting in insufficient bias voltage. Thus, a reduction in drive increases the current through the horizontal output circuit, contrary to what you might expect.

A third method of isolating trouble to this circuit is by signal injection. Insert a substitute signal from a special test generator at the grid of V9, and adjust it to the proper amplitude by a control on the in-

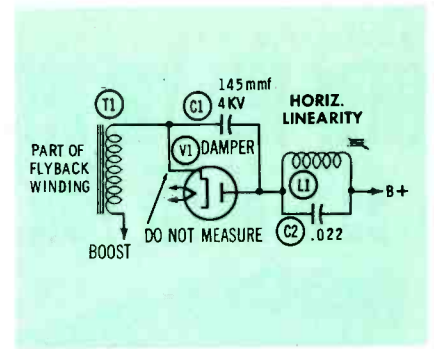

Fig. 4. Some sets have a horizontal linearity coil in series with damper.

strument. If this restores the high voltage and raster, then you know the oscillator or waveshaping network is at fault. If not, the trouble is beyond the injection point.

### Output Section

Troubleshooting the output stage is not too difficult. As a rule, troubles within this stage can be isolated with a voltmeter or ohmmeter. You can use your scope to check the plate waveform, but *do not connect it directly to the plate cap*. Just clip the scope input lead to the insulation of the plate-cap wire. Amplitude cannot be measured by this method, but many troubles in the flyback or yoke sections will cause a distorted plate waveform to appear.

This is where troubleshooting can get tricky, if you are not careful. Several interdependent functions are performed by the flyback-yoke circuit, and one trouble can result in loss of more than one function. However, if you adopt a logical troubleshooting procedure, you should have few problems.

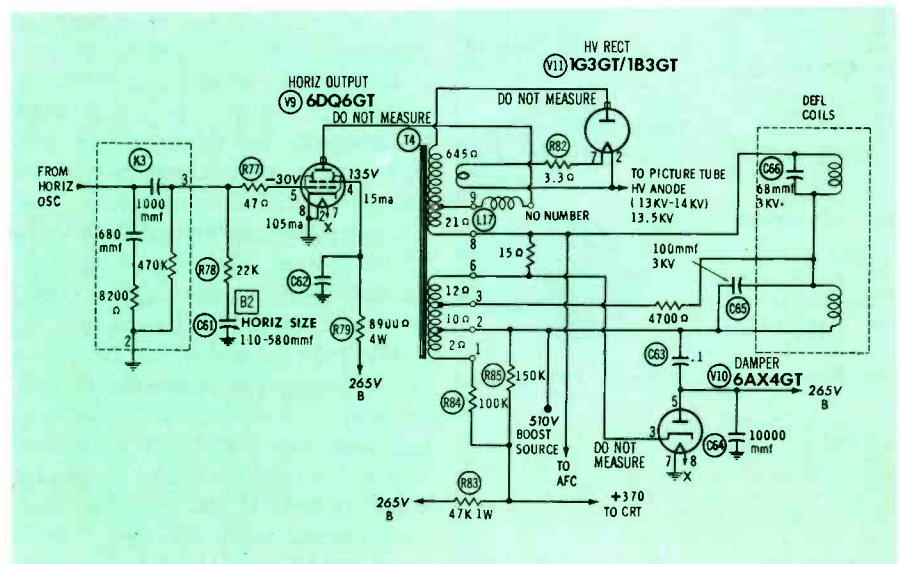

Fig. 3. Typical horizontal deflection system using autoformer-type flyback.

# SERVICE MASTER... EVERY TOOL YOU NEED 99% OF THE TIME



complete 23-piece kit for radio, TV,  
and electronic service calls

## 2 HANDLES:

shockproof plastic.  
Regular 4" length  
... 2" Stubby. Inter-  
changeable. Patented  
spring holds snap-in  
tools firmly in place.

## 9 NUTDRIVERS:

High Nickel chrome  
finish,  $\frac{3}{16}$ " to  $\frac{1}{2}$ "

## 3 STUBBY

NUTDRIVERS:  
 $\frac{1}{4}$ ",  $\frac{3}{16}$ ",  $\frac{3}{8}$ "

## EXTENSION BLADE:

Adds 7". Fits  
both handles.

## 3 SCREWDRIVERS:

Two slotted...  
 $\frac{3}{16}$ ",  $\frac{1}{4}$ "  
#1 Phillips

## 2 REAMERS:

$\frac{1}{8}$ "- $\frac{3}{8}$ ",  $\frac{1}{4}$ "- $\frac{1}{2}$ "

## ADJUSTABLE WRENCH:

6" thin pattern,  
1" opening

## LONG NOSE PLIER:

"Cushion Grip",  
 $2\frac{1}{4}$ " nose

## DIAGONAL PLIER:

"Cushion Grip"  
hand-honed  
cutting edges

## ROLL UP KIT:

Durable, plastic-  
coated canvas.  
Compact, easy-  
to-carry.

Ask your distributor to show you kit 99 SM



XCELITE, INC. • ORCHARD PARK, N. Y.  
Canada: Charles W. Pointon, Ltd., Toronto, Ont.

Start by lifting the plate cap from V11, the high-voltage rectifier (not while the set is operating!). This eliminates the high-voltage circuits from the flyback-transformer load. If an arc is now present at the plate cap, you have trouble in the high-voltage rectifier circuit. If there is no arc, the trouble lies somewhere within the flyback-yoke circuit.

If you have a flyback checker, now is the time to use it. If you do not have such an instrument, here are a few suggestions. After a few minutes, pull the line plug and feel the flyback transformer. A shorted winding will usually cause the transformer to heat up enough to be warm to the touch. Be sure the heat you feel is not due to the nearby output tube. If the winding is open, an ohmmeter check will help pinpoint the trouble, but this test is of little value for shorted windings unless they are shorted directly to the frame. Many times the short appears only when the high-amplitude horizontal pulses are present; therefore, it cannot be located with an ohmmeter.

Next, you will do well to examine the damper circuit. A defect here can have two effects on the flyback circuit: First, it loads down the circuit, causing it to operate very inefficiently; second, it removes the boost voltage from V9. Either effect can cause the flyback circuit to become completely inoperative. A common defect in damper circuits is a bad capacitor — especially C63.

Some damper circuits use a linearity coil in series with the boost line, as in Fig. 4. An open L1 would prevent application of B+ to damper V1, resulting in no boost voltage. If there is no pulse from the flyback, no boost action will take place; if everything else is normal in the damper circuit, you will get a B+ reading on both sides of the damper tube, indicating trouble elsewhere in the output stage. Of course, be sure C1 is okay.

The yoke assembly can be tested in two ways, by measuring it with an ohmmeter and by substituting a new unit. The yoke must be disconnected from the circuit for testing by either method. If you can't find anything wrong with the yoke, don't reconnect it until you have made one more flyback-circuit test to help

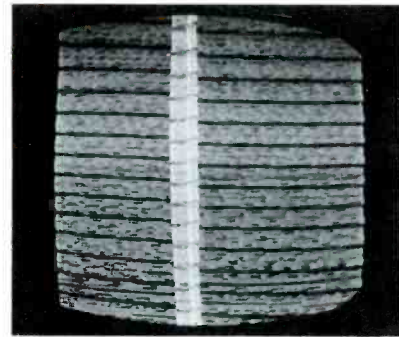
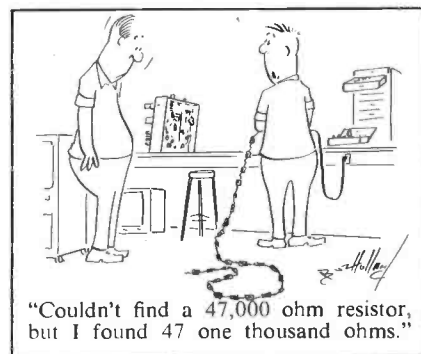

Fig. 5. After repairs, picture distortion indicated a need for adjustments. isolate the trouble. With the horizontal yoke winding disconnected, turn on the set and again check the waveform on the plate lead of the output tube. If the yoke is defective, a symmetrical waveshape will now be seen at this point, with a much greater amplitude than before. Now, as a further check, try drawing the usual arc from the high-voltage plate cap. If you can, chances are very strong the yoke is defective and the flyback is good. If neither of these tests gives the indicated result, the flyback transformer is probably bad, and you will gain little by further yoke testing.

If you decide the yoke is defective, it is worth trying to find the trouble, since the capacitors in the yoke often short, leaving the windings unharmed. If the trouble is not in one of these capacitors, it is better to get a new yoke than to waste time on the defective one.

## Final Touch-Up

By this time, you have no doubt found the trouble in Mrs. Jones' receiver. Let's say it was a bad flyback transformer, and you've replaced it. With a nice raster showing on the screen, connect the set to an antenna and tune in a channel. Chances are that other horizontal adjustments are needed (see Fig. 5), so let's do them.





# F.C.C. COMMERCIAL OPERATOR LICENSE

*Training...*

for **Jobs in Electronics**

## F. C. C. LICENSE — THE KEY TO BETTER JOBS

An F. C. C. *commercial* (not amateur) license is your ticket to higher pay and more interesting employment. This license is Federal Government evidence of your qualifications in electronics. Employers are eager to hire *licensed* technicians.

## WHICH LICENSE FOR WHICH JOB?

The **THIRD CLASS** radiotelephone license is of value primarily in that it qualifies you to take the second class examination. The scope of authority covered by this license is extremely limited.

The **SECOND CLASS** radiotelephone license qualifies you to install, maintain and operate certain radiotelephone equipment but not commercial broadcast station equipment.

The **FIRST CLASS** radiotelephone license qualifies you to install, maintain and operate every type of commercial radiotelephone equipment including all radio and television stations in the United States, its territories and possessions. This is the highest class of radiotelephone license available. Many companies which employ industrial electronics technicians require this license.

## GRANTHAM TRAINING PREPARES YOU

The Grantham Communications Electronics Course prepares you for a **FIRST CLASS** F. C. C. license, and it does this by **TEACHING** you electronics. Each point is covered simply and in detail, with emphasis on making the subject easy to understand. The organization of the subject matter is such that you progress, step-by-step, to your specific objective—a first class F. C. C. license.

## CORRESPONDENCE OR RESIDENCE CLASSES

Grantham training is available by correspondence or in resident classes. Either way, you are trained quickly and well. Write, or mail the coupon below, to any division of Grantham School of Electronics. Our free booklet will be sent to you immediately.

## HERE'S PROOF . . .

that Grantham students prepare for F. C. C. examinations in a minimum of time. Here is a list of a few of our recent graduates, the class of license they got, and how long it took them:

	License	Weeks
James C. Bailey, 217 Behrens Ave., Juneau, Alaska	1st	12
Edward R. Barber, 907 S. Winnifred, Tacoma, Wash.	1st	20
M. A. Dill, Jr., 20 Cherry St., Gardiner, Maine	1st	12
Bernhard G. Fokken, Route 2, Canby, Minn.	1st	12
Kenneth F. Foltz, Broad St., Middletown, Md.	1st	12
James C. Greer, Mound City, Kansas	1st	12
Thomas J. Hoof, 216 S. Franklin St., Allentown, Pa.	1st	22
Clyde C. Morse, 7505 Sharronlee Dr., Mentor, Ohio	1st	12
Louis W. Pavek, 838 Page St., Berkeley 10, Calif.	1st	16
Wayne Winsauer, 2009 B St., Bellingham, Wash.	1st	12

## FOUR SCHOOLS TO SERVE YOU

To better serve our many students throughout the entire country, Grantham School of Electronics maintains four Divisions—located in Los Angeles, California; Kansas City, Mo.; Seattle, Wash.; and Washington, D.C. Grantham offers rapid courses in F. C. C. license preparation, either by home study or in resident classes.

Accredited by the National Home Study Council

# Grantham School OF ELECTRONICS

LOS ANGELES  
CALIF.

1505 N. Western Ave.  
Los Angeles 27, Calif.  
(Phone: HO 7-7727)

SEATTLE  
WASH.

408 Marion Street  
Seattle 4, Wash.  
(Phone: MA 2-7227)

KANSAS CITY  
MO.

3123 Gillham Road  
Kansas City 9, Mo.  
(Phone: JE 1-6320)

WASHINGTON  
D. C.

821-19th Street, N.W.  
Washington 6, B. C.  
(Phone: ST 3-3614)

for **FREE** Booklet **CLIP COUPON** and mail  
in envelope or paste on postal card.



TO: **GRANTHAM SCHOOL OF ELECTRONICS**

1505 N. Western • 408 Marion • 3123 Gillham Rd. • 821-19th, NW  
Los Angeles • Seattle • Kansas City • Washington

Please send me your free booklet telling how I can get my commercial F. C. C. license quickly. I understand there is no obligation and no salesman will call.

Name \_\_\_\_\_ Age \_\_\_\_\_

Address \_\_\_\_\_

City \_\_\_\_\_ State \_\_\_\_\_

I am interested in:  Home Study,  Resident Classes 29-B

MAIL COUPON NOW

CHOICE OF OVER  
**250,000**  
SERVICEMEN



8 oz. ECONOMY SIZE... **\$1.98** DEALER NET  
FREE 12" SPRAY AID AND PREMIUM  
3 oz. "CADDY SIZE" ..... **98¢** DEALER NET  
FREE SPRAY AID

**CHEMTRONICS inc.**

870 East 52nd Street, Brooklyn 3, New York

in Canada Contact: Active Radio & TV Distributors  
431 King Street W. Toronto 2B, Canada

A good place to start is with the frequency controls. Use a jumper to short the horizontal frequency coil L19 (see Fig. 2), and see if the horizontal hold control will bring the frequency to normal. You find it will not, and a quick ohmmeter check of R74 and R75 reveals a change in the value of R75. After this resistor is replaced, the hold control locks in the picture, but sync is critical. As soon as you remove the jumper from across L19, the picture falls into diagonal bars again. Adjust the frequency slug in L19, until the picture comes into sync — this time very solidly. Now rotate the hold control each way to check its action, and slightly readjust L19 to make the picture lock in at the center of the hold-control range.

Adjustment of C61 takes care of the slightly narrow picture by increasing the drive to the output tube. In some sets, the width is controlled by an inductive component across a portion of the flyback winding. In these receivers, you should set the drive control for the grid voltage indicated in the service notes, and then adjust the width control for an overscan of about 1/2".

In sets using a linearity coil (such as seen in Fig. 4), now is a good time to adjust it. The best method is to adjust it first for minimum plate current in the output tube, and then to obtain the best possible linearity without increasing the current by too much. A meter inserted in series with the cathode resistor will measure the change in current while you adjust the coil. Some technicians use a #47 pilot lamp in series with the plate lead to monitor this adjustment; they simply set the linearity coil for minimum brilliance of the lamp.

After centering the picture, and checking for any other troubles, you load the set in the truck and return it to the Jones home. The children are overjoyed to get it back; it seems they didn't like the small-screen loaner.

#### Tube-Tester Modernizer

The need is increasing for facilities to test the latest tube types — especially *compactrons*, *novars*, and *nuvistors*. It isn't necessary to buy a new tube tester, for Sencore's



Model TM116 *Modernizing Panel* fills the bill adequately.

This unit is designed for use with any manually-operated tube tester capable of testing other tube types used in modern electronic equipment. Equipped with four setup switches, the Model TM116 permits the serviceman to make the same tests on the new types as on other tubes. For example, if you now own a mutual-conductance tester, the *Modernizing Panel* will allow mutual-conductance tests of the new types. Many tube-tester adapters merely set them up for a simple emission test, regardless of the tube-tester's capability. Of course, emission testers or grid-circuit testers used with the Model TM116 will perform only those tests for which they are designed.

The *Panel* is simple to use, and is accompanied by a chart which contains the information needed to set up both the *Panel* and the tester. The chart shows the filament voltage for the new type (in column 1). Column 2 lists a common tube type which uses the same tube-tester control settings as required for the new type to be tested; space is provided to record these settings for future use. To assure proper connections for the TM116, socket-pin connections are set for the tube type listed in column 3 of the chart, and the TM116 plug is inserted into the tube-tester socket for that type. Again, space is provided in the chart for recording the tube-tester settings. The final step involves setting up the switches on the *Panel* according to the information in column 4. ▲

TUBE TYPE	1		2		3		4	
	FILAMENT	TESTER CONTROLS SET AS FOR A	YOUR TESTER SETTINGS	SOCKET CONNECTIONS SET AS FOR A	YOUR TESTER SETTINGS	TM116 SETTINGS A B C D		
6AX3	6	6AX4	35Z5		4	7	0	0
6CW4	6	6FH5	6J5		4	8	2	0



# 30-second story on the WISE BUY in picture tubes



## Make \$2<sup>85</sup> to \$16<sup>00</sup> more profit on a 21" Admiral Ensign

Now Admiral's vast purchasing power and national distribution give you the one picture tube line with everything: Finest quality workmanship and material... famous brand-name acceptance... attractive list prices... plus the biggest profit margin in the industry.

You can actually pocket from \$2.85 to \$16.00 more profit on a 21"

Admiral Ensign than on other brands. (Comparably higher margin on all other tube sizes.) Get the facts! Compare Ensign quality, performance, prices and profits. Discover for yourself why dollar-wise servicemen are switching to the Admiral Ensign. Call your nearby Admiral Distributor today! Start earning more right now!

**NOTICE:** All materials and parts used in the manufacturing of Admiral Ensign tubes are new, except for the envelope, which prior to re-use, was carefully inspected to meet the standards of the original new envelope.



**NEW Admiral Tube Carton**  
Remarkable new package is lighter, stronger... has built-in carrying grips... takes 40% less space! Another Ensign "Extra."

# ADMIRAL® ENSIGN Picture Tubes

by Art Margolis

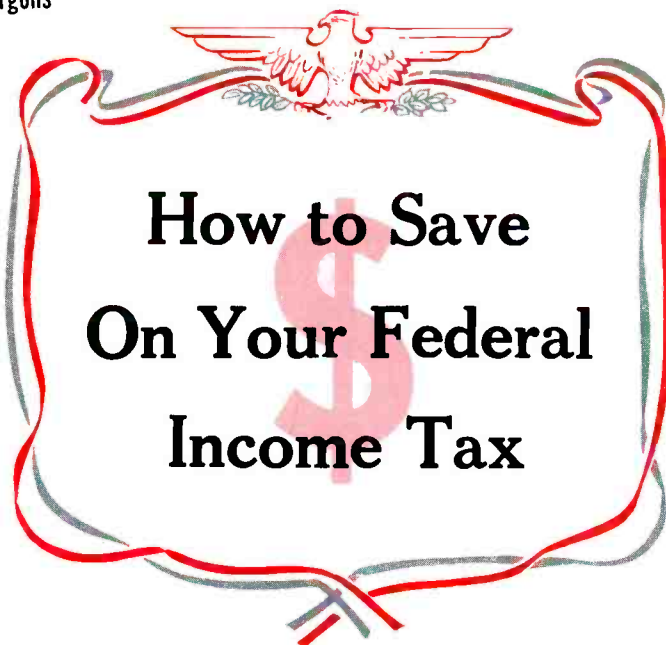

You can't get out of paying your income tax; nevertheless, the Revenue don't expect a penny more than they are entitled to. If you're busy fixing TV's, as I am, chances are good you're too generous as a taxpayer. You overlook deductions, don't utilize all your depreciation items, and pay more than necessary because you didn't use forethought in buying inventory. Even so, maybe you end up with an investigation due to innocent expenses that look fishy to a nontechnical IRS man.

You're only asking for trouble when you dash through Form 1040 because an unfinished service job is beckoning from the bench, or when you leave your tax return up to an equally rushed accountant. The past couple of years, I have found I can earn a good day's pay by giving close attention to the income-tax problem. Here are the things I look into with the greatest care:

#### Deductions

There are a lot of general deductions that apply to all citizens. However, there are also some unusual ones that apply to you in the TV service business. These are the ones that you or your accountant are most likely to forget. Maybe you won't; but check along anyway. If you find one, it will pay you many times the price of a year's subscription.

What do you do about petty cash purchases for your business? Office supplies, a new plastic hex-head wrench, a set of chains that you

needed suddenly for the truck, COD's on an odd part you ordered for an off-beat chassis, soap and paper supplies you picked up at the supermarket, first-aid supplies from the drug store, bridge tolls, outside phone calls and similar expenses seem like peanuts at the time. Even if you do get a receipt, it's likely to be stuffed away someplace and forgotten. These items don't amount to much per day, but add them up at the end of the year and the total may be as much as two or three hundred dollars. These are business expenses and wholly deductible. By not declaring them, you lose 20% to 50% of their total, according to what bracket you're in. If you are in the 20% bracket, and these forgotten items add up to \$200, you have thrown away 40 dollar bills.

You cannot "guesstimate" petty-cash expenses. Use vouchers to account for every penny that goes out of the petty-cash box, and obtain receipts whenever possible — even for a bar of soap. When you transfer funds into petty cash, write out a check so you will have proof that the stated amount of money was there to spend.

How about your bad debts? Suppose you do a job for a customer and are paid by check. Then, for reasons of their own, the dear people stop payment, and you receive the rubber check from the bank a week later. Meanwhile, you have entered the money in the *collections* column of your ledger. By the time

you're through dealing with these people, you lose out on part of the money. If you do not deduct the money from collections, you are going to pay tax on it. This hurts! Bad debts may hit you several times a year, so be sure to keep an accurate account of them, no matter how they occur. Remember, they are wholly deductible.

What about your magazine subscriptions, fees for correspondence courses, and expenses of attending service seminars sponsored by distributors, factories and test-equipment manufacturers? As long as you are increasing skills necessary to your business, these expenses are wholly deductible. Some confusion about this educational deduction stems from the fact that you can't deduct expenses incurred while originally learning your skill. But if you are *increasing* this skill as needed to improve your business position, the Internal Revenue Service says "yes" to a deduction. Any expenses you claim should be fully described, itemized, and dated to support their validity. You should obtain receipts, or use a check to indicate payment, if at all possible.

One last deduction I'll mention concerns charities. Did you know that if you give merchandise instead of money to your favorite charities, you can deduct the *retail* price of the merchandise even though you bought it at wholesale? Think that one over.

#### Depreciation

You are entitled to get back the cost of all your business fixtures, vehicles, equipment, and buildings by the end of their expected useful life. This is what "depreciation" means. The faster you get your money back, the better off you are. There is a "fastest" way for each category of business equipment. First of all, let's talk about building write-offs. If you own your own building, you should make sure that you are writing it off in the least possible number of years—normally 30 or 40. This is the best you can do. However, if you're *leasing* a property, the rules are different.

Suppose you improve the building with a new store front, special sanitary or comfort facilities, or an added-on shed for storage. Instead of having to write off such improve-

# New TRANSISTOR RADIO ANALYST

makes it Easy and Profitable to Service all Transistor Radios



**B&K**

Model 960

TRANSISTOR RADIO ANALYST

with Exclusive *DYNA-TRACE*  
Single-Point Probe—and Built-in  
Metered Power Supply and VTVM

Complete Transistor Radio  
Service Shop in One Instrument

Signal-Generator, Power Supply,  
Milliammeter, VTVM,  
Ohmmeter, and Both In-Circuit and  
Out-of-Circuit Transistor Tester—  
All in One

Check all circuits - Pinpoint any trouble ... in minutes

Now you can profit from transistor radio servicing! This amazing new B&K "960" ANALYST gives you *everything* in one complete easy-to-use instrument. Makes transistor radio servicing *quick and easy*. Nothing else is needed except the transistor radios themselves waiting to be serviced. Brings you new customers for service, parts, and batteries. Makes this new business *yours*.

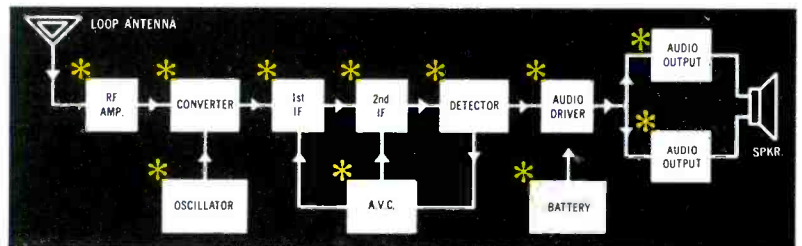

#### EASILY TROUBLE-SHOOT ANY STAGE BY UNIQUE POINT-TO-POINT SIGNAL INJECTION

The ANALYST gives you a complete signal-generating source for point-to-point signal injection. Easily enables you to trouble-shoot any transistor radio—check all circuits stage-by-stage—isolate and pinpoint the exact trouble in minutes.

Supplies modulated signals, with adjustable control, to check r.f., i.f., converter, and detector. Supplies audio signal to check audio driver and audio output. Provides unmodulated signal to test local oscillator. Provides separate audio low-impedance output for signal injection into loudspeaker voice coils to check speaker performance.

#### BUILT-IN METERED POWER SUPPLY FOR EASY SERVICING

Makes it easy to operate radio under test, while you inject your own signals. Provides from 1 to 12 volts in 1½ volt steps. Supplies all bias taps that may be required.

#### SIMPLIFIES IN-CIRCUIT TRANSISTOR TEST WITH NEW DYNA-TRACE SINGLE-POINT PROBE

Unique single-point probe needs only the one contact to transistor under test. No longer are three wires required to connect to emitter, base, and collector. Gives fast, positive meter indication. Saves time. Makes trouble-shooting simple and easy.

#### BUILT-IN VTVM

Includes high-input-impedance vacuum-tube voltmeter, which is so necessary for transistor radio servicing.

#### TESTS ALL TRANSISTORS OUT-OF-CIRCUIT

Meter has "Good-Bad" scale for *both* leakage and beta. Also has direct-reading Beta scale, calibrated 0-150. Assures quick, accurate test. Also automatically determines whether transistor is NPN or PNP. Meter is protected against accidental overload and burn-out.

Model 960. Net, \$99<sup>95</sup>

Solve Every Service Problem and Profit  
with a Modern B&K Service Shop. See Your  
B&K Distributor or Write for Catalog AP18-R



**B&K MANUFACTURING CO.**  
1801 W. BELLE PLAINE AVE • CHICAGO 13, ILL.  
Canada: Atlas Radio Corp., 50 Wingold, Toronto 19, Ont.  
Export: Empire Exporters, 277 Broadway, New York 7, U.S.A.

# NEW BUSINESS!

SELL

REPLACEMENTS and  
CONVERSIONS

by *Nortronics*

AND HERE ARE  
11 REASONS WHY YOU  
WILL BE SUCCESSFUL

1. All tape recorder customers past and present are prospects.
2. The line is complete covering all major tape recorders. So easy to install, customer can do it himself.
3. Advertising in major consumer publications stimulates customer interest.
4. Leads from this advertising are sent to you in your area.



5. Starter package includes attractive counter display unit complete with sales appealing literature.
6. Consumer coupon in each Conversion Kit good for \$1.45 saving on \$3.95 UST Sampler Tape. This "point-of-sale" closer required no handling by the dealer.
7. A complete Tape Reference Guide for counter use, covering conversion and replacement, is available.
8. United Stereo Tape is cooperating in the promotion of 4-track Stereo conversion. Nortronics insert enclosed in some raw tape cartons. Owners of 4-track equipment are its best salesmen.
9. Professional quality has gained world-wide acceptance for Nortronics super-laminated heads.
10. Fully guaranteed quality and workmanship.
11. The Dealer Starter Package makes it easy to display and profitable to sell the Nortronics line.

Send for information on this proven, PROFITABLE New Business!

**THE Nortronics CO., INC.**

"Music sounds best on tape—  
tape sounds best on Nortronics Heads!"

8101 W. 10th Ave. N., Minneapolis 27, Minn.

Please send me more information on  
Nortronics Dealer Sales Plan.

Name \_\_\_\_\_

Dealer \_\_\_\_\_

Address \_\_\_\_\_

City \_\_\_\_\_ Zone \_\_\_\_\_ State \_\_\_\_\_

ments over their useful life (which might be 10, 20, or 30 years), you can deduct a greater proportion of the cost each year over a shorter period. The total allowable deduction is still the same, but you are not placed in the position of having to move out before the equipment is fully depreciated.

You're permitted to use a depreciation period equal to your lease time plus renewal time, which could be one year or five years. This holds true even though your landlord has no intention of moving you out, so long as the landlord is not a relative or a corporation you own.

Your vehicles used for servicing can be written off in three years. The only thing to remember is that your vehicle still has a salvage value at the end of the third year. *You can't write this off!* Pick the lowest value your vehicle will have at the end of its useful life, and subtract that amount from your purchase price. The figure you have left is what you can depreciate over a three-year period.

In some circumstances, your vehicle is not going to last three years—for instance, if you put on a lot more than normal mileage. In a case like this, you might be able to lower the three-year depreciation period to two years; at least, it's worth checking with the Internal Revenue Service to see if you can obtain a special authorization for faster write-off. Another means of depreciating a heavily-used vehicle is the "40% method," in which the depreciation allowance for each year amounts to 40% of the remaining value of the vehicle.

There's a new wrinkle in writing off equipment. Suppose you are just going into color-TV servicing and have purchased \$600 worth of equipment. You figure its useful life with no salvage value is 10 years. Normally, you would write off the equipment at \$60 a year. But with the new, faster depreciation method, if the equipment you purchase has a useful life of at least six years, you can write off 20% of its cost the first year. Thus, \$120 depreciation could be taken on your \$600 worth of color equipment. (This quick depreciation is allowed on up to \$10,000 of property if you file a separate return, or up to \$20,000 worth if you file a joint return.)

## Inventory

Compare your inventory this year with what it was last year. Have you increased the number of tubes you lug around because of all the new type numbers? Have you put in a new stock of picture tubes? Each dollar you increase your inventory will cost you tax money on your next return. Here's why: Your accountant must compute your profits and losses on the *accrual* basis. The *cost of goods sold* is derived by first adding your inventory (at beginning of year) to your total merchandise purchases during the year, and then deducting the amount of your inventory at year's end. This *cost of goods sold* is subtracted from your total sales to compute your *gross profit* before expenses. Therefore, if your inventory is inflated at the end of the year, you will show a higher gross profit, with a resulting greater net income on which you must pay income tax. (Consignment goods are ignored in this computation.)

While TV parts inventories are seldom great, it still hurts to pay taxes on any large order which you may have purchased just before the end of your tax year. Large businesses purposely let their inventory run down at the end of their fiscal year. This doesn't mean you should run out of tubes, but it certainly suggests that you should postpone large parts purchases until after the start of the new year.

## Steer Clear of Investigations

Due to the cash nature of our business (like a doctor's), the Internal Revenue investigators cast a jaundiced eye at a TV service operator's income-tax form. It is quite possible that you might innocently make your figures look suspicious and bring on an audit. If you do have an audit, it's going to cost you money.

There are a few things you can watch out for to avoid an audit. First of all, your deductions have to appear reasonable. National averages for deductions go like this: If you are in the \$5,000-to-\$10,000 income bracket, you should have given about \$240 to various charities, had about \$310 in medical bills, come across with \$400 for interest on loans and spent \$350 on taxes. If this is about what you declared, your tax agent probably

**TESTS**  
All TV and Radio  
Tubes—Old and New

**TESTS**  
the Nuvistors  
and Novars

**TESTS**  
the New 12-Pin  
Compactrons

**TESTS**  
the New 10-Pin Tubes

**TESTS**  
for True Dynamic  
Mutual Conductance (Gm)

**TESTS**  
European Hi-Fi Tubes,  
Voltage Regulators, and  
Most Industrial Types

**OBSOLESCENCE  
PROOF**  
Designed for Maximum  
Use Today and  
Tomorrow



**NEWEST  
FINEST  
MONEY-MAKER**

*for Professional  
Servicemen*

# Multiple-Socket Speed with Gm Accuracy **PLUS** OBSOLESCENCE PROTECTION

## Model 700 DYNA-QUIK

*Fastest, Most Complete  
Most Up-to-Date*

### DYNAMIC MUTUAL CONDUCTANCE TUBE TESTER

*See your B&K Distributor,  
or Write for Catalog AP18-R*

**TESTS BOTH OLD AND NEW TUBE TYPES—SELLS MORE TUBES PER CALL**

*Again you benefit from proved B&K techniques! This up-to-date, obsolescence-proof, professional instrument is designed for maximum use today and tomorrow. Provides multiple-socket section to quick-check most of the TV and radio tube types the true dynamic mutual conductance way—plus simplified switch section to check new tube types in Dyna-Quik emission circuit. Also includes provision for future new sockets.*

*Makes test under set-operating conditions. Checks each section of multi-section tubes separately. Checks for all shorts, grid emission, leakage and gas. Makes quick "life" test. Exclusive adjustable grid emission test provides sensitivity to over 100 megohms.*

*Makes complete tube test in seconds. Checks average set in a few minutes. Discovers weak tubes that need replacement. Satisfies more customers. Sells more tubes. Saves call-backs. Insures your reputation.*

*Patented automatic compensation for line voltage variation. Large 4½" plastic meter with easy-to-read "Replace-Good" scale. Lists most commonly used tube types with settings directly on socket panel for fastest operation. Complete listing in reference chart in cover. Phosphor-bronze contacts for long life. 7, 9, and 10-pin straighteners on panel. Operates on 117 volts 50-60 cycle a.c. Hand-some leatherette-covered carrying case. Size: 16½" x 15¾" x 5⅞" deep. Net wt: 15½ lbs.*

Net, **\$169<sup>95</sup>**

#### NEW TUBE INFORMATION SERVICE

Available every 3 months, on subscription,  
for all B&K Dyna-Quik Tube Testers



#### B & K MANUFACTURING CO.

1801 W. BELLE PLAINE AVE • CHICAGO 13, ILL.

Canada: Atlas Radio Corp., 50 Wingold, Toronto 19, Ont.

Export: Empire Exporters, 277 Broadway, New York 7, U.S.A.

# MERIT

"COVERS THE WATERFRONT"



.....ON 110° - 114° YOKES!



**EXACT  
REPLACEMENTS  
(count 'em)**

**AND MORE COMING!**

CONTACT YOUR MERIT DISTRIBUTOR

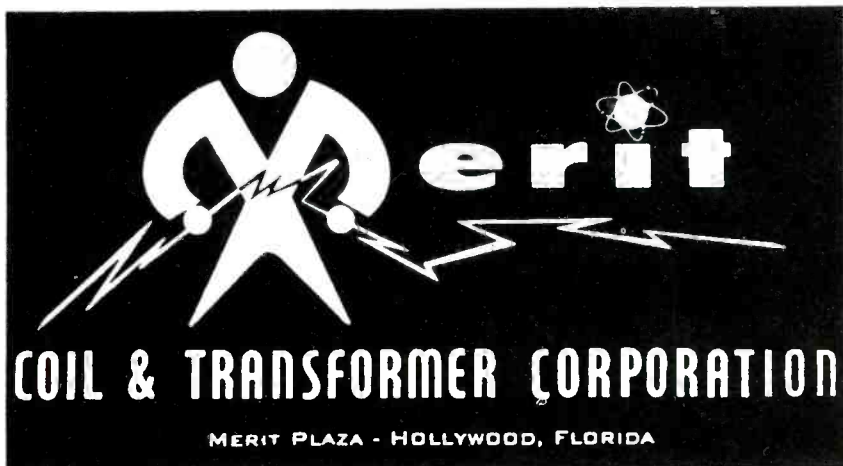

won't choose you for an audit. If you are in the \$10,000-to-\$15,000 bracket, add about \$170 to each of the above figures. If your deductions run higher be sure to have all the receipts handy in case you have to validate your claims.

Another thing to look for is tax refunds. As a self-employed man, you declare an estimated tax to within 70% of the actual tax due. Occasionally you will overestimate. You don't break a law that way; only underestimating puts you in jeopardy of a 6% penalty. However, if you do overestimate, don't ask for a cash refund. The IRS audits a large number of people who do this. On the other hand, the tax men haven't set up any procedure to check on people who merely ask for a credit on an overpayment. So ask for credit—it's as simple as that.

Another thing to be careful of in your books is the ratio of replacement-parts sales to total gross receipts. Parts should not account for over 40% of your total gross figure, but there are many reasons why they could. You might buy materials for friends or fellow servicemen, or you might supply someone with materials in a deal where you charge only a slight bit over cost. In your bookkeeping, make sure you isolate any no-profit deals so a tax agent doesn't think you are hiding anything. A separate account book, backed up with all the no-profit invoices, is an excellent idea.

One final note: If you have generous distributors who furnish gifts or trips, declare them as income, penny for penny. This means the *list* price of gifts. How will the government know about them? Your distributor is going to use them as deductions, listing you as a beneficiary.

To sum up, watch your deductions with a magnifying glass; you are legally entitled to every legitimate one you find. Also, take full advantage of all your depreciation factors. Write off everything as fast as the law will allow. Be careful with your inventory, and don't let poorly-timed purchases jack up your taxes. Lastly, make sure your figures do not look suspicious; avoid the complications (and possible expenses) of having your tax return audited. ▲



# exclusive in PHOTOFACT the world's finest electronic service data

famous Howard W. Sams **CIRCUITRACE**® and **SERVICING AIDS**!

handiest, most-complete data ever published to speed and simplify servicing—equally useful for troubleshooting in the home or on the bench...

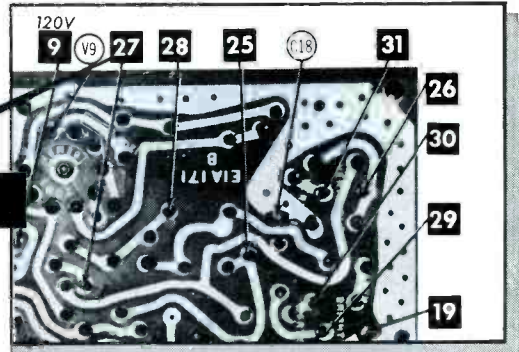
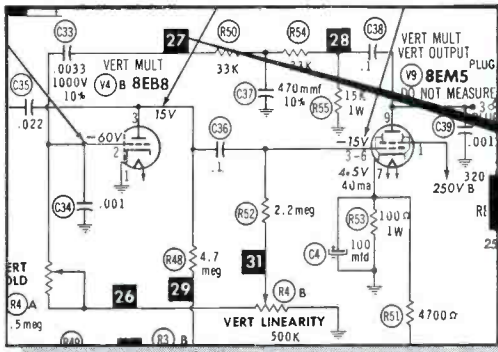

## CIRCUITRACE®

exclusive Sams standardized, uniform system for fastest, easiest printed board troubleshooting...

**Here's how CircuitTrace works:** All test points are clearly shown on the schematic and each is plainly coded (see illustration at left). The same test points are similarly coded on the printed board photo (see illustration at right) so you instantly know where to make your

measurement! No more costly hunting for test points...no more guesswork...no need to look at both sides of the board—identifies tubes, transistors, and foil connections of parts throughout circuits. CircuitTrace makes printed board servicing a breeze!

## TIME-SAVING SERVICE AIDS for field or shop

### FIELD SERVICING NOTES

#### SAFETY GLASS REMOVAL (MODEL KC366)

Remove 4 screws holding the trim strip at the top of the safety glass. Tilt glass out and remove.

#### FUSE AND FUSE DEVICE

TV: Sweep - 1/2 Amp. (M1)  
LV Supply - Fuse Wire (M2)  
Filament - Fuse Wire  
See "Tube..."

Valuable instructions for making all necessary adjustments in the home, locating fuses, removing safety glass, etc.

### TUBE PLACEMENT CHARTS

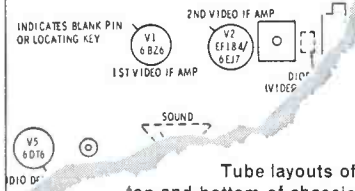

Tube layouts of top and bottom of chassis show sync and sound paths, tube keyways, fuses, rectifiers, etc. Helps you trace signal path to localize the trouble.

### TUBE FAILURE CHECK CHART

#### POWER SUPPLY FAILURE

No raster, no sound Fuse Wire (LV Power), Fuse V...

#### SWEEP FAILURE

No raster, has sound Fuse (Sweep), V8, V9, V10,  
No vertical deflection V7  
Poor vert. linearity or foldover V7  
Poor horiz. linearity or foldover V7  
Narrow picture V8, V9, V10  
Vert...

Points out probable causes of common troubles, tells you which tubes to replace to correct the symptom. Also shows series-string filament connections.

### DISASSEMBLY INSTRUCTIONS

#### TV CHASSIS REMOVAL

1. Remove 10 push-on type knobs
2. Remove 12 wood screws in...

You get step-by-step procedure for removing chassis, CRT, speakers, knobs, hidden bolts and connections. Avoids parts damage—saves valuable time.

### HORIZONTAL SWEEP CIRCUIT ADJUSTMENTS

Set the Horizontal Hold Control to Horizontal Frequency Slug (B1) tally. Keep turning B1 in the out of sync. Reverse t...

Detailed Instructions help you solve the troublesome problem of adjusting the horizontal circuits (oscillator, linearity, and width)—avoids guesswork!

These are just a few of the dozens of great features in PHOTOFACT for fastest, easiest, most profitable servicing. See your Sams Distributor for full details on an Easy Buy Library or Standing Order subscription!

## NOW IN PHOTOFACT!

**FREE BONUS 20-LESSON Second-Class Radiotelephone License Course!**

Will help you pass the exam for an FCC License—so you can upgrade your career in electronics and become an expert in communications! Now Free in current PHOTOFACT Sets. Don't miss it—enter your subscription with your Distributor!



**FREE**

## PHOTOFACT INDEX

Your invaluable guide to over 52,000 TV, Radio, Electronic listings—covering virtually every model produced since 1946. Helps you locate the proper PHOTOFACT Folder you need to solve any service problem in any model. Send coupon today for your FREE copy of the latest PHOTOFACT Index!

## HOWARD W. SAMS & CO., INC.

Howard W. Sams & Co., Inc., Dept. 7-B2  
1724 E. 38th St., Indianapolis 6, Ind.

Send FREE Photofact Cumulative Index  
Send full information on:  Easy Buy Plan  
 Standing Order Subscription  "Peet" Program

Shop Name \_\_\_\_\_

Attn.: \_\_\_\_\_

Address \_\_\_\_\_

City \_\_\_\_\_ Zone \_\_\_\_\_ State \_\_\_\_\_

# WHAT'S DIFFERENT

## ABOUT FM RADIO SERVICING?

by Leonard Feldman

Radio servicing, once considered a natural companion to TV servicing, has steadily declined in attractiveness for the past decade. Table-model AM radios, both domestic and imported, have reached retail price levels so low as to be considered "replacement" items, rather than repairable equipment. A \$5 to \$10 service charge, while perfectly reasonable in terms of travel time, troubleshooting, and parts replacement, never seems that way to the customer who can replace the entire radio for \$12.95!

Yet there is a large and expanding field of radio repair which remains virtually untapped by the thousands of electronics servicemen currently active in TV work. This "sleeper" is FM radio servicing. FM radio is really coming into its own. The growth of this medium has proceeded quietly, without fanfare, but it has been consistent over the past half-dozen years. Now, with FM

stereo standards approved by the FCC (no AM stereo standards are contemplated), FM is slated for an even greater growth than has been evidenced thus far.

Generally, the ratio of service cost to original purchase price is much more favorable for FM radios than

for the AM type. True, there are certain FM models that sell for under \$30, but there are also many FM-equipped hi-fi consoles with retail prices as high as (or higher than) TV sets. More important, the owner of an FM radio is generally more conscious of its quality of performance. He listens to radio in more than a casual way, and is therefore more than casually affected when his set fails to operate properly. Thus, he is more likely to appreciate the value of good service.

Because the rebirth of FM began with extremely high-quality receiving equipment, owned by audio fans who were exceptionally critical of performance, many TV men have been inclined to turn FM servicing over to specialists. In its present stage of growth, however, FM is broadening to include a mass market — and the need for readily-available service is increasing. While the servicing of popular-priced FM

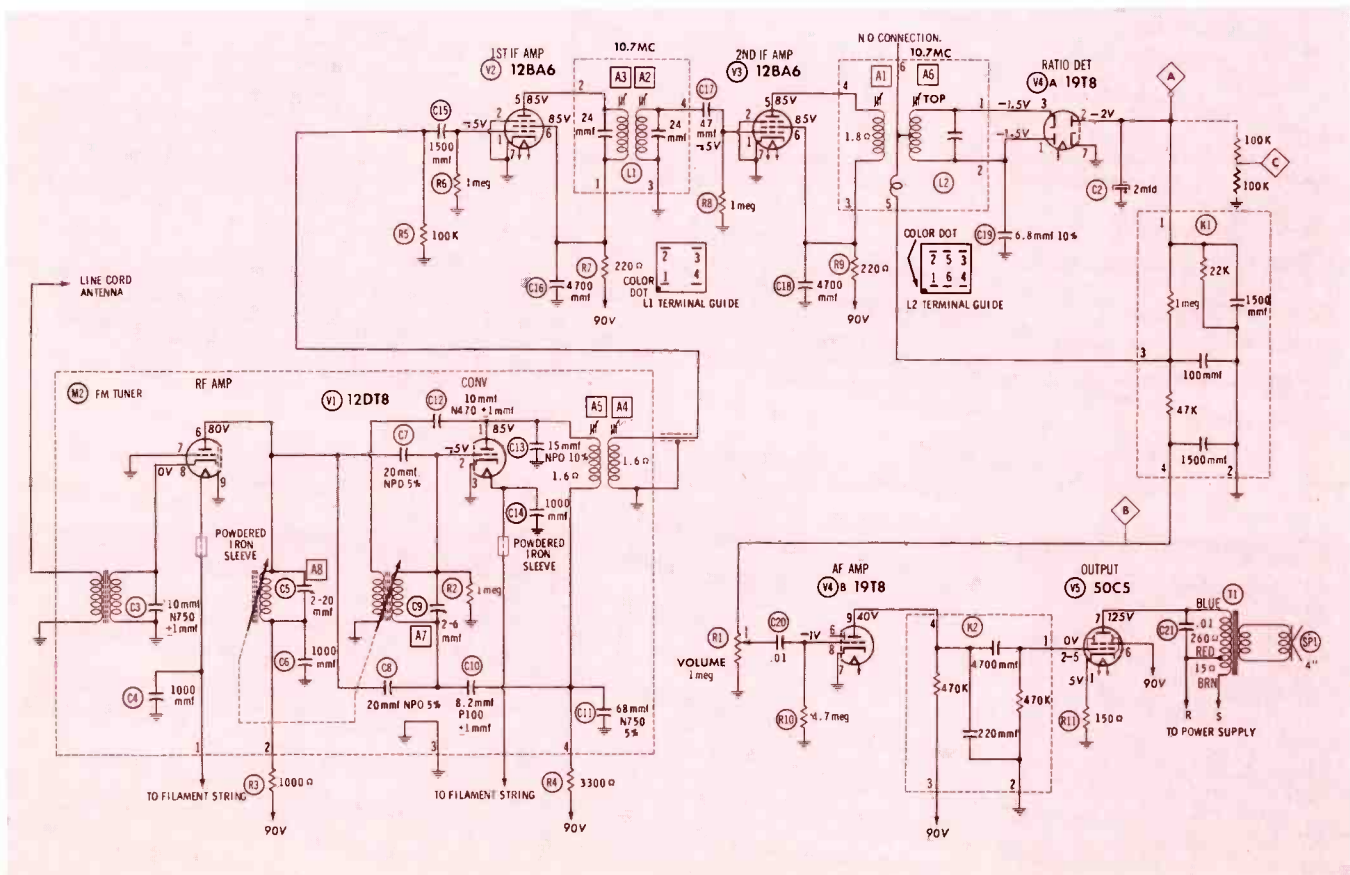
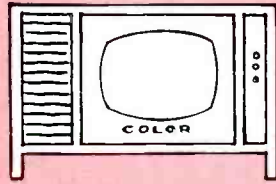

Fig. 1. Circuits typical of small FM table radios (excluding power supply).



# FIX OVER 90% OF ALL TV COLOR TROUBLES WITH THIS SENSITIVE TUBE TESTER

## THE NEW SENCORE MIGHTY MITE II



MODEL TC114  
**67<sup>50</sup>**

Thinking of buying equipment for color TV servicing? Here is the tester that you should place number one on your list. Why? Because this tester alone will help you repair over 90% of all color TV receivers.

Faulty tubes cause over 90% of all color TV troubles because the majority of color tubes have high impedance grid circuits. To detect faults in these critical tubes, sensitive grid circuit checks are essential. The Mighty Mite checks for grid leakage as high as 100 megohms or as little as .5 microamps of current. Large expensive testers and the drug store type offering only 2 or 5 megohm leakage checks will pass these critical tubes as good. You can find these tubes in a jiffy with the famous Mighty Mite . . . give real service to your new customers with color receivers . . . and make more money too.

*Typical high impedance circuits like these, need the Mighty Mite for accurate checks*

### INADEQUATE RED

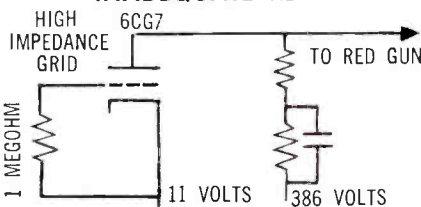

### RCA & ADMIRAL R-Y AMPLIFIER

If this tube draws as little as 2 microamps of grid current, the bias is upset 2 volts causing reduced red signal. To correct this, you may go to all the trouble of readjusting the red gun when the Mighty Mite, with its high sensitivity grid check, would have indicated the tube bad, saving you this trouble.

### INADEQUATE GREEN

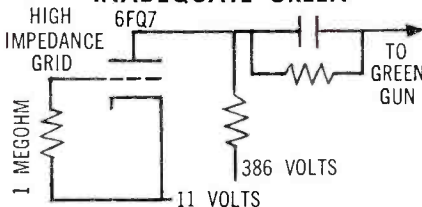

### RCA & ADMIRAL G-Y AMPLIFIER

If this 6FQ7 tube starts to draw only 2 microamps of grid current, the tube bias will be upset 2 volts because of the high impedance one megohm grid resistor. An old fashioned tube tester, or drug store type that requires 25 microamps of current to indicate the tube as bad, would pass the troublesome tube as good.

### INADEQUATE BLUE

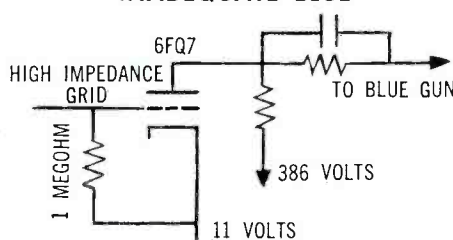

### RCA & ADMIRAL G-Y AMPLIFIER

Conventional tube testers will not show this tube bad until it develops a change of 25 volts positive bias in circuit. The Mighty Mite will find it as soon as it starts to cause poor color mixing.

### COLOR INTERFERENCE

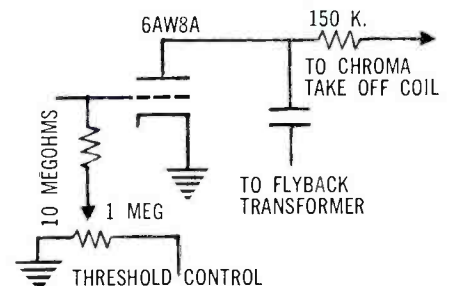

### RCA & ADMIRAL COLOR KILLER

If the tube draws only 1 microamp of current through this 10 megohm grid resistor the bias will be upset 10 volts restricting operation of the color killer. Color signal will interfere with black and white programs. The Mighty Mite will locate this faulty tube in a hurry while old fashioned testers will pass it as good.

Checks them all, including the New RCA Novars, Nuvisitors, Sylvania 10 Pin, GE Compactrons, and picture tubes too. A real money maker for servicing color, black and white, radio, Hi-Fi.

Available at Electronic Parts Distributors • Manufactured by Sencore, Inc., Addison, Ill.

## From ELECTRONIC DISTRIBUTORS EVERYWHERE!

### RESISTORS

Adjustable  
Axial Lead  
Composition  
Flat  
Lug Type

MIL Types  
Power  
Precision  
Vitreous Enameled  
Wire-Wound



### QUALITY POTS

½ and 2-Watt  
MIL Types  
Commercial Units  
Linear and Log



### QUALITY

# OHMITE

## COMPONENTS

### RHEOSTATS

12½ to 1000 Watts  
Vitreous Enameled  
MIL Types  
Commercial



### RELAYS

Plug-In  
Enclosed  
General Purpose



### VARIABLE TRANSFORMERS

1.5, 3.5, 7.5, 20 Amps  
Cased, Uncased  
Portable  
Tandem



### TANTALUM CAPACITORS

Foil, Slug, and  
Wire Types



WRITE FOR STOCK CATALOG 30C  
**OHMITE**  
MANUFACTURING COMPANY  
3644 Howard Street, Skokie, Illinois



radio equipment is in many ways a more precise science than AM radio repair, almost all the techniques used are well within the capabilities of a serviceman experienced in TV work.

### Circuit Features

Fig. 1 is a schematic of a typical low-cost FM radio (minus power supply), showing the minimum circuitry required for FM reception. Note that the audio section is practically identical to that of an AM table radio. All other stages except the detector work on the same principles as their AM equivalents, disregarding the difference in operating frequency.

The "front end" includes an RF stage which amplifies incoming signals in the frequency band from 88 to 108 mc. These signals are then applied to a mixer or converter stage, where they are heterodyned with the output of a local oscillator to produce a 10.7-mc IF signal. At least two IF-amplifier stages are provided; expensive FM tuners may have as many as six.

Most of the newer table radios, and many hi-fi consoles, use an efficient one-tube RF tuner mounted on a small separate subchassis. The circuitry is usually similar to that shown in Fig. 1, with one section of a dual triode being used as an RF amplifier, and the other operating as an autodyne converter. (Note the feedback from the plate circuit of this stage to the oscillator coil in the grid circuit.) Other receivers use a more elaborate front-end arrangement. As in Fig. 2, separate tube sections may be employed for the oscillator and mixer, and a stage for AFC (automatic frequency control)

may be included.

Because FM is broadcast at fairly high frequencies, local-oscillator drift is a considerable problem. A well-designed, temperature-compensated oscillator will operate with reasonably good stability, but greater precision is made possible by feeding a correction voltage into the oscillator to compensate for even slight drifting. A voltage suitable for this purpose is obtained as a by-product of detector operation. This voltage, which is proportional to the error in IF-signal frequency, is filtered and applied to the grid of the AFC triode. This tube section is connected across the tank circuit of the oscillator in such a way that it adds to the effective tuning capacitance. The amount of capacitive effect depends on the grid voltage of the triode. In the circuit shown, an upward drift of IF-output frequency causes a positive shift in the voltage at the AFC-tube grid. Current through this tube then increases; by effectively adding capacitance, it decreases the capacitive reactance of the tank circuit and lowers the oscillator frequency. The opposite action takes place when the IF-signal frequency drops below 10.7 mc.

### Detectors

The detectors in FM radios are quite different from those in AM broadcast radios, but almost identical to the dual-diode audio-detector circuits used in TV sets. The simplest type is the unbalanced ratio detector (see Fig. 1), in which the cathode of one diode section is grounded. When a frequency-modulated 10.7-mc signal is applied to the transformer primary, the fluctuations in frequency cause variations in the

# TV TUNERS

\* REBUILT OR EXCHANGED  
ALL TYPES

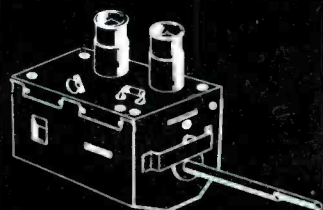

**\$9.95** Including all parts and labor  
(except broken wafers—billed at cost)

- Normally shipped same day received
- 90 day full guarantee
- U/V combinations \$17.95

FREE—If Mailing carton sent to you on request

Phone REpublic 3-9189

## L. A. TUNER EXCHANGE

4611 West Jefferson Blvd.  
Los Angeles 16, California

# Built to Stay Sold!



Ruggedness, Reliability, Range—these are the three R's that spell total customer satisfaction in the growing, exciting, new 100 MW transceiver market. This was our target in designing the CB-4. Peak performance under the most punishing conditions that sports and industry can create. A realistic price tag. For you . . . the Hallicrafters name and the Hallicrafters approach mean mass volume and clean profit.

*littlefone*

CB-4  
\$89<sup>95</sup>

Power input: 100 MW • Receiver sensitivity: 1 microvolt • Plug-in crystals and transistors for easy channel changeover and service • Shatter-proof, vinyl-clad aluminum cabinet • Fully transistorized • Mercury-type battery (not included).



the new ideas  
in communications  
are born at . . .



**hallicrafters**

Chicago 24, Illinois

No FCC license required

Dealers: A limited number of Authorized Hallicrafters Dealerships are available in some territories. See your Hallicrafters distributor, representative or write to: The Hallicrafters Company, 5th & Kostner Avenues, Chicago 24, Illinois.

# NEW SAMS BOOKS

**ONLY COURSE OF ITS KIND!**

## COMPUTER BASICS

This great 5-volume set on computer theory, design, operation, testing and maintenance provides all you need to know for a career in today's vital data processing field! Over 1200 pages, 455 illustrations.

5 Volumes in slip case ..... **\$22.50**  
(descriptive folder available on request)



### Howard W. Sams Handbook of Electronic Tables & Formulas, Revised Edition

Completely revised, updated and enlarged to include nearly 50% more material than the popular first edition. Truly a one-source reference for all electronics charts, tables, formulas, laws, symbols, constants, standards, codes, service, installation and design data. Six FULL-COLOR foldout pages show latest FCC assignments for the entire frequency spectrum. Only book of its kind! Hard cover. **\$3.95**  
192 pages; 5 1/2 x 8 1/2". Only.....

### Bench Servicing Made Easy

Bob Middleton's new and really practical book on troubleshooting techniques. Here is a step-by-step guide to the location of defective components in any TV circuit you're likely to run across—the kind of help servicemen want but haven't found until now. Presents brand-new material based on the author's own workbench experience. Eleven big-help chapters. 160 pages; 5 1/2 x 8 1/2". Only..... **\$2.95**

### Design & Operation of Regulated Power Supplies

Regulation of supply currents and voltages is an extremely important factor in today's electronic equipment. This valuable book describes dozens of different methods for controlling power supply outputs. Covers circuit operation; discusses variations in design parameters to achieve desired results. Six fact-packed chapters. 128 pages; 5 1/2 x 8 1/2". **\$2.95**  
Only.....

### Servicing Transistor Radios, Vol. 10

Covers 53 models produced in 1960-61. Includes famous PHOTOFACT® Standard Notation Schematics, chassis photos, alignment instructions, parts lists and replacement data for each model. **\$2.95**  
160 pages; 8 1/2 x 11". Only.....

### NEW! Howard W. Sams REPLACEMENT GUIDE

#### FOR TV & AUTO RADIO CONTROLS

Vol. 4. Greatly expanded—covers 30,640 TV and 1,286 auto-radio models. Lists recommended replacement controls of Centralab, Clarostat, CTS, IRC, and Mallory. 8 1/2 x 11". Only **\$1.00**



## HOWARD W. SAMS & CO., INC.

Order from your Sams Distributor today, or mail to Howard W. Sams & Co., Inc., Dept. B-32, 1720 E. 38th St., Indianapolis 6, Ind.

Send me the following books:

- Computer Basics, 5 Vol. (CSS)  Send folder
- Electronic Tables & Formulas (HTF-2)
- Bench Servicing Made Easy (BSE-1)
- Des. & Op. Reg. Power Supplies (RPS-1)
- Servicing Transistor Radios, Vol. 10 (TSM-10)
- Replacement Control Guide, Vol. 4 (RGC-4)

\$.....enclosed.  Send Free Book List

Name \_\_\_\_\_

Address \_\_\_\_\_

City \_\_\_\_\_ Zone \_\_\_\_\_ State \_\_\_\_\_

IN CANADA: A. C. Simmonds & Sons, Ltd., Toronto 7 (outside U.S.A. priced slightly higher)

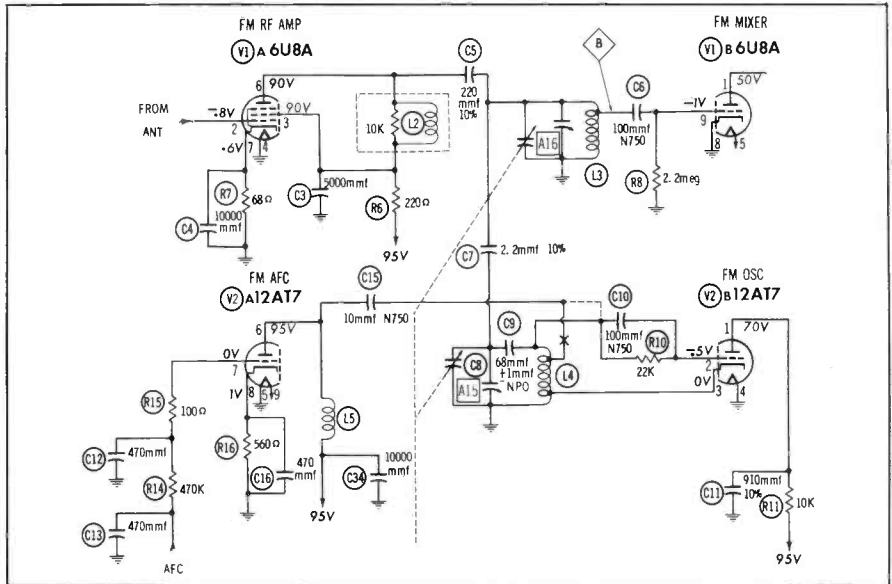

Fig. 2. Some FM sets have separate oscillator and mixer stages, plus AFC.

relative conduction of the two diodes. This action causes an audio signal to be developed in the circuit connected to the center tap of the transformer secondary. Many FM radios have a balanced ratio detector (Fig. 3); comparing this schematic with Fig. 1, note the differences in the diode-load circuit due to the changed location of the ground point.

Each of these circuits includes a stabilizing capacitor connected across the two diodes. This electrolytic capacitor charges and maintains a practically constant value of total voltage across both diodes, while permitting variations in the ratio between the voltages developed in the individual diode circuits. The detector is thus prevented from reacting to rapid changes in input-signal amplitude; in other words, the stabilizing circuit removes noise from the signal. Effective noise elimination is one feature an FM radio must have if it is to live up to its claims of superior performance.

A different type of detector often used in FM radios, the discriminator (Fig. 4), has no built-in means of suppressing noise. The two diode sections simply develop voltages of opposing polarity across the two 100K-ohm load resistors, and the algebraic sum of these two voltages becomes the audio output. Noise suppression requires an extra IF stage, called a limiter, just ahead of the detector. Its plate voltage is low (often less than 50 volts), and a special RC bias network is wired in series with its grid circuit; as a

result, this stage is easily overdriven to produce the desired amplitude limiting.

A DC voltage proportional to input-signal amplitude is developed across the limiter-grid bias network; therefore, this point can be used as a source of AGC bias for the preceding stages. However, most FM receivers actually have no AGC system, since no control of signal amplitude is required except that provided by the limiter or detector. If the signal peaks are clipped in earlier IF stages, so much the better for noise-free FM reception!

### Other Circuits

Typical FM table radios have simple audio circuits and small speakers. On the other hand, the output of an FM tuner in a hi-fi console is fed through an audio amplifier which, at the very least, is likely to include a phase inverter and a push-pull output stage.

The most common type of B+ power supply for table models is a simple, transformerless half-wave circuit utilizing one silicon rectifier.

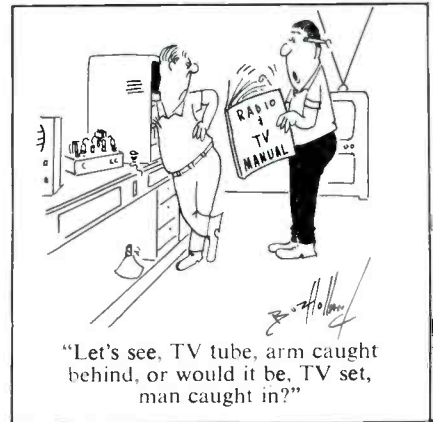

# Can you afford to guess

AT SWEEP, SYNC OR HIGH VOLTAGE TROUBLES?



SYNC. CIR. & H. SYNC. DISCRIM.	VERT. OSC.	VERT. OUTPUT	VERT. OUTPUT XFORMER	VERT. DEFLEC. YOKE
HORIZ. OSC.	HORIZ. OUTPUT	HORIZ. FLYBACK XFORMER	2nd ANODE VOLTAGE CIRCUIT	HORIZ. DEFLEC. YOKE



## NEW, IMPROVED SENCORE SWEEP CIRCUIT ANALYZER MODEL SS117

PUSH BUTTON TESTING . . .  
for Color and Black and White

How many times do you ask, "Why do I take so long finding that sweep trouble?" How often have you wondered whether weak horizontal sync was caused by defective sync circuit, horizontal oscillator, or sync discriminator? Can you quickly isolate inadequate width or low 2nd anode voltage to the oscillator, output, flyback transformer, or yoke? How many times have you changed a good yoke by mistake?

The SS117 will pinpoint troubles like these in minutes with tried and proven signal injection, plus yoke substitution for dynamic in-circuit tests. Error proof push button testing enables you to make all tests from the top of the chassis without removal from cabinet for maximum speed and profit on every job.

Here are the checks the SS117 makes . . .

- Horizontal Oscillator: Checked by substituting 15,750 variable output universal oscillator from SS117. Signal can be injected at any spot from horizontal output grid to horizontal oscillator to determine defective component.
- Horizontal Output Stage: Checked by reliable cathode current and screen voltage checks made with adapter socket and two push buttons.
- Horizontal Output Transformer: Checked for power transfer in circuit and read as good or bad on meter.
- Horizontal Deflection Yoke: Checked by direct substitution with adjustable universal yoke on SS117.

- Vertical Oscillator: Checked by substituting 60 cycle synchronized oscillator.
- Vertical Output Transformer: By simple signal injection for full height on picture tube.
- Vertical Deflection Yoke: By signal substitution for full height on picture tube.
- Sync Stages: Checked by synchronizing triggered horizontal SS117 oscillator from any stage. If oscillator synchronizes, sync is O.K.
- 2nd Anode Voltage: A new dynamic check using simulated picture tube load. C.R.T. does not need to be operating for current tests. No interpretations—read direct from 0 to 30 KV.
- External Circuit Measurements: By applying from 0 to 1000 volts AC or DC to external meter jacks. Meter will read DC or peak-to-peak volts. 0 to 300 milliamp scale also provided for measuring horizontal fuse current.
- New features include: Large 0 to 300 microamp meter for minimum circuit loading; all-steel carrying case with full mirror in adjustable cover; two 115 volt AC outlets in cable compartment.

Size: 10¼" x 9¼" x 3½". Wt. 10 lbs.

Model SS117

Dealer Net **\$89<sup>50</sup>**



Sencore Sam says . . . How can you miss . . .

EACH PACKAGED UNIT CONTAINS:

- An Easy to Follow Instruction Book Especially Prepared and Edited by H. W. Sams.
- A complete 33 RPM, 10 inch Permanent Record on "How to Simplify Sweep Circuit Trouble Shooting."

SEE YOUR AUTHORIZED SENCORE DISTRIBUTOR

**SENCORE**  
ADDISON, ILLINOIS

it's **VOCALINE** for  
advanced design and circuitry  
—newest features!



**SELF-POWERED  
RECHARGEABLE  
PORTABLE CB  
with  
AM RADIO—  
up to 8 miles  
Model PT-27**

- ✓ Tunable double conversion superhet receiver
- ✓ 4 fixed channels
- ✓ Antenna tuning and meter up-front
- ✓ 18 transistors—5 diodes
- ✓ Plus noise limiter, squelch, built-in battery charger, many other features

Complete with antenna, microphone, charger cord.

**NEW,  
IMPROVED  
VOCALINE MODEL ED-27M**

**4 CHANNEL  
BASE  
UNIT**



- ✓ double conversion superhet receiver
  - ✓ improved selectivity—eliminates undesirable adjacent channel interference
  - ✓ the most powerful "legal" set on the air today:
  - ✓ 6 VDC/115 VAC or 12 VDC/115 VAC
- complete with microphone, mounting bracket, AC-DC cords.

— WRITE FOR FREE LITERATURE —

**VOCALINE COMPANY OF AMERICA, INC.**  
22 Coulter St., Old Saybrook, Conn.

Name .....  
Address .....  
City ..... Zone ..... State .....

No fuses or circuit breakers are ordinarily provided, although fusible resistors are found in a few models.

Most FM-phono consoles, like component-type FM tuners, are transformer-powered — some through connecting plugs from a centralized power supply, and others with their own full-wave rectifier circuits.

The majority of FM radio tubes are familiar radio-TV types—series-string versions in most small radios, and 6.3-volt types elsewhere. A few of the most popular types are the 12AT7, 6AU6, 12BA6, and 6AL5. If you haven't been doing any FM servicing, though, you probably won't have a 19T8 detector-AF amplifier in stock, nor the newer 14GT8 for the same application. Likewise, your stock isn't likely to include any of the dual triodes being used in the new one-tube tuners—the 6/12DT8, ECC85/6AQ8, and 17EW8 in particular. If you have any 6AB4 triodes left on your shelf from days gone by, save 'em—you might need one to replace an oscillator or RF tube in an FM tuner.

### Alignment

Many servicemen are accustomed to aligning AM radios as a regular routine. In fact, they're usually able to do a fair job by simply tuning in a couple of stations and "aligning by ear." While this technique has never been recommended for AM radios, it may be flatly stated that it just won't work where FM is concerned. A signal generator covering frequencies of 10.7 mc and 88-108 mc *must* be used. Alignment can be accomplished with an unmodulated signal, although provisions for ex-

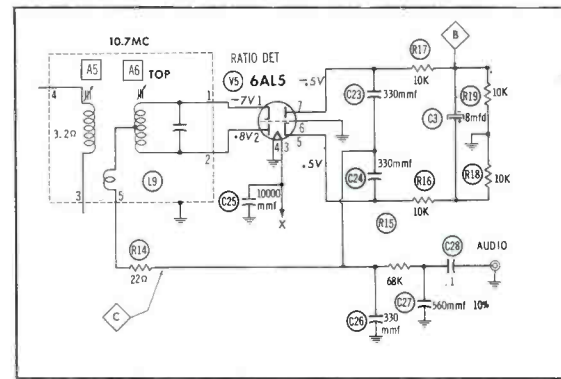

**Fig. 3. Balanced ratio detector is grounded through matched resistors.**

ternal or internal FM audio modulation give a generator additional flexibility for both alignment and troubleshooting. The only other items required for ordinary alignment are a VTVM and the usual assortment of plastic tuning tools. A scope is sometimes helpful for the more exacting or difficult jobs, but not absolutely essential for run-of-the-mill FM work.

The first step in alignment is peaking the IF transformers for maximum detector output at 10.7 mc. In ratio-detector circuits, the VTVM is connected across the stabilizing capacitor. Adjustments should be made slowly to allow the capacitor to charge — or the capacitor should be temporarily disconnected. In receivers with discriminators, the VTVM indications are obtained across the grid-bias network of the limiter. The meter is left in place while the RF adjustments are peaked, using a pair of test frequencies near the upper and lower ends of the 88-108 mc band.

The primary of the detector transformer is next tuned for a peak at 10.7 mc, using the VTVM connection recommended in service data. Finally, the VTVM is moved to the

**THE NEW DYNAMIC RAPID TROUBLE SHOOTER**

**METREX GENIE**

**POCKET-SIZED — TRANSISTORIZED  
SIGNAL GENERATOR**

Tunable 50 cy. to 3.3 mc.

**7 INSTRUMENTS IN ONE!**

FUNCTIONS AS • RF • IF • AUDIO  
VIDEO • PULSE • BAR GENERATOR  
& VOLTAGE CALIBRATOR



Pat. Pend.

Services — RADIO, TV, HI-FI,  
RECORDERS, PHONES AND INTERCOMS

The GENIE has a tunable range of 50 cycles to 3.3 mc. Output variable from zero to 9 volts peak to peak. The uniquely designed circuitry makes possible unusually stable operation and extremely low battery drain. The rugged diecast housing insures extreme durability and perfect shielding. 2 3/4" x 3 1/2" x 2" size is ideal for shop, lab, and field use.

**1495**  
less  
Batt.

**WRITE TODAY FOR  
FREE TROUBLE  
SHOOTING  
GUIDE**

**METREX** 519 HENDRIX ST., BKLYN 7, N. Y.



# PLANNING A MASTER TV SYSTEM ?

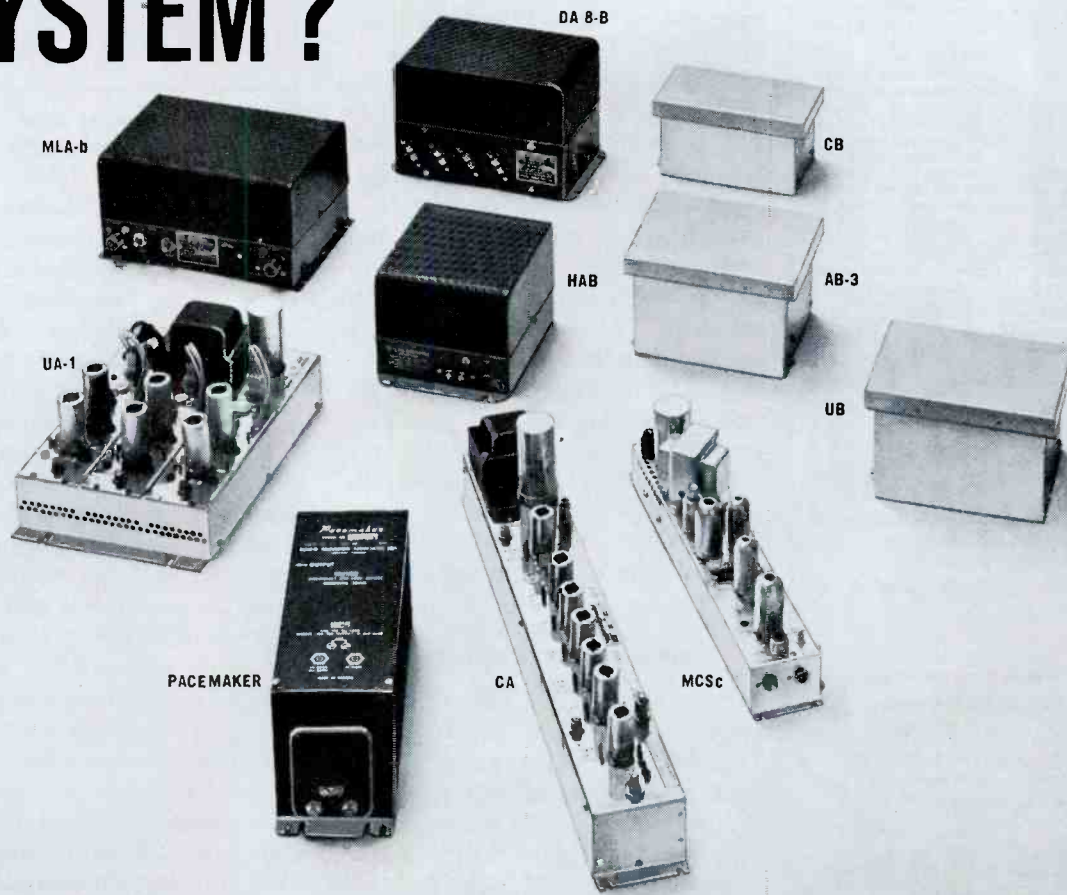

select the ideal head end from the world's only matched and integrated line  
**BLONDER-TONGUE MASTER TV AMPLIFIERS**

	MODEL	IMPEDANCE INPUT	IMPEDANCE OUTPUT	FREQUENCY	GAIN MINIMUM	MAXIMUM OUTPUT *1% distortion **3% distortion	FEATURES	LIST PRICE
BROADBAND AMPLIFIERS	MLA-b	75 ohms	75 ohms	VHF	40db	*2 v/band	Separate hi & lo band gain & tilt controls.	142.50
	HAB	75/300 o.	75/300 o.	VHF/FM	25db	*0.9 v loband *0.6 v hiband **2.5 v loband **1 v hiband	Separate hi & lo band gain controls.	72.75
	PACE-MAKER	75 ohms	75 ohms	VHF/FM	VHF, 35db FM, 30db	*2 v/band	Separate hi & lo band input.	99.50
	AB-3	300 ohms.	75/300	VHF/FM	25db	*0.9 v loband *0.6 v hiband **2.5 v loband **1 v hiband	Remote power supply. Weatherproof mast mounted.	104.95
	DA8-B	75/300 o.	75/300	VHF	10db per outlet	*0.2 v	8 outlets for distribution.	99.50
SINGLE CHANNEL	MCS c	75 ohms	75 ohms	VHF	35db to 46db	*1 v	Agc. dual mixing out-puts.	140.50
	CB	300 ohms	75 ohms	VHF	18db to 20db	*0.5	Weatherproof for mast mounting.	57.75
	PA (not illus.)	75 ohms	75 ohms	VHF/FM	65db	*1 volt	Agc. low noise figure.	275.00
	CA	75 ohms	75 ohms	VHF/FM	60db	*1 volt	Agc. dual mixing out-put.	235.00
	CAP (not illus.)	75 ohms	75 ohms	VHF/FM	60db	*5 volt	Agc. dual mixing out-put.	295.00
UHF	UA-1	75 ohms	75 ohms	VHF/FM (FM LIST 99.50)	35db	*1 volt	Requires external power supply.	59.25
	UB	300 ohms	300 ohms	CH 70 thru 83	14db	*0.5 volt	Mast mounted with remote power supply.	84.50
	STRATO BOOSTER (not illus.)	300 ohms	300 ohms	CH 72 thru 76	20db	*0.5 volt	Mast mounted with remote power supply.	103.75



Today, contact your Blonder-Tongue distributor. Write for Free 28 page planning and installation manual. Free layout service. Also, engineering service available.

engineered and manufactured by  
**BLONDER-TONGUE**  
 9 Alling St., Newark, N. J.

Canadian Div.: Benco Television Assoc., Toronto.  
 Export: Rocke Int'l. Corp., N. Y. 16, N. Y.-CABLES: ARLAB  
 home TV accessories • UHF converters  
 master TV systems • closed circuit TV systems

those who  
Serve Best  
Use  
**QUIETROLE**



6 oz. SPRAY PACK CAN  
(with FREE Extender Tube)

2, 4, 8 oz. Bottles  
(with dropper)

Product of

**QUIETROLE**  
COMPANY

Spartanburg, South Carolina

in Canada: CROSS CANADA ELECTRONICS  
12 Laurel Street, Waterloo, Ontario



There's never any doubt with QUIETROLE... it always says "Sh, Sh" to noisy controls and switches on TV, radio and electronics instruments. Now, Quietrole is even easier to use... has FREE EXTENDER TUBE that hits those hard to reach places right on the button. It's Quality Quietrole that makes those once pesty repairs easier than ever. See how Quietrole can ease the jangled nerves of even your hardest to please customers. Quietrole, helps the serviceman serve better than ever.



Send for NEW  
FREE CATALOG #961  
with oscillator  
circuits

**CITIZEN BAND  
CLASS "D"  
CRYSTALS**



3rd Overtone: Hermetically Sealed  
.005% tolerance—Meet F C C require-  
ments, 1/2" pin spacing—.050 pin di-  
ameters. (.093 pins available, add 15c per  
crystal.) **\$2.95**  
ALL 22 Frequencies  
In Stock **2.95** EACH  
(add 5c per crystal for postage and handling)

The following Class "D" Citizen Band frequencies  
in stock (frequencies listed in megacycles): 26.965,  
26.975, 26.985, 27.005, 27.015, 27.025, 27.035,  
27.055, 27.065, 27.075, 27.085, 27.105, 27.115,  
27.125, 27.135, 27.155, 27.165, 27.175, 27.185,  
27.205, 27.215, 27.225.

Matched crystal sets for all CB units... \$5.90 per  
set. Specify make and model numbers.

**RADIO CONTROL CRYSTALS**  
in H6C/U HOLDERS—SIX FREQUENCIES

In stock for immediate delivery (frequencies listed in  
megacycles); tolerance .005% 1/2" pin spacing,  
.050 pin diameter. (.093 pins available, add 15c per  
crystal.) Specify frequency desired. **\$2.95**  
26.995, 27.045, 27.095, 27.145, **2.95** EACH  
27.195, 27.255... (add 5c per crystal for postage-handling)

NOW! Engineering samples and small quantities for  
prototypes now made either at Chicago or at Ft.  
Myers Plant. 24 Hour Service!  
IN CHICAGO, PHONE Gladstone 3-3555

Send for FREE CRYSTAL CATALOG #961  
WITH OSCILLATOR CIRCUITS

ASK YOUR PARTS DEALER FOR TEXAS CRYSTALS  
See big red display... If he doesn't stock them,  
send us his name and order direct from factory.

RUSH YOUR ORDER NOW TO

**TEXAS CRYSTALS**

1000 Crystal Drive, Fort Myers, Florida  
Dept. (PF-2) Phone WE 6-2100

FOR SHIPMENT VIA FIRST CLASS MAIL AT NO EXTRA  
COST ATTACH THIS ADVT. TO YOUR ORDER!

audio-output connection, and the detector - transformer secondary is adjusted for exactly zero volts at 10.7 mc. In an unbalanced ratio detector, two resistors must be temporarily hooked up so that their junction (point C in Fig. 1) can serve as a connection for the common lead of the VTVM.

A few side notes concerning alignment are in order before we leave the subject. Short of tube failure itself, misalignment accounts for the majority of troubles encountered in FM servicing. In general, receiver operation will be improved by alignment whenever an RF or IF tube is changed, or if this service has not been performed in over a year or so. Trimmers and coils in the tuned circuits of FM sets are usually more delicate than their AM counterparts, so careful handling is required. In many sets, the RF and oscillator coils are just a few turns of heavy wire with no coil form; they are adjusted merely by compressing or expanding the turns. Only a minimal amount of repositioning will ever be required.

**Component Replacement**

Parts used in FM radios are not unlike those found in TV sets. Transformers and coils are generally constructed of finer wire (except for the RF coils mentioned in the last paragraph), with fewer turns than their AM-radio counterparts. The IF and detector transformers are generally wound on specially-constructed coil forms; they may be tuned by means of ferrite or powdered-iron slugs, or by surrounding "cup cores."

These specialized parts are gen-

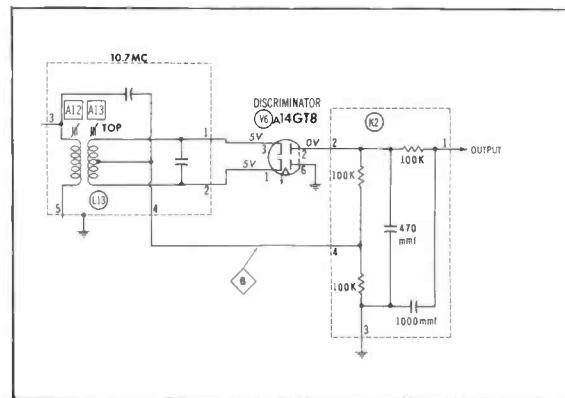

Fig. 4. Discriminator must be preceded by a limiter to suppress AM noise.

erally obtainable from local parts jobbers and are rather commonplace. Even the terminal layout of the shielded transformers has become fairly standard. Note the terminal-guide diagrams for L1 and L2 in Fig. 1. The color dot on each transformer indicates terminal 1, the start of the primary winding.

It has been mentioned that the "front end" section often consists of a separate, shielded subchassis. Such modular circuits should be approached with no more hesitation than a conventional layout. Radiation shields (to prevent external oscillator radiation in accordance with FCC rules) are easily removed.

It is particularly important that defective ceramic capacitors found in the RF section be replaced only with exact equivalent types. Since most coils are constructed so that a heat increase unavoidably causes a rise in inductance, capacitors with a controlled negative temperature coefficient are widely used in FM radios to compensate for the detuning effects of heat.

Such capacitors are available for providing many different degrees of

**PRECISION TUNER SERVICE**

P. O. BOX 272  
BLOOMINGTON, IND.

1200 S. WALNUT ST.  
EDISON 99653

**7.50**  
V or U

COMBO PLUS  
9.95 POSTAGE

6 MONTH WARRANTEE



All Types T.V. Tuners Cleaned, Repaired and Aligned to Factory Specifications. Same day in shop service on most Tuners. Price Includes Minor Parts, Major Parts at Cost Price. We use Original Parts if possible. State Make Model and Enclose all Parts and Tubes. Pack Well and Insure.

ALSO HAVE LARGE STOCK OF EXCHANGE TUNERS, WRITE FOR TYPES AND PRICES.

See Only the Scale You Want... in the Exact Range You Want

**just set the range switch  
and the correct scale appears  
AUTOMATICALLY**

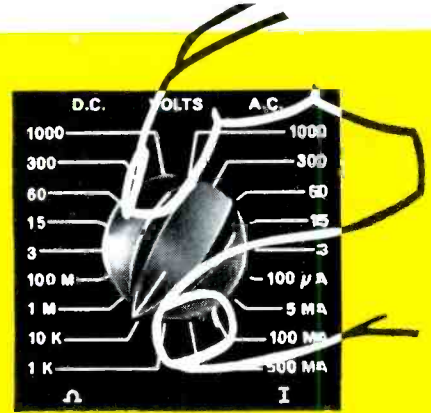

in the new **B&K**  
**VOM and VTVM**

**V O M A T I C 360**  
**AUTOMATIC VOLT-OHM MILLIAMMETER**

WITH  
BURN-OUT PROOF  
METER

Greatly simplifies your VOM use. Individual full-size scale for each range—and only one scale visible at any one time, automatically. Once you set the range switch, it is impossible to read the wrong scale. Reading in the range you want is amazingly easy—and direct. No reading difficulties, no multiplying, no errors.

**Sensitivity** 20,000 ohms per volt DC; 5000 ohms per volt AC. **Accuracy**  $\pm 3\%$  DC;  $\pm 5\%$  AC; (full scale). **DC Volts** in 6 ranges 0-6000. **AC Volts** in 6 ranges 0-6000. **AF (Output)** in 4 ranges 0-300 volts. **DC Current** in 5 ranges 0-10 amps. **Resistance** in 4 ranges 0-100 megohms. Supplemental ranges also provided on external overlay meter scales. Meter protected against extreme overload and burn-out. Polarity reversing switch. Automatic ohms-adjust control. Mirrored scale. Complete with 1½-volt and 9-volt batteries, test leads, and easy-viewing stand.

Net. \$5995



**DYNAMATIC 375**  
**AUTOMATIC VACUUM-TUBE VOLTMETER**

Once you set the range switch, you automatically see only the scale you want and read the exact answer directly. Saves time, eliminates calculation, avoids errors. Individual full-size direct-reading scale for each range. Simplifies true reading of peak-to-peak voltages of complex wave forms in video, sync and deflection circuits, pulse circuits, radar systems, etc. Includes DC current ranges, too.

**Accuracy**  $\pm 3\%$  full scale AC and DC. **Sensitive** 100 microampere meter movement. **DC Volts** in 7 ranges 0-1500. **AC Volts (rms)** in 7 ranges 0-1500. **AC Volts (peak-to-peak)** in 7 ranges 0-1500. **DC Current** in 3 ranges 0-500 ma. **Ohms** in 7 ranges 0-1000 megohms. Utilizes single DA-AC ohms probe and anti-parallax mirror. Swivel stand converts to carry-handle. Includes 1½ volt battery. Operates on 117 volts 50-60 cycle AC.

Net, \$8995

Ask Your B&K Distributor  
for Demonstration, or  
Write for Catalog AP18-R



**B & K MANUFACTURING CO.**  
1801 W. BELLE PLAINE AVE • CHICAGO 13, ILL.  
Canada: Atlas Radio Corp., 50 Wingold, Toronto 19, Ont.  
Export: Empire Exporters, 277 Broadway, New York 7, U.S.A.

# I'd walk a mile...



## for Centralab L & T Pad Attenuators



I'm not an ordinary camel—I'm a thinking man's camel—and I think highly of Centralab L & T Pad Attenuators.

These units work good—like an L & T Pad should—because of their small size, high wattage, and anti-backlash construction. Measuring less than  $1\frac{1}{16}$ " deep from the mounting surface, and with  $1\frac{3}{32}$ " diameter, they fit into any standard junction or switch box with room to spare.

In L & T Pads, though, it's what's in back that counts—and these Centralab units have exclusive "thermo-pass" insulation, which combines fast heat transfer with a high dielectric constant to achieve a conservative rating of 20 watts audio, 5 watts D.C., in a unit the size of conventional 2 watt controls.

Because of Centralab's anti-backlash construction, the "play" frequently found in dual controls is eliminated. The wiper contacts move in unison, so there's no alteration in frequency response due to variations in wiper position on the resistance tracks.

So hump down to your Centralab distributor and stock up on these L & T Pad attenuators. They satisfy!

B-6205S

**Centralab**

THE ELECTRONICS DIVISION OF GLOBE-UNION INC.  
942B EAST KEEFE AVENUE, MILWAUKEE 1, WISCONSIN  
In Canada: Centralab Canada Ltd., P.O. Box 400, Ajax, Ontario

ELECTRONIC SWITCHES • VARIABLE RESISTORS • CERAMIC CAPACITORS  
PACKAGED ELECTRONIC CIRCUITS • ENGINEERED CERAMICS

compensation, as indicated by markings such as N750 (negative coefficient of 750 parts per million per degree Centigrade); N1500; NPO (Negative - Positive - Zero, or no change in capacitance with application of heat); and even P150 (capacitance rise with temperature held to 150 parts per million per degree Centigrade). The designer of the particular set has carefully determined how much compensation these capacitors must contribute to the circuit.

A list of the most common troubles in FM sets, in order of occurrence, would look about like this:

1. Defective tube (or fuse, in certain models)
2. Misaligned RF-IF section
3. Antenna disconnected, defective, or inadequate
4. Local oscillator not functioning  
(sometimes due to low power-line voltage—be sure to check)
5. Drift off station, caused by component-value change in "front end"  
(or by malfunctioning AFC in some models)
6. Dirty selector switch or volume control (or tuning gang in some models)
7. The usual audio problems common to any radio

In summing up, nearly 18 million FM sets are now in use throughout the country. More are on the way every month. While this number is nowhere near as great as the number of TV sets in use, it is nevertheless large enough to deserve the attention of the service industry. FM owners, perhaps more so than TV fans, want competent and effective service. You can easily be there to provide that service, with mutual benefit to your new-found customer and yourself. ▲



# Housekeeping

IN THIS ISSUE

Ed. & S. Par.

Arthur S. Fleming

## THE BETTER WAY

THE INSIDE STORY  
 WHO'S WHO IN THE BUSINESS  
 CAN YOU REALLY BEAT THE DEAL?  
 IS IT WORTH IT?  
 WHAT ABOUT THE SERVICE?  
 PLANT CARE AT MOBILE  
 LOOK IT UP!  
 THE ABLE  
 WHEN WORK  
 FOR WOMEN  
 SPECIAL ADVERTISING  
 FROM AROUND THE WORLD  
 CENTER  
 YOUR MONEY  
 LIFE INSURANCE  
 MAY NEED

“How does a gal pick a good Radio-TV service dealer?”



### 1 DOES HE HAVE AN ESTABLISHED PLACE OF BUSINESS?

A big investment goes into a properly equipped TV-Radio service operation. The Service Dealer with a place of business has made this investment. As an independent, small businessman, his future depends on satisfying you.

### 2 DOES HE GUARANTEE HIS LABOR AND THE PARTS HE USES?

Most qualified dealers guarantee work and parts. Ask about the guarantee so you will know just how long you are protected, but remember, the guarantee covers only the parts replaced by the dealer, not everything in the set.

### 3 DOES HE CHARGE A FAIR PRICE; PROVIDE AN ITEMIZED BILL?

Your Service Dealer has taxes, rent, salaries, and other business expenses. He establishes his service charges fairly and renders itemized bills because he wants you to know what work was done and which parts were replaced.

### 4 DOES HE REPLACE WITH DEPENDABLE RAYTHEON TUBES?

Raytheon is the world's largest manufacturer devoted exclusively to electronic components. Raytheon TV-Radio replacement tubes carry the Good Housekeeping Guaranty to give you extra protection at no extra cost.

A “yes” answer to these four important questions is your assurance of fast and expert service at a reasonable price.

Your Raytheon Bonded Technician offers a 90-day work and parts guarantee that's actually backed up by a Bond issued through one of America's largest insurance companies. Look for the Raytheon Bonded Technician in your neighborhood.



**RAYTHEON COMPANY**

DISTRIBUTOR PRODUCTS DIVISION

The same Raytheon tubes which guard the nation in 23 missiles guard the life of your TV set

EDUCATIONAL TOY MISSILE CENTER  
 Special Offer from your Raytheon Service Dealer  
 Only \$1.00



To get this 9-piece missile center with operating scale model, send \$1 with a Raytheon tube box top. The name of your Raytheon Service Dealer will be included with the missile center if you send \$1 without a box top.

RAYTHEON, Box 500  
 Distributor Products Division  
 Westwood, Massachusetts

NAME \_\_\_\_\_  
 ADDRESS \_\_\_\_\_  
 CITY \_\_\_\_\_ ZONE \_\_\_\_\_  
 STATE \_\_\_\_\_

# 5 Million Housewives are being sold on your Service!

That's right! All Raytheon receiving and picture tubes now carry the famous Good Housekeeping Guaranty Seal — for years a symbol of trust with families all over America. And those families will have extra faith in the service dealer who uses Raytheon tubes backed by the Good Housekeeping Seal.

Raytheon is telling the whole persuasive story in full page ads in the March issue of Good Housekeeping. Nearly 5 million readers will be urged to call on the Radio-TV service dealer who uses Raytheon tubes with the Good Housekeeping Seal for extra protection at no extra cost.

You can be that dealer! Tie in now with Raytheon's “Seal Deal” . . . a complete, effective promotion program to help you build prestige and profits. See your Raytheon Distributor Salesman or mail this coupon today.

Mail this coupon for details on how you can profitably tie in with the Raytheon “Seal Deal.”

**RAYTHEON, Box 655**  
 Distributor Products Division  
 Westwood, Massachusetts

Name \_\_\_\_\_  
 Store Name \_\_\_\_\_  
 Address \_\_\_\_\_  
 City \_\_\_\_\_ Zone \_\_\_\_\_  
 State \_\_\_\_\_

**RAYTHEON COMPANY**

DISTRIBUTOR PRODUCTS DIVISION

www.americanradiohistory.com



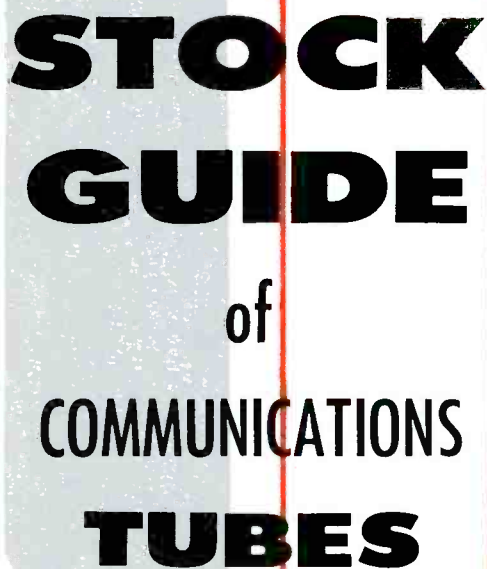

# STOCK GUIDE of COMMUNICATIONS TUBES

Many service technicians are now maintaining various types of two-way radio communications equipment, especially mobile radio and Citizens band transceivers. If you, too, are planning to branch out into this fast-growing phase of the service business, the list on this page will give you an idea of the tube stock you may need. Notice that two-way radios use quite a few of the same tube types employed in TV. However, there are also a number of types which are unfamiliar to TV men — including ruggedized receiving tubes, subminiature types, and RF beam pentodes for the final amplifier stages of transmitters.

The chart does not include all types that will ever be needed, but does give a good basic stock for servicing all makes and types of two-way equipment. Naturally, if you plan to specialize only in certain brands or in certain communications services, your tube needs will be governed accordingly.

The major use or uses for each type are given, to help in familiarizing you with typical applications. The designation "CB" next to a type indicates that it is found in Citizens band transceivers, but is not necessarily used exclusively in such equipment.

Type	Application	Type	Application	Type	Application
<b>0A2</b>	voltage regulator	<b>6BF6</b>	detector-AF amplifier	<b>12AT7</b>	oscillator-mixer
<b>1AD4</b>	submin. RF, AF amplifier	<b>6BF7</b>	submin. VHF tube	<b>12AU7</b>	CB AF amplifier
<b>1AG5</b>	submin. detector-amplifier	<b>6BH6</b>	RF amplifier, oscillator	<b>12AX7</b>	CB AF amplifier
<b>1AH4</b>	submin. RF amplifier	<b>6BH8</b>	CB RF oscillator-output	<b>12BA6</b>	CB RF amplifier
<b>1AJ5</b>	submin. detector-amplifier	<b>6BJ6</b>	CB RF amplifier	<b>12BE6</b>	CB converter
<b>2C39A</b>	UHF lighthouse tube	<b>6BQ5</b>	CB AF, RF beam-power output	<b>12BW4</b>	CB full-wave rectifier
<b>2E24</b>	RF beam-power output	<b>6BQ7A</b>	VHF amplifier	<b>12CR6</b>	CB detector-AF amplifier
<b>2E26</b>	RF beam-power output	<b>6BW4</b>	CB full-wave rectifier	<b>12X4</b>	CB full-wave rectifier
<b>3B4</b>	AF power output	<b>6BY6</b>	CB converter	<b>100TH</b>	VHF power amplifier
<b>4-125A</b>	RF power output	<b>6C4</b>	CB RF oscillator	<b>807</b>	RF beam-power output
<b>4X250</b>	RF power output	<b>6CB6</b>	RF amplifier	<b>813</b>	modulator; RF output
<b>5R4GY</b>	full-wave rectifier	<b>6CL6</b>	RF, AF amplifier	<b>816</b>	mercury-vapor rectifier
<b>5U4GB</b>	full-wave rectifier	<b>6CS7</b>	CB AF amplifier	<b>829B</b>	VHF twin beam-power
<b>5V4GA</b>	full-wave rectifier	<b>6CX8</b>	CB RF oscillator-output	<b>832A</b>	VHF twin beam-power
<b>5W4GT</b>	full-wave rectifier	<b>6EA8</b>	CB RF amplifier	<b>866A</b>	mercury-vapor rectifier
<b>5Y3GT</b>	full-wave rectifier	<b>6J4</b>	UHF amplifier	<b>1635</b>	AF output (R.R. radio)
<b>5Z3</b>	full-wave rectifier	<b>6J5</b>	amplifier; oscillator	<b>5651</b>	voltage regulator
<b>6AB4</b>	VHF amplifier	<b>6K6GT</b>	CB AF beam-power output	<b>5670</b>	VHF amplifier
<b>6AH6</b>	RF amplifier	<b>6T8A</b>	CB detector-AF amplifier	<b>5672</b>	submin. power amplifier
<b>6AK5</b>	VHF amplifier	<b>6U8A</b>	CB converter	<b>5678</b>	submin. RF amplifier
<b>6AK6</b>	CB AF power output	<b>6V6GT</b>	CB AF beam-power output	<b>5763</b>	VHF beam-power output
<b>6AL5</b>	CB detector; squelch	<b>6X4</b>	CB full-wave rectifier	<b>5829</b>	submin. rectifier
<b>6AN5</b>	RF beam-power amplifier	<b>7A6</b>	detector; rectifier	<b>6029</b>	submin. VHF oscillator
<b>6AN8</b>	CB RF, AF amplifier	<b>7A8</b>	converter; modulator	<b>6146</b>	modulator; RF output
<b>6AQ5</b>	CB RF, AF beam-power output	<b>7AG7</b>	VHF amplifier	<b>6883</b>	VHF beam-power output
<b>6AU6</b>	RF amplifier	<b>7C5</b>	AF beam-power output	<b>7054</b>	RF, AF power amplifier
<b>6AU8</b>	CB RF oscillator-output	<b>7C7</b>	amplifier; oscillator	<b>7056</b>	RF amplifier
<b>6AW8</b>	CB RF oscillator-output	<b>7F7</b>	AF amplifier	<b>7058</b>	AF amplifier
<b>6BA6</b>	CB RF amplifier	<b>12AB5</b>	AF beam-power output	<b>7059</b>	converter
<b>6BE6</b>	CB mixer-oscillator	<b>12AL5</b>	CB detector; squelch	<b>7060</b>	RF oscillator-output
		<b>12AQ5</b>	CB RF beam-power output	<b>7061</b>	AF beam-power output
				<b>7167</b>	RF amplifier

# NEW! BUSS

## Signal Indicating · Alarm Activating GMT Fuse & HLT Fuseholder

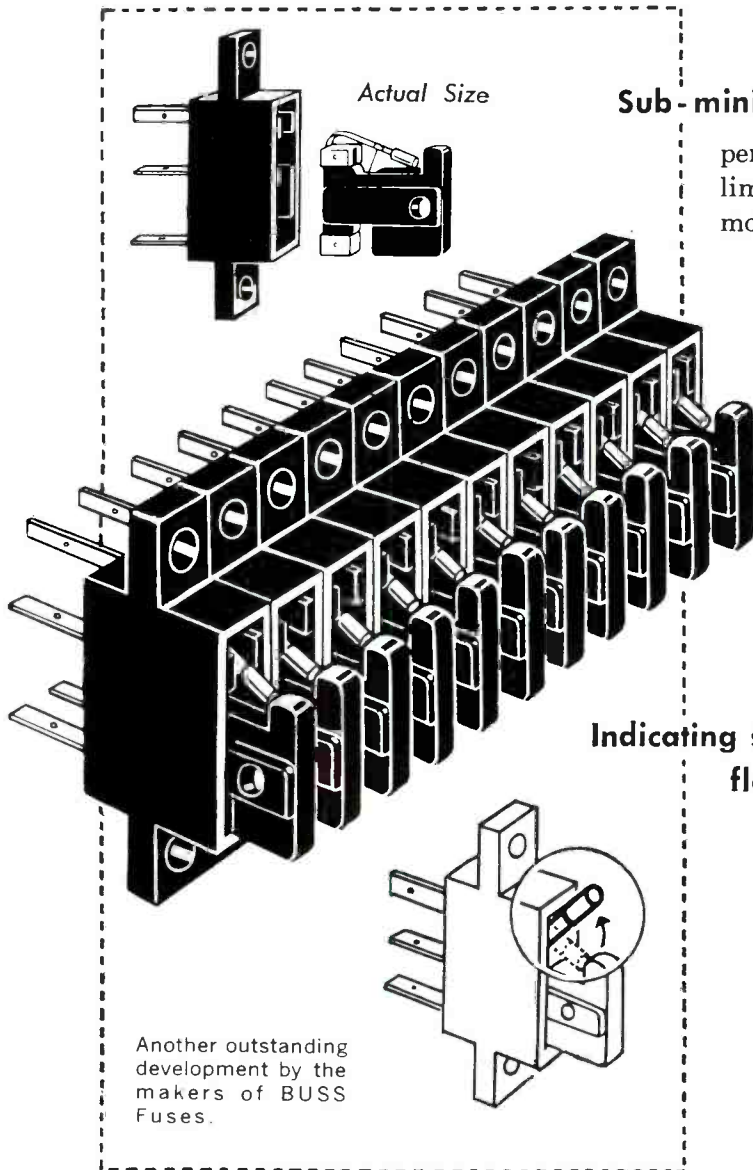

### Sub-miniature design

permits multiple mounting of fuses in limited space. Fuseholders can be mounted on  $\frac{1}{4}$  inch horizontal centers.

Fuse and holder combination readily adaptable for use in equipment operating at 300 volts or less, such as: communication equipment, business machines, computers, control equipment or other multiple circuit apparatus where space is at a premium.

### Indicating spring flashes color-coded flag when fuse opens

to give quick, positive identification of faulty circuit.

Indicator spring also makes contact with an alarm circuit so, it can be used to flash a light—or sound audible signal on fuse panel or at a remote location.

Ask for bulletin GMCS on BUSS GMT fuses and HLT holders.

Another outstanding development by the makers of BUSS Fuses.

**In the complete BUSS line, there are fuses and fuse mountings of unquestioned high quality to fit every protection need.**

**That's why it's more profitable to handle only BUSS fuses.**

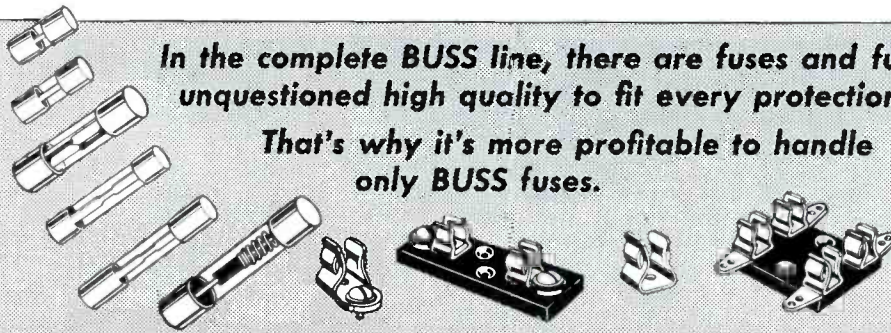

**BUSSMANN MFG. DIVISION, McGraw-Edison Co., UNIVERSITY AT JEFFERSON, ST. LOUIS 7, MO.**

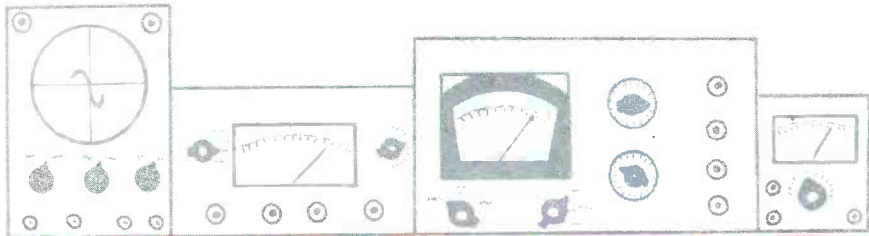

# NOTES ON TEST EQUIPMENT

by Forest H. Belt

## Let's Phase It!



Fig. 1. Compact transducers help the serviceman check the phase of speakers.

The old-fashioned method of phasing speakers, using a battery and observing cone movement, has become a thing of the past with the introduction of the RCA Model WG-360A Phase Checker (Fig. 1). This unusual device simplifies the proper phasing of any number of speakers in a multi-speaker system.

Specifications are:

1. **Power Requirements**—None. Power is obtained acoustically from the system being checked.
2. **Frequency Range**—40-4000 cps; transducer resonant frequency 180 cps.
3. **Indicator**—outputs available for oscilloscope, VTVM or VOM.
4. **Controls & Terminals**—Slide switch, chooses IN PHASE or OUT OF PHASE operation; phono jack for intercon-

necting cable; 3-terminal board for connecting indicator; all controls and terminals mounted on Unit B.

5. **Features**—a single 15' two-wire interconnecting cable between the two transducers.
6. **Size, Weight, and Price**—Each transducer 5" x 5" x 2 1/2"; both transducers with cable, approximately 2 lbs.; \$14.95.

The WG-360A uses two transducers to check the phase between any two speakers being operated from a common source. One transducer is placed in front of each speaker, with the 15' cable interconnecting the two. The sound from each speaker vibrates the transducers—which are high-impedance 50-ohm speakers—causing audio-frequency signals to be generated in their voice coils.

These signals are connected to a DPDT switch (see Fig. 2), which can be set for either of two modes of transducer operation—series-aiding or series-opposing. A step-up transformer raises the voltage of the transducer signals to a level suitable for input to an oscilloscope. To further facilitate output indications, a 1N60 diode is provided to rectify the transformer output, so a VTVM or VOM can be used as an indicator for the Phase Checker.

When the output of transducer A is connected (by switch S1) in series-aiding with the output of transducer B, these two outputs will add in output transformer T1, if the vibrations which drive the transducers are in phase. When the switch is placed so the transducer outputs are opposing, their outputs will cancel in T1.

The output indicator indicates which condition exists, by measuring which position of the slide switch results in greater output. By labelling the slide switch IN PHASE when the transducers are connected series-aiding, the checker identifies in-phase signals fed to both transducers. If an out-of-phase signal is fed to one transducer, S1 must be switched to series-opposing to provide the greater output. This position of the switch is labelled OUT OF PHASE. In this

manner, the WG-360A indicates whether the vibrations of the two transducers are in phase or out of phase.

In the lab, we tried phasing all the speakers in a four-speaker monophonic high-fidelity system. First of all, we found that we needed considerable volume, when using program sound, to drive the transducers sufficiently so that a usable output indication could be obtained with a VOM. We also found it necessary to use the 50-ua range of the VOM.

More satisfactory indications were obtained by using a 1000-cps sine-wave signal to drive the speaker system. Transducers A and B were placed in front of speakers 1 and 2 (respectively) of the system, as shown in Fig. 3. After proper connections were made to the Phase Checker, the switch was moved to both positions. The IN-PHASE position gave a reading of 40 ua on the meter, while the OUT-OF-PHASE position read only 5 ua. This proved that speakers 1 and 2 were in phase, and therefore were properly connected to the hi-fi system.

Moving transducer B to the third speaker of the system, we repeated the test by again moving the switch to both positions. This time, however, greater output was indicated when the switch was in the position marked OUT-OF-PHASE. Reversing the connections to this speaker (which had been connected without checking phase) put it in phase with speakers 1 and 2.

To check speaker 4, which was in another room, we moved transducer A to speaker 4, leaving transducer B at speaker 3. We suddenly found that we could get very little difference between the indications in either switch position. Investigation disclosed that we had inadvertently placed transducer A a few inches away from speaker 4. To show a definite difference between the indications, each transducer must receive an appreciable amount of acoustic power. Thus we learned the importance of placing the Phase Checker in close proximity to the speakers being checked. At times it may even be necessary to prop the transducers on something such as a pile

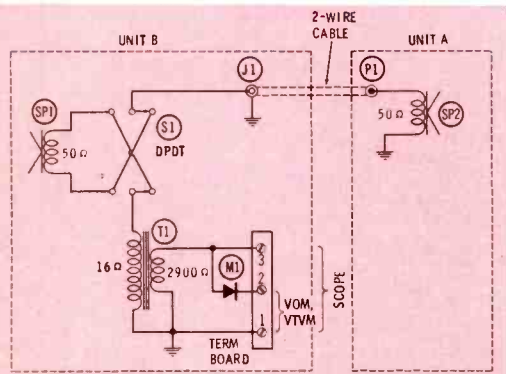

Fig. 2. Circuit of the WG-360A units.

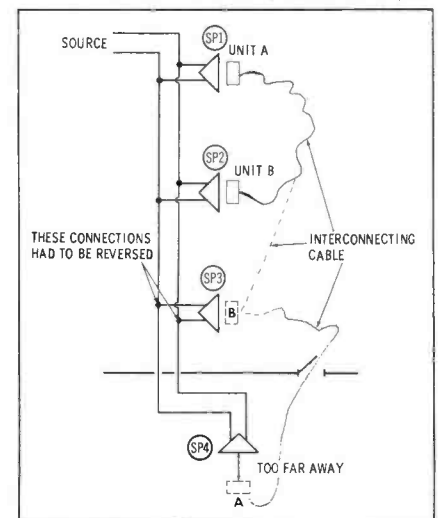
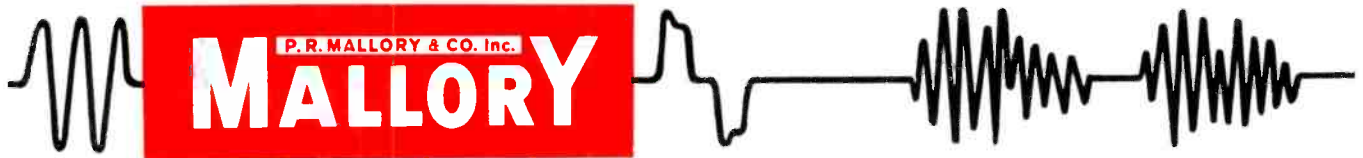

Fig. 3. Using the Phase Checker in a test of four monophonic hi-fi speakers.





## Tips for Technicians

Distributor Division, P. R. Mallory & Co. Inc.  
P. O. Box 1558, Indianapolis 6, Indiana

### Selector Switches for Circuit Shrinkers

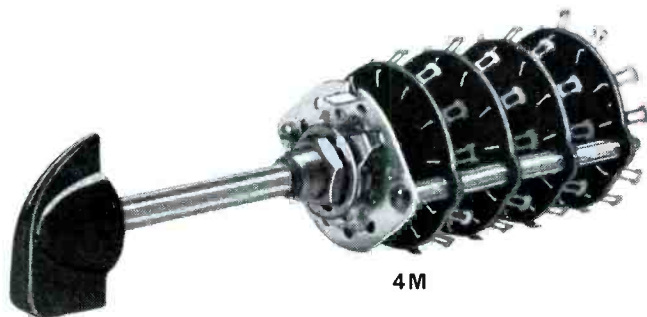

4M

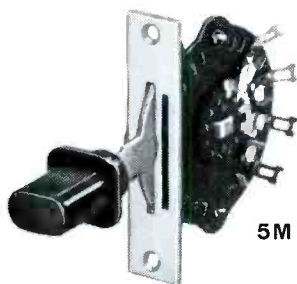

5M

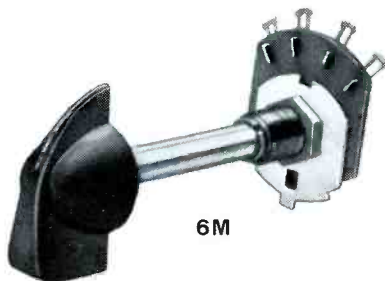

6M

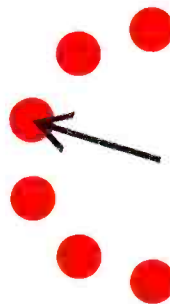
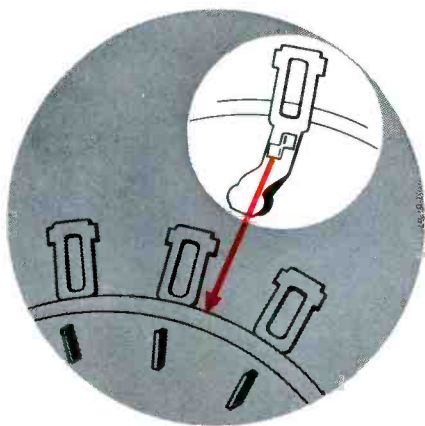

Selector switches are smaller now. Especially the new Mallory-Grigsby switches. They're handy when you're working on equipment that has to be squeezed down to minimum size. And they come in both rotary and lever action models.

The 4M series (30° indexing) have a wafer diameter of only 1 3/8". They meet or exceed MIL-S-3786 specifications. The phenolic wafer type has 11 positions while the ceramic type has 12. Of course there are shorting and non-shorting styles with up to six sections. 60° and 90° indexing styles are available with a two-piece metal and phenolic shaft for use in circuits with high RF signals.

The 6M series is lever action. It uses the same wafer construction as the 4M series. It projects only 1 1/4" behind a panel. It's 30° indexing, with or without spring return, and 3 position. Furnished with all hardware and handsome lever knob.

The 5M series is a truly low-cost general purpose rotary switch in several shaft and circuit combinations.

● Two things to remember about Mallory-Grigsby switches. . . . They have exclusive "Wedge-lock" terminal construction. That's a new way of attaching contacts to insure positive alignment and prevent distortion. And you can get Mallory-Grigsby switches from Mallory Distributors clear across the country.

**Write today for our Bulletin 9-250 and a handy cross-reference guide.** Better yet, see your Franchised Mallory Distributor for: Switches, Capacitors, Controls, Resistors, Rectifiers, Batteries, and Vibrators as well as every other electronic component.

**DON'T WASTE TIME**

# MAKING CONNECTING CORDS

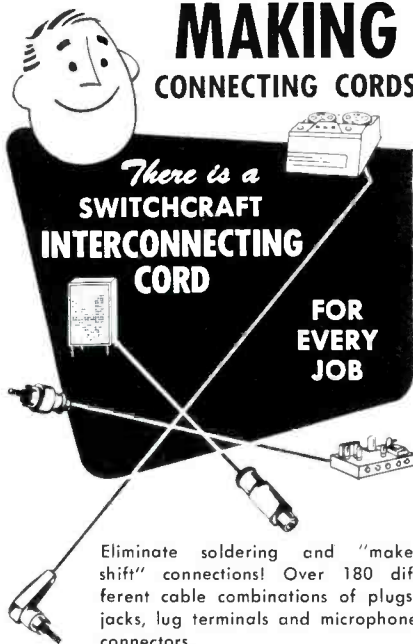

There is a  
**SWITCHCRAFT  
INTERCONNECTING  
CORD**

**FOR  
EVERY  
JOB**

Eliminate soldering and "make-shift" connections! Over 180 different cable combinations of plugs, jacks, lug terminals and microphone connectors.

Interconnect—quickly and simply—Stereo, Hi-Fi, Amplifiers, Speakers, Turntables, Tuners, PA, Ham and CB equipment.

Also, a complete line of ADAPTERS for interconnecting two pieces of equipment that do not have matching connectors.

Write for Audio Accessory Catalog A-401.

In stock at leading Electronic Distributors.

**SWITCHCRAFT**  
INC.

5573 N. ELSTON AVE. • CHICAGO 30, ILLINOIS  
Canadian Rep: Atlas Radio Corp., Ltd.,  
50 Wingold Ave., Toronto, Ontario

## New **BERNS** Perfect Pin Crimper

### Picture-Tube Repair Tool

Also for—5U4, 6SN7, 6BQ6, etc.

Eliminates that hard  
soldering job

only \$1.25  
each

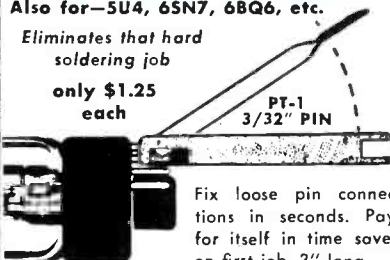

Patented

Fix loose pin connections in seconds. Pays for itself in time saved on first job. 3" long.

Intermittent operation of picture tubes due to defective solder connections easily corrected. Provides solid electrical connections, can also be used as channel-selector wrench and screwdriver. Pin keeps its original form. A 3-in-1 tool.

### 3 MODELS ELIMINATE SOLDERING

Makes Solid Electrical Connections  
**Phono Pin-Plug Crimper**

Slip wire in "pin plug," insert in tool, and squeeze... job is done.

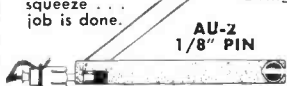

AU-2  
1/8" PIN

Use end of tool to push on C-ring for ground connection.

Ant. plugs, hi-fi, multiple plugs, public address, radio and TV tubes, radar, speakers, and loop connections. Many, many more uses.

**Model LC-3 for 5/32" pin diameter**

At your parts distributor or write us

**BERNS**

Mfg. Co.  
9853 Chalmers,  
Detroit 13, Mich.

of books. Speaker 4 was found to be in phase with the rest of the system.

The WG-360A can be used for other purposes, too. Among these are: As a test speaker, as a microphone (similar to intercom use), and for checking relative sound power among several speakers, or

between two channels of a stereo system. Directions for these uses are included in the instruction manual.

The Model WG-360A Phase Checker is certainly a new approach to one of the serviceman's many little problems, offering a quick, accurate solution.

## Sound Measurements

Serious audiophiles and audio technicians often need a sensitive VTVM for measuring voltages and power in low-level audio circuits. The instrument must be able to give accurate indications regardless of frequency. Such an instrument (see Fig. 4) has been introduced by EICO, Inc., of Long Island City, New York.

Specifications are:

1. **Power Requirements**—105/125 volts, 50-60 cps; power consumption 15 watts.
2. **AC Voltmeter**—six rms ranges of from 0 to 1, 3, 10, 30, 100, and 300 volts; accuracy  $\pm 3\%$  of full scale; frequency response, flat from 10 cps to 600 kc.
3. **AC Millivoltmeter**—six rms ranges of from 0 to 1, 3, 10, 30, 100, and 300 mv; accuracy  $\pm 3\%$  of full scale; frequency response, flat from 10 cps to 600 kc.
4. **Output Meter**—twelve ranges of from -80 db to +52 db; 0-db reference, 1 mw in 600 ohms; accuracy  $\pm 3\%$  of full scale; scale conversions for each range, at range switch.
5. **Input Impedance**—10 megohms shunted by 15 mmf; 600-volt input blocking capacitor.
6. **Panel Meter**—4½" face, 200-ua movement; two scales, 0 to 1 and 0 to 3, for voltage ranges; one scale -20 to +2 for decibel ranges; accuracy  $\pm 2\%$  full scale.
7. **Amplifier**—maximum gain 60 db; maximum rms output voltage 5 volts; frequency response, +0 and -3 db from 8 cps to 800 kc; maximum noise and hum, -40 db with 2 mv input signal or better; output impedance 5000 ohms.
8. **Controls & Terminals**—AMP-VTVM slide switch; OUTPUT control combined with ON-OFF power switch; frequency-

compensated rotary RANGE switch; calibration control, hum control, frequency-compensating capacitor, all mounted on chassis; combination-type INPUT and OUTPUT terminals; neon pilot lamp.

9. **Size, Weight, Price**—8½" x 5¾" x 7"; 7 lbs; \$49.95 kit, \$79.95 wired.

The Model 250 AC VTVM meets most needs of critical audio specialists. Many AC VTVM's fail to provide the sensitivity found in the Model 250; its lowest full-scale reading is 1 mv, enabling the audio technician to accurately read rms values as low as 100 uv.

The usefulness of the Model 250 applies primarily to sine-wave voltages. Complex voice or program waveforms can be measured, but the results are useful only for comparison, since the rms value of a complex waveform bears little relationship to its peak value. However, most audio-analysis methods make use

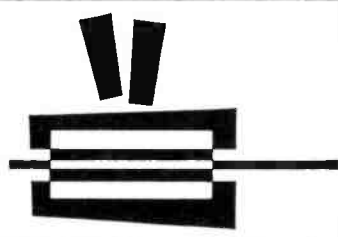

Fig. 4. Sensitive AC VTVM also has an amplifier to help the audio serviceman.

## MERCURY TUNER SERVICE, INC.

890-1 River Ave., Bronx 51, N.Y.

"Largest in the East"



### VHF-UHF TUNERS

7 Months Warranty

Price Includes Labor & Minor Parts

TUBES & MAJOR PARTS  
AT NET PRICES

When Shipping Tuner: Include Tubes,  
Shields and Damaged Parts.  
Give Model Number and State Complaint

PACK WELL AND INSURE  
24 HOURS ON POPULAR TYPES

ALL MAKES  
ONE PRICE!

**\$9.50**

**EASY  
WITH  
"ET"**

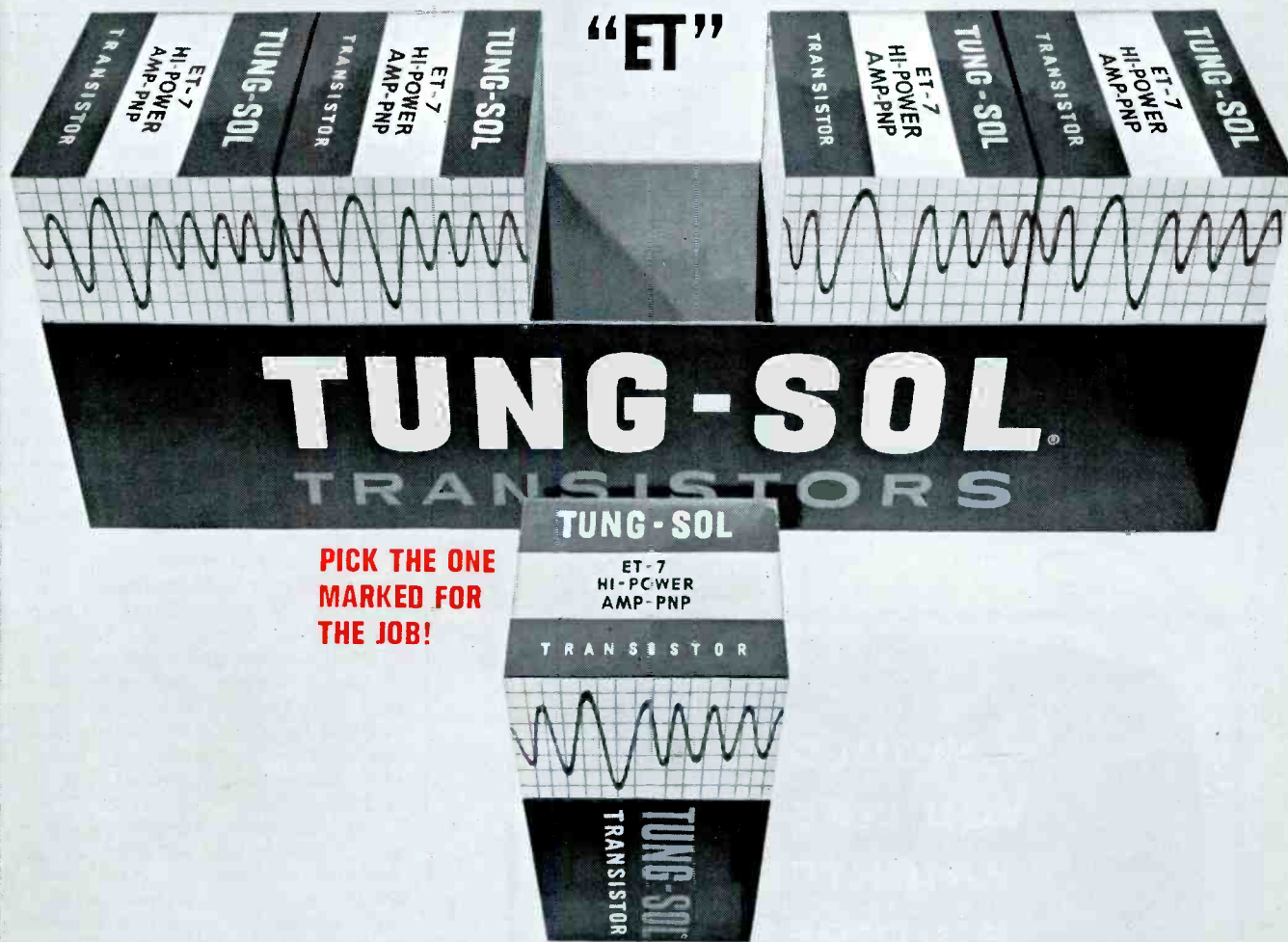

**PICK THE ONE  
MARKED FOR  
THE JOB!**

Tung-Sol "ET" transistor packages are marked to eliminate guesswork in selecting the correct replacement for every job. Type numbers, class of service and junction polarity is stamped on each end flap. This is a time saving feature as well as a safeguard against service slip-ups. Tells you at a quick glance where your inventory stands.

The compact "ET" line was engineered by Tung-Sol specifically to eliminate confusion in entertainment service resulting from almost endless similarity and duplication of types. Eleven PNP and NPN units replace hundreds of older transistors. "ET"

transistors measure up fully to Tung-Sol's one high standard of excellence and reliability. The most advanced quality evaluation techniques assure product uniformity, lot after lot.

When you order transistors, specify "ET." High turnover with low inventory and customer satisfaction will show that it's the profitable way to buy transistors. Tung-Sol Electric Inc., Newark 4, New Jersey.

 **TUNG-SOL®**

**A TYPE FOR EVERY JOB**

**PNP TYPES**

**Low power**

- ET1 Mixer/oscillator/converter
- ET2 IF amplifier
- ET3 AF amplifier 6v.
- ET4 AF amplifier 12v.
- ET5 AF amplifier 9v.

**Medium power**

- ET6 AF power amplifier

**High power**

- ET7 AF high power amplifier

**NPN TYPES**

**Low power**

- ET8 Mixer/oscillator/converter
- ET9 IF amplifier
- ET10 AF amplifier 9v.
- ET11 AF amplifier 12v.



Ask your Distributor for the Tung-Sol Transistor Interchangeability Guide

of sine- or square-wave test signals. Square waves definitely can be measured and compared in terms of their average values. For example, a sine wave having a peak value of 1.4 volts has an rms value of approximately 1 volt as measured on the Model 250. A square wave with a peak value of 1.4 volts gives an average indication of 1.4 volts on the AC VTVM, and therefore assumes a fixed relationship to the sine-wave measurement.

For measuring square-wave voltages—or the values of other complex waves—the frequency response of the instrument must be considered. Since the frequency response of the Model 250 is completely flat to 600 kc, the highest-frequency square wave which can be dependably

measured and compared will be in the neighborhood of 60 kc. Of course, this is much beyond the requirements for audio work, and need not trouble the audio technician. But, this consideration should be kept in mind when the Model 250 is used for ultrasonic measurements, or for certain dynamic response measurements in audio or other equipment.

The decibel range allows the user to measure voltage or power values directly in decibels. For voltage measurements, decibels can be read directly on the db scales, using the scale conversions listed on the RANGE switch. Voltage-gain comparisons are made by subtracting the input of an amplifier (in db) from its output. For example, an input voltage of 10 millivolts equals about -38 db. If this

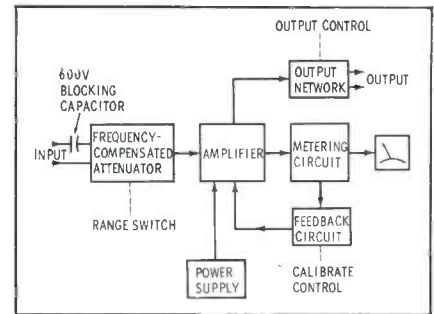

Fig. 5. Feedback circuit takes signal from the bridge-type metering circuit.

signal is amplified, and again measured, the output might be on the order of 1 volt, or about 2 db. The stage gain would be 40 db, a voltage gain of 100.

Stage gain can also be expressed in dbm or power gain. This measurement is useful for matching impedances of transmission cables at audio levels, and for checking power stages. The instruction manual provided with the instrument includes a chart which simplifies the conversion of dbm readings directly into milliwatts, in case a direct power-level measurement is needed. The decibel scale of the Model 250 can be read directly in dbm only if the measurement is taken across a 600-ohm load, since the dbm reference level (0 db) is 1 milliwatt in a 600-ohm load.

It is difficult to measure dbm in many circuits because their impedances are not the exact 600 ohms required. To simplify this situation, the instruction manual also contains a nomograph which can be used to correct readings taken with different load impedances. Dbm measurements can thus be taken in almost any circuit, and corrected to the accuracy found in other measurements taken with the Model 250.

The instrument amplifies input signals in a stabilized amplifier, and then measures the amplifier output with a bridge-type metering circuit (see Fig. 5). Input voltages are coupled by a blocking capacitor to the frequency-compensated attenuator network (Fig. 6). The attenuator adjusts the input voltage to a level which will not overload the amplifier. The amplifier increases the signal to a suitable level and then applies it to the metering circuit. A feedback network provides an adjustable amount of degenerative feedback, stabilizing the amplifier gain. Calibration of the instrument is accomplished by controlling this



Fig. 6. View of frequency-compensated attenuator-network-&-switch assembly.

## BOOST YOUR BRITENER SALES

with these

## SIX MAGIC WORDS

from *Perma-Power*

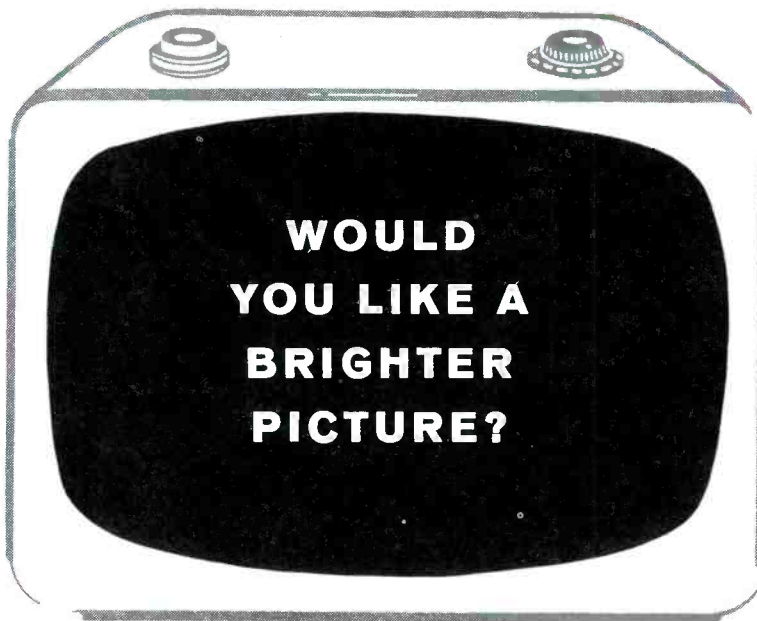

That's a question with only one possible answer—YES. Every customer wants a better, brighter picture... but doesn't realize how easy it is to get one.

When you say you'll brighten the picture—When you quote the low cost—you've sold the customer.

**Don't sell Briteners—sell Brighter Pictures!**

On every service call, remember to use Perma-Power's 6 Magic Words—Would You Like A Brighter Picture? You'll sell a 12-pack of Briteners almost as fast as you can say Perma-Power!

**Perma-Power** COMPANY—3102 N. Elston Ave.—Chicago 18

# K-950

## ... 8" 2-way coaxial distributed sound loudspeaker... MORE

**NEW**

**THAN  
50%  
LOWER  
INSTALLED  
COST!**

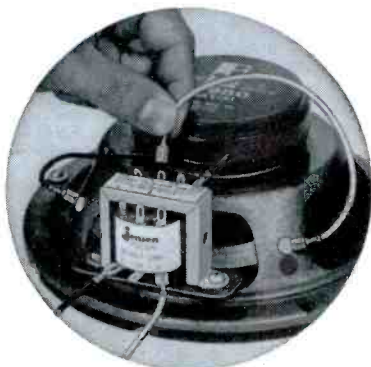
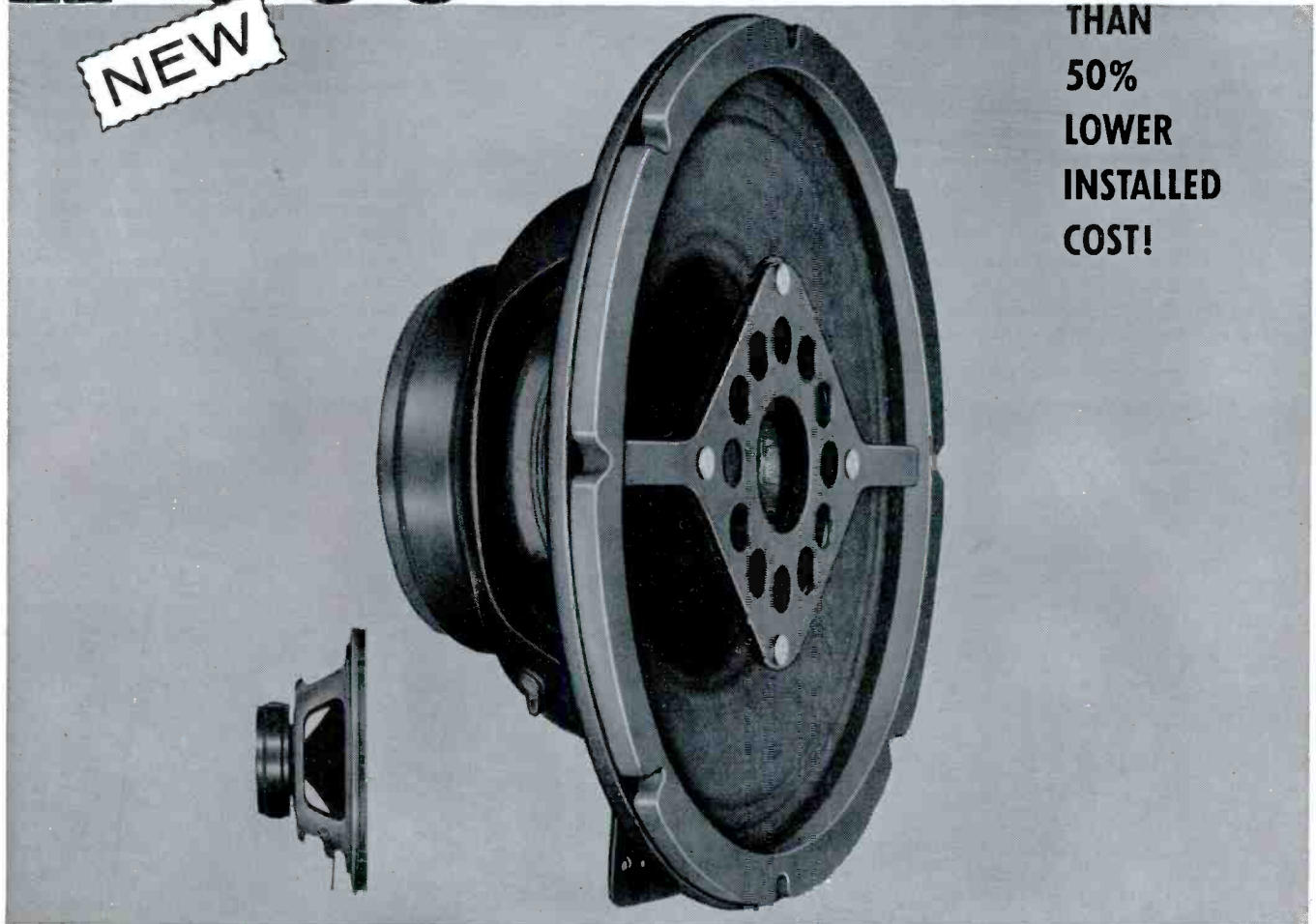

Available with factory installed 70.7 or 25 volt transformers.

KWIKON\* instant connectors and tap adjustments are a cost saving feature.

It's simple arithmetic to show that with the full 110 degree coverage angle of the K-950 (compared with 90° or less for conventional types) you can use *half as many speakers, transformers, ceiling baffles . . . have less than half the installation cost, because KWIKON\* instant connectors and factory preattached transformers further cut on-the-job time importantly. And amplifier cost goes down, too, due to reduction in the number of speakers plus higher efficiency.*

When the K-950 is used with conventional "90 degree" spacing, reproduction quality is substantially improved, and loudness and articulation variations with position are drastically reduced compared with the performance of simple cone speakers.†

So whether you're designing for lowest installed cost or highest quality distributed sound, investigate the advantages of the outstanding K-950. Write for Specification Sheet CSP-102 for complete technical details.

†Results of an impartial test by a world famous firm of acoustical consultants.

### NO OTHER DISTRIBUTED SOUND SPEAKER HAS ALL THESE FEATURES

1. Genuine coaxial 2-way system with electrically and acoustically independent tweeter.
2. High fidelity wide range response.
3. High efficiency.
4. Widest high frequency dispersion.
5. Lowest variation of articulation with position.
6. Super-shallow depth . . . will mount in the wall.
7. SYNTAX-6\* ceramic magnet (10 oz.).
8. Available with factory mounted 70.7 or 25-volt transformers.
9. Handy 10-pack is economical, easy to handle.
10. KWIKON instant connection and transformer tap adjustments.

©T.M.



**jensen** MANUFACTURING COMPANY

Division of THE MUTER COMPANY

6601 S. Laramie Avenue, Chicago 38, Illinois

In Mexico: Unversal De Mexico, S.A., Mexico, D.F.

feedback. (See Fig. 7.) The large amount of feedback serves to counteract variations in tubes and circuits due to aging.

Usefulness of the Model 250 is increased by its amplifier, which can be used independently of the VTVM function. By moving a slide switch from the VTVM position to the AMP position, the metering circuit is disconnected; also, the amplifier output is fed to the OUTPUT control, and then to a pair of terminals on the front panel. The OUTPUT control attenuates the amplifier output, while the input attenuator controls the amount of signal applied to the amplifier. The overall gain of the amplifier (in the most sensitive settings of the RANGE and OUTPUT controls) is 60 db, or a voltage gain of 1000.

Care must be taken when the Model 250 is used for measurements in circuits containing high-amplitude voltages. The blocking capacitor at the input of the attenuator network is rated at 600 volts;

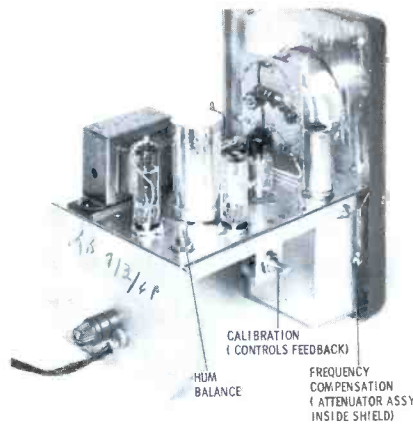

Fig. 7. Model 250's service controls.

thus, the total voltage applied to this capacitor should not exceed 600 volts. If, for example, measurements are taken in a circuit with 400 volts DC present, the maximum peak sine-wave voltage which

can be safely measured is 200 volts—which corresponds to about 140 rms volts as measured by the instrument. Therefore, it can be seen how easily the rating of the instrument might be exceeded, resulting in damage to the input network.

We tried a little experiment which proved helpful in tracing one audio problem in a preamp. A pair of earphones were attached to the OUTPUT terminals of the AC VTVM. During low-level measurements in preamplifiers, it is often difficult to be sure whether you are measuring signal, or hum and noise. With the arrangement described, we found it a simple matter to push the AMP-VTVM switch to the AMP position long enough to identify the exact nature of the voltage being measured. We also found it useful in tracing a case of hum to a ground loop between two chassis of a stereo system. In this case, the earphones again enabled us to identify the signal which we were measuring. ▲

NEXT BEST THING TO THE  
WINEGARD ELECTRONIC  
POWERTRON TV ANTENNA

MOUNTS ON  
ANTENNA

# NEW TRANSISTOR TV-FM WINEGARD TENNA- BOOST

MOUNTS ON ANY ANTENNA



Model  
MA-300

\$ **34<sup>95</sup>**  
only LIST

**INSTALL IT . . . FORGET IT!**  
ALL ELECTRIC, ALL-AC POWER  
SUPPLY costs less than 27c a  
year to operate. Many exclusive  
features.

No costly, nuisance batteries!

Built-in two set  
coupler.



## 19 DB GAIN! CUTS SNOW...BOOSTS SIGNAL!

Now you can make any TV or FM antenna work better by magnifying signals with the new Winegard transistor Tenna-Boost.

Tenna-Boost has up to 19 DB gain, no peaks and valleys. Ultra low noise. Linear frequency response. VSWR input better than 1.5:1 across all frequencies. Output VSWR 1.8:1 or better. This fine frequency response plus the very low VSWR make Tenna-Boost excellent for color.

Winegard's exclusive input band-pass filter eliminates interference from citizen's band, Hams, garage door openers, etc. Only TV and FM signals are amplified.

All metal parts are anodized, irridized or stainless steel. Completely weather-proof, trouble-free. Install it . . . forget it.

There's a big difference in antenna amplifiers! Ask your distributor or write for technical bulletin.

FOR THE ULTIMATE IN  
TV RECEPTION

Winegard Transistorized Electronic  
Powertron TV Antennas. 3 Models  
to Choose From.



# Winegard

ANTENNA SYSTEMS  
3009-28, Kirkwood • Burlington, Iowa

# THE TROUBLESHOOTER

answers your service problems

## Winks At Us

We are having a problem with a Capehart Model 323M (covered in PHOTOFACT Folder 112-3). As the antenna signal fades in and out—which happens every time someone walks by the set—the raster blooms. At times, it disappears completely. The same effect can be produced by advancing the AGC control. We have found nothing wrong in the AGC circuit, but we notice that the voltages in the low-voltage power supply vary a great deal according to the AGC-control setting. For instance, the main B-minus source voltage (applied to the cathodes of many tubes) ranges from -75 to -100 volts, and B+ varies from 195 to 220 volts. I believe this evidence of poor voltage regulation is the key to our answer, but can't pin down the exact source of the trouble. Incidentally, we've replaced all tubes including the low-voltage and high-voltage rectifiers.

RALPH R. FORKE

Instructor of Electronics  
Father Flanagan's Boys' Home  
Boys Town, Nebr.

*Correcting the poor regulation of the low-voltage supply should go a long way toward curing this trouble. Probably you need to replace the three multisection electrolytic filter capacitors in the power-supply circuit. Also check for horizontal-sweep and high-voltage troubles that might be aggravating the problem—for instance, leakage in the capacitor that filters the high voltage.*

## So That's What It Was!

Shortly after we wrote you about trouble in a Pontiac Model 988671 auto radio (see "Reckless Driver," December Troubleshooter), we dug a bit deeper into the radio and came up with a defective tube socket in the driver stage. Two of the pin connections were broken off underneath the upper wafer, but above the lower wafer. Although the tube pins were not making contact, the ohmmeter prods completed the circuit when shoved down through the pin holes; this is what threw us off the trail. We finally had to tear the socket apart to find the trouble.

L. R. PAYNE

Nipawin, Sask., Canada

*Guess you know you threw us a curve, L. R.*

## Going Crazy Over The Twist

A Zenith Chassis 17A30 (covered in PHOTOFACT Folder 408-4) constantly tries to pull out of horizontal sync; all the people in the pictures seem to be doing the "twist." I can't decide if I have horizontal AFC, sync, or AGC trouble, or a combination of these. Adjusting the horizontal hold coil reduces the trouble to just a slight wave at the right edge of the picture, but not for long.

Waveforms seem to be very close to normal, except that W12 at the cathode of the horizontal phase detector seems a little low in amplitude, and feedback signal W13 is a little higher than indicated on the schematic. The DC voltages in the horizontal section are all right except at the cathode of the phase detector; this point measures only 2.5 volts with no signal present.

The sync-input grid (pin 9) of the 6BU8 tube reads zero volts in the absence of a signal, and the sync plate (pin 8)

measures 45 volts. On the AGC section of the tube, the voltages change so much with the setting of the AGC control that I can't obtain any definite clues. When the control is turned counterclockwise, the picture goes negative. As I turn it back through the middle of its range, the picture regains normal contrast, but still shows horizontal AFC trouble and slightly weak vertical sync. Toward the clockwise end of the control range, the picture disappears. It can never be locked in at any AGC setting. Can you give me any suggestions for isolating this trouble?

R. VAN CAMP

Los Angeles, Calif.

*The action of the AGC control is normal; I'd say you probably have sync or AFC trouble. Check the grid waveform on pin 7 of the 6CN7 horizontal-AFC reactance tube. (A low-capacitance probe is recommended for this high-impedance point.) There should be practically no ripple voltage, even with the scope gain all the way up; if there is, substitute for AFC filter capacitors C50 and C51. Likewise check the reactance-tube cathode waveform, and bridge C54 if appreciable ripple appears. You might also check the stability of the oscillator-reactance tube combination by grounding pin 7 of the 6CN7 and carefully adjusting the horizontal hold slug. In this type of circuit, you should almost be able to stop the picture during this test. It will slowly roll from one side to the other, but should normally have no tendency toward tearing.*

*If you suspect that the amplitude of W13 is high enough to cause trouble, temporarily bridge C49 with a capacitor of approximately 1000 mmf. If this stabilizes the picture, check all capacitors in the AFC-feedback circuit for value and leakage (or replace them).*

*In case the horizontal section checks out OK, investigate the apparent decrease in sync-pulse amplitude. If you have a signal-substitution tester, unsolder the top end of C47B, inject horizontal sync pulses into this capacitor at 40 volts peak to peak, and check the results. As an alternative, check the waveform at the sync plate (pin 8) of the 6BU8, with the scope synchronized to 7875 cps. Use a low-capacitance probe here, too, and adjust the AGC control for best obtainable sync stability. The plate signal is normally 40 volts in amplitude, and contains two clean horizontal sync pulses—with little or no video information on the base line. Closely examine the tips of*

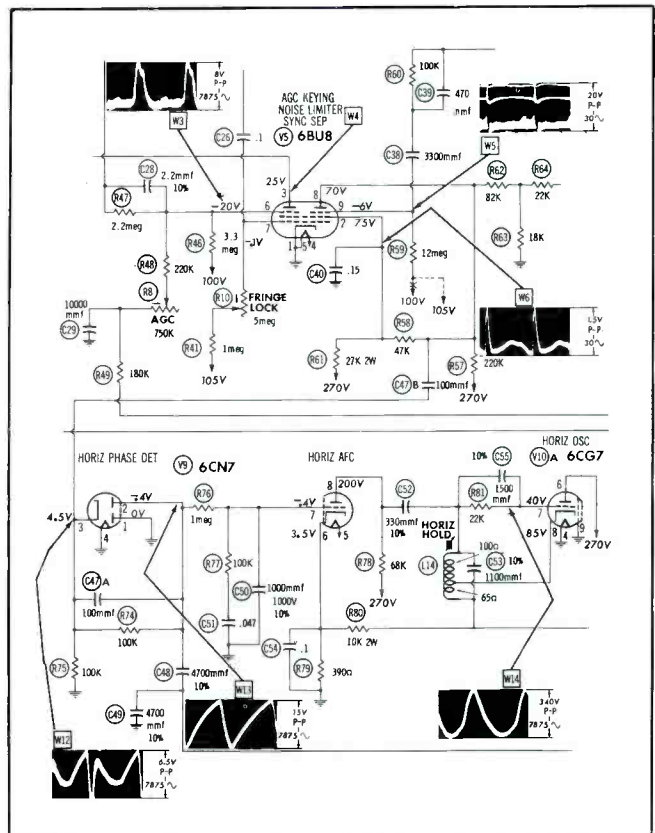



# New Stethotracer

\$29.95 DEALERS' NET

The instrument for every electronic signal tracing need in your vest pocket. Locates defective circuit fast!

The pen-size, transistorized STETHOTRACER locates hum, oscillations, ground loop, breaks in printed circuit boards and other common trouble shooting ailments in seconds! This dependable, top quality instrument detects and demodulates any low level microwatt audio or modulated radio frequency signal... the signal is then amplified 1,000 times into a high quality earphone, or observed on a scope, using a plug-in scope adaptor (available optionally).

Ideal for test and trouble shooting all types of radio, amplifiers, phonographs, magnetic tape recorders, dictating machines, hearing aids, and phono pickup cartridges, or used as a preamplifier.

Complete with earphone, cord, 4 interchangeable attenuator probes and R. F. detector-demodulator crystal diode probe, ground clip lead and battery.

Accessory probes (available optionally) include Vibration Pickup Probe, Miniature Microphone Probe, Magnetic Tape Head Probe, Microwave Demodulator Probe and Telephone Pickup Induction Probe.

Ask also about the famous MOSQUITO, the new vest pocket size signal injector—a signal source for every application! \$9.95 dealers' net.



See your local distributor or write for details to:  
**Don Bosco**  
 ELECTRONICS INC.  
 Littell Road • Hanover, N. J. • TUCKER 7-5575  
 A Subsidiary of Howell Electric Motors Company

the pulses for "flickering" that would indicate varying height, also inspect the waveform at 30 cps, and look for a ragged edge on the sync-tip level. If the signal shows video contamination or amplitude distortion, very carefully recheck the grid waveform at pin 9) for sync compression. I wouldn't worry about the voltages in the sync separator, since they vary greatly according to the noise present in the circuits.

If you find a defect in the grid signal, thoroughly check the input-coupling circuit and the video output stage before looking for AGC trouble.

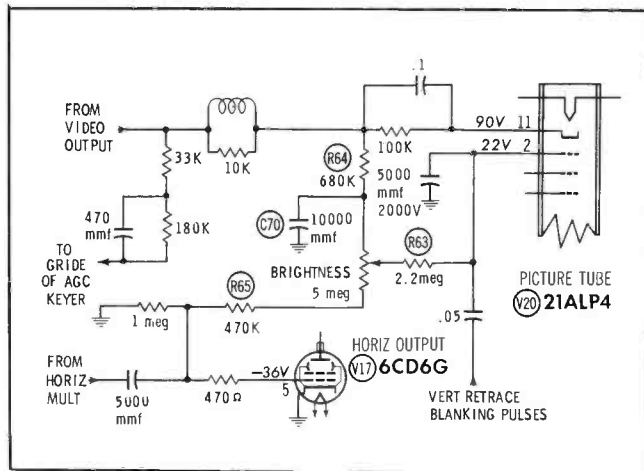

### Camouflage

I thought I had AGC trouble in a Motorola Chassis TS-534 (covered in PHOTOFACT Folder 312-8); the symptoms of overloading were present, and could be largely remedied by clamping the AGC line. However, the component at fault was C70 in the brightness-control circuit. Why did this component cause the symptoms it did, and not just produce a change in brightness?

EARL BLASS

Sturgis, Mich.

Sizable AC voltages are present in two circuits connected to the brightness control. Vertical retrace-blanking pulses measuring 70 volts peak to peak appear at the grid of the horizontal output tube; also, the grid circuit of the horizontal output tube (used as a source of negative voltage for the lower end of the brightness control) has a 100-volt sawtooth signal. Without the bypassing provided by C70, portions of both these waveforms can mix with the video signal at the cathode of the picture tube. In addition, they are coupled back through the video-output plate circuit to the grid of the AGC keying tube, producing symptoms that can be mistaken for AGC trouble.

### Coc-Keyed AGC

The picture on an RCA Chassis KCS72A (covered in PHOTOFACT Folder 184-12) indicates extreme video overloading, but can be brought back to normal by clamping the AGC line. I'm puzzled by several of the voltage readings in this

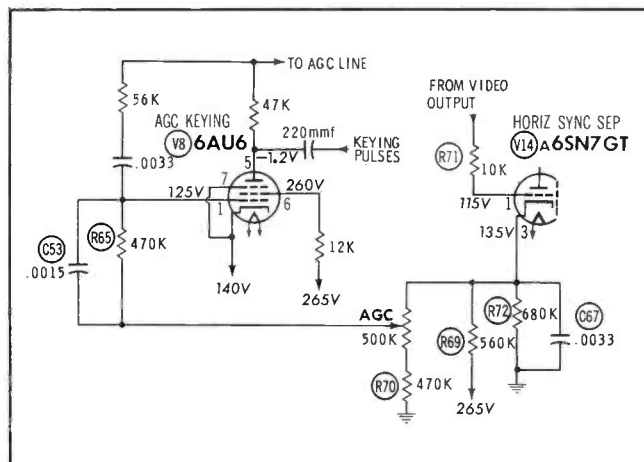



set. With no signal applied, all the voltages on AGC tube V8 and on the horizontal sync separator V14A are normal; they change in an inconsistent fashion when the overloading is present. The grid voltage of V8 varies from 55 to 110 volts, depending on the AGC-control setting, and the cathode voltage rises to 160 volts. At V14A, the cathode voltage goes down to 110 volts, but the grid voltage increases to over 200 volts. The video output tube, which is direct-coupled to V14A through R71, also has about 200 volts on the plate—far above normal, according to the schematic. A distorted video waveform, with badly compressed sync pulses, is present at the plate. The grid signal applied to the video output stage has a normal waveshape, but its peak-to-peak amplitude is very high (20 volts), and the DC grid voltage is -10 volts. I could sure use some help in interpreting these readings.

DELTON PANKO

Burr, Nebr.

*With a signal present, it is normal for the cathode voltage of V8 to rise, because there is less current drain on the 140-volt B+ line than under no-signal conditions. Also, the video output stage should react to overloading as you have described. With -10 volts on the grid, the output tube is practically cut off, and the plate voltage rises toward the B+ level. The grid voltage of V14A also rises because of the direct coupling through R71.*

*Normally, the cathode voltage of V14A should also increase. This positive shift in voltage should be coupled through the AGC-control circuit to the grid of the keying tube, thus stepping up the production of AGC bias to counteract the excessive video-signal strength. However, as you have noted, the cathode voltage of V14A is going down—not up—when the overloading occurs. This could point to trouble in C67, R72, R69, R70, or the AGC control. On the other hand, the observed distortion of the video signal could have some bearing on the voltage errors; so try clamping the AGC line again (to produce a normal signal) while you recheck those voltages. If the cathode voltage of V14A is still too low, check the indicated components by substitution.*

#### Set Helped Fix Own Trouble

Thank you for your answer to my request for help with an audio-distortion problem in a Motorola Chassis TS-528 (covered in PHOTOFAC Folder 278-7). Before I wrote you, I had given up looking for trouble in the cathode circuit of the audio output tube, and was checking the grid circuit to find out why the grid-to-cathode bias decreased to .2 volt after warm-up. But even before I received your letter telling me to check the cathode circuit again, the set lost high voltage; this started me on a new line of investigation, which led to the root of the trouble.

I found I had no screen voltage on the horizontal output tube. Screen resistor R96 proved to be defective. When I replaced it, I not only had a normal raster, but all traces of audio distortion were gone. This resistor is tied to the 145-volt B+ line through the yoke plug, and the defect evidently loaded down this line enough to reduce the cathode voltage of the audio output tube by several volts.

R. B. GATES

West Rye, N. H.

*Thanks, R. B.—We're always interested in hearing how these problems turn out.*

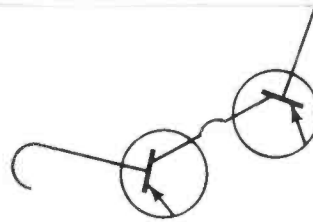
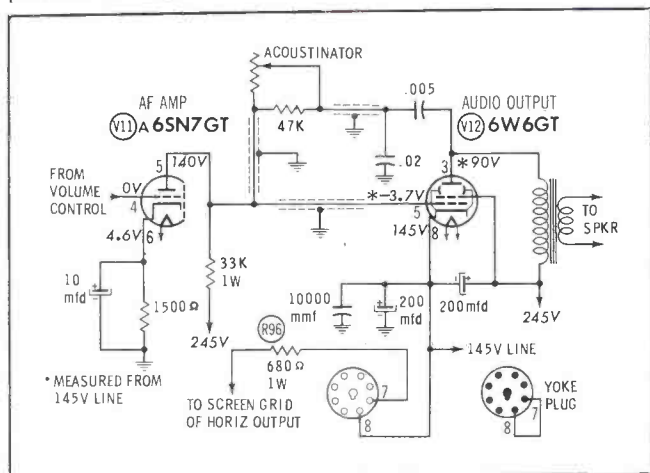

In  
March...

# PHOTOFAC REPORTER

focuses on

## transistors

8 PAGES  
ON  
UNDERSTANDING  
TRANSISTOR  
CIRCUITS

Transistorized  
**TV**  
Servicing

**AUTO  
RADIO  
TRANSISTORS**

UPDATE  
YOUR BASIC  
TRANSISTOR  
STOCK

TEST  
EQUIPMENT  
for  
Troubleshooting  
Transistor  
Radios

Six Steps  
to Quicker  
Transistor  
Radio  
Repairs

Mobile  
Radio  
Transistor  
Style

How To  
Handle  
Transistor-  
Radio  
Customers

MEET A  
Transistor Radio  
Service  
Specialist

Your choice of Premium Books with this Coupon

Enter my subscription to PF REPORTER  
and send me free book(s) checked.

3 Years \$9.00     2 Years \$7.00     1 Year \$4.00

The Troubleshooter's Handbook  
 Servicing Industrial Electronics  
 Servicing TV from Tuner to Picture Tube

Check one for each year you subscribe

Bill Me     Remittance Enclosed     Extend Present Subscription

Name \_\_\_\_\_

Firm \_\_\_\_\_

Address \_\_\_\_\_

City \_\_\_\_\_ Zone \_\_\_\_\_ State \_\_\_\_\_

Please Check Your  
Business Classification

Independent Radio, TV Serviceman     Owner, Mgr.  
 Retailer with Service Department     Service Mgr.  
 Industrial Electronics Service     Employee  
 Other (Specify occupation and title)

Take this coupon to your distributor, or mail to: Howard W. Sams & Co., Inc.,  
2201 E. 46th Street, Indianapolis, Indiana.



## Scope Servicing

(Continued from page 33)

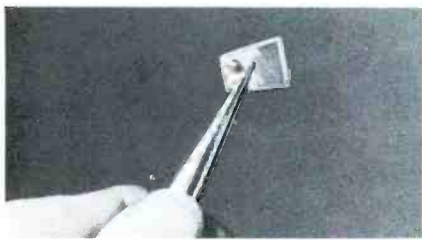

Fig. 7. Coupling capacitor, a special type for printed wiring, was leaky.

grid of the sync tube read a negative voltage even when the leaky capacitor was still in the circuit?" I leave these questions for the reader to ponder, with a couple of clues: A good look at Fig. 6A will answer the first one, and an acquaintance with the operating theory of sync separators will take care of the second.

### Scope Speeds Tube Changing

After quieting a noisy tuner in a Westinghouse portable, I was annoyed to find that the set played with a traveling bar in the picture (Fig. 8). The disturbance slowly moved from the top to the bottom of the raster, displacing scanning lines to the right a few at a time.

I had previously worked on another set with a similar defect, and since the earlier trouble had been cured by tube replacement, I surmised that the present one would respond to a similar treatment. I could have gone ahead and changed all tubes in the set, one at a time; however, since the bar did not appear until after the set had warmed up for about two minutes, I knew that a series of wrong guesses would cause me to spend 15 minutes or longer in finding the tube responsible for the defect. So, I decided to put the scope to work.

First I checked the plate of the video amplifier at a 30-cps scope-sweep rate. The trouble which had



Fig. 8. Displaced scanning lines produced bar that moved through raster.



## NEW VERSATILITY & COMPACTNESS in PROFESSIONAL TEST EQUIPMENT

**EICO**®

AC VOLT-WATT METER #260

Kit \$49.95

Wired \$79.95



AC voltmeter and load-compensated audio-wattmeter of unique quality and accuracy. Measures AC voltage from 1 millivolt to 1000 volts in 11 ranges, and power from .015 milliwatt to 150 watts in 7 ranges, across standard loads from 4 to 600 ohms. The instrument incorporates a tapped power resistor load (4, 8, 16, and 600 ohms) to handle up to 80 watts of power on 8 ohms, and 40 watts on other taps. It may be switched to external load up to 150 watts. The meter is automatically compensated for any load selected, internal or external, to provide a single watt scale for all loads and ranges.

**VOLTMETER:** Ranges: .01, .03, .1, .3, 1, 3, 10, 30, 100, 300, 1000 RMS volts. Frequency Response:  $\pm 0$ db 10c to 150kc,  $-3$ db at 500 kc. Input Impedance: 2 megohm shunted by 15mmf. Accuracy:  $\pm 4\%$ .

**WATTMETER:** Ranges: 15mw, 1.5mw, 15mw, 150mw, 1.5W, 15W, 150W. Frequency Response:  $\pm 0$ db 10c to 100kc. Accuracy:  $\pm 5\%$ . Internal Loads: 4 (40W), 8 (80W), 16 (40W), 600 (40W). External Loads: 4, 8, 16, 600 (all to 150W).

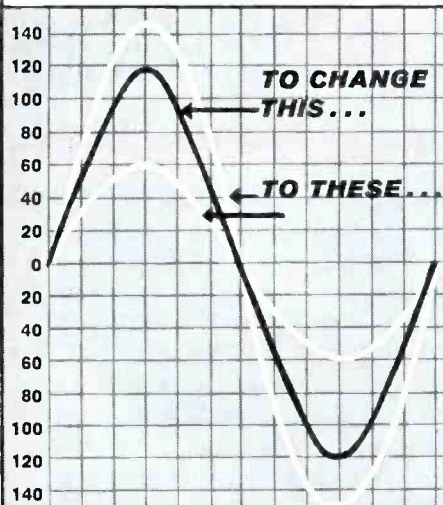

### ...USE THESE!



METERED VARIABLE  
AUTO-TRANSFORMER  
AC BENCH SUPPLIES

# 1073 (3-amp rating)  
Kit \$35.95 Wired \$47.95  
# 1078 (7½-amp rating)  
Kit \$42.95 Wired \$54.95

Connect to 60 cycle, 120 volt line and obtain any desired voltage between 0 and 140 volts. Highly efficient variable auto-transformer of toroidal core design gives you continuously variable output, linear versus rotation, with excellent regulation and negligible waveform distortion. Model 1078 permits either 50 or 60 cycle operation.

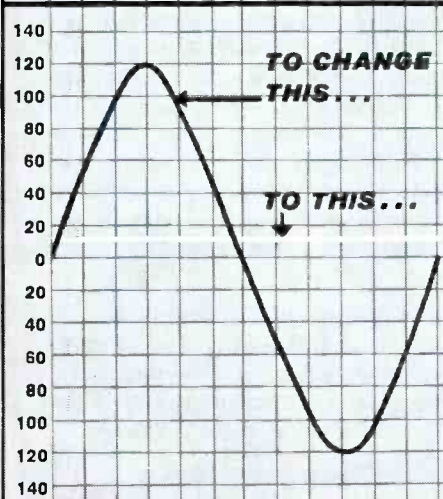

### ...USE THIS!



Extra-Low-Ripple  
6- and 12-Volt  
BATTERY  
ELIMINATOR AND  
CHARGER #1064

Kit \$43.95 Wired \$52.95

Connect to 60 cycle, 120 volt line and obtain highly filtered low dc voltage continuously variable over two ranges 0-8, 0-16 VDC. Heavy-duty pi-type LC filter is rated to take the full rated current output continuously (10 amps on 8V range, 6 amps on 16V range), reduces ripple as low as 0.3% at 2 amps on the 16V range. An essential instrument for servicing battery-operated equipment, including transistor or hybrid types, and an excellent battery charger.

### Also New From EICO:



AC VTVM &  
AMPLIFIER  
#250  
Kit \$49.95  
Wired \$79.95

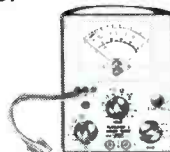

TRANSISTOR  
AND CIRCUIT  
TESTER #680  
Kit \$25.95  
Wired \$39.95



IN-CIRCUIT  
CAPACITOR  
TESTER #955  
Kit \$19.95  
Wired \$39.95

For complete catalog of over 80 EICO kits and wired units—hi-fi, test equipment, citizens radio, ham gear—plus name of nearest distributor, write to dept. PF-2

**EICO**®

ELECTRONIC INSTRUMENT CO., INC.  
3300 Northern Blvd., Long Island City 1, N. Y.

ADD 5% IN THE WEST Export Dept., Roburn Agencies Inc., 431 Greenwich St., New York 13, N. Y.

**NEW**

**ONLY  
PUBLICATION  
OF ITS KIND!**

*Howard W. Sams* **1962** 

# Test Equipment Annual

**the most complete,  
authoritative guide ever  
published on the practical  
application of test equipment**



**Only  
\$1.50**

132 Pages  
Over 100 Illustrations  
the most useful, practical, time-saving information on test equipment ever to appear in a single volume!

## UNIQUE BUSINESS SECTION

Here's the money-saving information you need to help you buy and use test equipment to best advantage:

- Prorating Your Equipment for Tax Deductions
- When Should You Buy New Equipment
- Kit or Factory-Wired—How to Decide
- He Owns a TV Shop—On Wheels!

### SPECIAL! TEST EQUIPMENT BUYER'S GUIDE

Lists complete specifications for virtually every instrument available through parts distributors—especially planned to help you choose just the instruments you need in your work. Instruments are listed by category with informative tips preceding each group.

**HERE'S YOUR TEST EQUIPMENT  
BUYING GUIDE IN ONE  
CONVENIENT VOLUME!**

## FACT-PACKED FEATURES!

So easy to understand—here's the help you need to increase your servicing know-how... here are the latest techniques developed by the experts for your benefit.

### Partial List of Contents:

• How to Get More Mileage From Your VOM and VTVM • How to Interpret Tube Tester Readings • Using a Scope Effectively • Circuit Analyzers Cut Troubleshooting Time • Choosing Your Color TV Equipment • Making Two-Way Transmitter Measurements • Using Component Testers and Substitutors to Advantage • The Versatility of Pulse Generators • Using and Understanding Probes • Radiation Detection and Measurements • Transistor Testers—What They Do and How They Do It.

**DON'T MISS THE 1962 TEST EQUIPMENT ANNUAL**—it's packed with lab-proved test equipment information and latest servicing techniques to make your work easier, more profitable!

**ORDER YOUR COPY TODAY**

**ONLY**

**\$1.50**

**HOWARD W. SAMS & CO., INC.**

Order from your local parts distributor, or mail to Howard W. Sams & Co., Inc. Dept. 7-CC2 1720 E. 38th St., Indianapolis 6, Ind.

Please send me \_\_\_\_\_ copy(ies) of "Test Equipment Annual"  
My (check) (money-order) for \$\_\_\_\_\_ enclosed.

Name \_\_\_\_\_

Address \_\_\_\_\_

City \_\_\_\_\_ Zone \_\_\_\_\_ State \_\_\_\_\_

(outside U.S.A. priced slightly higher)

## *Bonus* 16-PAGE BOOK SECTION

Gives you all the facts you need to take the guesswork out of using signal generators—written by Bob Middleton, the dean of test equipment authorities.

**YOU GET ALL THE FACTS!**



Fig. 9. Breaks in sync-tip and blanking levels correspond to visible fault.

caused the traveling-bar symptom in the previous set had also produced extra "dips" in the lines traced by the sync tips and blanking pedestals of the video waveform. (See Fig. 9.) On the strength of this symptom, I had traced the trouble to a tube in the picture section. This time, however, the video signal was free from distortion — as was the sync-output signal. This narrowed down the trouble area to four tubes: 6CN7 horizontal AFC, 7AU7 horizontal multivibrator, 12-DQ6 horizontal output, and 12D4 damper. When I replaced the 7AU7, I was most gratified to find the trouble gone. Time spent in scoping— one-half minute. I have had the faulty tube checked on at least five different tube testers (all expensive models), and not a single one has indicated even the slightest defect.

## Unexpected Scope Traces

Attaining speed in using a scope for troubleshooting depends partly on developing an ability to anticipate what the signals should look like at various points. A signal which appears normal, according to previous experience and available information, generally indicates that a whole stage or section of a receiver is operating properly. Also, as in the several cases discussed thus far, the serviceman can expect to correlate abnormal scope traces with certain raster defects. Analysis of these abnormal waveforms helps in selection of further troubleshooting procedures.

Occasionally, scope troubleshoot-

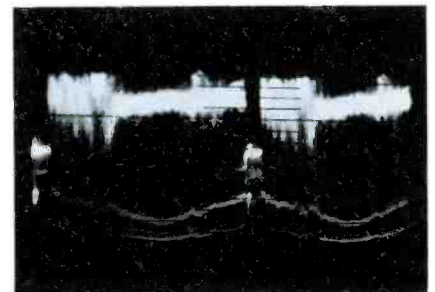

Fig. 10. This distorted video-output waveform caused touchy vertical sync.



Fig. 11. Ripple on 150-volt B+ line (1.5V p-p) was the cause of distortion.

ing turns up unusual traces that we have no logical reason to expect. Even though unconventional, they can also be utilized to speed up servicing. To cite an instance, an old Philco (Model 50-1404) was troubled by sporadic vertical flipping. Horizontal hold, contrast, and other functions were as good as might be expected in a set as old as this one—maybe better than average. The sync-output signal showed compression of vertical pulses. Looking for the source of this fault, I worked all the way back to the plate of the video output tube, where I found the unexpected trace shown in Fig. 10. This waveform showed not only sync-pulse distortion, but also a slight “sagging” due to 60-cps hum. The latter symptom led me to suspect poor filtering of the DC voltage supplied to the plate, so I made a quick scope check of several filter capacitors. I finally found a hum waveform (Fig. 11) on the 150-volt low-B+ line at the cathode of the audio amplifier. Replacing the electrolytic filter capacitor between this point and ground cleared up the flipping. I might never have suspected the loss of filtering if I hadn’t used a scope, since the defect gave no clear-cut symptoms other than the vertical-sync problem.

#### Scope for a Follow-Up

The picture on an RCA Chassis KCS47 was slightly out of horizontal sync (Fig. 12). This pattern was rock-solid, and could not be budged by turning the hold control. When I began checking voltages on the



Fig. 12. Horizontal oscillator locked firmly in sync — on wrong frequency.

## KEEP A CONSTANT CHECK ON YOUR LINE VOLTAGE

ACTUAL  
SIZE

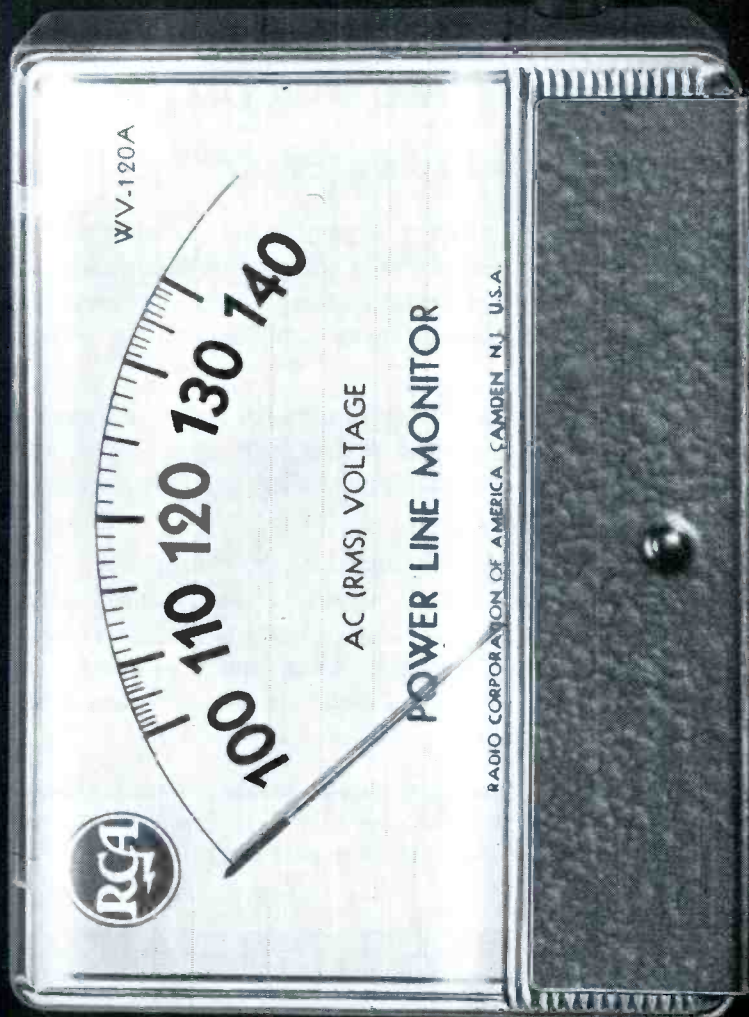

### with the New RCA WV-120A POWER LINE MONITOR

- **EXPANDED SCALE**  
Scale is expanded from 100 to 140 volts for easy reading
- **HIGH ACCURACY**  
±2% at 120 volts; ±3% at 100 and 140 volts
- **TRUE RMS READINGS**  
Moving-vane type meter gives accurate RMS readings, even when line voltage is not pure sine wave
- **FAST METER ACTION**  
Reveals “bounces” and fluctuations in line voltage
- **LARGE NUMERALS, LARGE POINTER, LARGE SCALE**  
Provide easy readability from distance of ten feet or more
- **CONVENIENT WALL MOUNTING**  
Holes are provided in rear of case for wall mounting
- **LOW PRICE—ONLY \$14.95\***  
Extremely low priced for a large-sized, expanded scale, RMS meter of such high accuracy

See the RCA WV-120A at your Authorized RCA Distributor.

\*User Price (Optional)

Electron Tube Div., Harrison, N. J.



The Most Trusted Name  
in Electronics

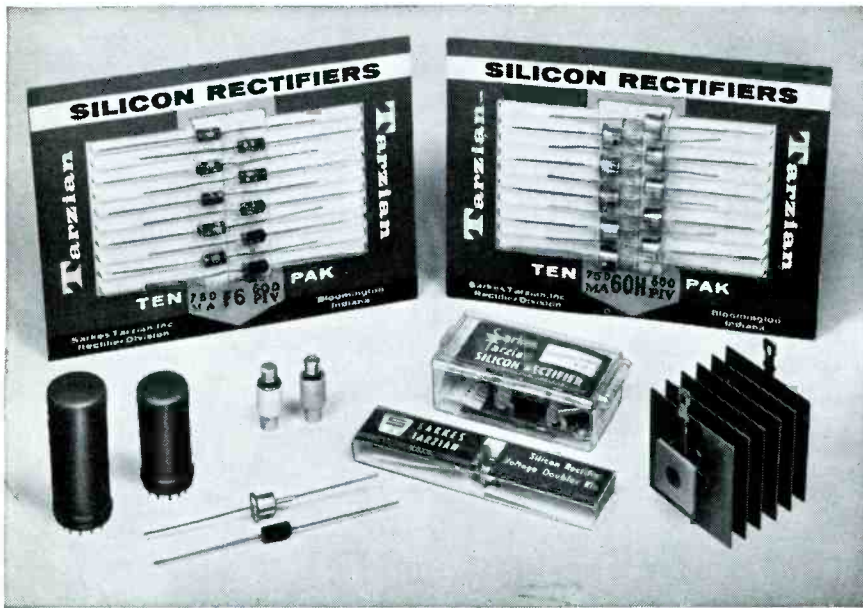

Tarzian 400 and 600 volt F and H series units are available in handy Ten-Paks, in Doubler Replacement Kits, and in bulk; M150 and M500 units are available in Conversion Kits and in bulk. Nine standard tube replacement rectifiers replace over 95% of all popular

vacuum tube rectifiers; S5347 replaces 6BW4 or 12BW4 in Citizen's Band radios; your 50 to 500 ma requirements are covered by four "condensed stack" selenium rectifiers, which Sarkes Tarzian has made more efficient—and smaller—than before.

## Sarkes Tarzian

*...the preferred silicon rectifiers that mean fewer call-backs*

■ Tarzian silicon rectifier dependability virtually eliminates call-backs that waste your time and profits. Units are available immediately from distributors throughout the country... in the shapes, sizes, and specifications you need to do your work quickly and easily.

Tarzian's industry-wide reputation for high quality at a pace-setting low price is a basic reason why more technicians like yourself prefer Sarkes Tarzian rectifiers than the next two most popular makes combined.

That statement is firmly based on the results of a 1961 mailing by Brand Name Survey, an independent research organization, to 23,000 service technicians in all major market areas of the United States, covering 36 states. You're in good company—and lots of it—when you make Tarzian rectifiers your first choice for replacement applications.

Free Tarzian "Distributor Line" catalog is available now as your guide to replacement rectifier quality. Ask your nearest Tarzian distributor for your copy.



### SARKES TARZIAN, INC.

World's Leading Manufacturers of TV and FM Tuners • Closed Circuit TV Systems • Broadcast Equipment • Air Trimmers • FM Radios • Magnetic Recording Tape • Semiconductor Devices

SEMICONDUCTOR DIVISION • BLOOMINGTON, INDIANA  
In Canada: 700 Weston Rd., Toronto 9 • Export: Ad Aurlima, Inc., New York

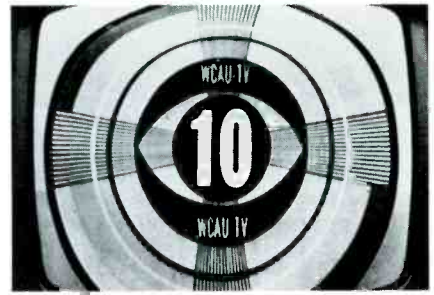

Fig. 13. Best linearity that was obtainable — top squeezed, bottom stretched.

pulse-width horizontal AFC tube, I was startled to find that the control was able to vary the plate voltage. Measuring the other voltages on this tube, I was again surprised when I found zero volts on the cathode. It didn't take long to find the culprit (a shorted cathode-bypass capacitor), but that didn't complete the job. While setting up for the usual scope check of the waveform-coil adjustment in this *Synchroguide* circuit, I scoped the drive signal being fed to the horizontal output tube. Here I found a waveform with a normal enough shape, but with a peak-to-peak amplitude of only about 90 volts. Replacing V17 (a five-year-old 6SN7) increased the amplitude to 115 volts. In turn, the high voltage increased by almost 1000 volts. Thus, I was able to make an improvement in set operation that I might have missed even if I had tried testing or substituting the oscillator tube.

#### Scoping to Eliminate a Possibility

A checkout of a Philco 8H25 portable after a bench repair indicated poor vertical linearity (Fig. 13). The linearity control, which is used mainly to spread the top of the raster, was at its maximum setting. Someone had merely decentered the

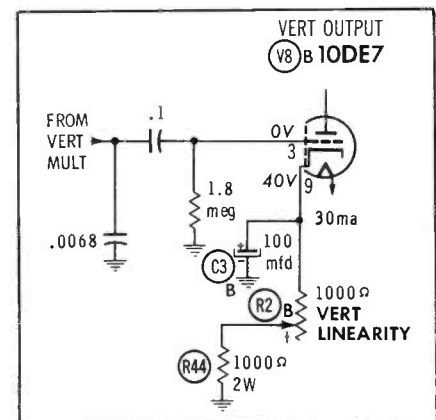
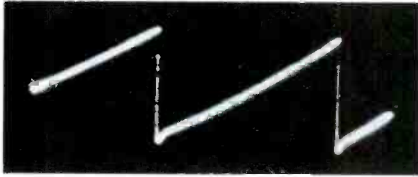

Fig. 14. Initial tests supported the suspicion of cathode-circuit trouble.



(A) Normal ripple—10V p-p.



(B) With open C3B—55V p-p.

Fig. 15. Output-tube cathode signal.

raster to hide the bunched lines at the top. Control adjustment would obviously not be enough to remedy this condition, so I proceeded to check the vertical output circuit.

Any one of three things seemed most likely to be at fault—a defective output section in the 10DE7 vertical sweep tube (Fig. 14), a loss of capacitance in cathode bypass C3B, or an increase in the value of a cathode resistor (either R44 or R2B). While some servicemen might argue that the logical first step would be to change the tube, I preferred to check the alternatives first. I knew I could do so in less time than it would take to pick out a new 10DE7, install it, and wait for it to warm up—and I wouldn't even have to get up from my seat. First I checked the cathode voltage and found it to be several volts more positive than the value shown in service literature. Considering the nature of the raster distortion, this slight excess of cathode bias was a clue that I'd find my trouble in the cathode circuit. Next, with the scope, I found that the ripple across C3B had the smooth waveshape shown in Fig. 15A, and an amplitude of only 10 volts. This proved that the capacitance was not lower than normal; if it had been, the waveform would have had sharper peaks and a higher amplitude (Fig. 15B).

Turning the set off and measuring the resistances in the cathode circuit, I found that R44 had increased in value. Replacing this part resulted in correct operation. Although the scope played a strictly minor part in solving the problem, this case has been mentioned to illustrate another of the many small ways in which a scope can contribute to speedier servicing. ▲

## NEW SECO "TRI-TESTER"

With Seco's Patented Grid Circuit Test—copied by many, equalled by none

Model 107A

ONLY \$14950 NET



Tests all tubes including the new Nu-Vistors, Novars, Compactrons and 10-pin types.

©1961 Seco Electron:

The Seco 107A "Tri-Tester" is the finest, fastest, most complete tester on the market—and at a popular price. Extremely accurate and easy-to-use, this deluxe model provides all essential tests for a wide range of Radio-TV, Industrial and Foreign tube types including sub-miniature types.

Eye and Line Adjustments are set up only once—not individually for each tube. Handy new "FLIP-CHART" tube index lists complete tube data set-up information. Cards on new tube types are issued to registered owners, keeping your unit up-to-date. The

107A "Tri-Tester" is compact, portable and completely self-contained in a handsome, vinyl plastic carrying case.

Seco is a pioneer in the field of modern tube testing research—the originator and exclusive patent holder of the nationally accepted Grid Circuit Test. The "Tri-Tester" is well accepted as a standard by both industry and government agencies. It meets specifications for: FEDERAL STOCK CLASSIFICATION, Tube Tester Type 107-FSN-6625-713-9075. Make your next purchase a Seco product. \*

ONLY SECO GIVES YOU ALL THESE TESTS IN ONE TESTER

GCT

### GRID CIRCUIT TEST:

All tubes get 11 positive, simultaneous checks for leaks, shorts and grid emission. This Seco designed and patented "Electron-Eye" test detects "hard to find" faults passed up by conventional short tests.

DMCT

### DYNAMIC MUTUAL CONDUCTANCE TEST:

Pre-wired chassis for effective testing of voltage amplifier and similar tube types. "Fil. Sel." and "Load" are the only settings required. "Good-?-Bad" meter indicates relative trans-conductance.

CET

### CATHODE EMISSION TEST:

The best method for testing pulse amplifier, power output and damper type tubes. Number of set-up operations is kept to a minimum. This test is provided by the free point selector system.

See your distributor for complete details on the Seco Model 107A Tube Tester. He has a complete line of quality Seco units for testing electronic equipment.

SECO ELECTRONICS, INC.

5031 Penn Ave. So., Minneapolis 19, Minn.

Please send Free...  Model 107A Operating Instructions and Schematic

"How to Test Tubes" Chart

Complete Seco Electronic Equipment Line Folder

NAME \_\_\_\_\_

ADDRESS \_\_\_\_\_

CITY \_\_\_\_\_

STATE \_\_\_\_\_

## Selective Calling

(Continued from page 35)

sender is a self-contained unit with its own power supply. Tone-generator and on-off relay connections to the transmitter are made through a terminal board, which also has connections for supplying both B+ and heater power to external equipment. This board offers several convenient test points for servicing.

### Decoder

Digital decoders, designed to count the pulses in the transmitted code, can be used with either AM or FM receivers. The decoder

should be connected to a circuit which provides a minimum signal voltage of 1 volt rms. In an FM receiver, the output of the discriminator is the best connection point. In AM, a suitable take-off point is at the secondary of the output transformer.

The most widely-used type of decoder has a driven code wheel which is energized by an electromagnet. This wheel (Fig. 3) is a special gear with either 41 or 70 teeth, depending upon the particular model. Each tooth contains a tiny hole into which a small wire *code*

*pin* or a *contact pin* can be inserted by hand. The electromagnet is equipped with two armatures; one of these is fast-operating, and (in some models) can respond to as many as 60 current pulses per second. This armature is coupled by a single linkage to a driving arm which turns the code wheel, one tooth at a time.

The selector can be set up so that it will respond to more than one code number. This feature is often useful in police-radio and similar systems. Each car in the fleet has its own individual code number, permitting each one to be called by the central station without signaling unwanted cars; however, as an alternative, each car can also be alerted by dialing a second number, which is the same for all cars. The *fleet number* provides a simple, fast way of broadcasting an "all cars" call. Additional contact pins can be used to establish a *group call* system. A number of cars, such as those in a certain class of service or in a certain district, can then be called simultaneously by dialing a special *group number*.

A schematic diagram of a typical decoder is shown in Fig. 4. Input signals are coupled from connector P1 through C1 to the grid of V1—a high-gain amplifier with a narrow-bandpass output circuit tuned to the operating frequency. The unby-passed screen grid allows degeneration to prevent strong signals from overdriving the unit.

The plate signal is further amplified by V2A, and is coupled through T1 to the grid circuit of V2B. A neon lamp, series-connected in the grid circuit, acts as a gating device and visually indicates the reception of digital tone pulses. Unless signals of the required amplitude are present, the lamp remains unlit and blocks the signal path. When signal strength reaches the proper level, the lamp conducts and transfers the signals to the grid circuit.

The cathode of V2B is held at +15 volts by a voltage divider (R10 and R11) across the B+ source. This cathode bias holds the tube in cutoff under quiescent conditions, when there is no charge on grid capacitor C5 and no tone-signal input. When a signal is applied to the grid circuit, it is rectified by crystal diode M1, and C5 is charged (grid side positive). The tone signal

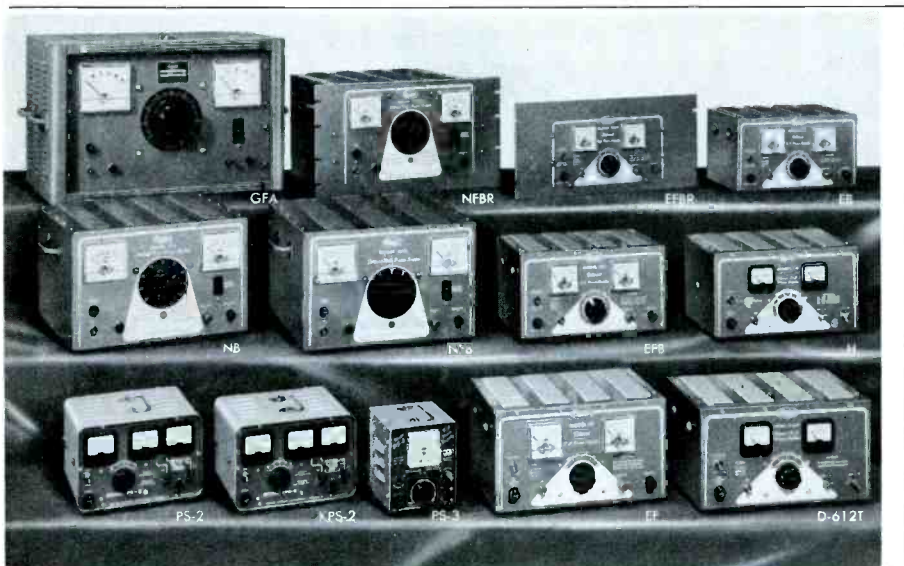

## HERE'S EVERYTHING YOU WANT IN A DC POWER SUPPLY

Economical price and operation  
Low ripple  
Efficient performance  
Continuously variable output  
Thermal cooling  
Reliability unsurpassed  
Overload protection

ELECTRO'S COMPLETE LINE . . . proved in 1000's of applications

Model	Voltage Output	Amperage Output	V/Amp. Meter Scales	Ripple %	Net Price
GFA	0-125	0-10	0-150, 0-20	1	\$575.00
NB	0-32	0-15	0-50, 0-25	5	225.00
NFB	0-32	0-15	0-50, 0-25	1	250.00
NFBR	0-32	0-15	0-50, 0-25	1	275.00
EB	0-32, 0-16	0-4, 0-8	0-40/20, 0-10	5	105.00
EFB	0-32, 0-16	0-4, 0-8	0-40/20, 0-10	0.1	130.00
EFBR	0-32, 0-16	0-4, 0-8	0-40/20, 0-10	0.1	150.00
PS-30*	12	0-30	0-20/0-50	1	195.00
EF	0-28, 0-14	0-5, 0-5	0-50, 0-6	1	98.00
PS-3	0-25, 0-15	0-100 ma; 0-200 ma	0-25, 0-100/200 ma	1 mv	79.50
PS-2	0-20, 0-16	0-75 ma, 0-5	0-20, 0-10, 0-75 ma	0.15, 0.5	56.00
KPS-2	0-20, 0-16	0-75 ma, 0-5	0-20, 0-10, 0-75 ma	0.15, 0.5	44.95
D-6 12T	0-16, 0-8	0-10, 0-10	0-20, 0-10	0.5	59.95
H	12, 6	0-10, 0-20	0-20, 0-30	5	86.00

\*Not shown

See Your Distributor or Write for Literature  
ELECTRO PRODUCTS LABORATORIES, 4501-T Ravenswood, Chicago 40  
Canada: Atlas Radio Corp., Ltd., Toronto, Ontario

2117



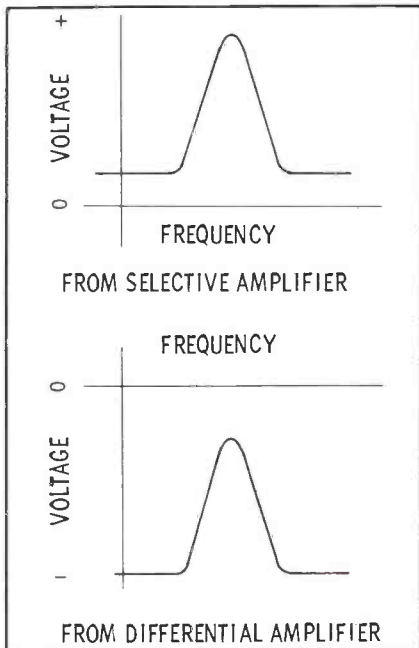

Fig. 5. Output signals from rectifier circuits of tone-selective receiver.

is also amplified by V2B; however, the pulsing relay M2 in the plate circuit cannot follow the alternations of this AC signal, and thus remains deenergized. When the tone is interrupted by a digital pulse, the neon lamp stops conducting. However, the accumulated positive charge on C5 holds the grid voltage above cutoff, so V2B conducts at a steady rate and energizes M2. In turn, the relay completes the low-voltage DC circuit which pulses the selector unit.

#### Call Head

A call-indicator head commonly includes a buzzer, lamp, interposing relay, and other circuitry necessary for producing visual and audible indications of an incoming call. When the selector unit receives the correct sequence of pulses, it completes a circuit that applies 6 or 12 volts to the call head. The lamp then lights, and the interposing relay connects the speaker to the output transformer of the receiver. (When no call is being received, a load resistor is substituted for the speaker.) The call head is also equipped with an OFF pushbutton that breaks the relay circuit, disconnects the speaker, and turns the lamp off; in addition, an ON button allows the operator to monitor the channel before placing a call.

#### Audio Tone Signaling

Tone signaling is a selective-calling system in which the different signal codes are produced by trans-

mitting tones of many frequencies. The use of audio frequencies permits the signals to pass over telephone wires as well as to be transmitted by radio.

At the transmitter, calling signals are produced by tone generators. Tuned reed relays, which are somewhat similar to tuning forks, are often used. When energized by a magnetic field of the correct frequency, a tuned reed will vibrate, and can be made to close an electrical contact. Every mobile station in a radiotelephone system can be equipped with a different combina-

tion of several reeds, and the base transmitter can be equipped to send out all the frequencies necessary to match the many different reeds used. When a certain combination of tones is transmitted, all the reeds at one mobile station will be set into vibration, thereby closing a circuit which signals the operator by turning on his loudspeaker.

The operator at the main transmitter first selects the desired code, either on a telephone dial or with push buttons. He then presses the call button on the microphone; this connects the transmitter to the tone

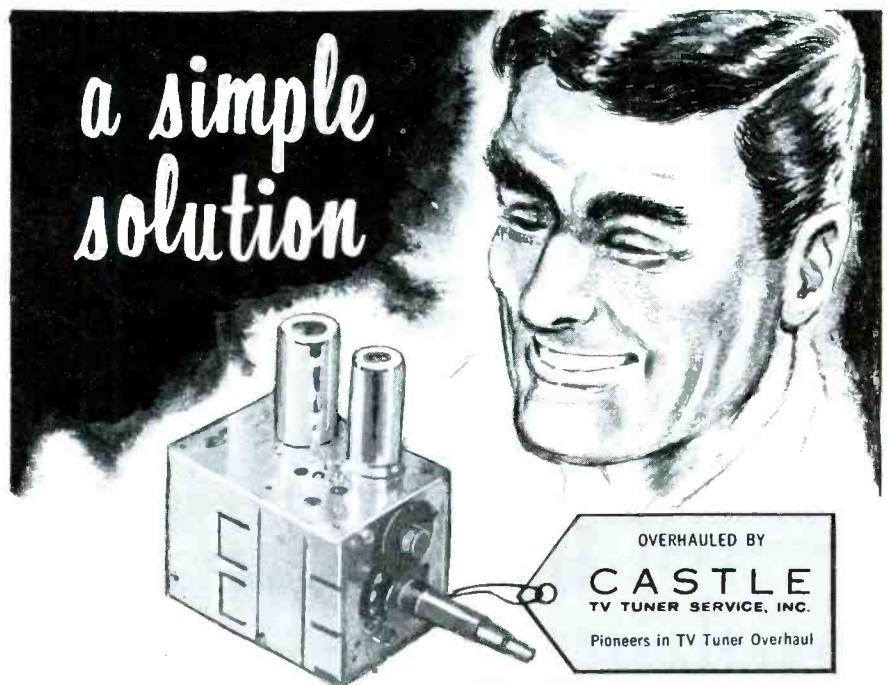

## THAT SOLVES ALL YOUR TV TUNER PROBLEMS

*Ask yourself*

- ... do you have the time to fool around drilling, sawing, filing ... trying to make a "Universal" replacement tuner fit in place of the original?
- ... do you have all the expensive instruments and equipment to complete the alignment so essential after each tuner repair or replacement?
- ... can you spare the time repairing and adjusting your own TV tuners and can you charge enough to justify the time spent?

**A Castle Overhaul eliminates every one of these problems.**

Castle replaces all defective parts, (tubes and major parts are extra at net prices) and then aligns your tuner to the exact, original specifications.

Simply send us your defective tuner complete; include tubes, shield cover and any damaged parts with model number and complaint.

Send for **FREE Mailing Kit** and complete details.

ONE PRICE

**9<sup>95</sup>**

ALL MAKES

**VHF TUNERS  
UHF TUNERS  
UV COMBINATIONS\***

\*UV combination tuner must be of one piece construction. Separate UHF and VHF tuners with cord or gear drives must be dismantled and the defective unit sent in.

90 Day Warranty

**CASTLE**  
TV TUNER SERVICE, INC.



Pioneers in

TV Tuner Overhauling

5710 N. Western Ave., Chicago 45, Illinois • 653 Palisade Ave., Cliffside Park, New Jersey  
In Canada: 136 Main St., Toronto 13, Ontario

generator for a short interval while the tone signal modulates the carrier. After about one-half second, the switch disconnects the tone generator and turns the microphone on for regular voice transmission.

All mobile units on the same carrier frequency receive this transmission, but they are not alerted by it unless they have received the proper tone code to actuate a frequency-sensitive vacuum-tube switch that unblocks the audio stages of the receiver. Once the tone signal has actuated this switch, the carrier signal holds the receiver in

operating condition so that it can receive the normal voice transmission. At the end of the message, the switch blocks the receiver until the proper tone code is again transmitted.

A tone-selective receiver must not only respond to the proper tone, but must also disregard all others. To help attain this objective, the tone signal from the receiver discriminator is fed to two parallel circuits. One, the selective amplifier, has an output which increases at the tone frequency, and is positive after rectification (see Fig. 5A). The

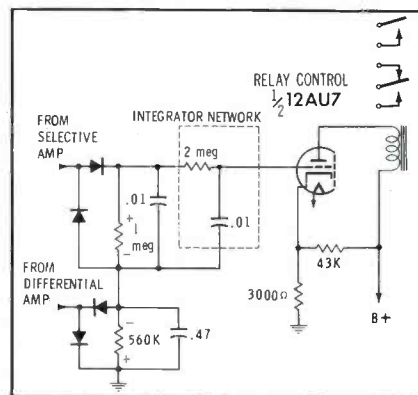

Fig. 6. At specified signal frequency, control tube is driven into conduction.

other circuit, the differential amplifier, has an output which is negative after rectification, and decreases at the tone frequency (Fig. 5B). The rectified outputs are combined in the circuit shown in Fig. 6, and the resultant voltage is applied to the control tube that operates the unblocking relay.

When the selective amplifier is resonant to the received tone signal, it produces a highly positive rectified output which causes the control tube to conduct and close the relay. The negative output from the differential amplifier at this time is low, and has little effect upon the control tube.

Off resonance, the output of the selective amplifier decreases, but the differential-amplifier output rises sharply. Therefore, the net voltage applied to the grid of the control tube is not sufficiently positive to operate the relay.

The selective and differential amplifiers are two-stage RC-coupled circuits. The most noticeable difference between them is that the selective amplifier has a tuned filter at the output of the second stage. Circuit feedback for both amplifiers is provided by a cathode follower; this feedback is positive for the selective amplifier, but negative for the differential amplifier.

Adding selective-calling equipment to a mobile radio system has several advantages. Users are not constantly distracted by a stream of chatter from the speaker, and are not likely to miss incoming calls or answer the wrong calls. As communications radio channels become more crowded, the need for these benefits becomes more acute; thus, a steadily-growing demand for selective calling seems certain. ▲

## TWO-WAY RADIO

communications equipment

VHF-FM FOR:	VHF-AM FOR:	VHF
MOBILE	AIRPORT VEHICLES	ANTENNAS
AIRCRAFT	GROUND STATIONS	REMOTE CONTROLS
MARINE	POINT-TO-POINT	ACCESSORIES
MOTORCYCLE		
PORTABLE		
BASE		

# NEW! "680 BASECOM"

FOR VHF-FM TWO WAY  
MOBILE RADIO

the new 680 series offers  
**HIGH PERFORMANCE at  
MODERATE COST with  
LOW MAINTENANCE!**



## "680 FLEETCOM"

COMBINATION

- MOBILE CONTROL HEAD
- SPEAKER
- TRANSISTOR POWER SUPPLY

ATTENTION DEALERS!  
Write for available territories.

### "680" FEATURES AND OPTIONS:

- ★ **PROVEN PERFORMANCE**... all the outstanding features of the popular "580" series, plus the following.
- ★ **HIGH POWER**... 100 watts output 25 to 50 mc, 75 watts 144 to 174 mc, both base and mobile.
- ★ **STONE SQUELCH**... two way tone squelch compatible with other systems to EIA standards.
- ★ Meets all FCC and OCDM requirements.
- ★ **SIMULTANEOUS RECEPTION**... dual front end receiver for monitoring two frequencies anywhere in the band.
- ★ **TRANSMITTER FILAMENT SWITCH**... reduces battery drain when on "stand-by".
- ★ **MONITORS REMOTE CONTROL**... base station monitors remote transmissions. Intercom provided. All functions available at remote position.

DESIGNERS AND MANUFACTURERS OF RADIO COMMUNICATIONS EQUIPMENT

# COMMUNICATIONS COMPANY, Inc.

FOUNDED 1938 CORAL GABLES, MIAMI 34, FLORIDA

## Background Music

(Continued from page 29)

months or a year. To a significant extent, this initial cost is eased by installation fees. Of course, the equipment is owned by the operator and can be reused if a subscriber terminates the service.

There is another side to the coin. In large central-system installations, the customer often prefers to own the amplifier and speakers for his system. These items then form the basis of a P.A. system which is sometimes considered as important as the music. In these instances, many operators have found that promotion of background music can lead to considerable activity in the outright sale of audio equipment. The primary attraction of the central system, however, is the continuing income derived from monthly rentals.

The initial investment comes primarily in setting up the "central office." The standard method for reproducing program material is with a special tape transport. This long-playing equipment is made by several of the major tape-recorder manufacturers and is capable of reproducing eight hours of continuous music. The tape rides through for four hours at 3¾ inches-per-second. Just before the end of the reel, the tape contains a silver strip (or sometimes an inaudible tone signal) which actuates an automatic reversing mechanism. The second tape track plays for four more hours, totalling eight hours of virtually uninterrupted music. At the end of the second track, the reversing strip (or signal) again causes the tape transport to reverse, and the 8-hour cycle starts over again.

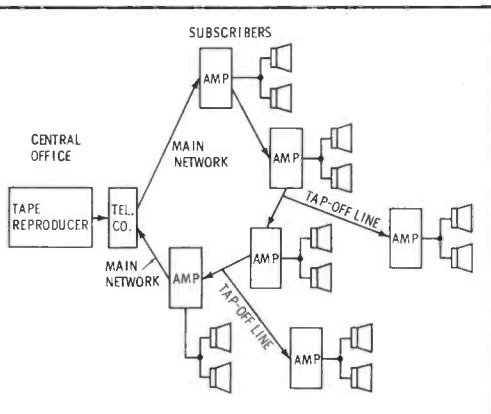

Fig. 3. Leased-line network system is economical if serving several locations.

Actually, a single 8-hour tape provides sufficient program material for around the clock service; it is assumed that no person will be listening to it for more than eight hours at any subscriber location. Specially-prepared tapes may be rented from packaging outfits that cater to background music operators. The program material is picked to suit a certain activity — factory, office, restaurant, etc.

The central-office equipment needs little physical room and may be located in a corner of the shop. One enterprising operator displays

the tape decks in his show window, which faces a busy thoroughfare, and feeds the sound to a small speaker outside. The turning tape reels, and the pleasant sounds, attract many inquiries and much favorable comment about this "live" display.

A standard relay rack can afford adequate space for the tape deck and audio amplifiers. A few nearby shelves will provide storage space for the thirty tapes usually forwarded by the music packager each month. Once set up, the central office needs little attention other than



*The most Famous Name in*  
**TOWERS of ALL KINDS!**

Here are the advantages you get  
when you insist on **ROHN TOWERS**

**LARGEST FULL RANGE OF TOWERS**—you can get anything from home TV and amateur radio towers to heavy-duty communication and micro-wave towers. Included are 170 foot self-supporting towers, 1,000 foot guyed towers, and "fold-over" towers. Regardless of your needs, ROHN can supply it.

**UNQUESTIONED LEADERSHIP IN DESIGN AND MANUFACTURE**—you get the latest in advanced tower engineering. All communication towers are engineered to EIA specifications, and are proved by thousands of installations. No other manufacturer can surpass the quality and fine reputation of ROHN.

**QUALITY MATERIALS AND WORKMANSHIP**—Only highest quality steel is used which fully meets the specifications for the job. ROHN towers are hot-dipped galvanized after fabrication—a feature ROHN pioneered!

**SERVICE WHEREVER YOU WANT IT**—ROHN representatives are world-wide. Complete erection service for communication systems, broadcasting, micro-wave, and other needs is available; also competent engineering service to help you.

**Settle for the BEST in TOWERS**—ROHN—today the world's largest, exclusive manufacturer of towers of all kinds!

*For your needs, contact your local ROHN salesman, distributor or dealer; or write direct for information.*

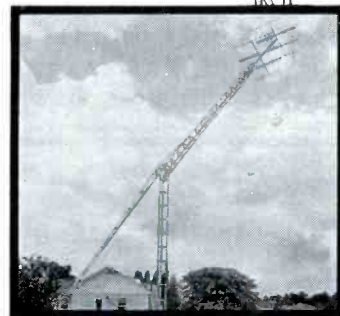

SEND THE HANDY COUPON INDICATING YOUR NEEDS

**ROHN**  
Manufacturing  
Company  
BOX 2000  
PEORIA, ILLINOIS

ROHN Manufacturing Company  
Box 2000  
Peoria, Illinois

Send me complete literature on the following ROHN Products:

- |   |  |
|---|--|
| <input type="checkbox"/> Home TV Towers       | <input type="checkbox"/> Amateur Radio Towers      |
| <input type="checkbox"/> Communication Towers | <input type="checkbox"/> AM-FM Broadcasting Towers |
| <input type="checkbox"/> Micro-Wave Towers    | <input type="checkbox"/> Government                |

Name \_\_\_\_\_  
Firm \_\_\_\_\_  
Address \_\_\_\_\_  
City \_\_\_\_\_ State \_\_\_\_\_

**SAMS BOOKS**  
FOR QUICKER, EASIER  
**TV SERVICING**  
available from your Sams Distributor



**TV Servicing Guide.** A quick reference guide showing how to apply proper troubleshooting procedures based on analysis of symptoms, illustrated by picture tube photos and listing possible causes for each symptom. Also includes troubleshooting and servicing hints for locating and eliminating various troubles. 132 pages, 8 1/2" x 11". **\$2.00**  
No. SGS-1 Only

**Radio and TV Alignment Handbook.** This book belongs on every service bench. Covers everything you need to know about alignment, including how to tell when alignment is needed, what test equipment to use and how to hook it up, step-by-step instructions and the purpose for each adjustment, and how to gauge the results. All-inclusive, covering alignment of VHF and UHF tuners, AM and FM radios, color TV circuits, etc. 160 pages, 5 1/2" x 8 1/2". **\$2.95**  
RTH-1 Only

**Servicing AGC Systems.** Describes the operation and circuit variations of the different AGC systems used and servicing techniques that can be applied. Illustrated by actual case histories and photographs of typical symptoms, and troubles. 128 pages, 5 1/2" x 8 1/2". **\$2.00**  
No. AGC-2 Only

**Servicing TV Tuners.** Here's just the information you need to become proficient at repairing TV front-ends. Covers fundamentals of operation; circuit design; physical construction; replacement and repair of the various component parts and of the tuner itself; complete alignment instructions; and troubleshooting hints to make your tuner servicing faster, easier. 5 1/2" x 8 1/2". **\$4.95**  
STD-1 Only

**101 Key Troubleshooting Waveforms.** Bob Middleton provides the most helpful aids to TV troubleshooting you've ever used! Each volume pictures 101 abnormal waveforms for typical TV circuits, and ties them directly to specific component defects. Also includes picture and circuit symptoms, tests, and evaluations of results. 182 pages each; 5 1/2" x 8 1/2".

**101 Key Troubleshooting Waveforms for Horizontal AFC-Oscillator Circuits.** Covers the three most popular horizontal AFC-oscillator configurations. No. WFM-1 Only **\$2.00**

**101 Key Troubleshooting Waveforms for Horizontal-Sweep Circuits.** Covers the four most popular horizontal-sweep circuits. No. WFM-2 Only **\$2.00**

**101 Key Troubleshooting Waveforms for Vertical-Sweep Circuits.** Covers the four most popular vertical-sweep circuits. No. WFM-3 Only **\$2.00**

**101 Key Troubleshooting Waveforms for Sync Circuits.** Covers the five most popular sync circuits. No. WFM-4 Only **\$2.00**

**Video Speed Servicing**

Invaluable TV trouble series. Each volume consists of 456 practical troubleshooting hints for hard-to-find faults in popular late-model TV receivers. Each hint is accompanied by an explanatory diagram or schematic. All models are indexed by brand, model and chassis number for quick reference. Each volume 160 pages, 8 1/2" x 11".

No. VSM-3 Only **\$2.95**  
No. VSM-4 Only **\$2.95**  
No. VSM-5 Only **\$2.95**

FREE SAMS BOOKLIST AVAILABLE—ask your Distributor or write us direct

**HOWARD W. SAMS & CO., INC.**  
1720 E. 38th St., Indianapolis 6, Ind.  
In Canada: A. C. Simmonds & Sons, Ltd., Toronto 7

a daily change of tape and occasional monitoring for correct audio levels.

**Wired Systems**

Next, consider the two principal means of transmitting music to the many remote locations. The telephone company offers a service known as the *leased line* (see Fig. 2). This is the same type used by radio stations to tie their downtown studios to a transmitter located miles away. In fact, it is often referred to as a radio line or remote line. The service is available for background music purposes; monthly charges are directed to the central office of the operator. The subscriber seldom sees these costs; they are considered operating expenses of the central office.

Starting a system with this facility calls for a careful analysis of line charges. It works two ways. With the simplest method, charges are based on mileage. Assume that the monthly cost of a line from your location to a subscriber is 60 cents per tenth of a mile. This means that a distance of one mile, between points, totals six dollars per month.

Whether this fixed expense is practical or not depends on how your accounts are geographically distributed. If you are centrally located and your customers are within a radius of a few miles, the answer is most likely "yes." Background music accounts usually pay from twenty to thirty dollars a month for the entire service, a figure that would absorb line charges in many cases.

Operators in some locations offer the service at a fixed rate, and the subscriber pays the long-line charge in addition. In other areas, the sub-

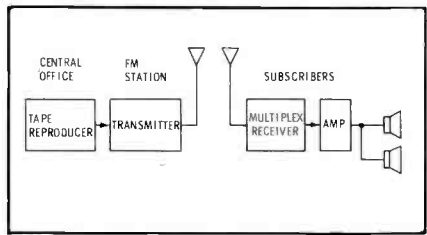

**Fig. 4. FM multiplex system saves the expense of a lengthy telephone line.**

scriber leases the line and the phone company bills him directly. This has the advantage of simplifying the billing procedures of the operator.

The wired system obviously does not lend itself to profitable performance if accounts are too distant. But, if it can be sold and made to work, within its mileage limitations, a second form of service offered by the phone company can take care of expansion problems. After the system operator acquires several dozen accounts, he may consult with the phone company about setting up a line "network" (see Fig. 3). Costs are sharply reduced, since it is not necessary to run single lines from each location to the central office. Instead, they are placed in a series. Lines can extend into new areas without running costs beyond reasonable limits. However, the network system is only practical after a nucleus of accounts has been built up.

**Radio System**

Some time ago, background music operators achieved a notable advance in technique. They began using, instead of leased lines, FM station broadcasts which were picked up by standard FM tuners. However, special adaptors at subscriber receivers responded to an ultrasonic tone, transmitted by the station, to mute the voice announce-

**Western T.V. Tuner Rebuilders**

**VHF or UHF ALL MAKES**

**\$9.95** Including all parts and labor

major parts extra at (low) net price.

**UHF-VHF COMB. \$17.50**

**90 Days Guarantee — 24 Hour Service**

All tuners are thoroughly cleaned, mechanically and electrically overhauled, aligned with crystal-controlled equipment, and finally given air check for sensitivity with TV transmitters located in Los Angeles at 5,000 feet height and 120 mile distance from us.

TUNERS ENVIADOS POR CORREO DE LA REPUBLICA MEXICANA SERAN RECOGIDOS Y ENVIADOS CON TODOS LOS REQUISITOS ADUANALES.

**WESTERN TUNER REBUILDERS**  
4130 El Cajon Blvd. San Diego 5, Calif.  
ATwater 4-2733

## WANTED! EXPERIENCED ELECTRONIC TECHNICIANS

Our rapidly expanding sales and new product lines have created several positions for experienced electronic technicians in our engineering research department. Knowledge of R-F amplifier and antenna theory, plus experience in installation or maintenance of TV antenna distribution systems desirable.

New plant and laboratory facilities with latest equipment in pleasant city of 35,000 on beautiful Mississippi, centrally located between Chicago, St. Louis, Omaha and Minneapolis. Write full details about yourself and your experience. Interviews will be arranged for selected applicants.



**Winegard**  
ANTENNA SYSTEMS

3000 Kirkwood Ave • Burlington, Iowa



## INJECTORALL

THE NEEDLE DOES THE JOB!



The BEST CLEANER  
on the market today!

### TUNER CLEANER AND LUBRICANT with... INJECTOR NEEDLE

The leak-proof steel Injectorall Needle lubricates where you need it... you can reach hard-to-get at Wafers without pulling Tuners apart, or even removing Chassis.

INJECTORALL CO. Brooklyn 14,  
New York

ments. This method has since been supplanted by a form of multiplexing (see Fig. 4). Background music is impressed on a subcarrier and transmitted along with the regular broadcast. FM tuners with suitable multiplex adapters are rented to subscribers, and reproduce only the program contained on the subcarrier.

Is there room for the service-shop owner in the multiplex field? As with the phone-line systems, the answer is in the affirmative. There are avenues of approach that do not involve enormous investments in transmitting equipment. Since multiplex entered the broadcast field, the FM industry has welcomed it as a source of additional revenue. Most have stated their intention to go into multiplex, and about one-third have already installed subcarrier equipment.

With these facilities in existence, the serviceman can capitalize on the fact that broadcasting and background music are two entirely different businesses. Many FM stations have installed multiplex equipment for the sole purpose of leasing subchannels to independent organizations. The station's responsibility ends with airing a signal of acceptable quality, for a certain number of hours daily. The music tapes are either played at the station or reproduced at the operator's location and sent to the station by phone line.

A meeting with an FM station owner might prove rewarding. There are several possibilities for working out a mutually-beneficial relationship. In one case the station may want to retain a service organization solely for installation work. The station may feel it can use its existing sales staff to solicit background-music accounts. Or you might settle on a fee to be paid to the station for the use of its facilities. This amount is usually keyed to the number of accounts secured by the operator. In the latter example, customer sales, installation and billing are handled by the operator.

### Equipment and Installation

Fig. 5 shows a number of possible equipment combinations. The heart of any background music system is the program source. In local sys-

## MASTER

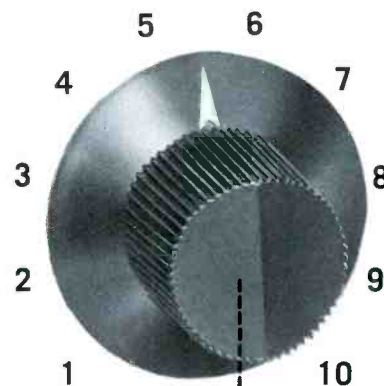

YOU WON'T FIND  
THIS CONTROL

ON ANY OTHER P.A.

AMPLIFIER IN

THIS PRICE CLASS

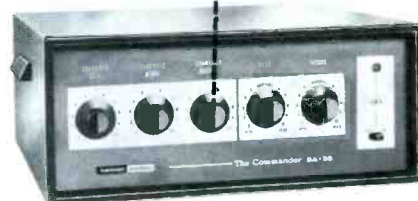

That's a fact. But all Harman-Kardon COMMANDER Series public address amplifiers incorporate a master volume control. These unique, popular-priced units include features generally found on much costlier "deluxe" equipment. For instance: Outputs for tape recorder, booster amplifiers and both 25 and 70 volt speaker lines; input for magnetic cartridge; DC on filaments of hi-gain stages; locking covers, etc. PLUS COMMANDER exclusives such as: multiple inputs for greater installation flexibility and optional single-control mixing of two program sources for convenience and ease of operation. Discover why sound men are switching to COMMANDER for all their needs. Write today, Commercial Sound Division, Harman-Kardon, Plainview, L.I., N.Y.

Send free detailed catalogs: Desk 2H

Name \_\_\_\_\_

Address \_\_\_\_\_

City \_\_\_\_\_ State \_\_\_\_\_

**harman kardon**



Type "CTC" . . . cardboard tube electrolytics especially designed for exact replacement in television sets . . . one end closed . . . long insulated leads out other end . . . sealed with high melting point wax . . . guaranteed for one year . . . individually packaged.

Write today for complete information.

**PLANET SALES CORPORATION**  
225 Belleville Avenue Bloomfield, New Jersey

tems, FM receivers and record changers are the same as used for hi-fi systems. High-quality equipment will serve well in the continuous service common to background-music applications. The only attempt to fabricate special units has been to adapt existing units for rack mounting. This is usually done only for very elaborate installations.

In central systems, there is one program source — the tape deck at the operator's location. For wired systems, an audio amplifier feeds the phone line. Here, the phone company is consulted for standards such as impedance and line levels. They are concerned primarily with maintaining proper audio levels in the line. Actually, little audio power is needed to drive the line, and broadcast-type VU meters are excellent for monitoring purposes. At the receiving end — the subscriber's location — the line signal is fed directly into the high-level input of a conventional audio amplifier.

For the multiplex system, the installation follows the basic requirements of all FM tuners. One difference is the poorer signal-to-noise ratio of the music subchannel. This necessitates installing a high-gain FM antenna in some locations. It should be sharply directional to minimize undesirable effects of multipath reception. Output of a FM-multiplex receiver should be sufficient to drive an audio amplifier. Some receivers already contain amplifiers capable of driving several speakers in small areas.

The rest of the background music system follows standard audio techniques used in public address work. Most amplifiers are conventional PA units in the 10- to 25-watt power range. Speaker systems need not be elaborate in terms of audio response; 70 to 7,000 cps is usually sufficient. Full-range reproduction of background music is undesirable, as it may cause the program material to be intrusive and often disturbing to the listener.

Certain refinements add flexibility to the music installation. One is the use of L-pads in speaker lines to provide a means of controlling volume in any given area. Another is providing voice-paging with the music. In the simplest arrangement, microphone level is boosted so voice will just override the music. Added

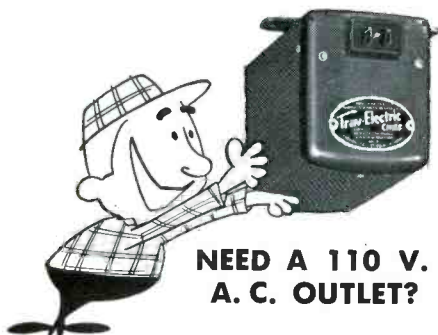

NEED A 110 V. A. C. OUTLET?

IN CAR, BOAT OR TRUCK, YOU HAVE IT WITH A

**terado POWER CONVERTER**

Actually gives you 110 volt, 60 cycle A.C. from your 6 or 12 volt D.C. battery! Plug converter into cigarette lighter, and operate lights, electric shavers, record players, electric tools, portable TV, radios, testing equipment, etc.

Models from 15 to 300 watts, priced as low as **\$12.95** LIST

See Your Electronic Parts Dealer or Jobber, or Write:

**terado COMPANY**  
1073 RAYMOND AVE.  
ST. PAUL 8, MINN.

In Canada. ATLAS RADIO CORP. LTD. — Toronto, Ont.

**REPLACEMENT I. F. TRANSFORMERS**

High efficient transformers for maximum gain and bandwidth. Electrostatically shielded, iron core tuned windings.

455 KC. UNIVERSAL REG. WIR. INPUT OR OUTPUT. CLIPS INCLUDED. 2/BOX #455



455 KC. UNIVERSAL PTD. CKT. INPUT OR OUTPUT. 2/BOX #455-P



455 KC. OUTPUT W/FILTER #455-P6

455 KC. FEEDBACK W/TAP #455-PF5

262 KC. INPUT PTD. CKT. AUTO RADIO REPLACEMENT. 2/BOX #262-P4



262 KC. OUTPUT PTD. CKT. AS ABOVE EXCEPT W/FILTER #262-P5

455 KC. FOR GE SETS EXACT REPLACEMENT. 1/BOX #455-G



10.7 MC. FREQ. MOD. 1st I.F. PTD. CKT. #107-P1  
2nd I.F. PTD. CKT. #107-P2  
3rd I.F. PTD. CKT. #107-P3  
DISCR. PTD. CKT. #107-PD  
RATIO DET. PTD. CKT. #107-PR  
RATIO DET. REG. WIR. #107-R



**Vidaire ELECTRONICS MFG. CORP.**  
365 BABYLON TPKE. — ROOSEVELT, N. Y.

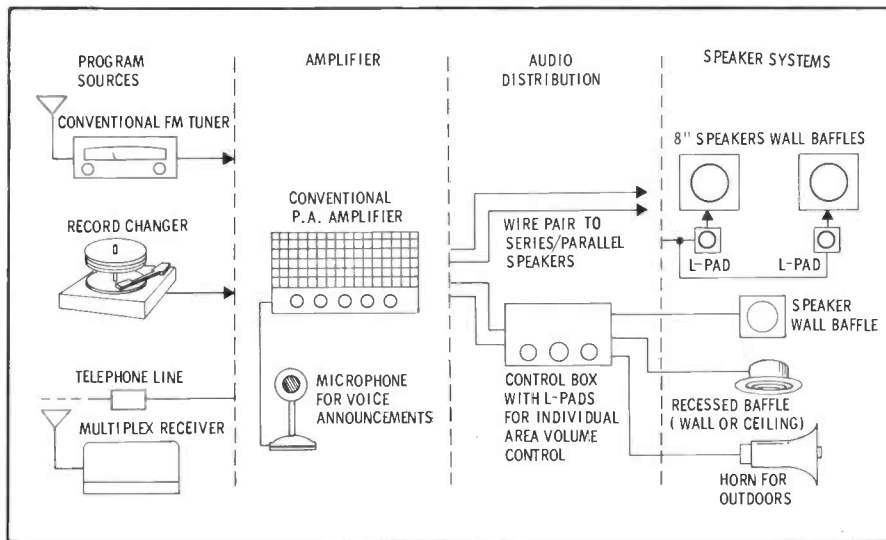

Fig. 5. Typical installation possibilities for subscriber locations.

intelligibility is imparted if a push-to-talk microphone is used to operate a relay which mutes the music as voice announcements are made. The relay contacts can short the output of the tuner, or open the input to the audio amplifier in the case of phone-line operation. In the latter case, the relay must substitute a load equal to the line impedance, or damaging transients might occur in the phone line.

### Maintenance

Problems encountered in the upkeep of background music equipment differ little from those of conventional electronic equipment. Perhaps the most unfamiliar piece of circuitry is found in the multiplex adapter of an FM receiver. As usual, defective tubes are responsible for most troubles in this section. When service is required, the important pieces of test equipment

are an oscilloscope and a generator capable of producing the sub-carrier tones. Conventional RF and audio stages can be checked by the usual voltage, resistance, and signal-tracing techniques.

As in other service fields, many problems arise from human error rather than equipment failure. One frequent complaint occurs during the first week of operation; the customer feels that the music is intrusive. This is usually traceable to the practice of running the system gain at an excessively high level. Background music should be just that — heard in the background. In fact, it should be conspicuous only by its absence. A mark on the volume control, to indicate a proper level, proves helpful in these cases. If the equipment is subject to tampering, a special lock-nut on the control shaft might solve the problem.

There are countless opportunities in the background music business. Potential customers can be found anywhere where people gather or work. Check into this interesting business at your first opportunity; you may find it very lucrative. ▲



### SIGNAL TRACER

Checks all stages from Antenna to Speaker or Picture Tube. Tests microphones, appliances, pickups, transformers, speakers, resistors, condensers, etc. Model 202 (with AF Probe). Net \$37.50

Model A Probe (RF Demodulator) . . . . . Net 4.50  
 Model B Probe (RF Demodulator, Amplifier) . . . . . Net 7.50



### TELEVISION CLARIFIER

... Removes annoying signals that cause picture distortion in TV receivers from FM, amateurs, shortwave, diathermy, ignition, and adjacent channels. Ghosts, lines, herringbone patterns, tears, and wavy effects are removed or reduced simply by adjusting the two control knobs on this NEW type INTERFERENCE ELIMINATOR. Net \$4.50.

**PRECISION ELECTRONICS, INC.**  
 9101-O King Ave., Franklin Park, Illinois

## For your custom stereo installations



### THE FISHER 800-B

### Three of the world's finest components on one chassis

- 1 AM-FM-Stereo Multiplex Tuner:** separate tuning indicators for FM and AM; *exclusive Fisher STEREO BEAM automatically* shows whether an FM station is broadcasting in stereo.
- 2 High-Power Stereo Amplifier:** 65 watts music power; special center-channel output connection for third speaker.
- 3 Master Audio Control-Preamplifier:** complete, easy-to-use control system assures total flexibility; provisions for every type of input. **Price \$429.50\***

\*Walnut or Mahogany cabinet \$24.95; prices slightly higher in the Far West

**USE THIS COUPON FOR DETAILED INFORMATION**

**Fisher Radio Corporation**  
 21-54 44th Drive, Long Island City 1, N. Y.

Please rush the following FREE literature:

Complete specifications on the Fisher 800-B Receiver.

The 1962 Fisher Handbook, a 40-page illustrated reference guide and component catalogue for custom stereo installations.

Name \_\_\_\_\_

Address \_\_\_\_\_

City \_\_\_\_\_ Zone \_\_\_\_\_ State \_\_\_\_\_

PF-201

ANOTHER  
SERVICE-PROVED  
**PRECISION**  
INSTRUMENT

**NEW MODEL P-25  
TRANSISTOR RADIO  
BATTERY  
ELIMINATOR  
AND CHARGER**



The sure way to save money and effort, for a minimum investment. The P-25 supplies 0-25VDC continuously variable, panel-controlled and metered to 0-100Ma. Has a +1.5VDC tap for radios using a tapped supply. A center tap is also provided for radios without output transformer and where one lead is connected to C.T. of the battery. Simulates weak battery conditions for checking overall performance and recharges nickel-cadmium batteries. See your PRECISION distributor or write today for a complete catalog. Net only **\$19.95**. This and all other PRECISION PRODUCTS are guaranteed for one full year

**PRECISION APPARATUS CO., INC.**

SUBSIDIARY OF PACOTRONICS, INC.  70-31 84th ST., GLENDALE, NEW YORK

**P R O D U C T**  
**r e p o r t**

For further information on any of the following items, circle the associated number on the Catalog & Literature Card.

**Electronic Yagis (38K)**

A transistor amplifier is built into the "Tapered T" driven elements of Winegard "Powertron" antennas. Delivering up to 28 db gain and having a low signal-to-noise figure, these antennas consume only .05 watts each. The line consists of six 8-element and eight 12-element cut-to-channel models plus two FM yagis. All cut-channel yagis are designed for use with 75-ohm coaxial lead-in, and contain a built-in mixing coupler which allows stacking without interaction.

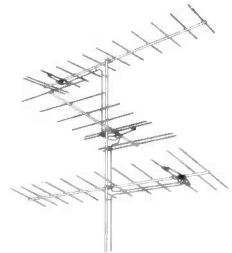

**Capacitor Assortment (39K)**

Individually identified compartments contain thirty miniature electrolytics (fifteen different values) in the Sprague EK-5 "Verti-Lytic" Assortment. Primarily designed for vertical mounting on printed circuit boards, these capacitors are intended for use in transistorized equipment. They feature low leakage current and long shelf life. Net price for the assortment and case is \$31.92.



**Stereo Cartridge (40K)**

A unique suspension and damping system help the General Electric "Orthonetic" stereo cartridge to achieve a response of from 20 to 20,000 cps  $\pm$  3 db. Separation of 25 db and channel balance of 2 db up to 1000 cycles is possible with the unit, which has a tracking force of one to three grams. Two versions of the cartridge are available; the VR1000-5 with a .5-mil diamond lists for \$29.90, and the VR1000-7 with a .7-mil stylus is \$24.95.



**CB Transceiver (41K)**

Four-channel crystal-controlled operation is featured in the Kaar Engineering Model TR327B transceiver. Snap-in, snap-out mounting speeds servicing or change of location. Employing a series impulse-type squelch circuit, the superheterodyne receiver has a sensitivity of .5 uv for a 6-db signal-to-noise ratio. The transmitter is capable of 95-100% modulation and suppresses spurious output 66 db below the carrier. Featuring squelch, volume, and power output peak controls, the front panel contains an illuminated signal-level meter.



**Noise Suppression Kit (42K)**

Intended to increase the performance of CB transceivers by decreasing automobile-ignition interference, two noise-suppression kits by Raytheon are now available. Both the standard (DP-200) and deluxe (DP-400) kits contain spark-plug and distributor suppressors, and bypass capacitors. In addition, the deluxe kit contains shielded wire and an RC network for use on the voltage-regulator field terminal. Both the deluxe and standard kits come with installation instructions at list prices of \$24.95 and \$10.95, respectively.

**NEW**

**HANDY TOOL THAT TAKES THE WORK OUT OF MAKING COMPONENT CONNECTIONS**

101 TIME-SAVING SHOP USES—ONLY \$2.00

PUT THIS NEW TWIRL-CON TOOL TO WORK FOR YOU TODAY.

— MANY EVERYDAY USES —

- ★ Makes a heavy iron unnecessary when connecting components to chassis.
- ★ Makes quick, neat, connections in difficult places. **MAKES CHASSIS REMOVAL UNNECESSARY.**
- ★ Lets you connect to short leads on transformers, coils, capacitors, etc.
- ★ Eliminates bad solder connections, resin joints, broken socket lugs, short circuits, and damaged PC boards.
- ★ Useful in modifying or repairing surplus equipment
- ★ Enables you to make connections without solder, where heat is undesirable or iron isn't available. Excellent for experimental circuits using transistors and diodes.

**SATISFACTION GUARANTEED—\$2.00 ea.**

ORDER FROM YOUR LOCAL DISTRIBUTOR OR WRITE TO FACTORY TODAY!  
ENCLOSE CHECK OR MONEY ORDER. NO C.O.D.  
COMPLETE INSTRUCTIONS WITH EACH TOOL.

**TWIRL-CON TOOLS®** 1101 N. East St. Edna, Texas



### Multi-Band Antenna (43K)



A mobile (10 - 15 - 20 - 40 - 75 meter) antenna system from **New-Tronics** offers a choice of two 54" aluminum fold-over masts to be used in combination with any one of five center-loaded resonators. Band-switching is accomplished by interchanging resonators, and tuning by means of an adjustable stainless-steel rod. SWR is less than 2:1 and the power rating is 75 watts for AM service and 150 watts for SSB.

### Plastic Tape Dispenser (44K)



Designed as a compact hand taping and cutting tool to speed on-the-job use of the 3/4" x 66' roll plastic tape, **Minnesota Mining and Manufacturing's** new "Scotch" electrical tape dispenser provides easy cutting of tape and leaves a clean, square edge. The tape roll is exposed for easy thumb control of wrapping tension, and a convenient end tab of tape remains ready for each new use. "Scotch" No. 33 is available in either the dispenser or the traditional metal can.

### Replacement Controls (45K)

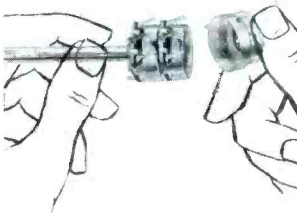

The "Snaprol" line by **IRC** provides a broad variety of basic, factory-assembled control sections which snap together to produce concentric dual controls. The assemblies consist of exact-length shafts which snap into control sections, and either rotary or push-pull switches which snap onto rear control systems. Units are available with 3/8", 7/16" and 1/2" diameter bushings of varying lengths and with different inside bores.

### Needle Display (46K)



Designed to help dealers and distributors promote sales of needles and accessories, the **Jensen TR-3795** display stands 14" high on a 7" base when used on a counter, or can be opened up to hang flat against a wall. The display contains four sapphire "Dyna-Points," four diamond "Dyna-Points," and four each of the following accessories: silicone-treated record brush, record inserts, and 45-rpm spindle adapter. A free barometer is given with each order.

### Utility Lamp (47K)



A swivel shade and flexible gooseneck for exact positioning of light where needed make the **Acme Utility Lamp (Model 52)** useful for close reading or troubleshooting where extra light is a necessity. Offered in either neutral brown or office grey, the lamp can be screwed to either a horizontal or vertical surface or clamped to a desk or workbench.

### Instrument Covers (48K)

A line of vinyl covers from **Robins Industries** provides protection for electronic equipment against damage by dirt, grime, and moisture. The nine standard cover sizes range from 10 3/8" x 6 1/2" x 7" to 20" x 14 1/4" x 10 1/4". Each cover is specifically designed to fit several makes and models of test equipment, amplifiers, tuners, and other equipment.

## ANOTHER SERVICE-PROVED PRECISION INSTRUMENT

### NEW MODEL CR-60 PICTURE TUBE TESTER AND REJUVENATOR. HEATER VOLTAGE CONTINUOUSLY VARIABLE FROM 1.5 TO 12V INDEPENDENT OF LINE VOLTAGE VARIATIONS



At last a picture-tube tester that can't become obsolete! Operating on the proven true "Beam-Current" circuit method, the CR-60 is a time and labor saver that pays for itself many times over. Tests and rejuvenates all picture tubes — black & white (110°, 114°, low G2) and color (each gun separately). Renews tube life, checks and repairs shorts, leakage, opens and low emission. Determines need for booster and predicts probable tube life. Portable, leatherette-covered case. See your **PRECISION** distributor or write. Net only **\$64.95**. This and all other **PRECISION PRODUCTS** are guaranteed for one full year

**PRECISION APPARATUS CO., INC.**

SUBSIDIARY OF PACOTRONICS, INC.  70-31 84th ST., GLENDALE, NEW YORK

## NEW! SARGENT ELECTRONIC CHEMICALS and FINISHES

### SARGENT TUNER CLEANER

Thoroughly cleans tuners and controls. Protects against future corrosion, oxidation and contact wear. Non-flammable.

Giant 16.4 Ounce Can **\$1.47** Dealer Net

Includes plastic extension tube.

### SARGENT GEAR AND PARTS CLEANER

Instant cleaning power for turntables, tape recorders, business machines and electronic devices. Flushes away dirt, oil and grease in gears and parts. Non-flammable.

Giant 16.4 Ounce Can **\$1.29** Dealer Net

Includes plastic extension tube.

### OTHER PRODUCTS IN THE SARGENT ELECTRONICS LINE

Red Insulator, Degreaser, Clear Acrylic Plastic, Penetrating Oil, Squeak Stopper, Enamels, Lacquers, Metallics, Engine Enamels, Stop Rust, and other Specialties.

For Free Literature and Prices, Check Your Electronics Parts Distributor, or write... **ELECTRONICS DIVISION**

**THE Sargent-Gerke co.®**

Producer of Paints and Chemicals for Over 60 Years  
P. O. Box 729 • INDIANAPOLIS 6, INDIANA

## ANOTHER SERVICE-PROVED

# PRECISION INSTRUMENT MODEL 650 GRID CIRCUIT ANALYZER TUBE TESTER AND MEGOHMMETER



Tests most tubes including 10-pin miniatures, 12-pin Compactrons, 5- and 7-pin Nuvistors, Novars, octals, picture tubes (with optional adapter AD-65) and a wide variety of foreign and industrial types. Indicates gas currents as low as 1 ua. Checks for intermittent shorts, gas content, grid emission, leakages (sensitivity over 100 megohms). Special megohmmeter circuitry for measurement of condenser leakage, continuity and leakage of printed circuitry. Complete in leatherette-covered case. See your PRECISION distributor or write today for a complete catalog. Net only \$69.95. AD-65 Adapter: Net only \$5.95. This and all other PRECISION PRODUCTS are guaranteed for one full year

**PRECISION APPARATUS CO., INC.**

SUBSIDIARY OF PACOTRONICS, INC. 70-3184th ST., GLENDALE, NEW YORK



Duotone needles, of course . . . tipped with genuine diamonds, sapphires or osmium. Most people forget to change their styli or don't know how to change them. Why not suggest a Duotone diamond needle replacement for every phonograph that comes into your shop? It's the stylus with the whole diamond tip that's handset and hand polished. Your customers will appreciate the service and you'll appreciate the increase in business.

Write for Free 1962 Duotone Needle Wall Chart and see DUOTONE Distributor.

**DUOTONE**

COMPANY INC. KEYPORT, N. J.

### Two-Way for Business (49K)

A fully transistorized receiver and power supply characterize Motorola's Business "Dispatcher" Radio. Capable of 15 watts output, the unit is available for operation on frequencies in the 150-170 and 25-50 mc bands. The single-piece unit mounts under the dash or on the floor and can be used in all trucks and cars.



### Horizontal Output Tube (50K)

The Amperex 6GB5 beam-power pentode features large plate to screen-grid current ratio and 5-watt screen dissipation. Especially suited for use with wide-deflection TV picture tubes, the 6GB5 allows the use of less sensitive deflection-yoke coils. The tube also finds application in TV sets using half-wave rectification. A new type of fused base with sealed-in pins is fused directly to the tube envelope.



### Communication Microphone (51K)

Delivering -55 db output, the Electro-Voice 714SR mobile-communications microphone is designed for paging, ham radio, and Citizens band applications. Additional specifications include an EIA sensitivity rating of -155 db and a frequency response of 60 to 7000 cps. The unit comes with a coiled cord that will extend to five feet, and a SPDT switch which shorts the mike in "off" position and completes a relay circuit in "on" position. List price is \$16.50.



### Portable CB Transceiver (52K)

Powered by seven standard "penlite" batteries, the Monarch TC-900 pocket-size transceiver delivers 100-mw output, affording a range of a mile or more. The receiver features a crystal-controlled transistorized superheterodyne circuit. Unit price of \$64.95 includes a leather carrying case with shoulder strap and belt clamp, earphone and earphone case, batteries, and crystals.



### Self-Service Tube Tester (53K)

Bringing customers into the shop to do their own testing of TV and radio tubes, and building tube sales for the service dealer, are two objectives of a self-service tester developed by ETA Division of Di-Acro Corp. The Model 1000 Deluxe Console allows servicemen to save time usually wasted testing tubes brought in by customers. Also available for use in a "loaner" program (the tester is loaned to the customer for home tube checks) are a Deluxe Portable Model 4000 and grid circuit and tube tester Model 5000.

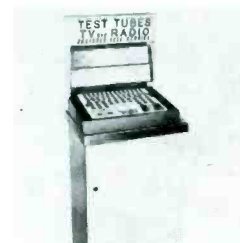

### Compressor Amplifier (54K)

A unit which increases a soft voice and decreases a loud voice is the WSC515 Compressor Amplifier manufactured by Webster Electric. Uses for the new unit range from simple amplifying systems to complicated announcing networks. It can also be installed into dial-type paging systems, intercoms, and music-distribution systems. A rear mounted toggle switch is provided to defeat compressor action when straight amplification is desired.



### High-Power Speakers (55K)



Two sizes of all-weather high-power speakers are available from Atlas Sound. Both the HP-75 with a bell diameter of 9" and weighing 7 pounds, and the SHP-75 with a bell diameter of 7 1/4" and weighing 6 1/2 pounds, are capable of handling 75 watts of audio. Applications include aircraft public-address systems and electronic sirens. Both units are supplied with a cast aluminum bracket.

### Two-Way Antenna (56K)



The Mark 30 Super Beacon, a voltage-fed half-wave vertical radiator, is Mark Mobile's latest contribution to the commercial two-way field. Nominal impedance is 50 ohms, and the matching cable is terminated in an SO-239 UHF fitting for direct connection to a feed cable. Affording lightning protection through a DC ground in

the cable assembly, the Mark 30 is noted for its low angle of elevation of the radiated signal. Price is \$49.95.

### Solderless Terminals (57K)



A complete selection of heavy-duty solderless terminals is available from Waldom Electronics in several styles for wires in the 16-14 range. 105 sizes are also available in butt and parallel connectors and ring-tongue terminals for wire ranges #8, #6, #4, and #2. All terminals have brazed barrels to allow crimping to any wire from any part of the barrel.

### Communications Receiver (58K)



The HQ-145V general-coverage receiver from Hammarlund provides a single crystal-controlled channel that can be used at any point in the frequency range of the instrument. Previously known as the HQ-145, the receiver was redesignated after the addition of the crystal-control feature —

which can be used to increase accuracy in the reception of time signals and weather information from station WWV.

### Picture Tubes (59K)

Three new tube types have been added to the General Electric "Black Daylight" line. An aluminized 90° glass tube with low grid no. 2 voltage, the 17CRP4 uses 6.3 volts on the heater and 0.45-amp heater current. The 19AXP4 is a 114° type which will replace the picture tubes used in approximately 110,000 existing sets. A twin-panel 110° tube with a 6.3-volt heater and .6-amp heater current, the 23EP4 also uses low grid no. 2 voltage.

### Replacement Yokes (60K)

Several new Merit replacement yokes are available from distributors: MDF-107 replaces Motorola 24D742835; MDF-115 replaces RCA 104482 (972958-3); MDF-119 replaces RCA 104369 (972913-2); MDF-126 replaces Admiral 94D187-2; MDF-128 replaces Philco 76-10282-5; MDF-130 replaces Truetone and Trav-Ler L-177; MDF-132 replaces Motorola 24K-754300 (24D65616A03B); and MDF-133 replaces Warwick-Silvertone 80-12-4.

### Stereo Hi-Fi Kits (61K)

Military-type terminal boards for component mounting are provided with each stereo kit in Harman-Kardon's "Citation" line. Three units available include a preamplifier control center with tone, blend, and equalization controls; a 120-watt power amplifier featuring a bias meter; and an FM tuner with .65 microvolts sensitivity (for 20 db of quieting). A less elaborate control center and an 80-watt amplifier are also available.

## ANOTHER SERVICE-PROVED PRECISION INSTRUMENT MODEL IC-60 "IN-CIRCUIT" CAPACITOR TESTER



A true time-and-labor saver, the IC-60 discloses opens and shorts in bypass coupling, blocking and filter capacitors of all types (dried-out electrolytics too) without removing them from the circuit. Also indicates actual electrolytic values, from 2 mfd. to 400 mfd. in two ranges, while capacitor is "in-circuit." Sharp, non-confusing readings on wide-angle indicator. See your PRECISION distributor or write today for a complete catalog. Model IC-60: Net only \$32.95. This and all other PRECISION PRODUCTS are guaranteed for one full year

**PRECISION APPARATUS CO., INC.**

SUBSIDIARY OF PACOTRONICS, INC. 70-31 84th ST., GLENDALE, NEW YORK

## JUST WHAT YOU NEED FOR TESTING TRANSISTORS

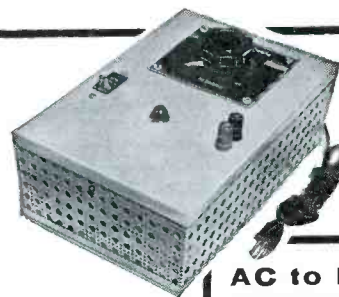

**AC to DC POWER SUPPLY**

Plug this instrument into any 60 cps, 95/130 volt circuit and get a stabilized source of direct current, adjustable over a range from 0 to 45 volts DC, with current output 0/2.5 amperes. Filtered direct current output range 0/45 volts, 0/2.5 amperes is continuously adjustable and stabilized  $\pm 1\%$  at any setting regardless of alternating current fluctuation. Voltage regulation is approximately 5% between full load and no load at full voltage setting.

This DC Power Supply instrument is ideal for use in transistor testing, circuit testing, to provide regulated voltage for light testing, eliminates the need of batteries by supplying exact DC voltage required.

Write for Bulletin 17-BLO1 which gives full details and models available.

### ACME ELECTRIC CORPORATION

942 Water St.

SAA3499/1952

Cuba, N. Y.

**Acme Electric**

February, 1962

Acme Electric Corp.	89
Admiral Corp.	41
ATR Electronics	16
B & K Mfg. Co.	43, 45, 57
Belden Mfg. Co.	23
Berns Mfg. Co.	64
Blonder-Tongue Labs	55
Bussmann Mfg. Div.	61
Castle TV Tuner Service	79
Centralab, A Div. of Globe-Union, Inc.	58
Chemtronics, Inc.	40
Communications Co., Inc.	80
Don Bosco Electronics, Inc.	70
Duotone Co., Inc.	88
EICO	73
Electro Products Laboratories, Inc.	78
Fisher Radio Corp.	85
Grantham School of Electronics	39
Hallcrafters Co., The	51
Harman-Kardon, Inc.	83
Hickok Electrical Instrument Co.	17
Injectorall Co.	83
Jackson Electrical Instrument Co.	90
Jensen Mfg. Co.	67
Jerrold Electronics Corp.	15
Littelfuse, Inc.	4th cover
Los Angeles Tuner Exchange	50
Mallory & Co. Inc., P. R.	63
Mercury Tuner Service, Inc.	64
Merit Coil & Transformer Corp.	46
METREX	54
Nortronics	44
Ohmite Mfg. Co.	50
PACO	86, 87, 88, 89
Perma-Power Co.	66
Philco Corp.—Accessory Div.	20-21
Planet Sales Corp.	84
Precision Electronics, Inc.	85
Precision Tuner Service	56
Quietrole Co.	56
RCA Electron Tube Div.	75, 3rd cover
RCA Institutes, Inc.	26
Raytheon Co.	59
Rohn Mfg. Co.	81
Sams & Co., Inc., Howard W.	47, 52, 74, 82
Sargent-Gerke Co. (Electronics Div.)	87
Sarkes Tarzian, Inc.	76
Semiconductor Div.	11
Seco Electronics, Inc.	77
Sencore, Inc.	49, 53
Sprague Products Co.	13, 14
Stancor Electronics, Inc.	72
Standard Kollsman Industries, Inc.	2nd cover
Switchcraft, Inc.	64
Sylvania Electric Products, Inc.	18-19
Terado Co.	84
Texas Crystals	56
Triplet Electrical Instrument Co.	1-2
Tung-Sol Electric, Inc.	65
Twirl-Con Tools	86
Vidaire Electronics Mfg. Corp.	84
Vocaline Co. of America, Inc.	54
Volkswagen of America	27
Western Tuner Rebuilders	82
Winexard Co.	22, 68, 83
Xcelite, Inc.	38
Zenith Sales Corp.	24-25

ANTENNAS AND ACCESSORIES

- 1K. JFD—Descriptive and promotional literature plus sales aids for new "Trans-Tennas"; also complete set of specifications for outdoor and indoor TV antennas and accessories, including exact replacement antenna data.
- 2K. JERROLD—Special bulletin on determining system noise figure, for use in eliminating snow from TV pictures; also new literature on transistorized *Powermate TV-FM Preamp*. See ad page 15.
- 3K. WINEGARD—Factfinder No. 201 giving complete specifications for Model PF-8, a special antenna for FM multiplex receivers; includes schematic diagram. See ads pages 22, 68, 83.

AUDIO AND HI-FI

- 4K. DUOTONE—Sheet describing new diamond needle dispenser which hangs on wall, stands on counter, or lies flat in display case. See ad page 88.
- 5K. EICO—New 32-page catalog of test equipment, kits and wired equipment for stereo and monophonic hi-fi, Citizens band transceivers, ham gear, and transistor radios. Also, "Stereo Hi-Fi Guide," and "Short Course for Novice License." See ad page 73.
- 6K. ELECTRO-VOICE—Component Systems Guidebook (No. 141) intended to serve as a guide for selecting compatible hi-fi systems; also 20-page catalog (No. 144) listing microphones, loudspeakers, and PA equipment; also Catalog No. 149 listing replacement phono cartridges.
- 7K. NORTRONICS—Six-page booklet "Principles of Tape Recording"; also conversion/replacement guide for using Nortronics heads to replace original equipment. See ad page 44.
- 8K. QUALITONE—Wall chart listing cross-reference numbers for replacing worn out needles with the correct Qualitone styli.
- 9K. SWITCHCRAFT—Bulletin No. 118 describing Stereo Cable Assembly No. 10FK25, designed for use with tape recorder requiring 3-conductor dual inputs; also provides a method for connecting a stereo mixer to a stereo or monaural tape recorder.

COMMUNICATIONS RADIO

- 10K. COMCO—Catalog sheets and price lists for Models 580 and 680 two-way VHF-FM radio communications equipment providing 25- to 100-watt outputs in the HF and VHF bands. See ad page 80.
- 11K. CREATIVE PRODUCTS—Brochure describing Model LCF antenna loading coils for use with Citizens band transceivers.
- 12K. HALLCRAFTERS—Booklet, "12 Field-Tested Tips on Selling Citizens Band," describing important techniques now being used by service dealers to promote CB sales. Available to established, qualified firms interested in becoming Hallcrafters-authorized CB dealers. See ad page 51.
- 13K. MOTOROLA TRAINING INSTITUTE—Information on the pay-as-you-learn home study course covering the principles and servicing of two-way radio systems.

COMPONENTS

- 14K. BUSSMANN—Compact new 64-page BUSS Television Fuse List, Form TVC, giving servicemen a quick reference for fuse replacements in old and new TV sets; includes fuse information for car and truck radios. See ad page 61.
- 15K. SONOTONE—14-page catalog BA-73 giving details on sintered-plate, nickel-cadmium cells; includes 13 individual spec sheets.
- 16K. SPRAGUE—Chart C-457 showing all popular TV-radio-hi-fi service items (designed to hang on wall). See ads pages 13, 14.
- 17K. SYLVANIA—Wall chart listing complete specifications for "Bonded Shield" picture tubes; only one chart available per customer. See ad pages 18-19.

SERVICE AIDS

- 18K. BERNs—Data on 3-in-1 picture-tube repair tools, on *Audio Pin-Plug Crimper* that lets you make pin-plug and ground connections for shielded cable without

soldering, and on *ION* adjustable beam bender. See ad page 64.

- 19K. CASTLE—Leaflet describing fast overhaul service on television tuners of all makes and models. See ad page 79.
- 20K. INJECTORALL—Catalog of electronic chemicals, including new No. 20 *Lens Kleen* (for removing scratches from plastic TV safety windows) and No. 30WC *Renew Spray* (for polishing cabinets and removing scratches); also pocket-sized catalog, "Open the Door." See ad page 83.
- 21K. PRECISION TUNER—Information on repair and alignment service available for any TV tuner. See ad page 56.
- 22K. SARGENT-GERKE—Catalog of service chemicals in aerosol spray cans; also spray-paint color cards. See ad page 87.
- 23K. YEATS—Literature describing *Appliance Dolly* and padded delivery covers.

SPECIAL EQUIPMENT

- 24K. ACME—Illustrated catalog sheet 24-B01 giving specifications and listing applications for magnetic amplifiers for control uses requiring capacities of 5 to 1000 watts and voltage ranges from 24 to 160 volts. See ad page 89.
- 25K. TERADO—Catalog sheets on power converters for obtaining 110-volt AC from auto battery or other mobile DC supply; information on battery chargers also provided. See ad page 84.

TECHNICAL PUBLICATIONS

- 26K. GRANTHAM—Booklet entitled, "Careers in Electronics," outlining training courses available. See ad page 39.
- 27K. HOWARD W. SAMS—Literature describing all current publications on radio, TV, communications, audio and hi-fi, and industrial electronics servicing. See ads pages 47, 52, 74, 82.

TEST EQUIPMENT

- 28K. B & K—Catalog AP18-R, giving data and information on Model 960 *Transistor Radio Analyst*, Model 1076 *Television Analyst*, *Dynamic 375 VTVM*, *V O Matic 360*, Models 700 and 600 *Dyna-Quik* tube testers, Models 440 and 420 *CR1 Cathode Rejuvenator Testers*, Model 1070 *Dyna-Sweep Circuit Analyzer*, and *B & K Service Shop*. See ads pages 43, 45, 57.
- 29K. DON BOSCO—Literature sheets describing the "Mosquito," a pocket-sized, transistorized, signal injector, and the "Stethotracer," a pen-size detector complete with earphone, used for signal tracing. See ad page 70.
- 30K. HICKOK—Literature on Model 656 NTSC-standard color-bar generator and other color television test equipment; also brochure, "Why NTSC?" See ad page 17.
- 31K. SADELCO—Information on transistorized TV field strength meter containing a zener-diode regulated battery power supply; supplied with leather carrying case.
- 32K. SECO—Literature on test equipment, featuring complete Model 107 tube tester which meets specifications for Federal Stock Classification; also, booklet, "Selling and Servicing Citizens Band Equipment." See ad page 77.
- 33K. SENCORE—New booklet, *How to Use the SS117 Sweep Circuit Troubleshooter*, plus brochure on complete line of time-saver instruments. See ads pages 49, 53.
- 34K. TRIPLETT—Catalog sheet describing Model 800 VOM, a versatile instrument with 70 ranges, a 7" scale, and overload protection. See ad pages 1-2.

TOOLS

- 35K. ADEL—Literature on "Nibbling Tool" that cuts, notches, and trims round or irregular holes to any size over 7/16"; ideal for radio chassis, templates, or shims.
- 36K. TWIRL-CON—Literature describing new tool used for making quick, neat, and secure connections; used for installing resistors, capacitors, pin plugs, wire ends, etc. See ad page 86.
- 37K. XCELITE—Bulletin 1261 describing two new tools: a terminal wrench for servicing transistor radios and a midjet, pocket clip screwdriver with nonmagnetic blade for electronic and electrical service and assembly. See ad page 38.

Latest Jackson Tube Test Data

MODEL 648		MODEL 598	
Tube Type	Phi.	Phi.	Phi.
1AUJ	1.4	1.4	1.4
6CG5	6.3	6.3	6.3
6Q11	6.3	6.3	6.3
17AX3	17	17	17

MODEL 658		MODEL 598	
Tube Type	Grid	Grid	Grid
1AUJ	1.2M	1.2M	1.2M
6CG5	6.3	6.3	6.3
6Q11	6.3	6.3	6.3
17AX3	17	17	17

# NOW! Only 4 Picture Tubes can fill 50% of your replacement needs\*



## RCA 21CBP4A, 21AMP4A, 21ZP4B and 21YP4A Universal Silverama® Picture Tubes Replace 33 Industry Types

Now, four—*only four* RCA Universal Silverama types can take care of *half* your picture tube replacements. Think of what this means to you in terms of simplicity, economy and efficiency:

- **Fewer trips to the distributor.**  
You can keep these four types in your shop, knowing that you will quickly have use for them.
- **Faster service.**  
For half your picture tube replacements, you have the right tube on hand, in the shop. Saves hours of time picking up the proper tube or waiting for it to be delivered. The time saved gives you a competitive edge!
- **Picture tube replacements from your service truck.**  
It's simple to carry one of each of these Universal types on your service truck so you can make half of your picture tube replacements *right on the spot*.
- **Fewer types to take care of.**  
Think of the headaches and extra bookkeeping this simplification saves.

These four types are part of a growing family of RCA Universal Picture Tubes designed to help you fill the maximum number of sockets with the minimum number of types.

RCA Universal Silverama Picture Tube types are made with an all-new electron gun, the finest parts and materials and a high-quality envelope that has been thoroughly inspected, cleaned and rescreened prior to reuse.

Start now to simplify your picture tube replacement problems. See your authorized RCA Distributor this week about RCA Universal Silverama Picture Tubes.

\*Based on EIA figures for the national movement of the picture tube types below.

RCA Silverama "Universal" Type	Replacing		
21CBP4A	21ALP4	21ANP4A	21CBP4B
	21ALP4A	21BTP4	
	21ALP4B	21CBP4	21CMP4
	21ANP4	21CBP4A	
	21ATP4	21BAP4	21CWP4
	21ATP4A	21BNP4	21DNP4
21AMP4A	21ATP4B	21CVP4	21FLP4
	21ACP4	21AMP4A	21BSP4
	21ACP4A	21AQP4	21CUP4
21ZP4B	21AMP4	21AQP4A	
	21ZP4	21ZP4A	21ZP4B
21YP4A	21YP4	21YP4A	21AFP4

RCA Electron Tube Division, Harrison, N. J.



The Most Trusted Name in Electronics

In Electronic Circuits . . .

**ALL AROUND PROTECTION**

**NEW MICROFUSE**  
 THE PIGTAIL VARIETY (278000) SERIES  
 THE PLUG-IN VARIETY (272000) SERIES  
 THE SUB-MINIATURE FUSE HOLDER (No. 281001)

**New Indicating 3AG Fuse Posts**

It G<sup>L</sup>OWS when the FUSE BLOWS

Labels around the circle:  
 THROUGH PANEL MOUNTING, SCREW TERMINAL MOUNTING, SOLDER TERMINAL MOUNTING, 4AG FINGER OPERATED POST, TERMINAL CLIP, FUSE CLIP EARLESS, FUSE CLIP, LC FUSE HOLDERS, MOUNTINGS FOR RECTIFIERS, 3AG FUSES, 3AG SLO-BLO, 3AB FUSE U/L, LC FUSES 250V TYPE C, LC FUSES 125V TYPE C, LC SLO-BLO 125V TYPE N, 8AG INSTRUMENT FUSES, 8AG U/L FUSES, AIRCRAFT FUSES, 4AG SLO-BLO, IN LINE FUSE RETAINERS, 3AG POST CORNER OPERATED, 3AG POST FINGER OPERATED, 3AG POST MINIATURE, CAN COVER MOUNTING, THROUGH PANEL MOUNTING.

It's **LITTELFUSE** First!  
DES PLAINES, ILLINOIS