

SEPTEMBER, 1961

35 CENTS



RF REPORTER

PHOTOFACT

including Electronic Servicing

- 1. A keyhole list
- A. one cycle
- B. 100 cycles
- C. 60 cycles
- D. 1,000,000 cycles
- E. 1,000 cycles

answers labeled A, B, C, D, and E. Select the one you think is the correct answer. Then blacken the corresponding space on this sheet with a soft lead pencil. Make your mark as long as the pair of lines; move the pencil point up- and down firmly to make a heavy black line.

Date _____
Please Print)

RADIO OPERATOR EXAMINATION

8
9
10
11
12
13
14
15
16
17
18
19
20
21
22
23
24
25

SPECIMIN

FCC Form 750 E

The United States of America
FEDERAL COMMUNICATIONS COMMISSION
RADIO TELEPHONE OPERATOR LICENSE
SECOND CLASS
(General Radiotelephone Certificate)

This certifies that **STANLEY MECHAN**

IS A LICENSED RADIO OPERATOR, AUTHORIZED, SUBJECT TO ANY SPECIAL ENDORSEMENT PLACED HEREON, TO OPERATE THE CLASSES OF LICENSED RADIO STATIONS FOR WHICH THIS CLASS OF LICENSE IS VALID UNDER THE ORDERS, RULES AND REGULATIONS OF THE FEDERAL COMMUNICATIONS COMMISSION, ANY STATUTE OF THE UNITED STATES AND ANY TREATY TO WHICH THE UNITED STATES IS A PARTY.

THIS LICENSE IS GRANTED UNDER THE AUTHORITY OF THE COMMUNICATIONS ACT OF 1934, AS AMENDED, AND THE TERMS AND CONDITIONS THEREOF AND OF ALL LEGISLATIVE ACTS, EXECUTIVE ORDERS, AND TREATIES TO WHICH THE UNITED STATES IS SIGNATORY, AND ALL ORDERS, RULES AND REGULATIONS OF THE FEDERAL COMMUNICATIONS COMMISSION, WHICH ARE BINDING UPON RADIO OPERATORS, ARE MADE A PART HEREOF AS THOUGH SPECIFICALLY SET OUT IN FULL HEREBY.

NEITHER THIS LICENSE NOR THE RIGHTS CERTIFIED THEREIN SHALL BE ASSIGNED OR OTHERWISE TRANSFERRED TO ANY OTHER PERSON.

Chicago, Illinois - December 2, 1965

PLACE AND DATE OF ISSUANCE: _____

DATE AND TIME OF EXPIRATION: December 2, 1965 AT THREE O'CLOCK A.M., EASTERN STANDARD TIME.

SPECIAL ENDORSEMENT: _____

Federal Communications Commission

Stanley Mechan (Licensee) *H. W. Sams* (Examining Engineer) *Ben F. Waple* (Secretary)

NOT VALID UNLESS SIGNED ACTING

C-Form 750 E

52 82
53 **Preparing for the**
2nd-Class Phone Exam

55 85 115
56 86 116

Service Bench Designs—Build 'Em or Buy 'Em

Using a Tube Tester to Advantage

TV Tuners—Repair or Replace

88
89
90

120

150

IA OK 7496 1224
WM. M. DAVIS
RAD. & TV SERV.
118 RIVERSIDE AVE.
CANON CITY, COLO.

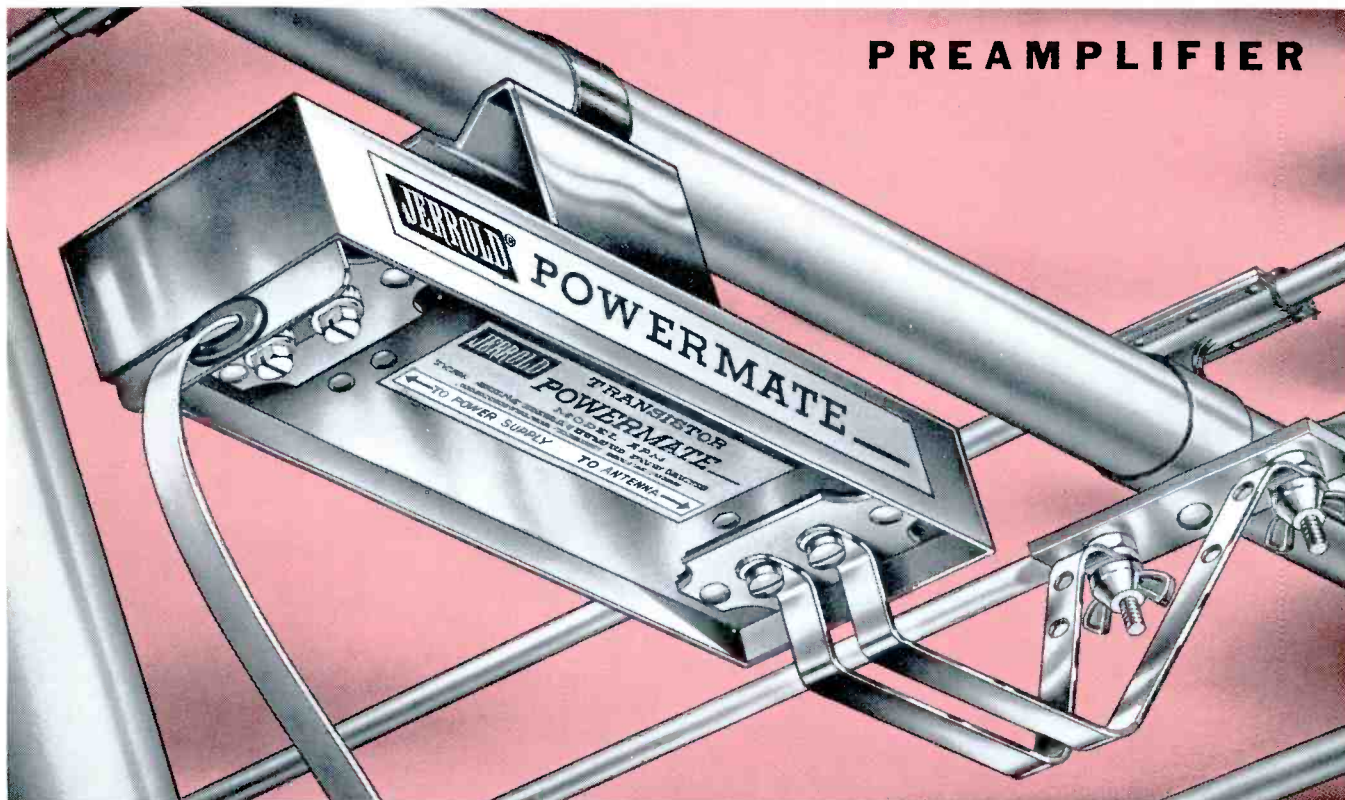
Introducing the perfect mate for any TV/FM antenna

NEW

JERROLD

TRANSISTOR POWERMATE

PREAMPLIFIER



**mounts on boom, mast, wall, window...
offers highest gain, lowest noise figure**

Here's the preamplifier for every TV antenna in your area, whether new or up for years! The exclusive universal bracket of the new JERROLD Transistor POWERMATE permits mounting directly on the antenna boom (for greatest boost before downlead losses) or at *any* other point—along the mast, on the wall or windowsill, behind the set—anywhere your best judgment dictates.

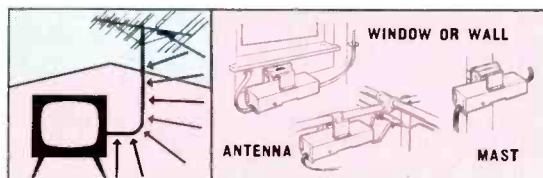
And look at this gain: An average of 13.9db at Channel 13 and 18.25db at Channel 2—by far the highest in the business! This remarkable gain gives any antenna system the lowest System Noise Figure obtainable—the key to better pictures.

See your distributor today, or write for special bulletin describing System Noise Figure. Begin cashing in on your big market for the new JERROLD Transistor POWERMATE!

\$39.95 list, \$26.63 net, complete with power supply

JERROLD [®] **ELECTRONICS CORPORATION**
Distributor Sales Division, Dept. IDS-168
The Jerrold Building, Philadelphia 32, Pa.

Jerrold Electronics (Canada) Ltd., Toronto, Ontario
Export Representative: CBS International, New York 22, N.Y.



MOUNT IT AND FORGET IT

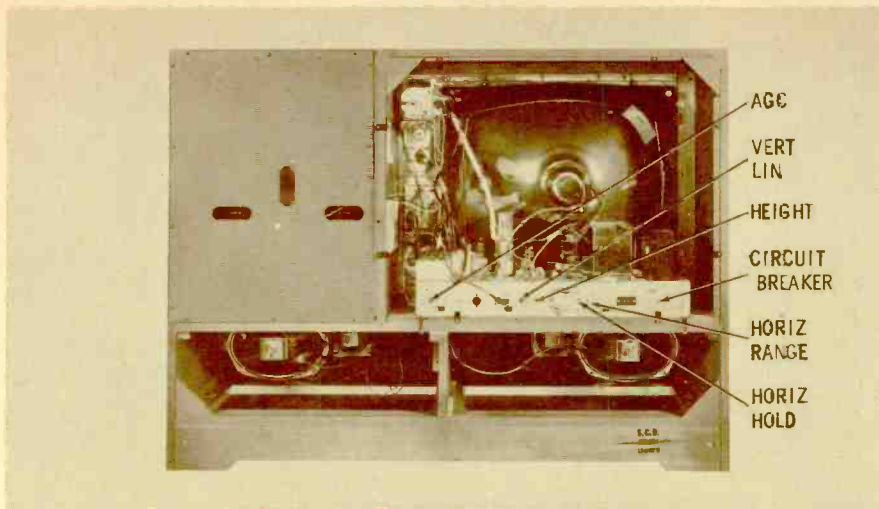
On the antenna or anywhere along the downlead, POWERMATE is up for good. Same 300-ohm lead that carries signal also carries 15 volts ac to POWERMATE. No tubes, no batteries to replace.

REMOTE A-C POWER SUPPLY

installs on or near receiver, draws less current than an electric clock. No polarity nuisance when attaching to lead, no danger of transistor damage.



AMERICA'S LEADING MANUFACTURER OF TV-FM RECEPTION AIDS AND MASTER-ANTENNA-SYSTEM PRODUCTS



**Admiral
Model STG24K131
Chassis 20L7**

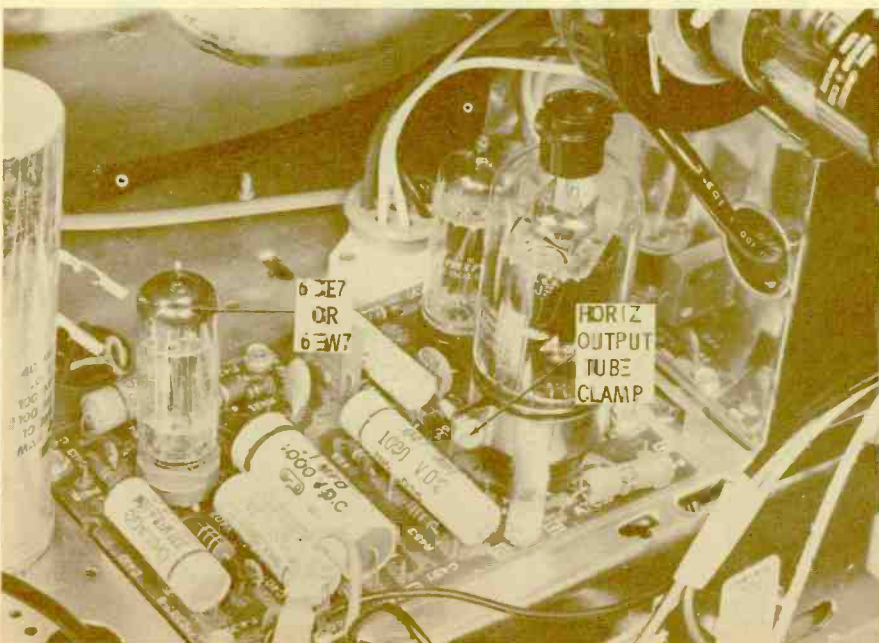
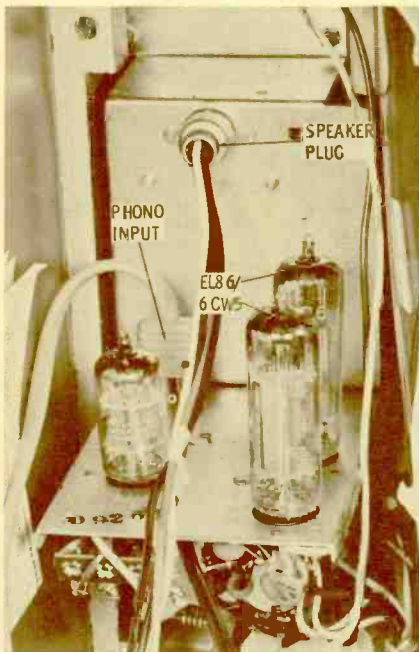
This combination TV and stereo phono, the *Berkeley* model from the *Presidential* line by Admiral, features a slide-out four-speed record changer of the RC7 series. The TV section uses a 92", 23" picture tube with separate safety glass — a 23AHP4 in early-production models, or a 23AUP4 in chassis coded Run 11 and higher. All operational controls except horizontal hold are grouped on the escutcheon between the picture tube and the phonograph compartment; the hold control is a plastic tube projecting from the rear apron of the TV chassis.

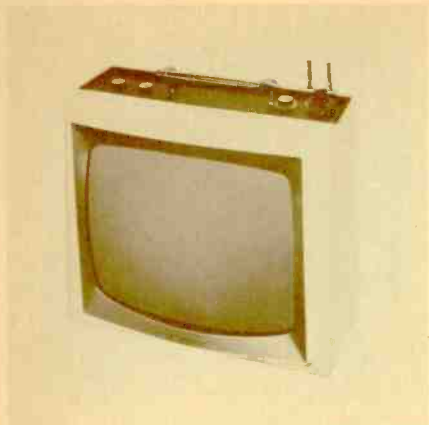
The 18-tube, transformer-powered chassis and the picture tube form a one-piece unit. Setup adjustments are clearly marked on the rear apron. The AGC and horizontal range controls are both covered with warning labels to protect them from customers and remind servicemen to follow procedures outlined in service data. When it becomes necessary to remove the chassis, the whole unit can be slid out the front of the cabinet after removal of the chassis bolts, as well as the four 5/16" hex screws which hold the mask in place and are located inside the front of the cabinet.

A compact, three-tube stereo amplifier chassis, using a pair of EL86/6CW5 output tubes, is mounted to the front escutcheon. Sockets for the speaker and phono-input plugs make it easy to disconnect the amplifier when removing the chassis.

TV sound output comes from a phono jack just to the right of the printed board which holds the signal circuits. As an aid in alignment, IF-coil frequencies are stamped into the shield covering the video IF strip. Although the remainder of the sweep circuits are contained on another board, the common-cathode AFC dual diode plugs into a socket on this board.

The sweep-circuit printed board includes the horizontal output stage, and the 6DQ6A used in this circuit is held rigidly in place by a screw-tightened clamp that grips the edges of the board. Early-production chassis had a 6DE7 tube in the combined vertical multivibrator and output circuit; however, starting with Run 11, a new type—the 6EW7—is used in this application.





**General Electric
Model M240WVY
Chassis LW**

G-E has introduced a new line of portable TV sets. Known as the *Celebrity* series, these 19" receivers have top-mounted controls and a built-in dipole antenna. All use a 114" 19ZP4 picture tube and a plastic safety glass. The inside of the glass can be cleaned after removing the chassis. *Caution:* Use only mild soap and water to prevent damage to the plastic.

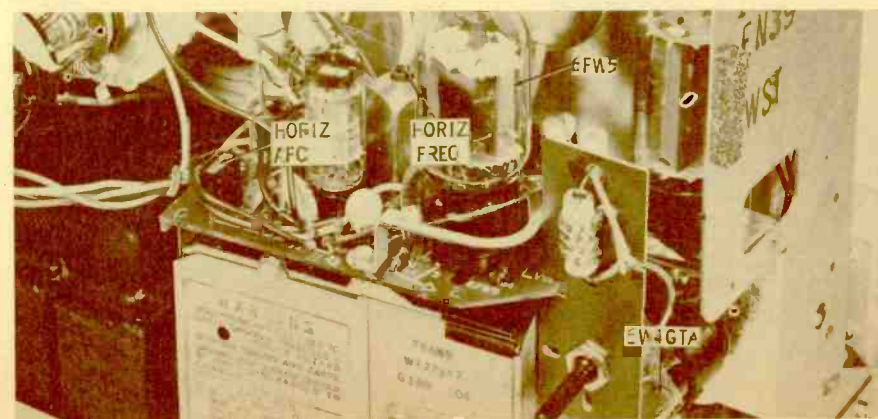
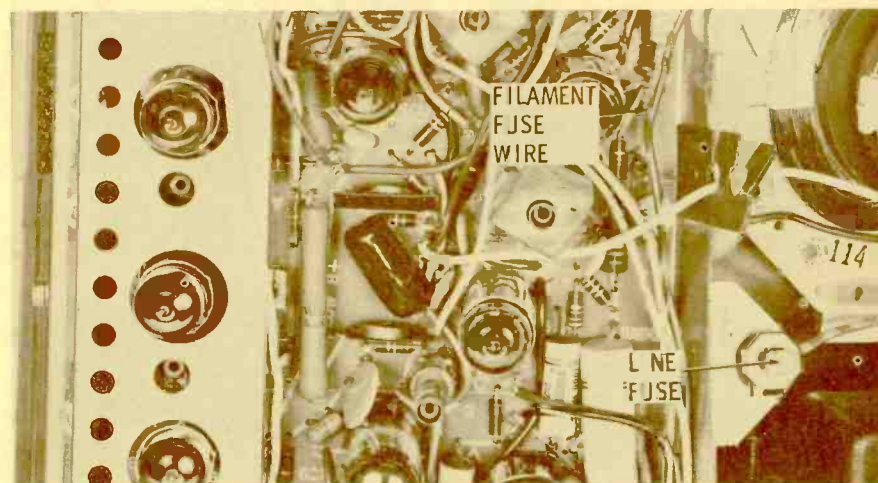
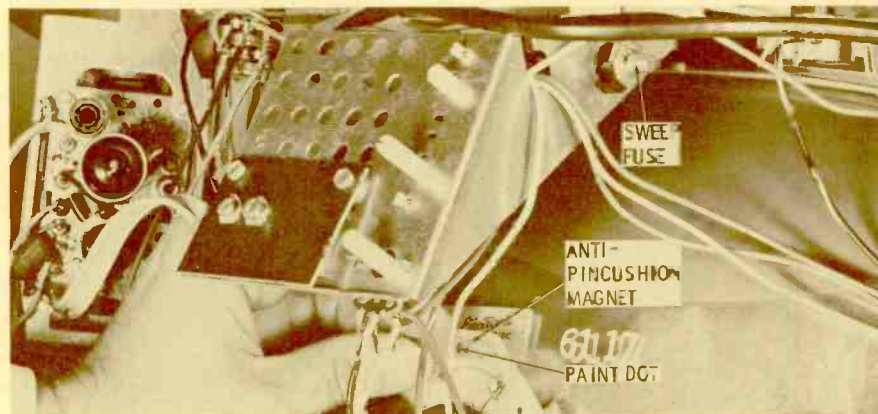
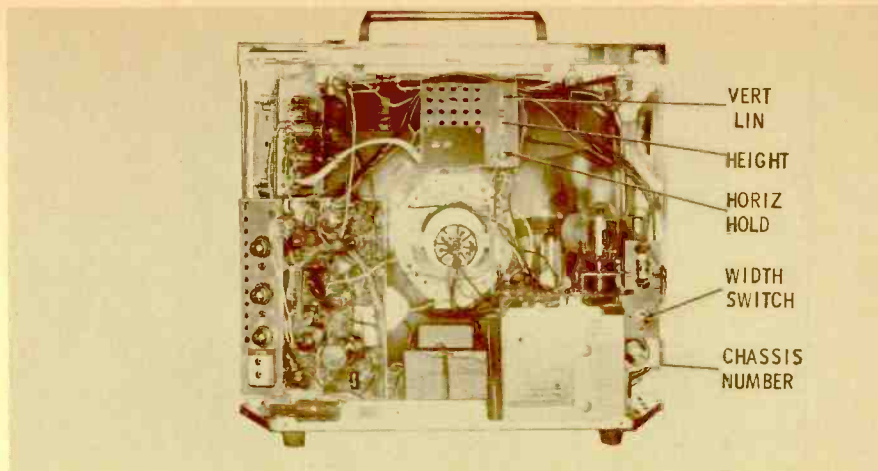
The 16-tube, transformer-powered chassis fits snugly around the bell of the CRT. Printed circuitry is used for all stages except the power supply and damper. Setup adjustments, except for a width switch, are mounted on a top control panel.

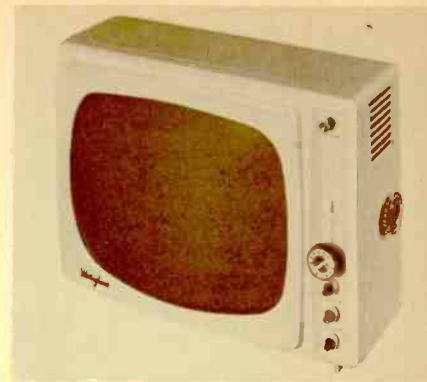
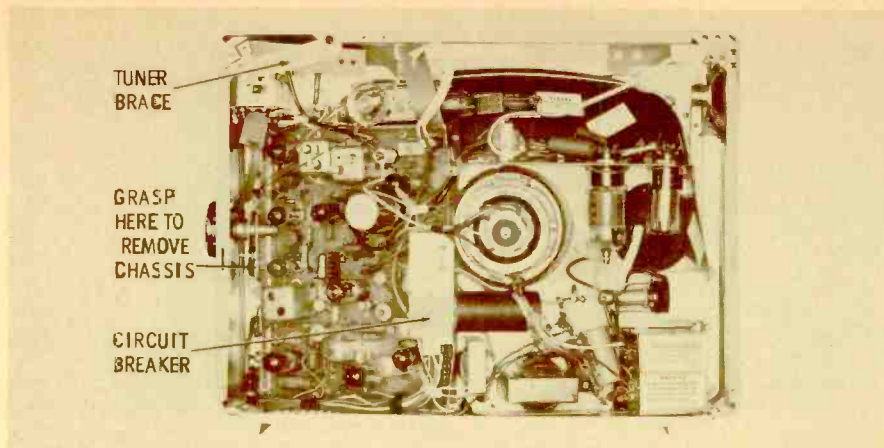
A 3/10-amp, type-N sweep fuse is mounted on the right side of the control panel. At the top and bottom of the yoke, holes are provided for snap-in anti-pin-cushion magnets. The magnets may be omitted if no correction is needed, mounted on the back side of the yoke for moderate correction, or plugged into the front side of the yoke for maximum effect. A paint dot identifies the polarity of the magnets. For a magnet attached to the top of the yoke, this dot should face the sweep board; for a bottom magnet, it should face the main printed board.

The latter contains all of the signal and vertical-sweep circuits. In addition, this section of the chassis includes a 2" length of No. 26 wire protecting tube filaments, and a 3 1/2-amp, type-C fuse in series with the transformer primary.

Tube-type numbers and lines indicating wiring paths are marked on the component side of both boards as a servicing aid. Although most service work can be performed from this side, it is also possible to gain access to the foil side of the main board by removing three metal screws from the left side and two from below.

Removing three metal screws from the sweep board also permits it to be raised for below-board servicing. The AFC diode and the horizontal multivibrator occupy the left end of the board. To the right is a new horizontal output tube with no cap, a 6FW5, held in place by a ring-type clamp. Below and to the right is the damper, a 6W4GTA — a modernized version of an old-time favorite.





**Westinghouse
Model H-P3150U
Chassis V-2384-15**

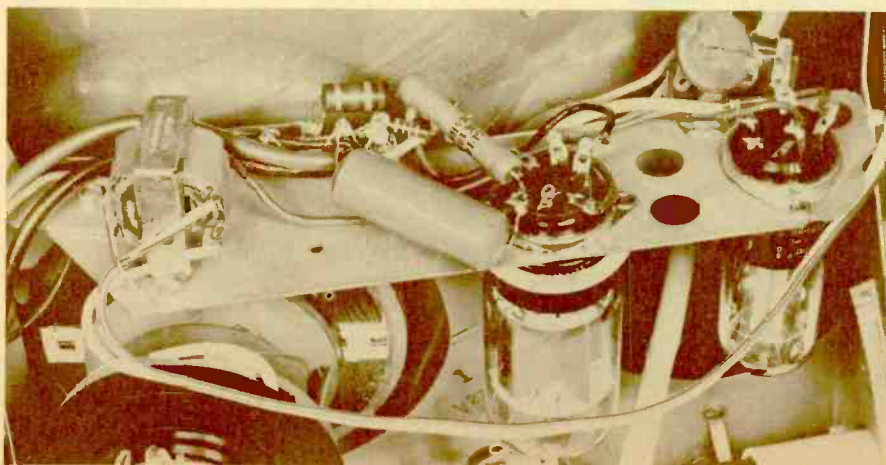
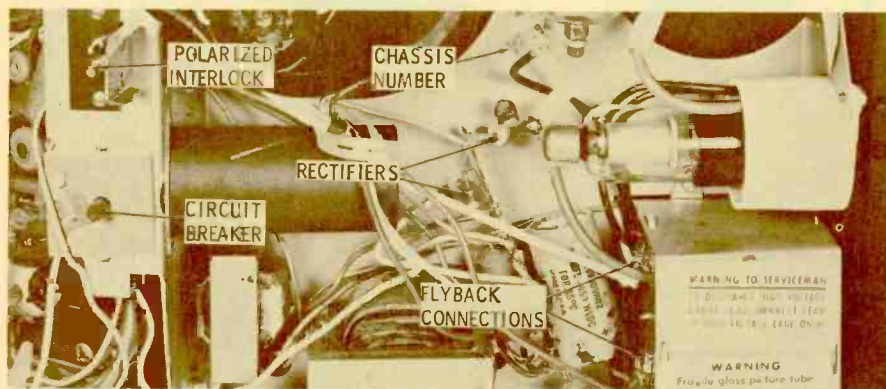
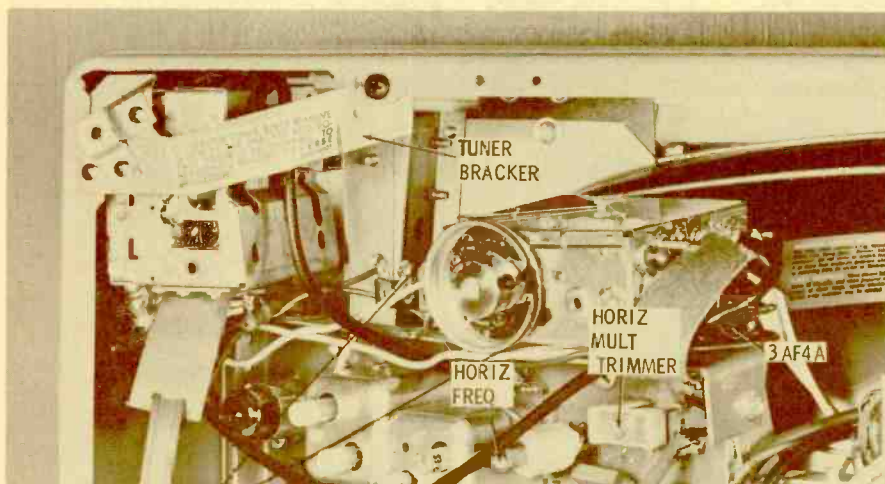
The 1961 line of Westinghouse portables includes both 17" and 19" models. This one is a UHF version with a 110°, 17EBP4 picture tube. The 19" sets use a 114°, 19AHP4 CRT and a V-2412-series chassis. Plastic safety shields are used in all models. All controls are front-mounted. The height and vertical linearity adjustments are accessible through holes in the cabinet hidden by the VHF channel selector knob.

Nearly every component in the set is within easy reach when the back is removed. The compact, one-piece chassis is nestled around the picture-tube bell. Since it fits the cabinet so snugly, there is a special knack to removing it. After three bolts are removed from the front, and six from the bottom, a screw holding the tuner brace can be removed and the brace swung down. Grasp the chassis at the point indicated in the accompanying photo, and pull on the chassis as you pry on the tuner to clear the cabinet. Pull it out as far as it will go; then tip the chassis forward slightly and remove it from the cabinet, tuner end first.

The tuner bracket must also be loosened and swung out of the way to permit access to the tubes in the VHF tuner when the chassis is in the cabinet. Notice that a 3EA5 RF amplifier and 3AF4A UHF oscillator are used in this chassis. These 450-ma series-string tubes are rare enough that you probably don't have them in your caddy. The same thing goes for the 8CS7 serving the combined vertical multivibrator-output circuit.

The "hot" chassis has a polarized line plug and AC interlock, with one terminal of larger diameter than the other, to guard against accidental shocks. Circuit protection for this chassis comes from a circuit breaker in series with the power supply. The latter contains a pair of silicon rectifiers in a half-wave-doubler configuration. Notice that the flyback connections have been brought outside the cage to simplify servicing.

The upside-down mounting of the horizontal output and damper tubes, with socket connections out in the open, also facilitates troubleshooting the horizontal circuits.





Zenith Model G3360W Chassis 17G28Q

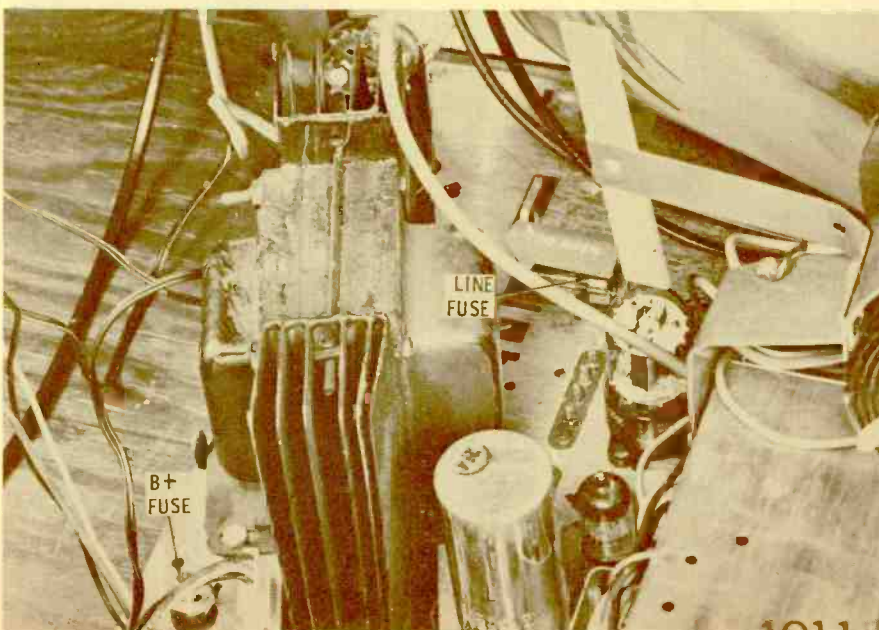
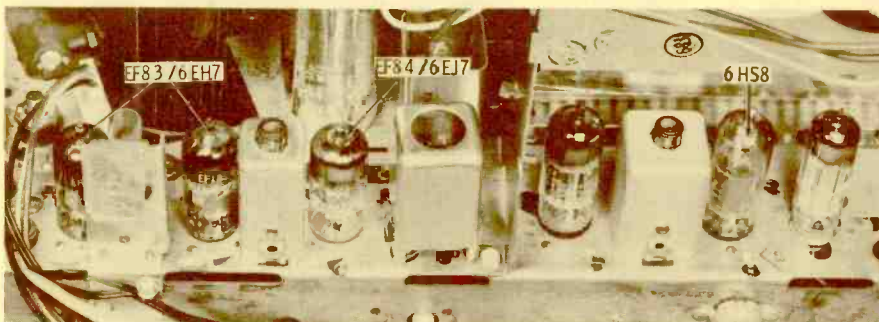
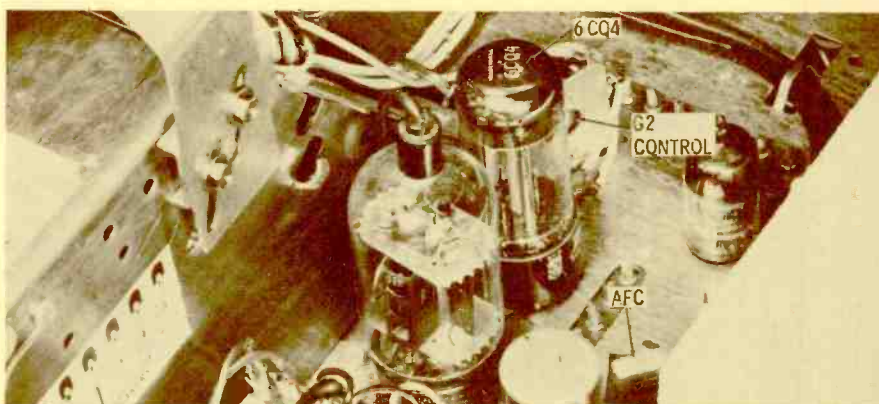
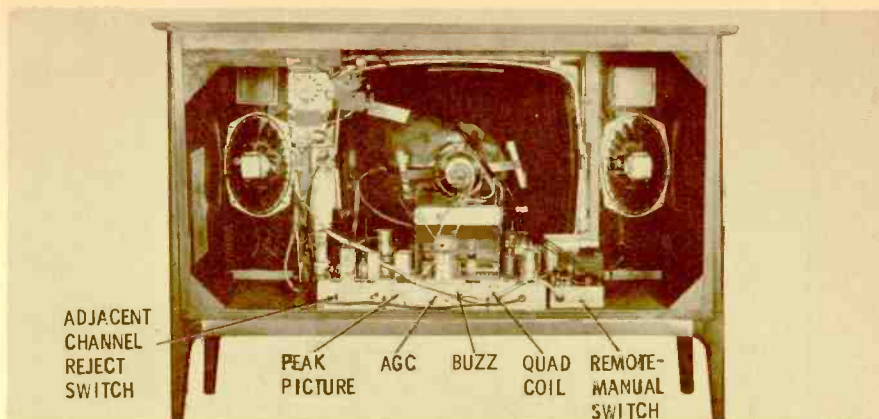
This is one of six models using the most deluxe chassis in the Zenith "G" line. All are equipped with the *Space Command 400* remote control system and a 92°, 23AFP4 picture tube with bonded safety shield. The tuner used in these receivers is the *Gold Video Guard*, a turret type with contacts made of a gold, silver and platinum alloy for improved performance. The door below the CRT covers most of the setup adjustments as well as the contrast and *dynamic contrast* push-pull switch. The latter is used to switch a DC restorer in or out of the circuit.

The rear apron of the chassis contains the remaining setup controls, plus a special switch and control which affect picture quality as follows: The *adjacent channel reject switch* cuts a 47.25-mc trap in and out of the circuit. If there is no interfering sound signal on the next lower channel, better video response is obtained with the switch in the *OUT* position. The *peak picture control* is a potentiometer in the video detector circuit for regulating video-frequency response.

Atop the chassis, behind the new 6CQ4 damper, an unmarked control provides adjustment of the voltage applied to the accelerating anode (G2) of the CRT. It should be adjusted for 450 volts on pin 10 of the picture tube with a station signal tuned in. To the right of the damper you'll find the plug-in dual horizontal AFC diode.

Most of the tubes along the back edge of the chassis are new types. The first and second video IF stages each use an EF183/6EH7, and the third video IF tube is an EF184/6EJ7. Both types are 9-pin miniatures with built-in shields. A 6HS8, a hopped-up version of the 6BU8, serves as the sync separator, AGC keyer, and noise limiter.

The left side of the chassis contains a 3DG4 low voltage rectifier and a 6AL5 serving as a DC restorer and retrace clamper. Fuses for the transformer-powered chassis are also located in this area. They include a 7/10-amp, type-N unit protecting B+, and a 5-amp, slow-blow type in series with the primary of the transformer. The filaments are protected by a 1½" length of #24 copper wire located beneath the chassis.



See PHOTOFACT SET 531, Folder 2

Mfr: Philco Chassis No. 11H25

Card No: PH 11H25-1

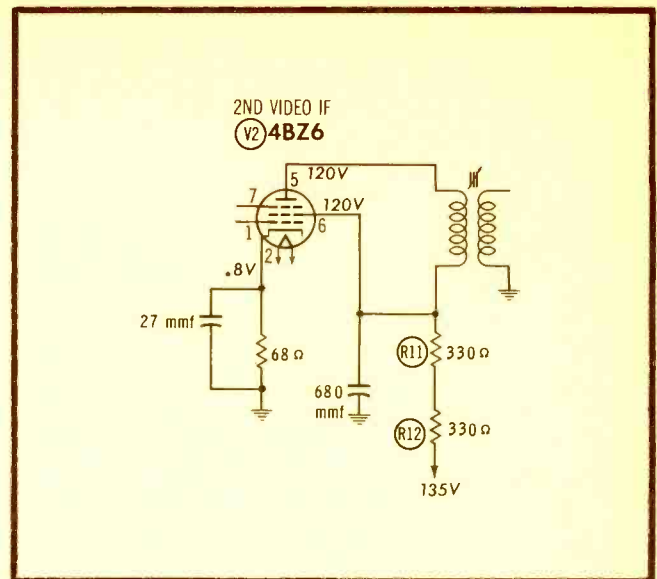
Section Affected: Pix and sound.

Symptoms: No picture or sound. Raster OK.

Cause: Shorted V2, 4BZ6 2nd video IF amplifier, causing decoupling resistors R11 and R12 to burn.

What To Do: Replace 4BZ6, and R11 and R12 (330 ohms each).

CAUTION: Replacing only tube will in some cases permit set to operate, but with lower IF gain. Be sure to check R11 and R12 when tube is replaced.



Mfr: Philco Chassis No. 11H25

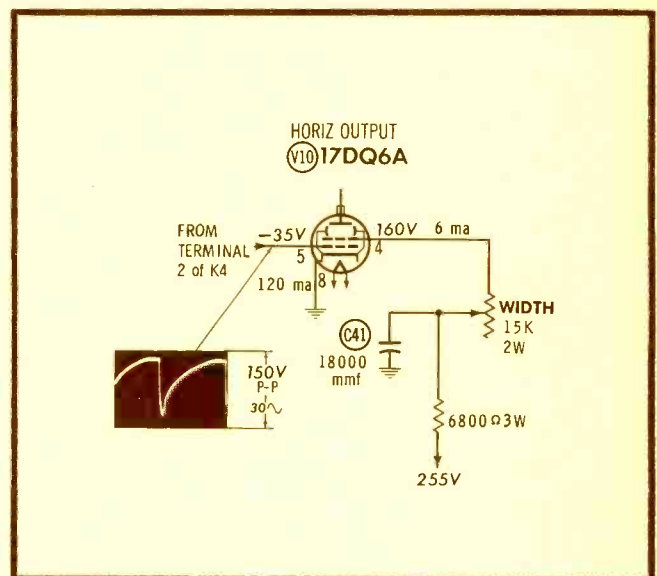
Card No: PH 11H25-2

Section Affected: Pix.

Symptoms: Picture shrinks horizontally.

Cause: Leaky horizontal output screen-bypass capacitor.

What To Do: Replace C41 (18000 mmf).



Mfr: Philco Chassis No. 11H25

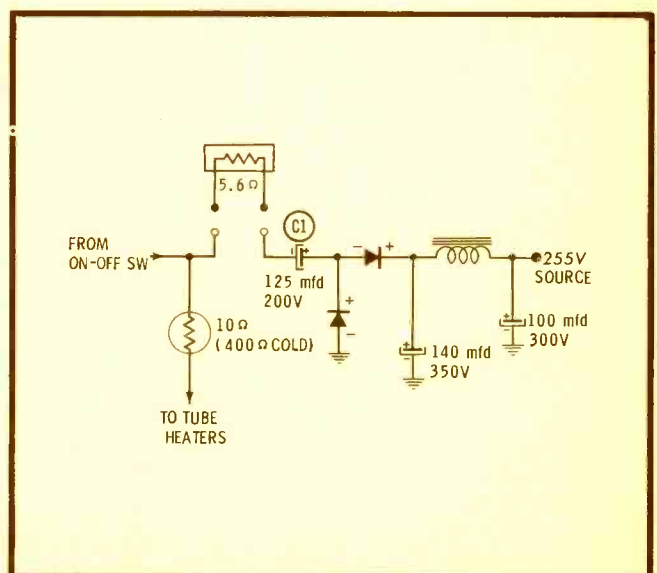
Card No: PH 11H25-3

Section Affected: Pix and sound.

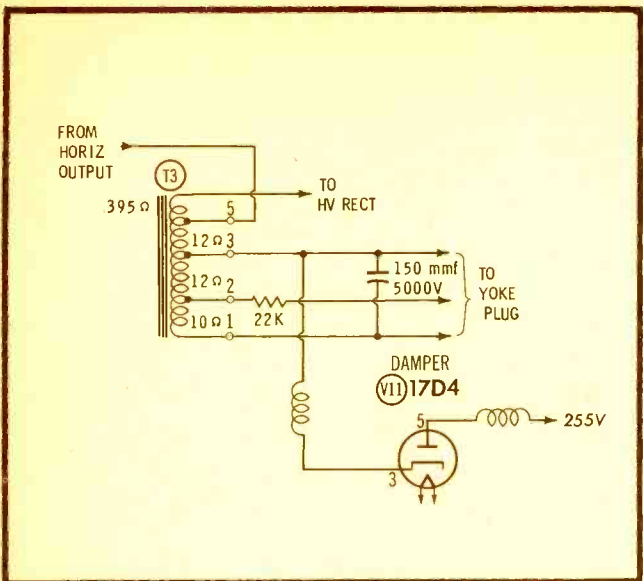
Symptoms: No picture or sound; no B+.

Cause: Open series feed capacitor to B+ rectifier input circuit.

What To Do: Replace C1 (125 mfd—200V). Note that both ends of this capacitor are above ground and proper case insulation is required.



PF REPORTER for September, 1961, Vol. 11 No. 9. PF REPORTER is published monthly by Howard W. Sams & Co., Inc., 2201 E. 46th St., Indianapolis 6, Indiana. Second-class postage paid at Indianapolis, Indiana. 1, 2 & 3 year subscription prices: U.S.A., its possessions, and Canada \$4.00, \$7.00, \$9.00. All other countries: \$5.00, \$9.00, \$12.00. Current single issues 35c each; back issues 50c each.



See PHOTOFACT SET 531, Folder 2

Mfr: Philco Chassis No. 11H25

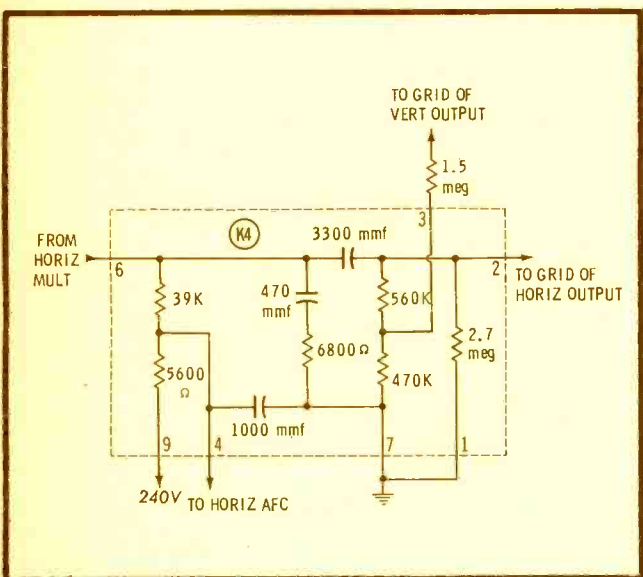
Card No: PH 11H25-4

Section Affected: Raster.

Symptoms: No raster; no high voltage.

Cause: Shorted flyback transformer.

What To Do: Replace T3. Check for proper voltages and waveforms in horizontal oscillator and output stages. Also check deflection yoke for leakage or shorts prior to changing transformer.



Mfr: Philco Chassis No. 11H25

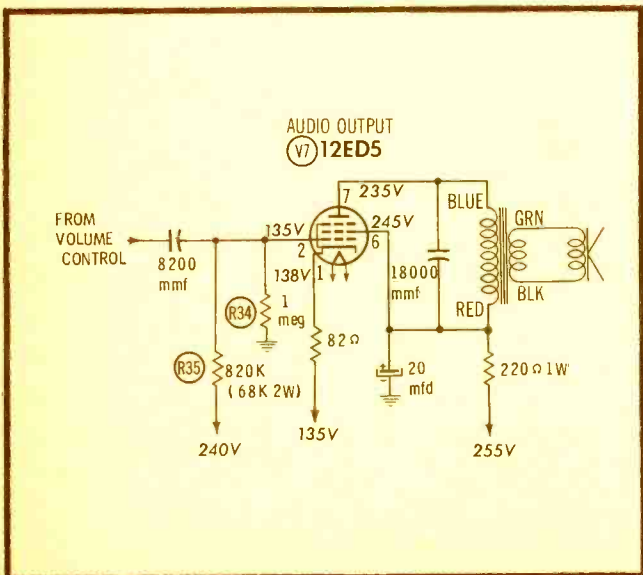
Card No: PH 11H25-5

Section Affected: Raster.

Symptoms: No high voltage; sound OK.

Cause: Shorted coupling capacitor in horizontal oscillator component pack K4.

What To Do: Replace K4 or capacitor section (3300 mmf) with a standard replacement. The component pack is designed so that individual components can be replaced.



Mfr: Philco Chassis No. 11H25

Card No: PH 11H25-6

Section Affected: Sound.

Symptoms: Distorted sound.

Cause: Audio output grid resistor increased in value.

What To Do: Replace R34 (1 meg, 5%).

See PHOTOFAC T Set 503, Folder 2

Mfr: Motorola Chassis No. TS-567Y

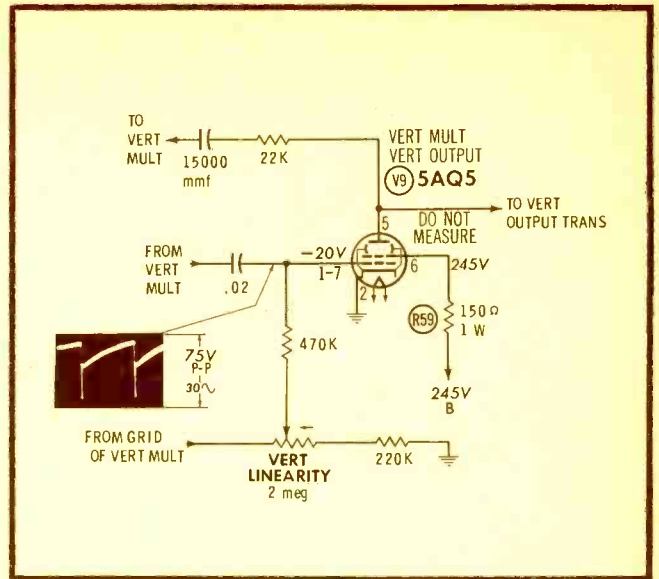
Card No: MO 567Y-1

Section Affected: Raster.

Symptoms: Vertical sweep collapses intermittently.

Cause: Vertical output screen-grid resistor open.

What To Do: Replace R59 (150 ohms — 1W).



Mfr: Motorola Chassis No. TS-567Y

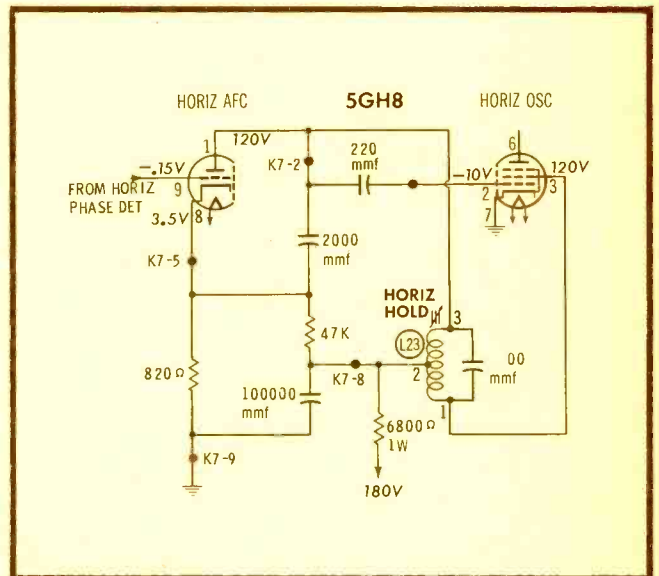
Card No: MO 567Y-2

Section Affected: Raster.

Symptoms: No raster; no high voltage.

Cause: Horizontal stabilizing coil open.

What To Do: Replace L23 or resolder open connection.



Mfr: Motorola Chassis No. TS-567Y

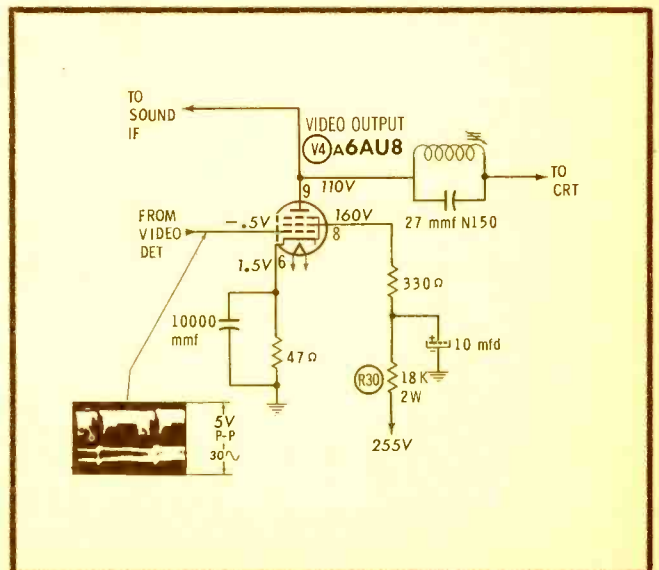
Card No: MO 567Y-3

Section Affected: Pix.

Symptoms: Weak video.

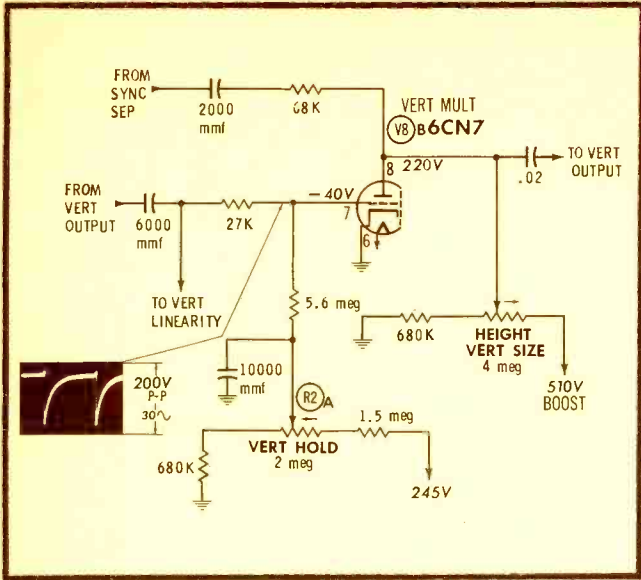
Cause: Video output screen resistor increased in value.

What To Do: Replace R30 (18K—2W).



See PHOTOFAC T Set 503, Folder 2

See PHOTOFACT Set 503, Folder 2



See PHOTOFACT Set 503, Folder 2

Mfr: Motorola Chassis No. TS-567Y

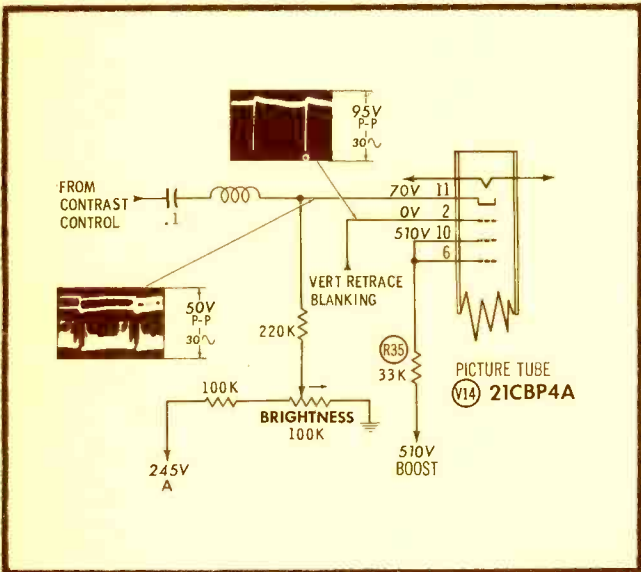
Card No: MO 567Y-4

Section Affected: Sync.

Symptoms: Drifting vertical hold.

Cause: Vertical hold control shorted to ground.

What To Do: Replace R2A (2 meg).



Mfr: Motorola Chassis No. TS-567Y

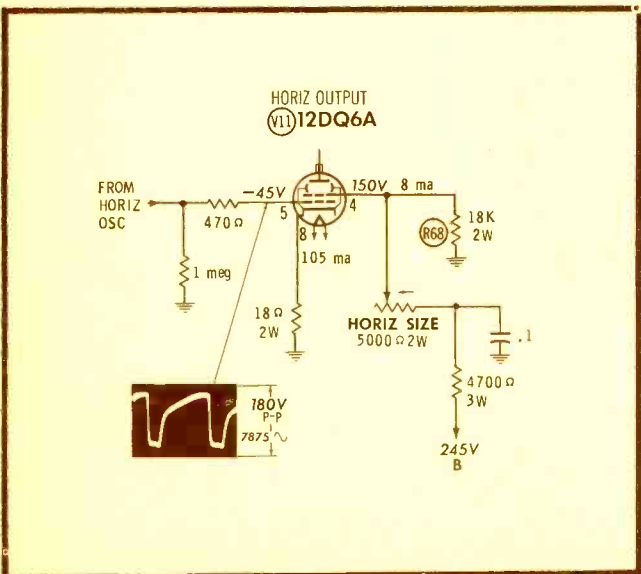
Card No: MO 567Y-5

Section Affected: Raster.

Symptoms: No raster.

Cause: Open series resistor in accelerating-grid circuit of picture tube.

What To Do: Replace R35 (33K).



Mfr: Motorola Chassis No. TS-567Y

Card No: MO 567Y-6

Section Affected: Raster.

Symptoms: Insufficient width. Voltage low at screen (pin 4) of V11, 12DQ6A horizontal output tube.

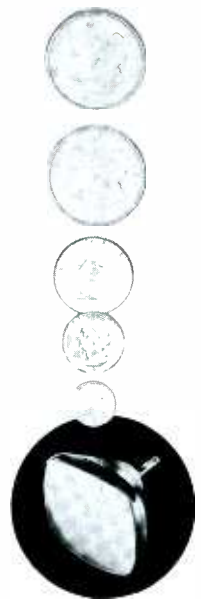
Cause: Screen grid voltage-divider resistor increased in value.

What To Do: Replace R68 (18K—2W).



Average \$2.85 more profit on every 21" tube

Turn the page to find out how ...



Average \$2.85 more profit on every 21" tube

Sell the Admiral Ensign—the top-quality picture tubes with the biggest profit margin in the industry!

Now Admiral's vast purchasing power and national distribution give you the *one* picture tube line with everything: Finest quality workmanship and performance, backed by a 1-Year Guarantee . . . famous brand-name acceptance . . . list prices that appeal to your most economy-minded

customers . . . peak dependability.

And you pocket an average of \$2.85 *more profit* on a 21" Admiral Ensign than on other brands. (Comparably higher margin on all other tube sizes.)

Get the facts! Compare the Ensign line with your present replacement tubes. Compare quality, performance, prices and profits! Discover for yourself why dollar-wise servicemen are switching to the Admiral Ensign.

Call your nearby Admiral Distributor! Start earning more now!

Arizona

Arizona Hardware Co.
P. O. Box 2110
Phoenix, Arizona
ALpine 8-5331

Arkansas

Orgill Bros. Arkansas Co.
301 Rector Street
Little Rock, Arkansas
FRanklin 2-5292

California

Don Anderson, Inc.
2500 California
Fresno 21, Calif.
AM 6-0401

Admiral Sales Corporation
P. O. Box 2092—Terminal Annex
Los Angeles 54, California
RAYmond 3-6451

Admiral Sales Corporation
P. O. Box 1270
San Diego, California
BEImont 9-0231

Admiral Sales Corporation
495 Beach Street
San Francisco 11, Calif.
TUxedo 5-6000

Colorado

Griffin Distributing Co.
1140 West 5th Avenue
Denver 4, Colorado
KEystone 4-6274

Louisiana

Orgill Brothers Louisiana Co.
1571 Texas Avenue
Shreveport, Louisiana
Phone: 425-4271

Montana

The Treasure State Gas &
Electric Co.
827 South Montana Street
P. O. Box 866
Butte, Montana
Phone: 2-2400

Nevada

Osborne & Dermody, Inc.
500 Evans Avenue
Reno, Nevada
FAirview 2-6957

New Mexico

Cunningham Distributing, Inc.
615 Haines, N.W.
Albuquerque, New Mexico
Phone: 7-8838

Oklahoma

Appliance Distributors, Inc.
700 North Pennsylvania
Oklahoma City, Okla.
CEntral 6-8308

Oregon

Seaport Appliance, Inc.
3055 N. W. Yeon Avenue
Portland 10, Oregon
CApital 6-6595

Texas

Price Supply Co.
P. O. Box 86
Amarillo, Texas
DRake 2-6730

Lone Star Wholesalers
8000 Ambassador Row
Dallas, Texas
FLetwood 7-1885

Cunningham Distributing, Inc.
2225 Mills Street
El Paso, Texas
Phone: KE 2-6994

Covington Distributing Corp.
34 North Hamilton St.
Houston 2, Texas
CApital 2-0326

Price Supply Company

3104 Avenue A
P. O. Box 1601
Lubbock, Texas
SHerwood 4-1431

Covington Distributing Corp.
P. O. Box 906
San Antonio 6, Texas
CApital 7-7547

Utah

Westward Distributors, Inc.
204 W. Fourth South
Salt Lake City, Utah
ELgin 5-7556

Washington

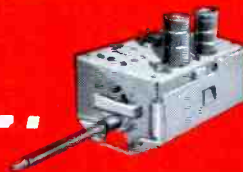
John E. Amberg Co.
757 Harrison Street
Seattle 9, Washington
MUtual 2-5566

John E. Amberg Co.
N. 210 Ralph Street
Spokane, Washington
KEystone 5-1794

NOTICE: All materials and parts used in the manufacturing of Admiral Ensign tubes are new, except for the envelope, which prior to re-use, was carefully inspected to meet the standards of the original new envelope.

ADMIRAL ENSIGN Picture Tubes

Standard Made It...



STANDARD CAN FIX IT BEST

\$11⁵⁰ Plus Parts . . . \$13.50 Maximum Total Cost

FREE Specially designed shipping cartons to prevent damage in transit

**6 Months
GUARANTEE**

Only BRAND NEW PARTS Used - 48 Hour
Service on All STANDARD Tuners • Latest
Testing Techniques Assure Proper Alignment •
\$3.00 Defective Tuner Trade-in Allowance
Against a New STANDARD Replacement Tuner
Carrying a 12 MONTH GUARANTEE

IN TV IT'S *Standard*

STANDARD has maintained uniform mounting centers for the last 13 years. Over 50% of the TV sets in existence today have STANDARD tuners—in the case of most other tuners one of the 8 STANDARD replacement models can be easily adapted or will fit directly in place of these units. All STANDARD replacement tuners carry a 12 Month Guarantee.

**SEE YOUR AUTHORIZED
STANDARD DISTRIBUTOR**

MORE PROFIT FOR THE SERVICE DEALER • GREATER CUSTOMER SATISFACTION
GUARANTEED BY THE WORLD'S LARGEST TV TUNER MANUFACTURER

standard kollman INDUSTRIES INC.

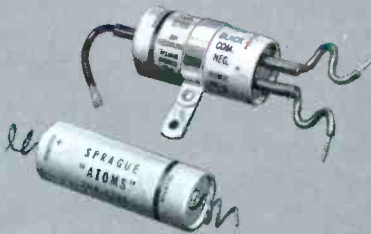
FORMERLY STANDARD COIL PRODUCTS CO., INC., MELROSE PARK, ILLINOIS

September, 1961/PF REPORTER 9



TVL TWIST-LOK® CAPACITORS

These 'lytics take on the toughest TV and radio duty, give maximum trouble-free service, *without HUMMM!* They are dependable at extremely high and low temperatures. Cathodes are etched to meet the needs of high ripple currents, high surge voltages.



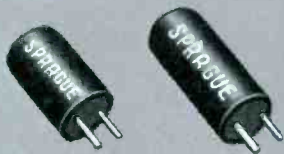
TVA ATOM® CAPACITORS

Atom tubulars are service favorites because they fit anywhere, work anywhere. They're the *only* small size 85 C (185 F) capacitors in ratings up to 450 WVDC. They have low leakage current, long shelf life, and withstand high ripple currents, high surge voltages.



TE LITTL-LYTIC® CAPACITORS

The very best ultra-miniature replacements for transistor circuits, offering unusual reliability through all-welded construction. No pressure joints to cause "open" or intermittent circuits. Long shelf life—extremely important in sets used only part of the year.



VL VERTI-LYTIC* CAPACITORS

These single-ended molded tubulars are the ideal replacement for units of this type found on printed wiring boards. Keyed terminals assure fast manual mounting and correct polarity. Resin end fill protects against drying of electrolyte or entrance of external moisture.



PCL PRINT-LOK® CAPACITORS

The printed circuit version of the Twist-Lok. Universal base replaces any of the printed circuit 'lytics in use today. No makeshift mounting adapters to damage capacitor or add extra height... no possibility of high resistance contacts.

EVERY 'LYTIC YOU NEED...

- every value
- every rating
- every style

Shown here are the more popular of Sprague's big family of Electrolytic Capacitors, the broadest in the industry. Other types include Metal-encased Screwbase; Plastic-encased High-MF; Metal-encased Octal-base; Ultra-low leakage Photoflash. All are listed and described in Sprague's NEW Catalog C-614. Get your copy from any Sprague distributor, or write Sprague Products Company, 105 Marshall Street, North Adams, Massachusetts.

*TRADEMARK

SPRAGUE®
THE MARK OF RELIABILITY

WORLD'S LARGEST CAPACITOR MANUFACTURER

publisher
Howard W. Sams

general manager
Mal Parks, Jr.

editor
Verne M. Ray

managing editor
Joe A. Groves

associate editors
Leslie D. Deane
Thomas A. Lesh

consulting editors
William E. Burke
Robert B. Dunham
George B. Mann
C. P. Oliphant
Paul C. Smith

art director
Don W. Bradley

advertising & editorial assistants
Georgeanna Caldwell
Paula Haffner
Jean Sekulski

production manager
Robert N. Rippy

circulation fulfillment
Fat Tidd, Mgr.
Constance McCawley, Ass't.
Katherine Smith, Ass't.

photography
Robert W. Reed

advertising sales offices
midwestern

John Groce, advertising sales manager
PF REPORTER
2201 East 46th Street, Indianapolis 6, Ind.
Clifford 3-6441

eastern
Charles Horner
Howard W. Sams & Co., Inc.
3 West 57th Street,
New York, N. Y.
MUrray Hill 8-6350

western
The Maurice A. Kimball Co., Inc.
2550 Beverly Blvd., Los Angeles 57, Calif.
Dunkirk 8-6178; and 681 Market Street,
San Francisco 5, Calif. EXbrook 2-3365

Address all correspondence to
PF REPORTER, 2201 East 46th Street,
Indianapolis 6, Indiana



Copyright © 1961 by Howard W. Sams & Co., Inc. PF REPORTER is a trademark of Howard W. Sams & Co., Inc. No part of PF REPORTER may be reproduced without written permission. No patent liability is assumed with respect to use of information herein. Acceptance of advertising does not in any manner signify the products, policies and services so advertised have been approved, endorsed or recommended by this magazine.

Indexed in Electronic Guide and Lectrodex.
Printed by the Waldemor Press Div.
of Howard W. Sams & Co., Inc.



PF REPORTER

including **Electronic Servicing**

VOLUME 11, NO. 9

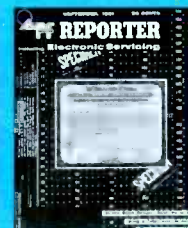
CONTENTS

SEPTEMBER, 1961

Previews of New Sets	1
Admiral Model STG24K131 (Chassis 20L7), General Electric Model M204WVY (Chassis LW), Westinghouse Model H-P3150U (Chassis V-2384-15), Zenith Model G3360W (Chassis 17G28Q).	
Video Speed Servicing	5
Service hints on Motorola Chassis TS-567Y and Philco Chassis 11H25.	
Letters to the Editor	14
Preparing for the Second-Class 'Phone Exam	22
How to apply for a license, what topics to study, and where to obtain help.	
New Ideas in Tube Design	24
The latest approach to conserving space in electronic equipment: Larger-diameter miniature tubes!	
Test Equipment for Audio Servicing	26
Audio Facts—Basic characteristics of special instruments used in professional hi-fi work.	
Service Bench Designs—Build 'Em or Buy 'Em	28
Four convenient layouts that can be built from scratch or assembled from ready-made components.	
Yoke Trouble Plus . . .	30
Across the Bench—A tale of an oddball symptom, with hints on adjusting width and horizontal linearity.	
TV Tuners—Repair or Replace?	32
Take your choice; you can bench-service them, "farm out" the job, or install whole new units.	
Renting Sound Equipment Leads to Sales	38
Dollar and Sense Servicing—Take the profitable "rental route" to launch or expand a commercial-sound business.	
Track Down That Visible Hum	40
Quicker Servicing—You shouldn't have to look far to find the cause of this unmistakable symptom.	
Service Dealer Advertising Program	48
Number 9 in a series.	
Using a Tube Tester to Advantage	50
This "old standby" instrument is trustworthy, not as an oracle, but as a troubleshooting partner.	
Notes on Test Equipment	56
Lab reports on the Jackson Model 600 Oscilloscope, RCA Model WR-64A Color Bar Generator, and Sencore Model SM112 VOM-VTVM.	
The Electronic Scanner	62
Developing Your Home-Call Technique	64
Like to know four specific ways to make a good impression on customers?	
The Troubleshooter	70
Product Report	86
Free Catalog & Literature Service	88
Monthly Index	on free literature card

ABOUT THE COVER

The second-class FCC radiotelephone license has a crisp, businesslike appearance, like a stock certificate. In fact, it is as good as a "gilt-edged security" because it unlocks many excellent sources of revenue. For tips on passing the exam to earn a license, turn to page 22.



Why the WINEGARD ELECTRONIC MOST EFFECTIVE TV ANTENNA...

**DESIGNED TOGETHER
TO WORK TOGETHER... WINEGARD
POWERTRON ANTENNA AND
BUILT-IN AMPLIFIER!**

TRANSISTORIZED!



MODEL SP-55X

"By FAR world's most powerful all-channel antenna"

WHY? BECAUSE . . .



IT CAPTURES MORE SIGNAL than any other all-channel antenna ever made. Patented design, electro-lens director system, dual "TAPERED T" driven elements, 30 precision-tuned elements in all.



IT'S THE ONLY TRUE ELECTRONIC ANTENNA. Only the Winegard Powertron is built with the amplifier as part of the driven element—not an "add-on" attachment.



IT ELIMINATES ALL SIGNAL LOSS that normally occurs between the driven element and the amplifier due to transmission and coupling mis-match.



IT BOOSTS WEAK SIGNALS UP OUT OF THE SNOW far better than any other antenna or antenna-amplifier combination made.



FOR VIVID COLOR, HIGH DEFINITION BLACK AND WHITE AND LONG DISTANCE RECEPTION, nothing can compare to the Super Powertron. Thousands have been installed all over the country and our files are full of testimonials from grateful TV viewers and Service-Technicians alike.



WINEGARD IS THE ONLY MANUFACTURER THAT MAKES BOTH ANTENNAS AND RF AMPLIFIERS. Because of this you can feel confident of getting the very best. But don't take our word for it—let your eyes and ears and field strength meter tell the story.



MODEL P-55
Powertron — transistorized, 14 elements.



MODEL P-55X
Powertron with Pack — Transistorized, 21 elements.



MODEL SP-55X
Super Powertron — transistorized, 30 elements.

POWERTRON is by far WORLD'S

Not 60%...Not 70%...but over 95% efficient

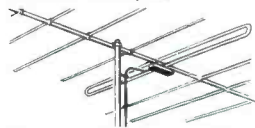
OUTFEATURES — OUTPERFORMS ORDINARY ANTENNAS WITH "ADD-ON" TYPE SIGNAL BOOSTERS!

THIS IS BETTER —



Exclusive amplified "Tapered T" driven element for perfect match and lowest possible signal-to-noise ratio. Only Powertron has it.

THAN THIS —



Not an after-thought "add on" signal booster hung on an ordinary antenna — not an old fashioned mast mounted booster.



ONLY POWERTRON HAS BOTH 300 OHM TWIN LEAD OR 75 OHM COAX TERMINALS ON BUILT-IN AMPLIFIER.



ONLY POWERTRON GIVES YOU YOUR CHOICE OF TRANSISTORS OR TUBES (TUBE MODELS 300 OHM ONLY).

POWERTRON HAS COMPLETELY AC POWER SUPPLY



Transistorized Model has rectifier and filter in power supply — not in amplifier, where servicing is difficult. No batteries. Costs 27c to operate for full year. Battery types require \$5 to \$9 in batteries a year to operate continuously at maximum efficiency.



ONLY POWERTRON HAS RANGE CONTROL SWITCH TO PREVENT OVER-DRIVING TV SETS ON EXTRA STRONG CHANNELS.

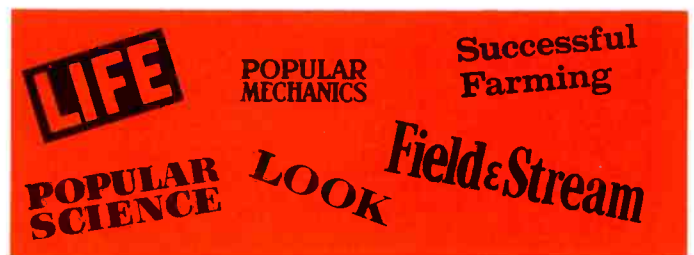


ONLY POWERTRON HAS AC PLUG-IN OUTLET FOR TV SET BUILT INTO THE POWER SUPPLY.

POWERTRON IS 100% CORROSION-PROOFED — ANTENNA IS GOLD ANODIZED, ALL HARDWARE IRRIDIZED, AMPLIFIER HOUSING OF HIGH IMPACT PLASTIC.

ONLY THE POWERTRON CAN DO ALL THIS!

1. Powertron will drive up to 10 TV sets and each set will have a better picture than an ordinary antenna will deliver to one set.
2. Powertron will drive a TV signal through one-half mile of lead-in with signal to spare—permits you unprecedented flexibility for remote installations.
3. Powertron will virtually eliminate snow and interference even on an old TV set.
4. Powertron will deliver superlative color reception far better than a non-electronic antenna.
5. Powertron brings in stations beyond the reach of non-electronic antennas—delivers greatest reception distance.



AND WINEGARD POWERTRON is the only antenna presold to your customers—nationally advertised in the biggest consumer advertising campaign yet! So stock up now—take advantage of the demand Winegard is building for you.

Write for free technical bulletins.



Winegard

ANTENNA SYSTEMS
Winegard Co., 3009-8 Kirkwood, Burlington, Iowa

ATR PRODUCTS FOR MODERN LIVING



ATR PLUG-IN TYPE PORTABLE INVERTERS*

A.C. HOUSEHOLD ELECTRICITY Anywhere... in your own car!
Operates Standard A.C.
● Record Players
● Dictating Machines
● Small Radios
● Electric Shavers
● Heating Pads, etc.
In your own car or boat!

MODELS
6-RMF (6 volts) 60 to 80 watts. Shipping weight 12 lbs. DEALER NET PRICE \$33.00
12T-RME (12 volts) 90 to 125 watts. Shipping weight 12 lbs. DEALER NET PRICE \$33.00
*Additional Models Available



ATR "A" BATTERY ELIMINATOR

For Demonstrating and Testing Auto Radios—TRANSISTOR or VIBRATOR OPERATED!
Designed for testing D.C. Electrical Apparatus on Regular A.C. Lines—Equipped with Full-Wave Dry Disc-Type Rectifier, assuring noiseless, interference-free operation and extreme long life and reliability.

MAY ALSO BE USED AS A BATTERY CHARGER
MODEL 610C-ELIF... 6 volts at 10 amps. or 12 volts at 6 amps. Shipping weight 22 lbs.
DEALER NET PRICE \$49.95
MODEL 620C-ELIT... 6 volts at 20 amps. or 12 volts at 10 amps. Shipping weight 33 lbs.
DEALER NET PRICE \$66.95

AUTO-RADIO VIBRATORS



By every test ATR Auto-Radio Vibrators are best! and feature Ceramic Stack Spacers, Instant Starting, Large Oversized Tungsten Contacts, Perforated Reed, plus Highest Precision Construction and Workmanship and Quiet Operation!

There is an ATR VIBRATOR for every make of car!
Ask your distributor for ATR's Low Priced type 1400, 6 volt 4-prong Vibrator; and 1843, 12 volt 3-prong; or 1840, 12 volt 4-prong Vibrator. THE WORLD'S FINEST!

There is a trim plate kit for YOUR CAR!

ATR CUSTOMIZED KARADIO

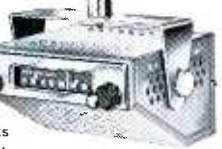


Vibrator-Operated with Tone Control
ATR KARADIO... is ideal for small import cars or compact American cars! Unit is completely self-contained—extremely compact! Powerful 8-tube performance provides remarkable freedom from engine, static, and road noises. The ATR Customized Karadio comes complete with speaker and ready to install. Can be mounted in-dash or under-dash—wherever space permits! No polarity problem. Neutral Gray-Tan, baked enamel finish. Overall size, 7" deep, 4" high, and 6 1/2" wide. Shipping weight, radio set, 7 lbs.
Model K-1278—12 for 12V Dealer Net Price \$33.57
Model K-1279—6 for 6V Dealer Net Price \$33.57

Airplane Style Overhead Mounting under Cab Roof

NO PRINTED CIRCUITRY

ATR TRUCK KARADIO



Excellent Tone, Volume, and Sensitivity!
Compact, yet powerful. Fits all trucks, station wagons, most cars and boats. Just drill a 3/8 inch hole in roof and suspend the one-piece unit (aerial, chassis and speaker) in minutes. Watertight mounting assembly holds antenna upright. Yoke-type bracket lets you tilt radio to any angle.
Extra-sensitive radio has 6 tubes (2 double-purpose), over-size Alnico 5 PM speaker for full, rich tone. Big, easy-to-read illuminated dial. Fingertip tuning control. Volume and tone controls. 33-in. stainless steel antenna. Neutral gray-tan enameled metal cabinet, 7 x 6 1/2 x 4 in. high over-all. Shipping weight 10 1/2 lbs.
Model TR-1279—12 A for 12V Dealer Net Price \$41.96
Model TR-1279—6 A for 6V Dealer Net Price \$41.96

See Your Electronic Parts Distributor Write Factory For Free Literature

ATR ELECTRONICS, INC.
Formerly American Television & Radio Co.
Quality Products Since 1931
ST. PAUL I, MINNESOTA—U.S.A.

LETTERS TO THE EDITOR

Dear Editor:

Your troubleshooting articles would be much more helpful if you would show the picture pattern that appears on the screen when a trouble is present — not just the scope waveform. An example is the article on "Final Scope Checks" in the June issue.

BERNARD TURNER

Washington, D.C.

Now that you mention it, we have been a little neglectful on this point. We'll take immediate steps to incorporate more picture symptoms in the future.—Ed.



Dear Editor:

The enclosed photo of my son might be interesting to you. I've been a PF REPORTER fan from the start, and it looks as if he'll also be one.

WOODWARD RADIO & TELEVISION SERVICE

Roanoke, Va.

He looks like a real go-getter—but if he wants to get anywhere in this business, he'd better learn that the set should have a "diaper" under its chassis, too.—Ed.

Dear Editor:

In regard to your question as to whether anyone agrees with the views expressed by Anthony Anelli (May issue), I, too, find that some of your articles drag out to a monotonous degree.

Also, I believe that your format has changed for the worse over the past five years. Articles like "Electronic Depth Finders," "Industrial Electronic Test Equipment," and "Photoelectric Control Circuits" all leave me cold.

But even with the articles I don't read, I still feel that the balance of the magazine is worth the price. Actually, I don't believe you could ever expect to succeed in publishing a 100% satisfactory magazine. But keep trying!

CHARLES W. RUFFNER

Tuscon, Ariz.

Dear Editor:

With reference to John J. Zeder's letter in the July issue, complaining against the procedures followed by authors of various articles in PF REPORTER, I suggest he take time out to check the author's name on some article he is planning. He might find that the same man has written a book which has helped him solve a service problem.

This fellow must be sharp if he's ready to attack all jobs with no more than a meter. I've got news for him! To my way of thinking, it takes a meter, scope, sweep and marker generators, and any other piece of equipment you can get your hands on to conquer some of these TV dogs.

Glen Mason, who says there isn't enough down-to-earth servicing material in PF REPORTER, should check up on some of the answers to servicemen's problems in *The Troubleshooter* column. Not long ago, I was having a vertical-roll trouble with a Hotpoint Model 21S505. The defect was almost the same as described by Mr. V. Morris (see "Cold Rolls" on page 52 of the July issue), except that the raster would also pull up about 1/4" from the bottom of the screen. I thought I had checked everything that could possibly cause the trouble, but after reading the answer given to Mr. Morris, I found I had overlooked the surge-limiting resistor. After I changed this part, back came a full picture with no more vertical roll.

Thanks a million for the time you and your authors take to help the hard-core serviceman do a good job, no matter what instrument he needs to solve a problem.

HERMAN DAVIS

Chicago, Ill.

Dear Editor:

To answer the letter by John Zeder, I also fix many sets by "using my head," because I can't always interpret waveforms well enough to obtain needed clues. But on countless occasions the scope has saved me hours of time.

I welcome the articles on servicing with a scope, because they are helpful. However, you could improve them by always mentioning the type of probe used.

If any skeptic could see a good scope man repair a TV—especially a "tough dog"—he would be sold on this instrument.

DON ALLEN

Broadway TV Service
Dallas, Texas

Dear Editor:

In your May "Letters" column you let Anthony Anelli speak his mind, and asked if there are any others who agree with him. The answer to that question is, without doubt, a big YES; but this is not your fault at all. Tony answers his own dilemma. TV repair work is passing him by. As he says, "The articles are for engineers." The trend is to better-qualified TV men with more background and ability to analyze the systems presented.

Your magazine must do one of two things — either take the newcomers to

• Please turn to page 18



**Model 650
GRID CIRCUIT ANALYZER
TUBE TESTER**

Tests all standard tubes plus 10 pin miniatures, 12 pin Compactrons, 5 and 7 pin Nuvistors, Novar tubes and a wide variety of voltage regulator types, foreign and industrial tubes. Indicates gas current as low as 1 micro-ampere. Leakage sensitivity over 100 megohms.

Net Price: \$69.95



**ADAPTER G-140
MULTI-SOCKET
ADAPTER UNIT**

Modernizes any tube tester for the test of • 10 pin miniatures • 12 pin Compactrons • 5 and 7 pin Nuvistors and Novar tubes.

Net Price: \$12.95



**Model ST-22
RF-AF SIGNAL TRACER**

High gain RF-AF Signal Tracer for AM, FM, TV and audio. Visual and audible signal indication from antenna to speaker. Noise test circuit, test amplifier and Wattmeter also included. Complete with shielded probe.

Net Price: \$59.95



**Model IC-60
IN-CIRCUIT
CAPACITOR TESTER**

A great time saver! Reveals open or shorted capacitors without removing them from the circuit. Electrolytic dial indicates actual in-circuit electrolytic values from 2 mfd. to 400 mfd.

Net Price: \$32.95



**Model ES-150
5 MC WIDE BAND
OSCILLOSCOPE**

A deluxe, laboratory-type instrument in every sense, the ES-150 oscilloscope covers the entire range between DC and 5 megacycles with outstanding sensitivity and stability.

Net Price: \$149.95



**Model E-75
RF SIGNAL GENERATOR**

A signal generator designed for AM-FM and TV. Frequency ranges from 160 kc. to 240 megs, direct reading in 8 bands. High RF output in excess of 100,000 microvolts. 400 cycle output approximately 15 volts.

Net Price: \$49.95



**Model 48
VACUUM TUBE VOLTMETER**

All-purpose VTVM includes 7 DC (11 megohms input) and 7 AC ranges to 1,500 volts. Measures P-P to 4,000 volts. Resistance in 7 ranges to 1,000 megohms. Three-way probe for voltages and resistance included.

Net Price: \$59.95

NOW! A TOP-QUALITY LINE FROM **PRECISION** THAT EVERY SERVICEMAN CAN AFFORD!

In designing test equipment, Precision has always maintained a firm policy of quality first, price afterwards. Now, thanks to improved manufacturing techniques, we are able to offer a popular priced line which meets the same exacting standards of engineering that have made Precision a leader in the field of over a quarter of a century! This puts Precision Electronic

Test Equipment within the reach of virtually every radio technician, student and engineer. On this page, you'll find apparatus that meets your own specific requirements. And you'll find you can save time and do more jobs when Precision does the trouble-shooting. REMEMBER, ALL PRECISION TEST EQUIPMENT IS GUARANTEED FOR ONE FULL YEAR!

See these and PRECISION'S Industrial Test Instruments at your local electronics distributor.

OTHER TOP ITEMS FROM THE NEW **PRECISION** LINE:

- Model CB-26 Resistance-Capacity-Ratio Bridge Net Price: \$79.95
- Model P-28 Battery Eliminator and Charger With Built-In Low-Ripple L/C Filter \$64.95
- Model RS-24 Regulated Power Supply \$99.95
- Model 1904 Decade Condenser \$29.95
- Model 1601 Decade Resistor/Divider \$29.95
- Model 1803 Condenser Substitution Box \$12.95
- Model 1702 Resistance Substitution Box \$15.95

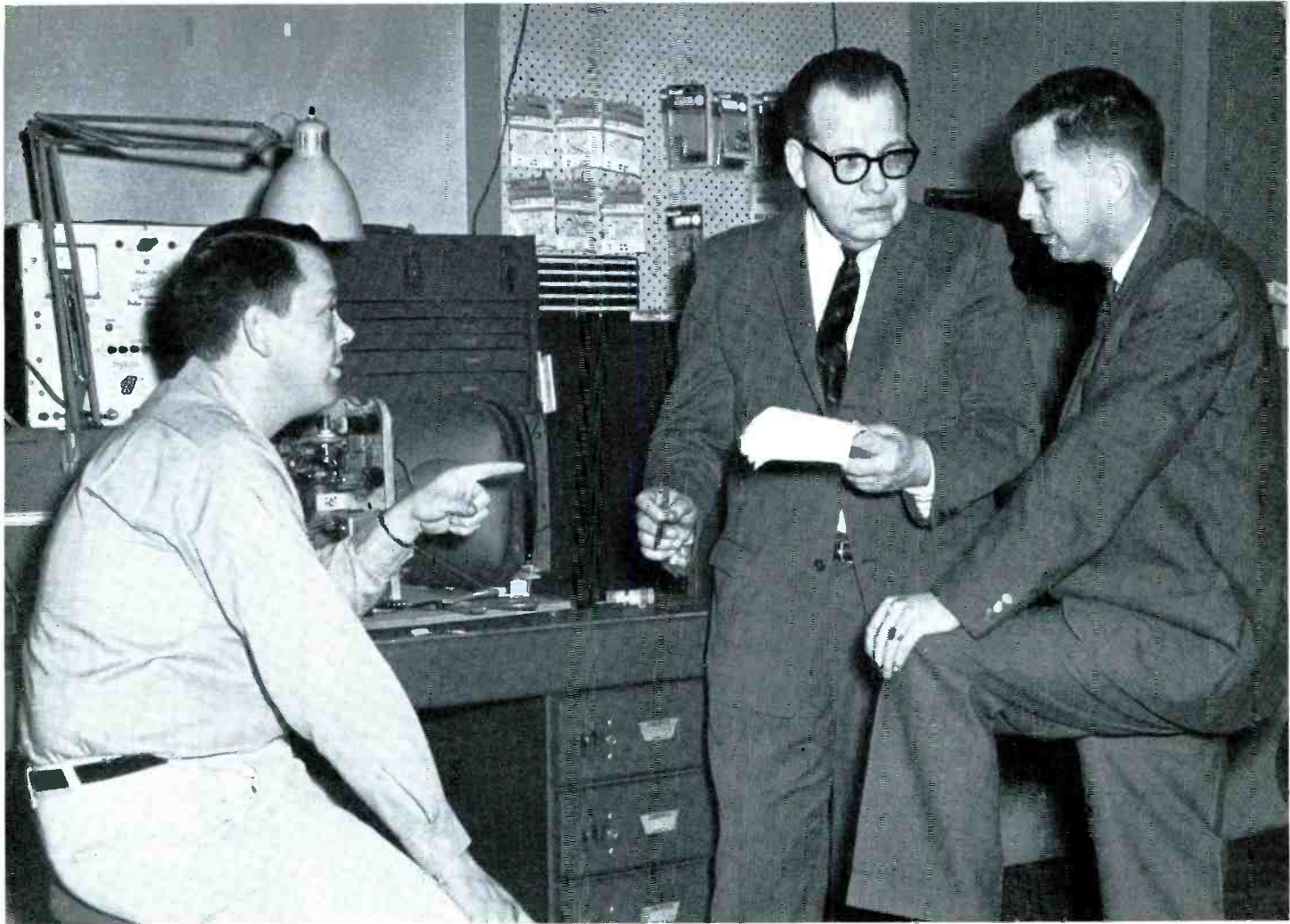
PRECISION Apparatus Company, Inc.,
70-31 84th Street, Glendale 27, N. Y.

Please send me more information on the model numbers circled below:

650	ES-150	P-28	1803
G-140	E-75	RS-24	1702
ST-22	48	1904	
IC-60	CB-26	1601	

Name _____
 Address _____
 City _____ Zone _____ State _____
 Dept. A

"When it's Mallory...I know it's reliable"



Don Domers (center), shown here with servicemen Everett Hammond and Jess Cody, has built a growing business on a reputation for quality servicing of radio, TV, auto radio, hi fi and stereo sets, and antennae

installation. Don has had his own shop for 29 of his 34 years in radio servicing, now has 7 employees. He's also an authorized Philco, Motorola and Sylvania dealer, having carried the first two lines for 20 years.

Your Mallory distributor stocks these quality components



TC TUBULAR ELECTROLYTICS

Economical filter capacitors. Hermetically sealed. Also special TCX type for -55°C . Twin-pack keeps leads free from kinks.



FP ELECTROLYTICS

Original 85°C capacitor, now better than ever. Etched cathode gives hum-free performance. Chassis or printed circuit mounting.



STA-LOC® CONTROLS*

Your distributor can custom build in just 30 seconds, any of over 38,000 single or dual controls.

*U. S. Patent 2,958,838.



GOLD LABEL® VIBRATORS

Quietest ever made... for the best in auto radio servicing. Buttonless contact design gives longest trouble-free service, sure starts.

says Don Domers, Terre Haute service dealer

"Wherever possible, I always use Mallory parts . . . and I've never had a call-back caused by one. When they're labeled 'Mallory', I know they're dependable. I first tried new PVC capacitors for that very reason—then I found a lot more reasons for liking them. For instance, the handy zip-lip plastic pack keeps stock visible and easy to count, can be hung on my rack for fast use; and PVC's flexible plastic jacket never cracks when we bend or solder the leads."

You'll find this kind of money-saving, customer-pleasing reliability in all Mallory replacement parts. It's the industry's broadest line . . . all top quality . . . all sensibly priced. See your Mallory distributor soon.



Don Domers buys all his parts from Mallory distributor C. T. Evinger Co., Terre Haute, a quality distributor who handles quality parts. He's shown here with Charlie Evinger and salesman Max Springer.

Put an end to call-backs . . . buy your parts from Mallory authorized distributors.

Distributor Division, Indianapolis 6, Indiana

P. R. MALLORY & CO. Inc.
MALLORY

In Canada: A. C. Simmonds & Sons, Ltd., Toronto 7, Ontario



MALLORY PVC CAPACITORS

New, blue Mylar** capacitors. Withstand moisture, heat, bending of leads and overloads.

**Reg. T. M., E. I. du Pont de Nemours & Co., Inc.



MALLORY MERCURY BATTERIES

Tops for transistor radios. Up to 7 times more *sound power*† . . . guaranteed against leakage . . . stay "live" for years when idle . . . won't fade. †T.M.



SILICON RECTIFIERS

Top quality, moisture-proof. 5-packs, in re-usable jewel boxes, on handy 3" x 5" file cards. 50 volt to 600 volt ratings.



RMC DISCAPS®

Quality standard for original equipment. 5-packs, in re-usable jewel boxes, on handy 3" x 5" file cards.

®Trademark Radio Materials Company, a Mallory division.

NEW BUSINESS!



SELL 4-TRACK STEREO CONVERSIONS by Nortronics

AND HERE ARE
11 REASONS WHY YOU
WILL BE SUCCESSFUL

1. All tape recorder customers past and present are prospects.
2. The line is complete covering all major tape recorders. So easy to install, customer can do it himself.
3. Advertising in major consumer publications stimulates customer interest.
4. Leads from this advertising are sent to you in your area.



5. Starter package includes attractive counter display unit complete with sales appealing literature.
6. Consumer coupon in each Conversion Kit good for \$1.45 saving on \$3.95 UST Sampler Tape. This "point-of-sale" closer required no handling by the dealer.
7. A complete Tape Reference Guide for counter use, covering conversion and replacement, is available.
8. United Stereo Tape is cooperating in the promotion of 4-track Stereo conversion. Nortronics insert enclosed in some raw tape cartons. Owners of 4-track equipment are its best salesmen.
9. Professional quality has gained world-wide acceptance for Nortronics super-laminated heads.
10. Fully guaranteed quality and workmanship.
11. The Dealer Starter Package makes it easy to display and profitable to sell the Nortronics line.

Send for information on this proven,
PROFITABLE New Business!



THE Nortronics CO., INC.

"Music sounds best on tape—
tape sounds best on Nortronics Heads!"

1021 South Sixth St., Minneapolis 4, Minn.

Please send me more information on
Nortronics Dealer Sales Plan.

Name _____

Dealer _____

Address _____

City _____ Zone _____ State _____

Letters

(Continued from page 14)

school or progress with the trend of the times. You know the answer to that: Go ahead.

A serviceman need not be a full-fledged electronics engineer, but he should have the ability to understand the basic references to electronic functions. However, this brings up a criticism of the electronics industry as a whole. It is fast becoming a "Tower of Babel" in which new words are coined every day, often with several different expressions referring to the same thing. The result is general confusion, even among those in the know. The remedy: Issue a dictionary—make it stick.

ERNEST LUKIS

Tyler Electronics
Bronx, N.Y.

Dear Editor:

Messrs. Zeder and Mason are symptomatic of too large a segment of the servicing fraternity. They seem interested only in how something is accomplished, not in the "why" of the problem.

I once ran a service clinic for a New York City servicemen's organization. Any member had the privilege of bringing in his "dogs" for clinic treatment at the very nominal fee of \$1 per set. Many availed themselves of this service, but it didn't take me long to realize that the great majority were abusing the privilege. A stock attitude was, "We don't care about your explanations; just fix the set and let us get out of here." In the face of such frank obnoxiousness, I quickly packed the project in.

Let us never forget the axiom, "He who knows *how* will always have a job, but he who knows *why* will always be his boss."

HARRY M. LAYDEN

Graduate TV Workshop
New York, N.Y.

Thanks to all for your comments, of which we've been able to print only a few representative examples. Generally, the response indicates that we should keep PF REPORTER just about the way it is.

For Don Allen, "Picking the Probe for the Job" has been scheduled for the January issue. Mr. Lukis, we have the manuscript of a 10,000-word dictionary in the house, and hope to publish it late in November. To Harry Layden, we offer special thanks for coming through with such an appropriate axiom.—Ed.

Dear Editor:

Even though I subscribe to several TV magazines, the one I read from cover to cover and save for future reference is PF REPORTER. The first article I read is always *Notes on Test Equipment*, because it has helped me very much in selecting good instruments.

I'd like to find out one more thing about the B & K Model 1076 *Television Analyst* described in the July issue. Is the high voltage used in the scanner system sufficient to cause X-ray emission?

ALI HESHMATI

Carmel TV and Radio Service
Carmel, Calif.

No! It is less than the CRT anode

voltage of a typical portable TV set—still high enough to be treated with plenty of respect, but not high enough to create an X-ray hazard.—Ed.

Dear Editor:

Your "Operation Vertical" articles in the January and February issues were tops, but they were too brief on two phases of the subject which should rate an entire article. One is vertical roll, especially intermittent upward rolling; the other is that peculiar condition in which the raster comes on full size, but the bottom creeps up an inch or more as the set plays. A high percentage of the TV sets in use have one or the other of these minor troubles, so an informative article on them would be appreciated.

WEBSTER H. FOULON

Cheney, Wash.

This article is already in the works and will appear some time early next year.—Ed.

Dear Editor:

Because I am 80 years old, I'm retiring from active radio and TV work. However, I do want to say that I've been well pleased with your magazine over the years and have found it very useful and interesting.

JAMES F. GAFFNEY

Steelton, Pa.

Thanks, J.F., and good luck to you. Incidentally, your letter is a jolting reminder of the great speed of modern progress; when you were born, electric lights were as great a novelty as transistorized TV is today!—Ed.

Dear Editor:

On examining the *Stock Guide for TV Tubes* which appeared in the May issue, I was amazed at the number of tubes you recommend for carrying on house calls. Is such a large stock really necessary for a man who makes 4 or 5 calls a day, if he restocks his caddy each morning?

I take along a sweep-circuit analyzer, VTVM, high-voltage probe, and tube-socket adapters, all of which I find useful for making complete repairs in the home.

ALBERT E. MORRA

Winthrop, Mass.

From your list of in-the-home test equipment, we begin to see why you don't want to carry an overly large number of tubes!

In selecting the tube stock, we had in mind a hypothetical serviceman who makes 7 or 8 calls a day without restocking, and who relies heavily on relevant tube substitutions for in-the-home troubleshooting. He's really not so hypothetical, because we know many successful servicemen who carry two caddies full of tubes.

However, if you can return to the shop more often, or can get by with a smaller tube stock, you can proportionally reduce the chart figures. This means leaving out some of the least-needed types, as well as reducing the quantity of more common types. You can also increase the figures in order to use the chart as the basis for a shop stock.—Ed.

F.C.C. COMMERCIAL OPERATOR LICENSE

Training... for Jobs in Electronics

F. C. C. LICENSE — THE KEY TO BETTER JOBS

An F. C. C. *commercial* (not amateur) license is your ticket to higher pay and more interesting employment. This license is Federal Government evidence of your qualifications in electronics. Employers are eager to hire *licensed* technicians.

WHICH LICENSE FOR WHICH JOB?

The **THIRD CLASS** radiotelephone license is of value primarily in that it qualifies you to take the second class examination. The scope of authority covered by this license is extremely limited.

The **SECOND CLASS** radiotelephone license qualifies you to install, maintain and operate certain radiotelephone equipment but not commercial broadcast station equipment.

The **FIRST CLASS** radiotelephone license qualifies you to install, maintain and operate every type of commercial radiotelephone equipment including all radio and television stations in the United States, its territories and possessions. This is the highest class of radiotelephone license available. Many companies which employ industrial electronics technicians require this license.

GRANTHAM TRAINING PREPARES YOU

The Grantham Communications Electronics Course prepares you for a **FIRST CLASS** F. C. C. license, and it does this by **TEACHING** you electronics. Each point is covered simply and in detail, with emphasis on making the subject easy to understand. The organization of the subject matter is such that you progress, step-by-step, to your specific objective—a first class F. C. C. license.

CORRESPONDENCE OR RESIDENCE CLASSES

Grantham training is available by correspondence or in resident classes. Either way, you are trained quickly and well. Write, or mail the coupon below, to any division of Grantham School of Electronics. Our free booklet will be sent to you immediately.

HERE'S PROOF . . .

that Grantham students prepare for F. C. C. examinations in a minimum of time. Here is a list of a few of our recent graduates, the class of license they got, and how long it took them:

	License	Weeks
Thomas Schutte, 736 Clinton, Hamilton, Ohio	1st	12
Gary Harrison, 29 Spencer Drive, N. Kingston, R. I.	1st	12
Louis W. Pavak, 838 Page St., Berkeley 10, Calif.	1st	16
William F. Bratton, Jr., 435 Etna Street, Russell, Ky.	1st	12
Darrell E. Cloce, 25 E. 32nd St., Kansas City, Mo.	1st	12
Thomas J. Hoof, 216 S. Franklin St., Allentown, Pa.	1st	22
P. B. Jernigan, Route 2, Benson, North Carolina	1st	12
Edward R. Barber, 907 S. Winnifred, Tacoma, Wash.	1st	20
Claude Franklin White, Jr., c/o Radio Sta. WJMA, Orange, Va.	1st	12
John M. Morgan, c/o KIRI-TV, 1530 Queen Anne Ave., Seattle, Wash.	1st	9½

FOUR SCHOOLS TO SERVE YOU

To better serve our many students throughout the entire country, Grantham School of Electronics maintains four Divisions—located in Hollywood, California; Kansas City, Mo.; Seattle, Wash.; and Washington, D.C. Grantham offers rapid courses in F. C. C. license preparation, either by home study or in resident classes.

Accredited by the National Home Study Council

Grantham School OF ELECTRONICS

HOLLYWOOD
CALIF.

1505 N. Western Ave.
Hollywood 27, Calif.
(Phone: HO 7-7727)

SEATTLE
WASH.

408 Marion Street
Seattle 4, Wash.
(Phone: MA 2-7227)

KANSAS CITY
MO.

3123 Gillham Road
Kansas City 9, Mo.
(Phone: JE 1-6320)

WASHINGTON
D. C.

821-19th Street, N. W.
Washington 6, D. C.
(Phone: ST 3-3674)

for **FREE** Booklet **CLIP COUPON** and mail
in envelope or paste on postal card.



To: **GRANTHAM SCHOOL OF ELECTRONICS**

1505 N. Western Hollywood • 408 Marion Seattle • 3123 Gillham Rd. Kansas City • 821-19th, NW Washington

Please send me your free booklet telling how I can get my commercial F. C. C. license quickly. I understand there is no obligation and no salesman will call.

Name _____ Age _____

Address _____

City _____ State _____

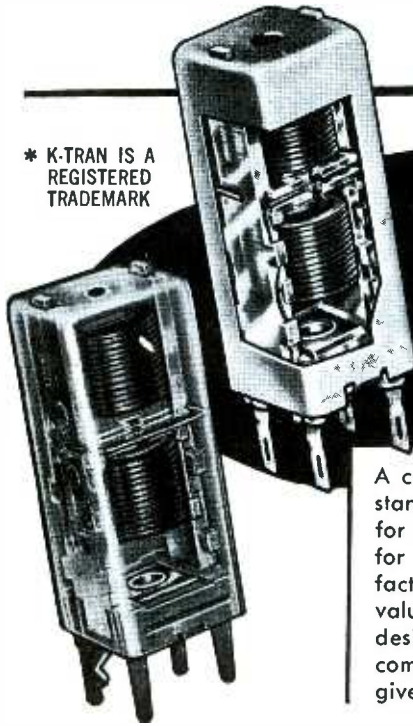
I am interested in: Home Study, Resident Classes 19-P

MAIL COUPON NOW

Miller



* K-TRAN IS A REGISTERED TRADEMARK



THE FAMOUS K-TRAN^{*} I.F. TRANSFORMERS

A complete line of the finest I.F. transformers available anywhere at any price. Both standard and miniature sizes in all of the commonly used I.F. frequencies are stocked for immediate delivery. Conventional as well as printed circuit types are available for both vacuum tube and transistorized applications. Original equipment manufacturers will find the K-Tran the ideal choice for new equipment designs thus saving valuable engineering manhours and being assured of a top quality transformer designed by engineers with over 30 years of manufacturing experience in electronic components. The K-Tran also makes an excellent replacement transformer and will give results equal to or better than the original.

AVAILABLE IN THE FOLLOWING FREQUENCIES

CAT. NO. Printed Circuit Types	CAT. NO. Regular Standard Types	Dimensions: 3/4" square x 2" high	FREQ.	USE
13-PH1	12-H1		262 KC	Input transformer
13-PH2	12-H2		262 KC	Output transformer
13-PH6	12-H6		262 KC	Output transformer with diode filter
13-PC1	12-C1		455 KC	Input transformer
13-PC2	12-C2		455 KC	Output transformer
13-PC6	12-C6		455 KC	Output transformer with diode filter
13-PC7	12-C7		455 KC	Input transformer for battery radios
13-PC8	12-C8		455 KC	Output transformer for battery radios
13-PC9	12-C9		455 KC	Input transformers for AC-DC radios
13-PC10	12-C10		455 KC	Output transformer for AC-DC radios
	12-C11		455 KC	IF transformer (G.E.-RTL 143 and 163)
	12-C12		455 KC	Tapped Pri. I.F. transformer
	12-C45		455 KC	Discriminator
	13-W1		1500 KC	Input and interstage transformer
	13-W2		1500 KC	Output transformer
6203-PC	6203		4.5 MC	Input or interstage transformer
6204-PC	6204		4.5 MC	Discriminator transformer
6205-PC	6205		4.5 MC	Ratio detector transformer
6206-PC			4.5 MC	Ratio Det. (GE-RTD-026)
6207-PC			4.5 MC	Ratio Det. (GE-RTD-025)
6208-PC			4.5 MC	Ratio Det. (GE-RTD-020)
1463-PC	1463		10.7 MC	Input or interstage transformer
1464-PC	1464		10.7 MC	Discriminator transformer
	1464-WB		10.7 MC	Discriminator 900 KC Peak to Peak
1465-PC	1465		10.7 MC	Ratio detector transformer
	1465-WB		10.7 MC	Ratio detector 800 KC Peak to Peak
	6260		21.25 MC	I.F. Transformer
	6261		21.25 MC	Discriminator transformer
	6262		21.25 MC	Ratio detector transformer
6230-PC	6230		44 MC	TV Converter I.F. Transformer
6231-PC	6231		44 MC	TV First I.F. Transformer
6232-PC	6232		42.5 MC	TV second I.F. Transformer
6233-PC	6233		42.5 MC	TV third I.F. Transformer
6234-PC	6234		44 MC	TV fourth I.F. Transformer

Available Through Your Local Distributor
Miller Quality Products are recognized by the entire electronics industry as representing the finest in workmanship, performance, and dependability.

^oManufactured under K-Tran patents of and by Automatic Manufacturing Corp., Division of General Instrument Corporation.

Miniature I.F. Transformers for printed circuit transistorized applications. These miniature I.F. Transformers have tuned primary and untuned secondary windings. Proper impedance match between primary and secondary insures optimum performance.

Dimensions: 1/2" square x 3/4" high

CAT. NO.	FREQ.	SPECIFICATIONS
2031	455 KC	10K Ohm pri. to 600 Ohm Sec., Input
2032	455 KC	10K Ohm pri. to 1000 Ohm Sec., Output
2041	455 KC	25K Ohm pri. to 600 Ohm Sec., Input
2042	455 KC	25K Ohm pri. to 1000 Ohm Sec., Output
2051	455 KC	100K Ohm pri. to 1000 Ohm Sec., Input

Sub-Miniature I.F. Transformers for printed circuit transistorized applications. To our knowledge the smallest I.F. Transformers in existence. Ferrite cup core construction permits the use of extremely small shields without adversely affecting transformer operation. A high impedance, tapped primary winding coupled to a low impedance secondary provides optimum energy transfer between stages.

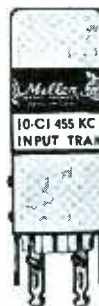
Dimensions: 3/8" square x 3/8" high

CAT. NO.	FREQ.	SPECIFICATIONS
9-C1	455 KC	25K Ohm pri. to 600 Ohm Sec., Input
9-C2	455 KC	25K Ohm pri. to 1000 Ohm Sec., Output

Also a sub-miniature I.F. Transformer for conventional circuitry using vacuum tubes. A 455 KC intermediate frequency transformer which has all the desirable features of the standard size I.F. and is smaller than a MINIATURE tube. Through the use of a ferrite cup core these sub-miniature I.F. Transformers offer the gain and bandwidth characteristics previously obtained only in larger I.F. assemblies. For AC-DC or battery radios.

Dimensions: 1/2" square by 1 1/2" high

CAT. NO.	FREQ.	USE
10-C1	455 KC	Input transformer
10-C2	455 KC	Output transformer



Write for Miller general catalog and Replacement Guide, or ask for them at your distributor.

J. W. MILLER COMPANY

EXPORT REPRESENTATIVE

Roburn Agencies, Inc.
431-435 Greenwich Street
New York 13, New York
WOrth 6-2130

FACTORY

5917 SOUTH MAIN ST., LOS ANGELES 3, CALIF.

Phone ADams 3-4294

FAX No. XCM

CANADIAN REPRESENTATIVE

Warehouse Stock
Atlas Radio Corporation, Ltd.
50 Wingold Ave.
Toronto 19, Ontario, Canada

Tarzian offers

FAST, DEPENDABLE TUNER REPAIR SERVICE



ALL
MAKES

It just makes sense that a manufacturer of tuners should be better-qualified, better-equipped to offer the most dependable tuner repair and overhaul service.

Sarkes Tarzian, Inc., pioneer in the tuner business, maintains a complete, well-equipped Factory Service Dept.—assisted by Engineering personnel—and staffed by specialized technicians who handle **ONLY** tuner repairs . . . on **ALL** makes and models.

Tarzian-made tuners received one day will be fixed and shipped out the next. Cost is only \$8.50 and \$15 for UV combinations. That includes **ALL** parts and labor, and a 6-month guarantee against defective workmanship and parts failure due to normal usage. Replacements available at low cost on tuners beyond practical repair.

Ⓢ Tarzian-made tuners are identified by this stamping. When inquiring about service on other tuners, always give tube complement . . . shaft length . . . filament . . . voltage . . . series or shunt heater . . . IF frequency . . . chassis identification. All tuners repaired on approved, open accounts. Check with your local distributor for Sarkes Tarzian replacement tuners, replacement parts, or repair service.

SERVICE MANAGER • TUNER DIVISION • DEPT. 3A



SARKES TARZIAN INC

east hillside drive • bloomington, indiana
edison 2-7251

MANUFACTURERS OF TUNERS . . . SEMICONDUCTORS . . . AIR TRIMMERS . . . FM RADIOS . . . AM-FM RADIOS . . . AUDIO TAPE . . . BROADCAST EQUIPMENT and SHISH-KABOB GRILLES

ONLY
\$8.50
INCLUDING

ALL PARTS and LABOR

24-HOUR SERVICE 6-MONTH WARRANTY

Tuners Repaired on Approved, Open Accounts

See your distributor, or
use this address for fast,
factory repair service

PREPARING FOR THE 2ND-CLASS PHONE EXAM

How to build a solid background without cramming . . . by Edward M. Noll

Obtaining an FCC radiotelephone operator's license is a major milestone in the career of an electronic technician. Generally speaking, it provides tangible proof of his sound technical background, which raises his professional standing in the eyes of the public and of prospective employers. A more specific benefit of a license is that it opens the door to many new lines of work. To the independent serviceman, the most important of these is two-way radio. A second-class license qualifies him to work on all radiophone units licensed in the public safety, industrial, and land transportation services. He is also eligible to service Citizens band equipment and nearly all marine and aviation radiotelephone gear. The success story of CB is already well known; in addition, small-boat electronics has grown into a business with a sizable dollar volume, and even the smallest of private aircraft carry a variety of electronic equipment.

The vast increase in the number

of two-way radio systems is only one reason why communications radio has a fast-growing influence on the independent electronics service industry. It is also true that many of the users of this gear are small businesses or private individuals who look to local repair firms for service on their equipment. In fact, the ready availability of good service is often the deciding factor in the original installation of a system. Here is a challenge that begs to be accepted. Your first step in meeting it is to aim for a second-class license.

The Exam—Where and How

Second-class radiotelephone license examinations are given at the various field offices of the Federal Communications Commission (listed in Table I), and also by traveling examiners in certain outlying districts according to an established schedule. You can obtain the necessary application form, and also find out when examinations are held, by writing to the field office nearest you.

A license application must be filed on FCC Form 756, a sample of which is shown in Fig. 1. This form is a single sheet with questions on both sides.

The examination takes several hours. Three sections (Elements I, II, and III) must be passed by applicants for a second-class license. Element I consists of 20 multiple-choice questions on basic law, and 5% credit is allowed for each question. Element II contains 50 multiple-choice questions on basic operating practice, with 2% credit for each question. Element III is on basic radiotelephone, and is made up of 100 questions—a mixture of multiple-choice, schematic completion, and correction of schematic

error. Each question has 1% credit. The passing grade for each element is 75%. Portions of the examination use a machine-graded answer sheet of the type shown in Fig. 2.

What to Study

An experienced electronics service technician, if he prepares himself by studying in advance, should have no trouble passing the examination. Many of the questions in Element III are quite elementary. You probably know the answers now, or can soon recall them by reviewing your training in basic electronics. Element III questions can be broken down into several categories. These are:

Electronic Terms and Principles

A good review of common electronic terms such as resistance, power factor, conductance, etc. is in order. Know how to handle simple Ohm's law problems. Refresh your memory concerning the im-

• Please turn to page 73

The image shows a sample of FCC Form 756, titled 'APPLICATION FOR LICENSE OPERATOR LICENSE'. It is a form with multiple sections for personal information and licensing details. A large 'SAMPLE' watermark is overlaid on the form. The sections include: 1. Name of Applicant (Last, First, Middle Initial), 2. Place of Birth, 3. Date of Birth, 4. Citizenship (with checkboxes for U.S. born, naturalized, or dual citizen), 5. Place of Residence, 6. Previous Licenses, 7. Fees, 8. Signature and Date, 9. License Type (with checkboxes for various license categories), and 10. Remarks.

Fig. 1. Sample of FCC Form 756, the application for a radiophone license.

All communications should be addressed to Engineer in Charge, FCC, at nearest field office. Mailing addresses are as follows:	
Mobile 35, Ala.	New Orleans 13, La.
P.O. Box 544	Baltimore 2, Md.
Anchorage, Alaska	Boston 5, Mass.
P.O. Box 142	Detroit 25, Mich.
Juneau, Alaska	St. Paul 3, Minn.
Los Angeles 14, Calif.	Kansas City 67, Mo.
San Diego 1, Calif.	Buffalo 3, N.Y.
San Francisco 35, Calif.	New York 13, N.Y.
San Pedro, Calif.	Portland 5, Ore.
Denver 2, Colo.	Philadelphia 6, Pa.
Washington 25, D.C.	P.O. Box 2987
P.O. Box 160	Sao Juan 13, Puerto Rico
Miami 1, Fla.	P.O. Box 2327
Tampa 2, Fla.	Beaumont, Texas
Atlanta 1, Ga.	Dallas 23, Texas
P.O. Box 77	El Paso 11, Texas
Savannah, Ga.	Norfolk 10, Va.
Honolulu 13, Hawaii	Seattle 4, Wash.
Chicago 4, Ill.	

Transmission Line Cables



8225



8226



8230



8285



8235

Microphone and Shielded Power Supply Cables



8410

RUBBER



8411



8413

PLASTIC



8420

Mr. Service Technician:

Ask your Belden jobber about this complete wire and cable line

What types of wire and cable do you need? Ask your Belden electronics jobber for complete specifications on types, sizes, insulations, and convenient spooled lengths. Available from stock.

Hi-Fi, Stereo, and Phonograph Cables



8421



8430



8419

Rubber-Vinyl Multiconductor Portable Cordage



8462

8888

Power Supply Cords

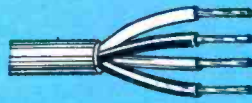


17106

Antenna Rotor Cables



8464



8484

Hook-Up Wire



8800



TV and Cheater Cords



8874



8875

Aluminum Ground Wire



8018



- power supply cords • cord sets and portable cordage • electrical household cords • magnet wire • lead wire • automotive wire and cable • aircraft wires • welding cable



ideas in tube design

More efficient cousins of miniature glass tubes are coming into use . . . by Thomas A. Lesh



Fig. 1. G-E Compactrons. Left to right: 6C10, 6FJ7, 6B10, 6AX3, 6D10, 6K11.

Probably you've handled thousands of octal-based "GT" tubes (6SN7's, 6AX4's, etc.) and are thoroughly familiar with the 1 1/8"-diameter "T9" tubular glass envelope used on these types. Although octals are getting rarer as they become outmoded by more modern designs, the T9 bulb has taken a new lease on life. Miniature-tube construction techniques have been applied to this generous-sized en-

velope, resulting in more efficient tubes. Developments are proceeding in several different directions at once, but they all boil down to only two major objectives. The new T9 tubes are designed for either *more different functions* or *more power capacity* than existing miniature types.

Three-In-Ones

In modernizing the T9 envelope, General Electric is concentrating mainly on developing multifunction designs to reduce the number of tubes needed in electronic equipment. *Compactrons* (Fig. 1) are radically changed from older T9 designs; G-E has replaced the octal base with a miniature-style, 12-pin base, and has found room inside the bulb for enough small, high-performance tube elements to make use of all 12 base connections. In low-power types, the small internal structures also permit using a "sawed-off" version of the T9 envelope. If you remember the 6H6

octal twin diode used in radios 20 years ago, and can visualize an all-glass unit the same size, you'll have some idea of a typical *Compactron*.

Several of these tubes have three independent triode sections, or other multiple-function arrangements never before used in radio-TV tubes. The operating characteristics and electrical ratings of each section are practically the same as for certain types of 7- and 9-pin miniature tubes; thus, existing circuits are easily adapted for use with *Compactrons*. These new devices have two main advantages over single- and dual-section tubes. First of all, wattage requirements are generally reduced because each *Compactron* draws less heater power than the combination of tubes it replaces. Furthermore, the physical layout of the chassis can be improved, since "centralizing" several circuit functions in one tube makes it more convenient to take advantage of modular construction, packaged circuitry, and other simplified, space-saving features. Even so, the wiring is not extremely crowded, because the 12 pins are arranged in a 3/4" circle—compared to less than 1/2" for a 9-pin miniature type.

Compactrons are already appearing in current radio-TV set production. All the black-and-white sets in the 1962 Admiral line use a 6K11 or 6Q11 triple triode in a new "Picture Guard" circuit (Fig. 2). The respective tube sections operate as an AGC keyer, sync separator, and noise limiter.

Another *Compactron* you can expect to see soon in TV receivers is the 6B10 dual triode-dual diode, a combined horizontal multivibrator and AFC tube. Effectively, the 6B10 is the same thing as a 6CG7 with a common-cathode dual AFC diode "under the same roof." Any defect in this new tube would show up as

• Please turn to page 84

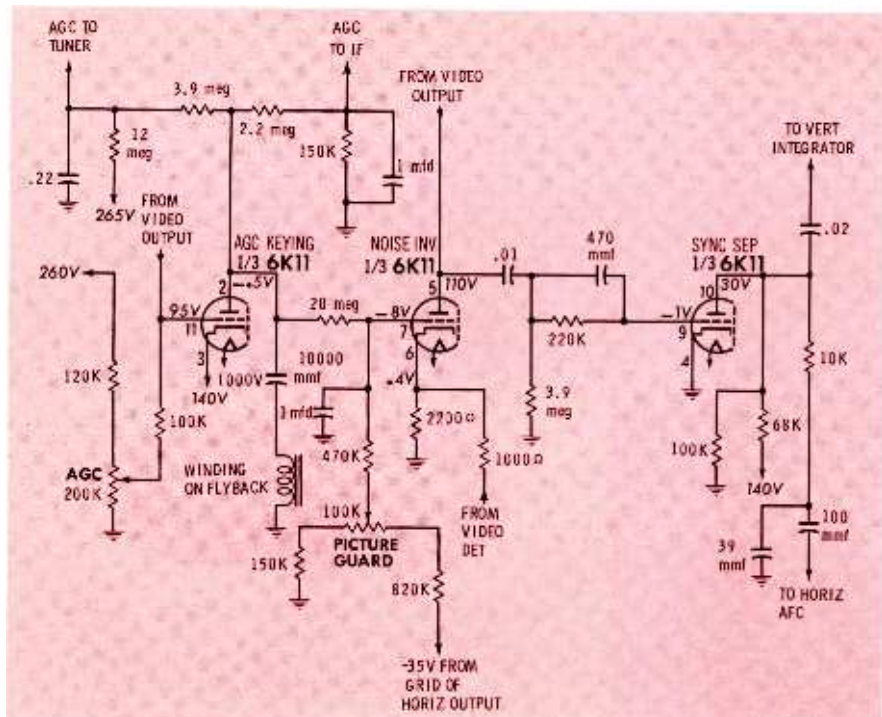
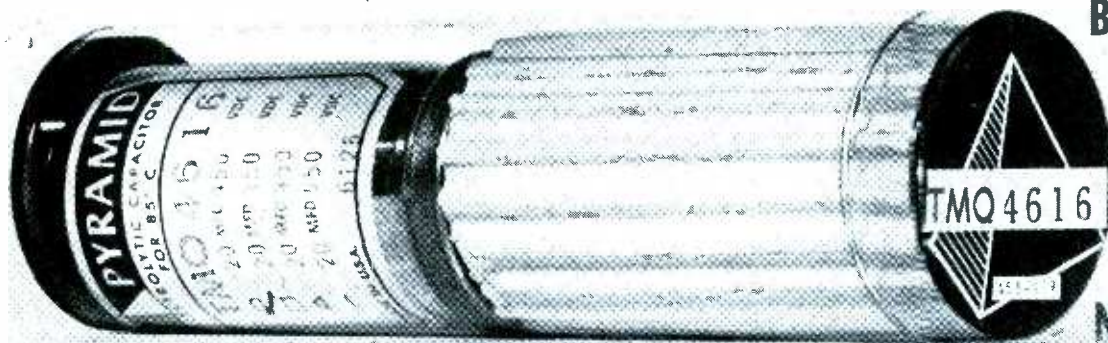


Fig. 2. Picture Guard circuit of Admiral Chassis 20A8, using Compactron.



**BEHIND THIS CAP IS A
COUPON WORTH UP
TO \$2.00 ■ EVERY
PYRAMID TWIST-
PRONG ELECTRO-
LYTIC YOU BUY FROM
NOW TO DECEMBER 31,**

WILL HAVE A COUPON WRAPPED IN IT THAT'S WORTH UP TO \$2.00! IT'S OUR WAY OF CELEBRATING WITH YOU THE MERGER OF PYRAMID WITH MICAMOLD TO FORM THE GENERAL INSTRUMENT CAPACITOR DIVISION ■ JUST GO TO YOUR PYRAMID DISTRIBUTOR, PICK THE TWIST-PRONG VU-PAKS YOU NEED FROM HIS CAPAC-O-MAT RACK, UNROLL THE WRAPPER AND CASH IN THE COUPON. COUPONS RANGE IN VALUE FROM 5c TO \$2—AND EVERY VU-PAK HAS ONE! BUT THAT'S NOT ALL. YOU GET A RELIABLE, PYRAMID ELECTROLYTIC THAT MEETS EVERY REQUIREMENT YOU SET FOR A TWIST-PRONG, SO YOU'RE A WINNER TWO WAYS. SEE YOUR DISTRIBUTOR TODAY. GENERAL INSTRUMENT CAPACITOR DIV., GENERAL INSTRUMENT CORP., DARLINGTON, S.C.

TEST EQUIPMENT FOR AUDIO SERVICING

BY ALAN ANDREWS

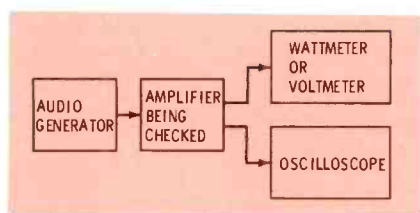


Fig. 1. Equipment connections for testing frequency response of amplifier.

Some repairs or adjustments to audio systems can be accomplished with the same test equipment used in radio and TV servicing—AC and DC voltmeters, ohmmeters, tube testers, oscilloscopes, and RF signal generators (both AM and FM). However, additional equipment is often necessary to get the job done properly. The most valuable types of specialized audio test instruments are the audio VTVM, audio signal generator, harmonic-distortion meter, and intermodulation-distortion analyzer. In addition, there are a number of other devices available for increasing the serviceman's efficiency in audio-servicing work.

Audio VTVM

Signal-level measurements are im-

portant in audio servicing, especially in test procedures involving signal tracing, signal generators, or distortion analyzers. Extremely small voltages are encountered in some phases of audio work; for example, the output signal from a magnetic phono cartridge may be as low as a few millivolts. Ordinary multimeters and VTVM's, which seldom have AC ranges of less than 3 volts, do not have sufficient accuracy to meet all these requirements. Thus, a special high-sensitivity AC meter is often needed.

An audio VTVM, designed specifically for AC measurements in the range from approximately 20 cps to 100 kc, fulfills the most critical audio requirements. The full-scale reading on the most sensitive scale is generally no higher than .03 volt, and several commercially-available meters have .01-volt ranges. As a further convenience, some of these instruments have several scales calibrated in decibels.

When a wattmeter is not available for amplifier-power measurements, an audio VTVM can be connected across the speaker terminals (or dummy-load resistor) to obtain a voltage reading from which the power can be calculated. Chart I shows the proper voltages across different load impedances for given power levels. For ratings not in the chart, the formula

$$E = \sqrt{PZ}$$

can be used to calculate the voltage from the power and the load impedance.

Audio Signal Generator

Even the most routine servicing

procedures can call for an audio signal generator with a minimum range of 20 to 20,000 cps, and an output extending up to 100,000 cps is useful for checking some of the more elaborate amplifiers.

Generators are available with either a sine- or square-wave output, or with both. Some dual-purpose generators basically produce a sine-wave output which can be modified to a square wave by simply switching a clipper stage into the circuit. The square-wave generator need not produce as wide a band of fundamental frequencies as a sine-wave generator, because of the high harmonic content of the square-wave output; a range of about 60 to 12,000 cps is adequate for most work. The rise time (the interval required for a square wave to change from 10 to 90% of peak amplitude) should be less than 2 microseconds over the audio range. For the sine-wave output, the maximum total harmonic distortion should be less than 1%. (Commercial models are

Chart I—Cross-Reference of Voltage and Power Readings

RATED MAXIMUM OUTPUT IN WATTS	VOLTAGE FOR 4 Ω LOAD	VOLTAGE FOR 8 Ω LOAD	VOLTAGE FOR 16 Ω LOAD
5	4.5	6.3	8.9
10	6.3	8.9	12.6
15	7.7	11.0	15.5
20	8.9	12.6	17.9
25	10.0	14.1	20.0
30	11.0	15.5	21.9
50	14.1	20.0	28.3

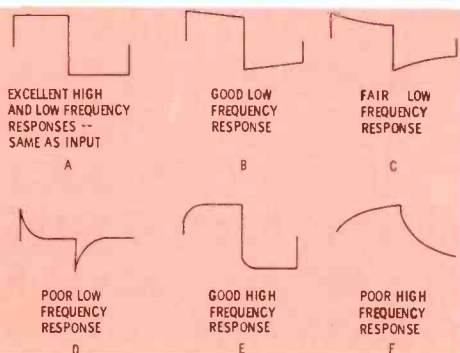


Fig. 2. Typical results of frequency-response tests using square waves.

available with distortion rated at less than 0.1% from 20-20,000 cps.)

In either type of generator, the output should remain constant within ± 1 db over the full frequency range; otherwise it would be necessary to meter the output and readjust the voltage for every different frequency setting. Some generators are equipped with built-in voltmeters to aid in setting the desired output level.

Most audio generators have a maximum output of at least 10 volts—more than enough for practical use. In most cases, the generator-output impedance is low (usually 600 ohms), in order to obtain proper impedance matching between the generator and load. A high-impedance output may cause serious distortion and loading when feeding into a low-impedance input stage, unless a separate impedance-matching network is connected between the two units. On the other hand, a low-impedance output can be fed into a circuit of almost any impedance without these disadvantages.

Using the Generator

One of the main uses of a sine-wave audio generator is in measuring the frequency response of an amplifier or an audio system. The basic setup shown in Fig. 1 is used.

At a frequency of about 1000 cps, the amplifier and generator controls are adjusted until the trace on the scope begins to show distortion of the sine-wave signal. The output reading is then noted and, with the amplifier controls always in "flat" position, the same procedure is repeated for different frequencies from about 20 to 20,000 cps.

The response will normally drop off at both the low and high ends of the audio range; the extent of drop-off can be used to determine frequency response. A high signal level is used for the test, on the theory that if the response is adequate at maximum level, it will be even better at lower levels.

This same test procedure can be used for checking tone controls and equalizer circuits, except that the object here is to obtain different degrees of attenuation at different frequencies.

A general indication of frequency response can be obtained by connecting an audio square-wave generator to the input of an amplifier

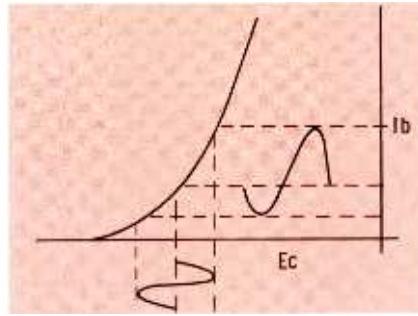


Fig. 3. This type of nonlinear amplification causes harmonic distortion.

and an oscilloscope to the output. Any square wave is composed of a fundamental frequency plus a number of odd-order harmonics. As an illustration, a 100-cps wave contains elements of 100, 300, 500, 700, etc., on up to 2100 cps or higher. Thus, the insertion of a square wave at the amplifier input applies a large number of frequencies at once, and observation of the output waveform gives definite indications regarding the response of the amplifier.

For best reproduction of a square wave, the response of the amplifier must extend from about one-tenth to at least ten times the fundamental frequency. For example, to minimize phase-shift distortion of a 100-cps square wave, the response of an amplifier must extend down to about 10 cps.

An audio system can be satisfactorily checked by applying square waves of only two frequencies—say 200 and 2000 cps. If the amplifier being tested can faithfully reproduce a 200-cps square wave, this means the response is adequate from about 20 to 2000 cps. Satisfactory reproduction of the 2000-cps square wave would then indicate good response up to 20,000 cps. If further facts are required as to exact char-

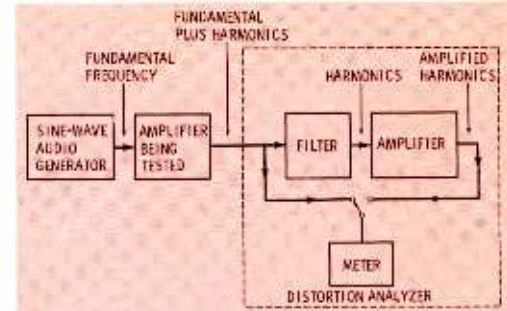


Fig. 4. Block diagram of test setup utilizing harmonic-distortion analyzer

acteristics at other frequencies, additional inputs can be used.

Fig. 2 illustrates several possible results from square-wave testing. In part A, the output waveform is a perfect replica of the input, indicating excellent response. Increasingly poorer low-frequency response is shown in B, C, and D, while E and F present a contrast of good with poor high-frequency response. In using these comparisons, the input frequency must be considered. For example, if waveform A or B was observed when the input wave had a fundamental frequency of 2000 cps, good bass response would not necessarily be indicated.

Harmonic-Distortion Meter

Virtually all sounds contain harmonics which determine the tone quality or timbre of the sound. These harmonics are extremely desirable; in fact, the primary characteristic of a good hi-fi system is its ability to reproduce a wide range of harmonic frequencies. When some defect causes nonlinear operation of an amplifier, additional harmonics may be generated and introduced into the signal. Produced in small amounts, these additions are not too serious, since they literally "harmon-

• Please turn to page 75

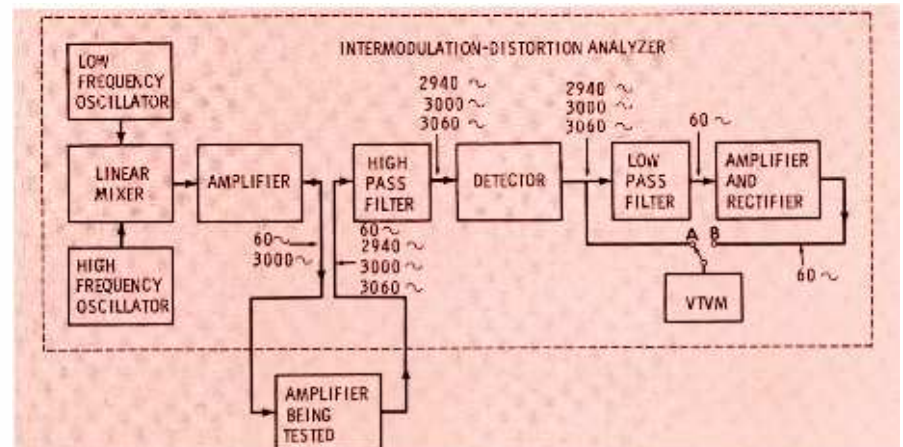
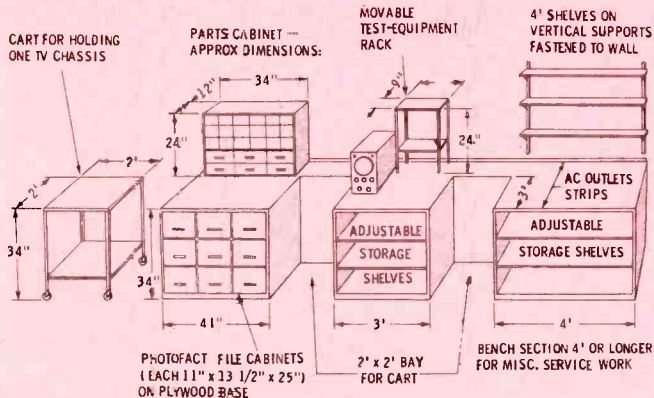
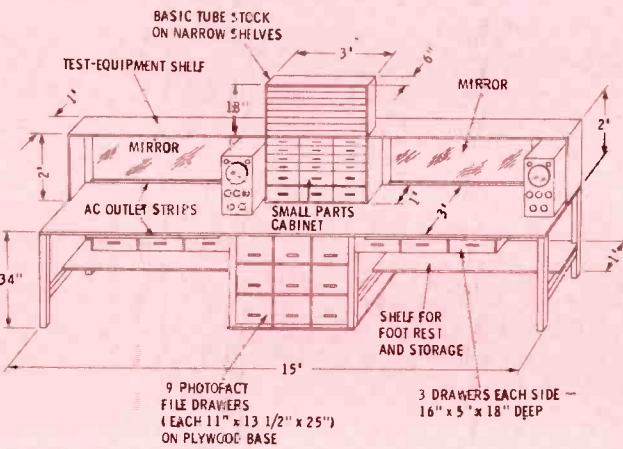
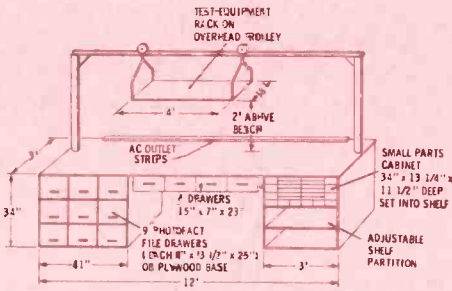
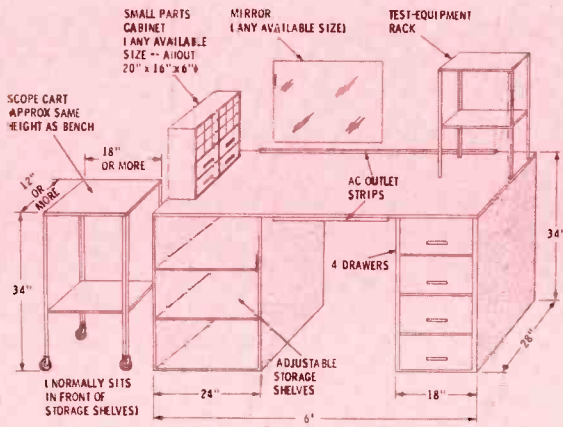


Fig. 5. Intermodulation-distortion analyzer uses a pair of test signals.



Right now, before the busy autumn season, would be a fine time to take stock of your present service-bench layout. Is it a help or a hindrance? A well-designed bench should satisfy two basic requirements:

MAXIMUM CONVENIENCE—Test equipment should be out of the way of the chassis being serviced, but close enough so that leads will reach easily without constantly shuffling the instruments back and forth. Also, often-used small parts, tools, and service data should be close at hand.

BEST USE OF SHOP SPACE—Tailoring benches to fit existing areas helps to establish a neat, step-saving floor plan. To reduce clutter in the shop, it's a good idea to utilize the generous space under the bench for storage.

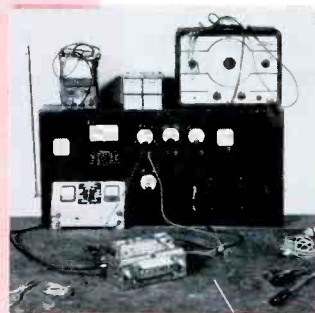
If an awkward arrangement is slowing you down, don't put up with it—make some changes! Use the representative bench designs on these pages as a source of ideas, freely modifying them to suit your individual needs. Also, suit yourself about building them "from scratch" or using ready-made components like those pictured.

This compact one-man bench fits into close quarters, and yet provides uncramped work space. All commonly-used test instruments except the scope are on a three-decker rack, and less frequently-used equipment is parked in a corner; thus, there is plenty of room for work. To conserve bench space, the bulky scope is mounted on a movable cart which can be positioned in any convenient spot.

Here's an efficient setup for a man who always has several sets in process at one time. The bench top is cleared for action, with parts and schematics stowed away "below decks." Test equipment is mounted on a traveling cradle, suspended from an overhead trolley. Hardware similar to that used to hang a barn door, supported on strong steel posts, serves as a track. The cradle holds all essential test gear, including a scope.

Two men can work at this long bench, with equal access to the parts stock and service-data files. A bench top fully 3' deep is used so the shelf for test equipment will not interfere with the "head room" needed for large TV chassis. Supplies and tools are kept in drawers beneath the bench top. Several nonconductive materials are suitable for the work surface. Favorites are Masonite, rubber, and Formica. The latter has the advantage of being available in pale colors that reflect light, thereby brightening up the work area.

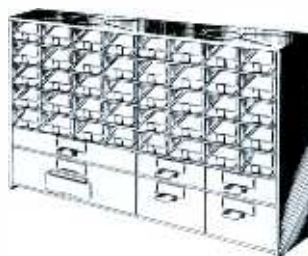
This system works well for anyone who frequently interrupts one job to take care of another, and it also lends itself to an "assembly-line" type of operation for larger shops. TV chassis can be loaded onto individual carts designed to roll neatly into "service bays." A central "island" holds all necessary items of TV test equipment. Bench space to the right of the bays can be utilized for special built-in servicing facilities such as the auto-radio service center shown in the photo.



SERVICE BENCH DESIGNS



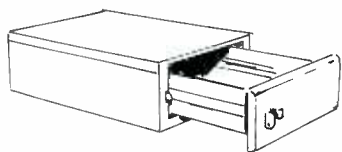
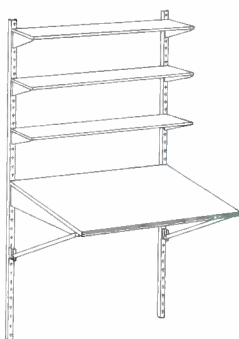
Compact metal racks serve as "test-equipment centers" to conserve space on bench top; size shown holds most-used items of equipment (except 5" scope).



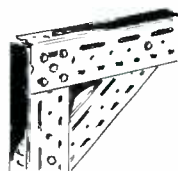
Cabinets with many small drawers are available in assorted shapes and sizes for handy, orderly storage of component stocks. Drawers usually have built-in dividers or compartmented trays.



Shelves 3' or 4' wide can be mounted at any desired heights on vertical brackets attached to wall. Shelf of greater-than-usual depth, supported by diagonal braces, can be used as supplementary bench.

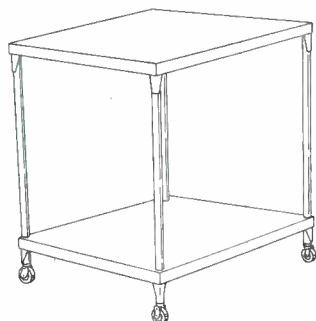


Encased metal drawer can be mounted under bench top, or several drawers can be interlocked or bolted into vertical stack.

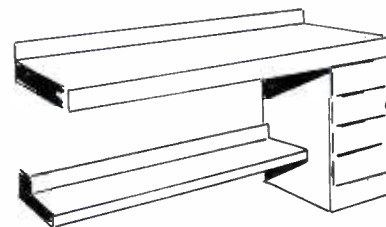
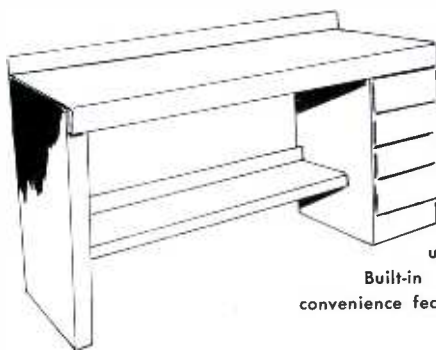
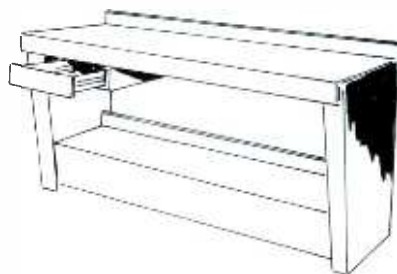
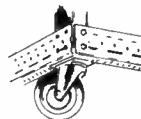


Metal cabinets and shelves are handy for storing additional test equipment, radios to be repaired, etc. Available in a wide variety of sizes, they can fit against end of bench or underneath bench top.

Placing each TV chassis on a "traveling" table is one way to increase convenience of shop layout. Tables can be utilized as movable bench sections.



Girders of 12- or 14-gauge steel, supplied in 10' or 12' lengths, are useful for framing benches, racks, carts, etc. Perforations speed up work of bolting together. Several accessories (casters, etc.) are designed for easy attachment.



Ready-made steel benches with Masonite or wood tops are obtainable in various lengths up to 6'; can be extended by adding "semi-trailer" units. Built-in drawers or cabinets are available, or user may add convenience features to suit his own needs.

YOKE

TROUBLE PLUS . . .

by Stan Prentiss

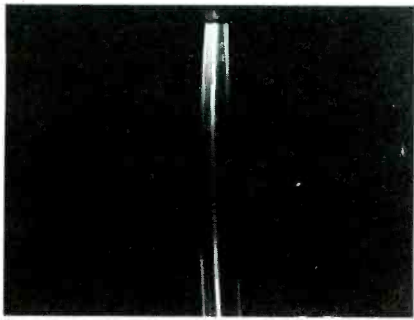


Fig. 1. Rare symptom: Horizontal sweep lost, but high voltage normal.

When the customer phoned and tried to describe his sadly distorted TV picture, my first thought was, "It can't look like that!" But when I arrived at his home and looked at the set, I realized he had been right; the raster was only a narrow vertical streak (Fig. 1). With the horizontal sweep all but dead, how

could the set be developing enough high voltage to produce a visible raster? Whatever the answer might turn out to be, this was no run-of-the-mill service call.

Horizontal oscillator, output, and damper tube substitutions produced not the slightest corrective effect. The width control wouldn't budge the picture even a mite, and the horizontal linearity slug was frozen stiff to the coil form. I felt there was no point in going any farther, at least not in the home. Remembering my experience with "The Case of the 10-Minute Fuses" (May issue), I knew I might have to put in several hours of good, hard troubleshooting before finding the answer. Of course, this job could also turn out to be easy; but fuses weren't blowing, there was a

visible (though narrow) raster, and the fault looked as if it might have a single, definite cause. Nevertheless, since the ailing set was an older RCA model with a direct-drive horizontal sweep circuit (Fig. 2), experience told me to be prepared for possible complications.

With apologies and a word of explanation to the customer for having to pull the set, I hauled it back to the shop for further investigation and repair. The first thing I did, mainly out of curiosity, was to measure the high voltage. Oddly enough, it was exactly 11.5 kilovolts, a perfectly normal output for this receiver. Here was evidence that the flyback transformer was operating correctly. However, when I checked boost, it was just under 400 volts—the same as B+.

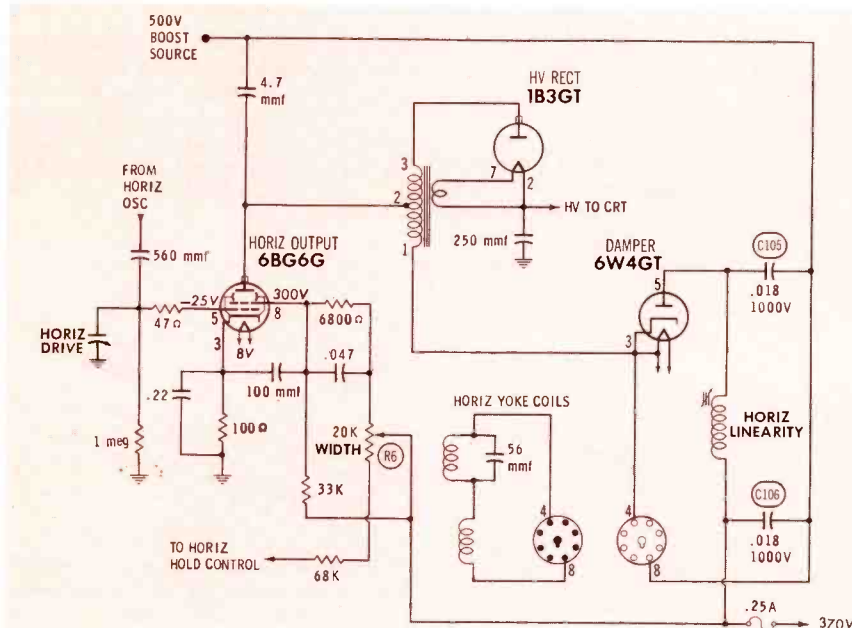


Fig. 2. Defect in this direct-drive circuit produced a pillar-shaped raster.

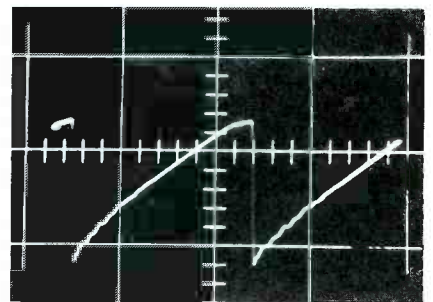


Fig. 3. Normal sawtooth wave at grid of horizontal output tube—150V p-p.

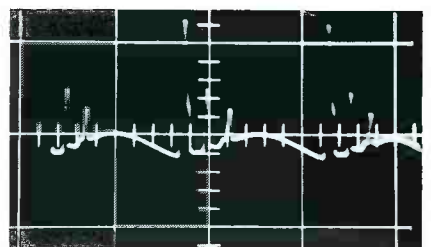


Fig. 4. Feeble, distorted waveform on high side of yoke indicated trouble.

I looked at the drive waveform at the grid of the horizontal output tube, just to make certain the trouble was not being caused by extreme distortion of this sawtooth wave. But the DC scope displayed a normal pattern (Fig. 3), 150 volts peak to peak, with a relatively linear rise of voltage. The most critical part of this waveform is above the center reference line on the scope graticule. Since this output tube has cathode bias, it does not really begin to go into heavy conduction until the grid voltage approaches zero (with respect to ground). In Fig. 3, the continued linear rise of the trace above this level, with only a slightly flattened top, showed that the grid was not drawing excessive current. Although flattening of positive peaks is not considered normal for sets with cathode bias, a certain amount is sometimes noticed in old models—probably because of factors such as component aging.

What's Cookin'?

Since tubes, horizontal drive components, and the output transformer were all apparently good, what could the trouble be? I went back to my most tangible symptom — lack of boost. Conceivably, one or both of the boost capacitors (C105 and C106) could be at fault. For a quick check of these units, I pulled the damper tube. All voltage disappeared from the boost line, indicating no shorts or DC



Fig. 5. Ringing test of bad yoke gave this overly-damped 120-kc waveform.

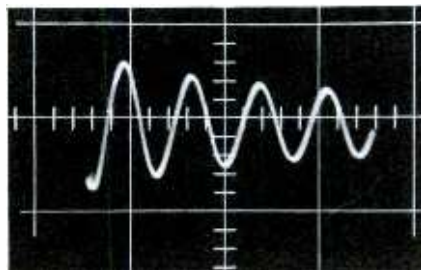


Fig. 6. Normal yoke should produce a gradually-damped wave—about 70 kc.

leakage from B+ to boost through the capacitors. I temporarily ruled out the rather remote possibility of an open boost capacitor, and decided that the next best approach was to tackle the horizontal coils of the deflection yoke. Although I wasn't completely sure of what waveforms to expect on either side of the yoke, I knew that the high end should receive a flyback pulse because it is tied directly to terminal 1 of the output transformer. Holding the tip of my scope probe against the insulated lead going to pin 4 of the yoke plug, I obtained the Raggedy Andy waveform in Fig. 4—a pair of undernourished spikes with transients popping out on either side. At pin 8, on the boost line, there wasn't enough of a waveform to record, even with the probe in direct contact with the circuit. I suspected more strongly than ever that the deflection yoke was the culprit. A quick look in the service literature produced the number for the replacement part. Luckily, I had one in stock; I'd bought it for a previous job, but hadn't needed it after all. When I plugged it in, boost returned, and all seemed well in TV land. A simple ringing test of the old yoke with my oscilloscope (see this month's *Troubleshooter* column) added further confirmation that I had found the trouble. Fig. 5 shows the damped sinusoidal wave I obtained in this check. Its frequency turned out to be 120 kc — well above the correct ringing frequency of 70 kc. Compare it with the indication produced by the new yoke (Fig. 6). Recalling your inductance theory, you may remember that shorted turns in a coil always produce a drop in voltage but an increase in frequency. This also explains why the wave in Fig. 5 is heavily damped, while Fig. 6 has the gradual taper that indicates a good coil in either the horizontal or vertical deflection circuit of any television receiver. Resting the scope probe on the lead going to the high side of the yoke produced the standard pattern of a smoothly-operating horizontal flyback system (Fig. 7).

Another Think . . .

The raster still wasn't com-
• Please turn to page 81

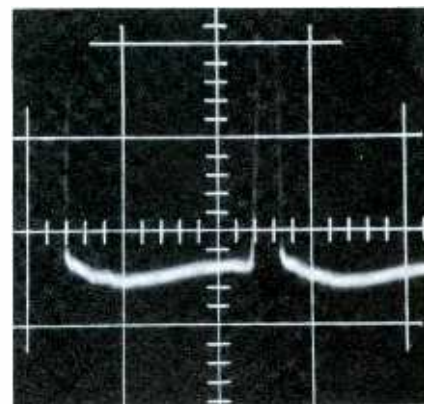


Fig. 7. Strong, clean flyback pulses indicated a return to normal operation.

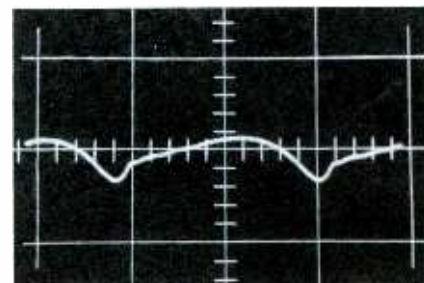


Fig. 8. Boost-ripple waveform should have this shape and 60-volt amplitude.

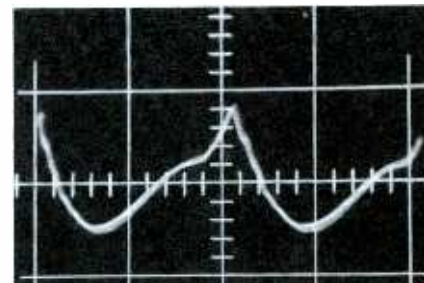


Fig. 9. Waveform found on boost line before the linearity coil was adjusted.

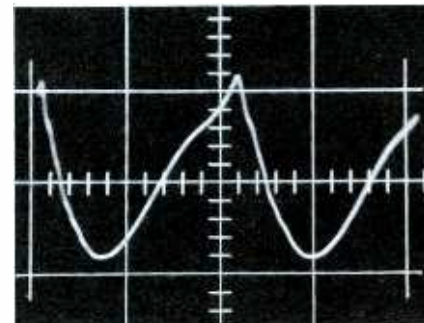


Fig. 10. Parabolic effect increased as linearity slug was turned wrong way.

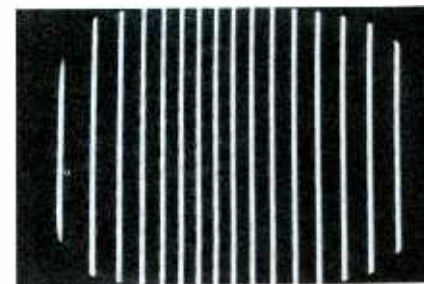


Fig. 11. Nonlinear picture-tube display when waveform appeared as in Fig. 9.

TV TUNERS

Although the tuner is an integral part of any TV receiver, it is generally thought of as a completely independent, self-contained component. This is natural, since it is usually a separate subassembly, and is often remotely positioned from the main chassis. Tuners are produced both by set manufacturers and by independent tuner companies; thus, servicemen are confronted with many different circuit hook-ups, all performing essentially the same duty.

Aside from variations in circuit design, there are several other reasons why many technicians consider TV-tuner servicing a headache. Some tuners are difficult to align, and, since relatively high frequencies are involved, the component values, tolerances, and lead dress are fairly critical. To complicate matters, all parts are usually confined in a small area.

After isolating trouble to the tuner, you must naturally decide whether to repair the tuner yourself, have someone else repair the unit, or replace it entirely. Factors that will govern your decision include the nature of the trouble, availability of parts, time required to do the job, and over-all cost to the customer. What's the best way for the average serviceman to handle tuner problems? To answer this question, let's examine some of the alternatives for dealing with front-

end trouble in a TV chassis.

Repairs

In deciding whether or not you'll do the job yourself, you should consider that alignment may be necessary after the repairs are completed. Do you have the necessary equipment for alignment, and do you know how to use it?

Many tuner repairs and adjustments are fairly easy. Some of these minor jobs include making oscillator adjustments, cleaning and tightening contacts, replacing strips of a turret tuner, repositioning oscillator slugs or screws that have fallen out, and replacing defective resistors or capacitors in untuned circuits (if readily accessible). In many cases, it is also a simple matter to tighten the contacts of a tube socket or to replace part of a fine-tuning or detent mechanism.

The number one cause of intermittent tuner operation is dirty or loose switch contacts. A wide selection of tuner cleaners are available to handle the dirt problem. Most of them are in spray cans with extended nozzles for reaching otherwise inaccessible spots in a tuner. As for adjusting switch contacts, the loop-spring units found in most turret tuners are relatively easy to tighten. Wafer switch contacts should be handled with greater care, since they require more precise alignment between fixed and movable contacts.

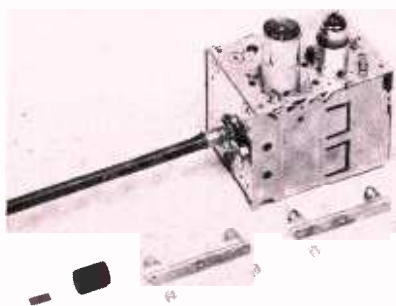
When replacing resistors and capacitors, always make it a practice to check for any special component characteristics. In the case of a capacitor, check to see if a special temperature coefficient or tolerance is required; for resistors, it's a good practice to use only 5% units made of the same material as the original type.

If lightning has damaged the tuner, installing a new pair of antenna-input coils will often complete the repair job. However, it may be necessary to replace an entire contact bank or several components in an RF stage. This, of course, calls for patience, experience in tedious work, and realignment.

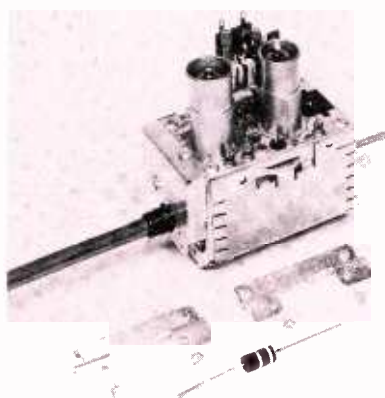
Other major tuner repairs include changing a tube socket, switch wafer, trimmer capacitor, or coil. Generally, any one of these operations calls for an RF-IF alignment when the repair is completed. The alignment of many TV tuners is not really difficult — provided you have the proper equipment and follow recommended procedures. *A word of caution:* If procedures call for expanding or compressing small incremental coils on a wafer switch, you'd better think twice before attempting a complete alignment. Unless you have had previous experience, you are apt to put more troubles into the tuner than you take out.

Specialized replacement parts, both electrical and mechanical, are usually available from the tuner manufacturer. To obtain specific parts, either refer to the parts list in the service data for the receiver, or consult a replacement-parts guide at your local distributor. In the latter case, you must know the make and model number of the tuner.

Most distributors also carry numerous replacement parts in addition to the usual tubes, resistors, and capacitors. For turret tuners, often-needed special parts are available in repair kits or as individual items. Also, while switch tuners generally require exact replacements for most parts, universal-replacement lines



(A) Sarkes Tarzian switch type.



(B) Standard Coil turret type.

Fig. 1. Typical universal-replacement tuners from two manufacturers' lines.

Repair or Replace

Considerations in handling front-end problems . . . by Les Deane

are carried for certain components such as antenna-input coils and fine-tuning shafts.

Troubleshooting a tuner fault, dismantling the unit, securing replacement parts, and perhaps performing an alignment may require more time and effort than you feel the job is worth. Should this be the case, there are a number of competent tuner service companies who offer professional repairs at very reasonable rates. For your convenience, a listing of such companies is included at the conclusion of this article. On the other hand, if you are bent on making your own TV tuner repairs, you'll find more specific information on this subject in the Howard W. Sams book, "Servicing TV Tuners."

Replacements

If a tuner is badly damaged, re-

placement parts are no longer available, or a customer's set must be returned immediately, it may be more practical to replace the tuner than to repair it. In this case, you also have several alternatives. You can obtain a new unit from the set manufacturer, exchange the original for a rebuilt unit of the same type, or select a recommended replacement from a line of universal tuners available to service dealers. Since the cost of a new duplicate tuner from a set manufacturer may be too high to let you price the job competitively, and an exchange transaction often requires a waiting period, universal replacements are finding increasing favor with many servicemen.

Two examples of universal-replacement tuners are shown in Fig.

** Please turn to page 79*

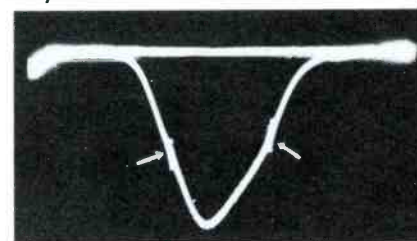
Chart I—Universal-Replacement Tuners

REPLACEMENT SPECIFICATIONS	SARKES TARZIAN	STANDARD COIL
12-POSITION TUNERS		
21-mc IF; 6.3V fil.	VS35A (Parallel)*	GG-2290-A
21-mc IF; 600-ma fil.	VS35A (Series)*	GG-2291-A
41-mc IF; 6.3V fil.	VS35B (Parallel)*	GG-4290-A
41-mc IF; 600-ma fil.	VS35B (Series)*	GG-4291-A
13-POSITION TUNERS		
VHF only; 41-mc IF; 6.3V fil.	VID45C (Parallel)*	GG-4220-A
VHF only; 41-mc IF; 600-ma fil.	VID45C (Series)*	GG-4221-A
VHF only; 21-mc IF; 6.3V fil.	GG-2220-A
VHF only; 21-mc IF; 600-ma fil.	GG-2221-A
UHF-VHF; 41-mc IF; 6.3V fil.	UVID45D (Parallel)*
UHF-VHF; 41-mc IF; 600-ma fil.	UVID45D (Series)*

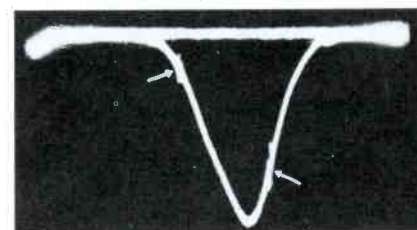
*Filament connection must be specified when replacement is ordered.



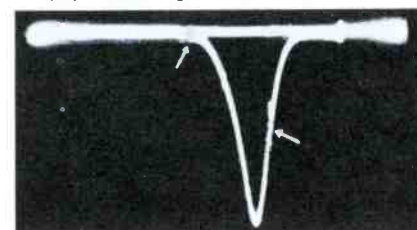
Fig. 2. On infrequent occasions, you may have to drill holes for new tuner.



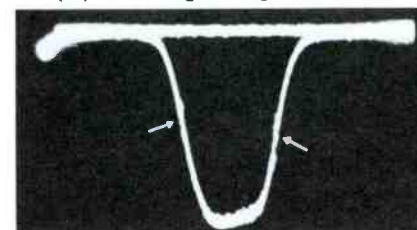
(A) Original response.



(B) Tuner replaced; no adjustments.



(C) With original capacitor added.



(D) Capacitor changed; set aligned.

Fig. 3. Response curve aids in process of matching a new tuner to IF strip.

WORLD SERIES WEEK

G. E. in Cooperation with Independent TV Servicemen Launches Unique National Campaign — Sells Immediate Need for Your Service to Millions of Set Owners.

Never before a sales-building campaign like this—combining the power, coverage and prestige of World Series television with the flexibility of actual business-building emphasis to *your customers in your own local area*. It is aimed at those set owners—your customers—who put up with sub-standard TV performance. *This is your campaign*. It sells the immediate need for your professional service right when demand hits its peak—World Series Time!

Plan now to tie-in with TV TUNE-UP WEEK. It's easy, effective—no red tape. Get full details from your General Electric tube distributor. HE MUST RECEIVE NAMES OF PARTICIPATING DEALERS BY SEPTEMBER 8. General Electric Company, Distributor Sales, Electronic Components Division, Room 7244D, Owensboro, Kentucky.

Complete sales package helps you cash in on **TV TUNE-UP WEEK**

World Series Week is TV Tune-Up Week
THIS G-E TEST PATTERN WILL HELP YOU CHECK THE PICTURE QUALITY OF YOUR SET

In New Jersey, Connecticut, NY State and Pennsylvania:
 ADDRESS: 1. NEW JERSEY: ...
 2. CONNECTICUT: ...
 3. NY STATE: ...
 4. PENNSYLVANIA: ...

In New York City, Long Island and Westchester:
 ADDRESS: 1. NEW YORK CITY: ...
 2. LONG ISLAND: ...
 3. WESTCHESTER: ...

TV GUIDE

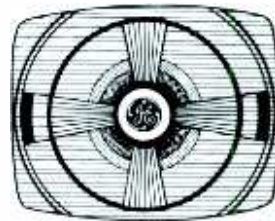
FULL-PAGE AD PLUS YOUR NAME IN SEPTEMBER 30 ISSUE OF TV GUIDE

This hard-hitting message launches TV TUNE-UP WEEK to 8 million television families... alerts your customers to the World Series TV Tune-Up commercial and sells your professional repair and maintenance service. Your name-and-address listing here ties you in directly—in your local edition of TV Guide—with this nationwide campaign.

Here's a TV first! Commercials on your local station that feature an actual test pattern with which your customers can check the picture quality of their sets.

You, the independent serviceman, are tied in directly through your listing in TV Guide.

IS TV TUNE-UP WEEK!



MOBILE WALL BANNER DISPLAY



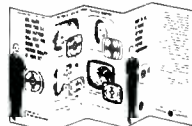
COUNTER DISPLAY



AD MATS



SET REPAIR STICKERS



MAILERS

BUILDS BUSINESS FOR YOU 3 WAYS

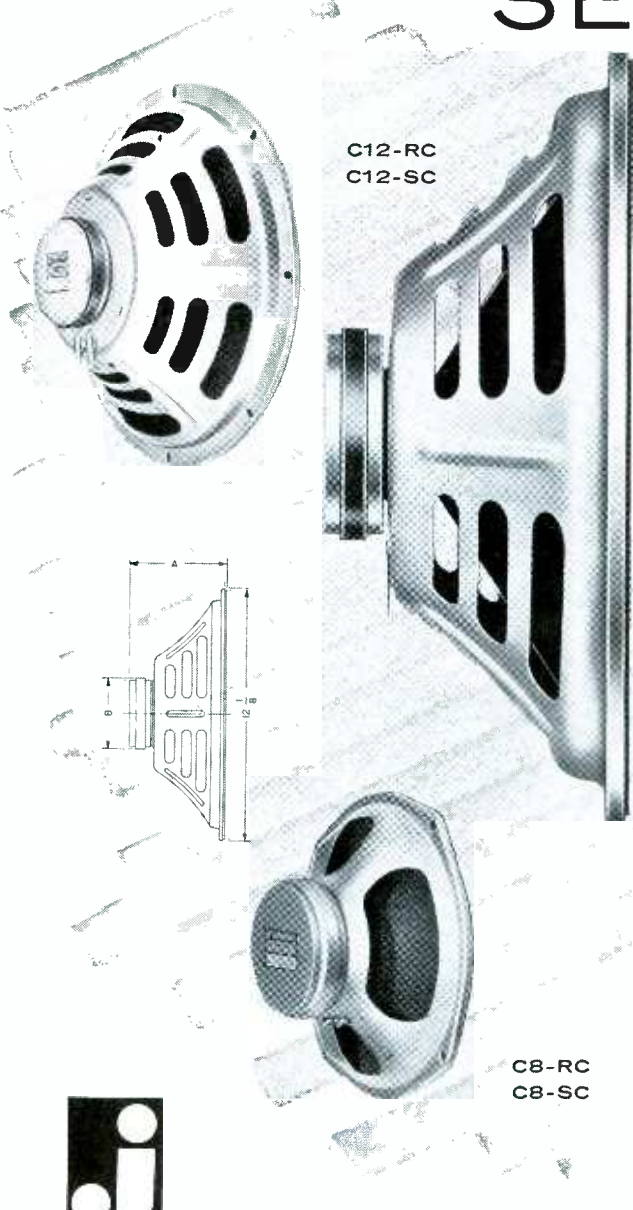
1. TV Tune-Up Week builds an awareness of picture-quality deterioration—helps your customers prove to themselves the need for TV check-ups and preventive maintenance by you, their independent TV serviceman.
2. You, the independent service dealer, are the hero of TV TUNE-UP WEEK. On World Series television and in your regional edition of TV Guide, *your customers are urged to see you for prompt, professional service.*
3. As a participating dealer, you benefit from this national campaign at the local level—in your city, in your neighborhood, with your customers.

Progress Is Our Most Important Product

GENERAL  ELECTRIC

NEW Jensen

PROFILE* LOUDSPEAKERS SERIES



For commercial sound applications
Super-shallow depth
New SYNTAX-6* Ceramic Magnets

These new 8- and 12-inch ruggedly dependable speakers are especially designed for all PA and sound reinforcement applications, yet are economically priced. They are ideal choices for schoolroom, office, store, restaurant, supermarket, and all similar applications. Extended high frequency range, smooth response and wide angular coverage for excellent music reproduction as well as voice. The new Jensen SYNTAX-6 ceramic magnets give 1/2 to 1 db more acoustic output than speakers employing 4.64 and 6.8 oz. Alnico 5 magnets. Extremely shallow 8-inch units permit in-the-wall mounting. Moisture proofed cone and voice coil plus corrosion resistant treatment of metal parts for maximum reliability. 1-inch 8-ohm voice coils. Transformer mounting facility.



MODEL	NOM. SIZE	POWER RATING	MAX. DIMENSIONS			MAGNET WT.		NET WT.	LIST PRICE
			O.D.	DEPTH A	MAGNET DIA.-B	SYNTAX-6	EQUIV. AL 5		
C8-RC	8"	12 watts	8 1/8"	3"	3 7/16"	10.0 oz.	6.8 oz.	2 lbs.	\$12.95
C8-SC	8"	11 watts	8 1/8"	2 1 1/16"	3 1/4"	6.0 oz.	4.64 oz.	1 3/4 lbs.	10.95
C12-RC	12"	14 watts	12 1/8"	4 1/2"	3 7/16"	10.0 oz.	6.8 oz.	5 lbs.	16.00
C12-SC	12"	13 watts	12 1/8"	4 7/16"	3 1/4"	6.0 oz.	4.64 oz.	4 3/4 lbs.	14.75

NOTE: Mounting holes conform to all existing EIA standards.

*T.M.

THERE IS ALWAYS
A BETTER
LOUDSPEAKER FROM...

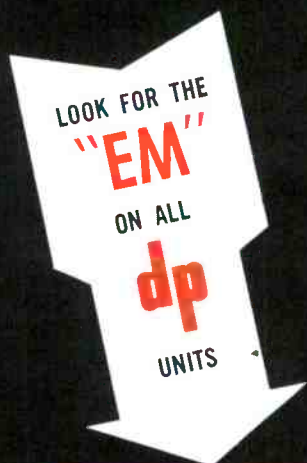
jensen / MANUFACTURING COMPANY
DIVISION OF THE MUTER CO. 6601 S. Laramie Avenue, Chicago 38, Illinois
In Canada: Renfrew Electric Co., Ltd., Toronto In Mexico: Universal De Mexico, S. A., Mexico D. F.

FIRST CHOICE WITH SERVICE TECHNICIANS . . . EVERYWHERE!

THERE IS ONLY ONE

MINIATURIZED **ELMENCO** DIPPED MYLAR* - PAPER CAPACITOR

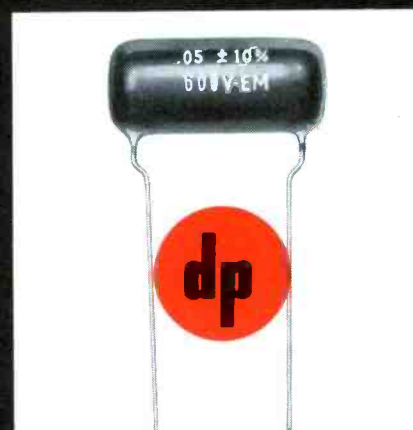
* Dupont Reg. Trademark



ASK FOR ELMENCO

*don't accept
substitutes
or
imitations!*

- OPERATES AT 125°C. WITHOUT DERATING
- STANDARD TOLERANCE ±10%
- MISSILE RELIABILITY
- COMPLETELY MOISTURE PROOF
- UP TO 50% SMALLER THAN OTHER TYPES



**OVER 54,000,000
SOLD IN LESS
THAN 2 YEARS**

IS PROOF POSITIVE
OF THE UNIVERSAL
ACCEPTANCE OF
ELMENCO dp
DIPPED MYLAR-PAPER
CAPACITORS



ARCO electronics inc.

Community Drive, Great Neck, New York • Branches: Dallas 7, Los Angeles 35

Available at every REPUTABLE distributor throughout the country!

Now being used in millions of television sets, radios, phonographs, electronic circuitry and military applications.

Write for Catalog dp 110.

by JOE A. GROVES

RENTING SOUND EQUIPMENT *leads to Sales!*



Service-shop owners who are looking for a way to enter the commercial sound business should investigate the potential in renting sound equipment. Such a venture provides an economical start, little competition, and an opportunity for rapid growth. By the same token, equipment rental can help an established sound dealer to increase his income, promote sales, and smooth out the peaks and valleys in business activity.

There are two distinct markets for sound-equipment rental. The larger and more profitable category includes many business and industrial firms who rent complete sound systems on a long-term leasing basis. The other consists of individuals and groups who have only an occasional need for equipment. Although this latter market is often shunned by many as a "two-bit" operation, it does provide a much-needed opportunity for exposing sound equipment to likely prospects for sales or leasing, and also establishes a dealer as a well-known sound specialist.

Leased Equipment

Many companies prefer to lease sound equipment rather than buy it. For one thing, no initial outlay of capital is necessary. Also, the user can charge off the rental fee as an overhead expense rather than computing depreciation over a 10-year period—thus gaining substantial tax advantages. This, in effect, means that leasing equipment is a money-saving opportunity from the day the system is put into operation.

Before any agreement to lease a sound system can be "jelled" into specific terms, the dealer must plan the system. This isn't too difficult—not even for the beginner. Several books, full of detailed background information, are available; in addition, many magazine articles provide specific suggestions in the way of equipment, plus charts which show the requirements for average installations. (See "Breaking the Commercial Sound Barrier" in the June issue.) Manufacturers also provide much assistance, and are more than willing to cooperate with dealers in planning various systems.

After completing his plans for the system, the dealer must decide on a rental fee. The rate should be set high enough to provide an early return on his investment, yet low enough to be attractive to the customer. Other factors in determining the charge are the size of the installation, the solvency of the firm buying the contract, and—last but not least—the dealer's own ability to finance

the venture.

The first step in quoting a fee is to compute the total investment in the system. To do this, the dealer figures his net cost of equipment; then he adds a normal mark-up, the expenses for installation, and the estimated maintenance cost for a period of 10 years. This total is divided into suitable monthly payments, which are typically large enough so that the dealer can recover his entire investment in one to three years. If he can collect for all of his expenses in less than three years, it's easy to see that he will have earned back twice his investment within six years. In nine years he will have, in effect, sold the system three times.

Another advantage of leasing complete systems is the built-in opportunity for selling extra equipment. It's easy to show users the desirability of expanding their systems to cover new areas and offer new services, for only a slight increase in the existing rental fee.

Looking beyond the simple fact that leased sound systems pay for themselves and then pay off profits, don't forget that the rental fee is based upon both the sale price and the maintenance cost. Therefore, each month's rent includes income for the service department. Since the contract continues for several years, the actual maintenance cost of the equipment is automatically paid for by the renter. In addition, the equipment still belongs to the dealer, who can depreciate it over a period of 10 years for tax purposes.

Occasional Renters

There is always a demand for sound equipment by the occasional renter. The Jaycees may be sponsoring a swimming meet, the Elks a dance, and the Tri Kappa a bingo party. All have a need for a complete sound system for a one-night stand. Naturally, none of them can afford to spend \$250 for a system and then use it only once or twice a year. However, they can set aside \$25 from an evening's receipts in order to rent equipment each time it is needed. Considering that a dealer may be able to rent a \$250 system ten times in a month, each time for \$25, it becomes obvious that there is good money in renting to the occasional user.

To serve this market, the dealer must determine who his renters will be, what equipment they will need, and how he can contact them. Once a dealer analyzes the prospects for sound-system rental in his own neighborhood, he will

be able to tell what kind of equipment will be needed. For example, if most of his renters will be holding indoor events in auditoriums of approximately 5000 square feet or less, a 30-watt amplifier and two 12" speakers will fulfill most demands. Of course, he will also need two or three microphones, and perhaps a record player or tape recorder. On the other hand, if most of the renters will be using the equipment for outdoor events, they will need a 50-watt amplifier that can be operated from either an AC line or automotive-type battery supply. Also, instead of ordinary speakers in baffles, 12" re-entrant horn-type speakers will be required.

Much of the equipment available to the sound dealer can be purchased in combination outfits that offer a wide degree of versatility. Therefore, only a moderate investment in equipment will provide him with the basic systems he needs to serve the occasional renter.

"One-time" rental charges can be computed in much the same manner as discussed under leasing. The biggest differences occur in considering the size of the system, and in recovering the investment in ten rentals rather than over a period of years. Obviously there will be some maintenance costs to figure into the rental fee. However, as experience has shown, there is amazingly little damage to the equipment. The most frequent trouble is wear and tear on microphone leads from considerable handling.

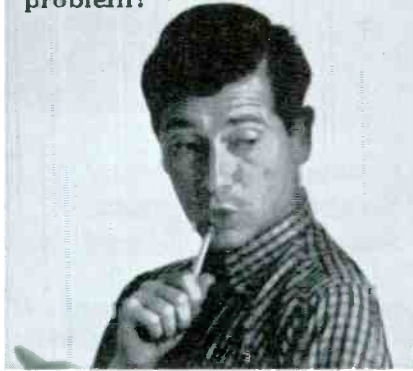
It isn't difficult to contact people who are interested in renting sound equipment. Begin by making a list of the clubs, organizations, fraternal groups, churches, sororities, and similar prospects in your neighborhood. Then you can contact the officers of these groups and let them know you stand ready to serve them when they need sound equipment. They will undoubtedly be glad to learn they can get the equipment from a local source, and will be likely to call you when the need arises.

Once a dealer makes it known that he rents sound equipment, persons belonging to more than one group spread the word around and automatically increase the number of rentals. With a little promotional effort on the part of the dealer, he can soon build a repeat business. In addition, his increased association with renters invariably leads to sales of new systems. This, of course, places the dealer right where he wants to be—on the road to success in the sound-equipment business. ▲

THERE'S ONE FOR EVERY CUSTOMER

University has the product to help you sell every type of customer—for every possible purpose (even underwater high fidelity).

For instance. Got a hi-fi enthusiast who's got a space problem?



1

Show him the TMS-2 single cabinet stereo speaker system. Problem solved.



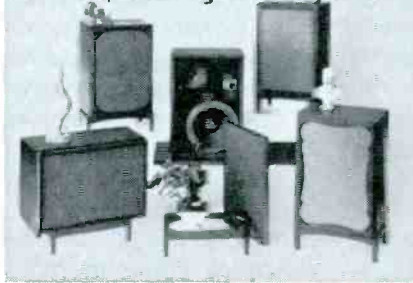
2

Lady customer with a decorating flair?



3

Let her see how the Medallion XII offers 2 different grille styles that snap on or off in seconds. (While you're at it, let her husband listen to its amazing sound.) Sold!



4

Is there a customer willing to pay for really big sound, but doesn't want a monster cabinet? Just give him a peek at the new Classic Mark II 3-way speaker system—only 35" wide. That's all the selling you'll have to do.



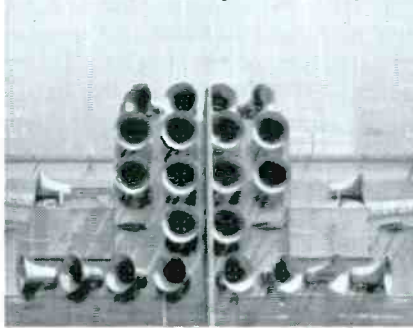
5

Are there patio or pool owners that demand outdoor hi-fi? Show them the University LC Series. They'll be so pleased with the price and the performance they'll invite you to their next barbecue.



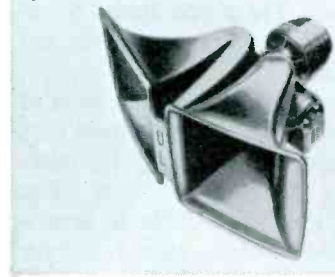
6

Got a ball park that needs a super-powered public address system? Try the 4A4 like they did at Comiskey Park.



7

Is there a bridge that needs a total traffic communications system? The Cobraflex trumpet system used on the George Washington Bridge might just be the answer.



8

How about underwater speaker installations? University's got em. Or explosion-proof speakers? Those, too. And sound columns and paging speakers—and well, just too many to mention in this space.



9

We did say microphones? Of course. Dynamic Modular Microphones—with total interchangeability between any basic microphone and all adapters. Ask about them.



10

As a matter of fact, ask about all the University products—stereo speaker systems, hi-fi speakers, outdoor speakers, public address speakers, microphones. There's one for every budget, every customer. Your customer.



University Loudspeakers, Inc., White Plains, N.Y.
A Division of Ling-Temco Electronics, Inc.



QUICKER
SERVICING



VISIBLE HUM

Back in the good old days, a radio used to develop quite a bit of hum before the owner noticed it. This was because the hum came in to the sound gradually, as the filters aged. When the serviceman turned on the radio, it might have sounded pretty bad to him; but the owner often didn't even notice it.

Not so in TV work. The eye is a lot more critical than the ear, and even a small amount of hum modulation in the picture brings forth a complaint. Fortunately for the hum-hunting technician, this is one defect that gives you a pretty definite set of clues. They almost tap you on the shoulder and say, "Look, Mac, here I am!"

Tracking down hum is a process of elimination, like every other troubleshooting routine. So, let's take up the trail. First check the visible symptom—*how many* hum bars or wiggles are there? Then look to see what kind of power supply the set has. These two items of information will start you down the right track.

The most easily-analyzed type of hum consists of two horizontal bars on the screen. These may be fairly faint (Fig. 1) or pretty dark (Fig. 2). This kind of trouble is invariably found in sets with full-wave power supplies—including nearly all transformer-powered receivers and an occasional model which has a full-wave voltage doubler. Since

these circuits rectify both halves of the 60-cps input, any ripple which appears in the DC output will have a frequency of 120 cps. Because the raster is being vertically scanned at a 60-cycle rate, two cycles of this ripple voltage will be picked up on each scan, and two hum bars will show on the screen. The characteristic soft shading at the edges of the bars tell us the waveform is sinusoidal. This pattern can't be produced by anything but a power-supply fault; so, if you see two bars, you may as well pull the chassis right away.

Once you have the set arranged so you can work on the power supply, you can track down the trouble in a hurry if you have a substitution box of electrolytic capacitors. (A typical unit includes several 450-volt capacitors in values ranging from 4 mfd up to 100 mfd or more.) Start out by bridging the output filter with the substitute unit nearest the rated size of the original. To be causing excessive ripple, the existing capacitor would have to be open or else have a high power factor; both of these conditions can readily be detected by the bridging test. Actually paralleling the suspected unit with an electrolytic of almost any size will tell you what's going on; even a 4-mfd substitution unit will cause a visible reduction in the density of the hum bars.

Before 120-cycle ripple gets bad

enough to cause strong hum bars in the picture, it may attract your attention by producing horizontal or vertical instability, weaving, and in some cases an S-bend that is a very good counterfeit of AGC bending. But don't be fooled—if the raster displays a *double* S-curve, and if a new electrolytic snaps the picture up straight, it's "filteritis"!

60-Cycle Hum

The other major type of hum is caused by a 60-cps waveform; thus, it puts only one dark bar or bend in the picture (Fig. 3). This symptom *can* be caused by a bad filter capacitor somewhere in the B+ distribution system, especially if the power supply is a half-wave type; but a more common cause is heater-cathode leakage in a tube. However, for 60-cycle heater voltage to modulate the plate current of a tube, the circuit must include some resistance between cathode and ground, so that a fluctuating voltage drop can be developed between these points. The amplitude of this voltage is proportional to the amount of resistance to ground, and also depends on the point at which the heater is shorted to the cathode. To explain the latter point, suppose the heater of a 6-volt tube were shorted at the middle. This would place about 3 volts AC on the cathode. A short closer to the grounded end of the heater would

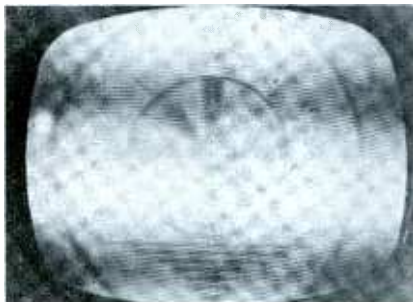


Fig. 1. Faint 120-cycle hum caused by moderate defect in filter capacitor.

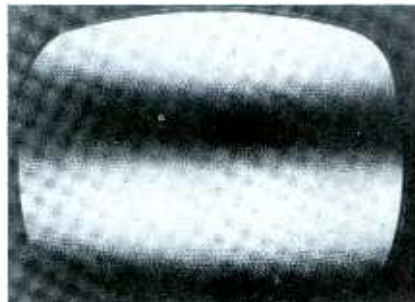


Fig. 2. Fairly severe 120-cycle hum with snow (on an inactive channel).

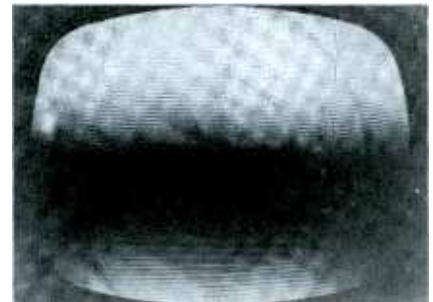


Fig. 3. Common cause of 60-cycle hum bar is heater-cathode short in tube.

SERVICE TECHNICIANS, ENGINEERS, TEST LABS SAY... THE ORIGINAL MIGHTY MITE WAS

"The Best Tube Checker they ever used."

Now... here is the

MIGHTY MITE II

New, Improved!

Designed for the present and far into the future. Tests all of your present tubes plus the new RCA Nuvistors and Novars, GE Compactrons and Sylvania 10 pin tubes.



67⁵⁰

Remember... there is only one Mighty Mite

A complete tube tester that is smaller than a portable typewriter yet outperforms testers costing hundreds of dollars. A real money maker for the serviceman and a trusty companion for engineers, maintenance men and experimenters.

Even though the Mighty Mite weighs less than 8 pounds, new circuitry by Sencore enables you to use a meter to check grid leakage as high as 100 megohms and gas conditions that cause as little as one half microamp of grid current to flow. Then too, it checks for emission at operating levels and shorts or leakage up to 120,000 ohms between all elements. This analytical "stethoscope" approach finds troublesome tubes even when large mutual conductance testers fail. And it does all this by merely setting four controls labeled A, B, C, & D.

Check these plus Sencore features: Meter glows in dark for easy reading behind TV set • Stainless steel mirror in ad-

justable cover for TV adjustments • Rugged, all steel carrying case and easy grip handle • Smallest complete tester made, less than one foot square. Mighty Mite II will test every standard radio and TV tube that you encounter, nearly 2000 in all, including foreign, five star, auto radio tubes (without damage) plus the new GE Compactrons, RCA Nuvistors and Novars and Sylvania 10 pin tubes.

Mighty Mite II also has larger, easy-to-read type in the set-up booklet to insure faster testing. Why don't you join the thousands of servicemen, engineers, and technicians who now own a Mighty Mite tube tester? Tube substitution is becoming impossible and costly with nearly 2000 tubes in use today. Ask your authorized Sencore Distributor for the New Improved Mighty Mite. Size: 10 1/4" x 9 1/4" x 3 1/2". Wt. 8 lbs.

MODEL TC114 Dealer Net **\$67.50**

Sencore Sam says...
"They all agree... the Mighty Mite is the real answer for the man on the go."



SENCORE

 ADDISON, ILLINOIS

SOLVE!
90%
 OF YOUR PROBLEMS
 IN CONNECTING TWO
 PIECES OF EQUIPMENT
 THAT DO NOT HAVE
 MATCHING CONNECT-
 ORS WITH
**THE
 NEW
 ADAPTER KIT**



Contains 11 popular audio adapters and 1 "universal" interconnecting cord—all in a handy reusable plastic box. Applicable for hundreds of various connections, such as —

- Two "Y" connectors let you drive both channels of a stereo amplifier with one signal generator — also, feed two inputs into one phone jack.
- Connect coaxial test leads directly to input or output jack of equipment (such as TV Remote Controls) —No clip-lead Hook-Ups.
- Save time, eliminate "make-shift" connectors, avoid soldering. Always a neat job with Switchcraft Adapters. When a special connector is needed — just slip on an adapter from your Kit.
- Also a handy - profitable way to stock adapters for your customers every need. The 331A Adapter Kit is now in stock at your distributors. Write for Bulletin No. 112.

SWITCHCRAFT
 INC.

5573 N. ELSTON AVE. CHICAGO 30, ILL.



(A) Hum actually present in signal.



(B) Stray pickup on test probe.

Fig. 4. 60-cycle waveform distortion.

produce proportionately less hum voltage.

Although a heater-cathode short in a grounded-cathode stage has no effect as far as hum is concerned, some side effects can stem from this condition. For example, if the filament of a 6-volt tube were shorted through the cathode to ground at the 3-volt point, only half of the filament would still be connected across the 6.3-volt supply. So, this particular tube would light up like a country church on Wednesday night. Several other effects, even including a species of hum, could also be produced if part of the cathode reached very high temperatures and liberated gas in the tube.

The easiest *dependable* way to run down a heater-cathode short is by tube substitution. The symptom can sometimes be identified in parallel-wired sets by simply pulling various tubes in the signal path, but the trouble cannot always be exactly pinpointed by this method. Theoretically, the hum should disappear only when you break the signal path between the offending stage and the picture tube. However, hum in a video IF or similar stage may be noticeable only under certain bias conditions, and when the input signal to this stage is removed, the hum may go with it.

The contrast control furnishes a convenient check point for finding the source of hum bars. If they do not change in tone when you move the control knob, look for trouble between the control and the picture tube. When the set is on the bench, scope waveforms at a 30-cps sweep frequency can further help you to troubleshoot hum. An S-curved distortion of the whole signal (Fig. 4A) is a dead giveaway to the presence of hum at the point being checked. But beware of confusing this effect with the less clear-cut "humpback" pattern in Fig. 4B, which is typical of the stray hum pickup you often find while scop-

ing high-impedance circuits.

In bench servicing, a signal-injection unit or pattern generator offers a rapid means of finding a heater-cathode short in the picture-signal circuits. Simply inject a fairly strong, unmodulated RF signal into each stage in turn, and watch for hum bars to appear. If a signal fed into the IF input produces no hum, but bars appear when a signal is placed on the antenna, look in the tuner for trouble.

Very bad cases of 60-cycle hum, caused by high-amplitude signals, can make the screen appear half black and half white (Fig. 5). Just a small slice of video remains visible at the center.

Some Weird Ones

In addition to bad filter capacitors, you will sometimes find some really strange causes of hum troubles. In most of them, you won't see the familiar hum bar; however, if you check the symptoms very closely, you'll see that each of them is *basically* a 60- or 120-cycle pattern.

One of these odd cases is the little "band of wiggles" that travels up or down the screen, usually on a pretty good picture. When it reaches the top or bottom of the screen, it can cause unstable vertical sync. This trouble is typically due to 60-cycle signal leakage somewhere in the picture or sync circuits. One case I handled was due to a leaky socket which allowed AC to cross over from the heater pin to the grid pin. Another trouble came from a very small heater-cathode leakage in a sync tube. Still another was due to moisture on a printed-wiring board. The cure: If the interference shows a basic 60-cycle repetition rate, change tubes (and check the power supply, if it's a half-wave type); if you've found a 120-cycle signal, start bridging all the electrolytics you can find, whether or not they're anywhere near the sus-

Wake Up

A new day is dawning in electronics.



Transistors are here to stay... they are now being used everywhere; in radio, television, Hi-Fi, intercom, and in nearly all new electronic equipment...

Why put off transistor circuit servicing any longer... there's gold in them thar hills. But you must be equipped to do the job fast and efficiently. Here are the tools that you will need.



NEW SENCORE TRANSI-MASTER

This Tester will analyze the entire circuit in minutes and test transistors in-circuit or out of circuit. Here is how you can pin point troubles step by step with the TR110.

First, check the batteries with the 0 to 12 volt meter. If the batteries are O.K., check the current drain with the 0 to 50 milliamp meter. A special probe is provided so that you do not need to break the circuit. Excessive current indicates a short; low current indicates an open stage or cracked board. All PF schematics indicate average current.

If trouble is not located by now, isolate the trouble to a specific stage by touching the output of the harmonic generator to the base of each transistor and note spot where sound from speaker (or scope where no speaker is used) stops or becomes weak. The generator becomes a sine wave generator for audio stages to help find distortion.

If trouble points to a transistor, check it in a jiffy with the exclusive in-circuit power oscillator check provided by the TR110. A special probe is also provided for this.

If the transistor checks bad in-circuit, remove it and give it an out of circuit check with the oscillator check or the more accurate DC check. The DC check is provided for comparison reasons, experimental or engineering work and to match transistors in audio output stages. Beta (current gain) is read direct or on a good-bad scale for service work.

DEALER NET. ONLY **\$4950**



Tests all transistors in-circuit or out-of-circuit

Model TR110

It's a COMPLETE TRANSISTOR TESTER

- SIGNAL TRACER • VOLTMETER
- BATTERY TESTER • MILLIAMMETER



NEW SENCORE TRANSISTOR AND DIODE CHECKER

Here is a low cost tester that has become America's favorite. The TR115 provides the same DC out of circuit checks as the TR110; leakage and current gain. Beta (circuit gain) can also be read direct or as good or bad. Opens or shorts in the transistor are spotted in a minute. The TR115 checks them all from power transistors to the small hearing aid type. Japanese equivalents are listed also. This famous tester is used by such companies as Sears Roebuck, Bell Telephone and Commonwealth Edison. New circuits enable you to make service checks without set-up charts even though charts are provided for critical checks.



Model TR115
Dealer Net
\$1995



SENCORE BATTERY ELIMINATOR AND TROUBLE SHOOTER

For replacing batteries during repair. Many servicemen say that they wouldn't service transistor circuits without this power supply. The tried and proven PS103 is a sure fire answer. It can be used to charge the nickel cadmium batteries as well. Dial the desired output from 0 to 24 volts DC and read on meter. Low ripple insures no hum or feedback. Total current drawn can also be read on the PS103 by merely flicking the function switch to milliamps. The PS103 is the only supply that will operate radios with tapped battery supplies such as Philco, Sylvania and Motorola. No other supply has a third lead.



Model PS103
Dealer Net
\$1995

Now in stock at your Authorized Sencore Distributor



SENCORE
ADDISON, ILLINOIS

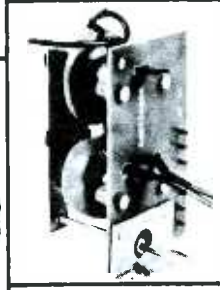
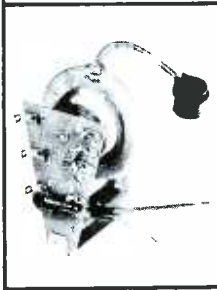
MERIT'S out in front



with

FLYBACKS!

Merit has added 24 new Flyback Transformers to its line of approximately 200 units (see new Catalog 810). All of the Flybacks manufactured by Merit were originally designed to be an exact replacement. However, these same exact Flybacks can be used in many other TV receivers with slight modifications. Merit continues to use materials in their Flyback units that are best suited for extreme high voltage application. This is evidenced by their record of minimum field returns.



erit

COIL & TRANSFORMER CORPORATION

MERIT PLAZA - HOLLYWOOD, FLORIDA

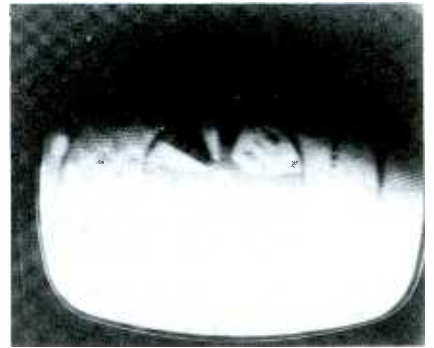


Fig. 5. Extreme 60-cycle modulation makes picture half black, half white.

pected circuit. You can track down the more difficult ones with a scope.

Another real howler that you'll find occasionally, if you're unlucky, is the "glitch." (This name was borrowed from a friend who is a TV transmitter engineer; he has 'em every once in a while.) Although it sounds like something out of *Alice in Wonderland*, the glitch is merely a small pip in the power-supply output voltage, due to an obscure trouble in the filter. A few sample causes are shorted turns in chokes, interelectrode leakage in multiple filter capacitors, peculiar resonances in the filters, and so on. The typical glitch causes a narrow bar to move slowly up or down the screen. It is usually about the same size as the vertical blanking bar, and the picture can even be synced with it! Glitches can be traced by looking for stray pips in the power-supply ripple waveform, as demonstrated in Fig. 6. In this case, a pip appears only on every other cycle of the 120-cps signal, indicating a freakish trouble in only one side of a full-wave power supply.

My favorite glitch story is about a family who owned two TV sets, a console and a portable. Both showed the characteristic narrow bar. After some head-scratching, I finally noticed that the little set worked perfectly when the console was turned off! One of the two 5U4's in the big set was found to be slightly gassy. New 5U4—no glitch! Evidently, the gassy tube went into a short burst of parasitic

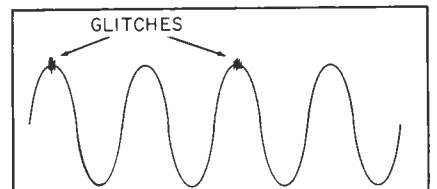


Fig. 6. Glitch is result of stray pip appearing in output of power supply.

with...



...you can service

COLOR TV

simply...swiftly...profitably!

Color TV service is a cinch with the right equipment—HICKOK *Color-Approved* test equipment is built to NTSC standards, recognized and approved by leading TV manufacturers.

These manufacturers have announced that they will be marketing color television sets this fall.

DUMONT **ADMIRAL**



ZENITH

Emerson

Magnavox

Olympic

PHILCO

Color TV Is Here To Stay! Cash in with

HICKOK *Color-Approved* test equipment! For full information, see your franchised HICKOK distributor.



656
NTSC Standard Color Bar Generator



660
White Dot-Bar Generator



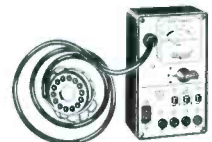
675A
Wide Band Oscilloscope



691
Heterodyne Marker-Adder



615
Sweep and Marker Generator



CR33
Color Tube Tester

The

HICKOK

Electrical Instrument Co.

10566 Dupont Avenue

• Cleveland 8, Ohio

Eliminate call backs...
use dependable,
industry-preferred...



3 WATT SIZE
5/8" x 1/4"

5 WATT SIZE
1 1/8" x 1/2"

AXIAL-LEAD RESISTORS
Vitreous-enameled, power-type, axial-lead units designed to withstand high temperatures.

LITTLE DEVIL® COMPOSITION RESISTORS
Meet all MIL-R-11A requirements. Available in 1/10, 1/4, 1/2, 1, and 2-watt sizes in all standard EIA values.

BROWN DEVIL® RESISTORS
Vitreous-enameled. In 5, 10, and 20-watt sizes.

TYPE AB POTENTIOMETERS
Resistance material is solid-molded, noise-free. Rated at 2 watts.

FR-75 FUSE RESISTOR
For easy replacement in many television receivers. 1 1/2" Tinned wire leads.

WRITE FOR STOCK CATALOG



OHMITE MANUFACTURING COMPANY
3644 Howard Street • Skokie, Illinois

oscillation at its peak of conduction.

Horizontal Hum

Page 34 of the July issue showed a dandy example of how 15,750-cycle interference from the horizontal sweep section can do the same things to the picture as 60-cycle interference — except, of course, the black bar runs up and down instead of across the screen. Almost all of these troubles are caused by insufficient filtering in the boost or horizontal circuits. I'd say the leading cause is failure of electrolytic capacitors between the boost line and the B+ source.

Now you know what to go looking for when you find a hum bar (either horizontal or vertical) on a TV screen. Keeping in mind the suggestion you've just read, you shouldn't have to look very far.



Miniature VOM

Many servicemen find it handy to carry a VOM along with them on home calls. If you're among those who do, you'll be interested in the *Pocketmeter* No. 30-240 recently introduced by Audiotex Mfg. Co., Div. of GC-Texton Electronics, Rockford, Ill.

Measuring only 5 1/2" x 3 1/2" x 1" and weighing a mere 14 ounces, the *Pocketmeter* is very versatile for its size. It provides the following ranges:

Current — 0-300 ua, 0-12 ma, 0-300 ma.

DC Volts—0-600 volts in five ranges.

AC Volts—0-600 volts rms in four ranges.

Ohms — 0-2 megohms in two ranges. (0-200 megohms using external voltage source).

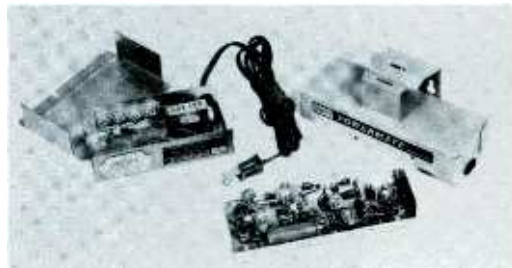
S Meter—0 to over 9.

Decibels—minus 15 db to plus 18 db, 32 db, 44 db.

Inductance — 0-1000 hy (using external voltage).

Capacitance — 0-.1 mfd, 2 mfd (using external voltage.)

Sensitivity of the meter is 6000 ohms/volt DC and 2700 ohms/volt AC.



Antenna Preamp

Tremendous strides have been made in improving TV-signal pre-amplifiers. Gone are the bulky boosters, almost as big as table radios, that used to sit on top of TV cabinets; in their stead we have mast-mounted, transistorized units not much larger than a blackboard eraser.

We recently examined and tested one of these new amplifiers, the *Powermate* Model APM-101 produced by Jerrold Electronics Corp. of Philadelphia. This device consists of two sections—the amplifier itself, and a remote power supply designed to be installed indoors near the TV set. The remote unit contains output-matching circuits for coupling two receivers to the antenna system; in addition, it includes a power transformer and an AC-coupling circuit which feeds approximately 20 volts AC to the mast-mounted section via the lead-in. A B+ rectifier and filter on the amplifier chassis supplies DC operating voltage to the 2N1742 transistor. Isolating networks couple the TV signals to the lead-in and provide protection for the RF circuits.

Since the amplifier is designed to be mounted as near to the antenna terminals as possible, the random noise picked up prior to amplification is held to a minimum. Also, the amplifier produces very little internal noise, so it has an excellent signal-to-noise ratio. The results of "before-after" tests on this unit, using several TV sets, showed that it can produce a good solid gain of 10 (measured at the video detector) with no perceptible increase in noise. ▲

PHOTOFACT world's finest electronic service data now greater than ever!

with dozens of exclusive new features for fastest, easiest, more profitable servicing

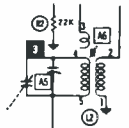
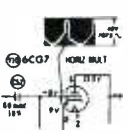
OVER 50,000 LISTINGS: Only service data of its kind—prepared from analysis of the actual equipment. Complete, uniform, accurate. Over 21,000,000 PHOTOFACT Sets now in use! If you're not using PHOTOFACT, you're not realizing your full earning power. So get the proof—try PHOTOFACT on any job—see how much time you save, how much more you can earn daily! Your Parts Distributor has the PHOTOFACT Folder Sets you need. Have *all* the help you'll ever want for greater servicing success and bigger earnings!



COVERS:
 Black & White TV
 Color TV
 AM Radios
 FM Radios
 Transistor Radios
 Auto Radios
 Amplifiers, Tuners
 Recorder Changers
 Tape Recorders

FAMOUS "STANDARD NOTATION" SCHEMATICS

- Uniform symbols in each schematic; same circuit layout form each time
- Voltages at tube pins and test points
- Waveforms at appropriate points on TV schematics
- "CircuitTrace" identification numbers for printed circuits
- Schematic items keyed to chassis photos and parts lists
- Special capacitor and resistor ratings
- Coil and transformer color codes or terminal identification



- Test points labeled
- Special currents shown (B+, horizontal output cathode, horizontal output screen)
- Alignment adjustments and test points labeled
- Tube functions shown
- Control and switch functions shown
- Switch sequence indicated
- Power supply "sources" shown
- Fuse ratings indicated
- Coil resistance over 1 ohm shown
- Coding of electrolytic capacitors shown

REPLACEMENT PARTS LISTS



- Lists standard, locally available replacement parts
- Includes notes for special installation or other considerations
- Includes ratings and/or measured values for assisting in selection of replacement parts
- All parts keyed to chassis photos and schematics for quick reference

TUBE PLACEMENT DIAGRAMS



- Shows tube types and functions; top and bottom views shown
- Includes filament connections on series string
- Indicates TV sound and sync paths
- Tube failure check charts included
- Shows blank pin or locating key on each tube
- Includes fuse locations and ratings.

ALIGNMENT INSTRUCTIONS



- Gives step-by-step easy-to-follow alignment data
- Procedure makes use of standard service-type equipment
- Alignment frequencies are shown on chassis photos near adjustment number—adjustments are keyed to schematic and photos

"CIRCUITRACE" FEATURE



- Invaluable printed board servicing aid—indicates points on board photo and schematic for quick, easy measurement of components, or test locations

FULL PHOTO COVERAGE



- All chassis views are shown in actual photographs
- All parts are numbered and keyed to the schematic and parts lists
- Test and alignment points indicated

FIELD SERVICE NOTES

- Outlines procedure for "in the home" adjustments
- Gives hints on quick access to pertinent adjustments, safety glass removal, etc.

"BONUS" FEATURES

- Disassembly instructions
- Dial cord diagrams
- Record changer and tape recorder "exploded views" for easy mechanical parts replacement or service

"PLUS" ADVANTAGES

- ★ Citizens Band Radio coverage
- ★ Tube Test data—provides setting for testing new tubes
- ★ Color TV Course "Bonus" beginning in Set No. 541
- ★ Eligibility for membership in "PEET" with ownership of a PHOTOFACT Library

SEND FOR YOUR PHOTOFACT INDEX NOW!

FREE

ONLY \$10 DOWN

puts the complete PHOTOFACT Library in your shop—and you have up to 30 months to pay. Right now—keep up with the industry—sign up for a Standing Order Subscription to PHOTOFACT! See your Sams distributor for full details on a Library or Standing Order purchase!

FREE!

VALUABLE PHOTOFACT INDEX

YOUR GUIDE TO OVER 50,000 TV, Radio, Electronic Listings! Send for it today! Your guide to virtually every model produced since 1946. Helps you locate the proper PHOTOFACT Folder you need to solve any service problem in any model. Send the coupon today for your FREE copy of the latest PHOTOFACT Index to the service data you need!



HOWARD W. SAMS & CO., INC.

Howard W. Sams & Co., Inc., Dept. 7-J1
 1724 E. 38th St., Indianapolis 6, Ind.

- Send FREE Photofact Cumulative Index
- Send full information on: Easy Buy Plan
 Standing Order Subscription "Peet" Program

Shop Name _____

Attn.: _____

Address _____

City _____ Zone _____ State _____

Sell the 2-Way Radio that Sells Itself... RCA MARK VII Radio-Phone



Manufacturer's Nationally Advertised Price
"Top-of-the-Line" Citizens' Band
2-Way Radio Equipment

The name "RCA" on this quality 2-way equipment is your best assurance of customer acceptance, dependable performance. Operates from car, home, office, boat or truck. Can be used at any location having 6 or 12 volt DC or standard 115 AC power source. Saves time! Saves money! Provides four crystal controlled channels for transmit and receive; manual receiver tuning for all 23 channels. Sensational value from RCA!

Additional RCA sales outlets are now being considered in many areas. Backed by a continuous national advertising program in leading publications, and by colorful promotional material. For full particulars about the Mark VII, as well as the new Personal-Com, hand-held 2-way radio, and a low-priced Intercom, write RCA Telecommunication Center, Dept. Z-429, Meadow Lands, Pa.



The Most Trusted Name
in Radio

RADIO CORPORATION OF AMERICA

SERVICE DEALER ADVERTISING PROGRAM

It's not too late to start your fall advertising campaign. You can add a lot of sparkle to your program by using a wide variety of ads to keep folks guessing about what you'll come up with next. If your promotional plans call for newspaper advertising, change ads every issue and repeat them every so often to obtain the best results. The whimsical cartoons featured in all of this month's ads will draw fresh attention to each new message.

Check with your printer to see if you should order newspaper mats (\$1.75 per set of 5), reproduction proofs (\$1 per set), or both (\$2.50). Then, fill in the handy coupon on page 87 to order either this month's selection or the entire program of 60 ads. (With the latter, you receive a comb-bound book of proofs.) To be sure of getting your ads in time for your promotion, mail the request as early as possible.

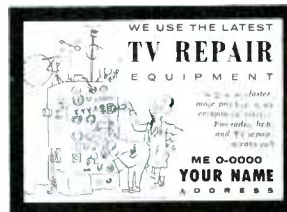
ES-17 1 7/8" x 4 1/4"

Who doesn't do a "slow burn" while waiting for service? Use this hard-hitting cartoon and capitalize on your ability to offer prompt service on radio, TV, and hi-fi equipment.



ES-24 1 7/8" x 4 1/4"

Overcome customers' reluctance to let a "clumsy ox" work on their TV; this ad assures them you handle sets with the same loving care as if they were your own.



ES-34 3 3/4" x 2 3/4"

Ads that emphasize your modern equipment and techniques are always effective. The "Rube Goldberg" machine in this one adds just the right touch to bring sure-fire results.

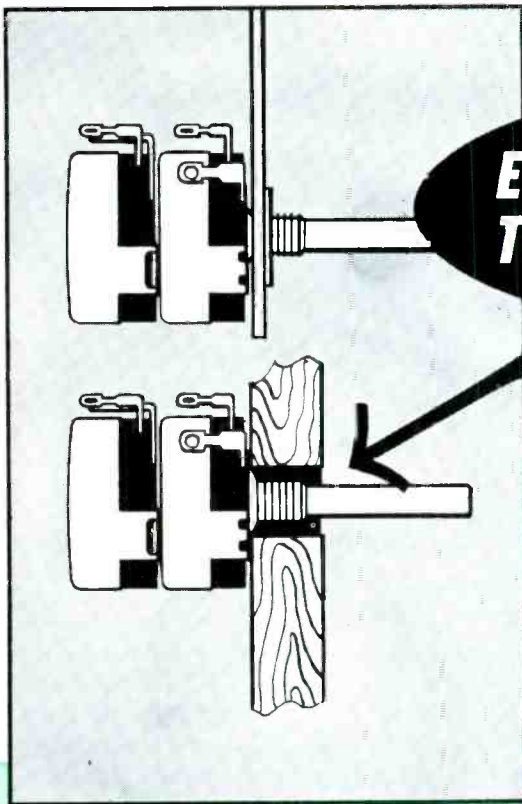
ES-2 1 7/8" x 3 3/4"

This ad tells the TV owner just what he wants to hear: You promise to repair sets in the home whenever possible, bringing them to the shop only when absolutely necessary.



ES-59 1 7/8" x 3 1/2"

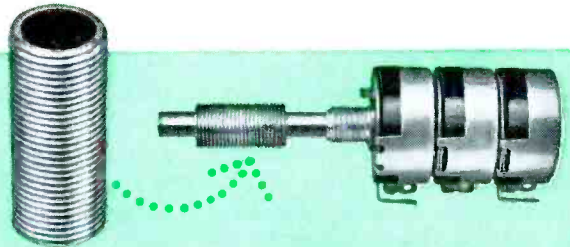
Here's one that catches the reader's eye and raises a pert question, reminding him to have his hi-fi, TV, or radio repaired—by you, of course.



ELIMINATE PANEL THICKNESS PROBLEMS

without dual bushing length stocking

New CLAROSTAT PANEL-JUSTER BUSHINGS



Now—another “first” from Clarostat that eliminates the need for ordering $\frac{3}{8}$ ” or 1” long bushing length controls—a single standard length meets all panel thickness requirements—Panel-Juster threads on any standard Clarostat $\frac{3}{8}$ ” long bushing to make it a full 1” long bushing. Cuts inventory requirements in half! Eliminates waiting time for you and your customer for “special” 1” bushing controls! Stock them and use them...

another good reason for always buying Clarostat

CONSTANT IMPEDANCE CONTROLS



Self-compensating L-pads and T-pads rated at 10 watts audio. Continuous range from 0.5 to 30 db attenuation.

CONSTANT IMPEDANCE OUTPUT ATTENUATORS



Linear attenuation in 3 db steps up to 24 db. Rated at 30 watts audio. Equipped with dial plate and bar knob.

CONSTANT IMPEDANCE ATTENUATORS



Compact controls rated at 4 watts audio. L-pads and T-pads. Attenuation of 30 db over 90% rotation, 60 db in remaining 10%.

THEATRE SPEAKER CONTROLS



Drive-in theatre controls for RCA, International, Motiograph and Simplex equipment. Available as L-pad, linear or tapered rheostat.



WRITE FOR COMPLETE DETAILS ON THE SOUNDEST SOUND CONTROL LINE IN THE INDUSTRY...

CLAROSTAT MFG. CO., INC.
DOVER, NEW HAMPSHIRE

Using a Tube Tester to Advantage



Are you getting as much good out of this time-proved instrument as you could be? by Joe A. Groves

Although a tube tester is one of the oldest and most common electronic test instruments, few servicemen take full advantage of owning one. Many "old pros" no longer use theirs for troubleshooting because they have been fooled by earlier tests. As a result, they have retired the tester to a little corner of the shop "for customers' use only." On the other hand, many newcomers consider the tube checker to be their most loyal friend and accept the result of every test as gospel. Neither of these attitudes is wise.

Before going into the subject of how you can get the most good from your tube tester, it should be understood that expecting a tester to supply information beyond its design capabilities is as foolish as expecting a compact automobile to pull a semi-trailer over a mountain. Yet this is what has made many technicians lose faith in tube testers—they have expected too much from them.

Certainly, tube testers have limitations. There is no commercially-available tube tester that will give a 100% accurate indication of tube merit. However, this shouldn't be a stumbling block for any technician.

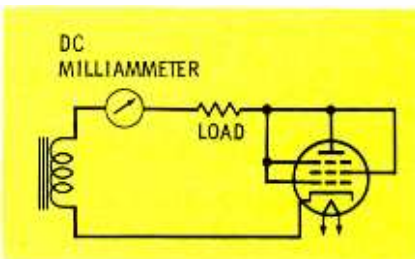


Fig. 1. All tube types are checked as diodes in an emission-type tube tester.

After all, you've learned to get along pretty well with VOM's and VTVM's, and find them useful test instruments. You accept a reading as an indication of the voltage present in a circuit, knowing full well that the meter introduces a parallel circuit path which causes a certain amount of change in the voltage. (For further explanation of this point, refer to "Pitfalls of Meter Readings" in the April, 1961 issue.) Why not learn to accept the limitations of a tube tester in the same way?

Types of Testers

Take off the frills, get down to bare facts, and you'll find three basic types of tube testers used by servicemen—emission, dynamic, and mutual conductance or transconductance. Each type is designed for certain applications and has certain limitations.

Emission Type

Tube checkers falling in the emission category are designed for easy operation. They show whether or not a tube is capable of emitting electrons, and provide a rough indication of merit. All tubes are connected as diodes (Fig. 1) and a DC milliammeter measures plate current. The load is selected for various tube types to obtain a GOOD indication for an average tube of the type under test.

This type of tester was developed primarily to show that tubes sold over the counter were good when they left the shop. The simple indication it provided eliminated the problem of a customer buying a "pig

in a poke," and met the need of fulfilling a tube guarantee. (Usually the only guarantee on tubes sold directly to a consumer is that the tube is good at the time of purchase.) These testers serve the same purpose today that they did 30 years ago; thus, they are more of a sales tool than a troubleshooting instrument.

Dynamic Type

Dynamic tube testers offer a more accurate indication of how a tube will operate in a circuit than those classified as emission testers. As shown in Fig. 2, an AC signal is applied between grid and cathode, and a milliammeter reads plate current. However, only the DC component is measured. This reading can be affected by the emission, as well as by other factors which affect the amplifying ability of the tube. Therefore, higher-than-normal emission can "cover up" for conditions (such as poor grid alignment) which lead to inefficient tube operation. Dynamic testers thus tend to favor tubes of the remote-cutoff type and tubes with ample emission.

Dynamic testers are easy to set up and generally small in size. Since

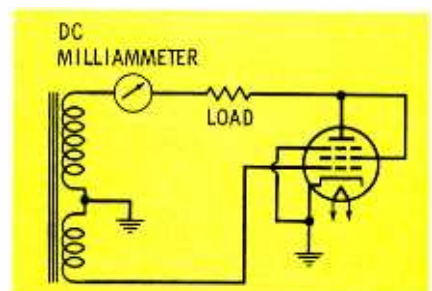


Fig. 2. Dynamic-type tester applies a signal to the grid and checks I_p .

TESTS
All TV and Radio
Tubes—Old and New

TESTS
the Nuvistors

TESTS
the New 12-Pin
Compactrons

TESTS
the New 10-Pin Tubes

TESTS
European Hi-Fi Tubes,
Voltage Regulators, and
Most Industrial Types

TESTS
for True Dynamic
Mutual Conductance (Gm)

**OBSOLESCENCE
PROOF**
Designed for Maximum
Use Today and
Tomorrow



**NEWEST
FINEST
MONEY-MAKER**

*for Professional
Servicemen*

Multiple-Socket Speed with Gm Accuracy **PLUS** OBSOLESCENCE PROTECTION

Model 700 DYNA-QUIK

*Fastest, Most Complete
Most Up-to-Date*

**DYNAMIC
MUTUAL CONDUCTANCE
TUBE TESTER**

*See your B&K Distributor,
or Write for Catalog AP18-R*

TESTS BOTH OLD AND NEW TUBE TYPES—SELLS MORE TUBES PER CALL

Again you benefit from proved B&K techniques! This up-to-date, obsolescence-proof, professional instrument is designed for maximum use today and tomorrow. Provides multiple-socket section to quick-check most of the TV and radio tube types the true dynamic mutual conductance way—plus simplified switch section to check new tube types in Dyna-Quik emission circuit. Also includes provision for future new sockets.

Makes test under set-operating conditions. Checks each section of multi-section tubes separately. Checks for all shorts, grid emission, leakage and gas. Makes quick "life" test. Exclusive adjustable grid emission test provides sensitivity to over 100 megohms.

Makes complete tube test in seconds. Checks average set in a few minutes. Discovers weak tubes that need replacement. Satisfies more customers. Sells more tubes. Saves call-backs. Insures your reputation.

*Patented automatic compensation for line voltage variation. Large 4½" plastic meter with easy-to-read "Replace-Good" scale. Lists most commonly used tube types with settings directly on socket panel for fastest operation. Complete listing in reference chart in cover. Phosphor-bronze contacts for long life. 7, 9, and 10-pin straighteners on panel. Operates on 117 volts 50-60 cycle a.c. Handsome leatherette-covered carrying case.
Size: 16½" x 15¼" x 5⅞" deep. Net wt: 15½ lbs.*

Net, **\$169⁹⁵**

NEW TUBE INFORMATION SERVICE

Available every 3 months, on subscription,
for all B&K Dyna-Quik Tube Testers



B & K MANUFACTURING CO.

1801 W. BELLE PLAINE AVE • CHICAGO 13, ILL.
Canada: Atlas Radio Corp., 50 Wingold, Toronto 19, Ont.
Export: Empire Exporters, 277 Broadway, New York 7, U.S.A.

Picture-Tube Repair Tool

Eliminates that hard soldering job

only \$1.25 each

PT-1
3/32" PIN



Fix loose pin connections in seconds. Pays for itself in time saved on first job. 3" long.

Patented

Intermittent operation of picture tubes due to defective solder connections easily corrected. Provides solid electrical connections, can also be used as channel-selector wrench and screwdriver. Pin keeps its original form. A 3-in-1 tool.

3 MODELS ELIMINATE SOLDERING

Makes Solid Electrical Connections

Phono-Plug Crimper

Slip wire in "pin plug," insert in tool, and squeeze job is done.

Use end of tool to push on C-ring for ground connection.

C-rings 1c ea.

AU-2
1/8" PIN

Ant. plugs, hi-fi, multiple plugs, public address, radio and TV tubes, radar, speakers, and loop connections. Many, many more uses.

Model LC-3 for 5/32" pin diameter

At your parts distributor or write us

BERNS Mfg. Co.
9853 Chalmers,
Detroit 13, Mich

SERVICE TECHNICIANS

Here's a fast dependable television tuner overhaul at your service . . .

\$6.00 plus postage and C.O.D. charges and major parts

VHF · UHF · U/V COMBOS
· FM TUNERS

- ✓ Two-day in and out handling.
- ✓ Repair and realignment to factory specs.
- ✓ Clean and lubricate switches and turrets.
- ✓ Discount prices for replaced parts.
- ✓ Return shipping charges prepaid.

Charges for this service, is \$6.00 plus major parts.

Send tuners by parcel post or air express. Include all broken parts and tuner model and number. Take special care to pack tuner well to prevent transit damage.

TELEVISION TUNER SERVICE CO.
2103 W. 3rd St. · Bloomington, Ind.

they provide at least some sort of an indication of the amplifying ability of a tube, they are often preferred over the emission type for tube-sale testing. In addition, they can be used for practical troubleshooting when their limitations are remembered.

Transconductance Type

Transconductance is the term used to indicate the amplifying ability of a tube. Testers designed to measure this characteristic use the basic test circuit shown in Fig. 3. Both an AC signal and a bias voltage are applied between grid and cathode. The metering circuit measures the amplitude of the AC signal appearing in the plate circuit to provide a reasonably accurate indication of transconductance.

Setup procedures for testers of this type are normally too complicated for the average layman to operate. Therefore, they are seldom used for do-it-yourself tube testing, even though they provide the most accurate quality check of any commercial tester.

One limitation of mutual-conductance testers is that they evaluate tubes as class A amplifiers. Since many TV circuits operate class B or C, and handle pulse signals, a class A test doesn't necessarily tell you how the tube will function under different bias conditions.

The Brighter Side

Now that we've looked at some of the limitations of tube checkers, let's examine their strong points. Obviously, they must serve a useful purpose, or they wouldn't be considered basic test equipment. For you skeptics, it's sheer nonsense to think public demand is the only reason a tube tester is a "must." Testers were being put to good use long before the do-it-yourself bug bit the American public.

In addition to checking tubes being sold to customers, a tester has many applications on the bench and on home calls. Up to this point we've considered only the emission and amplifying tests of tubes. So-called auxiliary tests such as shorts, leakage, gas, noise, etc., offer enough troubleshooting assistance in themselves to justify the price of a tester.

Testers at Work

Suppose you're on a home call

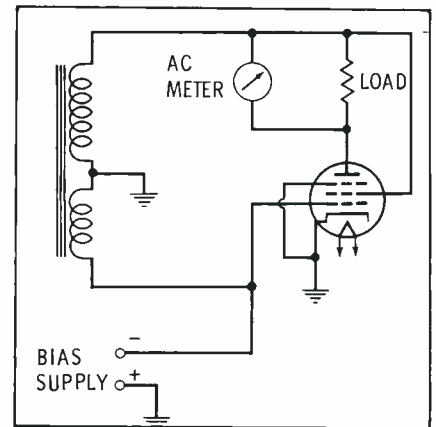
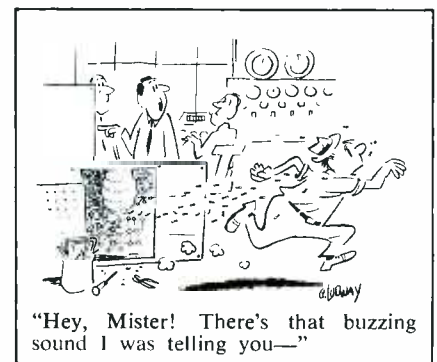
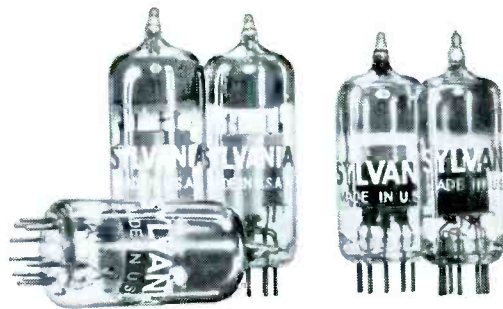


Fig. 3. Transconductance-type testers compare input and output AC signal. to handle a complaint of vertical roll, and you've substituted the tubes in the sync and vertical circuits to no avail. What would you do next—abruptly tell your customer the set requires shop service, and start pulling the chassis? Hold on a minute—a tube could still be causing the trouble. There's a fairly good chance the problem is due to some fault like a heater-cathode short or excessive grid current in a video, IF, RF, or AGC tube. Why not check these on the spot? To the customer, this will seem like a logical approach—and it will look more professional than continuing to fumble around with tube substitution.

Try another example. This time, let's assume you were greeted by an overloaded picture which righted itself when you disconnected the antenna. It looks like AGC trouble, but substitution of the keyer tube and adjustment of the AGC control haven't solved the problem. You could substitute the RF and IF tubes, anticipating gas or grid leakage—but it would be best to try a complete set all at one time, since more than one tube may be causing trouble. What if you don't have enough tubes of the right types in your caddy? Here's another logical place to put a tube tester to work.





18FW6A
 18FX6A
 18FY6A
 32ET5A
 36AM3B

SYLVANIA BEATS THE HEAT

Familiar numbers, aren't they? But the "A" and "B" versions are brand-new . . . introduced by Sylvania to help you hold onto your home radio service profits.

The 100-mA heater concept, pioneered by Sylvania, offers "cool" operation in series-string connection. But "series-string," as you know, can be pretty hard on heaters at the instant of "turn-on"; can shorten tube life; can mean a callback. Now, Sylvania has incorporated significant controls on warm-up time of the heaters. Surge voltages on any one heater in this 5-tube complement are therefore minimized, expectant tube life is extended. Benefits to you? Obvious . . . high probability of mighty few callbacks due to *Sylvania tube failure*.

You too can beat the heat of profit-burning callbacks. Don't just order "tubes." Always order SYLVANIA TUBES. Electronic Tubes Division, Sylvania Electric Products Inc., 1740 Broadway, New York 19, N. Y.

New, improved 100-mA AC-DC tubes feature controlled heater warm-up time . . . increased heater life . . . defeat profit-burning callbacks!



SYLVANIA

SUBSIDIARY OF

GENERAL TELEPHONE & ELECTRONICS



4 IMPORTANT NEW SAMS BOOKS

Two-Way Mobile Radio Maintenance



actual photos show proper step-by-step installation and maintenance. Only book of its kind for \$4.95 the technician. 224 pages; 5 1/2 x 8 1/2". Only

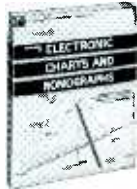
Troubleshooting Amateur Radio Equipment



Howard S. Pyle, W70E, provides a wonderful guide for all hams who want to repair their own equipment. The most common types of failures are stressed. You learn in detail what is most likely to cause the trouble and how to correct the problem right in the "shack". Includes 9 complete schematic diagrams for the most popular transmitters and receivers. Chapters cover: Receiver Troubles; Transmitter Troubles; the Antenna System; Accessory Equipment; Preventive Maintenance; Mobile Equipment; Component Color Codes; Schematic Symbols. \$2.50 128 pages; 5 1/2 x 8 1/2". Only

Handbook of Electronic Charts and Nomographs

Allan Lytel's important time-saving book—contains 58 electronic charts and nomographs to provide solutions to hundreds of formulas and ratios—in just the time it takes to rule a line. Shows you how to use each nomograph; provides examples. Includes bound-in clear vinyl overlay sheet for positioning over any nomograph; permits ruling in erasable pencil lines connecting appropriate points on the graph scales; can be used repeatedly without injuring the nomograph. Comb-binding; book lies flat with its 8 1/2 x 11" size providing large scales for best accuracy. Special chapter tells how to use nomographs most effectively and how to develop them on your own. 128 pages; 8 1/2 x 11". Only \$4.95



Basic Electronics Series: Amplifier Circuits

Thomas M. Adams, Captain, U.S.N., completely explains amplifier circuits. This second book in the series also provides dynamic circuit diagrams in FOUR COLORS to enable you to visualize exactly what action takes place every moment during circuit operation. You unmistakably identify each and every electron current in a particular circuit, and you learn in detail the changes each current undergoes for every moment of operation. Chapters include: Basic Vacuum Tube Actions; R-C Coupled AF Voltage Amplifiers; Transformer-Coupled AF Voltage Amplifiers; A-F Power Amplifiers; Audio Phase-Inversion Circuits; Impedance-Coupled AF Voltage Amplifiers; Transformer-Coupled RF Voltage Amplifiers. Here's the one book that helps you understand amplifier circuits. 128 pages; 5 1/2 x 8 1/2". Only \$2.95



HOWARD W. SAMS & CO., INC.

Order from your Sams Distributor today, or mail to Howard W. Sams & Co., Inc., Dept. J-31 1720 E. 38th St., Indianapolis 6, Ind.

Send me the following books:

- Two-Way Mobile Radio Maintenance (TWD-1)
- Troubleshooting Amateur Radio Equip. (AMP-1)
- Handbook of Electronic Charts (NOM-1)
- Basic Electronics Series: Amplifier Cir. (BEA-1)

\$..... enclosed. Send Free Book List

Name _____
 Address _____
 City _____ Zone _____ State _____
 IN CANADA: A. C. Simmonds & Sons, Ltd., Toronto 7
 (outside U.S.A. priced slightly higher)

The gas test of a tube tester really measures grid current, which may be caused by several things other than gas content. Regardless of cause, however, any appreciable "gas" indication when there is negative bias on the tube usually spells trouble. Testers use a circuit similar to the one in Fig. 4. Its sensitivity depends on the size of R. Grid current, if present, produces a voltage drop across R when the resistor is switched into the circuit. This alters the bias on the tube under test. Naturally, the greater the change in bias voltage, the greater the change in meter indication.

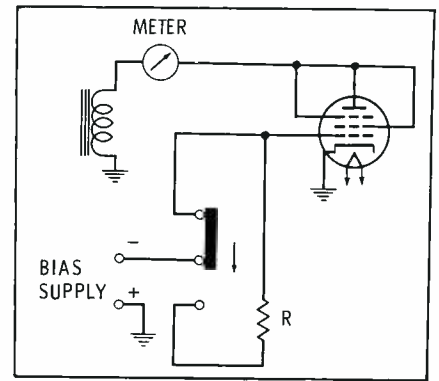


Fig. 4. Grid current through R alters bias and changes the meter indication.

In some applications, grid current must be drawn on positive peaks of the input signal to establish grid-leak bias. The gas-test circuit of Fig. 4 can gauge the ability of a tube to meet this requirement. The fixed bias is reduced to zero, and a relative measurement of the resulting grid current is provided by the voltage drop across R. This check, like the test for absence of grid current at high bias voltages, can furnish valuable troubleshooting clues.

We've already pointed out that a gain or quality check in a tester can't predict for sure how a tube will operate in one of the sync or sweep circuits. Nevertheless, such a test does have definite benefits. It often confirms suspicions of trouble—or, more important, tells you when you're on the wrong track in blaming trouble on a tube.

To illustrate this point, suppose you're called on to widen a narrow picture, or answer a complaint that the raster takes too long to fill the screen vertically. You put a new tube in the suspected stage, and the trouble is apparently cured. So, you make out your bill, collect, and go on your merry way, only to receive a call in a day or two telling you the same trouble has returned. Chances are the original tube wasn't any more at fault than the replacement—there's undoubtedly a circuit defect at the bottom of the trouble. In fact, you may have to pull the set for bench service on the second call. But what about that tube you've billed your customer for, and what about your lost time on the callback? Then the thought occurs to you, "Why didn't I check the original tube before I replaced it?"

An indication of excessive grid current and weak emission might have tipped you off to a leaky grid coupling capacitor. Or, if the tube had checked normal in every respect, this would have put you on the alert for the possibility of trouble in some component besides the tube.

When you're holding a "post-mortem" on a tube replacement that didn't hold up, there's every possibility in the world that the original and new tubes will both check up to par. The reason why the replacement provided a short-lived solution to the problem is that its initial high performance temporarily covered up a circuit defect. You'll probably find, in cases like this, that the original tube will work fine when you've solved the real problem.

Even though testers are not infallible in judging tubes "good" or "bad," they are valid and valuable servicing aids as long as you properly interpret the results. Developing this skill requires that you pay close attention to all tests, so you can learn the normal reaction of your instrument to different tube types. Make a practice of critically testing all tubes, and you'll soon learn how to get the most out of your tester.

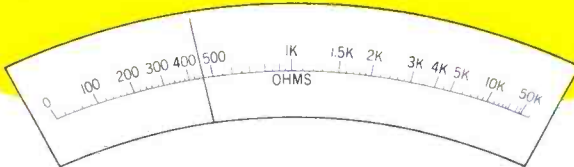


INDIVIDUAL
WIDE-VIEW
SCALE FOR
EACH RANGE
GIVES

Quick, Direct, Error-Free Readings *without Multiplying!*



New VTVM DYNAMATIC 375 Automatic Vacuum-Tube Voltmeter



- Individual Full-Size Scale for Each Range
- Range Switch Automatically Sets Correct Scale
- Only One Scale Visible at Any One Time
- All Scales Are Direct Reading
- No Multiplying . . . No False Readings
- Includes DC Current Ranges, too

Here's another exciting first by B&K. With direct-reading single scales, this professional *automatic* VTVM makes it easier, faster than ever to read the exact answer accurately on the correct scale . . . *without reading difficulty, calculation, or chance of error.* Greatly simplifies true reading of peak-to-peak voltages of complex wave forms in video, sync and deflection circuits, pulse circuits, radar systems, etc.

All scales are direct reading. Every scale is the same full size, and only one scale is visible at any one time. *Once you set the range switch properly, it is impossible to read the wrong scale.*

The DYNAMATIC 375 utilizes a single DC-AC ohms probe, anti-parallax mirror, and other desired features . . . to make accurate measurements with utmost convenience and reliability in laboratory, factory production, or service shop.

Includes sturdy swivel stand which permits tilting "375" to any desired viewing angle, swings up as convenient carry-handle.

Ranges: DC Volts	0 - 1.5, 5, 15, 50, 150, 500, 1500
AC Volts (rms)	0 - 1.5, 5, 15, 50, 150, 500, 1500
AC Volts (peak-to-peak)	0 - 1.5, 5, 15, 50, 150, 500, 1500
DC Current	0 - 5 ma, 50 ma, 500 ma
Ohms	0 - 500 ohms, 5 k, 50 k, 500 k, 5 meg, 50 meg, 1000 meg

Input Resistance: 11 megohms on all DC ranges

Accuracy: $\pm 3\%$ full scale AC and DC

Meter Movement: Sensitive 100 microampere

Precision Multiplier Resistors with $\pm 1\%$ accuracy

Anti-Parallax Mirrored Scale for precise readings

Easy-to-See Iridescent Knife-Edge Pointer

Single DC-AC Ohms Probe (supplied)

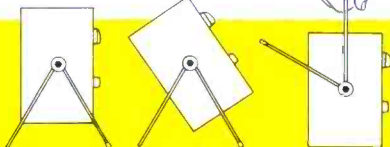
Includes 1½ volt Battery. Operates on 117 volts 50-60 cycle AC

Sturdy, handsome metal case with convenient combination swivel stand and handle. Size: 10¾" x 6¾" x 4" deep. Net wt: 8 lbs.

Model 375

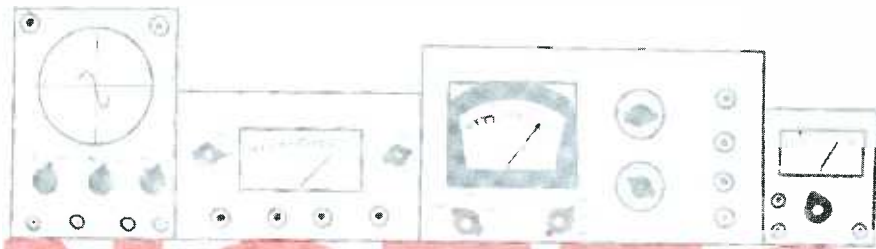
Net, \$89⁹⁵

See Your B&K
Distributor
or Write for
Catalog AP18-R



B & K MANUFACTURING CO.
1801 W. BELLE PLAINE AVE • CHICAGO 13, ILL.
Canada: Atlas Radio Corp., 50 Wingold, Toronto 19, Ont.
Export: Empire Exporters, 277 Broadway, New York 7, U.S.A.





NOTES ON TEST EQUIPMENT

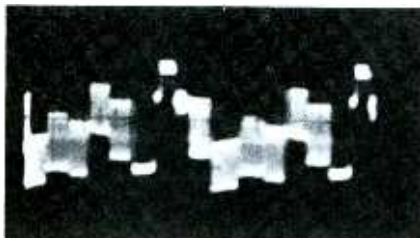
by Les Deane

Convertible Scope

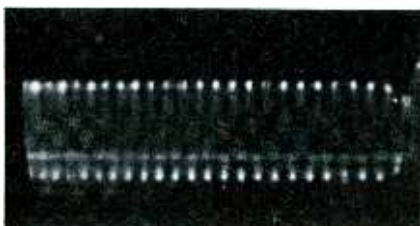


Fig. 1. Jackson 5" scope has ample response and gain for any service work.

If you're having trouble deciding between a wide-band oscilloscope and a narrower-band, higher-gain type for your shop, you'll be interested in the unit shown in Fig. 1. By flipping a front-panel switch, you can modify the vertical amplifier to favor either bandwidth or gain. This scope is the new Model 600 produced by the Jackson Electrical Instrument Co. of Dayton, Ohio.



(A) NTSC color-bar signal.



(B) Expanded 3.58-mc signal.

Fig. 2. Waveforms photographed from screen of new Model 600 oscilloscope.

Specifications are:

1. **Power Requirements**—105/125 volts, 60 cps; power consumption 75 watts; regulated supply line-isolated and fuse-protected; pilot light on panel.
2. **Vertical System**—input impedance 1.5 megohms shunted by 20 mmf (30 mmf for x1 position); maximum input 600 volts rms (or peak AC plus DC); attenuator switch with three positions for wide-band and three for high-sensitivity operation, plus vernier control; wide-band operation gives flat frequency response from less than 10 cps to 4.9 mc \pm 1 db, down 3 db at 5.2 mc and 6 db at 5.6 mc, with sensitivity of .3 volt rms/inch; narrow-band operation gives frequency response from less than 10 cps to 120 kc \pm 1 db, down 3 db at 200 kc, and 6 db at 400 kc, with sensitivity .02-volt rms/inch; input cable supplied.
3. **Horizontal System**—input impedance 1.1 megohms shunted by 22 mmf (12 mmf with x10 attenuator switched in); maximum input 600 volts AC plus DC; frequency response from less than 10 cps to 200 kc \pm 2 db, down 6 db at 650 kc; sensitivity .8 volt rms/inch.
4. **Internal Sweep System**—frequency continuously variable in six overlapping ranges from 10 cps to 100 kc; internal 60-cycle sweep, gain control, and variable sweep expansion provided.
5. **Sync Provisions**—vertical input signal, internal 60 or 120 cps, and external source; SYNC LEVEL and STABILITY controls provided on panel; maximum external sync input 100 volts AC, 400 volts AC plus DC.
6. **Other Features**—flat-face 5" CRT with lighted graticule, signal polarity reversal, internal and external intensity modulation, astigmatism control, negative gate-pulse output, built-in 10V P-P calibration voltage, direct deflection inputs, and camera mount provided; accessory low-capacitance, demodulator, and high-voltage probes available.
7. **Size and Weight**—15" x 9 1/8" x 13", 24 1/4 lbs.

The vertical amplifier of a scope can go only so far in offering both high gain and broad frequency response, without increasing the number of stages beyond a "point of no return." Thus, if a scope has a flat response out to 4 or 6 mc, its sensitivity is likely to be relatively low. Consequently, you may be able to view every detail of a high-frequency waveform, but may not obtain sufficient vertical deflection when sampling low-level signals. If a scope has a high sensitivity, on the other hand, its frequency response will generally be limited; therefore, the abrupt voltage changes in a high-frequency signal will not be accurately reproduced. Instead of compromising between wide-band and high-sensitivity operation, the Model 600 offers a choice of one or the other—depending on the attenuator-switch setting.

While lab-testing the instrument, I fed in a composite color-bar signal from our closed-circuit transmitter to see how it would be reproduced in wide-band operation. The results are indicated in Fig. 2A, taken with the scope sweep set at 1/2 the horizontal sync-pulse rate to show two complete lines of the composite signal. In Fig. 2B, I increased the sweep rate and used the expanded-sweep feature of the instrument to reproduce a 3.58-mc chroma signal from a color-bar generator. Although brightness is reduced, the waveform is clearly visible.

To check the sensitivity of the instrument, I viewed waveforms produced by microphone and phono-cartridge outputs, small B+ ripple voltages, and demodulated video-IF signals. The gain of the vertical system was more than adequate to reproduce these signals for clear observation and peak-to-peak measurements. Employing an audio analyzer with built-in output meter as a signal source, I found that the scope could actually reproduce a usable waveform down to signal levels of less than .005 volts rms. The built-in calibration-voltage source and scaled graticule are useful aids in measuring signal amplitudes.

The negative gate terminal mentioned in the specifications furnishes a pulse output for testing inductive components by a simple ringing process outlined in the manual.

Two-in-One Meter

If you do much servicing or maintenance work, you undoubtedly have frequent use for both a portable volt-ohm-meter and a vacuum-tube voltmeter—one for quick reference checks in the field and the other for troubleshooting and alignment jobs at the bench. Realizing this twofold need, Sencore, Inc., of Addison, Illinois has introduced a new meter that combines all the functions of both instruments in one compact unit. (See Fig. 3.) The Service Master Model SM112 also offers a number of unique features not found in conventional VOM's or VTVM's.

VTVM specifications are:

1. **DC Voltmeter**—six ranges of from 0 to 3, 10, 30, 100, 300 and 1000 volts; input resistance 10 megohms; accuracy \pm 3% of full-scale deflec-

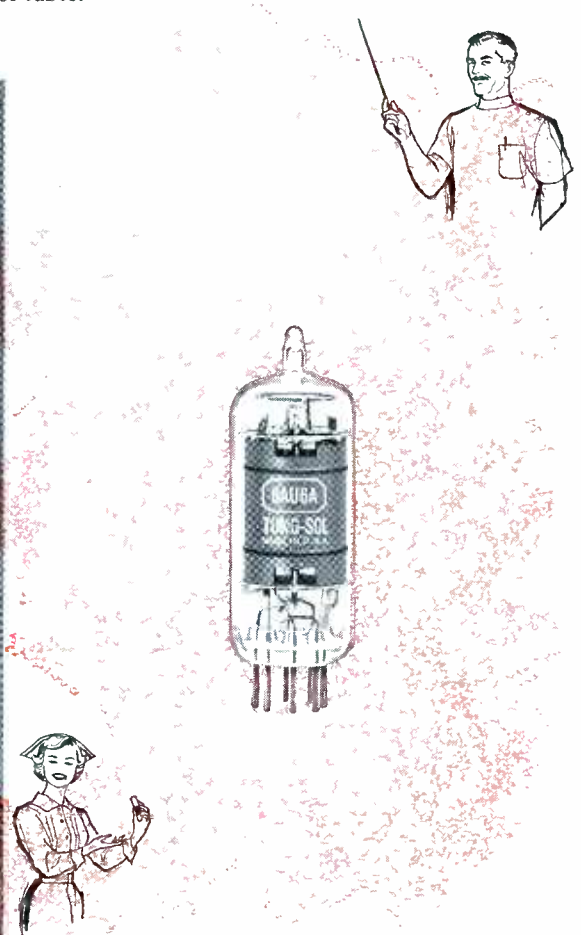
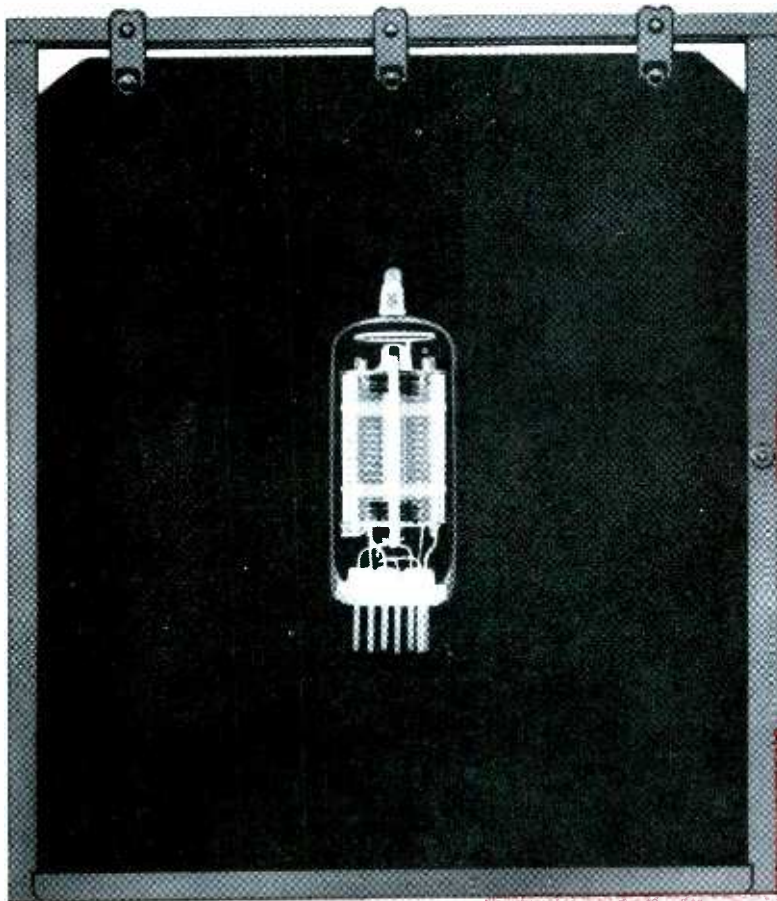
ABSENCE OF "GRID EMISSION" AND GAS DEMONSTRATES GOOD HEALTH OF TUNG-SOL IF AMPLIFIER TUBES

Radio and TV doctors know that IF amplifier tubes must be physically sound in order to enjoy a healthy long life. Because they operate in a high impedance circuit, internal cleanliness is vital to avoid gas distress. Grid emission, which displays identical symptoms, likewise must be carefully avoided. Tung-Sol's exacting engineering standards and rigid quality control in every step of manufacture assure vigorous long life. Tung-Sol IF amplifier tubes are made in a humidity-controlled, dust-free atmosphere. The operator's hands never touch the cathode coating. Gas evacuation

and metal heating are done with critical precision by means of the most advanced equipment. As a result, Tung-Sol IF amplifier tubes possess unusual stamina and help you to maintain enviable standards in your service business.

GOOD MEDICINE FOR PROFITS

One of the most highly recommended medicines for profits in radio and TV service business is the prescribing of tubes that are reliable. Cuts radio and TV set hospital visits. You can rely on Tung-Sol tubes.



HERE ARE SOME OF THE MORE POPULAR
TUNG-SOL IF AMPLIFIERS:

10J4; 6AG5; 3AU6; 4AU6; 6AU6A; 12AU6; 3BA6; 4BA6;
6BA6; 12BA6; 3BC5; 4BC5; 6BC5; 6BH6; 6BJ6; 3CB6;
4CB6; 6CB6; 3BZ6; 4BZ6; 6BZ6; 12BZ6; 3DK6; 4DK6;
6DK6; 12AC6; 12BL6; 12AF6; 12EK6; 12EZ6; 18GD6A;
18FW6A



the first name to ask for when ordering



TUNG-SOL[®]
IF AMPLIFIER TUBES

TUNG-SOL ELECTRIC INC., NEWARK 4, N. J.

EARN EXTRA SERVICING INCOME

AIR CONDITIONERS • P. A.
CITIZENS BAND • INTERCOMS
TRANSISTOR & AUTO RADIOS

RIDER BOOKS

CITIZENS BAND RADIO by Allen Lytel. The tremendous amount of Citizens Band equipment now being used by the public spells a profitable market for the service technician. This book is an excellent introduction to citizens band radio equipment for the technician who must repair and maintain it. It provides all the information that will make you thoroughly familiar with CB. Early chapters describe the historical development of citizens band radio, its applications, classifications and types of CB equipment. FCC Rules and Regulations are discussed. Design features of different types of transmitting and receiving equipment are compared, with emphasis on single-channel and multi-channel transceivers and receivers. Portable units, kits and standard transceivers, antennas and power supplies are covered. Separate chapters are devoted to the installation and repair of citizens band radio equipment. #273, \$3.90.

REPAIRING TRANSISTOR RADIOS by S. Libes (Dir. Technical Publ., Bogen-Presto). Provides practical procedures which you can apply to faster troubleshooting and to finding those elusive 'dog troubles.' Basic theory is presented in a way that you will understand easily, quickly. Operation and service of the latest transistorized circuit designs are covered. All new ideas about transistors as used in current transistor radios are explained. Also included are the latest design practices in transistor portables, AM, multi-band, imported, all-transistor, auto-hybrid and FM radio receivers. High power transistorized P.A. power amplifiers and high fidelity applications covered. #270, \$3.50.

BASICS OF FRACTIONAL HORSEPOWER MOTORS & REPAIR by Gerald Schweitzer. Training & Service Publications Supervisor, Fedders Corp. Fractional horsepower motors are used in air conditioners, fans, refrigerators, washing machines, dishwashers, sewing machines, record changers, power motors, power tools, etc. It is so easy to learn the theory of fractional horsepower motors from this 'pictured-text' course so that you can apply it to servicing and maintenance for additional profits. #236, \$3.90; #236-H, cloth, \$4.90.

HOW TO INSTALL & SERVICE INTERCOMMUNICATION SYSTEMS by Jack Darr. A most lucrative and rewarding field for the service-technician who has the know-how. This book covers the entire field of commercial intercommunication equipment—installation and maintenance. It deals with basic amplifiers, special speakers, switching arrangements, AC and AC/DC systems, wireless systems, cabling networks, all-call systems, paging systems, remote and master systems, one and two-way intercom systems, installation for home and industrial use, outdoor wiring, and system requirements for particular applications. The text on servicing techniques covers amplifiers, power supplies, boosters, components, tubes, intermittents, switching, cabling, speakers and microphones. Also, test equipment and tools needed for trouble-shooting. Illustrations of test set-ups. #189, \$3.60.

HOW TO INSTALL AND SERVICE AUTO RADIOS (2nd edition) by Jack Darr. The 2nd edition of this extremely informative and practical book brings auto radio installation and servicing right up to date. All the new tricks of the trade are to be found here. The techniques applicable to the most modern auto radios—signal-seeking tuners, hybrid auto radios, transistor auto radios, conversion from 6 to 12 volt operation, and many more new things are explained in great detail. The author, an expert in this field runs a very successful auto radio and mobile radio installation and service shop. #159, \$3.25.

HOME AIR CONDITIONING—Installation & Repair by J. Derman, F. Makstein, H. Seaman. This modern, completely practical text by three experts in the field of home air conditioning, enables anyone to understand the organization, operation, installation and repair of all types of home air conditioners. Starting with the principles of the process of cooling air, it covers all facets of home air conditioners. #211, \$3.50.

Get these books at your distributor today!
Write for FREE 1961 catalog. PF-9

JOHN F. RIDER PUBLISHER, INC.
116 West 14th St., New York 11, N. Y.

tion; zero-center scale and polarity-reversal switch provided.

2. **AC Voltmeter**—6 rms ranges of from 0 to 3, 10, 30, 100, 300, and 1000 volts; 6 peak-to-peak ranges of from 0 to 8.4, 28, 84, 280, 840, and 2800 volts; accuracy $\pm 5\%$ of full-scale deflection; frequency response approximately 30 cps to 4.5 mc.

3. **Ohmmeter**—six ranges with multipliers of $R \times 1$, 10, 100, 1K, 10K, and 1 meg; center-scale value 10; zero and ohms-adjust knobs on panel. VOM specifications are:

1. **DC Voltmeter**—six ranges of from 0 to 3, 10, 30, 100, 300, and 1000 volts; sensitivity 5000 ohms/volt; accuracy $\pm 3\%$ of full-scale deflection.

2. **AC Voltmeter**—six rms ranges of from 0 to 3, 10, 30, 100, 300, and 1000 volts; sensitivity 500 ohms/volt; accuracy $\pm 5\%$ of full-scale deflection.

3. **DC Ammeter**—full-scale range 1 amp; smallest scale division 20 ma; accuracy $\pm 3\%$.

4. **Ohmmeter**—two ranges with multipliers of $R \times 1$ and $R \times 100$; center scale value 75. Ohms-adjust provided on panel.

General specifications are:

1. **Power Requirements** — 105/125 volts, 60 cps; power consumption less than 10 watts; supply isolated from AC line; standard flashlight battery supplied for VOM-VTVM resistance measurements.

2. **Panel Meter**—6" face, 200-ua movement; accuracy $\pm 2\%$; separate scales for VTVM and VOM functions; scale-indicating lights provided for VTVM ranges.

3. **Size and Weight**— $8\frac{1}{8}'' \times 7\frac{7}{8}'' \times 3\frac{1}{2}''$, 5 lbs.

Since using a conventional multimeter or VTVM is second nature to many of us, we're often apt to take its facilities for granted. Thus, it comes as a pleasant surprise to find a basic design innovation such as the combining of a VOM and VTVM into one easy-to-use piece of equipment. Another appealing feature of the SM112 is its simplicity of operation, which stems from the fact that only one pair of permanently-attached test leads is used for all measurements, and only two panel knobs select the numerous functions and ranges.

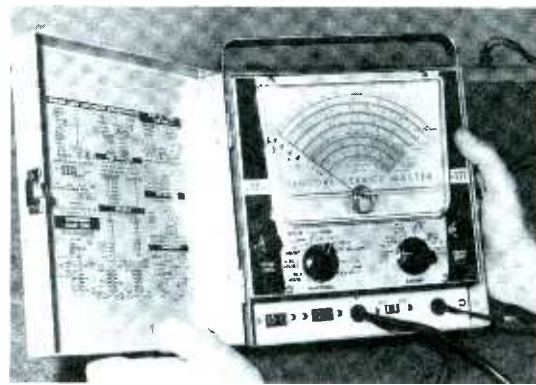


Fig. 3. New Sencore instrument is both a sensitive VTVM and portable VOM.

Since the VTVM section affords the accuracy and sensitivity necessary for precise measurements, the VOM was purposely designed with a relatively low sensitivity for rugged field work. Requiring no AC power, it serves as a handy portable meter for such applications as checking antenna and speaker systems in remote locations and servicing mobile equipment. An all-steel case with detachable lid protects the instrument during transit, and a storage compartment for test leads and power cord adds to its portability.

One of the most ingenious extra features of the Model SM112 is the automatic indicator that tells you which scale to read when employing various functions and ranges of the VTVM. As illustrated in Fig. 4, a small arrow-shaped cutout is lined up with the left edge of each

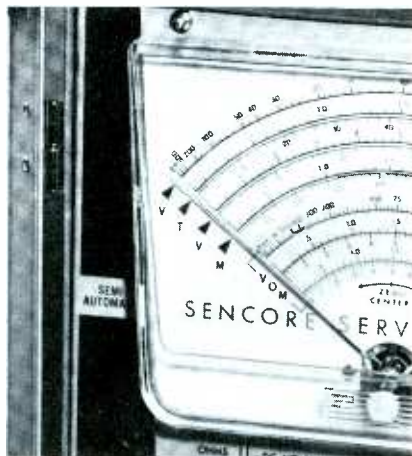
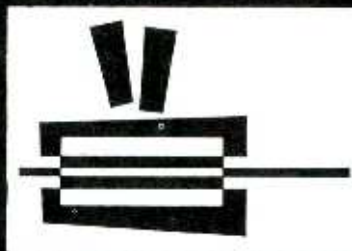


Fig. 4. Neon lights on VTVM scales are an unusual Service Master feature.

MERCURY TV TUNER SERVICE

890-1 River Ave., Bronx 51, N.Y.

"Largest in the East"



VHF-UHF TUNERS

7 Months Warranty

Price Includes Labor & Minor Parts

TUBES & MAJOR PARTS
AT NET PRICES

When Shipping Tuner: Include Tubes,
Shields and Damaged Parts.
Give Model Number and State Complaint

PACK WELL AND INSURE
24 HOURS ON POPULAR TYPES

ALL MAKES
ONE PRICE!

\$9.50

DOUBLES YOUR EFFECTIVE MANPOWER



Fix "Tough Dogs" Fast!

Save Half Your Time!

Step Up Your Profit!

B&K NEW
MODEL 1076

TELEVISION ANALYST

for Black & White and Color



Check all circuits—Pinpoint any TV trouble...in minutes

**By Easy Point-to-Point Signal Injection,
You See the Trouble on the TV Screen and
Correct it—Twice as Fast and Easy!**

There's no longer any need to "lose your shirt" (and customers)—and worry about the lost hours you never recover—on "tough dogs" or even intermittents. The remarkable *B&K Analyst* enables you to inject your own TV signal at any point and watch the resulting test pattern on the picture tube itself. *Makes it quick and easy to isolate, pinpoint, and correct TV trouble in any stage throughout the video, audio, r.f., i.f., sync, and sweep sections of black & white and color television sets—including intermittents.* Makes external scope or wave-form interpretation unnecessary. Most useful instrument in TV servicing! Its basic technique has been proved by thousands of successful servicemen the world over.

The Analyst enables any serviceman to cut servicing time in half, service more TV sets in less time, really satisfy more customers, and make more money.

Model 1076. Net, \$29995

Available on Budget Terms. As low as \$30.00 down.

Combines all the features of both
the Model 1075 and Model A107

- | | |
|--|--------------------------------------|
| COMPLETE R.F. and I.F. | HI-VOLT INDICATOR |
| VIDEO TEST PATTERN | YOKE and HI-VOLTAGE TRANSFORMER TEST |
| COMPOSITE SYNC | Also Now Provides: |
| FM MODULATED AUDIO | SWITCH-TYPE TUNER |
| COLOR PATTERNS | NEGATIVE BIAS SUPPLY |
| HORIZONTAL and VERTICAL PLATE and GRID DRIVE | AGC KEYING PULSE |
| B+ BOOST INDICATOR | PICTURE TUBE MODULATION |



B & K MANUFACTURING CO.
1801 W. BELLE PLAINE AVE • CHICAGO 13, ILL.
Canada: Atlas Radio Corp., 50 Wingold, Toronto 19, Ont.
Export: Empire Exporters, 277 Broadway, New York 7, U.S.A.

See Your B&K Distributor or Write for Bulletin AP18-R

VTVM scale. Behind these panel cutouts are four miniature neon bulbs wired to a separate switch section that operates in step with the function and range selectors. As each VTVM function and range is selected, the neon bulb glows to mark the appropriate scale. This feature greatly aids readability—especially on a meter with so many scales.

Other features include often-used measurement and circuit-reference data (printed inside the lid), and two AC receptacles on the recessed control panel for powering soldering guns, other test units, or the equipment being serviced. A high-voltage probe is also available for use with the *Service Master*. This accessory fits directly on the tip of the regular test probe and extends the DC range of the VTVM to 30,000 volts.

Pattern Maker

With color TV sets moving into more and more homes each year, progressive servicemen are finding an increased need for specialized equipment to troubleshoot and adjust these receivers. RCA, Camden, N.J., has recently made a contribution toward this end in the form of a relatively low-cost pattern generator. Pictured in operation in Fig. 5, the Model WR-64A generates RF signals for producing color-bar, dot, or crosshatch displays.

Specifications are:

1. Power Requirements — 105/125 volts, 60 cps; power consumption 40

watts; line-isolated supply; pilot light on panel.

2. RF Output—modulated picture carrier with or without unmodulated sound carrier for TV channel 3 (instrument may be realigned for channel 4 output); maximum picture-carrier output .05 volts rms with 10% sound carrier level.
3. Output Impedance — approximately 300 ohms; 4' permanently-attached output cable supplied.
4. Color-Bar Pattern—provides 10 bars simultaneously at 30° phase intervals including R-Y, B-Y, G-Y, I, and Q signals; crystal-controlled offset sub-carrier of 3,563,795 cps \pm 20 cps, keyed at 189 kc; signal amplitude continuously variable; color sequence yellow-orange, orange, red, magenta, reddish blue, blue, greenish blue, cyan, bluish green, and green.
5. Dot Pattern—RF modulation producing 9 vertical and 14 horizontal rows of white dots on normally-operating receiver; fixed size and number.
6. Crosshatch Pattern—RF modulation producing fixed display of 9 vertical and 14 horizontal narrow white bars.
7. Synchronization—internally generated 60- and 15,750-cps sync signals for reproduction of standard interlaced raster; external sync not required.
8. Size and Weight—10" x 13½" x 8", 13¼ lbs.

The Model WR-64A is a keyed rain-



Fig. 5. New RCA pattern generator furnishes a pulse-modulated RF output.

bow generator utilizing an "offset sub-carrier" method to generate color-bar signals equally spaced at 30° phase intervals. Briefly, here's how the instrument works: Its crystal-controlled subcarrier operates below the standard color-oscillator frequency of 3.579545 mc by one horizontal-scan interval (or 15,750 cps). This 3.563795-mc signal is keyed at a rate of 189 kc and fed to the color receiver. The resultant output signals from the chroma demodulators (15,750-cps sine waves of different phase relationships) control the color guns in the CRT. Thus, for each horizontal scan, a series of color bars is displayed across the screen.

The instrument is portable for in-the-home servicing, and has only three controls and a single output cable for simpli-

EFFICIENT!
SAFE!
FAST!

ARROW'S
T-25 Low Voltage Wire
STAPLE GUN
For Fastening Any
Inside or Outside
Wire Up to 1/4" in Diameter

- Takes 3
Staple
Sizes:
- Telephone wire
 - Intercom wire
 - Bell wire
 - Thermostat wire
 - Radiant heating wire
 - Hi-Fi, Radio & TV wires
- Tapered striking edge gets into close corners!
- Available in: Brown, Ivory, Beige, Monel, Bronze, Natural

ARROW
ARROW FASTENER CO., INC.
ONE JUNIUS STREET • BROOKLYN 12, N. Y.

THE NEW DYNAMIC RAPID TROUBLE SHOOTER
METREX GENIE
POCKET-SIZED — TRANSISTORIZED
SIGNAL GENERATOR
Tunable 50 cy. to 3.3 mc.

7 INSTRUMENTS IN ONE!

FUNCTIONS AS • RF • IF • AUDIO
VIDEO • PULSE • BAR GENERATOR
& VOLTAGE CALIBRATOR

Services — RADIO, TV, HI-FI,
RECORDERS, PHONES AND INTERCOMS

The GENIE has a tunable range of 50 cycles to 3.3 mc. Output variable from zero to 9 volts peak to peak. The uniquely designed circuitry makes possible unusually stable operation and extremely low battery drain. The rugged diecast housing insures extreme durability and perfect shielding. 2¾" x 3½" x 2" size is ideal for shop, lab, and field use.

Pat. Pend.

14.95
less
Batt.

**WRITE TODAY FOR
FREE TROUBLE
SHOOTING
GUIDE**

METREX 519 HENDRIX ST., BKLYN 7, N. Y.

PRECISION TUNER SERVICE
P. O. BOX 272 1200 S. WALNUT ST.
BLOOMINGTON, IND. EDISON 99653

7.50
V or U
COMBO PLUS
9.95 POSTAGE

6 MONTH WARRANTEE

All Types T.V. Tuners Cleaned, Repaired and Aligned to Factory Specifications. Same day in shop service on most Tuners. Price Includes Minor Parts, Major Parts at Cost Price. We use Original Parts if possible. State Make Model and Enclose all Parts and Tubes. Pack Well and Insure.

ALSO HAVE LARGE STOCK OF EXCHANGE TUNERS, WRITE FOR TYPES AND PRICES.

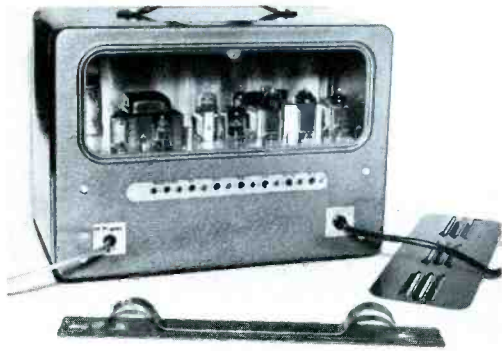


Fig. 6. Tubes, test points, and adjustments as seen from rear of WR-64A.

fied operation. A reproduction of the color-bar pattern is printed on the front panel of the instrument for reference. A removable panel on the rear of the case makes all tubes and test points readily accessible. Fig. 6 shows this panel removed and also reveals the location of the service and calibration controls. Incidentally, a cable-holding bracket (visible in the foreground of Fig. 6 is attached to the removable panel.

The output is strictly RF—factory-aligned to the picture-carrier frequency of channel 3. If interference is caused by a strong local station on this channel, the RF oscillator can be accurately realigned for channel-4 operation by following the instructions given in the manual.

Actual patterns produced by the Model WR-64A are shown in Fig. 7. I set these up on color receivers in the lab and found all three to be stable and jitter-free for adjusting and troubleshooting the receivers. The crosshatch display also proved to be of value for checking linearity and overscan in black-and-white receivers. ▲

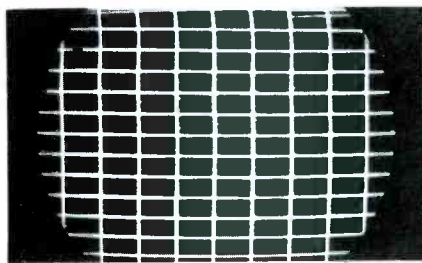
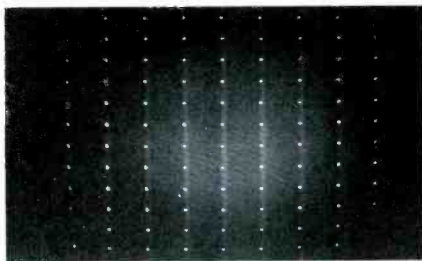
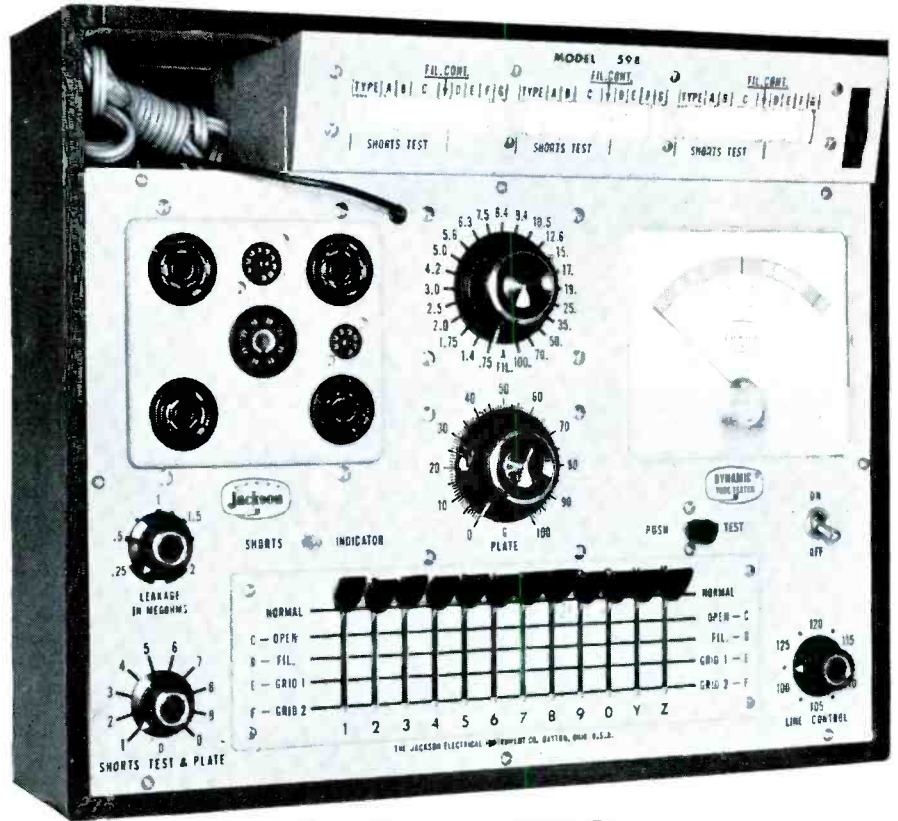


Fig. 7. Color-bar, dot, and crosshatch patterns produced by RCA generator.

NOT A KIT! FULLY ASSEMBLED FULLY CALIBRATED FULLY GUARANTEED \$89.95



Jackson 598 Dynamic[®] Tube Tester

Don't let the price fool you. This is a genuine Dynamic tester . . . not a low quality emission type! The 598 is completely flexible . . . tests TV and Radio tubes under load to show you the true condition. It has all these famous Jackson "Service-Engineered" features:

- Variable Plate Voltage & Load
- 23 Separate Heater Voltages
- Variable Shorts Sensitivity Test
- Line Voltage Indicating Control
- Convenient Lever Switching
- Zig-Zag Roll Chart

This is the ideal low cost tube tester for profit-minded service-men. See it at your distributors . . . you'll recognize the value at a glance!

New tube test data appears every month in PF Reporter and Photo-Fact Folder



ELECTRICAL INSTRUMENT COMPANY

124 McDonough St., Dayton, Ohio

In Canada: Tri-Tel Associates Ltd., Willowdale, Ontario

NEW CB VERSATILITY

WITH **EICO**®

New Deluxe Citizens Band Transceivers give you everything you need for fast, reliable, economical communication



770 Series

	kit	wired
Model 770: 117 VAC only	\$69.95	\$99.95
Model 771: 117 VAC and 6 VDC*	79.95	109.95
Model 772: 117 VAC and 12 VDC*	79.95	109.95

*Including Posi-Lock® Mounting Bracket (Pat. Pend.)

Front panel selection of one of 3 transmit crystals with continuous receiver tuning over all 23 CB channels, or a fourth transmit crystal with appropriate receiving crystal. Press-to-talk button on microphone; transmit-receive switching accomplished by high-quality relay with minimum capacity between contacts to prevent current leakage at RF frequencies. Superhet receiver with RF stage for high sensitivity & proper signal-to-noise ratio. 1750 KC IF strip for unequalled image rejection & freedom from oscillator "pulling" on strong signals. IF strip realigned so that only "touchup" alignment without instruments is needed. Current metering jack in series in cathode circuit allows checking of input power to transmitter final & adjusting it to FCC limit. 13-tube performance (4 dual function tubes, 4 single function tubes, plus germanium diode). Adjustable squelch control (in addition to automatic noise limiter). Optimum adjustment to any popular CB antenna assured through use of variable pi network in output. AVC. 3" x 5" oval PM speaker. Supplied complete with 8 tubes & 1 transmit crystal (extra crystals \$3.95 each).

The entire transmitter oscillator circuit and RF final in every EICO transceiver, kit and wired, is pre-mounted, prewired, pretuned, and sealed at the factory (about 3 hours of skilled labor, precision adjustments and testing), complying with FCC regulations (section 19.71, part d). This permits you to build the kit and put it on the air without the supervision of a commercial radiotelephone licensee.



Standard 760 Series of CB Transceivers from
Kit \$59.95 Wired \$89.95

You profit with EICO Test Equipment & Hi-Fi



DC-5 MC
5" Scope #460
Kit \$79.95
Wired \$129.50



New Transistorized Stereo/Mono 4-Track Tape Deck
Wired Model RP100W \$399.95
Semi-Kit Model RP100K, Electronics in Kit form. \$299.95

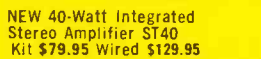
An exclusive EICO product designed and manufactured in the U.S.A. (Pat. Pend.)



NEW FM-AM Stereo Tuner ST96
Kit \$89.95 Wired \$129.95 inc. FET



NEW 70-Watt Integrated Stereo Amplifier ST70
Kit \$94.95 Wired \$149.95



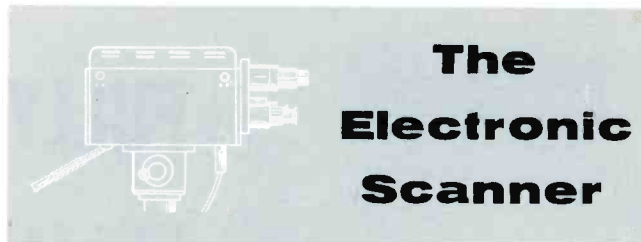
NEW 40-Watt Integrated Stereo Amplifier ST40
Kit \$79.95 Wired \$129.95

Over 80 products to choose from. Write for free Catalog PF-9 & name of nearest distributor. Most EICO distributors offer budget terms.



Electronic Instrument Co., Inc. 3300 N. Blvd., L.I.C. 1, N.Y.
ADD 5% IN THE WEST ©1961

Export Dept., Roburn Agencies Inc., 431 Greenwich St., New York 13, N. Y.



The Electronic Scanner

New Westinghouse Warranty-Service Plan

Independent service dealers will be appointed by local Westinghouse distributors to handle all service work on TV, radio, and hi-fi equipment under the terms of a new 90-day labor warranty plan. Ken Brown, service manager of the Westinghouse TV-radio division, explained that the appointments would be made on an open-bid basis. "It is our opinion," Mr. Brown said, "that this method of local control at prevailing local service rates is most fair and equitable for the independent service contractors to whom we look for product support."

The plan features a telephone information service; owners of Westinghouse sets can phone Western Union Operator 25 to locate the nearest authorized service dealer.

Sencore Holds Clinic in Chicago Suburb



More than 500 service clinics held by Sencore, Inc., have been attended by servicemen across the nation in the past two years. One of the latest, held at the Oak Park Arms Hotel in Oak Park, Ill., was sponsored by Melvin Electronics. Over 200 Chicago-area servicemen took advantage of the meeting, which highlighted transistor-radio and TV sweep-circuit troubleshooting. Ed Flaxman, Sencore V-P, and Jim Newman, product specialist, conducted the meeting.

EIA Predicts 6.2 Million TV Sales This Year

Mr. Frank W. Mansfield, Chairman of the EIA Marketing Data Policy Committee, has predicted that the public will buy 6.2 million or more TV sets during 1961. This projected total, based on reports gathered during the first five months of this year, is substantially higher than 1959 and 1960 sales figures—which were 5.7 and 5.9 million, respectively. This upward trend is appearing even though the TV market has changed from a demand for initial installations to one for replacements and extra sets.

Musi-Pak Expands Franchise Program



One of the best-known names in background music has opened its doors to the radio-television servicing industry. Musi-Pak, Inc. of Valley Stream, N.Y., offers an opportunity for qualified technicians, who have at least two years of servicing experience, to become franchised dealers in a nationally-known organization.

Earlier this year, the U.S. Background Music Institute presented Musi-Pak with the "No. 1 Award for Finest Programming in Music Service, Originality, and Design" for 1961.

"World Series Week Is TV Tune Up Week"

This is the title of an advertising campaign prepared by General Electric Co. on behalf of independent radio and television service dealers, to be televised during the week of Sept. 30 to Oct. 6—coinciding with the start of the World Series. Coverage will include the top 70 markets in the nation, and is expected to reach 24 million homes and 55 million people.

Mel Allen, noted sports announcer, will be featured in the commercials. Based on a "test pattern" theme and keyed to preventive maintenance, the ads will urge people to put their sets in top operating shape so a breakdown won't occur "... in the last of the ninth, when three men are on base, two out, and the call on the last batter is three and two."

Kits of promotional material will be available through General Electric tube distributors to help service dealers tie in with the program.

Picture of a Service-Dealer making a

\$6.96 profit

in 7 minutes
installing a
JFD exact replacement
antenna installation
for an RCA portable TV

the place: Any service-dealer shop.

the time: Every working day.

the product: Two JFD Exact Replacement No. TA398 Antennas —one model of 74 (was 62) different O.E.M. antennas for portable TV sets, available from your JFD distributor.

the facts: RCA set using two JFD TA398 Antennas requiring replacement

Your Actual Selling Price (2 @ \$4.95 ea.)	\$9.90
Dealer Cost at 40% off (2 @ \$2.97 ea.)	5.94
Profit on Sale	3.96
Installation Charge	3.00

your profit \$6.96

No cut-down "rabbit-ear" profit here. You make a decent profit on the sale *and* a profit on the installation. Your customer gets the *exact* antenna replacement for his portable TV. No call-backs. No drug store competition ever.

the aids: Self-merchandising floor and counter displays... antenna kits ... 1961 portable TV Antenna Cross Reference Guide... streamers, newspaper mats, direct mail literature ... listings in Sams Photofact folders.

the moral: See your distributor for your JFD Exact Replacement Antenna kits and promotion-pak. Remember, next to receiving tubes, the antennas of portable and "tole-able" sets require the most frequent replacement.



Now in transparent "Skin-Peck" that sells on sight!

THIS COUPON HAS STARTED THOUSANDS OF SERVICE-DEALERS IN TODAY'S PROFITABLE \$3,500,000 PORTABLE TV ANTENNA REPLACEMENT BUSINESS. MAIL IT IN TODAY!

JFD

THE BRAND THAT PUTS YOU IN COMMAND OF THE MARKET

JFD ELECTRONICS CORPORATION

6101 Sixteenth Avenue, Brooklyn 4, New York

JFD International, 15 Moore Street, New York, New York

JFD Canada, Ltd., 51 McCormack Street, Toronto, Ont., Canada

JFD ELECTRONICS CORPORATION
6101 Sixteenth Avenue, Brooklyn 4, N. Y.

Gentlemen:

- I want to participate in the JFD Exact Replacement Profit Plan. Send me full details.
- Also send me the name of my local JFD distributor.
- Send FREE JFD 1961 Exact Replacement Wall Chart.

The name of my local JFD distributor is:

NAME _____
ADDRESS _____
CITY _____ ZONE _____ STATE _____

DEVELOPING YOUR HOME CALL TECHNIQUES

ADVICE FROM A SUCCESSFUL SERVICE MANAGER ON CULTIVATING A GOOD "SETSIDE MANNER"—BY ART MARGOLIS

At least twice a week I get up from my service manager's desk, grab my tube caddy, and take a turn on house calls. Besides the fact that I enjoy getting away from supervising and getting my hands on TV's, I always come up with ideas for customer satisfaction I can get in no other way.

My last few field trips were no exception. I came up with four policies we are all aware of but do not put enough emphasis on, even though the emphasis means dollar bills in our pockets.

Keep Technical Data Up to Date

The first thing I did upon getting back to my desk was to set up a wire basket labeled "Latest Service Info." Then I checked over the tech literature that arrives by mail, and made sure we were receiving everything available. While this should be standard procedure for every service shop, one of the calls I had just completed drove home the importance of this point.

The call, oddly enough, was from an electronic design engineer. At present John is working on computers; however, he had once developed TV circuit designs for a well-known manufacturer. When I arrived at his home, he was busy installing a new CRT.

He moaned, "Art, this is the fourth picture tube I've put in this thing, and it's only two months old. Something must be burning them out, but I can't figure what."

I began checking voltages—everything read correctly. He finished the installation and turned on the TV. The picture came on bright and clear. Two pugilists began a waltz around a ring. I asked, "What did

you need me for?" His wife brought in some coffee.

"Wait," he answered. In the middle of the second round it happened. The raster cut off, came back on, and then went out for good. We could hear the crowd screaming.

Both of us went to the back of the TV set. I tapped the CRT neck and jiggled the base socket. The picture came on and went off again. The symptoms did resemble a bad picture tube. John left the room and came back in with his tube tester. He opened the case, pulled out the 110° CRT adapter, and started to connect it to the new tube. I knew then what had happened. John was not up on the latest technical information.

"Hold it, buddy," I warned. "Is that how you've been testing the tubes?"

He nodded with a look that showed he knew he had goofed somehow. "John," I said slowly, "You've been booby-trapped. Didn't you know that your picture tube takes only 2.68 volts for its filaments? Your tester provides 6.3. You'll burn those filaments open every time."

While he mulled over this fact, I found a cold-solder joint at the cathode connection on the printed circuit board. A little heat from my

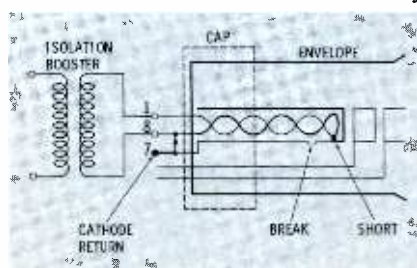


Fig. 1. CRT heater-cathode short is remedied by isolation unit and jumper.

soldering gun cured that.

I take a firm resolution to make sure our technicians would never make the same mistake—and they would never be lacking in the latest service data!

Keep an Adequate Tube Stock

After a recent call, I grabbed the first parts salesman who came in the door, gave him a comfortable chair, and made him go over our tube inventory with me, tube by tube. I didn't want a repeat performance of what happened to me at *that* stop.

Naturally, you should carry all needed tubes in your tube caddy. Yet you also want to avoid duplication, so you find out which ones will serve as substitutes. For instance, a 6BQ7 does an excellent job in replacing a 6BK7, 6BZ7, 6BC8, X155, etc. There's no real reason to carry them all when the 6BQ7 does the trick. However, be sure of *your* tube facts, or you'll find yourself in a situation like this.

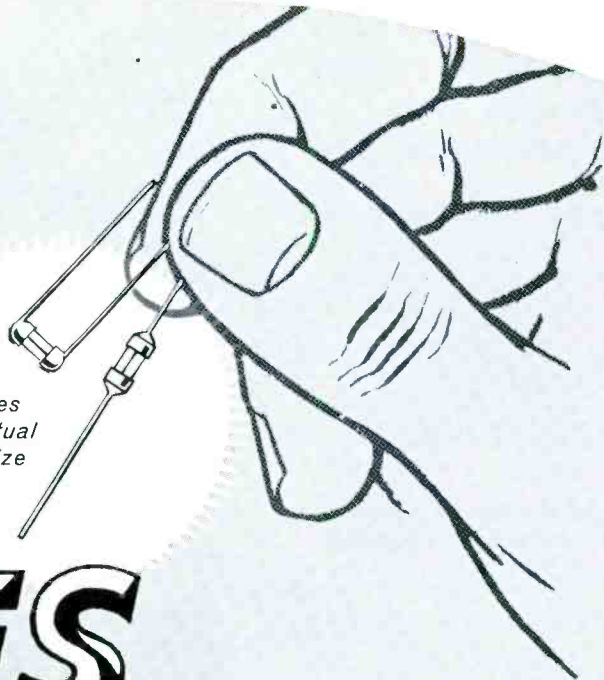
Since I go out on the street only occasionally, I carry a small tube caddy. I was servicing this portable TV just around the corner from the shop. The symptom was easy—snowy picture. I examined the tubes in the tuner. The RF amplifier was a 5BQ7, and one of its twin lights was out. I looked in my caddy. I didn't have a 5BQ7, but I did have a 5BK7. I removed the 5BQ7, substituted the 5BK7, and turned the TV on again. The snow was still there. I figured the 5BQ7 had shorted and burned out one of the B+ dropping resistors.

I took the set into the shop and placed it on the counter. Since it belonged to our neighbor, I was going

Another outstanding development by the Makers of BUSS fuses

TRON FUSES

Fuses actual size



Sub-miniatures — hermetically sealed Body size only .140 x .300 inches

For Use Where Space is at a Premium

Tron fuses are so small they can easily be used as an integral part of circuit — to protect miniaturized devices — or gigantic multi-circuit electronic devices — without sacrifice of space.

Fuse elements hermetically sealed. Tron fuses may be potted or encapsulated without danger of sealing material affecting operation. They are not affected by atmospheric conditions. They are designed for installation in high shock and vibration ambients.

They are self-protecting and operate without exterior flash or venting, so they can be installed anywhere in the circuit. Likewise, they may be teamed in one capsule or replaceable unit with such components as resistors or condensers.

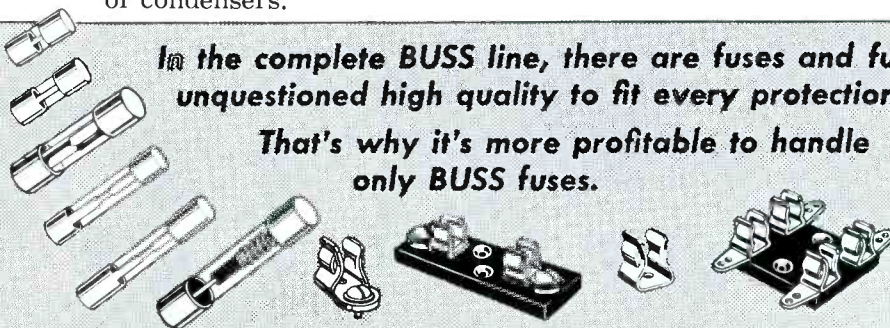
Available in ratings from 1/20 to 5 amps. for use on circuits of 125 volts or less where available fault current is not over 50 amps. Color coding indicates ampere rating and assists in final inspection of fused circuits.

Made with Axial pigtailed that are adapted to feed through automatic wire forming machines — or with right angle pigtailed conveniently spaced for assembly on printed circuit chassis.

Get the full story: —
Write for BUSS Bulletin TRON

In the complete BUSS line, there are fuses and fuse mountings of unquestioned high quality to fit every protection need.

That's why it's more profitable to handle only BUSS fuses.



BUSSMANN MFG. DIVISION, McGraw-Edison Co., UNIVERSITY AT JEFFERSON, ST. LOUIS 7, MO.

VALUABLE SAMS BOOKS ON INDUSTRIAL ELECTRONICS
available from your local
SAMS DISTRIBUTOR

Servicing Unique Electronic Apparatus



Cash in on growing new opportunities in electronics servicing. Jack Darr gives you the know-how on such equipment as: Watchmaster watch timer and tester; RF diathermy machines; liquid-flow timers; electronic photoflash units; electric scoreboards; RF heaters; gas-fired boiler controls; garage-door openers; movie sound systems; strobe tuning devices; photoelectric cells; ultrasonic cleaners, etc. 128 pages; 5½ x 8½".

No. SED-1. Only..... **\$2.50**

Howard W. Sams Handbook of Electronic Tables and Formulas



A time-saving, one-source reference for all those valuable charts, tables, formulas, and laws indispensable to the service technician. This is the reference book you'll refer to again and again. Five comprehensive sections contain most-used and most-needed information on: Formulas and Laws; Constants, Standards, Symbols, and Codes; Service and Installation Data; Mathematical Tables and Formulas; Miscellaneous Data. Full-color six-page foldout shows frequency spectrum chart, based on latest FCC allocations. 134 pages; 5½ x 8½", hardbound.

No. HTF-1. Only..... **\$2.95**

Handbook of Electronic Circuits



A practical reference book on important circuits. Covers: 4 power supply circuits; 14 circuits used in radio stages; 8 circuits used in transmitter stages; 32 circuits used in TV receiver stages; 7 additional circuits having special applications. An analysis of the operation of each circuit is given; a schematic for each is included; a component failure analysis describes troubles which could occur if particular components should fail. Of real value to service technicians, engineers, and students. 72 pages; 8½ x 11".

No. HEC-1. Only..... **\$1.00**

ABC's of Computers



Allan Lytel's clearly written book tells what computers are, how they operate, and what they can be expected to do. Contains clear and concise explanations of analog and digital computers, binary numbers, computer circuitry, memory devices, arithmetic functions, symbolic logic, input-output devices, programming, information storage. A perfect introduction to this fantastically-expanding field, especially valuable to technicians and engineers. 128 pages; 5½ x 8½".

No. ABC-1. Only..... **\$1.95**

Electronics Reference Data, Vol. 2



A valuable compilation of reference data. This volume covers: antennas and transmission lines; UHF television; circuit design; audio measurements; radar; meters and measurements; microwave tubes; RF transistors; traveling wave amplifier; etc. 122 pages; 8½ x 11".

No. ERA-2. Only..... **\$2.50**

FREE SAMS BOOKLIST AVAILABLE—ask your Distributor or write us direct

Available from your Sams Distributor
HOWARD W. SAMS & CO., INC.
1720 E. 38th St., Indianapolis 6, Ind.

to throw in the resistor and return it immediately. After removing the chassis and exposing the "innards" of the tuner, I aimed my flashlight at the pins of the 5BQ7 tube socket. The resistors all looked shiny—not a charred one in the lot.

I took some B+ plate readings—they were all on the nose. Then some light filtered through to my brain. I pulled out a tube manual. Yes, the pin connections were exactly alike for both the 5BK7 and the 5BQ7. Their characteristics were similar—all except one! The 5BQ7 needed only 450 ma of filament current, while the 5BK7 needed 600. With only 450 mils flowing in this series circuit, the 5BK7 wasn't getting hot enough to do any good.

I installed a 5BQ7 from the shelf and the snow disappeared. As I put the compact TV back together, I mentally kicked my seat. I vowed I'd have the right tube the next time, or be doubly sure of my substitutions.

Increase the Use of Tube Testers

Ask any TV serviceman what he thinks is the best way to test a tube, and he'll answer, "Direct substitution." While this is true, it does not discount a tube tester's worth. For example, if you don't have a replacement for the tube you suspect, you can test it with a tube tester. Of course it's not 100% perfect, but it provides information you wouldn't have otherwise!

A tube tester is a valuable piece of service equipment in the hands of a skilled technician who understands its limitations. It is, of course, much less valuable in the hands of an inexperienced operator—but such people generally don't realize this. They take the red-green meter reading as gospel. There's nothing much you can do to change that situation. However, there is some "public-relations work" you can do to give your customers more confidence in you. This was one of the points brought home strongly to me on one of my latest sojourns.

The call was from a perplexed do-it-yourselfer. He pointed to the TV and said, "I tested all the tubes. It must be something else."

I asked him what was wrong. It boiled down to the fact that he was getting a raster and slight snow—but no picture or sound.



I plucked out the local oscillator (a 5EU8), replaced it as a first try, and then turned on the TV. The sound and picture came on loud and clear. He was astounded. "You test that tube!" he demanded.

"I did," I answered, "by direct substitution."

"No—I mean really—on a tube tester." he said. I obliged, and the 5EU8 read GOOD. He made me put it back in the TV. Again, the TV wouldn't work. He was very upset.

I explained, "Tube testers can't check the wide variety of tubes used in television in exactly the same circuits that they occupy in your receiver. This tube might work OK in some other type of circuit, but not in this one. Here—I'll show you. You tested all the tubes before calling me. Now I'll test them, interpret my findings and show you the difference." I tested all of his tubes; six of them read shorted or gassy. Replacing them gave him increased contrast and width, and eliminated a slight vertical fold.

The customer was happier when I left. His faith in tube testers was restored, and he understood plainly that the tester is used to best advantage in the hands of a technician. My servicemen won't leave the shop without one. It doesn't hurt the profit picture a bit, either.



DON'T OPEN,



EVER!

(and watch your profits and reputation soar)

The housing lock screws on Cornell-Dubilier's Radiart AR-22 antenna rotor are the last thing you'd ever want to touch on this heavy-duty beauty. Why? Because this rugged standard of the industry is backed by CDE's lifetime service warranty — a warranty that offers you a big, extra Profit-and-Reputation Builder. In fact, the AR-22 offers you three big Profit-and-Reputation Builders.

Profit-and-Reputation Builder No. 1. In appearance and performance, the AR-22 practically sells itself. The rotor's one-piece streamlined aluminum housing is rugged, rust-proof and it's sealed against the worst possible weather conditions. Rain, snow or ice just can't affect it. It shrugs off hurricane winds.

Your prospect has immediate confidence in the AR-22, and in you for carrying such an obviously reliable product line. If he hasn't agreed to buy yet, point out that inside the famous bell-shaped housing is an in-line precision planetary gear train and 12 heavy-duty bearings in two 6½" ball-bearing races, for smoother turning power, more dependability, longer life.

But that's just half the performance story, because the AR-22 is completely automatic! Just set the selector on its handsome control box and walk away. The antenna turns and stops precisely at the desired position — even in the most severe weather! That's the clincher ... your prospect is now your customer!

On the sale price alone, you've made a handsome profit. Dealer cost of the AR-22 is \$31.95. List price to your customer is \$45.95. Your profit: \$14.00. Sweet? You said it! But that's just the beginning.

Profit-and-Reputation Builder No. 2. Installation of the AR-22 is a breeze, on mast, tower or platform. Installation charges are your own business, but if you

can install the AR-22 safely, quickly, neatly ... need we say more?

Profit-and-Reputation Builder No. 3. Here's where those housing lock screws come in. Years pass. The AR-22 continues to deliver perfect, trouble-free performance. More years pass. Has CDE forgotten you? Not on your life!

One day, a phone call from your AR-22 customer. What's this? The AR-22 that you sold six, eight years ago is starting to creak a bit and will you be good enough to repair same?

Are you worried? Has technology left you behind? Do you have the right spare parts? Is there any profit in it for you?

No need to fret. CDE will take on the headaches. But you take the profit. And the reputation. Here's all you do:

Remove the rotor and ship it, with the control box, to us. Enclose a check for \$7.50. And before you can say "Cornell-Dubilier has the best darned rotor program in the world," your rotor and control box will be back in your shop, factory-rebuilt, retested, resealed.

How much can you charge your customer for this service? That's your business. But the lock screws are our business. And that's why we say, "Don't open ... ever!"

CDE makes a complete line of Profit-and-Reputation Building rotors: ham, heavy-duty automatic, heavy-duty manual, standard-duty automatic, standard-duty manual. See your CDE Radiart distributor.

CDE **CORNELL-DUBILIER**

CORNELL-DUBILIER ELECTRONICS, DIVISION OF FEDERAL PACIFIC ELECTRIC COMPANY, 118 E. JONES STREET, FUQUAY SPRINGS, N. C.

We're pushing the full line...

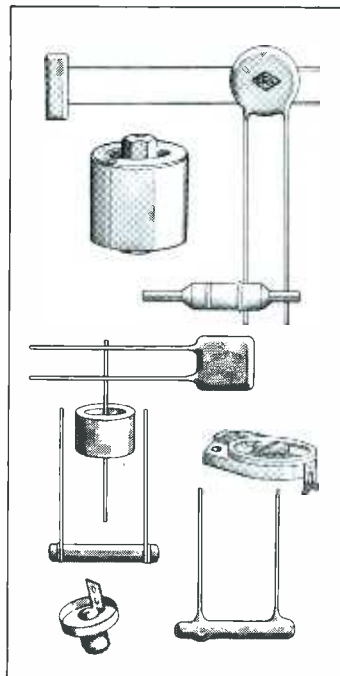


(of Centralab Ceramic Capacitors)

Sometimes we get so wound up in talking about our "only from CENTRALAB" ceramic capacitors that we forget to remind you about the *standard* ones.

CENTRALAB has plenty of both—as well we should. We *pioneered* ceramic capacitors many years ago—and we still give you the finest product and the widest choice.

Discs, tubulars, buffers, trimmers, feed-thrus —for every standard and special application, in radio-tv servicing or industrial use —CENTRALAB makes them and makes them best. That's why CENTRALAB is the best ceramic capacitor line for you to buy.



Centralab.

THE ELECTRONICS DIVISION OF GLOBE-UNION INC.
942W EAST KEEFE AVENUE • MILWAUKEE 1, WISCONSIN
CENTRALAB CANADA LIMITED—AJAX, ONTARIO

D-61335

ELECTRONIC SWITCHES • VARIABLE RESISTORS • CERAMIC CAPACITORS

PACKAGED ELECTRONIC CIRCUITS • ENGINEERED CERAMICS

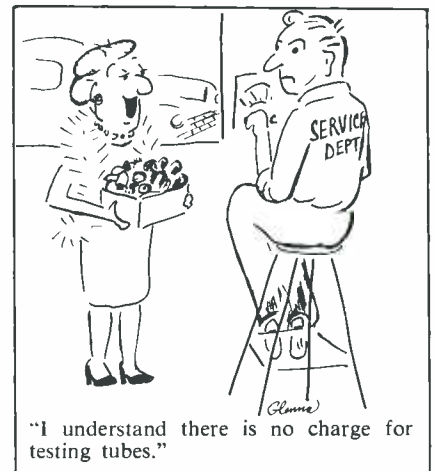
Identify With the Big Names

One of the best, and most obvious, bets we all lose out on is identifying ourselves with large, heavily-advertised manufacturers. To insure that we obtain maximum benefits from these free plugs, I posted a bulletin that everybody must be in some kind of uniform during working hours. Through the years we've all accumulated plenty of uniforms.

I realized the benefits while I was servicing a name-brand portable. The set owner was a nice old widow who didn't have any money to spare. The video was gone, the raster was bright, and hum bars rolled merrily through the picture.

I was about to start checking the tuner and IF tubes for filament-to-cathode leakage when I realized the audio was loud and clear. While this wasn't a definite indication, I figured, "Oh-oh, filament to cathode in the CRT." My CRT tester confirmed the suspicion.

I took out a CRT isolation unit for the miniature-necked picture tube and plugged it in. The raster disappeared. The loss of raster added a complication. If there is a simple filament-to-cathode short, and you install an isolation unit, your repair is complete. However, the heater short will sometimes break the cathode structure, causing an open cathode. That's what happened this time. The raster stayed on because the heater connections provide a cathode return. When the isolation transformer was installed, it opened the cathode circuit. The problem was to provide some sort of cathode return with the isolation transformer installed. This was easy. On this tube (a 17BRP4) it meant connecting a piece of wire between the cathode (pin 7) and the fila-

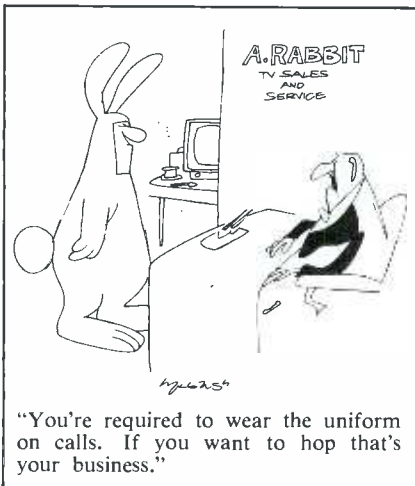


ment (pin 8). This I did, and the picture returned bright and clear. (See Fig. 1.)

If the CRT had simply shorted between the filament and cathode, it would have brought the cathode potential down to the heater level, which is right near ground. The isolation transformer would have taken the heater off ground level and left it floating. Thus, the two shorted units would have reassumed the normal cathode potential, and the CRT would have worked again.

As I replaced the back, I could see that the widow was quite pleased with the repair. She smiled, pointed at a manufacturer-supplied pocket holder I was wearing and said, "I knew you knew your way around my TV when I saw that." I smiled, wrote up the bill and left. She was really impressed with the pocket holder. She didn't say a word, though, about my shirt (which plugged another manufacturer) or about my tube caddy (which bore still another trade name).

Anyway, reflecting upon my latest setside experiences, they boil down to these four points: (1) Obtain and make use of all the technical data you can, whether it comes in printed form or is learned through your own or other servicemen's experiences. (2) Make sure your tube stock is adequate; use substitutes if you must, but be sure they won't cause you or your customer trouble. (3) Make effective use of your tube tester. (4) And, last but not least, use the advertising materials available from brand-name manufacturers to best advantage. These hints have helped us—and I'm sure that, properly applied, they'll help you. Try them, won't you? ▲



high-profit replacement twins



#1 choice of 16 leading high fidelity manufacturers

These 2 new Sonotone stereo cartridges are "original replacements" for the bulk of sets you service. They give brilliant, crisp highs...full lows. Satisfy the most critical audiophile's ear!

When you're all stocked up on Sonotone cartridges, good servicing is easy to do—and really brings in the profits.

The Sonotone 16T and 18T stereo cartridges are natural replacements. They are already being used as original equipment by America's leading phonograph manufacturers.

As for sets without Sonotone, replacement

with a Sonotone will make 2 out of 3 sound better. The specifications—especially the channel separation—would do anyone proud. The cartridges have no audible hum—never sound tinny.

There are Sonotones for every kind of set—from the simplest portable to the most extravagant stereo equipment. Stock Sonotone, and keep your customers happy...your profits high!

SPECIFICATIONS

Sonotone 16T
 Response.....flat ± 1 db from 20 to 10,000 cps, with smooth rolloff to 12,000 cps.
 Output Voltage... 0.5 volt
 Compliance..... 2.4×10^{-6} cm/dyne
 Tracking Force.... 4-6 grams for professional arms, 5-7 grams for changers.
 Mounting
 Dimensions.... fits all standard mounting centers.

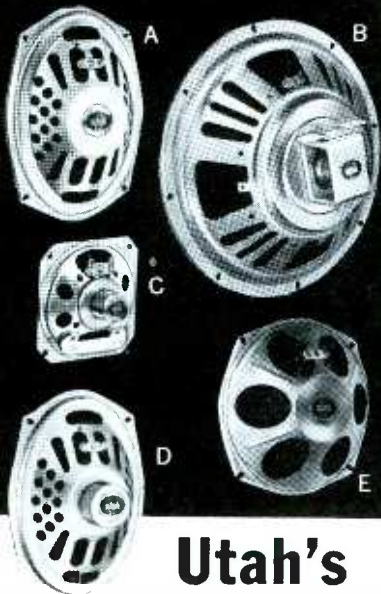
Sonotone 18T
 Response.....flat ± 1 db from 20 to 10,000 cps, with smooth rolloff to 12,000 cps.
 Output Voltage... 0.7 volt
 Compliance..... 1.5×10^{-6} cm/dyne
 Tracking Force.... 6-8 grams for professional arms, 7-9 grams for changers.
 Mounting
 Dimensions.... fits all standard mounting centers.

Sonotone

© ELECTRONIC APPLICATIONS DIVISION,
 O R DEPT. C10-91, ELMSFORD, N. Y.
 P. In Canada, contact Atlas Radio Corp., Ltd., Toronto

Leading Makers of Cartridges • Speakers • Tape Heads • Mikes • Electronic Tubes • Batteries

VERY BIG ON RESPONSE

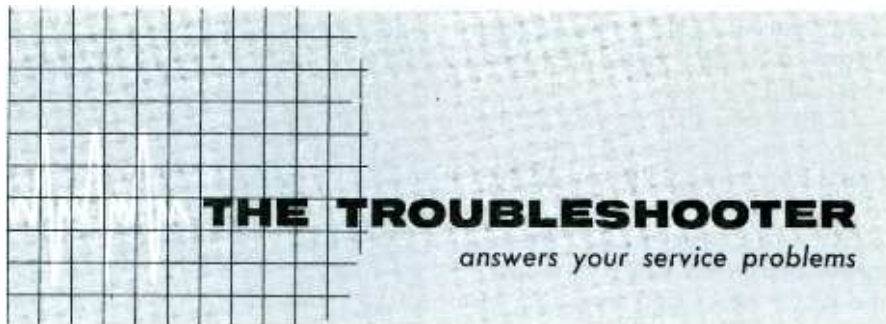


Utah's famous micro-gap replacement SPEAKERS

Better response — better sound reproduction than original equipment! Better customer response, too, when you install Utah Micro-Gap replacement speakers. Single-packed in custom-fitted cartons. Illustrated above:

- A** SP69NF 6x9" Oval Inverted Auto Speaker
- B** SP12J 12" Round Speaker
- C** SP4A 4" Square Outdoor Speaker
- D** SP69G 6x9" Oval Auto Speaker
- E** SP8NF 7½" Inverted Pin Cushion Speaker.

Write for illustrated literature



Faulty Flickerer

A Telectro Model 300 tape recorder operates normally in both RECORD and PLAYBACK positions, but the record-level indicator doesn't work. The only voltage reading that's out of line is at the grid of V2B, where I get +.7 volts rather than the —.5 volts called for. All resistors and capacitors check normal. Help!

LEON HENNES

Riverdale, N.D.

The most likely causes of this trouble are a faulty M9, an open R25, or a defect in the PLAY-RECORD switch between terminals s, t, and u. However, since V2B operates only as a record-level amplifier when the machine is recording, the symptom you describe could also be caused by a defect in this tube section

or the surrounding circuit. To help isolate the trouble, operate the unit in RECORD position and use a scope to see if a signal is present at the plate of V2B.

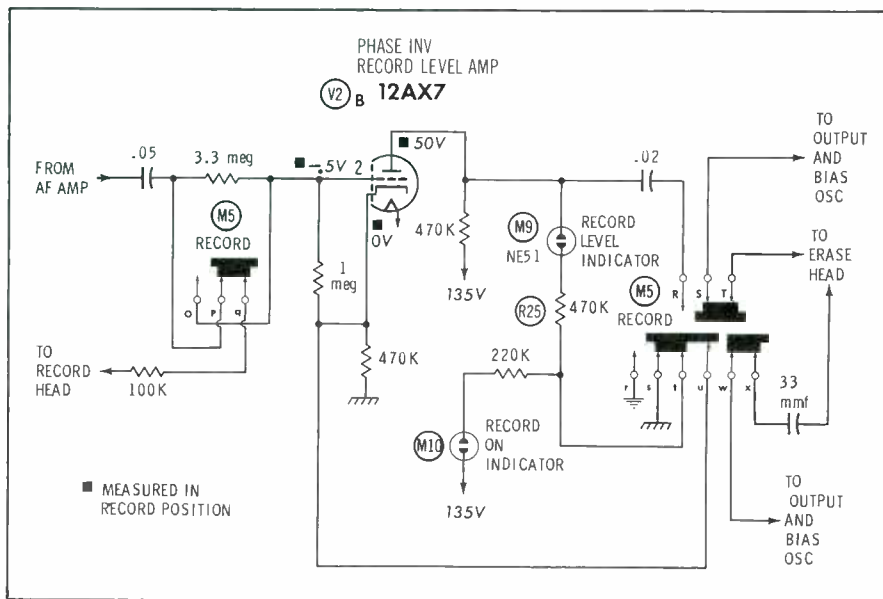
Hi-Fi Headphone Hook-Up

I have a pair of hi-fi crystal headphones (85K-ohm) I want to hook into an Admiral Chassis 19B1. When I disconnect the speaker and connect the headphones from the plate of the 6AS5 to ground, I get weak sound with the volume wide open, but it's distorted. How can I hook up the headphones to get the best results?

SHIG TAKAHASHI

Richmond, Calif.

The easiest way is to use a double-pole, single-throw switch and a phone jack.



TV TUNERS * REBUILT OR EXCHANGED

ALL TYPES

\$9.95

Including all parts and labor (except broken wafers—billed at cost)

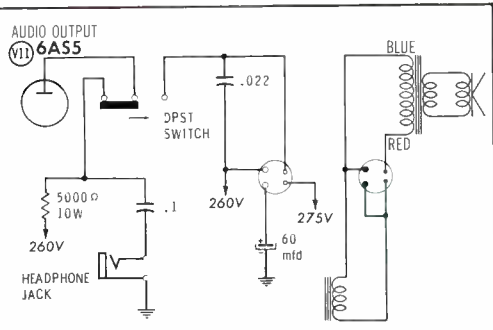
- Normally shipped same day received
- 90 day full guarantee
- U/V combinations \$17.95

FREE—If Mailing carton sent to you on request

Phone Republic 3-9189

L. A. TUNER EXCHANGE

4611 West Jefferson Blvd.
Los Angeles 16, California



Crystal headphones don't operate like carbon types. They won't pass DC voltage, and they have a high-impedance input. When you disconnect the speaker, you must feed plate voltage to the 6AS5 through a 4500- to 5000-ohm, 10-watt resistor and connect the phones in series with a .1-mfd capacitor between the plate and ground. Hook it up as shown in this schematic and you should get good sound with plenty of volume if the phones are in good condition.

Scope Test Verification

The December, 1960 article, "A Little Trouble With an Admiral 21F1" by Stan Prentiss, mentioned a way to add a 680-mmf capacitor to a scope to test sweep transformers and coils. I've tried this with my scope, but the only "waveforms" I've been able to obtain are stray AC or a diagonal line. What is wrong?

CHARLES R. WHITE

Winston-Salem, N.C.
Make certain the 680-mmf capacitor is connected to the high side of the common cathode resistor in the sweep multi-vibrator circuit of the scope. Unless the resistor has a very low value, you should obtain enough signal for the test.

Run a test lead from the unattached end of the capacitor to one lead of the transformer being tested, and connect the vertical input of the scope to the other lead of the same winding. The scope ground lead should be connected to the TV chassis. In general, the scope sweep rate should be adjusted to provide the maximum amplitude indication. For vertical components, this will normally be attained with the sweep rate set on one of the lower ranges. To test horizontal components, you'll find that a sweep rate of 2500-5000 cycles will give the best indication.

Choosy Interference

I'm having trouble eliminating ignition interference from an Emerson Model 1153. Another set, operating right alongside, has no trace of interference. I've tried using filters such as amateurs use, but have had no success. Can you suggest a solution?

PETER GERNAT

Warren, Ohio
The trouble is probably in the antenna or RF circuits of the tuner. By all means substitute for the RF amplifier. If this doesn't solve the problem, you'll undoubtedly find an open or shorted component that is reducing the signal-to-noise ratio.

NOW... Master System Performance at a Home Booster Price!



Blonder-Tongue signal master, AB-4 (new transistor, mast-mounted TV/FM 4-set booster)... \$29.95 list

- ✓ Transistor circuit provides lowest noise, maintenance free operation—no tubes to burn out or replace—no heat dissipation problems.
- ✓ Mast mounting takes advantage of best signal-to-noise ratio—minimizes snow. (Can also be mounted at any convenient point along the downlead.)
- ✓ World's smallest and lightest booster—no additional weight or wind resistance for mast to bear.
- ✓ Remote power supply at set uses 4 low-cost flashlight batteries for pure d.c.—eliminates AC power line, and components which may fail.
- ✓ Converts existing antenna into a powerful amplifier-distribution system—no need to invest in a new antenna.
- ✓ Eliminates costly installation of giant antenna arrays in most fringe areas.
- ✓ Provides improved FM reception (gain 12-15 db).
- ✓ Stripless 300-ohm terminals on booster and remote power supply for fast installation, positive contact.

✓ No separate balun needed—matches impedance of antennas and TV sets.
ALL THIS PLUS . . . 4 set coupler incorporated in remote control power supply distributes fully isolated amplified signals for brilliant reception on up to 4 TV or FM sets.
Improve TV and FM reception today. Add the new Blonder-Tongue AB-4. Sold thru distributors. For details write. Dept. PF-9.



<p>1 set gain: up to 19 db, channel 2 Up to 10.5 db, channel 13</p>	<p>2 sets gain: up to 14 db, channel 2 Up to 6 db, channel 13</p>	<p>3 sets gain: up to 13 db, channel 2 Up to 4 db, channel 13</p>	<p>4 sets gain: up to 10.5 db, channel 2 Up to 2 db, channel 13</p>
--	--	--	--

Patent applied for

engineered and manufactured by
BLONDER TONGUE
9 Alling St., Newark, N. J.

Canadian Div.: Benco Television Assoc., Toronto, Ont. • Export: Morhan Export Corp., N. Y. 13, N. Y.
home TV accessories • UHF converters • master TV systems • closed circuit TV systems

QUALITY is a seven-letter word and so is **HITACHI**

PRODUCTS OF INTERNATIONAL RENOWN...THROUGH CONTINUING RESEARCH



SELL • SERVICE • SATISFY
with
HITACHI
CERTIFIED-QUALITY
RECEIVING TUBES

Choice as original equipment by manufacturers in the U.S. & abroad.

MORE PROFIT PER CALL—more satisfaction for all—these fine receiving tubes can't be beat for performance and reliability. Strict quality control to fully meet top American standards goes into the careful manufacture of each Hitachi tube. Yet important cost savings guarantee you extra profits. Most popular types available. And distribution is on a localized, prompt delivery basis.

See your HITACHI Distributor, or write for Catalog No. CT-400A.



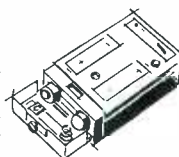
Distributed throughout the U.S. by

THE SAMPSON COMPANY (Est. 1921) ELECTRONICS DIVISION
2244 SOUTH WESTERN AVENUE, CHICAGO 8, ILLINOIS



SELL • PROMOTE • PROFIT
with the Newest from
HITACHI
TH-660 TRANSISTOR
SHIRT-POCKET RADIO

FEATURES EXCLUSIVE
"QUICK-ACTION"
BATTERY RELEASE



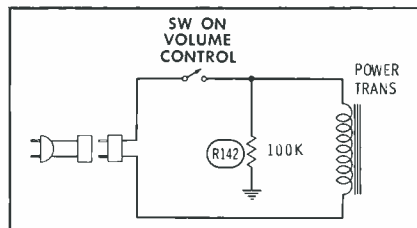
Startling reach-out reception of distant stations. Unbelievable output—100MW: Undistorted, 150MW: Maximum. Precision fine-tuning, too, and magnifier tuning dial. Radio is only 2½" x 3¼" x 1½". Exclusive button-release trips open bottom of cabinet; permits the 2 inexpensive penlite batteries to drop into palm for "split-second" changing without need to remove back. Radio incorporates 6 transistors; 2 diodes plus thermistor; 2½-inch P.M. speaker; self-contained ferrite core antenna; range 535—1605 kc.

GIFT BOXED—Complete with batteries, 2 luxurious glove-leather carrying cases, earphone.

only **\$24⁹⁵**

with FULL PROFIT for you!

• Other fine Hitachi 6, 7, and 8-transistor radio portables in AM and SW/AM combinations . . . from \$24.95 to \$79.95.



Transformer-Powered But "Hot"

Occasionally I encounter a transformer-powered TV that has a "hot" chassis. My latest experience was with an RCA KCS108C. My shop has a cement floor, and an AC voltmeter showed 110 volts AC either between the TV chassis and the floor or from the chassis to my hand. When I sat on a chair and lifted my feet, the reading dropped to between 20 and 30 volts. What makes these chassis hot?

LESTER C. HICKS

West Alexander, Pa.

Notice that one side of the AC line is connected to chassis through R142 in the primary circuit of the transformer. Undoubtedly you obtained the reading when R142 was connected to the "hot" side of the AC line. The cement floor is obviously damp enough to provide a good earth ground. Therefore, even though the 100K value of R142 prevented any appreciable current from flowing, you were still able to obtain a reading of full line voltage from the chassis to ground. When you sat on the chair you were, in effect, adding series resistance between chassis and ground. You were measuring only the voltage drop across your body; the remaining 80 to 90 volts was dropped across the chair.

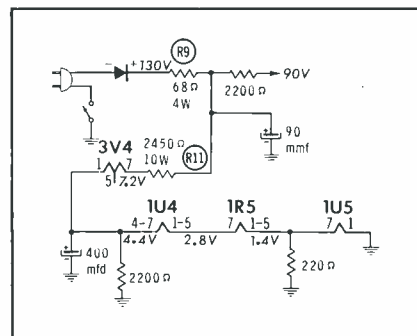
"Three-Way" Question

A General Electric Model 670 portable keeps burning out the 1R5. All voltages and resistances check out. Can you offer a possible solution?

THOMAS J. TUCCI

Philadelphia, Pa.

Did you check filament voltage? Adjust the applied AC voltage to 117 volts and see if the DC voltages indicated on the schematic are actually being applied to all of the filaments. If not, R9 or R11 may have changed value. If the voltages are correct, they should stay very close to normal when the AC input is varied from 100-125 volts AC. Any appreciable change in filament voltage means there's trouble along the filament line.



Phone Exam

(Continued from page 22)

portant properties of resistors, capacitors, inductors, conductors, and insulators. Review frequency and wavelength relationships, plus frequency assignments and propagation characteristics.

Tubes and Transistors

Certainly you are already well up on these subjects. However, a good review will help to consolidate the facts you know almost instinctively. Refresh yourself on major tube characteristics and classes of amplifier operation. Transistor questions are very basic.

Power Sources

Questions on power sources cover the subject in a fundamental way from dry cells and storage batteries through rectifier power supplies to motors and generators. You will probably have to spend more review time on the battery and motor-generator supplies than on half-wave and full-wave rectifiers using tubes or semiconductors. Go over filter characteristics. Give some time to vibrators and special rectifier tubes.

Transmitters; Antenna Systems

The study of this material will probably be your most time-consuming job unless you have been a radio amateur or have had other experience with transmitters. You must know the various types of oscillators and have a good knowledge of class-C amplifiers. Tuning procedures are important. Become familiar with the modulation process and various types of modulators. Interstage and antenna coup-

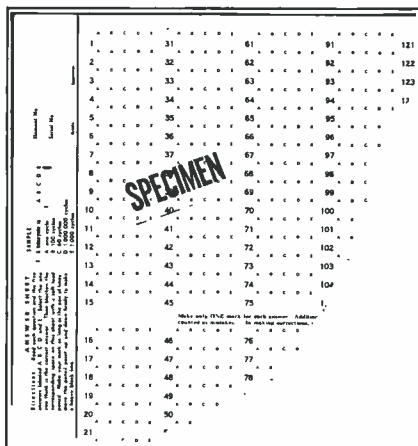


Fig. 2. Part of exam uses electrically-graded multiple-choice answer sheet.

ling systems must be understood, and a review of antenna fundamentals will also be of help. Use of meters in tuning and troubleshooting are important topics.

Receivers

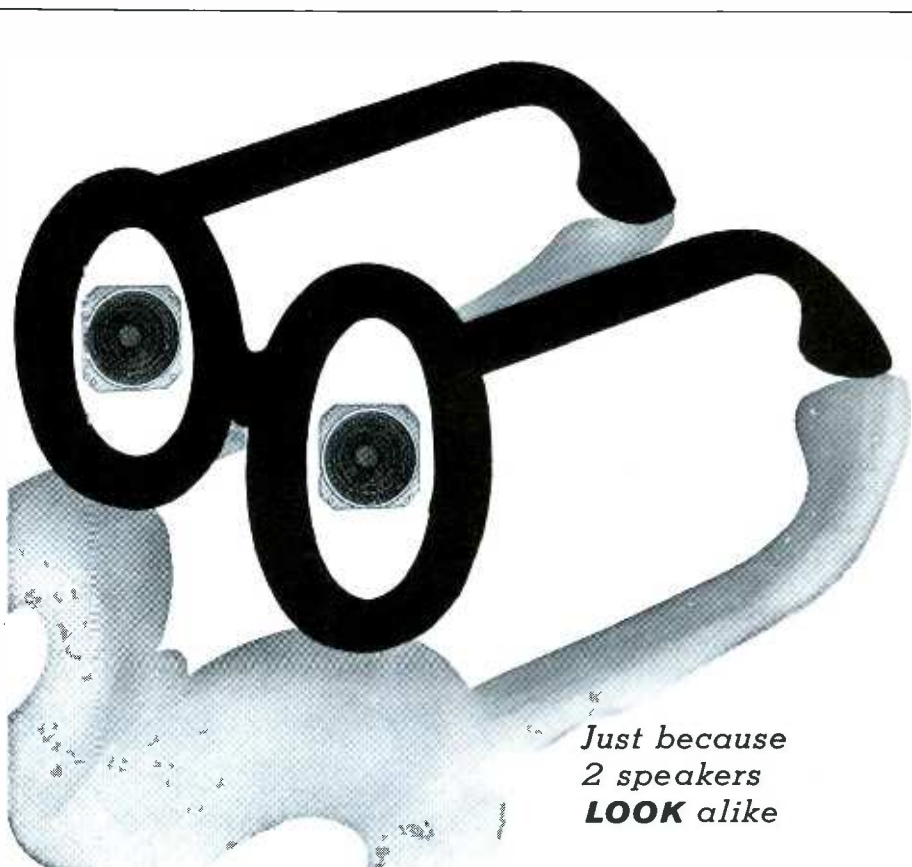
These questions will be right down your "channel." However, there are some questions on types of detectors you may have thought no longer existed. Review operation and schematics.

Measurements and Regulations

Making measurements and using

meters are subjects you know instinctively. However, you may have forgotten how some of the basic meter movements function. The use of meter shunts and series resistors are topics one is likely to forget. Some additional FCC rules and regulations of a more technical nature than those in Element I are also included in Element III.

Since you can count on already knowing much of the material included in the FCC examination elements, you're much better off than if you were starting from scratch. The main problem is that



Just because
2 speakers
LOOK alike

doesn't mean they'll **SOUND** alike...
or that they'll give the same
trouble-free performance.

ask for **QUAM**

The NO CALL-BACK speaker with the exclusive Adjust-a-Cone Suspension
Completely manufactured in the United States of America

QUAM-NICHOLS COMPANY
234 East Marquette Road • Chicago 37, Illinois

★ **EARN MORE MONEY**

★ **BUILD A BETTER FUTURE**

NOW you can learn 2-way radio servicing at home from Motorola

NOW, for the first time, a home study course devoted exclusively to *2-way FM radio servicing*.

The MOTOROLA TRAINING INSTITUTE trains you for a professional career with unlimited potential. The booming 2-way radio market should triple in the next 10 years. Qualified servicemen are urgently needed!

The Motorola Training Institute course covers everything in 2-way radio from basic principles to system analysis and troubleshooting the latest transistorized equipment.

Course Includes:

- 38 STUDY LESSONS WITH COMPLETE SECTION ON TRANSISTORS
- 9 UP-TO-DATE TEXTS
- MORE THAN 20 TECHNICAL ARTICLES

HERE'S WHAT STUDENTS SAY ABOUT THE MOTOROLA TRAINING INSTITUTE COURSE

"The section on transistors alone is more than worth the price of the full course." (K. F.—Illinois)

"Although I have an FCC license and some experience as a technician, I did not have a good working knowledge of the squelch circuit. Now, through my Motorola Training Institute training, I am able to do a decent troubleshooting job." (P. C.—Indiana)

"Personally, I think any technician that does not sign up for this course is missing a good opportunity to ease his servicing problems." (N. V.—New Jersey)

Write Today for
Complete Information

**NO OBLIGATION AND
NO SALESMAN WILL CALL**



NEW TECHNICIANS: Learn in just a few months what could take years. Course prepared by experienced faculty and highly skilled technicians. Easy-to-grasp lessons—reference library—individualized instruction.



TV-RADIO SERVICE MANAGERS: Here's a great growth opportunity for you and your technicians. The Motorola Training Institute home study course teaches your technicians the right way to do 2-way radio servicing and enables you to expand your range of services.



EXPERIENCED TECHNICIANS: Learn advanced servicing techniques and technological improvements. Get new information and know how on all the new transistorized equipment. An excellent "brush-up" course.

MOTOROLA
TRAINING INSTITUTE

4501 Augusta Blvd., Chicago 51, Ill.

Please send me complete information on
the MOTOROLA TRAINING INSTITUTE
No. A-167.

(please print)

NAME _____

ADDRESS _____

CITY _____ ZONE _____ STATE _____

of organizing your present knowledge so it can be readily recalled during the exam. A careful review will serve this purpose, and will probably enable you to answer more than 50% of the Element III questions correctly. Additional concentrated study of transmitter topics should make Element III a breeze. The passing of Elements I and II is a matter of memory and common sense.

Study Aids

The FCC makes available a complete set of study questions for the various elements. This "Study Guide and Reference Material for Commercial Radio Operator Examinations" is available from the U.S. Government Printing Office, Washington, D.C. for 75c. Answers are not given in this publication. However, the questions are the basis for several "question and answer" books which are available from various commercial sources to help license applicants prepare for FCC examinations. (One such book is the "Second-Class Radiotelephone License Handbook" published by Howard W. Sams & Co., Inc.) Some "Q & A" material gives special emphasis to two-way radio equipment, thus familiarizing you with communications - radio practices as you study for the examination.

Those who feel they need more than a "brush-up," or want a better-organized training program than they can obtain by independent study, would do well to consider investing in a home-study or evening-school course specifically designed to prepare applicants for the license exam.

If your purpose in obtaining a license is to qualify for two-way radio servicing, you can find much useful theory and practical data in the large variety of handbooks and textbooks now on the market. (In searching for background information on transmitters, don't overlook amateur publications dealing with mobile and VHF equipment.) Books on mobile radio, marine electronics, Citizens radio and related equipment will not only help you to get ready for the examination, but will also prepare you for earning money in communications-radio work. ▲

Audio Test Equipment

(Continued from page 27)

ize" with the original input. However, they can be developed in sufficient quantity to cause serious distortion.

Fig. 3 shows one way in which spurious harmonics are added to the signal. In this case, the tube is operating on a nonlinear portion of the Ib-Ec curve; so, although a pure sine wave (only one frequency) is applied to the grid, the increase of plate current on the positive half-cycle of grid voltage is greater than the decrease on the negative half cycle. This is equivalent to adding even-numbered harmonics to the basic signal, and is thus defined as harmonic distortion.

Any measurement of harmonic distortion consists of measuring the amplitude of the added harmonics with respect to that of the fundamental frequency. Fig. 4 shows, in simplified block form, the method generally used. An audio sine-wave generator supplies a single-frequency input signal to the amplifier being tested, and the output of the amplifier—consisting of the fundamental frequency plus any added harmonics—is applied to the distortion analyzer (enclosed in dashed lines). The meter-selector switch is first set in the position shown, and the meter setting is adjusted to a level which indicates the amplitude of the fundamental plus harmonics.

The meter switch is then changed to the other position, so the meter can read the output of the analyzer. The filter is either a high-pass type which eliminates all frequencies lower than and including the fundamental, or a rejection type which attenuates only the fundamental. (An advantage of the high-pass filter is that it also eliminates hum, which might artificially increase the indicated harmonic amplitude.) This filtering action leaves only the harmonics, which are amplified before being applied to the meter. The amplification and meter circuits are designed so that the amplitude of the harmonic signal is read as "percentage distortion" when the meter adjustment is left at the setting established in the first step of the procedure. A reading of 5% distortion, for example, would mean that 5% of the total signal consisted of harmonics added by the amplifier

Most Unusual Watch Radio Ever Offered!

SAMPSON

DUALARM transistor watch radio



DOES THINGS NO CLOCK RADIO CAN DO... YET YOU CAN PUT IT IN YOUR POCKET!

THIS is the watch radio idea brought to its finest fulfillment. The new SAMPSON SC4000 with its unique two-way alarm system is a blending of creative engineering and highest production standards... exquisite jewelcase styling and unusual performance exclusives. A uniquely pocketable combination, providing features and functions unprecedented in versatility, in efficiency, in intriguing customer appeal. Yet its modest price puts the new SAMPSON Dualarm into the hands of *everyone!*

Powered, Priced, Promoted to Your Customers!

National advertising as unique and compelling as the product itself. A complete package of SAMPSON Dualarm newspaper ad mats ready to run under Your Store Name. Plus distinctive displays, window streamers, "spec" sheets, and other powerful in-store selling materials. And through The Sampson Company and its more than 300 distributing and servicing points in the United States... you are assured full profit, prompt delivery, dependable service the year around.

"Synchro-Eye" Night Light

Flashes on when radio-alarm or electronic-signal sounds. Stays on with dependable glow till alarm-cycle is completed.

Exclusive Time-Selector

Simplifies time-setting with no eye-strain, no knob-fumbling. Just turn beveled watch-rim till indicator is at desired time.

Exclusive Beaumont Swiss Watch Movement

Precision engineered, reliably accurate 32-hour timepiece. Easy-to-read, luminous dial with sweep-second hand.

Patented Automatic Dual-Alarm System

Turns itself on for 12 minutes, off for 6, then repeats with a 12-minute encore. Shuts itself off. Both radio and independent electronic-signal alarm work same way.

U. S. Patent Pending
Foreign Patent Nos. 13559, 12680

Exclusive "Slenderette" Circuit

Gold-trim, high-impact cabinet a slim 2 3/4" x 4 1/4" x 1 1/8"—in choice of Black/White or Coral/White.

Advanced Superheterodyne Circuit

6 lifetime transistors in specially designed circuit provide unusual power, sensitivity and tonal quality for a radio so compact.

\$39⁹⁵ Suggested Retail Price

Beautifully GIFT-BOXED, complete with leather carrying case and all accessories, including batteries and earphone.



Model S640

MORE FROM SAMPSON...

"Little SAMPSON 6" (Model S640) the extra sensitive, high performance transistor pocket portable, packaged in distinctive book-styled presentation box. \$19.95

SAMPSON Deluxe Table Radio (Model ST61) strikingly styled, 5-tube superheterodyne circuit, engineered to exacting specifications.



Model ST61

Write today for full details and the name of the Sampson distributor nearest you
products of **THE SAMPSON COMPANY** (EST. 1921)
ELECTRONICS DIVISION • 2244 SOUTH WESTERN AVE. • CHICAGO 8, ILL.




SIGNAL TRACER

Checks all stages from Antenna to Speaker or Picture Tube. Tests microphones, appliances, pickups, transformers, speakers, resistors, condensers, etc. Model 202 (with AF Probe) Net \$37.50

Model A Probe (RF Demodulator)	Net	4.50
Model B Probe (RF Demodulator, Amplifier)	Net	7.50




TELEVISION CLARIFIER

Removes annoying signals that cause picture distortion in TV receivers from FM, amateurs, shortwave, diathermy, ignition, and adjacent channels. Ghosts, lines, herringbone patterns, tears, and wavy effects are removed or reduced simply by adjusting the two control knobs on this NEW type INTERFERENCE ELIMINATOR. Net \$4.50.

PRECISION ELECTRONICS, INC.
9101-0 King Ave., Franklin Park, Illinois

under test. For good reproduction, the total harmonic distortion should be less than 2%, although 2-5% is often considered within the limits of acceptable reproduction. Most analyzers can also be used to measure noise or hum by the same general methods, but using zero input signal. Different makes and models vary somewhat as to specific details of operation and procedure, but proper results can be obtained by carefully following the directions given in the instruction manual.

Intermodulation-Distortion Analyzer

When the operation of an audio amplifier is not completely linear, other frequencies besides harmonics can be introduced. The various frequencies making up the complex audio signal heterodyne with each other in the nonlinear stage, producing sum and difference frequencies. As an illustration, input-signal components of 80 and 2000 cps can heterodyne to produce "beat notes" of $2000 + 80$ or 2080 cps, and $2000 - 80$ or 1920 cps. The numerical relationships between the original and beat frequencies usually do not correspond to the musical scale; hence, discordant sounds are produced. This type of distortion is usually more prevalent at the higher signal levels, since nonlinear operation shows up more severely when stronger input signals are used. This statement also applies to harmonic distortion.

Although harmonic and intermodulation distortion both stem from the same basic cause (nonlinearity), they are separate and distinct entities, and are therefore measured differently. Measurement of intermodulation distortion involves applying two audio frequencies to the amplifier under test and determining the total amplitude of the additional frequencies created.

A simplified block diagram of an intermodulation analyzer is given in Fig. 5. The low-frequency oscillator in most models produces a signal at 100 cps or below; some units make direct use of the 60-cycle line voltage. The output of the high-frequency oscillator is usually at several thousand cycles. Amplitude of the low-frequency signal is several times that of the high-frequency

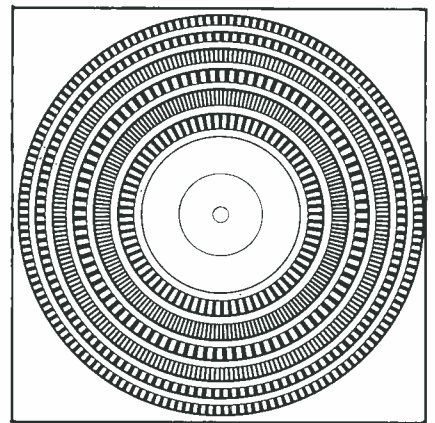


Fig. 6. Stroboscope disc for checking speed of phonograph rotation.

signal (usually by a 4:1 ratio), to simulate the signal conditions normally encountered in actual service.

These two signals are mixed in a linear circuit which produces no intermodulation; then they are amplified and passed through a calibrated attenuator before being applied to the amplifier under test. If there is intermodulation, two additional frequencies are present at the amplifier output. Using inputs of 60 and 3000 cps as an example, beat frequencies of 2940 and 3060 cps would be added. All four frequencies are fed back to the proper terminals of the analyzer, and the high-pass filter removes the low-frequency component. The detector stage demodulates the signal, producing 60-cps beat notes between the components in the 3000-cps range. The higher-frequency signals are eliminated by the low-pass filter. This leaves the 60-cps components, which are then amplified, rectified, and applied to terminal B of the VTVM switch.

The total output of the detector is available at position A of the VTVM for use in adjusting the meter to a predetermined level. The switch is then changed to position B, and the resulting reading is in terms of "percent intermodulation distortion." For best results in audio amplification, the reading should be less than 5%, although up to 10% is often considered acceptable.

Optional Equipment

In addition to the four basic pieces of audio test equipment just described, there are other items which can help the audio serviceman increase his efficiency. Among these are a wow and flutter meter, stroboscope disc, test records, and audio wattmeter.



the business-like approach

to SERVICE CHARGES and RECORD KEEPING

For customer's prices on every replacement part, plus flat rate and hourly service charge data, regional and national. Dave Rice's OFFICIAL PRICING DIGEST, listing over 63,000 items. \$2.50.

▲ AVAILABLE FROM YOUR DISTRIBUTOR ▼

If you want to operate on a professional level, Dave Rice's OFFICIAL ORDER BOOKS give you triplicate forms for order, invoice, and office records... spaces for tubes, parts, serial numbers, labor and tax charges, signatures, etc. 75c per book, \$6.50 for dust-proof box of 10.

Dave Rice's

ELECTRONIC PUBLISHING COMPANY, INC.
133 N. JEFFERSON ST. • CHICAGO 6, ILL.

Wow and Flutter Meter

When the sound source of an audio system is either a tape or a disc recording, the frequency (pitch) of the reproduced sound is determined in part by the speed of rotation. If the motor runs at a constant speed, even though it might be slightly different from the recording speed, no adverse effects are noted (except by a trained musician, who might observe the change in pitch). But if the tape drive or turntable does not run at a constant speed, the result is "flutter" (rapid variations in speed) or "wow" (slow variations). Both are quite annoying because of the continual changes in pitch. A "wow and flutter meter" can be used to measure the extent of these variations.

In order to use this meter, a constant-frequency signal—usually several thousand cycles—must be applied to the audio system from a test record or tape. The meter contains a bandpass filter which eliminates all frequencies except the test tone and any frequency modulations caused by flutter or wow. Amplitude variations are clipped by a limiter stage, and then the signal is applied to a discriminator which transforms the frequency change into a voltage for actuating the meter in the instrument. The meter scale is calibrated in "percentage of flutter," which can be defined by the following:

$$\% \text{ flutter} = \frac{\text{max.} - \text{min. freq.}}{\text{avg. freq.}} \times 100$$

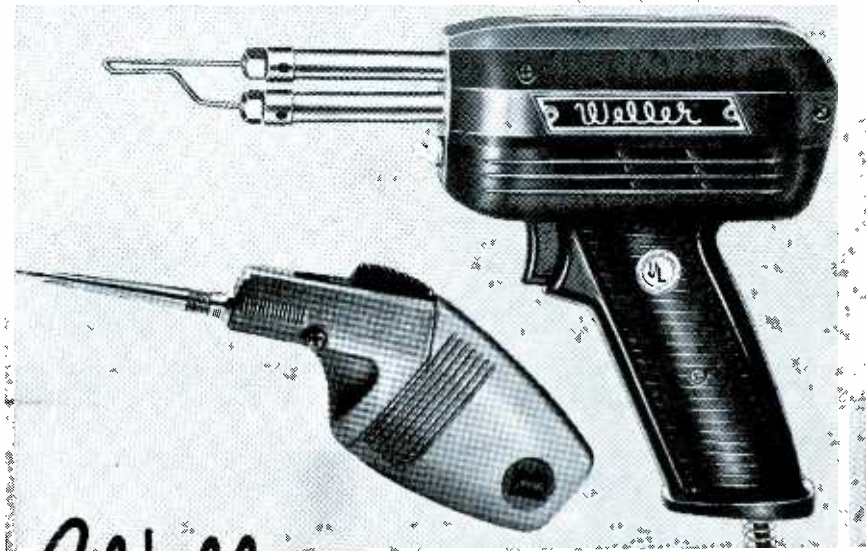
Average frequency is that applied to the system, and max. freq. - min. freq. represents the total frequency change due to motor-speed variations. A reading of less than 1% is acceptable; better-quality systems may give readings as low as 0.1%.

Stroboscope Disc

The speed of a phonograph turntable (or tape reel) can be measured quite easily by using a stroboscope disc (Fig. 6). The several rings of dots or lines correspond to various standard speeds of rotation. When the disc is placed on the turntable and viewed under AC incandescent, neon, or fluorescent light with the turntable in motion, the appropriate ring should seem to stand still. When rotation is too slow, the marks in the ring will appear to move counter-clockwise; when rotation is too fast,

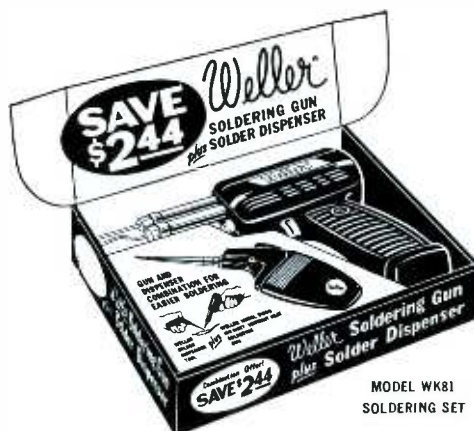
Special Combination Offer

SAVES \$2⁴⁴



Weller® Instant Heat Gun PLUS Solder Dispenser Tool

New, money-saving Weller combination assures faster, better soldered connections. Gun tip heats instantly when trigger is pulled—cools immediately when trigger is released. Spotlight illuminates work. Tip made of copper for maximum heat transfer, iron-plated for long life. Weller-Kormat Dispenser saves time—particularly in difficult-to-reach spots. It eliminates manual handling of the solder, and resulting contamination that causes faulty connections. It also reduces solder waste and prevents finger burns.



100 Watt Soldering Gun
Guaranteed 1 year.
Model 8100B. Reg. list price..... **\$6.44**

Weller-Kormat Dispenser
for wire solder from .028 to .074". Reg. list price... **\$5.95**

Reg. list price value.... **\$12.39**

COMBINATION PRICE..... \$9⁹⁵
list

AT YOUR ELECTRONIC PARTS DISTRIBUTOR

WELLER ELECTRIC CORP., EASTON, PA.

they will move clockwise.

Test Records

Musical recordings give some idea of how a hi-fi system sounds, but do not provide truly accurate information about the over-all performance of the system. Also, while signal generators can furnish concrete indications of amplifier capabilities, they are unable to test a system all the way back to the disc or tape source. So, to provide more complete "stem-to-stern" testing, a number of test records and tapes have been developed.

For measuring frequency re-

sponse, the test recording includes bands of different frequencies, usually ranging from about 50 to 10,000 cps. The reproduced output for each frequency can be measured with an AC VTVM or a wattmeter for purposes of comparison.

Sweep-frequency records can also be used in determining response. These contain a series of "frequency runs" varying from 50 to 10,000 cps or more, all occurring at a constant rate. The output of the system is applied to the vertical input terminals of an oscilloscope. The horizontal sweep of the scope is

synchronized to the sweep-repetition rate used on the record, so that the screen presents a graph of the frequency response.

Intermodulation test records can be used to check an entire system, including the phonograph, and one such type can be used without an intermodulation analyzer. This record includes two tones which sweep downward very slowly, always staying 1000 cycles apart in frequency. When there is intermodulation distortion, a 1000 cps difference tone is heard. Comparing the loudness of the 1000-cycle tone with a reference-level tone on the record gives an approximate indication of distortion. When the two tones have equal loudness, the distortion is 2%. Other test records are available to measure hum, rumble, noise, stylus wear, tracking ability, wow, and flutter, among other things.

Audio Wattmeter

As previously stated, output-power measurements can be calculated from AC-voltmeter readings when the load resistance is known. This is a time-consuming process, especially if a large number of readings are necessary. Audio wattmeters, usable at any audio frequency, contain several load resistors (usually 4, 8, 16, and 600 ohms) which can be selected by a front-panel switch. Readings on the meter are in terms of watts, and the measurable levels may vary from about 5 milliwatts to 50 watts or more. Most audio wattmeters also contain a decibel scale.

Accessory Equipment

Other items which may be found useful from time to time are a noise generator, a calibrated microphone, an audio sweep generator, and a complete hi-fi system arranged so that other units can be quickly and easily inserted for checking or testing. This hi-fi system could include a tuner (AM, FM, or both), three-speed turntable, preamplifier, amplifier, and speaker system. These units should be of high quality to make it easier to spot troubles in equipment being checked.

As a matter of fact, all audio test equipment should be of a quality equal to or better than the components being checked. Good-quality test instruments in many reasonably-priced forms are readily available to technicians in the audio field. ▲

NEW 3 IN 1 TRANSISTOR TESTER

GC
MODEL
36-560



MADE IN AMERICA
BY AMERICANS

all three transistor
tests in one unit...

TESTS: SHORTS-LEAKAGE-GAIN

only 19⁹⁵



TEST PNP, NPN, POWER TRANSISTORS, DIODES AND RECTIFIERS with this High Styled but rugged, compact transistor tester. Only 5" x 5" x 1 1/2" in overall size and weighing only 1 1/4 pounds, this unit operates on two penlite batteries which under normal operating conditions last a lifetime. An ON-OFF switch eliminates possible meter or battery damage through accidental shorts. The body is finished in "Anti-Scratch" case with stylized chrome handle for easy carrying. The high visibility recessed panel is in a two-tone classic finish of pale gold and copper brown. Foreign equivalents listed in accompanying FREE MANUAL.

Write for our FREE 400 page Catalog

GC ELECTRONICS CO.

Division of Textron Electronics, Inc.

Western Plant: 3225 Exposition Place, Los Angeles 18, Calif.
Main Plant: 400 S. Wyman St., Rockford, Ill., U.S.A.

TV Tuners

(Continued from page 33)

1. A is a Sarkes Tarzian switch-type unit with a tetrode RF stage, and B is a Standard Coil Guided Grid turret tuner. Both offer high gain and exceptional signal-to-noise ratios. The units are relatively compact, but have conventional mounting provisions. They are supplied with mounting hardware, installation adapters, and complete replacement instructions. Each manufacturer has a line of eight different tuners—four with 12-position and four with 13-position detents. The various models are designed to replace original UHF-VHF and VHF-only tuners having 21- or 41-mc IF's, with either series or parallel filament arrangements. (See Chart I.)

Authorized parts distributors who stock the general-replacement units have TV-tuner replacement guides showing the correct universal models to use in replacing various original tuners. Each replacement line covers most other units produced by the same manufacturer, and also many tuners made by other companies. Electrically, the replacements can always be made to work; the only limitations have to do with physical mounting and adaptations of special knobs or accessories (for example, automatic and remote tuning devices).

Installing Replacements

Let's take a look at a typical replacement installation to see how much work is involved. After you have selected a proper replacement and removed the original tuner, size up the new tuner and figure out a good physical mounting. Once you know where the tuner will fit, dismantle the fine-tuning shaft assembly and cut both the channel-selector and fine-tuning shafts to the required length. Then reassemble the shaft and mount the tuner securely in place. By the way, always check the original mounting for any special insulation that must be replaced when the new tuner is installed. The tuner may be isolated from its mounting bracket, especially in series-string receivers.

If the original and replacement tuners were both produced by the same manufacturer, you should have no trouble mounting the unit. In some cases, however, it may be nec-

essary to drill new mounting holes as illustrated in Fig. 2. If any alterations must be made in the mounting, always be sure the tuner shaft is long enough and doesn't bind.

You can make all electrical connections by following the simple diagrams on the installation instruction sheet. These include the filament supply leads, AGC, either one or two B+ supply lines, the IF output cable, and, of course, the antenna lead-in. For optimum fringe-area performance, B+ voltage to the tuner should be close to

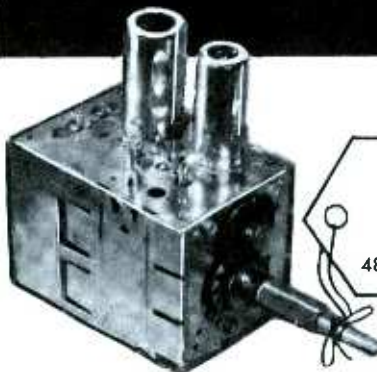
the value recommended in the replacement instructions. A series dropping resistor is necessary in some cases, but an ordinary 2-watt unit should fill this need. Leads to the tuner may be shortened or extended, except for the IF output cable. If at all possible, the original length and lead dress of this cable should be carefully preserved. In a few instances, it may be necessary to remove a plug from the end of the IF cable in order to connect it to the replacement tuner.

After installing the tuner, check to see that all shields are in place;

Eliminate the pitfalls of Universal Replacement Tuners

No drilling, filing or sawing required when you use...

CASTLE'S TV TUNER OVERHAUL



SAME DAY SERVICE!

on Popular Types
48 Hours most Others

Castle overhaul charge includes all labor and minor parts and written 90 day warranty. Tubes and major parts are extra at net prices. Tuner to be overhauled should be shipped complete; include tubes, shield cover and any damaged parts. Write down model number and state complaint. Pack well and insure.

Write for Special Quantity Rates and Discounts

CASTLE

TV TUNER SERVICE, INC.

5710 N. Western Ave. • Chicago 45, Ill.

IN CANADA

136 Main Street • Toronto 13, Ontario

**ALL MAKES
ONE PRICE**

\$9⁹⁵

**VHF TUNERS
UHF TUNERS
UV Combinations***

*UV combination tuner must be of one piece construction. Separate UHF and VHF tuners with cord or gear drives must be dismantled and the defective unit only sent in.



Overhauling TV tuners is our only business. We do not manufacture and sell you a so called "universal" replacement tuner. When the original equipment tuner is overhauled by Castle you are assured that it will fit properly and the electrical specifications, set by the receiver manufacturer, will be met exactly.

Castle



then connect an antenna, and apply power to the receiver. Before making an operational check, tune in a local station and permit the set to warm up for at least five or ten minutes. If the rest of the receiver is functioning properly, both picture and sound should be reproduced. Normally, it is necessary to touch up the IF-output adjustment on the tuner and the IF-input adjustment on the receiver, until a clear, snow-free picture with sufficient sound is obtained on each available channel. Certain signal-coupling circuits between tuner and IF strip may require modification, although this step is seldom necessary. Recommendations for such changes are offered in the installation instructions.

For a final touch-up when installing a new tuner, you may wish to perform an over-all response check. Follow the regular procedure for a final alignment touch-up, using an oscilloscope in combination with both sweep and marker generators. The response patterns shown in Fig. 3 are typical of what you will encounter in recent-model sets. Pattern A represents the normal IF response of a receiver, with

markers placed at the 50% point on each slope of the curve for reference. (Note arrows.) Pattern B is the response obtained after installation of a universal-replacement tuner, but before adjustment of the IF coupling circuits. Notice that the peak is narrower and has shifted to the right, thus placing one of the markers too high on the slope and the other too low. Under such conditions, the picture and sound may still appear fairly normal to the untrained eye. This does not, however, eliminate the need for touching up the IF-coupling alignment.

In this particular example, the original tuner had a 100-mmf capacitor connected directly across the IF-output cable at the tuner end. Connecting this component in the same spot on the replacement tuner did not improve the response, but actually narrowed it even more (see pattern C of Fig. 3). Adjustment of only the tuner-output and IF-input coils broadened this response somewhat, but at the expense of considerable gain. In making this replacement, it was found that reducing the value of the capacitor from 100 to 50 mmf and retouching

the IF-coupling adjustments resulted in the response of pattern D—actually a more desirable IF curve than the original. Although such improvement is exceptional, this example shows how picture quality can be increased by the installation of a replacement tuner. ▲

Tuner Service Companies

- Atlas TV Tuner
6856 S. Halsted, Suite 210
Chicago 21, Illinois
- Castle TV Tuner
5710 N. Western Ave.
Chicago 26, Illinois
653 Palisade Ave.
Cliffside Park, N. J.
152 Main St.
Toronto 13, Ontario, Canada
- J. W. Electronics
Box 51
Bloomington, Indiana
- L. A. Tuner Exchange
4611 W. Jefferson
Los Angeles, Calif.
- Mercury TV Tuner
890 River Ave.
Bronx, New York
- Precision Tuner Service
601 N. College
Bloomington, Indiana
- R & K Tuner Mfg. Co.
16865 Shaffer
Detroit, Michigan
- Sarkes Tarzian
Tuner Service
E. Hillside Dr.
Bloomington, Indiana
- Standard Kollsman
2085 N. Hawthorne Ave.
Melrose Park, Illinois

NEW TUBE TYPES ARE REVOLUTIONIZING YOUR BUSINESS

We promised you the answer and here it is...

NEW TUBE TESTER MODERNIZING PANEL

Now, you can test all of these new tubes in the Sencore Mighty Mite or any other tube tester except the "cardomatic" type. Don't throw away your tube tester just because you can't check the RCA Nuvistors, the GE Compactrons, the Sylvania 10 pin tubes or the all new RCA Novars.

These new tubes, which are the industry's answer to the transistor, are causing a revolution in electronics today. Thousands are being installed in electronic equipment every day from coast to coast. You will be called on to test them tomorrow. Be prepared with the TM116 Tube Tester Modernizing Panel.

For use with any manually operated tube tester.

Tests are made by plugging the TM116 into an octal socket on your tester and setting controls from the chart provided with the unit. All tests are the same as your tester now makes. Some other adaptor units merely reduce all tests to an emission check. Sencore uses additional internal circuitry to provide complete mutual conductance or high grid leakage checks if

your tester now makes them.

You can own the TM116 for less money than it costs to keep substitutes in your shop or lab.

Model TM116 Dealer Net Only **\$2495**

Ask your Authorized Sencore Distributor for the New TM116. He has them in stock.

SENCORE

ADDISON, ILLINOIS

Yoke Trouble

(Continued from page 31)

pletely normal, though. There was not quite enough width, and the picture appeared somewhat compressed toward the center. Remembering that the linearity slug was solidly stuck, I disconnected the coil from the receiver and very carefully flowed a little household wax solvent into the coil form. Then, for the sake of accuracy in setting up the linearity adjustment, I connected a bar-dot generator to the antenna terminals of the receiver, and hooked up the scope to the lower (boost) side of the horizontal yoke coils. In place of the normal boost-ripple waveform (Fig. 8), I found the peculiar, almost parabolic pattern shown in Fig. 9.

As I turned the core counter-clockwise to back off the linearity adjustment, the waveform on the oscilloscope began to rise and form a truer parabola such as you see in Fig. 10. The vertical-bar display on the TV screen then appeared as in Fig. 11—compressed in the center, and spread apart at the sides. Turning the linearity coil back clockwise through its range lowered the peaks of voltage and even introduced secondary humps into the waveform (Fig. 12). The pattern on the CRT began to widen appreciably, and the bars pulled into more normally-spaced positions. Eventually, the waveform looked as in Fig. 8, and a series of evenly-spaced vertical lines covered the TV screen. Flipping a switch on the signal generator and turning up the brightness on the TV, I obtained the familiar dot pattern (Fig. 13) which has found so much use in color-television static and dynamic convergence. This time, though, I just wanted to use the dots to confirm that the linearity had been properly adjusted.

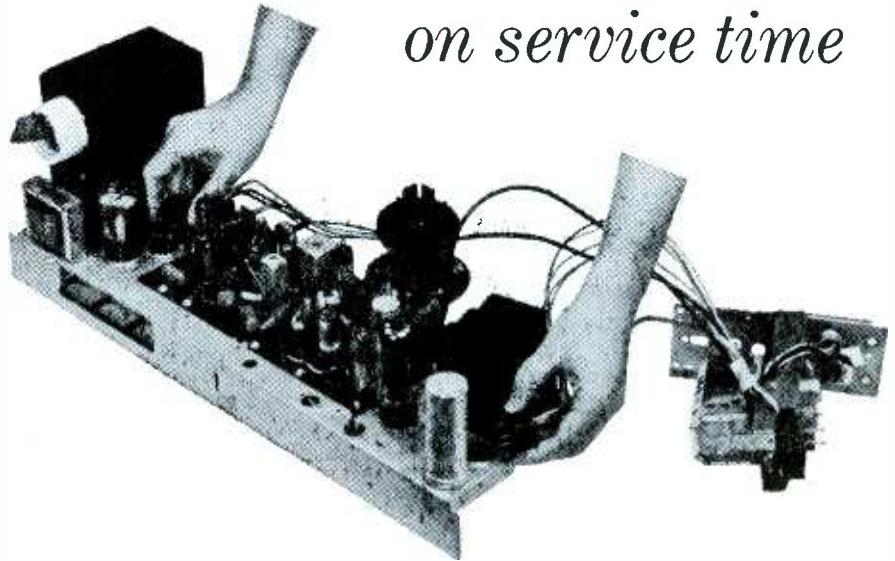
As a final touch, I slightly advanced the setting of width control R6 (Fig. 2) so that the raster filled the screen. I was relieved to find that R6 functioned normally, because this component in the KCS47 bears careful watching. Note that it feeds variable DC voltages to the horizontal hold control and the screen (pin 8) of the horizontal output. Minimum screen voltage is obtained with the control turned fully clockwise. Adjusting the screen voltage has a great effect on the



The "Big Picture"

...informative shop talk from
Sylvania Field Service Headquarters

Now... "pull the plugs"
on service time



"Time is money," you know... and untangling, pulling and remounting wired-together TV assemblies eats up plenty of valuable service time. But see how this new GT-555 chassis on the new 1962 Sylvania TV Sets "unplugs" that time-tangle and frees you for profitable servicing.

All wiring from major components to the chassis has easy-to-remove plugs... tuner cluster, deflection yoke, picture tube high voltage lead, speaker system and remote receiver. The HaloLight® mechanism is also a plug-in. Now you can separate and pull whole assemblies in seconds (put them back in seconds, too, so you're saving time at both ends).

But that's not the whole "plug-in" story. The mountings make good use of the same principle. The chassis, for instance, has push-studs on front that fit neatly into special cabinet-mounted brackets. That means no more of those tough-to-get-at front screws to struggle with.

You don't have to remove any screws to get at the Mylar-insulated high voltage transformer, either. It has a new, hinged lid (with safety-lock device) for easy access. A simple thing, but typical of the thought and care in this new, service-designed GT-555 chassis, and another reason why TV service experts like the new Sylvania TV Sets.

SERVICE TIP OF THE MONTH

Symptom—Noisy or intermittent tuner (button contact type).

Cause—Faulty bonding of buttons to solder strips at the rear of the wafers.

Cure—Spraying with cleaner fluid will produce temporary repair. Resoldering the button of the noisy or intermittent channel will effect a permanent cure.

Sylvania Home Electronics Corp., Batavia, N. Y.

SYLVANIA

SUBSIDIARY OF

GENERAL TELEPHONE & ELECTRONICS





Larger, longer scale meters

... Just what you asked for — AND MORE!

The previous "D-612T", rated best by servicemen, is now even *more* efficient with these improvements.

New ... Clear plastic meters with 88% longer scale! Attractive — easier to read.

New ... Insulated binding post terminals for increased versatility! Accommodate any common connection.

New ... One full year warranty! Your proof of superior quality.

Special filter circuit holds ripple to less than 0.5% RMS up to 5A, less than 2% up to 10A ... well below minimum critical requirements for transistor auto and personal radio work. Ideal for testing and servicing citizen's band transceivers, tube radios, DC motors, etc. still only \$59.95 net.



1924-1961
25th
ANNIVERSARY

Write for New Catalog PS-561 giving all advantages

ELECTRO PRODUCTS LABORATORIES
4501-T Ravenswood, Chicago 40, Ill., Longbeach 1-1707
Canada: Atlas Radio Ltd., Toronto 1279



Type "CTC" ... cardboard tube electrolytics especially designed for exact replacement in television sets ... one end closed ... long insulated leads out other end ... sealed with high melting point wax ... guaranteed for one year ... individually packaged.

Write today for complete information.

PLANET SALES CORPORATION
225 Belleville Avenue Bloomfield, New Jersey

high voltage, which may range from approximately 10.5 kv (at maximum width setting) to 15.5 kv (at minimum width). Naturally, then, R6 will affect the brightness and sharpness of the picture as much as it will influence the width of the raster.

There are definite limitations on using R6 to compensate for inefficient operation of other components. If the width control is set at maximum to make up for weak horizontal drive, the high voltage suffers. Below 11 kv, brightness and contrast are not likely to be acceptable, and blooming becomes a problem. On the other hand, beware of sacrificing width to improve picture clarity when the picture tube or video amplifier is old and weary. The high voltage should not exceed 13 kv, or you'll probably hear frying or arcing in the high-voltage cage. This "cry for help" indicates overdriving of the flyback transformer, which frequently results in arcing from the high-voltage rectifier filament winding to the lower section (between taps 1 and 2) of the transformer. Should this occur, the filament winding will have to be replaced; or, if the arcing is severe enough to melt the wax insulation on the main winding, you may have to replace the entire transformer. Some part of the flyback may even become open and extinguish the high voltage.

With current continually flowing through it year after year, R6 is likely to increase in value and cause gradual "softening" of the picture. During the long career of a typical KCS47, some serviceman may even have put this trouble into the set by applying a soldering iron to R6 for too long a period. If you ever encounter this defect, go ahead and replace the control, but watch that high voltage!

Comments

This case happened to involve one of our favorite "whipping boys"—an RCA KCS47. However, you'll be dealing with many of the same troubleshooting procedures and waveforms when you work on other receivers with similar troubles. Of course, the KCS47 is exceptional in one important re-

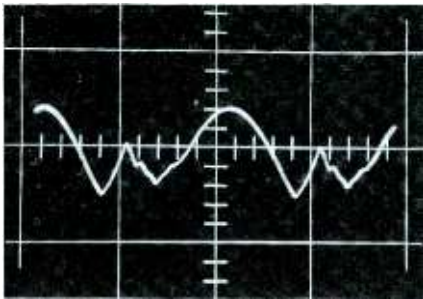


Fig. 12. Secondary peaks appear in trace at some linearity-slug settings.

spect—it has a linearity coil to help you stretch or squeeze the raster into the correct shape after a horizontal-circuit repair. Very few of the receivers made during the past several years have any provision for adjusting the damper-current waveform, although I've noticed that several of the very latest models do include a tunable linearity coil.

As Figs. 9 through 13 have demonstrated, the linearity coil does its job by shifting the phase of the ripple waveform at the damper plate. This is often all you need to smooth out the transition between damper-tube conduction and output-tube conduction, and thus eliminate bunching or stretching in the sweep trace.

Although fixed-current damper circuits do not offer this convenience, they are relatively noncritical, and are not prone to develop linearity troubles. If changing a flyback or deflection yoke in one of these systems should ever result in nonlinearity of the picture (and you're sure the new part is a correct replacement and in good condition), you can often make the required correction by slightly altering the value of the boost capacitors; or, if you've installed a multi-tapped output transformer, try connecting the damper to a different point for additional stretch or compression. ▲

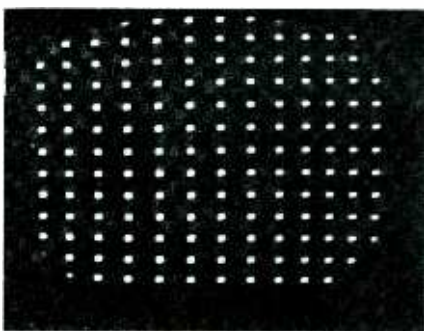


Fig. 13. Final linearity adjustment resulted in acceptable horizontal scan.







FONO-MAGIC—a compound of special rubber and carbide . . . eliminates turntable slipping and dragging; makes changers cycle properly. Contents are equivalent to the replacement of 100 idler wheels; will not wear off. dealer net . . . **\$1.95**

STRAPLESS CHIMNEY MOUNT—saves 90% of the time required for antenna installations . . . outlasts stainless type mounts. No chimney too large; installs on corner of buildings too. dealer net . . . **\$1.75**

HUMI-KUP 2 SET COUPLERS—hermetically sealed for outdoor installation; all inductive circuitry; skin packaged for self service sales; list **\$3.95**. dealer net . . . **\$1.95**

MAGNA-LITE—super powerful magnet clamps light to chassis, transformers, brackets, etc. 3-way swivel arm puts light exactly where needed. net . . . **\$5.95**

KLEENTROL MAGIC SOLVENT—approved by C.A.A.; contains no Carbon-Tet; non-flammable; will not harm finishes of wood, metal, or acetate parts. net (5 oz. spray can incl. injector tube) **\$1.25**; pint size **\$1.95** net.

CARDIO MASTER—super powerful magnetic device designed to hold a portable transistor radio in the area of a car's windshield and make it operate as a car radio. List Price **\$4.95** dealer net . . . **\$2.97**

METAL STROBE—handy all metal speed determining tool that lasts a lifetime; 4 speed design. dealer net . . . **.99**

KLEENTROL TAPE—cleans oxide from heads of tape recorders without dismantling housing which surrounds heads. Process takes 2 min. List **\$2.69**. net **\$1.88**

Detailed literature upon request—sold at better jobbers everywhere.

R-COLUMBIA PROD. CO., INC. 208 St. Johns Ave. Highland Park, Ill.

WEBCOR IS BUILT for easy servicing



NEW! Technical information on all 1962 Webcor products available on subscription!

Service Manuals and Bulletins on all current models, plus literature on new models as they are released—from July 1961 to July 1962 . . . punched for filing in Webcor folder.

only \$5.00 per year's subscription

SUBSCRIBE NOW!

WEBCOR Service Dept., 912 W. North Ave., Chicago 22, Ill.
Enclosed is \$5.00 (by check , money order).
Please send a full year's subscription of Webcor technical literature to:

NAME _____
TITLE _____
COMPANY _____
ADDRESS _____
CITY _____ ZONE _____ STATE _____

New Tube Design

(Continued from page 24)

a form of horizontal sync or sweep trouble.

Two other examples of *Compactrons* are the 6C10 and 6D10, triple triodes with identical basing but different characteristics. The former, an audio tube, can be used as a two-stage RC-coupled amplifier and phase inverter; the latter is intended for use in FM radio "front ends" as an RF amplifier, converter, and AFC tube.

As you've probably noticed, the numbering system is the same as for conventional tubes, but the large number of active elements usually makes the final number either 10 or 11 instead of 4, 5, 6, 7, or 8. Not all *Compactrons* have 10 or more elements, however. A few types are single-function tubes in which the large T9 envelope is used simply to promote heat dissipation. These tubes have power ratings comparable to octal types, and also offer the advantages of miniature-style bases (smaller size, ease of mounting on printed-wiring boards, and lower cost).

Present TV design trends are



Fig. 3. New Sylvania 6EW7 vertical sweep tube has a standard 9-pin base.

causing an especially urgent demand for vertical output tubes and dampers with this combination of features. To obtain reliable vertical sweep with 110°-114° deflection angles, square-cornered picture tubes, and high voltage above 20 kv, several manufacturers have recently had to turn to octal types such as the 6EM7. However, miniatures would allow greater simplicity and flexibility in chassis construction. This also applies to damper tubes, which have not yet been miniaturized to any great extent.

For this reason, the *Compactron*

line includes a damper diode, the 6AX3 (Fig. 1). This tube is virtually a twin to the 6AX4GTB octal damper, except that the over-all height has been considerably reduced by substituting a 12-pin miniature base for the octal style. Two pins (4 and 10) are connected to the plate to increase heat conduction away from this element.

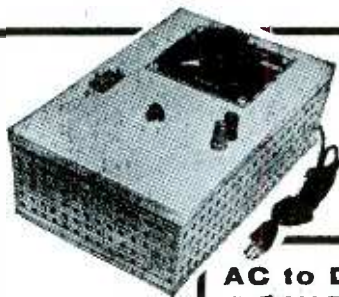
The 6FJ7, the tallest tube in Fig. 1, is a dual triode (with one low-power and one high-power section), designed to meet the current need for a more efficient vertical sweep tube. The output section has a plate-dissipation rating (design maximum) of 10 watts. This is the same as for the octal 6EM7, and well above the 7-watt rating of the 9-pin miniature 6DE7 used in many 110° vertical circuits.

General Electric is considering the use of even larger glass bulbs with the miniature 12-pin base, so we may see a *Compactron* horizontal output tube before long.

Big Tubes on Little Feet

Sylvania's 9-T9 tubes exemplify another way of solving vertical-circuit heat problems with a T9 envelope. Even though these tubes are as

JUST WHAT YOU NEED FOR TESTING TRANSISTORS



**AC to DC
POWER
SUPPLY**

Plug this instrument into any 60 cps, 95/130 volt circuit and get a stabilized source of direct current, adjustable over a range from 0 to 45 volts DC, with current output 0/2.5 amperes. Filtered direct current output range 0/45 volts, 0/2.5 amperes is continuously adjustable and stabilized $\pm 1\%$ at any setting regardless of alternating current fluctuation. Voltage regulation is approximately 5% between full load and no load at full voltage setting.

This DC Power Supply instrument is ideal for use in transistor testing, circuit testing, to provide regulated voltage for light testing, eliminates the need of batteries by supplying exact DC voltage required.

Write for Bulletin 17-BLO1 which gives full details and models available.

ACME ELECTRIC CORPORATION

949 Water St.

5AA3499/1952

Cuba, N. Y.

Acme Electric

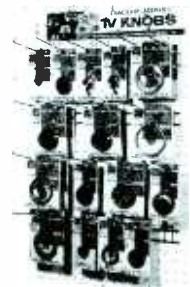


tune in on **LARGE PROFITS** with the **GC ELECTRONICS**

GENERAL ELECTRIC KNOB DEAL

CASH IN ON A TERRIFIC MARKET FOR EXACT REPLACEMENT TV KNOBS.

- THIS DEAL CONTAINS BEST KNOB SELLERS
- FREE DISPLAY MERCHANDISER
- PRE-PACKAGED, CLEAN MERCHANDISE
- PRE-PRICED AT FULL MARGIN MARK UP
- PROVIDES IMMEDIATE MERCHANDISE AND SALES



Deal No. 49-576
Dir. Net . . 26.31

FREE COMPLETE CROSS REFERENCE GUIDE

Packed with every display you order.. a complete cross reference guide that lists TV Set Model No. and Manufacturers Part No. to GC Number. Also the list price on every Knob in the GC Line.

See Your GC Electronics Distributor Today, or Write to

GC ELECTRONICS COMPANY

DIVISION OF TETRON ELECTRONICS, INC.

Main Plant: Rockford, Illinois, USA

Western Plant: Los Angeles 18, California

large as some "GT" octals, they have a standard-sized 9-pin miniature base. One type, the 6-/10EW7 (Fig. 3), is a dual triode with a 10-watt output section. Another, the 6-/17HC8, is something new in TV-tube design—a vertical output *pentode* in the same envelope with a vertical discharge triode.

The newest 19" Philco sets contain a different type of vertical sweep tube with a 9-pin miniature base, T9 bulb, and 10-watt output rating. This type, the 6FD7, has the same base connections as the Sylvania 6EW7.

Jumbo Miniatures

Still another glass-based T9 design, the RCA *Novar*, looks like a magnified version of a typical 9-pin miniature. (See Fig. 4.) Tubes in this series are taller than average—some nearly 3". The base consists of nine wire pins in a .687"-diameter circle (wider than in conventional tubes), and the pins are longer than usual (.335"). Since the pins are spaced farther apart than on ordinary miniatures, relatively

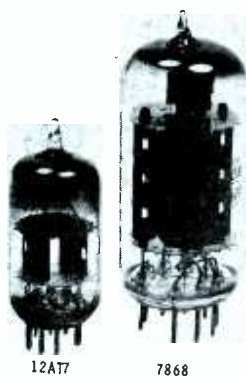


Fig. 4. RCA *Novar* design features a large bulb, 9 wide-spaced base pins.

high pulse voltages can be applied between pins without arcing. This consideration is very important in the *Novar* series, since most of the first types introduced are heavy-duty dampers.

Of the two series of damper diodes now available, the 6-/12-/17AY3 are the "milder" types. Heater current is 1200 ma for the 6-volt version, the PIV rating is 5000 volts, and maximum DC plate current is 175 ma. These figures

correspond to the ratings of the 6DE4 octal damper, except that the 6AY3 requires less heater current. A more rugged *Novar* type, the 6-/17-/22BH3, draws more heater power (1600 ma at 6.3 volts, or equivalent), but has a higher PIV rating of 5500 volts and a DC current rating of 180 ma.

Another *Novar* tube, the 7868, is designed for audio output service with a maximum plate-dissipation rating of 19 watts. Two of these tubes can operate in a push-pull hi-fi amplifier with maximum signal-power output of 44 watts.

Testing

Suitable sockets and necessary setup data for checking the new glass-based T9 types are already provided in the latest models of tube testers, and plug-in adapters are also becoming widely available for conversion of older instruments.

As new sockets are added, old ones move aside to make room. The familiar octal socket seems destined to take its place among the local, 4-pin, 5-pin, and other "relics." ▲

TRUST YOUR TV TUNER
REPAIR and ALIGN to **JW**

24 HR SERVICE

VHF or UHF—ALL MAKES

VHF Tuners	\$950
UHF Tuners	
UHF Converters	
UHF-VHF Combinations	\$17.95



Prices are for service and un mutilated units. Missing, broken and damaged parts, defective tubes charged extra at LOW net prices. We ship C.O.D.

10 STEPS IN OUR GUARANTEED SERVICE

1. All tuners mechanically and electronically inspected.
2. All necessary parts replaced.
3. Contact surfaces correctly cleaned and lubricated.
4. First test run for intermittents and drift indication.
5. Fine tuning range checked on all channels.
6. Local osc aligned to correct frequency all channels—XTAL controlled.
7. RF alignment—all channels—XTAL controlled.
8. AGC check, all channels—cut off of RF amp checked.
9. Overall response all channels, shield covers in position.
10. Quality control FINAL CHECK ALL UNITS, UHF-VHF.

IMPORTANT: Ship complete. Include all broken parts. State model and complaint. Package well to avoid transit damage.

JW ELECTRONICS 1539 W. Jarvis Avenue
CHICAGO 26, ILLINOIS Broadway 4-9757

NEW! SARGENT
ELECTRONIC CHEMICALS
and FINISHES



Specially Formulated for Today's Service Needs

SARGENT RED INSULATOR
Stops corona discharge and arcing. Waterproofs exposed wires and circuits. Impervious to moisture and temperature variations. Dielectric strength exceeds 20,000 volts. Excellent for use in printed circuit repairs. Laboratory tested and approved.

Giant 16.4 Oz. Can \$1.29 Dealer Net

OTHER PRODUCTS IN THE SARGENT ELECTRONICS LINE
Tuner Cleaner, Gear and Parts Cleaner, Degreaser, Clear Acrylic Plastic, Penetrating Oil, Squeak Stopper, Enamels, Lacquers, Metals, Engine Enamels, Stop Rust, and other Specialties.

For Free Literature and Prices Check Your Electronics Parts Distributor, or write . . .

ELECTRONICS DIVISION
THE SARGENT-GERKE CO.
Producer of Paints and Chemicals for Over 60 Years
P. O. Box 729 • INDIANAPOLIS 6, INDIANA



SWING-O-LITE FEATURED ON PF REPORTER COVER

To illustrate how magnification helps solve servicing problems of transistor radios, PF Reporter used Swing-O-Lite's famed "Inspector" lamp for their July cover. Especially designed for precision work, the "Inspector" will enable you to take full advantage of the lucrative transistor servicing market.

THE INSPECTOR magnifying lamp for precision work

- 22 watt, shadow-free circline fluorescent lamp
- 5" dia. precision-polished magnifying glass (7" dia. available)
- Adjusts to any position
- Choice of arm reaches, colors and mounts
- Exclusive convenience electric outlet in base (optional)

Dealer & Dist. Inquiries Invited



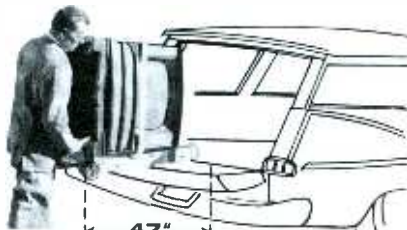
NEW!
GOOSENECK
MODEL M-4
\$27.00
list
Less Bulb

Write for literature on our complete line

Swing-O-Lite INCORPORATED

13 MOONACHIE ROAD HACKENSACK, N. J.

SAVES
your back...
SAVES
your time...



YEATS

**SHORTY
DOLLY**
for
RADIO and TV

just 47 inches high for STATION WAGONS
and PANEL PICK-UPS



FOLDING PLATFORM
15 1/4" x 24 1/2" top.
Snaps on or off.
(Platform only)
\$11.95

Designed for TV, radio and appliance men who make deliveries by station wagon or panel truck... the short 47 inch length saves detaching the set for loading into the "wagon" or pick up. Tough, yet featherlight aluminum alloy frame has padded felt front, fast (30 second) web strap ratchet fastener and two endless rubber belt step glides. New folding platform attachment, at left, saves your back handling large TV chassis or table models. Call your YEATS dealer or write direct today!



YEATS
Model No. 5
Height 47"
Weight 32 lbs.



FURNITURE PAD

"Everlast" COVER AND PADS

YEATS semi fitted covers are made of tough water repellent fabric with adjustable web straps and soft, scratchless white flannel liners. All shapes and sizes — Write



TV COVER

YEATS

APPLIANCE DOLLY SALES COMPANY

2103 N. 12th STREET MILWAUKEE, WISCONSIN

PRODUCT report

For further information on any of the following items, circle the associated number on the Catalog & Literature Card.

Redesigned Tube Tester (43F)

An improved version of the Sencore "Mighty Mite" tube tester checks RCA "nuvistor" and "novar," G-E "Compac-tron," and Sylvania "10-pin" tubes, plus all types that can be tested on the earlier model. In the new TC114 "Mighty Mite II," a friction device holds the mirror-equipped lid at any angle for convenience in making TV adjustments. The set-up data booklet is printed in new, larger type. Dealer net price is \$67.50.



Matched Stereo Speakers (44F)

The two 8" speakers in the Wilder Model 808-A "Twin Speaker Stereo Set" are laboratory-matched to be as nearly identical as possible. Each speaker has an extended-range biaxial cone with a frequency response of 30-17,000 cps. Impedance is 8 ohms, power rating is 25 watts (continuous program material), and resonant frequency is 44 cps. List price is \$98 per set.



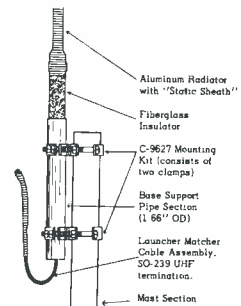
Pocket CB Units (45F)

Weighing less than 1 lb. the RCA "Personal-Com 300" provides low-power two-way communications on the Citizens band, in compliance with part 15 of FCC rules. The transistorized circuitry is powered by an 11-volt mercury battery. Accessories include a leather carrying case, an earphone, and a factory-installed plug-in module for increasing transmitter power. (With the latter, the unit requires an operating license.) A slightly larger model, the "Personal-Com," is also available.

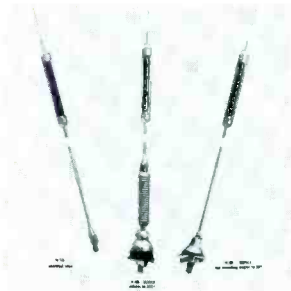


CB Base-Station Antenna (46F)

The Mark II "Super Beacon" antenna for 27-mc Citizens band base stations, manufactured by Mark Mobile, is a half-wave vertical radiator fed at the bottom high-impedance point through a "launcher-matcher" cable. The radiator is 19' long and has a "Static Sheath" (high-dielectric plastic coating) to prevent charged particles in the air from striking the metal surface and causing hiss interference.



Compact CB Antennas (47F)



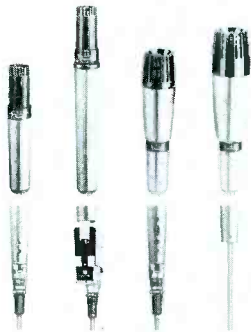
Wald center-loaded whip antennas for mobile Citizens band installations have an over-all length of 60". The loading coil, which is sealed in transparent plastic, is an integral part of the stainless-steel top section. Models are available with either standard or flex mounts, and also less mount (with universal adapter). A 54" or 144" coaxial cable is supplied with each antenna.

Transistor Kits (48F)



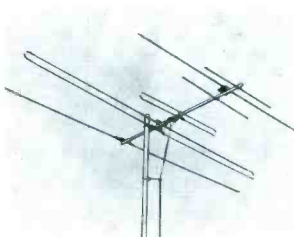
The newest kit of American-made replacement semiconductors marketed by **Semitronics Corp.** (No. 5PT) contains five power transistors designed to replace more than 100 types used in auto radios. Other kits in the "Popular-Quick" series are No. 8JP, with replacements for Japanese and other foreign transistors and diodes; 9TK, with nine popular PNP transistors and diodes; 10SP, with 10 silicon power rectifiers; and 5GP, with five glass-cased germanium diodes. Each kit contains replacement and interchangeability charts.

Dynamic Microphones (49F)



A series of plug-in adapters extends the usefulness of the six **University** "Modular Microphones." Any model can be used with or without Cannon plugs, with either slide-on or threaded stands, and with or without a thumb-operated on-off switch. Models 401 and 402S are omnidirectional, while Models 501 and 502S have a cardioid pickup pattern. The "S" versions feature internal shock mounting. Also available are Models 404L and 403L—small and extra-small lavaliers.

Medium-Gain Antenna (50F)



A six-element, all-channel VHF antenna designed for peak performance in areas of intermediate signal strength, the **Channel Master Model 309** "Commuter," has separate driven dipoles for the low and high bands. Since all elements lie flat, this antenna can be installed even in a low-roofed attic. List price is \$10.56.

Replacement Transistors (51F)

A kit of nine transistors, designed to replace hundreds of other types in specific stages of radios, is available from **Sylvania** semiconductor distributors. NPN types are as follows: SYL 101, converter-mixer-oscillator; SYL 102, IF amplifier; SYL 103, AF amplifier-driver; and SYL 104, AF power amplifier. PNP types include the SYL 105, converter-mixer-oscillator, SYL 106 IF amplifier, SYL 107 AF amplifier-driver, SYL 108 AF output, and SYL 109 auto-radio power output. Supplied with the "Big 9" kit are a replacement guide and a coupon worth \$12.50 toward enrollment in a correspondence course on transistor servicing.



"MORE EFFICIENT CLEANING IS POSSIBLE!"



INJECTORALL COMPANY
Brooklyn 14,
New York

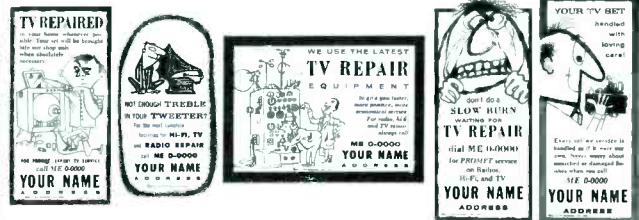
... thru the use of
INJECTORALL TUNER CLEANER
CLEANING... our formulation gets contacts sparkling clean. **LUBRICATION**... our spray leaves a lubricant as a protective coating. **NEEDLE APPLICATOR**... the 6 inch Injectorall Needle is made of stainless steel, with a special fitting to prevent the needle from blowing out of the can.
Non-toxic, non-inflammable.
6 oz. spray can with needle... \$1.95 net.

**Service Dealer Program
No. 9 in a Series**

All 5 ads only

\$1.00 for glossy proofs

\$1.75 for ad mats



USE THIS COUPON TO ORDER ADS DESCRIBED ON PAGE 48

PF REPORTER
2201 E. 46th Street
Indianapolis 6, Indiana

Please send me:

ad mats @ \$1.75 glossy prints @ \$1.00 both for \$2.50

Entire series of 60 mats, plus bound glossy proof book @ \$25.00
Enclosed is \$_____ to cover cost.

Name _____

Address _____

City _____ Zone _____ State _____

961

September, 1961

Acme Electric Corp.	84
Arco Electronics, Inc.	37
Arrow Fastener Co., Inc.	60
ATR Electronics	14
B & K Mfg. Co.	51, 55, 59
Belden Mfg. Co.	23
Berns Mfg. Co.	52
Blonder-Tongue Labs	71
Bussmann Mfg. Div.	65
Castle TV Tuner Service	79
Centralab, A Div. of Globe-Union, Inc.	68
Clarostat Mfg. Co., Inc.	49
Cornell-Dubilier Electric Corp.	67
EICO	62
Electro Products Laboratories, Inc.	82
Electronic Publishing Co., Inc.	76
G-C Electronics	78, 84
General Electric Co.	
Receiving Tube Dept.	34-35
Grantham Schools, Inc.	19
Hickok Electrical Instrument Co.	45
Injectorall Co.	87
JFD Electronics Corp.	63
JW Electronics	85
Jackson Electrical Instrument Co.	61, 88
Jensen Mfg. Co.	36
Jerrold Electronics Corp.	2nd cover
Littelfuse, Inc.	4th cover
Los Angeles Tuner Exchange	70
Mallory & Co. Inc., P. R.	16-17
Mercury TV Tuner Service	58
Merit Coil & Transformer Corp.	44
METREX	60
Miller Co., J. W.	20
Motorola, Inc.—	
Communications & Electronics Div.	74
Nortronics Co., Inc.	18
Ohmite Mfg. Co.	46
Pacotronics, Inc.	15
Planet Sales Corp.	82
Precision Electronics, Inc.	76
Precision Tuner Service	76
Pyramid Electric Co.	60
Quam-Nichols Co.	73
Radio Corp. of America	
Electron Tube Division	3rd cover
Telecommunication Center	48
R-Columbia	83
Rider Publisher, Inc., John F.	58
Sampson Co., The (Electronic Div.)	72, 75
Sams & Co., Inc., Howard W.	47, 54, 66
Sargent-Gerke Co.	85
Sarkes Tarzian, Inc.	
Tuner Div.	21
Sencore, Inc.	41, 43, 80
Sonotone Corp.	69
Sprague Products Co.	10
Standard Kollsman Industries, Inc.	9
Swing-O-Lite Inc.	86
Switchcraft, Inc.	42
Sylvania Electric Products, Inc.	
Home Electronics	81
Electronic Tube Div.	53
Television Tuner Service Co.	52
Tung-Sol Electric Co.	57
University Loudspeakers, Inc.	39
Utah Radio & Electronic Corp.	70
Webcor, Inc.	83
Weller Electric Corp.	77
Winegard Co.	12-13
Yeats Appliance Dolly Sales Co.	86

ANTENNAS AND ACCESSORIES

- 1F. **JFD**—New 1961 Exact-Replacement Antenna Guide Wallchart for Portable and Teatable TV Sets. Gives TV-receiver model number, manufacturer's antenna part number, and model number of corresponding JFD exact-replacement antenna. Also Form 940 dealer catalog illustrating and describing 1961 line of TV antennas, mounts, masts, *Mardi Gras* TV tables, accessories. See ad page 63.
- 2F. **JERROLD**—Special bulletin on determining system noise figure, for use in eliminating snow from TV pictures; also new literature on transistorized *Powermate TV-FM Preamp*. See ad 2nd cover.
- 3F. **R-COLUMBIA**—Complete literature on new, time-saving strapless chimney mount. See ad page 83.
- 4F. **TACO**—New literature setting forth the importance of tuned antennas for FM stereo (multiplex).
- 5F. **WINEGARD**—Information on transistorized Model AT-6 *Booster-Pak* home TV-signal amplifier. See ad pages 12-13.

AUDIO AND HI-FI

- 6F. **CLAROSTAT**—Illustrated flyer on *Panel-Juster* extension bushings and audio controls on which they can be used. See ad page 49.
- 7F. **NORTRONICS**—Information on converting tape recorders to four-track operation and replacing worn tape heads. See ad page 18.
- 8F. **QUAM-NICHOLS**—Catalog 61, listing complete line of replacement, public-address, and high-fidelity speakers. See ad page 73.
- 9F. **SWITCHCRAFT**—New 12-page, two-color *Audio Accessory Catalog No. A-401*, featuring selector switches, couplers, adapters, plugs, jacks, connectors, and cables; includes guide for selecting proper microphone mixers and cables. See ad page 42.
- 10F. **UNIVERSITY**—*Informal Guide to Component High Fidelity* (16-page booklet), 12-page microphone guide and catalog; 16-page PA speaker catalog. See ad page 39.

COMMUNICATIONS RADIO

- 11F. **SONOTONE**—Flyer on CM-30 series of microphones for use with mobile communications systems and tape recorders. See ad page 69.
- 12F. **TEXAS CRYSTALS**—New 8-page catalog, No. 961, covering all types of quartz crystals; includes oscillator circuits. Also CB directory giving crystal information on 64 of the most popular transceivers.

COMPONENTS

- 13F. **BUSSMANN**—Form SFB, 24-page booklet giving detailed information on complete line of BUSS and FUSETRON *Small Dimension* fuses and fuse holders—the ones most used in protecting electronic equipment. See ad page 65.
- 14F. **GENERAL ELECTRIC**—Capacitor catalog and interchangeability guide (No. ETR-2600). See ad pages 34-35.
- 15F. **MERIT**—Catalog sheet giving specifications and prices for new line of input, interstage, and output transformers for transistor circuits. See ad page 44.
- 16F. **J. W. MILLER**—Literature on RF, IF, and TV-sound transformers designed as exact replacements for popular original parts of eight major radio-TV manufacturers. See ad page 20.
- 17F. **SPRAGUE**—Catalog C-457 of capacitors, printed-circuit components, and wire-wound resistors (designed to hang on wall). See ad page 10.
- 18F. **TRIAD**—Replacement-parts catalog TV-62; also Bulletin PTM-4 in *Service Aids* for the *Professional Television Man* series.

SERVICE AIDS

- 19F. **BERNS**—Data on 3-in-1 picture-tube repair tool, on *Audio Pin-Plug Crimper* that lets you make pin-plug and ground connections for shielded cable without soldering, and on *ION* adjustable beam bender. See ad page 52.
- 20F. **CASTLE**—Leaflet describing fast overhauling service on television tuners of all makes and models. See ad page 79.
- 21F. **G-C ELECTRONICS**—400-page combined catalog FR-62 of all electronic components and service aids, including chemicals, hardware, test equipment, antennas, communications gear, audio accessories, microphones, etc. See ads pages 78, 84.
- 22F. **MERCURY TV TUNER**—Information sheet describing immediate tuner-exchange service, 24- to 48-hour tuner re-

pairs, and additional services; states prices and announces new seven-month warranty. See ad page 58.

- 23F. **PRECISION TUNER**—Information on repair and alignment service available for any type of TV tuner. See ad page 60.
- 24F. **TENSOR**—Literature on portable, swivel-arm *Fold-Away Model 6975* utility lamp which produces concentrated, high-intensity beam.
- 25F. **YEATS**—Literature describing *Appliance Dolly* and padded delivery covers. See ad page 86.

SPECIAL EQUIPMENT

- 26F. **ATR**—Information on inverters for operating standard 110-volt AC PA systems in mobile applications; an example is Model 12U-RHG which delivers 150-watt, 110-volt continuous output from 12-volt storage-battery source. See ad page 14.
- 27F. **ACME ELECTRIC**—Catalog sheet 17 BL01 on portable and rack-mounted DC power supplies with continuously variable output from 0 to 45 volts, stabilized within $\pm 1\%$; maximum current output 2.5 amps. See ad page 84.
- 28F. **EMCEE**—Complete planning kit on HVF translators for extending TV service into difficult reception areas.
- 29F. **STANDARD ELECTRICAL**—40-page catalog of *Adjust-A-Volt* variable transformers, with illustrations, descriptions, electrical ratings, specifications and dimension diagrams.
- 30F. **VIRGINIA**—Data sheet on *Classroom TV Stand*—a rack with tubular metal frame, mounted on casters, which holds TV set approximately 5' off floors for viewing in schools, hospitals, institutions, and industry.

TECHNICAL PUBLICATIONS

- 31F. **GRANTHAM**—Booklet entitled, "Careers in Electronics," outlining training courses available. See ad page 19.
- 32F. **HOWARD W. SAMS**—Literature describing all current publications on radio, TV, communications, audio and hi-fi, and industrial electronics servicing. See ads pages 47, 54, 66.

TEST EQUIPMENT

- 33F. **B & K**—Catalog AP18-R, giving data and information on *Dynamatic 375 Automatic VTVM*, *V O Matic 360*, *Dyna-Quik* tube testers, Model 1076 *Television Analyst*, Models 1070 and A107 *Dyna-Sweep Circuit Analyzers*, Model 610 *Test Panel*, Model 440 *CRT Cathode Rejuvenator Tester*, Model 160 transistor tester, and Model 960 *Transistor Radio Analyst*. See ads pages 51, 55, 59.
- 34F. **EICO**—New 32-page catalog of test equipment, kits and wired equipment for stereo and monophonic hi-fi, Citizens band transceivers, ham gear, and transistor radios. Also, "Stereo Hi-Fi Guide," and "Short Course for Novice License." See ad page 62.
- 35F. **HICKOK**—Literature on Model 656 NTSC-standard color-bar generator and other color television test equipment. See ad page 45.
- 36F. **JACKSON**—Bulletin MK-61 on new Socket Modification Kit that enables Model 658 and 648R tube testers to check any of the newest types of tubes. See ads pages 61, 88.
- 37F. **METREX**—Serviceman's guide, "Cramful of Shortcuts," dealing with troubleshooting, alignment, and calibration of radio, TV, hi-fi, and related equipment; also manual for operation of new *Genie* pocket-size signal generator. See ad page 60.
- 38F. **PACOTRONICS**—12-page catalog with specifications and illustrations of *Precision* test equipment for radio-TV servicing. See ad page 15.
- 39F. **PRECISION ELECTRONICS**—Specifications on Model 202 aural-visual signal tracer, *Television Clarifier* for rejecting interference and *Grommes Little Genie* series of hi-fi kits. See ad page 76.
- 40F. **SECO**—Pocket-sized folder describing complete line of radio, TV, transistor, and communications test equipment.
- 41F. **SENCORE**—New booklet, *How to Use the SS105 Sweep Circuit Troubleshooter*, plus brochure on complete line of time-saver instruments. See ads pages 41, 43, 80.

TUBES

- 42F. **SAMPSON**—*Hitachi* receiving-tube manual, giving extensive specifications, basing diagrams, and outlines for complete tube line; also catalog sheet with color photos and descriptions of *Hitachi* broadcast-band and two-band transistor radios. See ads pages 72, 75.

Latest Jackson Tube Test Data

MODEL 648				MODEL 598			
Tube Type	Pin	Grid	Heater	Tube Type	Pin	Grid	Heater
3AN4	3.0	12	9	32 YZ	3.5	3Y2	4
3AX3	2.5	A324	A37	30 XZ	3.0	2	1358
208Z7	15	15	15	30 XZ	3.0	2	1358
35H8B	35	137	8089	30 XZ	3.0	2	1358
30F5	30	C123	467	40 V W	5.0	3Z	5



HOW SILVERAMA BECOMES "SILVER"

High-Vacuum Aluminizing Assures Sharpest TV Picture Possible

Here RCA Silverama picture tubes become "silver" at the aluminizing station on our Marion, Indiana, production line. In a burst of light, aluminum is vaporized in a high vacuum and is deposited over the entire inner surface of the tube. Then the operator, with an RCA-designed electronic gauge, checks to be sure the aluminum film is of proper thickness. If it is not, the tube is rejected.

Such extra care in manufacture is an important reason why the Silverama you install today is free from "picture-spoiling" dark centers caused by an excess of aluminum deposited on the tube face. This extra care is the reason, too, why Silverama delivers

the brightest, sharpest picture your customers' sets can produce. Obviously, Silverama picture tube service is the surest way toward satisfied customers, repeat business, favorable word-of-mouth advertising for you—plus freedom from call backs and costly in-warranty failures.

Equally important is the fact that RCA is a picture tube manufacturer. This means that your customers can take advantage of the latest innovations in picture tube design and manufacture when they buy RCA Silverama. It is made with a precision electron gun, the finest parts and materials, plus a reused envelope.



Final checkout before shipment. Here Silverama tubes receive final focus check before being shipped to customers.



Packing for final shipment. Before it can go into this box, RCA has made certain this Silverama is the best picture tube modern science and technology can produce.

RCA ELECTRON TUBE DIVISION, HARRISON, N. J.



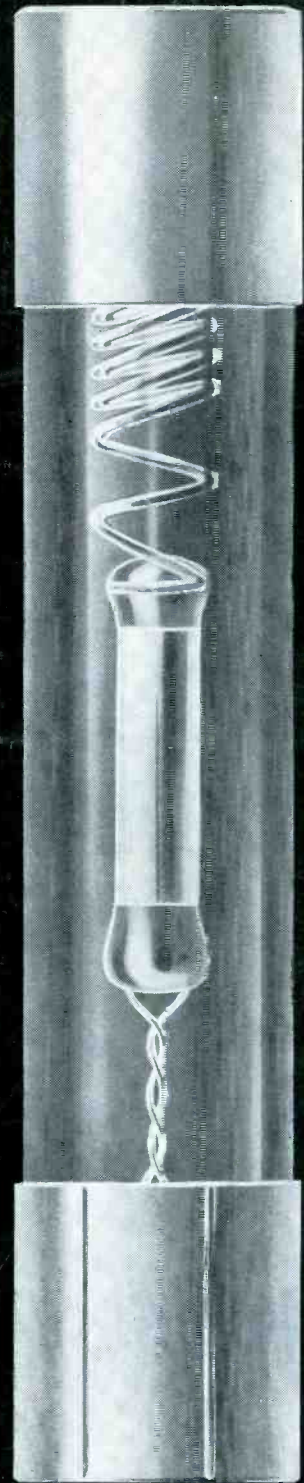
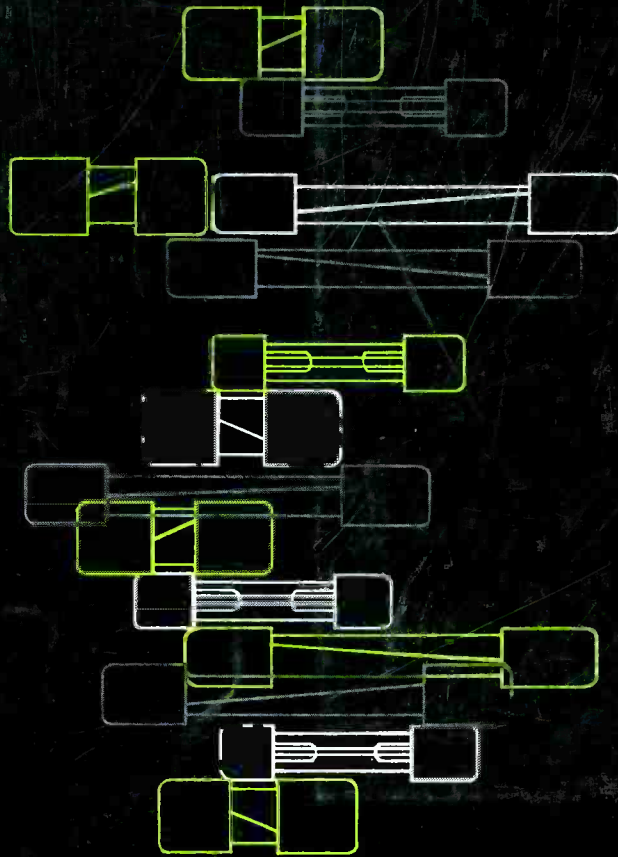
The Most Trusted Name in Television.

WHAT'S IN A FUSE?

Only a fuse element, glass & caps?

No! Every fuse carries
with it the skill and quality of its manufacturer.

You can't reach out and touch or taste this,
you can't even be sure it will do
its job when needed except
by purchasing from a company
that has the know how of 30 years
of manufacturing fine fuses.



BURTON BROWNE ADVERTISING

LITTELFUSE

1865 Miner Street · Des Plaines, Illinois