

JUNE, 1961

35 CENTS



PHOTOFACT

# RF REPORTER

including **Electronic Servicing**



**Breaking the Commercial  
Sound Barrier**

**Air Conditioner  
Repairs Made Easy**

**Troubleshooting TV  
Wireless Remotes**

**Final Scope Checks  
Reduce TV Callbacks**

IA OK 7496 1264  
WM. M. DAVIS  
RAD. & TV SERV.  
118 RIVERSIDE AVE.  
CANNON CITY, COLO.

# Universal Replacement Parts Kit

## MODEL 31T 3890

Popular Standard Coil field replacement parts used extensively by servicemen for STANDARD tuners manufactured from 1947-1956.

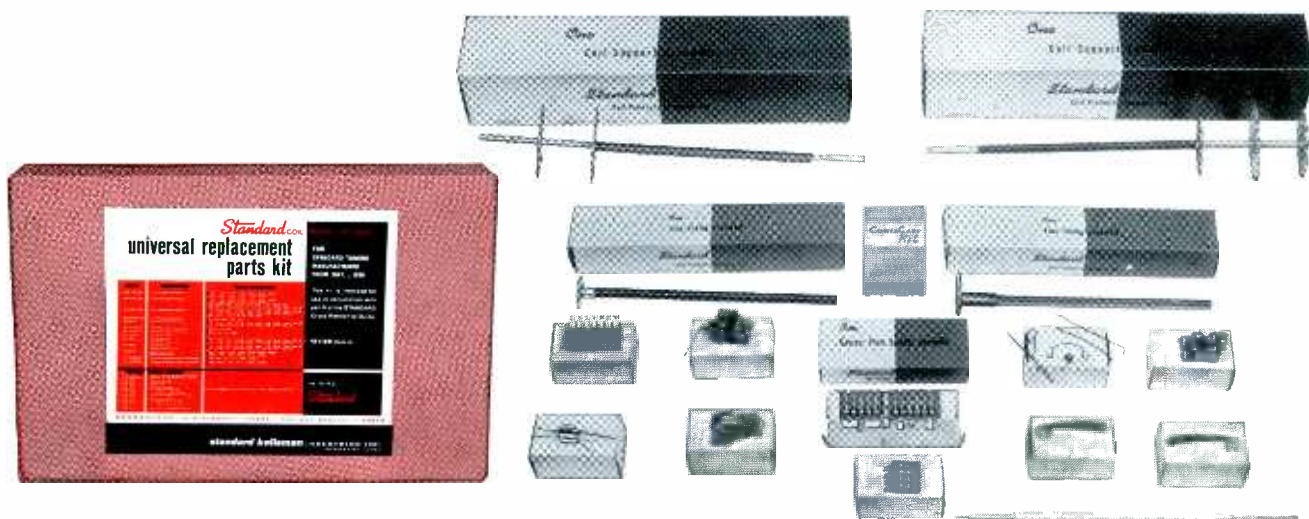

## MODEL 31T 3890

A kit of mechanical and electrical parts for shop and field use to be used in conjunction with Section II of the STANDARD Cross Reference Guide. These parts make up 90% of the replacement parts most commonly used in field service.

**INCLUDED**

**FREE**

- Special IF alignment tool for late model STANDARD TV and FM tuners.
- Popular special springs, detent springs and roller assembly, detent ball assemblies, etc.

**BE PREPARED... GET YOURS TODAY** from any authorized

*Standard* **COIL** distributor

• **\$27.99 DEALER NET**

**standard kollman** INDUSTRIES INC.

FORMERLY STANDARD COIL PRODUCTS CO., INC., MELROSE PARK, ILLINOIS

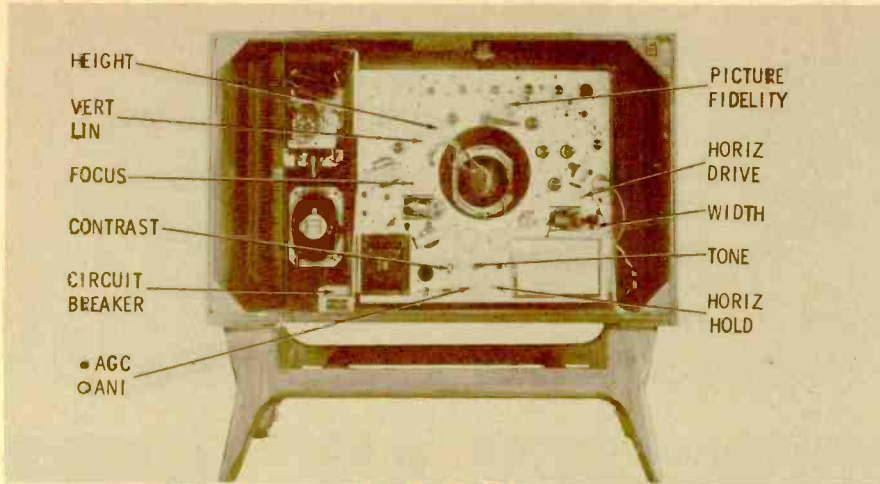

### Packard-Bell Model 23DD3 Chassis 98D10

Chassis 98D10 and 98D11 are used in the 1961 *Signature* TV series produced by Packard-Bell. The chassis are alike except for the added wired remote-control circuitry in the 98D11. All models in the series use a 114°, 23MP4 picture tube with a conventional safety glass. To remove the glass, press gently at bottom center, insert a piece of card stock (like a business card) between the glass and the metal trim strip, and slide the card to the right to release the spring which holds the trim strip. The plastic part of the escutcheon directly above the channel selector is the *computer dial*. An individual panel lamp lights a square for each channel as the selector is rotated to complete each circuit.

No fewer than 14 controls are provided; 11 are mounted on the vertical chassis, while the remaining three are attached to the tuner-mounting panel. Contrast, tone, *picture fidelity*, and horizontal hold adjustments have phenolic extensions protruding through the back. The *ANI* control provides for manual adjustment of the grid-cathode bias of the automatic noise inverter stage—half of a 12AX7.

The picture signal is fed to the control grid of the CRT (pin 2) from a two-stage video amplifier which utilizes a 6CB6 and the pentode section of a 6CX8. The *picture fidelity* control is connected to the coupling circuit between these stages to provide an operational adjustment of frequency response. Two 6BN8 tubes are used—one as a radio detector/AF amplifier, and the other for the sync separator and horizontal AFC functions.

No semiconductors are used in this hand-wired chassis, which is transformer-powered and protected by a circuit breaker in series with the AC line. Unlike most chassis these days, the 98D10 has no fuse wire to protect the filament circuit. Because of the higher-than-usual B+ demands (320 ma) created by the 20-tube chassis, a 5V3 (huskier than a 5U4) is used as the low-voltage rectifier.

A convenient tube-placement chart, glued to the captive lid of the high-voltage cage, identifies all of the controls as well as the tubes. While looking over the tube types shown, you'll find that the set uses a 6V6GT for an audio output—rather unusual for a new set these days.

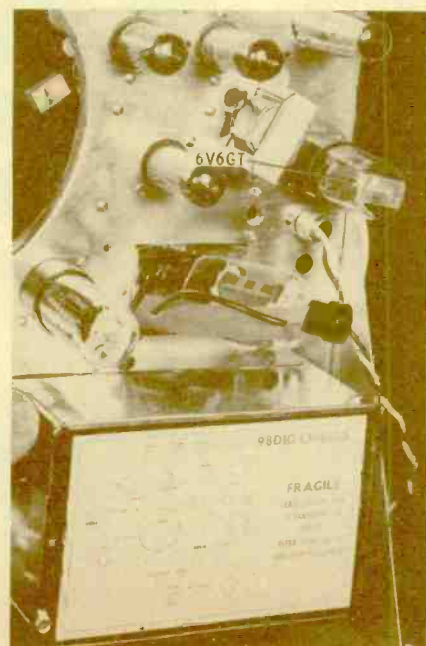
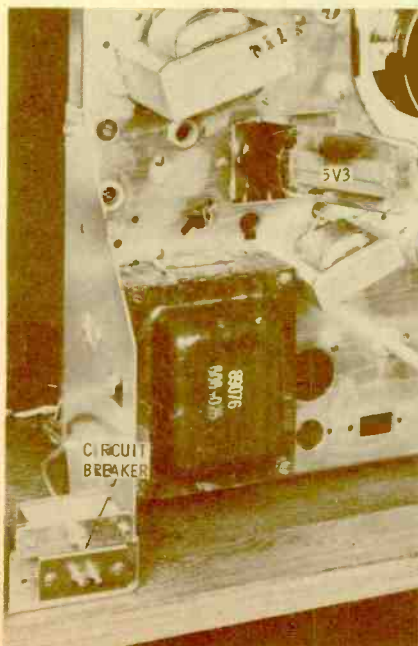
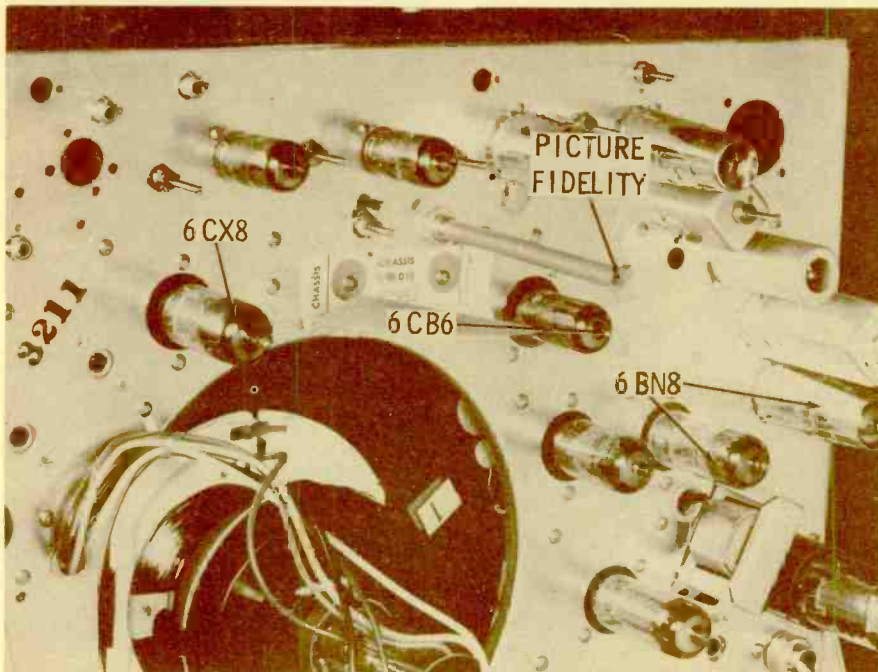



**RCA Victor Model  
232B152MV  
Chassis KCS136A**

Here's one of the new 1962 sets just introduced by RCA. This particular 90° model has a 23BJP4 picture tube, but some models in this series have a 23BKP4 or 23BCP4. All use a separate safety glass which can be removed for cleaning after prying off a trim strip along the top edge. The operational controls are all mounted on the front and clearly marked. Though this set isn't equipped with remote control, some models are equipped with a supersonic system to turn the set off and on, regulate volume, and change channels in ascending order. Automatic brightness control is also featured in some of the receivers; a circuit built around a light-sensitive resistor adjusts both brightness and contrast as ambient light changes.

Setup adjustments for the 17-tube horizontal chassis are located on the rear apron and well identified. The rear apron also has two "spare" metal screws to provide a means of temporarily fastening the tuner bracket to the main chassis when both these sections are removed from the cabinet for servicing. Three bolts along the back and three wedge-type guides along the front secure the chassis to the cabinet.

After loosening four metal screws (heavy arrows), the *New-Vista* tuner assembly is easily removed by lifting it up until the elongated mounting slots clear the screws. All of the tuners used with this chassis use a 6CW4 *nuvistor* as the RF amplifier.

The transformer-powered chassis is protected by two chemical fuses. One is rated at 3 amps and located in series with the AC line; the other is a 4/10-amp unit in the B+ circuit. One 6.3-volt winding on the power transformer feeds the parallel filament circuit, which is divided into two main branches—each protected by a length of #28 fuse wire mounted on top of the chassis. The horizontal output tube (a new 6GW6 type) and the 5U4GB rectifier are held in place by ring-type base clamps which must be pressed down to free the tubes for removal.

Several other new tube types appear on the two printed boards. A 6GY6 pentode serves as the AGC keyer; a 6CG7/-6FQ7 dual triode is used in the horizontal AFC and oscillator circuits; the pentode section of a 5HF8 serves as video output, while the triode section fills the sound IF spot; and a 6GX6 (a new version of the 6DT6) is employed as an FM detector.

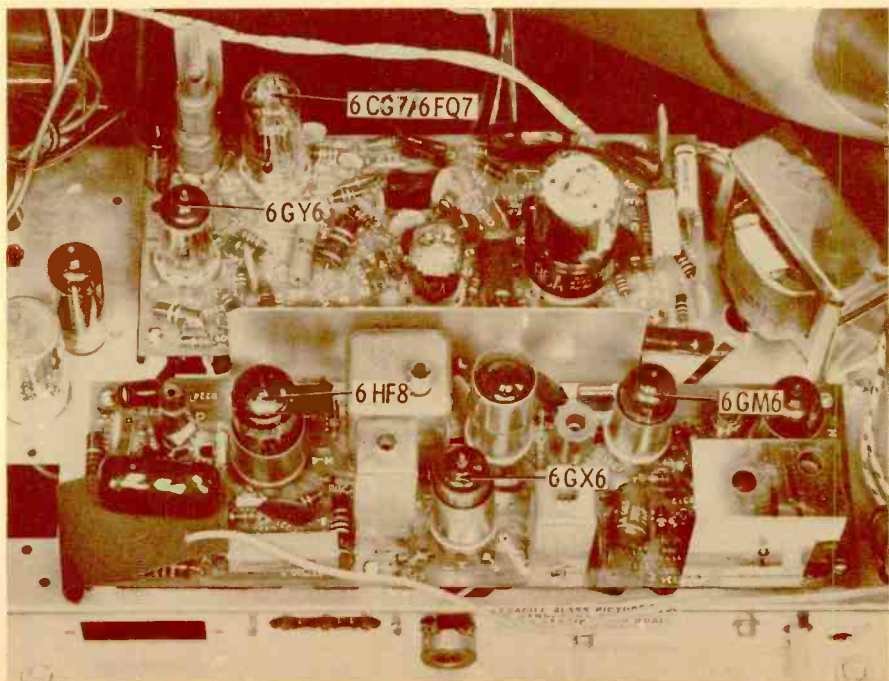
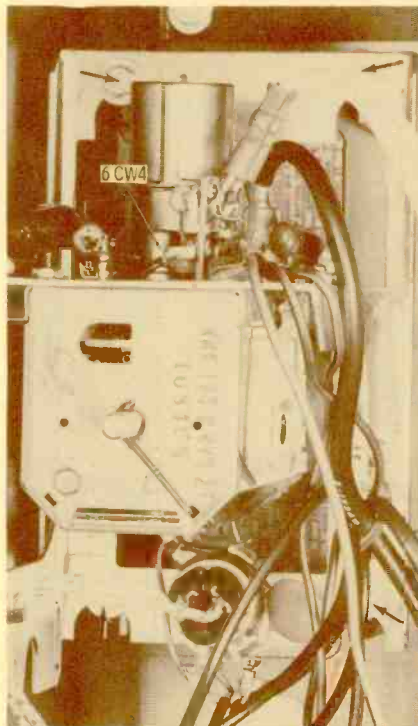
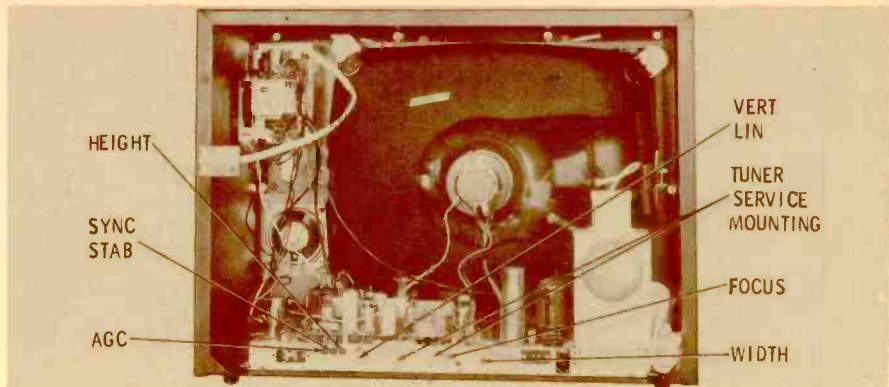

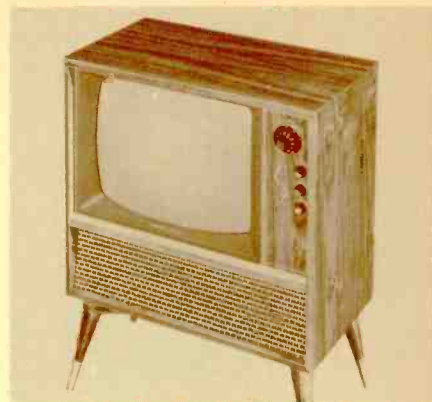
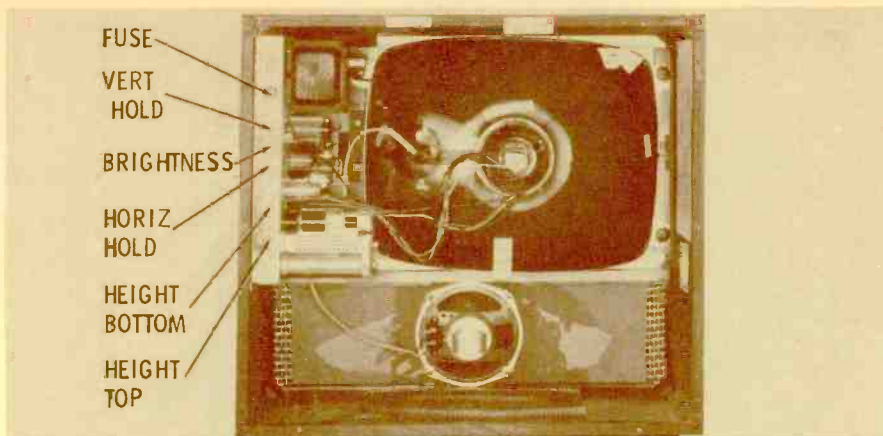

### Setchell-Carlson Model 19C61 Chassis 361

Prominent in the 1961 line of Setchell-Carlson receivers is a brand-new one-piece chassis known as the *Classic 361*. It's found in two 23" consoles, one 19" table model, and one 19" console. The 23" models use a 23CP4 with bonded safety shield, while the 19" versions have a 19XP4 and are equipped with an easily removable safety glass. All operational controls except the rear-mounted brightness and hold controls are on the front.

The 17-tube, hand-wired chassis is mounted on the left wall of the cabinet. Console models have a 6" PM speaker, and table models use a 4" PM type.

The transformer-powered chassis uses a pair of 500-ma silicon rectifiers in a half-wave doubler circuit. The surge resistor protecting the silicons is in series with the primary of the transformer. This same circuit is also protected by a conventional 3-amp fuse, while the filaments are protected by a length of #26 wire. As in previous chassis, a 3-ohm *Pix. Tube Saver* resistor is connected in series with the 6.3-volt CRT filament across an 8-volt AC supply; jumpering this resistor achieves the same result as adding a conventional picture-tube brightener.

The vertical output circuit is unusual in that the cathode voltage is used as B+ for the 6CS6 sync separator (which is mounted next to the cage, between the yoke plug and the 6EB8 video output-AGC keyer). The 6EM5 vertical output tube is driven by a cathode-coupled multivibrator using both sections of a 12AU7A—an unusual circuit in its own right, by present-day standards. Over near the tuner, a 6BN8 serves the dual function of ratio detector and AF amplifier.

Another 12AU7A is used in the horizontal multivibrator circuit. Notice that it is covered by a tube shield; this is particularly interesting since it is the only shielded tube outside of the tuner. Speaking of shields, the lid of the high-voltage cage is held securely in place by two knurled nuts, and is also held captive by a chain so it won't become lost. These features, plus the somewhat isolated location of the 6DQ6B horizontal output tube, emphasize that Setchell-Carlson has gone directly to the source of horizontal-sweep radiation in order to keep interference at a minimum. When you have occasion to check the horizontal section of this chassis *replace those shields!*

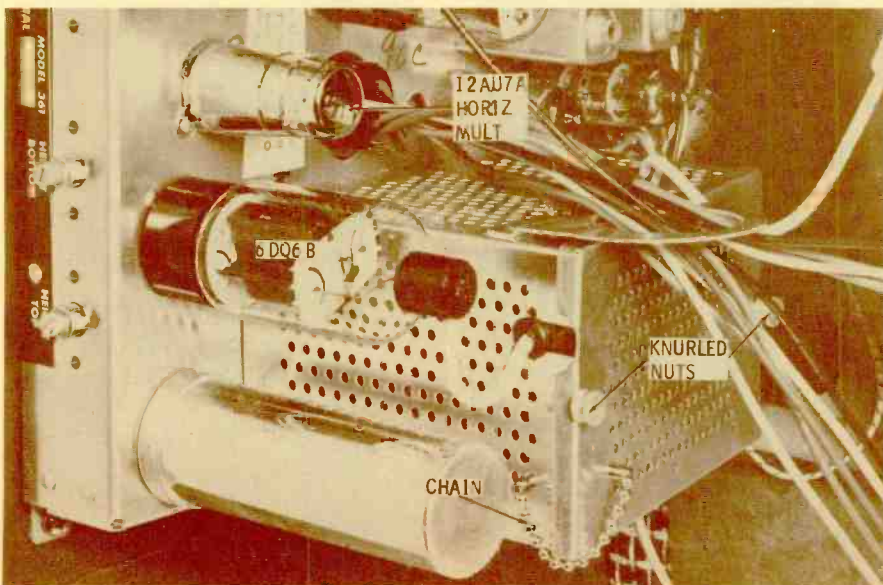
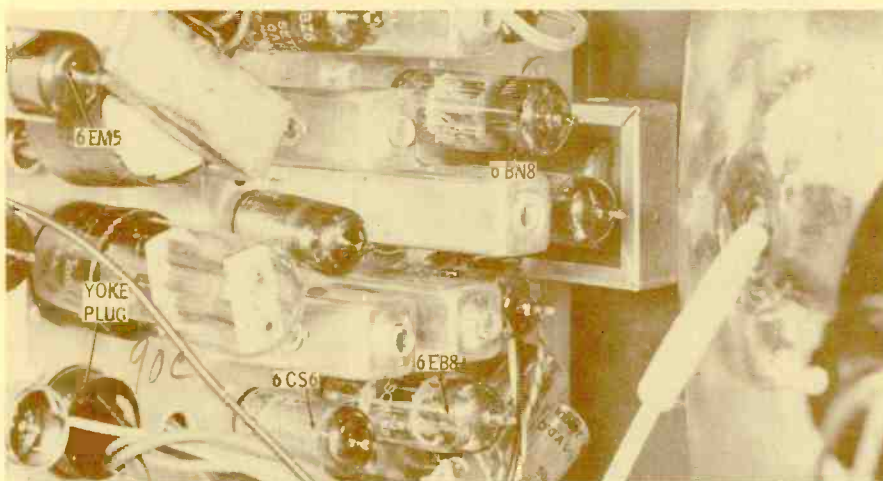

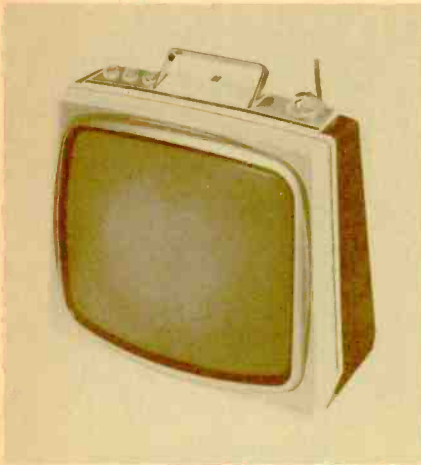

**Sylvania Model 19P11  
Chassis 546-1**

A large group of 19" portable and table models of the 1961 Sylvania line use the 546 chassis. A refined version of an earlier chassis, it has a 114° 19AFP4/-19AUP4 picture tube with a reflection-free bonded safety shield. All operational controls except those for horizontal and vertical hold are top-mounted on the portable models and front-mounted on the table models.

The 16-tube, transformerless chassis fits snugly around the CRT. All stages except the power supply and deflection circuits are contained on one large printed board. If it becomes necessary to remove the chassis, removal of three mounting bolts (indicated by the heavy arrows) permits it to be slipped from the cabinet. It isn't necessary to remove the top-mounted control knobs when disassembling these models; they come out with the chassis—escutcheon, handle, and all.

We have received many requests to explain how a Sylvania chassis number can be identified. Take a look at the serial number glued to the heat shield. The first three digits (546) designate the basic chassis number, and the fourth digit (1) indicates the run number. The remainder of the figures give manufacturing information and the serial number. Incidentally, the tube immediately below the label is a new type—a 10EG7 serving both functions in the combined vertical-multi-vibrator-output circuit.

Heat problems have been minimized by grouping the high-wattage deflection circuits away from other components and installing a heat shield. A panel along the left side of the chassis contains most of the setup controls and the power supply. A pair of silicon rectifiers are connected in a conventional half-wave doubler circuit to supply a 260-volt B+ potential. Rectifier protection is afforded by a circuit breaker and 4.7-ohm surge-limiting resistor. A length of fuse wire in series with the off-on switch provides protection for both the filament and B+ circuits.

As in previous models, the AGC control and horizontal frequency coil are mounted directly on the printed board. Also on the board is a new 8ET7 tube, a pentode-dual diode serving the video output and horizontal AFC stages. The remaining circuits are essentially unchanged from previous chassis.

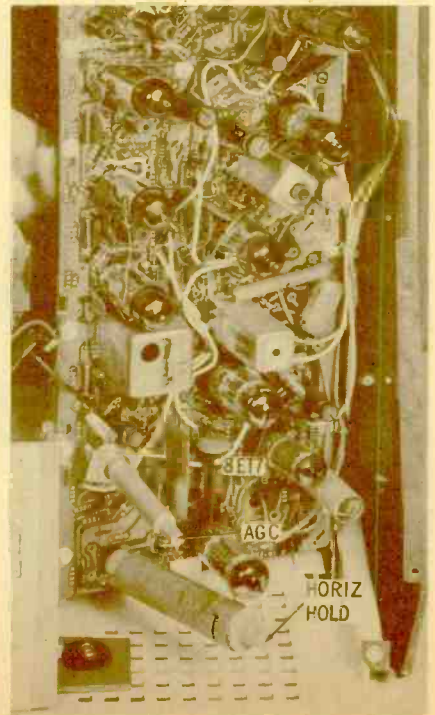
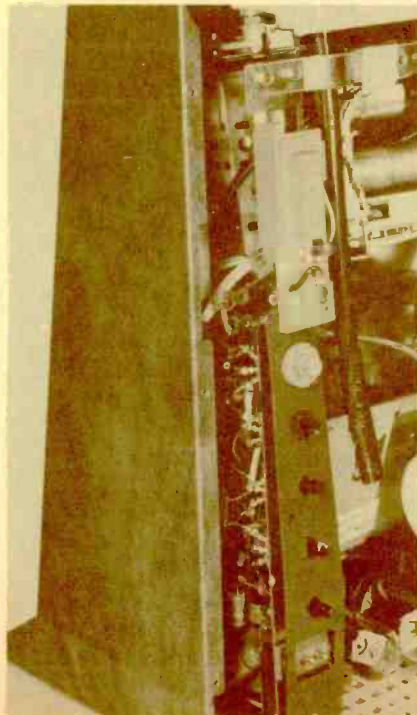
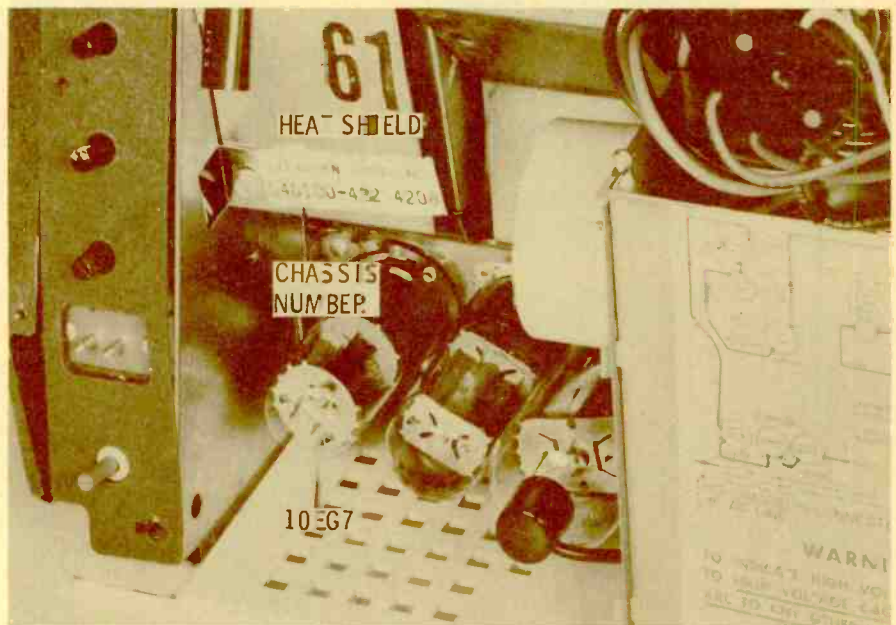
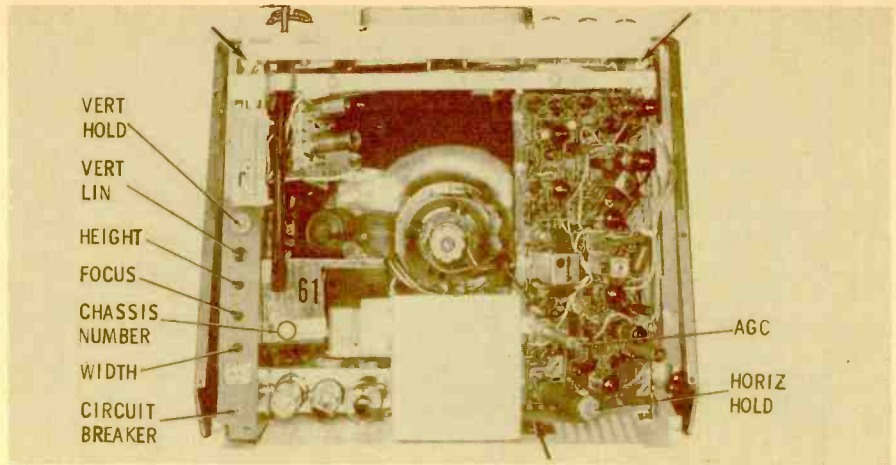

See PHOTOFACT Set 482, Folder 1

Mfr: Admiral Chassis No. 20H6

Card No: AD 20H6-1

Section Affected: Sync.

**Symptoms:** Unstable horizontal hold; plate voltage on first section of V12 higher than normal.

**Cause:** Plate-load resistor decreased in value.

**What To Do:** Replace R107 (10K).

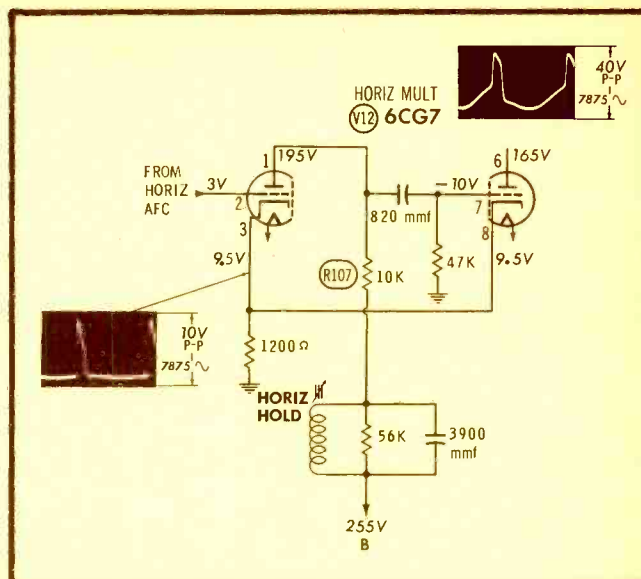

Mfr: Admiral Chassis No. 20H6

Card No: AD 20H6-2

Section Affected: Sync.

**Symptoms:** Unstable vertical hold; horizontal tearing of picture. Low voltage on plate of V10A.

**Cause:** Leaky capacitor in vertical integrator.

**What To Do:** Replace C68 (4700 mmf).

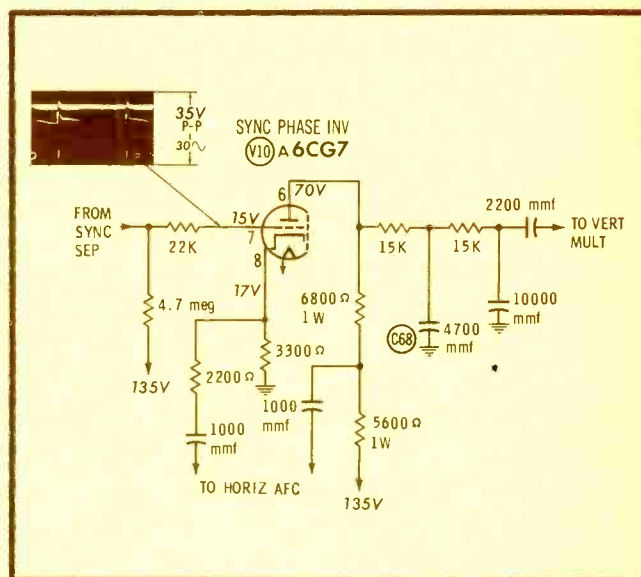

Mfr: Admiral Chassis No. 20H6

Card No: AD 20H6-3

Section Affected: Pix.

**Symptoms:** No picture.

**Cause:** Shorted screen-bypass capacitor C2B in video output circuit.

**What To Do:** Replace C2 (four-section electrolytic; 60-5-50-25 mfd, 350-350-50-50 V).

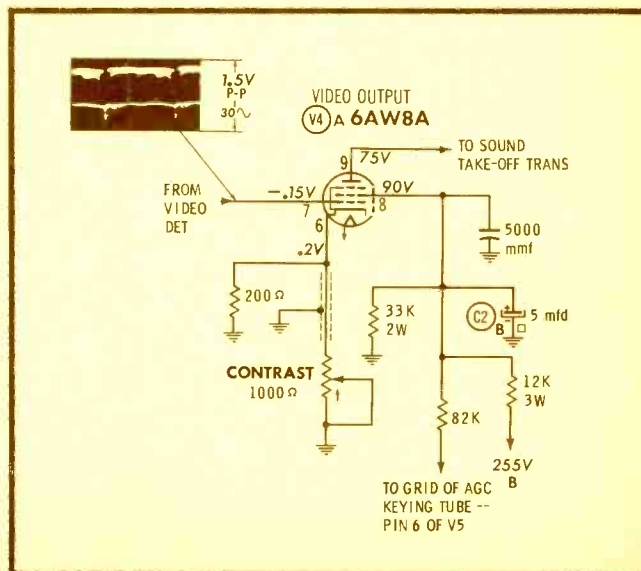

See PHOTOFACT Set 482, Folder 1

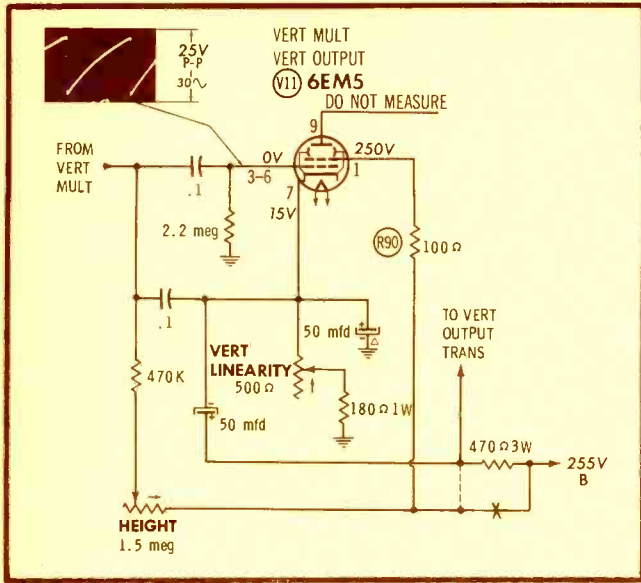

See PHOTOFACT Set 482, Folder 1

Mfr: Admiral Chassis No. 20H6

Card No: AD 20H6-4

Section Affected: Raster.

Symptoms: Intermittent collapse of vertical sweep. Screen voltage of V11 lower than normal.

Cause: Open screen-grid resistor in vertical output stage.

What To Do: Replace R90 (100 ohms).

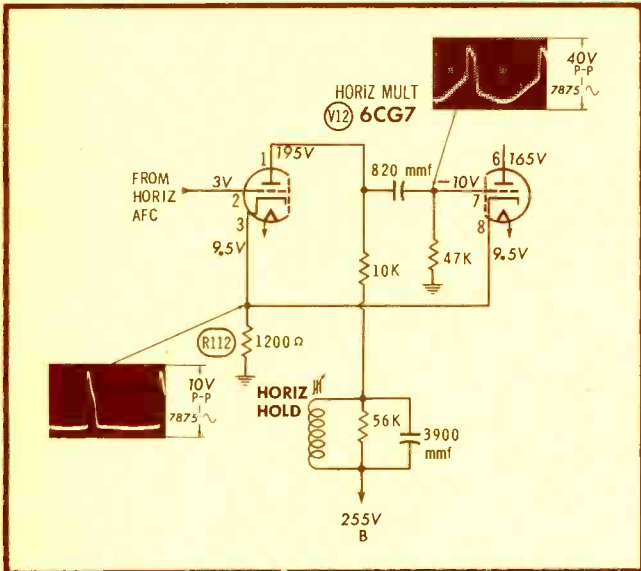

Mfr: Admiral

Chassis No. 20H6

Card No: AD 20H6-5

Section Affected: Sync.

Symptoms: Horizontal-multivibrator frequency drifts out of normal range. Cathode voltage of V12 increases to higher-than-normal level.

Cause: Cathode resistor of horizontal multivibrator increases in value as receiver operates.

What To Do: Replace R112 (1200 ohms).

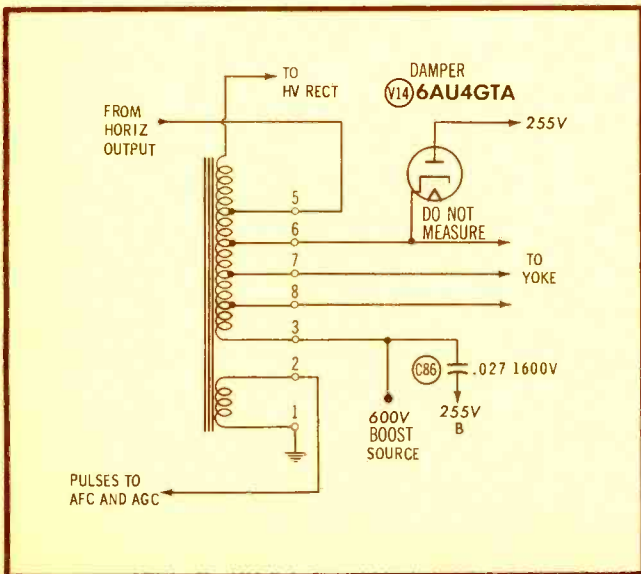

Mfr: Admiral

Chassis No. 20H6

Card No: AD 20H6-6

Section Affected: Raster.

Symptoms: No raster; no high voltage.

Cause: Shorted boost capacitor.

What To Do: Replace C86 (.027 mfd—1600V, 10%).



See PHOTOFACT Set 484, Folder 1

Mfr: Olympic Chassis No. JB

Card No: OL JB-1

Section Affected: Pix.

Symptoms: Weak, smeared picture. Plate voltage of V2B too high.

Cause: Plate-load resistor of video output tube burned and reduced in value.

What To Do: Replace R32 (5600 ohms—2W).

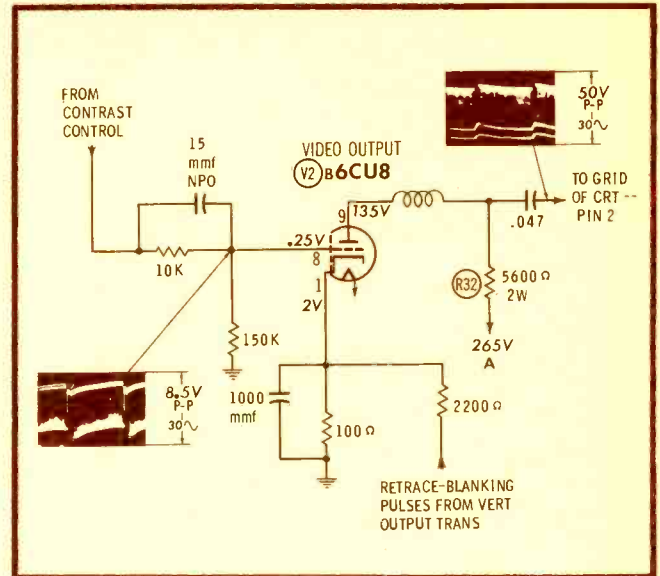

Mfr: Olympic Chassis No. JB

Card No: OL JB-2

Section Affected: Sound.

Symptoms: Intermittent loss of sound. No voltage on plate of V3A when sound is absent.

Cause: Intermittently open sound-IF plate-load resistor.

What To Do: Replace R39 (22K); check V3 (6AW8A) for shorts.

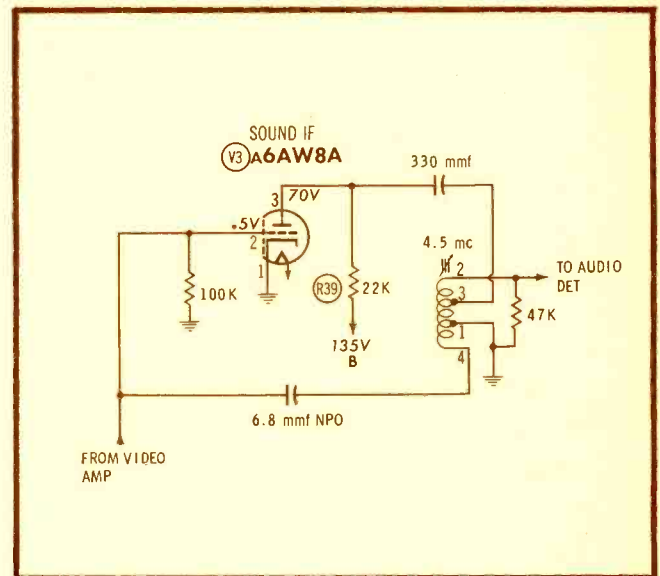

Mfr: Olympic Chassis No. JB

Card No: OL JB-3

Section Affected: Sync.

Symptoms: Poor horizontal and vertical hold; high negative voltage on grid of V6B at all times.

Cause: Open grid-leak resistor in sync-separator stage.

What To Do: Replace R53 (2.2 meg).

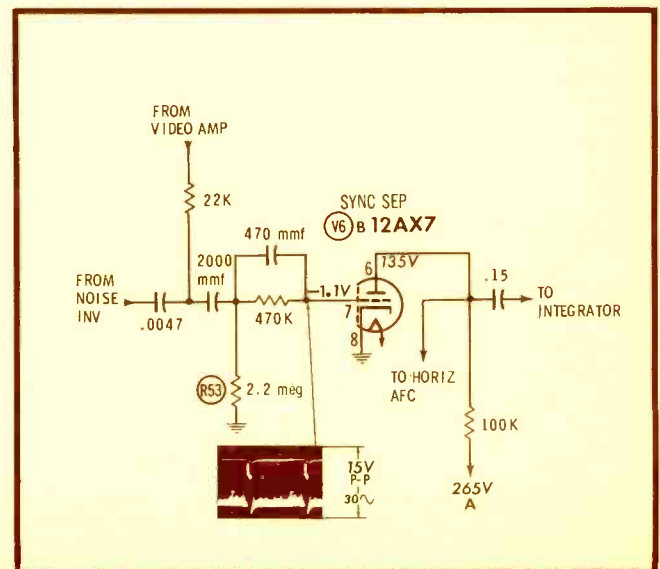



Tarzian offers

# FAST, DEPENDABLE TUNER REPAIR SERVICE

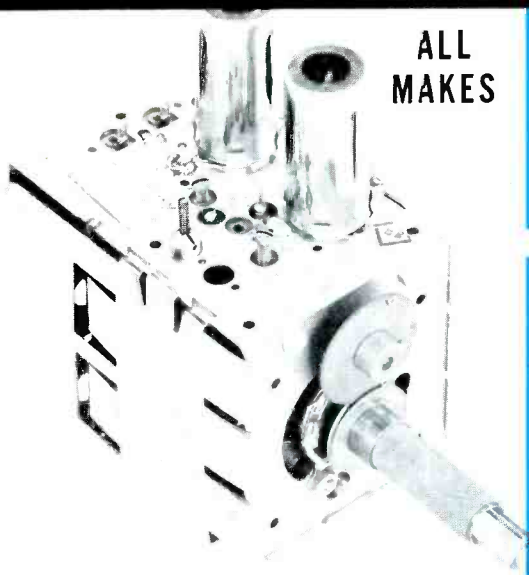

ALL  
MAKES

ONLY  
**\$850**  
INCLUDING

**ALL PARTS  
and LABOR**

**24-HOUR SERVICE  
6-MONTH WARRANTY**

**Tuners Repaired on  
Approved, Open Accounts**

**See your distributor, or  
use this address for fast,  
factory repair service**

It just makes sense that a manufacturer of tuners should be better-qualified, better-equipped to offer the most dependable tuner repair and overhaul service.

Sarkes Tarzian, Inc., pioneer in the tuner business, maintains a complete, well-equipped Factory Service Dept.—assisted by Engineering personnel—and staffed by specialized technicians who handle **ONLY** tuner repairs . . . on **ALL** makes and models.

Tarzian-made tuners received one day will be fixed and shipped out the next. Cost is only \$8.50 and \$15 for UV combinations. That includes **ALL** parts and labor, and a 6-month guarantee against defective workmanship and parts failure due to normal usage. Replacements available at low cost on tuners beyond practical repair.

Ⓢ Tarzian-made tuners are identified by this stamping. When inquiring about service on other tuners, always give tube complement . . . shaft length . . . filament . . . voltage . . . series or shunt heater . . . IF frequency . . . chassis identification. All tuners repaired on approved, open accounts. Check with your local distributor for Sarkes Tarzian replacement tuners, replacement parts, or repair service.

SERVICE MANAGER • TUNER DIVISION • DEPT. 3A



**SARKES TARZIAN INC**

*east hillside drive • bloomington, indiana  
edison 2-7251*

MANUFACTURERS OF TUNERS . . . SEMICONDUCTORS . . . AIR TRIMMERS . . . FM RADIOS . . . AM-FM RADIOS . . . AUDIO TAPE . . . BROADCAST EQUIPMENT and SHISH-KABOB GRILLES

**publisher**  
Howard W. Sams

**general manager**  
Mal Parks, Jr.

**editor**  
Verne M. Ray

**managing editor**  
Joe A. Groves

**associate editors**  
Leslie D. Deane  
Thomas A. Lesh

**consulting editors**  
William E. Burke  
Robert B. Dunham  
George B. Mann  
C. P. Oliphant  
Paul C. Smith

**art director**  
Don W. Bradley

**advertising & editorial assistants**  
Georgeanna Caldwell  
Paula Haffner  
Jean Sekulski

**production manager**  
Robert N. Rippy

**circulation fulfillment**  
Pat Tidd, Mgr.  
Constance McCawley, Ass't.  
Katherine Smith, Ass't.

**photography**  
Robert W. Reed

**advertising sales offices**  
midwestern

John Groce, advertising sales manager  
PF REPORTER  
2201 East 46th Street, Indianapolis 6, Ind.  
Clifford 3-6441

**eastern**  
Howard W. Sams & Co., Inc.  
3 West 57th Street,  
New York, N. Y.  
Murray Hill 8-6350

**western**  
The Maurice A. Kimball Co., Inc.  
2550 Beverly Blvd., Los Angeles 57, Calif.  
Dunkirk 8-6178; and 681 Market Street,  
San Francisco 5, Calif. Exbrook 2-3365

Address all correspondence to  
PF REPORTER, 2201 East 46th Street,  
Indianapolis 6, Indiana



Copyright © 1961 by Howard W. Sams & Co., Inc. PF REPORTER is a trademark of Howard W. Sams & Co., Inc. No part of PF REPORTER may be reproduced without written permission. No patent liability is assumed with respect to use of information herein. Acceptance of advertising does not in any manner signify the products, policies and services so advertised have been approved, endorsed or recommended by this magazine.

Indexed in *Electronic Guide* and *Lectrodex*.  
Printed by the Waldemar Press Div.  
of Howard W. Sams & Co., Inc.



# PF REPORTER

including **Electronic Servicing**

VOLUME 11, No. 6

JUNE, 1961

## CONTENTS

<b>Previews of New Sets</b>	1
Packard-Bell 23DD3 (Chassis 98D10), RCA 232B152MV (Chassis KCS136A), Setchell-Carlson 19C61 (Chassis 361), Sylvania 19P11 (Chassis 546-1).	
<b>Video Speed Servicing</b>	5
Service hints on Admiral Chassis 20H6 and Olympic Chassis JB.	
<b>Letters to the Editor</b>	14
<b>Final Scope Checks Reduce TV Callbacks</b>	18
Shop Talk—Waveforms help you catch troubles that don't show in the picture. <i>Allan F. Kinckiner</i>	
<b>Troubleshooting TV Wireless Remotes</b>	20
The basic technique is always the same, in spite of differences between systems. <i>Thomas A. Lesh</i>	
<b>Breaking the Commercial Sound Barrier</b>	22
Here's your chance to learn what it takes. <i>Joe A. Groves</i>	
<b>Air-Conditioner Repairs Made Easy</b>	24
A troubleshooting chart with added suggestions for checking operation of major parts.	
<b>Electronic Depth Finders</b>	26
Echo-sounding devices offer still another opportunity for service business. <i>Allan Lytel</i>	
<b>Eliminating TV Buzz</b>	30
Quicker Servicing—This symptom may be hard to pin down, but it definitely can be cured.	
<b>The Electronic Scanner</b>	34
<b>Business Forms Boost Efficiency</b>	36
Dollar and Sense Servicing—Every phase of your operation benefits from regular use of written records.	
<b>Output-Transistor Failures in Auto Radios</b>	40
If a transistor burns out, something must be wrong with the circuit or the mounting hardware.	
<b>Notes on Test Equipment</b>	48
Lab reports on the Jackson Model 607 Power Supply and Sprague Model TCA-1 Capacitor Analyzer. <i>Les Deane</i>	
<b>Service Dealer Advertising Program</b>	53
Number 6 in a series.	
<b>The Troubleshooter</b>	54
<b>Product Report</b>	70
<b>Free Catalog &amp; Literature Service</b>	72
<b>Monthly Index</b>	on free literature card

### ABOUT THE COVER

Installing and servicing commercial sound equipment can get you into some of the darndest situations. Our cover serviceman has a bird's-eye view of Al Vidble's elephants as he readies the PA system for some circus ballyhooing. If you are thinking of joining the ranks of sound men, be sure to read the feature beginning on page 22.

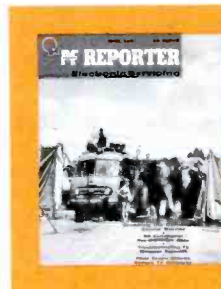

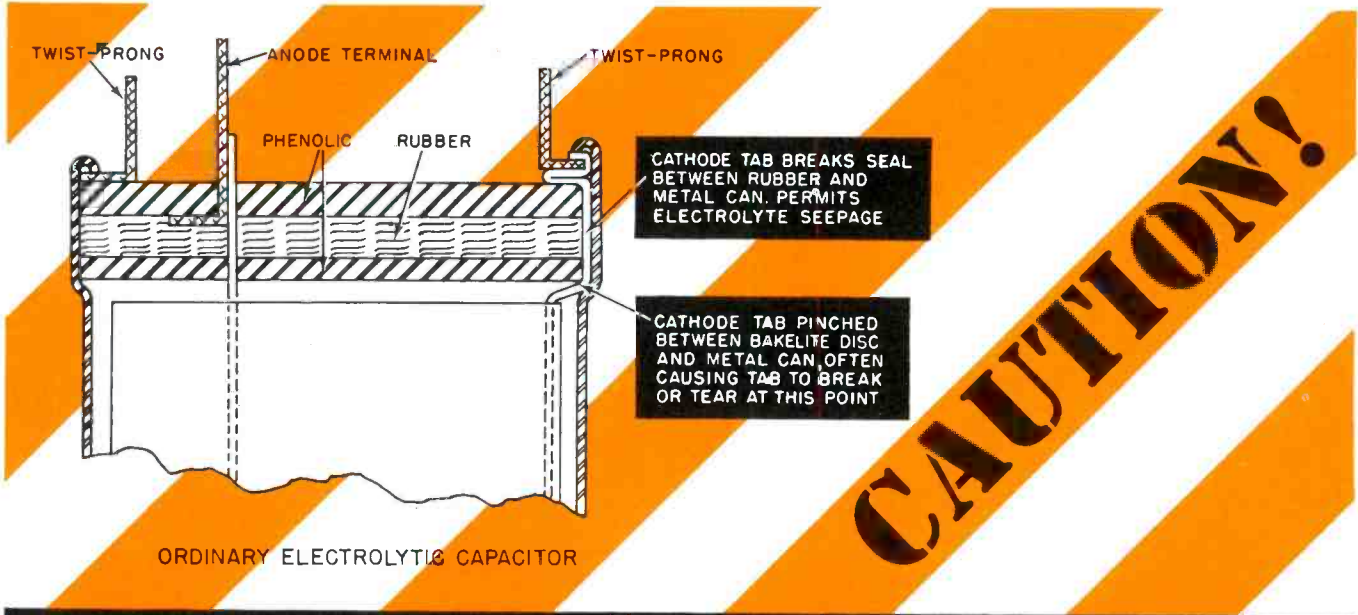

ORDINARY ELECTROLYTIC CAPACITOR

# DON'T RUIN CUSTOMERS' SETS WITH OBSOLETE 'LYTICS

ONLY SPRAGUE TWIST-LOKS® HAVE THE NEW IMPROVED COVER DESIGN

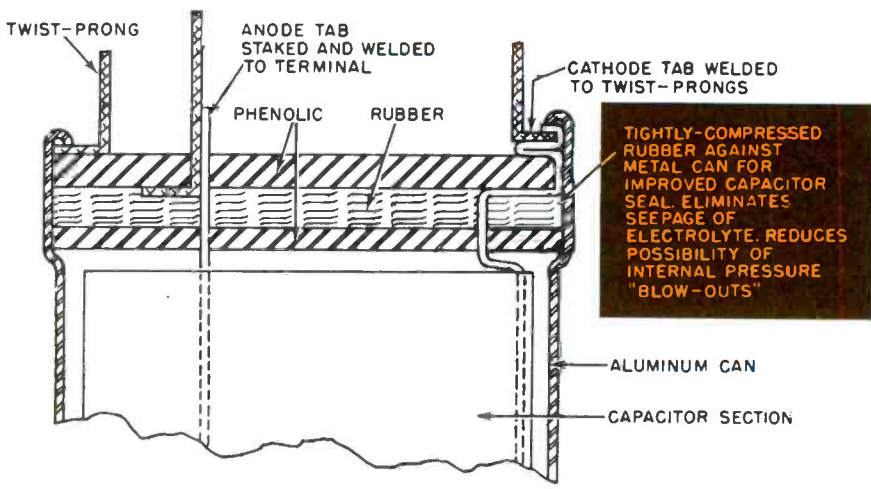

SPRAGUE TWIST-LOK® ELECTROLYTIC CAPACITOR

Type TVL Twist-Lok Capacitors are now more dependable than ever! Sprague has developed a new cover design which provides a truly leak-proof seal and permits capacitors to withstand higher ripple currents.

Don't risk your reputation with "second-best" electrolytics—insist on SPRAGUE TWIST-LOKS!

Complete listings are shown in Catalog C-614. Get your copy from any Sprague distributor, or write Sprague Products Company, 105 Marshall Street, North Adams, Massachusetts.

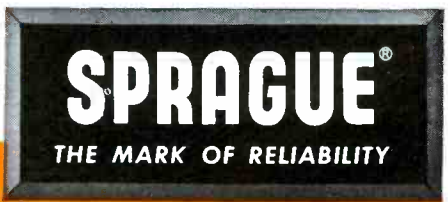

WORLD'S LARGEST CAPACITOR MANUFACTURER

Another outstanding product by the **HIDDEN 500\*** who plan for your future:

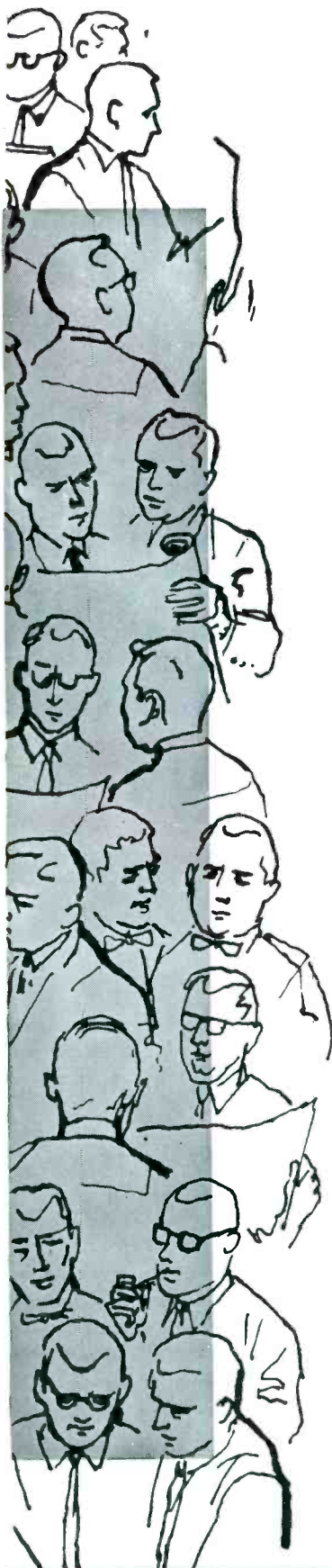

## TYPE TE LITTL-LYTIC® CAPACITORS



Transistors revolutionized the industry. And to make the most of their inherent advantages, they called for an entirely new group of components. Here, Sprague Research was the first to answer the call with the smallest truly reliable dry electrolytic made for transistor circuits—the Littl-Lytic. This reasonably priced capacitor is the most reliable subminiature you can buy for transistorized radios, hearing aids, wireless microphones, pocket wire recorders, and other miniature electronic equipment.

The remarkable reliability of Littl-Lytic is the result of a new manufacturing technique in which *all the terminal connections are welded*. Units are hermetically sealed and metal encased . . . *with no pressure joints* . . . there are no “open circuits” with the passage of time. Leakage current is extremely low as the result of the use of high purity foil and ultra-stable formation techniques. Sprague’s catalog replacement ratings are the most comprehensive in the industry. They assure you of exact replacements to meet your day-to-day service requirements.

Littl-Lytic is a typical example of how Sprague Research keeps its products up-to-the-minute. Reliable components mean reliable service work—your business keeps pace with the electronic industry when you use Sprague.

\*The “Hidden 500” are Sprague’s 500 experienced researchers who staff the largest research organization in the electronic component industry and who back up the efforts of some 7,000 Sprague employees working in 14 manufacturing operations—four at North Adams, Mass.; Bennington and Barre, Vt.; Concord and Nashua, N.H.; Lansing, N.C.; Grafton, Wis.; Visalia, Calif.; two at Ponce, Puerto Rico; and Milan, Italy.

**SPRAGUE®**  
THE MARK OF RELIABILITY

WORLD'S LARGEST CAPACITOR MANUFACTURER



# DOUBLE PLAY

FOR **JFD HI-FI** TV ANTENNA SERVICE-DEALERS!

Buy any 6 **HI-FI**

**HELIX, FIREBALL, BANSHEE ANTENNAS...**

for this **FREE** CUSTOM-CRAFTED FOLDING ALUMINUM CHAIR!



HI-FI HELIXES			
Silver Aluminum		Gold Anodized	
MX211	SX711	AX211	AX711
JX311	SX711S	AX311	AX911
RX511	PX911	AX511	AX1111
	VX1111		

HI-FI FIREBALLS			
Silver Aluminum		Gold Anodized	
FB490	FB510	AB490	AB510
FB500	FB520	AB500	AB520

HI-FI BANSHEES			
Silver Aluminum		Gold Anodized	
<b>HEAVY DUTY DIPOLES</b>			
B300	BS300	AN300	ANS300
B400	BS400	AN400	ANS400
<b>PREASSEMBLED DIPOLES</b>			
B350	BS350	AN350	ANS350
B450	BS450	AN450	ANS450

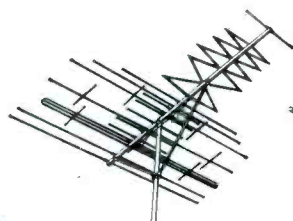

**HI-FI HELIX**

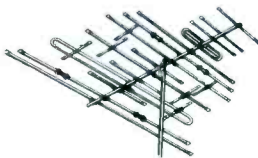

**HI-FI FIREBALL**

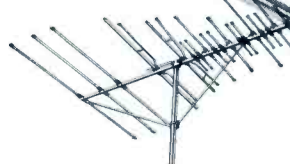

**HI-FI BANSHEE**

Buy any 12  
FOR THIS **FREE**

luxurious folding aluminum chaise  
or 2 **FREE** folding aluminum chairs!

You win *both* ways when you buy a JFD Hi-Fi Helix, Fireball or Banshee. You get the TV antenna replacement that insures satisfaction—plus *free* aluminum furniture for your happier relaxation.

See your JFD distributor today while this special offer lasts.\*

\*Expires July 15, 1961

**JFD ELECTRONICS CORPORATION**

6101 16th Avenue, Brooklyn, New York

JFD International, 15 Moore Street, New York, New York • JFD Canada, Ltd., 51 McCormack Street, Toronto, Ont., Canada

THE BRAND THAT PUTS YOU  
**JFD**  
IN COMMAND OF THE MARKET



# PRODUCTS FOR MODERN LIVING

**ATR PLUG-IN TYPE PORTABLE INVERTERS\***

A.C. HOUSEHOLD ELECTRICITY Anywhere... in your own car!

Operates Standard A.C.:

- Record Players
- Dictating Machines
- Small Radios
- Electric Shavers
- Heating Pads, etc.

In your own car or boat!

**MODELS**

6-RMF (6 volts) 60 to 80 watts. Shipping weight 12 lbs. DEALER NET PRICE **\$33.00**

12T-RME (12 volts) 90 to 125 watts. Shipping weight 12 lbs. DEALER NET PRICE **\$33.00**

\*Additional Models Available



**ATR "A" Battery ELIMINATOR**

For Demonstrating and Testing All Radios TRANSISTOR or VIBRATOR OPERATED!

Designed for testing D.C. Electrical Apparatus on Regular A.C. Lines—Equipped with Full-Wave Dry Disc-Type Rectifier, assuring noiseless, interference-free operation and extreme long life and reliability.

**MAY ALSO BE USED AS A BATTERY CHARGER**

**MODEL 610C-ELIF** 6 volts at 10 amps, or 12 volts at 6 amps. Shipping weight 22 lbs. DEALER NET PRICE **\$49.95**

**MODEL 620C-ELIT** 6 volts at 20 amps, or 12 volts at 10 amps. Shipping weight 33 lbs. DEALER NET PRICE **\$66.95**

**AUTO-RADIO VIBRATORS**

By every test ATR Auto-Radio Vibrators are best!... and feature Ceramic Stack Spacers, Instant Starting, Large Oversized Tungsten Contacts, Perforated Reed, plus Highest Precision Construction and Workmanship and Quiet Operation!

There is an ATR VIBRATOR for every make of car!

Ask your distributor for ATR's Low Priced type 1400, 6 volt 4-prong Vibrator; and 1843, 12 volt 3-prong; or 1840, 12 volt 4-prong Vibrator. **THE WORLD'S FINEST!**

There is a trim plate kit for YOUR CAR!



**ATR CUSTOMIZED KARADIO**

Vibrator-Operated with Tone Control

ATR KARADIO is ideal for small import cars or compact American cars! Unit is completely self-contained—extremely compact! Powerful 8-tube performance provides remarkable freedom from engine, static, and road noises. The ATR Customized Karadio comes complete with speaker and ready to install. Can be mounted in-dash or under-dash—wherever space permits! No polarity problem. Neutral Gray-Tan, baked enamel finish. Overall size, 7" deep, 4" high, and 6 1/2" wide. Shipping weight, radio set, 7 lbs. Model K-1279—12 for 12V Dealer Net Price **\$33.57** Model K-1279—6 for 6V Dealer Net Price **\$33.57**

Airplane Style Overhead Mounting under Cab Roof

**ATR TRUCK KARADIO**

Excellent Tone, Volume, and Sensitivity!

Compact, yet powerful. Fits all trucks, station wagons, most cars and boats. Just drill a 3/8 inch hole in roof and suspend the one-piece unit (aerial, chassis and speaker) in minutes. Watertight mounting assembly holds antenna upright. Yoke-type bracket lets you tilt radio to any angle.

Extra-sensitive radio has 6 tubes (2 double-purpose), over-size Alnico 5 PM speaker for full, rich tone. Big, easy-to-read illuminated dial. Fingertip tuning control. Volume and tone controls. 33-in. stainless steel antenna. Neutral gray-tan enameled metal cabinet, 7 x 6 1/2 x 4 in. high over-all. Shipping weight 10 1/2 lbs. Model TR-1279—12A for 12V Dealer Net Price **\$41.96** Model TR-1279—6A for 6V Dealer Net Price **\$41.96**

SEE YOUR ELECTRONIC PARTS DISTRIBUTOR WRITE FACTORY FOR FREE LITERATURE...



**ATR AMERICAN TELEVISION & RADIO CO.**

Quality Products Since 1931

SANIT PAUL 1, MINNESOTA—U. S. A.

## LETTERS TO THE EDITOR

Dear Editor:

I have enjoyed reading your fine magazine for many years. Keep up the good work.

Can we have more troubleshooting articles and schematics on color TV, including the new Zenith that will be out soon?

MIKE L. REVELS

Spartanburg, S. C.

*You're on the ball, Mike. With several manufacturers entering the color TV field this year, wise service dealers are making early plans to hone up on color theory, circuitry, and servicing techniques. As for us, we have already made definite plans to bring you up-to-date coverages on the Zenith, General Electric, RCA, and other new color receivers due this coming season.—Ed.*

Dear Editor:

The special Test Equipment Issue in April is worth the whole yearly subscription price of the magazine, several times over.

FRED BLOOMER

Grants, N. Mex.

*Thanks, Fred—any other subjects you'd like to see given the same treatment?—Ed.*

Dear Editor:

What happened to the colored sheets with *Previews of New Sets and Video Speed Servicing* for your April issue? Don't discontinue this service.

The feature you substituted in their place is a fine article, and worthy of a place in your publication; many servicemen will undoubtedly clip it out, just as I have been doing with the color stock section.

R. P. DARYMAN

York, Pa.

*Don't flip, R. P., we only changed the format for the special Test Equipment edition.—Ed.*

Dear Editor:

I am a new and ardent fan of your magazine. I was vaguely aware of PF REPORTER'S existence, but never realized what a really wonderful magazine it is. I would heartily recommend you conduct more intense circulation campaigns, as I really feel sorry for those interested in electronics who do not know what they are missing.

ROBERT D. ANDERSON

Kalamazoo, Mich.

*With such a magnetic personality, you must have lots of friends in the business. But, why didn't they feel sorry for you—or do you suppose they thought you didn't need PF REPORTER? Seriously, we hope*

*all our readers feel the same, and will recommend our magazine to their friends in the industry.—Ed.*

Dear Editor:

We have been using your service dealer advertising series, and have received very favorable comments. Keep those advertising aids coming—please! We like them.

E. C. BASTIAN

Jerry's Radio & TV Service  
Hudson, Mich.

*Thanks, E. C. You'll find this month's series on page 53. Incidentally, the entire series of 60 mats and reproduction proofs is available at the special price of only \$25.00. Credit will be allowed for any ads you've already ordered.—Ed.*

Dear Editor:

Would you please sign me up for a subscription to PF REPORTER? The roughest ones in the county come to my shop, and they're driving me nuts

ROBERT H. BACHMAN

Washtucna, Wash.

*Relief is just an issue away!—Ed.*

Dear Editor:

Will you please tell me how to read the code numbers on my PF REPORTER address plate? I would like to know when the subscription is about to expire, so I can take advantage of any special offers that come along.

While I am writing, I'd like to say I think PF REPORTER is the best in the industry. I really put it to good use in my shop. It seems that hardly a day goes by without my referring to some back issue for a specific article to help me in my work.

VICTOR BEEBE, JR.

Vic's Radio & TV Service  
Loveland, Colo.

*Good thing you checked, Vic. A typical code line would read 1A-7M64-961. The last group of numbers (961) indicates the month and year your subscription expires—in this case, this coming September. Incidentally, you don't have to wait until the last minute to renew. A subscription can be extended anytime. (You'll find a handy order form on page 67 of this issue.)*

Dear Editor:

I just got around to reading Harold Davis's story, "Excessive AGC Leads to Wild Goose Chase," in the January issue, and was surprised to read, "You can get a good indication by sticking the end of the probe in one side of the AC outlet. That will give you around 325 volts peak to peak." I can't figure that!

BILL WHITE

Bill White's Service  
Princeton, Fla.

*This statement assumed that the ground terminal of the scope would be returned to the other side of the line; it might have been clearer if it had read, "by connecting the scope across the AC-line terminals." The resulting wave will have the stated peak-to-peak value. The peak voltage of either the positive or negative half cycle is 1.414 times the rms voltage, but the resulting figure must be doubled to obtain the true peak-to-peak voltage.—Ed.*



First real VOM advance in 20 years

SET IT!

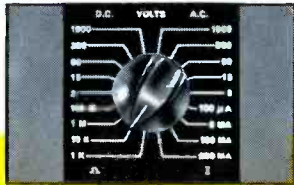

SEE IT!



READ IT!

DIRECTLY—ACCURATELY  
WITHOUT MULTIPLYING



ALL-NEW

**B&K**

# V O Matic 360

AUTOMATIC VOLT-OHM-MILLIAMMETER

- Individual Full-Size Scale for Each Range
- Range Switch Automatically Sets Correct Scale
- Only One Scale Visible at Any Time
- No Multiplying . . . No False Readings
- Meter Protected Against Extreme Overload
- Mirrored-Scale for Precise Readings



WITH  
BURN-OUT PROOF  
METER

## EASIEST—FASTEST—ERROR-FREE READINGS

Once you set the range switch properly, *it is impossible to read the wrong scale.* Readings are easiest, fastest of all—so easy the meter “practically reads itself.” Eliminates reading difficulties, errors, and calculations.

All scales, including the ohms scale, are *direct reading.* You do not have to multiply. Saves time and trouble. Gives you the right answer immediately. Ohms-adjust control includes switch that automatically shorts out test leads for “zero” set.

Every scale in the V O Matic 360 is the same full size . . . and only one scale is visible at any one time, automatically. Supplemental ranges are also provided on separate external overlay meter scales.

This new-type automatic VOM is another innovation by B&K that gives you features you’ve always wanted. Outdates all others.

Includes convenient stand to hold “360” for correct viewing in 4 positions.

Net, **\$59<sup>95</sup>**

Ask Your B&K Distributor for Demonstration  
or Write for Catalog AP17-R

- Ranges:** DC Volts — 0 - 3, 15, 60, 300, 1000, 6000 (20,000  $\Omega/v$ )  
 AC Volts — 0 - 3, 15, 60, 300, 1000, 6000 ( 5,000  $\Omega/v$ )  
 AF (Output) — 0 - 3, 15, 60, 300 volts  
 DC Current — 0 - 100  $\mu a$ , 5 ma, 100 ma, 500 ma, 10 amps  
 Resistance — 0 - 1000 ohms (3  $\Omega$  center)  
                   0 - 10,000 ohms (50  $\Omega$  center)  
                   0 - 1 megohm (4 k  $\Omega$  center)  
                   0 - 100 megohms (150 k  $\Omega$  center)

- Supplemental Ranges:** 18 separate external overlay meter scales for:  
 DC Volts—0 - 250 mv      Capacitance—100 mmfd to 4 mfd  
 Audio Power Output—up to 56 watts      DB (decibels)  
 Peak-to-Peak AC (sine) Volts—0 - 170, 850

**Polarity Reversing Switch and Automatic Ohms-Adjust Control**

**Frequency Response AC:** 5 - 500,000 cps

**Burn-Out Proof Meter:** Protected against overload and burn-out

**Complete with 1½-volt and 9-volt batteries and test leads**

**B&K**

**B & K MANUFACTURING CO.**  
 1801 W. BELLE PLAINE AVE • CHICAGO 13, ILL.  
 Canada: Atlas Radio Corp., 50 Wingold, Toronto 19, Ont.  
 Export: Empire Exporters, 277 Broadway, New York 7, U.S.A.

# NOW...A Complete Line of

Built-in Amplifier clears up snow, improves

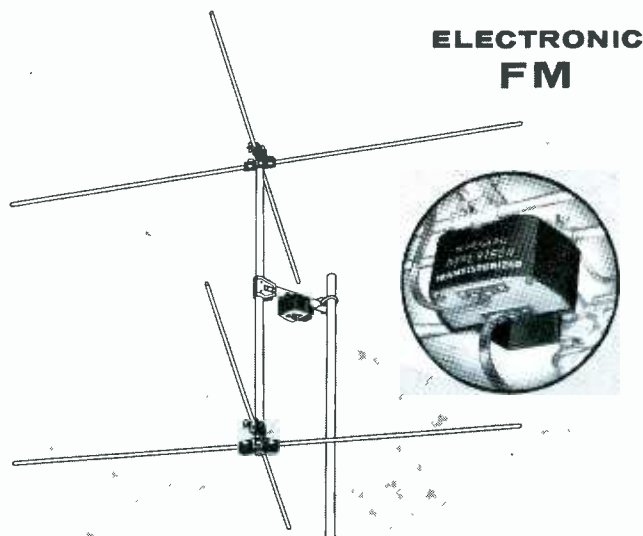

**MODEL PF-T FM POWERTRON TURNSTILE** Non-directional FM antenna with 16 DB gain in all directions over a folded dipole. Has unique offset mount and comes complete with built-in transistorized amplifier and TV-FM coupler.

## NEW, POWERFUL TRANSISTORIZED FM POWERTRONS WITH FM-TV COUPLERS

For the first time, FM antennas with built-in transistorized amplifiers are available for long range FM reception. Winegard offers two models—FM Powertron Turnstile (omni-directional) and the FM Powertron Yagi (directional). Both models have two 300 ohm terminals on the amplifier: one for down-lead connection to the set and one for connection to a TV Powertron antenna.

**MODEL PF-8 FM POWERTRON YAGI** This is the world's most powerful FM antenna. Makes weak signals come in like "locals". Has 25 DB gain over folded dipole. Eight elements with exclusive Winegard "tapered T" driven element. Built-in TV-FM coupler allows you to couple into TV Powertron with only one power supply. Complete with built-in transistorized amplifier.

In addition to three all-channel (VHF) Powertron antennas, Winegard now offers you 14 cut-channel and broad band Powertron yagis and two FM Powertrons. Each of these high gain antennas has the following important features:

1. Electronic amplifier for unprecedented antenna gain.
2. Amplifier connected *directly* to the yagi "Tapered-T" driven elements for best possible signal-to-noise ratio.
3. Linear frequency response for crisp, clear black and white and brilliant, true color reception.

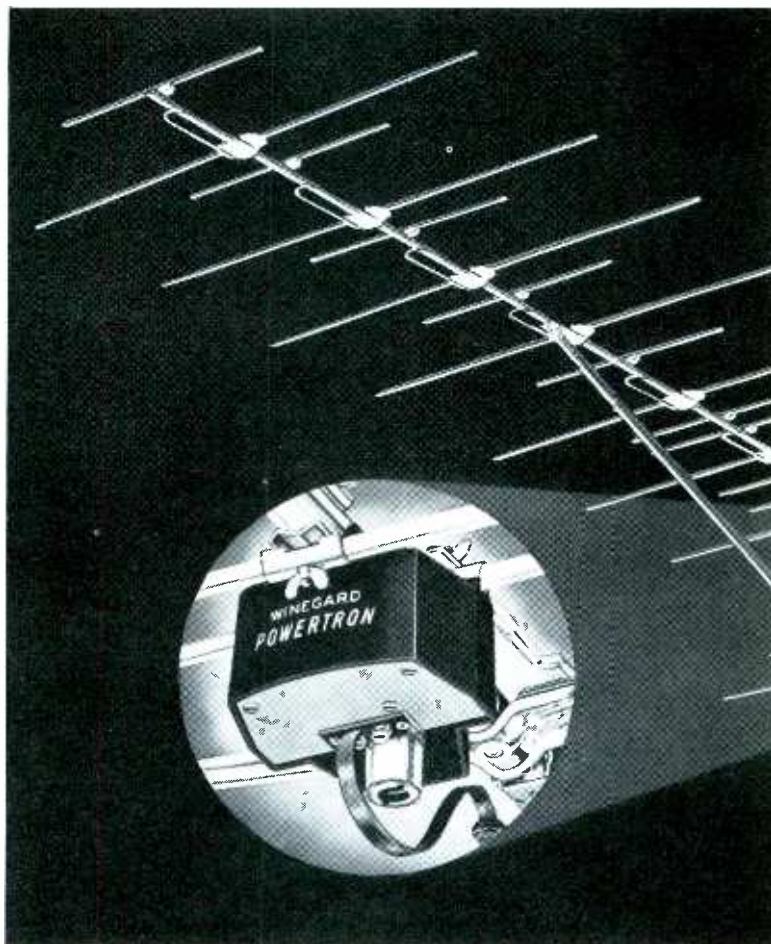

## ELECTRONIC ALL-CHANNEL YAGIS

... will greatly improve every channel. Weak, faded pictures become crisp and clear. "Good" channels will be even better. In many areas you'll watch channels you couldn't possibly see before. Because Powertrons are powerful enough to drive up to 10 TV sets, you can have plug-in outlets in every room ... and in many locations you can install a Powertron lower than other antennas.

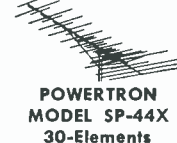
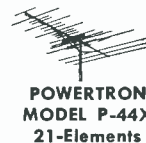
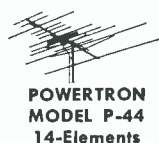
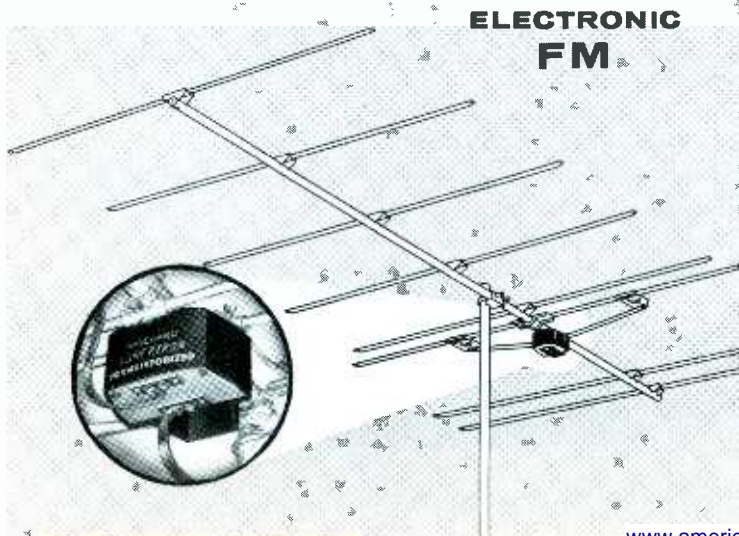

# Winegard Electronic Antennas

contrast... gives you greater reception distance!

4. Gold Anodized finish for permanent corrosion protection and fine appearance.
5. Deluxe quality materials and workmanship.

Try a Powertron and see for yourself. Take a field strength meter reading with your present antenna and then take a Powertron reading. When you see the meter jump 5 to 10 times . . . and see the sharp, contrasty reception you get, you'll be convinced . . . and so will your customers.

**"Amplifies the Signal  
at the point  
of Interception"**

**MODEL SP-44X**

**"By FAR world's most powerful all-channel antenna"**

## ELECTRONIC Cut-Channel TV

Each channel  
amplified  
individually.  
No antenna couplers  
needed!

## NEW, TRANSISTORIZED CUT-CHANNEL YAGI POWERTRONS FOR THE FINEST INSTALLATIONS

Here are the highest gain (28 db) TV antennas ever made! Each is powered by a built-in transistorized amplifier. Because TV signals are amplified right at the point of interception, you get the best possible signal-to-noise ratio . . . resulting in the ultimate in reception!

Each Powertron yagi amplifier has two 75 ohm coaxial connectors: one for the down-lead to the power supply and one from the built-in coupler for connection to another Powertron yagi.

Because of the built-in mixing coupler, they can be connected directly to each other without interaction. The negligible power consumption of these transistorized antennas (.05 watt each) means you can tie as many as 8 Powertron yagis together and run them all from one power supply on one down-lead.

There are six (8-element) cut-channel and broad low band models — eight (12-element) cut-channel and broad high band models. Ideal for hotels, motels, apartment buildings or wherever the finest installation is needed.

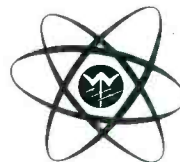

**Winegard**

**ANTENNA SYSTEMS**

Winegard Co., 3009-6 Kirkwood St., Burlington, Iowa

Write today for technical bulletin on Winegard's complete line of Powertron antennas. Ask your distributor for details.

**THE  
"SIX-SET"**

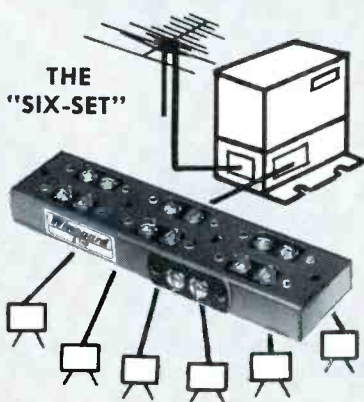

### WINEGARD "SIX-SET" TV COUPLER

With the Powertron, hook up 3, 4, 5, or 6 sets by adding a Winegard "Six-Set". Here's the only 6 tap coupler on the market. Six no-strip terminals give you instantaneous taps with complete electronic isolation. Model LS-63.

©1961

Waveforms tell you when all troubles are completely cured . . . by Allan F. Kinckiner



# FINAL SCOPE CHECKS REDUCE TV CALLBACKS

Every time I hear or read about a scope being "mounted in a permanent alignment setup," or "fired up to troubleshoot a tough-dog trouble," I wonder why so many scope owners limit themselves to such infrequent use of this instrument. A scope can be used to good advantage on every set that comes into a TV shop. Even when it isn't needed to locate the immediate cause of trouble, it is ideal for making a final check of receiver performance before the set is returned to the owner. Besides giving assurance that the original trouble has been definitely corrected, a review of key waveforms can indicate room for further improvement in the equipment being serviced—and can also predict future troubles.

These capabilities of the scope are extremely valuable to the serviceman. Properly-interpreted waveforms can reveal many slight faults which would not be noticed on a casual inspection of the TV picture. Following up on these minor troubles prevents them from developing into time-wasting callbacks, and also results in a more thorough service job which leads to greater customer satisfaction.

Just for your own peace of mind, it's good to know that you've done all you can to complete the repair—especially if the set is one of those old dogs I call "Gullivers" because they have traveled to so many service shops.

For making a final "quality test"



Fig. 1. Video waveform is distortion-free, but low amplitude is a bad sign.

of a TV receiver after a bench job, probably the most useful waveform is the one at the plate of the video output tube. Low amplitude at this point indicates room for improvement in video gain, and mild distortion forecasts trouble to come—even if the picture looks fairly clear. Conversely, a normal trace is insurance against many annoying types of callbacks. Additional waveform checks in the sync, sweep, and power-supply circuits are also well worth the short time they take, since these tests can reveal borderline troubles long before they develop into identifiable service complaints.

The long-term benefits of habitually scope-tracing every set brought to the bench are even more valuable than the immediate results, since this practice is more educational to the serviceman than a whole library of textbooks. From looking at a large number of signals in many different receivers, he becomes familiar with the peculiarities of specific models; also, he learns to relate various distortions of the signal to certain faulty circuits or even to certain components.

The benefits of final scope checks can best be illustrated by several actual case histories.

### Why Tolerate Weak Video?

A Westinghouse Model 626K16 was just about ready to leave the shop. High-voltage arcing had been corrected by replacing the 1B3 filament wire, and the receiver seemed to be operating normally. Nonetheless, I subjected it to a video-signal test. The composite signal at the plate of the video amplifier (Fig. 1) showed no serious distortion, and the ratio of sync to picture signal was satisfactory, but the peak-

to-peak amplitude was only 50 volts with the contrast control turned to maximum. Of course, this was enough to produce an acceptable picture; however, I knew through experience that the model in question should be capable of supplying over 80 volts of video.

Transferring the scope probe to the grid of the video amplifier, I found only about 2 volts of signal. This indicated a healthy gain of 25 in the video stage, so the loss of efficiency was apparently occurring ahead of this point. Replacing the tubes in all stages from the RF amplifier to the final IF did not increase the gain. I began probing the IF strip with a VTVM, and soon found that the B+ supply voltage to this section was only 100 volts — around 30 volts too low. Checking back to the low B+ source at the cathode of the audio output stage (Fig. 2), I discovered that R56 had been replaced with a 10K-ohm resistor. Removal of the unit and installation of the correct value (5000 ohms) resulted in a partial improvement, with 120 volts on the low B+ line and an increase

• Please turn to page 67

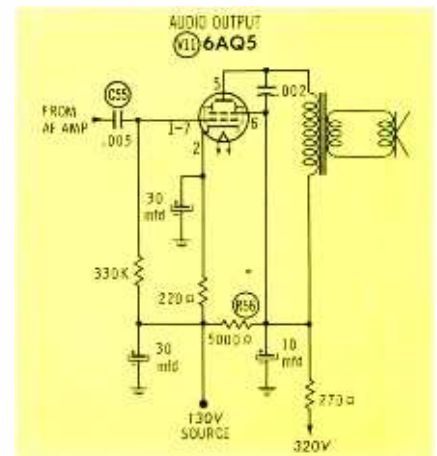

Fig. 2. Trouble in this audio output stage indirectly caused a weak picture.

# NEW

TESTS All TV and Radio Tubes  
—both old and new

TESTS the Nuvistors

TESTS the new 10-pin tubes

TESTS the new 12-pin Compactrons

TESTS voltage regulators, thyratrons,  
auto radio hybrid tubes,  
European hi-fi tubes, and  
most industrial types.



Model **600**  
**DYNA-QUIK**

only \$69<sup>95</sup>  
NET

8½" x 11" x 4½"  
Handsome, sturdy  
leatherette-covered  
carrying case

NEW TUBE  
INFORMATION  
SERVICE

available every 3  
months for all B&K  
Dyna-Quik Tube Testers



for the first time, a  
**B & K QUALITY**  
**TUBE TESTER**  
at this  
*amazing low cost!*

Checks for all shorts, grid  
emission, leakage, and gas

Checks each section of multi-  
section tubes separately

Checks tube capability under  
simulated load conditions

Rejects bad tubes  
—not good tubes

For the man who wants the performance and reliability of a B&K professional-quality tester at minimum cost . . . there's nothing like the new "600". No other tube tester in this price range is so complete and up-to-date. Tests the newest tube types, as well as the old. It's fast . . . it's accurate . . . it's easy to use. Quickly reveals tube condition. Saves customers. Sells more tube replacements. Stops call-backs. Steps up servicing profit . . . day after day. Pays for itself over and over again.

*Exclusive adjustable grid emission test. Sensitivity to over 100 megohms. Phosphor bronze socket contacts. Complete tube listing in handy reference index. Extremely compact.*

**B & K MANUFACTURING CO.**  
1801 W. BELLE PLAINE AVE • CHICAGO 13, ILL.  
Canada: Atlas Radio Corp., 50 Wingold, Toronto 19, Ont.  
Export: Empire Exporters, 277 Broadway, New York 7, U.S.A.



# TROUBLE SHOOTING

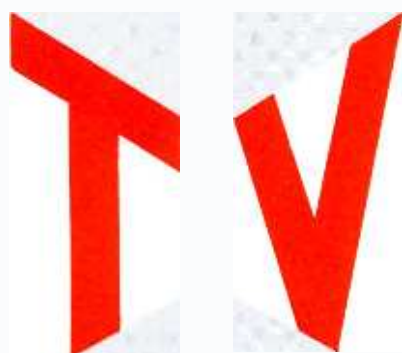

## WIRELESS REMOTES

Basic procedures that can be applied to all systems . . .

by Thomas A. Lesh

Most of the major TV manufacturers now offer wireless remote control as an optional accessory. Although the various systems now in use are distinctly different in circuit details and physical layout, they all follow practically the same basic sequence of actions. This makes it possible to develop a general troubleshooting method which you can apply to any system.

Remote-control circuitry can be conveniently divided into three major sections for trouble analysis, as shown in Fig. 1. The first "block" is a small, hand-held transmitter which the viewer uses to generate control signals; the second is a remote-control receiver inside the TV set, which amplifies and detects these signals for the purpose of actuating relays; the third is a group of relay-operated devices (motorized channel selector, remote volume control, etc.) which perform the desired functions.

The link between transmitter and receiver may be either an RF signal (electromagnetic radiation) or supersonic sound waves. Systems in current use are predominantly of the sonic type, with an operating frequency in the region of 40 kc. The transmitted signal is picked up by an antenna inside the TV cabinet (in RF systems) or by a small, microphone-like transducer on the front of the TV set (in supersonic systems). After amplification by a series of RF stages, the signal is applied to a bank of detector circuits which are tuned to accept the various control frequencies. Some systems use discriminators, while others have diode rectifiers (see Fig. 2); in either case, a positive DC voltage normally appears in one of the detector-output circuits when an input is applied to the receiver. This voltage is used to overcome an existing grid or cathode bias on a tube which has a relay in its plate circuit. Thus, the input signal drives the tube into conduction and energizes the relay.

One interesting exception to the above method is found in a few RF-type systems, where the incoming signal is modulated with different low-frequency audio tones to control different functions. After detection, the audio signals are fed to a circuit containing a *reed relay*—a unit with several pairs of contacts

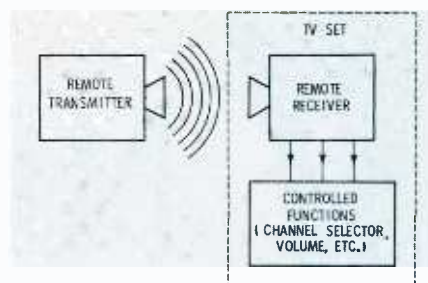

Fig. 1. Basic block diagram common to all types of wireless remote systems.

which respond to AC magnetic fields of different frequencies. Each pair is wired to complete the circuit of some other relay which actually applies power to the load.

The various types of relays used to activate different control functions are shown in Fig. 3. The simplest unit is a normally-open type, with contacts that close only when sufficient current is applied to the relay winding. Such relays are used almost universally as momentary-contact devices for initiating the operation of automatic channel selectors, as described in "Examining Motorized TV Tuners" (December, 1960 issue). They are also used to supply power to motorized volume controls, etc., in some systems where a signal is continuously produced as long as the control button on the transmitter is held down.

Another method of controlling volume makes use of a momentary-contact relay to actuate a ratchet-operated *stepper switch* (also shown in Fig. 3). Each time the relay is energized, the switch is reset to a new position. This arrangement provides a choice of audio levels.

Most remote-control units also perform the additional function of turning the TV set on or off. In some installations, the volume-level stepper switch includes one position in which the primary circuit of the TV power transformer is interrupted; in other systems, a cam-operated power switch is mounted on the tuner so that one of the unused channel positions can be utilized as an "off" position. Then, too, a separate frequency may be used to control TV power by actuating a *bistable* or *latching* relay (Fig. 3) — a remotely - controlled toggle switch.

Some systems provide additional control features, but these generally involve control circuits similar to those already described.

## Routine Troubleshooting

While there are many possible causes for unsatisfactory operation of a remote-control system, troubleshooting need not be difficult or time-consuming. As long as a systematic procedure is followed, defects can be localized just as readily as those occurring in other parts of the TV receiver. Here are some of the most useful tests:

### In the Home

When first sizing up the problem, search for obvious clues which will help you pinpoint the trouble source. A system may be completely inoperative for the simple reason that it is turned off. Check the rear of the TV set for a REMOTE-MANUAL or REMOTE ON-OFF switch, and make sure it is set for remote operation. The next step is to key the transmitter and see if the relays for all functions are being actuated. You don't even need to remove the rear cover of the set; just listen for a clicking noise. If the relays are operating, you can assume that the remote transmitter and receiver circuits are all working normally, and the trouble must be in the relay contacts or associated circuitry (tuning motor, stepper switch, etc.).

If one or more relays do *not* respond to the transmitted signal, look for a defect in the remote unit. But first, confirm your diagnosis by manually closing the relay contacts (using an insulated tool). A normal reaction in the controlled circuit is further proof of trouble in the remote transmitter or receiver.

Check to see if power is being applied to the remote receiver. Do

the tubes light? If the receiver is equipped with a fuse, see if it is blown. Also check the setting of the sensitivity or gain control. Try substituting tubes; in most cases, they're fairly common radio-TV types like the 6AU6, 6AL5, 6CM7, 6CX8, 6U8, and 6X4.

Before proceeding any further, inspect the remote transmitter. The simplest type, entirely mechanical in operation, contains metal rods which generate supersonic waves when struck by small spring-loaded hammers. When working properly, these units produce a characteristic audible "plink" in addition to the supersonic tone. If this sound is dull or absent, check to see if the rods are correctly mounted in their spring suspensions, and if the hammers are being properly cocked and released.

Another type of acoustic-wave generator consists of a battery-powered transistorized oscillator driving a small transducer. In some designs, a faint hum or buzz may be produced when the transmitter is keyed; however, absence of this sound is not conclusive evidence of transmitter trouble. The most likely cause of faulty operation is a dead or weak battery, so try a new one if you happen to have the correct type on hand. (Remote transmitters use some of the same types as miniature transistor radios.)

RF systems also use transistorized transmitters, with a ferrite-core antenna in place of a transducer. To check the operation of systems in which the RF carrier is modulated, you can sometimes pick up a harmonic of the output signal on a standard AM radio as evidence of normal transmitter operation.

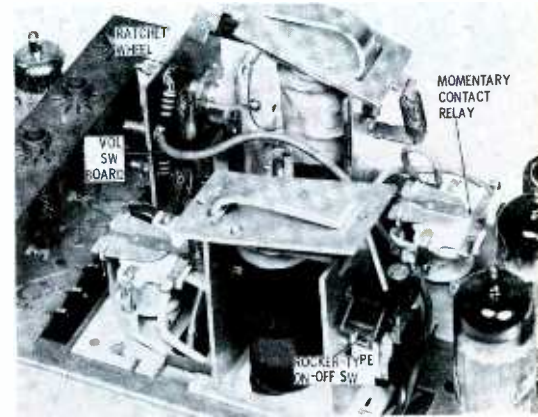

Fig. 3. Several different types of relays are used for remote control of TV.

The most unusual transmitting device now in use is a supersonic whistle actuated by a bellows. A physical inspection will catch most defects, including air leaks.

If trouble in a remote-control system cannot be traced to its source by the above tests, the remote units should be removed from the TV set and taken to the shop for further checking. It is not necessary to haul in the entire TV chassis, since you can check the effectiveness of your test procedures by watching the relays on the remote-receiver subchassis. Most models of remote-control receivers have self-contained power sources which can be supplied with AC line voltage through jumper wires or plug adapters. In the few cases where B+ and filament voltages must be externally generated, they can be obtained from a bench power supply or "borrowed" from another set.

As a rule, the TV owner can continue to operate his set after the remote unit has been disconnected. Placing the power switch in

• Please turn to page 57

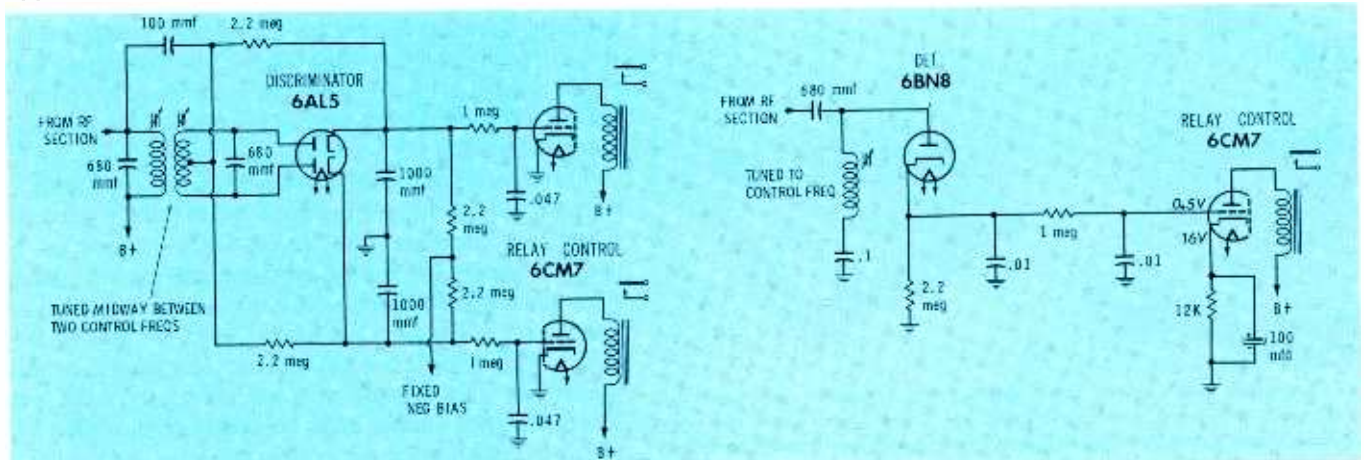

(A) Discriminator; grid bias.

(B) Diode rectifier; cathode bias.

Fig. 2. Two types of detectors, and two different ways of biasing relay tube.

# BREAKING THE COMMERCIAL

## A quick guide to planning and installing typical sound systems . . .

by Joe A. Groves



ASTATIC



ELECTRO-VOICE



SHURE



TURNER



SONOTONE



UNIVERSITY

Crystal and ceramic microphones always have a high output impedance and are excellent for paging and general public-address work. Dynamic-type microphones usually cost a little more than ceramic or crystal types, but they are less easily damaged by rough handling and are available with either high- or low-impedance outputs.

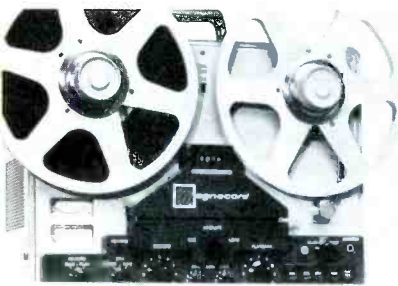

Most tape recorders used with background music systems play either two- or four-track tapes to provide uninterrupted music for a period of 2 to 8 hours without changing reels. As with a conventional recorder, music from FM, phono, etc., can be recorded for future playback.



Amplifiers with self-contained phonograph turntables are often used in all types of commercial sound installations except hi-fi background-music systems, which generally employ auxiliary single-play transcription turntables or automatic record changers. These separate units are normally designed for stereo output and have broader frequency response than conventional built-in equipment.

Alert electronics service dealers all over the country are constantly expanding into additional activities to provide for future growth. Many of these dealers are finding that the commercial sound field offers one of the best opportunities because it has a great potential and is closely allied with their present sales and service facilities.

If you've been thinking about going into the commercial sound business, you need to know what kind of equipment is available, and what technical knowledge is required to plan, install, and maintain sound systems. You also need to size up the potential market in your area. Remember that doctors, lawyers, dentists and even self-service laundries are all prospects for a background-music system. Grocers, department stores, new and used car dealers, industrial plants, and restaurants can be sold a background-music system with provisions for paging employees. Fraternal organizations, civic groups, and others will want public address facilities, while churches and schools are excellent prospects for systems suited to their particular needs. Of course, this list represents only a small fraction of the potential customers just waiting to be sold on the convenience, the added service, and the practicality of installing some form of commercial sound system.

To satisfy the different requirements of all these users, the commercial-sound specialist must be prepared to supply many types of equipment in an almost endless variety of combinations. Let's take a look at the various types of individual components and see how they fit into the complete systems.

### Inputs

A wide variety of input devices are used in sound systems. Almost all commercial sound applications require one or more microphones. The selection is generally made by considering price in respect to the required impedance, frequency response, and directional characteristics.

Microphones with cardioid pickup patterns are normally used in applications where their directivity minimizes problems due to multiple echoes or high random noise. On the other hand, mikes with omnidirectional characteristics are better suited for areas with low noise levels where a wider range of pickup is desired. High-impedance outputs are acceptable for all installations that require a relatively short mike cable. However, if the cable must be longer than about 35', a low-impedance mike and cable must be used to reduce stray pickup and provide a higher output to the microphone input of the amplifier.



# SOUND BARRIER!

Sometimes it's desirable to design a commercial sound system with a telephone-line input. This requires an adapter to match the 600-ohm impedance of the telephone line to the regular input impedance of the amplifier. Such an input device must be used when a centralized system feeds different plants or stores at widely-separated locations.

## Amplifiers

Selecting the proper amplifier for a specific job may seem to be an almost impossible task for those just entering the sound field. Knowing what type of service is desired and what type of installation the unit is to be used in — mobile, portable, or fixed — greatly reduces the number to choose from. Then, a study of the inputs to be fed to the amplifier, and of the total power demands to be placed on the system, quickly narrows the selection down to only a few units. Of course, it's never wise to design a system that just meets the needs of an initial installation; a built-in reserve of power should be included so that additional speakers can be added if needed.

Two basic points to consider when selecting an amplifier are cost and frequency response. A few amplifiers have a limited frequency response of 20 to 10,000 cps. However, the overwhelming majority have a response ranging from 20 or 30 cps to 15-20,000 cps. These meet the requirements of almost any system. A limited number of amplifiers are designed especially for hi-fi applications and have frequency responses that exceed the 20,000-cps rating. When choosing an amplifier, remember that frequency response and power output are proportional to cost.

Relatively small systems may have up to 10 speakers connected in series, parallel, or series-parallel, with lines running for only short distances. This type of installation demands an amplifier with a 4-, 8-, or 16-ohm output. In more complex systems having several speakers and longer line runs, you'll need an amplifier with constant-voltage output taps or a wide selection of output impedances to simplify the job of connecting the speakers for a maximum transfer of power.

Constant-impedance or constant-voltage line-matching transformers are normally used in installations requiring several speakers. Such a device makes it easier to obtain the exact power level required for each speaker, while also reducing power losses in the lines. Because of this, smaller wire size can be used for the feed lines.

The constant-impedance unit normally has a tapped primary rated in ohms. Mathematical computations must be made to determine what tap will deliver the desired ratio of total power to the speaker. Most secondaries have 4-, 8-, and 16-ohm outputs to match the voice coil of various speakers.

• Please turn to page 62



Many systems employ conventional AM and/or FM tuners as a signal source. Some tuners contain single- or dual-channel amplifiers capable of 30-watt output per channel. These units have a selector switch to provide connections to a microphone, phonograph, or tape deck in addition to the built-in tuner.

A wide variety of auxiliary tone generators are available for use with commercial sound systems. They can produce the wail of a siren, the sound of a jangling bell, a pure tone, a melodious chime, the blast of a horn, and even the music of a carillon.



Amplifier outputs range from 8 to 100 watts. Select one with the required wattage, output impedances, and number and types of inputs.

# AIR

# CONDITIONER

# REPAIRS



Capacitors

Motor-starting capacitors often used in conjunction with compressors and fan motors generally range from 50 to 250 mfd, while running capacitors seldom exceed 20 mfd. These components can easily be tested by substituting identical types. (Radio-TV types are unsatisfactory.) Substitutes should be within 5 mfd of the original value. Ohmmeter checks can also be helpful in finding capacitor trouble.

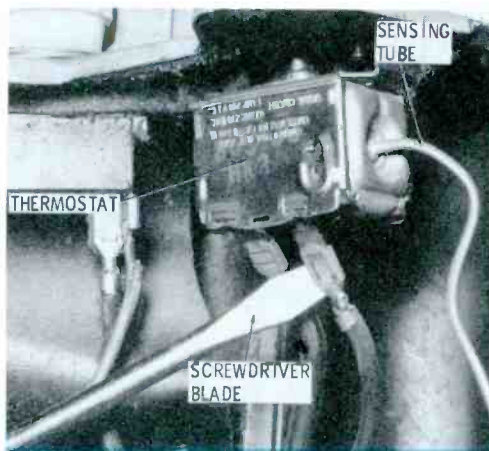

Thermostat

You can isolate trouble to a built-in thermostat by shorting across its terminals. If the compressor starts, the thermostat is at fault. Make sure the sensing tube is properly positioned in the air-flow path and has not been damaged.

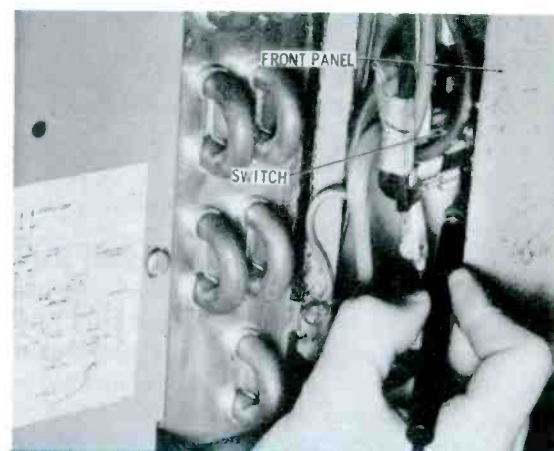

Switch

You can usually reach the terminals of the switch with a meter probe to check voltage or continuity. As an aid to tracing switch and motor circuitry, you'll find a wiring diagram inside nearly every unit.



Fan and Motor

Two types of fans—propeller and “squirrel-cage”—are used to circulate air through the evaporator and condenser coils. Common troubles are loose motor mounts, fan blades bent or loose on the motor shaft, and worn or noisy bearings. If a fan motor won't start, measure applied voltage; check the starting capacitor (and relay if used); sample the operating current of the motor; and check the resistance of the motor windings. Also, if the unit has oil cups, check for dry bearings. (However, most motors are permanently lubricated.)



Overload

The “overload” is a bimetallic thermal device that automatically interrupts power to the compressor or fan motor in case of overheating. If a motor won't start, and its housing feels relatively cool, short across the overload terminals for an instant and see if it starts. If it does, and there are no apparent signs of overloading, leave the terminals shorted and measure motor current. The overload can also be tested for continuity with an ohmmeter. Low line voltage is often responsible for trouble with overload units.



Compressor

Ammeter readings of compressor-motor current can be compared with the rating stated on the motor plate. A low reading indicates no load on the compressor, while a high reading usually points to a shorted winding, relay, or capacitor. Motor windings can be checked for opens and shorts by measuring the resistance of each winding; it is also advisable to check for leakage or shorts from the windings to the metal case. If a compressor unit leaks oil or is excessively noisy, it should be overhauled or replaced.

# MADE EASY!

Why not add to your summer profits by servicing room air conditioners? No specialized equipment is really necessary for most jobs; you can do the electrical work, and "farm out" the jobs involving repairs to the refrigerant system, if you so desire. Here's a servicing guide, with a series of "how-to" procedures to help you solve the most common troubles.

## TROUBLESHOOTING CHART

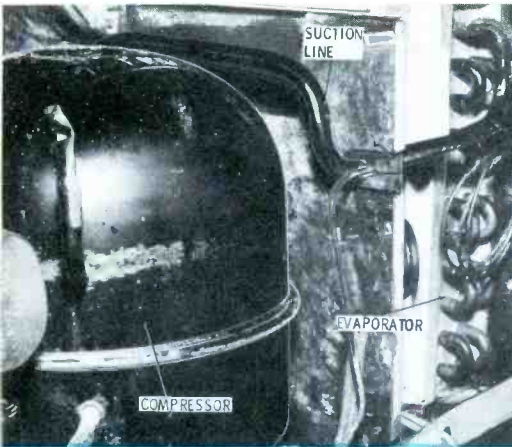

Refrigerant

The large line running between the compressor and evaporator can be used to check the refrigerant charge. In a normally-operating unit, it will be cool and sweating; if it isn't, block off air from the evaporator and see if frost develops on the line and coils within 20 minutes. Lack of frost indicates need for recharging. If a unit is overcharged, the compressor will feel cool, or excessive frost will form.

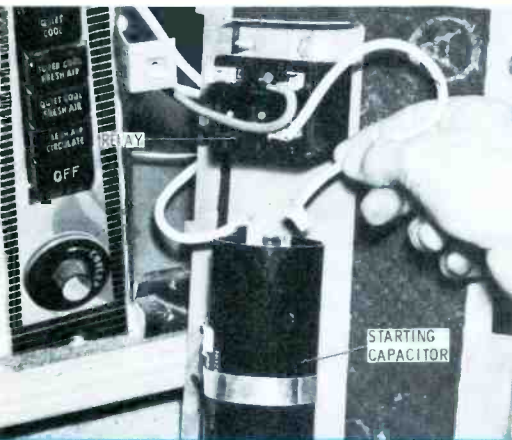

Relays

Many units employ a relay to open a starting-capacitor circuit when a motor reaches operating speed. If a starting relay fails to open, the compressor may sound as though it is laboring or slowly pulsating. In such cases, disconnect the lead from the starting capacitor, turn the air conditioner on, touch the lead to the capacitor terminal, and hold it there until the compressor starts; then remove it. If the unit runs normally, this indicates a faulty relay. A shorted starting capacitor sometimes causes a relay to fail.

CUSTOMER COMPLAINT	ADDITIONAL SYMPTOMS	TEST PROCEDURES
Unit will not run	Compressor and air fans will not start. Input voltage at power plug normal.  No input voltage at power plug. House fuse blown.	Check for voltage on both sides of starting switch. Look for broken wiring or loose connection between plug and motor terminals.  Make visual inspection and check for burnt odor. Test for short circuit in unit (including starting components and compressor) before restoring power. Replace fuse with proper type. Measure operating currents.
Unit blows air but does not cool.	Air fans operate. Compressor will not start.  Air fans operate. Compressor will not start. Line voltage normal.  Fans and compressor motor operate. Oily film on lower parts and panel.	Measure line voltage. Must be at least 104 for 115V unit, 207 for 230V unit, and 187 for 208V unit. If insufficient, measure voltage at mains; check wire size used; and look for high-resistance connections.  Check overload protector (compressor circuit breaker). Check compressor starting switch and thermostat. Check starting relay and capacitor (if used), running capacitor, compressor motor* and all wiring.  Make visual inspection for broken refrigerant line. Test for refrigerant charge.*
Unit runs but makes noise.	Vibration (rumble).  Vibration (rattle).  Sharp "striking" sounds.	Check cabinet installation—make sure packing parts were removed. Look for loose or worn motor mounts. Check fan blade alignment.  Look for loose paneling or refrigerant tubing hitting side of cabinet. Check fans and lubricate if needed.  Check to see that fan blades are not touching surrounding objects. Check slinger ring system and operation of any solenoids used. Check compressor motor.*
Unit does not cool properly.	Fans and compressor run. Unit not blowing sufficient amount of air into room. Frost on evaporator coils. High Power consumption.  Fans and compressor run. Unit blowing air. Frost on part of evaporator. Low power consumption. Abnormally warm suction line.  Evaporator and/or condenser fan not running.  Unit runs but compressor labor is noisy, or overheats.  Frost on capillary tube. Low power consumption.  Unit runs but compressor does not cycle often enough.	Check for dirty air filter and clogged or damaged evaporator and/or condenser fins. Check operation of vents for correct air circulation. See that evaporator fan blade is not slipping on motor shaft. Check fan motor running capacitor (if used).  Check for low refrigerant charge.  Check switch, circuit wiring, fan, motor, and overload (if used).  Check motor mountings. Check compressor operation.* Check for excessive refrigerant charge.*  Check for restricted or damaged tubing or strainer.*  Measure input voltage. Check thermostat, overload protector, starting capacitor, and relay.
Water drips from unit.	Inside parts sweating normally.	Make sure unit is leveled properly. Inspect evaporator drip hose, pan, and trough. Check water slinger system. Look for leaks or obstructed drain holes caused by rust.
Unit runs erratically.	Fans operate. Compressor hums and does not always start.  Compressor operates intermittently.	Measure input voltage. Check starting capacitor and relay (if used). Inspect compressor mounting. Check for excessive refrigerant charge.*  Measure input voltage. Check switch, thermostat, overload protector, and wiring. Check condenser fan and air circulation.
Electrical shock obtained from unit's case	House fuse not blown.	Look for broken or loose ground connection at power line input. (Case should also be grounded to this point.) After repairing or tightening ground connection, check for electrical short before restoring power.

\* If preliminary tests indicate need for repairs to refrigerant system or sealed compressor unit, and you aren't equipped to handle this work, subcontract the job to a competent refrigeration-repair station.

by Allan Lytel

# DEPTH FINDERS



Ultrasonic "fish finders" are easy to install and maintain.

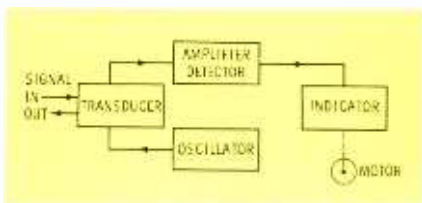

Fig. 1. Block diagram showing the circuits found in popular depth finders.

Electronic depth finders are now a familiar sight on boats of all sizes. Besides their usefulness as a navigational aid, they are helpful in locating underwater objects such as schools of fish — hence their popular name of "fish finders." These units are fairly easy to service, and they furnish the independent serviceman with an opportunity for both installation and maintenance work. A typical piece of equipment contains three to six tubes or transistors, with power obtained from a battery or vibrator-type supply. Installation involves mounting a transducer (an underwater transmitting and receiving "antenna") according to the manufacturer's suggestions, locating an indicator unit (transceiver) in a convenient spot for observation, and connecting the unit to the power

source. No FCC license is required to install, service, or operate depth finders, since they are not considered radio transmitters.

## Operation

In addition to the transducer, the circuits used in a depth finder include an RF oscillator (the "transmitter") and a tuned amplifier coupled to an indicator (the "receiver"). A simple block diagram is shown in Fig. 1. The oscillator operates at frequencies in the 40- to 300-kc range. Its output is fed to the transducer, which sends out a burst of ultrasonic energy at the same frequency. This ultrasonic signal behaves in practically the same way as an ordinary sound wave, except that it is above the range of human hearing.

The transducer output is beamed downward through the water. When the signal strikes an object, such as the ocean floor, it is reflected; these reflections are returned to the transducer and converted into electrical signals, which are amplified and fed to the indicating device.

The simplest units use a flashing neon bulb which rotates around a

circular scale to indicate depth. Others have a meter with a dial scale calibrated in feet or fathoms, a recording device that makes a permanent trace on paper, or a cathode-ray oscilloscope rigged to indicate depth.

In the simple indicator in Fig. 2, a small electric motor rotates a neon bulb in a clockwise direction behind a translucent scale calibrated in feet. The speed of rotation depends on the range of depths being measured; in some units, the speed can be changed to provide more than one depth scale. To see how this unit works, let's start at the beginning. A switch is momentarily closed when the bulb rotates past the zero mark. This triggers the transmitter oscillator and sends an ultrasonic pulse through the water from the transducer. After being reflected and returned, the pulse is amplified by the RF circuit; then it is detected and fed to a power amplifier. This stage triggers the neon bulb, producing a flash. The point where the flash occurs is read directly from the scale as the depth in feet, fathoms, or both.

If there are several underwater

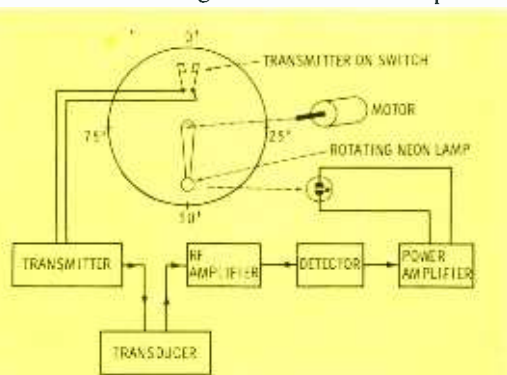

Fig. 2. This expanded diagram shows the basic operation of a depth finder.

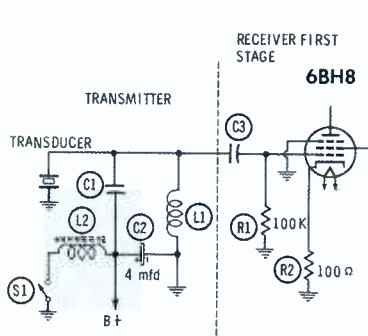

Fig. 3. Oscillations occur in this tubeless circuit when switch S1 closes.

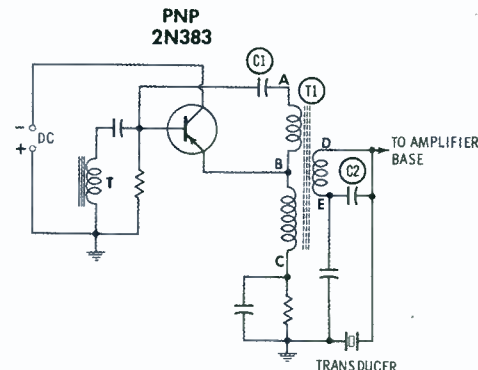

Fig. 4. A magnet passing coil T induces pulse that starts this oscillator.

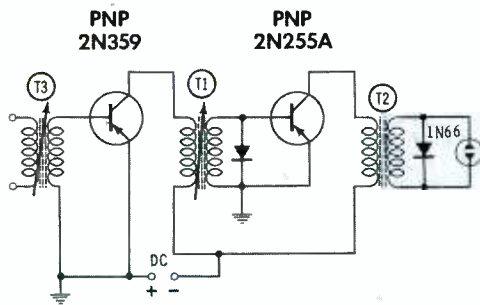

Fig. 5. Only two stages are found in this simple transistorized receiver.

objects in the path of the beam, the bulb will flash several times. The brightest of these flashes, which is also the reading of greatest depth, indicates the bottom of the body of water. A sensitivity control in the receiver provides a means of moderately reducing its gain, if the user wishes to exclude the weaker flashes and concentrate on the bottom reading. The range of the depth finder may be doubled by allowing the neon bulb to rotate twice between pulses, thus doubling the usable travel time of each pulse. On the other hand, the range may be decreased by speeding up the rotation of the indicator; for example, doubling the speed of rotation will cut the maximum measurable depth by one-half. A continuous series of readings is made to give the operator a running record of the depth beneath his keel.

### Transmitter Circuits

Basic circuit operation and troubleshooting techniques can best be learned by studying typical units.

The relatively simple transmitter circuit in Fig. 3 consists only of the transducer and a tubeless oscillator. Between pulses, switch S1 is open, and C2 charges to the applied B+ voltage. When the rotating indicator reaches zero, it closes S1, and L2 provides a return path to ground from the left side of C2. The capacitor then discharges, causing the tank circuit of C1 and L1 to oscillate at its resonant frequency. An RF voltage is thus applied across the transducer, and an ultrasonic pulse is produced.

Soon afterward, a return pulse from an underwater object is picked up by the transducer and changed back into an electrical signal. (This

Troubleshooting Chart for Neon-Indicator Depth Finder		
Trouble	Cause	Remedy
Unit fails to operate	Faulty power supply	Check fuse, vibrator, rectifier and power source
Unit operates with neon flashes at "0" but no depth reading	If actual depth does not exceed range of the unit, transducer or amplifier is defective	Check condition of transducer and its connections; check tubes or transistors
Neon lamp rotates but does not flash	Possible defect in lamp, amplifier tubes, or cable to transducer	Check neon lamp and amplifier if cable is properly connected. Keying contacts may require adjustment
Weak flashes of the neon lamp	Trouble in voltage source or amplifier, or poor location of transducer	Check transducer location, voltage applied from source of power, and amplifier gain
Extra or stray neon flashes	Noise or signal interference	May come from vibration, external noise source (ignition), vibrator "hush," or water turbulence

process is similar to what occurs in a ceramic or crystal phonograph cartridge.) The resonant circuit consisting of C1 and L1 provides a high input impedance for the signal, which is coupled through C3 to the grid of the first stage in the receiver.

A thyatron or transistor can also be used in the transmitter. In a typical transistorized circuit (Fig. 4), an oscillator is triggered when a current pulse is induced in coil T by a small permanent magnet on the rotating dial of the indicator. The primary winding of transformer T1 (B-C) induces a feedback signal in winding A-B — which, together with C1, forms the tank circuit of the oscillator. The secondary winding D-E resonates with C2 at the tank frequency and couples the oscillator signal to the transducer. As in the previous unit, the tuned circuit across the transducer forms a high-impedance input for the amplifier.

### Receiver Circuits

After being picked up by the transducer, the receiver signals pass through a series of sharply-tuned

RF amplifiers. Alignment of the receiver means peaking these stages at the oscillator frequency, which varies from unit to unit.

Fig. 5 shows a typical transistorized receiver with two grounded-emitter stages. The first of these stages uses a 2N359 and has a tuned input and output. The signal which it feeds to the 2N255A final amplifier is limited by the diode connected across the secondary of T1. The final stage produces pulses of voltage across the secondary of T2, which light the neon indicator. The lamp is connected to the circuit through slip rings so it can be rotated.

A typical amplifier using vacuum tubes (Fig. 6) has four stages. Gain of the unit is adjusted by varying the screen potential of the 6BH6 pentodes, while sensitivity is controlled by varying the cathode bias of the first 6BH6. The last stage, a cathode follower, supplies a signal to the neon lamp.

Whether it uses tubes or transistors, the single-frequency RF amplifier is straightforward and can

• Please turn to page 59

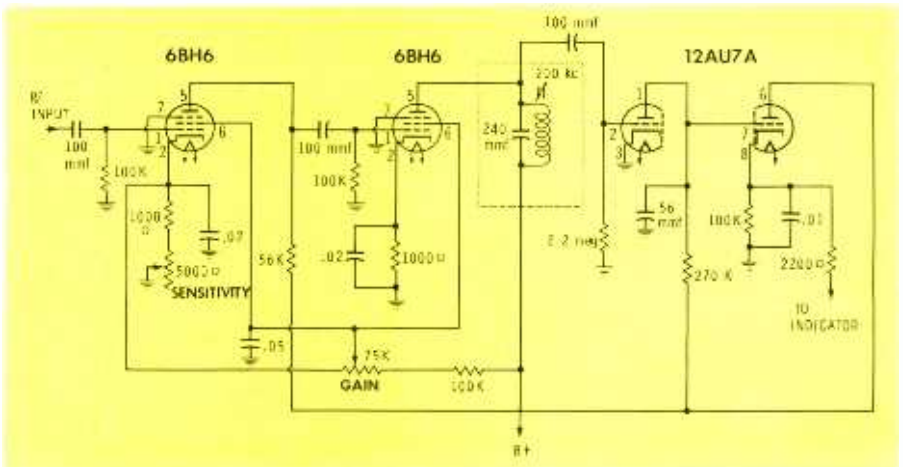
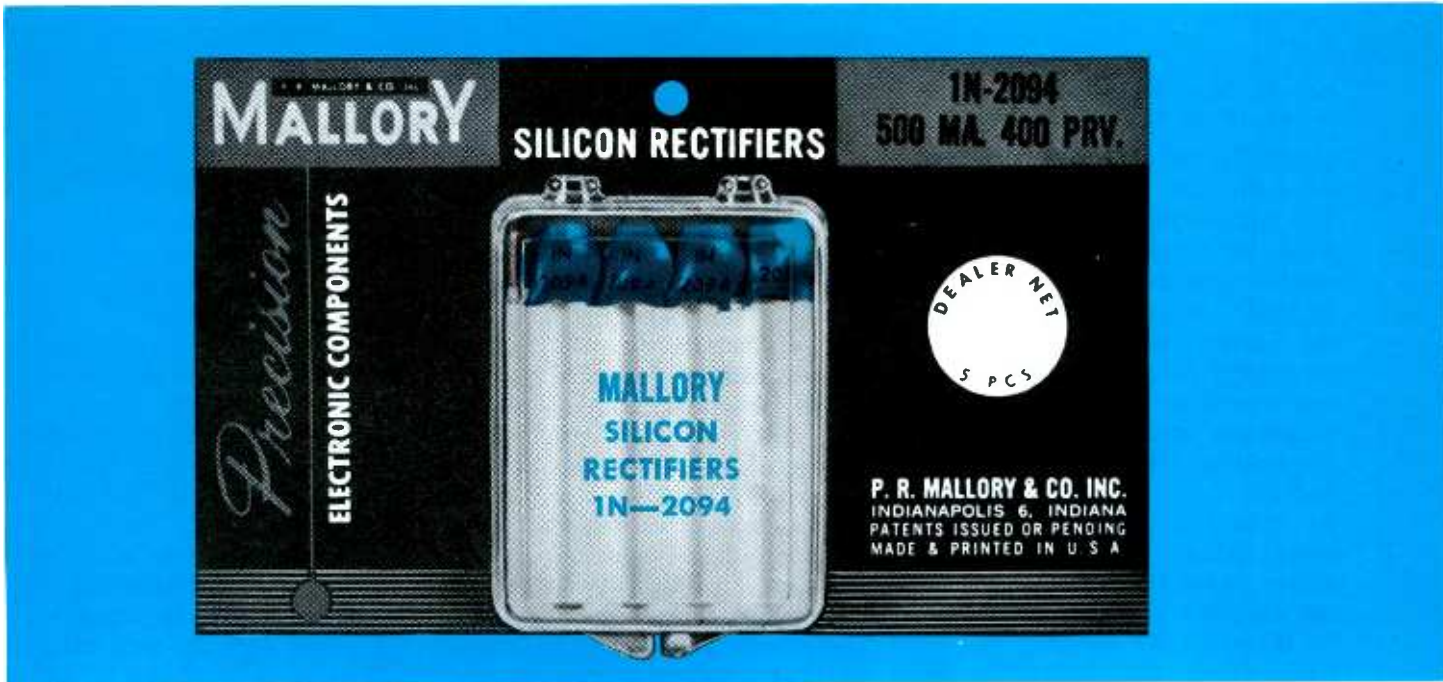

Fig. 6. Typical receiver circuit is simple and straightforward in design.

# NEW MALLORY SILICON



For top performance *every time*, use Mallory silicon rectifiers. From 50 to 600 PRV, you'll get all of the rating you pay for. You can stake your reputation on the quality of these rectifiers. They meet the standards required for military types, yet you don't have to pay premium prices. You'll get 750 ma up to +50°C and 500 ma at +85°C. Quality is

so high you won't even need equalizing resistors in most cases.

Available in parallel lead "T" type and axial lead "A" type from your nearest Mallory distributor, five to a pack, in a reuseable jewel box, on a handy file card.



**ELECTROLYTIC CAPACITORS**  
Famous FP-WP metal can types, reliable TC tubulars, and tiny TT tubulars.



**VIBRATORS**  
Sure-start Gold Label® and every other type for auto or mobile communications.



**PVC CAPACITORS**  
Premium quality Mylar\* Capacitors in handy zip-lip package.

\*Reg. Trademark E. I. du Pont de Nemours, Inc.



**STA-LOC® CONTROLS\*\***  
30 second delivery on every imaginable control.

\*\*U.S. Patent 2,958,838

# RECTIFIERS STOP CALL-BACKS

## ... premium quality at no extra cost

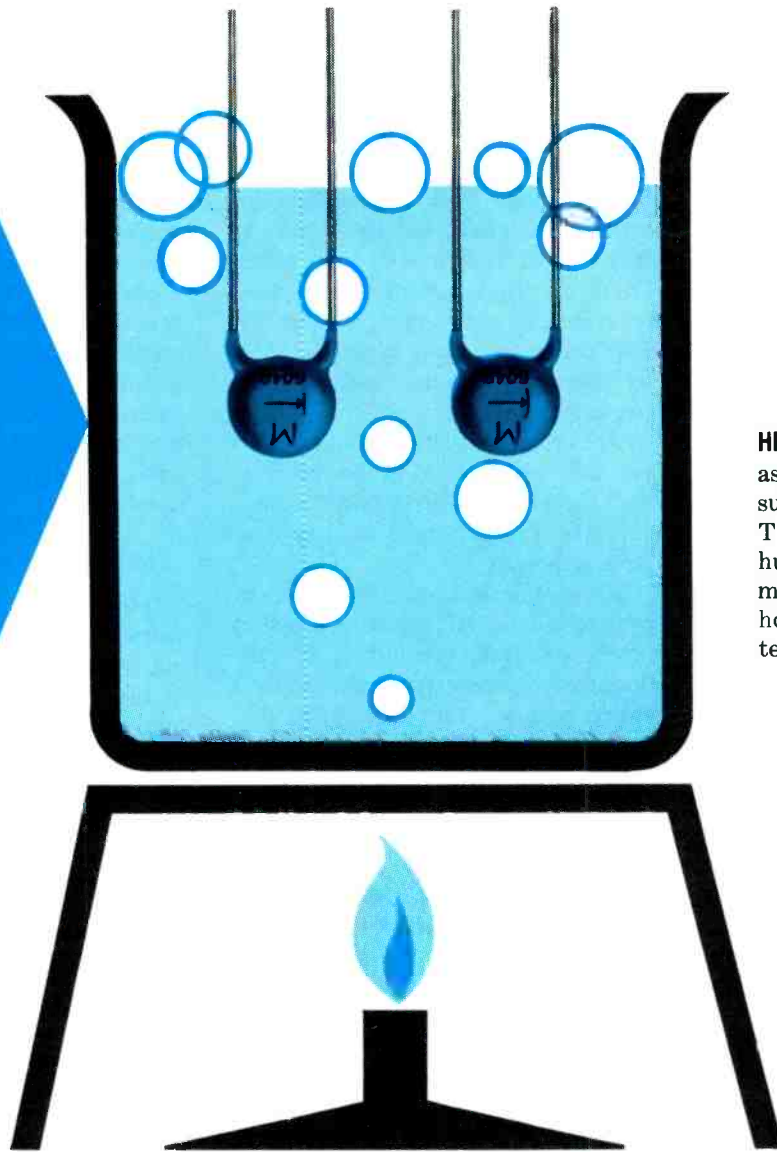

**HIGH HUMIDITY PROTECTION** is assured by the unique encapsulating material. The Type T withstands four times the humidity cycling required by military tests . . . takes 500-hour boiling water immersion test without failure.



### DISCAPS®

The standard of the ceramic capacitor field.

®Trademark Radio Materials Company, a Mallory Division



### MERCURY BATTERIES

Get the details on the New Mallory Battery Program today.

*Distributor Division, Indianapolis 6, Indiana*



*In Canada: A. C. Simmonds & Sons, Ltd., Toronto 7, Ontario*



# ELIMINATING TV BUZZ

Ask any serviceman, "What gives you the most trouble in the TV sound section?" and he will probably reply, "Buzz." This persistent symptom, much as it annoys the TV owner, is even more of a headache to the service profession. Besides being hard to localize, it also presents somewhat of a customer-relations problem. Many set owners seem willing to put up with buzz in the sound for a long time without calling for service, but when the set finally develops a more serious trouble, they are apt to think that the buzz should automatically be corrected along with the other repairs. On the serviceman's part, there is some tendency to shrug off buzz problems as being due to inherent design faults or poor signal transmission from stations. Regardless of these attitudes, buzz is usually the result of genuine circuit defects which can be cured by applying technical know-how.

## Types of Buzz

In troubleshooting, a clear distinction must be made between "hum" and "buzz." Both of these effects

are produced by low-frequency interference signals, but the similarity ends there. The smooth tone called "hum" is the result of a sine wave entering the audio section from the B+ or heater power supply, whereas "buzz" is a more rasping sound caused by a pulse signal.

These pulses can originate from two different sections of the receiver, and the first step in solving a buzz problem is determining what type of buzz is present.

If the interference can be heard even when no RF signal is applied to the receiver, the pulses are undoubtedly coming from the vertical sweep section. You can verify this by simply turning the vertical hold control and listening for a slight change in the pitch of the buzz. Once you've recognized the sweep circuit as the interference source, a scope will help you find the undesired coupling path between the vertical and sound sections. You'll most often find a boost-filter or vertical-decoupling capacitor at fault, but an occasional case is due to a defective vertical output transformer or improper lead dress.

If the trouble is present only when

a station signal is being received, it is probably intercarrier sync buzz. This annoying sound ordinarily changes in intensity according to the content of the video signal, and its amplitude can also be varied by adjustment of the fine-tuning control. Intercarrier buzz is a tricky condition that defies analysis unless its basic underlying cause is plainly understood.

## Sound Trouble in Video Circuits

The sound-IF signal in an intercarrier system is derived from mixing the sound and picture carriers at the video detector. Most of the modulation on this 4.5-mc signal is FM sound information; however, it also picks up a certain amount of amplitude modulation (primarily sync pulses). The job of the sound IF and detector is to amplify and recover the frequency modulation while ignoring the amplitude variations. If something goes wrong with the AM-limiting function of the sound circuit, the amplitude ratio between picture and sound carriers, or the sync-pulse amplitude, a 60-cycle buzz will result.

Poor alignment or a faulty part in the sound section can either defeat limiting or attenuate the 4.5-mc signal to a point where the normal sync pulses produce a noticeable buzz. The same symptom can also be caused by overloading of the video IF or detector stages. Anything causing the vertical sync pulses to be clipped or inverted ("sucked out") leaves gaps in the sound signal; these are effectively the same thing as amplitude modulation but cannot be removed by the limiting action of the sound system. Attenuation of the sound carrier, due to signal reflections reaching the antenna or to a poor response in the RF or video-IF stages, can also result in buzz.

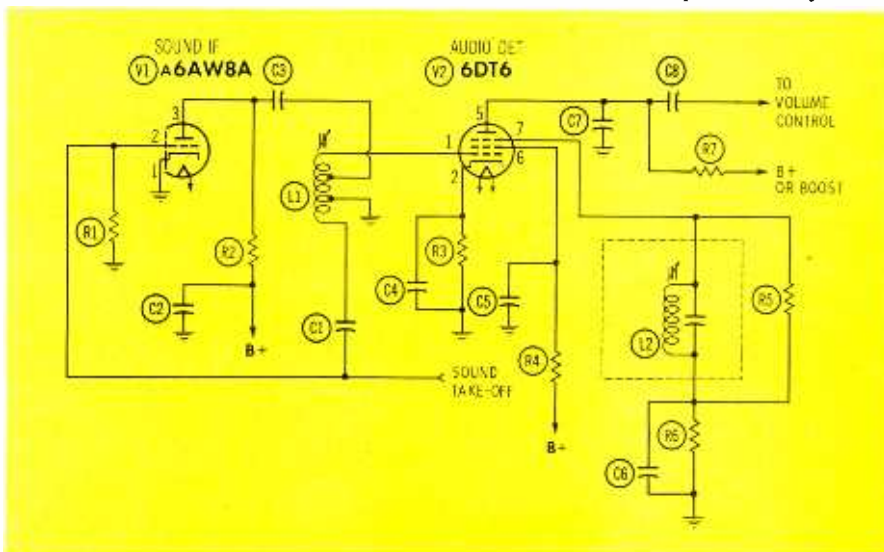
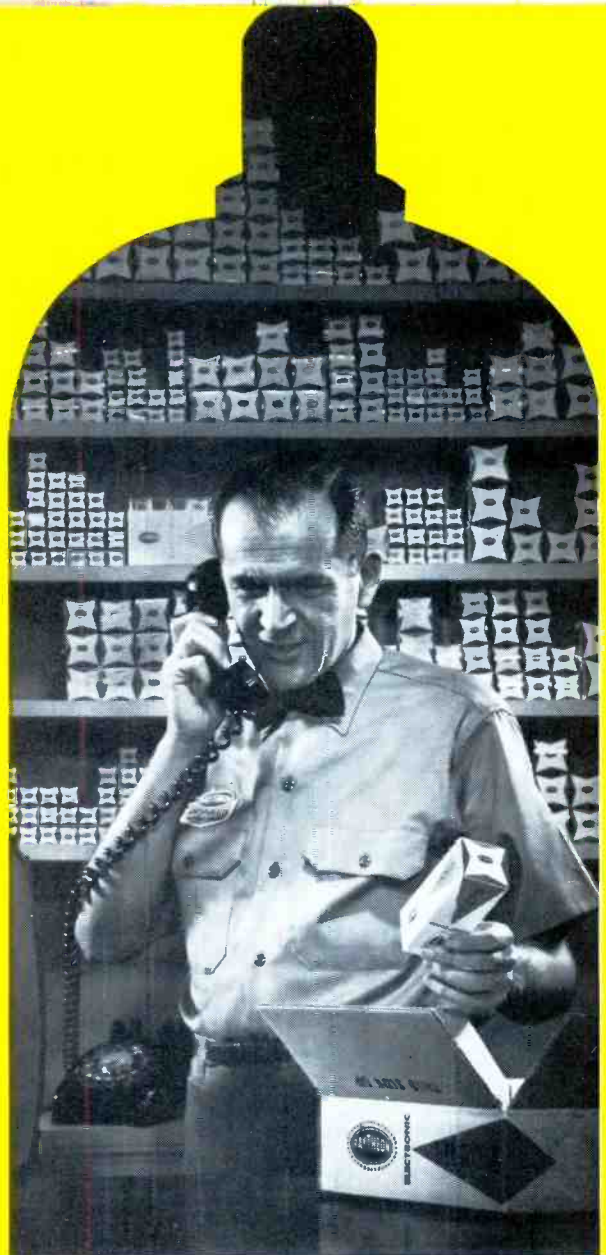
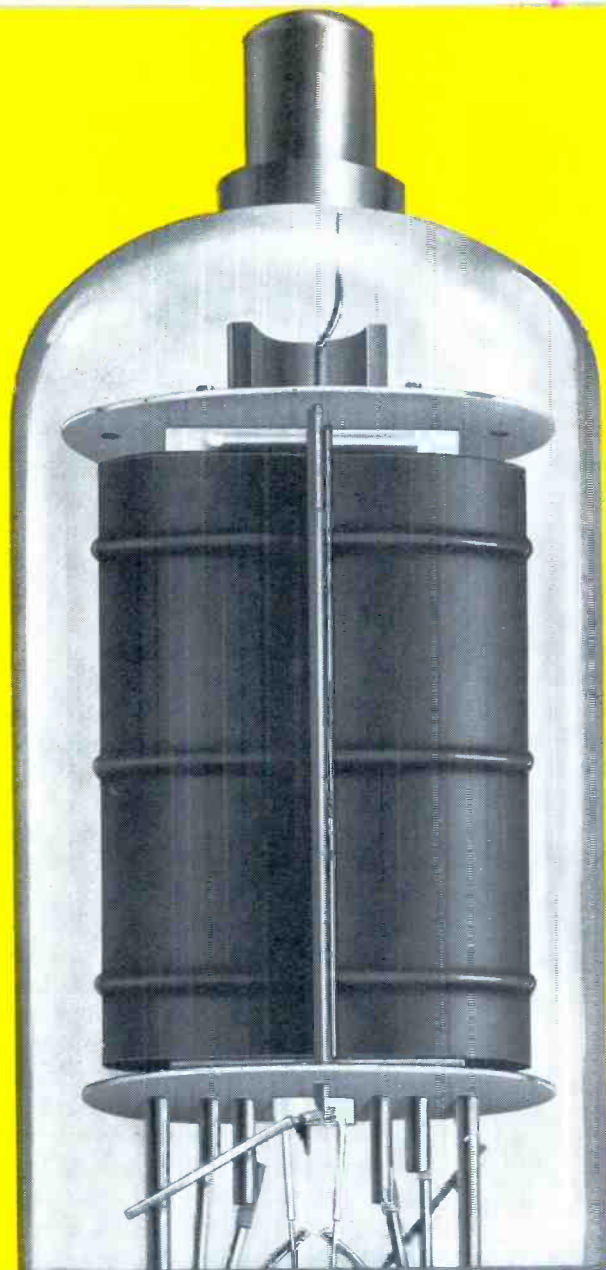

Fig. 1. Sound IF and detector circuit of a typical late-model TV receiver.





**RAYTHEON**  
**UNILINE**  
*FIRST IN QUALITY*

THE "FIRST IN QUALITY"  
CLEARLY PRINTED ON ALL  
RAYTHEON UNILINE TUBES  
GUARDS AGAINST CALL-  
BACK LOSS... ASSURES  
ALL YOUR CUSTOMERS OF  
HIGHEST QUALITY SERVICE

RAYTHEON

RAYTHEON  
COMPANY

DISTRIBUTOR PRODUCTS DIVISION

411 Providence Turnpike • Westwood, Mass.

[www.americanradiohistory.com](http://www.americanradiohistory.com)



**Specially Designed**  
**CHANNEL LOCK**  
No. 728 Long-reach  
**Diagonal Cutter**

You'll strip off plastic insulation quick as a wink—clean and smooth—with the patented wire-stripping notch of this CHANNELLOCK Diagonal Cutter. And you'll like the handy long reach . . . the precision-matched, hand honed cutting edges, too; A versatile cutter for electrical, radio, TV, Hi-Fi and all other types of electronics work. Comfortable, blue-plastic grips. Top quality, polished forged steel. Ask your tool supplier for a CHANNELLOCK No. 728 Diagonal Cutter. If he's out of them, ask him to order one for you.



Write for Catalog of  
Complete Line of Pliers

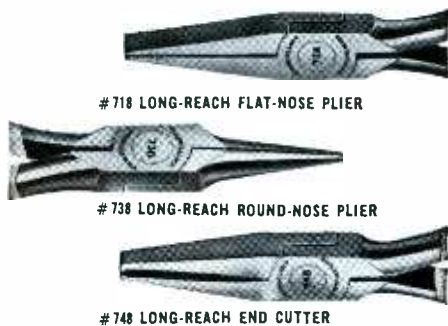

Channellock Pliers are made only by

**CHAMPION DeARMENT TOOL COMPANY**  
Meadville, Pennsylvania



(A) Normal background noise.

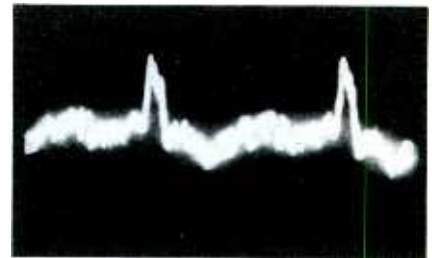

(B) Audible sync buzz (10V p-p).

**Fig. 2. Buzz waveforms during pause in sound modulation (30-cps sweep rate).**

Most picture-circuit troubles that lead to the sync-buzz symptom also cause the composite video waveform to develop visible defects; therefore, a scope check of the video-detector output signal is a good way to determine that such troubles are present. Obvious compression or distortion in this waveform is a warning to check for gassy IF tubes, loss of AGC bias, RF or IF misalignment, and similar troubles.

**Sound-Circuit Troubleshooting**

If you can determine with reasonable certainty that sync buzz is not due to a fault in the RF, IF, video, or AGC sections, turn your attention to the sound stages.

During the past several years, practically all TV manufacturers have adopted some type of quadrature detector circuit—particularly the 'DT6 version shown in Fig. 1. Generally, one IF tube precedes the detector stage. It may be either a triode (as shown) or a pentode, but it is almost always a section of a multipurpose tube.

If an intermittent sync buzz is occurring, and you find low plate voltage on the IF tube, check R2 in the circuit of Fig. 1. An increase in value of this component will invariably cause a slight buzz in the audio output.

Should you find that the 'DT6 cathode voltage is about twice normal, make sure R3 hasn't increased in value. If it is at fault, you may also find that most of the buzz can be eliminated by adjustment of the quadrature coil L2. Always replace the resistor, however, when you find it off value.

Another symptom to look for is low voltage on the screen (pin 6) of the 'DT6. Check to see if R4 has increased in value; if this resistor goes up to about 1 meg, the sound output will drop considerably and you'll hear an overriding buzz. Cath-

ode- and screen-bypass capacitors of this circuit can also give you trouble. If the buzz is fairly constant and cannot be tuned out by the quadrature coil, try a substitute for both C4 and C5 in Fig. 1.

Generally speaking, adjustment of the quadrature-grid coil in the average 'DT6 circuit is not extremely critical as far as intercarrier buzz is concerned. A misadjustment will produce buzz, especially on strong input signals; however, if the slug setting is very far off, the sound will also be considerably distorted. If the coil or one of its connections is open, you'll detect a buzz, but the sound will also be garbled and low in volume. Adjustment of the coil will, of course, have no effect.

Another component that can produce tricky symptoms is bypass capacitor C6. If it changes value, buzz will develop and the sound will become distorted. However, you can usually compensate for the shortcomings of this capacitor by adjusting the quadrature coil. If C6 opens completely, buzz will be heard, but the over-all output will be extremely reduced.

Buzz may be due to misalignment of the sound section, rather than to any specific component defect. Fortunately, a complete realignment of a typical quadrature detector and sound IF circuit is a simple three-

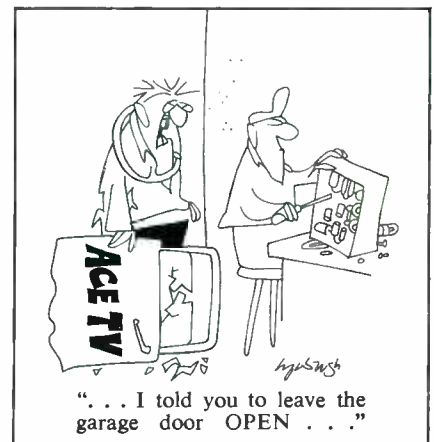

step procedure which can be "played by ear," using a regular station transmission as a signal source. All slugs are merely tuned for maximum sound with minimum buzz.

It should be possible to reduce buzz practically to the vanishing point. A faint suggestion of pulses may still be apparent in the signal fed to the volume control during breaks in audio transmission, as shown in Fig. 2A. This slight modulation can easily be tolerated, but an audible buzz soon appears if the pulses become stronger (Fig. 2B). Small wonder!

### Yagi With Helper

Recent comments from the field about a new high-gain antenna with built-in booster, reported to be "really pullin' in the signals," aroused my curiosity. I followed up on the reports and found this antenna to be from the *Powertron* line produced by Winegard Co. of Burlington, Iowa.

The antenna package includes an all-channel yagi, signal amplifier, 24- to 28-volt AC power supply, connecting plugs, and all necessary hardware. The secret of the improved performance is the booster, which rides "kangaroo style" under the main boom of the yagi. A small power supply, designed to be placed near the TV set, feeds the booster via the antenna lead. Since the booster receives signals directly from the antenna terminals, it amplifies them before they are attenuated by the transmission line and coupling devices — thus improving the signal-to-noise ratio of the antenna system.

Winegard is currently supplying three all-band VHF models and 14 cut-to-channel VHF and FM antennas with the *Powertron* feature. ▲

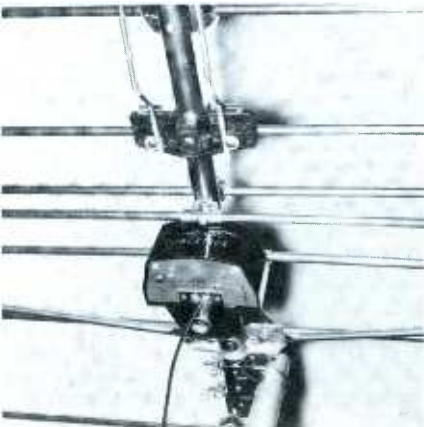

## Centralab L&T PAD ATTENUATORS

offer these advantages  
in any  
sound installation

### SMALL SIZE . . .

less than  $1\frac{3}{16}$ " deep from mounting surface, these units fit into any standard junction or switch box with room to spare . . . diameter is only  $1\frac{3}{32}$ ".

### HIGH WATTAGE . . .

conservatively rated at 20 watts audio, 5 watts D.C. yet they are no larger than units rated at 2 watts D.C. One size takes care of all your 2, 3, 4, and 5 watt requirements. Centralab's exclusive "thermo-pass" insulation combines fast heat transfer with a high dielectric constant to achieve this high rating.

### ANTI-BACKLASH CONSTRUCTION . . .

the "play" frequently found in dual controls is eliminated. The wiper contacts move in unison, assuring that there will be no alteration in frequency response due to variations in wiper position on the resistance tracks.

B-6124

**Centralab**

THE ELECTRONICS DIVISION OF GLOBE-UNION INC.  
942F EAST KEEFE AVENUE • MILWAUKEE 1, WISCONSIN  
In Canada: Centralab Canada Ltd., P.O. Box 400, Ajax, Ontario

**ELECTRONIC SWITCHES • VARIABLE RESISTORS • CERAMIC CAPACITORS  
PACKAGED ELECTRONIC CIRCUITS • ENGINEERED CERAMICS**

June, 1961/PF REPORTER 33

## NEW CB VERSATILITY

WITH **EICO**®

*New Deluxe Citizens Band Transceivers give you everything you need for fast, reliable, economical communication*



**770 Series**

	kit	wired
Model 770: 117 VAC only	\$69.95	\$99.95
Model 771: 117 VAC and 6 VDC*	79.95	109.95
Model 772: 117 VAC and 12 VDC*	79.95	109.95

\*Including Posi-Lock® Mounting Bracket (Pat. Pend.)

Front panel selection of one of 3 transmit crystals with continuous receiver tuning over all 23 CB channels, or a fourth transmit crystal with appropriate receiving crystal. Press-to-talk button on microphone; transmit-receive switching accomplished by high-quality relay with minimum capacity between contacts to prevent current leakage at RF frequencies. Superhet receiver with RF stage for high sensitivity & proper signal-to-noise ratio. 1750 KC IF strip for unequalled image rejection & freedom from oscillator "pulling" on strong signals. IF strip prealigned so that only "touchup" alignment without instruments is needed. Current metering jack in series in cathode circuit allows checking of input power to transmitter final & adjusting it to FCC limit. 13-tube performance (4 dual function tubes, 4 single function tubes, plus germanium diode). Adjustable squelch control (in addition to automatic noise limiter). Optimum adjustment to any popular CB antenna assured through use of variable pi network in output. AVC. 3" x 5" oval PM speaker. Supplied complete with 8 tubes & 1 transmit crystal (extra crystals \$3.95 each).

The entire transmitter oscillator circuit and RF final in every EICO transceiver kit is premounted, prewired, retuned, and sealed at the factory (about 3 hours of skilled labor, precision adjustments and testing), complying with FCC regulations (section 19.71, part d), and permitting you to build the kit and put it on the air without the supervision of a commercial radiotelephone licensee.

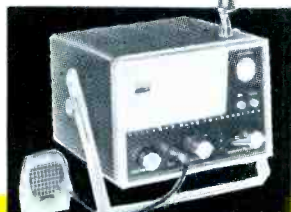

**Standard 760 Series of CB Transceivers from**  
Kit \$59.95 Wired \$89.95

### You profit with EICO Test Equipment & Hi-Fi



DC-5 MC  
5" Scope ±460  
Kit \$79.95  
Wired \$129.50



New Transistorized Stereo/Mono 4-Track Tape Deck  
Wired Model RP100W \$395.00  
Semi-Kit Model RP100K, Electronics in Kit form, \$289.95

An exclusive EICO product designed and manufactured in the U.S.A. (Pat. Pend.)



NEW FM-AM Stereo Tuner ST96  
Kit \$89.95 Wired \$129.95 inc. FET



NEW 70-Watt Integrated Stereo Amplifier ST70  
Kit \$94.95 Wired \$149.95

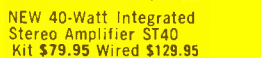

NEW 40-Watt Integrated Stereo Amplifier ST40  
Kit \$79.95 Wired \$129.95  
Over 80 products to choose from. Write for free Catalog, PF-6 & name of nearest distributor. Most EICO distributors offer budget terms.

**EICO** Electronic Instrument Co., Inc. 3300 N. Blvd., L.I.C. 1, N.Y.  
ADD 5% IN THE WEST © 1961

Export Dept., Roburn Agencies Inc., 431 Greenwich St., New York 13, N. Y.

## The Electronic Scanner

### Self-Merchandising Display Racks

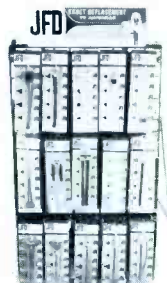

To help dealers merchandise their exact-replacement indoor antennas, **JFD Electronics Corp.** will provide self-service display racks, absolutely free, along with a back-up inventory purchase. Rack DMP530 (shown), a free-standing unit which can also be wall-mounted, will be included with orders for 30 antennas (2 each of 15 basic types). Rack PA515, designed for use as a counter display, will be included with orders for one each of the 13 most popular **JFD** antennas. Each order also includes a package of sales promotion aids.

### Buy Brighteners—Get Tools Free



As long as they last, each twelve pack of **Perma-Power** "Vu-Brite" picture tube brighteners will include a specially-assembled wrench kit for the regular \$9.95 price of the brighteners alone. The wrench set, especially made for **Perma-Power** by a leading tool manufacturer, contains 8 units of various types and sizes, including those needed for volume controls and knobs with set screws.

### New Wire Products Catalog

**Columbia Wire and Supply Co.** has just published their 1961-1962 wire products catalog, a 40-page guide to the selection of items from AC line cords and anode connectors to TV transmission lines and zip cords. Copies are available through authorized **Columbia Wire** distributors.

### Sounds Like a Sound Business

If you're really eager about getting into the commercial sound business, or are already in this field but would like to learn more about system planning and merchandising, you'll want to avail your self of the aids provided by **Bogen-Presto**. In addition to practical catalogs and booklets such as "Getting Started in the Sound and Intercom Field," "What You Should Know About Sound Systems," and "Sound Merchandising Techniques," this manufacturer has made available a 4-page "Sound System Survey" form on which you can fill in your customer's system requirements and obtain equipment recommendations from the company's engineering staff.

### Import vs. Export

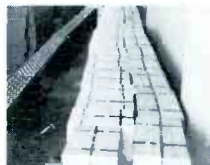

In these days of much publicity about foreign imports, it is refreshing to note that **Merit Coil & Transformer Corp.** has recently filled the largest single export order in its history. The photo shows the record shipment being readied for its journey to the Far East.

### Green Light for Stereo Multiplex

The FCC has given the "go" signal to stereo FM broadcasting. Effective the first of this month, stations are authorized to use a multiplex system based on standards proposed by **Zenith Radio Corp.** and **General Electric Co.** Stereo information is transmitted as AM on a supersonic subcarrier, which in turn frequency-modulates the main RF carrier. Many manufacturers are readying FM stereo tuners as well as multiplex adapters for existing FM sets.

### Old Company Gets New Name

**Chicago Standard Transformer Corp.** has changed its corporate name to **Stancor Electronics, Inc.** There is no change in personnel or policies, and both the **Stancor** and **Chicago** product lines will be maintained. Magnetic Windings, with plants in Easton and Gettysburg, Pa., is being consolidated into the **Stancor** firm.

*there's a gold mine in the sky with the..*

# NEW TRANSISTOR MAST-MOUNTED TV/FM 4-SET BOOSTER

*Blonder-Tongue Signal Master, AB-4  
master system performance at  
a home booster price! \$29.95 list*

Thousands of TV antennas in your area can be converted into powerful, amplified 4-set home distribution systems with this remarkable new transistor booster. It is service-free, weather-proof and low-priced for volume. Check these engineering features:

- Transistor circuit provides lowest noise, maintenance free operation—no tubes to burn out or replace—no heat dissipation problems.
- Mast mounting takes advantage of best signal-to-noise ratio—minimizes snow. (Can also be mounted at any convenient point along the downlead).
- World's smallest and lightest booster—no additional weight or wind resistance for the mast to bear.
- Remote power supply at set uses 4 low-cost flashlight batteries for pure d.c.—eliminates AC power line, and components which may fail.
- Converts existing antenna into a powerful amplifier-distribution system—no need to invest in a new antenna.
- Eliminates costly installation of giant antenna arrays in most fringe areas.
- Provides improved FM reception (gain 12-15 db).
- Stripless 300-ohm terminals on booster and remote power supply for fast installation, positive contact.
- No separate balun needed—matches impedance of antennas and TV sets.

**ALL THIS PLUS . . .** 4 set coupler incorporated in remote power supply distributes full isolated amplified signals for brilliant reception on up to 4 TV or FM sets.

*Sold thru distributors.*

*For details write.*

*Dept. PF-6*



<p>1 set gain: up to 19 db, channel 2 Up to 10.5 db, channel 13</p>	<p>2 sets gain: up to 14 db, channel 2 Up to 6 db, channel 13</p>	<p>3 sets gain: up to 13 db, channel 2 Up to 4 db, channel 13</p>	<p>4 sets gain: up to 10.5 db, channel 2 Up to 2 db, channel 13</p>
---	---	---	---

Patent applied for.

engineered and manufactured by

**BLONDER-TONGUE**

9 Alling St., Newark, N. J.

Canadian Div.: Benco Television Assoc., Tor., Ont. Export: Morhan Export Corp., N. Y.  
home TV accessories • UHF converters • master TV systems • closed circuit TV systems

**DOLLAR & SENSE**  
*Serviceing*  
by Joe A. Groves



# BUSINESS FORMS BOOST EFFICIENCY



A service dealer isn't in business very long before he realizes that printed forms serve more useful purposes than simply impressing customers. In fact, itemized repair bills, work reports, sales slips, etc., are just as important to over-all shop operations as good test equipment.

Statistics show that a lack of accurate records is one of the primary causes of small business failures—second only to inadequate working capital. Therefore, regardless of the size of your service operation, you must record all transactions to know how you stand. The best way to get this information efficiently is through the use of proper business forms.



All over-the-counter sales should be written up in a booklet that provides two carbon copies. Use of this form gives your customer a receipt, and supplies you with an accurate record of cash taken in, plus providing a copy for inventory control.

The service bills presented to customers should contain as much information as possible about the set and the services performed. Also, they should be imprinted or stamped with your name and address for the customer's future reference. TriPLICATE forms enable you to use one copy for accounting, and the other for your customer-records file. One-

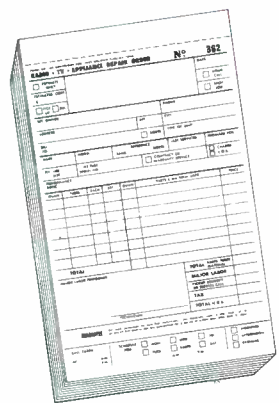

time carbon and *no carbon required* forms cost slightly more per form, but this minor difference is often compensated for in time saved.

Bills, work orders, and service contracts should be designed to spell out your guarantee and the customer's obligation, as a precaution against future disputes and misunderstandings. With a little advance planning, your forms can be arranged so that the customer's signature is a legally binding agreement to one or more of the following: Certifying that work has been performed satisfactorily; releasing you from any responsibility for bodily injury or property damage caused directly or indirectly by the services rendered; or paying the bill in a specified manner. In fact, if your service-order forms contain a complete promissory note imprinted on the back of the file copy, you'll find it easier to make COD collections—simply because many persons would rather pay cash than sign a note. For those who *are* willing to sign, the promissory note is a practical means of extending credit, with prompt recourse if you have any difficulty in collecting.

Many dealers have found it more expedient to use larger forms which have various shop services printed right on the bill. The services per-

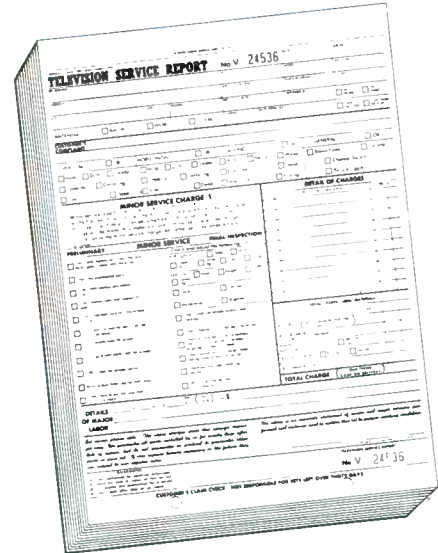

formed can be checked to show the customer exactly what was done to his set. This provides an easy method of billing, and at the same time helps to build better customer relations by indicating the thoroughness of your service.

Statements are used by nearly all service dealers to remind credit customers of bills they still owe. When statement time rolls around, just think how much easier the job would be if your forms were designed so the customer's name and address could be seen through a window in the mailing envelope.

Also, special follow-up statements are available to eliminate the need of writing collection letters or making personal calls when you're trying to collect delinquent bills. These reminders are to the point—yet help you retain customer good will.

If you maintain a service records file, you'll get good use from it whenever a repeat customer calls in for service. A glance at his card gives you all the necessary background information about his electronic equipment, previous services performed, and charges made in the past. A file like this reduces the time you must spend on the phone, and tells you what service data to check so you'll be sure you have

# BUSS and FUSETRON FUSES

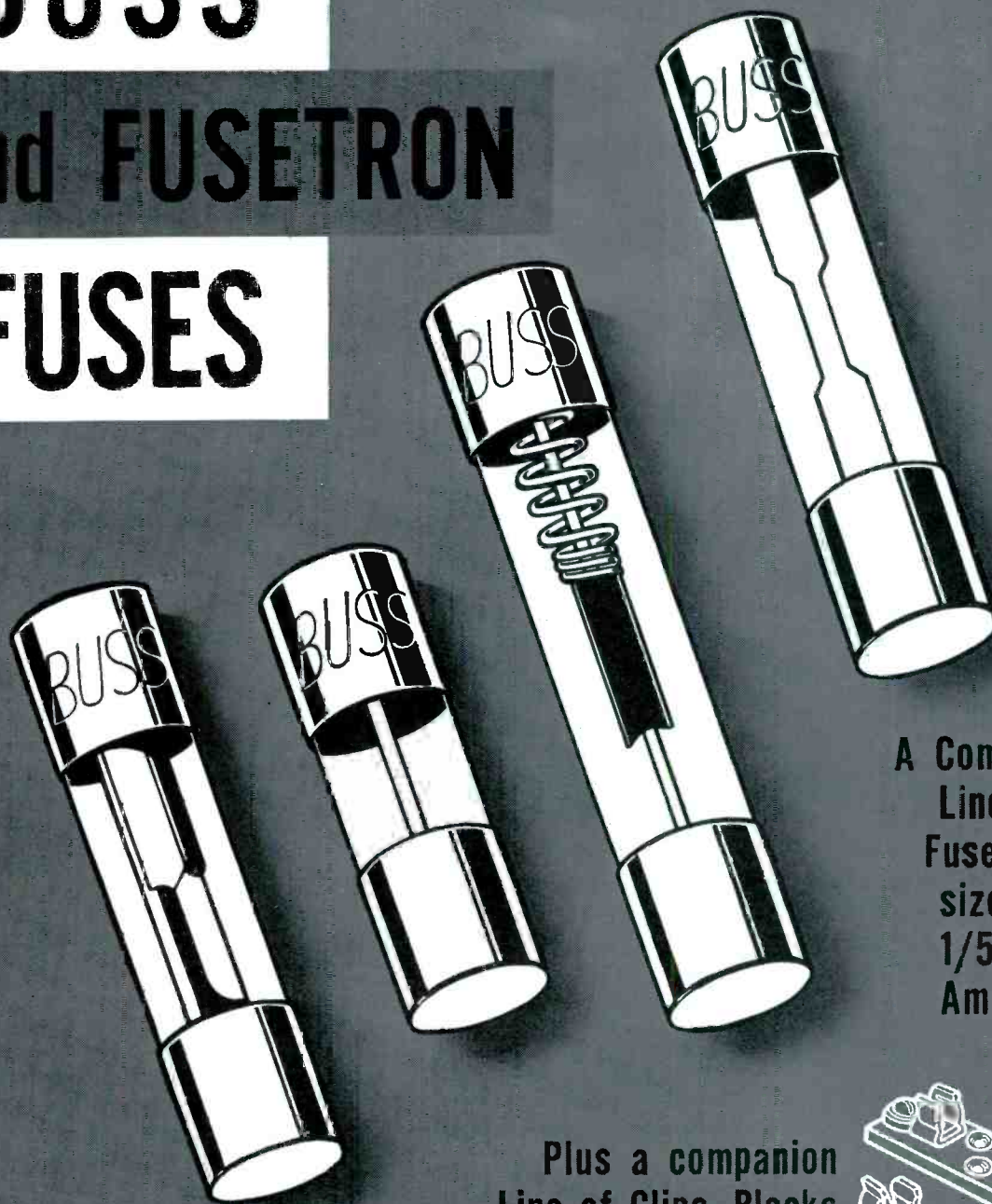

A Complete  
Line of  
Fuses in  
sizes from  
1/500  
Amps. up

Plus a companion  
Line of Clips, Blocks  
and Holders

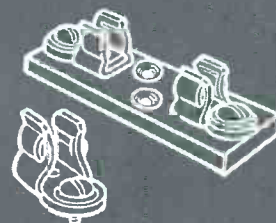

By installing BUSS and FUSETRON fuses, you provide the finest available electrical protection and you safeguard your customers against the possibility of faulty fuses causing trouble.

To assure proper operation under all service conditions, every BUSS and FUSETRON fuse is tested in a sensitive electronic device that

automatically rejects any fuse not correctly calibrated, properly constructed and right in all physical dimensions.

Why risk handling other fuses that might cause service troubles when BUSS and FUSETRON fuses are available?

Write for the BUSS bulletin on small dimension fuses and fuseholders. Form SFB.

661

BUSSMANN MFG. DIVISION, McGraw-Edison Co., UNIVERSITY AT JEFFERSON, ST. LOUIS 7, MO.



# 5 ways Merit makes a better Transformer...

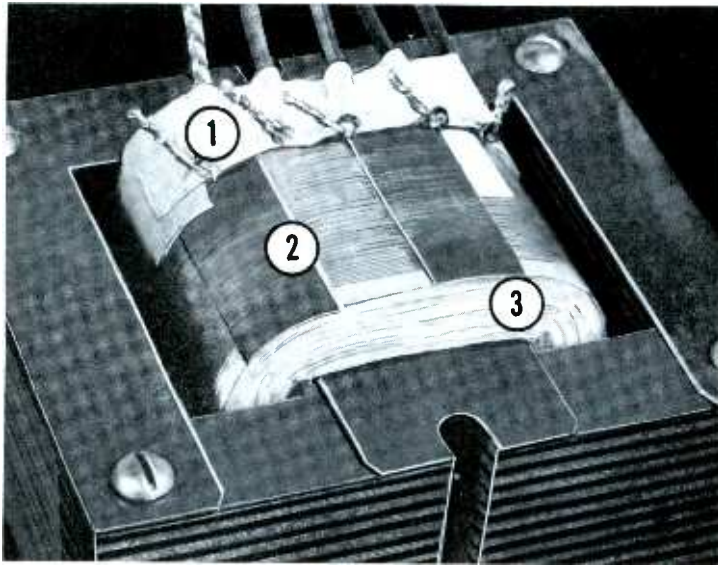

1. New type lead anchorage (saddle) eliminates metal lugs or staples which could corrode and cause ultimate transformer failures.
2. Thermal setting tapes are used instead of inferior, pressure-sensitive tapes.
3. Mylar sheets provide superior inter-winding insulation.
4. Vacuum wax (or varnish) impregnation replaces the wax dipping method to assure **thorough** impregnation throughout the winding.
5. **Individually tested under actual use conditions** to assure many years of operation without failure.



Coil and Transformer Corporation

MERIT PLAZA HOLLYWOOD • FLORIDA



everything you need when you make the service call. It can also serve as a quick reference source for compiling an excellent direct-mail advertising list if you've made it a practice to note which customers are good prospects for future sales.

Copies of repair orders, shop tickets, and other work reports help keep you informed on how productive your bench and outside men are. From such records, you can determine fair but profitable service charges by having accurate information regarding the amount of your overhead costs.

You'll make your entire book-keeping job easier by using the proper forms to keep track of all income and expenses every day. If you keep your own books, you can safely figure on saving an hour or so a week by using a well-planned system of billing and record-keeping. Even if you figure only a modest \$5 an hour for your time, it adds up to a \$20-a-month raise from the additional "earning time" you'll have.

There is an even more important reason for using adequate business forms: With complete records, you'll know where you're headed in business; but without them, you may be going out of business and never know it. ▲





SPECIAL INTRODUCTORY OFFER FROM GENERAL ELECTRIC

**NEW  
G-E STOCK SAVER KIT  
CONTAINS 14  
CAPACITOR TYPES  
THAT MEET 90%  
OF YOUR TUBULAR  
REPLACEMENT NEEDS**

The capacitors with this handy kit are part of General Electric's new line of "Service-Designed" capacitors—each engineered and clearly marked for range of capacitance and voltage requirements. No more guessing or substituting for exact replacements. Save time and cost of single-unit ordering and pickup. With your Stock Saver Kit you can carry a minimum inventory and turn it into profits faster.

The complete "Service-Designed" line—especially designed for replacement sales—contains tubulars, twist-prong and miniature electrolytic and paper Mylar\* types. Reduce from 1,200 to 295 the types needed to make all aluminum electrolytic capacitor replacements.

Get your G-E Stock Saver Kit, plus the most complete catalog and replacement guide ever published, from your G-E capacitor distributor. General Electric Company, Electronic Components Division, Room 7149B, Owensboro, Kentucky.

RECEIVING TUBES • CATHODE RAY TUBES • CAPACITORS  
"COMPACTRON" DEVICES • AUDIO ACCESSORIES

*Progress Is Our Most Important Product*

**GENERAL  ELECTRIC**

\*T.M. duPont Company



JUST  
**\$17.95**  
A REGULAR  
\$35 VALUE

## A Scuffed 2N235

Sometimes the cause of transistor damage is readily obvious, as in Fig. 1. This particular transistor was mounted in a Ford Model 75BF set which was blowing fuses one after the other. As soon as the radio was removed from the car, a scuffed spot on the transistor dome (light-colored area in photo) was apparent. Inspection under the dash turned up a loose bracket which had been rubbing on the transistor dome, thus grounding the collector and destroying the transistor. The service job consisted merely of tightening the bracket and bending it out of the way, replacing the transistor, adjusting its circuit for correct bias, and reinstalling the radio in the car.



Fig. 1. The damaged spot on transistor case was evidence of a short to ground.

### Voltmeter Turns Up Clue

The transistor in a Motorola radio was definitely known to be shorted, so a replacement was obtained. Before it was installed, the bias adjustment was set for minimum collector current. This step is not at all involved; it consists simply of measuring the voltage difference between the emitter and base connections as shown in Fig. 2, and setting the bias control to reduce this voltage to minimum.

In making the preadjustment in this set, it was revealed that the control intermittently shorted out. Obtaining a new control was easy, but mounting it was not. The old control was mounted by way of a two-ply fiber sandwich, which was in turn riveted to the chassis—easily done in manufacturing, but not in servicing! Mounting was finally accomplished by adding an insulated wiring strip, and connecting the new control from this point to a terminal of a wiring strip already in the set. After mounting the control and set-

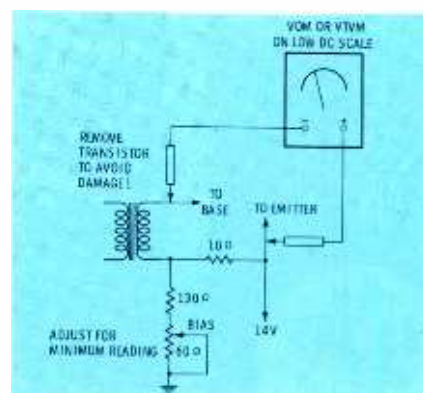

Fig. 2. Preliminary bias check protects new transistor and reveals troubles.



### Another Fuse-Eater

The owner of a Chevrolet 987727 complained that a loud noise came from the speaker immediately before the fuse blew, so the serviceman suspected that the transistor might be momentarily lapsing into collector-current runaway. Bench-testing the set revealed that the total current drain was normal, and that the bias was set for normal collector current. No wiring fault on the 12-volt line was found, though it was noted that the rather elaborate heat sink was spaced unusually close to the bottom cover. Further, when the set was vigorously shaken, sparks flew from the heat sink to the cover, and with each spark the current drain increased to about seven amps. Cementing fiber strips to the heat sink where the arcing had been taking place resulted in a complete cure.

Why the transistor was not harmed when its collector was grounded can be determined from a study of transistor ratings, which shows that the 2N278 used in this set can safely draw 12 amperes of collector current.

### Troubleshooting with Test Equipment

Not many troubles can be spotted merely by inspection, as in the cases just described. However, as the next case will demonstrate, the reasons for transistor damage can often be explained with the aid of test equipment—sometimes even before the replacement transistor has been installed.

The ruggedness of power transistors used in hybrid auto radios has apparently impressed most technicians who have been servicing them since their inception some five years ago. While other components used in these sets are prone to the same types of failures as similar components in all-tube sets, transistor failure is uncommon enough so that when it does occur, the wise serviceman seeks (and usually finds) something else contributing to the trouble.

Two common causes are grounding of the transistor collector (case) or heat sink, and circuit or component defects causing incorrect biasing of the transistor. The following case histories give typical examples.

# NEW SENCORE Transi Master

**Analyze Every Transistor Circuit  
Trouble in Minutes!**

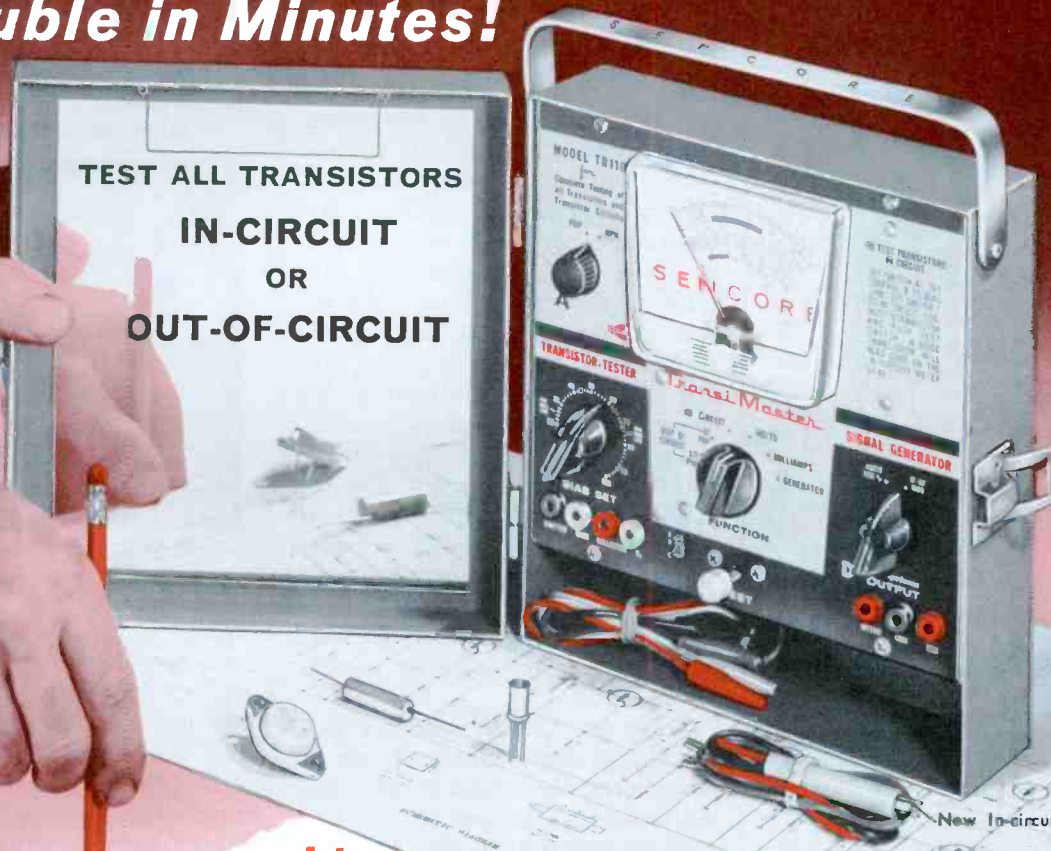

Model TR-110  
ONLY **49<sup>50</sup>**

**Now you can . . .**

**It's a . . . COMPLETE TRANSISTOR TESTER • SIGNAL TRACER  
VOLTMETER • BATTERY TESTER • MILLIAMETER**

Transistors are tested in-circuit with a new unique AC GAIN check and out of circuit with an accurate DC GAIN and LEAKAGE check. Set-up chart included for reference only.

- Test all transistors in-circuit with a new unique AC GAIN check. It works every time and without the use of the set-up booklet.
- Test all transistors out of circuit with the AC GAIN check or with a more accurate DC current gain and leakage check.
- Read current gain (beta) direct for experimental, engineering work or for matching transistors.
- Check diodes simply and accurately with a forward to backward ratio check.
- Signal trace from speaker to antenna with a special low impedance generator. No tuning, adjustments, or indicating device needed for transistor radio trouble shooting. Just touch output leads to transistor inputs and outputs until 2000 cycle note is no longer heard from speaker. (Generator output monitored by meter.) It's a harmonic generator for RF-IF trouble shooting and a sine wave generator for audio amplifier trouble shooting.
- Check batteries under operating conditions as well as the voltage dividers with a special 12 volt scale.
- Monitor current drawn by the entire transistor circuit or by individual stages with a 0 to 50 Ma current scale. A must for alignment and trouble shooting cracked boards.

### **Benefit from these Sencore extras**

- Lists Japanese equivalents.
- Automatically determines NPN or PNP.
- Mirror in detachable cover to reflect opposite side of printed board.
- Special clip to fit between batteries for current check.
- Transi-probe for making in-circuit transistor checks.

Color . . . . . modern two tone gray  
Size . . . . . 8" x 7<sup>7</sup>/<sub>8</sub>" x 3"  
Weight . . . . . only 5 lbs.  
Meter . . . . . 0 to 3 Ma, 3<sup>1</sup>/<sub>2</sub>", 5% tolerance,  
modern plastic  
Batteries . . . . . two size "C" cells

ALL PARTS ARE **SENCORE** MADE IN AMERICA

**SENCORE**  
ADDISON, ILLINOIS

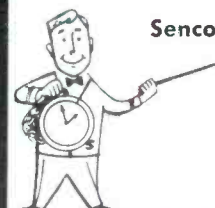

Sencore Sam says, "You'll save hours servicing transistor circuits. Only 49.50, see it at your distributor."

## Outstanding **SAMS** **AUDIO BOOKS**

available from your Sams Distributor



**Electronic Organ Handbook.** Only book of its kind. Provides complete and accurate data for the servicing and maintenance of all the most popular organs. Over 1,000,000 are now in use, representing a lucrative service market this book will help you enter. 272 pp., 5 1/2 x 8 1/2". No. EOA-1. Only. **\$4.95**

**Industrial Sound Systems.** Fully describes installation, operation and servicing of commercial and industrial sound and intercom systems. Covers amplifiers, input devices, control circuits, portable and mobile equipment, distribution methods, etc. 276 pp., 5 1/2 x 8 1/2". No. ISS-1. Only. **\$3.95**

**The Audio Cyclopaedia.** Comprehensive reference on every phase of audio, with accurate explanations of all subjects in the field — the accepted authority on every aspect of sound and audio. No other work like it. 1280 pp. No. ACT-1. Only. **\$19.95**

**From Tin Foil to Stereo.** The whole fascinating history of the phonograph from the use of tin foil down to the stereo record. An exciting story, illustrated with dozens of rare photographs. 576 pp., 6 x 9". No. EPR-1. Only. **\$9.95**

**Servicing Hi-Fi & FM in the Customer's Home.** Gives easy-to-apply methods for servicing amplifiers, tuners, turntables, changers, and tape recorders, using just a VTVM or VOM. A practical guide for on-the-spot troubleshooting. 160 pp., 6 1/2 x 8 1/2". No. SHK-1. Only. **\$2.95**

**Attenuators, Equalizers and Filters.** Describes design, application and theory of operation of every type of attenuator, equalizer and wave filter used in audio, recording and reproducing systems. 176 pp., 5 1/2 x 8 1/2". No. AET-1. Only. **\$2.75**

### Record Changer Manuals

PHOTOFACT coverage giving full servicing data for most popular changers produced during years shown.

Vol. No.	Model Year	Each
RC-12	1958-59	\$2.95
RC-11	1957-58	2.95
RC-10	1956-57	2.95

### Tape Recorder Manuals

Full PHOTOFACT coverage for easy servicing of popular model tape recorders. Makes proper repair and adjustment a cinch.

Vol. No.	Model Year	Each
TR-5	1958-59	\$2.95
TR-4	1958	2.95
TR-3	1957-58	2.95
TR-2	1957	2.95
TR-1	1956-57	2.95

### Hi-Fi Manuals

PHOTOFACT service data covering popular makes of Hi-Fi amplifiers and tuners. Full information on each piece of equipment.

Vol.	Coverage	Each
HF-5	Tuners produced in 1958-59	\$2.95
HF-4	Preamps & Amps (1957-58)	2.95
HF-3	Tuners (1957-58)	2.95
HF-2	1956-58 Equipment	2.95
HF-1	1956-58 Equipment	2.95

## HOWARD W. SAMS & CO., INC.

1720 E. 38th St., Indianapolis 6, Ind.  
In Canada: A. C. Simmonds & Sons, Ltd., Toronto 7

ting it for minimum voltage difference between base and emitter, the serviceman installed the new transistor and adjusted it for correct collector current according to instructions given in service data.

### Scope Explains Reason for Trouble

The owner of a Ford 75BF was not highly impressed by transistors, and with good reason. This was the third time in a little over a year that the transistor needed replacing. Before removal of the set from the car, an under-dash examination was made to be sure that the collector was not grounded. No such condition existed, but it was noted that a rear-seat speaker had been added, along with a speaker-selector switch.

The set operated normally on the bench after the transistor was replaced. Failing to find any reason for transistor breakdown, the serviceman reflected on the possibility of transistor breakdown being due to the rear-seat speaker hook-up. This thought led to the following experiment:

Using two speakers and a switch which alternately connected one or the other to the output transformer, the serviceman hooked his scope to the collector terminal. Fig. 3A is the scope trace obtained with the volume control turned to minimum. The waviness of the line is due to power-supply hum, and the sharp pulse spikes occurred when the switch was used to change speakers.

Fig. 3B was taken when the volume was advanced for barely perceptible sound. Note that the pulse amplitude increased far more than the hum and audio. The pulses grew even more rapidly as the volume was advanced, soon reaching a ratio of 20 volts peak-to-peak of pulse to less than one volt of audio. Further readings indicated that, if the set were operating at 200 to 400 milliwatts of audio output, the pulse voltage would probably rise to as high as 1200 to 1500 volts—a value capable of destroying the transistor. Not wishing to take this risk, the serviceman never turned the volume up enough to find out for sure.

The set was returned to the car only after the speaker switch was replaced with a variable control to fade one speaker in while fading the other out. (Either of the circuits shown in Fig. 4 would have worked

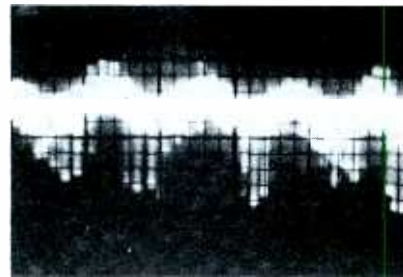

(A) At minimum volume setting.

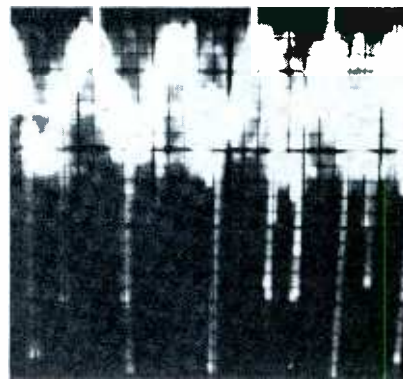

(B) With sound barely audible.

Fig. 3. Pulses due to speaker switch.

equally well.) The trouble analysis must have been correct, for this set was serviced over two years ago, and the transistor installed at that time is still going strong.

By the way, pulse damage to transistors has been a thorn in the side of engineers when testing transistor circuits with square waves. The pulses are produced by overshoot on the leading and trailing edges of the square wave.

The scope also helped solve a different problem in another Ford radio of the same type. The complaint was a peculiar form of distortion which had neither the rattle nor rubbing raspiness that ordinarily distinguishes speaker distortion. Instead, it had all the earmarks of signal clipping. Deciding that a re-adjustment of the bias control might be sufficient to cure this trouble, the serviceman removed the radio, leaving the speaker in the car.

The set played normally through the bench speaker, so the original speaker was removed from the car. When it was hooked up to the set, distortion reappeared. The speaker cone had no perceptible fault (rattle, looseness, nor rubbing). A scope was used to compare the performance of the suspected speaker with that of a new one. Fig. 5A shows the audio signal at the collector with the new speaker connected, while Fig. 5B is the scope trace at the same

# NEW

## From a deluxe

# VTVM to a VOM with the flick of a switch!

Typical examples where a VTVM performs best . . .

- minimum circuit loading
- very high resistance measurement
- measuring peak to peak voltage
- alignment, AGC trouble shooting or ratio detector touch up
- reading 2nd anode voltage
- transistor radio voltage measurements

Typical examples where a portable VOM is best . . .

- instant action when you can't wait for warm up and stabilization. The VTVM can be warming up while you are using the VOM.
- working on a hot TV chassis
- checking anything remote where power isn't available such as antennas, auto, etc.
- reading DC current

And look at these specifications!

### Voltage

6 AC and DC ranges from 0 to 1000 volts on both VTVM and VOM  
 5 peak to peak ranges from 0 to 2800 volts peak to peak on VTVM  
 Zero center scale on VTVM

### Resistance

6 ranges from 0 to 1000 megohm on VTVM  
 2 ranges from 0 to 1 megohm on VOM

### Current

one easy reading scale from 0 to 1000 milliamp on VOM

### Batteries

one 1.5 volt "D" cell

### Accuracy

3 percent on DC volts; 5 percent AC volts with a 6 inch, 200 microamp, 2 per cent meter.

### Circuit Loading

10 megohms on VTVM, 15,000 ohms on VOM low range, 5 megohms on highest range.

For the First Time in Electronic History . . . a VTVM with laboratory accuracy for bench, lab, or anywhere 115 volt AC current is available . . . flick the function switch and it's a portable VOM that you can use anywhere, anytime.

*Look! Another Sencore first . . . automatic scale indication. What a time saver! Rotate the controls and watch the indicating lights follow you. You can't go wrong!*

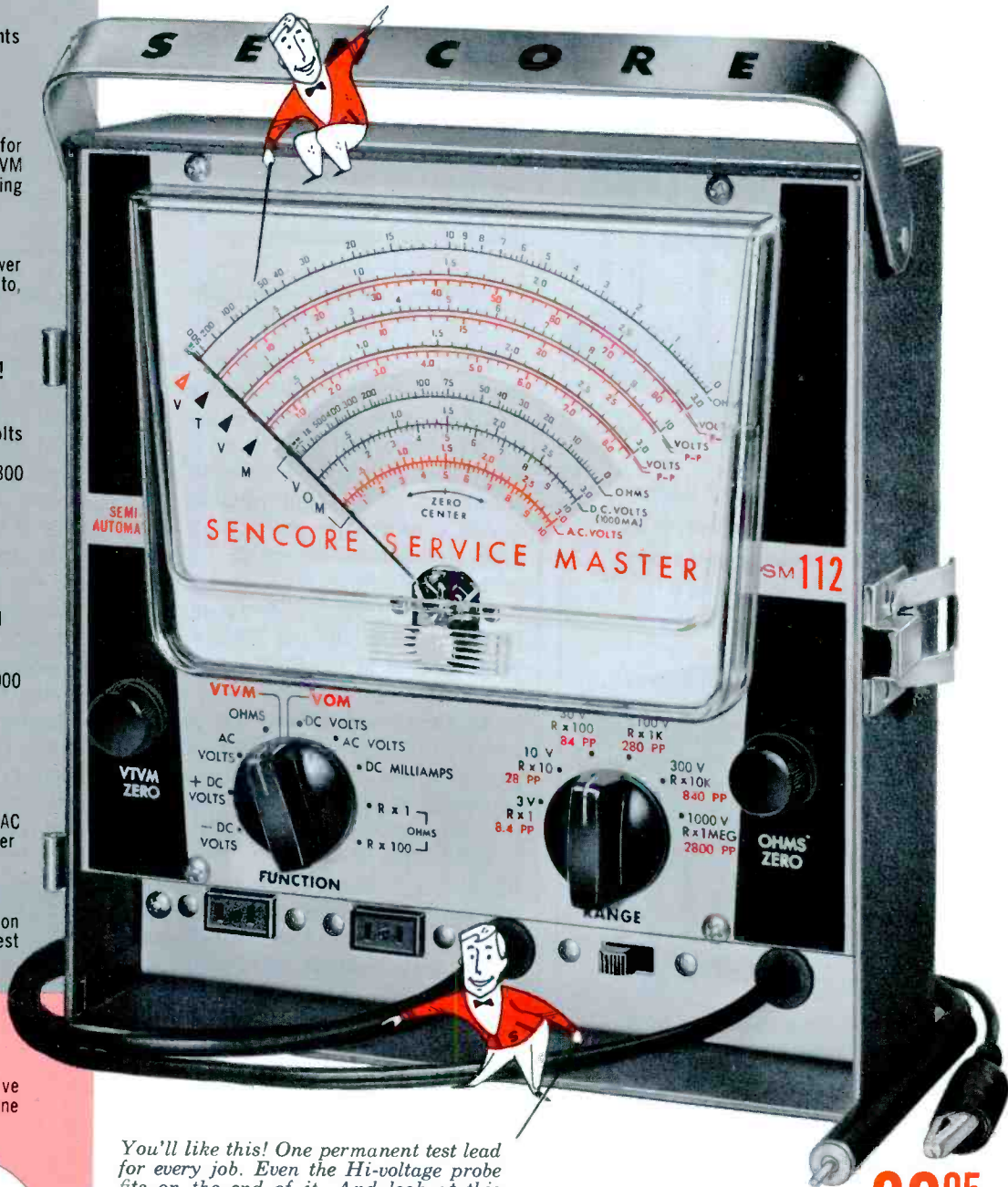

### Special Servicing Features for the Man on the Go!

Unbreakable steel case and protective removable cover. No leads to drag or line cord to "hank".



Inside the cover is a real surprise: short cut technical data to make every job easier and faster . . . standard transformer lead color code, fuse resistor burn out voltage, transistor testing guide, etc.

*You'll like this! One permanent test lead for every job. Even the Hi-voltage probe fits on the end of it. And look at this storage compartment for test lead and line cord. The two 115 volt AC outlets sure come in handy on service calls!*

# 69<sup>95</sup>

Model SM112 Only  
 No more than a complete VTVM alone!

Ask your Sencore distributor for the New Combination VTVM-VOM - there is no other!

MADE IN AMERICA



BY AMERICANS

# SENCORE

ADDISON, ILLINOIS

# COLOR CODED NUTDRIVER SETS

no fumbling...  
you reach for  
the right one  
every time!



No. 17  
HANDY  
BENCH STAND

- 7 Most-used sizes —  $\frac{3}{16}$ " thru  $\frac{3}{8}$ "
- High carbon steel, polished and plated
- Precision fit case-hardened sockets
- Shockproof plastic handles (UL)
- Large, readable size indexes



No. 127  
SPACE-SAVING  
WALL RACK (Lockable)

OTHER SETS, TOO: hollow-shaft or mixed  
PLUS A FULL RANGE OF SEPARATE NUTDRIVERS:  
 $\frac{3}{32}$ " thru  $\frac{3}{4}$ " — Regular, Stubby, Extra-long,  
Midget (Pocket clip)  
available through leading electronic distributors

XCELITE, INC. — ORCHARD PARK, N. Y.  
Canada: Charles W. Pointon, Ltd., Toronto, Ont.

## XCELITE

### HAND TOOLS

Quality screwdrivers, nutdrivers, pliers,  
wrenches, service kits, and special purpose tools.

point with the original speaker attached to the set. Note the clipping in the second waveform. The volume control was set at a normal listening level in both cases.

An ohmmeter indicated that the voice-coil resistance was much less than normal. Dismantling the cone revealed a badly charred voice coil. Apparently, with the enamel burned, adjacent turns were shorting; this accounted for the low resistance.

The serviceman deduced that at one time the ground end of the output transformer was open, allowing the collector current to flow through the voice-coil winding. This suspicion was borne out by a close inspection which revealed a poorly-soldered ground connection.

#### More on Bias-Control Preadjustment

The precaution of setting up minimum base-emitter bias before installing a new transistor is an extremely important step in servicing any circuit containing a variable bias control. It matters not whether the circuit conforms to the commonly-used arrangement shown in Fig. 2, or to the alternate hook-up of Fig. 6, nor will it matter if the manufacturers eventually use NPN transistors instead of the PNP types now universally used.

As mentioned before, setting the control for minimum voltage difference between emitter and base assures that transistor current will be at a minimum when a transistor is inserted into the circuit. Furthermore, this preliminary check of voltage can also detect other circuit conditions which might possibly damage the transistor, simply by application of Ohm's law to the known circuit values. For instance:

In the circuit of Fig. 2, with the control at maximum resistance, the current through the bias-circuit voltage divider would be equal to the applied voltage (14 volts) divided by the total resistance ( $10 + 130 + 60$ , or 200 ohms). This figures out to .07 amp. This much current flowing through the 10-ohm leg of the voltage divider would produce .7 volt between the base and emitter of the transistor. On the other hand, with the control at the minimum-resistance setting, the current would be  $14/140$  or .1 amp, and the volt-

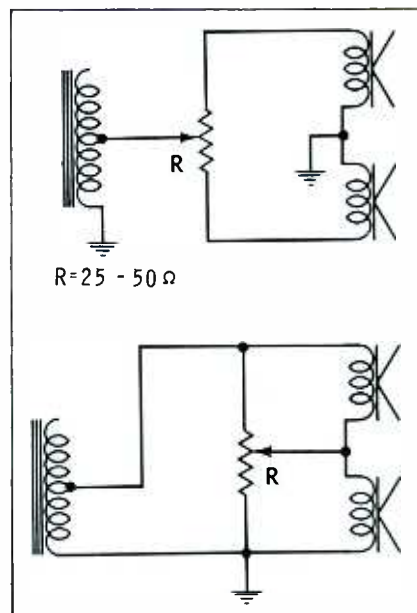

Fig. 4. Two types of fader-control circuits for front and rear auto speakers.

age drop between base and emitter would be 1 volt. A noticeable difference between these calculated values and the measured values would be a sign of a faulty resistor, a leakage path through the transformer, or some other potential cause of trouble.

The foregoing calculations show that the control should be set at maximum resistance before the transistor is wired into the circuit. An ohmmeter could be used to determine the correct setting, but the voltmeter check between base and emitter is usually easier and more effective in revealing troubles. Relying on a voltmeter also gives a more foolproof check, for the ohmmeter test has a deadly pitfall: *The*

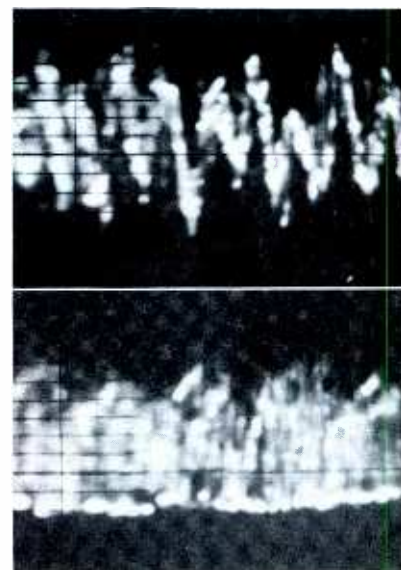

Fig. 5. Normal audio versus clipping distortion caused by speaker mismatch.

# NEW! RCA High-fidelity tube gives to RCA VICTOR COLOR TV the truest, sharpest picture ever- with up to 50% more brightness



The new RCA High-Fidelity tube is by far the biggest improvement in Color TV since RCA introduced the first 3-gun color tube years ago!

It's the result of unending research and development at RCA, the only manufacturer in the U.S. now commercially producing color television picture tubes.

**How does it differ from previous color TV tubes?** This new RCA tube features a phosphor-dot screen utilizing a new sulphide group of color phosphors. This outstanding new phosphor group is more efficient, producing color pictures up to 50% *brighter!* It has medium short persistence to provide *sharper pictures* on rapid-action scenes and produces white light with nearly equal current from each of the three electron guns. As used in the new receivers, this adds up to more beautiful color pictures . . . remarkably clear black-and-white pictures!

Furthermore, it incorporates all of the previously announced RCA improvements in color picture tubes such as graded-hole shadow mask, simplified color-field set-up, and an all-glass envelope.

This important Color TV development will stimulate interest *and sales* . . . and will encourage even more manufacturers to enter the color field. For further information about the new RCA High-Fidelity Color Tube, contact your RCA Victor Distributor.

TMS(R)®



The Most Trusted Name  
in Color Television

RADIO CORPORATION OF AMERICA

maximum-resistance setting of the control does not establish minimum bias in all circuits! In Fig. 6, where the control is in the emitter-to-base leg of the voltage divider, a minimum-resistance setting is required. This can again be proved by Ohm's law. At minimum resistance, the base is shorted to the emitter, and there is no bias. However, at maximum resistance, a 7.5-ohm resistance between base and emitter is in series with a 100-ohm resistance, for a total of 107.5 ohms. The current (E/R) is  $14/107.5$ , or .13 amps, and the base-emitter voltage (IR) is

$.13 \times 7.5$ , or .975 volts. Once again, if you find discrepancies from the calculated bias value, look for trouble.

#### More Service Hints

Heavy current flow resulting from a defect in an auto-radio output circuit can produce hidden damage which, if not detected, may cause repeated burnout of transistors. Therefore, before a bad transistor is replaced with the recommended type, it is often wise to use a low-cost type as a temporary test unit. Then, if the transistor fails, it costs

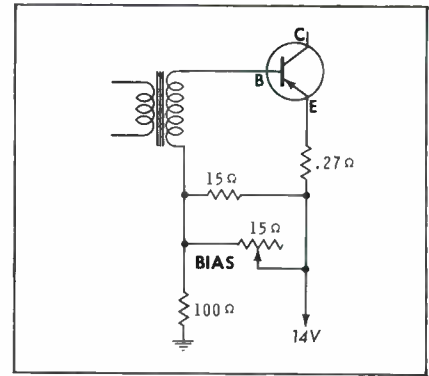

Fig. 6. Bias control is sometimes in base-emitter leg of the voltage divider.

you less to find out that you still have trouble in the circuit. When using one of these lower-cost types, do not attempt to adjust the bias control for the full value of collector current specified in the service data for the radio, but stay within the more modest current ratings of the substitute unit.

These ratings depend largely on the amount of heat generated, and one of the best ways to assure long transistor life at full output is to maintain good contact between the collector and the heat sink to which it is attached. For maximum heat transfer, silicone grease should be spread on both surfaces to fill in the many microscopic gaps in the contact area.

Improper use of heat sinks, and several other obvious faults in installation, are to blame for numerous failures of output transistors. Therefore, a quick physical inspection is enough to reveal the cause of many troubles. Most other service problems can be solved by following the simple test procedures described in this article. ▲



## BUY A DOZEN VU-BRITES



... get the Tool Kit  
**FREE!**

Eight American-made wrenches—to give you every wrench needed to service all volume controls and all TV knobs with set screws—yours free with the purchase of 12 Vu-Brites!

### WHAT A DEAL!

For a limited time, Perma-Power is offering you this wonderful gift absolutely free with the purchase of 12 Vu-Brites at the regular price. Vu-Brites are the brighteners that really do a job—on series or parallel sets (Model C401 for parallel; Model C402 for series). They come colorfully packaged in individual boxes . . . and are priced at \$9.95 the dozen, net.

Hurry—this special gift offer will end when current stocks are gone. Call your distributor today.

**Perma-Power** COMPANY  
3102 N. ELSTON AVENUE • CHICAGO 18, ILLINOIS



# New Sylvania Technique eliminates erratic pin soldering

*Picture tube callbacks due to "open-pin connections" dramatically reduced*

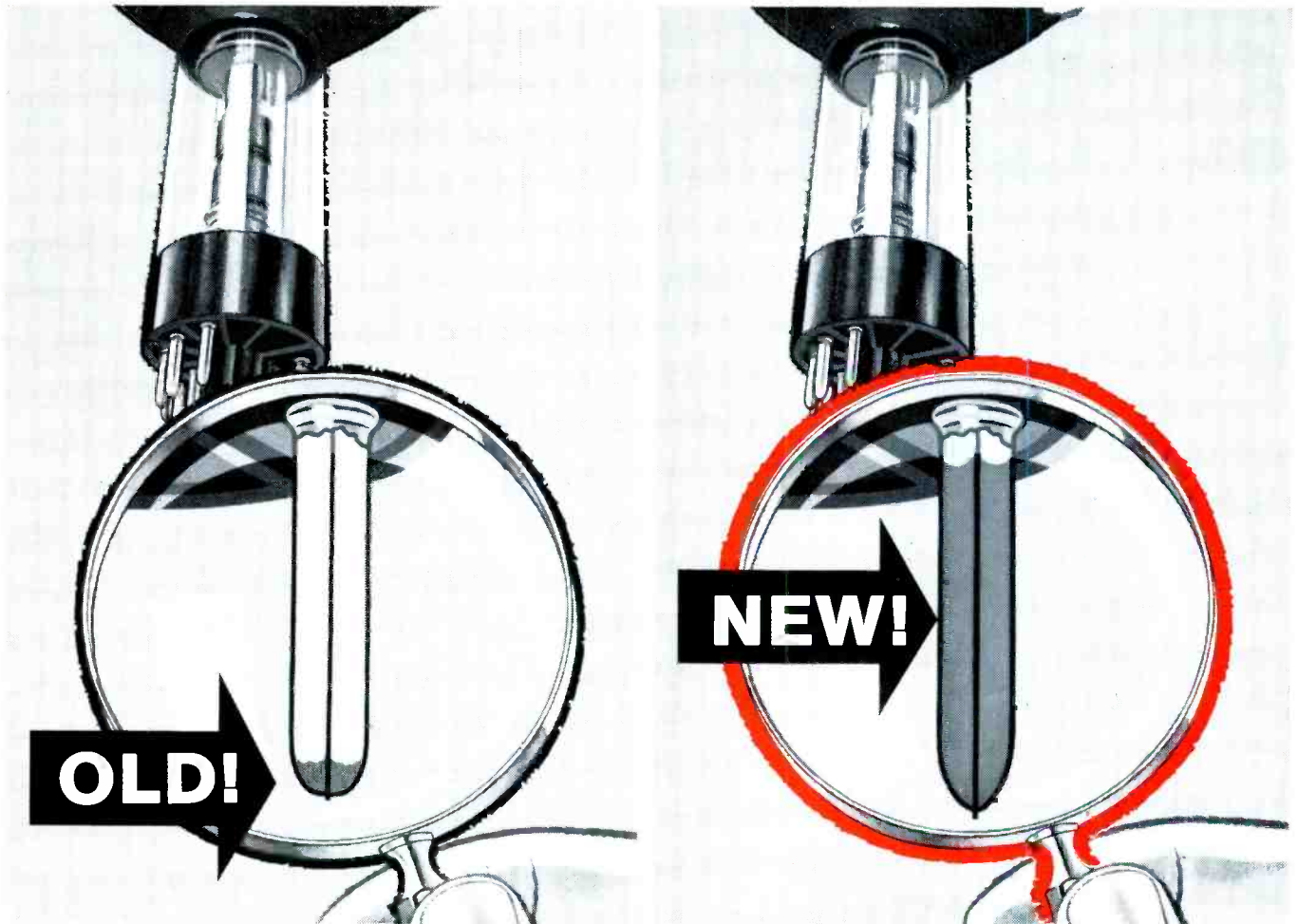

The "old" conventional pin soldering method relied upon contact between pin and wire only at their tips.

New Sylvania pin soldering technique extends solder far up into the pins—provides maximum contact with the wire—assures low electrical resistance and high mechanical strength.

What does the new Sylvania pin soldering technique mean to you? It means the solution of a long-standing, industry-wide pin soldering problem. Callbacks will be reduced—crimping and resoldering will be a thing of the past.

Thousands of service technicians have proven for themselves—in millions of service calls—that Sylvania SILVER SCREEN 85 TV PICTURE TUBES are the surest way to build a better business. You should, too. Electronic Tubes Division, Sylvania Electric Products Inc., 1740 Broadway, New York 19, N. Y.

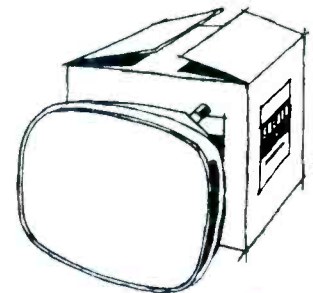

# SYLVANIA

SUBSIDIARY OF

## GENERAL TELEPHONE & ELECTRONICS



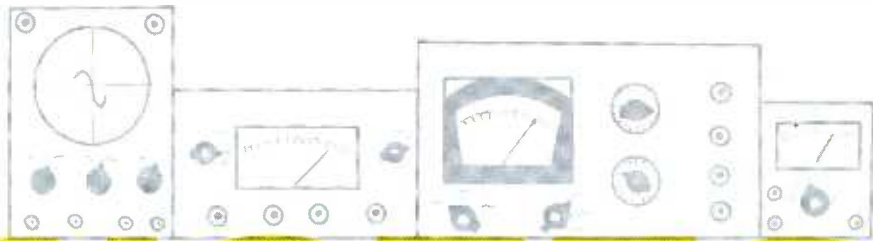

# NOTES

## ON TEST EQUIPMENT

by Les Deane

### Variable Power Source

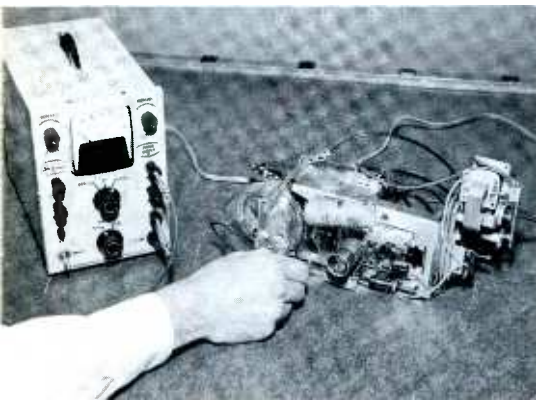

Fig. 1. Jackson unit supplies variable positive and negative DC; 6.3V AC.

Jackson Electrical Instrument Co. of Dayton, Ohio now has in production a regulated power supply, the Model 607. This compact unit, shown in Fig. 1, furnishes three output voltages — regulated positive DC, negative DC, and an AC heater supply. Of the five vacuum tubes in the instrument, three are for regulation of the positive DC output.

Specifications are:

1. *Power Requirements*—105/125 volts, 60 cps; *power consumption* approximately 10 watts with no load, 105 watts maximum; *power switch and ON indicator* provided on panel; *supply lines* isolated and fused.

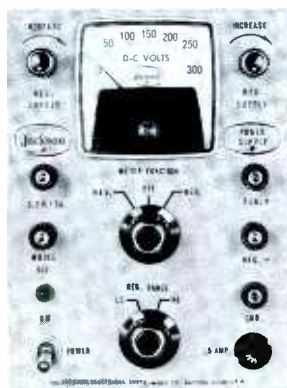

Fig. 2. Output voltages are taken from universal-type binding posts on panel.

2. *Positive Output*—continuously variable from 150V to 300V DC in two ranges; maximum current load 100 ma; regulation maintained within 1.5% from 0 to 100 ma at 300V; ripple less than .005% under maximum load.
3. *Negative Output*—continuously variable from 30V to 275V DC with no load, and from 15V to 150V DC at maximum load of 20 ma; ripple less than .003% under maximum load.
4. *AC Output*—6.3V AC at 60 cps; maximum current rating 3 amps.
5. *Other Features* — voltmeter with full-scale reading of 300V, for monitoring either positive or negative DC outputs; metering selector, HI-LO range switch, and universal-type binding posts provided.
6. *Size and Weight*—steel case 8 1/4" x 5 3/8" x 9 3/4", 10 1/4 lbs.

All output terminals and operating controls are located on the front panel (Fig. 2). The knob labeled NEG-OFF-REG is merely a function switch for the meter; its setting has no effect upon the potentials at the various output terminals. Directly beneath this knob is a HI-LO switch for selecting the desired range of regulated positive DC voltage—either 150-225 or 225-300 volts. Controls for selecting the exact positive and negative DC output voltages are located in the upper corners of the panel. Since the

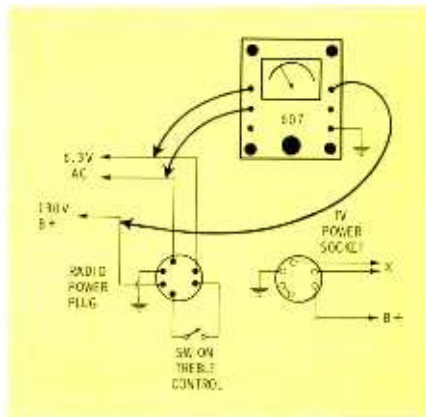

Fig. 3. Model 607 furnishing power to a portion of radio-phono combination.

positive and negative outputs are obtained from separate rectifier circuits, a load should not be connected between the REG+ and NEG- supply terminals in an attempt to increase the total output voltage available.

On the service bench, the Model 607 is handy for supplying B+ and heater power to many different types of sub-chassis which do not have self-contained power sources. (See Fig. 3.) Most radio-TV-phono combinations and hi-fi consoles have one or more units of this type—for example, the radio tuner and audio amplifier. It is often possible to isolate trouble to one of these sections during a home call. If an external power source is available at your bench, you can pull the defective subchassis for servicing and leave all the other sections in the cabinet.

An independent source of B+ and heater voltages also makes it practical to remove a TV tuner from the main chassis and install it in a test jig for maximum convenience in troubleshooting and alignment. Another application is in servicing certain models of TV remote-control receivers which require an external power supply. In all of the above uses, the power requirements of the load circuit are well within the capabilities of the Model 607.

The 6.3-volt AC output of the instrument, which can be substituted for the original heater supply of one or more tubes on a transformer-powered chassis, comes in handy for several troubleshooting procedures. For instance, it can be used to check for heater-to-cathode leakage in a picture tube. This condition may cause hum bars, loss of video, or loss of control over brightness, since the cathode circuit is shunted by the low resistance of the heater circuit. Powering a CRT heater from the 607 isolates it from the rest of the TV heater circuit, thus breaking the low-resistance path from cathode to ground. If the picture returns to normal during this check, you have proof of heater-cathode leakage. The CRT can then be replaced, or a brightener of the isolation-transformer type can be installed to nullify the effect of the leakage.

Of course, the above applications represent only a few of the uses for a portable power supply. The Model 607 would be useful wherever a well-regulated power source with moderate power output is needed.

### Cap Analyzer

The impact of transistorized circuitry on the service business not only has brought transistor checkers into being, but also has led to the modification and redesigning of other component testers. A case in point is the capacitance-bridge instrument pictured in Fig. 4, which features low-voltage tests for types of capacitors found primarily in transistorized equipment. This unit, the Model TCA-1 *Transfarad Capacitor Analyzer*, is manufactured by Sprague Products Co., North Adams, Mass.

Specifications are:

1. *Power Requirements*—105/125V, 60 cps only; *power consumption* 40

# WHAT YOU'LL NEED TO SERVICE THE ALL-NEW 1962 DELCO RADIOS

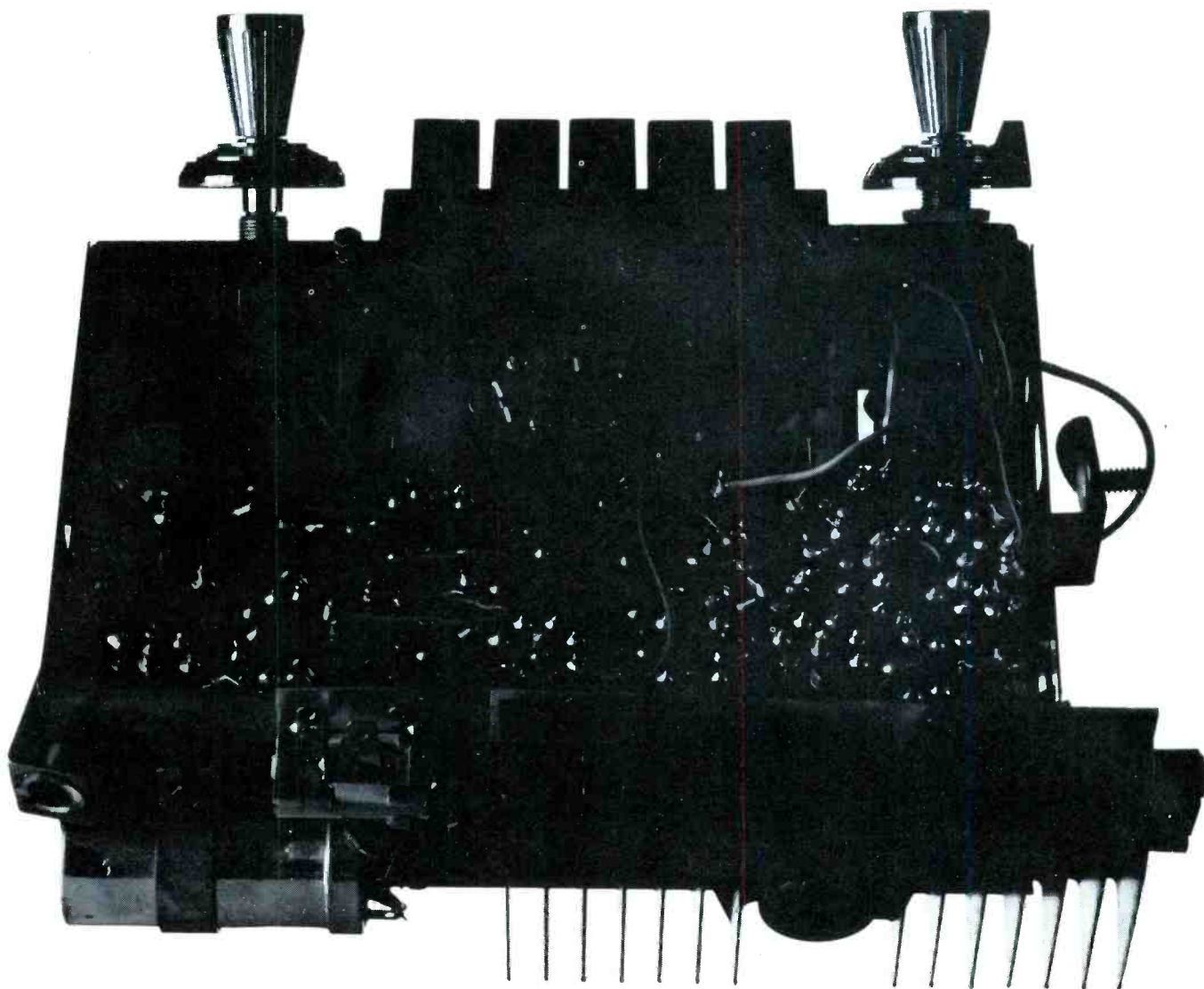

Very soon now you'll be able to see for yourself the big change we've made in the new model Delco Radios for General Motors 1962 cars. ■ To service them we have a special new parts package. It contains the 1962 parts—parts that are popular and fast moving. No "dogs"—we assure you! ■ Your Delco Electronic Parts Distributor will undoubtedly be swamped with orders for this new parts package (part #1962). So we can't urge you strongly enough to get your bid in early and have the new Delco parts on your shelf the day the new GM cars are on the street. ■ The service dealer who can take care of customers right away gets the most customers to take care of. We sure hope you'll be the one.

**DELCO**  
**RADIO**  
RELIABILITY

DIVISION OF GENERAL MOTORS · KOKOMO, INDIANA

**FAST,  
ACCURATE TESTERS  
FOR C/B INSTALLATION  
AND ALIGNMENT BY  
SECO**

**TRANSMITTER TESTER**

Designed especially for citizens band (C/B) and other low power transmitters up to 160 MC. Calibrated for direct percentage reading of amplitude modulation; 0-5 watts RF output; 0-400 ma. RF output. Connection provided for headphones or scope.



**MODEL 510**—complete with all necessary cables and adapters  
**\$46.95 NET**

**2-WAY RADIO TEST SET**

Combination Crystal Checker, RF Signal and Field Strength meter—ideal for C/B. 0-50 ma. meter for final amplifier tuning. Use as RF output indicator. Checks activity on third overtone transmitter crystals—checks fundamental and high overtone crystals at fundamental frequency. Powered by two 1.5 c. "C" cells.



**MODEL 520**—complete with instructions  
**\$42.95 NET**

**ANTENNA TESTER**

For 50 ohm coaxial transmission line applications. 1000 watt maximum dual air cylinder coupler inserts no error up to 160 MC. Simplified direct reading scales give quick GOOD-POOR results as well as percent. Direct reading of FORWARD POWER and REFLECTED POWER. 0-10, 0-100 and 0-1000 watt ranges



**MODEL 500**—wired and factory tested  
**\$29.95 NET**

**ATTENU-LOAD**

Ten db "T" pad attenuator for reducing power levels by ratio of 10 to 1 . . . fully shielded 50 ohm termination for coaxial cable applications.



**Model 511A**—  
**\$21.50 NET**

**SECO TUBE TESTERS**

**GRID CIRCUIT TUBE TESTER**—Tests for Grid Emission, leakage, shorts and gbs in one operation! Two new exclusive tests—Cathode Continuity Check and Inter-element Short Test with short identified to pin number. Easy to operate.  
**MODEL GCT-9 \$32.95 NET**

**GRID CIRCUIT & TUBE MERIT TESTER**—Offer complete TV tube type coverage—incorporates patented Seco Grid Circuit Test plus reliable Cathode Emission Test—also checks filament continuity and provides open element test.  
**MODEL 78 \$69.50 NET**

**DELUXE COMPLETE TUBE TESTER**—Three complete tests: Dynamic Mutual Conductance Test on pre-wired chassis—Cathode Emission Test for all tubes by free point selector system—"Good-Bad" meter indicates merit. Nationally accepted Grid Circuit Test.  
**MODEL 107 \$139.50 NET**

**DYNAMIC TRANSISTOR CHECKER**—checks transistors "in" or "out" of circuit. Permits matching of similar transistor types. No set-up necessary.  
**MODEL 100 \$19.95 NET**



**SECO ELECTRONICS INC.**  
5015 Penn Ave. So.,  
Minneapolis 19, Minn.  
Please send more information on MODELS . . .

510  500  520  511A  GCT-9W  107

100  78  FREE Selling and Installing Citizens Band Equipment Bulletin

Name \_\_\_\_\_

Address \_\_\_\_\_

City \_\_\_\_\_ State \_\_\_\_\_

watts; AC line isolated and fused; panel ON indicator and polarized line plug provided.

2. **Capacitance Measurement**—5 overlapping ranges from 1 mmf to 2000 mfd; accurate within 2% to 5%,  $\pm 1$  mmf, depending on range; Wien-bridge circuit with tuning eye as indicator; direct-drive  $5\frac{1}{4}$ " bridge-balance dial provided.
3. **Leakage Measurement**—electrolytics tested by regulated DC potential, continuously variable from 0 to 150 volts in four ranges; applied voltage and leakage current indicated on panel meter with 7 current ranges from .6 to 600 ua.
4. **PF Measurement**—Power factor of electrolytics indicated by action of tuning eye and read on percentage scale.
5. **Resistance Measurement**—insulation resistance indicated on 50- to 20,000-megohm scale of panel meter for plastic-film, paper, ceramic, and mica capacitors rated at 25V or more, as well as for cable insulation and other dielectrics; values for low-voltage ceramics calculated from leakage-current measurements; calibration and zero adjustments provided.
6. **Other Features**—universal binding posts on front panel; snap-on metal shield for protecting binding posts and capacitor against stray fields; provisions for discharging capacitors after testing; eye-sensitivity adjustment; basic operating instructions on slide-out panel at base of instrument.
7. **Size and Weight**— $8\frac{7}{8}$ " x  $14\frac{1}{8}$ " x 9" over-all, 27 lbs.

Designed to meet laboratory requirements for capacitor testing, the TCA-1 can check value, power factor, and insulation resistance of film, paper, mica, and ceramic units, and provides an additional leakage test for electrolytics (including low-voltage types used in transistorized circuitry).

A tuning-eye tube and DC meter are located on the front panel of the analyzer as test indicators. The eye tube, a No. 1629 with hooded shield, is employed as a bridge-balance monitor for measurements of both capacitance and power factor. The meter, a 1-ma unit with 2% accuracy, provides direct readings of leakage current, voltage applied for leakage tests, and insulation resistance (on a special high-ohms scale). A three-tube amplifier system increases the sensitivity of the leakage-measuring circuit for electrolytics. On the most sensitive range, the first division on this meter scale represents .02 ua; hence, a current of only .01 ua can be accurately detected.

The elaborate power-supply circuit of the Model TCA-1 (Fig. 5) is one of the major contributing factors to its stability and accuracy. A fused AC input is coupled to the primary of the power transformer through choke L1—an iron-core, series-regulating impedance. The output of the 6X4 full-wave rectifier is filtered by electrolytics C1A and C1B. Constant voltage is maintained on the B+ line by two VR tubes (V2 and V3),

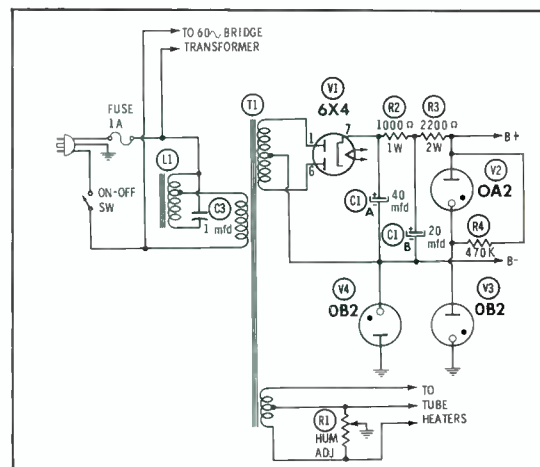

**Fig. 4.** Sprague Model TCA-1 has condensed instructions on slide-out panel.

while the B— return is stabilized by a third VR tube (V4); consequently, this highly regulated supply is virtually unaffected by AC line fluctuations.

One of the most important troubleshooting applications I've found for a bridge instrument such as the Sprague TCA-1 is the detection of capacitors which have a tendency to change value during operation. This capacitance-drift effect (usually caused by temperature change) is often hard to pin down, and the resulting intermittent symptoms can really give you a fit. However, you can quickly spot any tendency toward a change in value by heating or cooling the suspected capacitor while checking it on a capacitance bridge.

The procedure for measuring the values of capacitors with the instrument is relatively simple for such an accurate method. The most dependable results are obtained when the capacitor in question is connected directly across the binding posts on the panel, and the shield supplied with the instrument is snapped in place over the entire test area. (For capacitors with values greater than approximately .1 mfd, test leads may be used and the metal shield omitted.) Next, the range selector (Fig. 6A) is set to one of the five positions C1 through C5—whichever includes the anticipated value of the capacitor. The unknown value is then determined by varying the large dial (Fig. 6B) until a bridge balance is indicated by the widest possible opening



**Fig. 5.** B+ voltage is highly stable over AC-input range of 105-125 volts.

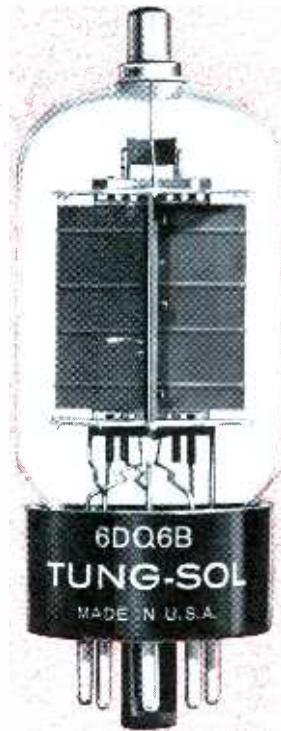
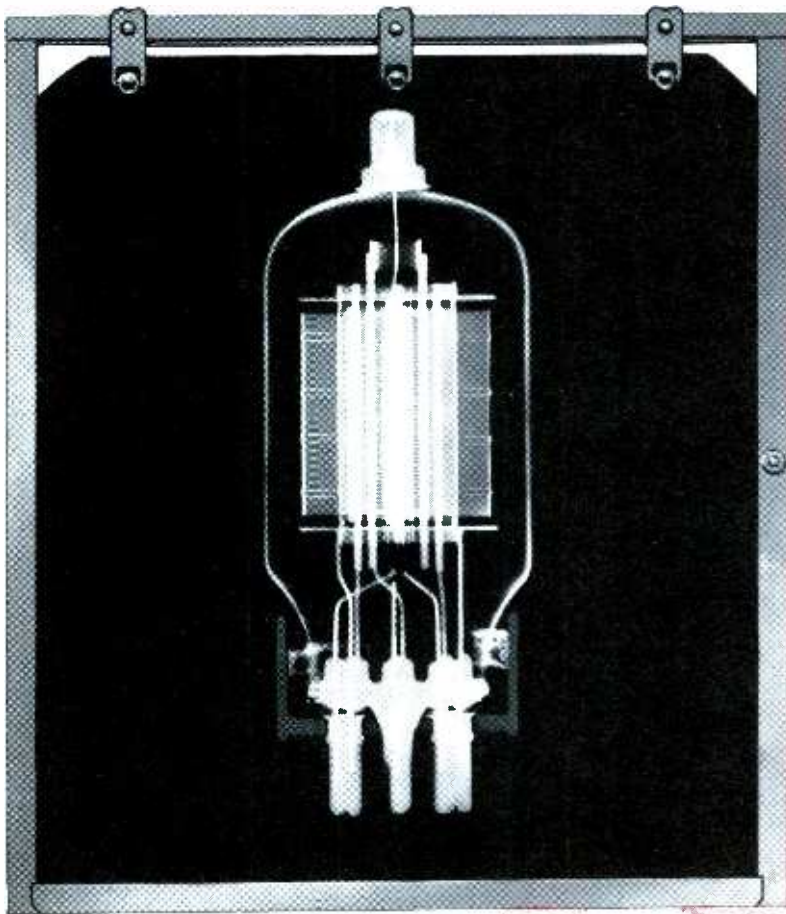

## HORIZONTAL DEFLECTION TUBE PROGNOSIS INDICATES STABLE EMISSION OVER LONG LIFE SPAN

Prolonged observation of Tung-Sol horizontal deflection tubes indicates a consistent behavior pattern: virtual immunity to chronic deflection tube illnesses. They exhibit a remarkable ability to withstand the high temperatures and high pulse voltages encountered in TV deflection service, which too frequently have a fatal effect on tubes of less hardy ancestry. Diagnosis shows unusual physical fortitude. The plate design, with special large area cooling fins plus high conductivity core aluminum-clad steel material, is a combination of ingredients that safeguards against "hot-spotitis".

Tung-Sol "circuit design"\* approach has eliminated Barkhausen oscillations and snivets. Qualified specialists agree that continued use of Tung-Sol deflection tubes is certain to result in an epidemic of successful service work of very pleasing proportions.

### PRESCRIPTION FOR PROFIT

When diagnosis of your customer's TV set reveals an ailing horizontal deflection tube, it's best to prescribe Tung-Sol. Customer satisfaction with the results is certain to be contagious. These are some of the more popular Tung-Sol horizontal deflection tubes:

*\*Designed by Tung-Sol to fit circuits already in use in the market.*

6/12/17/25 BQ6G TB	6/12/17 DQ6B
6/12/17/25 CU6	6/25 DNG
6/12/25 BQ6GA	6CD6GA
25CD6GB	



the first name to ask for when ordering



**TUNG-SOL®**  
DEFLECTION TUBES

TUNG-SOL ELECTRIC INC., NEWARK 4, N. J.

# Quality you can count on **EVERY SINGLE TIME!**

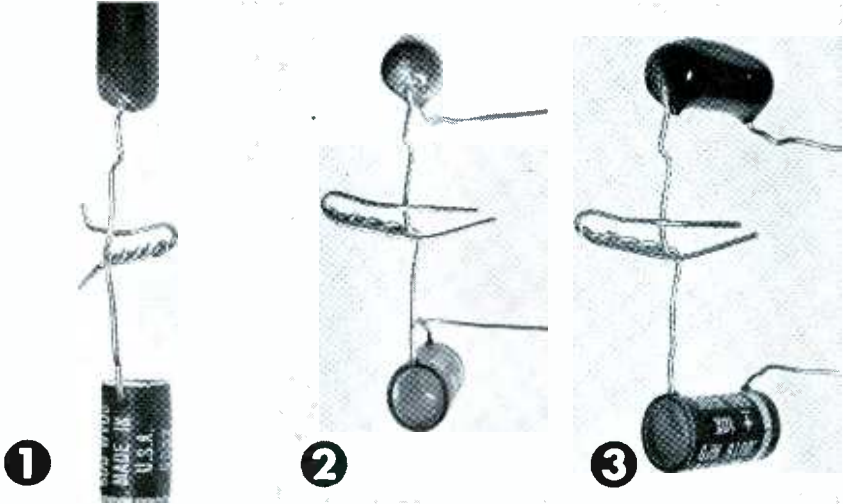

## TESTS SHOW...

# AEROVOX BI-ELECTRIC Mylar\* Paper Bypass Capacitors **ARE YOUR BEST BUY!**

All Aerovox Bi-Electric bypass capacitors have a uniform, protective Polycap case from end-to-end... and the ends are process-controlled for sealed-protection. Their special design and construction eliminates end-seal cracking and chipping. These unretouched photos show what happens in an actual test when a conventional dipped bypass capacitor is tied to an Aerovox Bi-Electric unit and the two are pulled apart:

- 1 The end seals of the dipped capacitor quickly crack as soon as the two units are pulled apart while the Bi-Electric unit does not crack at either end.
- 2 When the leads are bent back into original position, the end seals of the dipped unit chip even more... the Bi-Electric unit "seals itself."
- 3 This view of the end sections shows the extensive damage to the dipped capacitor... and the full protection offered by the Aerovox Bi-Electric Polycap plastic case and special end seal.

For sealed-in performance and reliability **EVERY SINGLE TIME**... even when using the Bi-Electric unit for an axial lead installation... be sure to ask your distributor for Aerovox Bi-Electric Capacitors only.

\*Registered DuPont trademark



**AEROVOX CORPORATION**  
DISTRIBUTOR DIVISION  
NEW BEDFORD, MASS.

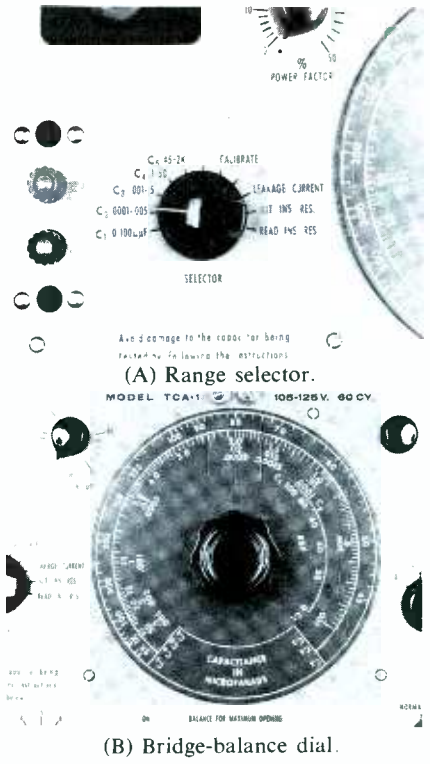

Fig. 6. Transfarad panel controls used for measurement of capacitance values.

of the eye-tube wedge. The exact capacitance reading appears directly under the hairline marker on the dial scale corresponding to the range selected. An off-scale reading generally means a shorted or open capacitor. If the eye tube flickers, the capacitor is probably intermittent and in need of replacement.

The Transfarad Capacitor Analyzer is especially well adapted to testing the miniature electrolytic capacitors found in transistor radios. Even when I tried evaluating capacitors with only 3- and 4-volt ratings, I found the tests safe and the results accurate. The resistance-measuring feature of the analyzer is useful for detecting leakage paths between tube elements, transformer windings, cables, etc., as well as for its main purpose of checking capacitor insulation. ▲



# SERVICE DEALER ADVERTISING PROGRAM

Response to the unique PF REPORTER advertising program has proved beyond any doubt that such a service is needed. This response is a healthy sign that the radio-TV electronics service industry is aware of the necessity for *good* advertising copy.

To make sure these ads will get results, the program has been carefully developed and field-tested. As a service to our readers, each month's selection of 5 ads is available *at cost* in two forms—durable newspaper mats at \$1.75 per set, or high-quality reproduction proofs at only \$1.00 per set. The latter will serve as finished artwork for offset printing of handbills, postcards, doorknob hangers, direct-mail pieces, etc. To obtain your set of this month's ads, or the entire series at a reduced rate, use the convenient order form on page 71. Your ads will be sent to you postpaid.



**ES-13: 1 7/8" x 4"**  
There's no question about the pulling power of this ad. It plugs TV tune-ups in an ad that's sure to gain the attention of potential customers.

**ES-14: 1 7/8" x 3 1/2"**  
Here's an eye-catching backdrop that you can use to promote your own special offer. Write your own copy—this ad will sell it for you.



**ES-39: 1 7/8" x 5"**  
Snow all gone? Sledding a little rough? Here's an ad that points out you're honest enough to offer a discount on labor *after* the customer receives the bill.



**ES-55: 1 7/8" x 4 1/4"**  
Summer sun makes daytime viewing of dim TV pictures a real problem. Ads that stress specific TV problems always get best results.



**ES-49: 1 7/8" x 4"**  
It's time for summer outings and vacations—time for folks to get their auto radios fixed. This novel ad will increase traffic in your store. It gets in a plug for radio and TV service, too.

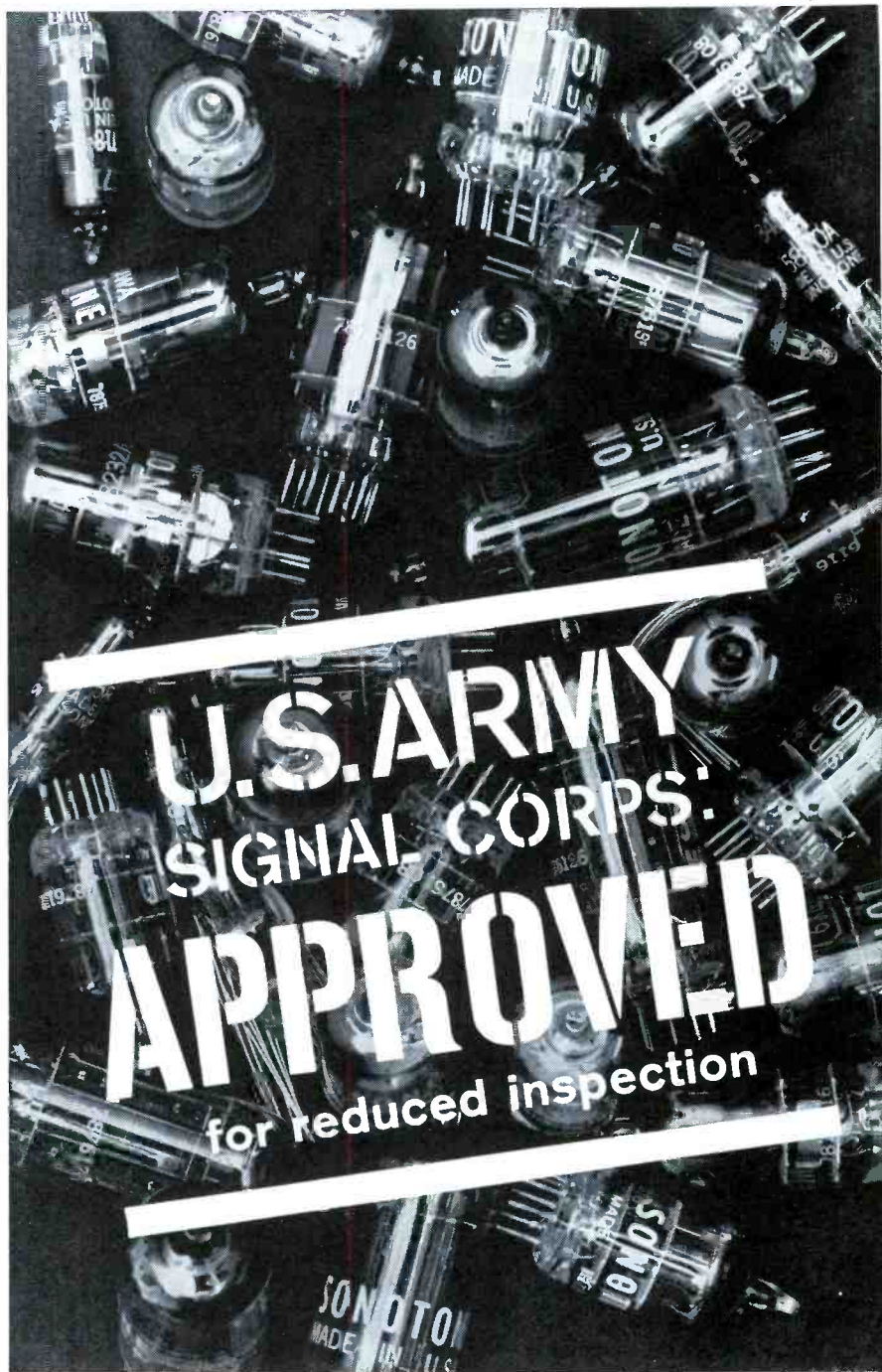

# U.S. ARMY SIGNAL CORPS: APPROVED

for reduced inspection

## SONOTONE GRANTED FULL PARTICIPATION IN U.S. ARMY SIGNAL CORPS R.I.Q.A.P. PROGRAM

Sonotone's methods of production and quality control on electronic tubes are so rigid, the U.S. Army Signal Corps has officially reduced inspection of the company's full line of military tubes. This company is the first electronic tube manufacturer to qualify for complete R.I.Q.A.P. participation utilizing the concept of "paired attributes-verification" for acceptance by government inspection. All Sonotone tubes—military and industrial—conform to the same high standards. Over 200 to choose from—including many hard-to-get European types. Specify Sonotone when you want to be sure of quality.

**Sonotone** <sup>®</sup> C O R P. ELECTRONIC APPLICATIONS DIVISION  
ELMSFORD, N.Y. DEPT. T10-61

IN CANADA, CONTACT ATLAS RADIO CORP. LTD., TORONTO • LEADING MAKERS OF PHONO CARTRIDGES, SPEAKERS, MICROPHONES, TAPE HEADS, ELECTRONIC TUBES AND RECHARGEABLE BATTERIES

# IMPORTANT NEW SAMS BOOKS

This Picture Book Diagnoses TV Tube Trouble

## TV Tube Symptoms & Troubles

by Bob Middleton



Most TV troubles are caused by faulty tubes. This new Sams book shows over 150 actual photos of defective TV screens, arranged by trouble symptom (picture tube displays of picture, sync, size and linearity, raster and sound troubles). Tells you what each section of a TV set is

supposed to do, what happens when it doesn't, and shows how to pinpoint troubles to specific sections and tubes. Special Tube Trouble Chart instantly relates troubles to specific tubes. No theory—just the practical photos and brief descriptions you need to locate most TV troubles in short order. 96 pages; 5 1/2 x 8 1/2". Only \$1.50

## All You Need to Know to Align Radio & TV

### Radio & TV Alignment Handbook

by Warren J. Smith



If TV or radio alignment is hard for you, here's the book you'll want handy for constant reference. Tells you when alignment is necessary; shows what equipment you'll need, how to hook it up, how to follow alignment procedures in service literature, and how to evaluate results. Complete; covers UHF and VHF tuner alignment, adjustment and alignment of color TV, AM and FM radios, etc. Includes numerous photos, drawings and circuit diagrams. Helps you earn more through faster, better, customer-pleasing service work. 160 pages; 5 1/2 x 8 1/2". Only \$2.95

## The Latest on Stereo—Hi-Fi

### Hi-Fi—Stereo Handbook

by William F. Boyce



This authoritative Sams book is fully revised to include the very last word on Stereo. Answers almost any question on Stereo and hi-fi anyone may want to ask. Covers sound fidelity and distortion, monophonic and stereophonic sound, stereo techniques, program source material, amplification and

control, loudspeakers, enclosures, system design, selection and installation, multiplexing, etc. Profusely illustrated with diagrams and photos of equipment setups to guide you in detail along the way to better sound reproduction. 256 pages; 5 1/2 x 8 1/2". Only \$3.95

**NEW! VOL. 8 SERVICING TRANSISTOR RADIOS!**  
Just out—covers 51 important models produced in 1959-60. Complete PHOTOFACT® servicing data. 160 pages; 8 1/2 x 11". Only \$2.95

## HOWARD W. SAMS & CO., INC.

Order from your Sams Distributor today, or mail to Howard W. Sams & Co., Inc., Dept. F-31 1720 E. 38th St., Indianapolis 6, Ind.

Send me the following books:

- TV Tube Symptoms & Troubles (TVT-1)
- Radio & TV Alignment Handbook (RTH-1)
- Hi-Fi—Stereo Handbook (HFB-2)
- Servicing Transistor Radios (TSM-8)

\$.....enclosed.  Send Free Book List

Name.....

Address.....

City.....Zone.....State.....

IN CANADA: A. C. Simmonds & Sons, Ltd., Toronto 7  
(outside U.S.A. priced slightly higher)

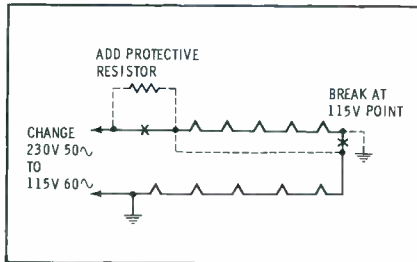

### More About Conversion

In the March "Troubleshooter" column, you replied to Mr. Charles B. Wagner's letter about U.S. operation of a Grundig-Majestic television receiver.

Grundig-Majestic makes products available to most parts of the free world. Therefore, you may find the following procedure to be more economical and time-saving.

Secure, from Grundig's U.S. branch, the proper tuner-turret strips for operation in the Western Hemisphere.

Retune the sound IF to 4.5 mc; add a little capacitance if necessary. (Use mica capacitors in these circuits.) If a quadrature detector is used, the change will be easy. However, if the set uses a ratio detector or discriminator, you will probably have to replace the detector transformer.

If the receiver is transformer-powered, you need change only the primary taps in order to convert from 230- to 115-volt operation. However, if the receiver is a series-filament type, you will need to make a voltage doubler by adding another rectifier and electrolytic capacitor. Make sure there is a surge resistor in series with the "hot" side of the input in this B+ supply. A change in the filament wiring will also be required, as shown in the attached schematic: the 230-volt, 300-ma series string is converted into a series-parallel arrangement drawing 600 ma at 115 volts. If a negative-temperature-coefficient resistor is not in the circuit, install one.

CHARLES E. KOONTZ

Decatur, Ill.

Thanks for your comments, Charles. The conversion job still requires rather extensive work, though, and should not be taken lightly.

### Importers

We are located right next to an Army base and get a lot of Grundig and Telefunken equipment to service. Will you please tell us where we can obtain replacement parts for these sets?

D. E. OLNEY

Belton, Texas

The importer's addresses are:

Grundig  
Majestic International Sales  
743 N. LaSalle Street  
Chicago 10, Illinois  
Telefunken  
American Elite, Inc.  
48-50 34th Street  
Long Island City 1, N.Y.

### Measuring Generator Output

I was aligning a TV the other day when I came upon the instructions, "Set generator for approximately 1-volt output at 4.5 mc." The output of my generator isn't calibrated, so how do I go about setting it for a 1-volt output?

JOSEPH COLLAZO

Union City, N.J.

Simply attach the output cable of your generator to the specified injection point and connect the AC probe of a VTVM (not a VOM) across the same point. You can then regulate the gain control of your generator to obtain a 1-volt reading on the low-range AC volts scale of the meter.

### Pilot Lamp Failure

A General Electric Model C450 radio keeps burning out the pilot lamp about once a week. I'm using a #12 lamp, as called for in service data. I've checked tubes, etc., but everything seems OK.

FRED WITTICH

Middle Village, N.Y.

Apparently the pilot lamp is burning out as a result of excessive current in the B+ supply. It acts as a fuse for the circuit by limiting the amount of plate current in the 35W4. Since you have replaced it with the proper lamp type, the only logical conclusion points to B+ trouble. The schematic shows 50 ma as the normal B+ drain. This current splits almost equally between the audio output tube and the remaining three stages. Making current checks of both B+ lines should help you determine where the excessive current is going.

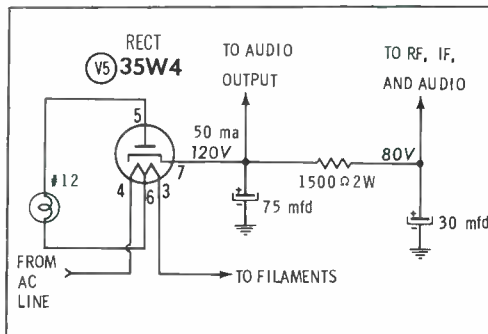



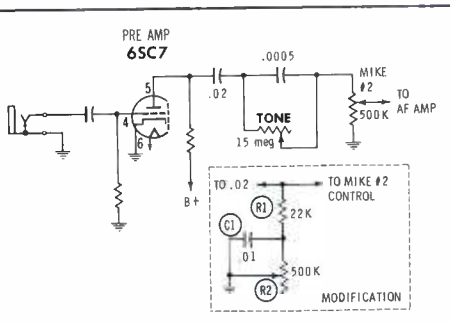

### Voice Changer

One of my customers has a Model TR25M Newcomb amplifier he uses when calling square dances. His voice is high-pitched and he wants to increase the bass response of the Mike #2 circuit without affecting the over-all operation of the amplifier. What would you suggest?

R. MITCHEM

Evansville, Ind.

The easiest way to get more bass tones is to do away with some of the highs. The tone-control associated with the Mike #2 input circuit provides only a minimum amount of control and lets the highs through with little attenuation. Replacing it with modified circuits shown here bypasses most of the highs and leaves only the bass tones for amplification. Although you may have to experiment with various values for R1, R2, and C1 to obtain the desired results, the circuit should do the trick for you.

### Noisy Fords

I've been trying to overcome motor noise in two Granco Model ARC-60 FM tuners installed in 1957 and 1959 Fords. I've replaced all of the noise suppressors in both cars, but this hasn't helped. AM reception is fine, but the FM has a lot of noise in it.

H. HOWARD ANDERSON

Elon College, N.C.

Undoubtedly you have hit upon one of the roughest interference problems that ever came along. Every CB or FM radio installation in a Ford becomes a specialized case of interference elimination. Noise suppressors used in conjunction with regular broadcast-band receivers are worthless for the higher-frequency noise affecting FM and CB. Special non-inductive feed-through capacitors in series with the armature lead of the generator and the primary lead of the coil help kill some of the unwanted noise. Similar units which also include a 5-ohm resistor in series with the ground lead of the capacitor should be used at the field terminal of the voltage regulator to overcome the noise it generates.

All gauges and wiring leads in the car can radiate noise signals. Sometimes it is advisable to grab a handful of 1000-mmf mica or ceramic capacitors and start bypassing every "hot" lead connection you see. You may be amazed to find that your problem is completely solved when you bypass one of the headlight leads or something else just as ridiculous.

Two Howard W. Sams books provide more detailed information on eliminating interference in auto radios, if you'd like

## Service Technicians! YOU EARN MORE... YOU RATE with the public when you own the PHOTOFACT® service data library!

You enjoy maximum earnings as the owner of a complete PHOTOFACT Service Data Library! It's inevitable, because no matter how expert you are, you can always *save more time on any job, get more jobs done daily*—EARN MORE, DAY IN AND DAY OUT...

What's more—as the owner of a complete PHOTOFACT Library, you know your customers' sets *best*. You can actually show each customer you have the PHOTOFACT Folder covering his very own set. Result: You command public respect and acceptance which paves the way to more business and earnings for you.

### HOW TO STAY AHEAD...

Yes, the truly successful Service Technicians are those who own the complete PHOTOFACT Library, who can meet and solve any repair problem—faster and more profitably. And these men keep ahead because they're on a Standing Order Subscription with their Distributors to receive all new PHOTOFACTS as they are released monthly. (They're eligible for the benefits of membership in PEET, too—see below!)

**ONLY \$10 DOWN** puts the complete PHOTOFACT Library in your shop—and you have up to 30 months to pay. See your Sams Distributor today, or write to Howard W. Sams

**NOW IS THE TIME TO JOIN "PEET"**

**THE POWERFUL NEW PROGRAM FOR QUALIFIED TECHNICIANS**

If you now own a PHOTOFACT Library or plan to own one, you can apply for membership in "PEET." It's the first industry program really designed to build powerful public acceptance for the Service Technician who qualifies. Builds enviable prestige and business for its members. Benefits cost you absolutely nothing if you qualify. Ask your Sams Distributor for the "PEET" details, or mail coupon today.

**HOWARD W. SAMS & CO., INC.**  
1728 E. 38th St., Indianapolis 6, Ind.

Send me full details on the new "PEET" Program.  
 Send full information on the Easy-Buy Plan and Free File Cabinet deal.  
 I'm Interested in a Standing Order Subscription.  
 I'm a Service Technician  full-time;  part-time

My distributor is \_\_\_\_\_

Shop Name \_\_\_\_\_

Attn: \_\_\_\_\_

Address \_\_\_\_\_

City \_\_\_\_\_ Zone \_\_\_\_\_ State \_\_\_\_\_

# 20,000 VOLTS DIELECTRIC STRENGTH

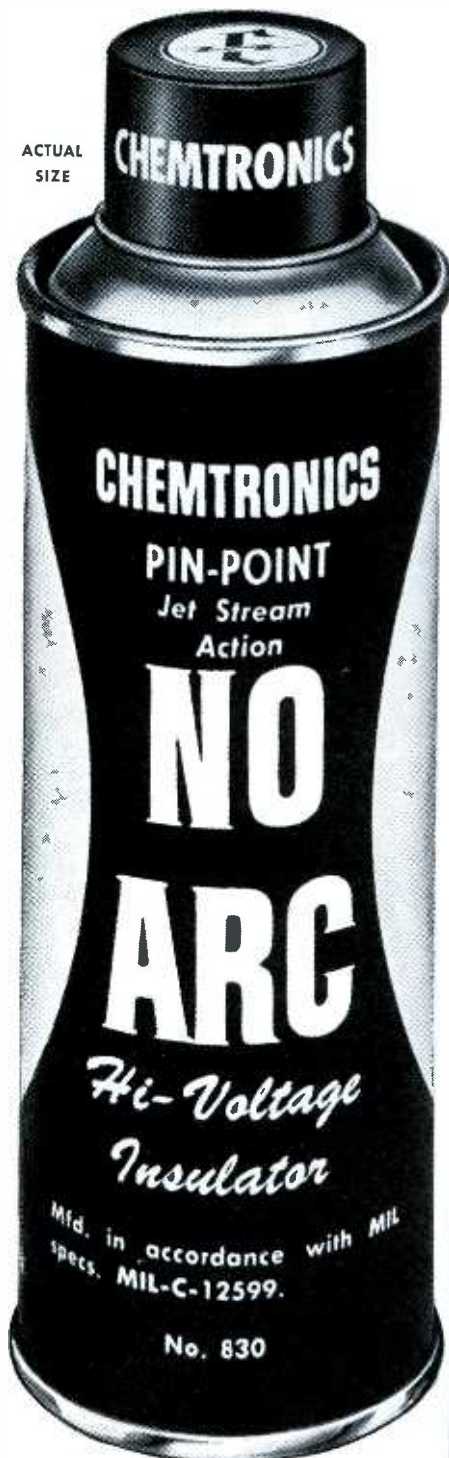

USES THE NEW PRINCIPLE OF JET-ACTION NOT A SPRAY!

WRITE FOR LITERATURE



**CHEMTRONICS Inc.**  
878 East 52nd Street, Brooklyn, New York

to pursue the subject further. These are: "Rapid Auto Radio Repair" (RAH-1), and "Two-Way Mobile Radio Handbook" (MRS-1).

## Add An Eye

I've been called upon to install a tuning indicator in an FM tuner, and I'm not sure just how to proceed. Can you offer some suggestions on how to go about doing this job?

R. W. UNGER

Mather AFB, Calif.

To solve a problem like this, you need something that will monitor the signal level. Tuning-eye tubes are very useful for this purpose. All you need to do is obtain a DC bias voltage that varies with the signal strength, and apply the bias to the control grid of the tuning eye.

The easiest place to obtain the bias voltage in an FM receiver is from the AFC line. (In an AM set, the AVC line would be the best source.) Take the voltage off the line on the output side of the filter resistor R1, as shown in the accompanying schematic of a typical circuit. In order to determine whether to use a 6E5 or a 6U5 tuning eye, you will need to measure the AFC voltage. If it is relatively low, you will find that the 6E5 with its sharp cutoff characteristics will work better than the 6U5. The latter has a remote cutoff characteristic and requires a larger AFC voltage.

Some tuners do not have AFC. In this case, you can install a filter network at the output of the detector (corresponding to R1 and C1 in the schematic) and feed its output to the tuning eye.

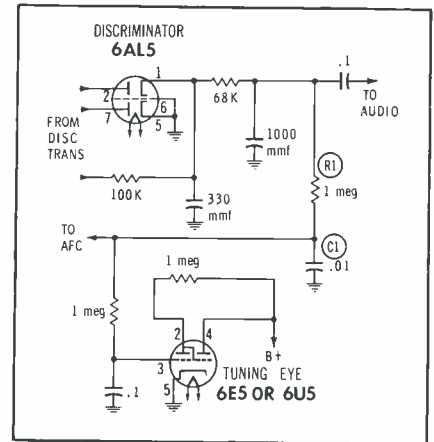

## Light Only

I have a Motorola Model 19P1-1 all-transistor TV in for service because it loses picture and sound after a short time. The raster stays on, and there is a very faint outline of a picture. Any help you can give would be appreciated.

BECCI RADIO AND TELEVISION  
Cleveland, Ohio

Don't let the fact that the receiver is completely transistorized throw you for a loss. Making scope checks through the detector and video stages should give you some clue of where to look. Make very critical voltage measurements throughout the IF, video, and AGC circuits with no signal applied, and compare them with those shown on the schematic. Remember, even two-tenths of a volt variation is significant in transistorized equipment. Therefore, be alert for even minor changes.

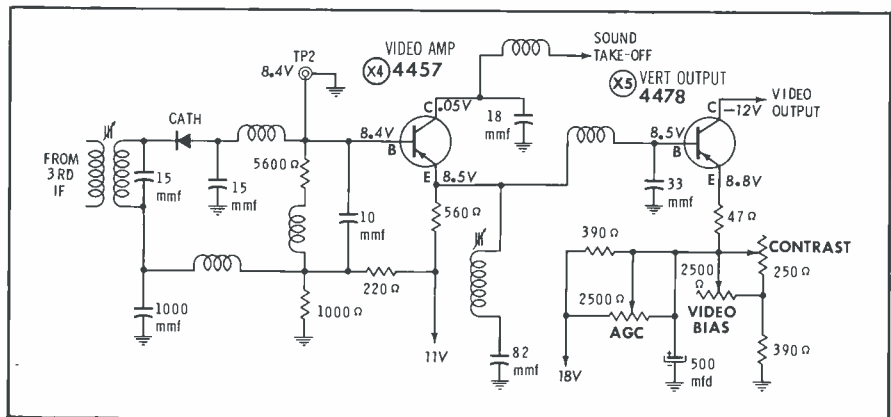

# TV TUNERS \* REBUILT OR EXCHANGED

ALL TYPES

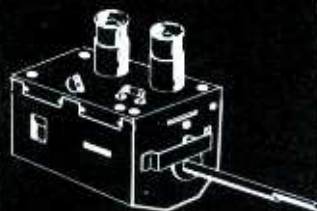

**\$9.95** Including all parts and labor (except broken wafers—billed at cost)

- Normally shipped same day received
- 90 day full guarantee
- U/V combinations \$17.95

FREE—If Mailing carton sent to you on request

Phone Republic 3-9189

**L. A. TUNER EXCHANGE**

4611 West Jefferson Blvd.  
Los Angeles 16, California

## TV Wireless Remotes

(Continued from page 21)

the MANUAL position may complete all the necessary connections; if not, jumpers should be installed across the remote-plug terminals to complete the TV power circuit.

### In the Shop

Once you have set up the remote system on the bench, check the grid circuits of the relay-control tubes with a VTVM. Practically all receivers, except transistorized or reed-relay types, depend on a positive-going shift of DC grid voltage to drive the control tubes into conduction. In a normally-operating receiver, a change of several volts should be observed when the appropriate button on the transmitter is pressed. If the meter pointer moves only slightly or not at all, the trouble is somewhere ahead of the relay-control stage. Try to localize the defective circuit by making rapid voltage checks at the plates, screen grids, and cathodes of all preceding receiver stages. (Beware of control-grid voltages, which are likely to vary according to the amount of electrical noise picked up by the "front end" of the set.

If voltage tests still leave you in doubt, try signal injection. A conventional RF generator can be employed as a signal source; when slowly tuned through the operating range of the remote receiver, it should trigger the various relays at the correct frequencies. Approximate stage-gain checks, as well as continuity tests, can be made by this method. In supersonic systems, the pickup transducer is part of the first-stage input circuit; so, for a complete check of this first stage, it's common practice to feed the generator output to a small speaker which is placed close enough to the transducer to provide acoustic coupling.

Realignment of the receiver should be tried only as a last resort, unless you have definite evidence of mistuning. A precisely-calibrated signal generator, or a known good transmitter, is essential.

If the transmitter is mechanically operated, you can check it just as easily in the customer's home as in the shop. On the other hand, a transistorized transmitter can be more readily analyzed in the shop,

# NEW RCA ALKALINE BATTERIES

*increase your profit opportunities*



Now, you can increase your profit while reducing the number of battery types you have to stock. What makes this possible? The new RCA Alkaline Battery! This new type of cell outlasts comparable zinc-carbon batteries yet sells at a lower price than premium mercury types.

## *here's how you benefit...*

- **MORE PROFIT PER SALE:** Provides perfect opportunity to "sell up".
- **SIMPLIFIED INVENTORY NEEDS:** The RCA Alkaline multi-purpose type is designed for use in radios, flashlights, photoflash, toys and electronic instruments. A few types cover a wide range of applications.
- **LONGER SHELF AND OPERATING LIFE:** A useful life of 2-to-8 times that of zinc-carbon types, depending on application.
- **NO REST PERIOD NEEDED:** A big advantage in portable radios.

Four of these money-making new Alkaline types are now available from your Authorized RCA Distributor. These include: VS1334, a 1.5-volt penlite cell; VS1335, a 1.5-volt "C" cell; and VS1073, a 1.5-volt "N" cell. Each of these is a multi-purpose type. The VS1149, a 4.5-volt battery, is specifically designed for transistor radios.

*RCA Batteries*...Zinc-Carbon, Mercury, and the new Alkaline types...mean more opportunities for dealer profit right down the line. See your RCA Distributor now for full details.

RCA Electron Tube Division, Harrison, N. J.



The Most Trusted Name in Electronics  
RADIO CORPORATION OF AMERICA

*New G-E Profitable Service Management Course Tells...*

## HOW TO INCREASE YOUR BUSINESS, MAKE MORE MONEY BY PROVEN EFFECTIVE METHODS

**Are you making as much money as you should? Charging enough for service calls? Paying more in taxes than you should? How can you protect against stock pilferage, overstocking, understocking? Overdue bills a problem? ... Getting your share of new business? Is your personal selling and advertising as effective as it could be? How about special offers, seasonal promotions? How many TV and radio homes are in your county?**

Find the answers to these and hundreds of other problems that affect your everyday business, in General Electric's new Profitable Service Management Course. A complete business management and development program specially prepared for TV and radio service dealers. Learn step by step how to assure a satisfactory profit margin, increase business with methods proven successful by service dealers from coast to coast. Four-part program includes:

**1. "Sound Business Practices,"** an 85-page manual which will help you set up a successful business or increase your present business. 17 topics in 4 chapters: Business for Profit • Planning Your Business • Organizing Your Business • Controlling Your Business.

**2. "Selling Electronic Service,"** a 57-page guide to increased sales through modern advertising, sales promotion and merchandising techniques. 14 topics in 3 chapters: Attracting New Customers • Promoting Your Business • Keeping Customers Satisfied.

**3. "Sounds of Success,"** 33 1/3 LP record reveals the secrets of operating a profitable electronic service center as told by successful dealers.

**4. Workbook** for checking your acquired knowledge, prior to receiving your Management Award Certificate.

This is not a get-rich-quick course—not an electronics course, but a down-to-earth guide for turning your technical skills into more business and profits. It's easy to study; complete; prepared by experts; handsomely packaged for your bookshelf. Send for your Profitable Service Management Course today!



**GENERAL ELECTRIC**

GENERAL ELECTRIC CO.  
DEPT. B  
3800 N. Milwaukee Ave.  
Chicago 41, Illinois

Please ship prepaid.

..... ETR 2208 Profitable Service Management Course, \$12.50 each, or \$10.00 plus 10 6BQ6G-A or GTB G-E tube carton tops.

My check or money order is enclosed for the required amount plus any sales or use tax applicable in my area.

Name.....

Address.....

City..... Zone..... State.....

where you can make use of your bench test equipment. To see if a signal is being generated, connect a scope across the transducer or antenna, and see if a pattern appears when you key the unit. For more detailed information about operating efficiency, compare the DC voltages in the oscillator circuit with those given in service data.

### Insufficient Range

A remote transmitter should maintain control over a distance of 20' or more; a complaint of short range indicates a weak link in the remote system. If this problem remains unsolved after you have checked all obvious possibilities (weak tubes, low B+ in receiver, weak battery in transmitter, etc.), turn your attention once more to the relay-control grid circuits.

While keying the transmitter, bring it closer to the receiver input until the signal is just strong enough to operate the relays. Check the grid-cathode bias at this time—is it reasonable, considering the plate-current strength needed to actuate the relay? The 6CM7 and similar tubes are usually supplied with about 20 volts of fixed or cathode bias under no-signal conditions, and a reduction of bias to 5-10 volts should cause the relay armature to pull in. (The exact "kick-in" point depends on the size of the relay.) Certain other tube types like the 6GH8 and 6U8 can be held in cutoff by only 10 volts of bias, and a shift to 5 volts or less is usually needed to actuate the relay.

If a relay fails to operate until the bias is reduced to an abnormally low value, the trouble is almost certain to be found in the relay or its control circuit. However, in most cases of poor sensitivity in remote controls, the relay tubes are operating normally; the other circuits are simply unable to deliver enough signal to raise the grid voltage to the necessary value. To solve this type of problem, carefully study the receiver and transmitter for signs of a weak stage or component. Don't forget to recheck the setting of the sensitivity control.

### Erratic Operation

Complaints of irregular performance fall into several categories: *Wrong function is activated* — for

example, the set changes channels when the volume button is pressed. This condition indicates a mix-up of frequencies; if accompanied by poor sensitivity and/or a complete loss of some functions, it is a clue to misalignment.

*Function operates continuously or will not stop in desired position* — Failure of the control relay to "drop out" may be due to sticking contacts or a loss of bias on the relay-control tube. In systems using transistorized transmitters, the relays will be held in as long as the control buttons are pressed down—and this may have to be explained to the set owner!

*Interference* — Supersonic systems are occasionally triggered by random noises such as squeaking hinges and jangling keys; however, this problem is minimized by safeguards built into the remote receivers. In RF systems, the main problem is interference from the sweep and high-voltage circuits of the TV set. This can be kept under control if the remote-receiver antenna is carefully oriented and the high-voltage cage is in place and well grounded. When a remote receiver is removed from the TV cabinet and upended on the bench, sensitive circuits may be exposed to enough stray RF interference to cause spurious operation of the relays. If this problem is encountered, some type of temporary shielding should be devised.

*Function operates sometimes, but not always* — This is just another way of saying you have an intermittent trouble. Treat it the same as any other intermittent, looking for such conditions as sticking relay contacts, borderline defects in tubes, etc. To save time in pinpointing the fault, get as many facts as possible from the customer.

### Save a Trip

One parting hint: Why take a remote unit to the shop if you can repair it in the home? Many remote-control systems are designed so they can be worked on while the receiver is still plugged into the main TV chassis. Therefore, if you know you're going to be servicing a remote system, make it a point to take along such extra items as a VTVM, a spare transmitter battery (if needed for testing), and the service data for the unit. You may fix it on the spot! ▲

## Depth Finders

(Continued from page 27)

be serviced in the same manner as any similar circuit. Signal tracing can be employed to follow the RF signal from input to output.

### Other Indicators

A direct-reading meter is next in popularity to a flashing neon lamp as an indicator. Remember that the depth of the water is measured by the time interval between the transmitted and reflected signals, which is relatively short in shallow water, but longer in deep water. This variation in pulse timing can be translated into a variable DC voltage for the grid of the receiver's output stage (called a *meter amplifier* in this application). The resulting changes in plate current of the stage are registered on a milliammeter calibrated to read depth directly in feet.

In recording systems, a pointer makes a trace along a sheet of graph paper, and the line "zigs" and "zags" according to movements of the meter dial.

### Amplifier Alignment

A special test pad is required for alignment of the amplifier, to compensate for removing the transducer-lead capacitance from the amplifier-input circuit. Fig. 7 shows a typical test setup. Component values in the pad will vary, depending on the unit; therefore, always be sure to check the service data for the required values. In constructing the input pad (dummy transducer), keep the leads short and cover the assembly with a grounded metal shield to assure consistent results.

The usual procedure in alignment is to adjust the input signal to a level just below that required to

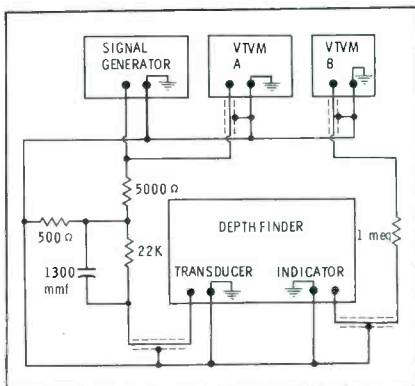

Fig. 7. Typical depth-finder alignment setup uses standard test equipment.

# WE WANT MERCURY!

and no wonder they do! MERCURY TEST EQUIPMENT meets all their every day servicing requirements and will meet all yours too! You want test instruments that save you valuable time, increase your earning power and build customer goodwill. You want all these things but you don't want to go overboard on price! And you don't have to! Mercury test equipment is priced sensibly low and represents extraordinary value... Brilliantly engineered — constructed of top name brand components — carefully hand-wired throughout. Ask to see them at your jobber today! Learn why thousands of servicemen from coast-to-coast say "We Want Mercury".



### Model 103 TUBE TESTER



SPOT  
HARD-TO-  
FIND  
TUBE DEFECTS  
IN JUST  
SECONDS!

\$4775  
Net

The Model 103 is compact in size but is a whale of a money-maker. Although unusually low in price it has a range of operation that will outperform far more expensive testers. It checks all radio and TV tubes (including all black and white picture tubes) for cathode emission, shorts, grid leakage and gas content. The speed and accuracy achieved with the 103 is so great that you will find it profitable to check all tubes when repairing a TV set.

### Model 500 COMPONENT SUBSTITUTOR



A complete range  
of components  
at your fingertips  
for fast  
substitution

The Model 500  
does the whole job

\$2995  
Net

All the substitutes for electronic components you want and need in your every day work are here in this advanced design component substitutor... more than any other instrument of its type! Covers a full range of resistors, condensers, electrolytics... and also contains many exclusive features covering the substitution of crystal diodes, power rectifiers, power resistors and bias voltages.

Prices slightly higher  
in the west

### Model 300 COMBINATION TESTER



\$9975  
Net

3 ESSENTIAL INSTRUMENTS COMBINED INTO  
ONE COMPACT UNIT!

- ✓ Multiple socket tube tester
- ✓ CRT tester-reactivator
- ✓ Volt ohm milliammeter and capacity meter

Here is a complete portable service shop at your side wherever you go. As a TUBE TESTER, it will check cathode emission, inter-element leakage and gas content of all tubes... As a CRT TESTER-REACTIVATOR it will test, repair and reactivate all black and white and all color picture tubes... As a VOM sensitivity is 20,000 ohms per volt/DC, 5,000 ohms per volt/AC... Capacity Range: .001 mfd. to 80 mfd. Handsome wood carrying case.

### Model 800 CRT TESTER-REACTIVATOR



- TESTS
- REPAIRS
- REACTIVATES  
ALL  
BLACK AND  
WHITE  
AND ALL  
COLOR  
PICTURE  
TUBES

\$4995  
Net

The Model 800 employs a new brilliantly engineered circuit designed to handle every black and white or color picture tube made — whether in the set or in the carton. It will TEST for emission, inter-element leakage and life expectancy... REPAIR inter-element shorts and weld open elements... REACTIVATE low emission tubes with a controlled high voltage pulse (reactivation is seen and controlled on the meter). Wood carrying case.

### Other Mercury profit-making instruments

- Model 201-F Self-Service Tube Testers
- Model 600 In-Circuit Rectifier Tester
- Model 700 Transistor-Diode Tester
- Model 102-P Tube Tester
- Model 400 VOM-Capacity Tester
- Model MH-1 Multi-Head
- Model MP-1 Multi-Probe
- Model MT-1 Multi-Tracer

SEE THEM AT YOUR LOCAL DISTRIBUTOR OR WRITE FOR CATALOG

**Mercury**

**ELECTRONICS CORP.**

111 Roosevelt Ave.,  
Mineola, N. Y.

manufacturers of quality electronic products

CANADA: Wm. Cohen Ltd., 8900 Park Ave., Montreal • EXPORT: Terminal Radio Int., 240 W. 14 St., N.Y., N.Y.

“fire” the neon lamp or produce a reading on a meter-type indicator. Where a specific input level is given in the directions, it should be set with the aid of VTVM “A” (Fig. 7). Generally, it is best to use the strongest possible signal (without actuating the indicator) in order to overcome ambient noise.

In setting up the equipment as shown in Fig. 7, the power-supply voltage should be at its rated value, and the load of the indicator motor (if one is used) should be included for accurate results. The motor and indicator must be in place to pre-

serve the correct value of distributed capacitance in the circuit. After the amplifier being aligned is connected as shown in Fig. 7, it can be turned on and allowed to warm up. The tuned slugs can then be adjusted until no further improvement in output is indicated on VTVM “B.”

#### Power Sources

The boat battery is most commonly used as a power source. Transistorized depth finders may use this voltage directly, or they may have their own self-contained batteries. Indicator motors in these units are driven by DC. Tube-type

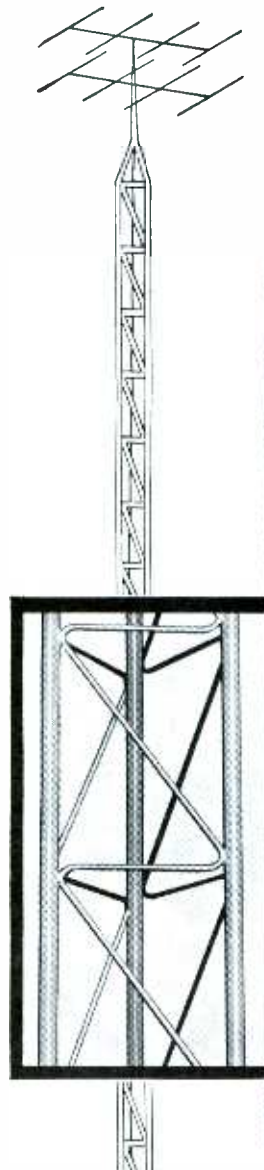

## THE MOST FAMOUS LINE OF TOWERS IN THE WORLD ARE ROHN!

*Here are the features that make them the largest selling and most accepted tower for television, radio, industrial and communications uses:*

- **ZIG-ZAG CONSTRUCTION**—proven zig-zag design means sturdiness and dependability that is truly outstanding. Tower sections are completely assembled and electric welded throughout for maximum strength and greater economy in erection.
- **HOT DIPPED GALVANIZED AFTER FABRICATION**—Entire tower sections are completely zinc coated after fabrication for the finest outer protection possible. Being galvanized after fabrication means no uncoated bolt holes, weld spots or seam to rust. All ROHN Towers last far longer and have less maintenance than competitive towers because of this feature.
- **HIGHEST QUALITY MATERIAL USED**—only highest quality laboratory-certified steel tubing is used (not pipe). Quality steel plus heavy gauges combine to give far greater strength than competitive towers.
- **COMPLETE LINE FOR WHATEVER YOUR NEEDS**—Fully self-supporting towers are available to 170 feet or lower; heavy duty guyed towers available up to 500 feet. Whatever your needs, check ROHN.
- **UNEXCELLED ENGINEERING**—all ROHN Towers are engineered to meet the most rigid requirements as outlined by all major communications equipment manufacturers and electronic industry associations.
- **UNIVERSAL ACCEPTANCE**—Hundreds of thousands of Rohn Towers are in use all over the world. They have withstood the “test of time”—the only true test as to the superiority of a tower. So why settle for less than the BEST? Insist on the largest selling tower in the world—ROHN.

For your needs and for all allied tower accessories, contact your local ROHN salesman or write direct for full information.

SEND THE HANDY COUPON INDICATING YOUR NEEDS

**ROHN**  
Manufacturing  
Company  
BOX 2000  
PEORIA, ILLINOIS

ROHN Manufacturing Company  
Box 2000  
Peoria, Illinois

Send me complete literature on the following ROHN Products:

- TV Towers                       Amateur Towers  
 Communication Towers       ROHN Accessories

Name \_\_\_\_\_

Firm \_\_\_\_\_

Address \_\_\_\_\_

City \_\_\_\_\_ State \_\_\_\_\_

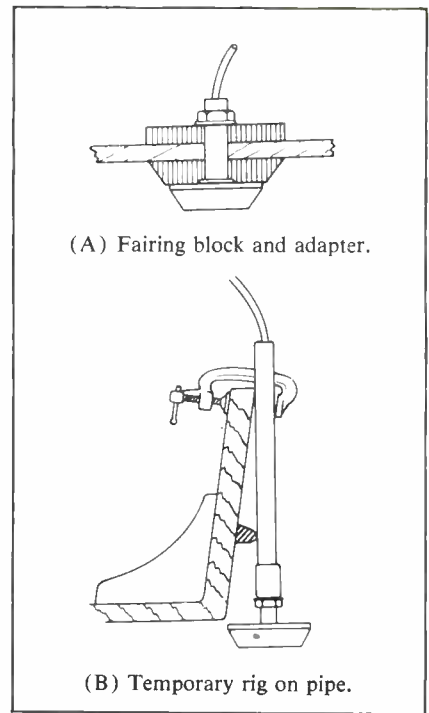

Fig. 8. Ways to mount transducer.

depth finders generally use a vibrator-type power supply similar to the circuit found in older auto radios. Tube heaters are supplied with DC directly from the battery, and the vibrator supply changes the DC to 300-volt, 115-cycle AC which is then rectified and filtered for use as plate voltage. A portion of this AC voltage is often used to drive a synchronous motor at 1150 rpm for the indicator.

#### Installation

There are few difficulties in the installation of a depth finder, since only two parts (the transducer and the indicator unit) require mounting. However, the installer must take care *not* to cut or change the transducer cable, since its length



This RCA Depth-Meter III is a typical example of the rotating-lamp indicator. Its scale measures depths up to 120' with one revolution of the lamp.

and other characteristics affect the tuning and efficiency of both the transmitter and receiver circuits.

Depth-finder indicators may be mounted in almost any convenient spot, although they should be kept as far away from other electrical wiring as possible in order to avoid interference. The indicator should be located where it can be read without difficulty, and where it will not be in the way of normal operations aboard the boat. Space should be allowed at the rear of the case to connect the cable to the transducer. If power is obtained from the boat battery rather than from a self-contained DC source, the wires should go directly to the battery — in the correct polarity, of course.

In mounting the transducer, three considerations must be kept in mind. The unit must always be in the water, pointed directly downward for best results, and located where water turbulence is at a minimum. The installer can mount the transducer through the hull as shown in Fig. 8A, being careful to seal the hole on both sides; or, for temporary installations, he can use a pipe mount (Fig. 8B). The mounting location should be reasonably easy to reach for cleaning, since the outer surface of the transducer must be kept clean to insure accurate readings.

Electrical noise is a problem in some installations. Appearing as "spikes" in the receiver-input signal, it causes spurious flashes of neon-bulb indicators or false readings of meter-type indicators. A ground strap from the boat engine to the transducer ground lead is often helpful in curing this trouble; in addition, it may be necessary to



The Wintronix Depthmeter "400" is typical of direct reading units. A switch selects either of two ranges—one for depths up to 12', the other for depths to 120'.

install ignition - noise suppression devices similar to those used in automobiles.

The chart at the beginning of this article gives general directions for troubleshooting depth finders of the neon-indicator type. When a defect develops in a unit using a meter or depth recorder as an indicator, the power source and the indicating device should be checked first; then the tubes (or transistors), other circuit components, and the transducer should be checked — in that order. ▲

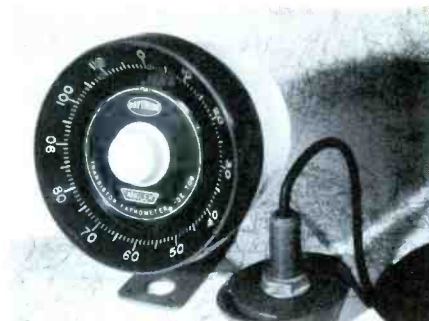

The Raytheon "Angler" DE708 is a completely transistorized fathometer. It operates on the rotating-lamp principle, with the scale graduated to read depths up to 120'.

Professional Technicians Use CASTLE'S

## Complete TV TUNER OVERHAUL

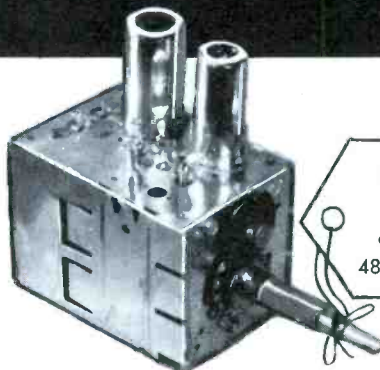

**SAME DAY  
SERVICE!**

on Popular Types  
48 Hours most Others

Castle overhaul charge includes all labor and minor parts and written 90 day warranty. Tubes and major parts are extra at net prices. Tuner to be overhauled should be shipped complete; include tubes, shield cover and any damaged parts. Write down model number and state complaint. Pack well and insure.

NOW ALSO IN THE EAST

# CASTLE

TV TUNER SERVICE, INC.

- 5710 N. WESTERN AVE., CHICAGO 45, ILLINOIS
- NEW! 653 PALISADE AVE., CLIFFSIDE PARK, NEW JERSEY
- IN CANADA: 136 MAIN ST., TORONTO 13, ONTARIO

ALL MAKES  
ONE PRICE  
**\$9.95**

VHF TUNERS  
UHF TUNERS  
UV Combinations \*

\*uv combination tuner must be of one piece construction. Separate UHF and VHF tuners with cord or gear drives must be dismantled and the defective unit only sent in.



Overhauling TV tuners is our only business. We do not manufacture and sell you a so called "universal" replacement tuner. When the original equipment tuner is overhauled by Castle you are assured that it will fit properly and the electrical specifications, set by the receiver manufacturer, will be met exactly.

Castle



TV TUNERS

## Commercial Sound

(Continued from page 23)

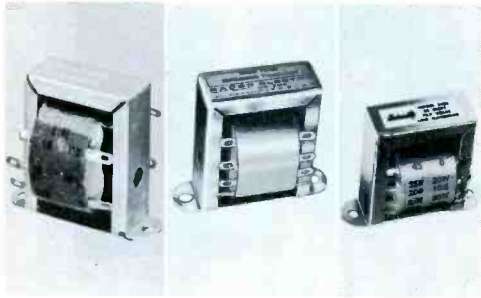

Constant-voltage types have tapped primaries rated in watts (for example, 5/10/15/20 watts). These are generally designed for use with amplifiers having standard 70- and 140-volt outputs. When the desired wattage tap is connected to the feed line, the 4-, 8-, or 16-ohm secondary connection supplies the correct ratio of total power to the speaker. The simplicity of obtaining the proper power-rating connection is the biggest advantage of the constant-voltage transformer. However, this type also has the distinct advantage of maintaining proper power distribution even if a higher-wattage amplifier is added at some later date.

### Power and Speaker Requirements

Application	Sq. Ft. Area	Amplifier Rating (Watts)	Number of Speakers	Type of Speaker
Auditoriums	2,000	15	2	12" Cone and Baffle
	5,000	30	2	12" Cone and Baffle
	15,000	50	4	12" Projector Horn
Ballrooms	2,000	15	4	12" Cone and Baffle
	4,000	30	4	
	10,000	50	6	
Churches	1,000	10	2	12" Cone and Baffle
	4,000	15	2	10" Cone and Baffle
	15,000	30	4	
Classrooms, Offices and Stores	500	10	1	8" Cone and Baffle
	2,000	15	2	10" Cone and Baffle
	8,000	30	4	
Factories	1,000	15	2	12" Projector Horn
	4,000	30	4	Re-Entrant Horn
	8,000	50	4	
	40,000	100	10	
Funeral Parlors	1,000	10	1	12" Cone and Baffle
	4,000	15	4	
	10,000	30	8	
Restaurants and Night Clubs	1,000	15	2	12" Horn
	5,000	30	6	
	10,000	50	12	
Stadiums and Gymnasiums	3,000	15	2	12" Cone and Baffle
	10,000	30	4	
	50,000	100	8	

The values given in the above chart are for average installations. Exact power requirements can be obtained by adding up the wattage demands of each speaker.

# SOUND

FOR EVERY PA PURPOSE



### MODEL 30 PA 30 WATT AMPLIFIER

De Luxe, dependable amplifier with constant duty transformer and quality components. Input mixing for 2 microphones and phono channel. Bass and Treble controls. Frequency response  $\pm$  2DB. 30-15,000 CPS. Hum and noise 70DB. below rated output. Output 4, 8, 16 and 250 ohms. Two tone brown enamel wrinkle finish cabinet. Also available with phono turntable. Net \$65.00



10-20  
30-60  
WATTS

BY PRECISION ELECTRONICS

AT LEADING SOUND DISTRIBUTORS OR WRITE

Precision Electronics, Inc.  
9101-O King Ave., Franklin Park, Ill.  
Please Rush Public Address Equipment Catalog.

Name \_\_\_\_\_  
Street \_\_\_\_\_  
City \_\_\_\_\_ Zone \_\_\_\_\_ State \_\_\_\_\_

### Picture-Tube Repair Tool

Eliminates that hard soldering job

only \$1.25 each

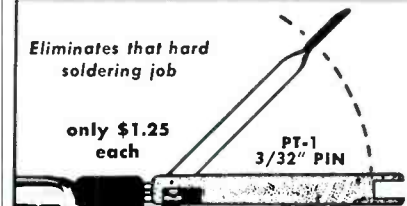

Fix loose pin connections in seconds. Pays for itself in time saved on first job. 3" long.

Patented

Intermittent operation of picture tubes due to defective solder connections easily corrected. Provides solid electrical connections, can also be used as channel-selector wrench and screwdriver. Pin keeps its original form. A 3-in-1 tool.

3 MODELS

ELIMINATE SOLDERING

### Makes Solid Electrical Connections Phono-Plug Crimper

Slip wire in "pin plug," insert in tool, and squeeze... job is done.

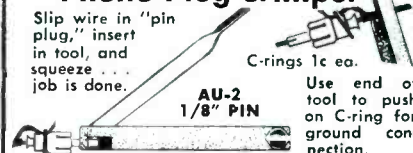

C-rings 1c ea.

Use end of tool to push on C-ring for ground connection.

Ant. plugs, hi-fi, multiple plugs, public address, radio and TV tubes, radar, speakers, and loop connections. Many, many more uses.

Model LC-3 for 5/32" pin diameter

At your parts distributor or write us

**BERNS**

Mfg. Co.  
9853 Chalmers,  
Detroit 13, Mich



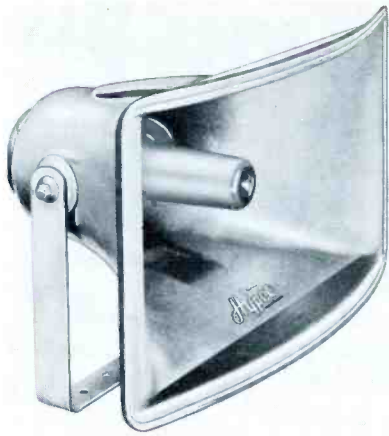

**Speakers**

Determining the power requirements for each area to be served is one of the first steps in planning a sound system. Since speakers are the components which actually reproduce the sound, the selection of suitable units comes high on the planning agenda. In small areas, the



# The "Big Picture"

*...informative shop talks*

by AL MERRIAM, *Sylvania Natl. Service Mgr.*

## New GT-555 chassis...

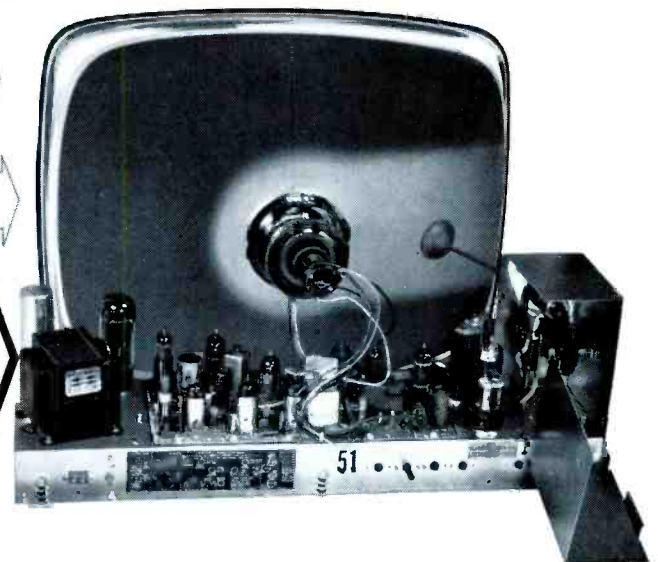

This new GT-555 chassis is the transformer-powered, modern version of the famous, performance-proved S-110 chassis. Just look at it . . . clean, modular, and service-designed with easy access to all components.

The new transformer that powers the GT-555 is a Sylvania exclusive and a modern marvel. It's called the Flexi-Core transformer, and it's up to 30% smaller and lighter than conventional types, and far more efficient in dissipating heat. The formed core strips are 100% interleaved and welded (rather than bolted) to eliminate lamination buzz and reduce core losses.

If you have to take the chassis to the shop, pulling the GT-555 is a breeze. You don't have any front screws to fight with — just chassis studs that push neatly into cabinet-mounted brackets, instead. Simply remove the three back screws, and slip the chassis completely free — the deflection yoke, tuner cluster, remote receiver and speaker are all plug-ins and quickly detachable.

You'll like this great, new one-two combination — the GT-555 chassis with Flexi-Core power. For more information on this and other big electronic advances, contact your local Sylvania TV distributor for dates and location of the Service Clinic in your area.

### SERVICE TIP OF THE MONTH

Don't throw away that broken portable TV antenna — repair it. Cut above the break with tubing cutter, making sure the inside rod section is fully extended while cutting. Remove the broken part from ball socket, then push antenna rod through ball and flare end with flaring tool or needle-nose pliers. Sylvania Home Electronics Corp., Batavia, N. Y.

# SYLVANIA

SUBSIDIARY OF

## GENERAL TELEPHONE & ELECTRONICS



**SILENT SERVICE**  
with  
**QUIETROLE**

the first, the quality, the proved silencing "Lubri-Cleaner" for noisy controls and switches on TV, radio and electronic instruments. **SPRAY IT OR DROP IT . . . it's easy—efficient—effective.** Make QUIETROLE your silent partner in providing satisfactory service.

manufactured by  
**QUIETROLE Company**  
SPARTANBURG, South Carolina

In Canada: CROSS CANADA ELECTRONICS  
12 Laurel St., Waterloo, Ont.

**SAMS PHOTOFAC INDEX**

MASTER INDEX TO SAMS PHOTOFAC

sent direct to your shop  
**FREE**  
SEND FOR IT!

Yes, now you can have the valuable SAMS MASTER INDEX TO PHOTOFAC FOLDERS and Index Supplements sent direct to your shop at no cost to you! Just mail coupon below and you'll be sure to receive regularly your handy guide to the world's finest service data covering over 33,000 TV, Radio, Amplifier, Tuner Tape Recorder and Changer models. Send for it—it's FREE!

**MAIL COUPON**

Howard W. Sams & Co., Inc.  
1720 E. 38th St., Indianapolis 6, Ind.

Put me on your mailing list to receive the Sams Photofact Master Index and Supplements

I'm a Service Technician: \_\_\_\_\_ full time; \_\_\_\_\_ part time

My Distributor is:

Shop Name: \_\_\_\_\_

Attn: \_\_\_\_\_

Address: \_\_\_\_\_

City \_\_\_\_\_ Zone \_\_\_\_\_ State \_\_\_\_\_

choice can be made by using common sense. In larger areas, however, experimentation is a better way to find out what's needed.

To survey an area, simply attach a trumpet-type speaker to a ladder, feed a music signal to it, and move it about. In this way, you can determine the power requirements and the number of speakers to be used. You can then study the power ratings and dispersion patterns of various speakers to select a suitable unit for each location. Of course, each specific installation also imposes several other requirements which enter into the final choice of a speaker. For example: Is it for indoor or outdoor use? What frequency response is required? Must it double as a "talk-back" unit? Remember that horn-type speakers are about four times as efficient as cone types; therefore, you'll be able to get much more sound out of a horn with the same power rating as a cone-type unit.

#### Typical Systems

To obtain a better understanding of how individual components are combined into finished installations, let's look at five basic types—public-address (PA), paging, background-music, church, and school systems.

PA systems are designed primarily to amplify and distribute announcements and speeches, while music and tone signals are of secondary importance; therefore, components having a frequency response ranging from 100 to 10,000 cps can be used in any PA installation.

Permanently-installed PA systems are found in a wide range of indoor and outdoor locations. Let's assume we are planning one for an auditorium of 10,000 square feet. From

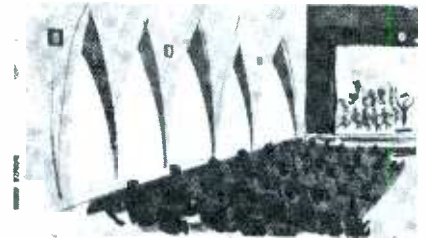

the chart on page 62, we see a 50-watt amplifier and four 12" speakers will meet average demands.

Cone-type speakers, mounted in baffles, will probably be used in



order to blend in with the surroundings. Since only four speakers are required, they can be wired directly to the amplifier, eliminating the cost of line-matching transformers. Auditoriums generally have "live" acoustics; therefore, it's best to use a microphone with a cardioid pickup pattern to reduce the amount of



**PHONE**  
ED 9-9653

**\$7.50**  
plus parts,  
C.O.D. and postage charges

**90 DAY WARRANTY**

**Precision Tuner Service**

ALL TYPES T.V. TUNERS REPAIRED AND ALIGNED TO FACTORY SPECIFICATIONS ON CRYSTAL-CONTROLLED SWEEP GENERATORS  
24-HOUR SERVICE ON MOST TUNERS  
UHF - VHF COMBINATIONS — \$13.50

See your local distributor or send to:  
P.O. Box 272, 601 N. College  
BLOOMINGTON, INDIANA

State make and model. Send all parts, tubes and shields



feedback. The distance between the mike and amplifier will determine whether a high- or low-impedance output is required.

With the above information at hand, the proper components can be selected to provide adequate public

address facilities. It's also advisable to suggest auxiliary units that can make the installation more versatile. For example, a tape recorder could be furnished with a system such as this to supply occasional background music and to record addresses.

Portable PA systems find wide usage among entertainers, civic organizations, auctioneers, etc. One or two speakers are mounted in the carrying case, which also serves as a baffle. The amplifier is usually rated at 10 to 30 watts—plenty for general use.

Portable megaphones, which operate from self-contained batteries, have outputs ranging from 5 to 25 watts. Some have a music-input jack and provisions for use as a listening device.

Most mobile PA systems use shock-mounted amplifiers rated at 20-30 watts. Any number of speakers can be used to provide the desired dispersion pattern. Dynamic mikes with low-impedance outputs are normally preferred, since they reduce interference pickup and can be used with longer cables.

A paging system may provide

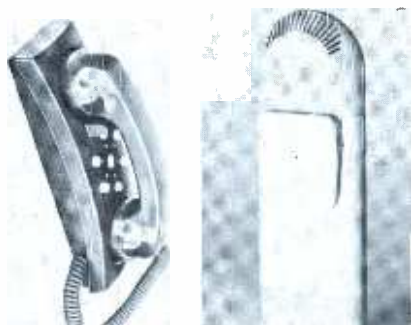

Cat. No. 52

**NEW!**

**Built To Stay Up!**

# STRAP-LESS Chimney Mount



- Installs In Seconds
- No Chimney Too Large
- Can't Rust Away
- Up To 1,500 lbs Clamping Pressure

DEALER NET PRICE \$1.25 Write for literature. Ask for bulletin P-6

**R-Columbia Products Co., Inc.**  
2008 St. Johns Ave. Highland Park, Illinois

**THE NEW DYNAMIC RAPID TROUBLE SHOOTER**

**METREX GENIE** POCKET-SIZED — TRANSISTORIZED SIGNAL GENERATOR  
Tunable 50 cy. to 3.3 mc.

**7 INSTRUMENTS IN ONE!**

FUNCTIONS AS • RF • IF • AUDIO VIDEO • PULSE • BAR GENERATOR & VOLTAGE CALIBRATOR

Services — RADIO, TV, HI-FI, RECORDERS, PHONES AND INTERCOMS

The GENIE has a tunable range of 50 cycles to 3.3 mc. Output variable from zero to 9 volts peak to peak. The uniquely designed circuitry makes possible unusually stable operation and extremely low battery drain. The rugged diecast housing insures extreme durability and perfect shielding. 2 3/4" x 3 1/2" x 2" size is ideal for shop, lab, and field use.

**1495** less Batt

Pat. Pend.

**METREX** 519 HENDRIX ST., BKLYN 7, N. Y.

WRITE TODAY FOR FREE TROUBLE SHOOTING GUIDE

either one- or two-way communications. Ordinary intercoms, special telephone systems, modified CB equipment, and high-powered intercoms resembling regular PA amplifiers are all used in this phase of commercial sound work. The latter is often combined with a background-music system to provide two services over the same set of facilities.

The speakers (either cone- or horn-type) used in two-way systems must be designed to double as microphones. Adapters are available to permit connecting the systems to internal or external telephone systems, thus making it possible to originate paging calls from in-plant phones and to connect the system of one plant to that of another.

Chime tones or CB paging systems are often preferred for making frequent calls without annoying shoppers, hospital patients, etc.



Background music is now a generally accepted means of creating a more favorable atmosphere for working, shopping, or relaxation. Since "piped music" has a wide range of applications, the equipment demands for individual systems vary greatly.

Many offices, industrial plants, etc., want the music to be heard but

not listened to. In this case, regular PA or paging equipment has a sufficiently wide frequency response to do the job. On the other hand, supper clubs, motels, etc., have higher listening-to-hearing ratios and should have systems capable of hi-fi or stereo reproduction. Of course, these systems are more expensive.

Generally, the amplifiers used in deluxe music installations must have a large number of input circuits, or else additional mixer amplifiers and preamps must be included in the system. In addition, a broad frequency response is required for all amplifiers and speakers used in these systems. Indoor installations may use either hi-fi speaker enclosures equipped to handle a full range of frequencies, or extended-range cone-type speakers in ordinary baffles. Outdoor systems use hi-fi horns.

Churches and schools can use every type of system we've discussed. Therefore, providing an adequate system requires a lot of thought and careful planning.

You'll find in many cases that individual pieces of equipment can be moved from place to place within a



system to extend their usefulness. For example, the same amplifier can be used at different times in a permanent, portable, or mobile installation. In addition, you'll find uses for special signaling and remote-control devices not mentioned above.

If you are in doubt as to what will best fulfill the demands of a particular job, manufacturers are more than willing to help with the planning. In addition, they provide sales aids, instructional materials, and typical layout data to help you improve your knowledge of the subject.

#### Additional Information

While it has been impossible to go into great detail about specific requirements for individual components or systems, we have outlined the basic requirements underlying every sound job. To those who desire a better understanding of what is involved in selecting the proper equipment to fit specific jobs, we suggest these previously-published PF REPORTER articles dealing with the subject of commercial sound:

An Introduction to Commercial Sound Systems .....	Jan., 1957
Between the PA Amplifier and Speakers .....	May, 1957
Choosing PA Amplifiers .....	Nov., 1959
How to Choose and Use Microphones .....	Aug., Oct., 1959
PA Speaker Installation Tips .....	June, 1960
Portable Sound Systems .....	Nov., 1958
Public Address Speakers and Their Application .....	Mar., 1957
Sound Systems .....	Jan., 1959
What You Should Know About Speakers .....	May, 1961

**COMING  
IN THE  
JULY  
ISSUE**

**Here's just a hint on what the next issue holds in store for you.**

**Servicing Imported Transistor Radios**

**Two-Way Radio Antennas**

**Home-Call Sales Techniques**

**Monochrome Trouble in a Color Set**

**Service Benches You Can Build or Buy**

**Semiconductor Diode & Rectifier Replacement Guide**

## Final Scope Checks

(Continued from page 18)

in video-signal amplitude to 65 volts. However, distortion in the sound told me I wasn't quite through with the job.

I installed a new 6AQ5 with no effect. Checking further with a VTVM led me to discover that C55 was leaky. When I replaced this capacitor, the audio distortion cleared up, the low B+ rose to 135 volts, and — as I had anticipated — the amplitude of the composite video signal increased beyond the 80-volt level. When I returned the set to its owner, he was more than satisfied with the considerable increase in picture contrast — an improvement he didn't know was possible.

### Hum Trouble Averted

After clearing up a sync problem in an RCA receiver, I scoped the output of the two-stage video amplifier. The trace at the plate of the second stage (Fig. 3A) had normal amplitude, polarity, and syncto-picture ratio, but a distinct 60-cycle hum could be seen. This much hum modulation might be considered perfectly normal in some series-filament receivers, but not in this transformer-powered set. I hadn't substituted all the tubes in the picture circuits during the original repair, so I proceeded to check those I had missed. When I installed a new mixer, the hum virtually disappeared (Fig. 3B).

Even though no definite symptoms of hum could be observed in

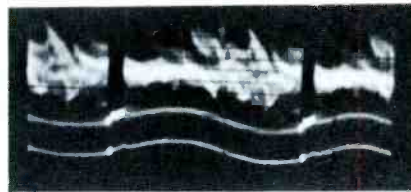

(A) Slight 60-cps hum.

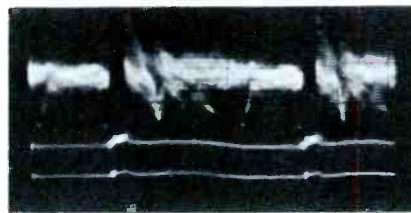

(B) Hum practically eliminated.

Fig. 3. Video—before and after.

the picture, the scope trace furnished a basis for predicting future trouble. I had no crystal ball to tell me when the defective mixer tube might have deteriorated enough to affect the picture, but I did know that a tube which produces 5% distortion today can easily develop 10% or more tomorrow. So I figure that I saved myself a callback by replacing this tube when the opportunity arose.

### "Gulliver" Settles Down

Sometimes it's a good idea to



Fig. 4. Distorted vertical sync pulses were clue to occasional loss of sync.

make "final" scope checks *before* doing any other troubleshooting operations! This is especially true when you know the set has recently been in one or more other shops for servicing.

I was recently called on by a fellow serviceman to look at a Hotpoint which was troubled with sporadic vertical flipping. It had already earned a reputation as a "Gulliver" by having made the rounds of several service shops, as well as having been examined on house calls by enough "TV doctors" to satisfy a rich hypochondriac. Before doing any troubleshooting, I examined the chassis for signs of the other servicemen's treatments. Among other things, the 6BL7 vertical and 6CS6 sync tubes had been replaced, as well as several capacitors in these circuits.

Scoping the plate of the 6AU8 video output tube, I saw the waveform shown in Fig. 4. Note the sloping "back porch" on the vertical sync pulse. Since a scope check at the grid of this tube showed no distortion, I replaced the 6AU8. The plate waveform returned to normal, and the vertical flipping has never reappeared.

After finding the trouble, I temporarily reinstalled the old 6AU8 to study its effect on the signals in the sync circuits. The output waveform of the sync separator seemed normal; this was only natural, considering that the vertical sync was stable most of the time. The video-amplifier defect apparently made

Renew or extend your subscription now, and get your choice of these three books.

The Troubleshooter's Handbook



### "THE TROUBLESHOOTER'S HANDBOOK"

A 96-page collection of questions and answers on troublesome servicing problems.

### "SERVICING INDUSTRIAL ELECTRONICS"

An 8½"x11", 64-page book containing industrial electronics features from past issues.



### "SERVICING TV from Tuner to Picture Tube"

A 96-page book containing 14 of the best PF REPORTER features. Covers all TV circuits.



Enter my subscription to PF REPORTER and send me free book(s) checked.

3 Years \$9.00       2 Years \$7.00       1 Year \$4.00

The Troubleshooter's Handbook  
 Servicing Industrial Electronics  
 Servicing TV from Tuner to Picture Tube } Check one for each year you subscribe

Bill Me       Remittance Enclosed       Extend Present Subscription

Take this coupon to your distributor, or mail to:  
 Howard W. Sams & Co., Inc.  
 2201 E. 45th St., Indianapolis 6, Ind.

Please Check Your Business Classification

Independent Radio, TV Serviceman       Owner, Mgr.

Retailer with Service Department       Service Mgr.

Industrial Electronics Service       Employee

Other (Specify occupation and title)

Name \_\_\_\_\_

Firm \_\_\_\_\_

Address \_\_\_\_\_

City \_\_\_\_\_ Zone \_\_\_\_\_ State \_\_\_\_\_

# 45 STOCK SERVICE FORMS AND SYSTEM ITEMS

For Radio-TV Service

## • SALESBOOK TYPES

- No. 104 TV Service Call Book
- No. 225 Radio-TV Repair Order
- No. 44 TV Service Invoice
- No. 212 TV Service Shop Report
- No. 209 Radio Service Work Sheet
- No. 152 Statement Book
- No. 100 Radio-TV Cash Sales Book

## • ONE TIME CARBON SETS

- No. 120 Radio-TV Service Order
- No. 125 Radio-TV Service Invoice
- No. 106 TV Service Report

## • SYSTEMS

- No. 700 Master Service File
- No. 705 Customer Service File
- No. 1800 "Profit Guard" System
- No. 1805 Ledger File
- No. 300A Service Ticket File

Also "Message Minder" TV Call Router, Collection Aider, Vinyl & Aluminum Holders for Books and Forms. Guarantee Books, Job Ticket Books. Many other items.

SEE THEM AT YOUR PARTS JOBBER

Write for FREE Catalog #51 and SPECIAL Rubber Stamp Offer

**OELRICH** SERVICE FORMS  
4308 Milwaukee Ave., Chicago 41, Ill.

the separator unusually sensitive to intermittent disturbances in the input signal.

This experience with the Hot-point further convinced me that a scope is also a highly efficient tube tester, in that it can accurately check the performance of tubes under actual operating conditions.

### Horizontal AFC Hash

A short time ago I bench-serviced an RCA Chassis KCS81 for infrequent horizontal tearout. The set owner reported that several other shops had worked on the set, and some improvement had been obtained; but the condition had not been thoroughly corrected. There was a new 6SN7 in the horizontal AFC-oscillator circuit, and an examination with the scope showed me that the waveform coil had been properly adjusted. Horizontal sync showed no tendency toward tearing, and it looked as if I'd have to let the receiver operate until it began to misbehave.

While setting it up for monitoring, I decided to take a quick look at the combination sync and feedback signal at the grid of the horizontal AFC stage. Expecting a

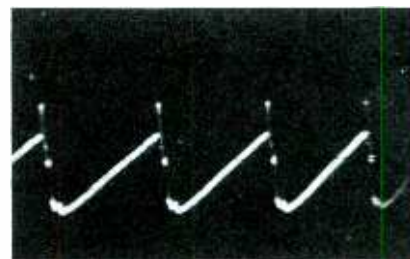

(A) Normal pattern.

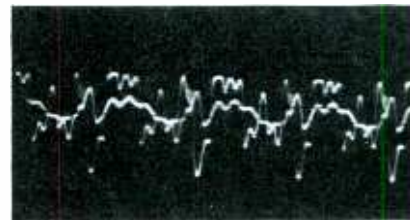

(B) Cause of intermittent tearing.  
Fig. 5. Pulse-width AFC input.

waveform like Fig. 5A, I was surprised to find the ragged trace shown in Fig. 5B. If the previous serviceman had been a believer in final scope checks, I never would have seen this set!

In the KCS81, the horizontal and vertical sync signals travel along considerably different paths (see partial schematic, Fig. 6), so I realized that distortion could be entering at almost any point in the sync section. For that matter, it could be developing in the AFC-oscillator stage itself. However, I decided to begin by checking the grid waveform of the horizontal sync separator (at pin 2 of V18), which looked perfectly normal. Advancing to the plate of this stage, I picked up an important clue; the waveform (Fig. 7A) was full of the same distortion I had seen at the AFC-tube grid.

It did no good to replace V18. Likewise, I learned nothing definite from a check of the sync-separator cathode waveform. But when I applied the scope probe to the B+ end of plate resistor R96, I saw the jittery trace pictured in Fig. 7B. Since this B+ line is bypassed by 70-mfd electrolytic filter capacitor C3A, virtually no signal should be present. Obviously, the filter was defective.

Replacement of C3 restored all waveforms to normal. Considering the shape they had been in, it was surprising that horizontal sync had not been a great deal worse.

### Accuracy Counts

In all of the above cases, the solution hinged on a fairly careful evaluation of the waveform, above

## MERCURY TV TUNER SERVICE

890 River Ave., Bronx 51, N.Y.  
"Largest in the East"



When Shipping Tuner: Include Tubes, Shields and Damaged Parts.  
Give Model Number and State Complaint  
PACK WELL AND INSURE  
24 HOURS ON POPULAR TYPES

### VHF-UHF TUNERS

90 Day Warranty  
Price Includes Labor & Minor Parts  
TUBES & MAJOR PARTS AT NET PRICES

**ALL MAKES ONE PRICE!**  
**\$9.50**

## SERVICEMEN KNOW!

Here they pay less and get the best  
**HUSH®**

*Chemically-Electronically, engineered for Tuners and Switching Mechanisms.*

When New HUSH is applied it will wash-away that dirt, leaving clean and positive contacts protected by a lasting lubricant. New HUSH is made from the finest solvents and it contains Electro-Silicone oils.

Also available—2 oz., 8 oz., 32 oz. containers      6 oz. Spray can **\$2.25 net**

### EVER - QUIET®

Since 1949  
**VOLUME CONTROL AND CONTACT RESTORER**

EVER-QUIET is a free-flowing liquid that leaves no powder residue. Scientifically designed to seep around the shaft and penetrate the control or potentiometer, cleaning the contacts and leaving a safe protecting film. Harmless to metals, wire or carbon.

Also available—32 oz. containers      6 oz. Spray can **\$1.59 net**  
2 oz. Bottle & dispenser **79c net**





**CHEMICAL ELECTRONIC ENGINEERING, INC. Matawan, New Jersey**

# TARZIAN

Silicon rectifiers that mean fewer call-backs for you



Now 600 piv F Series and H Series units for stereo...hi fi...television

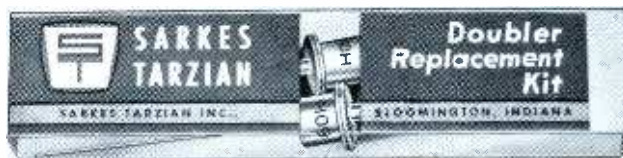

Tarzian 600-volt F and H series units are now available to meet the popular demand for them for servicing stereo, hi fi, television. The 600-volt units reduce failures due to line voltage transients. 400 and 600 volt F and H series rectifiers are available in Doubler Replacement Kits—also in Ten Packs and in bulk. And remember—M 150 and M 500 conversion Kits are available for those who prefer snap-in mounting.



Plus

## Tarzian Tube Replacement Silicon Rectifiers



Tarzian's 9 standard models of tube replacement rectifiers are directly interchangeable with over 95% of all popular vacuum tube rectifiers. An added plus is the Full Wave Silicon Rectifier (S5347), replacing 6BW4 or 12BW4 in Citizen's Band radios for maximum performance in reception quality and range.

Plus

## Tarzian "Condensed-Stack" Selenium Rectifiers



Model 300-500 now 1/2 smaller than before; only 1 1/4" wide. Other models are 50-75, 100-150, 200-250

Tarzian's four "condensed-stack" selenium rectifiers replace the 20 types that formerly made up the 50 to 500-milliamper line. Their small size eases both your application and inventory problems. Improved production processes have substantially reduced watt losses by as much as 50%.

Send for Tarzian "Distributor Line" Rectifier Catalog



## SARKES TARZIAN, INC.

World's Leading Manufacturers of TV and FM Tuners • Closed Circuit TV Systems • Broadcast Equipment • Air Trimmers • FM Radios • Magnetic Recording Tape • Semiconductor Devices

SEMICONDUCTOR DIVISION • BLOOMINGTON, INDIANA  
In Canada: 700 Weston Rd., Toronto 9 • Export: Ad Auriema, Inc., New York

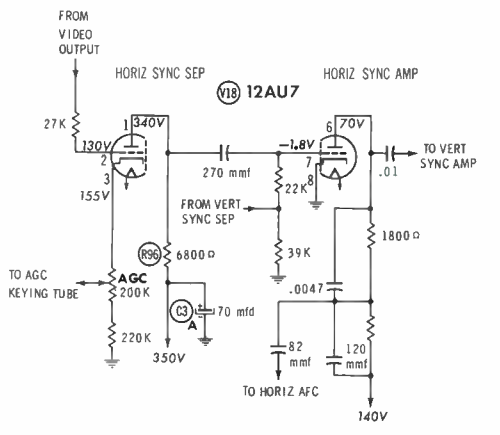
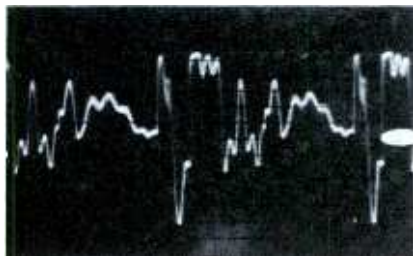

Fig. 6. Source of trouble was traced all the way back to the sync separator, and beyond merely checking for its presence.

Correct calibration of a scope makes it easy to find out the amplitude of a signal—often a valuable piece of information. Also, to insure that any observed distortion is actually present in the waveform and not being created by the scope, the proper probe should be used for each test. To meet the above requirements, the waveforms in this article were taken with a low-capacitance probe, and the scope screen was calibrated so that 2" of deflection would indicate 100 volts peak to peak.

When its capabilities are fully realized, a scope is obviously too talented to be employed on only a limited or part-time basis. If you could use it enough to wear it out, you'd be earning enough money to buy a dozen scopes. ▲



(A) At end connected to plate.

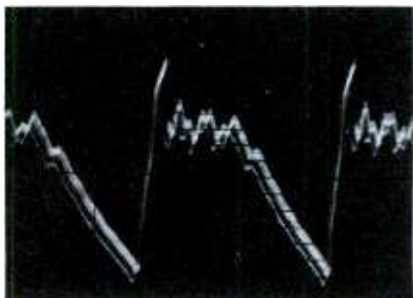

(B) At end connected to B+.

Fig. 7. Signals at terminals of R96.

# PRODUCT r e p o r t

For further information on any of the following items, circle the associated number on the Catalog & Literature Card.

## Transistor Radios (39C)



Two new Hitachi radios have been announced by Sampson. The 6-transistor Model TH-666ES (shown; \$39.95) can be used as a pocket portable or plugged into a table stand containing a larger speaker. The 8-transistor Model WH-829 (\$59.95) tunes across the 3.8-12 mc short-wave band in addition to the broadcast band. Both radios come in a choice of two-tone color combinations, with leather carrying case and ear-phone.

## Subminiature Electrolytics (40C)



Cornell-Dubilier has introduced a line of "Electomite" subminiature electrolytic capacitors, featuring hermetically-sealed aluminum cases, welded connections, and low leakage current. Two lead arrangements are available — axial (Type NLW) or both leads at one end (Type NLP). Nine different DC working-voltage ratings, from 3V to 150V, are supplied. Capacitance values range from 1 to 750 mfd at 3V, and from 1 to 18 mfd at 150V.

## Vibrators for CB Radios (41C)

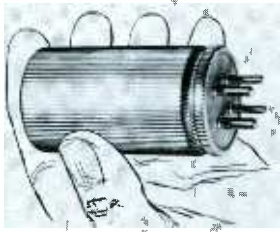

Three models of James vibrators are designed for use in Citizens band transceivers. Model CB-40 is a 4-prong, 6-volt unit with a maximum current rating of 5 amps on "receive" and 10 on "transmit"; list price is \$4.95. Models CB-41 and CB-42 are 4- and 3-prong types, respectively, with 12-volt input and 3-amp/6-amp output; price is \$5.15.

## Battery Merchandiser (42C)

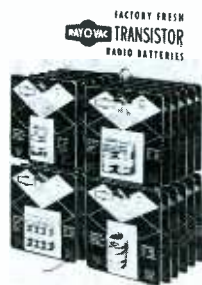

A counter display rack, holding a stock of transistor-radio batteries, is offered to dealers by Ray-O-Vac. The batteries are packed in clear plastic "bubbles" on cards, as follows: 4 doz. 1.5V "AA" size, in groups of 4 each; 1 doz. 1.5V "C" size, 2 to a card; and 16 singly-packaged 9V units (1 doz. No. 1604 and 4 No. 1600). Dealer price of this RB-6 assortment is \$24.80.

## Tube Inventory Book (43C)

To help service shops keep track of tube-stock requirements Westinghouse has published a "Tube Inventory Guide" containing a full list of entertainment tube types, with space for 12 sets of inventory figures. Squares are provided for noting the quantity of each type on hand, number to be ordered, and number received. In addition, recommended percentages of total inventory (based on national tube-sales figures) are given for all common types. The latest edition is available through distributors at 35c per copy.

## Book on Alignment (44C)

"Radio & TV Alignment Handbook" by Warren J. Smith, published by Howard W. Sams & Co., Inc., covers the following subjects: Determining the need for alignment, selecting and using test equipment for this job, analyzing response curves in sweep alignment of various radio-TV circuits, and aligning color TV, UHF, AM radio, and FM equipment. The book has 160 pages in 10 chapters, and is priced at \$2.95.



## Variable-Response Microphone (45C)

A compact, high-output dynamic microphone, the Shure Model 540S "Sonodyne II," has a variable frequency response so the user can adjust the tone to suit different job requirements. Low and high frequencies can be independently modified. An on-off switch is mounted on the housing. This omnidirectional microphone, usable in both public-address and home-recording applications, is priced at \$49.95.



## Heavy-Duty DC Supply (46C)

For servicing mobile electronic equipment and furnishing shore power to boats, Electro Products Labs has developed a 12-volt DC power supply which delivers 30 amps continuously, or as high as 50 amps for short periods. Ripple is less than 1% at the maximum continuous rating. Other features include low output impedance and conduction cooling. This unit, the Model PS-30, is priced at \$185.



## Components for Background Music (47C)

Two new Grommes high-fidelity components for background-music systems are equipped for microphone input, allowing announcements to be mixed with musical programs. The Model 510 (shown) is a combined FM tuner, preamp, and power amplifier with auxiliary tape and phono inputs; price is \$149.95, plus \$10 for enclosure. Model G22 (\$99.95) is an audio amplifier with a usable power output of 20 watts and choice of tuner, tape, phono, or 600-ohm telephone-line inputs.



## Sound Synchronizer (48C)

A tape-recorded commentary can be conveniently added to a photographic slide or strip-film presentation by use of a slide-projector synchronizer developed as an accessory for V-M tape recorders. The unit responds to a 60-cps pulse signal on the tape by triggering the slide-changing device on a remotely-controlled projector. The \$49.95 price of the Model 1412 synchronizer includes a certificate that entitles the buyer to a trip cord which fits his own projector; cords are available for many popular brands.





### Stereo Amplifiers (49C)



The new Sherwood S-5000 II integrated stereo amplifier-pre-amp unit is an improved version of the S-5000, with the combined music-power output of both channels raised to 80 watts. Also newly introduced is a similar but smaller amplifier, the S-5500, rated at 50 watts. A loudness control with in-out switch, and 12 db/octave scratch and rumble filters, are among the many front-panel controls common to both models. Prices are: S-5000 II, \$199.50; S-5500, \$159.50.

### Replacement Electrolytics (50C)



Arco electrolytic capacitors are now being displayed by distributors in two self-service racks, the "ArcoLytic Twins" — one containing 123 different values of tubular units, and the other holding 541 twist-mount types. All capacitors in this line are made with extra-high-purity (99.99%) aluminum foil. Maximum operating temperature for all twist-mount cans and many tubular units is 85° C.

### Toggle-Operated Leaf Switches (51C)

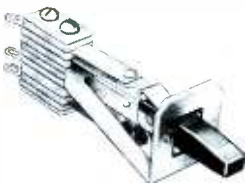

Multiple, leaf-type contacts in Switchcraft Series 23000 "Tini-Toggle" switches are operated by 2- or 3-position toggle levers. Standard models have silver contacts, rated at 3 amps and 120 VAC (for noninductive load). The frame has four tapped holes for panel mounting with 3-48 machine screws.

### Antenna-Matching Coils (52C)



An assortment of 20 different antenna-matching coils is being marketed by Colman as a source of replacements for original parts used in the following brands of TV sets: Admiral, Airline, Bendix, Coronado, Firestone, G-E, Hallicrafters, Hotpoint, Magnavox, Motorola, Muntz, Olympic, Packard-Bell, Philco, RCA, Silvertone, Truetone, Westinghouse, Zenith, and others.

### Tunable Miniature Generator (53C)



The transistorized, battery-operated Metrex "Genie" signal generator is pocket-sized; its die-cast housing measures 2 3/4" x 3 1/2" x 2". The output frequency is adjustable from 50 cps to 3.3 mc in two bands, and the amplitude can be varied from 0 to 9 volts peak to peak. Price is \$14.95, including two different types of plug-in test probes.

### Probes With Four Functions (54C)



Mercury multipurpose test probes have a rotating head with four operating positions. Two different designs are available. The Model MT-1 "Multi-Tracer" (\$12.75 — see photo) serves as a demodulator probe, signal tracer, signal injector (using transistorized oscillator)

and neon-type AC or DC voltage tracer. The Model MP-1 "Multi-Probe" (\$9.75) is usable with meters and scopes as a direct, resistive-isolation, RF, and low-capacitance probe.

TRUST YOUR TV TUNER  
REPAIR and ALIGN to



**24 HR SERVICE**

VHF or UHF—ALL MAKES

VHF Tuners ..... \$9.50 net  
UHF Tuners .....  
UHF Converters .....  
UHF-VHF Combinations ..... \$17.95

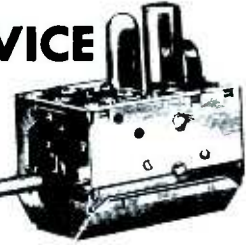

Prices are for service and unutilized units. Missing, broken and damaged parts, defective tubes charged extra at LOW net prices. We ship C.O.D.

### 10 STEPS IN OUR GUARANTEED SERVICE

1. All tuners mechanically and electronically inspected.
2. All necessary parts replaced.
3. Contact surfaces correctly cleaned and lubricated.
4. First test run for intermittents and drift indication.
5. Fine tuning range checked on all channels.
6. Local osc aligned to correct frequency all channels—XTAL controlled.
7. RF alignment—all channels—XTAL controlled.
8. AGC check, all channels—cut off of RF amp checked.
9. Overall response all channels, shield covers in position.
10. Quality control FINAL CHECK ALL UNITS, UHF-VHF.

**IMPORTANT:** Ship complete. Include all broken parts. State model and complaint. Package well to avoid transit damage.

**JW ELECTRONICS** 1539 W. Jarvis Avenue  
CHICAGO 26, ILLINOIS Broadway 4-9757

## Service Dealer Program No. 6 in a Series

All 5 ads only

\$1.00 for glossy proofs

\$1.75 for ad mats

TECHNICIAN WRITES OWN OFFER 18 WORDS OR LESS!  
CALL ME 0 000  
**YOUR NAME**  
ADDRESS

AUTO RADIO REPAIR  
CALL ME 0 000  
**YOUR NAME**  
ADDRESS

Bring the action right into your living room...  
TV TUNE-UP!  
CALL ME 0 000  
**YOUR NAME**  
ADDRESS

GOT TV SQUINT?  
CALL ME 0 000  
**YOUR NAME**  
ADDRESS

**CLIP**  
THIS TO THE BACK OF YOUR TV SET

**TV SERVICE**  
10% OFF  
CALL ME 0 000  
**YOUR NAME**  
ADDRESS

USE THIS COUPON TO ORDER ADS DESCRIBED ON PAGE 53

**PF REPORTER**  
2201 E. 46th Street  
Indianapolis 6, Indiana

Please send me:

ad mats @ \$1.75     glossy prints @ \$1.00     both for \$2.50

Entire series of 60 mats, plus bound glossy proof book @ \$25.00  
Enclosed is \$\_\_\_\_\_ to cover cost.

Name \_\_\_\_\_

Address \_\_\_\_\_

City \_\_\_\_\_ Zone \_\_\_\_\_ State \_\_\_\_\_

661



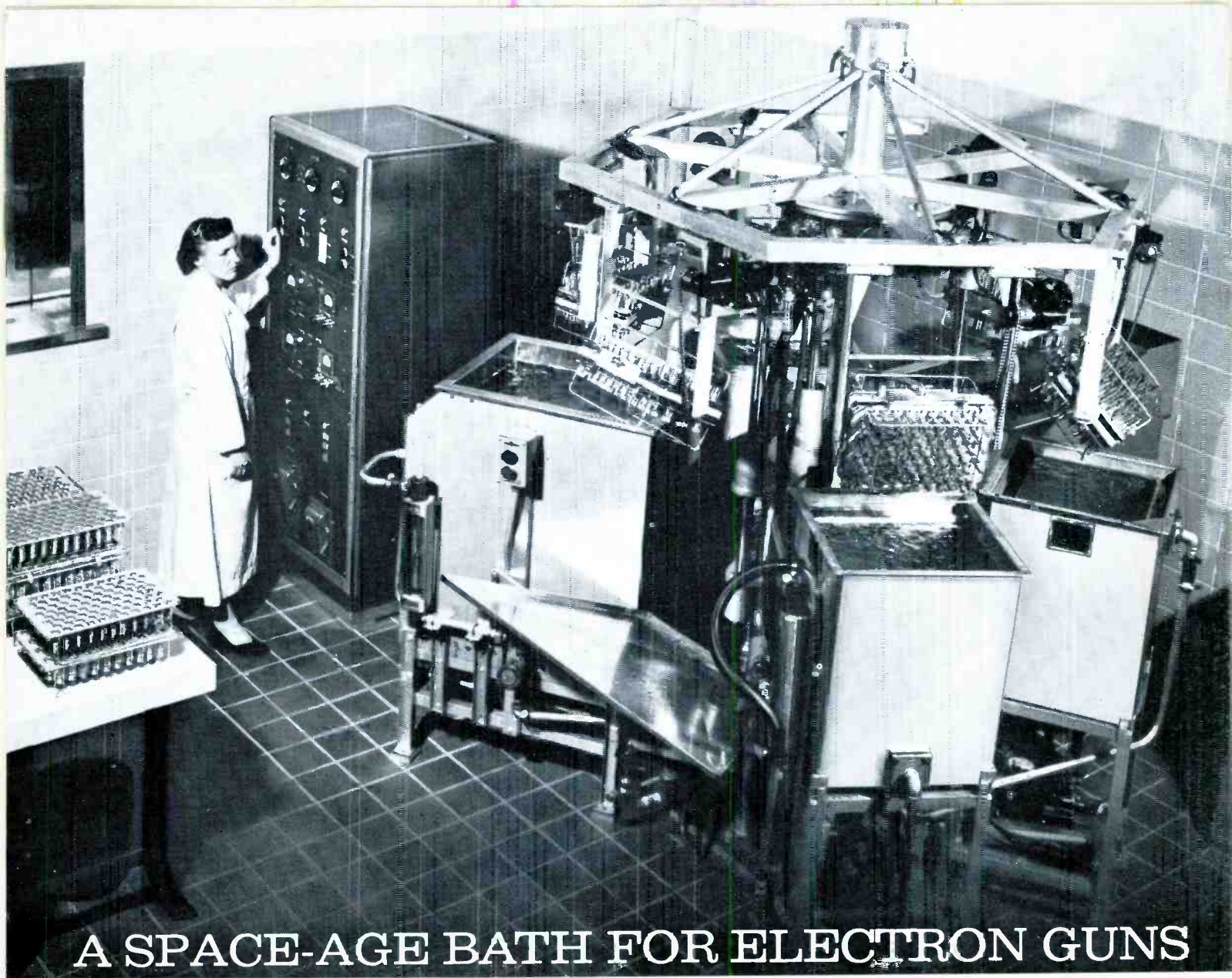

## A SPACE-AGE BATH FOR ELECTRON GUNS

### Another RCA Precaution Against Picture Tube Callbacks

Superior TV picture tube quality depends largely on an electron gun that is precision-made and clinically clean. RCA assures the cleanest guns possible in *Silverama Picture Tubes* by employing the costly space-age technique of ultrasonic cleaning: scrubbing gun mounts with high-frequency vibrations in a super-wet detergent to remove even microscopic foreign particles.

In this and every respect, RCA Silverama Picture Tubes are built to the highest standards of the picture tube industry. They

contain an all-new electron gun, all-new parts and materials except for the envelope which is used.

These extra precautions help substantially to reduce troublesome "in-warranty failures" and costly callbacks. So give yourself the advantage of selling the best *name brand* picture tube: RCA Silverama. It's now merchandised in an attractive, distinctive new package and is competitively priced with other leading brands of picture tubes. See your Authorized RCA Distributor this week.

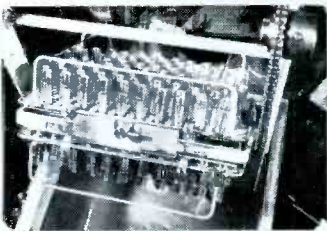

Guns emerging from ultrasonic cleaning tank. Still in the same tray, they are placed immediately in the radiant drying oven shown in the photograph at right.

Gun mounts are dried for one hour at 150°C (302°F.). Then, super-dry and super-clean, they are taken out for final processing in our dust-free "White Room".



RCA ELECTRON TUBE DIVISION, HARRISON, N. J.



The Most Trusted Name in Electronics  
RADIO CORPORATION OF AMERICA

# WHAT'S IN A FUSE?

Only a fuse element, glass & caps?

No! Every fuse carries  
with it the skill and quality of its manufacturer.

You can't reach out and touch or taste this,  
you can't even be sure it will do  
its job when needed except  
by purchasing from a company  
that has the know how of 30 years  
of manufacturing fine fuses.

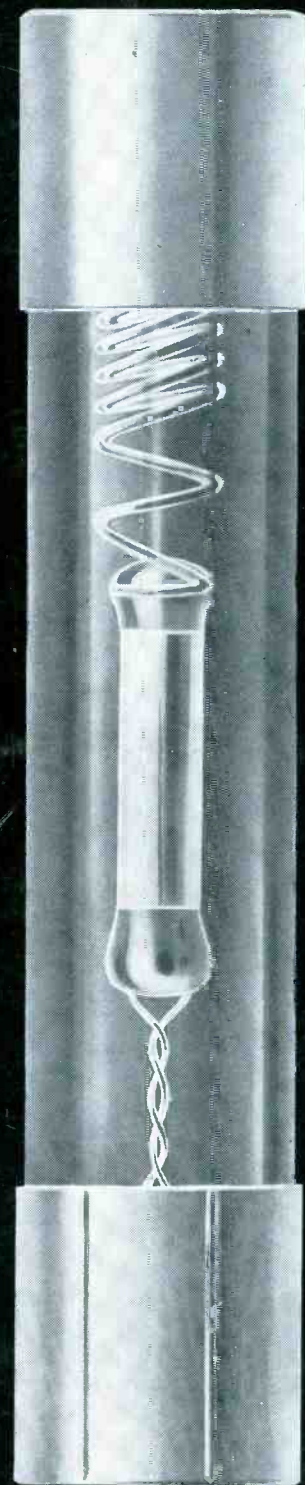
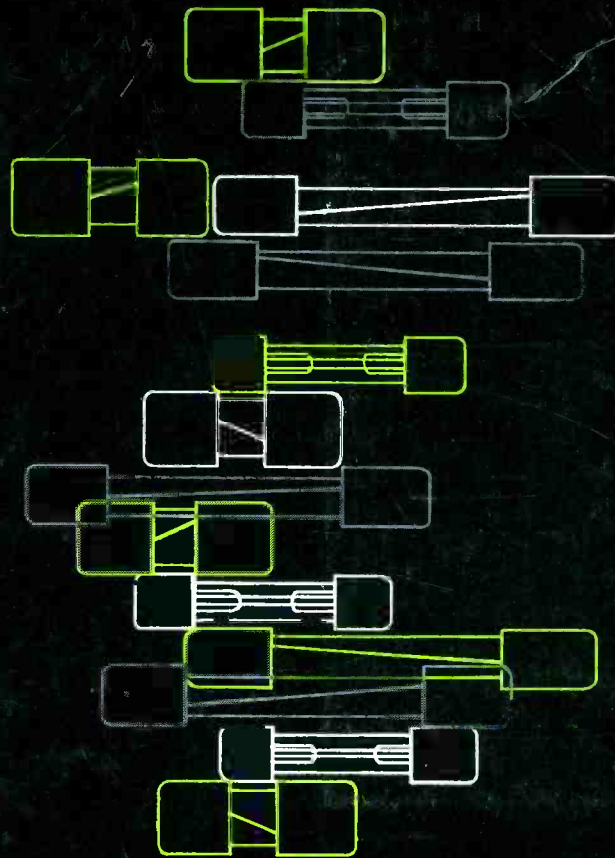

BURTON BROWN ADVERTISING

## LITTELFUSE

1865 Miner Street · Des Plaines, Illinois