

DECEMBER, 1960

35 CENTS



PHOTOFACT REPORTER

including **Electronic Servicing**



Regeneration in Picture-Signal Circuits

Report on TV Radiation Hazards

Examining Motorized Tuner Mechanisms

Speed Problems With Phonos

FRANCIS J. GRONDOLSKY
9404 BEACON AVE.
CLEVELAND 5, OHIO



PUZZLED

...no need to be

look to this sign of assurance!

The Distributor displaying this sign will solve your tuner problems at a profit to you.

He has available the New Standard Tuner Replacement Guide, including replacement parts listings. This is the only Guide of its kind in the world. Covers all Standard tuners produced through 1959. Includes replacements for many tuners not produced by Standard. He handles our 48-hour Factory Guaranteed Repair Service and Trade-In Allowance on unreparable Standard tuners.

See This Authorized Distributor Today

AUTHORIZED

Standard **COIL**

TV TUNER DISTRIBUTOR

GUARANTEED  **REPLACEMENT TUNER** **FACTORY SERVICE - PARTS**

standard kollman

INDUSTRIES INC. Formerly Standard Coil Products Co., Inc.
2085 N. HAWTHORNE AVENUE, MELROSE PARK, ILLINOIS

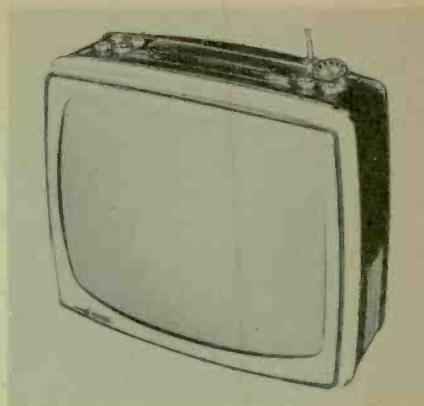
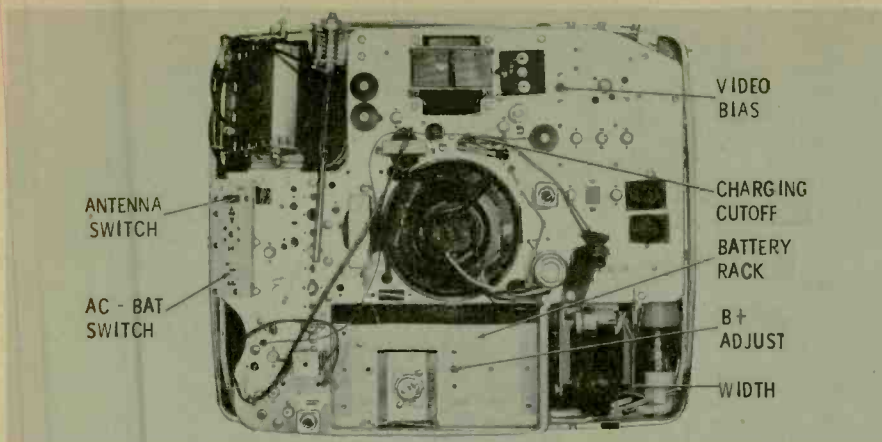

Motorola Model 19P1 Chassis TS-432

One of the outstanding models in Motorola's 1961 line is this 19" *Astronaut* transistorized portable. The 114° CRT used in this set (a 19AEP4) has a special filament rating of 12.5 volts, 150 ma. All operational controls are top-mounted, the channel selector and fine tuning knobs tilting forward for easier viewing. Height and linearity adjustments are accessible through the hollow shafts of the vertical and horizontal hold controls.

Removal of the cabinet exposes the clean-looking vertical chassis. The earliest versions were equipped with 23 transistors; however, horizontal output and B+ filtering circuits were changed to increase the number to 25. Several "never-before-heard-of" controls are employed in biasing and regulating circuits; consult the service data before attempting to make any setup adjustments. Two adjustments, AGC and vertical bias, are accessible through two holes in the bottom of the cabinet—these controls are hidden in the photo by the battery rack. The 1S2A high voltage rectifier is the only tube in the set other than the CRT. NOTE: High voltage should be checked with a meter; arcing the anode lead to chassis may damage the horizontal output transistors.

A full-wave silicon-rectifier power supply, used during AC operation, also charges the battery for portable operation. This circuit uses transistors as filters and voltage regulators, and its output should be adjusted to provide 19.5 volts at the test point with the set connected to a 122-volt AC source. Both the AC and battery supplies are fused. The heat sinks shown in the photo merely slide onto the transistor cases; be sure they are in place before operating the set.

Most of the transistors are plug-in units. Several sockets have four openings and are wired to ground the transistor shield through a fourth pin. An index tab or paint dot is provided on both three- and four-pin transistors to indicate how the transistor is to be inserted in the socket. When removing a transistor, make a special point to note the position of this tab or dot, since there are no mechanical stops to prevent you from incorrectly reinserting the unit.

The horizontal deflection circuits are mounted on a side panel that doubles as a heat sink. Since some of the sweep transistor and diode mountings are different from those you are accustomed to, we've pointed them out to help you find your way around.

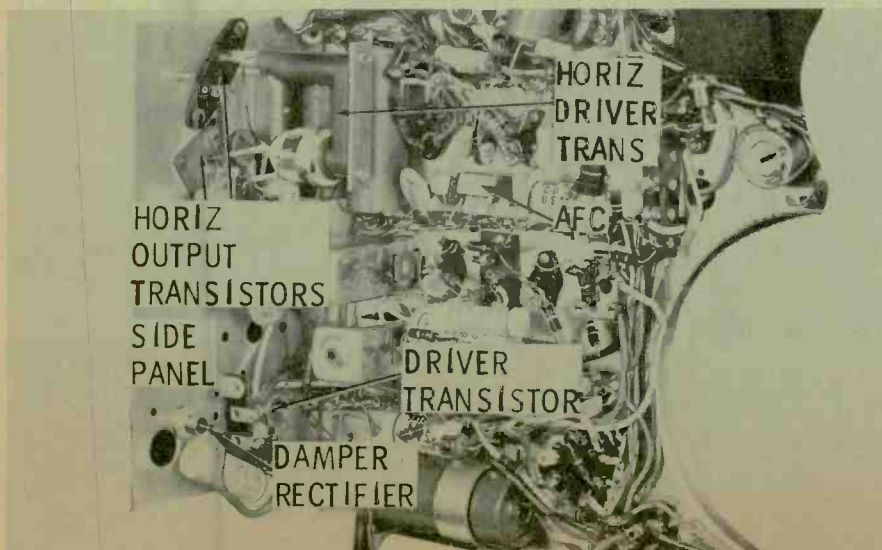
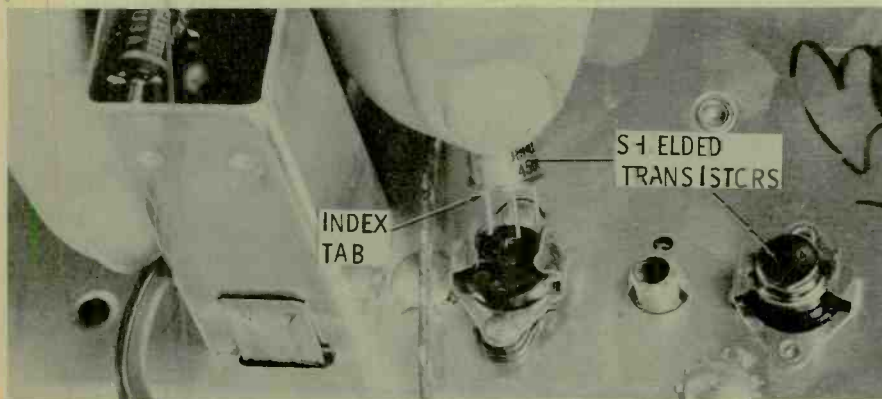
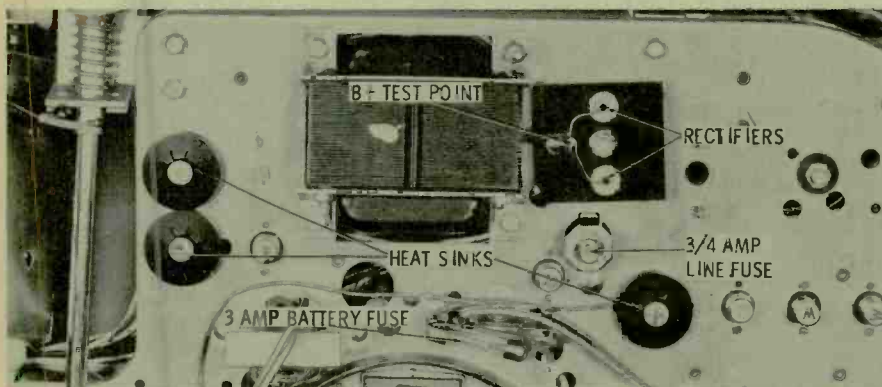

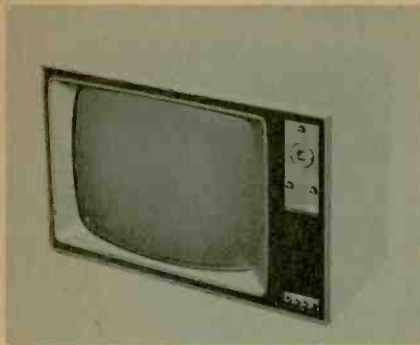

**RCA Victor
Model 231-BE-627
Chassis KCS132ZH**

You'll do well to read this preview carefully, for it is applicable to 121 models and 33 chassis variations in RCA's 1961 line, and you're almost sure to encounter one of these sets. The vast majority of the models use the 23EP4, 110° tube with bonded safety shield like this set, but models equipped with the KCS131-series chassis use a 21DSP4—a 90° tube. The *New Vista* emblem attached to this set is reserved for chassis containing the *Nuvistor*-equipped tuner. Other variations include UHF provisions, two different versions of remote control, and AM-FM-stereo additions.

The general layout of the chassis is roughly "U" shaped, conforming quite closely with some previous designs. Most of the circuitry is contained on the two printed boards at the left—except the horizontal output stage and low-voltage supply, which are conventionally-wired. All setup controls are easily accessible, once the rear cover is removed.

As mentioned, this chassis contains RCA's *Nuvistor*-equipped tuner — a marked departure in tuner design and tube basing. (For a full account of this tuner, see "Advances in TV Tuners" in the September issue of *PF REPORTER*.) Other versions of the chassis use either a turret tuner or a standard RCA incremental-switch type.

The printed-wiring detail follows the same pattern established in earlier RCA receivers. The contrast control is mounted in a rather unusual manner, and is connected by two couplings to the knob on the front. Power for the tuner is provided through a plug-and-socket arrangement at a junction of the printed boards. The *thermistor* at the lower left is connected in series with the AC line to provide controlled tube warm-up; it's rated at 120 ohms cold. A printed component combination including the sync and vertical size controls also contains two printed resistors associated with the sync circuits, as does its three-control counterpart used in some other chassis this year.

Most of the circuit variations between the KCS131 and 132 series are centered in the horizontal deflection circuits, so be sure you're following the correct service data when confronted with trouble in this section. Consistent with RCA's policy of previous years, the fusible resistor is defined as a surge limiter and rated at 3/10 amp. (It's connected to provide sweep-circuit protection.) Two lengths of #28 wire, located beneath the chassis, are used for filament protection.

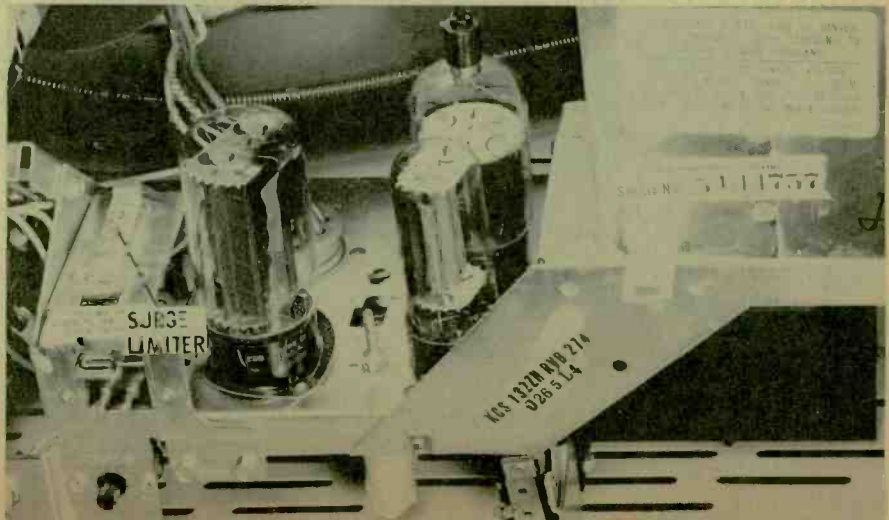
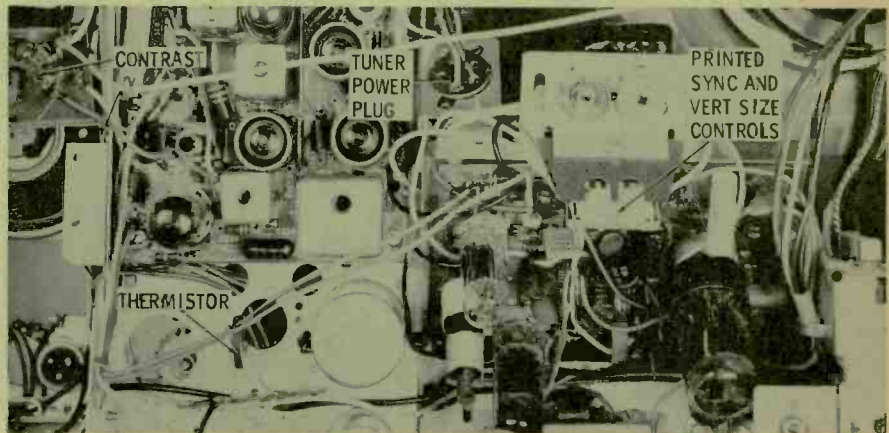
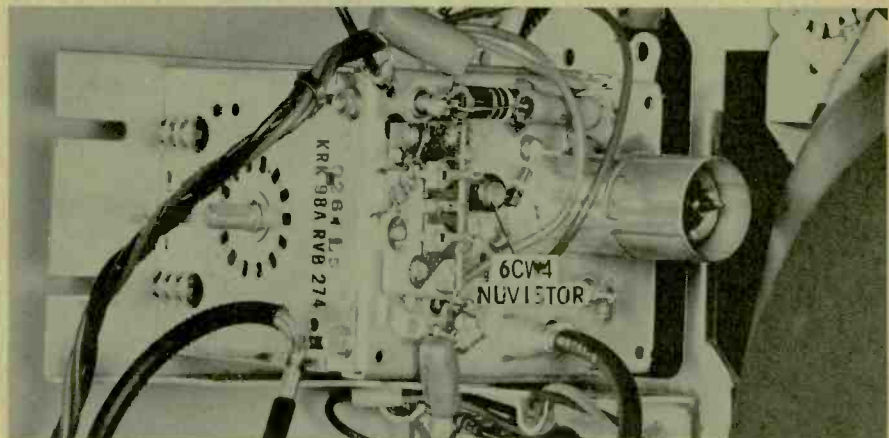
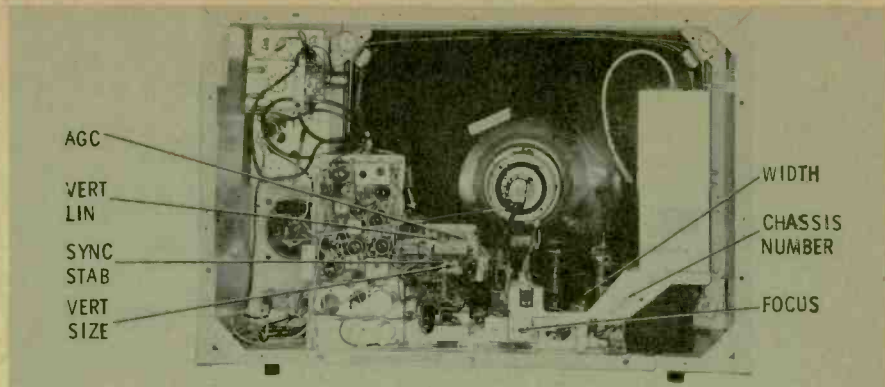

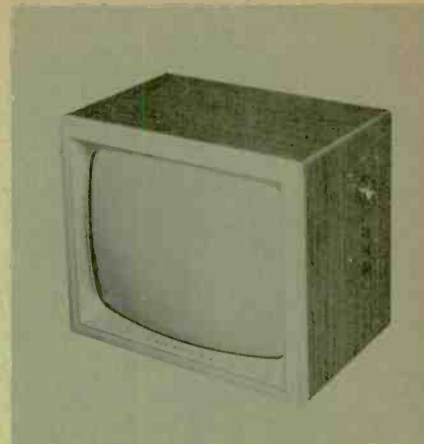
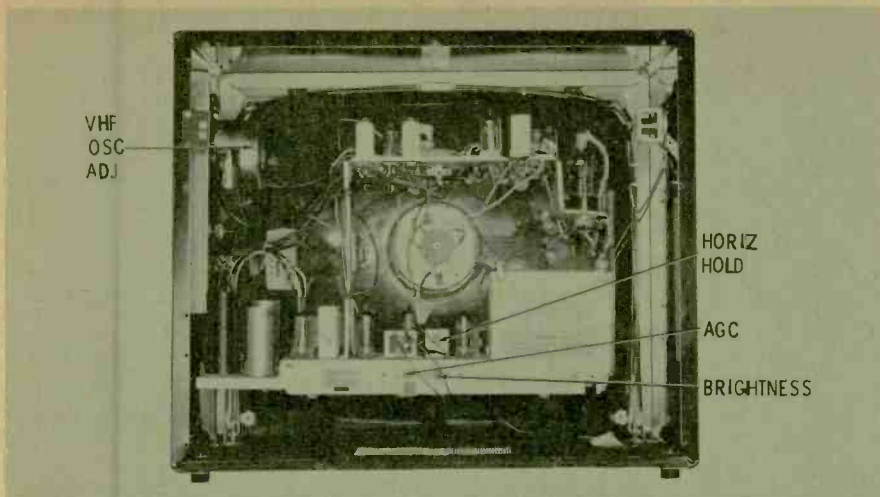

Trav-Ler Model 23MT6055 Chassis 1150-80

This early 1961 Trav-Ler table model is equipped with a 23GP4 CRT with bonded safety shield. Two very similar chassis, the 1150-89 and 1156-89, use a 17DTP4. All are 110° versions with only minor electrical variations. Side-mounted controls are common to all the models, and provide channel selection, on-off-volume, contrast, and vertical hold. The last two have hollow shafts for access to the vertical linearity and height adjustments.

Following the same general layout of one of its 1960 predecessors, the 15-tube chassis is one of the last series-filament versions of the Trav-Ler line. (All later designs use power transformers.) As in its '60 counterpart, a *Fireball* tuner is used, making the VHF oscillator adjustments accessible from the rear of the set. The AGC control of this chassis serves as an adjustable grid-load resistor which varies the amplitude of the input signal fed to the grid of the 3BU8 keyer. All of the rear-mounted controls are fitted with phenolic tubing which protrudes through the rear cover to permit adjustment and still maintain isolation from the "hot" chassis.

The top shelf of the chassis is divided sharply between the two-stage video IF section to the left, and the video output, sound IF, and 3DT6 audio detector circuits to the right. The pair of silicon rectifiers serving the conventional half-wave voltage-doubler circuit are directly below the shelf on the vertical chassis support, while the 5.6-ohm fusible resistor protecting them plugs into a board mounted on the shelf.

The left end of the base chassis contains the combined vertical multivibrator and output circuit, which uses one section of a 6CG7 and a 12DT5. The other 6CG7 section serves in a sync phase inverter circuit. On the extreme left of the subchassis, the 1150-89 chassis used in one of the 17" versions uses two different electrolytic filters and omits the *surgistor*. The latter is a thermal switch that protects tube filaments during warm-up.

The chassis used in any Trav-Ler model can be identified by referring to the number printed on the tube layout chart glued to the side of the cabinet. Above the high-voltage cage, the horizontal output and damper stages are mounted on a subchassis equipped with shields to keep the heat away from the remaining circuits.

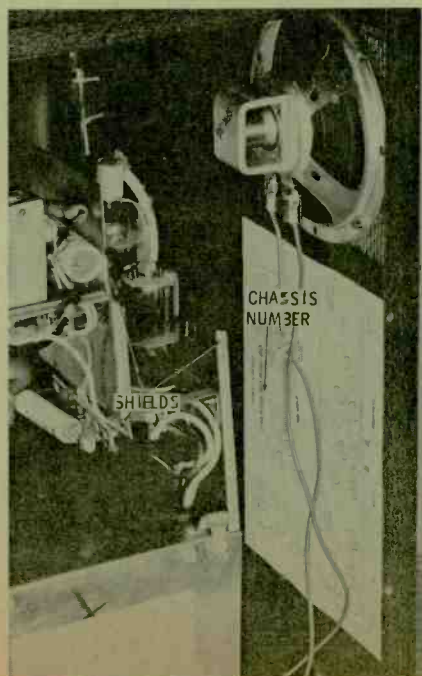
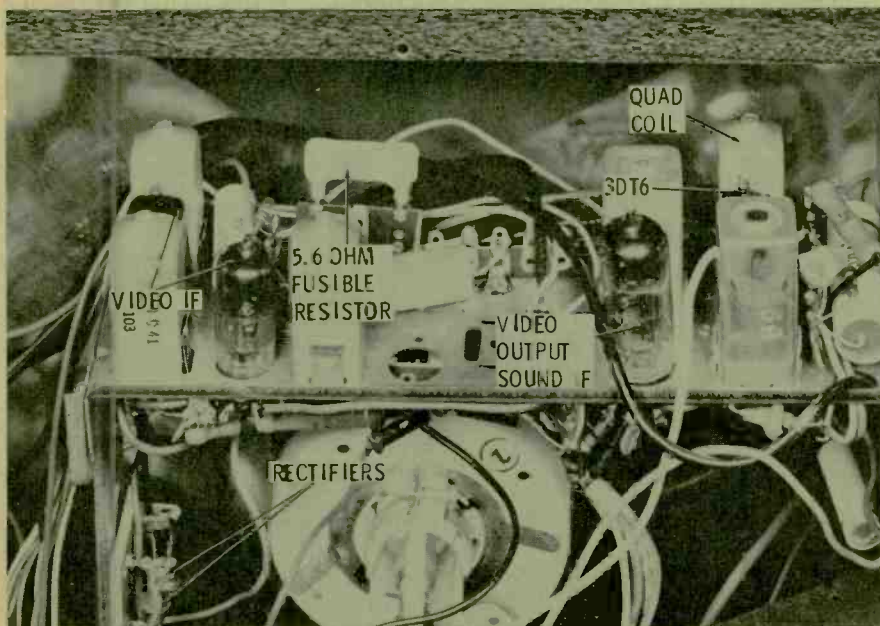



**Westinghouse
Model H-K4410
Chassis V-2389-3**

Using the largest chassis in the 1961 Westinghouse line, this 23", 114° model has a conventional safety glass secured by three wood screws and a trim strip along the top edge. VHF, UHF-VHF, and remote-control versions are designated by -1, -2, and -3 numbers associated with the basic V-2389 chassis number.

The horizontal chassis, characterized by two large, curved rails holding the CRT, has surprisingly great width. Two conventionally-wired end sections contain the power supply and horizontal output circuits, while one large printed board, containing the rest of the circuitry, fills the area between them. Height and vertical-linearity adjustments are the only rear-mounted controls on this 18-tube chassis. A new adaptation of the conventional width sleeve, in the form of a piece of copper bonded into a phenolic tab, is inserted between the yoke and bottom side of the CRT neck. It's held in place by the yoke clamp, and *must* retain its position along the bottom of the neck.

The bottom side of the printed board contains the *See-Matic* identification system introduced by Westinghouse in their 1960 models. The horizontal frequency and multivibrator trimmer adjustments are directly below the CRT neck, just in front of the partially shielded 6CG7 multivibrator.

In models equipped with power tuning, plastic bars above and below the nameplate provide bidirectional channel selection. Bass and treble switches are positioned at the bottom of the control panel, next to the *memory tuning* knob — a "do-it-yourself" fine tuning adjustment. The PULL-ON REMOTE switch at the top works in conjunction with the regular off-on switch to turn on the 7-tube remote receiver — a supersonic unit controlled by transistor-generated signals.

A 3½-amp, type-N line fuse protects the power transformer, which has a 12-volt center-tapped secondary for filament power. The center tap is grounded, providing two 6-volt legs (each with its own fuse wire). Three 12-volt tubes are used in the chassis—a 12AX4GTB, 12DT5, and 12DQ6B. These are connected in parallel across the entire 12-volt winding. A plug-in cable coming from the power supply feeds power to the tuning unit. These 1961 models have the same programming adjustments as for '60. With the cam for a certain channel pushed in, the tuner skips that channel; leaving the cam in the outer position stops the tuner.

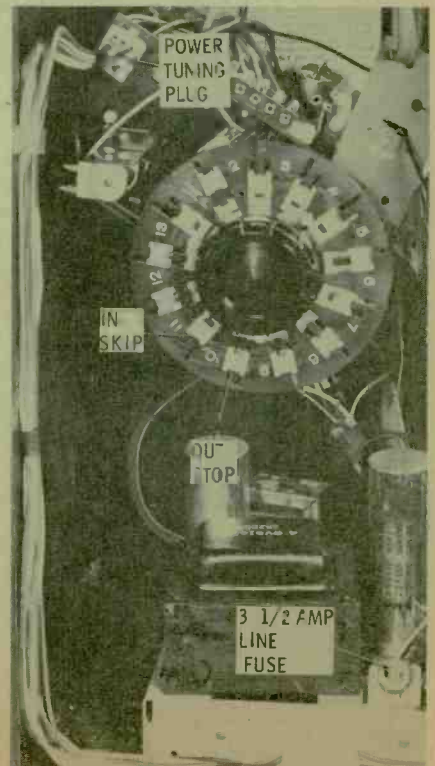
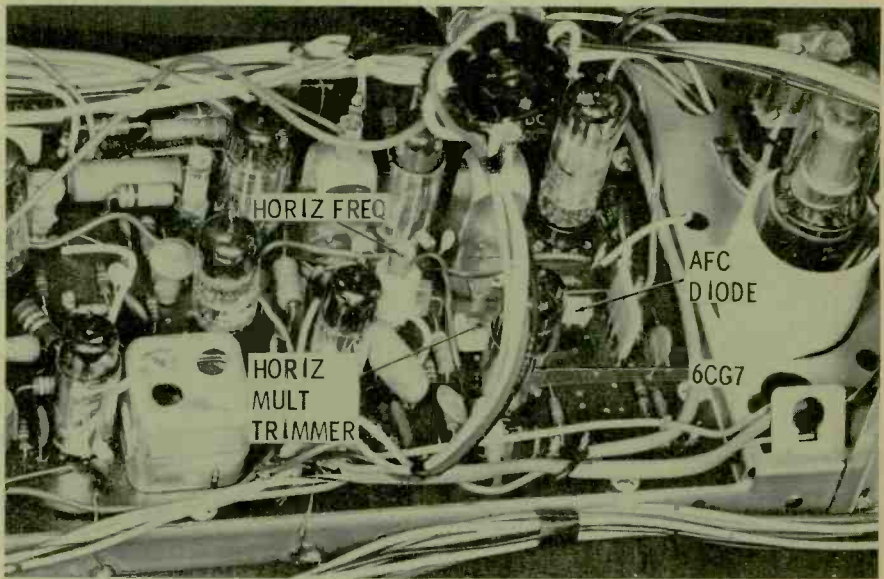
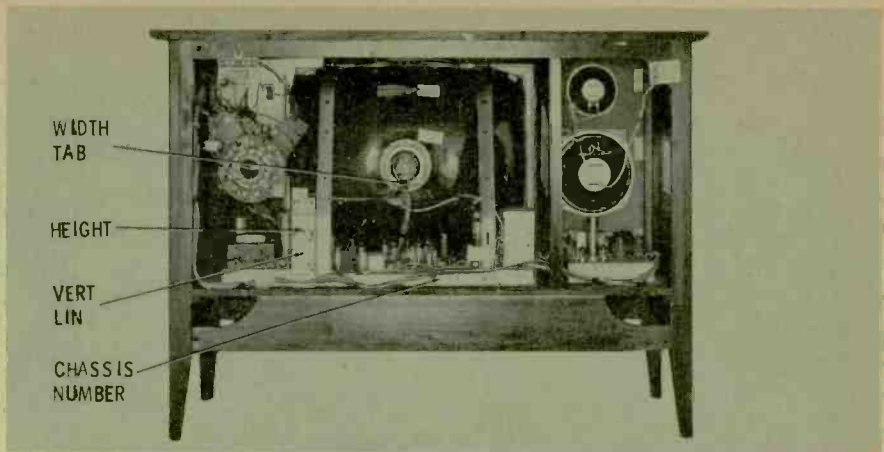

See PHOTOFAC T Set 483, Folder 1

Mfr: General Electric **Chassis No.** U4
Card No: GE U4-7.
Section Affected: Pix and sound.
Symptoms: Loss of both picture and sound.
Cause: Video overloading as a result of shorted AGC cathode-bypass capacitor.
What To Do: Replace C39 (800 mmf).

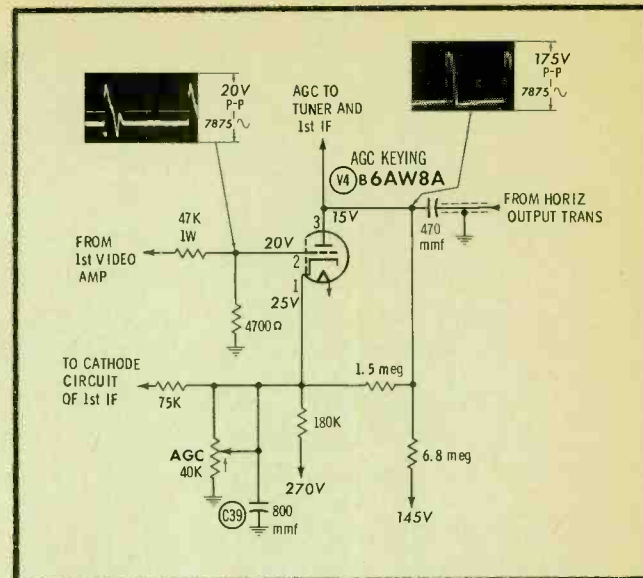

Mfr: General Electric **Chassis No.** U4
Card No: GE U4-8
Section Affected: Sync; possibly also sound.
Symptoms: Unstable sync; horizontal phase shift; possible audio buzz. Positive voltage on control grid (pin 7) of 6BY6 sync separator.
Cause: Leaky or shorted capacitor in sync-separator grid circuit.
What To Do: Replace C56 (5000 mmf).

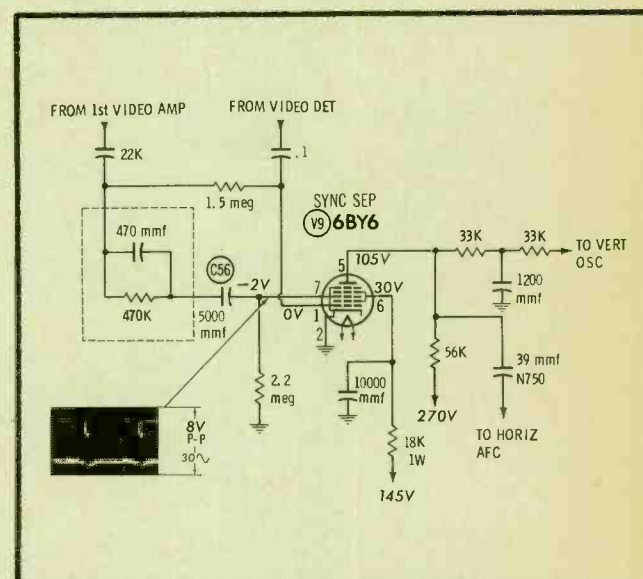

Mfr: General Electric **Chassis No.** U4
Card No: GE U4-9
Section Affected: Sync and raster.
Symptoms: Insufficient height and poor vertical sync.
Cause: Open capacitor in vertical sawtooth-forming network.
What To Do: Replace C63 (.1 mfd).

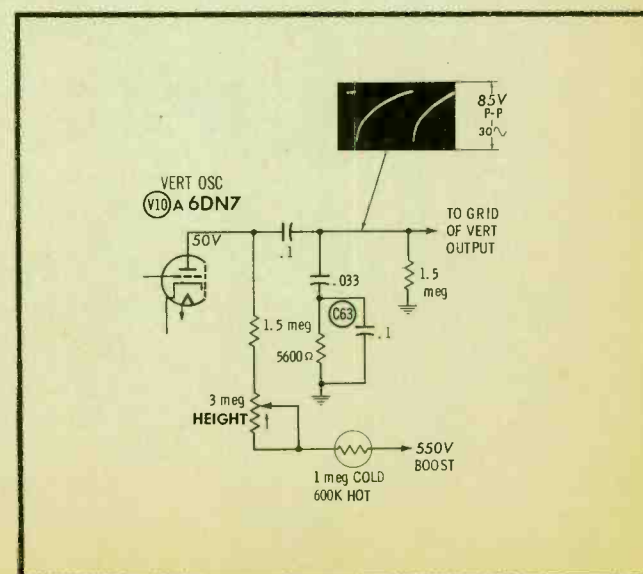

See PHOTOFACT Set 483, Folder 1

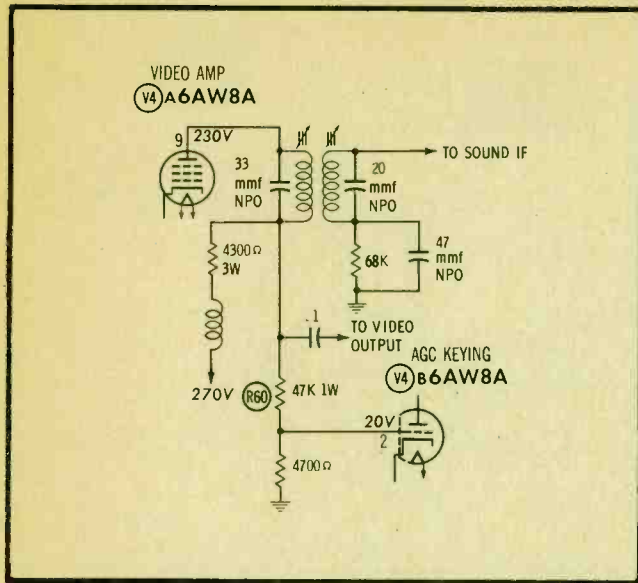

See PHOTOFACT Set 483, Folder 1

Mfr: General Electric Chassis No. U4

Card No: GE U4-10

Section Affected: Pix and sound.

Symptoms: No pix; buzz in sound; incorrect grid voltage on AGC keying tube.

Cause: Increase in value of series resistor between plate of video amplifier and grid of AGC tube.

What To Do: Replace R60 (47K—1W).

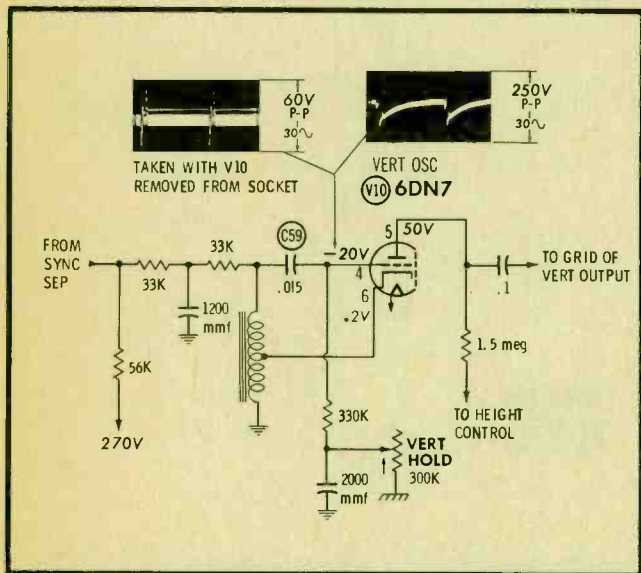

Mfr: General Electric Chassis No. U4

Card No: GE U4-11

Section Affected: Raster and sync.

Symptoms: Vertical foldover at top; unstable vertical sync. Positive or only slightly negative voltage at grid (pin 4) of V10, vertical oscillator.

Cause: Leaky vertical-oscillator grid capacitor.

What To Do: Replace C59 (.015 mfd).

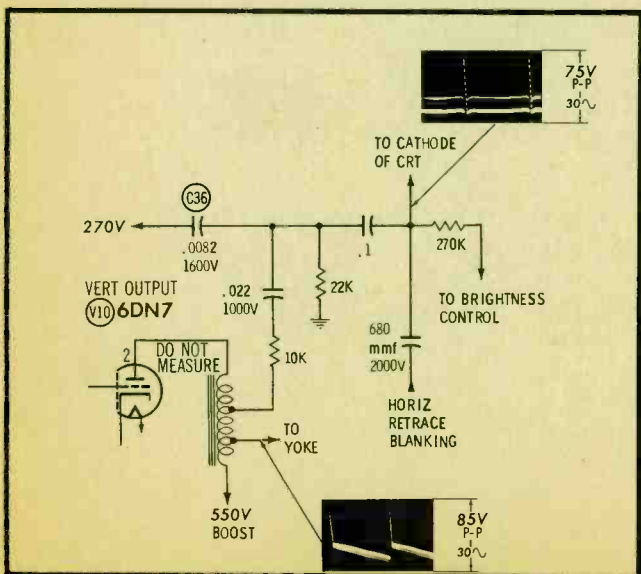

Mfr: General Electric Chassis No. U4

Card No: GE U4-12

Section Affected: Raster.

Symptoms: Dim raster with dark shading on right.

Cause: Open vertical retrace-blanking capacitor.

What To Do: Replace C36 (.0082 mfd — 1600V, 10%).



SYLVANIA-6AU4-GTA

WITH

SARONG CATHODE

HELPS YOU

"WRAP-UP" PROFITS!

New life-giving, profit-building features are built into every SYLVANIA-6AU4-GTATV-damper tube. Consider, for one feature, the SYLVANIA SARONG CATHODE and how it adds dependability to tube life. SARONG provides uniform spacing between cathode and plate—reduces possibility of plate-to-cathode arc-over. SARONG prevents the build-up of “whiskers” inside the cathode sleeve that can develop during other types of coating processes—reduces possibilities of cathode-to-heater arc-over.

Consider, too, the “pigtail” heater in SYLVANIA-6AU4-GTA. Welded securely to the stem-lead, it reduces heater “hot spots” and the possibilities of heater burnout. More . . . rectangular top and bottom micas with exceptionally wide slots increase the resistance of dc leakage paths, further reduce the possibilities of internal arc-over and breakdown.

There’s extra profit assurance, too, with SYLVANIA-6AU4-GTA. Every one of them is tested for shorts, emission and the ability to withstand arc-over at 5000-volts peak inverse on the anode.

So, “wrap up” the profits you make by putting a “damper” on call-backs. When you ask your distributor for 6AU4-GTA’s, always specify SYLVANIA.

Electronic Tubes Division, Sylvania Electric Products Inc., 1740 Broadway, New York 19, New York.



SYLVANIA

Subsidiary of **GENERAL TELEPHONE & ELECTRONICS** 

Another outstanding product by the HIDDEN **500*** who plan for your future:



TYPE TE LITTL-LYTIC® CAPACITORS



Transistors revolutionized the industry. And to make the most of their inherent advantages, they called for an entirely new group of components. Here, Sprague Research was the first to answer the call with the smallest truly reliable dry electrolytic made for transistor circuits—the Littl-Lytic. This reasonably priced capacitor is the most reliable subminiature you can buy for transistorized radios, hearing aids, wireless microphones, pocket wire recorders, and other miniature electronic equipment.

The remarkable reliability of Littl-Lytic is the result of a new manufacturing technique in which *all the terminal connections are welded*. Units are hermetically sealed and metal encased . . . *with no pressure joints . . . there are no "open circuits" with the passage of time*. Leakage current is extremely low as the result of the use of high purity foil and ultra-stable formation techniques. Sprague's catalog replacement ratings are the most comprehensive in the industry. They assure you of exact replacements to meet your day-to-day service requirements.

Littl-Lytic is a typical example of how Sprague Research keeps its products up-to-the-minute. Reliable components mean reliable service work—your business keeps pace with the electronic industry when you use Sprague.

*The "Hidden 500" are Sprague's 500 experienced researchers who staff the **largest research organization in the electronic component industry** and who back up the efforts of some 6,000 Sprague employees working in 14 manufacturing operations—four at North Adams, Mass.; Bennington and Barre, Vt.; Concord and Nashua, N.H.; Lansing, N.C.; Grafton, Wis.; Visalia, Calif.; two at Ponce, Puerto Rico; and Milan, Italy.

don't be vague . . . insist on

SPRAGUE®

world's largest capacitor manufacturer

See PHOTOFACT Set 491, Folder 2

Mfr: Zenith Chassis No. 18E20
 Card No: ZE 18E20-1
 Section Affected: Raster.
 Symptoms: No raster; no high voltage.
 Cause: Open cathode winding on horizontal output transformer.
 What To Do: Replace T4.

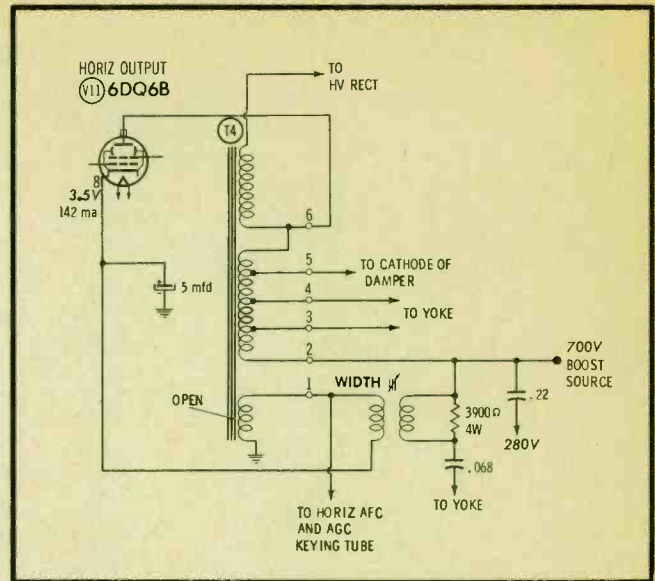

See PHOTOFACT Set 491, Folder 2

Mfr: Zenith Chassis No. 18E20
 Card No: ZE 18E20-2
 Section Affected: Raster.
 Symptoms: Raster flashes on and off.
 Cause: Intermittently open RF choke at plate of damper.
 What To Do: Replace L14.

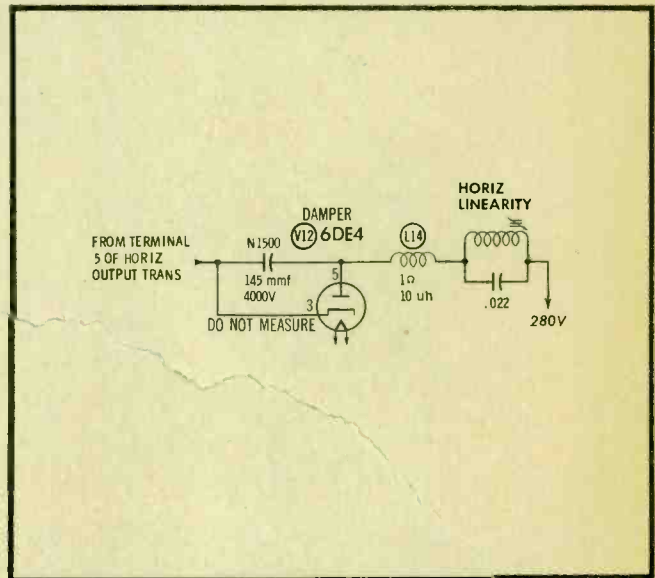

Mfr: Zenith Chassis No. 18E20
 Card No: ZE 18E20-3
 Section Affected: Pix.
 Symptoms: Video disappears about one-half hour after set is turned on.
 Cause: Open series resistor in 100-volt (low B+) line.
 What To Do: Replace R36 (27K—2W).

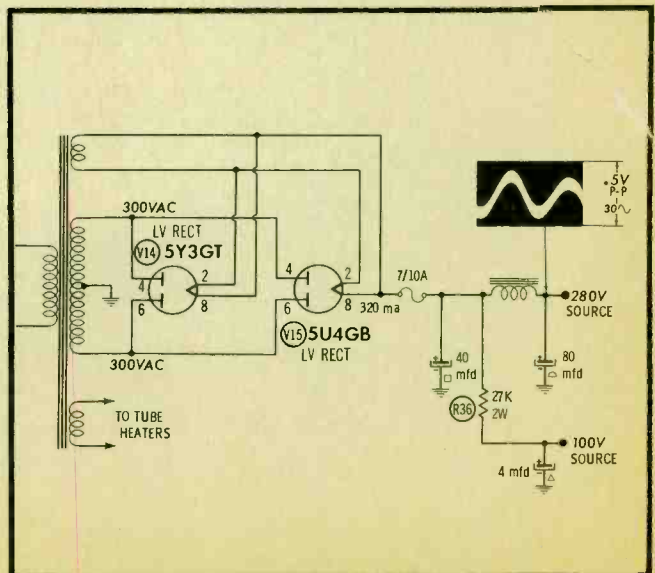

See PHOTOFACT Set 491, Folder 2

See PHOTOFACT Set 491, Folder 2

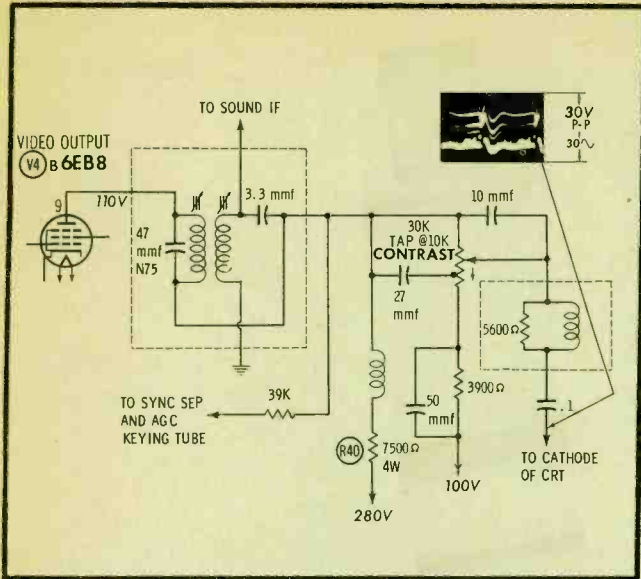

Mfr: Zenith Chassis No. 18E20

Card No: ZE 18E20-4

Section Affected: Pix.

Symptoms: Picture weak and smeared.

Cause: Plate-load resistor in video output stage has decreased in value.

What To Do: Replace R40 (7500 ohms—4W).

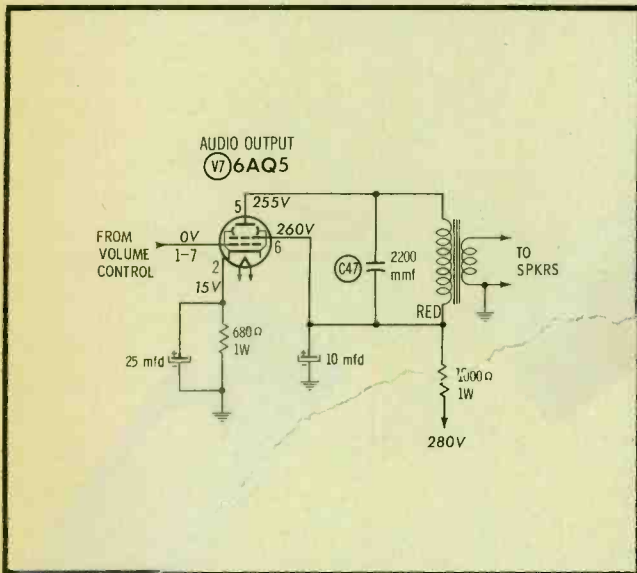

Mfr: Zenith

Chassis No. 18E20

Card No: ZE 18E20-5

Section Affected: Sound.

Symptoms: No sound.

Cause: Shorted plate-bypass capacitor in audio output stage.

What To Do: Replace C47 (2200 mfd).

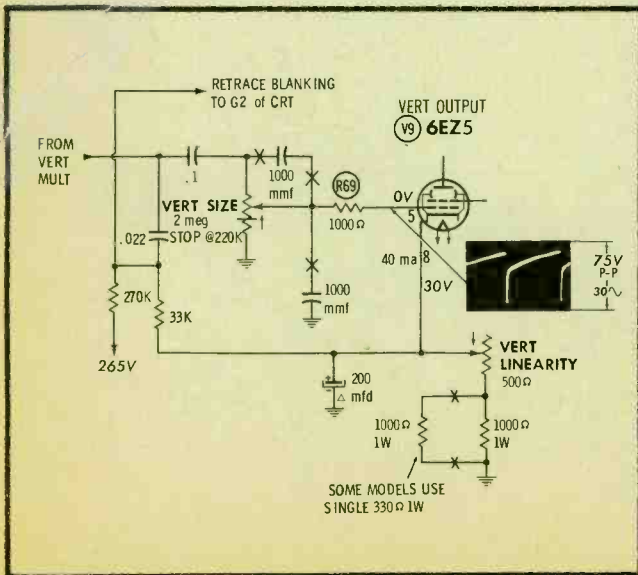

Mfr: Zenith

Chassis No. 18E20

Card No: ZE 18E20-6

Section Affected: Raster.

Symptoms: Intermittent vertical collapse.

Cause: Defective series resistor in grid circuit of vertical output tube.

What To Do: Replace R69 (1000 ohms); also check V9 (6EZ5).

publisher
Howard W. Sams

general manager
Mal Parks, Jr.

editor
Verne M. Ray

associate editors
Leslie D. Deane
Thomas A. Lesh
Joe A. Groves

consulting editors
William E. Burke
Robert B. Dunham
George B. Mann
C. P. Oliphant
Paul C. Smith

art director
Don W. Bradley

advertising & editorial assistants
Georgeanna Caldwell
Paula Haffner
Jean Sekulski

production manager
Robert N. Rippy

circulation fulfillment
Pat Tidd, Mgr.
Constance McCawley, Ass't.
Katherine Smith, Ass't.

photography
Robert W. Reed

advertising sales offices
midwestern

John Grace, PF REPORTER
2201 East 46th Street, Indianapolis 6, Ind.
Clifford 3-6441

eastern

Howard W. Sams & Co., Inc.
Corning Glass Building
717 Fifth Ave., New York 22, N. Y.
MUrray Hill 8-6350

western

The Maurice A. Kimball Co., Inc.
2550 Beverly Blvd., Los Angeles 57, Calif.
Dunkirk 8-6178; and 681 Market Street,
San Francisco 5, Calif. Exbrook 2-3365

Address all correspondence to
PF REPORTER, 2201 East 46th Street,
Indianapolis 6, Indiana



Copyright © 1960 by Howard W. Sams & Co., Inc. PF REPORTER is a trademark of Howard W. Sams & Co., Inc. No part of PF REPORTER may be reproduced without written permission. No patent liability is assumed with respect to use of information herein. Acceptance of advertising does not in any manner signify the products, policies and services so advertised have been approved, endorsed or recommended by this magazine.

Indexed in Electronic Guide and Lectrodex.
Printed by the Waldemar Press Div.
of Howard W. Sams & Co., Inc.



PF REPORTER

including **Electronic Servicing**

VOLUME 10, No. 12

DECEMBER, 1960

CONTENTS

Previews of New Sets	1
<small>Motorola Model 19P1 (Chassis TS-432) RCA Model 231-BE-627 (Chassis KCS132ZH) Trav-Ler Model 23MT6055 (Chassis 1150-80) Westinghouse Model H-K4410 (Chassis V-2389-3)</small>	
Video Speed Servicing	5
<small>Service hints on General Electric Chassis U4 and Zenith Chassis 18E20.</small>	
Letters to the Editor	16
"A Little Trouble" With an Admiral 21F1	24
<small>Stan Prentiss Across the Bench — A voice on the phone said, "O! buddy, if I brought my TV over, could you throw it on the bench and fix it?" Then the fun began.</small>	
Report on TV Radiation Hazards	26
<small>Les Deane Results of special laboratory tests to help settle the question of whether or not TV receivers give off dangerous X rays.</small>	
Regeneration in Picture-Signal Circuits	28
<small>Allan F. Kinckiner One of the most elusive TV faults is finally cornered and placed under investigation.</small>	
Examining Motorized Tuner Mechanisms	30
<small>Close-up photos reveal details of TV tuning motors and their associated switching circuits.</small>	
The Electronic Scanner	32
Dollar & Sense Servicing	34
<small>Joe A. Groves</small>	
Notes on Test Equipment	36
<small>Les Deane Lab reports on the Arkay Model CA-40 Capacity Meter and Mercury Model 300 Combination Tester.</small>	
Troubles in '57 Ford Radios	42
<small>Calvin C. Young, Jr. Quicker Servicing — An account of field experiences with early-model hybrid auto receivers.</small>	
Speed Problems With Phonos	48
<small>Alan Andrews Audio Facts — What to do when turntable rotation is slow or erratic, and how to find the cause of jammed changer mechanisms.</small>	
The Troubleshooter	54
Product Report	69
Free Catalog & Literature Service	72
Monthly Index	on free literature card

ABOUT THE COVER

It isn't Macy's, but then you don't have to have a fancy address for a window display to be worthwhile. With a little thought and ingenuity, you can come up with a "do-it-yourself" display that will do wonders for your Christmas business. Time is short, but there's still a couple of weeks left to attract last-minute shoppers. While we're on the subject of Christmas, a very merry one to you and yours from the entire staff.



NEW SENCORE Transi Master

**Analyze Every Transistor Circuit
Trouble in Minutes!**

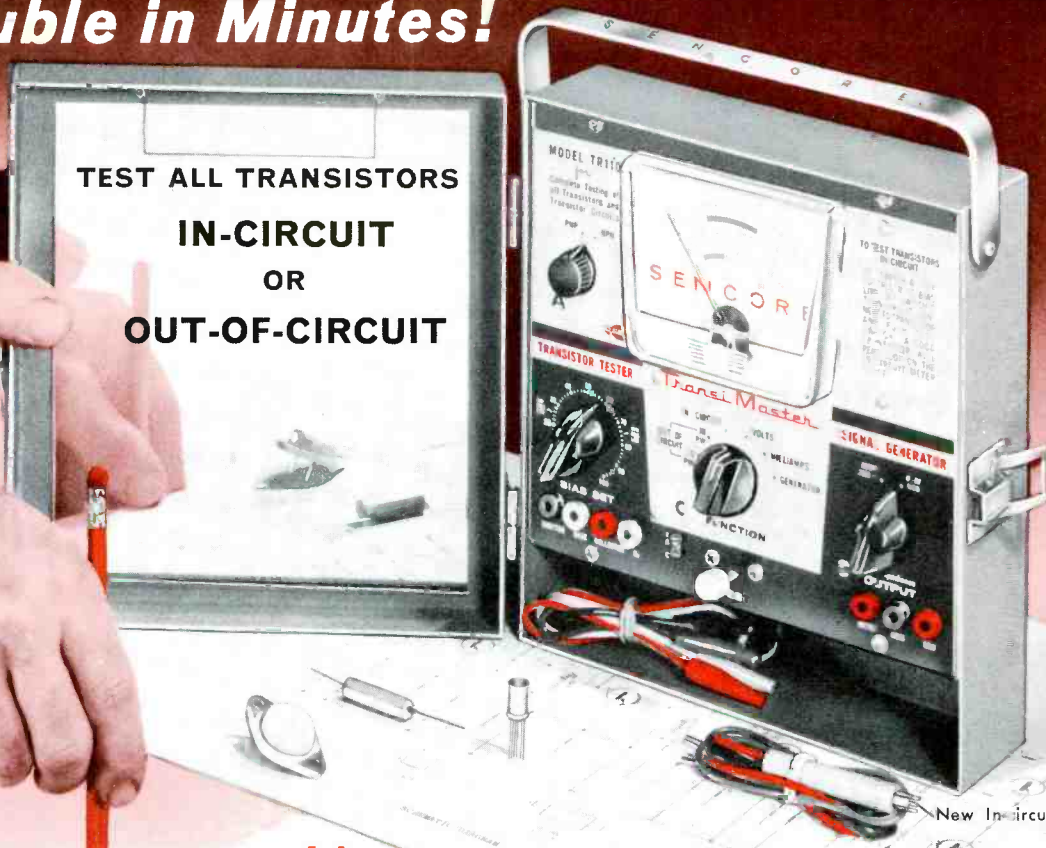

Model TR-110
ONLY **49⁵⁰**

Now you can...

**It's a... COMPLETE TRANSISTOR TESTER • SIGNAL TRACER
VOLTMETER • BATTERY TESTER • MILLIAMETER**

Transistors are tested in-circuit with a new unique AC GAIN check and out of circuit with an accurate DC GAIN and LEAKAGE check. Set-up chart included for reference only.

- Test all transistors in-circuit with a new unique AC GAIN check. It works every time and without the use of the set-up booklet.
- Test all transistors out of circuit with the AC GAIN check or with a more accurate DC current gain and leakage check.
- Read current gain (beta) direct for experimental, engineering work or for matching transistors.
- Check diodes simply and accurately with a forward to backward ratio check.
- Signal trace from speaker to antenna with a special low impedance generator. No tuning, adjustments, or indicating device needed for transistor radio trouble shooting. Just touch output leads to transistor inputs and outputs until 2000 cycle note is no longer heard from speaker. (Generator output monitored by meter.) It's a harmonic generator for RF-IF trouble shooting and a sine wave generator for audio amplifier trouble shooting.
- Check batteries under operating conditions as well as the voltage dividers with a special 12 volt scale.
- Monitor current drawn by the entire transistor circuit or by individual stages with a 0 to 50 Ma current scale. A must for alignment and trouble shooting cracked boards.

Benefit from these Sencore extras

- Lists Japanese equivalents.
- Automatically determines NPN or PNP.
- Mirror in detachable cover to reflect opposite side of printed board.
- Special clip to fit between batteries for current check.
- Transi-probe for making in-circuit transistor checks.

Color.....modern two tone gray
Size.....8" x 7⁵/₈" x 3"
Weight.....only 5 lbs.
Meter.....0 to 3 Ma, 3¹/₂", 5% tolerance, modern plastic
Batteries.....two size "C" cells

ALL PARTS ARE **SENCORE** MADE IN AMERICA

SENCORE
ADDISON, ILLINOIS

Like to try it? Let Sencore Sam show you how and then see your Sencore Distributor. He has it in stock. . .



SENCORE SAM

THE MINIT-MAN



SHOWS YOU HOW TO USE THE
**SENCORE
TRANSI-MASTER**

A. TO TEST TRANSISTORS IN-CIRCUIT

SAVE THE VALUABLE TIME YOU WASTE SOLDERING AND UNSOLDERING TRANSISTORS FOR SERVICE WORK ONLY!

1. Set to PNP or NPN
2. Set to Bias Line Transistor Radio
3. Set to in-circuit
4. Touch Special Probe to Transistor in-circuit
5. Push to Test
6. Read Meter

The in-circuit check can also be used for a quick check on transistors out of circuit

LIKE THIS? it's fast too

B. TO TEST TRANSISTORS OUT OF CIRCUIT FOR GAIN, LEAKAGE, OPENS, SHORTS

USE THIS DC CHECK FOR MOST ACCURATE TEST. USE SET-UP BOOKLET.

1. Determine Transistor Type Set-up according to book
2. Connect to transistor. Use 4th leader for tetrode only.
3. Read Leakage and Compare to Chart
4. Push to test Gain
5. Normal Transistor will be in Green area of Gain Scale

Want to read Beta direct? Just set Bias Control to bias line and read meter. It's handy for engineers and when matching transistors.

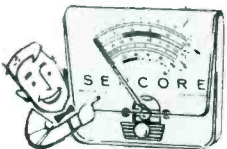

For matching . . . pick the two transistors with closest Beta reading. The two transistors should also have approximately same leakage.

C. TO SIGNAL TRACE TRANSISTOR CIRCUIT

YOU CAN FIND THE DEFECT IN A JIFFY!

1. Set Switch to Generator
2. Set according to stage
3. Meter will indicate when generator is putting out
4. Connect to common or ground

5. Touch to transistor inputs and outputs from speaker to antenna. 2000 cycle note from speaker will stop or decrease at trouble spot.

D. TO CHECK CURRENT DRAIN BY COMPLETE SET OR INDIVIDUAL STAGE

A REAL TIME SAVER FOR SPOTTING CRACKED BOARDS OR FOR ALIGNMENT. SEE SAM'S PF FOR AVERAGE CURRENT.

1. Set to milliamp
2. Connect in circuit for reading current. Use special clip at end of battery.
3. Read current. Average Transistor Radio is 10 to 15 ma.

For alignment—just tune in any station and adjust slugs for maximum current.

E. TO CHECK BATTERIES AND VOLTAGE DIVIDERS

CHECK BATTERIES UNDER OPERATING CONDITIONS AND SEE THAT VOLTAGE IS DISTRIBUTED PROPERLY.

1. Set to volts
2. Connect to batteries or across voltage dividers
3. Read voltage. Batteries should be within 10%

AND LAST OF ALL . . . the mirror in the detachable cover. Just place it under the printed board to see the other side as you work. Use pen light to see where you are.

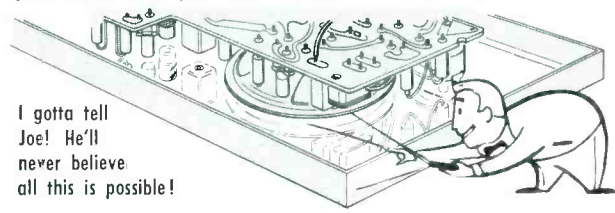

ALSO FREE . . . Current transistor listings booklet, even has Japanese equivalents . . . just send in your warranty card and factory will keep you up to date!

Ask your distributor to show you the most useful equipment in servicing —



TransiMaster
by **SENCORE**
ADDISON, ILLINOIS

SENCORE

Most Popular Time Savers for Servicemen, Technicians, Engineers, Maintenance Men, Hobbyists!



"MIGHTY MITE"

TUBE CHECKER

Smaller than a portable typewriter . . . yet will outperform testers costing hundreds of dollars.



\$5950

A new dynamic approach to tube testing. Check over 1,300 tubes for cathode emission, grid emission, leakage, shorts and gas. A "mite" to carry but a whale of a performer that outperforms testers costing much more. New unique "stethoscope" approach tests for grid emission and leakage as high as 100 megohms yet checks cathode current at operating levels. Special short test checks for shorts between all elements. The Mighty Mite will test every radio and TV tube that you encounter (over 1,300!) plus picture tubes. Set up controls as easy as "ABC" from easy to follow tube chart. New features: • Meter glows in dark for easy reading behind TV set. • Stainless steel mirror in cover for TV adjustments. • Rugged, all steel carrying case and easy grip handle. • Smallest complete tester made. Measures only 9" x 8" x 2 1/2" and weighs just seven pounds.

It's a real money-maker

LC3 LEAKAGE CHECKER

Provides grid emission and leakage checks with the same sensitivity as the famous Mighty Mite but checks critical tubes only; 172 types

\$2895



Ask any serviceman who owns one . . . or try one for just one day of servicing. You'll see for yourself how much time the LC3 can save you. Checks for leakage between all elements, whether caused by gas, grid emission or foreign particles. Also checks leakage on all capacitors with voltage applied — including electrolytics. Provides instant filament checks in "Fil-Check" position—no need for a second filament checker. One spare pre-heating socket and new roll chart prevent obsolescence. New charts provided free. For 110-120 volts, 60 cycle AC.

SENCORE SS105 SWEEP CIRCUIT TROUBLE SHOOTER

The Missing Link in TV Service . . .

IT'S A . . . UNIVERSAL HORIZONTAL OSCILLATOR. For direct substitution. No wires to disconnect in most cases. Traces trouble right down to the defective component. Variable output from 0-200 volts, peak-to-peak. Oscillator will sync to TV sync signal giving check on sync circuits.

HORIZONTAL OUTPUT CATHODE CURRENT CHECKER. A proven method that quickly checks the condition of the horizontal output tube and associated components. Adaptor socket prevents breaking wires. Easily replaceable Roll Chart gives all necessary pin, current and voltage data. New Roll Charts are Free.

UNIVERSAL DEFLECTION YOKE. A new, simple way to determine yoke failure accurately—without removing yoke from picture tube. Merely disconnect one yoke lead and substitute. If high voltage (also bright vertical line) is restored, TV yoke is defective.

DYNAMIC FLYBACK TRANSFORMER CHECKER. Merely flip switch to "Flyback Check" and meter will indicate condition of flyback transformer, in degrees of horizontal deflection. Extremely sensitive and accurate; even shows up one shorted turn on flyback.

VOLTMETER. For testing bootstrap, screen and other voltages. Direct-reading voltmeter, 0-1000 volts.



\$4295



HORIZ. OSC.	VERT. OSC.
HORIZ. O.P. STAGE	VERT. O.P. STAGE
HORIZ. FLYBACK XFORMER	VERT. O.P. XFORMER
HORIZ. DEFLEC. YOKE	VERT. DEFLEC. YOKE

UNIVERSAL VERTICAL OSCILLATOR. Checks oscillator, output transformer and yoke. Merely touch lead to component and check picture on screen. **SS105 is completely self-contained, nothing else is needed. New, improved Circuit.**

FC4 FILAMENT CHECKER

The ideal tool for servicing series string filaments.

\$275



Purposely works off your cheater cord to give you a positive check on line voltage. Prevents checking all tubes to find that your trouble was no line voltage. Only checker that checks all tubes automatically and has no batteries to replace. Cost half that of battery operated testers. Patented.

FC4 with test leads for checking continuity or AC or DC Voltage . . . \$295

VB2 "VIBRA-DAPTOR"

Checks 3 and 4 prong Vibra tors Faster and Easier . . .

Plugs into any tube checker; ideal for use with LC3 or the Mighty Mite. To check 6v. vibrators, set for 6AX4 or 6SN7; for 12 v. vibrators, set for 12AX4 or 12SN7. Two No. 51 lamps indicate whether vibrator needs replacing. Instructions on front panel. Steel case.



\$275

"FUSE-SAFE" CIRCUIT TESTER FS3

Instantly tells you whether or not it is safe to replace fuse resistors, fuses, or circuit breakers. Separate red and green scale for each commercially available fuse resistor used in radio and TV. Eliminates guesswork, wasted time. Also handy for wattage checks up to 1100 watts at 115v.

\$895



Time Savers for America's ALL PARTS



Radio, TV and Electronic Mini-Men MADE IN AMERICA

See your Parts Distributor Now or Mail Coupon on Opposite Page

SENCORE

You can own all these popular Time Savers for less than some Mutual Conductance Tube Testers!



For TRANSISTOR RADIO SERVICING

Everything you need for less than \$50.00

SENCORE TRC4

TRANSISTOR-RECTIFIER CHECKER

\$1995



Now lists Japanese equivalents

Checks Transistors, Diodes, Rectifiers . . .

A transistor tester that is used by over 50,000 servicemen, engineers and experimenters from Coast to Coast. Recommended by TV and Radio manufacturers; used by such leading companies as Sears Roebuck, Bell Telephone and Commonwealth Edison. Tests indicate that the TRC4 will outperform testers costing many times more. The TRC4 tests all transistors for gain, leakage, and open or shorts. Simple to operate without set-up chart for service work and with set-up chart for more accurate checks. With batteries.

SENCORE PS103

BATTERY ELIMINATOR & TROUBLE SHOOTER

\$1995

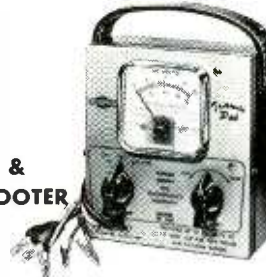

Replaces Batteries During Repair . . . Replaces batteries during repair time of transistor radios and helps trouble shoot, too. For transistor radio servicing, experimenting and to charge nickel cadmium batteries. Dial output voltage from 0 to 24 volts DC and read on meter. Low ripple insures no hum or feedback problem. Meter reads from 0 to 100 MA. Shorted stage will cause current to read high as indicated on PF schematics; open stage will cause current to read low. To align transistor radio, tune in station signal and adjust IF slugs for maximum current. The PS103 is the only supply that will operate radios with tapped battery supplies; such as Philco, Sylvania, Motorola, etc.

SENCORE HG104

HARMONIC GENERATOR

\$995



Finds Defective Stage in a Minute . . . Believe it or not. Just touch the output leads of the HG104 to inputs and outputs of transistors and a clear 1000 cycle note from speakers will tell you whether or not the stage is defective. Here is an unexcelled time saver, not a "pencil" gimmick. It actually works every time from speaker to antenna. Two leads and calibrated output (not found on pencils) are a must for speaker connection, grounding to prevent RF spray and front end checks. Also saves time when servicing HiFi, TV and radios. With life-time batteries.

Get all 3

COMPLETE TRANSISTOR RADIO SERVICE LAB

All 3 Time Savers shown above in handsome display carton carrying case

MODEL TL107

\$4985



For SUBSTITUTION SERVICING

Goodbye to messy parts . . . the mess of soldering and unsoldering in testing.

SENCORE H36

"HANDY 36"

\$1275



Substitute for Capacitors, Resistors . . .

Provides the 36 most often needed resistors and capacitors for experimenting, substituting or testing. Eliminates searching for replacement components, unnecessary soldering and unsoldering and the mess it creates. Says goodbye to crumpled parts. Flick of a switch instantly selects any of: 24 Resistors from 10 ohms to 5.6 meg-ohms, 10 Capacitors from 100 mfd to .5 mfd, 2 Electrolytics, 10 mfd and 40 mfd at 450 Volts. All components are standard American brand.

SENCORE ES102

ELECTRO-SUB

\$1595



Substitute for Electrolytic Capacitors . . .

Complete, safe substitution . . . from the smallest electrolytics used in transistor radios to the largest used in costly Hi-Fi amplifiers. Contains 10 electrolytics from 4 to 350 mfd. Select correct value with the flick of a switch. Features automatic discharge, surge protector circuit. Prevents accidental "healing" of capacitor being bridged. Completely safe—no arc or spark when connecting or disconnecting. Usable from 2 to 450 volts, DC.

SENCORE RS106

RECTIFIER TROUBLE-SHOOTER

\$1275



Locate faulty Rectifiers, Diodes . . .

This unique substitution unit simplifies trouble shooting rectifiers and diodes, gives you a positive check every time. Substitute for suspected rectifier or diode, watch picture or listen to sound and you'll know in seconds whether or not the rectifier or diode should be replaced. No guess work, soldering mess or time lost. The RS106 costs less than having loose rectifiers and diodes in the shop for testing and is worth many times more. A must for servicing voltage doubler circuits. Protected by a ½ amp. Slow Blow Fuse.

All 3 Time Savers shown above in handsome display carton carrying case

MODEL SL108

\$4145

See your Distributor . . . if he cannot help you, Pat will . . .

SENCORE BE3 "ALIGN-O-PAK"

Eliminates messy batteries in TV service work. Hardy for alignment, ACC troubleshooting or checking gated sync circuits. Dial the voltage you need, 0-18 volts, positive or negative. Completely isolated DC supply, less than 0.1% ripple. Covers all voltages recommended by TV set manufacturers and in Photo Fact schematics. For 110-120V, 60 cycle AC.



\$785



SENCORE, ADDISON 4, ILLINOIS

Dear Pat: Will you please . . .

Send me _____ Time Savers

(Model Numbers)

Check or M.O. enclosed (PP Prepaid.) Send C.O.D.

PAT RUDE, Customer Service

Distributor's Name (if any) _____

Your Name _____

Street _____

City _____ Zone _____ State _____

ALL UNITS FULLY GUARANTEED OR MONEY BACK WITHIN 10 DAYS

ATR**PRODUCTS FOR MODERN LIVING****ATR UNIVERSAL INVERTERS**

A. C. Household Electricity Anywhere . . . in your own car!

• Tape Recorders • TV Sets
• Dictating Machines • Radios
• Public Address Systems• Electric Shavers • Record Players • Food Mixers • and
Emergency Lighting. NET6U-RHG (6 V.) 125 to 150 W. Shp. Wt. 27 lbs. \$66.34
12U-RHG (12 V.) 150 to 175 W. Shp. Wt. 27 lbs. \$66.34

Auto Plug-in Home-type Portable

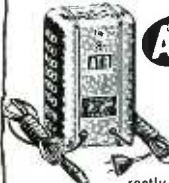
**ATR BATTERY CHARGERS**

NO INSTALLATION . . . PLUG INTO CIGARETTE LIGHTER RECEPTACLE!

Keeps car battery fully charged in your own garage! Needed more now than ever before—makes motor starting easy! Operates directly from standard 110 volts A.C. current.

612CA4 (4 amp.) 6/12 V. Shp. Wt. 6 lbs. NET \$19.46
612CA6 (6 amp.) 6/12 V. Shp. Wt. 8 lbs. NET \$22.46
612CA10 (10 amp.) 6/12 V. Shp. Wt. 10 lbs. NET \$27.71**ATR SHAV-PAKS**

Keep Clean-Shaved! Plugs into Cigarette Lighter Receptacle. Keep in Glove Compartment. Operates Standard A. C.

• ELECTRIC SHAVERS
• Small Timing Devices . . . In CARS,
Buses, Trucks, Boats, or Planes.6-SPB (6 V.) 15 W. Shp. Wt. 2½ lbs. NET \$7.97
12-SPB (12 V.) 15 W. Shp. Wt. 2½ lbs. NET \$7.97**ATR****ELECTRONIC TUBE PROTECTORS**

Will Double or triple the life of all types of electronic tubes, including TV picture tube.

Automatic in operation, for use with any electronic equipment having input wattage of 100 to 300 watts. Fuse protected, enclosed in metal case for rugged construction and long life.

MODEL 250 (Wall Model) 115 V.
A. C. Shp. Wt. 1 lb.
DEALER NET \$2.63**ATR MODERN TABLE RADIOS**

Trim, modern clock radio in ebony or ivory plastic. Powerful 5 tubes including rectifier AM radio chassis with built-in "Magna-Plate" antenna. Full-toned 4" PM speaker. Popular features include: Musical Alarm—radio turns on automatically at any pre-set time; Sleep Selector—lulls user to sleep; Automatic Appliance Timer—outlet on back of radio times any electric appliance automatically (up to 1100 watts). Cabinet 10½ in. wide, 5 in. high, 5½ in. deep. Wt. approx. 8 lbs.

Model T-91

Clock Specifications:

- Genuine Telechron Movement.
- Self-Starting . . . Never Needs Winding, Oiling, or Regulating.
- Simplified Clock Controls for Radio and Sleep Switch.
- 1100 Watt Controlled Outlet.
- Automatic Buzzer Alarm.
- Gold-Plated Bezel and Numerals on Large Bone-White Dial. UL Approved.

ATR HAND WIRED—NO PRINTED CIRCUITRY "TILT-A-STAND" RADIO

MOUNT ON THE WALL—UNDER A SHELF—OR SET ON A TABLE. PERFECT for every room in YOUR home.

Power-packed 5 tubes including rectifier chassis. Built-in loop antenna. Automatic volume control. Full 4" Alnico 5 speaker. Distinctive Roman numerals on dial. Size: 9½" W x 4" D x 5½" H. AC/DC. U.L. approved. Beautiful bakelite cabinet—Resists heat. Shipping Weight 5½ lbs.

Model T-87

Model T-91 Clock Radio, Black NET \$22.45
Model T-91 Clock Radio, Ivory NET 23.15
Model T-87 (Tilt-A-Stand), Black NET 17.47
Model T-87 (Tilt-A-Stand), Red NET 18.10SEE YOUR ELECTRONIC PARTS DISTRIBUTOR
WRITE FACTORY FOR FREE LITERATURE . . .**ATR****AMERICAN TELEVISION & RADIO Co.**
Quality Products Since 1931
SAINT PAUL 1, MINNESOTA—U. S. A.*Letters to the***EDITOR**

Dear Editor:

We are real PF REPORTER fans and that's saying a lot, since my husband is the serviceman in the family, and I know nothing about electronics.

I read your magazine from cover to cover, and encircle various items of interest. The combination of PF REPORTER and my soothing telephone voice has satisfactorily handled many unhappy customers. When my husband makes the call, they tell him what a doll I am and express amazement over my technical knowledge.

Enclosed is our check for \$9.00 to extend our subscription another three years. Also, please note the new mailing address. Our customers are beginning to pay us, so we can afford a better location.

HERTA GJUROVICH

Tillson TV
Tillson, N. Y.

No doubt about it, Herta, you really are a doll!—Ed.

Dear Editor:

Can you furnish me with a schematic for a Zenith TV Chassis 17T22? This is a special T chassis and I cannot find it listed in your index. I have written Zenith and contacted the local distributor; they are out of this schematic.

I am also in need of a schematic for a Model 5TB-1 transistor radio manufactured by the Victor Co. of Japan. Can you furnish the address for the importers of this radio?

I enjoy reading your magazine and think it's tops. Your service information is the most valuable tool in the department.

WM. B. WOOD

J. H. Wood Supply Co.
Hampton, S. C.

PHOTOFACT Folder 286-13, covering Zenith Chassis 17T20, should be close enough for most purposes. Sorry, but we have no schematic for the 5TB-1; the importer is Petely Enterprises, Inc., 300 Park Ave. South, N. Y. 10, N. Y.—Ed.

Thanks for the bouquets, Bill.

Dear Editor:

I want to thank you very much for your help on a "tough dog" set. The two components you suggested checking were way off value. Replacement of these items cured the trouble.

Your magazine and your service information are worth—well, I'm stumped. How can anyone place a value on such products and information?

JOHN J. MURROW

Louisville, Ky.

Dear Editor:

Thank you for the advice on my service problem.

As I sit here with my bare face hanging out, I remember reading, in "The Troubleshooter" column, of another chap who had the same trouble with this set. Thanks again for the helping hand.

JOE DIMOND

Casey's Appliance
Sales and Service
Port Orford, Ore.

Dear Editor:

Please send me the 1958 and 1959 Subject Reference Indexes.

I find your magazine the best in the field, and I'm happy to see you expanding your coverage to include industrial electronics.

JOHN R. MISCAVISH

J & B Electronics
St. Louis, Mo.

Dear Editor:

I am very proud of my three-year collection of PF REPORTER. It's the best in serviceman's magazines. Would you please send me reference indexes for the years '57, '58, and '59. Thanks.

WILLIS N. HOFF

Hoff TV Service
Hope, Ark.

We're kinda proud, too, fellas, of files full of similar comments. Thanks to you and all the other loyal readers who have supported us over these past 10 years.

To make your PF REPORTER reference libraries as useful as possible, and to mark our first decade of publication, our January issue will be somewhat special. Among other things, it'll include a 16-page bonus section, indexing the entire 10-year contents of PF REPORTER. Don't miss it!—Ed.

Dear Editor:

Have been buying your magazine from my distributor for the past few months, and certainly think it is one of the finest books on the market for aiding radio and TV servicemen. The articles it contains are very helpful.

G. R. BABCOCK

Janesville, Wisc.

Dear Editor:

Here is a poem which may give you a chuckle.

IMPEDANCE

Ohm's law has been accepted
And Kirchoff's has too,
But I have been rejected.
It only makes me blue.
I know the color coding
And how to align a set.
I recognize 'overloading'
But benchwork I can't get.
My technician's mind is nimble
But, for me, there is no joy.
The reason is quite simple;
I'm a girl—instead of boy!

I have been in and out of radio-TV servicing for 10 years. Reasons for being out are Nancy, Eleanor, Sally, and Clark, ages 3 to 13. I hope someday to write technical articles that will be acceptable in PF REPORTER.

ILAMAE V. WEBBER

San Carlos, Cal.

It's a real pleasure to hear from the top "man" in the organization.—Ed.

**Hold that line
against callbacks**



Just one callback throws your profits for a loss on the next three service calls. But you can tackle any service job and make big gains in profit territory, when you back your line with Tung-Sol Blue Chip quality. Made to industry's top standards, Tung-Sol tubes are best for every replacement — radio, tv or hi-fi. Tung-Sol Electric Inc., Newark 4, N. J.

Tell your jobber you'd rather have

ts TUNG-SOL®

Blue Chip Quality

TUBES • TRANSISTORS • DIODES



clear
as
a
"bell"...

CDE rotors get

the biggest customer reception!

CDE TV antenna rotors are the big-ticket sales that build big customer acceptance for your reputation. Take the AR-22 for example: installed on roof or tower, this heavy-duty beauty weathers the winter like old St. Nick himself. The reason? A sealed, die-cast bell housing which encloses precision *planetary* drive gears instead of conventional worm gears. The AR-22 is also *automatic*. Just set the selector knob—and walk away. The AR-22 turns the antenna to the desired position, stops and locks itself in place—automatically! Examine this and other rugged CDE rotors . . . there are models for every budget . . . at your CDE Distributor. Or write today for catalog No. 1630 to: Distributor Sales, Cornell-Dubilier, South Plainfield, New Jersey.

**CORNELL-DUBILIER
ELECTRONICS DIVISION**
Federal Pacific Electric Company



Miller



* K-TRAN IS A REGISTERED TRADEMARK

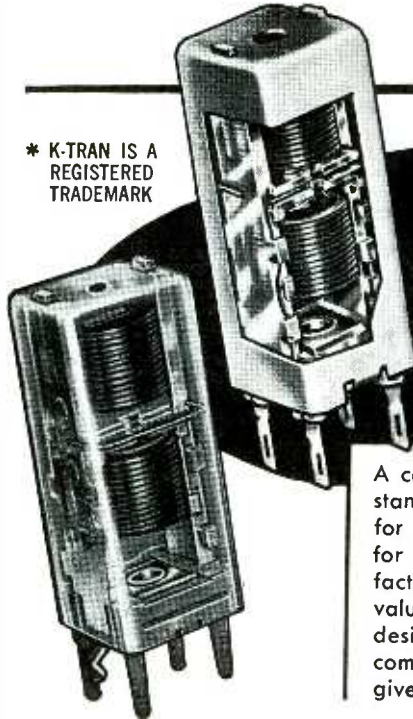

THE FAMOUS K-TRAN* I.F. TRANSFORMERS

A complete line of the finest I.F. transformers available anywhere at any price. Both standard and miniature sizes in all of the commonly used I.F. frequencies are stocked for immediate delivery. Conventional as well as printed circuit types are available for both vacuum tube and transistorized applications. Original equipment manufacturers will find the K-Tran the ideal choice for new equipment designs thus saving valuable engineering manhours and being assured of a top quality transformer designed by engineers with over 30 years of manufacturing experience in electronic components. The K-Tran also makes an excellent replacement transformer and will give results equal to or better than the original.

AVAILABLE IN THE FOLLOWING FREQUENCIES

CAT. NO. Printed Circuit Types	CAT. NO. Regular Standard Types	Dimensions: 3/4" square x 2" high	FREQ.	USE
13-PH1	12-H1		262 KC	Input transformer
13-PH2	12-H2		262 KC	Output transformer
13-PH6	12-H6		262 KC	Output transformer with diode filter
13-PC1	12-C1		455 KC	Input transformer
13-PC2	12-C2		455 KC	Output transformer
13-PC6	12-C6		455 KC	Output transformer with diode filter
13-PC7	12-C7		455 KC	Input transformer for battery radios
13-PC8	12-C8		455 KC	Output transformer for battery radios
13-PC9	12-C9		455 KC	Input transformers for AC-DC radios
13-PC10	12-C10		455 KC	Output transformer for AC-DC radios
	12-C11		455 KC	IF transformer (G.E.-RTL 143 and 163)
	12-C12		455 KC	Tapped Pri. I.F. transformer
	12-C45		455 KC	Discriminator
	13-W1		1500 KC	Input and interstage transformer
	13-W2		1500 KC	Output transformer
6203-PC	6203		4.5 MC	Input or interstage transformer
6204-PC	6204		4.5 MC	Discriminator transformer
6205-PC	6205		4.5 MC	Ratio detector transformer
6206-PC			4.5 MC	Ratio Det. (GE-RTD-026)
6207-PC			4.5 MC	Ratio Det. (GE-RTD-025)
6208-PC			4.5 MC	Ratio Det. (GE-RTD-020)
1463-PC	1463		10.7 MC	Input or interstage transformer
1464-PC	1464		10.7 MC	Discriminator transformer
	1464-WB		10.7 MC	Discriminator 900 KC Peak to Peak
1465-PC	1465		10.7 MC	Ratio detector transformer
	1465-WB		10.7 MC	Ratio detector 800 KC Peak to Peak
	6260		21.25 MC	I.F. Transformer
	6261		21.25 MC	Discriminator transformer
	6262		21.25 MC	Ratio detector transformer
6230-PC	6230		44 MC	TV Converter I.F. Transformer
6231-PC	6231		44 MC	TV First I.F. Transformer
6232-PC	6232		42.5 MC	TV second I.F. Transformer
6233-PC	6233		42.5 MC	TV third I.F. Transformer
6234-PC	6234		44 MC	TV fourth I.F. Transformer



Miniature I.F. Transformers for printed circuit transistorized applications. These miniature I.F. Transformers have tuned primary and untuned secondary windings. Proper impedance match between primary and secondary insures optimum performance.

Dimensions: 1/2" square x 3/4" high

CAT. NO.	FREQ.	SPECIFICATIONS
2031	455 KC	10K Ohm pri. to 600 Ohm Sec., Input
2032	455 KC	10K Ohm pri. to 1000 Ohm Sec., Output
2041	455 KC	25K Ohm pri. to 600 Ohm Sec., Input
2042	455 KC	25K Ohm pri. to 1000 Ohm Sec., Output
2051	455 KC	100K Ohm pri. to 1000 Ohm Sec., Input

Sub-Miniature I.F. Transformers for printed circuit transistorized applications. To our knowledge the smallest I.F. Transformers in existence. Ferrite cup core construction permits the use of extremely small shields without adversely affecting transformer operation. A high impedance, tapped primary winding coupled to a low impedance secondary provides optimum energy transfer between stages.

Dimensions: 3/8" square x 3/8" high

CAT. NO.	FREQ.	SPECIFICATIONS
9-C1	455 KC	25K Ohm pri. to 600 Ohm Sec., Input
9-C2	455 KC	25K Ohm pri. to 1000 Ohm Sec., Output

Also a sub-miniature I.F. Transformer for conventional circuitry using vacuum tubes. A 455 KC intermediate frequency transformer which has all the desirable features of the standard size I.F. and is smaller than a MINIATURE tube. Through the use of a ferrite cup core these sub-miniature I.F. Transformers offer the gain and bandwidth characteristics previously obtained only in larger I.F. assemblies. For AC-DC or battery radios.

Dimensions: 1/2" square by 1 1/2" high

CAT. NO.	FREQ.	USE
10-C1	455 KC	Input transformer
10-C2	455 KC	Output transformer

Write for Miller general catalog and Replacement Guide, or ask for them at your distributor.

Available Through Your Local Distributor
Miller Quality Products are recognized by the entire electronics industry as representing the finest in workmanship, performance, and dependability.

*Manufactured under K-Tran patents of and by Automatic Manufacturing Corp., Division of General Instrument Corporation.

J. W. MILLER COMPANY

EXPORT REPRESENTATIVE

Roburn Agencies, Inc.
431-435 Greenwich Street
New York 13, New York
WOrth 6-2130

FACTORY

5917 SOUTH MAIN ST., LOS ANGELES 3, CALIF.
Phone ADams 3-4294
FAX No. XCM

CANADIAN REPRESENTATIVE

Warehouse Slack
Atlas Radio Corporation, Ltd.
50 Wingold Ave.
Toronto 19, Ontario, Canada

Why are more Service-Dealers Switching to **JFD EXACT REPLACEMENT TV ANTENNAS?**

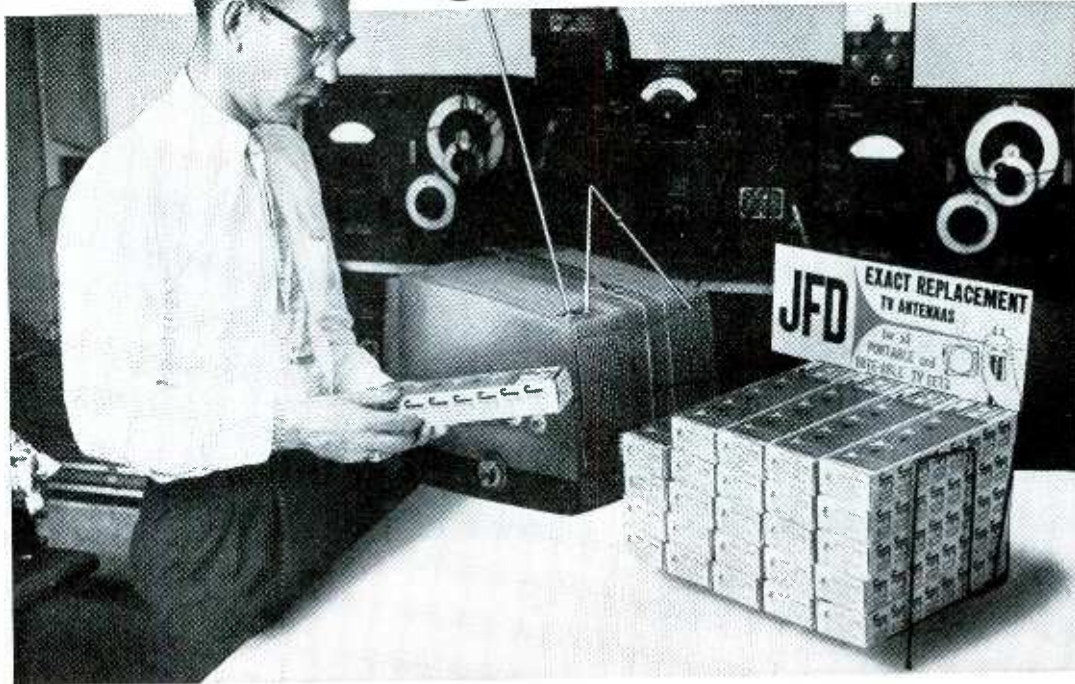

because

50 per cent of all TV sets made in the last 4 years are portables—sending *more* antenna replacement business to service-dealers every day.

because

with the JFD PA500 and PA515 Exact Replacement Kits, dealers are ready and able to service *90%* of antenna replacements for portables and tote-ables.

because

as JFD Exact Replacement Specialists, service-dealers can get out of the unprofitable “rabbit-ear” business—earn a *profit* on the antenna *sale* (at full mark-up) *and* on the *installation*.

because

with JFD guides, streamers, and sales helps, service-dealers get the merchandising *know-how* that nets them a bigger slice of the *3,500,000* dollar portable antenna replacement market.

NOW IS THE TIME TO WRITE JFD OR ASK YOUR JFD DISTRIBUTOR FOR YOUR EXACT REPLACEMENT PROFIT PLAN PORTFOLIO!



Check Sams Photofact folders for JFD Exact Replacement information. Only JFD keeps you up-dated with the 1960 Portable TV Antenna Guide covering every portable TV set made since 1956 (compiled and edited by Howard W. Sams & Co., Inc.)



THE BRAND THAT PUTS YOU

JFD

JFD ELECTRONICS CORPORATION BROOKLYN 4, NEW YORK
 JFD International, 15 Moore Street, New York, New York • JFD Canada, Ltd., 51 McCormack Street, Toronto, Ont., Canada IN COMMAND OF THE MARKET

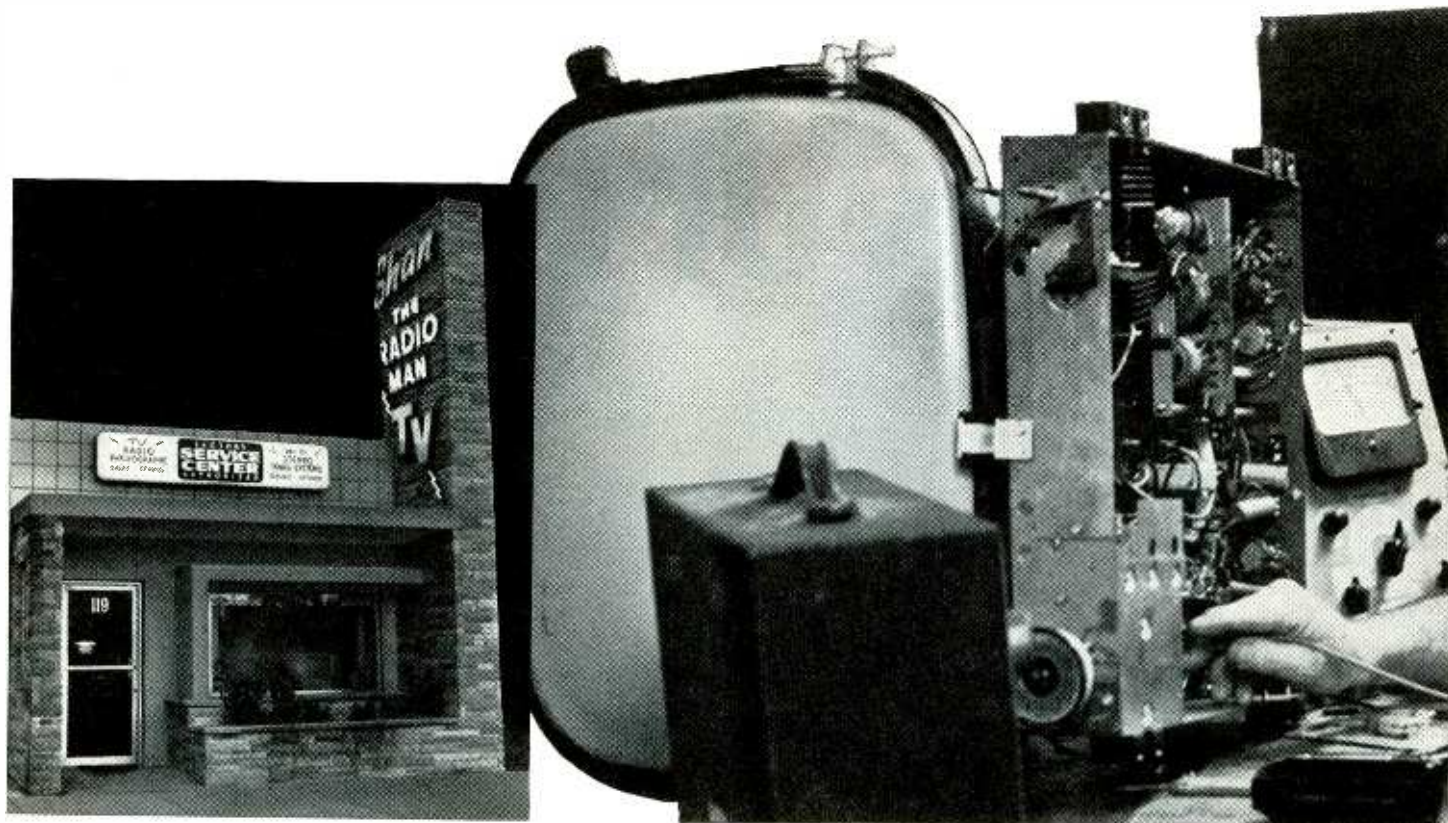

Shan the Radio Man says:

“100 years’ experience

has proved we can depend on Mallory components.”



“To be successful, you must make a profit, hire competent technicians, pay a fair salary, give prompt, dependable service and use the best quality components,” states Shan Des Jardins, discussing the growth of his business.

“I’ve used Mallory components since I first started my shop. My shop people and I have a total of a century of experience and we know we can depend on Mallory for top quality components.”

Shan runs an exceptional shop . . . the first in Miami to have a complete transistor radio service department, and among the first to service color TV. In all

his operations, he relies on quality Mallory components. When electrolytics need replacement, for instance, he knows—as do thousands of other service technicians—that Mallory FP’s give extra service in the smaller, hotter cabinets now common for TV and hi-fi . . . or when mounted next to a hot rectifier or output tube, where ordinary replacement filters wilt. They’re the original 85°C capacitor. Leak-proof seal and etched cathode construction—available without premium price only in Mallory FP’s—assure long life and hum-free performance.

Whatever your component needs, see your Mallory distributor. He carries the widest line of quality Mallory products . . . at sensible Mallory prices.

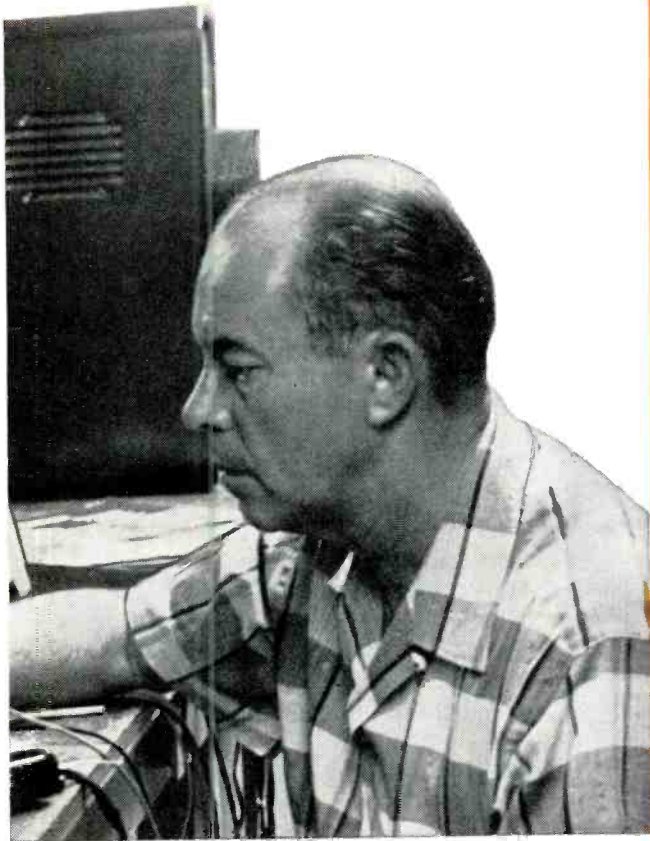

Shan Des Jardins is owner and manager of Shan the Radio Man Inc. in Miami. A charter member of TESA and Miami Service Association, he also is zone governor of NATESA. In 1928, Shan opened a one-man service shop for battery-powered radios. He now has five technicians and three trucks, handling 20 to 25 calls a day, servicing radio, TV, stereo and hi-fi.

THESE QUALITY MALLORY PRODUCTS PUT AN END TO CALL-BACKS



GEMS

Handy five-pack dispenser of rugged, moistureproof Mallory "Gem" tubular capacitors . . . keeps stock fresh, clean, easy to find . . . prevents kinks in lead wires. Unequaled for service in buffer, by-pass or coupling applications.



RMC DISCAPS*

Made by the world's largest producer of ceramic disc capacitors. Long the original equipment standard, they are available for replacement in a handy 3 x 5" file card five-pack package.

*Regr. Trademark of Radio Materials Company, A Division of P. R. Mallory & Co. Inc.



GOLD LABEL® VIBRATORS

For the best in auto radio servicing, use Mallory Gold Label vibrators every time. The quietest vibrator ever made. Exclusive buttonless contact design gives longest life, sure starts.

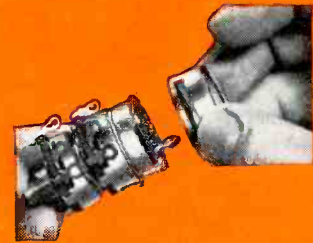

STA-LOC® CONTROLS

No waiting for out-of-stock controls. In just 30 seconds, your distributor can custom-build any of over 38,000 single or dual controls. You can replace the line switch by itself, without unsoldering control connections.



TC TUBULAR ELECTROLYTICS

Twin-pack of economically priced filter capacitors with a reputation for top performance. Proved in service and backed by years of Mallory experience. Also special Type TCX capacitor available for -55°C .



MERCURY BATTERIES

Unequaled for transistor radios. They give steady power several times longer . . . stay live for years when idle. Chosen as the "power package" in U. S. satellites. Made by the world's largest manufacturer of mercury batteries.

Distributor Division

P. R. MALLORY & CO. Inc.
MALLORY
 P. R. MALLORY & CO. Inc., INDIANAPOLIS 6, INDIANA

It was 10 in the morning, and the first rush of the day's service calls had tapered off to the point where I could begin to "unlax" and do some work — at least, that's what I thought. But then the phone rang, and a familiar voice piped through:

"Stan, old boy, this is Joe. I've got a little trouble with my television; if I came right over, could you throw it on the bench and fix it? I'll be glad to wait."

Intuition and experience told me, "Don't you dare!" But the hope that springs eternal in the human breast whispered that perhaps he really did have only "a little trouble." Maybe I could repair it quickly, garnering a few bucks along with some extra good will to start off a crisp winter morning. "O.K., Joe," I replied, "but which are you bringing, the Admiral or the RCA?"

"The Admiral," Joe replied. Right then and there I began to have misgivings. In the first place, I'd not seen the receiver in two years; secondly, it was a 21F1 chassis that hadn't had a capacitor changed in its nine years of existence. Mentally I saw fugitive atoms and electrons escaping everywhere. But, like all optimists who repair television sets, I still hoped for the best.

Old Buddy

Soon Joe arrived, and I put the receiver on the bench for a quick check. It had no raster, even though high voltage was present and both the B+ and boost voltages were only slightly low; furthermore, the tuner was very, very dirty. What else might be wrong I didn't know, so I asked Joe what trouble he'd been having. "Oh, some picture fading, slanting white lines across the screen . . . that's about all," he replied.

Well, now, picture fading plus retrace lines could be anything from a combination of high-voltage and picture-tube troubles to a whole string of sync, vertical, and video faults all rolled into one. These were the general possibilities — but my immediate problem was a specific point from which to start.

After a moment's consideration, I decided to measure the CRT anode potential to see if it was strong enough to produce a visible raster. The high voltage turned out to be approximately 10,000 volts—a bit



ACROSS THE BENCH by Stan Prentiss

"a little
trouble"
with an

ADMIRAL 21F1

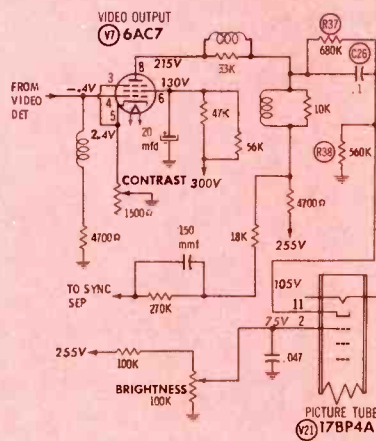

Fig. 1. Quick quiz: What faults could place 200 volts on cathode of CRT?

short of the 12.5 kv specified by Admiral. Was it low enough to extinguish the raster? I had my doubts, and decided I'd better look for another trouble source.

I've been in this business a bit too long to panic, so I simply picked up the schematic, swung my chair away from the pesky receiver, and adjusted the fluorescent bench lamp for a bright, comfortable view. Now if a lack of high voltage wasn't killing the raster, what in the name of consternation was? Not a defective electron gun in the CRT, I hoped.

By golly, just the thought of the electron gun gave me an idea. Brightness control R2 should vary the control-grid voltage of the 17BP4 picture tube from 0 to 125 volts. I swung around in my chair, picked up the scope probe, and switched the oscilloscope's vertical attenuator so that one major division on the scale would represent 100 volts. Putting the probe on the arm of R2, I rotated the shaft of the control. Sure enough, the DC level on the scope screen dutifully rose from 0 to a little more than 125 volts. Now, I thought, how about the cathode? I touched the scope probe to the junction of R37, R38, and C26 (Fig. 1). The waveform was there, all right, but the DC voltage was far different from the 105 volts specified. Come to find out, the signal was riding at a DC level of *more than +200 volts*.

Hopelessly Cut Off

How could this be? Actually, there are two ways in which excessive DC voltage could reach the CRT cathode. If you follow the signal path in Fig. 1 from the plate of video amplifier V7 to the cathode of the picture tube, you'll see that R37 and R38 form a voltage divider between the plate circuit of V7 and ground, limiting the bias on the cathode of the picture tube to approximately 100 volts. The AC video signal is superimposed on this DC bias; the signal amplitude (and also, to some extent, the DC voltage) can be controlled by manual variation of the contrast control R1A in the video amplifier cathode circuit. If C26 became shorted, or R38 opened, the voltage divider would be disabled—and the full DC

• Please turn to page 61

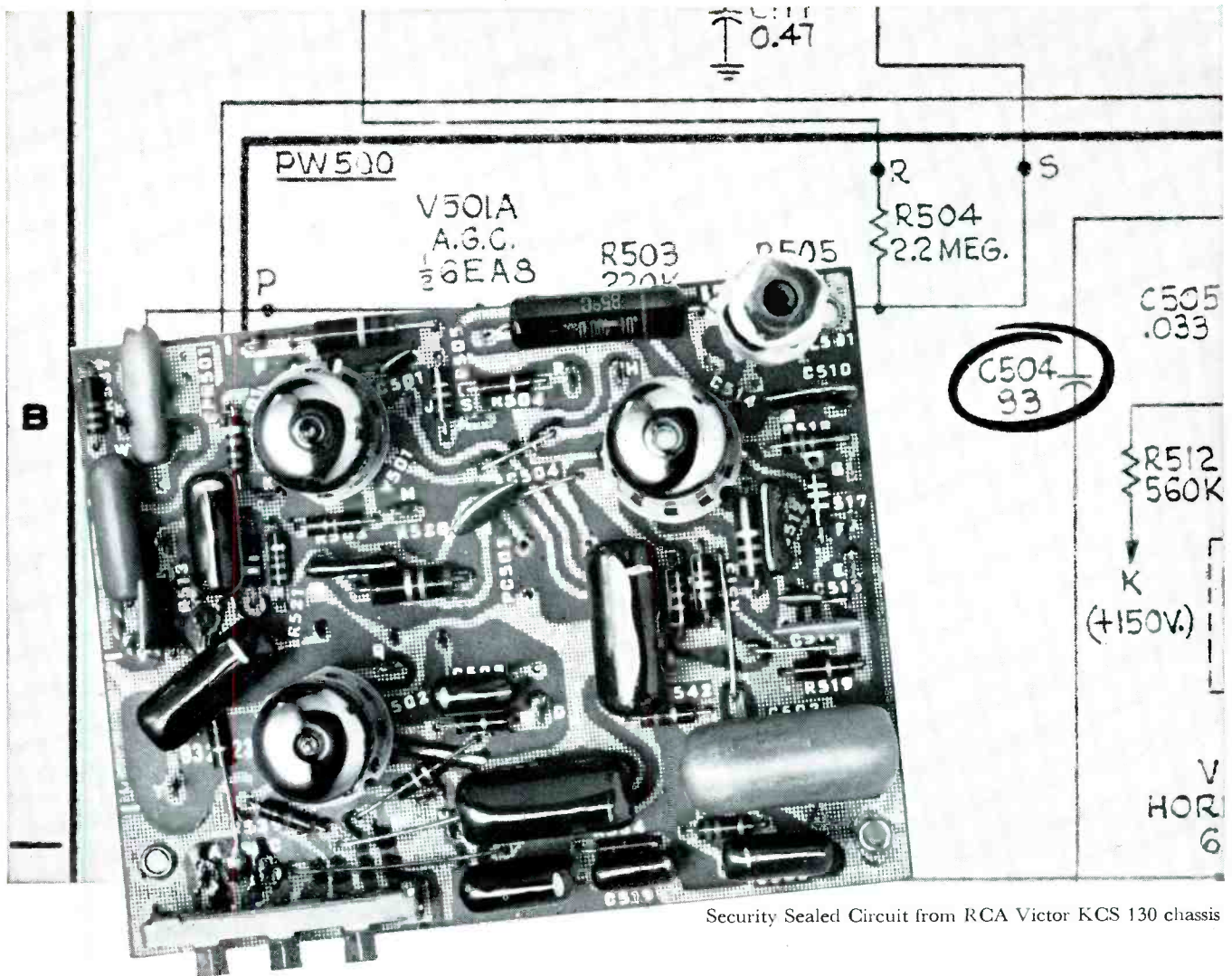

How fast can you find C 504? (Average time—10 seconds)

You know how valuable minutes are in TV servicing! Every one you save means money in your pocket.

With this all-important fact in mind, take a good look at the RCA Security Sealed Circuit in the picture above. All components are plainly marked. So are meter and scope take-off points and signal injection points. RCA Security Sealed Circuits take the *guesswork* out of servicing. That's for sure!

Now compare the RCA Security Sealed Circuit with any old-fashioned point-to-point wired chassis you have on your bench. Which do you vote for as a timesaver and error eliminator? If you vote for the printed circuit, you

are voting along with the nation's top missile, satellite and computer engineers! *Long ago, they chose printed circuits because printed circuits alone offer the maximum dependability.*

But, you may be thinking, how about parts replacement? Do printed circuits make this easier or tougher? The answer is—*easier!* All you need is a light, low wattage iron or gun, which is a good thing to have around the shop anyway. No special techniques are needed . . . just plain common-sense methods.

Next time a customer asks, explain that printed circuitry is the mark of modern, dependable, easy-to-service home entertainment equipment—such as RCA Victor!

TMK'S®



The Most Trusted Name in Television

RADIO CORPORATION OF AMERICA

Exactly what dangers, if any, are presented by X rays emanating from television receivers? . . . by Les Deane

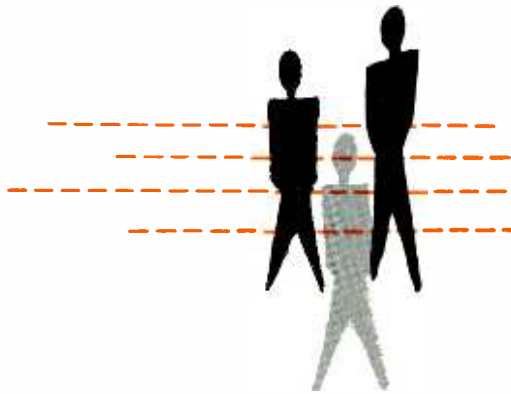

report on TV RADIATION HAZARDS

Fact or Fantasy?

A technician working at one of the final check-out positions on a TV assembly line develops a form of bone cancer in one hand. Is it possible that this disease could have been related to his eight-hour-a-day job?

A radio-TV serviceman experiences a periodic burning sensation about the eyes. This annoying symptom seems to grow worse with every passing year. Could it be that the big-screen TV's are emitting rays which are capable of damaging these delicate tissues?

Technically-minded people from other walks of life are often heard refusing their children front-row seats in the living-room "theater." Are they keeping their children a safe distance from the TV screen because of eyestrain alone—or are they concerned with the possibility of energy radiation from an operating cathode-ray tube?

Why should we even suspect that X rays are being emitted from a television receiver? To answer this, let's consider how X rays are pro-

duced for commercial and medical purposes.

The X-ray tube used to generate this energy is composed essentially of a cathode and an anode in a vacuum envelope. When heated, the cathode readily emits electrons, while the anode or "target" is charged with a high positive potential—usually above 50 kv. Thus, the free electrons boiled off the cathode are traveling at an extremely high speed by the time they reach the anode. This action might be compared to what takes place in a TV picture tube, except that the electrons in the X-ray tube strike a metal target rather than a phosphor screen. The sudden stopping of electrons on the surface of the target material results in the generation of X rays. Although the accelerating potentials used in today's TV picture tubes are considerably lower than those employed in modern X-ray equipment, the voltages used in Roentgen's original discovery some 65 years ago were in the neighborhood of only 20 kv. From this we can see why many people acquainted with X-ray phenomena support the belief that there *could be* radiation from the cathode-ray tubes used in television receivers.

The TV serviceman is made aware of possible radiation through statements appearing in tube manuals and even by warnings on the CRT's themselves. (See Fig. 1.) It's quite natural for some of us to become a little alarmed upon reading these notices when we realize that many TV picture tubes are now operated at anode voltages above 16 kv.

What are X rays?

Before going too far with our discussion, the term "X ray" should be properly defined. X rays are non-luminous electromagnetic radiations of extremely short wavelengths, produced by bombarding a substance with electrons moving at great velocity. X rays are capable of penetrating opaque or solid substances, ionizing gases and tissues through which they pass, and affecting photographic plates and fluorescent screens.

This invisible, wave-like radiation represents a form of energy somewhat similar to the rays of ordinary light. Comparing X rays to RF frequencies, we might say that their spectrum extends from about 3×10^{10} mc to 3×10^{16} mc. Naturally, at these extremely high frequencies, their wavelengths are microscopic. The penetrating power of an X ray depends largely on its wavelength; the shorter it is, the more effective it becomes. X rays are often classified as either "hard" or "soft"—those with more intense energy or

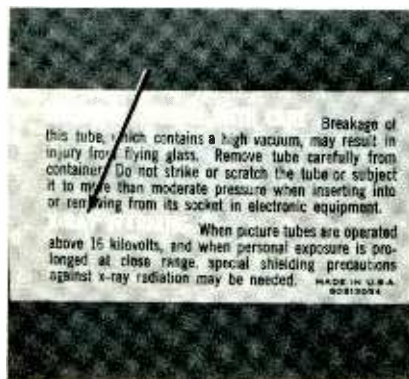

Fig. 1. Typical radiation warning label employed on most TV picture tubes.

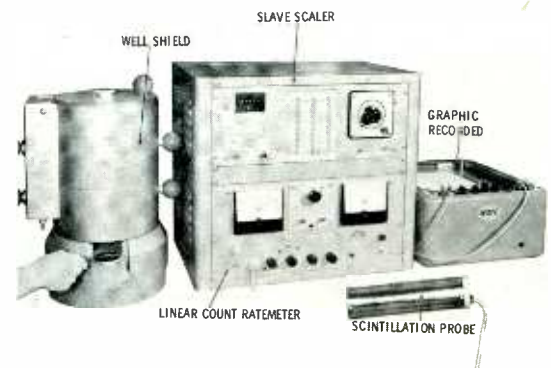

Fig. 2. Type of test equipment used for our TV radiation measurements.

penetrating power being the harder.

The density of X-ray radiation is proportional to the density of the material which emits it; therefore, if X rays are to be generated, the two major factors involved are the accelerating potential and the nature of the substance or substances under bombardment. It is the property of all such substances not only to transmit X rays in varying degrees, but also to absorb and scatter them in all directions. In the case of a CRT, we are concerned with materials such as specific types of glass, phosphor, and aluminum—of which little is actually known with respect to X-ray behavior.

A common unit of measure for X-ray radiation is the *roentgen* (r), which expresses radiation in terms of the amount of ionization produced in air by the X rays. The *milliroentgen* (mr) is one thousandth of a roentgen. Energy levels of such radiation are expressed in electron-volts, or more often in thousands of electron-volts (kev).

Lab Test Procedure

When I began research on this subject, I was forced to swallow a pinch of salt with every opinion I heard, because no one was able to conclusively substantiate his theories with factual findings. Many said that, if X rays are generated within a CRT, they would never be capable of penetrating the relatively thick glass. Some were firm believers that, since electrons strike the front screen with such great force, some are bound to pass right on through. Others contended that there would probably be more X-ray radiation at the neck of the tube, where some electrons pound against metal parts of the gun assembly. Still others had the idea that X rays are more likely to be given off at the high-voltage rectifier tube.

After making a fruitless effort to obtain some authoritative data on this controversial subject, we decided that the only way to prove or disprove the theory of harmful radiation from TV receivers was to perform a series of practical tests. By combining the technical know-how of both TV technicians and radiation specialists, we hoped to come up with the answers.

Our initial problem was to con-



Fig. 4. Two radiation "hot spots" found on each side of the CRT bulb.

tact qualified personnel and to arrange for the use of the most suitable equipment for our highly specialized tests. Fortunately, Nuclear Measurements Corp. here in Indianapolis, who manufactures precision radiation-measuring and detecting equipment, was kind enough to give us full cooperation with this research program.

A Geiger counter was neither sensitive nor accurate enough for our particular radiation measurements. The type of measuring equipment employed for this project is shown in Fig. 2. This *gamma spectrometer* system is capable of detecting, tracing, and identifying radiation down to very low energy levels. The system offers three different forms of monitoring or read-



Fig. 5. Mr. W. H. Bradley, president of NMC, probes a tube for X radiation.

out: Counts per given time cycle, continuous counting rate, and permanent graphic recordings.

The *scintillation probe* in Fig. 2 is a portable radiation detector. Basically, radiation enters through a "window" at the end of the probe and reacts upon a spectrometer-grade crystal. The crystal gives off light energy in direct proportion to the radiation energy. A photomultiplier tube converts this light to electrical pulses, which are in turn detected and amplified by transistor circuitry within the probe.

Output of the scintillation probe is coupled to a *linear count rate-meter*, which detects the radiation and provides a continuous meter reading of relative energy. In addition:

• Please turn to page 56



Fig. 3. A test setup which helped us find answers to the X-ray question.

REGENERATION IN PICTURE-SIGNAL CIRCUITS

by Allan F. Kinckiner

How to diagnose, localize,
and cure spurious oscillations
in video IF and related stages.

The trouble commonly called "regeneration" is also known by a variety of other names (oscillation, feedback, looping, etc.), but whatever term a serviceman may use to describe this unwelcome condition, he is likely to add an uncomplimentary adjective. Regeneration can, and does, occur in practically all sections of a TV receiver, producing confusion wherever it appears. However, its most baffling effects are observed in those stages which handle the picture signal.

The results of regeneration in RF, IF, or video circuits can show up in the picture itself, the most common symptoms being poor definition and ghosts. The same basic trouble can also lead to erratic horizontal and vertical sync, or to supercritical fine tuning. Furthermore, since the picture and sound signals are jointly handled by many of the same amplifier stages, regeneration in these circuits also affects the sound. The

audible symptoms vary considerably; rushing or panting noises are not uncommon, and in some cases the effect is almost identical to ignition noise in an auto radio. Since the disturbances in the sound generally seem more severe than those in the picture, customers may complain mostly of the excessive noise being created—even if this noise occurs mainly between stations.

Because regeneration is masked or swamped out by strong input signals, it often assumes the appearance of intermittent trouble. Operation may be normal except when a change in atmospheric conditions or antenna orientation produces a drop in RF signal level; then the raster becomes broken up or distorted. The appearance of the screen varies greatly from case to case, as illustrated by the three examples in Fig. 1 (all taken with antenna disconnected). Some receivers that operate normally with rooftop antennas

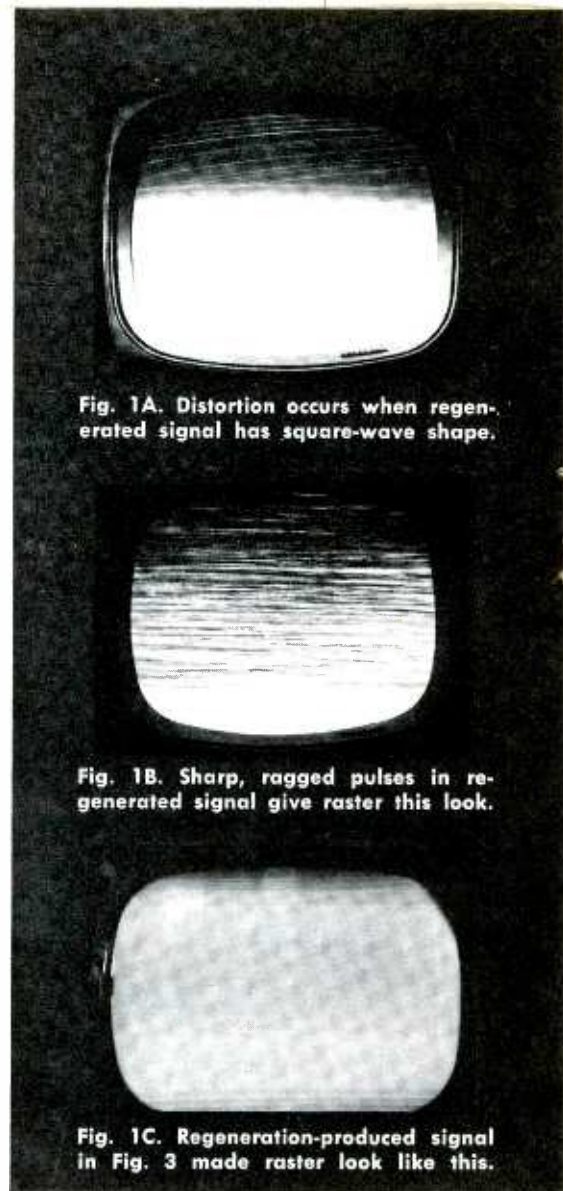

Fig. 1A. Distortion occurs when regenerated signal has square-wave shape.

Fig. 1B. Sharp, ragged pulses in regenerated signal give raster this look.

Fig. 1C. Regeneration-produced signal in Fig. 3 made raster look like this.

will suffer from raster breakup if operated with rabbit ears; on the other hand, some portables will not function correctly with their own antennas, but will present a faultless picture if an outdoor antenna is attached.

From this behavior, we can conclude that the presence of regeneration can be verified by merely disconnecting the antenna. A "break-up" symptom in place of a clean, slightly snowy raster (Fig. 2) not only proves regeneration is taking place, but also represents a steady-state trouble condition which can be isolated and corrected. (In some high-noise areas, it might be necessary to short across the receiver's antenna terminals to prevent variations in random noise from affecting the regenerative condition.)

Another method of determining the presence of regeneration and localizing its cause is to measure the voltage across the load resistor of



Fig. 2. Normal raster with antenna disconnected means "no regeneration."



Fig. 3. Wildly distorted video input to the CRT in the case of Fig. 1C.

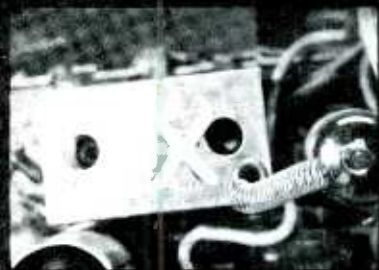

Fig. 4. "X" marks the shield responsible for regeneration in RCA KCS109.

the video detector. This test, made with no antenna connected to the set, should normally result in a maximum reading of minus 1 volt DC. An output of several volts not only proves that regeneration is taking place, but also shows it is being developed somewhere between the RF input and video detector. Regeneration in the video amplifier can be localized by disabling the last IF stage. If regeneration is occurring in or after the video detector, it will show up as distortion somewhat like that in Fig. 1.

To localize the trouble still further, we can check the video IF stages with a typical alignment setup using a sweep generator and scope. If the IF bandpass curve looks normal when the generator output is strong, but breaks up into jagged peaks and valleys when the sweep-signal amplitude is decreased, regeneration in the IF section should be suspected.

Looking at the input waveform to the picture tube when regeneration is present explains why the raster or sound distortion can take so many different forms. The scope trace shows that regeneration-produced signals can have any number of different shapes—an almost square-wave pulse in the case of Fig. 1A, a sharp pulse for Fig. 1B, and the "you-name-it" pulse in Fig. 3, corresponding to Fig. 1C. From this, you might conclude that scope troubleshooting is not much help in these sets; but it can sometimes be of real value, as the following example will prove.

At first the raster shown in Fig. 1C was believed to be the result of vertical trouble, or a feedback loop between the vertical and video-signal sections, but the scope quickly indicated that such was not the case. The distortion evident in Fig. 3 was still present even when the vertical sweep tubes were removed. Further troubleshooting proved that the regeneration was caused by a positive-feedback loop from the sync and keyed AGC stages back to the video amplifier. The condition was cured by adding a decoupling network at the screen grid of the video amplifier. Voltage had previously been fed to this element from a source common to the screen grid of the keyed AGC tube.

Cases, Causes, and Cures

The simplest regeneration-creating condition is brought on by a tube which provides too much gain—one with an "overactive thyroid," as one serviceman described it. At the other end of the scale are the complex, hard-to-find problems involving positive feedback loops due to faulty lead dress. Between these extremes is an assortment of other causes—some easy to correct once they are located, others not so easy.

Surely everyone who has been in the service business for very long has experienced a case of regeneration due to extra-high transconductance in a tube. Most such occasions are well remembered. In my own experience, this fault has occurred most frequently in Admirals of the 1950-52 period.

One of my earliest and most memorable bouts with regeneration was experienced with a 7" Philco. The chassis had never been out of its case, and the customer claimed

he had not so much as removed the back. Yet, here it was on the bench with a classic case of raster breakup due to regeneration. This, in turn, was due to a shield missing from a 6AU6 sound IF tube—which was in a virtually inaccessible location even with the chassis pulled out for inspection!

Resistor Changed in Value

A more recent case involved an RCA portable using Chassis KCS109C—a late-production version of this chassis with three IF's. The customer had had his set serviced by another technician who had replaced the 6CU8 third IF tube. The set worked well with an outside antenna, but when the built-in antenna was employed, the picture sporadically broke up as in Fig. 1A. Completely removing the antenna caused the condition to be displayed continuously. A diagnosis of IF regeneration was verified by hooking a sweep generator and scope to the set.

To my relief, I had good luck on this set. Here's how I went about finding the trouble: With the sweep-generator output decreased to the point of waveform breakup, I started changing tubes, eyeing the waveform all the while. In doing so, my attention was focused on two well-browned resistors. Going to work on these, I found they were cathode-bias resistors in the first and third IF stages, respectively. The former (a 47-ohm unit) had increased to 150 ohms, while the other had risen from 180 to 500 ohms. After replacing both resistors, I repeated the sweep-generator test and found that the regeneration had been corrected.

My guess was that the cathode resistors had been damaged by a shorted tube or tubes; this explained why the third IF had recently been replaced. The reason why this trouble produced such odd behavior is just a calculated guess. I have an idea that the entire video IF strip may have acted somewhat like a multivibrator under weak-signal conditions, with the necessary regenerative signal being fed back from the video detector by way of the AGC filter and bias network.

Poorly-Grounded Shield

Another RCA portable, by coincidence also a KCS109, was re-

• Please turn to page 65

EXAMINING MOTORIZED TUNING MECHANISMS

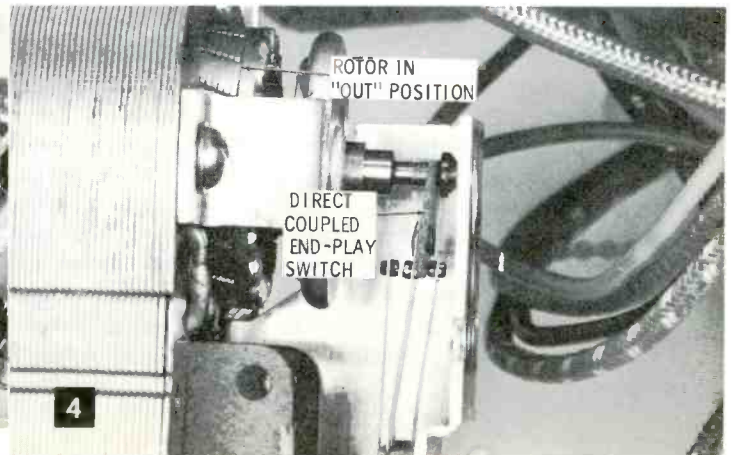
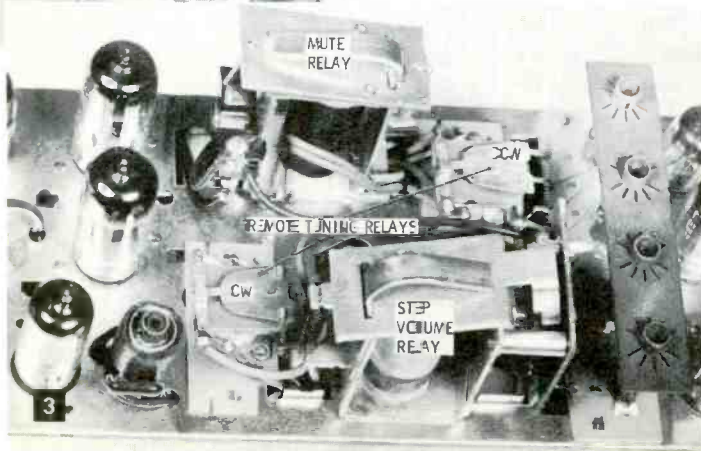
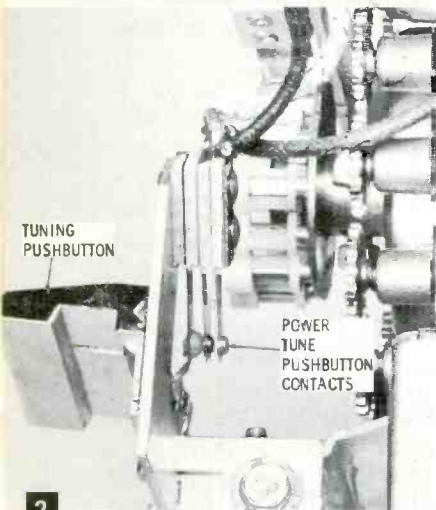
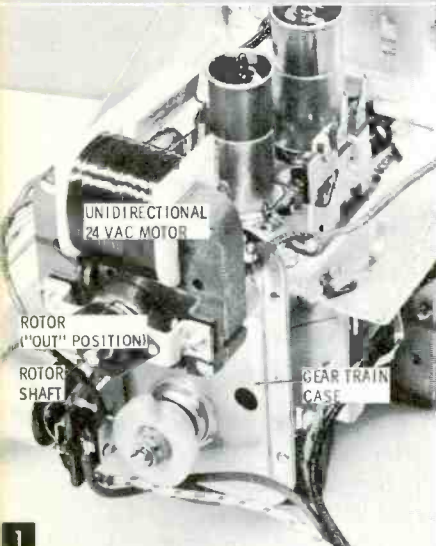
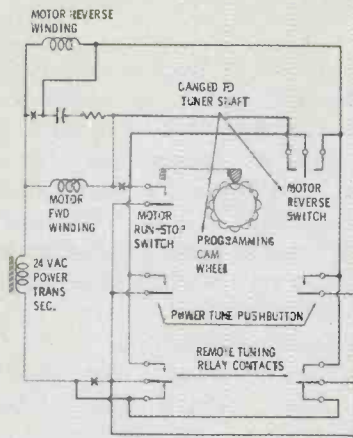

Channel selection may be either bi-directional or unidirectional: that is, the tuner may rotate in either direction, or in just one—from low to high. The heavy lines in the circuit diagram indicate the additional circuitry required for bidirectional operation. While many different switching systems are used, all are similar to the one shown here, and follow the same general principles of operation. Depressing a push button supplies power to the motor from a secondary winding on the power transformer. As soon as the motor is energized, a run-stop switch automatically closes, keeping the circuit closed until the next "on-channel" position is reached.

The 24-volt split-phase motor requires a starting capacitor, in series with a resistor across the winding, in order to develop the required torque. If control is bidirectional, a second motor winding is used for reverse

drive. When the motor is energized, the rotor engages a gear train that drives the tuner shaft. When the motor stops, the rotor returns to an "out" position (photo 1), disengaging the gear train.

The tuning cycle begins when either the power tuning push-button contacts (photo 2) or one of the remote tuning relays (photo 3) are closed. Although these switch devices are often located at some distance from the motor assembly, they can be easily identified by their basic physical characteristics.

Some manufacturers use the rotor end-play action to also perform one or more of the switching functions. In photo 4, end-play action closes the motor run-stop contacts and opens a pair of muting contacts when the motor starts. When the motor stops, the spring-loaded rotor returns to the "out" position, opening the run contacts and closing the audio contacts.

Power TV tuning units have grown in popularity until, today, every major manufacturer has at least one remote-control or power-tuned receiver. The accompanying photos will give you a close-up view of the "muscles" in modern motorized tuning mechanisms.

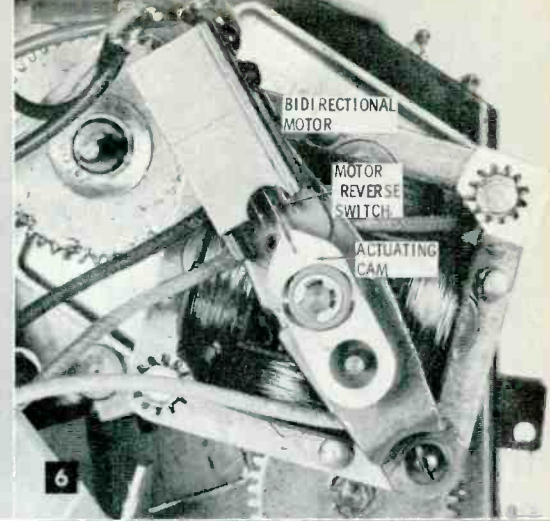
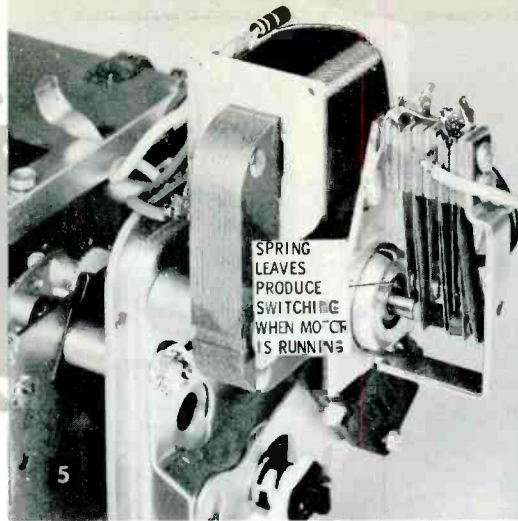

The three-gang end-play switch in photo 5 depends only on the spring action of the leaf switch to close the contacts when the motor runs, and closes an additional set of contacts to bypass the circuit-activating switches.

In bidirectional systems, after the initial starting action, some form of motor-reverse switch is employed to keep the proper motor winding connected into the circuit. Photos 6 and 7 show the methods used to properly position the switch contacts. While there are minor variations from these designs, all use rotor torque to drive a mechanical linkage which closes the correct contacts before the initial contact is broken.

One of the major differences between units is in the programming system. In the mechanism of photo 8, the motor-reverse contacts double as motor run-stop contacts. They are opened by the cam-follower arm when

the cam is in the flat position, thus breaking the circuit and stopping the tuning cycle. The cam system in photo 9 operates just the opposite of the one shown in the schematic. With the flat part of the cam toward the switch contacts, they open the motor-run circuit. The other two sections of the leaf switch disconnect the audio and darken the picture tube while channels are being changed.

Two separate sets of switch contacts are used with the programming wheel in photo 10. The contacts of the conventional run-stop switch are hidden by the cam that actuates them; however, the special detent-switch contacts are clearly visible. This unit is used with tuners which do not have a stiff detent spring; the detent switch is wired in parallel with the run-stop switch to provide precision stopping.

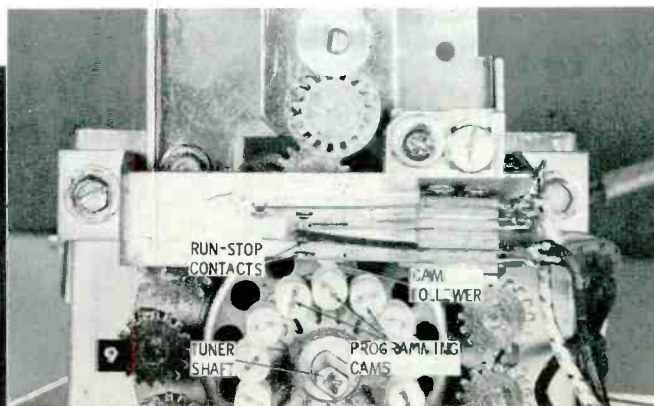
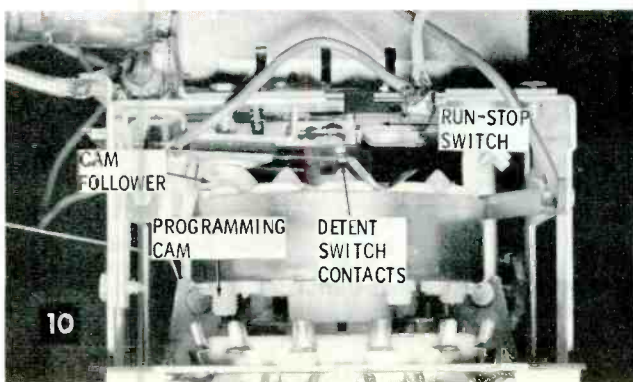
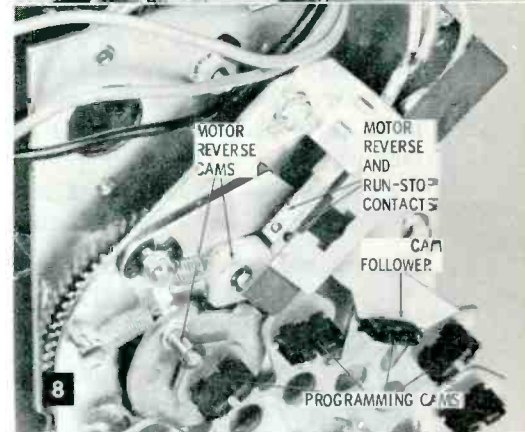
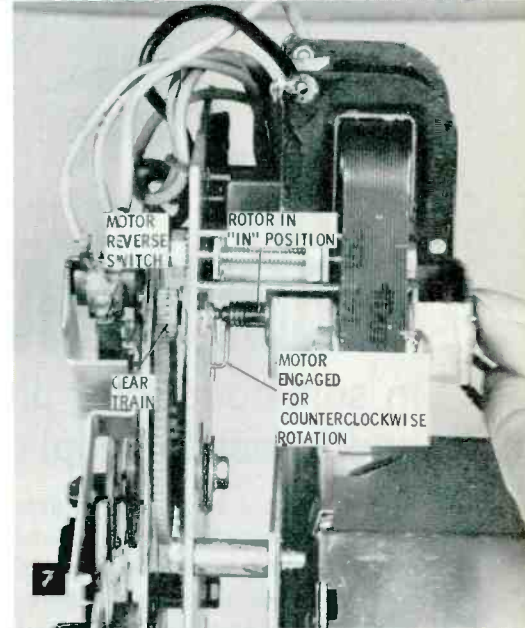

Need to
know more about
TRANSISTORS?

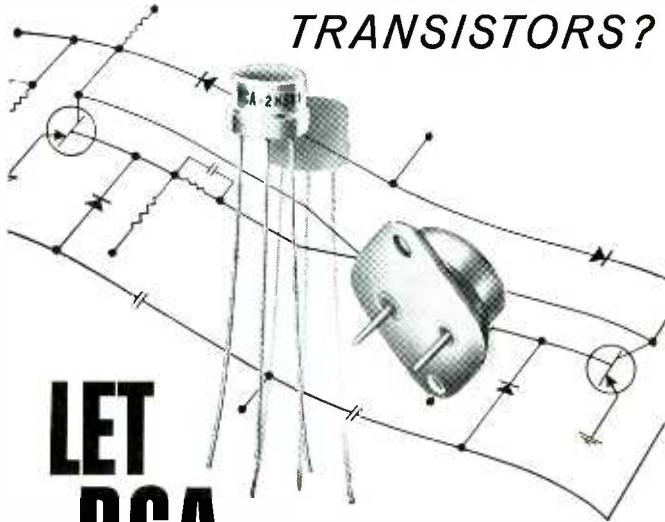

LET RCA TRAIN YOU AT HOME

in semiconductor physics
and transistor applications

RCA Institutes Home Study School's new Transistor course is designed to meet the needs of men and women in the field of electronics who realize the growing importance of semiconductor technology. The course covers transistor characteristics and testing methods... prepares you to move up in your job as you increase your knowledge and skills. *No monthly installment payments.* Pay-as-you-learn using the most economical possible home study plan... you pay for your next study group only when you order it.

Courses also available in Electronic Fundamentals, TV Servicing, Color TV, and Electronics for Automation.

SEND FOR THIS FREE 64-PAGE CAREER BOOK TODAY!



RCA INSTITUTES, INC.
A Service of Radio Corporation of America

The Most Trusted Name
in Electronics



Licensed by the University of the State of New York

RCA Institutes, Inc., Home Study Dept. PF-DO
350 West Fourth Street, New York 14, New York

Please rush me your FREE illustrated 64-page book "Your Career in Electronics," describing your home training programs, including complete information on the new Transistor course. No obligation. No salesman will call.

Name _____ Age _____
(PLEASE PRINT)

Address _____

City _____ Zone _____ State _____

Korean Vets: Enter discharge date _____

IN CANADA: No postage, no customs, no delay. Send coupon to:
RCA Victor Company, Ltd., 5581 Royalmount Ave., Montreal 9, Que.

The Electronic Scanner

Premiums Galore

Service aids, toys, cameras, watches, and other useful items for home and shop are among the 17 valuable premiums available with the purchase of RCA receiving tubes. Heading the premium list in this "Front Page Program" is the Meter Chest, a 200-tube caddy equipped with RCA's WV-38A VOM.

Diamonds are Whose Best Friend?



Or... "Oh, for the life of a distributor salesman." Winner in Duotone's diamond needle sales contest is Tom Kendrick (left) of Electro-Sonic Supply Co., Ltd., Toronto. Bill Pointon (right, Canadian representative, is shown awarding the prize — a \$500 diamond ring!

Tube Test Data by Subscription

Owners of B & K tube testers may obtain setup data on new tube types from B & K Mfg. Co. The "New Tube Information Service" is issued by the manufacturer every 3 months. An annual subscription includes all 4 issues for \$2.50. Single copy price is \$1.50.

... and Now They Have Tape, Too

First in Sarkes Tarzian's new line of magnetic recording tape is a general purpose 1/4" size with 1 1/2-mil acetate base. Initially, it is being offered in lengths of 150', 600' and 1200' on 3", 5" and 7" reels.

Tubes by the Bucketful



Buy a special assortment of Amperex tubes, consisting of widely used radio and TV types, and you get a B. F. Goodrich Ice Bucket free. Various quantities of the following tube types are included in the \$49.46 deal: 2ER5; 4ES8/XCC189; 6AQ8/ECC85; 6AT6/EBC90; 6AV6/-EBC91; 6BA6/EF93; 6BL8/ECF80; 6BM8/ECL82; 6BQ5/EL84; 6CA4/-EZ81; 6CA7/EL34; 6ER5/EC95; 6EH7/EF183; 6EJ7/EF184; 6ES8/ECC189; 6FG6/EM84; 6FY6; 6V4/EZ80; 6X4/-EZ90; 12AT7/ECC81; 12AU7/ECC82; 12AX7/ECC83; 6267/-EF86; and 7025.

CB Franchises Awarded

Vocaline Company of America, manufacturer of Citizens band radio equipment and wireless intercoms, is in the process of setting up a network of warranty repair stations. Many areas are open for franchising to recognized and qualified service companies. Write to Service Mgr., Old Saybrook, Conn.

Buy 9, Get 1 Free

... is the program CBS Electronics is using to let service dealers prove to themselves the "total reliability" of CBS receiving tubes. Beginning Dec. 1 and ending Dec. 30, it gives you the opportunity to "blast test" the popular 6AX4 type.

Gets 'Em There Faster

Merit Coil & Transformer Corp., with a network of warehouses from coast to coast, has just moved the midwestern operation to Chicago, only 1/2 mile from the largest trucking terminal in the U.S. Now, your distributor can obtain needed transformer and coil replacements for you faster than ever.

Transmission Line Cables



8225



8226



8230



8285



8235

Microphone and Shielded Power Supply Cables



8410

RUBBER



8411



8413

PLASTIC



8420

Mr. Service Technician:

Ask your Belden jobber about this complete wire and cable line

What types of wire and cable do you need? Ask your Belden electronics jobber for complete specifications on types, sizes, insulations, and convenient spooled lengths. Available from stock.

Hi-Fi, Stereo, and Phonograph Cables



8421



8430



8419

Rubber-Vinyl Multiconductor Portable Cordage



8462

8888

Power Supply Cords



17106

Antenna Rotor Cables



8464

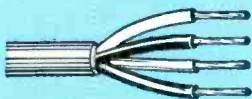

8484

Hook-Up Wire



8800

TV and Cheater Cords

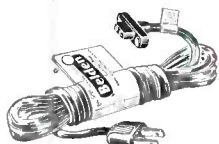

8874



8875

Aluminum Ground Wire



8018



- power supply cords • cord sets and portable cordage • electrical household cords • magnet wire • lead wire • automotive wire and cable • aircraft wires • welding cable

*More Signal
Power with Winegard
TV Amplifiers and
Booster Couplers!*

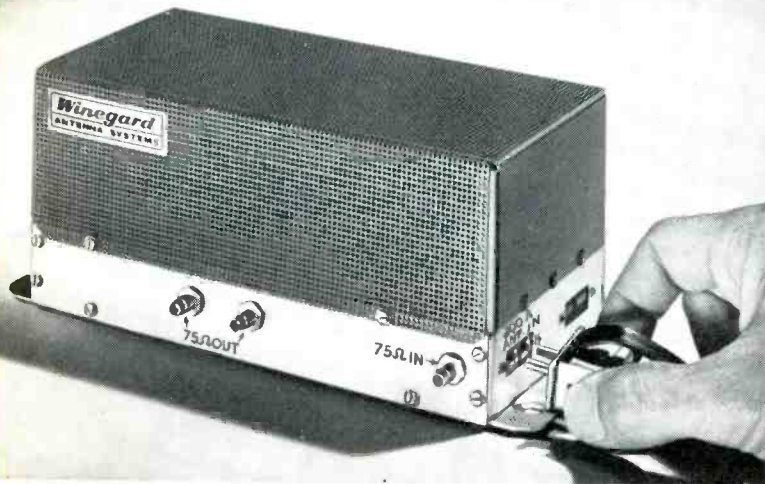

New Precision Amplifier A-400 drives 1 to 30 TV sets. You get up to 26db gain on TV and FM bands with the Winegard A-400. Has four 6FY5 neutroelectrode tubes with extremely low noise characteristics. Dual 75 ohm outputs—300 ohm balanced input with no-strip disconnect plug and 75 ohm coaxial input. Unit completely fused. Finest amplifier in its class—\$79.95.

Booster Coupler WBC4—operates 1 to 4 TV and FM sets. Delivers up to 12.5 db gain all channels on one set. Operates 2, 3 or 4 sets with up to 6 db gain for each set. Powerful 6DJ8 tube, shielded and protected. 4 sets of no-strip lead-in terminals—quick disconnect plug for antenna lead-in—\$27.50.



Write today for full information
on Winegard TV distribution systems
and famous Winegard TV antennas.



Winegard Co.

3009-12 Scotten Blvd. Burlington, Iowa

Antenna Systems

Everything from the
antenna to the set



Count-down. If by some not too strange chance you're among the thousands who haven't yet seen the need for rigid inventory control, now is an excellent time to think about taking a physical count of every resale component you have. Sure, it's work! But it's some of the most profitable work you can undertake.

Once the original inventory has been taken, you'll need only minutes a day to keep an up-to-date perpetual inventory. Such a system can keep the shelves and stock bins reasonably free of slow-moving items that tie up capital. Just to prove a point, take a look around your shop at the "well-aged" look of some of the stock.

Once you have a physical count, and have recorded quantities in some categorized order of your own choosing, you can easily deduct parts as they're used (referring to the office copy of customer work orders). New items, when purchased are added to the inventory record, and a daily, weekly, or monthly calculation is made of all items in inventory. Records must be accurate or the program is worthless. Since the turnover of every item is automatically recorded, new stock can be ordered intelligently. This system also permits stocks of "going-out-of-use" items to dwindle at the right time, thereby diverting working capital into more profitable channels. It's also a good idea to keep a record of items needed but not in stock. When the usage rate reaches a certain point, a supply can be added to the inventory.

S & C

How do you rate? Not long ago an appliance service survey was conducted in a leading metropolitan area to determine customer reaction to the cost, quality, and speed of service received. While radio and television service differs in many respects from appliance service, customer reactions are prone to follow the same patterns in both cases. Some very interesting facts came to light. For one thing, the survey showed that a healthy percentage of newly-purchased items required service during the first year, which indicates the necessity for keeping abreast with new designs.

Questioned about the promptness of service, nearly one out of four people felt they received slow service. Of these, almost half thought this was because the service organization didn't have the required parts in stock, while over a third felt the call just wasn't handled as promptly as it should have been. These are the dissatisfied customers whose business is ready for "wooing." That one-fourth of the country's consumers feel this way is appalling.

The feelings regarding quality and promptness dovetailed when cost was brought into the picture. Two-thirds of the group polled felt the service they received was both prompt and satisfactory; only 7% of these folks thought the charges were high. On the other hand, among the third who felt service was generally poor or slow, 24% were of the opinion that the cost was too high. It's the same old story: When people receive good service, they rarely complain about price. How do you rate?

"Here's the slickest reminder board I've ever used!"

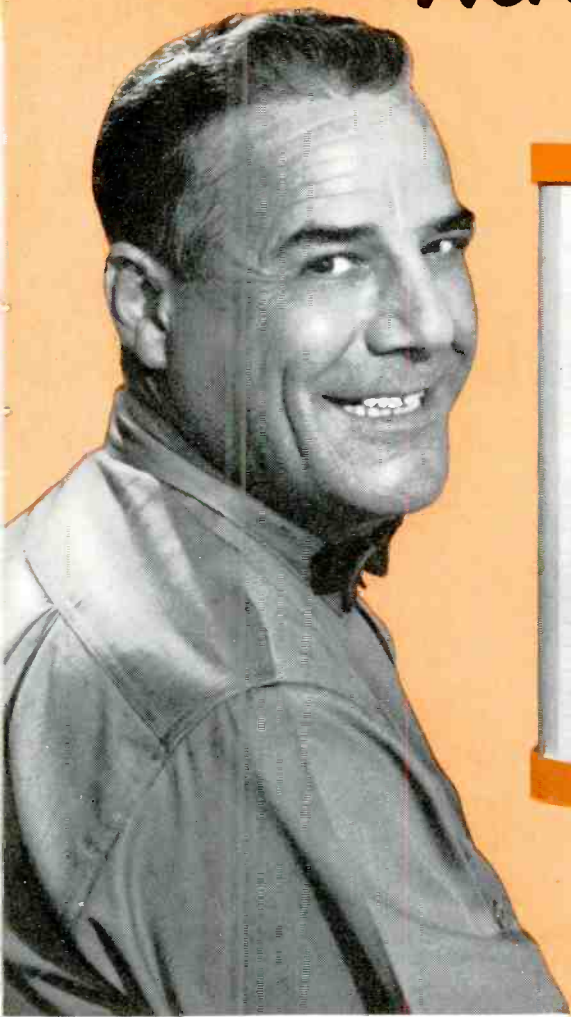

TV-RADIO SERVICE CALL BOARD

TIME	MONDAY	TUESDAY	WEDNESDAY
9.00	Halvorson 406 Main pickup set	DELIVER REPAIRED HI-FI TO APEX CLUB	
10.00	J. Watts 8 Bayside Service call	MRS. DUNN, 451 Riverview New 21inch TUBE	Call CLARK (main 3021) about repairing TV
11.00	Sam Caldwell bringing portable to shop	MAPES, 816 Washington PICK UP SET	
12.00	ASSN. LUNCH	Y.M.C.A - check speaker system	Pick up set at Rockwood CAFE
1.00			
2.00	HAVE DOWNEY TV READY TO INSPECT AT SHOP		
3.00	PAUL DEVERS, 16 Parkview Service call		
4.00	HENDERSON WILL CALL OR PHONE		
5.00	ANDREWS, 161 Girard deliver set		

CALL YOUR G-E TUBE DISTRIBUTOR FOR SERVICE

Rotating Sleeve

\$10.95 VALUE

SHOWS WHAT'S HAPPENING—AT A GLANCE!

This G-E Service Call Board makes it easy to keep track of jobs. You see at once what calls, pick-ups, and deliveries are to be made—when and where.

BIG (21½" by 14")...EASY TO SEE AND USE!

Entries are written on a rotating plastic sleeve with a marking pencil, and erased or changed quickly with the wipe of a cloth.

ALWAYS UP-TO-DATE. HANDSOME, MODERN!

The rotating sleeve is the real feature. As you turn it each day, all deadlines move up. No job is overlooked. See your General Electric tube distributor about your Service Call Board, or mail coupon at right to the Chicago warehouse address given. *Distributor Sales, Electronic Components Division, General Electric Company, Owensboro, Kentucky.*

Progress Is Our Most Important Product



- **ONLY \$5!** Schedules your service calls... pick-ups... deliveries... back orders... inventories... work assignments... sales. You'll want more than one Service Call Board. Order today!

General Electric Company, Dept. B
3800 North Milwaukee Avenue
Chicago 41, Illinois

Kindly ship me prepaid:
_____ Service Call Boards (ETR-2144) at \$5.00 each.
My check or money order is enclosed for the required amount plus any sales or use tax applicable in my area.

NAME _____
STREET ADDRESS _____
CITY _____ ZONE _____ STATE _____

STOP that interference!



ELIMINATE OR REDUCE
TV AND FM INTERFERENCE

Tunable
MOSLEY
Wave Traps

Now! High Q series-resonant wave traps help knock out TVI and BCI. High Q series-resonant type wave traps may be used on any receiver input, 50 to 600 ohms, balanced or unbalanced. Easy to install. Solderless. Choose type whose range includes frequency of interfering station.



List Price **\$4.82**

TYPE	RANGE (mcs.)
WT-7	6.8-8.5
WT-14	13.8-16
WT-21	16-28
WT-41	27-55
WT-78	47-110
WT-165	100-230



NOTES

ON TEST EQUIPMENT

by *Les Deane*

Farad Finder

The instrument pictured in Fig. 1 is designed expressly for measuring capacitor values. Manufactured by Arkay International, of Richmond Hill, New York, the Model CA-40 Capacity Meter is a direct-reading instrument well suited for radio and TV service work as well as laboratory and industrial applications. The unit comes complete in either kit or factory-wired form.

Specifications are:

1. *Power Requirements* — 105/125 volts, 50/60 cps; power consumption approx. 25 watts; transformer provides line isolation.
2. *Capacitance Range* — five switch positions provide full-scale ranges of 50, 100, and 1000 mmf, .01 and 0.1 mfd; special test jack provides additional range of 0.1 to 1.0 mfd.
3. *Calibration* — five individual calibrating controls provided; precision calibrating capacitors available.
4. *Other Features* — 6" 50-ua panel meter with two scale arcs for all six ranges; two 30" test leads supplied.
5. *Size and Weight* — case 6½" x 7¾" x 4¼", 4½ lbs.

At first glance, this unit looks somewhat like a VTVM. It is housed in a black bakelite case and has an all-metal front panel. The wide-angle meter occupies the top half of the panel, the lower half serving as a mounting plate for an off-on switch, capacitance range selector, and three test terminals. Each terminal on the panel is a combination banana-plug jack and universal binding post. The test leads are equipped with banana plugs on one end for connection to the meter, and alligator clips on the other end for connection to capacitors under evaluation.

To measure capacitance, you merely select the proper range and connect the questionable capacitor across the test leads. A value between 1 mmf and 1 mfd is then indicated directly on the appropriate meter scale (MMF or MFD). The instrument is not designed for in-circuit testing, nor is it intended to measure electrolytics, since they have very high leakage characteristics. Accuracy of its



Fig. 1. Arkay's new meter measures capacitor values from 1 mmf to 1 mfd.

readings depends largely on how precisely the meter is initially calibrated. After calibrating the Model CA-40 with capacitors of $\pm .5\%$ tolerance, I found it to be as accurate as some of the more expensive bridge-type instruments.

A complete circuit of the CA-40 is shown in the schematic of Fig. 2. Dual triode V1 functions as a cathode-coupled multivibrator which supplies a pulsating output across cathode resistor R7. Capacitors C1 through C5 provide a means

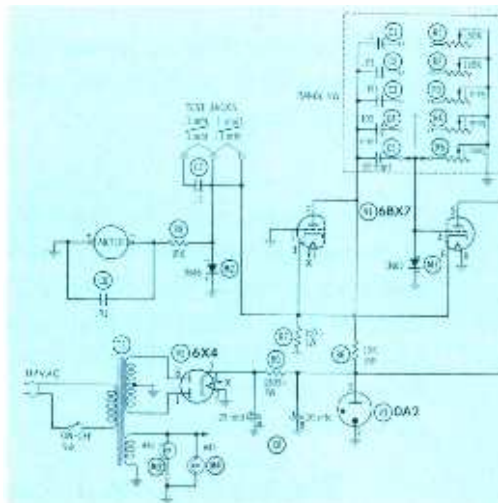
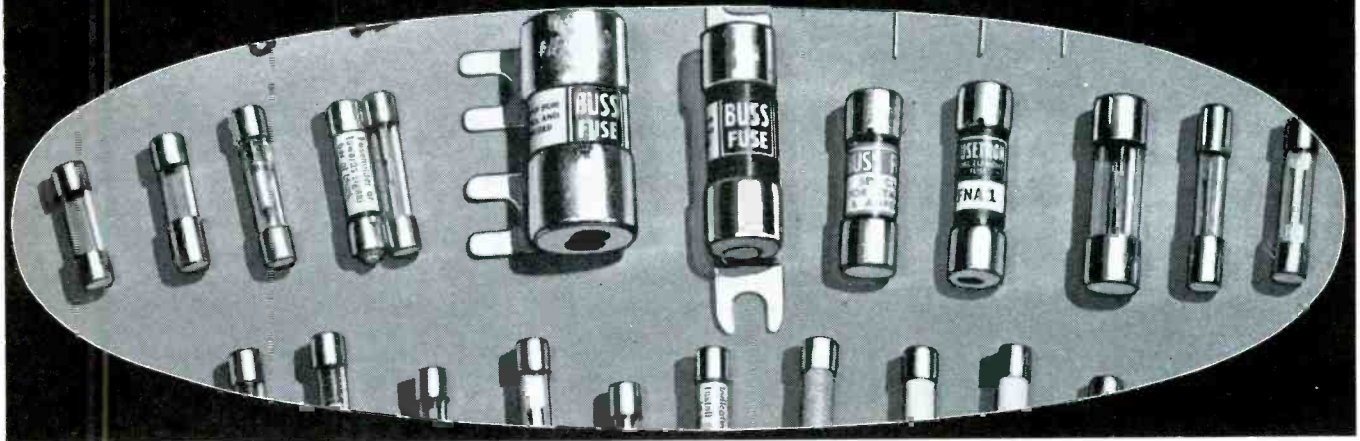

Fig. 2. The CA-40 consists of an oscillator, meter circuit, and power supply.



You'll save time, trouble..



*... by turning FIRST to BUSS for
fuses of unquestioned high quality*

By relying on BUSS as your source for fuses, you can quickly and easily find the type and size fuse you need. The complete BUSS line of fuses includes: dual-element "slow-blowing", single-element "quick-acting" and signal or visual indicating types . . . in sizes from 1/500 amp. up — plus a companion line of fuse clips, blocks and holders.

BUSS fuses are made to protect —not to blow needlessly

When you install BUSS fuses — you are sure your customers receive maximum protection against

damage due to electrical faults. And just as important, your customers are safeguarded against irritating, useless shutdowns caused by faulty fuses blowing needlessly.

It pays to rely on dependable BUSS fuses because there are no 'kicks' or complaints from users about their operation . . . and you avoid costly, unnecessary call-backs.

Capitalize on the BUSS trademark

The universal trade and consumer acceptance of BUSS fuses

is based on the millions upon millions of BUSS fuses used in homes, on farms and in industry over the past 46 years. Handling BUSS fuses — and other KNOWN items — helps safeguard your reputation for service and quality.

For more information on BUSS and Fusetron small dimension fuses and fuseholders . . . Write for bulletin SFB.

BUSSMANN MFG. DIVISION,
McGraw-Edison Co.
University at Jefferson, St. Louis 7, Mo.

1260

BUSS fuses are made to protect - not to blow, needlessly.

BUSS makes a complete line of fuses for home, farm, commercial, electronic, electrical, automotive and industrial use.



ALL THE TUBES YOU NEED... SONOTONE HAS!

Now you can simplify your inventory, boost discounts, add higher quality to your tube line... with Sonotone's expanded new line of more than 150 top-quality tube types. All Sonotone tubes undergo rigid performance and production tests...many reliable tubes are being used right now for rigorous space and military projects. Available for industrial and entertainment uses, as well. For high quality and top profits, you can rely on Sonotone tubes.

Sonotone PROG.

Electronic Applications Division, Dept. T10-120
ELMSFORD, NEW YORK

Leading makers of rechargeable batteries, phono cartridges, speakers, microphones, tape heads and electronic tubes. In Canada, contact Atlas Radio Corp., Ltd., Toronto

for altering oscillator frequency, and potentiometers R1 through R5 are used for the calibration of each range. Diode M1 provides a low resistance charging path for the oscillator coupling capacitor, thus eliminating R7 from the charge path. Consistent pulse amplitude and stable operation of the oscillator are assured by the use of a regulated plate supply voltage.

As illustrated in Fig. 3, output of the multivibrator is developed across cathode resistor R7 and applied to the unknown capacitor. The positive-going pulse of the applied signal (W1) causes the meter rectifier M2 to conduct and charge the unknown capacitor. Between pulse intervals, M2 ceases to conduct, and the capacitor discharges through the meter circuit. The meter reading thus provides a direct indication of the charge stored by the unknown capacitor. With a damped meter movement and components R8 and C6 acting as filters, the reading obtained represents the average value of the pulse signal (W2).

Since the amplitude of the multivibrator signal and the impedance of the metering circuit are relatively constant, frequency of the test signal is made variable to compensate for the different capacitance ranges. For example, the multivibrator frequency is increased by 10 times when changing the range setting from full-scale indications of .1 to .01 mfd. Hence, repetition rate of the charging pulses increases as capacitance of the measured component decreases, and the

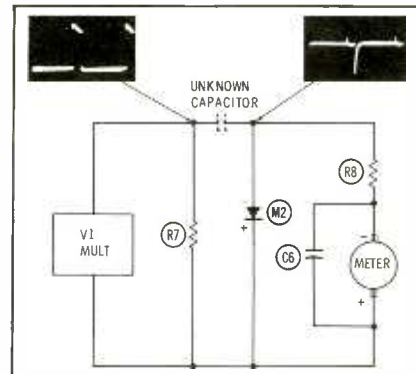

Fig. 3. Diagram showing operation and test signal of the Capacity Meter.

meter is calibrated accordingly.

Since the Model CA-40 is a direct-reading instrument and its operation is so simple, I found it ideal for quick measurements of stock parts. It would also be useful in production line work. I've found such an instrument very helpful when trying to pinpoint the cause of frequency drift or phase shift in an oscillator circuit. For instance, if a capacitor is changing value in a horizontal or vertical oscillator stage, about the only way to find it is by direct substitution or through an accurate measurement of its value. The precise value of a capacitor is not always of concern in ordinary coupling or bypass applications, but when it comes to tuned stages or wave-shaping networks, this factor is extremely important.

Portable Service Shop

Mercury Electronics Corp., Mineola, New York, has recently introduced a new instrument that accomplishes the work of several. The Model 300 Combination Tester shown in Fig. 4 incorporates a multiple-socket tube tester, picture tube tester-reactivator, and a VOM section that measures voltage, current, resistance, and capacity.

Specifications are:

1. Power Requirements — 105/125 volts, 60 cps; AC power consumption less than 5 watts standby; power indicator on front panel; transformer provides line isolation;

self-contained 1.5- and 6-volt batteries supplied.

2. Tube Tester — checks over 700 different tube types for shorts, leakage, gas, and emission; 17 prewired test sockets provided on panel; shorts and leakage indicated by neon lamps; built-in 7- and 9-pin straighteners; tube chart supplied and new listings furnished to registered owners.
3. CRT Tester — tests both monochrome and color picture tubes for leakage, shorts, and emission; provides tests for types with 2.35-,

TV TUNERS * ALL TYPES REBUILT OR EXCHANGED



\$9.95 Including all parts and labor
(except broken wafers—billed at cost)

- Normally shipped same day received
- 90 day full guarantee
- U/V combinations \$17.95

FREE—!! Mailing carton sent to you on request

Phone REpublic 3-9189

L. A. TUNER EXCHANGE 4611 West Jefferson Blvd.
Los Angeles 16, California

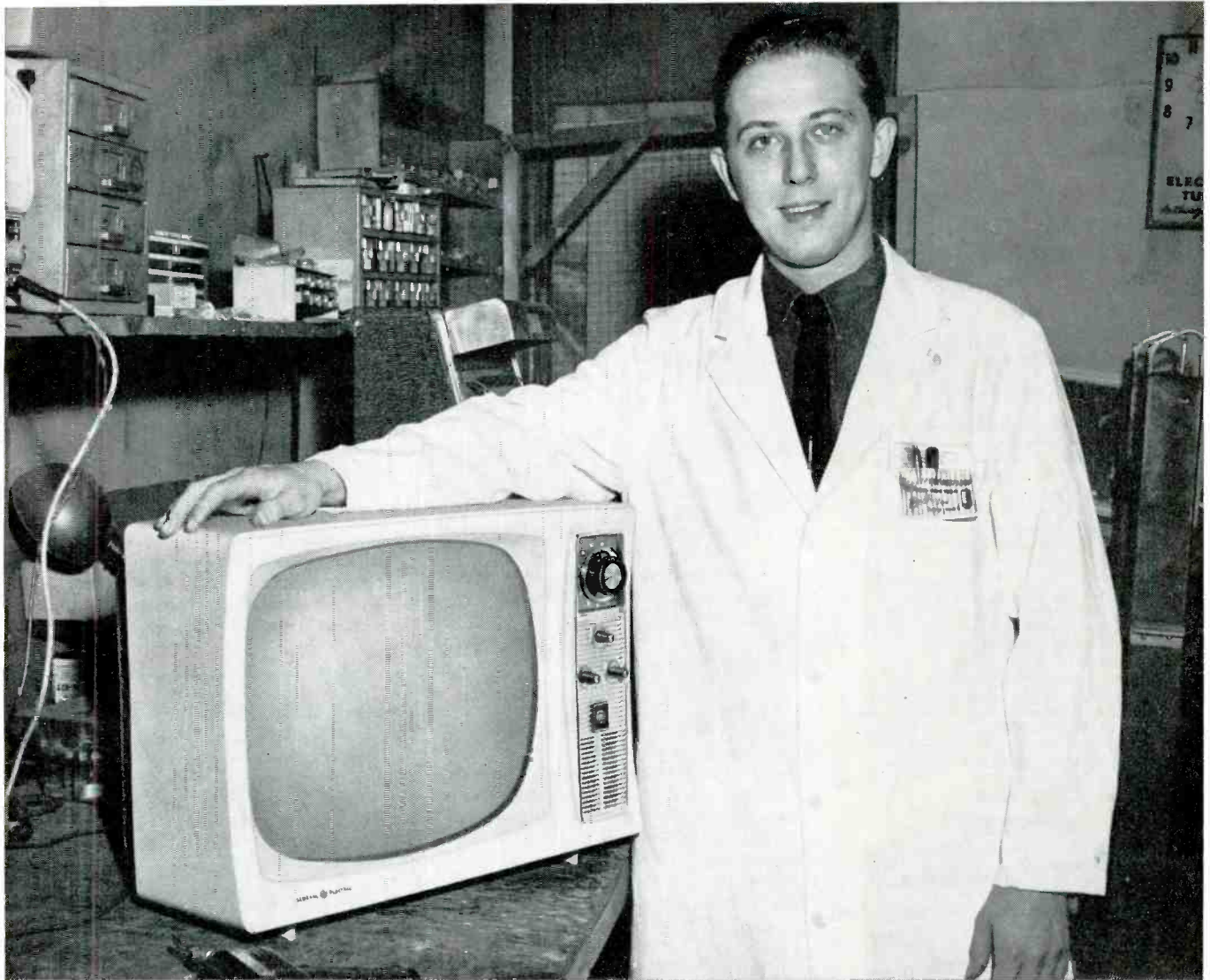

“EASIEST TO SERVICE—

that's why I like General Electric Designer TV”

says Albert Glasser, Manager of the Acme Television Service Company, 4750 Liberty Street, Pittsburgh, Pennsylvania.

“We have no trouble with repairs on General Electric Designer sets. As a matter of fact, one reason our customer relationships are so pleasant is the high quality of the product.”

Mr. Glasser went on to say, “Designer sets are particularly easy to service because 90% of the key points are reachable when you take the back off. This makes it possible to do the bulk of the service work right in the home.”

The General Electric Designer chassis was created with exactly that simplicity in mind. It permits

you to get at the circuitry while the chassis is still in the set.

When you've serviced just one, you'll be an authority on the Designer, thanks to reliable, uniform Precision Crafted Circuitry. A painted schematic diagram makes it easy and quick to pinpoint repairs.

Designer TV—the easiest-to-service set in all television. General Electric Company, Television Receiver Department, Syracuse, New York.

Progress Is Our Most Important Product



GENERAL  ELECTRIC

Mr. Service Technician:
 Want to service transistor radios rapidly
 —accurately? You can with

REPAIRING TRANSISTOR RADIOS

by S. Libes (Director Technical
 Publications, Bogen-Presto)

The man who wrote this book knows his subject well and provides practical procedures that you can apply to faster troubleshooting and to finding those elusive 'dog troubles'.

Basic theory is presented in a way that you will understand easily, quickly. Operation and service of the latest transistorized circuit designs are covered. All new ideas about transistors as used in current transistor radios are explained. Also included are the latest design practices in transistor portable AM, multi-band, imported, all-transistor, auto-hybrid and FM radio receivers. High power transistorized public address power amplifiers and current high fidelity applications are covered.

Servicing is explained on a step-by-step basis including trouble check points and charts, instruction of handy-to-use test equipment (e.g. signal source, power supply). And, there's another feature—*transistor and diode substitution charts*. Also included is information on how to select test equipment and tools for repairing transistor radios. #270, \$3.50

TV SERVICING

MASTER RECEIVING — PICTURE TUBE SUBSTITUTION GUIDEBOOK, H. A. Middleton, \$7.45
RECEIVING TUBE SUBSTITUTION GUIDEBOOK 4th suppl., H. A. Middleton, \$1.35
TUBE CADDY-TUBE SUBSTITUTION GUIDEBOOK, H. A. Middleton, 90c
HOW TO TROUBLESHOOT TV SYNC CIRCUITS, I. Remer, \$2.90
REPAIRING TELEVISION RECEIVERS, C. Glickstein, \$4.40

AUDIO & HIGH-FIDELITY SERVICING

HOW TO INSTALL & SERVICE INTERCOMMUNICATION SYSTEMS, J. Darr, \$3.60
HOW TO SERVICE TAPE RECORDERS, C. A. Tutküll, \$2.90
REPAIRING HI-FI SYSTEMS, David Fidelman, \$3.90

TEST EQUIPMENT

HOW TO USE METERS (2nd ed.), J. F. Rider & S. Prenskey, \$3.50
HOW TO USE TEST PROBES, A. Ghirardi & R. Middleton, \$2.90
OBTAINING INTERPRETING TEST SCOPE TRACES, J. F. Rider, \$3.00
HOW TO USE SIGNAL & SWEEP GENERATORS, J. Richard Johnson, \$2.40
HOW TO USE GRID-DIP OSCILLATORS, R. P. Turner P. E., K6AI, \$2.50

RADIO SERVICING

RADIO RECEIVER LABORATORY MANUAL, A. W. Levey, M. S., \$2.00
RADIO TROUBLESHOOTING GUIDEBOOK, VOL. 1, Rider & Johnson, \$2.40
HOW TO INSTALL & SERVICE AUTO RADIOS (2nd ed.), J. Darr, \$3.25
REPAIRING PORTABLE & CLOCK RADIOS, B. Criscea & D. Gneasin, \$2.75

PROFITABLE SERVICING AREAS

HOME AIR CONDITIONING, Installation & Repair, J. Derman, M.S., F. Makstein, H. Seaman, \$3.50
BASICS OF FRACTIONAL HORSEPOWER MOTORS & REPAIR, Gerald Schweitzer, soft cover \$3.90; cloth \$4.90
INDUSTRIAL CONTROL CIRCUITS, Sidney Platt, \$3.90

Prices subject to revision.

At distributors or order direct!

Write for new catalog, Dept. PF-12.

JOHN F. RIDER, PUBLISHER, INC.
 116 West 14th Street, New York 11, N.Y.
 Canada: Chas. W. Pointon, Ltd.,
 66 Rivington Rd., Rexdale, Ont.

2.68-, 6.3-, and 8.4-volt heaters; re-activates CRT's with low emission, shorts, and opens; provides life expectancy test; special socket adapter furnished for color, 7-, 8-, and 12-pin bases.

4. DC Voltmeter—six full-scale ranges of 15, 75, 150, 300, 750, and 1500 volts; sensitivity 20,000 ohms/volt; accuracy within 2%; two 36" test leads supplied.
5. AC Voltmeter — six full-scale ranges of 15, 75, 150, 300, 750, and 1500 volts; sensitivity 5,000 ohms/volt; accuracy within 5%.
6. Ohmmeter — 0 to 10 megohms in three ranges of R x 1, R x 100, and R x 10K; center-scale indication 12; zero-ohms adjustment provided on panel; circuit operates from 1.5- and 6-volt internal batteries.
7. DC Ammeter — five full-scale ranges of 75 ua, 7.5 ma, 75 ma, 750 ma, and 15 amps; leads and terminals color-coded for polarity.
8. Capacity Meter — capacitor values including electrolytics indicated on two ranges of from .001 to .5 mfd and 1 to 80 mfd; calibration adjustment and HI-LO range selector provided on panel.
9. Size and Weight — case 17½" x 13⅛" x 4½", 12½ lbs.

From the long list of specifications, you can easily see where the *Combination Tester* gets its name. The instrument is mounted in an attractive hand-rubbed oak case with detachable lid. A metal spring clip is attached inside the lid for securing the tube-data binder and instruction manual supplied with the unit. The instrument's case also includes a storage compartment for tools, test leads, and cables.

Although the panel meter is loaded with scales for the various functions and ranges, its wide-angle D'Arsonval movement makes it easy to read. The meter measures 6" across and is heavily damped.

After making use of the Model 300 in the lab the past few weeks, I found it to be a very versatile instrument — yet one that presents no problem at all when switching from one application to another. I'm often skeptical of instruments which claim to do a number of different jobs, because in many cases it may re-



Fig. 4. A tube and capacitor checker, VOM, and CRT restorer all in one unit.

quire too much time and effort to convert the unit from one mode of operation to another.

This is not the case with the Model 300; in the center of its panel, directly below the meter, is a 4-position master switch which enables you to select the proper function with a twist of the wrist. There is also no interaction between test sections, and therefore less danger of in-

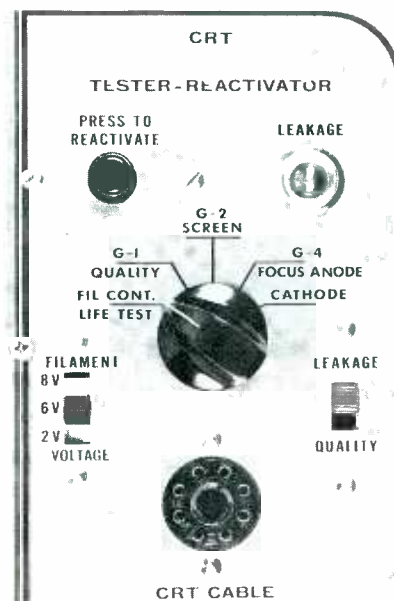

Fig. 5. Portion of the Model 300 panel devoted exclusively to CRT testing.

SERVICEMEN KNOW!

Here they pay less and get the best

HUSH®

Chemically-Electronically, engineered for Tuners and Switching Mechanisms.

When New HUSH is applied it will wash-away that dirt, leaving clean and positive contacts protected by a lasting lubricant. New HUSH is made from the finest solvents and it contains Electro-Silicone oils.

Also available—2 oz., 6 oz. Spray can \$2.25 net
 8 oz., 32 oz. containers

EVER-QUIET®

Since 1949

VOLUME CONTROL AND CONTACT RESTORER

EVER-QUIET is a free-flowing liquid that leaves no powder residue. Scientifically designed to seep around the shaft and penetrate the control or potentiometer, cleaning the contacts and leaving a safe protecting film. Harmless to metals, wire or carbon.

Also available— 6 oz. Spray can \$1.59 net
 32 oz. containers

2 oz. Bottle & dispenser 79c net

CHEMICAL ELECTRONIC ENGINEERING, INC. Matawan, New Jersey

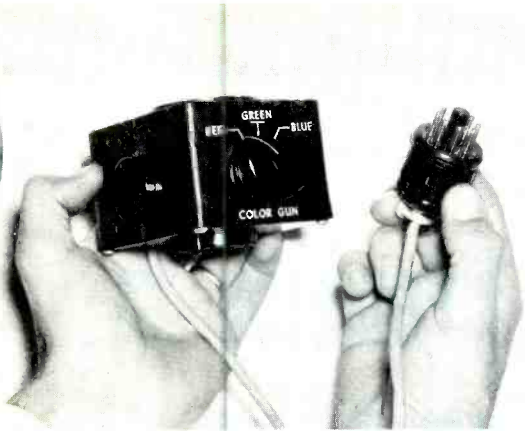

Fig. 6. The CRT test cable supplies 4 individual sockets for all tube types.

strument damage.

Not having space to give you a report on all my experiences in the various applications of the Combination Tester, I've singled out the picture tube tester-reactivator for your particular attention. The instrument panel is divided into three major sections — tube testing, VOM functions, and CRT testing. The entire CRT section is shown in the close-up photo of Fig. 5.

To test a picture tube, the master switch is placed in the CRT position and AC power is applied. The selector switch in the center of the CRT section is then turned to the position labeled FIL CONT. The LEAKAGE-QUALITY slide switch (lower-right of Fig. 5) is positioned on LEAKAGE; and the FILAMENT VOLTAGE switch (lower left) placed in either the 8-, 6-, or 2-volt position, depending on the filament rating of the tube being tested.

The octal plug of the *Multi-Head* socket adapter (Fig. 6) is connected to the socket at the bottom of the CRT panel. The picture tube is then connected to the proper base socket at the other end of the adapter cable. Note that on one end of the *Multi-Head* unit there is a color gun selector. This switch permits you to test or reactivate each gun of a color tube separately.

With the instrument set up in this manner, the yellow-jeweled lamp labeled LEAKAGE will glow immediately if the tube's filament is intact. To check for shorts, the selector switch is advanced to the remaining four positions — G-1, G-2, G-4, and CATHODE. If the leakage lamp glows steadily, either a short or leakage of less than one megohm is indicated.

For an emission check, which can also help to detect an open element, the selector switch is placed in the G-1 position, and the LEAKAGE-QUALITY switch in the QUALITY position. Relative emission will then register on the BAD-REACTIVATE-GOOD scale of the panel meter.

Two modes of CRT reactivation are offered by the Model 300: One is a "boost method," which increases heater voltage by 50%; and the other is a "shot method," which employs approximately 1000 volts DC to clean the cathode coating or to weld a shorted or open element. The reactivation circuits are energized by the small red button in the upper-left corner of the CRT test panel. ▲

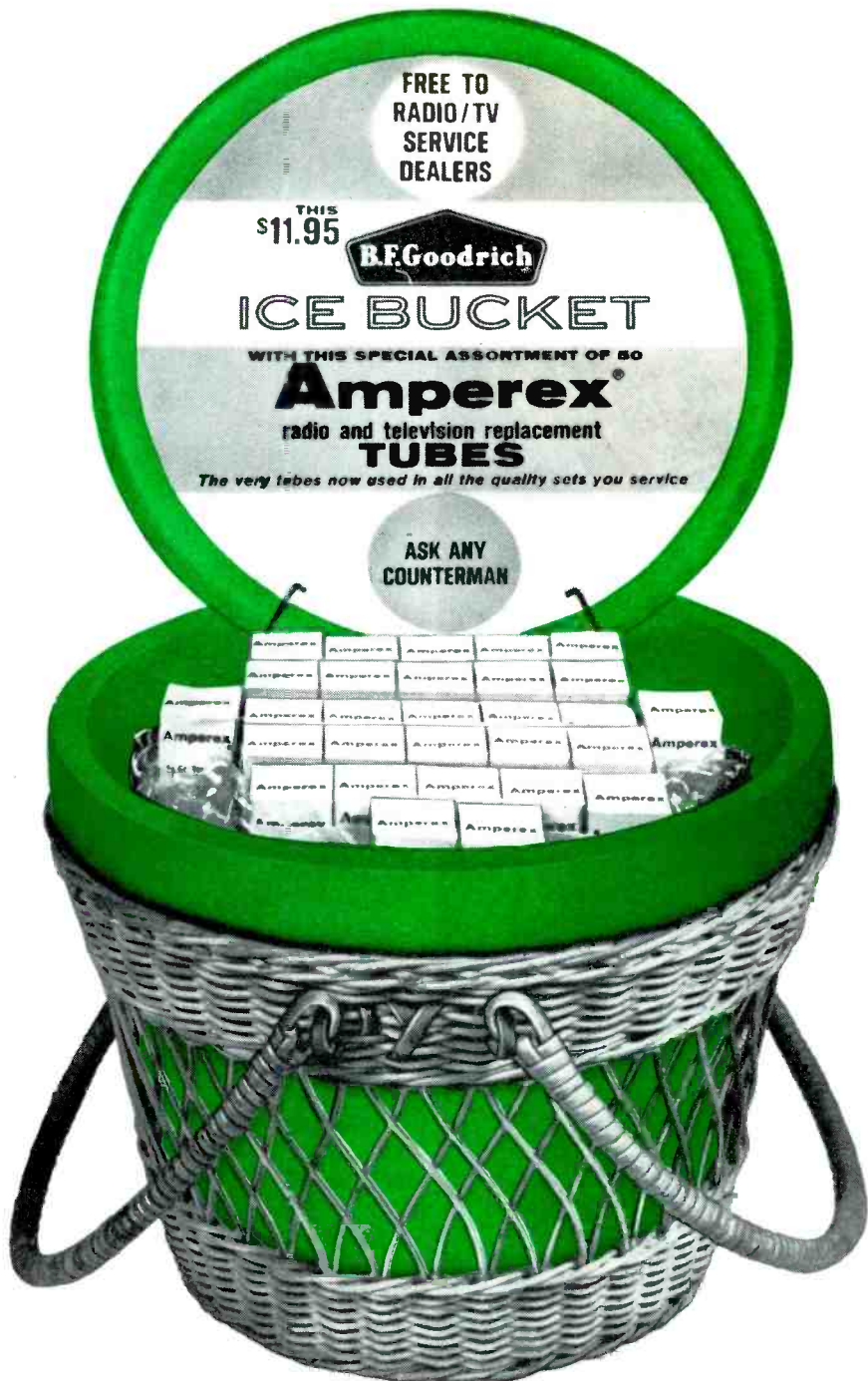

The very tubes now used in all the quality sets you service, *plus* . . . the famous B. F. Goodrich NICER BUCKET . . . *both* yours for the price of the tubes alone! The 'Nicer Bucket', made of miracle PVC won't rust, scratch or break. From the night before to the morning after, it keeps hot food hot or cold beer cold. Smart, simple design . . . no fragile liner to break . . . in fact for food — hot or cold . . . for ice . . . there's no other bucket like it at any price! Pick up this 2-for-1 offer today. You'll service your customers with the best, pocket the profits, take home the bucket! Act today, supplies are limited.



GET YOUR FREE GOODRICH 'Nicer Bucket' from any Amperex replacement tube distributor. Ask Amperex for the name of the franchised distributor in your neighborhood.

AMPEREX ELECTRONIC CORPORATION
230 Duffy Avenue, Hicksville, Long Island, New York



RELIABLE REPLACEMENT



TWIST-PRONG ELECTROLYTICS

A satisfactory repair job means a satisfied customer. To keep your customer happy and to prevent costly call-backs you must depend on a reliable replacement. Aerovox AFH Twist-Prong Electrolytics can always be depended on to give long-life and excellent service because they're made better . . . high-purity aluminum foil construction throughout, 85°C operation, improved hermetic sealing and rugged prongs and mounting terminals.

Available in the widest selection of exact-duplicate replacements including printed-wiring and selenium rectifier types. Your local Aerovox Distributor stocks the replacement you need when you need it. Call on him today for all your capacitor requirements.

BUY THEM BY THE KIT . . .

Your Aerovox Distributor offers you special "Stack-A-Lytic" kits (AK-400 and AK-401) with a selection of 8 or 16 popular TV replacements with a FREE handy metal storage rack with stacking features.

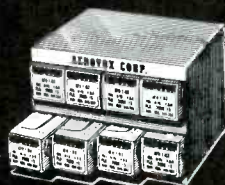

AEROVOX CORPORATION
DISTRIBUTOR DIVISION
NEW BEDFORD, MASS.

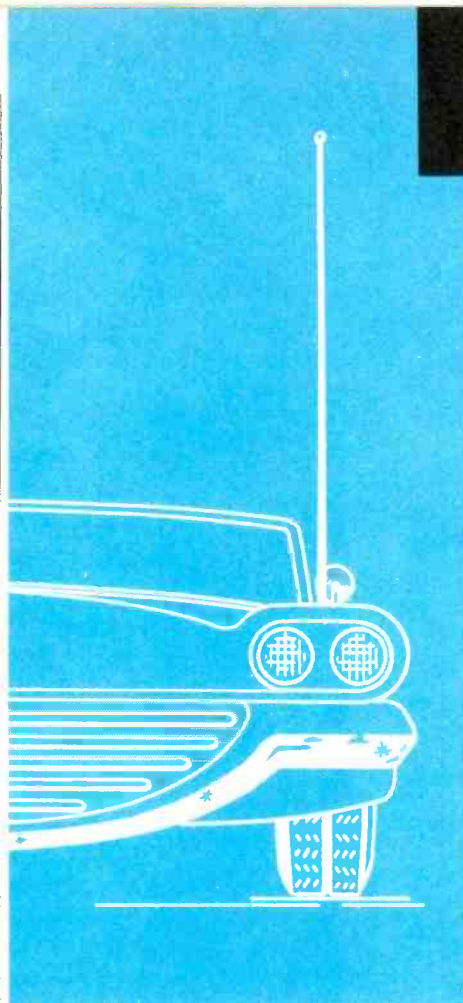

Troubles in 57 FORD Radios

We're not deliberately picking on a certain model — but we have noticed an unusually large number of troubles in the 74BF and 75BF auto radios used in 1957 Fords. There are several reasons for this. One is the popularity of the car itself, leading to a large quantity of these radios in the field; the other is that 1957 was the first full year of hybrid-radio use. Some of the following troubles occur in enough different radios to be of special interest; in other cases, the trouble is more unusual, but still interesting.

Open Emitter Resistor

As you may have already recognized, these are the models that use a piece of special wire several inches long to produce exactly 1 ohm of resistance in the emitter circuit of the output transistor. As Fig. 1 shows, the emitter returns to the 12-volt battery supply, so the 1-ohm resistance is in series with the output transistor and collector-circuit transformer across the source. Besides serving as a check point for proper emitter current, the 1-ohm resistor—although not specifically designed to act as a fuse—also helps protect the transis-

tor in case of heavy current overload.

We have taken in several of these radios with the 1-ohm wire burned open; as fast as we put in replacements, they also burn open. In a surprisingly large number of radios, we have found the cause of this trouble to be a shorted spark plate at the center tap of the output transformer (Fig. 1). The resulting current increase is not great enough to ruin the transistor, since the output (collector) circuit is not completely shorted; however, enough extra current does flow to take the resistive wire out.

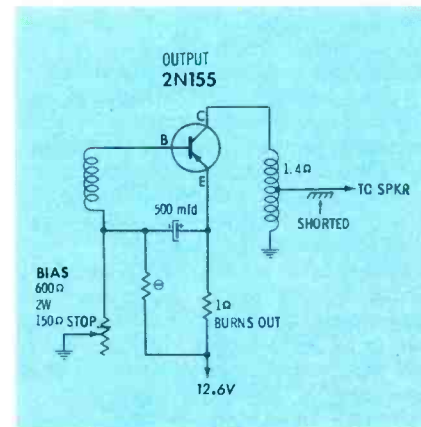

Fig. 1. Emitter return of output stage in Model 74BF is through 1-ohm wire.

CBS 6AX4GTB CAN

POSITIVELY CUT YOUR CALL-BACKS

let me
prove it...
try me... FREE!

You'll get no fireworks and costly call-backs from me. I've been arc-proofed from heater . . . to cathode . . . to plate. And I'm "blast-tested" to guarantee it. That goes for my whole family of CBS damper diodes. We've been completely redesigned to give you CBS total reliability that can positively cut your call-backs.

Get one CBS 6AX4GTB FREE with your purchase of nine from your distributor of CBS Electronics products. Let me *prove* to you, at my expense, CBS TOTAL RELIABILITY . . . proved in performance, year in year out, by leading TV and radio set manufacturers. Act now . . . offer ends December 31.



I won't bore you with all the details. But typical of my many new design features is my anchored heater-cathode insulator. Actually a tungsten coil coated with insulating material, it is mechanically anchored to prevent any movement that might cause me heater-cathode shorts. This coil also has fewer turns to minimize cathode-to-insulator contact . . . yet keep my heater-cathode spacing perfect.

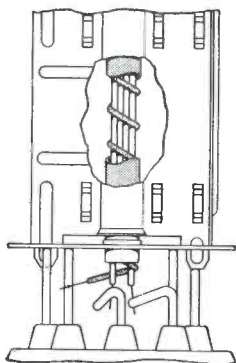

CBS ELECTRONICS

Danvers, Massachusetts

A Division of Columbia Broadcasting System, Inc.

Receiving, industrial and picture tubes • transistors and diodes • audio components • and phonographs



The "Big Picture"

...informative shop talks

by AL MERRIAM

Sylvania National Service Manager

"Out front" feature reflects nothing but quality

All the latest developments for faster, easier servicing on the new Sylvania TV's I've shown you so far are behind the set . . . back on the "service side." But big, important news is taking place "out front," too. You know what I mean . . . Reflection-Free TV!

Here's the newest, most exciting development in the industry! For the first time, your customers can place their sets anywhere and enjoy a TV picture free of all those irritating, mirrorlike reflections from lamps, windows or bright objects. You'll have to see for yourself that Reflection-Free TV is nothing short of sensational, but this comparison will give you a good idea.

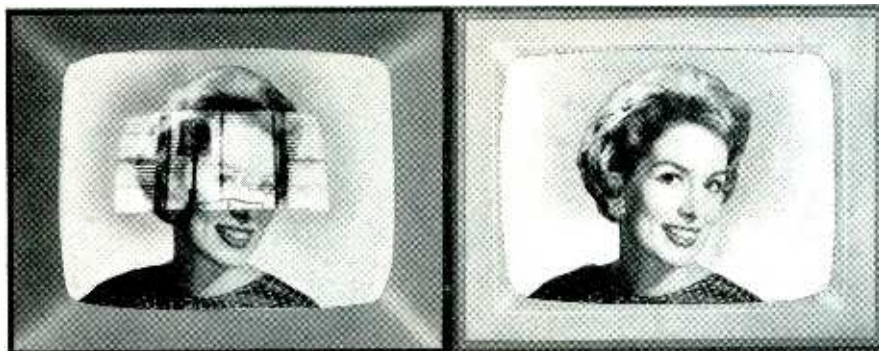

ORDINARY TV reflects light from windows, interiors.

NEW SYLVANIA TV is Reflection-Free! Bright and clear—indoors or out.

This unique method of producing a true, reflection-free screen is possible only with another successful "first" from Sylvania . . . the Bonded Shield picture tube. A fine mist of glass particles fused on the Bonded Shield faceplate creates an amazing, reflection-free "satin finish." Today, only Sylvania offers the new, reflection-free screens in both 19" and 23" tubes . . . but you can bet the industry will follow, just like they did when Sylvania introduced the 23" squared screen!

SERVICE TIP OF THE MONTH

Symptom (Effect)—Squegging (horizontal oscillator "takes off" at some odd frequency) accompanied by a squealing sound.

Cause—Antenna picks up radiated pulses from scanning system which disrupts AFC network.

Cure—Increase the value of the cathode resistor of the horizontal oscillator from 1000 ohms to 1200 ohms or slightly higher.

Sylvania Home Electronics Corp., Batavia, N. Y.

SYLVANIA

Subsidiary of **GENERAL TELEPHONE & ELECTRONICS**

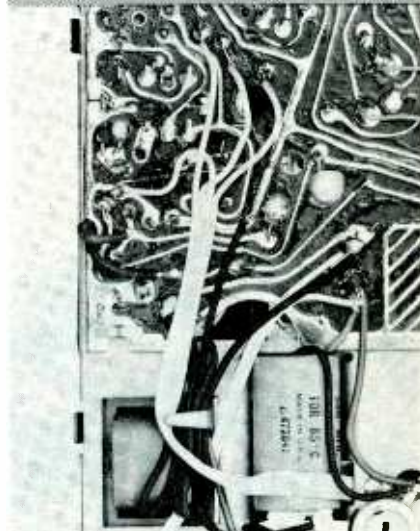
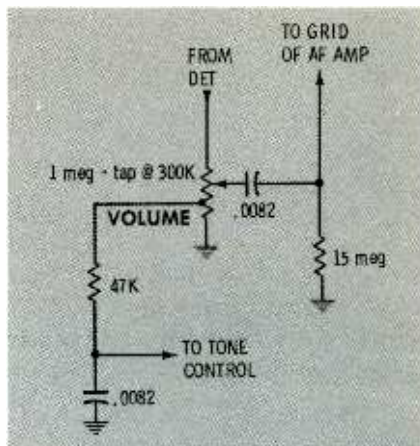

Fig. 2. Whistle in a Model 75BF was traced to the volume control circuit.

Whistle While You Work

One 75BF we had in the shop emitted a piercing, strange-sounding whistle. Probing around on the wiring side of the printed board caused this noise to occur intermittently. We finally traced the trouble to the volume-control circuit (Fig. 2A). In this set, the volume control is connected to the printed wiring by the white, flat, four-conductor cable shown in Fig. 2B, which is soldered to appropriate places on the board. Careful manipulation of this cable indicated that one of its conductors was broken—apparently the ground lead. We did not suspect this fault at first, because the insulation at the end of the wire had become melted and mixed with the solder at the connection—thus giving a firm mechanical connection when it again solidified, and defying our first tugs in attempts to find a loose wire.

Stations Few

Troubled with weak reception of

local stations in these '57 Ford radios, and no reception at all on weaker stations? Maybe the trouble is the same one we have been having—an open coil in the plate circuit of the RF amplifier (Fig. 3). Since this coil is shunted by a fairly low-value resistor, the stage still seems to function—but sensitivity is not what it should be. Another possible cause for the trouble is an open RF cathode resistor, part of a component-combination unit.

Speak Up!

Here's one case that wasn't the fault of the radio at all. The lack of volume in one of the 74BF's under our care was a real puzzler. The transistor had been replaced, necessary bias adjustments had been made, IF and RF sections had been realigned, tubes had been checked and replaced if they were at all weak—yet the maximum output wasn't enough to rattle the speaker. Although the sound was loud enough for ordinary circumstances, it wasn't adequate for conditions of rolled-down windows and high speeds. Besides, other radios of the same type had much more volume.

A casual glance at the speaker, when the radio was out of the car, revealed that a standard 6" x 9" oval unit was being used. Just on the chance that the speaker might be the problem, the service literature was consulted with the idea of obtaining a recommended replacement. The lack of any listing other than the original Bendix part number made us wonder if perhaps the

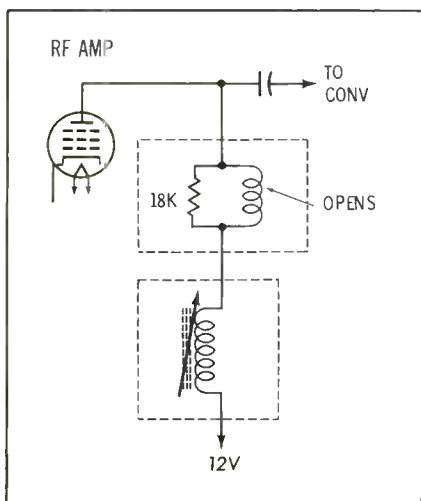
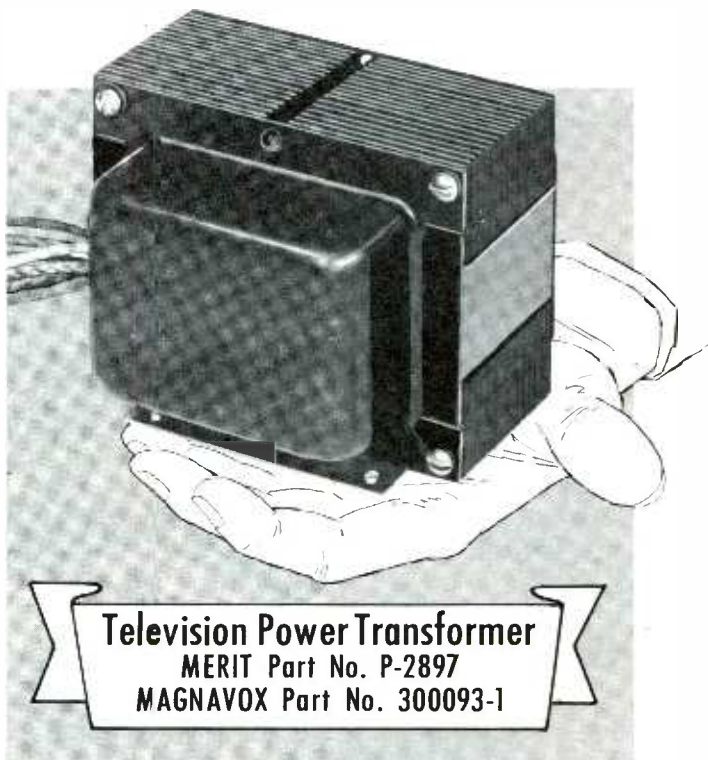

Fig. 3. Several cases of weak reception were traced to open RF plate coil.

READY... *Another* Merit 'First'!



Exact replacement for MAGNAVOX #24 and #25 television chassis series. Designed to fit more than 30 Magnavox chassis.

PLUS — Merit's assurance of maximum performance through pre-testing of *each unit* under actual use conditions!

Ready now at your Merit Distributor.

erit
Coil and Transformer Corporation
MERIT PLAZA HOLLYWOOD • FLORIDA

speaker was a special unit. When the original type was installed, the volume level returned to normal. Further checks revealed that somehow a 6-8 ohm unit had been installed instead of the required 3-4 ohm unit. Mounting requirements and space considerations probably had a lot to do with the choice of an improper unit.

Beat on Dash for More Volume

This auto-radio trouble symptom is characteristic of tube or transistor defects, so the problem was not

at first considered serious when it occurred in one 74BF. When substitution of tubes and the output transistor failed to improve reception, however, all sorts of reasons began to come to mind — cracks in the printed board, a defect in an IF can, a bad volume control, a bad tube socket, etc. Hoping for the best, though, I started a careful visual analysis of the wiring board. A strong light was employed, and every connection was carefully inspected. When the area occupied by C2, R2, and R15 was scrutinized (Fig. 4), a long "whisker" was

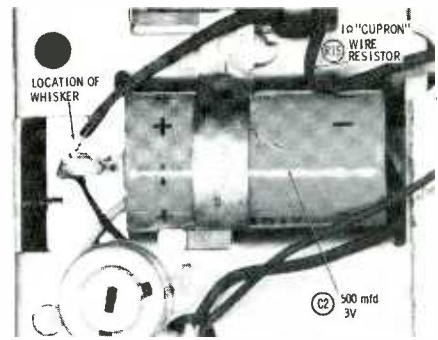

Fig. 4. Wire stub shorting to chassis caused intermittent volume changes.

noted on the C2 end of R15. It seemed to be dangerously near the metal chassis. A little pulling and tugging on C2 quickly convinced me that this was the "brute-force volume reducer."

When the whisker had been removed, the set was given an operational check. The intermittent condition was gone, but the volume still wasn't up to par. A complete IF alignment helped, but it didn't produce entirely satisfactory results. The dummy antenna recommended for RF alignment was next constructed by attaching a 30-mmf capacitor from the antenna input to chassis and another between the antenna input and the hot lead of the signal generator. Adjustment of the oscillator, RF, and antenna trimmers, using the recommended procedure, brought the volume up still further. It was at this point that I noticed and began to wonder what to do about the SENSITIVITY control (Fig. 5). No adjustment procedure could be found for it. However, after studying the circuitry a few minutes, I decided that this control provided an adjustable bias voltage for the cathode of the RF stage. The control was obviously not likely

Now—24-Hour Tuner Service

**Tarzian Offers 24-hour
Direct Factory Service
on TUNER REPAIRS
... \$8.50**



TARZIAN tuners received one day will be repaired and shipped out the next. No increase in price: \$8.50 per unit and \$15 for UV combinations. That includes *all* replacement parts, and a 6-month warranty against defective workmanship and parts failure due to normal usage. Tuners repaired on approved, open accounts. Replacements available at low cost on tuners beyond practical repair.

⊕ Tarzian-made tuners easily identified by this stamping. When inquiring about service on other than Tarzian-made tuners, always give tube complement . . . shaft length . . . filament voltage . . . series or shunt heater . . . IF frequency . . . chassis identification. And, allow a little more time for service on these tuners. See your distributor, or use this address for fast, factory repair service:



SERVICE MANAGER • TUNER DIVISION • DEPT. 2A

SARKES TARZIAN INC

east hillside drive • bloomington, indiana
edison 2-7251

Mfgs. of Tuners, Semiconductors, Air Trimmers, FM Radios, Audio Tape, and Broadcast Equipment

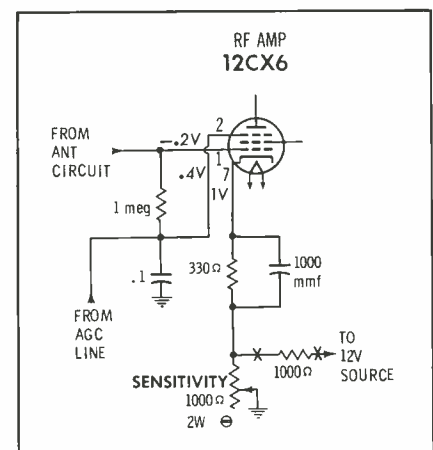

Fig. 5. Sensitivity control adjusts the cathode bias of the RF amplifier stage.

to cause any trouble through burn-out of components if misadjusted (as is sometimes the case with controls in transistorized output circuits); therefore, it was rotated throughout its range. The volume varied from very weak at one extreme to strong and distorted at the other. Reasoning that the control's action was similar to that of the AVC circuit, I proceeded to tune in the strongest local station (with test-bench antenna fully extended) and adjusted the control for maximum undistorted volume.

The net result of these operations was a repaired radio and a satisfied customer. However, this job caused me to think about the number of times I had aligned a radio IF without a touch-up of the oscillator, RF, or antenna trimmer, and made me wonder how many of these sets would have worked better if I had just taken the time. As you well know, each signal generator is just a little bit different and has a slightly different frequency-tracking characteristic. This means that retuning an IF without retracking the antenna, RF and oscillator stages can result in a slight case of misalignment caused by alignment!

One further hint: Using the two 30-mmf capacitors for a dummy antenna during RF, oscillator and antenna trimmer alignment eliminated the need to readjust the antenna trimmer with the radio installed in the car.

CRT Brighteners

At one time, selecting a picture-tube brightener was a simple matter—there was only one type. Also, the usefulness of brighteners was limited, since they were applicable only to picture tubes which were good in every respect other than emission.



Today, the story is much different. Modern CRT heaters have six different voltage ratings and five different current ratings. Brightener manufacturers have kept pace, and are producing a wide range of units to meet the various needs.

Perma-Power's *TV Tube Restorer* is a good example of a unit which does more than increase cathode emission. Designed for use with standard tubes having 6.3-volt, 600-ma filaments, it can be used in either a series or parallel filament circuit. Furthermore, it provides a connec-

tion which permits selection of either normal or boosted heater voltage. Other design features make it possible to restore operation in tubes suffering from open cathodes, heater-cathode leakage, and even grid-cathode shorts—a far cry from boosting emission only!

By the way, Perma-Power has recently produced a handy leaflet entitled, "Guide to Proper Britener Selection," which includes a "Quick Selector Chart" that shows the proper type of brightener to be used with each type of picture tube.

NOW TEST ALL TUBES

with Models 500, 550, or 650 DYNA-QUIK

SIMPLY BY ADDING THIS

NEW MODEL 610 TEST PANEL



TESTS OVER 1600 TUBE TYPES



Photos above show how easily the new Model 610 Test Panel fits into the B&K Models 550 and 650 Dyna-Quik Tube Testers.

TESTS OLD AND NEW TUBE TYPES
Measures Genuine Dynamic Mutual Conductance

Also Tests Thyratrons, Voltage Regulators, Auto Radio Hybrid Tubes, Battery Radio Tubes, European Hi-Fi Tubes, and most Industrial Types

Merely by adding the new "610" to your Dyna-Quik, you have all the advantages of fast, multiple-socket testing, *plus freedom from obsolescence*. Makes your B&K Model 500, 550, or 650 Tube Tester *more useful and more valuable than ever!* Enables you to test all present plus future TV, radio and other tube types for all shorts—gives highly sensitive grid emission and gas test—checks for leakage and life—with *laboratory accuracy*.

Speeds complete tube test, sells more tubes on-the-spot, saves call-backs, insures your professional reputation, and brings more servicing profit. *It pays to invest in B&K professional equipment.* Net, **\$4995**

NEW TUBE INFORMATION SERVICE

Get test data on new tubes even before you encounter them in the field. Subscribe now to *New Tube Information Service* for owners of B&K tube testers. Issued every 3 months, at \$2.50 per year.



B&K MANUFACTURING CO.
1801 W. BELLE PLAINE AVE • CHICAGO 13, ILL.
Canada: Atlas Radio Corp., 50 Wingold, Toronto 19, Ont.
Export: Empire Exporters, 277 Broadway, New York 7, U.S.A.

SERVICE MASTER... EVERY TOOL YOU NEED 99% OF THE TIME



complete 23-piece kit for radio, TV,
and electronic service calls

2 HANDLES:

shockproof plastic.
Regular 4" length
... 2" Stubby. Inter-
changeable. Patented
spring holds snap-in
tools firmly in place.

9 NUTDRIVERS:

High Nickel chrome
finish, $\frac{3}{16}$ " to $\frac{1}{2}$ "

3 STUBBY

NUTDRIVERS:

$\frac{1}{4}$ ", $\frac{5}{16}$ ", $\frac{3}{8}$ "

EXTENSION BLADE:

Adds 7". Fits
both handles.

3 SCREWDRIVERS:

Two slotted...
 $\frac{3}{16}$ ", $\frac{1}{8}$ "
#1 Phillips

2 REAMERS:

$\frac{1}{8}$ "- $\frac{3}{8}$ ", $\frac{1}{4}$ "- $\frac{1}{2}$ "

ADJUSTABLE

WRENCH:

6" thin pattern,
1" opening

LONG NOSE PLIER:

"Cushion Grip",
 $\frac{1}{2}$ " nose

DIAGONAL PLIER:

"Cushion Grip"
hand-honed
cutting edges

ROLL UP KIT:

Durable, plastic-
coated canvas.
Compact, easy-
to-carry.

Ask your distributor to show you kit 99 SM

XCELITE

XCELITE, INC. • ORCHARD PARK, N. Y.
Canada: Charles W. Pointon, Ltd., Toronto, Ont.

AUDIO FACTS BY ALAN ANDREWS

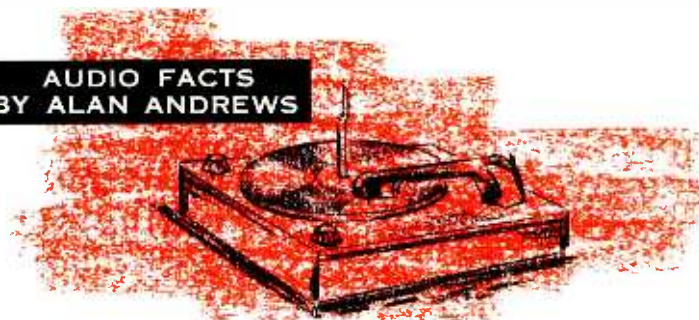

speed problems with phonos

One of the most prevalent problems you are apt to be faced with when servicing phonos is that of speed. Most often these problems fall into three general groupings: The turntable does not rotate at all; it turns too slowly; or the speed varies depending upon operating conditions. As might be expected, the more expensive types are usually less afflicted with speed problems than their less expensive counterparts. Also, as a rule, turntables designed to operate at only one speed, and those not involving a changer mechanism, have fewer speed problems than the three or four-speed record changers found in most home installations.

Basic Drive Mechanism

Turntables which operate at more than one speed use a single motor which has the same rpm for all available record speeds. Turntable speed is varied by switching in different-sized drive elements between the motor and the turntable. And, not surprisingly, these switching components greatly multiply the speed problems.

While phonos employ various types of drives, such as gear and

belt, most home changers use a system like one of those shown in Fig. 1. The one in part A is a three-speed turret-type drive, with three idler pulleys on a single mount, and was widely used in earlier three-speed phonos. The system in part B differs from A in that the drive pulleys are mounted directly on the motor shaft. (Notice the four steps common to today's four-speed phonos.) Except for other minor variations involving the mechanics of shifting from one pulley size to another, the principles of the two arrangements are pretty much the same. Both are referred to as rim-drive systems because the turntable is driven by force applied to the inside of the rim. In operation, the motor shaft turns the active idler pulley which, in turn, drives the idler wheel and thereby rotates the turntable. A rubber tire surrounds the outer diameter of the idler wheel to increase traction between it and the smooth metal surface of the turntable rim.

Fig. 2 is a side view of a portion of the rim-drive arrangement. This drawing shows how the various drive elements are situated with respect to each other, and how each in turn drives the next section.

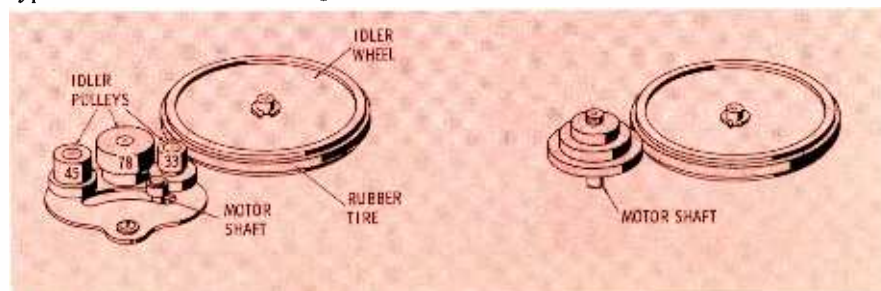

Fig. 1. Two types of rim-drive systems often used in home record changers.



LEARN

SUBJECTS OFFERED AT NO COST TO YOU:

- ① TRANSISTOR FUNDAMENTALS—complete coverage of transistor theory without the use of mathematics.
- ② GUIDE-MATIC POWER HEADLIGHT CONTROL (Autronic Eye)—lecture and lab.
- ③ TWILIGHT SENTINEL ELECTRIC HEADLIGHT SWITCH—lecture and lab.
- ④ TROUBLE-SHOOTING PROCEDURES for dead or weak low voltage auto radio tuners and trigger circuits.
- ⑤ LECTURE AND LAB. PRACTICE ON "SIGNAL SEEKER" AND "WONDER BAR" auto radio tuners and trigger circuits.
- ⑥ TRANSISTOR CIRCUIT TROUBLE-SHOOTING—lecture and lab. work analyzing defects in transistor circuits.
- ⑦ HYBRID-TYPE AUTOMOBILE RADIOS—low voltage tube and output transistor circuits. Lecture and lab.
- ⑧ DELCO-MATIC ALL-TRANSISTOR GARAGE DOOR OPERATORS—lecture and lab.
- ⑨ AUTO PORTABLE RADIOS—lectures and lab. practice on all-transistor portable radios. Get prepared for the all-transistor auto radio that will appear in the next few years.

THE LATEST ON TRANSISTORS AND AUTOMOTIVE ELECTRONICS 9 SUBJECTS AVAILABLE TO YOU AT THE FREE DELCO RADIO-GUIDE LAMP ADVANCED TRAINING SCHOOL. One week of instruction. No lab. fees. No tuition charge. Textbooks supplied.

In 1960 over 900 electronics technicians completed our one-week course. You, too, can receive this same valuable training in 1961. Bring yourself up to date on transistors and automotive electronics with personalized instruction at the General Motors Training Center near you. (See schedule below.)

Classes will be conducted by graduate engineers with special training in your field. Diplomas, awarded only to those who successfully complete the courses, will mean a great deal to you—and to your customers.

Register now through your local Delco Electronics Parts Distributor or write directly to Delco Radio Division, General Motors Corporation, Kokomo, Indiana, Attention: Service Manager.

GUIDE LAMP DIVISION GENERAL MOTORS CORP. ANDERSON, INDIANA



DELCO ELECTRONICS TRAINING SCHOOL SCHEDULE						
DATE	REGION 1	REGION 2	REGION 3	REGION 4	REGION 5	REGION 6
1-16	Philadelphia		Detroit			
1-23		Charlotte	Detroit		Dallas	
2-6	Washington			St. Louis		
2-13	Washington	Atlanta			Houston	
2-20			Cincinnati		Houston	Los Angeles
2-27						Los Angeles
3-5	Tarrytown	Memphis		Omaha		
3-13	Tarrytown					
3-20		Jacksonville	Cleveland			San Francisco
4-10	Boston		Cincinnati	Kansas City	El Paso	Portland
4-17	Boston	Atlanta		Kansas City	El Paso	
5-1		New Orleans	Pittsburgh	Minneapolis		Los Angeles
5-8	Union		Pittsburgh		Oklahoma City	
5-15				Milwaukee		
5-22		Memphis	Buffalo			San Francisco
6-5	Philadelphia			Chicago	Denver	
6-12		Charlotte		Chicago		Portland
6-19			Cleveland			
6-26	Union	Atlanta		Minneapolis	Dallas	Salt Lake City

FAMOUS SAMS SERIES BOOKS

available from your local SAMS DISTRIBUTOR



Video Speed Servicing

Sam Marshall's invaluable series. Each volume consists of 456 practical troubleshooting hints for hard-to-find faults in popular late-model TV receivers. Each hint is accompanied by an explanatory diagram or schematic. All models are indexed by brand, model and chassis number for quick reference. Each volume 160 pages, 8½" x 11".

No. VSM-3. Only.....	\$2.95
No. VSM-4. Only.....	2.95
No. VSM-5. Only.....	2.95

Servicing Transistor Radios

This best-selling series provides complete servicing data for popular transistor radios. Includes the famous Sams Standard Notation Schematics, with CircuitTrace® used throughout; photo views of each chassis; alignment data; servicing tips; full replacement parts data. Each volume includes a special section on helpful servicing information. Each 160 pages, 8½" x 11".

No.	Vol.	Period	Each
TSM-1	1	1956-58	\$2.95
TSM-2	2	1956-58	2.95
TSM-3	3	1957-59	2.95
TSM-4	4	1958-59	2.95
TSM-5	5	1958-59	2.95
TSM-6	6	1959-60	2.95
TSM-7	7	1959-60	2.95

TV Tube Location Guides

Shows position and functions of tubes in hundreds of models. Indicates major component placement; signal path; pin orientation on socket; series string filaments; fuse location. Includes tube failure check charts. Helps you find the trouble and replace defective tubes without removing chassis! Each volume 5½" x 8½".

No.	Vol.	Period	Each
TGL-10	10	1959-60	\$1.25
TGL-9	9	1958-59	1.25
TGL-8	8	1957-58	2.00
TGL-7	7	1956-57	2.00
TGL-6	6	1955-56	2.00
TGL-5	5	1953-54	2.00
TGL-4	4	1952-53	2.00
TGL-3	3	1951-52	2.00

Auto Radio Service Manuals

Complete Photofact® coverage on auto radios, including Standard Notation Schematics, chassis view photos, alignment data, parts lists and valuable extra features for quicker, more profitable servicing. Volumes contain from 160 to 396 pages; each 8½" x 11".

No.	Vol.	Period	Each
AR-11	11	1959-60	\$2.95
AR-10	10	1958-59	2.95
AR-9	9	1958-59	2.95
AR-8	8	1957-58	3.95
AR-7	7	1956-57	3.95
AR-6	6	1955-56	3.95
AR-5	5	1954-55	3.50

Record Changer Manuals

Clear and simple explanation of every detail of all important models makes it easy to service record changers. Each manual includes detailed diagrams, chassis photos, exploded views, parts lists, adjustments, etc. Each volume, 8½" x 11".

No.	Vol.	Period	Each
RC-10	10	1956-57	\$2.95
RC-11	11	1957-58	2.95
RC-12	12	1958-59	2.95

See your Sams Distributor for the popular Series of HI-FI MANUALS (5 Volumes) and TAPE RECORDER MANUALS (5 Volumes)

FREE SAMS BOOKLIST AVAILABLE—ask your Distributor or write us direct

HOWARD W. SAMS & CO., INC.
1720 E. 38th St., Indianapolis 6, Ind.

No Rotation

One common complaint is that the turntable does not rotate at all or, with changers, stalls during the change cycle. Here, two general trouble possibilities exist—mechanical and electrical. The mechanical faults occur when the motor or some part of the changer mechanism jams. Electrical faults consist of opens or shorts in the motor or its wiring, thus preventing electrical operation of the motor. Many manual phonos use a 90-volt motor wired in series with a single 25-volt tube. In these units, a burned-out tube filament is a common cause for no rotation.

Rotating the turntable by hand will give an indication of whether any part of the changer is jammed or excessively loaded in any way. In some cases the mechanism may be freed by rotating the turntable in the reverse direction. Recycling by hand, while observing the operation, may reveal the cause of jamming or binding. This condition is most often caused by accumulation of grease and dirt, bent parts, and burred or excessively worn moving parts. Cleaning with alcohol, carbon tet, or a similar solvent, will remove all foreign matter. Bending or filing parts of the changer mechanism may be necessary in some cases. Parts which are worn excessively should be replaced to effect a more permanent repair.

If the changer mechanism is not binding in any way, the lack of rotation could be caused by a motor defect. First, check to see if the idler wheel and pulley are making contact as they should. Usually, poor contact in these areas only

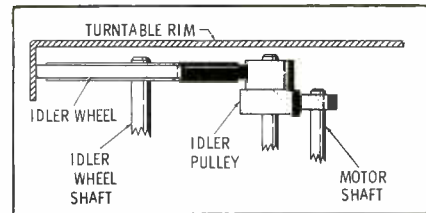

Fig. 2. Side view of pulley and wheel arrangement for turret drive system. slows the speed, but these parts should be checked anyway. Next, try to turn the motor rotor by hand.

If the rotor cannot be easily turned, check the spacing between the stator and rotor through a complete revolution. If necessary, the rotor can sometimes be realigned by loosening the end plates and tapping the shaft very lightly until alignment is correct. Then tighten the screws so that the end plates remain in correct position. Worn bearings may also cause uneven alignment between motor and stator. In this case, replacement of the entire motor is easier and less time-consuming than replacement of the bearings.

Other conditions which hamper rotation of the motor are hardened grease and dirt, tight bearings, dust accumulation, and rust. Disassembling the motor and cleaning its parts with a solvent may remedy the situation. Polishing the rusted metal parts with crocus cloth may also result in some improvement. When lubricating the motor use only a high grade of motor oil; SAE 10 is about the right weight. *And use the oil sparingly!* In record changers, excess oil almost always causes trouble sooner or later. For lubricating cams, gears, and sliding parts, a thin coat of *Lubriplate*, or equivalent, is recommended.

If there is no mechanical defect in the motor, the trouble is probably



**Model 103
TUBE TESTER**

SPOTS HARD-TO-FIND TUBE DEFECTS IN JUST SECONDS!



Although low in price the Model 103 has a range of operation that will outperform more expensive tube testers.

Here's how easy it is to test all tubes completely, accurately — IN JUST SECONDS!

1 SET 3 CONTROLS

2 INSERT TUBE

3 PRESS QUALITY BUTTON

- Tests picture tubes with a specially designed built-in CRT socket
- Positively cannot become obsolete... circuitry is engineered to accommodate all new tube types
- New tube charts furnished periodically to registered owners

See your electronics parts distributor

Model 103
TUBE TESTER

\$4775
Net

MERCURY ELECTRONICS CORP. 77 SEARING AVENUE, MINEOLA, NEW YORK

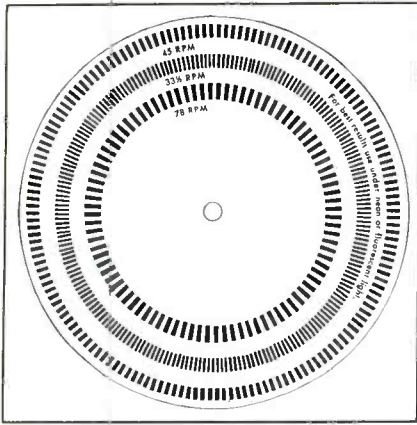

Fig. 3. Sample of strobe disc used for checking variations in turntable speeds.

electrical. Assuming that the switch and connecting wires are all right, the trouble possibilities include opens or shorts within the windings, or shorts to ground. An open circuit in the motor usually results in no rotation at all. Shorts in the stator coils cause overheating and decreased turning force. Here again, it usually is better for the average technician to replace the entire motor rather than attempt to repair it.

Slow Speed

Slow or erratic speed can be caused by some of the same faults which produce complete loss of rotation. In these cases, the trouble has not yet reached the stage where operation is halted altogether. Repairs, in many cases, are similar to those mentioned previously.

In the synchronous motors used in record players, basic speed is determined primarily by the frequency (60 cps) of the supply line. It is unusual to encounter a condition where the speed is too fast (except slightly so). Excessively slow rotation is much more common, usually because of slippage between the motor shaft and the turntable itself, or because of gummy motor and drive assemblies.

Ordinarily, the idler wheel is positioned in a slot and held against the turntable rim by a spring. A loss of tension in this spring is a possible cause of slippage between wheel and turntable. It is better to install a new spring than to try cutting off a section of the old one, since the latter remedy sometimes increases turntable rumble by reducing damping of the unit.

Gradual accumulation of oily sub-

stances on any of the drive elements causes them to lose traction, with a resulting decrease in turntable speed. Cleaning the various parts with alcohol or a special cleaner designed for this purpose will clear up the condition. Carbon tet is not too good for cleaning rubber parts because it acts as a solvent; many such cleanings may make the rubber gummy. Drive-element surfaces which have become slick can be coated with a special non-slip chemical to provide better traction.

Again, lubricate as little as possible, consistent with good oper-

ation. Immediately wipe off any excess oil because it will only cause trouble later on. Any rubber drive components which have become hard or glazed should be replaced because they are beyond repair. The entire idler wheel could be replaced, or only the rubber tire which surrounds it. Assortments of these tires are available from most parts distributors.

Wow and Flutter

Actually, a slight error in turntable speed is not very objectionable to most listeners as long as the speed

Professional Technicians Use CASTLE'S

Complete TV TUNER OVERHAUL

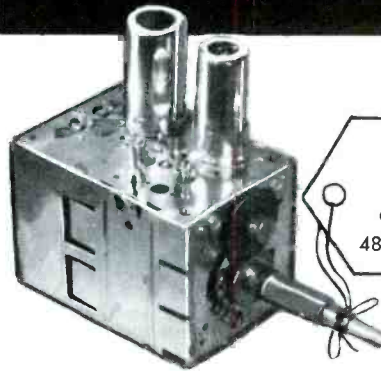

**SAME DAY
SERVICE!**

on Popular Types
48 Hours most Others

Castle overhaul charge includes all labor and minor parts and written 90 day warranty. Tubes and major parts are extra at net prices. Tuner to be overhauled should be shipped complete; include tubes, shield cover and any damaged parts. Write down model number and state complaint. Pack well and insure.

Write for Special Quantity Rates and Discounts

CASTLE

TV TUNER SERVICE, INC.

5710 N. Western Ave. • Chicago 45, Ill.

IN CANADA

136 Main Street • Toronto 13, Ontario

ALL MAKES
ONE PRICE

\$9⁹⁵

VHF TUNERS
UHF TUNERS
UV Combinations*

*UV combination tuner must be of one piece construction. Separate UHF and VHF tuners with cord or gear drives must be dismantled and the defective unit only sent in.

Overhauling TV tuners is our only business. We do not manufacture and sell you a so called "universal" replacement tuner. When the original equipment tuner is overhauled by Castle you are assured that it will fit properly and the electrical specifications, set by the receiver manufacturer, will be met exactly.

Castle



TV TUNERS

is constant. Much more annoying is the condition where the speed continually changes. When these changes occur at a relatively slow rate, the condition is called "wow"; when they occur at a faster rate, the term "flutter" is used.

Before attempting to track down the cause of the speed variations, make sure the fault is not in the record. Center holes which are too large, warped discs, or poor recordings can all cause unwanted speed variations. Does the trouble occur for all records or just for certain ones? Does the trouble occur on all

speeds or on just one? Is there any difference in reproduction when several records are stacked on the changer? The answers to these questions sometimes point the way to a solution of the trouble.

Slippage between drive components sometimes produces random speed variations which occur in no set pattern. This slippage may be caused by too little tension on the drive elements, accumulation of oil or grease, or hard or broken rubber on the drive elements. These troubles can usually be cured by cleaning the drive components so that

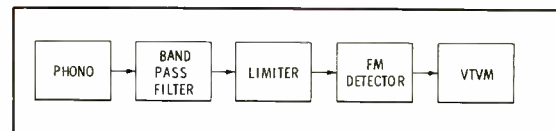

Fig. 4. Block diagram showing the stages used in wow and flutter meter.

proper traction occurs between them. Replacement of various elements may be necessary when the wear has been excessive. Improperly lubricated motor bearings or drive elements also produce random speed variations. It may seem odd, but in the case of wow, too little lubrication can cause the same effects as too much.

One test for slippage is to touch the rim of the turntable while it is in motion. It should slow down to some extent, but the pull should remain constant throughout each revolution. Any slippage can be felt with the finger.

Indentations or breaks in the idler wheel rubber can cause rhythmic variations in speed. That is, the fluctuations occur at a regular rate for each turntable speed, and are more noticeable for the slowest speed (usually 33 $\frac{1}{3}$ or 16 $\frac{2}{3}$ rpm). Installing a new idler wheel or new rubber tire is the only cure. As a note of advice for the user, urge him to set the speed control to "off," thus disconnecting the drive wheels from each other. Leaving the turntable on the same speed setting for long periods of time when the player is not in use very often leaves a flat spot on the idler-wheel tire. A similar type of wow could be produced if the turntable rim were accidentally dented by being dropped or struck a hard blow.

Measurements

Turntable speed can be checked by using a stroboscope disc of the type shown in Fig. 3. Most often made of cardboard, it is imprinted with several rings of dots or bars. It is placed on the turntable in the same manner as a record, and with the mechanism in motion, the dots are observed under a light energized from a 60-cps source. A neon or fluorescent lamp is best.

As an example, let's assume we are checking the 33 $\frac{1}{3}$ -rpm speed. The middle ring of dots would be used on the disc of Fig. 3. If the speed is correct, the dots in this ring



MODEL C412 VU-BRITE
110° Button Base—Series
ALL Filament Voltages
\$1.75 net

MODEL C403 VU-BRITE
Duodecal Base—Series
ALL Filament Voltages
\$1.12 net

MODEL C411 VU-BRITE
110° Button Base—Parallel
ALL Filament Voltages
\$1.49 net

MODEL C311 UNIVERSAL
110° Button Base—6.3 Volts
Series or Parallel
\$2.98 net

all available from your
Perma-Power Distributor

Perma-Power COMPANY

3102 NORTH ELSTON AVENUE

CHICAGO 18, ILLINOIS

When you're trying to brighten a 110° button base picture tube, watch those series heaters! Many of the newer sets have controlled warm-up filaments with ratings of 2.34 and 2.68 volts. (Older sets are usually rated at 6.3 volts.)

These new tubes use finer heater wire and closer element spacings—which makes them more efficient, but more fragile. *Too much power boost will "blow" these low voltage filaments!*

On these newer tubes, you can not safely use a Britener made for older sets. But you can use the new Perma-Power Model C412 on these and older style tubes. For the first time, here's one Britener for all 110° button base series string heaters—the only Britener that works properly for 2.34, 2.68, 4.70, 6.3 and 8.4 volt filaments! No switching necessary—no adjustments required.

The Model C412 Vu-Brite is one of four new Perma-Power Briteners, all engineered to fit properly and work properly. Without excessive inventory, Perma-Power—and only Perma-Power—can now assure you of complete coverage—a Britener that's right for every picture tube in general use today.

will appear to be standing still. If rotation is too fast, the dots will move in a clockwise direction; if too slow, the apparent motion will be counterclockwise. The presence of wow is indicated when the dots seem to move back and forth. Slippage can also be observed by using the strobe disc. In this case the dots would alternately stand still and move counterclockwise.

While speed variations can also be checked by playing a test recording of a steady tone at some frequency, this method is not too practical because it requires comparison of the reproduced note with some known frequency standard.

A strobe disc can also help to determine if turntable speed varies with line voltage. By using a variac with a range of about 105 to 125 volts to supply AC input to the phono motor, the strobe disc can be observed to see whether or not there are unwanted variations.

The extent of wow and flutter can be measured using a "wow and flutter meter," a block diagram of which is shown in Fig. 4. Speed changes cause variations in pitch, so they really frequency-modulate the signal. Thus, the basic method of measuring speed changes is to measure the FM which is produced when the phono is operated.

To make the measurement, a steady sine-wave signal is supplied by a test record. The most commonly used signal frequency is 3,000 cps. Inside the meter, this signal is fed to a bandpass filter which eliminates everything except the test frequency and a small band on both sides. Amplitude variations are then eliminated by a limiter (clipper) circuit, after which the signal is applied to a discriminator that converts the FM caused by wow into amplitude variations. This detector circuit is very similar to that used in FM radio receivers.

The output voltage of the discriminator is applied to the VTVM circuit in the instrument. The meter scale is calibrated in "percent of flutter," which can be defined by:

$$\% \text{ flutter} = \frac{\text{max. freq.} - \text{min. freq.}}{\text{avg. freq.}} \times 100$$

The average frequency is that which is applied to the system (3,000 cps as mentioned). The maximum frequency minus the minimum frequency represents the total

frequency change. If there is no frequency variation, there is no output from the FM detector, and the meter reading is zero. As speed changes become more pronounced, there is greater detector output, and a higher meter reading. A reading of 1% or less is acceptable for a turntable; some of the better-quality units may produce readings as low as 0.1%.

Measurements made under actual playing conditions are of more value than any others. Therefore, the measurements should be made with the changer loaded with records and

with the stylus on a record. In this way any drag produced is more noticeable. Also, by checking a unit both with and without a full record load, it can be determined whether or not the load has any effect on the speed.

Every phono model is different from all others, so no general servicing procedure can be expected to apply in all details of every case. Careful and thoughtful observation of the unit being repaired, plus reference to the instruction manual for that particular player, can aid greatly in getting rid of speed trouble. ▲

yes

STANCOR[®]

has a complete line of
RF-IF COILS

The Stancor name is a synonym for quality and dependability. Just as you rely on Stancor for the best in exact replacement flybacks and yokes, so you can expect the highest standard of performance from Stancor coils. Your parts distributor has them in stock.

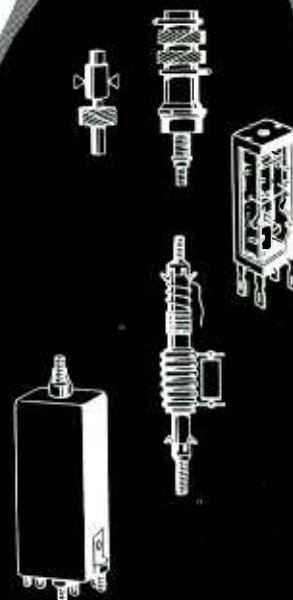

CHICAGO STANDARD TRANSFORMER CORPORATION
3501 ADDISON STREET • CHICAGO 1E, ILLINOIS



ALL ABOUT TV FRONT ENDS

Servicing TV Tuners

by Jess E. Dines



Here, at last, is the much-needed, complete and authoritative book on TV Tuners! This single book incorporates everything you need to know to be an expert at servicing the difficult TV front-end. Covers tuner circuitry right down to the smallest detail; describes the mechanical and electrical

characteristics of practically every type of tuner made. Complete sections are devoted to fundamentals, construction, replacement, repair, alignment and servicing. It's the kind of time-saving, truly helpful book every service technician should have at his bench. \$4.95
272 pages; 5 1/2 x 8 1/2". Only

HOW TO GET HIGHER QUALITY HI-FI

All About Crossover Networks



by Howard M. Tremaine

The author of "The Audio Cyclopedic" tells you in this new book (the only one on the subject) how to get the highest possible reproducing quality from a hi-fi system. Explains in detail the theory and design of crossover networks, shows you how to determine their frequencies and actually tells how to build as well as test crossover networks. Handy charts and tables make it easy to compute component values. This book is your best source of valuable information on this little-understood but highly important subject. Valuable for the hi-fi serviceman, audiophile and hobbyist. \$1.50
80 pages; 5 1/2 x 8 1/2". Only

80 pages; 5 1/2 x 8 1/2". Only

JUST OUT—NEW VOLUME 11!

Auto Radio Manual



Keeps you right up-to-date on auto radio repairs. Contains complete PHOTOFACT® coverage on 47 popular auto radio models produced in 1959 and 1960, including these makes: Allstate, American Motors, ATR, Automatic, Buick, Ford, International, Mercury, Mopar, Motorola, Oldsmobile, Pontiac, Riverside, and Stromberg-Carlson. Includes alignment information, comprehensive schematics, parts lists and every bit of useful data you need to help you service auto radios faster and more profitably. 160 pages; 8 1/2 x 11". Only \$2.95

160 pages; 8 1/2 x 11". Only

HOWARD W. SAMS & CO., INC.

Order from your Sams Distributor today, or mail to Howard W. Sams & Co., Inc., Dept. M-30 1720 E. 38th St., Indianapolis 6, Ind.

Send me the following books:

- "Servicing TV Tuners" (STD-1)
- "All About Crossover Networks" (CNT-1)
- "Auto Radio Manual" Vol. 11 (AR-11)

\$.....enclosed. Send Free Book List

Name _____

Address _____

City _____ Zone _____ State _____

(Outside U.S.A. priced slightly higher)

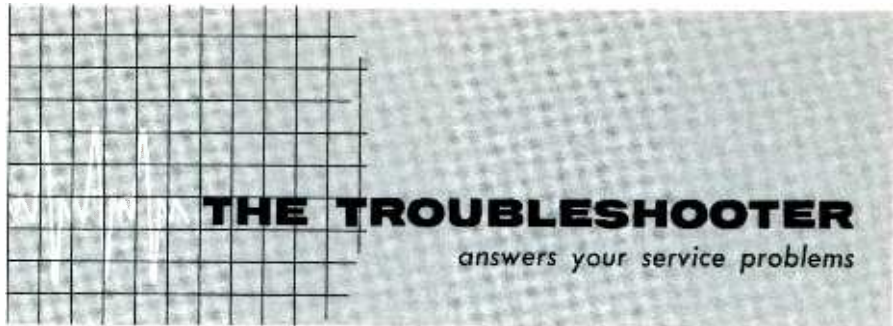

Advisable Change

A Philco color chassis TV-123 keeps blowing the #26 fuse wire protecting the filaments. In checking the current on this line, I find it surges to 27 amps when the set is first turned on, then drops to 8 amps (its rated level) in 8 seconds. There's absolutely nothing wrong in the filament circuit. I put in a length of #22 fuse wire and it works fine. Is it OK to leave the #22 wire in the circuit?

E. J. CAROLAN

Natalia, Tex.

In the case of color receivers with their many tubes, it is quite normal for the current surge to reach the proportions you indicate, and for the interval of time you report. Field experience dictates that #26 wire does not make a satisfactory fuse line for the filament supply in a color receiver. New chassis use #22 wire, so you are justified in making this field change.

Common Damper Troubles

I've got a stinker. The damper-filament winding of the power transformer in an RCA KCS47C chassis shorted out and was replaced by a separate filament transformer. This arrangement hasn't worked; two replacement transformers have been knocked out. I've been advised to use an isolation transformer with 10-kv insulation, but haven't been able to locate such a unit at any distributor. Can you please suggest something other than power-transformer replacement?

BEWILDERED

Advanced TV Service Center
Amsterdam, N. Y.

The damper-tube filament and cathode are wired together in a Capehart Model 323M. This has caused the filament winding to short to ground. Is there any way to get around replacing the power transformer?

JOHN GALLO

Brooklyn, N. Y.

Both of you have encountered the same trouble in almost identical circuits. The direct-drive horizontal sweep circuit in these receivers was designed when the 6W4 was about the only damper available. In view of the relatively low peak heater-to-cathode voltage rating of the 6W4, it was necessary to connect heater and cathode and use the specially insulated winding of the power transformer.

The solution to your problem is quite simple. Just remove the wire connecting the cathode and filament, leave the fly-

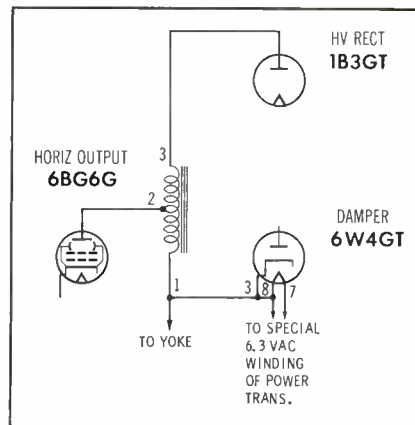

back connected to the cathode, use a regular filament transformer (with 2500-volt insulation) of the correct current rating to feed all tube filaments in the set, and replace the 6W4 with a 6AX4GTB. The higher heater-cathode voltage rating of this improved tube design will solve the problem for you.

Won't Erase

I'm having trouble finding out why a Federal Model 37-B tape recorder won't erase. All voltages agree with those shown in PHOTOFACT Folder 259-6. The head has been replaced and aligned, and the selector switch has also been changed.

PAUL A. KALUZNÉ

Savannah, Ga.

Connect a scope across the erase coil to see if you have any signal. If you do, be sure the pressure pad is holding the tape in firm contact with the head. If no signal is present, or if it's extremely low in amplitude, see if there is a greater signal amplitude at the transformer secondary; it may be advisable to disconnect the leads in making this test to be

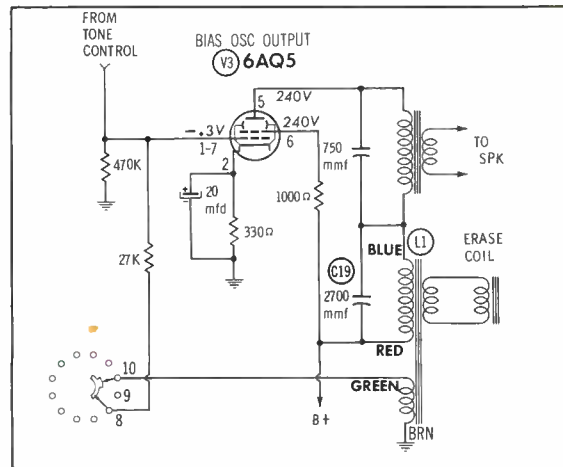

sure the signal is not being shorted by the connecting cable. If there is still no signal, substitute for C19; be sure the bias-oscillator feedback signal from the green lead of L1 has a continuity path to the control grid of V3. If there is still no erase signal, bias-oscillator coil L1 is probably the culprit.

Silicon Score

Looking through some back issues of PF REPORTER, I noticed the "Troubleshooter" recommending to Mr. R. E. Rumpf (March, 1960) that he use a 7.5-ohm resistor when converting from selenium rectifiers to silicon. Does this hold true in every case? If not, what do you use where?

ARTHUR DOEHNERT

Houston, Tex.

The required value of series resistance used in conjunction with selenium, silicon, or germanium rectifiers depends primarily on two things: (1) the circuit configuration; (2) the specific rating of the rectifier itself. Each rectifier has certain specifications; one is the minimum value of the limiting resistor. This is normally around 4.7 ohms for silicon units; however, typical operating conditions usually call for a value somewhat above the minimum standard. Since silicon has a much lower forward resistance than seleniums, conversions normally require an increase in value for the series-limiting resistor to provide surge protection for the rectifiers. More or less standardized values are as follows: For a half-wave circuit, 6.8 ohms; for both half- and full-wave doubler circuits, 7.5 ohms. In making conversions, it's a good policy to experiment with different values until you find the one that produces the normal B+ of the receiver.

Like a Sponge

I'm fully aware that rain and snow affect television signal strength. However, I've been told that reception varies according to whether or not trees have their leaves. Is this true? I don't remember ever seeing an explanation of either phenomenon — can you fill me in on the "why"?

KENNETH E. CRAWFORD

South Covington, Va.

You're so right! Trees, snow, rain, etc., all have a pronounced effect on a TV signal. For that matter, anything and everything the signal may encounter between the transmitting antenna and the receiving antenna absorbs a certain amount of the transmitted energy, just as a sponge soaks up so much water. The amount of signal attenuation varies with the material, weather, etc. Another rather important factor is the area of the material. For example, a tree with leaves will absorb considerably more energy than one with no leaves. Also, both snow and rain attenuate the signal by providing a leakage path to ground. Normally, such losses are not even noticed in strong-signal areas. However, under fringe or weak-signal conditions, they may have a pronounced bearing on reception.

"A Complete Library of PHOTOFACT is a 'must'..

The customer appreciates knowing that all facts about his receiver are available to me, and I appreciate not having to guess or wonder about component values and circuitry throughout the set... Yes, PHOTOFACT users are informed about each and every receiver...and the public has knowledge of this through PEET publicity..."

—Robert L. Gaither
Gaither Radio and TV
Parker, Ariz.



Service Technicians! YOU EARN MORE... YOU RATE with the public when you own the PHOTOFACT® service data library!

You enjoy maximum earnings as the owner of a complete PHOTOFACT Service Data Library! It's inevitable, because no matter how expert you are, you can always *save more time on any job, get more jobs done daily—EARN MORE, DAY IN AND DAY OUT...*

What's more—as the owner of a complete PHOTOFACT Library, you know your customers' sets *best*. You can actually show each customer you have the PHOTOFACT Folder covering his very own set. Result: You command public respect and acceptance which paves the way to more business and earnings for you.

HOW TO STAY AHEAD...

Yes, the truly successful Service Technicians are those who own the complete PHOTOFACT Library, who can meet and solve any repair problem—faster and more profitably. And these men *keep ahead* because they're on a Standing Order Subscription with their Distributors to receive all new PHOTOFACTS as they are released monthly. (They're eligible for the benefits of membership in PEET, too—see below!)

ONLY \$10 DOWN puts the complete PHOTOFACT Library in your shop—and you have up to 30 months to pay. See your Sams Distributor today, or write to Howard W. Sams

NOW IS THE TIME TO JOIN "PEET"

THE POWERFUL NEW PROGRAM FOR QUALIFIED TECHNICIANS

If you now own a PHOTOFACT Library or plan to own one, you can apply for membership in "PEET." It's the first industry program really designed to build powerful public acceptance for the Service Technician who qualifies. Builds enviable prestige and business for its members. Benefits cost you absolutely nothing if you qualify. Ask your Sams Distributor for the "PEET" details, or mail coupon today.

HOWARD W. SAMs & CO., INC.
1728 E. 38th St., Indianapolis 6, Ind.

Send me full details on the new "PEET" Program.

Send full information on the Easy-Buy Plan and Free File Cabinet deal.

I'm interested in a Standing Order Subscription.

I'm a Service Technician full-time; part-time

My distributor is _____

Shop Name _____

Attn: _____

Address _____

City _____ Zone _____ State _____

TV Radiation Hazard

(Continued from page 27)

tion, this instrument features a completely transistorized spectrometer circuit which supplies all the necessary signals to activate the graphic recorder also pictured in Fig. 2.

The *slave scaler* is a digital computer with a highly accurate built-in timer and mechanical register. Through its use, the radiation count may be tabulated for certain pre-selected time cycles. This unit also receives its controlling impulses from the linear count ratemeter. Although not used during our low-level experiments, the *well shield* is also a component part of the entire Spectrometer System. When "hot" radioactive materials are under analysis, they are placed in this isolation chamber.

Some of the others items of equipment assembled for our X-ray tests were a special mechanical arm for securing the detector probe, an accurate high-voltage meter, a variable AC power supply, and, of course, a number of television receivers. (See Fig. 3.) Since the major factor governing the amount of radiation is accelerating potential, we chose only those TV chassis that developed normal anode voltages in excess of 16 kv for our principal guinea pigs. This involved popular brands with both 21" and the newer 23" screens.

Test Results

The task of performing accurate radiation measurements is not as simple as taking voltage readings or checking TV waveforms. Aside from the highly specialized equipment re-



service dealer's
**SEMICONDUCTOR
COMPLEMENT
MANUAL**

Complete guide, by equipment brand and model number TO Sylvania direct replacement transistors, diodes and rectifiers.

50c

**New
Timesaving
Guide for
Service
Dealers!**

Now at your Distributor's!

A complete guide, by equipment brand and model number, to Sylvania direct replacement transistors and diodes. Interchangeability information is included for rectifiers, too. Gives Sylvania equivalents of foreign transistor-types. Helps you find the right replacement unit . . . fast! Get your copy from your SYLVANIA SEMICONDUCTOR DISTRIBUTOR or write Sylvania, P. O. Box 37, Buffalo 9, N. Y. Only 50¢ for this valuable booklet!

Check your semiconductor stock. Fill in with top-quality Sylvania transistors, diodes and rectifiers. Your Sylvania distributor has the best! Sylvania Semiconductor Division, Woburn, Mass.

SYLVANIA

Subsidiary of **GENERAL TELEPHONE & ELECTRONICS**



quired, the receiver's operating conditions had to remain constant, the detector system had to be calibrated or zeroed continually to compensate for background readings, and the sampling probe had to be held absolutely rigid for given time intervals. We also had to make certain that light and stray magnetic or electrostatic fields did not upset our readings.

The first few tests we performed were on sets operating with normal rasters, high voltages from 16 to 19 kv, and no picture modulation on the screen. After sampling all surface areas of the picture tubes, we found an almost unmeasurable amount of X-ray radiation. For all practical purposes, the radiation detected even at maximum points was at a rate of considerably less than 1 mr per hour.

We also investigated the possibility of radiation from the neck of the CRT, and in or around the high-voltage compartment. Our findings here were nil; if there was any radiation present, it was certainly less intense than that slight amount detected on the larger surfaces of the picture tube.

In our next series of tests, we performed various readouts with the receivers "bugged" to simulate a number of abnormal operating conditions that could very well prevail at the service bench. Brightness and sweep controls were all varied, centering misadjusted, vertical sweep collapsed, high voltage varied, and ion traps moved to different positions. Radiation readings were relatively unchanged except for one certain set of conditions.

With receiver brightness above a normal viewing level, high voltage in the vicinity of 20 kv, and the vertical sweep collapsed, we detected a radiation peak at several locations on the back side of the picture tube bulb. (Two of the four "hot spots" are illustrated in Fig. 4.) The radiation count was considerably higher under these conditions and at these particular points, but still in the vicinity of 1 mr/hr even though the probe was as close to the source as possible.

Under the same conditions of no vertical sweep, we did detect a few spots on the front of the TV screen where the count approached 1 mr/hr. Much to our surprise, however,

How do you rope 5 watts of Power in a 2-watt sized Wirewound?



it's easy with
Centralab's
"Thermo-Pass"
Insulation



Nowadays all kinds of critters have Texas capacity with Rhode Island size. Tubes, relays, and many other components have gotten smaller without any sacrifice in performance.

Now it's true with wirewounds, too! CENTRALAB has corralled 5 watts of power in a 2-watt size wirewound . . . by using "Thermo-Pass" insulation. A control's rating and size depend on the speed with which heat can be transferred from the resistance element to the atmosphere. CENTRALAB "Thermo-Pass" insulation combines exceptional heat transfer with a dielectric strength of 4500 volts per mil at 25° C. Result: a conservatively rated 5 watt Radiohm control measuring only 1 3/32" in diameter and 9/16" in depth. They are available in values from 1 ohm to 100 K ohms.

Meanwhile, back at the ranch, you'll find this one small size taking care of your 2, 3, 4 and 5 watt replacements in tv, hi-fi, home and auto radio sets. Just make sure you use the wirewounds—short (Model WN) or long (Model WW) shaft style—that carry the  brand.

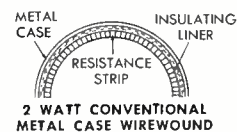
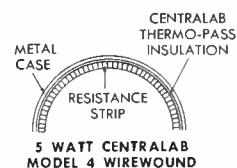

Centralab

 (R)

CONTROLS • ROTARY SWITCHES • CERAMIC CAPACITORS
PACKAGED ELECTRONIC CIRCUITS • ENGINEERED CERAMICS

ELECTRONIC DIVISION OF GLOBE-UNION INC.
942M E. KEEFE AVE. • MILWAUKEE 1, WIS.
IN CANADA: 669 Bayview Avenue • Toronto 17, Ont.

it was not in the center of the screen where the beam was concentrated, but near the corners (Fig. 5).

Singling out one of the receivers with which we could obtain an anode voltage of about 23.5 kv, we ran a complete spectrum analysis of the radiated X rays, using the graphic recorder pointed out in Fig. 2. While monitoring the X-ray radiation, the spectrometer system scans a predetermined energy range and graphically records at what precise levels the energy peaks occur. For our experiments, a scanning range of from approximately 1 kev to 100 kev was selected. Higher ranges were also scanned, but no peak radiation was indicated.

The graph shown in Fig. 6 represents the results of our spectrum analysis. Once we obtained an energy peak from the TV X rays, we needed an accurate way of determining the energy level at which the peak occurred. This was a simple task for the radiation specialist; he merely selected a low-level radiation substance of known activity and superimposed its energy peaks on the original graph. The substance used for this calibration was "lead 210,"

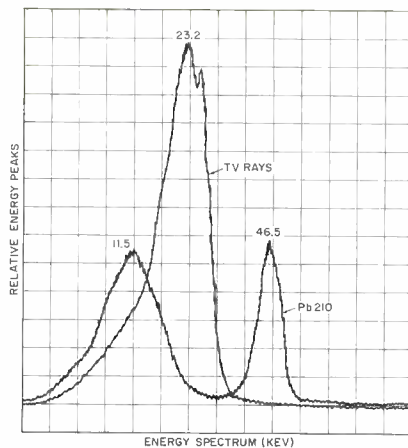

Fig. 6. Spectrogram showing the energy peaks of TV radiation and "lead 210."

which exhibits energy peaks at both 11.5 and 46.5 kev. As can be seen in Fig. 6, the two calibration peaks straddled the TV radiation curve and thus gave us a means by which to interpolate the energy value noted.

We also ran spectrometer tests at slightly lower accelerating-anode potentials. Here, we came up with energy peaks at 22, 20.6, and 19.4 kev. We noticed, however, that they were a little lower in magnitude than on our original run. It was interesting to note, too, how settings of the

receiver's brightness control affected the radiation count. When a brightness control is advanced, beam current increases but high voltage decreases. We found, therefore, that peak radiation did not occur at either maximum brightness or maximum high voltage, but at an in-between point where voltage was relatively high, yet there was adequate beam current to bombard the screen.

Summarizing the results of our tests, we found no measurable quantity of radiation in receivers operating with anode potentials of less than 16 kv. On large-screen receivers with higher potentials, we found that only the CRT itself offered emitting surfaces, and no radiation of any significance was detected on any other portion of the TV chassis.

TV Radiation and You

Undue exposure to X-ray radiation has been known to affect the well-being of both humans and animals. Some of the obscure biological effects caused by large doses of radiation are malignant tumors, impaired fertility, cataract, obesity, and

6A7	6AG7Y		5GC8	5EU8
6A8	6AH4G2		5CL8A	5J6
6AB4	6AL5		5CQB	5T8
6AC7			5CZ5	5U4JB
6AC7Y				
6AD7G				
6AF3	6.			
6AF4	6AH			
6AF4A	6AK5			

483 tubes in all, and all first quality!

Fill your tube caddy with new Admiral Supertron receiving tubes. Your assurance of one call profitable service. All highest quality for all makes of TV, Hi-Fi, Stereo and radio replacement service.

ADMIRAL MARK OF QUALITY THROUGHOUT THE WORLD

ADMIRAL NATIONAL SERVICE DEPT.
903 Morrisey Blvd., Bloomington, Illinois

For free literature
and full details,
mail this coupon.

Name _____
Address _____
City _____

P-64

A PAGE FROM THE NEW
EASTERN JEWEL CATALOG
NEW SPECIAL PRODUCTS NOW
THAT TV - RADIO - HI-FI
SERVICEMEN NEED

SEE COMPLETE  LINE
AT YOUR DISTRIBUTOR

ZENITH RADIO I.F. TRANSFORMERS
5 EXACT REPLACEMENT TYPES
EJ Part No. Zenith Part No.
ZK1 95-1101
ZK2 95-1102
ZK3 95-1153
ZK4 95-1350
ZK5 95-1150

 EJ Part No. ZK 1 thru 5

CLOCK MOTOR COIL
Telechron clock motor field coil. Exact replacement as used in most clock radios from Admiral to Zenith.

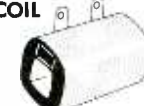
 EJ Part No. CMC13

SCHEMATIC DIAGRAM BINDER
Economically holds all original mfrs. schematics or 10 H. W. Sams Photofact folders.

 EJ Part No. SDB8

Available at Distributors EVERYWHERE
ASK FOR  PARTS
AT YOUR DISTRIBUTOR TODAY
EASTERN JEWEL CORP.
PLAINVIEW, NEW YORK

over-all reduction in life span—not to mention the total genetic effects which have yet to be determined. Milder doses of radiation have been known to lead to various degrees of skin burns, leukopenia, low blood pressure, and anemia. These, of course, are only a few of the reasons why we concern ourselves with this energy that we can neither see or feel.

Now for the paramount question: What is a permissible limit of radiation dosage? One widely-accepted recommendation (by National Committee on Radiation Protection quoted in *National Bureau of Standards Handbook 59*) states that, for long-term exposure of the whole body to X rays for an indefinite period of years, the basic permissible dose should not exceed 300 mr per week in the blood-forming organs—considered the most critical tissue in the body.

The NCRP has defined a permissible weekly dose as “a dose of ionizing radiation accumulated in one week, of such magnitude that, in the light of present knowledge, exposure at this weekly rate for an indefinite period of time is not expected to cause appreciable bodily injury to a person at any time during his lifetime.”

Although absolute limitations on radiation exposure cannot be stated at this time, we concluded from our tests and medical references that even if a technician or serviceman remained in direct contact with a radiating picture tube for 40 hours a week, the dose received would still be extremely unlikely to exceed the present-day safety ratings. Another encouraging point is that radiation intensity is inversely proportional to

Have a New Mailing Address?

If so, notify us by the 15th of the month to assure uninterrupted delivery of PF REPORTER.

Please be sure to give us both your old and new address, including your postal zone number. (Or better yet, enclose a current mailing label with your new address.) Send to:

PF REPORTER
Circulation Dept.
2201 E. 46th Street
Indianapolis 6, Ind.

RECTIFIER PERFORMANCE THAT PLEASURES CUSTOMERS



TARZIAN TUBE REPLACEMENT SILICON RECTIFIERS

Tarzian's 9 standard models of tube replacement rectifiers are directly interchangeable with over 95% of all popular vacuum tube rectifiers. An added plus is the new Sarkes Tarzian Full Wave Silicon Rectifier (S5347), replacing 6BW4 or 12BW4 in Citizen's Band radios where maximum performance in reception quality and range is desired.

TARZIAN SILICON RECTIFIERS (PLUS CONVERSION KITS)

Sarkes Tarzian silicon rectifiers are made in production quantities by a special Tarzian process that provides optimum forward to reverse ratios, extremely low voltage drop, high reliability and long useful life. Compact conversion kits are available for both the M-150 and M-500 units.

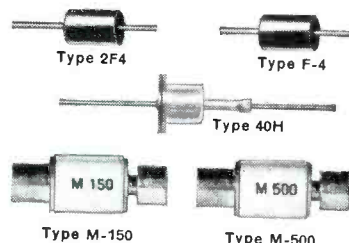

TARZIAN "CONDENSED-STACK" SELENIUM RECTIFIERS

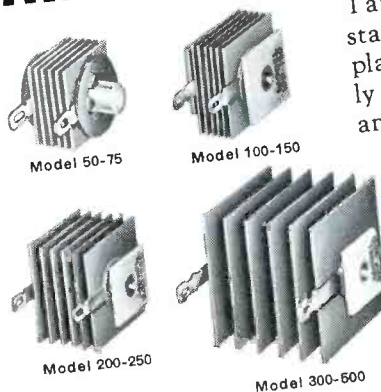

Tarzian's four "condensed-stack" selenium rectifiers—replacing the 20 types that formerly made up the 50 to 500-milliampere line—not only cover your selenium rectifier needs, but their small size eases both your application and inventory problems. Improved production processes have substantially reduced watt losses by as much as 50%.

Tarzian "Distributor Line" Rectifier Catalog

• The new "Distributor Line" Rectifier Catalog is now available on request. It contains complete details on ratings, dimensions, electrical specifications. For additional information write Section 5554D



SARKES TARZIAN, INC.

World's Leading Manufacturers of TV and FM Tuners • Closed Circuit TV Systems • Broadcast Equipment • Air Trimmers • FM Radios • Magnetic Recording Tape • Semiconductor Devices

SEMICONDUCTOR DIVISION • BLOOMINGTON, INDIANA
In Canada: 700 Weston Rd., Toronto 9 • Export: Ad Auriema, Inc., New York

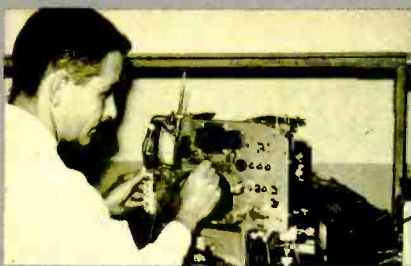

These Three Free Books Will Help You Speed Up Your Servicing—Whether It's Radio, TV, or Industrial Electronics



"THE TROUBLESHOOTER'S HANDBOOK"

A 96-page collection of questions and answers on troublesome servicing problems, reprinted from "The Troubleshooter" column.



"SERVICING TV from Tuner to Picture Tube"

A 96-page book containing 14 of the best PF REPORTER features. Covers all TV circuits.



"SERVICING INDUSTRIAL ELECTRONICS"

An 8½"x11", 64-page book containing industrial electronics features from past issues. 20 chapters of helpful and informative material.

In addition to your choice of these helpful books, you'll be getting PF REPORTER regularly every month. And, for 1961, plans are bigger and better than ever—starting with next month's BIG 10th Anniversary Issue.

Not only will you get special business-oriented features to help you build a more profitable operation, but there'll be many new technical features. Some of those scheduled for upcoming issues are:

Converging the New Color Sets
Servicing Synchros and Servos
Analyzing Reverberation Circuits

Understanding Transistor Testers
Conquering Those Vertical Troubles
Choosing a CRT Substitute

... plus many others

Just fill out and send in the coupon below. Be sure to check your choice of premium books—one for each year of your new or renewal subscription.

Enter my subscription to PF REPORTER and send me free book(s) checked.

1260

3 Years \$9.00 2 Years \$7.00 1 Year \$4.00

The Troubleshooter's Handbook
 Servicing Industrial Electronics
 Servicing TV from Tuner to Picture Tube } Check one for each year you subscribe

Bill Me Remittance Enclosed Extend Present Subscription

Take this coupon to your distributor, or mail to:
Howard W. Sams & Co., Inc.
2201 E. 46th St., Indianapolis 6, Ind.

Please Check Your Business Classification

Independent Radio, TV Serviceman Owner, Mgr. Department
 Retailer with Service Service Mgr.
 Industrial Electronics Service Employee
 Other (Specify occupation and title)

Name _____
 Firm _____
 Address _____
 City _____ Zone _____ State _____

the square of the distance from source to object; for example, if we had simply moved our detector probe back about 6" from any given spot on the tube's glass, the radiation intensity would have been approximately ¼ that previously obtained.

Thus, as far as present-day TV receivers are concerned, there is no real reason for alarm, especially when you take into consideration the following points:

1. Only certain TV receivers operating under abnormal conditions produce enough radiation to be actually recorded, even with measurements made as close to the radiation source as is physically possible.
2. The relatively soft X rays produced by a TV set would have a difficult time even penetrating the outer layers of the skin.
3. X rays can be entirely blocked or reduced in intensity by the shielding effects of objects such as a metal chassis or safety glass.
4. The average close-range exposure time is usually only a small fraction of the maximum periods considered. (One seldom rests his hand habitually on the back of an operating CRT!)

What does all this prove? Simply that the X-ray radiation detected during our experiments could very well be classed in the same category as that produced by the luminous dial of a wrist watch—something we live with every day. ▲

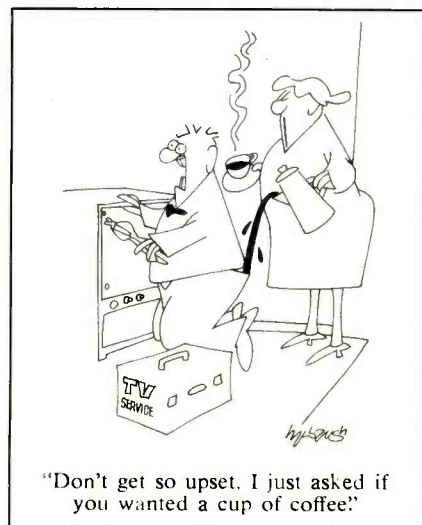

"Don't get so upset. I just asked if you wanted a cup of coffee?"

Admiral 21F1

(Continued from page 24)

plate voltage of V7 would also appear on the cathode of the CRT. On the other hand, if R37 opened, the DC voltage would not reach the cathode. Then, due to insufficient bias, the brightness control would fail to cut the CRT off.

Measurement of C26 revealed some leakage, and a resistance check of R38 (a half-watt resistor) showed this component to be wide open. With more than 200 volts applied to the cathode, and never more than 125 volts on the grid, the picture tube was driven well into cutoff—an excellent reason for the lack of a raster! Replacing C26 with a 0.1-mfd, 600-volt molded capacitor and R38 with a new 560K-ohm, 1-watt resistor brought back a picture, of sorts, with a fair amount of contrast and brightness. But a lot of work was still necessary before the set was restored to the pink of condition.

I started by checking all tubes and cleaning that decrepit tuner. Then I decided to try increasing the boost and high voltage, in hope of brightening the picture. The DC voltage on the boost line measured 370 volts, not quite 10% below the stated value of 400 volts. The B+ voltage itself was a bit low (280 volts DC, instead of 300), but the low voltage supply circuit was otherwise normal. Checking the boost circuit (Fig. 2), I found that C61 was OK, but C62 through C64 were leaky—and C65 (in series with the low side of the yoke) was almost shorted. After I finished replacing

*lowest cost
master antenna system
ever developed*

NEW BLONDER-TONGUE TRANSISTOR 4-SET BOOSTER—MODEL IT-3

All the gain you need from one antenna for 4 TV or FM sets!

This new transistor-operated 4-set booster provides higher gain and lower noise than any comparable vacuum tube unit. There are no tubes to replace, lower power drain and negligible heat—all contributing to lower cost, longer maintenance-free operation than any unit on the market. List price of model IT-3, \$32.50.

SUPERB 1, 2, 3 or 4 SET PERFORMANCE

- **1 SET**—B-T 'straight thru' circuit provides full gain without isolation losses (Gain: 9 to 14 db, TV; 8 to 12 db, FM).
- **2, 3 OR 4 SETS**—splitting circuit provides gain and inter-set isolation necessary to provide top performance on 2, 3 or 4 sets. Gain two sets—each set 4 to 8 db; Gain three sets—each set 3 to 4 db; Gain four sets—each set 2 to 3 db.

*Sold through Distributors. For details write: Dept. PF-12
engineered and manufactured by*

BLONDER-TONGUE
9 Alling St., Newark, N. J.

Canadian Div.: Benco Television Assoc. Ltd., Toronto, Ont. • Export: Morhan Export Corp., N. Y. 13
home TV accessories • UHF converters • master TV systems • industrial TV systems • FM/AM radios

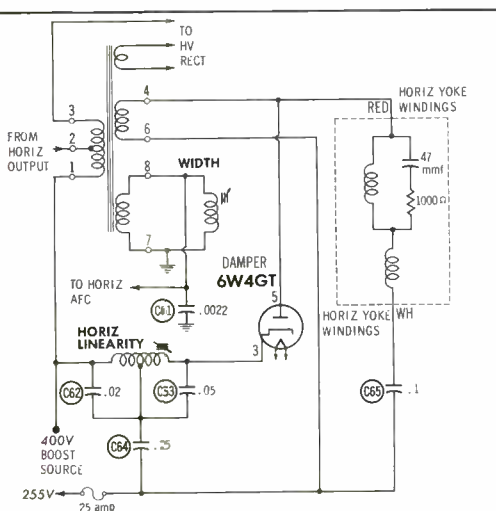

Fig. 2. Horizontal sweep and boost circuits used in the Admiral Model 21F1.

DIAMOND DUOTONE SAPPHIRES

DUOTONE NEEDLES ALWAYS YOUR BEST BUY!

DD-1

STEREO DIAMONDS	MONAURAL DIAMONDS
4-733D	4-647D/S
4-735D	4-661D
4-737D/S	4-585D/S
12	12

6-699 Sapphires Free
1 Handsome Display Cabinet FREE



DD-2

STEREO DIAMONDS	MONAURAL DIAMONDS
9-733D	9-699D
9-735D	9-661D
9-737D/S	9-585D/S
9-899D	9-647D/S
36	36

18 Free Sapphires—
6-899
6-825
6-735

1 Handsome Display Cabinet FREE
See your Duotone Rep. or call

DUOTONE
REPAIR NEW JERSEY

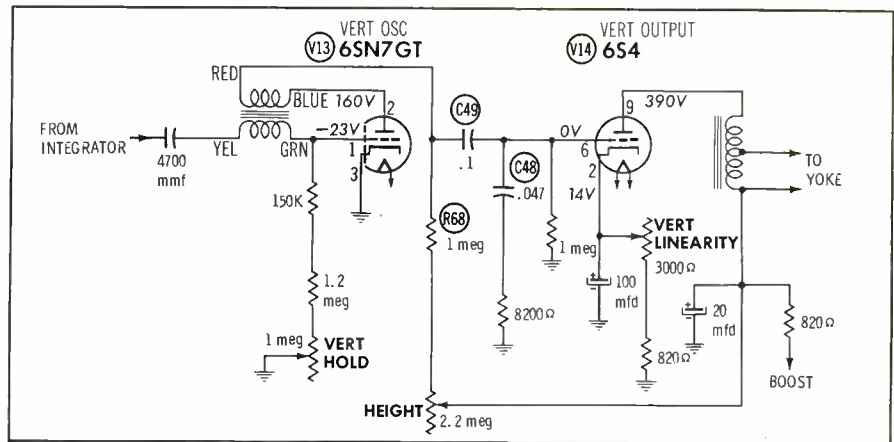

Fig. 3. The vertical sweep circuit operated at 120 cps.

these parts, the boost voltage rose only about 5 volts. However, the time hadn't been wasted, because the raster and picture were noticeably improved. By the way—these capacitors, plus a new 1B3, raised the high voltage to 11.5 kv. I figured this was good enough, considering the age of the set. Even so, my friend and I still had plenty of trouble on our hands.

Poor Joe

What the Sam Hill was wrong with the picture now? The bottom had pulled up several inches into a

white fold, and there were heavy retrace lines across the screen that wouldn't come out at any combination of brightness and contrast settings. By this time, the old 21F1 had exceeded my worst expectations. To put it mildly, the set was a mess! Poor Joe; over an hour had already gone by, and there he sat patiently waiting. "Friend," I said, with a sigh of resignation, "don't you think you'd better leave this and come see me another time?" He nodded in mute agreement and departed — disappointed, I suppose, that I wasn't the perfect miracle man after all. For my part, I turned the set off, went over to the coffee urn, poured a generous portion of the blackest, and strolled about the shop considering whether or not to call it quits. If ever a set needed repairing, this one certainly did. I figured I was going to earn every cent of my labor fee this time—and definitely the hard way.

Rock 'N' Roll

"Oh, well," I thought, "might as well get on with it." So I turned the receiver back on. Much to my surprise, the raster was full, and the vertical hold control would execute a perfect center lock. In addition, all retrace lines were gone. I sat dumfounded; such things could happen, I'd heard, but why to me? I was just about to grab the phone and call friend Joe when the bottom of the picture whitened, curled, and began a slow roll. "A vertical output tube will fix this in a hurry," I jubilantly told myself, knowing that 6S4's have a habit of failing when they get hot. But a new 6S4 did absolutely nothing to remedy the situation. The picture began to roll

Mercury

Model 300
COMBINATION TESTER

A complete portable service shop at your side wherever you go
Housed in handsome wood carrying case.

\$99.75
Net

3 ESSENTIAL INSTRUMENTS IN ONE COMPACT UNIT!

- 1 A multiple socket tube tester
- 2 A CRT tester-reactivator
- 3 A 20,000 ohms per volt VOM and capacity tester

Handy mirror in cover for TV adjustments

AS A TUBE TESTER . . . will check emission, inter-element leakage and gas content of all tubes.

AS A CRT TESTER-REACTIVATOR . . . will test, repair and reactivate all black and white and all color picture tubes.

AS A VOM AND CAPACITY TESTER
(20,000 ohms/volt)
DC Voltage: 0 to 7500 volts
AC Voltage: 0 to 1500 volts
Ohms: 0 to 10 megohms
DC Current: 0 to 15 amperes
Capacity: .1 mfd. to 180 mfd.

See your electronics parts distributor!

MERCURY ELECTRONICS CORP. 77 SEARING AVENUE, MINEOLA, NEW YORK

PHONE
ED 9-9653

\$7.50
plus parts,
C.O.D. and postage charges

Precision Tuner Service

ALL TYPES T.V. TUNERS REPAIRED AND ALIGNED TO FACTORY SPECIFICATIONS ON CRYSTAL-CONTROLLED SWEEP GENERATORS
24-HOUR SERVICE ON MOST TUNERS
UHF - VHF COMBINATIONS — \$13.50

See your local distributor or send to:
P.O. Box 272, 601 N. College
BLOOMINGTON, INDIANA

State make and model. Send all parts, tubes and shields

90 DAY WARRANTY



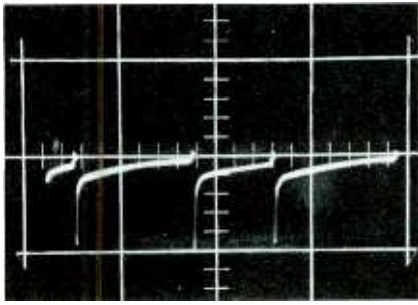

Fig. 4. Grid waveform of oscillator revealed increase in sweep frequency.

even faster, and I could almost feel my eyes clicking like pool balls. I was well behind No. 8 on this one.

I began concentrating on the vertical sweep circuit (Fig. 3). With the scope-sweep frequency still set at 30 cps, I checked the grid waveform of the vertical oscillator. The pattern locked in fairly easily (see Fig. 4), but I was surprised to see that the oscillator was running at double the normal frequency. In addition, the waveform was composed of alternate long and short cycles. Puzzled, I took another glance at the picture. There appeared to be a single image, but the raster fell far short of filling the screen vertically. The retrace lines were more pronounced than ever.

Resistance checks across the vertical hold control and its series resistors showed nothing unusual. The height control and R68 were also well within tolerance. Both C48 and C49 showed a little leakage, but substituting new units failed to change the symptoms. Since the remaining components were not immediately in the circuit being explored, they were ignored for the time being. I decided to take a chance on substituting another new 6SN7 for the vertical oscillator, but as I suspected, this didn't do a bit of good. What else was left? Just what I had avoided tackling all along—the blocking-oscillator transformer.

The DC resistance readings across



(A) Nonsinusoidal in primary.



(B) Overly-damped in secondary.

Fig. 5. Pulse test of transformer produced a pair of abnormal waveforms.

after
61
years

it's the radio-tv
serviceman's
"best friend"!

KESTER SOLDER

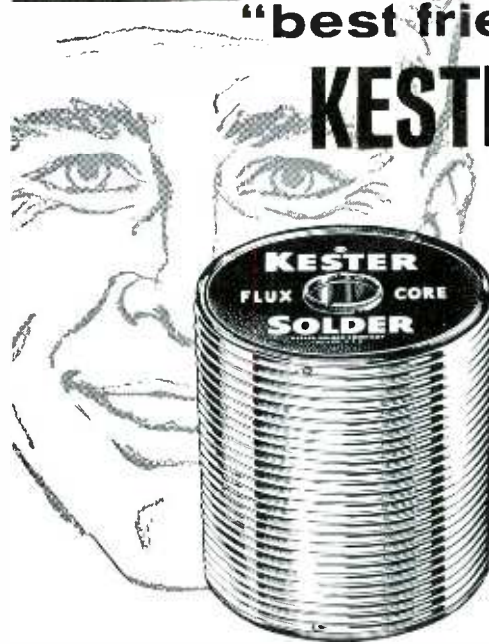

KESTER "RESIN-FIVE" FLUX-CORE SOLDER enjoys almost 100% acceptance by the radio-television-electronics service industry. Servicemen like its fast action and easy application . . . its non-corrosive, non-conductive activated flux does a perfect job every time.

Send for detailed information on Kester "Resin-Five" Flux-Core Solder.

KESTER SOLDER CO.

4228 Wrightwood Ave., Chicago 39, Illinois
Newark 5, N. J., Anaheim, Calif.,
Brantford, Ontario, Canada

OVER 60 YEARS' EXPERIENCE IN SOLDER AND FLUX MANUFACTURING



NEW TRANSISTORIZED



MODEL PS-3 \$69.50 net
0-25v. DC variable output voltage

REGULATED DC POWER SUPPLY

NOW service technicians and industrial users can afford the performance of a regulated variable-voltage power supply.

Set It and Forget It—Voltage remains essentially constant at any output voltage setting regardless of load (within ratings) and AC supply voltage fluctuations.

Extremely Low Ripple—Less than 1 MV (.001 V) RMS for all conditions of rated operation . . . less than ½ MV (.0005 V) for AC line voltage between 115 and 120 volts.

Output—0-200 MA, 0-15 volts. 0-100 MA, 0-25 volts.

Input Voltage—110 to 130 volts, 60 cycles.

Regulation—500 MV maximum, for above mentioned ratings.

Sold by Leading Electronic Distributors. Send for Catalog Sheet PS-3

ELECTRO PRODUCTS LABORATORIES

4501-T Ravenswood, Chicago 40 / Canada: Atlas Radio Corp., Ltd., Toronto, Ont.

AT ONE-HALF THE COST!

TOP PERFORMER
...and **profitmaker!**

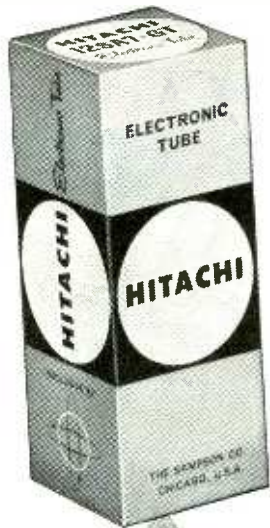

SELL—SERVICE—SATISFY

RECEIVING TUBES

MADE BY
GRAND PRIX AWARD-WINNING

HITACHI



Choice as original equipment by
manufacturers in the U. S. & abroad

From all points come good words about Hitachi tubes produced by one of the world's largest manufacturers—Hitachi, Ltd., Tokyo, Japan. Tubes that can't be beat for performance and reliability. Most popular types are available . . . each made with strict quality-control to fully meet *top American standards*. Yet important cost savings guarantee you extra profits. And distribution is on a localized prompt-delivery basis.

THE SAMPSON COMPANY
ELECTRONICS DIVISION, 2244 S. Western Ave., Chicago 8, Ill.

See your HITACHI Distributor
—or write for CATALOG
CT400-A

A COMPLETE LINE
OF QUALITY ELECTRONIC
COMPONENTS

the primary and secondary windings tallied almost exactly with the values given in the sweep-transformer parts list. However, I wasn't too impressed with this finding, since I knew that the trouble had not been evident when the set was first turned on. I still suspected the transformer, even though the "cold check" with the ohmmeter had failed to turn up any trouble; thus, I felt that a more conclusive test was needed. Since I had some blocking transformers in stock, I decided to see if a substitution check was possible.

Checking the replacement-unit numbers given in PHOTOFAC T Folder 135-2, I was pleased to find that a transformer in my stock was electrically similar to one of these replacements. Since both the secondary and primary leads of the old transformer were already disconnected, I connected my spare into the circuit with some hook-up wire and alligator clips I keep handy for such occasions. When I turned the receiver on again, everything worked fine; even the height and linearity controls could be adjusted without producing picture flipping. Neither was there any vertical foldover. With a silent prayer, I walked away from the set and helped myself to another large mug of black coffee. As the receiver "cooked," I steadily became more cheerful. After 20 minutes, there still was neither flip nor fold. Evidently another transformer was the ticket to this repair.

Now to select the new part. Original specifications called for Admiral transformer 79A18-2, but I noted that the defective unit carried the number 79A18-4. This version called for a slightly different replacement, according to the local distributor from whom I ordered the new part.

—and Double Check

The new unit turned out to have a different DC primary resistance from the 79A18-2, so the supposedly "good" resistance reading on the old transformer actually would have pointed to trouble—if I'd only known. It's a good thing I didn't take the resistance check too seriously.

Suppose my stock hadn't included a suitable transformer for the substitution check—could I still have

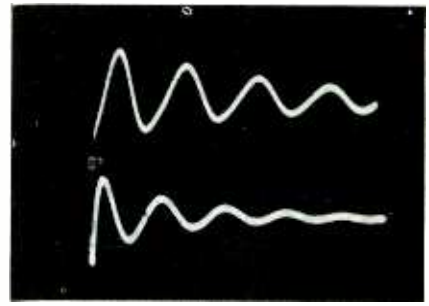

Fig. 6. Compare these normal "ringing" waveforms with those in Fig. 5.

found the trouble? The answer is yes, because it so happens that I've wired a 680-mmf capacitor from the cathode of my oscilloscope's time-base sweep oscillator to a jack on the front panel for occasions just like this. With the pulse voltage thus obtained, I can check the condition of most TV transformers in-circuit as well as out. Connecting a jumper from this special scope jack to one primary lead of the old blocking transformer, and hooking the vertical input terminal of the scope through a direct probe to the other primary lead, I obtained the top waveform in Fig. 5. Notice that the ringing produced by the scope pulse is not in the form of a pure sine wave. Also notice the highly-damped waveshape on the secondary (lower waveform in Fig. 5). Now look at Fig. 6, produced by applying the sweep pulse to the primary and secondary coils of the new transformer. It's easy to tell which is the good one, isn't it? The same test can be made on some units in-circuit, but it would have been much more difficult to evaluate the waveforms in this case.

It's evident from the wave configurations in Fig. 5 that there are shorted turns in the old transformer's primary, secondary, or both. The effect was insignificant with the transformer cold, but continued operation of the receiver made the condition steadily worse until the circuit eventually resonated at 120 cycles instead of 60 . . . a real mystery to an ohmmeter, but a "natural" for an oscilloscope.

After a few finishing touches, mostly in the sync circuits, the set was ready for Joe to pick up and take home. In spite of my forebodings, the job had not been so bad after all, and this particular 21F1 is now in good enough condition that I don't expect to see it again for some time. ▲

Regeneration

(Continued from page 29)

cently brought in with the complaint that the raster broke up into coarse horizontal lines through which no picture detail could be seen. The set acted normally when turned on. Assuming that I was dealing with a severe and intermittent horizontal-frequency trouble, I let the receiver operate for some time; but the symptom still did not appear. Finally, I removed the rear cover, and attached a cheater cord. In so doing, I disconnected the antenna, thereby bringing forth the ragged-line symptom shown in Fig. 1B. Since the chassis type and complaint were the same as in the previous case, I half-hoped the trouble source would prove to be the same. Sad to relate, the cause was different.

Trying all the tricks known to cure oscillation led nowhere. As is usual in such cases, an accidental discovery finally pointed to the solution. I found the trouble could be made to disappear if the shield enclosing the first IF transformer was pushed in a certain direction. An examination of all the grounding lances on this shield revealed that one was not soldered to the printed board. One drop of solder, and the trouble was gone.

I have found this same condition in five of these chassis thus far, with the cause and cure always the same. The shield, shown in Fig. 4 as an oblong object marked with an X, is positioned at the top center of the vertically-mounted PW board. It has six separate grounding lances; the troublemaker is the one nearest the 6AQ5 socket.

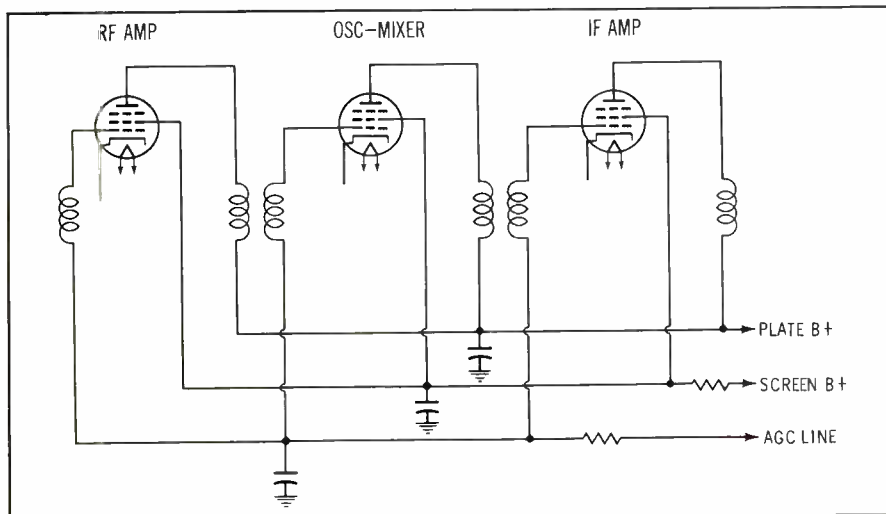

Fig. 5. In typical radio, bypass capacitors are common to several stages.

Tube Pin Not Contacting Socket

Regeneration was observed in a new 1960-model Motorola portable when the set was removed from the factory - sealed carton for pre-delivery testing. Knowing that regeneration troubles can be time-consuming, we debated whether to work on the set or to return it to the distributor. We decided that we would at least remove the back and examine the chassis. This inspection revealed that the first IF tube was inserted at an angle. We seated the tube correctly in its socket, and — no more regeneration. Judging from the position of the tube, it appears that the suppressor grid was not contacting its socket connection. Ah, if only more jobs could be this simple!

Above Ground—Above 100 mc

We once took in a Muntz 624 which presented the breakup symptom only on Channel 10. The other available channels (3 and 6) operated normally, so this was obviously a case of tuner trouble. We therefore proceeded to examine the tuner wiring, which was accessible after removing all the turret strips except those for Channel 10. Gently probing the wiring, we spotted a broken solder connection to ground from pin 2 of the 3BC5 RF tube. Resoldering this connection provided a cure. Reference to a tube manual supplied the interesting information that pins 2 and 7 are internally connected in a 3BC5 tube. This means that pin 2, even with no external connection, was still grounded through pin 7. The internal connecting lead, less than 1/4" long,

Introducing

Dry Battery
Point-of-Purchase
**PROFIT
PAK**

Plus Quality Profit

Eye-Catching New Self-Displayer Carton features 8 of the fastest-moving, performance-proved transistor battery types — needed for

- ✓ Radios ✓ Toys ✓ Flashlights
- ✓ Small Tools and Appliances, etc.

PLUS—Colorful Window Streamer

PLUS—Cross Reference Retail Price Guide



DRY BATTERIES BY FUJI ELECTRIC

Contact your Sameco Distributor Today or Write:

THE SAMPSON COMPANY
ELECTRONICS DIVISION
2244 S. Western Avenue
Chicago 8, Illinois

GC ELECTRONICS **ZERO-MIST**

FINDS TROUBLE FAST!

Cool circuits instantly and isolate intermittent defective components. Zero-Mist sprays on quickly and saves you time.

No. 8667 (16 oz. can) List \$3.65



G-C SPRAY GUN HANDLE makes a spray can easy to use. You get trigger-quick and accurate spraying. Fits any spray can. No. 9288 List Price \$1.49



G-C SPRAY-O-WAX—Now famous G-C Creme-O-Wax in a 16 oz. spray can. Gives a hard glossy finish. No. 96-12 (16 oz. can) List \$2.75



GC ELECTRONICS CO.
Division of Textron Electronics, Inc.
Western Plant: Los Angeles 18, Calif.
Main Plant: ROCKFORD, ILLINOIS, U.S.A.

SAMS PHOTOFAC INDEX

sent direct to your shop **FREE** SEND FOR IT!



Yes, now you can have the valuable SAMS MASTER INDEX TO PHOTOFAC FOLDERS and Index Supplements sent direct to your shop at no cost to you! Just mail coupon below and you'll be sure to receive regularly your handy guide to the world's finest service data covering over 33,000 TV, Radio, Amplifier, Tuner Tape Recorder and Changer models. Send for it—it's FREE!

MAIL COUPON Howard W. Sams & Co., Inc.
1720 E. 38th St., Indianapolis 6, Ind.

Put me on your mailing list to receive the Sams Photofact Master Index and Supplements

I'm a Service Technician: ___ full time; ___ part time

My Distributor is: _____

Shop Name: _____

Attn: _____

Address: _____

City _____ Zone _____ State _____

provided enough inductance to create regeneration on the high-VHF band without affecting the lower frequencies.

Alignment

... or more appropriately, misalignment — does not produce such a large number of regeneration cases as might be expected. Tuned IF circuits seem to tolerate a wide latitude of misadjustment before regeneration or oscillation sets in, except when two adjacent stages are peaked at the same frequency. Oscillation is then much more easily induced by improper alignment.

We once unearthed this condition in a Bendix T-19 which we were servicing for sync trouble. The poor sync was directly attributable to a shorted capacitor and a charred, off-value resistor. After replacing these, we could lock in a picture, but oh, what a picture! It had no clear definition, and was rich in multiple images. When we tried the "no antenna" test, raster breakup appeared, so we knew we were again face-to-face with our old friend, regeneration. Suspecting that the IF slugs had been fiddled with by the owner or his brother-in-law, we fired up the sweep generator and attached the scope. Honestly, the bandpass waveform was so jagged that I doubt it could be equaled intentionally. Happily, the bandpass responded to realignment, and we were able to return the set with good picture and sound.

Lead Dress

Regeneration due to poor lead dress is most often the result of previous servicing, during which certain critically-positioned wiring was unknowingly re-routed. For example, take the case of an RCA

Chassis KCS47 which presented typical symptoms of regeneration. In the shop, the usual cures were applied without success. Finally, it was noticed that the shielded cable feeding audio to the volume control was running almost parallel to the entire IF strip. Shifting the cable to its orthodox position along the end apron of the chassis cleared up the regeneration.

Disturbed lead dress can also cause the decline in picture quality and sync stability frequently noted in Muntz 624 receivers. Improvement calls for a careful repositioning of the leads in the last IF transformer. It is not possible to describe the operation as "shift red lead 1/2" forward," etc., but directions can be given as follows: Operate the set without an antenna and check for raster breakup. If breakup occurs, remove the shield covering the wiring beneath the second IF tube (a 6BA8); in doing so, look for evidence of the shield having been previously removed. Check the value of the bias resistor on the cathode of the 6BA8 pentode; it should be 100 ohms. Now, with the set on and regeneration present, separate and dress the leads of the transformer until the regeneration symptoms disappear from the raster. (Of course, a fiber or plastic dressing tool must be used in order to avoid detuning the circuit.) Now try the set on a station with normal antenna; a definite improvement in both picture and sync will very probably be revealed.

If further improvement in picture quality is sought, carefully tune the fine-tuning control for the best possible picture; then watch the screen while making further slight changes in the lead dress of the transformer.

Mercury Model 500 COMPONENT SUBSTITUTOR

PROVIDES A COMPLETE RANGE OF COMPONENTS AT YOUR FINGERTIPS FOR FAST SUBSTITUTION

SPECIFICATIONS

- Substitutes for 20 values of resistors from 33 ohms to 10 megohms
- Substitutes for 10 values of condensers from .0001 mfd. to .5 mfd.
- Substitutes for 10 values of electrolytics from 4 mfd. to 330 mfd.
- Substitutes for all power rectifiers up to 500 ma.
- Substitutes for all diodes
- Substitutes for power resistors... continuously variable up to 5000 ohms
- Substitutes for bias voltages... continuously variable up to 15 volts either polarity

\$29.95 Net

Model 500

See your electronics parts distributor!

MERCURY ELECTRONICS CORP. 77 SEARING AVENUE, MINEOLA, NEW YORK



One compact instrument substitutes for resistors, condensers, electrolytics, rectifiers, diodes, power resistors and bias voltage.

SAVE MONEY! No need to buy several different component substitutors... The Model 500 does the whole job!

This lead-dress problem has been uncovered in several receivers of this same model. In each case, the original cause of the trouble appears to have been a heater-to-cathode short in the 6BA8 tube, leading to a burn-out or change in value of the cathode resistor. Whenever this resistor is replaced, it is highly probable that the unsuspecting serviceman will accidentally move the transformer leads to incorrect positions.

Defective Decoupling— Common Cause?

TV servicemen who got their start in radio servicing are naturally inclined to troubleshoot regeneration in TV receivers by the same method they successfully employed to locate the cause of motorboating or chirping in radios. Most frequently the result is only a waste of time. Despite the fact that RF-IF regeneration produces comparable results in both radios and TV's, the actual cause is very often not the same.

In radios, regeneration is due to defective decoupling networks approximately 90% of the time. The balance of the problems are caused by poor shielding, tubes, lead dress, etc. On the other hand, regeneration in TV receivers is due to defective decoupling networks in only about 10% (or less) of all cases, and then only in receivers of simplified design. A comparison of RF-IF signal circuits in radio and TV receivers will immediately reveal why this is so. Fig. 5 is a typical circuit of the RF-IF portion of a radio, with emphasis placed on the decoupling networks; Fig. 6 is a schematic of the corresponding sections in a typical TV receiver. Note that the screen grids of all the various stages in the radio are tied together and bypassed with a single capacitor. The same is true of the plate and grid circuits. In Fig. 6, however, note that each individual element has its own RF bypass capacitor and series resistor to decouple it from the other feed lines in the B+ and AGC circuits. (In some receivers, the plate and screen of a stage share a common decoupling network, but isolation is still maintained between stages.)

Therefore, if an RF bypass on the common line feeding the various screen grids in the radio circuit were to open, regeneration or oscillation would almost certainly occur as a

Why "The Man On The Roof"

prefers

South River



for making superior television antenna installations

Take "Snap-In" Type CHIMNEY MOUNTS and WALL BRACKETS for instance . . .

Unique U Bolts instead of two screws make for quick, simple, antenna installation. Spring tension on steel mast retainers holds antenna mast while Special U Bolts are inserted and tightened. Saves installer time — permits greater safety. Same features are included in Snap-In Wall Brackets.

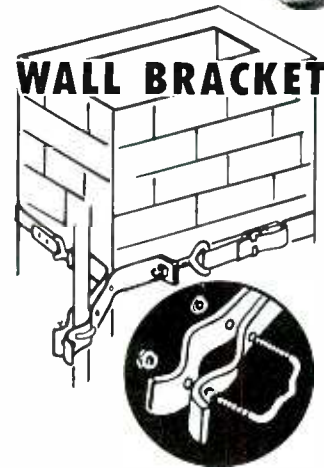

SN-50 CHIMNEY MOUNT
(Two To A Set)

*Products made better by design
— with the installer in mind*
MAKE IT EASY FOR YOURSELF
. . . Better for your Customers

Insist on mountings and accessories made by

South River **METAL PRODUCTS CO., INC.**
South River, New Jersey

PIONEER MANUFACTURER AND OUTSTANDING PRODUCER OF THE FINEST LINE OF ANTENNA MOUNTING ACCESSORIES

BERNS **PERFECT
PIN-CRIMPER**

Picture-Tube Repair Tool

*Eliminates that hard
soldering job.*

only \$1.25

PT-1

Fix loose pin connections in seconds. Pays for itself in time saved on one job alone. 3" long.

U. S. Pat. 2,878,698
Canadian Pat. 592,702

Intermittent operation of picture tubes due to defective solder connections at socket pins is easily corrected through the use of the Berns Perfect Pin Crimper. Actually a 3-in-1 tool that can also be used as a channel-selector wrench and screwdriver, it serves to notch pins and element leads to provide solid electrical connections. Pin keeps its original form.

3 models: PT-1 for 3/32" pin diameter; AU-2 for 1/8" pin diameter and installing C rings; LC-3 for 5/32" pin diameter.

Available at your parts distributor.
Another fine product from:

BERNS Mfg. Co.
9853 Chalmers,
Detroit 13, Mich

GC **ELECTRONICS** — **STACKPOLE**
CARBON RESISTORS

NEW Coldite 70+

A New Series Of Cold Molded Resistors Designed For The Most Stringent Requirements

Now you can get carbon resistors scientifically packaged to prevent damage. All values are clearly indicated in these handy re-usable boxes. Buy several now — then you'll always have what you need. Packed 3 or 4 to box — only 72c net each.

GC ELECTRONICS CO.
Division of Textron Electronics Inc.
West Plant: Los Angeles 18, Calif., Main Plant: Rockford, Ill., U.S.A.

ASK YOUR JOBBER
FREE CATALOG — send postcard today!

BUY WHAT YOU NEED!



NEW Walco

KOIL-PIK

EXACT REPLACEMENT TRANSFORMERS SAVE TIME IN SELECTION

NEW WALSCO KOIL-PIK TRANSFORMERS save you time and money because they're so easy to select—44 exact replacements that are clearly identified and protectively packaged.

EXACT REPLACEMENTS FOR

- IF & RF Coils & Transformers
- TV Sound Discriminators
- Miniature IF Transformers
- Portable Radio & Auto Capacitors
- Printed Circuit Capacitors

SEND FOR FREE CATALOG!



WALSCO ELECTRONICS MFG. CO.
 Division of Textron Electronics, Inc.
 West Plant: Los Angeles 18, California
 Main Plant: Rockford, Illinois, U.S.A.

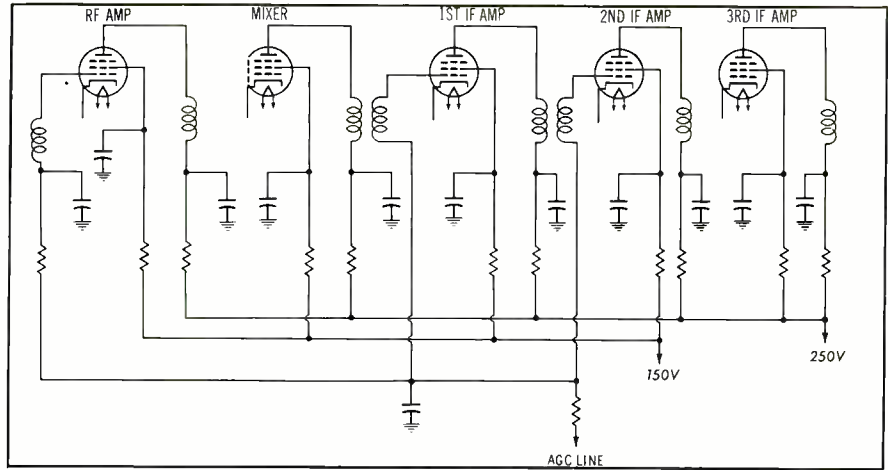

Fig. 6. TV sets usually have separate decoupling networks in each stage.

result of signal coupling between stages. But when one of the RF bypass capacitors in the TV circuit opens, the decoupling networks in other stages still maintain sufficient isolation so that regeneration is not likely to occur. The only symptom might be a drop in the gain of the affected stage. Exceptions are possible, of course, particularly when a common bypass capacitor on the AGC or filament line of a TV receiver opens. As a general rule, however, regeneration is not apt to occur in plate or screen-grid circuits unless the manufacturer has skimped on the use of decoupling networks, or unless several components have deteriorated at the same time.

Video Amplifier

We have said very little thus far about the possibility of regeneration in the video amplifier; however, this trouble is fairly common if ringing at various narrow frequency bands is considered, in its true light, as a form of regeneration. Normally it is caused by overpeaking at high video frequencies, perhaps due to the use of incorrect-value or insufficiently-

damped peaking coils in the video amplifier.

A rarer case of regeneration due to positive feedback in a two-stage video amplifier was described on pages 44 and 45 of the January, 1960 PF REPORTER.

Conclusion

Since a strong input signal often masks the presence of regeneration, there is a temptation to ignore the signs of this condition. However, if a tendency toward regeneration is present in a set, it will not usually perform as well as it should. Deficiencies are created in the "marginal" category (occasional vertical flipping, difficulty of adjusting the fine tuning for quiet sound, etc.); ridding the set of the regeneration tendency not only will cure the set of these marginal defects, but will also improve reception in other ways.

So, next time you're faced with a set whose performance isn't what should be expected from that particular model, give it the regeneration check. If it has this trouble, cure it; your customer will be glad you did. ▲



SIGNAL TRACER

Checks all stages from Antenna to Speaker or Picture Tube. Tests microphones, appliances, pickups, transformers, speakers, resistors, condensers, etc.

- Model 202 (with AF Probe) . . . Net \$37.50
- Model A Probe (RF Demodulator) Net 4.50
- Model B Probe (RF Demodulator, Amplifier) Net 7.50



VTVM KIT

Easily assembled! Solves numerous problems. Sensitive voltage measurements with negligible circuit loading. Accurate AC voltage ranges for checking line voltages, amplifier power output, frequency response. Positive and negative DC voltage ranges. Checks resistance. Radio, TV servicing; maintenance of electronic equipment; many other uses. Net \$27.95.

PRECISION ELECTRONICS, INC.
 9101-0 King Ave., Franklin Park, Illinois



Model 800 CRT TESTER-REACTIVATOR

✔ TESTS ✔ REPAIRS ✔ REACTIVATES ALL BLACK and WHITE and ALL COLOR picture tubes

TESTS

- Emission • Inter-element leakage • Life expectancy . . . estimates the remaining life of picture tube

REPAIRS

- Inter-element shorts
- Welds open elements

REACTIVATES

- Low emission tubes with a controlled high voltage pulse
- Reactivation is seen and controlled on the meter

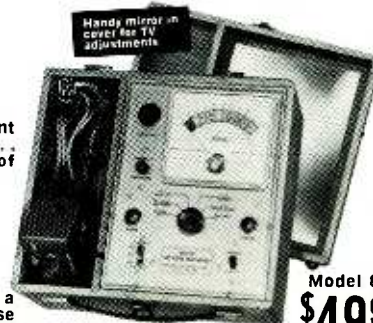

✔ Also accommodates the new 8-pin, 7-pin, and 14-pin base picture tubes

✔ Also provides the newer 2.35 and 8.4 filament voltages

✔ Tests the red, green and blue sections of color tubes separately

Model 800

\$49.95 Net

Housed in hand-some wood carrying case.

See your electronics parts distributor!

MERCURY ELECTRONICS CORP. 77 SEARING AVENUE, MINEOLA, NEW YORK

PRODUCT REPORT

For further information on any of the following items, circle the associated number on the Catalog & Literature Card.

Tube-Transistor Handbook (41W)

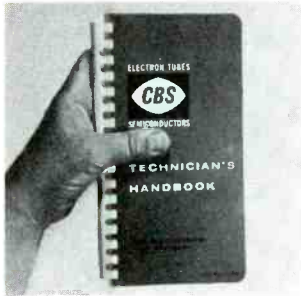

A revised 1960 edition of the CBS "Technician's Handbook" has just been issued. This 480-page, 5" x 9" book provides technical data for receiving, industrial, hi-fi, special-purpose, and foreign tubes; an expanded transistor and crystal-diode section; a complete picture-tube data chart; and a transistor cross-reference chart. The comb binding permits the book to lie open at any page. Price is \$1.95.

Jack for Thick-Panel Mounting (42W)

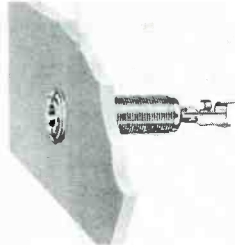

Equipped with an extra-long threaded barrel, the Switchcraft "Thick Panel Phone Jack" lends itself to mounting in a panel or wall up to 1 1/4" thick. This style of jack is designed to accept standard "Littell Plugs." Two types are available—two-conductor (Part No. 151) at a list price of \$1.35, and three-conductor (No. 152B) at \$1.50.

Mylar Capacitors (43W)

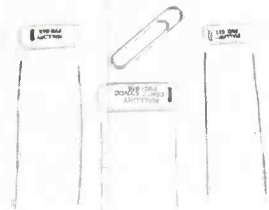

The light-blue outer coating of Mallory PVC capacitors is made of flexible polyvinyl chloride that allows the leads to be bent freely in any direction without risk of cracking the moistureproof seal. This material is also unaffected by heat applied during soldering. Units rated at 600 VDC are available in 42 values ranging from .001

to .47 mfd there are also three other series, respectively rated at 400, 200, and 100 VDC. Capacitance tolerance of all types is $\pm 10\%$.

Telephone Accessory (44W)



The RMS Model TA-4 "Ampli-Phone" allows the user to carry on phone conversations without holding the instrument to his ear. When the telephone receiver is placed on the unit's cradle, incoming voices are amplified and fed to a movable 4" speaker. (Output volume is adjustable.) For transmission in the other direction, a parabolic pickup device focuses room sounds on the telephone mouthpiece, effectively amplifying the outgoing portion of the conversation. Power requirement of the TA-4 is 110 to 120V, AC or DC; retail price is \$39.95.

plified and fed to a movable 4" speaker. (Output volume is adjustable.) For transmission in the other direction, a parabolic pickup device focuses room sounds on the telephone mouthpiece, effectively amplifying the outgoing portion of the conversation. Power requirement of the TA-4 is 110 to 120V, AC or DC; retail price is \$39.95.

Semiconductor Specialties (45W)

Several new series of semiconductor devices have been introduced by Sarkes Tarzian. High-voltage silicon cartridge rectifiers are available as ferrule-mounted or axial-lead units; PIV ratings of various types range from 1,000 to 16,000 volts. Silicon Zener voltage-regulator diodes are supplied in ratings from 5.6 to 100 volts at 1/4, 1, or 10 watts. A number of modular silicon rectifiers are also available for use as open bridges or for easy assembly into various 3- or 6-phase configurations.

from EICO... a completely new CITIZENS BAND TRANSCEIVER

that meets
FCC regulations*



Model 760: 117 VAC
Kit \$59.95 Wired \$89.95

Model 761: 117 VAC & 6 VDC { Kit \$69.95
Model 762: 117 VAC & 12 VDC { Wired \$99.95
incl. mtg. bracket (Pat. Pend.)

*EICO premounts, prewires, pretunes, and seals the ENTIRE transmitter oscillator circuit to conform with FCC regulations (Section 19.71 subdivision d). EICO thus gives you the transceiver in kit form that you can build and put on the air without the supervision of a Commercial Radio-Telephone Licensee!

Highly sensitive, selective SUPERHET (not regenerative) receiver with 5 1/2 dual function tubes and RF stage. Continuous tuning over all 23 bands. Exclusive Super-Hush® noise limiter. AVC. 3" x 5" PM speaker. Detachable ceramic mike. 5-Watt crystal-controlled transmitter. Variable "pi" network matches most popular antennas. 12-position Post-Lock® mounting bracket. 7 tubes and 1 crystal (extra xtals \$3.95 each). Covers up to 20 miles. License available to any citizen over 18—no exams or special skills required, application form supplied free. Antennas optional.

YOU PROFIT WITH EICO

Everything in top-quality
TEST EQUIPMENT for Shop
and Field—at savings of 50%.



COLOR & Mono DC-5MC
Lab & TV 5" Oscilloscope #460
Kit \$79.95, Wired \$129.50
5" Push-Pull Oscilloscope #425
Kit \$44.95, Wired \$79.95



Peak-to-Peak VTVM #232 & *UNI-PROBE®
Kit \$29.95, Wired \$49.95
*U. S. Pat. No. 2,790,051
Vacuum Tube Voltmeter #221
Kit \$25.95, Wired \$39.95

More typical EICO values: Signal Generators from \$19.95, Tube Testers from \$34.95, Sweep Generators from \$34.95, Power Supplies from \$19.95, VOMs from \$12.90.

Everything in CUSTOM HI-FI:
finest quality at 1/2 the cost.



FM Tuner HFT90
Kit \$39.95, Wired \$65.95
Cover \$3.95. Includes FET.
AM Tuner HFT94
Kit \$39.95, Wired \$65.95
Includes Metal Cover and FET.
FM/AM Tuner HFT92
Kit \$59.95, Wired \$94.95
Includes Metal Cover and FET.



Stereo Dual Amplifier-Preamp HF81
Kit \$69.95, Wired \$109.95
Includes Metal Cover.
Stereo Dual Amplifier AF4
Kit \$38.95, Wired \$64.95
Includes Metal Cover.

Write for free catalog PF-12 and name of nearest distributor.
Most EICO distributors offer budget terms.

EICO

3300 N. Blvd., L.I.C. 1, N. Y.
Add 5% in the West

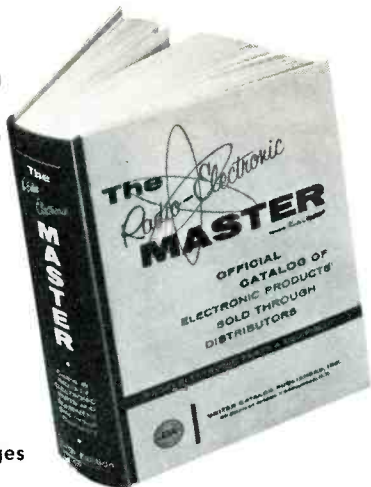
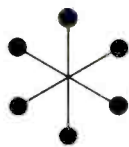

1600 pages



- IT'S NEW. Covers all the latest products for servicing radio-TV-hi-fi and industrial equipment: • miniature and sub-miniature components • printed circuit components • silicon rectifiers • stereo equipment • automatic test equipment • citizens band, SSB and mobile ham gear, etc.
- IT'S THE WORLD'S BIGGEST ELECTRONIC CATALOG. 1600 pages—more than 175,000 items—with specifications, illustrations and prices. Contains hundreds of items not found in smaller catalogs.
- IT'S THE EASIEST TO USE. Quickest way to get current catalog data on the products of more than 330 manufacturers. Systematically organized in 32 product sections for rapid reference.
- SAVES TIME AND MONEY FOR SERVICE TECHNICIANS. Whether you're servicing radio, TV, audio or industrial electronic equipment, you find the right part to do the job best in The MASTER. The reason: you're shopping in the electronic supermarket. The MASTER is easy to sell from because it contains list prices. It's easy to buy from because your distributor has it and all you need do is select the item you want and order by part number. No matter what product or component you require, you'll find it faster in the 1961 MASTER.

AND IT'S NOW AVAILABLE AT
YOUR LOCAL DISTRIBUTOR

1961 MASTER

\$3.95 at parts distributors
\$4.95 in Canada

FREE from your distributor: New Foreign Tube Interchangeability Guide, or write direct, enclosing 25c.

RADIO-ELECTRONIC MASTER — 60A MADISON AVE., HEMPSTEAD, N. Y.

25-Watt Rheostat (46W)

The standard version of the **Tru-Ohm RE-25** "Economy" power rheostat has a resistance range of 25 to 500 ohms with $\pm 10\%$ tolerance. Its power rating is 25 watts in free air. This unit has three terminals, permitting its use as a potentiometer rather than as a rheostat, if so desired. Optional features, available on special order, include lower or higher resistances, various special types of lugs, an "off" position (in "dead-lug" types), and detent action at either end of rotation.

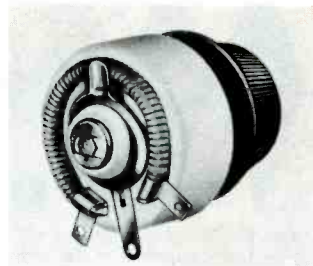

Pocket-Size Soldering Iron (47W)

The "Solder-Chief" Model A-1000 pencil iron, manufactured by **L. I. Electro-Labs**, has a removable hollow handle which can be utilized as a sheath for the soldering tip — permitting the iron to be transported safely while still hot. Length is 10½" in use, 6½" when closed; weight is 13 oz.; power rating is 30 watts.

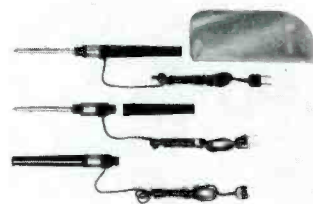

Ceramic Microphone (48W)

An omnidirectional, high-impedance ceramic microphone for audio-visual labs, PA systems, and communication stations, the **Sonotone Model CM-17** "Flex-Mike" has a rubber-cushioned transducer mount for increased shock resistance. The flexible 13" stand terminates in a removable mounting plate. Sensitivity is -56 db, and frequency response is 50 to 13,000 cps with a controlled amount of midrange boost for added "presence." Price is \$24.50.



Mast-Mounted VHF Preamp (49W)

The two-tube **Jerrold Model DSA-202** "De-Snow" preamplifier provides 20-db gain on all VHF-TV channels, with a maximum noise figure of 4.5 db on the low band and 6 db on the high band. An improved type of remote power supply includes a switch to adjust the amplifier-supply voltage according to cable length. A sliding cover on the 8½" x 6¼" x 4" case gives access to the tubes. List price is \$79.95.

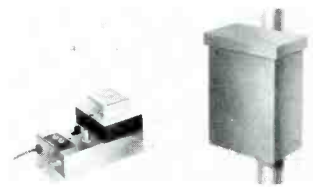

AC-DC Radio Tubes (50W)

Some of the newest AC-DC radio receivers are using tubes with a 100-ma heater current (instead of the conventional 150 ma) for the purpose of reducing heat dissipation. **RCA** has announced a series of five tubes for this service, including the 18FX6 pentagrid converter, 18FW6 IF pentode, 18FY6 twin diode/high- μ triode, 34GD5 beam-power output tube, and 36AM3A rectifier. A different series, for low-cost four-tube radios, comprises the 36AM3A, 18FX6, 20EQ7 detector diode/IF pentode, and 50FK5 high-sensitivity power-output tube. The audio and rectifier tubes in these groups are also applicable to inexpensive stereo phonograph circuits.

Wire-Wound Resistors (51W)

Six different wattage sizes of **IRC Type PW** resistors are available—3, 5, 7, 10, 15, and 20 watts. The wire element is wound on a glass fiber core and sealed in a rectangular ceramic case filled with a fireproof, inorganic material. Ranges of values available are as follows: For 3 and 5 watts, 0.1 to 7500 ohms; for 7 watts, 0.1 to 18K ohms; for 10 and 15 watts, 0.18 to 30K ohms; and for 20 watts, 0.6 to 5100 ohms. Both 5% and 10% tolerances are furnished.

VU Meter (52W)



A VU meter for precise indication of recording level in tape recorders, the **Robins Model VU-100**, has both low- and high-impedance inputs. A 200-ua meter movement produces readings on a 2-color scale covering a range from -20 to +3 VU; in addition, there is a 0-100% modulation scale. The unit is 1½" deep and mounts in a 2¾"-diameter hole; its list price is \$22.

Audio Transformers (53W)



Chicago Standard Transformer Corp. has announced a 65-watt high-fidelity audio output transformer, the **BO-15**, intended for use with 6550, EL34, or KT88 tubes in a 40- or 60-watt amplifier having tertiary feedback. Complete construction details for these amplifiers are available on request. Also newly introduced are three new PA transformers for matching 8- and 16-ohm speaker voice coils to a 70.7-volt line. Model numbers and power ranges are as follows: A-8080, 1-5 watts; A-8081, 6-10 watts; and A-8082, 11-15 watts.

Switches and Controls (54W)

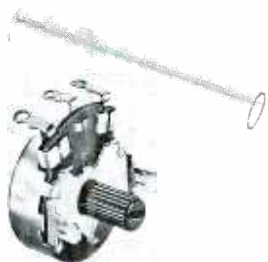

Centralab Model TT controls have very short, slotted shafts, and a 2" polyethylene tube is packed with each control for use as a shaft extension where needed. These half-watt, twist-tab units come in 25 values from 200 ohms to 7.5 megohms. Other new products include a complete line of push-pull and push-push on-off switches in universal - shaft, "Adashaft," "Fastatch," and stereo-twin types, plus a No. 1486 "Local - Remote - Both" stereo speaker switch.

Stereo Changer (55W)

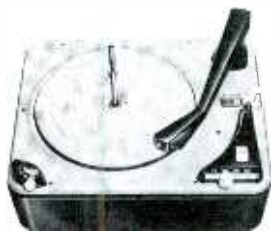

The **EICO "Dual-1007"** can operate as a changer accommodating up to 10 records, or as an automatic or manual single-record player. Included with the unit is a snap-in stereo crystal cartridge with dual styli—0.7 mil diamond and 3-mil sapphire in Model 1007D (\$59.75), or 0.7- and 3-mil sapphires in Model 1007S (\$49.75). Accessories include metal base MB-1 at \$3.95, automatic 45-rpm spindle 45AS at \$4.80, and precut wood mounting board WM-1 at \$2.40.

Phono Preamp (56W)

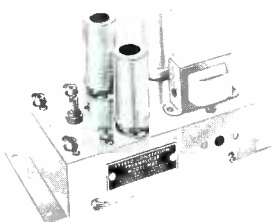

The **Shure Model M65** pre-amplifier provides the added small-signal amplification and equalization needed to operate a magnetic cartridge with an amplifier originally designed for a ceramic cartridge (for example, most of those included in packaged stereo phonographs). The only restriction is that the changer used with the preamp must have a 4-pole motor to avoid excessive hum. The M65, which can also be employed as a tape or mike preamp, is priced at \$24.

BUY PYRAMID! GET MORE!



Only Pyramid offers you so much! Only Pyramid gives you highest quality capacitors plus so many "all new" extras.

THE VU-PAK

An entirely new way to package capacitors . . . clear plastic tubes, plainly labeled and packed with the highest quality electrolytic twist-mount capacitors. Each re-usable Vu-Pak comes with a blank label, ideal for storing small parts and tools on your bench or in your tool kit.

EXTRA OFFER!

Save 50 Vu-Pak labels and get the fabulous new Pyramid storage rack the **Capac-o-mat**, at tremendous savings from your authorized Pyramid distributor. The **Capac-o-mat** fits right on your shelf, is dust-free and holds 54 Vu-Paks.

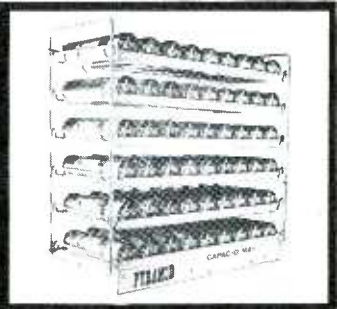

JEWEL BOX

Handsome tan plastic, high impact cabinet with 9 drawers, contains 45 assorted Mylar*-paper Gold Dip capacitors, type 151. Practical . . . convenient . . . for storage in your shop, or home. Actual value of the Jewel Box with 45 Gold Dip capacitors—\$19.50, dealer net only \$9.25.



Gold Dip capacitors are also available in Clear-Vu paks . . . 5 to a package. Find them on Pyramid's new Whirl-o-mat on your favorite parts distributor counter.

"GOLD STANDARD" 111 KIT

Clear lucite hinged box containing 75 Pyramid's popular assorted Gold Standard Mylar* capacitors. You'll find so many uses for the Gold Standard 111 Kit. Actual value is \$26.00, dealer net only \$13.00.



515 LYTIK-KIT

Hinged cover, clear lucite box with 15 assorted miniature low voltage electrolytic capacitors for transistorized circuit replacements, type MLV. This Kit is a constant companion to any busy serviceman. Actual value, \$20.60, dealer net only \$10.30.



PYRAMID ELECTRIC COMPANY

DISTRIBUTOR DIVISION: UNION CITY, NEW JERSEY

Factories: Gastonia, North Carolina • Darlington, South Carolina
In Canada: Wm. Cohen, Limited, 8900 Tanguay Street, Montreal
Export: Morhan Exporting Co., 485 Broadway, New York 13, N. Y.

December, 1960

Admiral Corp.	58
Aerovox Corp.	42
American Television & Radio Co. (ATR)	16
Amperex Electronic Corp.	41
B & K Mfg. Co.	47
Belden Mfg. Co.	33
Berns Mfg. Co.	67
Blonder-Tongue Labs	61
Bussmann Mfg. Co.	37
CBS Electronics	43
Castle TV Tuner Service	51
Centralab, A Div. of Globe-Union, Inc.	57
Chemical Electronic Engineering, Inc.	40
Chicago Standard Transformer Corp.	53
Cornell-Dubilier Electric Corp.	18-19
Delco Radio Div. (GMC)	49
Duotone Co., Inc.	62
EICO	69
Eastern Jewel Corp.	58
Electro Products Laboratories, Inc.	63
General Cement Mfg. Co.	66, 67, 68
General Electric Co. Receiving Tube Dept.	35
Television Receiver Div.	39
JFD Electronics Corp.	21
Jackson Electrical Instrument Co.	72
Kester Solder Co.	63
Littelfuse, Inc.	4th cover
Los Angeles Tuner Exchange	38
Mallory & Co. Inc., P. R.	22-23
Mercury Electronics Corp.	50, 62, 66, 68
Merit Coil & Transformer Corp.	45
Miller Co., J. W.	20
Mosley Electronics, Inc.	36
Perma-Power Co.	52
Precision Electronics, Inc.	68
Precision Tuner Service	62
Pyramid Electric Co.	71
RCA Electron Tube Div.	3rd cover
RCA Institutes, Inc.	32
RCA Sales Corp.	25
Rider Publisher, Inc., John F.	40
Sampson Co., The (Electronic Div.)	64, 65
Sams & Co., Inc., Howard W.	50, 54, 55, 66
Sarkes Tarzian, Inc. Semiconductor Div.	59
Tuner Div.	46
SENCORE	12-13, 14-15
Sonotone Corp.	38
South River Metal Products	67
Sprague Products Co.	10
Standard Kollsman Industries, Inc.	2nd cover
Sylvania Electric Products, Inc. Electronic Tube Div.	9
Home Electronics Div.	44
Semiconductor Div.	56
Tung-Sol Electric, Inc.	17
United Catalog Publishers	70
Winegard Co.	34
Xcelite, Inc.	48



MODEL 598					MODEL 648					MODEL 658																			
Tube Type	Fil.	D.	E.	Plate	A.	B.	C.	Crnt.	E.	F.	G.	Tube Type	Fil.	D.	E.	Plate	A.	B.	C.	Crnt.	E.	F.	G.						
2EY5	2.5	A234	AC156	20	21	25	3Y	2	4	5	1	6	30	2EY5	2.5	A234	AC156	20	21	25	3Y	2	4	5	1	6	30		
2EY5	2.5	A234	AC156	20	21	25	3Y	2	4	5	1	6	30	2EY5	2.5	A234	AC156	20	21	25	3Y	2	4	5	1	6	30		
6E03	6.3	A234	AC156	20	21	25	3Y	2	4	5	1	6	30	6E03	6.3	A234	AC156	20	21	25	3Y	2	4	5	1	6	30		
12BM7	12.6	A234	AC156	20	21	25	3Y	2	4	5	1	6	30	12BM7	12.6	A234	AC156	20	21	25	3Y	2	4	5	1	6	30		
		A234	A17	26	2	82																							

ANTENNAS AND ACCESSORIES

- 1W. FINNEY — Large Performance Guide wall chart describing complete line of Field-Proven TV and FM antennas, specifying performance of each FINCO antenna as determined through use of the Mobile Research Laboratory Unit.
- 2W. JFD—1960 Exact-Replacement Antenna Guide for Portable and Toteable TV sets (20 pages), compiled and edited by Howard W. Sams & Co., Inc. Gives TV receiver model number, manufacturer's antenna part number, and model number of corresponding JFD exact-replacement antenna. Also Form 940 dealer catalog illustrating and describing 1960 line of natural silver and gold anodized Hi-Fi TV antennas, mounts, masts, and accessories. See ad page 21.
- 3W. MOSLEY—Catalog of TV antenna and audio accessories; also sample mailing piece designed to help service dealers promote Model F-1PK TV Wall Outlets. See ad page 36.
- 4W. WINEGARD—Descriptive catalog with schematic drawing on 1- to 30-set distribution amplifier Model A-400. See ad page 34.

AUDIO & HI-FI

- 5W. CBS ELECTRONICS—Retail price list and cross-reference chart of CBS-Ronette phono cartridges. See ad page 43.
- 6W. DUOTONE — "How-to-" booklet on identifying and replacing phono needles; wall chart of replacement-needle data; needle identification and replacement catalog to bona fide dealers and repairmen. See ad page 62.
- 7W. EICO—New 28-page 1960 catalog of kits and wired equipment for stereo and monophonic hi-fi. test instruments, "ham" gear, Citizens band transceivers, and transistor radios. Also "Stereo Hi-Fi Guide" and "Short Course for Novice License." See ad page 69.
- 8W. SWITCHCRAFT — New-product bulletins on Thick Panel Phone Jack for mounting in any panel up to 1 1/4" thick, and on TR Series Micro-Plugs which match ultra-miniaturized Micro-Jax.

COMPONENTS

- 9W. BUSSMANN—Three-color bulletin on two types of Stak-Pak fuse assortments, showing TV servicemen how new packaging idea provides convenient way to carry a complete line of fuses at all times. See ad page 37.
- 10W. CHICAGO STANDARD—Form P-60-P, short-form TV Replacement Guide. See ad page 53.
- 11W. EASTERN JEWEL—Catalog 160 describing exact replacement line of printed-circuit electrolytics, and non-polarized types for hi-fi crossover networks; miniature "buzz" controls; ferrite rod antennas; push-push switches; frozen yoke remover. See ad page 58.
- 12W. PYRAMID — New "hang-up" Catalog J-10 on expanded line of replacement capacitors. See ad page 71.
- 13W. SPRAGUE—44-page Catalog C-613a, describing all popular replacement components in company's line. See ad page 10.
- 14W. SAMPSON — Transistor Battery Data and Reference Guide, with size, price, and cross-reference data on batteries used in Japanese transistor radios; also information on "Point-of-Purchase Profit Pak," a counter display for Samsco dry batteries. See ads pages 64, 65.
- 15W. WORKMAN—Catalog sheet describing non-inductive dummy load resistors available in ratings from 10 through 500 watts for service-shop and industrial applications, and for special functions such as parasitic suppression.

PROMOTIONAL AIDS

- 16W. SYLVANIA — Free booklet No. 2015, "And Now a Word From Sylvania," telling dealers how to tie in with national advertising campaign featuring the most successful salesman in the U.S.A. — Arthur Godfrey. See ad page 9.

RADIOS & PHONOGRAPHS

- 17W. ELECTRONIC PRODUCTS CORP.—Brochure and dealer price list on battery-operated, transistorized Futura portable phonographs, radios, and combinations.

SERVICE AIDS

- 18W. CASTLE—Leaflet describing fast overhauling service on television tuners of all makes and models. See ad page 51.
- 19W. CHEMICAL ELECTRONICS — Descriptive folder on HUSH, EVER QUIET, EVER KLEER, and SURE-N-EASY electronic chemicals. See ad page 40.
- 20W. PRECISION TV TUNER — Information on repair and alignment service available for any type of TV tuner. See ad page 62.
- 21W. SWING-O-LITE—Literature on In-

spector swiveling bench lamp with fluorescent bulb and built-in magnifying lens, and on Craftsman shaded bench lamps in choice of goose-neck and swinging-arm styles.

22W. VIDAIRE—Comprehensive catalogs of TV-radio accessories, service aids, and hi-fi accessories; also cross-reference sheet on power transistors.

SPECIAL EQUIPMENT

- 23W. ATR—Data on complete line of emergency lighting and power supply units for use in the event of commercial power-line failure. See ad page 10.
- 24W. RADIO MERCHANDISE SALES (RMS) — Information on Model TA-4 Ampli-Phone which enables user to carry on telephone conversations while phone receiver rests on desk or table.

TECHNICAL PUBLICATIONS

- 25W. GENERAL ELECTRIC—10-page guide to profitable servicing, Techni-Talk, with work-saving short cuts, and photographic reproductions of TV faults. See ad page 35.
- 26W. J. W. MILLER—Vol. 1, Nos. 1 and 2 of The Coil Forum, a new technical bulletin to assist electronics experimenters in designing and constructing equipment, featuring hints on wise use of coils. Also data sheet on J-Tran miniature IF transformers. See ad page 20.
- 27W. MOTOROLA—Complete brochure describing Motorola Institute training course on two-way radio communications, plus sample lesson SA-7 on transistorized receiver circuits.
- 28W. RCA INSTITUTES — 64-page illustrated booklet describing comprehensive training program for home study, ranging from electronics fundamentals to transistors and automation. See ad page 32.
- 29W. RIDER—Latest book list. See ad page 40.
- 30W. HOWARD W. SAMSON—Literature describing all current publications on radio, TV, communications, audio and hi-fi, and industrial electronics servicing. See ads pages 50, 54, 55, 66.
- 31W. SYLVANIA HOME ELECTRONICS — Information on availability of service literature on television, radio and high fidelity, and monthly Service Digest. See ad page 44.

TEST EQUIPMENT

- 32W. B & K—Bulletin AP16-R gives information on new Model 1076 Television Analyst, Models 1070 and A107 Dyna-Sweep Circuit Analyzers. Models 550, 650, 675, and new 685 Dyna-Quik dynamic mutual conductance tube testers, new Model 610 Test Panel, new Model 160 Transistor Tester, and Model 440 CRT rejuvenator-tester. See ad page 47.
- 33W. ELECTRO PRODUCTS — Information on Model PS-3 low-cost regulated DC power supply for servicing transistor circuits. See ad page 63.
- 34W. MERCURY—Bulletin 103, giving complete specifications on new Model 103 tube tester plus full information on other instruments in the line. See ads pages 50, 62, 66, 68.
- 35W. SENCORE—New booklet. How to Use the SENCORE Sweep Circuit Troubleshooter, plus brochure on complete line of time-saver instruments. See ads pages 12-13, 14-15.

TOOLS

- 36W. BERNIS—Data on 3-in-1 picture-tube repair tool, on Audio Pin-Plug Crimper that lets you make pin-plug and ground connections for shielded cable without soldering, and on ION adjustable beam bender. See ad page 67.
- 37W. L. I. ELECTRO-LABS — Flyer on Solder-Chief Model A-1000 Solder-Pen, a 30-watt pencil-type iron with removable handle which fits over the tip so the iron can be carried around while still hot.

TUBES AND TRANSISTORS

- 38W. AMPEREX — New 25-page condensed catalog containing descriptions and specifications on full line of tubes. Covers cold cathode trigger types, entertainment tubes, ignitrons and thyratrons, magnetrons, klystrons, noise diodes, power tubes, photomultiplier tubes, radiation counter tubes, traveling wave and UHF special tubes. See ad page 41.
- 39W. ELECTRONIC TRANSISTOR CORP.—Transistor interchangeability chart—recommended replacements from American-made ETCO 1800 Series for Japanese types.
- 40W. SAMPSON — Hitachi receiving-tube manual, giving extensive specifications, basing diagrams, and outlines for complete tube line; also catalog sheet with color photos and descriptions of Hitachi broadcast-band and two-band transistor radios. See ads pages 64, 65.



FRONT PAGE NEWS

NOW FOR A LIMITED TIME, GET VALUABLE SERVICE AIDS AND GIFTS WHEN YOU BUY RCA TUBES!

RIGHT NOW'S the best time to stock up on the RCA receiving tubes you'll need through the coming season. Shown here are *just a few* of the exciting gifts and premiums you get FREE with RCA tubes purchased from participating RCA distributors.

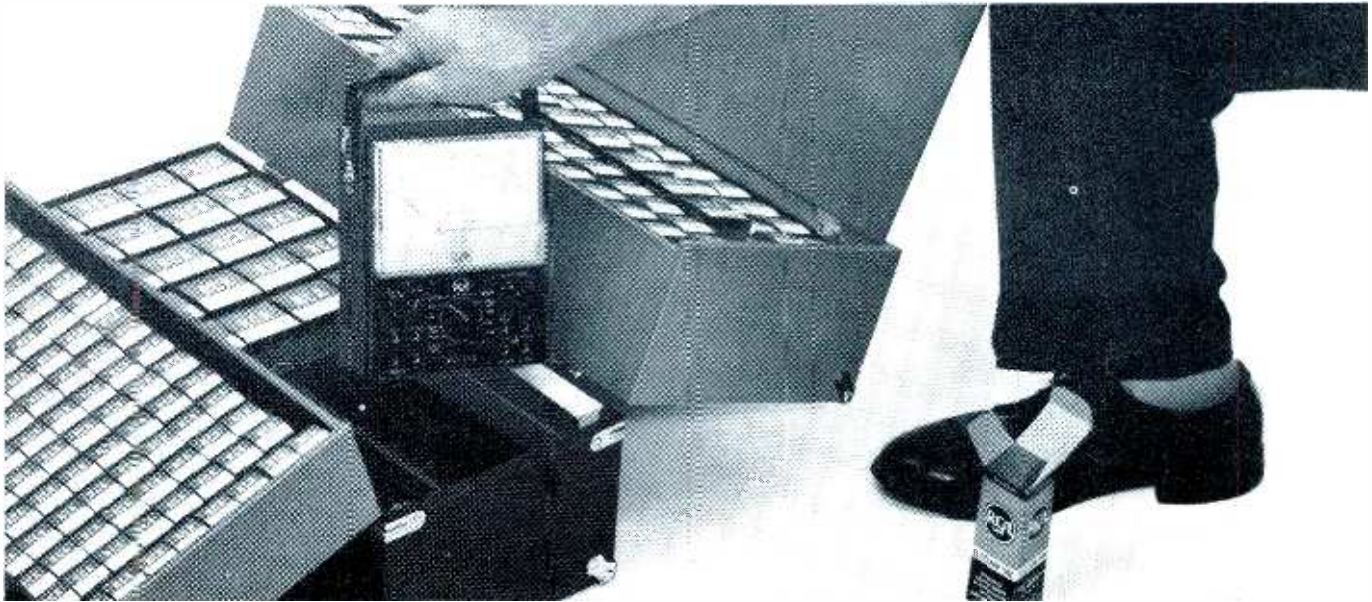

RCA METER-CHEST—a combination of famous RCA WV-38 VOM and "Treasure Chest" Tube Caddy. 750 tubes!*



TV TOTER TABLE—simplifies moving heavy chassis. 350 tubes.*

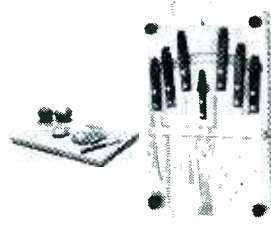

CUTLERY SET—7 utensils and cutting board. 325 tubes.*

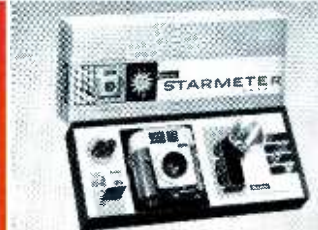

KODAK BROWNIE PHOTO OUT-FIT—550 tubes.*



BROWNIE 8 MOVIE CAMERA—575 tubes.*

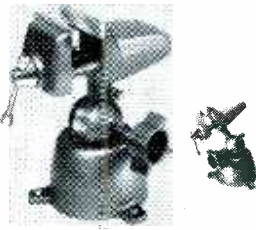

PANAVISE—for easier bench work. 300 tubes.*

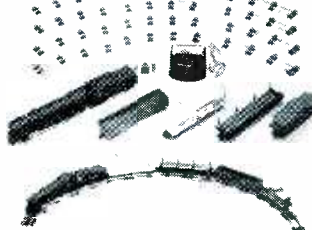

ELECTRIC TRAIN SET—350 tubes.*



MAN'S WATCH—precision swiss movement. 475 tubes.*



LADY'S WATCH—precision swiss movement. 475 tubes.*

For complete selection of gifts and full details, check with your participating RCA distributor.

*Suggested Value



The Most Trusted Name in Electronics
RADIO CORPORATION OF AMERICA

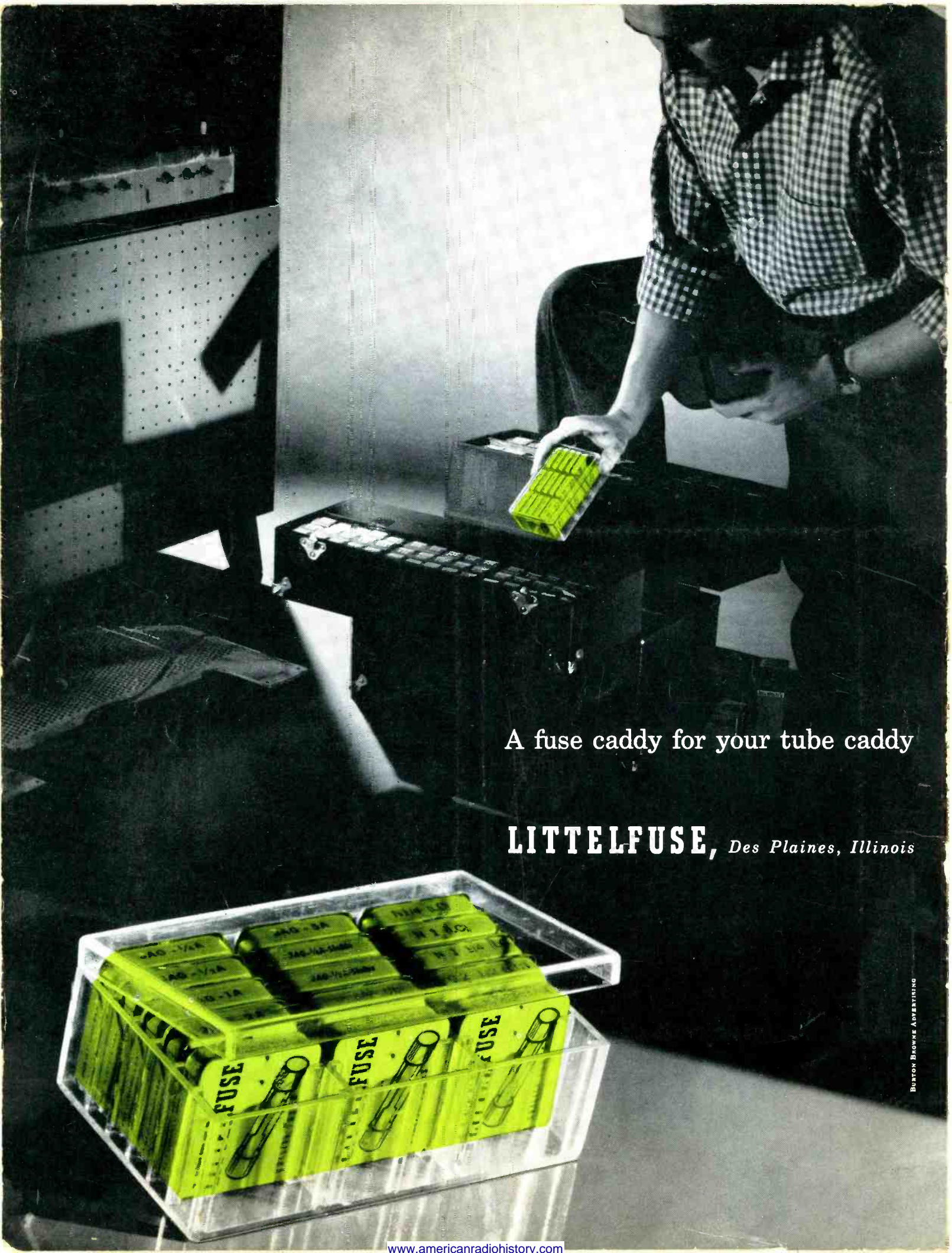

A fuse caddy for your tube caddy

LITTELFUSE, *Des Plaines, Illinois*

BURTON BROWN ADVERTISING