

FEBRUARY, 1960 35 CENTS



# PHOTOFACT REPORTER

including **Electronic Servicing**



**What About This New Citizens Band Service?**

**Analyzing Hi-Fi Troubles in the Home**

**Dealing With "Tough-Dog" Sync Troubles**

**Replacing Flyback Transformers**

OMAHA 17, NEBR.  
4660 - L - ST.  
RICHARD GAHL  
IA SM 1252 767

**kills TV tuner  
noise fast  
while it  
cleans and  
lubricates!**



**Walsco  
CONTACTENE  
IN THE HANDY SPRAY CAN**

**MAKES SPEEDIER SERVICING A CINCH**

For eliminating noise on controls, switches, tuners and other mechanical components, there's nothing better than fast-acting, easy-to-use WALSCO CONTACTENE in the handy spray can. Fast-drying Contactene lubricates as it cleans, is absolutely non-oxidizing. Specially compounded solvent removes coatings of oxide, grease, dirt and corrosion without harming metal or insulation. Always use Walsco Contactene . . . the complete cleaner-lubricant in one handy can.

**No. 80-12 Giant 16 oz. size only \$1.49 Dealer Net**

Also available in 6 oz. size No. 80-06

**WALSCO PHONO DRIVES**

. . . the only complete line of replacement phono and recorder drives and belts on the market, includes all the latest model turntables and changers.



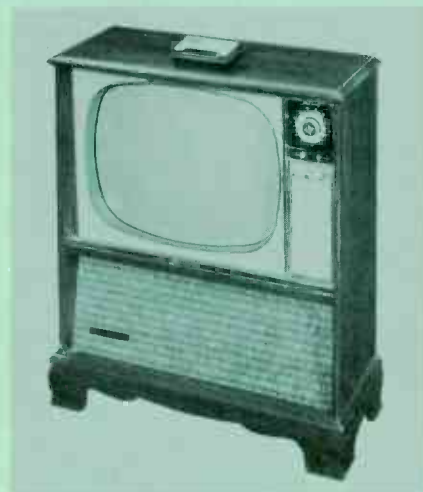
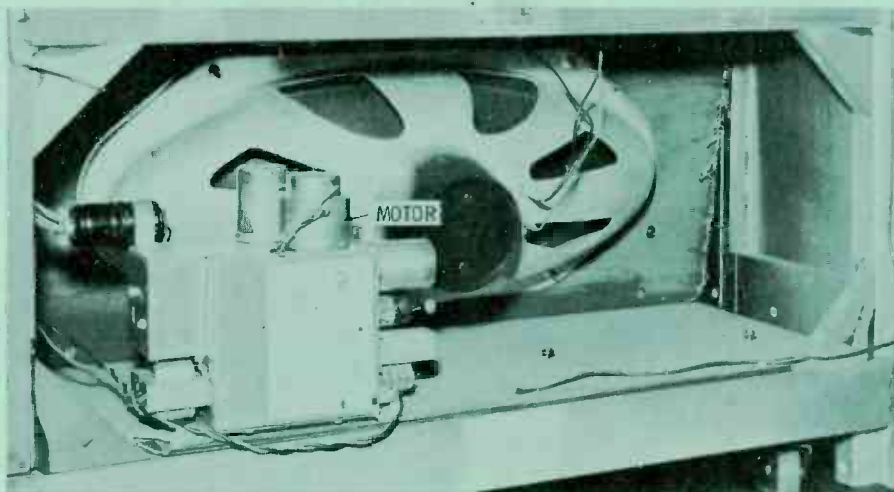
**WRITE** for your free copy of the big Walsco Catalog. Send postcard today!



**Walsco ELECTRONICS MFG. CO.**  
Division of Textron Inc.

West Plant: Los Angeles 18, California • Main Plant: ROCKFORD, ILLINOIS, U.S.A. • Canada: Atlas Radio Corp., Ltd., Toronto 19

**YOU CAN GET WHAT YOU WANT FROM WALSCO!**



### General Electric Model 21C3580—Chassis U4

This 21" console from GE's *Designer* line houses a 17-tube VHF chassis with remote control. Front panel controls include channel selector, fine tuning, bass, treble, brightness, contrast, vertical hold, and volume with push-push off/on switch.

The most outstanding thing about the rear view of the set is the unique 9" x 21" speaker which occupies most of the speaker compartment. The remote-control receiver is also housed in this area, and is on continually whenever the remote-manual switch is in the remote position. Included in this receiver is a motor to control the volume level.

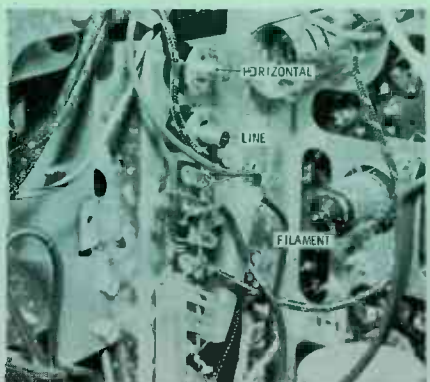
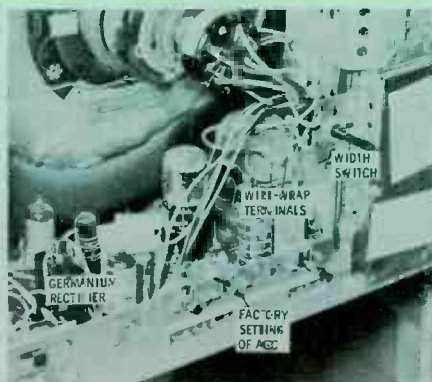
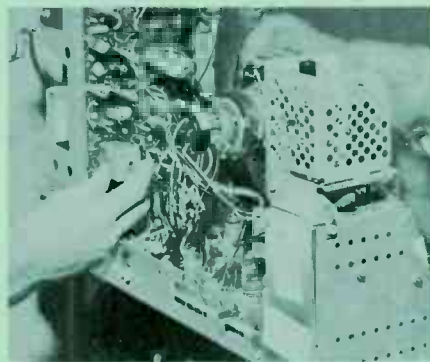
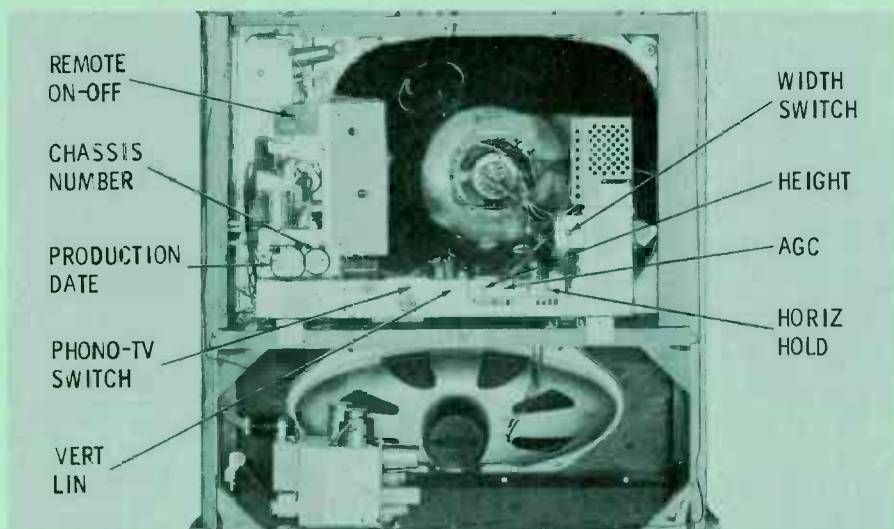
The "U"-shaped chassis is identified by a rubber-stamped production date and chassis designation. The vertically-mounted printed board on the left has all the main TV circuits, while the bottom one contains those for power, sync, and sweep oscillators. The chassis section on the right contains the horizontal output, damper and HV stages.

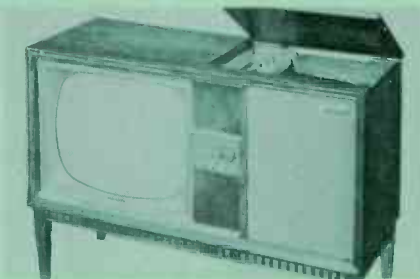
This set has a real "jazzy" setup for channel selection. It can be tuned manually by rotation of the inner control knob which, when pulled outward, serves also as the fine-tuning and channel-programming adjustment. Rotating it approximately 6 turns counterclockwise causes the channel to be skipped on remote tuning. Surrounding this central knob are individual push-buttons for power selection of any channel. Then, of course, there is the wireless remote-control selector which was the subject of a feature article in the September, 1959 issue.

Practically all trouble analysis work can be performed without chassis removal due to the positioning of the chassis in the cabinet, easily removed shields, and other features.

Other interesting features are the wire-wrap terminals on the filter capacitor providing the focus voltages, a painted stripe showing the factory setting of the AGC control, and a width switch to permit fixed values of inductance to be selected.

All protective devices are grouped together near the tuner, including a 3-amp type-C line fuse, a 3/10-amp slow-blow type N fuse for the horizontal circuit, and a length of #26 wire as tube filament protection.





### Packard-Bell Model 21K2 Chassis TVP-2, TVT-2, 7TV-3

This 21" model combines television, AM and FM radio, and a 4-speed stereo phono into one modern-styled cabinet. The front controls for off-on, contrast, brightness, volume, channel selection and fine tuning are all clustered in a plastic escutcheon. The cross-hatch design on this control panel has a functional purpose. The channel numbers are illuminated on the individual squares as the miniature "rabbit-ear" selector knob is rotated. The phono compartment contains controls for radio tuning, function selector, loudness and balance (the slip-clutch variety where the inner knob for balance must be pushed down and rotated while holding the loudness knob), bass (with push-pull switch for AFC), and treble.

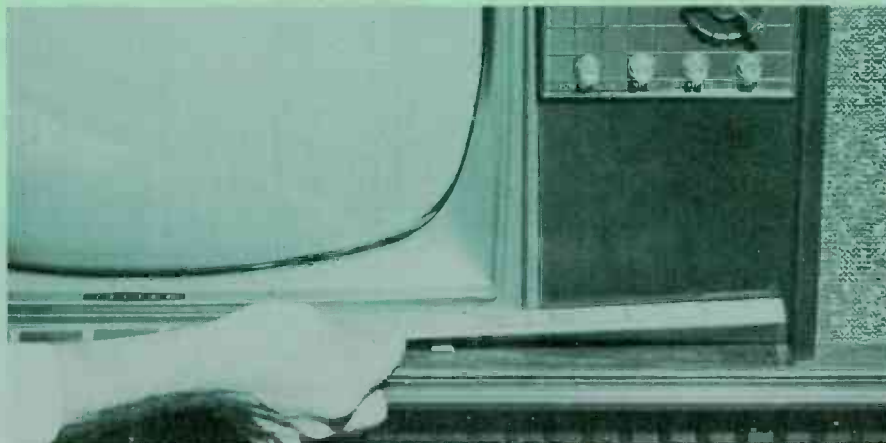
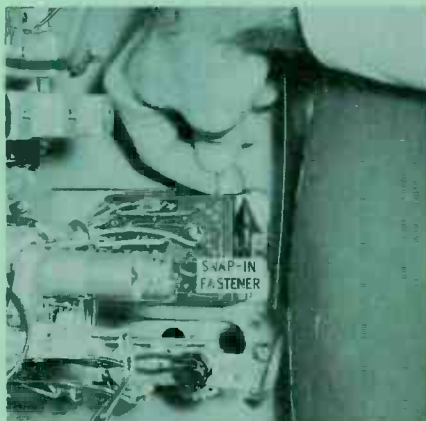
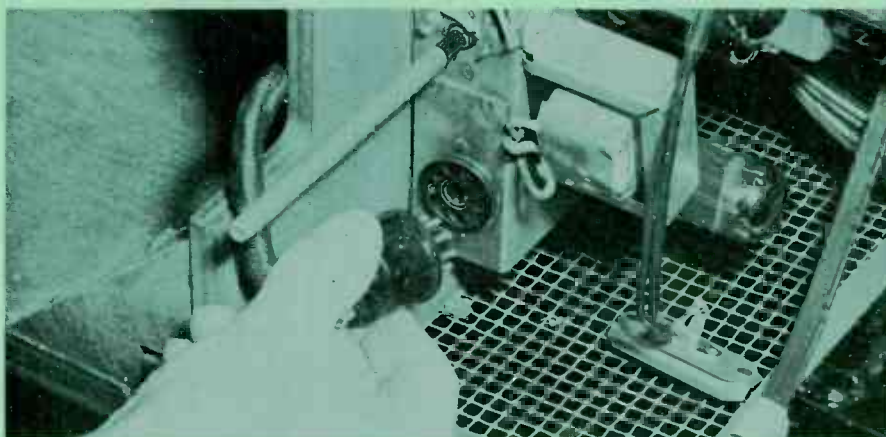
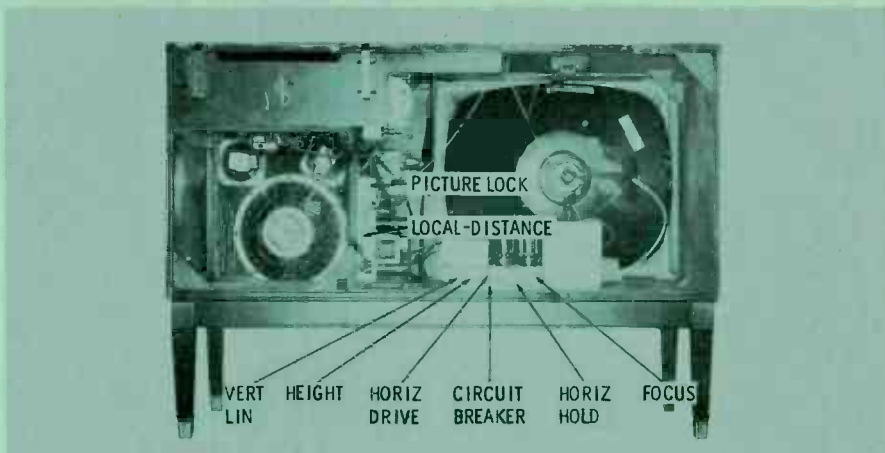
Removal of the rear cover exposes the 10" woofer and two 4" tweeters in the space under the phono. The transformer-powered chassis, protected by a circuit breaker, is really three units—one for AM-FM tuner, another for power supply and sweep, and the third for all other circuits. The newest tube types are the 6BN8, 6EM5 and 6DE4. A wiring change has been issued regarding arcing in the power chassis: Disconnect the red yoke lead from the terminal strip beneath the chassis, and the red lead with black tracer going to the same point. Splice the two disconnected ends, solder the junction, and wrap it well with high-voltage tape.

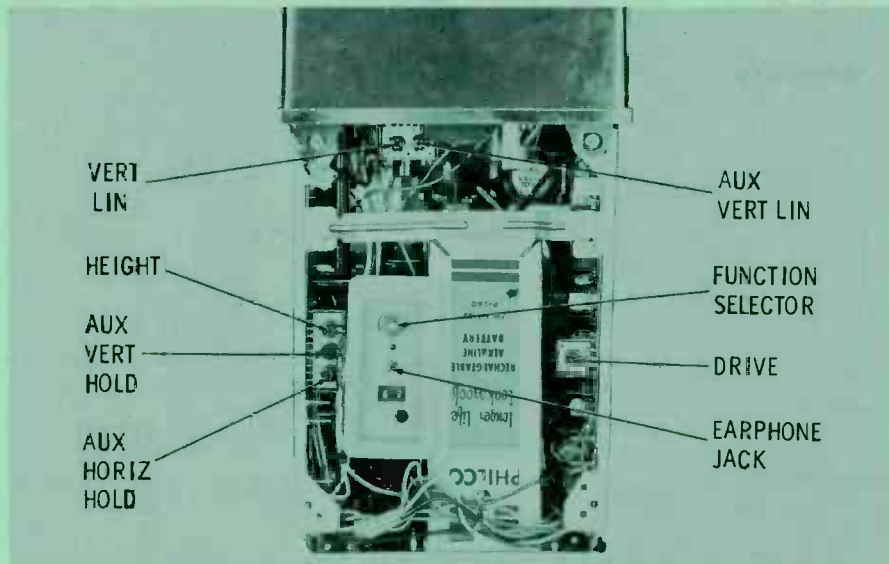
In case the TV sections have to be pulled, the radio tuner can be left in the cabinet. While this eliminates the means for controlling volume, the set can be operated after jumpering pins 9 and 2, 5 and 6, and 3 and 4 of the radio power socket.

The two-section TV chassis is easily removed. The only thing that might give you trouble is the phenolic board containing the channel-selector lamps. To free it, use the blade of a small screwdriver as a lever between the board and lamp case.

Getting the radio out is a little more difficult. The wooden front inside the changer compartment must be removed first, then six Phillips-head screws which secure the chassis. The changer compartment lamp socket is labeled for ease in identifying connections. However, there are no provisions for distinguishing between left and right stereo channels, so keep this in mind when disconnecting the phono leads.

Removing the safety glass for cleaning is no problem. Using your fingers, start at the right edge of the long trim strip along the bottom of the glass, lifting up and working your way toward the center.





**Philco Model H2010L  
Chassis 10AT10**

This truly portable unit, which operates from either a rechargeable battery or 110 volts AC, contains 21 transistors and 3 tubes including the 2" picture tube. The front of the top swings up to reveal a slanted frosted glass that picks up the image from a concave mirror.

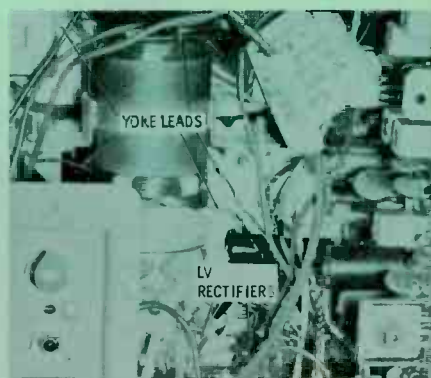
With removal of the four Phillips-head screws holding the base, the chassis slips out of the leather case. At this point in disassembly, most of the setup adjustments are accessible.

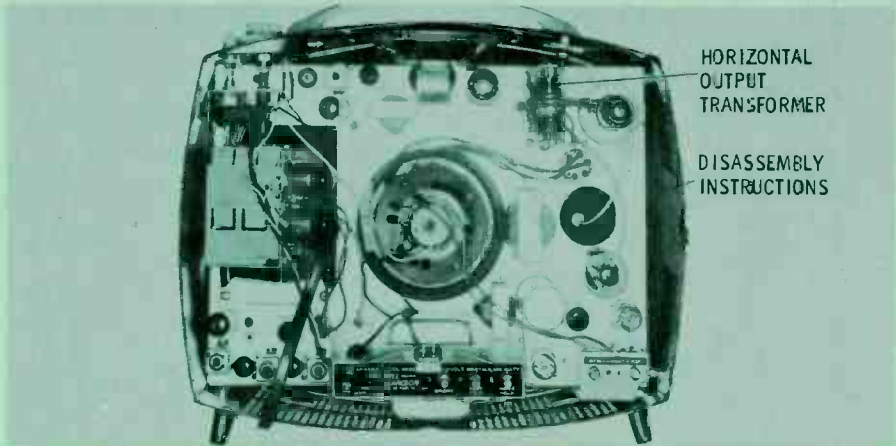
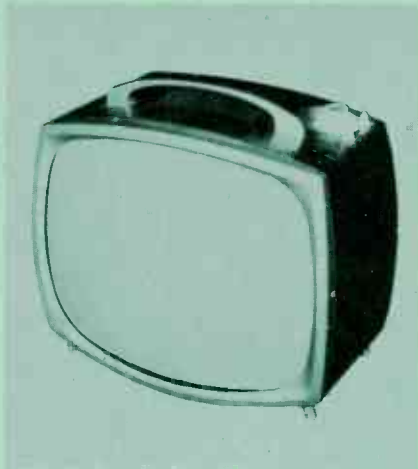
The battery compartment slides out the bottom after removal of 5 screws. The cross-chassis brace can be removed, permitting room to get at the remaining setup adjustments. The battery can be replaced without removing the chassis, and has an operating time of about 4 hours. Recharge time is about 18 hours.

The chassis frame supports three printed boards which, when viewed from the rear, form an inverted "U." The horizontal circuits are on the left, vertical circuits are on the top, and the remaining stages (except for power supply) are on the right. All of the printed wiring is toward the outside, and all of the components are on the inside, but the boards swing out as described in *Servicing TV Portables*, in last month's issue. My first reaction was, "Oh for the good old days, when the HV cage and tuner together were bigger than this whole set." However, some pains were taken to provide component accessibility, which is no easy job in a receiver as compact as this one.

The exposed yoke leads may scare you at first, but they have a good coating of varnish which minimizes the shock danger. Care should be exercised, though, not to rub them against something which might scrape off the insulation. The conventional main-chassis wiring is mostly for the power supply, and is grouped toward the bottom of the chassis.

A pair of 5642 high-voltage rectifiers, connected in a voltage-doubling circuit, are the only tubes in the chassis other than the picture tube. In the photo, the lid covering the high voltage cage has been removed. That's the flyback behind the tubes. The "cage" is a part of the main chassis.





**Setchell-Carlson Model P66 Chassis C106**

Your first glance at this 17", 110° portable may lead you to think you've worked on it before. It has the same leatherette cabinet, the same knob well, and the same controls, but here is where the resemblance stops.

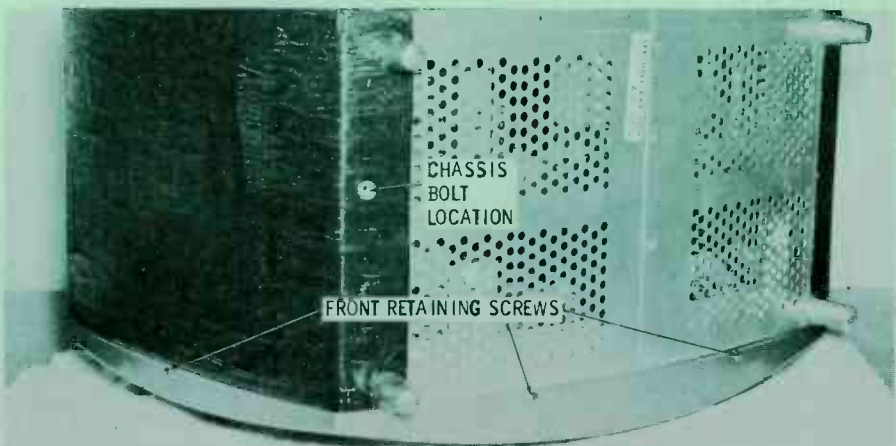
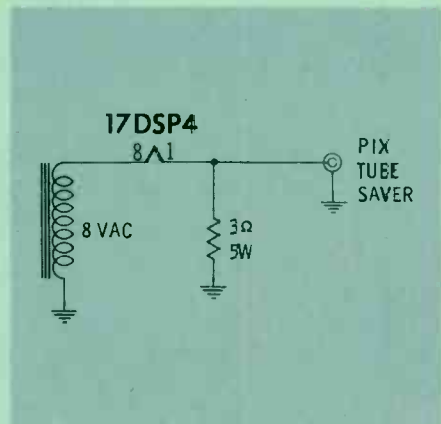
As soon as you get the back off, you'll see that the familiar plug-in units have been replaced with a conventionally-wired vertical chassis. At the same time, you'll probably wonder who left the high voltage cage off. The set is made that way, with the horizontal-output transformer setting up in the corner as big as you please. This section is the only carryover from the manufacturer's former styling, which incorporated plug-in units throughout. Two screws hold the high-voltage transformer section in place.

At the bottom of the chassis, you'll see the power transformer and 2-amp line fuse. There is also a phono-type socket labeled PIX TUBE SAVER. What it amounts to, as the schematic shows, is a built-in CRT brightener. The 8-volt secondary applies voltage to the picture tube filament, which is then connected in series with a 3-ohm, 5-watt resistor to drop the voltage to its normal value. When the tube has aged and needs brightening, inserting a shorted phono plug in the socket shunts the resistor and allows the full 8 volts to be applied across the filament. The power transformer feeds two silicon rectifiers connected in a conventional half-wave voltage-doubler circuit.

Although you can't do any extensive servicing with the cabinet, the chassis is easy to remove. There are only three plug-type connections to break—the picture tube socket, yoke plug, and high voltage lead.

Disassembly instructions are provided on both the inside rear cover and on the right side of the cabinet. After removing the four push-on type knobs from the top and one chassis bolt from the bottom, the chassis tilts out on the left side and slips off two pins attached to the right side of the cabinet.

The front is easily removed for cleaning the picture tube and safety glass. Six Phillips-head screws hold the front to the cabinet. With these removed, the front panel and safety glass slide right off.



See PHOTOFACT Set 395, Folder 1; PCB 221

Mfr: Admiral Chassis No. 16AX1, 16X1

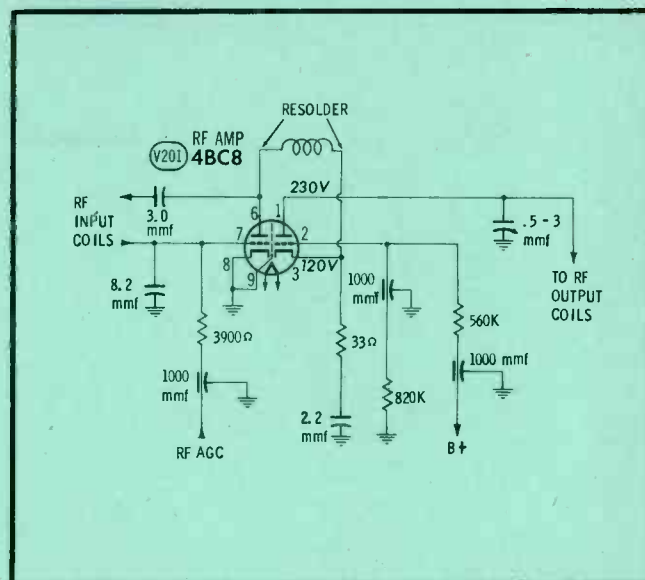
Card No: AD 16X1-1

Section Affected: Pix and sound.

Symptoms: Sound and picture both disappear at slightest vibration.

Cause: Loose coil connections in RF amplifier circuit.

What To Do: Resolder leads of interstage coil connected between pins 3 and 6 of V201.



Mfr: Admiral Chassis No. 16AX1, 16X1

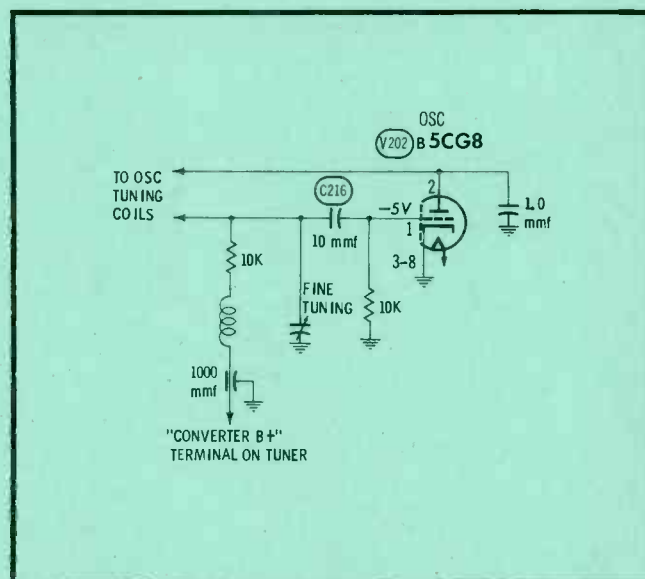
Card No: AD 16X1-2

Section Affected: Pix and sound.

Symptoms: RF oscillator drifts off frequency.

Cause: Defective capacitor in oscillator circuit.

What To Do: Replace C216 (10 mmf—N1500, 5%).



Mfr: Admiral Chassis No. 16AX1, 16X1

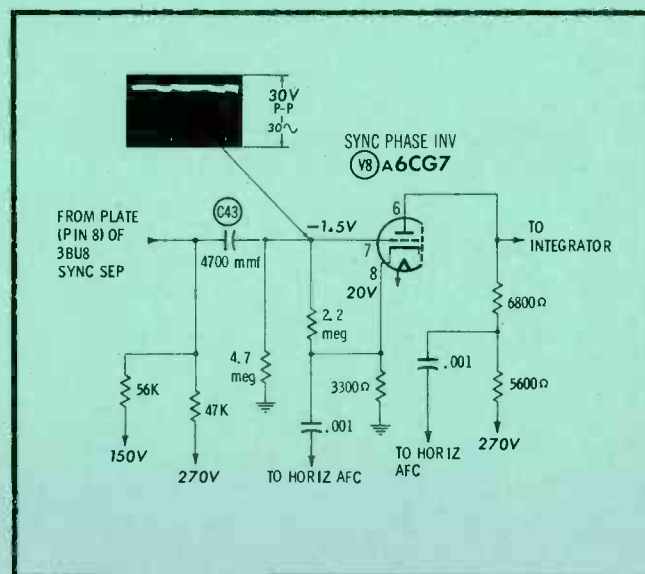
Card No: AD 16X1-3

Section Affected: Sync.

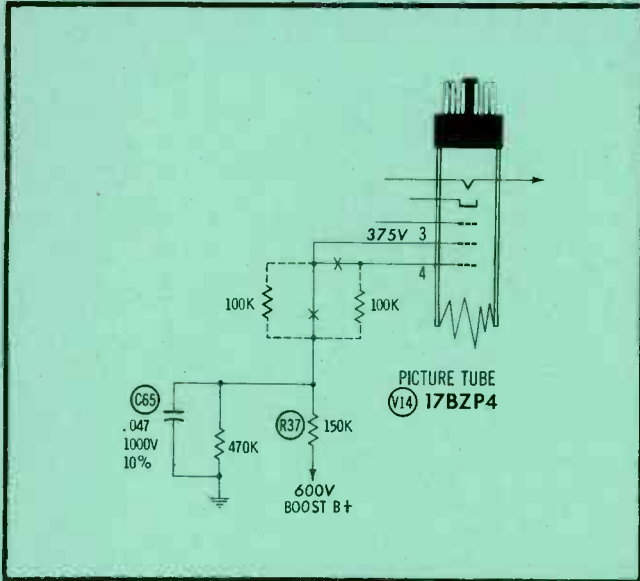
Symptoms: "Hook" at top of picture and slow vertical rolling after about an hour of operation.

Cause: Leaky coupling capacitor between sync separator and sync inverter.

What To Do: Replace C43 (4700 mmf—500V).



See PHOTOFACT Set 395, Folder 1; PCB 221



See PHOTOFACT Set 395, Folder 1; PCB 221

Mfr: Admiral Chassis No. 16AX1, 16X1

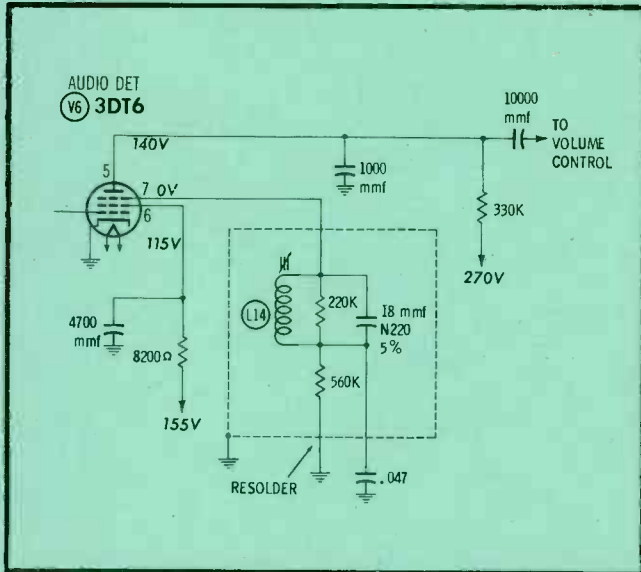
Card No: AD 16X1-4

Section Affected: Raster.

Symptoms: Brightness gradually diminishes until raster is no longer visible.

Cause: Voltage on accelerating anode decreases as a result of defective components in anode circuit.

What To Do: Replace C65 (.047 mfd tubular—1000V). Check R37 (150K— $\frac{1}{2}$  W) and replace if increased in value.



Mfr: Admiral Chassis No. 16AX1, 16X1

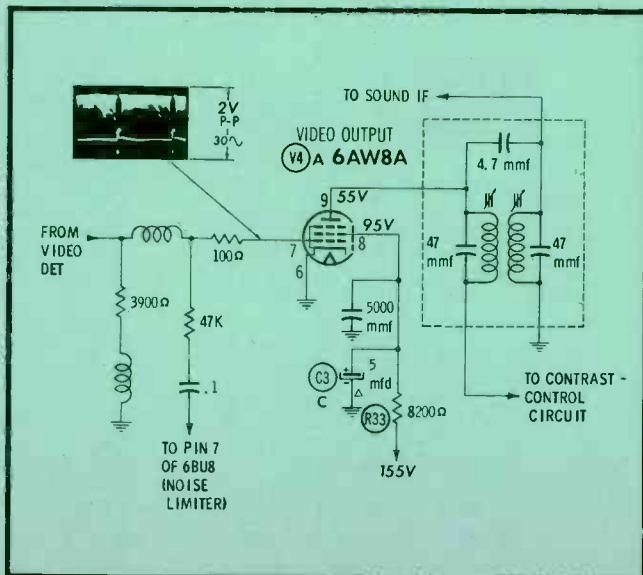
Card No: AD 16X1-5

Section Affected: Sound.

Symptoms: Buzz in sound after about an hour of playing.

Cause: Poorly soldered ground connection on quadrature transformer of sound detector.

What To Do: Resolder ground connection to L14.



Mfr: Admiral Chassis No. 16AX1, 16X1

Card No: AD 16X1-6

Section Affected: Pix.

Symptoms: No picture, no sound, burning odor.

Cause: Shorted capacitor in screen-grid circuit of video amplifier, accompanied by burned resistor.

What To Do: Replace C3 (60-20-5-50-mfd—200-200-200-50V, four-section electrolytic) and R33 (8200 ohms— $\frac{1}{2}$  W).



See PHOTOFACT Set 341, Folder 15

Mfr: Sylvania Chassis No. 1-532-3

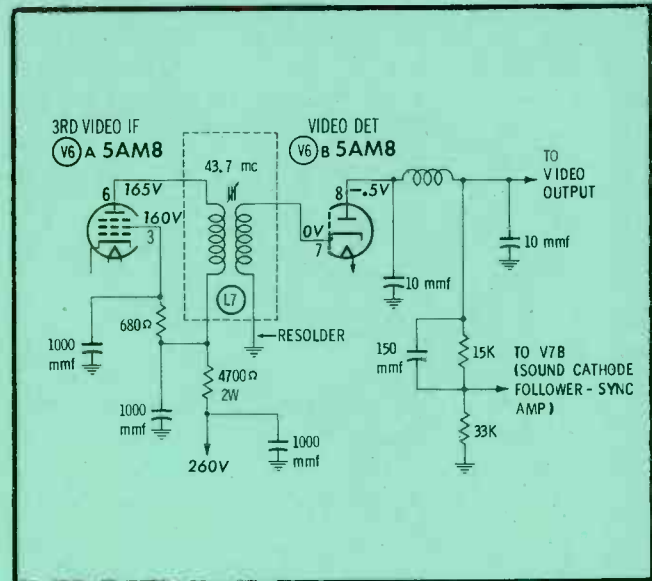
Card No: SY 1-532-3-7

Section Affected: Pix and sound.

Symptoms: Picture and sound disappear intermittently.

Cause: Ground connection to video detector transformer opens intermittently.

What To Do: Resolder ground connection to L7.



Mfr: Sylvania Chassis No. 1-532-3

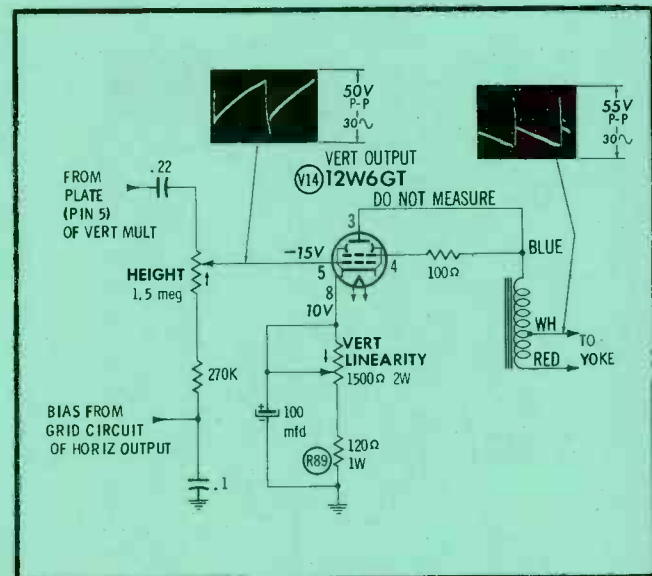
Card No: SY 1-532-3-8

Section Affected: Pix.

Symptoms: Vertical linearity cannot be properly adjusted.

Cause: Cathode resistor in vertical output circuit has increased in value.

What To Do: Replace R89 (120 ohms—1W).



Mfr: Sylvania Chassis No. 1-532-3

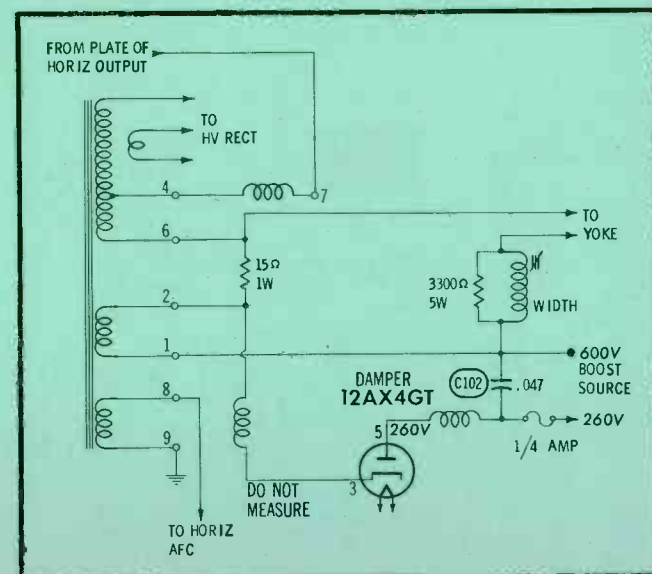
Card No: SY 1-532-3-9

Section Affected: Raster.

Symptoms: No raster, no high voltage.

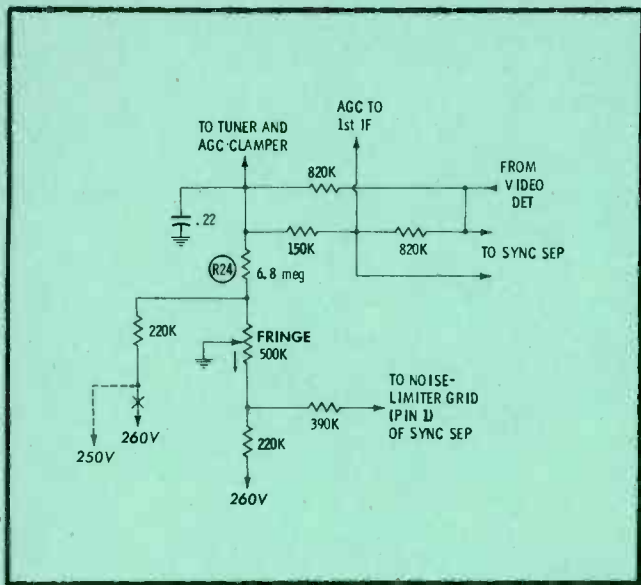
Cause: Shorted boost capacitor.

What To Do: Replace C102 (.047 mfd—600V).



See PHOTOFACT Set 341, Folder 15

See PHOTOFACT Set 341, Folder 15



Mfr: Sylvania Chassis No. 1-532-3

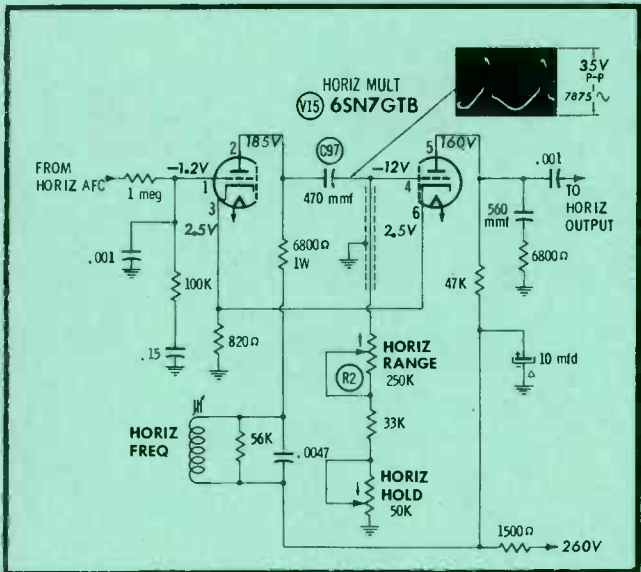
Card No: SY 1-532-3-10

Section Affected: Pix.

Symptoms: Snowy picture, becoming worse as set continues to play.

Cause: AGC delay resistor increases in value.

What To Do: Replace R24 (6.8 meg).



Mfr: Sylvania Chassis No. 1-532-3

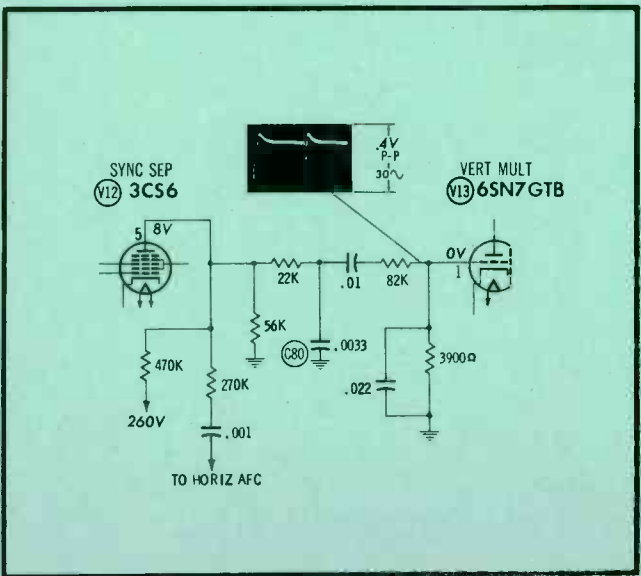
Card No: SY 1-532-3-11

Section Affected: Sync.

Symptoms: Horizontal oscillator operating far off frequency.

Cause: Open horizontal-range control.

What To Do: Replace R2 (250K) and check C97 (470 mmf).



Mfr: Sylvania Chassis No. 1-532-3

Card No: SY 1-532-3-12

Section Affected: Sync.

Symptoms: Periodic loss of vertical hold after first half hour of operation.

Cause: Leaky capacitor in integrator network.

What To Do: Replace C80 (.0033 mfd).



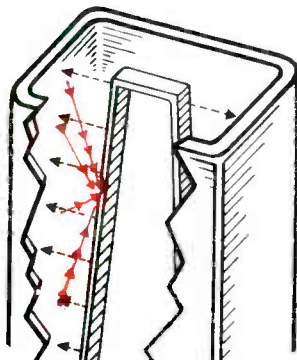
My new plates  
behave like plates...  
not filaments

(FORGET YOUR  
LOW-VOLTAGE  
RECTIFIER PROBLEMS)

### HOW BACK EMISSION IS ELIMINATED

Back emission from overheated plate to filament causes most rectifier failures. Reverse current mounts . . . filament is stripped . . . overheats . . . burns out.

That's why the new CBS 5U4GB plates are of non-emissive material, are larger, and run cooler. These and many other advance engineered features make the new CBS 5U4GB the best you can buy. Here's typical proof. Dynamic "blast" tests brutally cycle the tube between 4 and 6.8 volts with 800 volts plate potential. Yet back emission is just measurable . . . less than one milliamperere!



"My new plates don't heat up and start acting like filaments. They can't because my plate material is designed not to emit wrong-way electrons. So back emission can't build up and burn out my filament. And you aren't pestered with premature failures."

That is right. The new CBS 5U4GB offers you *total reliability* . . . proved in performance by leading TV and radio set manufacturers. You, too, can profit from the *total reliability* of CBS tubes. Just replace with CBS . . . always.

TOTAL RELIABILITY...  
proved in performance



Receiving, industrial  
and picture tubes  
transistors and diodes  
audio components  
and phonographs

**CBS ELECTRONICS**


Danvers, Massachusetts

A Division of Columbia Broadcasting System, Inc.

Send 10c to Sprague  
for window-size blow-  
ups of this message.



# EVERY DAY IS INDEPENDENCE DAY

FOR YOU AND YOUR  
 **INDEPENDENT**    
TV SERVICE DEALER



Your independent TV Service Dealer is in business for himself because he too wants to exercise his independence just as you do. You purchased your TV or radio set where you wanted to . . . when you wanted to . . . and at the price you decided was right.

Your TV service dealer is also an independent in the things he buys in his day-to-day work. He buys his repair parts where he can get the highest quality and the best service. And, he trained himself in his own way, on his own time, at his own expense to be able to do this in the very best way for YOU.

He has no crutch to support him . . . no "home office" to mother him along. He stands or falls on what you think of him and his work. He has to do good work to keep your business . . . and he knows it!

We're lucky in these United States that every day is Independence Day. Independent buying, selling, and servicing is the very lifeblood of American business. Let's keep it that way.

**THIS MESSAGE WAS PREPARED BY SPRAGUE PRODUCTS COMPANY,  
DISTRIBUTORS' DIV. OF SPRAGUE ELECTRIC CO., NORTH ADAMS, MASS. FOR**

**YOUR INDEPENDENT TV-RADIO TECHNICIAN**

**publisher**  
Howard W. Sams

**general manager**  
Mal Parks, Jr.

**editor**  
Verne M. Ray

**associate editors**  
Leslie D. Deane  
Thomas A. Lesh  
Joe A. Groves

**consulting editors**  
William E. Burke  
Robert B. Dunham  
George B. Mann  
C. P. Oliphant  
Paul C. Smith

**art director**  
Don W. Bradley

**advertising & editorial assistants**  
Georgeanna Caldwell  
Marjorie Spiegel

**production manager**  
Robert N. Rippy

**circulation fulfillment**  
Pat Tidd, Mgr.  
Constance McCawley, Ass't.

**photography**  
Robert W. Reed

**advertising sales offices**  
midwestern

John Groce, PF REPORTER  
2201 East 46th Street, Indianapolis 6, Ind.  
Clifford 3-6441

eastern  
Cliff Landis  
Corning Glass Building,  
717 Fifth Ave., New York 22, N. Y.  
Murray Hill 8-6350

western  
The Maurice A. Kimball Co., Inc.  
2550 Beverly Blvd., Los Angeles 57, Calif.  
Dunkirk 8-6178; and 681 Market Street,  
San Francisco 5, Calif. Exbrook 2-3365

Address all correspondence relating  
to circulation and editorial to  
PF REPORTER, 2201 East 46th Street,  
Indianapolis 6, Indiana



Copyright © 1960 by Howard W. Sams & Co., Inc. PF REPORTER is a trademark of Howard W. Sams & Co., Inc. No part of PF REPORTER may be reproduced without written permission. No patent liability is assumed with respect to use of information herein. Acceptance of advertising does not in any manner signify the products, policies and services so advertised have been approved, endorsed or recommended by this magazine.

Printed by the Waldemar Press Div.  
of Howard W. Sams & Co., Inc.



# PF REPORTER

including **Electronic Servicing**

VOLUME 10, No. 2

FEBRUARY, 1960

<b>Previews of New Sets</b> General Electric Chassis U4, Packard-Bell Model 21X2, Philco Chassis 10AT10, and Satchell-Carlson Chassis C106.	1
<b>Video Speed Servicing</b> Service hints on Admiral's 16X1 chassis and Sylvania's Chassis 1-532-3.	5
<b>Letters to the Editor</b>	16
<b>"Tough Dog" Sync Troubles</b> Joe A. Groves A close look at scope waveforms gives accurate clues to sync-separator performance.	28
<b>Key to Quicker Color Servicing</b> Warren J. Smith Color TV troubles won't lead you up a blind alley if you use this systematic check list.	30
<b>Flyback Transformer Replacement</b> Les Deane Good installation techniques can make the difference between a healthy flyback and an early callback.	32
<b>Analyzing Hi-Fi Troubles in the Home</b> Alan Andrews Audio Facts — You'll be surprised how many defects you can fix without hauling the whole system into the shop.	34
<b>What About This New Citizens Band Service?</b> Allan Lytel People will be quizzing you about 27-mc Class D operation; here's some background material for you.	36
<b>Tonic for an Emerson 700B</b> Stan Prentiss Across the Bench — Restored vertical sweep and an extensive overhaul perks up an old receiver.	38
<b>Dollar &amp; Sense Servicing</b> Thomas A. Lesh	40
<b>Tips for Techs</b> John A. Comstock	44
<b>The Troubleshooter</b>	48
<b>TV Repair the Customer Expects</b> Art Margolis See yourself as the public sees you, and check your "setside manner."	54
<b>A Direct Approach to Oscillator-Circuit Servicing</b> Calvin C. Young, Jr. Quicker Servicing — How to recognize and cure troubles in all the common types of oscillators.	60
<b>Notes on Test Equipment</b> Les Deane Lab reports on the Seco Model 78 tube tester, B & K Model 1070 Sweep Circuit Analyzer, and Winston Model 800 Hi-Fi Analyzer.	68
<b>Product Report</b>	94
<b>Free Catalog &amp; Literature Service</b>	96

1959 Subject Reference Index

Check 59M on Literature Card

## ABOUT THE COVER

"Base station TVS calling unit 3—your 10-20 please." Our front cover shows a service manager helping to dispatch a service call to one of his outside men via Citizens Band Radio. Will it work for you?

Yes—within certain limitations. And, you can sell, install, and service it, too—but first, see the story beginning

on page 36.



GET THAT SYLVANIA SIGN UP TODAY!

# ARTHUR GODFREY IS SELLING YOU!

Now sponsored by Sylvania Silver Screen 85 picture tubes, Arthur Godfrey is telling America about you, selling America on you — the independent TV service dealer!

He's spreading the word to millions — on the CBS Radio network — 197 stations coast-to-coast — that you are the man to see for the finest TV service. Millions more are reading about you in the pages of *The Saturday Evening Post*. When Arthur Godfrey tells his audience to look for the "Sylvania decal in the window of your local independent TV service dealer's shop," are you with it?

See your Sylvania distributor for Sylvania Silver Screen 85 picture tubes and Sylvania quality receiving tubes. Get your display kit of colorful window streamers and posters. Get that Sylvania sign up today!

*Sylvania Electronic Tubes, a division of Sylvania Electric Products Inc.,  
1740 Broadway, New York 19, New York*

*See your local paper for time and station*

**"IT'S ARTHUR GODFREY TIME"...** brought to you by

 **SYLVANIA**

Subsidiary of **GENERAL TELEPHONE & ELECTRONICS** 





**SYLVANIA SILVER SCREEN 85**

**4 WAYS BETTER**

- \*Sharper focus*
- \*Clearer picture*
- \*Greater contrast*
- \*More light output*



*TV Shop Owners AL GOGEL and TOM WALSH Say:*

# “Performance and flexibility why we prefer



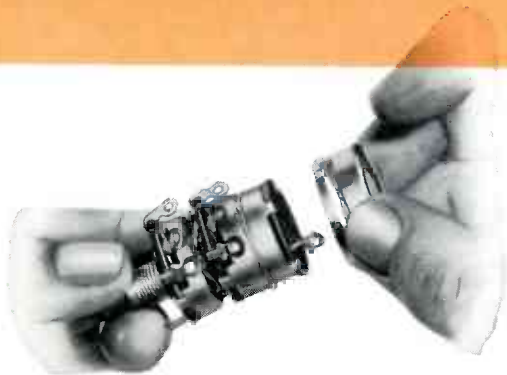
Al Gogel is a co-owner of Ferguson Television Sales and Service Company, Ferguson, Missouri, and Florissant Television, Florissant, Missouri, suburbs of St. Louis. After training at the American Television School, he started his own service shop.

Nine years ago, Al teamed up with Tom Walsh

and opened the store in Ferguson. They recently expanded into a new store in adjoining Florissant, and now employ one bench technician and three servicemen, with three trucks making 25 to 30 calls a day. They handle the warranty work on auto radios for the area's four major new car dealers, plus repair work for other dealers and used car lots.



# ...two good reasons MALLORY components”



“In our business, using quality replacement parts is as important to steady growth as fast, courteous service is. That’s why we use Mallory parts whenever we can; we know we can depend on their quality. We particularly like the Gem tubular capacitors and Sta-Loc® controls.

“There are two good reasons why we prefer Sta-Loc: first, naturally, is performance. There’s never a call-back on these controls. Second, there’s their flexibility. We can get any control we need with Sta-Loc—immediately—without having to check every distributor in town.”

Thousands of technicians have discovered that the flexibility of Mallory Sta-Loc controls spells real convenience. You can get any of over 38,000 types of single or dual controls—even the hard-to-find ones—made to order by your distributor in just 30 seconds. No more shopping, no more waiting. Convenient, too, because you can replace the line switch by itself, without unsoldering the control connections. As for dependability, you can always depend on Sta-Loc controls to work long and quietly.

Whatever your component needs, your best bet is your Mallory distributor. He has the widest line of Mallory quality products at sensible prices.

Stop Callbacks with These  
Quality Mallory Products . . .

Distributor Division

P. R. MALLORY & CO. Inc.  
**MALLORY**

P. R. MALLORY & CO., Inc., INDIANAPOLIS 6, INDIANA



#### FP ELECTROLYTICS

The original 85°C capacitor. Etched cathode construction—standard in FP’s at no extra cost—assures hum-free performance. High ripple current ratings.



#### GEMS

5 rugged, moisture-proof Mallory “Gem” tubular capacitors in a handy dispenser that keeps your stock fresh, clean, easy to find; prevents kinks in lead wires.



#### RMC DISCAPS\*

Made by the world’s largest producer of ceramic disc capacitors. Long the original equipment standard. Supplied in a handy 3x5” file card package.



#### TC TUBULAR ELECTROLYTICS

Economically priced filter capacitors. Top performance proved in service and backed by years of Mallory experience. Hermetically sealed.



#### GOLD LABEL® VIBRATORS

The quietest vibrator ever made . . . for the best in radio servicing. Buttonless contact design gives longest life, sure starts for sure customer satisfaction.



#### MALLORY MERCURY BATTERIES

Unequaled for transistor radios . . . last several times longer, give steady power, stay “live” for years when idle. “First in space” in U. S. satellites.

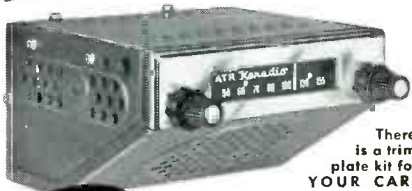
\*Trademark of Radio Materials Company,  
A Division of P. R. Mallory & Co. Inc.

# Introducing ATR CUSTOMIZED Karadio



Can be installed  
in dash or under  
dash as desired!

for  
small import cars  
and  
compact U.S. cars



There  
is a trim  
plate kit for  
YOUR CAR!

## ATR CUSTOMIZED Karadio

### • VIBRATOR-OPERATED with Tone Control

The ATR Customized Karadio is a compact, new, self-contained airplane-styled radio for small import and compact American cars. This economical unit is perfect for all small cars because it can be easily and inexpensively installed in-dash or under-dash on most any make or model automobile—and its powerful 8-tube performance provides remarkable freedom from engine, static, and road noises. ATR Karadios are built to look and fit like original equipment with sleek, modern styling and solid, single-unit construction. They offer many customized features and provide highest quality fidelity—yet cost far less than comparably designed units. The ATR Customized Karadio comes complete with speaker and ready to install... and is the ideal way to add fun and value to your small import or American automobile!



ATR KARADIO  
... is ideal  
for small import  
cars or com-  
pact American  
cars! Unit is

completely self-contained—extremely compact!  
Can be mounted in-dash or under-dash—where-  
ever space permits! For 6 volt or 12 volt!

**SEE YOUR JOBBER OR WRITE FACTORY**

• "A" Battery Eliminators • DC-AC Inverters • Auto Radio Vibrators

**ATR** AMERICAN TELEVISION & RADIO CO.  
Quality Products Since 1931  
SAINT PAUL 1, MINNESOTA, U. S. A.

## Letters to the EDITOR

Dear Editor:

I have been following with great interest the various pro and con letters about the part-time servicer. In the Los Angeles area the problem is extremely severe, due to the growth of the electronics industry here. (It now outranks aircraft.)

My personal attitude toward the part-timer is this: If he operates like any other businessman, paying the same taxes, license fees, insurance, etc., and if he charges the same rates as the regular shops, let him operate. But if he cuts his overhead by not meeting the expenses the rest of us have to, and thereby is able to undercut our charges, give him h—.

J. W. "JACK" MASSECAR

Editor, ITVSDA Newsletter  
Los Angeles, Calif.

Dear Editor:

I agree wholeheartedly with Fred Hoffman and W. Lee Terrell (*Letters*, December issue). Some few years ago I got my training the hard way, working at night and studying with NRI in the daytime. I hope to be operating full time soon, having moved my shop into a new area with good prospects for a thriving business.

Paying for equipment as I go, I have not hurt anyone in the full-time repair business by cutting prices; I don't believe in it. My stock inventory has gone up during the past few years and is to the point where I can operate without going in debt too much. I keep books, as anyone should, and know just what I am doing.

There are quacks in every field; but, if they are left alone, they will take care of themselves and soon go out of business.

O. R. HAYS

Hays Radio & TV Service  
Poway, Calif.

Dear Editor:

We ran across a situation a few days ago which would have taxed the ability of even the best serviceman, if he didn't have an exceptional amount of tact and a good sense of humor.

We had sold a new TV to an elderly couple in a rural area. Since we had set it up rather late at night, we had temporarily attached a set of rabbit ears and decided to wait for a good day to put up an outdoor antenna. When we went back to install this antenna, a few days ago, the couple told us how much they enjoyed having television — but missed being able to use it early in the evening, since they liked to retire early. Our serviceman asked them if something was wrong with the early-evening recep-

tion in the area. They replied that the reception was good, but their neighbor had asked them not to turn on the TV until he had completed his chores. Since they had bought the television, he claimed, he was unable to use his milking machines in the barn across the road. The cups kept popping off the cows!

You can imagine the reaction our man got when he returned to the shop and told us this story. We tossed it around and found all kinds of explanations, none of which made any sense. Needless to say, we assured the customer that it wasn't necessary to keep the set quiet while their neighbor was milking, because neither the electricity consumed nor the programs viewed would affect the milking machines or the cows.

ROYCE WHEELER

Wheeler's Radio-TV Service  
Orleans, Vt.

*This complaint smells like a "red herring" tossed out by the dairy farmer to keep the neighbors from blaming his machines for a milky appearance of the TV screen! Congratulations to your man for a public relations problem well ironed out.—Ed.*

Dear Editor:

I have been reading your magazine thoroughly for the past several months, and believe it to be the most informative in our field.

I was wondering, however, if there is any way to be brought up to date on past "Video Speed Servicing" columns.

WALTER CARPENTER

Wal-Mar Television Sales  
Columbus, Ohio

*Thanks for the kind words, Walt. By the way, if you, or any of our readers, find we haven't covered what you want in the way of subject material, just ask.*

*"Video Speed Servicing" began in September, 1958, and most back issues are available; price is 50¢ per copy. In addition, three bound volumes of "Video Speed Servicing" (not duplicated in PF REPORTER) have been published. Volume I is out of print, but Volumes II and III, \$2.95 each, are available from your distributor. Volume IV will be introduced shortly.—Ed.*

Dear Editor:

I look forward to your magazine each month and read it from cover to cover. It's the only magazine I know of that prints advertising in such a way as to make a man want to read it.

JIMMIE E. MCDANIEL

McDaniel's TV Service  
Pyote, Texas

*We're fortunate in having advertisers who use newsworthy copy in their messages to servicemen. As for the format of PF REPORTER, we think it best to spread the ads out rather than bunch them in a solid, formidable wall.—Ed.*

Dear Editor:

In moving from here to Florida and back again, I've fallen six months behind in my reading. In your "Letters" column for May, I note that a 1958 Subject

• Please turn to page 20

# PHILCO<sup>®</sup> THE FIRST NAME IN ELECTRONICS

# ... THE LAST WORD IN QUALITY

All Philco UNIVERSAL AND HIGH FIDELITY SPEAKERS are audio-engineered for top performance. Your Philco Distributor has a complete line—from miniature "Space-Saver" speakers to complete High Fidelity Systems. For all TV, Home and Auto Radio replacements, as well as Inter-com Systems and special applications, choose Philco—the first name in electronics ... the last word in quality!



**AUTO RADIO REAR SEAT  
SPEAKER KITS** for all cars.



**REPLACEMENT SPEAKERS**  
for all makes of TV and  
radio receivers.



**HIGH FIDELITY SPEAKERS**  
and speakers for all spe-  
cial purposes.

**SEE YOUR PHILCO DISTRIBUTOR TODAY!**

## PHILCO ACCESSORY DIVISION

*WORLD-WIDE DISTRIBUTION*

Service Parts • Power-Packed Batteries • Universal Components • Long-Life Tubes • Heavy-Duty Rotors • Star Bright 20/20 Picture Tubes • Long Distance Antennas • Appliance Parts • Laundry Parts • Universal Parts and Accessories



PHILCO CORPORATION ACCESSORY DIVISION  
ATTN. Carl Areschoug  
P. O. Box 3635  
Philadelphia 25, Pa.

If you service television and radio receivers and would like to receive valuable promotional mailings from Philco, attach this coupon to your Company letterhead and forward to above address.

NAME \_\_\_\_\_

ADDRESS \_\_\_\_\_

CITY \_\_\_\_\_ ZONE \_\_\_\_\_ STATE \_\_\_\_\_

# ***YOU'RE AS SUCCESSFUL GENERAL ELECTRIC'S***



# AS YOU WANT TO BE WITH NEW PSM\* METHOD!

## \*PROFITABLE SERVICE MANAGEMENT

Earn the good things of life for yourself and your family by following the Profit signposts on every page of General Electric's PSM\* Method! The engraved Certificate which says you have completed this instruction program, will mean new success for you as a TV technician.

Says Dr. John K. Pfahl of Ohio State University, under whose direction the new General Electric program was prepared: "The electronic service dealer must be, at the same time, a technician, good businessman, and sales manager." You learn step-by-step how to realize these aims, by following General Electric's Profitable Service Management Method. You are shown how to assure a satisfactory profit margin, not merely

hope for it—how to increase business by methods others have found unfailingly effective.

In the LP record "Sounds of Success" you will hear from the lips of experienced TV technicians just how they have built greater incomes. After completing the two volumes of instruction that make up the study course, a questionnaire is available to check your acquired knowledge, prior to receiving your Certificate.

All come handsomely packaged for your bookshelf. Check the highlights of General Electric's PSM\* Method given below! Then see your G-E tube distributor! *Distributor Sales, Electronic Components Division, General Electric Company, Owensboro, Kentucky.*

### HERE ARE SOME OF THE MANY SUBJECTS YOU WILL STUDY:

#### BOOK NO. 1. "SOUND BUSINESS PRACTICES"

**BUSINESS FOR PROFIT:** Your reasons for owning a business...How much money should you make?...How to make your business profitable.

**PLANNING YOUR BUSINESS:** Planning expansion...Cash planning...Shop planning.

**ORGANIZING YOUR BUSINESS:** Overhead costs...Pricing...What it costs you to make a service call...What it costs you to make a shop repair...Inventory control...Credit organization...Choosing a form of organization.

**CONTROLLING YOUR BUSINESS:** Why use records?...What records are needed...Taxation...Use an accountant.

#### BOOK NO. 2. "SELLING ELECTRONIC SERVICE"

**ARE YOU ATTRACTING NEW CUSTOMERS?:** Attracting new business...Businesslike appearance...Effective selling...Good identification...Basic market research.

**PROMOTING YOUR BUSINESS:** Advertising technique...Advertising campaign planning...Special offers...Seasonal planning...Customer contact.

**KEEPING YOUR CUSTOMERS SATISFIED:** Customer relations...Customer grievances...Guaranteeing repairs...Building new customers.



*Progress Is Our Most Important Product*

GENERAL  ELECTRIC

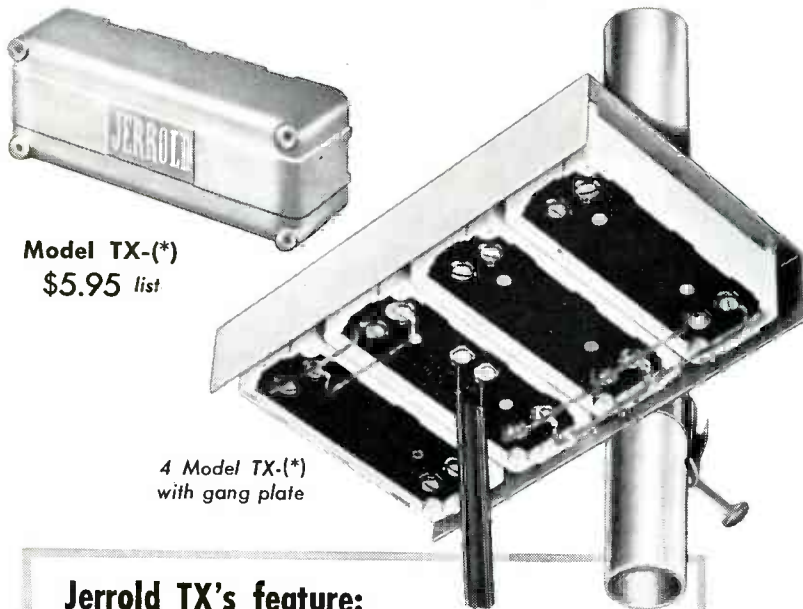
**NEW!**

# JERROLD ANTENNA MIXING NETWORKS

**MODEL TX-(\*)**

**Give Multi-Channel, All-Direction Reception Simultaneously...for FM, TV, UHF and Color!**

Now multi-set families can have all-direction reception at the same time on one common line! No more rotators or switches . . . the versatile Jerrold Model TX-(\* ) can be used individually or in any combination to reject unwanted channels and to bring in weaker stations bright and clear. They will mix cut-to-channel antennas with a single broad band antenna . . . separate individual channels . . . mix or separate VHF and UHF . . . and mix or separate VHF TV and FM . . . all without loss of signal.



Model TX-(\* )  
\$5.95 list

4 Model TX-(\* )  
with gang plate

### Jerrold TX's feature:

- up to 9 antennas on a single down lead
- high Q band-pass circuit for highest rejection
- negligible feed-thru loss . . . less than a knife switch
- matched mixing jumpers . . . for low VSWR
- unbreakable attractive housing, complete with hardware
- universal mounting . . . indoor or outdoor

\*SPECIFY UNITS DESIRED: any TV channel from 2 through 13; FM; H-L (VHF high-low) or VHF-UHF

**JERROLD** ELECTRONICS CORPORATION, Distributor Sales Division  
Dept. IDS-8, The Jerrold Building, Phila. 32, Pa.

Jerrold Electronics (Canada) Limited  
Export Representative: CBS International, New York 22, N. Y.

**LOOK TO JERROLD FOR AIDS TO BETTER TELEVIEWING**

## Letters

(Continued from page 16)

Reference Index was made available. I would like to know if I can still obtain a copy.

It sure feels good to relax in the evening and read PF REPORTER. I have quite a few issues on hand to keep me going; more new ones come before I get the old ones all read.

TAUNO C. TAMMINEN

Westminster, Mass.

Yes, indexes for '57, '58, and '59 are available for the asking. Prior indexes were included in each December issue.—Ed.

Dear Editor:

I have recently read, in PF REPORTER and other sources, that many TV servicemen are having trouble with the ratio detectors in General Electric receivers, especially those with printed circuits. Nearly 95% of my service work is on GE sets, and I have had many cases of hum, sound going on and off, fading, etc. In almost all cases, the trouble has not been in the ratio-detector transformer itself, but in the solder joints inside the detector can and at its base.

MURRAY ALFORD, JR.

TV Service Manager  
Caldwell & Alford, Inc.  
Lumberton, N. C.

Thanks for the good news!—Ed.

Dear Editor:

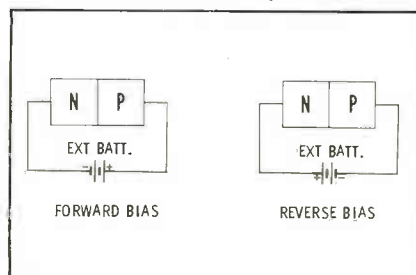
Looking back through the July, 1959 issue, I noticed that the explanations for Figs. 2 and 3 of P's and Q's of Transistors (page 30) seem to be interchanged. Shouldn't Fig. 2 be shown as a reverse-bias condition, with holes and electrons moving away from the junction!

J. O'BRIEN

Brooklyn, N. Y.

Oops again! The symbols indicating external batteries in these figures are reversed from their proper positions. Just to set the record straight, the accompanying figures show the correct way to apply forward and reverse bias to an NP junction.

Don't become misled by the battery-like "potential hill" symbols we used in the original illustrations. These were merely intended to show "the presence of positively-charged atoms in the N material, and negatively-charged atoms in the P material, in the immediate area of the junction." These charges tend to discourage electron and hole flow across the junction—not to increase it, as you might assume from a casual look at Figs. 2 and 3 in the P's and Q's article.—Ed.



EXCITING NEWS FROM RCA!

Announcing a new plan  
to give your store

**THE SUCCESSFUL LOOK**

FIND OUT  
HOW THIS PLAN CAN HELP YOU:

- Attract new customers
- Display and merchandise your products and service more effectively
- Utilize your present floor space to far better advantage
- Increase the efficiency of your service operation

SEE NEXT PAGE FOR  
IMPORTANT DETAILS...



# Your Store...Key to Successful Sales with the new **RCA**

## **STORE IMPROVEMENT PLAN**

Your skill, experience and integrity are the basic qualities that help you sell your service to the public. The appearance of your store can impress them with these facts—invite them inside to call on you with confidence.

The components shown here—and many more—are all available from your Authorized RCA Tube Distributor under the new RCA Store Improvement Plan. With minimum effort on your part, they will help you give your store *the successful look* inside and out. *No expensive store renovation is required.* No fancy, impractical blueprints are offered. Instead you are provided with carefully thought-out components that increase the business potential of any shop—big or small, old or new.

### **THE SUCCESSFUL LOOK—OUTSIDE**

#### **STORE FRONT**



**PROFESSIONALLY INSTALLED  
WINDOW DISPLAYS—  
CHANGED EVERY SEASON**

With this plan, your store window becomes a strong invitation to new customers. It will be decorated and fitted with attractive seasonal displays—prepared by RCA—without any fuss or bother on your part.



**RCA ILLUMINATED WINDOW VALANCES—ALSO USED AS  
IN-STORE MODULAR DISPLAY PANELS**

Here's a brand new idea that can be used to decorate your store window—or the interior of your shop as shown in the "Sales Area" photograph on opposite page. A choice of two- or four-foot lithographed panels, in gold-finished satin steel, gives you complete flexibility in designing your own customized illuminated window valance. Complete with hanging hardware and fluorescent lighting.



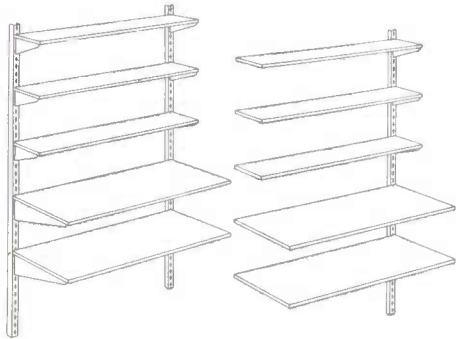
A good looking store front is your first opportunity to convert a passerby to a customer. The RCA Store Improvement Program offers you the elements to make your store front a working partner in your business.

Talk to your Authorized RCA Tube Distributor about this exciting plan right away. Ask him for your copy of RCA's new Store Improvement Guide (4F257), with a complete list of the components available and the order forms to secure them. Find out how easily and quickly you can add those few extra touches to your store to give it that Successful Look for 1960.



## SALES AREA

The interior of your shop should be an important sales aid. Here, good first impressions can be reinforced, to make it easier for you to sell your products and services.



### RCA DISPLAY AND STORAGE SHELVING UNITS

Attractive, sturdy shelving helps you display your merchandise more effectively for added sales. The RCA Plan offers basic four-foot shelving units, with add-on units to fit every need. Units may be set up in a variety of arrangements—and are easily disassembled and re-arranged.



## THE SUCCESSFUL LOOK—INSIDE

## SERVICE AREA

An efficient service area, providing faster, better organized work flow, is an important key to profits.



### SHOP BENCH UNITS

These sturdy benches mount on shelving units to provide additional storage and work space, efficient work flow, better use of floor space. They save you time and money.



### ADDITIONAL SALES AIDS— TO HELP BRIGHTEN YOUR PROFIT PICTURE

Eye catching sales accessories can draw attention to the services you offer. Sales-boosting accessories include illuminated clocks, signs, product display units, door bars, streamers, decals, service auto lights—even uniforms.



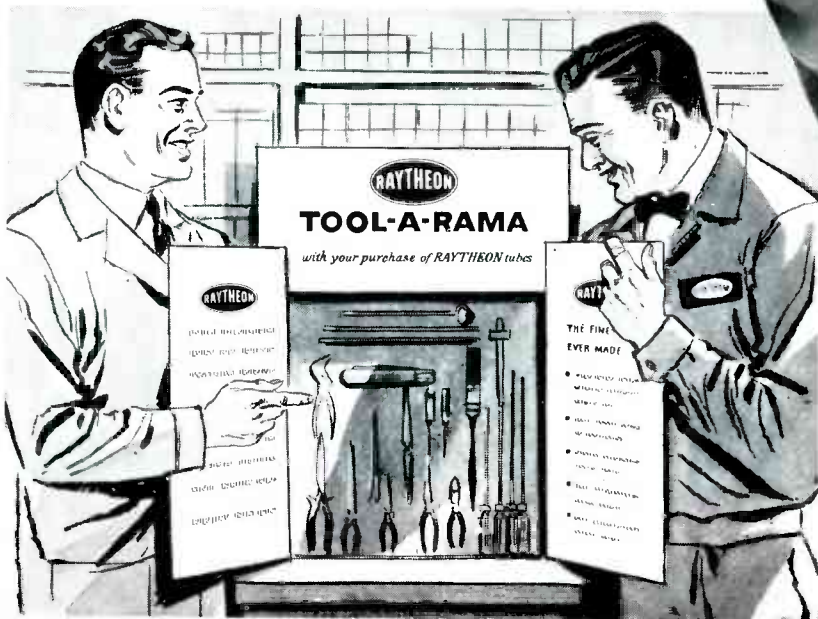
**RADIO CORPORATION OF AMERICA**

Electron Tube Division

Harrison, N. J.

**Announcing the Exclusive**

# **TOOL-A-RAMA**



Look for this display at your Raytheon Distributor's store. See for yourself why Raytheon guarantees these are the finest tools ever made!



# Raytheon

# PROMOTION

Next to his tube stock, a service dealer's most valuable assets are the tools he uses in the performance of his daily business. Now, the world's finest service tools are available to service technicians exclusively through Raytheon Distributors.

Raytheon takes pride in announcing the most exciting service tool program ever offered in the industry. Without a doubt, these tools, precision-crafted in West Germany, are the finest tools you've ever seen or used. Surgeon-quality in design and appearance, they have the "heft and feel" that tells you at once they are designed and manufactured to the very highest quality standards.

You can get these tools in the master Tool-a-Rama set of unusual and especially assembled tools with your regular purchases of Raytheon tubes. Or, if you prefer, your Raytheon distributor is also offering them in a special Tool-of-the-Week program that lets you build your own matched set week by week. Either way you won't want to pass up this opportunity to get started on this once-in-a-lifetime tool offer.

Visit or call your Raytheon distributor today and ask about the Raytheon Tool-a-Rama. Find out how easy it is to own your own matched set of exclusive Raytheon tools.



**RAYTHEON  
COMPANY**

DISTRIBUTOR PRODUCTS DIVISION  
UNICENTER  
WESTWOOD, MASSACHUSETTS



• Polished chromium plating  
on nickel base

• Chrome vanadium  
alloyed electric steel

• Imported from  
West Germany

• Fully guaranteed

• Plastic handle covering—  
insulated for 10,000 volts



***NOW take another look at***

**NEW  MODEL 644**

**SOUND SPOT MICROPHONE • LIST \$110.00**

If you are in the commercial sound business, you have had your share of . . . "they couldn't be done" . . . jobs at one time or another in your business life. These jobs could not be solved because general purpose microphones just couldn't do the job. That, fortunately, is past history. E-V's new Model 644 ushers in a new era in the concept of microphone pick-up. So *take another look* and see how many of those "tough" jobs the 644 reclassifies to "simple and easy". Your local E-V distributor has all the details on the Model 644. Why not call him today or write Dept. 20R for our new Commercial Sound Catalog No. 132.

***Electro-Voice***<sup>®</sup>

**The New E-V Model 644 is in stock now at**

**ALABAMA**

Birmingham — Forbes Distributing, 2600 3rd Ave.

**ALASKA**

Anchorage — Yukon Radio Supply, 645 "I" St.

**ARIZONA**

Phoenix — Culver Electronic, 231 N. First Ave.  
Phoenix — High Fidelity Sound Systems, 1809 E. McDowell

**CALIFORNIA**

Burbank — Valley Electronic, 1302 W. Magnolia  
Fresno — Dunlap Radio, 2617 Tulare St.  
Hollywood — Hollywood Radio, 5606 Hollywood  
Los Angeles — Kierulff Sound, 820 W. Olympic  
Los Angeles — Radio Product Sales, 1501 S. Hill St.  
Oakland — Elmor Electronics, 140 Eleventh  
Pasadena — Audio Associates, 689 S. Fair Oaks Ave.  
Pasadena — Daw Radio, 1755-59 E. Colorado  
Pomona — Anderson-Maggs Electronic, 1095 E. 3rd  
Sacramento — Dunlap Radio & TV, 1800 22nd  
San Diego — Wrights House of Hi Fi, 5140 El Cajon  
San Francisco — Columbia Music & Electronics, 1080-86 Market St.  
San Francisco — San Francisco Radio, 1284 Market  
San Francisco — Eber Electronics, 2355 Market St.  
San Jose — Alco Paramount, 79 South Third  
San Rafael — Catania Sound, 1541 Fourth St.  
Santa Barbara — Channel Radio Supply, 18 E. Ortega  
Stockton — Dunlap Radio, 27 North Brant St.

**COLORADO**

Denver — Fistells Electronic Supply, 1001 Bannock  
Pueblo — L. B. Walker Radio, 100 N. Victoria

**CONNECTICUT**

Hartford — Dressler Electronics, 401 Trumbull St.  
Hartford — Hatry of Hartford, Inc., 100 High St.  
Meriden — Business Music, Inc., 99 Colony  
Middletown — G. U. Reed, 143 Williams St.  
Waterbury — The Bond Radio Supply, 439 W. Main

**DELAWARE**

Wilmington — W. S. Wilson Co., 405 Delaware

**DISTRICT OF COLUMBIA**

Washington — Commissioned Electronics, 1776  
Columbia Rd., N.W.  
Washington — Electronic Whlsr., 2345 Sherman, N.W.  
Washington — Shrader Sound, 2803 "M" St., N.W.  
Washington — Silberne Radio & Electronic Co.,  
3400 Georgia Ave., N.W.  
Washington — U.S. Recording, 1121 Vermont Ave.  
Washington — Wilson-Gill, 1 Thomas Circle, N.W.

**FLORIDA**

Jacksonville — Fidelity Sound, 1427 Landon Ave.  
Miami — Electronic Equipment, 2701 N.W. 42nd  
Miami — Electronic Supply, 61 N.E. 9th St.  
Miami — Flagler Radio, 1068 West Flagler St.  
Tampa — Thuro Distributors, 121 South Water  
Winter Park — Laird Electronics, 803 Fairbanks Ave.

**GEORGIA**

Atlanta — Cathoun Co., Inc., 121 Forrest Ave., N.E.  
Atlanta — Radio Television, 526 Plaster Ave., N.E.

Atlanta — Southeastern Radio Parts Co., 400 W.  
Peachtree St.

**HAWAII**

Honolulu — Precision Radio, 1160 South Kings St.

**IDAHO**

Boise — Robbies Radio & TV, 3801 Hill Rd.

**ILLINOIS**

Benton — Lampley Radio Co., 452 East Church St.  
Broadview — Hi Fi Unlimited, 1303-05 Roosevelt Rd.  
Chicago — Allied Radio, 100 North Western  
Chicago — deHann Hi-Fi, Evergreen Shopping Plaza  
Chicago — Newark Electric, 223 W. Madison St.  
Chicago — Private-Tele-Communications, Inc., 1010  
West Diversey Parkway  
Chicago — Woodlawn Appliance, 1215 East 63rd  
Jacksonville — Besco, 419 South Mauvaisterre St.  
Peoria — Klaus Radio, 403 East Lake

**INDIANA**

Anderson — Seybert's, 1331 Main St.  
Bloomington — Stansifer Radio — 1805 S. Walnut  
Evansville — Ohio Valley Sound, 20 E. Sycamore  
Fort Wayne — Warran Radio, 1716 S. Harrison  
Fort Wayne — Workrite Intercommunication Sys-  
tems, 5341 Gardenview  
Indianapolis — Graham Electronics, 122 S. Senate  
Indianapolis — Radio Distributing, 1013 N. Capitol  
Indianapolis — Warren Radio, 732 N. Capitol Ave.  
Kokomo — Georges Electronic, 320 W. Superior  
Peru — Clingaman Sound, 814 West Main  
Richmond — Fox Electronics, 711 South Ninth  
Rolling Prairie — Rolling Sound, Rural Route 1  
South Bend — Colfax Company, 747 S. Michigan  
South Bend — Industrial Sound Engineers, 531 1/2  
Eddy St., South  
South Bend — Radio Distributing, 1212 S. High St.  
Terre Haute — C. T. Evinger Co., 1216 Wabash  
Wabash — Mark's Camera & Hi-Fi Shop, 14 Canal

**IOWA**

Council Bluffs — World Radio, 3415 W. Broadway  
Des Moines — Radio Trade Supply, 1224 Grand Ave.  
Iowa City — Woodburn Sound, 218 East College St.

**KANSAS**

Kansas City — D. Beatty Stereo Hi-Fi, 1616 W. 43rd  
Wichita — Radio Supply Co., 115 Laura St.  
Wichita — Stark-Suburban Sound, 807-09 South  
Woodlawn

**KENTUCKY**

Lexington — J. M. Hisle, 405 South Upper St.  
Lexington — Radio Equipment Co., 480 Skain St.  
Louisville — Universal Radio Service, 533 S. 7th St.  
Paducah — Rowton TV & Sound Corp., 4815 Clarks  
River Rd.

**LOUISIANA**

New Orleans — Electronic Parts, 3622 Toulouse

**MAINE**

Bangor — Maine Electronic Supply, 494 Broadway  
Portland — Maine Electronic Supply, 148 Anderson

**MARYLAND**

Baltimore — Henry O. Berman, 12 E. Lombard St.

Baltimore — Industrial Electronics, 127 Light St.  
Baltimore — Kann Ellert Electronics, 9 S. Howard  
Baltimore — R. Selway Collmus, 627 N. Bend Rd.

**MASSACHUSETTS**

Boston — Cramer Electronic, Inc., 811 Boylston St.  
Boston — DeMambo Radio, 1095 Commonwealth  
Boston — The Louis M. Herman Co., 885 Boylston St.  
Boston — Radio Shack Corp., 730 Commonwealth  
Boston — Tape & Music Inc., 1026 Commonwealth  
Boston — Trimount Coin Machine, 40 Watham Ave.  
Cambridge — Hi Fi Lab Electronic, 1077 Mass.  
Springfield — Regent Sales, 999 Worthington St.  
Worcester — Fred G. Walters Co., 1308 Grafton St.

**MICHIGAN**

Ann Arbor — Wedemeyer Electronic, 213-17 N. 4th  
Battle Creek — Electronic Supply, 94 Hamblin Ave.  
Detroit — Audio Equipment, 15747 Wyoming  
Detroit — KLA Laboratories, 7375 Woodward Ave.  
Detroit — Pecar Electronics, 11201 Morang Ave.  
Detroit — Rissi Electronic Supply, 14405 Wyoming  
Flint — Folsom's Commercial Sound Engineering,  
1608 Albert St.  
Grand Rapids — Radio Electronic Supply Co., 505  
Jefferson, S.E.

Grand Rapids — Radio Parts, 542 Division, S.  
Lansing — Offenbauer Company, 5019 W. Saginaw  
Lansing — Tape Recording Industries, 3335 East  
Michigan Ave.

Muskegon — West Michigan Sound, 1932 Peck  
Saginaw — Audio Communications, 1511 Janes

**MINNESOTA**

Minneapolis — Lew Bonn, 67 South Twelfth St.

**MISSISSIPPI**

Jackson — Swan Distributing, 342 North Gallatin  
Tupelo — Pate Electronics, Highway 45 South

**MISSOURI**

Cape Girardeau — Seudekum Electronics, 2215  
Broadway  
Kansas City — Audio Communications, 1515 Balti-  
more Ave.

Kansas City — Burstein Applebee, 1012-14 McGee  
Kansas City — McGee Radio Co., 1901 McGee St.  
Kirkwood — Kirkwood Camera, 122 W. Jefferson  
St. Louis — Ebinger Electronics, 2501 S. Jefferson  
St. Louis — Gasco, Inc., Box 113, Lambert Field  
St. Louis — Hollander & Co., Inc., 3900 W. Pine  
St. Louis — Interstate Supply, 4445 Gustine  
St. Louis — Phone Craft Co., 427 North Euclid  
St. Louis — Van Sickle Radio Co., 1113 Pine St.

**NEBRASKA**

Omaha — J-B Distributing Co., 1616 Cass St.

**NEW JERSEY**

Camden — Radio Electric Service, 513 Cooper  
Jersey City — Nidisco-Jersey City, Inc., 713 Newark  
Mountainside — Federated Purchaser, 1021 Rte. 22

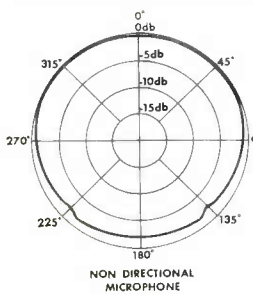
**NEW YORK**

Albany — Audio-Viaeo Corp., 324 Central Ave.  
Albany — Fort Orange Radio, 904 Broadway  
Auburn — Dare Radio, 22 East Genesee St.

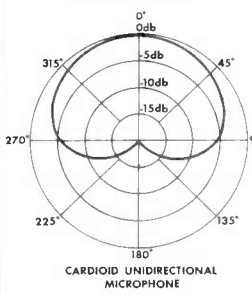
# those "impossible" sound jobs!

compare polar patterns yourself

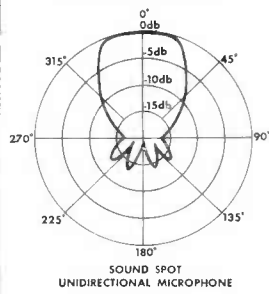
## NON-DIRECTIONAL



## CARDIOID



## SOUND SPOT



- Four times greater working distance than the best cardioids, depending on acoustics
- Greatly reduces feedback
- Retains "on-mike" presence despite extended working distance
- Excellent outdoors . . . less wind noise
- Priced low to fit most budgets
- Lasts a lifetime

Another better product for better sound from . . .

**ELECTRO-VOICE, INC.**

Commercial Products Division • Loudspeakers-Microphones

BUCHANAN, MICHIGAN



## your Electro-Voice Microphone Headquarters

Binghamton — Stack Electronics, 25 State St.  
 Buffalo — Radio Equipment, 147 Genesee St.  
 East Meadow — South Service Engineers, 1778 Hempstead Turnpike  
 Elmira — Chemung Electronics, 403 East Third St.  
 Farmingdale, Long Island — Gem Electronics Distributors, 34 Hempstead Turnpike  
 Jamaica — Lafayette Radio, 165-08 Liberty Ave.  
 Mineola, Long Island — Arrow Electronics Inc., 525 Jericho Turnpike  
 New York — Airex Radio, 64 Cortlandt St.  
 New York — Goody Audio, 235 West 49th St.  
 New York — Harvey Radio, 103 West 43rd St.  
 New York — Heins & Bolet, 68 Cortlandt  
 New York — Hudson Radio, 37 West 65th St.  
 New York — Leonard Radio, Inc., 69 Cortlandt  
 New York — Magic-Vue Television, 323 E. 13th St.  
 New York — Milo Trading, 215 Fulton  
 New York — Recording Tape Co., 123 East 88th St.  
 New York — Sonocraft, 115 West 45th St.  
 New York — Terminal Radio, 85 Cortlandt  
 Rochester — Rochester Radio, 600 East Main St.  
 Syracuse — Brawn Sound Equipment, 521 E. Washington  
 Valley Stream — Sam Goody Green Acres, Inc., 44 North Parking  
 White Plains — Westchester Electronic Supply, 602-610 Mamaroneck Ave.

**NORTH CAROLINA**  
 Asheville — Freck Radio & Supply Co., 38 Billmore  
 Charlotte — Dixie Radio, 4131 Bryant St.  
 Gastonia — Stroup Hi Fi Center, 112 Green Drive  
 Winston Salem — Dalton Hege Radio, 938 Burke

**NORTH DAKOTA**  
 Fargo — Walter Electronic, 402 North P. Ave.

**OHIO**  
 Akron — Olson Radio, 69 West State St.  
 Akron — The Sun Radio Co., 110 East Market St.  
 Canton — Burroughs Radio, 2705 Fulton Rd., N.W.  
 Columbus — Associated Sound, 671 Dennison Ave.  
 Columbus — Electronic Supply, 134 E. Long St.  
 Dayton — Custom Electronics, 1918 S. Brown  
 Dayton — Srepa, Inc., 314 Leo St.  
 Lima — Hutch & Son, Roberts at Lenore  
 Marion — Servex Electronics, 220 N. Prospect  
 Massillon — M. H. Martin Co., 1118 Lincoln Way, E.  
 Steubenville — The D & R Radio Supply 221 S. 3rd  
 Toledo — Warren Radio Co., 1002 Adams St.  
 Zanesville — Thompson Radio, 110 South 6th St.

**OKLAHOMA**  
 Oklahoma City — Johnson Wholesale Electronics, 927 Northwest First St.  
 Oklahoma City — Trice Wholesale, 800 N. Hudson

**OREGON**  
 Portland — United Radio, 22 Northwest 9th  
 Salem — Universal Sound Corp., 1461 Capitol, N.E.

**PENNSYLVANIA**  
 Allentown — A. A. Peters, Inc., 231 North 7th St.  
 Allentown — Radio Electronic Service, 1313 Linden  
 Bethlehem — Buss Radio, 431 West Broad St.  
 Erie — Warren Radio, Inc., 1313-17 Peach St.  
 Harrisburg — D & H Distributing, 2535 N. 7th St.  
 Johnstown — Cambria Equipment, 17 Johns St.  
 McKeesport — McKeesport Electronics, 1661 5th Ave.  
 Philadelphia — Airtone, 1710 Sansom St.  
 Philadelphia — Alma Radio, 913 Arch St.  
 Philadelphia — General Sound, 3500 N. 9th St.  
 Philadelphia — Magnetic Recorder & Reproducer, 1533-35 Cherry  
 Philadelphia — Radio Electric Service Co., N.W. 7th and Arch Sts.  
 Pittsburgh — Cecil T. Hall Labs, 770 Washington  
 Pittsburgh — Radio Parts Co., 6401 Penn Ave.  
 Pittsburgh — Olson Radio Warehouse, 5918 Penn  
 Pottsville — Mayer Electronic, 330 N. Norwegian  
 Reading — George D. Barbey, Second and Penn Sts.  
 State College — Alvo Electronic, 103 S. Pugh  
 Wilkes-Barre — Shelborne Electronics, 169 N. Penn

**RHODE ISLAND**  
 Providence — W. H. Edwards, 92 Broadway  
 Providence — Gertz, Inc., 257 Adelaide Ave.

**SOUTH CAROLINA**  
 Charleston — Radio Labs, 475-477 East Bay St.  
 Columbia — Dixie Radio Supply 1628 Laurel St.

**TENNESSEE**  
 Knoxville — McClung Appliance, 310 Georgia, NE  
 Knoxville — Roden Electrical, 708 Central, N.W.  
 Knoxville — Smith Electronic, 301 E. Magnolia  
 Memphis — Bluff City Distributing, 234 East St.  
 Memphis — Glenn Allen Co., 1150 Union Ave.  
 Memphis — Lavender Distributors, 180 S. Cooper  
 Memphis — W & W Distributing, 644 Madison Ave.  
 Nashville — D & N Dist., 113 19th Ave., S.  
 Nashville — Electra Distributors, 1914 W. End Ave.

**TEXAS**  
 Arlington — Audio Acoustics, 130 Fairview  
 Corpus Christi — Electronic Equipment and Engineering, 805 South Staples  
 Dallas — All State Distributing, 2411 Ross Ave.  
 Dallas — Southwest Radio, 1820 W. Harwood  
 Fort Worth — C. Herring Sound, 1705 7th St., W.  
 Fort Worth — Rae Ganit Sound, 12th & Throckmorton  
 Houston — Sound Equipment, 2506 Crawford  
 Lubbock — R & R Distributing, 1607 Avenue G  
 Lubbock — Sound Photo Sales, 2107 Broadway  
 Waco — Best Electronics, 324 North 18th St.

**UTAH**  
 Ogden — Carter Supply, 3214 Washington Blvd.  
 Ogden — Ballard Supply, 3109 Washington Blvd.  
 Salt Lake — Custom Sound by Poll, 1651 S. 11th

Salt Lake — Ballard Supply Co., 44 E. 6th St., S.

**VIRGINIA**  
 Arlington — Rucker Electronic, 1213 Wilson  
 Danville — Womack Radio, 513 Wilson  
 Newport News — General Supply Co., 4215 Huntington Ave.  
 Norfolk — Cain Electronics, 14th and Monticello  
 Norfolk — Electronic Engineering, 4201 Hampton  
 Norfolk — Priest Electronics, 6431 Tidewater Dr.  
 Norfolk — Radio Parts Dist'ng., 128 W. Olney  
 Norfolk — Radio Supply Co., 711 Granley St.  
 Richmond — Cottrell Electronics, 408 East Main St.  
 Roanoke — L. C. Hartman, 3236 Cove Rd., N.W.  
 Staunton — Southern Electronic, 818 Greenville

**WASHINGTON**  
 Everett — Pringle Radio, 2514 Colby  
 Seattle — Electricraft, Inc., 1408 6th Ave.  
 Seattle — Western Electronic Supply, 717 Dexter Ave.  
 Seattle — Pacific Electronic Sales, 1209 First Ave.  
 Tacoma — C & G Radio Supply, 2502 Jefferson Ave.  
 Tacoma — Wibbe Radio Supply, 2360 S. Fawcett Ave.

**WEST VIRGINIA**  
 Charleston — Chemcity Electronic Dist., 1637 4th  
 Charleston — Mountain Electronics, 708 Bigley Ave.  
 Parkersburg — Hausfeld Radio Supply, 536 7th St.

**WISCONSIN**  
 Manitowac — Harris Radio Corp., 115 N. Tenth St.

**BRITISH COLUMBIA**  
 Vancouver — D. Eldon McLennan, 1624 W. 3rd Ave.

**NEW BRUNSWICK**  
 Moncton — Lewis-Price TV Radio, 330 St. George

**ONTARIO — CANADA**  
 Kitchener — MacDonald Electric, 307 Queen St., S.  
 London — C. M. Peterson Co., 575 Dundas St.  
 London — Provincial Electronic Supply, 641 York  
 Ottawa — Tower Productions, 278 Sparks St.  
 Scarborough — R. C. Kohnert, 73 Crockford Blvd.  
 Sudbury — Sanic Northern, 300 Elm St., East  
 Toronto — Electro-Sonic Supply, 540 Yonge St.  
 Toronto — Electro-Voice Sound Systems, 126 Dundas  
 Toronto — General Sound & Theatre, 861 Bay  
 Windsor — Adams Electronics, 2471 Ouellette Ave.  
 Windsor — C. M. Peterson & Co., 800 Howard Ave.

**QUEBEC — CANADA**  
 Montreal — Electric Labs, Reg'd, 7556 St. Hubert  
 Montreal — Payette Radio, 730 St. James West  
 Montreal — Radio Service, 2022 McGill College  
 Quebec City — Crobel, Ltd., 790 Blvd. Charest E.  
 Quebec City — George Latour, Inc., 1540 Third

**MANITOBA — CANADA**  
 Winnipeg — Dollard Recording Ltd., 138 Portage

**EXPORT**  
 New York — Telesco International, 36 W. 40th St.

# 'TOUGH DOG'



## SYNC TROUBLES

How to use waveform analysis to isolate evasive lock-in problems — Joe A. Groves

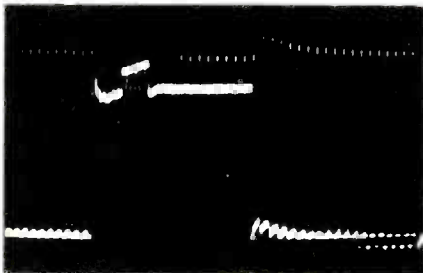


Fig. 1. Sync-input waveform expanded to show details of vertical pulse.

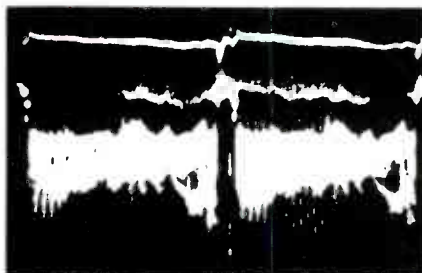


Fig. 2. Composite video signal normally fed to sync separator (30 cps).



Fig. 3. Sync-input signal at 7875-cps sweep rate shows horizontal pulses.

Let's change those "tough dogs" into lap pets!

Did you ever stop to think that sync circuits are similar in many ways to some of the RC-coupled audio amplifier stages we have been servicing for years? It's easy to overlook this similarity, because there is a big difference in the servicing techniques generally applied to these two types of circuits. In audio, we have our ears to help us troubleshoot, but we have no such aid in sync circuits. To be sure, we have a picture that reacts to sync troubles by rolling, jittering, bending, etc., but these distortions are all too often caused by something outside the sync circuits themselves.

In order to troubleshoot sync circuits efficiently, something must be used to give us that extra crutch our ears provide in audio. Of course, that "something" is a scope. Although we do not have room in this

article to give detailed instructions in scope use, we want to emphasize that each scope and probe has its own personality and oddities—the same as our ears—and we must know our own equipment's peculiarities so that it doesn't mislead us.

Looking into some typical sync circuits, we find RC-coupled amplifiers designed to handle the fundamental frequencies of the vertical, horizontal, and equalizing pulses, along with sufficient harmonics to reproduce the proper pulse shapes. These frequencies are all low enough so that no special circuit elements (such as peaking coils) are needed to insure uniform frequency response. However, there is a great difference (in both frequency and waveshape) between the vertical and horizontal pulses. This makes it easy to direct them into separate take-off paths, as we'll explain later.

To better understand what is expected of sync circuits, let's look at Fig. 1. This waveform is a "stretched-out" portion of the composite video signal fed to the input of the sync section. The horizontal gain control of the scope was turned wide open, and the centering control readjusted to observe a portion of the waveform including a vertical sync pulse. The long, heavy trace near the positive peak is the vertical blanking pedestal. You'll notice that the amplitude of positive signal peaks above this pedestal is slightly lower than the amplitude of the horizontal sync-pulse tips at either side of the pedestal. This effect occurs because the grid-leak bias on the sync stage increases slightly during the vertical blanking interval. The slight change in amplitude has no ill effect on circuit operation.

Details of the waveform, from left to right, are as follows: Horizontal sync pulses preceding the vertical blanking pedestal; steep leading edge of the pedestal; six equalizing pulses, occurring at twice the frequency of the horizontal pulses (important for good interlace); the vertical sync pulse, with serrations (to maintain normal horizontal sync); six more equalizing pulses; nine ordinary horizontal sync pulses during the rest of the vertical blanking period; trailing edge of the blanking pedestal and

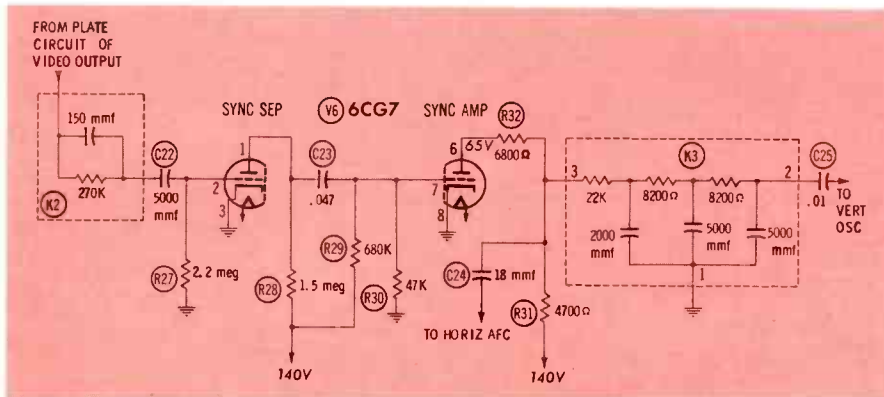


Fig. 4. This widely-used sync circuit consists of two triode stages.

• Please turn to page 84



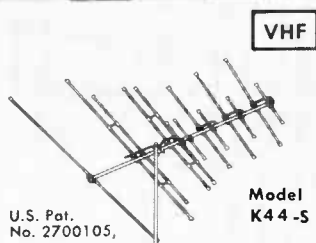
# Winegard's

## "K" SERIES, NEW, PLAIN-ALUMINUM ANTENNA LINE

Now, Winegard introduces a complete new series of plain aluminum antennas in addition to Winegard's incomparable line of GOLD ANODIZED TV and FM antennas. Winegard "K" Series antennas are priced so you can meet any competitive situation . . . at the same time, you can give your customers

a much better antenna for the money.

Compare "K" Series antennas with plain aluminum models offered by others. See for yourself how *much more* you get from Winegard. You'll find a "K" Series model for every reception requirement. Ask your Winegard distributor or send in the coupon below.

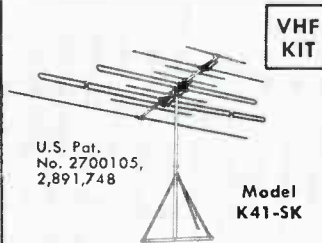


U.S. Pat. No. 2700105,

Model K44-S

### POWERCEPTOR

Four 9 and 11-element models with fold-out driven elements. Electro-Lens director system. All-channels 2-13. List \$19.50 and \$21.50.

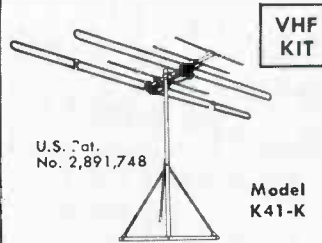


U.S. Pat. No. 2700105, 2,891,748

Model K41-SK

### SUPER POWERBEAM

Three complete fringe area kits. Patented tripod roof mount, Chimney mount; Mast and guy wire mount. All channels 2-13. List: \$26.20, \$29.35, \$36.70.

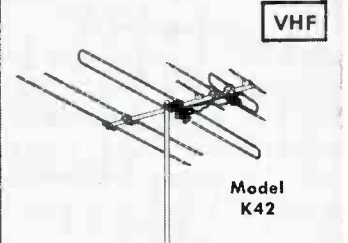


U.S. Pat. No. 2,891,748

Model K41-K

### POWERBEAM

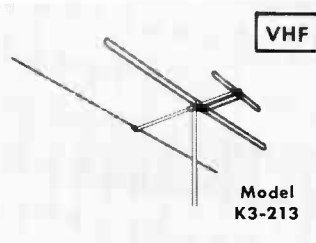
Complete kit including patented universal tripod roof mount. Excellent for primary and near-fringe areas. All ch. 2-13. List, \$14.95.



Model K42

### POWER PIX

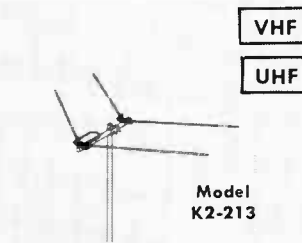
Ideal replacement for old style "Con Yagis". Full-power gain on all channels 2-13. Stacking increases power 84%. List, \$13.00.



Model K3-213

### INLINE

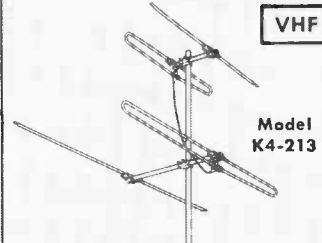
Well-built standard inline for all (VHF) channel coverage in primary areas. Dual moisture-barrier insulators. List, \$6.60.



Model K2-213

### VEE

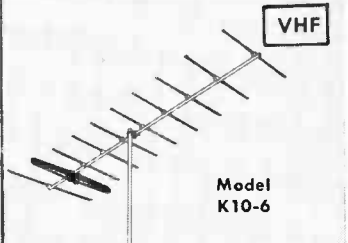
Improved version of the popular "Vee". Reflector has inductance loading coil for more uniform gain and frequency response. List, \$5.55.



Model K4-213

### HI-LO

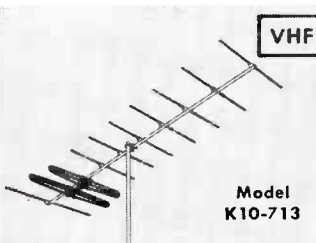
For use in city and suburban areas. List, \$7.90. HI only, List, \$2.60. LO only, List \$5.05. Includes one-piece wrap-around mast clamp.



Model K10-6

### CUT-TO-CHANNEL

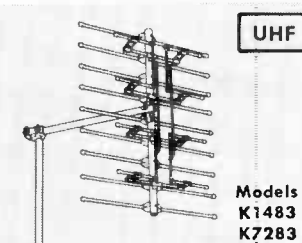
Complete series of wide-spaced 5-element and 10-element cut-to-channel yagis. Center bar of driven element snaps out for stacking. List, \$4.90 up.



Model K10-713

### BROAD-BAND

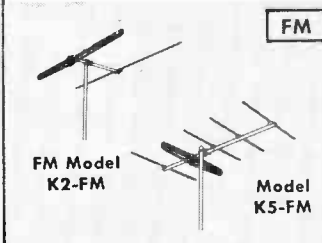
Complete series of wide-spaced 5-element and 10-element broad-band yagis. Center bars of driven elements snap out for stacking. List, \$7.20 up.



Models K1483 K7283

### UHF COLINEAR

High gain antenna with exclusive offset mount. Stacks horizontally for greatest efficiency. Regular UHF or Translator UHF model, List \$9.80.



FM Model K2-FM

Model K5-FM

### FM

Two-element and 5-element wide-spaced FM yagis for improved reception on 88-108 mc. Directive, high-gain design. K2-FM, List \$5.05. K5-FM, List \$13.80.

### GET THE DETAILS

The Winegard Company  
3009-2 Scotten Blvd.  
Burlington, Iowa

Please send technical bulletins on the following "K" Series models:

\_\_\_\_\_

Name \_\_\_\_\_

Address \_\_\_\_\_

# KEY TO QUICKER COLOR SERVICING

Troubleshooting sequences based on actual field experiences with causes for the nine most common color problems — by Warren J. Smith

Color TV has come a long way from the original 15" metal picture tube and complex circuitry to the 21" glass tube and comparatively simple circuits of today. Still, to the service technician who has not serviced color receivers on a regular basis, an occasional job is all too often a profitless "time-eater." To help speed the pinpointing of color troubles, we've prepared this detailed servicing guide, which is based on the nine most common color symptoms. The troubleshooting steps are arranged in a logical sequence, emphasizing the troubles most commonly encountered in actual field experiences.

## I. No Color—Monochrome Pix & Sound Normal

### Cause

Trouble area very broad; defect may be in chrominance channel, color killer, or color sync circuits. (Refer to Fig. 1, a block diagram of a typical color receiver.)

### Procedure

(1) Check all tubes in color section, including the 3.58-mc subcarrier oscillator, reactance tube, bandpass amplifier, color killer, burst keyer (burst gate), burst phase detector, demodulator driver, color demodulators, and color-difference amplifiers.

(2) Narrow trouble area by first checking chrominance channel. Measure bandpass-amplifier bias voltage (color killer voltage). If sufficient to cut off bandpass amplifier, disable color killer by opening its cathode circuit. If chrominance channel then functions properly and a color broadcast or color-bar signal is present at the input, color of sorts will be seen in the picture—although it probably won't be correctly synchronized. If color appears, proceed to step (4); if not, a defect in the bandpass amplifier or demodulator driver is indicated.

(3) Using wide-band scope and low-capacitance probe, check for

normal input signal to bandpass amplifier (Fig. 2A). In most receivers, this signal consists mainly of chrominance information in the 3- to 4-mc band. However, some luminance (video) information may also be present, as evidenced by the distorted sync pulses in Fig. 2A. If input signal is normal, signal-trace through bandpass-amplifier circuits to color demodulators, checking for presence of pure chroma signal (Fig. 2B). Carefully check voltages and test individual components as required in any circuit where signal is lost or distorted.

(4) Further narrow trouble area by checking to see if subcarrier oscillator is operating. Check all voltages with a VTVM, particularly grid bias. Low or zero bias means oscillator is not functioning. To make a more positive check for oscillator operation, connect a wide-band scope with low-capacitance probe—or VTVM with RF probe—

• Please turn to page 76

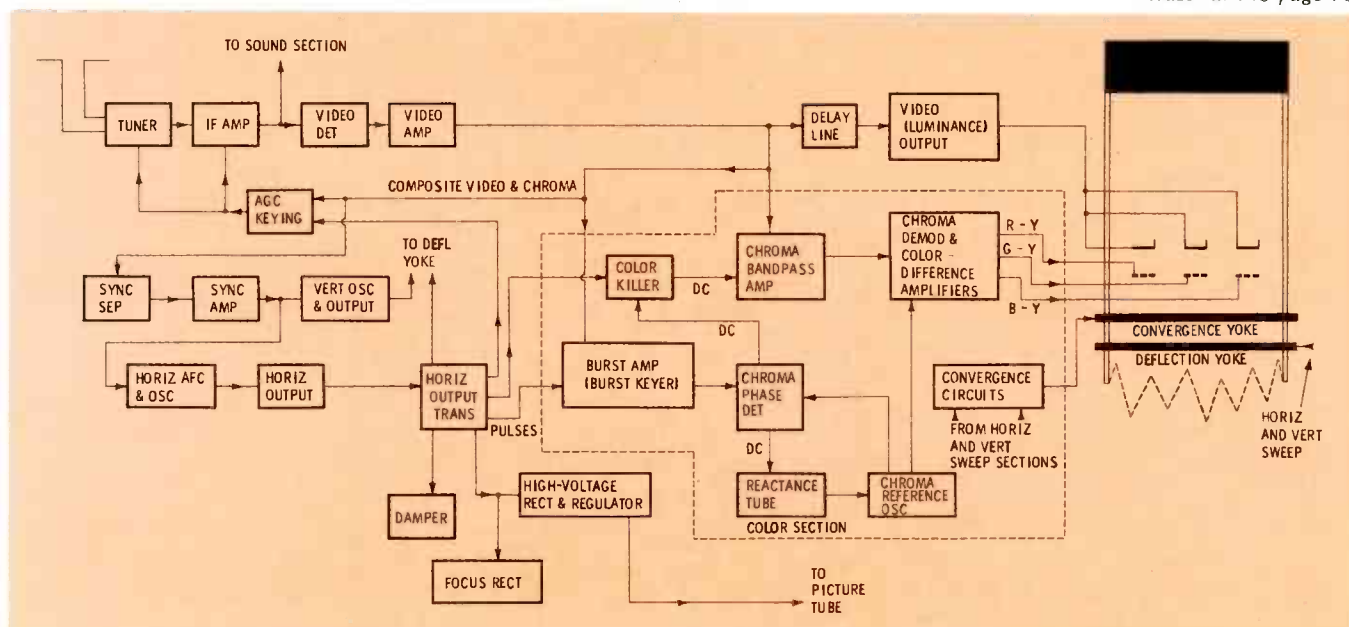
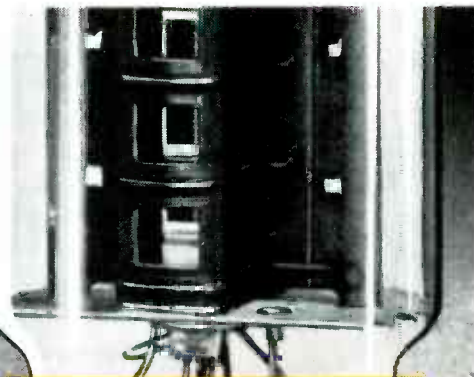


Fig. 1. Basic block diagram of late-model color television receiver.

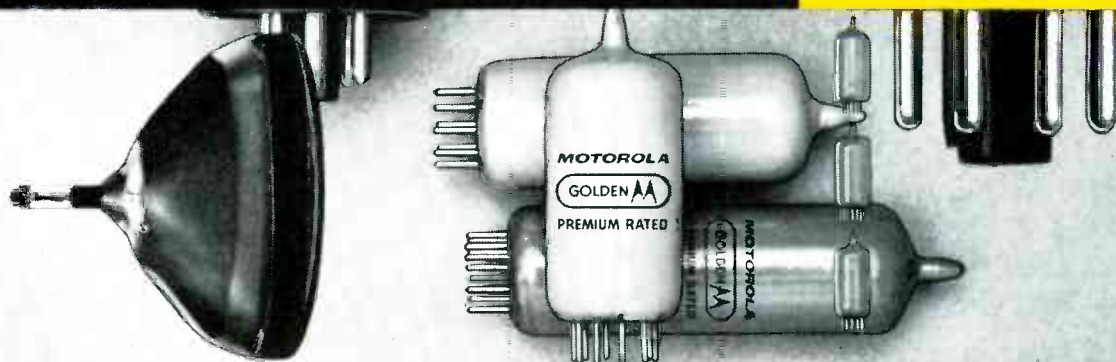


Look for the label that looks out for you



Golden Symbol of Service...

GENUINE  
**MOTOROLA**  
Golden M  
PREMIUM RATED  
PICTURE TUBES  
RECEIVING TUBES



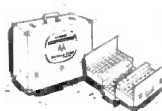
# The most reliable tubes ever for every set you service

The circuit tubes that "couldn't be built" are at your service . . . Motorola *Premium Rated* Golden "M"® Tubes. While ordinary tubes have no safety factor beyond maximum ratings, Golden "M" Tubes are tested to **TWICE MAXIMUM RATINGS**.

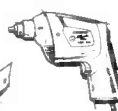
Zooming sales indicate that service technicians everywhere are experiencing far fewer call backs and winning increased customer good will by stocking and selling Golden "M" Tubes. They're *Premium Rated* . . . at no premium cost to you.

Contact your Motorola distributor today for further details on fabulous Golden "M" Receiver Tubes . . . and Golden "M" Picture Tubes as well.

## SPECIAL OFFER! For a Limited Time Only



Tube and Tool Tote



Allenite Electric Drill and Bit Set



Triplett Pocket Volt-Ohm-Milliammeter



Portable Parts Cabinet

Time-saving service tools and cases can be yours with purchase of Motorola Golden "M" Picture Tubes/Receiving Tubes. Call your Motorola Distributor today for details!



# MOTOROLA

PARTS AND ACCESSORIES, FRANKLIN PARK, ILLINOIS



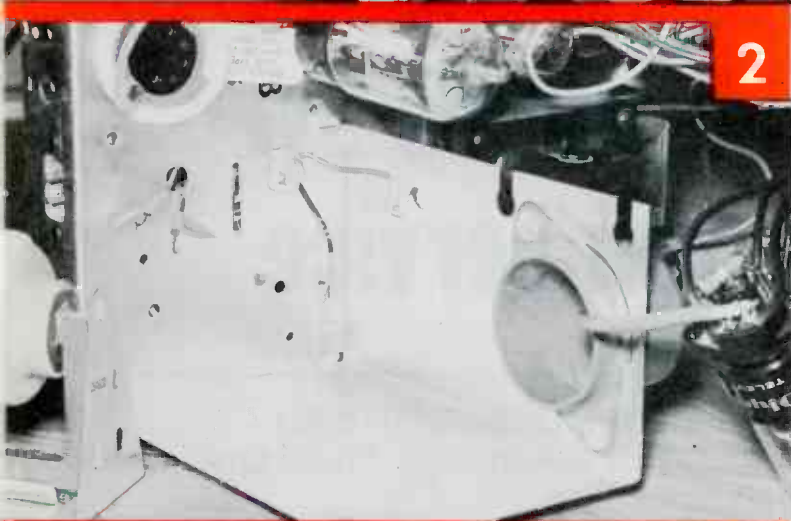
REG. PENDING

When called upon to replace a flyback transformer, you have two major factors to consider. First, you must choose a suitable replacement; second, you must make sure that it works right. Choosing a suitable replacement was the subject of a May, 1957 article; this story shows you how to insure a lasting repair through use of proper installation techniques. It should serve as a reminder that any job worth doing is worth doing right.

# FLYBACK



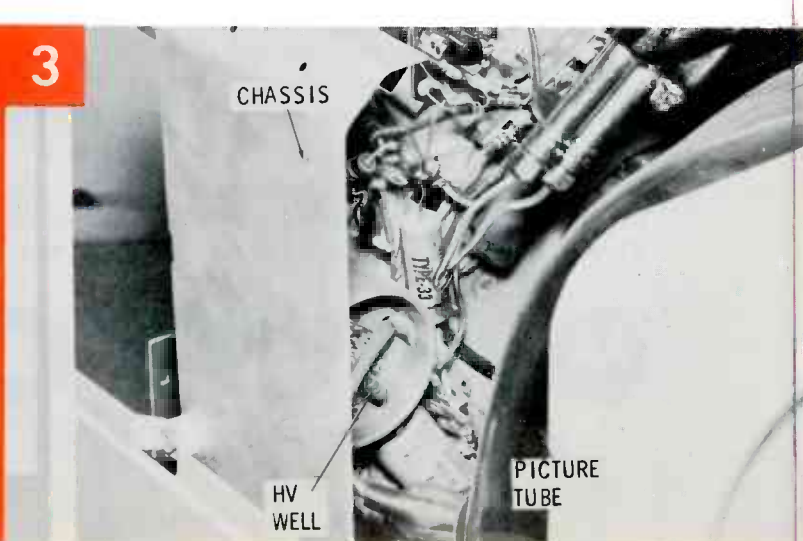
**1 Clear The Deck For Action!** Don't make the installation tougher by trying to work in close quarters. Whenever possible, give yourself plenty of elbow room by removing the high-voltage cage as well as the tubes around the flyback, and dressing all leads not associated with the project away from the area. Also, avoid the bad habit of working in the dark; make sure you have adequate lighting for the job.



**2 Which Wire Goes Where?** Be sure to identify all leads either before or as you disconnect them. Don't rely on your memory and end up with a new flyback that resembles a piece of charcoal. Here are a couple of suggestions, whether it be for an exact or universal type replacement. Before picking up the soldering iron, use masking tape to tag and identify each terminal number. Or, if you prefer, draw a partial schematic, indicating colors of the lead or leads connecting to each terminal.



**3 Now for the Filament Winding.** Time was when the high-voltage rectifier socket was either soldered to a filter cap or perched on special stand-off insulators. In today's sets, you'll find most of these sockets nestled in a malded plastic "well." In many cases, the back of the "well" will be open, and filament leads should be accessible. If somewhat difficult to reach, as pictured here, you'll find it much simpler to remove the two screws holding the "well," rather than to pull the picture tube or the entire chassis. In some designs, the back of the "well" may be completely enclosed. In this case, simply remove the two screws holding the socket for access to the filament connections.



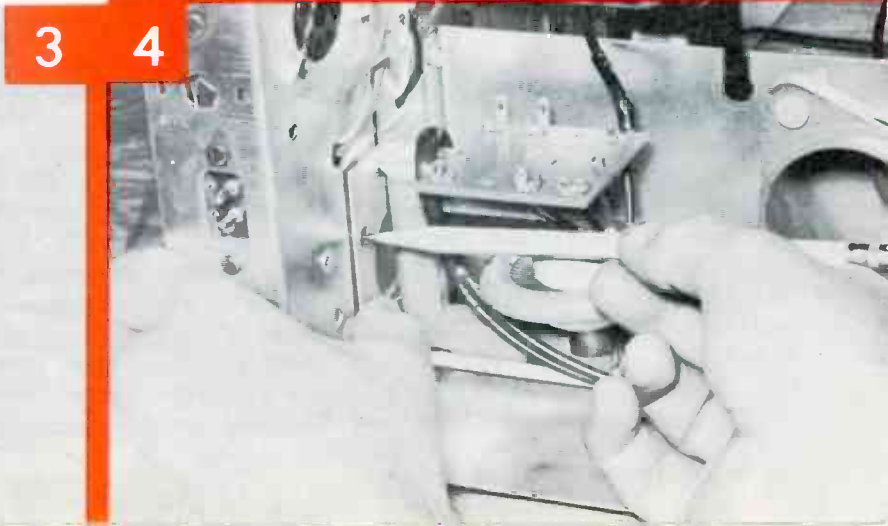
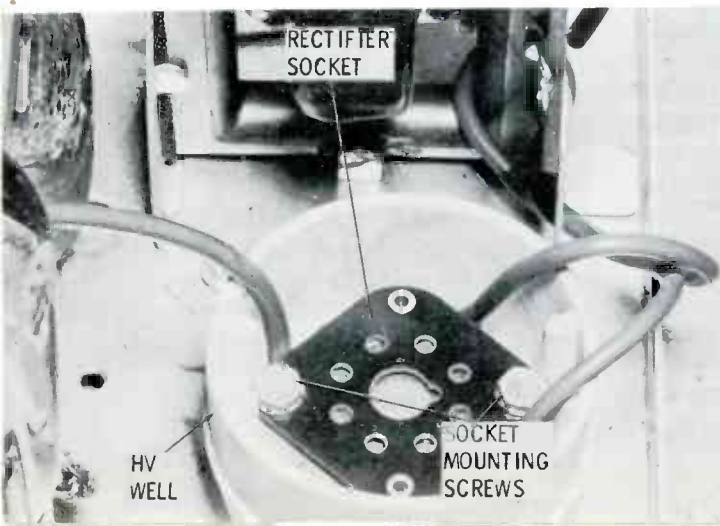
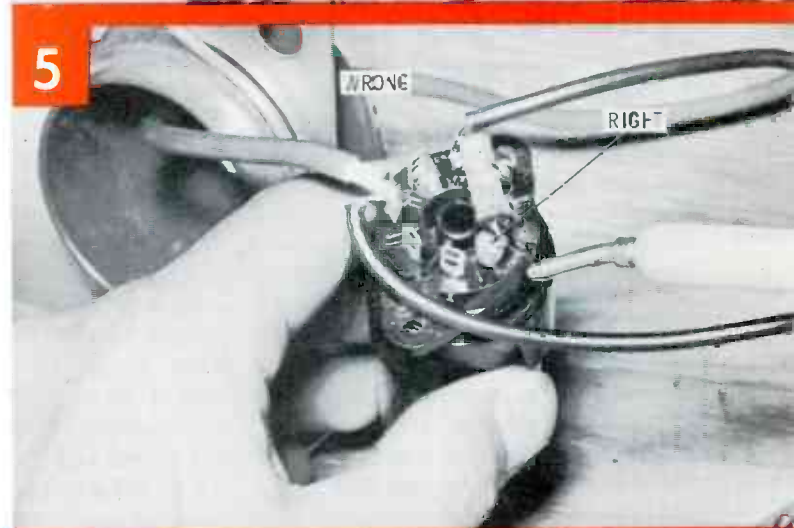
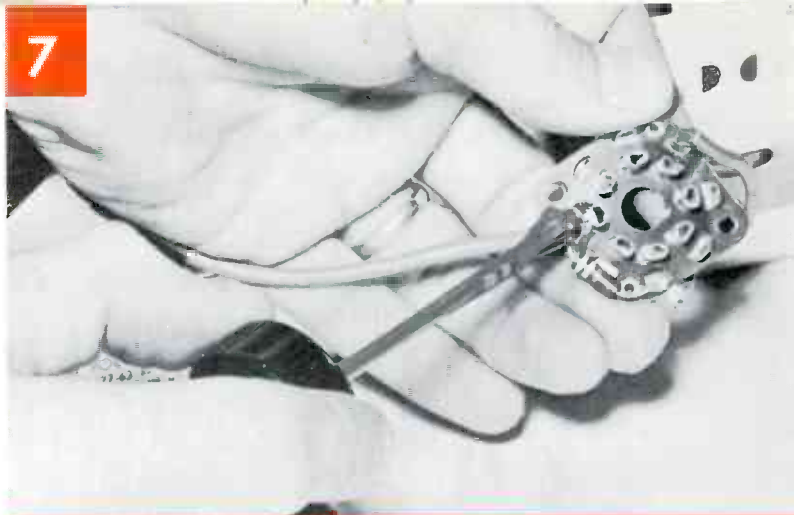
# TRANSFORMER REPLACEMENT

**7** **Eliminate Callbacks.** Since dust and moisture are bound to collect on parts and connections, it's a good idea to use a chemical insulator to prevent arcing and corona discharge. However, don't use chemical compounds to hide a "botched-up" repair. They should be used as safeguards against future arcing conditions, and not as cures for poor soldering, etc.

**6** **Quality Control.** Check the installation by evaluating sweep width, high voltage, boost, and operating conditions of the output tube. Adjust linearity for minimum current in the output tube. Back off the drive adjustment until the drive line just disappears. Set width for enough sweep, but don't force a  $110^\circ$  deflection on a  $90^\circ$  CRT. To monitor output tube current, either use one of the modern socket-adaptor type test instruments, or insert a milliammeter in place of the horizontal sweep circuit fuse as illustrated.

**5** **Soldering Techniques.** "Warning, High Voltage." How often are we actually conscious of this caution notice? When replacing a flyback, remember that high voltage means easy arc-over. Make a good physical connection first, and then flow solder into the joints. Don't leave strands of wire or points of solder sticking out—especially on socket connections to the high-voltage rectifier.

**4** **"X" Marks The Spot.** Exact replacements or original manufacturer's parts should not require any mounting modifications. However, be sure not to use original shields, insulators, or mounting hardware if damaged or otherwise beyond restoration. If you do, all your efforts may be for nothing. A replacement which matches the original electrically but not mechanically may require drilling of a new mounting hole. This is really no problem; merely position the replacement so that its terminals aren't too close to the sides of the cage and plate-cap leads are not excessively long. Then, mark the location of the new hole as shown, and drill.



7

6

5

3

4

*analyzing*

**HI-FI**

*troubles in the home*



Hi-fi equipment should be repaired “on the spot” whenever possible, instead of being taken to the shop for service. This idea is nothing new to the TV technician, because he has always done as much servicing as possible in the home, both to save time and increase profit. Home service is even more desirable for hi-fi than for TV. In the first place, bringing an entire audio system to the shop is often impractical, either because the cabinet is too bulky, or because there are too many independently mounted (and often built-in) subassemblies. In the second place, by taking a single unit such as a preamp to the shop, you are removing it from the system in which it normally operates. It may react differently in another system, say a test setup at the shop, and also may not sound the same because of acoustic differences in the listening areas.

The hi-fi serviceman thus needs to be able to diagnose and repair a great variety of defects without relying on bench-test procedures. Of course, once a trouble has been definitely isolated to a particular subchassis in a hi-fi system, this unit can be disconnected and carried in to the shop for the detailed test procedures needed to “zero in” on the defect.

**Answering Home Calls**

Home service calls for hi-fi re-

pair are similar to TV calls in many respects, but definitely different in other ways. Hi-fi owners typically take more pride and interest in their sets than TV owners, with the result that hi-fi owners are likely to know more about the equipment. Another point of difference is that hi-fi work demands more attention to small details which may be overlooked in TV work. Servicing hi-fi only to the point where it “works” is often insufficient; how well it works is of utmost importance.

At the time a complaint is received, get as much information as possible about the type of equipment owned by the customer, as well as about the nature of the service problem. Either during the initial phone call, or when first arriving at the customer’s home, ask as many as necessary of the following questions: Does the trouble exist all the time, or just at certain times of the day? Is it intermittent? Does it exist for all program inputs—phono, tuner, tape, etc? If only on phono, does it exist for all recordings? Does the trouble persist all the way through the record? Has the system been working normally prior to this trouble? Have the units been disconnected, moved, dropped, or subjected to any unusual treatment? Queries such as these greatly narrow down the field of possible defects and give the technician a good

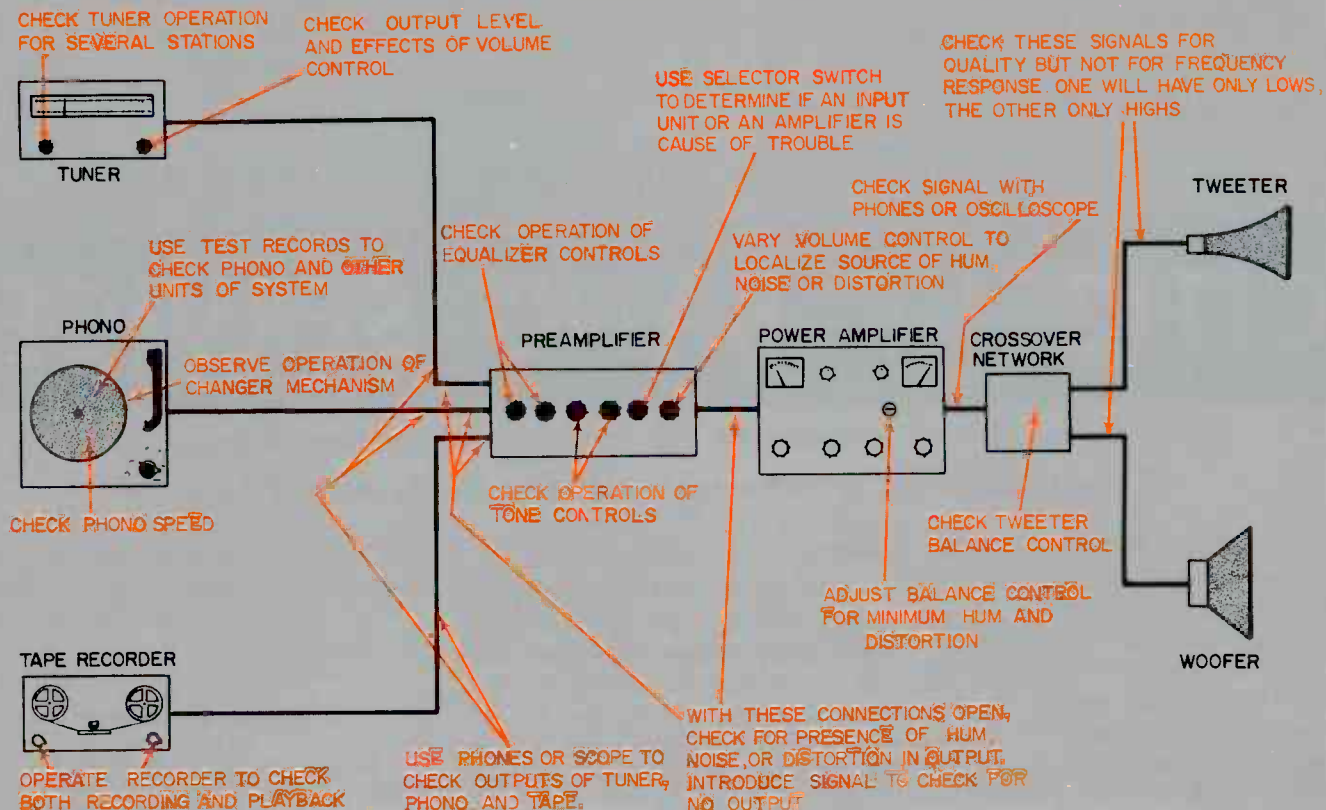
starting point for trouble analysis. Fortunately, most (though not all) hi-fi owners give a better account of symptoms than TV owners.

Next comes listening. A competent hi-fi technician should be able to listen to a system and know what he is hearing. Are the low bass tones coming through clearly, or are the higher bass tones being accentuated as in juke boxes? Do the various instruments sound lifelike? Is there too much treble? Do the various controls have the proper effect on system operation?

When listening, consider the program source. Noise and hum are both more noticeable with some music (such as piano solos) than with a full orchestra playing, no matter where the noise originates. In orchestral recordings, the sustained music only covers up the noise without eliminating it.

**Locating the Trouble Source**

Even when the owner is able to provide helpful clues, it remains largely up to the technician to determine just what the trouble is. It is even more his responsibility to determine *where it is*. Unless the fault is immediately obvious, there is no substitute for a logical, systematic sequence of testing procedures. This trouble-isolating technique is based on common sense (plus a reasonable understanding of hi-fi operation), and is funda-



mentally very simple. Fig. 1 outlines the standard procedure for localizing defects in pictorial form for easy reference. The following paragraphs contain a summary of the more important points in logical order.

From the owner's complaints and your own listening, determine the nature of the fault as exactly as you can. Then determine if the fault exists for all program sources or just for one. For example, if the AM-FM tuner furnishes normal signals but records sound distorted, then the fault obviously must be in the phonograph unit or in the phono-input circuit of the preamp. However, if the trouble is noticeable for all inputs, a circuit common to all signal channels must be faulty. Such a defect could lie anywhere in the preamp, power amplifier, crossover network, or speaker system. Incidentally, don't forget the possibility of cable and connector faults, especially in complex systems which have been formed by interconnecting several separate units. Also, while making tests, be sure all the controls are set at their normal operating positions. Tone controls should normally be set to "flat" unless specific circumstances dictate otherwise.

The source of distortion, hum, or noise can be roughly located by observing the effects produced when

the volume control is varied. If distortion is present at all settings of this control, it is probably being introduced in a prior stage. However, if the distortion varies with the volume, the fault is likely to be somewhere on the output side of the control. (For example, it might be due to overdriving of the final amplifier stage at high volume settings.) For hum or noise, the above reasoning is reversed. If the volume control varies the level of the offending hum or noise, you can assume it is entering the signal channel at a point ahead of the control; however, if its level is not affected by a change in the volume setting, it is evidently being introduced in a stage following the control. After the initial volume-control tests have been made, manipulating the other controls may give additional information.

The source of hum or noise may be further localized by either short-circuiting or disconnecting the signal path at various points. Where the system contains several units, begin by disconnecting the input to the power amplifier chassis. Naturally, there will be no signal output, but the hum or noise will be heard if it is being generated within the power amplifier. If not, reconnect the input and perform this same test at different points, working back through the system. If everything is

on a single chassis, you can make noise-isolation tests by short-circuiting various signal points to ground. It is wise to connect a capacitor in series with the shorting lead so that points where high DC voltage is present can be safely checked. The value of the capacitor should be large enough (say .25 mfd) to have little reactance at 60 cps for effective shunting of hum signals. This short test is also helpful in stage-by-stage testing of a specific chassis indicated as faulty by the "disconnect test." Don't overlook the possibility of hum being introduced by the power supply and thus appearing in more than one stage or unit.

No output (no sound) is one of the easier defects to isolate. Various input connections (grids, phono-jack tips, etc.) can be touched with the finger or with some metal object to insert a 60-cps hum signal. Scratching a terminal or signal point with a screwdriver is another crude, but effective, method of signal insertion. Of course, a portable audio signal generator—if you have one—will supply a more dependable signal for these tests. The most efficient procedure for signal insertion is to start at the loudspeaker and work toward the front end of the system. The fault

• Please turn to page 87

# What About This New CITIZENS BAND SERVICE

**Up-to-date information on the facilities and equipment for  
the latest thing in radio communications. — by Allan Lytel**

The Citizens radio service has been given new life by recent changes in FCC rules. The former 11-meter amateur band (26.96-27.23 mc) has been reassigned in favor of two new classes of low-powered Citizens-band stations. These supplement, but do not replace, the CB service previously established in the 465-mc UHF band. Present-day Citizens radio facilities are summarized in Table I.

**Table I — Citizens Band  
Frequency Assignments**

Class	Frequencies (mc)	Characteristics
A	Following bands: 460-461 462.525-463.225 464.725-466.475	Maximum power* 50 watts; AM or FM two-way radiotele- phone; stations 50 kc apart.
B	465.00	Maximum power* 5 watts; AM or FM radiotelephone; remote operation permitted.
C	Six channels: 26.995, 27.045, 27.095, 27.145, 27.195, 27.255	Maximum power* 5 watts (except on 27.255 mc, where it is 30 watts); "carrier on-off" or AM tone modu- lation only; NOT radiotelephone, but for remote control devices only.
D	22 channels, in- cluding all those in band 26.96-27.23 mc not allocated to Class C. Operation on 27.255 mc also permitted on shared basis with Class C.	Maximum power* 5 watts; AM mobile two-way radiotelephone; stations 10 kc apart except where separated by Class C channels.

\*Input to plate of final RF stage in transmitter.

**Table II — FCC Field  
Engineering Offices**

All communications should be addressed to Engineer in Charge, FCC, at nearest field office. Mailing addresses are as follows:

Mobile 10, Ala.	New Orleans 12, La.
P. O. Box 644 Anchorage, Alaska	Baltimore 2, Md.
P. O. Box 1421 Juneau, Alaska	Boston 9, Mass.
Los Angeles 12, Calif.	Detroit 26, Mich.
San Diego 1, Calif.	St. Paul 2, Minn.
San Francisco 26, Calif.	Kansas City 6E, Mo.
San Pedro, Calif.	Buffalo 3, N. Y.
Denver 2, Colo.	New York 14, N. Y.
Washington 25, D. C.	Portland 5, Ore.
P. O. Box 150 Miami 1, Fla.	Philadelphia 6, Pa.
Tampa 2, Fla.	P. O. Box 2987 San Juan 13, Puerto Rico
Atlanta 3, Ga.	P. O. Box 1527 Beaumont, Texas
P. O. Box 77 Savannah, Ga.	Dallas 22, Texas
Honolulu 1, Hawaii	Houston 11, Texas
Chicago 4, Ill.	Norfolk 10, Va.
	Seattle 4, Wash.

## Class A

Commercial FM two-way radio gear, built for operation in industrial, land transportation, or public safety services in the 450-470 mc band, can also be used for this highest-grade Citizens service. Selective calling equipment is available.

## Class B

Typical equipment for this service is a superregenerative UHF transceiver, considerably simpler than Class A equipment. Power output is much less than for Class A, but still adequate for short-range mobile communications.

## Class C

For remote operation of garage doors, model aircraft and boats, etc., several types of simple radio systems are available. These may use either an interrupted CW transmission or a tone-modulated (AM) signal for control purposes. One channel in this band (27.255 mc) has been available for some time; the other five have only recently been released for CB use.

## Class D

This is the new band which has been creating a flurry of interest in Citizens radio. The relatively low frequencies overcome some of the extreme "line-of-sight" limitations on transmission that have discouraged some potential users from operating in the 465-mc band. As yet, there are no restrictions on the use of Class D equipment except operation within the law. The band is open for business or personal use, but there is no guarantee of protection from interference. A total of

22 channels are available. Station licenses are obtainable upon application; no specific proof of need is required.

## Typical Equipment

There is a very wide choice of CB radio equipment — everything from do-it-yourself kits to complete, ready-to-use sets of gear. Hand-held, battery-operated portable sets are available, as well as units for all types of mobile vehicles from small boats to cars and trucks. CB rigs can be used in all sorts of applications, from camping trips to everyday industrial communications.

Mobile equipment is generally operated from a 6- or 12-volt DC power supply, or from 115 volts AC in some locations near power lines. Both single-channel and multichannel transmitters and receivers are offered. To demonstrate the variety of equipment available, a number of representative Class D units—kits as well as factory-wired transceivers—are shown on these pages.

## Getting Your Station License

Citizens band equipment may be licensed as a two-way mobile system to any citizen of the United States who is 18 or more years of age. The citizen to whom the station (or group of stations) is licensed need have no particular technical qualifications, and no examination is necessary. The only requirement for station licensing and registration is to fill out Form 505, available from the nearest field office of the FCC (See Table II). A copy of this form is usually provided by manufacturers supplying

\* Please turn to page 80

## A CROSS-SECTION OF CB TRANSCEIVER EQUIPMENT

A typical unit contains a crystal-controlled transmitter section (which may be fixed-tuned or may include a channel-selector switch) and a superhet receiver (usually crystal-controlled, but may be continuously tunable). A squelch circuit, to keep the receiver silent when no message is being received, is virtually a standard feature. The list price of each transceiver normally includes a ceramic or crystal microphone and a set of frequency-control crystals for operation on one channel. Some manufacturers furnish power cords and mounting brackets for mobile installations, and a simple antenna, for short-range use, may also be included. Additional crystals and more elaborate antennas are available as accessories to most pieces of equipment.



Multi-Products Co., Oak Park, Mich. — Multi-Elmac Citi-fone, supplied as Model CD-5/6 for 117 VAC/6 VDC operation or Model CD-5/12 for 117 VAC/12 VDC; 5 channels; 4¼" x 11" x 8" 12 lb; \$134.50.



Arkay International, Inc., New York—Sky-Vox Model SQ-9. Operates on 117 VAC or 12 VDC, 3 channels; 5" x 8½" x 11"; \$79.95 for kit with prewired front end, or \$119.95 wired and tested.



Gonset Div., Young Spring & Wire Corp., Burbank, Calif. — Citizens Communicator G-12. 117 VAC/12 VDC power supply; 4-channel transmitter and receiver; 4½" x 7" x 10", weight 11 lb; price \$149.95.



Regency Div., IDEA, Inc., Indianapolis, Ind.—Model CB-27 (for 117 VAC only) or CBM-27 (for 12 VDC). 2-channel transmitter; continuously-tunable receiver; adjustable speech-amplifier gain; 9 lb; \$124.95.



Dunlap Electronics, Inc., Des Moines, Iowa—Citizens Band Transceiver. Choice of 117 VAC or 6/12 VDC power supply; either in kit form or factory-wired; ruggedized trunk-mounted version optional.



E. F. Johnson Co., Waseca, Minn.—Viking Messenger. Three versions available, with 117 VAC/12 VDC, 117 VAC/6 VDC, or straight 117 VAC power; 5 channels; 5½" x 7" x 11¾"; AC-only model \$129.75, others \$139.75.



Utica Communications Corp., Chicago, Ill. — Town and Country Model PT 27. Universal 117 VAC/6-12 VDC power supply; single-channel operation; separate connectors for long- and short-range antennas; \$159.50.



Globe Electronics, div. of Textron, Council Bluffs, Iowa — Citizens Broadcaster CB-100. Choice of 117 VAC/6 VDC or 117 VAC/12 VDC power; 3 channels selectable; 3½" x 13" x 10½", 13 lb; \$129.95.



Kay-Townes Antenna Co., Rome, Ga. — Citizens Radio Telephone Model BS-27. Separate types for 117 VAC, 6 VDC, and 12 VDC operation; single channel; front-panel RF wattmeter; 7¼" x 8¼" x 5½"; \$99.95.



Vocaline Co. of America, Inc., Old Saybrook, Conn. — Commaire Model ED-27. Either 117 VAC/6 VDC or 117 VAC/12 VDC supply; DC portion of power supply transistorized; single-channel; 5" x 9" x 7½"; \$179.50.

by Stan Prentiss

The customer complained only of a bright horizontal line across the screen of his Emerson 700B. You think immediately of a vertical multivibrator or output tube with an open filament, an unexpected loss of cathode emission, or perhaps even interelement shorts or leakage. So, when you arrive at his home and unbutton the back cover of the set, your first move naturally is to test or substitute tubes. I personally prefer testing, since a good checker with levers for each tube pin will tell you what happened in the tube to cause a breakdown. If you're in doubt about a short, *increase* the filament voltage one or two volts, and any leakage or short will show up more clearly. If the tube's Gm or its emission capability is in doubt, a slight *decrease* in filament voltage will cause the meter reading to fall off quite rapidly if the tube is weak.

On this call, the vertical multivibrator and output tubes both check out okay, and no other obvious faults are in evidence—so you decide to pull the set to the shop. Back at the bench, before firing up the set, you glance at the schematic and mull over the possible source of the trouble. You note that a shorted C60 or various open components such as C61, R74, R5, R72, or R73 would cause vertical sweep to collapse. But instead of checking these individual components right away, you decide to check basic DC operating voltages first—especially the 205-volt supply to the underside of vertical output transformer T3. You also limber up the scope in readiness for comparing waveforms to the normal signals shown in Fig. 1.

When you finally turn on the set, however, you wait in vain for a spark of life to appear on the 17" picture tube. Can this be double trouble? Maybe you've fractured something on the trip to the shop! You rock the brightness control—futilely—and then try to draw a

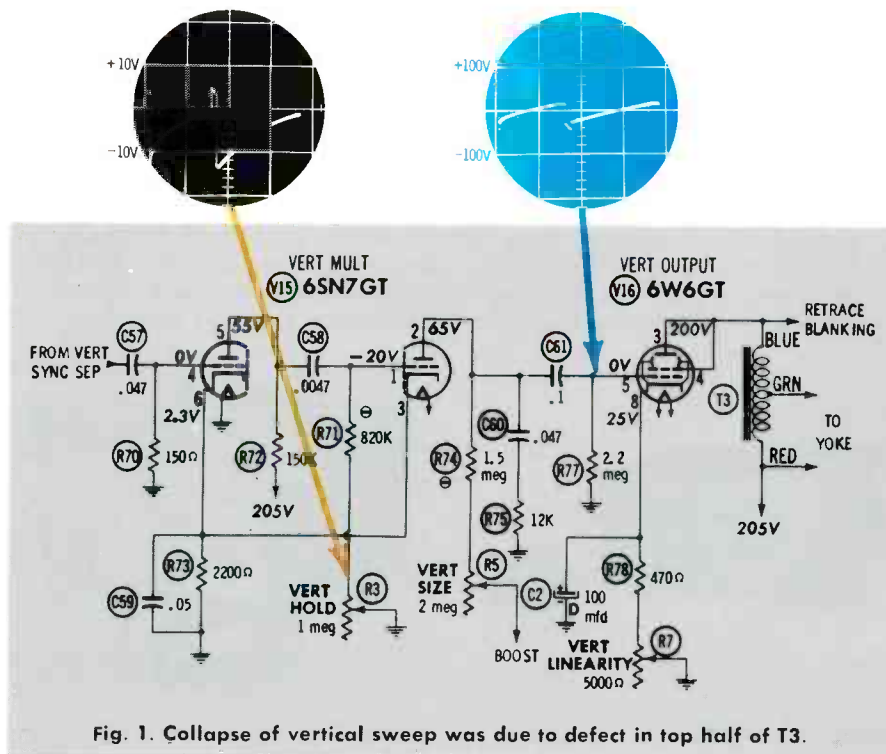


Fig. 1. Collapse of vertical sweep was due to defect in top half of T3.

# Tonic for an

1/2" arc from the high-voltage rectifier. There is only a puny sputter . . . the high voltage is obviously gone, too. Now the going is beginning to get a little rough. Out of curiosity, you check the DC voltages at the plates of vertical multivibrator and output tubes V15 and V16. The latter is only 20 volts instead of the normal 200, and the former is 32 instead of 65! From the plate of V15, you go to the high side of vertical size control R5, expecting

to find approximately 400 volts of boost B+ voltage. The measurement here is 210 volts, half of what it should be.

Now which way do you go? You decide it would be best to begin by finding out why there is almost no DC operating voltage reaching the plate of the vertical output tube. Touching the DC probe of the VTVM to the center tap of T3, you find this point to be 210 volts above ground. Evidently, then, continuity exists between the red and green leads of the transformer; what's more, the 205-volt B+ line obviously is supplying almost exactly the right value of voltage to the vertical output circuit. But, as you remember, there is a mere 20 volts on the blue lead going to the plate and screen of V16. This indicates that the upper section of the auto-transformer is practically open. (A short would have lowered the voltage on the 205-volt line.) Disconnecting the blue lead and measuring between it and the green lead with

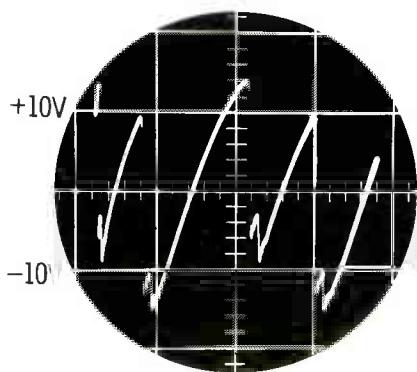


Fig. 3. Horizontal drive signal was far off frequency and only 29V p-p.



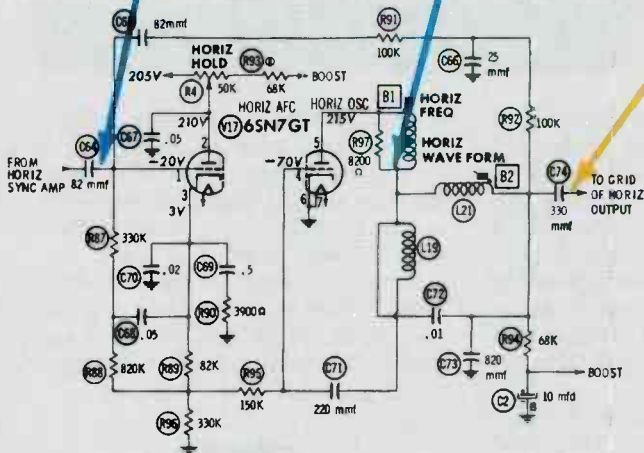
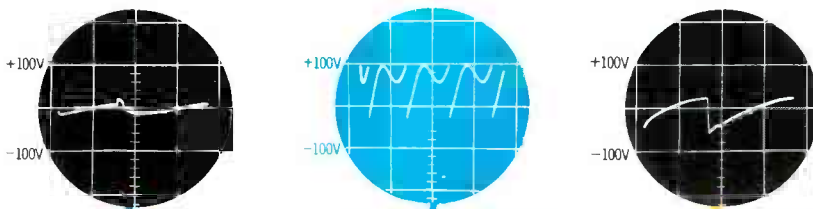


Fig. 2. Shorted B1 killed oscillator, and thus high voltage.

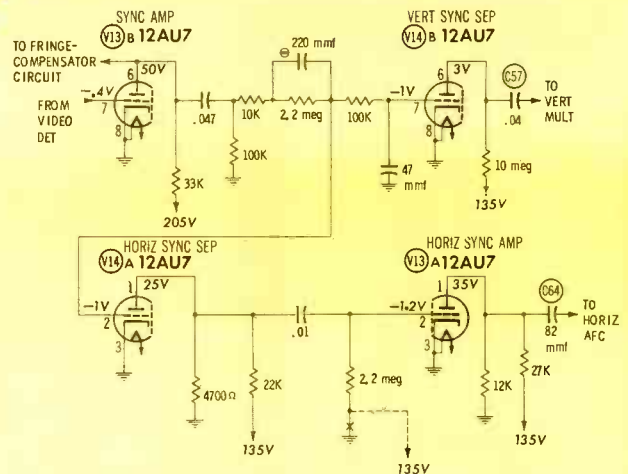


Fig. 5. Emerson 700B's sync circuit has dual separators.

# EMERSON 700B

an ohmmeter, you get a reading of 60K ohms—a far cry from the 1000 ohms of DC resistance which is normal for this section of T3. All right, so the transformer has to be replaced. This part of the trouble is fairly simple. But what about the remainder?

## Oscillator or Output Trouble

What's the best way to determine whether the seat of your high-voltage trouble is inside or outside the HV cage? More servicemen seem to be baffled by this service problem than by any other. Frankly, I don't blame anybody for becoming confused occasionally. Horizontal sweep is unquestionably the toughest circuit in a television receiver—at least it is for me. Even the most carefully laid plans of attack sometime add up to double confusion—especially when dealing with the horizontal oscillator.

As you will note from Fig. 2, the Emerson 700B uses the old tried-and-true pulse-width horizontal

AFC and oscillator system. This circuit works like a charm when good input waveforms and adequate DC voltages are applied. Try to make it operate without these, or attempt to "eye-align" the horizontal waveform coil B2 without using a scope, and you'll wind up with a receiver that throws itself out of horizontal sync whenever you change channels. Develop a serious defect in the oscillator circuit, and it quits alto-

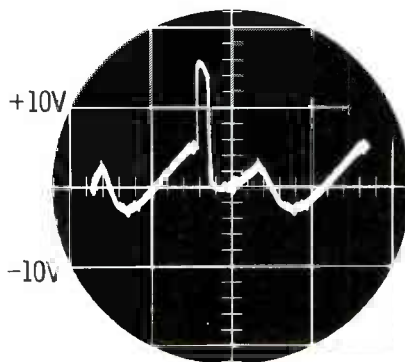


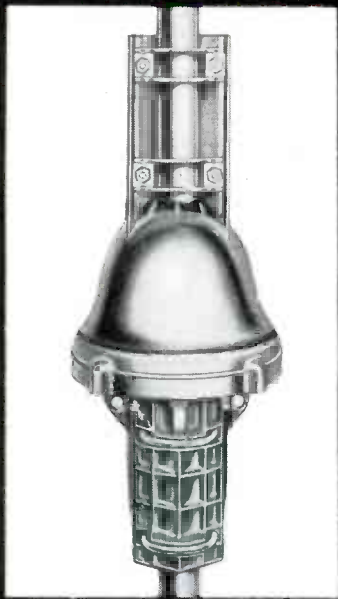
Fig. 4. Sawtooth-shaped component of waveform at AFC grid was missing.

The easiest means to attack the problem you now face is to enlist the aid of the technician's best friend, the oscilloscope. First, you check at the horizontal output tube (pin 5) to see if an adequate sawtooth waveform (W14) is arriving from the horizontal oscillator. It's there—but weak and wild (Fig. 3). Thus, your suspicions are directed at the AFC and oscillator stages, at least for the time being. As a double check, you feed a substitute drive signal (see *Shop Talk*, March, 1959 issue) to the grid of V18 to produce a horizontal sweep and partial vertical sweep. (Remember, T3 has not yet been replaced.) This test confirms that the flyback and horizontal output circuits are all right, so the AFC-oscillator section is now the target.

Trying a new 6SN7 for V17 doesn't restore high voltage. Moving the oscilloscope probe to the input grid of the AFC stage (pin 1), you find the waveform pictured in

• Please turn to page 91

## Cornell-Dubilier Rotors

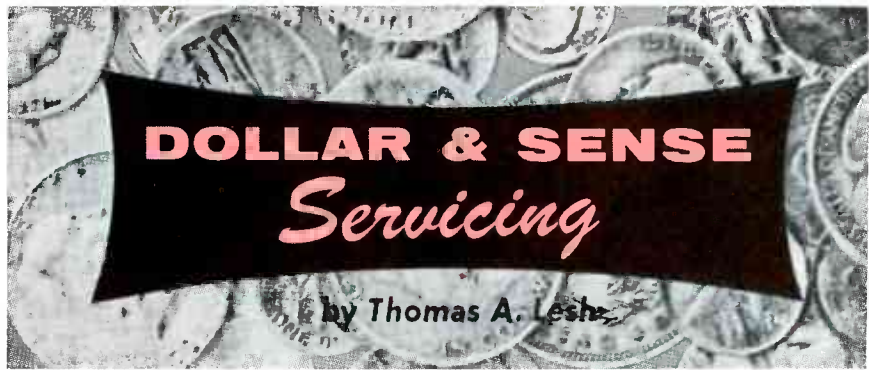


turn profits  
your way

Whether you are after original installation business or replacement sales, you'll find the rotor best-suited for any job in the complete CDR line. Consider, the heavy-duty TR-4 recommended for areas where ice-storms, heavy snowfalls and strong winds impair the efficiency of antennas turned by ordinary rotors. Your CD Rotor distributor is ready to show you why the TR-4 and other CD Rotors are the easiest to install...most satisfactory in the long run. Write for catalog TVR to Cornell-Dubilier Electric Corp., S. Plainfield, N. J.

**CDE** **CORNELL DUBILIER**

Affiliated with Federal Pacific Electric Company



by Thomas A. Lesh

**Careful Aim.** Direct mail is a "big expense — small audience" proposition if you think only in terms of statistics. Its success lies not in numbers, but in reaching a high proportion of *interested* people. A few hundred well-planned, well-placed letters can result in as much business as an impersonal broadcast or billboard message exposed to thousands.

However, inefficient use of direct mail can squander even the most liberal advertising budget. Mailing lists need to be carefully pruned so that messages will hit where they will do the most good. There is no reason why every mailing has to go to everyone on the shop's master address list. Each ad should have some definite purpose—announcing an introductory offer, suggesting a seasonal checkup, giving details of a sale on accessories, or anything else with news value. Before preparing a mailing, it is wise to stop and decide who should get it. For instance, if you were planning to send out a coupon good for a discount on a general chassis inspection and tube check, don't bother someone whose set has just been in the shop. And, prior to sending a "Thanks for your loyal patronage" card, check to see how loyal the customer has been *lately*. An inappropriate mailing, besides wasting postage and materials, is likely to offend customers.

So it's worth some extra time and effort to make up short, specialized mailing lists for individual campaigns. It's naturally easier to follow through on this chore if paper work is kept to a minimum. Here's one idea that should help: Along the top of your master service-record cards (which you should already be using!) use small code marks to keep track of various points of information about customers. Check those with sets you judge to be about ready for new picture tubes, extensive overhaul, antenna work, or just plain trading in; if you come up with a special offer along any of those lines, let

them know. Recent shop jobs or other extensive work could also be indicated, perhaps by writing in the date the set was returned; this would come in handy on future service calls as well as on mailings.

One more twist on the code-mark idea—when you run into a grouch or a poor credit risk, "X" his card and avoid going out of your way to solicit any more of his business!

### \$ & C

#### Old Sets Never Die . . . They Just Sync Out of Sight

Exasperating, isn't it, to get involved in a long and expensive repair of an old receiver—only to have a hard time collecting a fair return for your efforts? It's enough to make you swear you'll never again undertake shop work on a set more than six years old.

Such a drastic move isn't necessary, but maybe it would be sensible to scale down the level of repairs on these sets. Though it may be professionally satisfying to restore an old receiver to like-new condition, why push your luck if you can get the set working acceptably well at minimum cost? Your main objective is satisfying a human being, not meeting a technical specification. And, if a set is obviously very run-down, chances are the owner is bent on squeezing every last bit of service out of it. He'll willingly put up with twitchy sync, smeary video, intermittent reception of some channels, and other infirmities—if he thinks the set is outliving its normal life span. When catastrophe finally strikes, he'll let the set gather dust or scrap it.

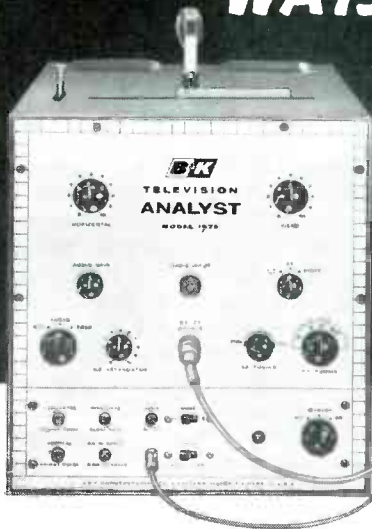
So, before accepting a badly deteriorated set for shop work, make absolutely sure the customer understands what cost this may entail. He may happen to be proud of the set, or better able to pay for a major overhaul than for a new receiver. If so—and expensive sweep

# SAVE $1\frac{1}{2}$ THE TIME

## Make Twice The Profit!

in TV  
Trouble-Shooting

**THIS EASY  
SIGNAL INJECTION  
POINT-TO-POINT  
DIRECT VIEWING  
WAY**



## MODEL 1075 TELEVISION ANALYST

### Solve Rough Sweep Output Problems



### NEW Model A107 DYNA-SWEEP CIRCUIT ANALYZER

Saves many hours of service work. Provides vertical and horizontal sync and driving pulses that enable you more easily and quickly to check out every stage in the sync and sweep sections of a television receiver.

Tracks down troubles in the horizontal and vertical output circuit including defective output transformer and yoke; checks for shorted turns, leakage, opens, short circuits, and continuity. Includes unique high-voltage indication. Eliminates trial and error replacements.

**Model A107 Dyna-Sweep.** Companion unit for use only with B&K Model 1075 Television Analyst for driving source  
Net, \$49.95

**Model 1070 Dyna-Sweep.** Same as Model A107 but has its own horizontal and vertical driving pulse, and is used independently of the Model 1075.  
Net, \$69.95

### New Technique Makes TV Servicing Easier, Faster, More Profitable

Thousands of service technicians already save thousands of hours every day with the amazing B&K TELEVISION ANALYST. Enables you to inject your own TV signal at any point and watch the resulting test pattern on the picture tube itself. Makes it quick and easy to isolate, pin-point, and correct TV trouble in any stage throughout the video, audio, r.f., i.f., sync, and sweep sections of black & white and color television sets—including *intermittents*. Makes external scope or wave-form interpretation unnecessary. Enables any serviceman to cut servicing time in half, service more TV sets in less time, really satisfy more customers, and make more money. Color generator provides both rainbow pattern and color bars.

**MODEL 1075 TELEVISION ANALYST.** Complete with standard test pattern, white dot, white line, and color-bar slide transparencies, and one clear acetate. Net, **\$259<sup>95</sup>**

See your B&K Distributor or Write for Bulletin ST24-R

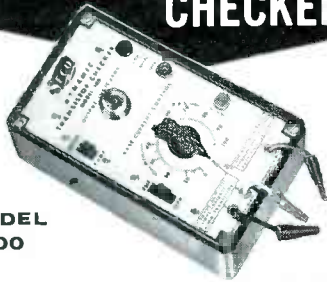


**B & K MANUFACTURING CO.**

1801 W. BELLE PLAINE AVE • CHICAGO 13, ILL.

Canada: Atlas Radio Corp., 50 Wingald, Toronto 10, Ont.  
Export: Empire Exporters, 277 Broadway, New York 7, U.S.A.

## NEW FROM SECO DYNAMIC TRANSISTOR CHECKER



MODEL  
100

### DYNAMICALLY CHECKS WIDE RANGE OF TRANSISTOR TYPES EITHER "IN OR OUT" OF CIRCUIT!

This new low-cost checker uses an entirely new approach but a proven DYNAMIC principle for checking transistors. Safely tests PNP and NPN transistors either "in or out" of the circuit. Covers wide range of types: small signal including "drift" types, medium power; and power types. Provides positive check for "opens," shorts, and gain—condition indicated by means of a visual indicator plus jacks for meter or scope. Also provides GO-NO-GO test at practical currents—and permits matching of similar transistor types. No set-up required—no further leakage tests necessary. Model 100 is compact, lightweight, complete, and ready-to-use . . . helps you cash-in on the big profits in the fast growing transistorized equipment servicing field!

MODEL 100—Wired and factory tested . . . . \$19.95 NET

## NEW FROM SECO LOW COST, COMPLETE TUBE TESTER



MODEL 78

### GRID CIRCUIT and TUBE MERIT TESTER

Complete test coverage of all modern TV tube types as well as all heater type radio tubes including hybrid types, using only 5 sockets. Incorporates patented Seco GRID CIRCUIT TEST plus a reliable CATHODE EMISSION test using new low impedance low test voltage circuit—also checks filament continuity and provides open element test. One easy-to-read meter indicates results for both Grid Circuit and Tube Merit Tests. Two-stage dc amplifier isolates meter from tube under test to protect meter—and makes it possible to achieve a wide range of load currents and test conditions. Complete with portable carrying case, pin straighteners, and flip-chart for quick set-up data.

MODEL 78—Wired and factory tested . . . . \$69.50 NET

MODEL 107  
TUBE  
TESTER



### outstanding reliability, accuracy

Provides 3 important tests: amplifier types tested for gain by Dynamic Mutual Conductance method—power types tested for cathode current by Cathode Emission method—all types tested for shorts and grid error by Grid Circuit Test developed and patented by Seco. Dynamic Mutual Conductance Test pre-wired to eliminate elaborate set-up. Cathode Emission Test done by free point pin-selector method—will not be obsolete. Completely self-contained in portable carrying case.

MODEL 107—Wired and factory tested \$139.50 NET



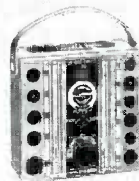
MODEL HC-6  
IN-CIRCUIT  
CURRENT  
CHECKER

### positive, on-the-spot check of horizontal output current!

This new, low-cost current checker provides simple means for making a positive on-the-spot check of TV horizontal circuits. Can be placed into the circuit in seconds—no unsoldering of circuit wiring—immediately indicates whether horizontal tube cathode current is within manufacturer's recommended limits. Valuable as a fast, accurate indicating device when adjusting horizontal drive and linearity. Eliminates one of the most common causes of callbacks. Compact, inexpensive, easy to use.

MODEL HC-6—Wired and factory tested \$12.95 NET

MODEL GCT-8  
GRID CIRCUIT  
TESTER



### fast check of critical "control grid" conditions

Model GCT-8 checks "control grid" condition of vacuum tubes faster, more accurately than any other tester! As many as eleven simultaneous checks—automatically! Quickly spots grid errors and leakage—stops guessing, substitution checking, and costly rechecks. Electron-Eye tube indicates faults at a glance. Truly portable. The perfect companion to any tester that employs only conventional gas and shorts test. Carry it on all calls.

MODEL GCT-8 Complete kit . . . \$19.95 NET

MODEL GCT-8 Wired and tested . . \$29.95 NET

components, CRT, and tuner seem basically sound—you can suggest a restoration job that will please both you and him. Otherwise, if a minor treatment in the home will put the set back in usable (though wobbly) shape, let it go—even though the voltage readings in some circuits are completely cockeyed, and capacitors are drooling wax all over the place.

Callbacks are naturally a greater-than-usual hazard if you follow a "just get it running" philosophy; therefore, it's important to emphasize that you can guarantee only those parts you replace. On a \$7 to \$10 home call, the customer can see that you are putting in only a few small parts—so he shouldn't expect miracles. A \$25-\$50 shop job, where he *doesn't* see what you do to the set, is another story.



**Time Tip—VI.** Think back—how many working hours have you wasted in troubleshooting nonexistent defects, or in trying to determine if there was any defect at all? And how much of this confusion was due to spurious RF energy running wild? Even if you perform all test procedures strictly "according to the book," unidentified radiation can still pop up and produce effects not covered in the book. This is especially true in a larger shop, where several receivers and test setups are all going full blast at the same time.

If these words have a familiar ring, better take a good, long look at your antenna system. It must be able to supply clean TV signals, of normal strength for your community, even at the expense of a fairly complex distribution system. At the very least, tap-off units should be used for down-leads to individual benches in order to prevent impedance mismatch.

When you locate some source of perpetual and unnecessary interference, such as abnormal radiation from a signal generator or arcing in a neon sign, don't grin and bear it. Do all you can to fix it!

If it seems hopelessly difficult to remedy your interference problem—for example, if local-oscillator radiation from a half-dozen sets is a constant threat—you might be smart to build a "screen room" in one corner of the shop. There, you can perform delicate jobs such as alignment in an interference-free atmosphere, and you will be more confident of the results.

SEND FOR  
COMPLETE SECO  
STORY ON . . .

- Three Tube Testers
- VTVM
- Dynamic Transistor Checker
- In-Circuit Current Checker
- 100% Accurate Flyback Checker
- Battery Eliminator

Sold Only Thru Electronics Parts Distributors

OUTSTANDING RELIABILITY—TOP DOLLAR VALUE!



SECO MANUFACTURING CO.  
5015 Penn Ave. So., Minneapolis, Minn.

NAME \_\_\_\_\_

ADDRESS \_\_\_\_\_

CITY \_\_\_\_\_ ZONE \_\_\_\_\_ STATE \_\_\_\_\_



*Here is the new Standard Coil Tuner Replacement and Repair Program that enables you to offer better service to your customers at greater profit. Now Standard Coil Products provides the tools that will enable you to cash in on the profitable tuner repair and replacement market.*

#### TUNER REPLACEMENT LISTING IN SAMS PHOTOFACT

Starting in January, Standard Coil tuner replacement listings will appear in all Sams TV Photofact. Tuner replacement information will be right at your finger tips. Standard Coil is the *only* manufacturer ever to provide this service.

#### NEW TV TUNER REPLACEMENT GUIDE

Lists original equipment TV tuners with the Standard Coil equivalent replacement for each. Also includes major mechanical replacement parts for all Standard Coil Tuners — those used in original equipment as well as the universal replacement. Eliminates all guesswork—minimizes your tuner repair and replacement problems.

#### 48 HOUR FACTORY GUARANTEED REPAIR SERVICE

Standard Coil's special service department set-up assures factory guaranteed repairs—*on a 48 hour in-plant cycle!*

All repaired tuners carry a *six month warranty* on defective workmanship and parts failure (excluding tubes). Gives you more time for additional service calls—promptly returns your customer's set to like new operating condition.

#### DEFECTIVE TUNER TRADE-IN ALLOWANCE

Tuners which can *not* be repaired can be traded in against a new replacement tuner which carries a full *twelve month factory guarantee*. See your Standard Coil Distributor for complete details on how trade-ins can increase your tuner sales and profits—create greater customer satisfaction.

#### JUMP ON THE STANDARD COIL PROFIT WAGON TODAY!

For additional details, see your authorized Standard Coil Distributor or write to:

*Standard*

**Coil Products Co., Inc.**

2085 North Hawthorne Avenue, Melrose Park, Illinois

February, 1960/PF REPORTER 43

# How do you rope 5 watts of Power in a 2-watt sized Wirewound?




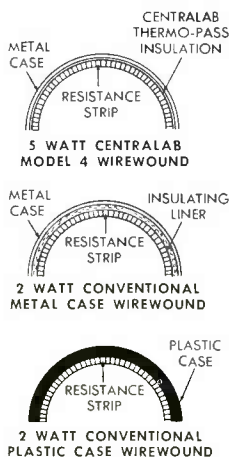
it's easy with  
**Centralab's**  
"Thermo-Pass"  
Insulation



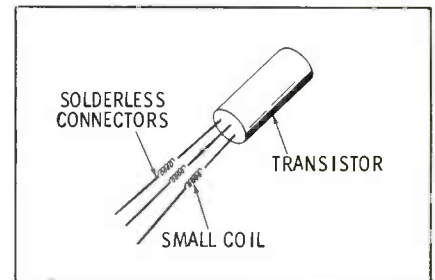
Nowadays all kinds of critters have Texas capacity with Rhode Island size. Tubes, relays, and many other components have gotten smaller without any sacrifice in performance.

Now it's true with wirewounds, too! CENTRALAB has corralled 5 watts of power in a 2-watt size wirewound . . . by using "Thermo-Pass" insulation. A control's rating and size depend on the speed with which heat can be transferred from the resistance element to the atmosphere. CENTRALAB "Thermo-Pass" insulation combines exceptional heat transfer with a dielectric strength of 4500 volts per mil at 25° C. Result: a conservatively rated 5 watt Radiohm control measuring only 1 3/8" in diameter and 9/16" in depth. They are available in values from 1 ohm to 100 K ohms.

Meanwhile, back at the ranch, you'll find this one small size taking care of your 2, 3, 4 and 5 watt replacements in tv, hi-fi, home and auto radio sets. Just make sure you use the wirewounds—short (Model WN) or long (Model WW) shaft style—that carry the  brand.



## TIPS for TECHS

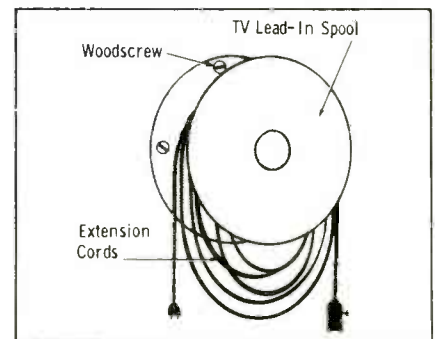


### "Solderless" Connectors

Rather than chance ruining lead-type transistors by soldering them into circuits, use "solderless" connectors like those shown in the drawing. Take some lengths of solid copper wire and wind a small "spring" or coil in the end of each wire. Fit these coils over the transistor leads and pinch each turn tightly. Heatless connections like these have good conductivity and mechanical rigidity.

### Tape "Childproofs" TV Controls

Small children have a habit of "twiddling" the rear-panel controls of the family's TV set, and in some homes, the serviceman is called almost weekly to reset controls, etc. To prevent a recurrence of this problem, place a wide strip of masking tape over the controls. This is not only a good cure for small prying hands, but large ones belonging to screwdriver mechanics as well!



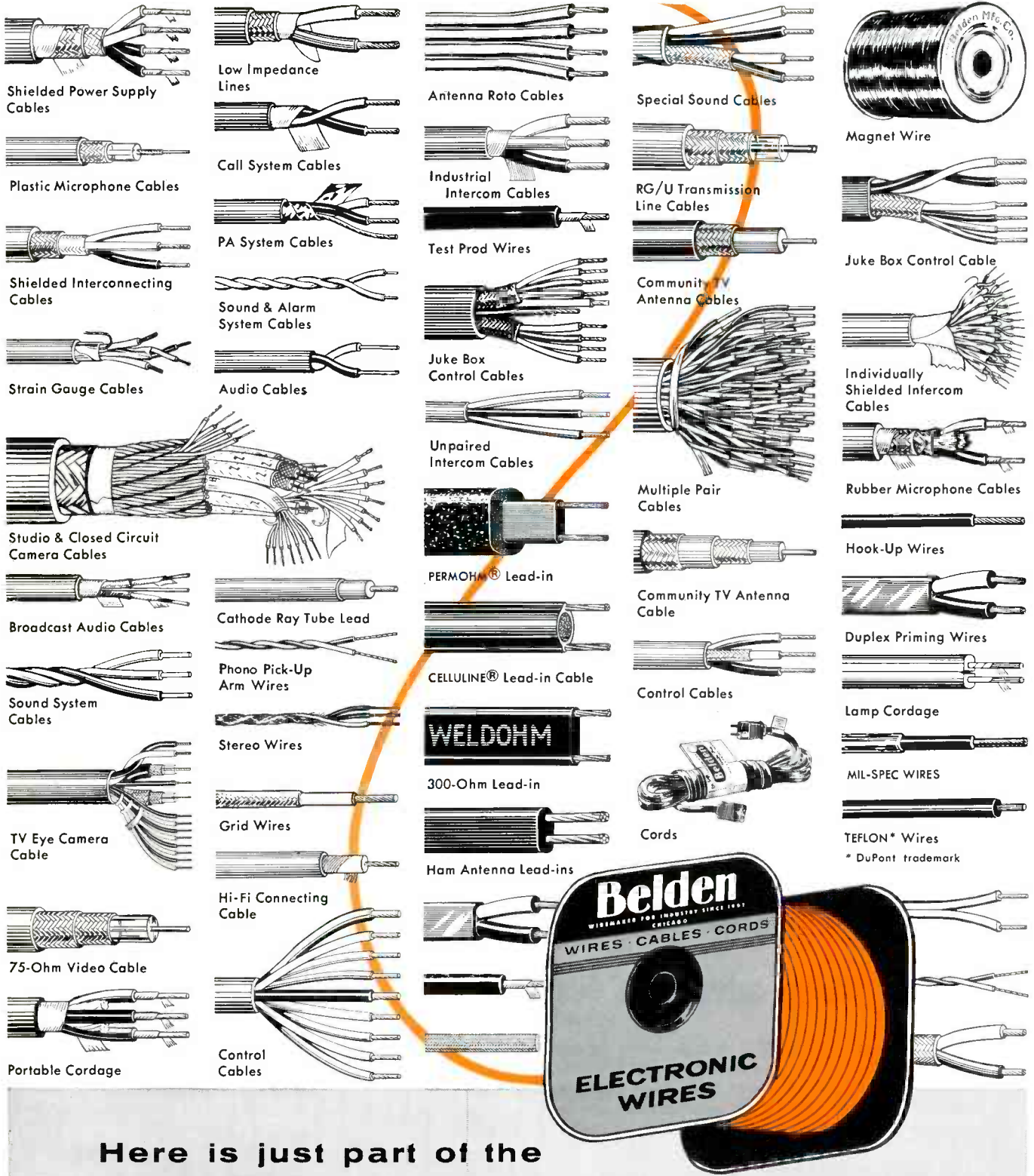
### Don't Discard That Wire Spool!

Before you toss away that empty lead-in wire spool, ask yourself this question: Is there any way the spool can be useful around the shop? Why not fasten it to the wall with wood screws and use it as a handy rack for extension cords? Also attach some small hook-up wire spools to the wall as test-lead hangers.

# Centralab

ELECTRONIC DIVISION OF GLOBE-UNION INC.  
942B E. KEEFE AVE. • MILWAUKEE 1, WIS.  
IN CANADA: 669 Bayview Avenue • Toronto 17, Ont.

CONTROLS • ROTARY SWITCHES • CERAMIC CAPACITORS  
PACKAGED ELECTRONIC CIRCUITS • ENGINEERED CERAMICS



Here is just part of the  
**WORLD'S MOST COMPLETE LINE**  
of Electronic Wire and Cable!



**Available from Stock**

*One Wire Source for Everything  
Electronic and Electrical*

- magnet wire • lead wire • power supply cords • cord sets • portable cordage • electronic wire
- automotive replacement wire and cable • aircraft wire • electrical household replacement cords

8-3-9

# Newest Soldering Gun Value on the market!

MODEL 8100B

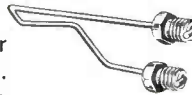
**NEW  
DESIGN**  
for 1960 from

*Weller*

...and  
it's  
only **\$644**  
LIST PRICE

## Check these advanced features:

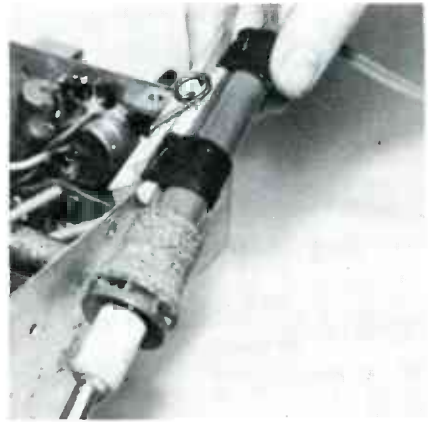
- ✓ **New Long-Life Wellertip**—Utilizes copper for superior heat transfer, plus iron-plating for rigidity and long life. Copper conducts heat 5 times faster than steel, permits operation at lower temperature, prevents damage to components. Long reach for easier use in difficult places.
- ✓ 150 watts—single heat
- ✓ Tip heats instantly when trigger is pulled—no waiting
- ✓ Prefocused spotlight illuminates work, eliminates shadows
- ✓ New compact, streamlined design with rugged housing
- ✓ Perfect balance for greatest soldering accuracy
- ✓ Guaranteed for 1 year—UL approved



On sale now at your Electronic Parts Distributor

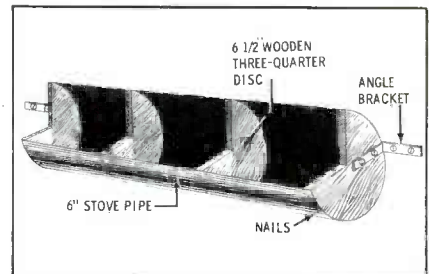
Send for Weller Gun Bulletin

**WELLER ELECTRIC CORP.** 601 Stone's Crossing Rd.  
Easton, Pa.



### Clothespin Holds Pencil Iron

Taping a spring clothespin to the handle of your soldering pencil lets you clip it to the chassis of a set when working on the underside, or to a heavy tool when you have a "two-handed" soldering job. This will keep the hot iron off the bench where it might burn something, and yet keeps it handy for immediate use.



### Parts Bin for Shop

If you have some vacant space on your shop wall that isn't being put to good use, why not take a few spare moments to build a wall-mounted parts bin? If you keep most-often-needed pieces of hardware or parts in a bin made from some 6 1/2" three-quarter discs and a length of 6" stovepipe, parts selection will be fast and efficient. In case you don't have enough space left on your shop wall for such a bin, mount it on one end of the bench.

### Fine Files for Filing

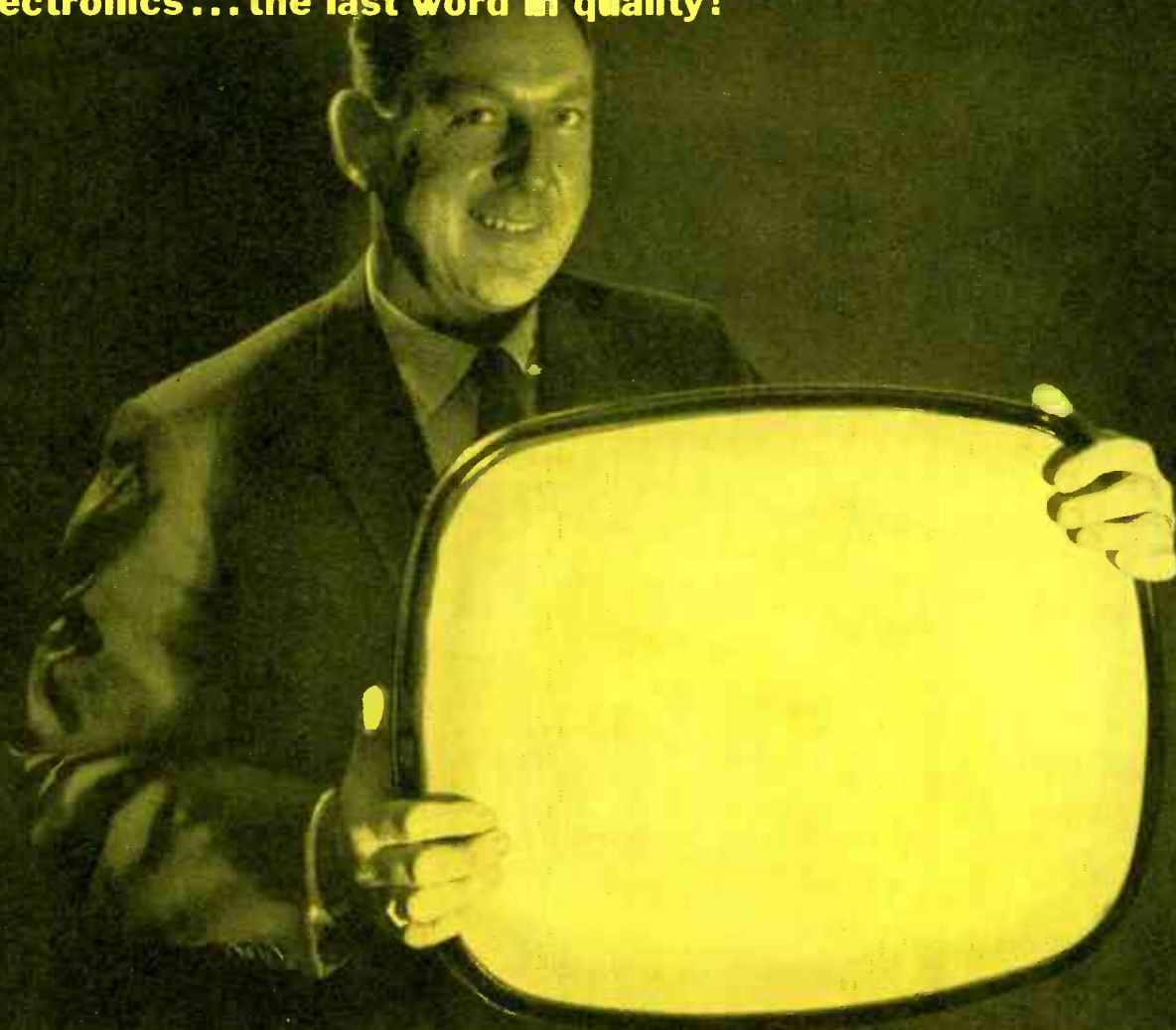
Emery boards—the kind used by manicurists — are excellent for filing soldered tips prior to tinning, preparing wires and parts for the application of solder, or smoothing rough solder joints. Also, these inexpensive and expendable items are handy for cleaning and brightening various types of connector contacts, removing enamel insulation from fine wire, and smoothing out cabinet scratches and gouges. You can buy emery boards for about a dime a dozen at any drugstore.



# PHILCO<sup>®</sup> THE FIRST NAME IN ELECTRONICS

# ... THE LAST WORD IN QUALITY

For all CR tube replacements, use **PHILCO STAR BRIGHT 20/20 ALUMINIZED TUBES**. Their premium quality reflects Philco leadership in creating the revolutionary S-F (semi-flat) Picture Tube and many other famous firsts in the industry. In addition, you can offer your customers the double protection of Bond and Warranty. For the newest advances in CR tubes, look to Philco—the first name in electronics... the last word in quality!



**SEE YOUR PHILCO DISTRIBUTOR TODAY!**

## PHILCO ACCESSORY DIVISION

WORLD-WIDE DISTRIBUTION

Service Parts • Power-Packed Batteries • Universal Components • Long-Life Tubes • Heavy-Duty Rotors • Star Bright 20/20 Picture Tubes • Long Distance Antennas • Appliance Parts • Laundry Parts • Universal Parts and Accessories



PHILCO CORPORATION ACCESSORY DIVISION

ATTN. Carl Areschoug

P. O. Box 3635

Philadelphia 25, Pa.

If you service television and radio receivers and would like to receive valuable promotional mailings from Philco, attach this coupon to your Company letterhead and forward to above address.

NAME \_\_\_\_\_

ADDRESS \_\_\_\_\_

CITY \_\_\_\_\_ ZONE \_\_\_\_\_ STATE \_\_\_\_\_

**NEW \***  
**TV/FM** with "Anti-Stub" Switch  
**ANTENNA OUTLETS**

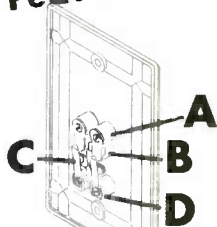


New Type FD-1PK MOSLEY TV & FM Outlet permits multiple antenna outlets to be wired in tandem without losses due to stub effect of unused line.

\*When polarized plug is inserted, the silver-plated spring leaf switch opens the circuit beyond the outlet in use. Action is positive... fail-safe!

Type FD-1PK, complete with polarized plug and mounting brackets. List Price \$2.20

**Exclusive Features!**

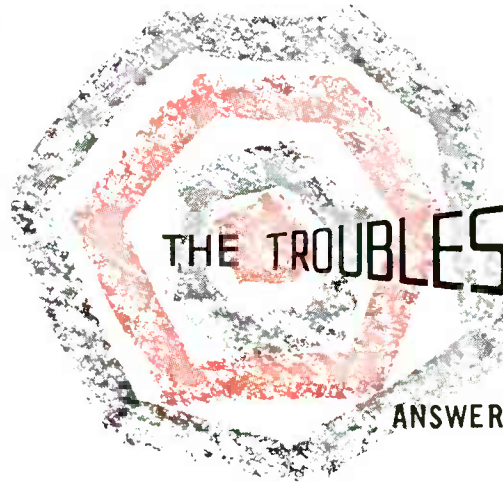


- A. Strong one-piece molded construction!
- B. Passive contacts lock in place!
- C. Contacts are silver-plated... positive, corrosion proof!
- D. Molded guide holds contacts parallel... prevents shorts!

Available at your favorite parts distributor.

**Mosley Electronics, Inc.**

8627 ST. CHARLES ROCK ROAD  
 ST. LOUIS 14, MISSOURI



# THE TROUBLESHOOTER

ANSWERS YOUR SERVICE PROBLEMS

## Make 'Em Blanker

What component breakdown could cause vertical retrace lines to appear on the screen of an RCA Chassis KCS72?

TOMMY GONZALES

Tommy's Radio & TV Service  
 Ysleta, Texas

This early-vintage chassis has no special retrace-blanking circuit. Since DC coupling is used all the way from the video detector to the cathode of the CRT, blanking pulses in the video signal are normally able to keep the retrace lines suppressed regardless of changes in over-all background brightness. The only requirement is that the brightness and contrast controls be accurately adjusted.

Due to aging of this receiver, you may find it advisable to install a special network to insure more effective retrace blanking. The required blanking pulse should be fed to the grid of the CRT to avoid interference with the video signal arriving at the cathode. Negative-going pulses, occurring in each vertical retrace period, are what you need. The usual source for such pulses is the high side of the vertical-output transformer secondary. Unfortunately, this point in the KCS72 is unsuitable for your purpose because positive pulses are present there.

On the other hand, you should be able to obtain satisfactory negative pulses in the grid circuit of the vertical output tube, across the resistive portion of the sawtooth-forming network. This type of

hook-up was illustrated in Fig. 7B of the article, "Vertical Retrace-Line Elimination" in our August, 1958 issue. Following the general instructions in this figure, break the connection to pin 2 of the picture tube. Then insert a 330K-ohm isolation resistor in series with the wire going to the junction of C50 and the brightness control, and connect a .05-mfd capacitor from pin 2 to the junction of R88 and R92. If this does not give the desired results, try transferring the "lower" connection of the capacitor to the junction of R88 and C76, or moderately increase the values of the newly-added components.

## Focus Short

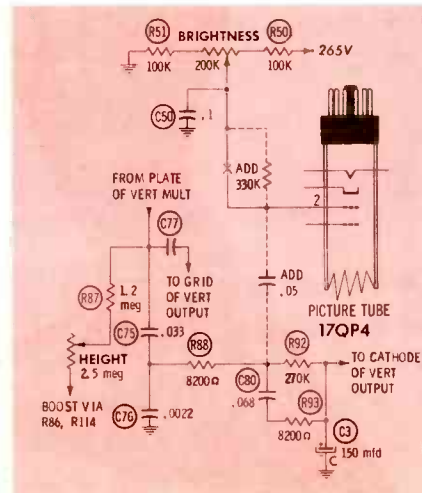
I replaced a burned-out focus control in an Olympic Model 752, and the replacement unit burned out within 10 minutes. The 390-ohm series resistor also went out. All the B+ filter capacitors and bleeder resistors check good.

LOUIS ABDOO

Clinton, N. Y.

The focus coil has probably increased in resistance or may even have become open. (It normally has a DC resistance of 415 ohms.) If this defect has developed, the focus control and its series resistor are being forced to carry excessive current—enough to burn them out in a hurry.

If the coil is not bad, the next most



NUMBER **2** OF A SERIES

OF **CD**

50TH ANNIVERSARY  
PROMOTIONS!

**30% - CD - 30%**

SMALLER

MORE RELIABLE



## SUB-MINIATURIZED C-D ALUMINUM-FOIL ELECTROLYTIC CAPACITORS

Cornell-Dubilier aims a 30-30 promotion at you for a big birthday bull's eye—and hits the mark with “Electomites”®—the sub-miniature, metal-cased electrolytic capacitors that are 30% smaller and 30% more reliable than conventional electrolytics. Fabricated from selected highest-purity aluminum foil and unsurpassed in performance, “Electomite” tubulars also have a “short”-preventing plastic sleeve which makes them perfect for those close-fitting coupling, bypass and filter applications you come across every day in low-voltage, transistorized and printed circuitry.

### HERE'S THE PROMOTION:

Quantity	Type No.	Capacitance (mfd.) Tolerance: -10%, +150%	Voltage
4	NLW 40-3	40	3
4	NLW 10-15	10	15
3	NLW 50-15	50	15
3	NLW 100-15	100	15

### ALL 14 for \$8.67

This 30-30 promotion is good for 60 days. So get the full story—and the promotion—from your Cornell-Dubilier Distributor today! Or write Cornell-Dubilier Electric Corporation, South Plainfield, New Jersey. Also ask about C-D's complete, special capacitor line for industrial electronic maintenance.



**CORNELL-DUBILIER ELECTRIC CORPORATION**

AFFILIATED WITH FEDERAL PACIFIC ELECTRIC COMPANY

# DON'T GUESS...

KNOW THE TEMPERATURE OF YOUR SOLDERING GUN BEFORE TOUCHING PRINTED CIRCUITS AND LAMINATED WIRING BOARDS!



## ESICO GUNCHOKE®

REDUCES TEMPERATURE OF YOUR SOLDERING GUN TO TWO CONSTANT HEATS - 500° OR 600°

- Assures correct temperature for soldering printed circuits and laminated wiring boards.
- No need to wait for a slow-heating iron — and still have doubtful temperature.
- Just plug into GUNCHOKE and GUNCHOKE into outlet.
- Small, compact, to fit in your tool kit.

FOR ALL WIDELY USED GUNS  
Get GUNCHOKE from your distributor

ESICO

## LUGER GUN

Perfect balance permits delicate touch for most intricate work. Transformer built in handle eliminates tip heaviness. Long, thin tips simplify soldering connections inaccessible with other guns. LUGER is 150-watt capacity.

ELECTRIC SOLDERING IRON CO., INC.  
559 W. Elm Street DEEP RIVER, CONN.

## PROFESSIONAL technicians

USE *Dave Rice's* OFFICIAL ORDER BOOKS for every TV-RADIO service call



This is the businesslike approach to service record keeping. TriPLICATE forms serve as order form, invoice and office record, with spaces for complete information on every job. Separate listings for receiving tubes, pix tube, parts, serial numbers, labor and tax charges, signatures, etc. 75c a book, \$6.50 for dust-proof box of 10. In stock at your distributor. Write for your free folder describing Dave Rice's OFFICIAL ORDER BOOKS, including an actual size sample copy of the handy order form.

\*\*\*\*\*  
For customer's prices on every replacement part, plus flat rate and hourly service charge data, regional and national, Dave Rice's OFFICIAL PRICING DIGEST, listing over 63,000 items. \$2.50.

ELECTRONIC PUBLISHING CO., INC.  
180 N. WACKER DRIVE  
CHICAGO 6, ILLINOIS

probable trouble is a short in a load circuit connected to one of the B+ source points at or below the 287-volt level. Test for this condition by disconnecting the various B+ feed lines and checking each one with an ohmmeter for shorts to ground.

## More Bloomin' Trouble

What, besides a weak high-voltage rectifier, can cause blooming of the TV picture?

RUDY PORATH

Bark River, Mich.

Anything which slows down the electron beam will cause blooming. When the beam is traveling at a slower-than-normal speed, a magnetic or electrostatic field of a given strength will be able to deflect it farther than usual from a straight-line path. As a result, the entire raster will appear to expand.

It is normal for some blooming to occur when the brightness control is turned up to a high setting, because the high-voltage supplies in most black-and-white TV sets are not designed for good voltage regulation. Operating a receiver at high brightness increases the average beam current in the CRT, thereby increasing the drain on the high-voltage supply; this causes output voltage to vary by as much as 1.5 or 2 kv between the minimum and maximum limits of brightness. Such changes in HV potential will affect beam velocity enough to produce, say, a 10% to 20% variation in raster size.

If high voltage is abnormally low, an objectionable amount of blooming will occur. Brightness and focus will also be inadequate, since the electron beam will not strike the CRT phosphor hard enough to produce a sharp, clear trace. A lack of high voltage is most often due to a weak rectifier tube, but there are several other common causes. For example, leakage might exist from the high-voltage supply to ground through the high-voltage filter capacitor or within the picture tube. Then, too, insufficient AC drive voltage might be arriving at the plate of the high-voltage rectifier because of a defective horizontal output or oscillator stage. One more thing— is the HV rectifier tube getting enough filament voltage?

When a CRT has both inner and outer aquadag coatings, these serve as a high-voltage filter capacitor—sometimes the only one in the receiver! Various ill effects (including blooming in some instances) will be noted if the outer coating is not properly grounded to chassis.

High voltage is not the only factor in maintaining proper beam speed; a normal potential on the accelerating anode of the CRT is also essential. Most sets use boost B+ as an accelerating voltage source. This potential will vary considerably, depending on operating conditions in the horizontal sweep circuit, but it should be at least within 50 to 100 volts of the value indicated in service data.

The grid and cathode voltages on the

## Shortcuts For SERVICE... PROFIT From R-Columbia

### New FONO MAGIC

A compound of special rubber and carbide... eliminates turntable slipping-dragging. Makes automatic changers cycle properly.

ONLY \$1.95



FREE 16 PAGE SERVICEMAN'S CATALOG

R-Columbia Prod. Co., Inc.

305 WAUKEGAN AVE.  
HIGHWOOD, ILLINOIS

ASK FOR CATALOG NO. PF-2

## SERVICEMEN KNOW!

Here they pay less and get the best

### HUSH®

Chemically-Electronically, engineered for Tuners and Switching Mechanisms.

When New HUSH is applied it will wash-away that dirt, leaving clean and positive contacts protected by a lasting lubricant. New HUSH is made from the finest solvents and it contains Electro-Silicone oils.

Also available—2 oz., 8 oz., 32 oz. containers 6 oz. Spray can \$2.25 net

### EVER-QUIET®

Since 1949

VOLUME CONTROL AND CONTACT RESTORER

EVER-QUIET is a free-flowing liquid that leaves no powder residue. Scientifically designed to seep around the shaft and penetrate the control or potentiometer, cleaning the contacts and leaving a safe protecting film. Harmless to metals, wire or carbon.

Also available—32 oz. containers 6 oz. Spray can \$1.59 net

2 oz. Bottle & dispenser 79c net



CHEMICAL ELECTRONIC ENGINEERING, INC. Matawan, New Jersey

**There's a better way  
to cut off callbacks**



Your choice of the parts you use has a lot to do with the number of calls you get that become callbacks. When it comes to tubes, Tung-Sol Blue Chip quality is practically built-in callback insurance. Tung-Sol tubes are made to set manufacturers highest standards. They're best for every set — radio, tv or hi-fi. Use them. They'll keep the line clear for money-making service calls. Tung-Sol Electric Inc., Newark 4, N. J.

*Tell your jobber you'd rather have*

**ts TUNG-SOL®**

*Blue Chip Quality* TUBES • TRANSISTORS • DIODES

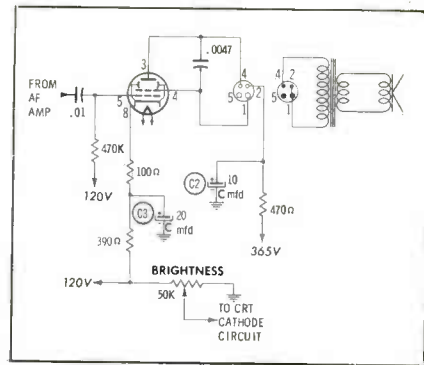
picture tube have greater influence on beam current than on beam velocity, so trouble in this area is more likely to produce brightness fluctuations than blooming. As for the picture tube itself, it can suffer from defects capable of causing blooming. (The most likely trouble of this sort is gassiness.) If in doubt as to the condition of the CRT, substitute a new one or a check tube, and observe results.

Don't overlook the low-voltage supply if a set is troubled by excessive blooming. A weak B+ rectifier will reduce all DC power-supply voltages throughout the receiver, and blooming will be among the many symptoms observed. Something else to consider is the AC line voltage.

If it fluctuates from time to time, the filament voltage as well as the B+ and HV potentials will vary. Besides blooming in response to brightness-control adjustment, the raster will periodically grow and shrink as the sweep-circuit output signals fluctuate.

#### Bass Bars

A group of symptoms including sync buzz, sound bars, and a slight darkening of the picture appear intermittently on an RCA Chassis KCS47F. The trouble occurs only two or three times a week, and then for only about an hour at a time. Ordinary speech sometimes modulates the picture to a mild degree, while low musical frequencies (such as



the bass notes from an organ) cause severe modulation. When the scene shifts to or from a commercial, the buzz and distortion often disappear, only to reappear on the next picture change. I have made the usual tube checks and substitutions, and voltages check normal. The 2-mfd AGC filter capacitor C5 was open, but replacing this component did not cure the complaint.

JOHN SCHINKEL

John's Radio & TV Service  
Richmond Hill, N. Y.

The usual cause of sound bars in this chassis, as outlined on page 148 of *Video Speed Servicing*, Vol. 2, is an open C2C in the plate circuit of the 6K6 audio output tube. An open C3C, in the 6K6's cathode circuit, could cause similar symptoms. In either case, audio signals would be coupled through the B+ line to the video amplifier and possibly the brightness control.

Since only the lowest frequencies produce strong sound bars in your set, I have an idea that one of the above capacitors might be only partially open—in other words, an intermittent loss of capacitance. The easiest way to test C2 and C3 would be to install substitute units and see if the trouble ceases.

The decrease in filter capacitance could make either the video or sound circuits more susceptible to stray pickup of 60-cps sync buzz or vertical sweep signals. Also, if C3C were faulty, the DC potential on the 120-volt line might change enough to make a visible difference in screen brightness.

If replacing the above filters doesn't solve your problem, wait for the trouble to appear again—get out a scope—and go hunting for another source of buzz and sound-bar signals.

#### Mush on 3

An Emerson Model 1440 has garbled, mushy sound on Channel 3. The picture is perfect from this station, and both picture and sound are fine on the other two channels (6 and 10). Voltage, waveform and alignment checks do not indicate any trouble. PHOTOFACT FOLDER 416-1 for this set does not give any alignment data for the Fireball tuner; can you supply some information to help me check its performance on Channel 3?

WALT SMITH

Walt's TV Service  
Burlington, N. J.

Tuner trouble sounds logical, since the symptom appears on only one channel. Before we plunge into the tuner,

1500  
servicemen  
told us\*



1500 servicemen recently gave us their good *business* reasons for choosing Perma-Power Vu-Brites. You and your colleagues told us that your customers invariably had confidence in the neat-looking product and the attractive package . . . and were pleasantly surprised by the low price (\$9.95 the dozen, net). Result: no sales resistance—a happy satisfied customer who is sure to call back next time—virtually guaranteeing you a highly profitable picture tube sale.

Of course, you have a lot of other good reasons for choosing Perma-Power Vu-Brites. One outstanding reason is that you've never found a defective one. That's because Perma-Power Vu-Brites are engineered for quality, and 100% tested. They instantly restore brilliance and clarity to fading TV pictures. You can use them on either electro-static or electro-magnetic picture tubes, Model C-401 in Series sets, Model C-402 in Parallel sets.

Perma-Power also makes a full line of special purpose brighteners, tube restorers, and accessories, all described in our latest catalog, available free from your distributor, or by writing direct to us. Don't say "brightener," say "Perma-Power" . . . the standard of all comparison.

\* on their entry blanks in Perma-Power's Las Vegas contest.

Perma-Power COMPANY

3102 N. ELSTON AVENUE • CHICAGO 18, ILL.

however, I'd like to ask one question: Is the RF signal level noticeably stronger (or weaker) on Channel 3 than on the other two channels? If it is, you still can't say for certain that the IF and sound circuits are completely normal in operation.

Use the AGC bias voltage as a handy signal-strength indicator. With an attenuator pad or a change of antennas, adjust the RF level on Channel 3 until AGC is approximately the same as for the other channels. If this test produces clearer sound, you should suspect trouble outside the tuner. Perhaps the IF response curve is shifting abnormally at high AGC-bias levels; this action would not have been revealed by the usual type of alignment check. The FM sound detector circuit could also be operating erratically. (It wouldn't be "overloaded" in the ordinary sense, since it is normally supposed to limit signal peaks; but detection could become nonlinear.)

If the signal-strength check gives indefinite results, use the following procedure to check tuner response. Set the selector knob to channel 3, clamp the RF-AGC line at -1.5 volts, connect a scope to the mixer-grid test point, and connect a sweep generator to the antenna terminals with a 120-ohm resistor in series with each lead. Use a 10-mc sweep with a center frequency of approximately 63 mc, and look for response-curve peaks of equal height at 61.25 and 65.75 mc. The "valley" between these peaks should dip not more than 10%. If the RF response on this channel is distorted, you may be able to improve it by carefully bending the RF and antenna coils involved. (These are located on the left side of the tuner as viewed from the rear.) This is an exacting process and must NOT be attempted without fully adequate equipment.

### Ripple Limits

What is the maximum permissible peak-to-peak AC ripple in the output of TV low-voltage power supplies, measured at the output side of the filter circuit?

C. B. DAVIS

Atlanta, Ga.

This is not an absolute quantity, since some receivers are designed for a lower level of ripple than others. In general however, a ripple voltage of much more than 2 volts peak to peak would be cause for suspicion if the receiver shows signs of 60- or 120-cps brightness modulation, hum in the sound, bending in the picture, or related troubles.

### Sync Sunc?

A General Electric Model 17T2 has very critical horizontal and vertical sync. All tubes in the set have been checked by substitution, and all coupling capacitors in the sync circuit have been replaced. Sync pulses in the vertical blanking bar of the raster look normal, so it doesn't seem likely that the trouble is in the tuner or IF strip. Voltages all appear normal.

ALAN McFARLANE

Aberdeen, S. Dak.

In cases like this, it's vitally important to know whether or not the output signal of the sync section is normal in both shape and amplitude. It can be defective even though all tubes and voltages seem normal.

Fortunately, I've been able to find the waveform information you need to service this ancient set. (Note: During these tests, adjust the receiver to produce 45 volts peak to peak at the plate of the second video amplifier.)

The plate of the sync separator (pin 2 of 6SL7GT) should have clean, negative-going sync pulses measuring 80 volts peak to peak.

The plate of the sync preamplifier (pin 5 of 6SL7GT) should have a 45-volt composite video signal with positive-go-

ing sync pulses of somewhat exaggerated size.

The sync-preamp grid (pin 4) should receive a 45-volt composite video signal with negative sync tips, almost identical to the signal at the plate of the second video amplifier stage.

If some or all of these signals are distorted, here are a few possible causes:

Defective integrator.

Improper filtering of B+ to sync separator.

Poorly filtered or off-value AGC voltage reaching sync separator grid.

Defect in boost B+ circuit affecting plate voltage of sync preamplifier and second video amplifier.

Moderate sync compression due to RF, IF, detector, or AGC defect.

**Now Completely SELF-CONTAINED**

For Testing & Rejuvenating  
BLACK AND WHITE and COLOR including 110° TUBES

**NEW CRT 440**

**CATHODE REJUVENATOR TESTER**

**B&K**

#### TESTS AND REJUVENATES

all black & white and color picture tubes at correct filament voltage from 1 to 12 V.

#### TESTS AND REJUVENATES

110° tubes with 2.34, 2.68, 6.3 and 8.4 volt filaments.

#### TESTS AND REJUVENATES

color picture tubes. Checks each color gun separately same as black & white tubes.

Used by Thousands of Professional Servicemen  
MAKES NEW PICTURE TUBE SALES EASIER

Gives you more value than ever—all-in-one. Quickly checks and corrects most TV picture tube troubles in a few minutes right in the home without removing tube from set. Gives new useful life to weak or inoperative tubes. Checks leakage. Restores emission and brightness. Repairs inter-element shorts and open circuits. Life test checks gas content and predicts remaining useful life of picture tube. Completely self-contained in leatherette-covered carrying case. Net, \$69.95

#### ACCESSORIES for USE ONLY with FORMER B & K Models 400 and 350 CRT



**Model C40 Adapter.** For use only with all previous B&K Model 400 and 350 CRT's. Tests and rejuvenates TV color picture tubes and 6.3 volt 110° picture tubes. Net, \$9.95

**Model CR48 Adapter.** For use only with all previous B&K Model 400 and 350 CRT's. Tests and rejuvenates 110° picture tubes with 2.34, 2.68, and 8.4 volt filaments. Net, \$4.95

See your B&K Distributor  
or Send now for Bulletin ST24-R

#### B & K MANUFACTURING CO.

1801 W. BELLE PLAINE AVE • CHICAGO 13, ILL.  
Canada: Atlas Radio Corp., 50 Wingold, Toronto 10, Ont.  
Export: Empire Exporters, 277 Broadway, New York 7, U.S.A.



**A top-flight service manager's experiences in solving those "don't-want-to-pay-the-service-charge" blues — by Art Margolis**

Imagine you are an average TV set owner. You arrive at your home after a hard day's work, looking forward to a good dinner and an evening of relaxation. Your little darlings meet you at the door screaming, "Daddy, the set is broke," like it's your fault.

The TV repairman is called, and arrives just as you are buttering your bread. A dirty, unsmiling know-it-all pushes his way into your living room. Not too gently, he swings the TV away from the wall. He pushes and pulls, clatters his tools, sends smoke curling up to the ceiling, gets the TV working, and presents you with a bill for \$14.00.

You check the set. Yes, it's working again—but the big unattractive smear of dirt across the screen is still there, as well as those three dead flies that somehow or another trapped themselves behind the safety glass. Touching the channel selector knob still makes the picture jump, and the picture is still its same dull self, not like when it was new. How happy are you? How thrilled with the repair can you be?

Now get out of the non-tech's shoes and shoe-horn back into yours for a different view of the same scene. You are about to close shop and go home for dinner. It's been a rough day, and your clothing has absorbed a lot of dirt from running a lead-in wire through the crawl space under a customer's ranch house. You're hungry, and you can't smile when you're hungry. The phone jangles; it turns out to be some joker who wants immediate TV service because his kids are heartbroken without it. "Yeah, sure—I'll bet it's for his kids," you think to yourself.

Begrudgingly, you decide to make the stop on your way home (well, only a couple of miles out of the way). The set turns out to be a 21" Philco with no sound or pix, although the screen displays what looks like 60-cycle hum—that is, it would be if it wasn't turned 90° with the black and white bars running vertically.

You think about this as you remove the back cover. Apparently, half of each individual horizontal sweep line is being blacked out.

Could it be that the horizontal sawtooth is being allowed to mix with the video output? Since both the horizontal and video circuits derive B+ from the power supply, you surmise they must be mixing there. Evidently, one of the decoupling filters isn't doing its job.

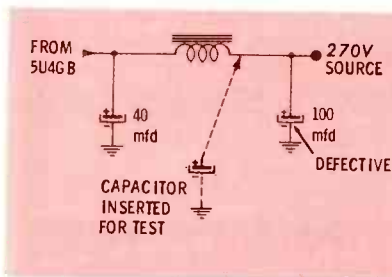
The chassis is vertically mounted, and the multiple electrolytic unit containing all the power-supply filters is easily accessible. You start bridging them one by one, and hit pay dirt on the third try (see Fig. 1). Fortunately, you happen to have a replacement filter in the truck. You install it, button up the rear cover, and write up the bill for \$14.00. Handing it to the man of the house, you can't understand the reason for his sour puss. He had a real wing-ding of a job at a bargain price. Oh well, that's customers for you.

Why was the customer unhappy? Let's face it—you didn't do what he expected! Sure the TV was fixed, but he took that for granted. That is your automatic unquestioned function. Nobody disputes the fact that you can fix TV's; however, the flies under glass, the scratchy tuner, the dull picture, and the unfortunate circumstance of your being dirty and hungry are the points this customer is thinking about. The only reason he'll ever call you again is if your competition is worse.

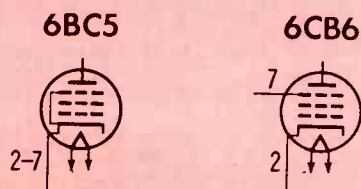
A few years ago we put ourselves in the customer's shoes, tried to analyze his dissatisfactions and change them to satisfactions. We concluded that there are four areas of importance for every service call.

1. The repair
2. Cleaning
3. Restoration to peak performance
4. Setside manner

In the first category, from all reports, we were well above average. Whenever we had a dissatisfied customer, it was almost invariably because of our failure to satisfy in one or more of the latter three categories. Just fixing the set confines your actions strictly to category No. 1. Fixing the customer is concerning yourself with Nos. 2, 3, and 4. Whether he can put it into words or not, the customer expects services in all these areas as his proper due. To not fulfill his wishes is an indication that you don't want his business. We

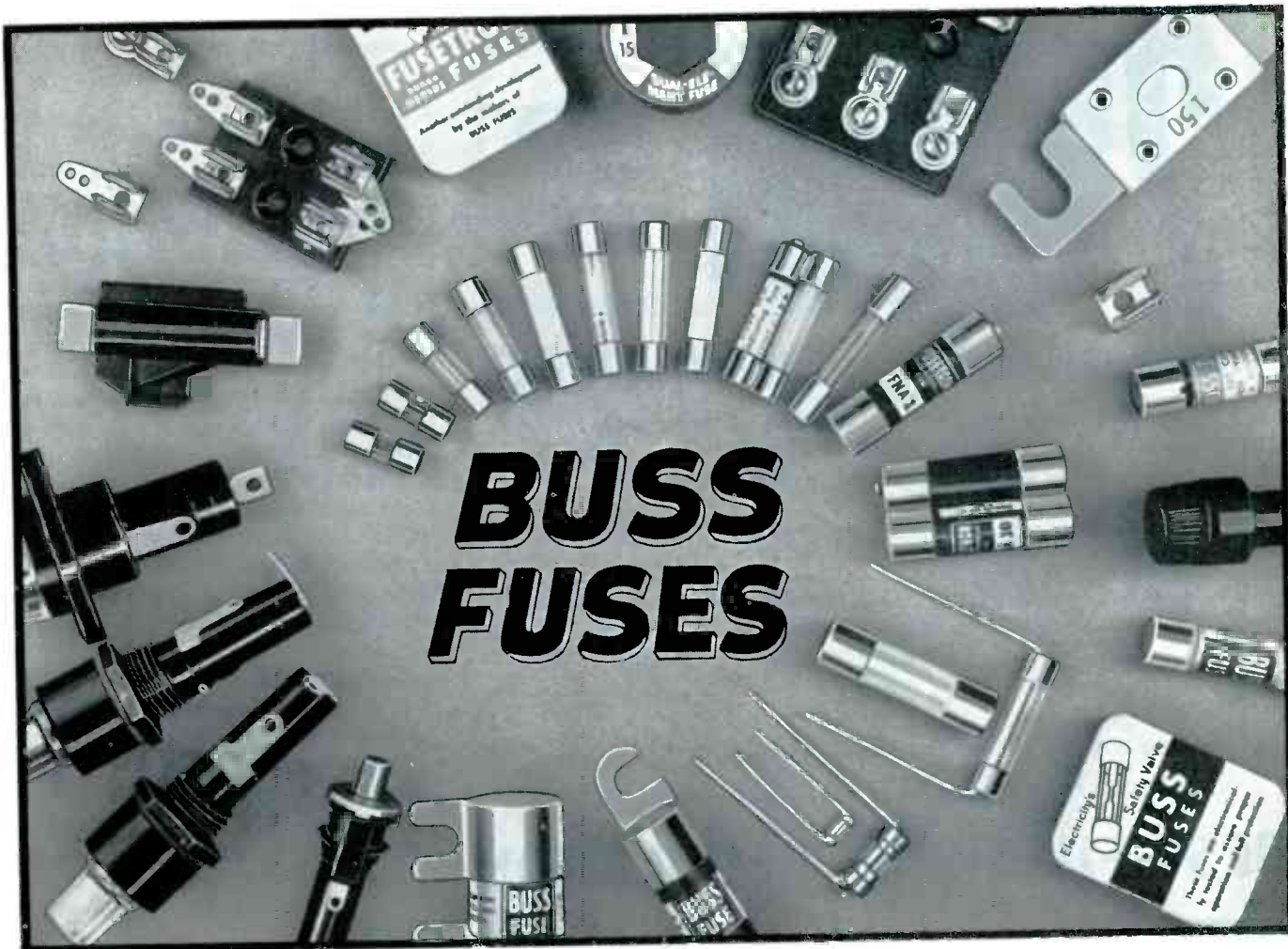


**Fig. 1. Defective B+ filter permitted horizontal sawtooth to modulate CRT.**



**Fig. 2. Difference between 6BC5 and 6CB6 is in connection of suppressor.**





# TWO-WAY PROTECTION

Dependable BUSS Fuses protect  
your customer's equipment . . .  
help safeguard your profit and  
reputation

Whether you sell or install fuses — it doesn't pay to handle one that may open needlessly or fail to protect when trouble occurs. Such fuses are a threat to your profits and reputation for service and reliability.

You and your customers can depend on BUSS and FUSETRON fuses. Why? Because if they're not right, they never leave our plant. Every BUSS and FUSETRON fuse is tested

in a sensitive electronic device that automatically rejects any fuse not correctly calibrated, properly constructed and right in all physical dimensions.

So why take a chance? Standardize NOW on genuine BUSS and FUSETRON fuses . . . fuses that unflinchingly protect against electrical faults and by so doing, also helps protect your profits, helps you maintain the goodwill of your customers.

To meet service needs . . . there's a complete line of BUSS and FUSETRON fuses plus a companion line of fuse clips, blocks and holders.

*For more information on BUSS and FUSETRON Small Dimension fuses and fuseholders, write for bulletin SFB.*

**BUSSMANN MFG. DIVISION,**  
McGraw-Edison Co.  
University at Jefferson, St. Louis 7, Mo.

260

*BUSS fuses are made to protect - not to blow, needlessly.*

*BUSS makes a complete line of fuses for home, farm, commercial, electronic, electrical, automotive and industrial use.*



# 2



MODEL PS-2  
2 OUTPUT RANGES  
\$49.95 net

## -IN-1 DC POWER SUPPLY

1... use it for operating ALL TYPES of auto radios  
(transistor, hybrid and tube)

2... use it for operating personal portable radios  
(transistor)

...also operates experimental transistor circuits, relays; use it for electroplating, laboratory work.

- Transistor protection with separately fused milliammeter.
- Longer life with EPL patented conduction cooling.

### 2 OUTPUT RANGES

VOLTS	CURRENT	RIPPLE
0-16	5 amps.	0.5%
0-20	75 ma.	0.15%

Compare With Others At Your Distributor... Send For Literature!

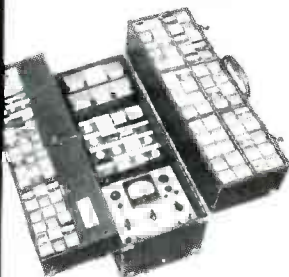
ELECTRO PRODUCTS LABORATORIES 4501-T Ravenswood, Chicago 41

Canada: Atlas Radio Corporation Ltd., Toronto

## BEST FILTERING, REGULATION

**VIS-U-ALL**  
BUSINESS BUILDING TEST EQUIPMENT FOR SERVICE DEALERS

here's  
**MONEY MAKING  
CONVENIENCE**



tubes, tools and built-in  
tube tester... all in one  
handy case!

### THE V100 DYNAMIC CADDY-TESTER

Built-in tester checks over 800 TV-radio tubes dynamically; also tests picture tubes and selenium rectifiers. On house calls, you test all tubes in a set... sell more, make more! Only 4 sockets and exclusive Master Switch test all receiving tubes, past, present and future. Never obsolete. Well built, professional caddy holds 150 tubes.

ONLY \$109.00

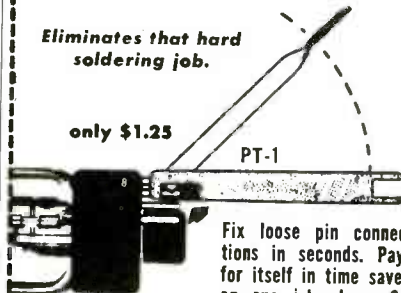
Write  
for  
Details  
**VIS-U-ALL**  
PRODUCTS CO.  
643 EASTERN, S. E.  
GRAND RAPIDS 6,  
MICHIGAN

## BERNS PERFECT PIN-CRIMPER

### Picture-Tube Repair Tool

Eliminates that hard  
soldering job.

only \$1.25



Fix loose pin connections in seconds. Pays for itself in time saved on one job alone. 3" long.

Patent 2,878,698

Intermittent operation of picture tubes due to defective solder connections at socket pins is easily corrected through the use of the Berns Perfect Pin Crimper. Actually a 3-in-1 tool that can also be used as a channel-selector wrench and screwdriver, it serves to notch pins and element leads to provide solid electrical connections. Pin keeps its original form.

3 models: PT-1 for 3/32" pin diameter; AU-2 for 1/8" pin diameter and installing C rings; LC-3 for 5/32" pin diameter.

Available at your parts distributor.  
Another fine product from:

**BERNS** Mfg. Co.  
9853 Chalmers,  
Detroit 13, Mich

set up specific tactics to handle cleaning, restoration, and personality procedure. Here is how they work for us.

### Cleaning

Most households are neat, clean, and tastefully decorated. Homeowners take pride in their property, and if you do things to augment their pride, you're in solid. If you treat their property carelessly, you're dead. There is no in-between.

As a case in point, I recently serviced a dated 16" set owned by a young ambitious couple with a home excellently furnished in do-it-yourself Early American. The TV chassis was not in its original cabinet, but mounted perfectly in a carefully-picked cabinet which the husband mentioned he had refinished himself.

She said, "The sound and picture went off last night."

He added authoritatively, "It still has all the rasters."

She continued, "We looked inside and that little tube was out," pointing to the first video IF. "We bought one at the drug store."

I turned on the power and tuned in a station. It came on with weak video, audio and sync. She hung over my left shoulder, he over my right. I pulled out the 1st IF; it was a drug store brand 6CB6. I took a 6BC5 from my tube caddy, which is the tube called for, and installed it in the socket. The picture came on perfectly, the audio blasted out clearly, and sync lock-in was very precise.

I thought of the schematic on this chassis. Pin 7 of the tube socket is open. For both the 6BC5 and 6CB6, this is the suppressor grid. The difference is that pin 7 of the 6BC5 is internally tied to the cathode. In the 6CB6, pin 7 has a separate base connection (see Fig. 2). Installing a 6CB6 instead of the 6BC5 left the suppressor grid floating, which drastically reduced the gain of the tube. I had been in the house less than ten minutes and the repair was consummated. I could see a case of I - don't - want - to - pay - the service - charge - blues beginning to develop.

I began tactic No. 2, and pulled out my contact-cleaner spray can and slowly sprayed down the tuner and controls. Next, I removed the front glass and washed off all the

scum. Then I took my brush and cleaned out the high voltage cage. In just fifteen minutes, the picture was 50% brighter, the scratchiness was gone from the tuner, the wee bit of corona discharge had ceased, and the service charge blues had vanished.

As I was leaving, I could hear the wife say, "See, we didn't save anything by buying that tube . . ."

#### Restoration to Peak Performance

When a customer calls you for service, he has an immediate problem. But there are other things, lots of small annoyances he has been putting up with, that are also on his mind. He doesn't call for service until he absolutely has to, and he'd like to have all the minor imperfections taken care of before you leave. This is actually an ideal situation—a beautiful profit and reputation maker. For just a little effort above and beyond the call of duty, your business mushrooms and you can smile when you total up your receipts.

A husky gentleman lugged a 21" RCA table model into our shop. He stated categorically, "The picture won't hold. It goes off into lines. Call me as soon as it's done."

I filled out a tag and gave him the numbered end. He grabbed a handful of my business cards from the counter and left. On the bench, the set turned out to be a mess; it hadn't been touched in years. After routine cleaning, I turned it on. The pix came in fine, then after a minute or two it whipped off into horizontal lines. I checked the tubes and found one half the 6SN7 horizontal oscillator a little weak. I replaced it, hooked the scope to the horizontal phasing can, and set the waveshape adjustment according to the book. It looked fine.

A few minutes later, the pix started pulling again. I analyzed the schematic. What components could cause such instability? The horizontal oscillator transformer? Maybe, but it seemed quite stable. A 180-mmf silver mica connecting the grid of the oscillator to the transformer? Could be, if it were changing in capacity. I soldered a new one in. When I turned the set on again, it was way off frequency. That was good; the old one was obviously not



## replace with **RCA** **RECTIFIER TUBES** for long-term reliability

Your RCA Industrial Tube Distributor is the man to call when you need replacement rectifier tubes. He can supply all standard types—vacuum, gas and mercury vapor—in a wide choice of power ratings for every industrial purpose.

The built-in reliability and long life of RCA rectifier tubes pay-off profitably in reduced downtime and lower tube cost per hour of operation. Always specify RCA and get top value for your tube dollar.

Remember—your local RCA Industrial Tube Distributor is as close as your telephone. Call him for fast, efficient service whenever you need replacement tubes.



**RADIO CORPORATION OF AMERICA**  
Electron Tube Division  
Harrison, N. J.

the 180-mmf value it was supposed to be (see Fig. 3).

I realigned the waveshape and waited; the pix held firm. Good—that was it! I began checking other circuits: A new damper for the arcing one, a new 2nd IF amplifier for the one that had some filament-to-cathode leakage, an audio detector that was pinging, a horizontal output tube for more width, and a 5U4 to brighten everything up. Now the picture was gorgeous; the sound was loud and clear.

I let the set “cook” about eight hours, then called the gent. I

couldn't wait for him to come in and see the results of my handiwork. He arrived, looked at the bill, and grunted. I was going to turn it on, but he said indifferently, “Don't, I'm in a hurry.”

That took the wind out of my sails, but by the end of the week, I noticed a flurry of new calls from this gruff gent's neighborhood. I asked one lady how she happened to call us. She answered, “From the TV you fixed in the bowling alley. There's a pile of your cards sitting in front of the set.”

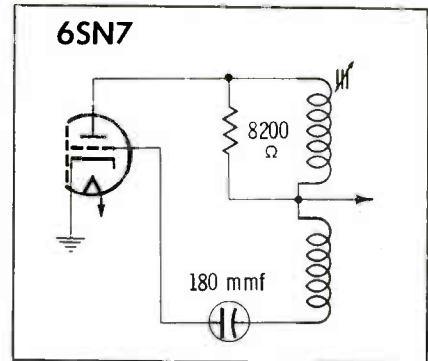


Fig. 3. Value change in 180-mmf unit caused oscillator frequency to drift.

### Setside Manner

It has been said the most prized possession a businessman has is his ability to get along with others. This is especially true in the service business. No matter how good a technician you are, if you don't hit it off with the customer personally, somebody else will get the next call.

Setside manners can be learned; all it takes is a little effort. Here are the rules we follow: *Always smile*, and never talk about anything but the weather. *If asked* for details about the trouble, think before you speak and don't say any more than you have to—but be tactfully truthful. *Never complain* about anything, including the set, your competitor, or other customers. *Impress the customer* by your actions; show him you are happy and enjoy your work. *Never, no matter what*, lose your temper with a customer. I'm a bug on this last point, and perhaps pursue it too strongly with our servicemen.

One morning, after I had lectured Mac, our newest outside tech, on the subject, a medium-sized man walked boldly into the shop. He instructed me out of the corner of his mouth, “Hey, buddy, I got a TV in the car. Carry it out for me.”

To say the least, his attitude was obnoxious, but I made myself smile, went out to the car, and hefted in his 21" Motorola table model. I put the set on a cart and rolled it past the counter into the shop. The customer followed me closely past the NO ADMITTANCE — EMPLOYEES ONLY sign.

With the customer's chin literally resting on my shoulder, I turned on the set, shrugging my shoulder in the process. He spoke loudly into my ear, “You don't mind if I watch, do you, buddy?”

I wanted to say I did, but re-

# HICKOK

TWICE AS MANY IN USE AS ALL OTHER MAKES COMBINED

## World's Leader in Tube Testers!



**MODEL 820**  
**\$99<sup>55</sup> NET**  
**TUBE Caddy-Pal**

**VTVM — OHMMETER — TRANSISTOR CHECKER — GRID CIRCUIT TUBE & CRT CHECKER**

- An innovation in test equipment, designed for radio-TV home service.
- Replaceable 11-socket tube panel covers most popular Radio—TV—Hi-Fi tubes.
- Tests low-signal and power transistors, with special high-current test for power transistors.
- Reads Beta gain and reverse current collector leakage.
- Four voltage and three resistance ranges specifically designed for radio-TV service.



**MODEL 121**  
**\$329<sup>50</sup> NET**

**HIGH-SPEED CARDMATIC®**

- A truly modern tube tester—specifically developed for today's critical tube applications.
- Now, you can not only make critical “fringe” tests, but you actually can test such types as 6SN7 and 6BQ6 for pulse operation.
- Its exclusive card-programmed switch, developed and patented by HICKOK, which positively and automatically sets up exact conditions, is the key to the 121's rapid and automatic tests.



**MODEL 800**  
**\$169<sup>50</sup> NET**

**LOW-COST DYNAMIC MUTUAL CONDUCTANCE**

- Dynamic Mutual Conductance tube and transistor-diode tester.
- New leakage and shorts test and new grid current (gas) test feature.
- Lowest cost tester available in its completeness and accuracy range.



**MODEL 6000**  
**\$197<sup>50</sup> NET**

**HIGH-SPEED DYNAMIC MUTUAL CONDUCTANCE**

- Features the original HICKOK-patented Dynamic Mutual Conductance circuit—the  $G_m$  method that has long been accepted as standard in the industry.
- Snap-in master socket panel, easily removable to accommodate future adapters, to prevent obsolescence.
- Reserve cathode capacity test, filament continuity test, extra sensitive shorts test, new gas test.

THE HICKOK ELECTRICAL INSTRUMENT CO.

10566 Dupont Ave.  
Cleveland 8, Ohio

strained myself. The pix brightened the screen nicely, then darkened, turned negative, weaved, and finally lost all sync. I flipped the channel selector; all local stations produced the same condition. Distant channels, however, had the usual, slightly snowy appearance. A new 6AU6 in the keyed AGC circuit didn't help. I checked the IF's, video, and tuner tubes—still no change.

Meanwhile, my customer was buzzing around the shop. He played with the scope leads, pulled tools out of a drawer, punched buttons on the tube tester, and then began reading the papers on my desk. I grimaced and started removing the chassis. "If I can get his hand across the 117-volt AC input, maybe . . ." but I pushed the thought from my mind.

I hooked a bias box into the AGC line; at -4 volts, the pix came in perfect. That spelled AGC trouble. I made some voltage readings; the plate of the 6AU6 had zero volts. I turned off the set and checked resistance from plate to ground—zero ohms!

Meanwhile, the customer was gabbing away like an old woman. He wanted to know about the repair. In a general way, I calmly told him what I was doing. He said he thought the set was a lemon. I said it was an excellent set; they all have maintenance problems. He blasted one of my competitors. I gritted my teeth and as casually as possible stood up for the other serviceman without offending this creep. This went on and on.

I checked the components in the 6AU6 plate circuit; they all passed inspection. The only thing left was the shielded cable coming from the plate; I disconnected it. Aha, the short disappeared! The inside conductor was shorted to the shielding (see Fig. 4). With a new piece of cable, the pix came on like new.

As I reinstalled the chassis, the customer said, "So that's all it need-

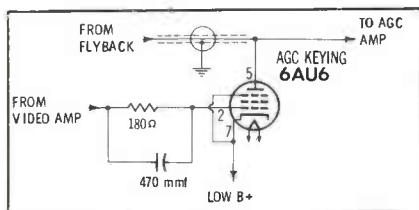


Fig. 4. Loss of AGC voltage was traced to short in shielded cable to flyback.

ed, a piece of wire. You're not going to charge me for that, are you?"

This time I smiled genuinely, "Of course, sir," and made up the bill. It was the only thing enjoyable about the job.

He yelled. Very nicely I said, "I'm sorry, sir, these are the charges."

I expected a tirade. It's our policy to be nice, but it's not our policy to work for nothing. The one thing on which we're most firm is cash on delivery. I had my answer all ready for his beat tactics.

Then he floored me. He laughed,

and his personality changed. "I'm Mac's brother. He told me to bring the TV in for you to fix. He asked me to give you the needle to see how much you could take."

We both laughed at the practical joke. I was lucky I didn't lose my temper; I never would have heard the end of it.

Anyway, these are our ideas on the repair the customer expects. In addition to attending the immediate trouble, we go beyond the normal call of duty. It works for us, and I know it will work for you. Try it, won't you? ▲

# HICKOK

tube testers,

transistor and diode checkers



800

## DYNAMIC MUTUAL CONDUCTANCE

**Professional Serviceman's Accuracy and Quality . . .**

Hickok patented mutual conductance (bridge circuit) in the world's most popular model.

Highest in reliability and thoroughly field proven as the most-profitable-to-use tester available in its price range. Permits accurate tube, transistor and diode evaluations . . . plus the important "fringe" tests for grid current (gas) and future tube life. Features completeness of test function for TV, communications or industrial electronic maintenance. **\$169.50**



**High-Speed Dynamic Mutual Conductance**

High accuracy with the additional time-saving features of automatic shorts or leakage identification, constant indication of line voltage, new filament continuity test and a single, easily removable tube socket panel. **\$197.50**

Ask your distributor for a "Hickok-demonstration" . . .

The world's most complete line of quality tube testers.

Priced from \$99.55 to \$499.50.

6000

GREATEST NAME IN TESTERS

**THE HICKOK ELECTRICAL INSTRUMENT CO.** 10566 Dupont Ave. Cleveland 8, Ohio

**NEW FROM HOWARD W. SAMS**

**"From Tinfoil to Stereo"**

The Evolution of the Phonograph



by Oliver Read  
& Walter L. Welch

Here is the most complete history of the phonograph ever written—from the use of tinfoil to the revolutionary stereo record—the whole exciting story of the men and events responsible for the development of the phonograph!

You'll be fascinated by this masterful account of the evolution of the phonograph. Covers everything: man's earliest dreams of imitating sound; the Edison tinfoil phonograph and the development of the earliest prototypes; the patent struggles; the development of cylinders and discs; the coin-slot phonograph; the introduction of the internal horn; the beginnings of radio and its contribution to recording and reproduction; sound pictures and the phonograph; the war of the record speeds; growth of component systems; tape vs. discs—right down to today. Includes dozens of rare photographs. A wonderful book for every hi-fi enthusiast and phonograph connoisseur. 576 pages, 6 x 9", fully illustrated. Only **\$9.95**

**MORE NEW SAMS BOOKS**

**"101 Ways to Use Your Ham Test Equipment"**



by Bob Middleton

A practical "how-to-do-it" book for amateur radio operators and service technicians who specialize in the repair of ham radio equipment. Gives concise applications for grid dip meters, antenna impedance meters, oscilloscopes, bridges, simple noise generators and reflected power meters. Each use is clearly described, with full data on connections required, proper test procedures and evaluation of results. 168 pages; 5 1/2 x 8 1/2"; illustrated. Only **\$2.50**

**"Servicing Hi-Fi and FM in the Customer's Home"**



by Milton S. Kiver

Describes a wide range of quick, easy test methods for hi-fi amplifiers, AM-FM receivers, record changers, turntables and tape recorders. Includes several unusual new methods, such as the use of an AM detector probe to trace FM circuits. Methods are selected for their quick, practical application and their ability to locate actual and potential trouble spots in hi-fi equipment. Indispensable to anyone interested in servicing hi-fi. 160 pages; 5 1/2 x 8 1/2"; illustrated. Only **\$2.95**

**HOWARD W. SAMS & CO., INC.**

Order from your Sams Distributor today, or mail to Howard W. Sams & Co., Inc., Dept. B-30 1720 E. 38th St., Indianapolis 6, Ind.

Send me the following books:

- "From Tinfoil to Stereo" (EPR-1)
- "101 Ways to Use Your Ham Test Equip." (TEM-6)
- "Servicing Hi-Fi in the Customer's Home" (SHK-1)

\$.....enclosed.  Send Free Book List

Name \_\_\_\_\_

Address \_\_\_\_\_

City \_\_\_\_\_ Zone \_\_\_\_\_ State \_\_\_\_\_

(outside U.S.A. priced slightly higher)



**QUICKER  
SERVICING**

by Calvin C. Young, Jr.

**a direct approach  
to oscillator-circuit  
servicing**

Even though most oscillator circuits are rather simple and straightforward, they give the most experienced serviceman trouble on some occasions. Wouldn't you like these occasions to become fewer and farther between? If you absorb the information in this article, you'll rarely be stumped by an oscillator trouble.

The oscillator circuits most often encountered in radio and TV are series-fed Hartley, Armstrong, Colpitts, blocking, and multivibrator types, or variations of these basic designs. In the process of understanding how these oscillators work, I find it helpful to consider them as amplifiers with regenerative feedback. Since most practicing servicemen are already familiar with amplifier circuits, we really need to discuss only the various means of obtaining feedback. With this in mind, let's look at the various oscillator circuits, starting with those found in radios.

**Hartley Circuit**

The series-fed Hartley shown in Fig. 1 is the simplest oscillator encountered—in the sense that it contains fewer parts, and certainly fewer connections than the others.

Feedback in this circuit is by means of tapped coil L1. Tube conduction causes a positive pulse to be applied to the grid (pin 1), which then draws current. As a result, C1 charges very rapidly and biases the tube beyond cutoff. This charge leaks off through R1 and allows grid voltage to rise until the tube comes out of cutoff. Then, the entire cycle repeats itself.

From a servicing standpoint, the checks necessary to isolate trouble in a Hartley oscillator are as follows:

1. Proper voltage on the screen grid (pin 6), which serves as the anode of the oscillator.
2. Continuity of L1.
3. Value of R1.
4. Condition and value of capacitor C1.

Note: These checks assume oscillator trouble is present and tube replacement failed to cure it.

The reasoning behind the above-listed checks is as follows: Screen voltage is checked first because no oscillator (or any other vacuum-tube circuit) can operate without anode potential in one form or another. In addition, components in circuits carrying B+ voltages are the most likely to fail. For instance, bypass capacitors have higher poten-

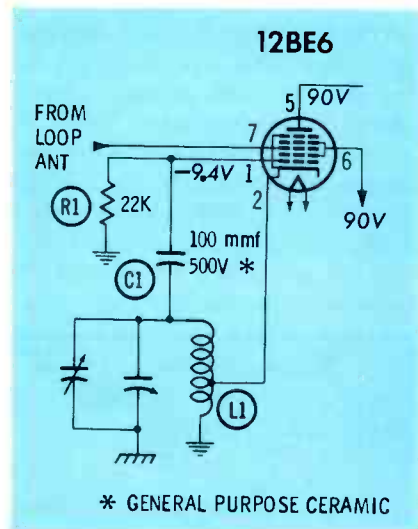


Fig. 1. Series-fed Hartley oscillator circuit used in 5-tube AC-DC radio.

tials impressed across them, and more voltage is usually dropped across plate-load or decoupling resistors.

Trouble in L1 is singled out as the next most probable cause of oscillator failure, since cathode current (equal to plate *plus* screen *plus* grid current) flows through this coil. A current overload due to a defective tube may have weakened the coil at some previous time, making it a prime suspect.

The third test is made because of its simplicity. A resistor is just easier to check than a capacitor, especially when it doesn't have to be removed from the circuit for testing.

The capacitor is best checked by direct substitution; this is why it is last on the list. I recommend that the grid load resistor be replaced whenever a substitute capacitor is installed, and that both of these parts be left in the circuit even if they don't correct the trouble. Too much soldering on those little ceramic capacitors isn't good for them and should be avoided.

If the procedure outlined here fails to locate the trouble, don't start pulling your hair out; instead, check the tuning gang for shorts between rotor and stator elements, and look for defects in the compression-type mica trimmer.

#### Armstrong Circuit

The Armstrong circuit in Fig. 2 features an oscillator coil with two separate windings—one in the grid circuit and one for the feedback circuit. Energy is coupled from cathode to grid when the tube conducts. Polarity of the feedback is such that the grid goes positive and draws current; thus, the 47-mmF capacitor C1 is charged very rapidly and the tube is driven into cutoff. Just as in the Hartley circuit, conduction cannot resume until C1 partially discharges through R1.

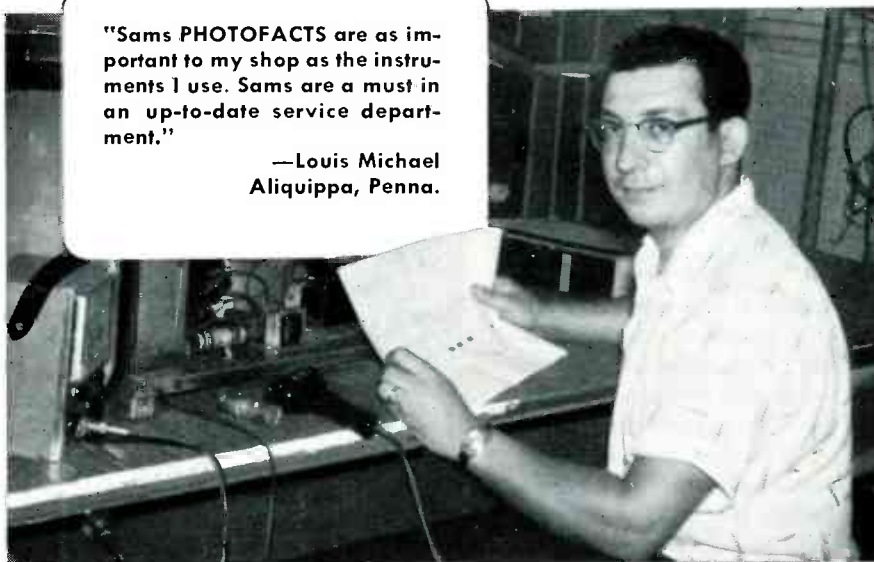
The recommended troubleshooting procedure is identical to that outlined for the Hartley circuit, except that you should also check for shorts or leakage between the primary and secondary windings of L1.

A variation of the basic Armstrong circuit (Fig. 3) employs a tickler winding on the oscillator coil in place of a 47-mmF grid capacitor. If you ever suspect that the tickler winding is defective, dis-

## Service Technicians! YOU EARN MORE... YOU RATE with the public when you own the PHOTOFACT® service data library!

"Sams PHOTOFACTS are as important to my shop as the instruments I use. Sams are a must in an up-to-date service department."

—Louis Michael  
Aliquippa, Penna.



YES, if you are one of the thousands of owners of a complete PHOTOFACT Service Data Library, you are enjoying maximum earnings. It's inevitable, because no matter how expert you are, you can always *save more time on any job, get more jobs done daily—EARN MORE, DAY IN AND DAY OUT...*

Moreover—as the owner of a complete PHOTOFACT Library, *you know your customers' sets best. You can actually show each customer you have the PHOTOFACT Folder covering his very own set. Result: You command public respect and acceptance which paves the way to more business and earnings for you...*

#### HOW TO STAY AHEAD...

Today, the truly successful Service Technicians are those who own the complete PHOTOFACT Library, who can meet and solve any repair problem—faster and more profitably. And these men *keep ahead* because they're on a Standing Order Subscription with their Distributors to receive all new PHOTOFACTS as they are released monthly.

For PHOTOFACT Library Easy-Buy Plan details and Standing Order Subscription, see your Sams Distributor today, or write to Howard W. Sams...



If you now own a PHOTOFACT Library, you can apply for membership in the powerful new "PEET" program, designed to build prestige and business for the Service Technician who qualifies. Ask your Sams Distributor for the "PEET" details, or mail coupon today!

**HOWARD W. SAMS & CO., INC.**  
1728 E. 38th St., Indianapolis 6, Ind.

- Send me full details on the new "PEET" Program. Include full information on the Easy-Buy Plan and Free File Cabinet deal.
- I'm a Service Technician:  full-time;  part-time

My Distributor is: \_\_\_\_\_

Shop Name \_\_\_\_\_

Attn: \_\_\_\_\_

Address \_\_\_\_\_

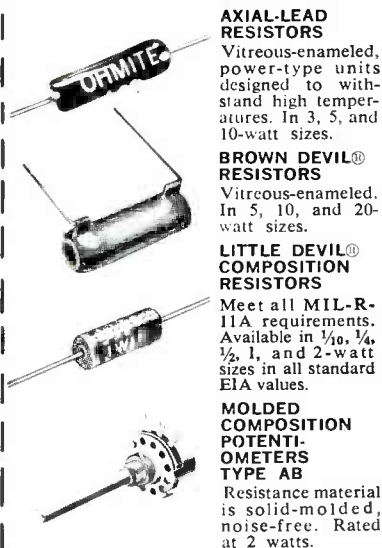
City \_\_\_\_\_ Zone \_\_\_\_\_ State \_\_\_\_\_

# A Profitable New Field!

## INDUSTRIAL ELECTRONIC SERVICING

with  
**OHMITE**<sup>®</sup>  
QUALITY  
Components

Industrial electronic servicing is profitable new business for you. Especially when you stock and replace with dependable Ohmite components . . . the line your industrial customers know and prefer. Service such industrial equipment as mobile radio, aircraft and marine radar and radio, electronic controls for factory processes and automation, industrial P.A. and intercom systems, and—medical and dental electronics.



Write for Stock Catalog 28

**OHMITE**<sup>®</sup>  
DEPENDABLE  
RESISTANCE  
UNITS

OHMITE MANUFACTURING COMPANY  
3644 Howard Street, Skokie, Illinois

connect it and install a small capacitor (about 47 mmf) between the top of the tuning gang and the oscillator grid. Appearance of a negative grid voltage means the tickler was bad. If you can determine the correct value of capacitance to make the oscillator track properly, it won't be necessary to replace the coil.

### Colpitts Circuits

While we are on the subject of RF oscillators, let's take a look at the circuit most often used in TV tuners. The circuit shown in Fig. 4 is representative of the type found in a popular turret tuner. The Colpitts circuit differs from the Hartley in that it has a split capacitive network, rather than a tapped inductor, in the tuned tank circuit. The biggest reason for using a Colpitts oscillator in a TV tuner is the need for very small values of inductance and capacitance at VHF frequencies.

The feedback network of the Colpitts circuit is a little more complex than those previously mentioned. When the tube conducts, its plate voltage decreases. Since the fine-tuning capacitor is connected between plate and ground, this voltage change is impressed across it, as well as across L1 and C1.

The resultant oscillation in the tank circuit causes a signal to appear at the grid, which draws current on positive signal peaks to charge the 10-mmf capacitor C2 in the grid-leak network. This charge holds the tube in the cut-off state until the charge leaks off across resistor R1.

The setting of the fine-tuning control and the adjustment of the oscillator slug determine the value of capacitance and inductance in the oscillator tank, and thereby the amplitude of the feedback voltage applied to the grid of the oscillator. The amplitude of the feedback voltage, in conjunction with the discharge time of the 10-mmf capacitor through the 10K resistor, determine frequency of oscillation.

The components having the most critical values are the 5- and 10-mmf capacitors. As indicated in Fig. 4, they are of the temperature-compensating variety, and any unit used to replace them must have identical characteristics.

The recommended troubleshoot-

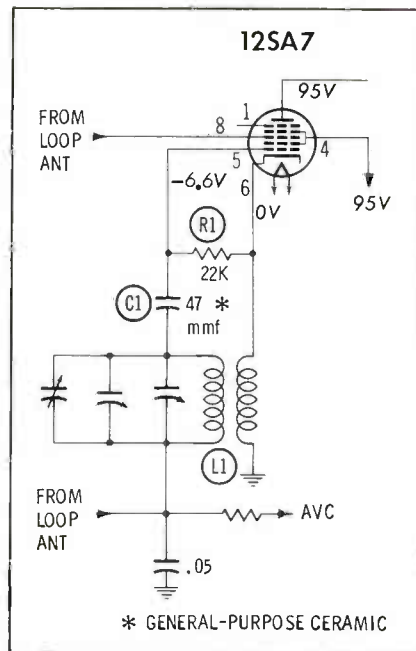


Fig. 2. Armstrong oscillator employed in some 5-tube AC-DC receiver models.

ing procedure is to check the tube first, then R1, then the B+ network (R2 and C3), next the fine-tuning capacitor and C1, and finally the 10-mmf grid-leak capacitor C2. It is also recommended that, once a capacitor is removed from the circuit, a new capacitor be installed in its place. This will help avoid introducing trouble into the circuit. The oscillator coil and fine-tuning capacitor rarely give trouble other than being subject to dirty contacts.

Occasionally, you may run across a tuner with no coupling capacitor between the oscillator and mixer stages, and with oscillator and mixer tuning coils apparently too far apart to permit inductive coupling of the oscillator signal into the mixer. In

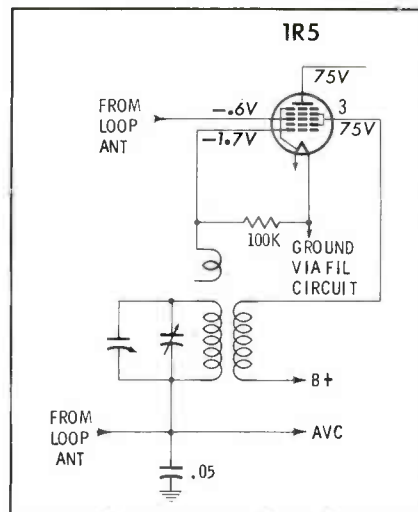


Fig. 3. Armstrong circuit with tickler winding to provide feedback to grid.



**20% LARGER CATHODE.  
HANDLES MORE CURRENT.**

**25% HEAVIER  
GRID SIDE RODS.  
A COOLER-RUNNING GRID.**

**FAMOUS 5-PLY  
G-E PLATE MATERIAL.  
BETTER HEAT CONDUCTION.**



**HIGHER ELECTRICAL RATINGS.  
MORE TUBE IN EVERY RESPECT!**

- ✦ 17% higher max plate dissipation than the 6DQ6-A—17.5 w vs. 15 w.
- ✦ 17% higher max screen dissipation—3.5 w vs. 3 w.
- ✦ 25% higher avg DC cathode current—175 ma vs. 140 ma.
- ✦ 25% higher peak cathode current—550 ma vs. 440 ma.
- ✦ 15% higher zero-bias plate current (typ. operation)—345 ma vs. 300 ma.

## Your Big NEW Business-BUILDER: G-E 6DQ6-B!

Hand-tailored for servicing the new 23" television sets...  
gives you better-than-ever performance in older TV's!

The Service-Designed 6DQ6-B is General Electric's brand-new horizontal-sweep tube with big performance *designed in*. Example: the 15% higher zero-bias plate-current characteristic gives ample sweep in the new 23" TV sets with their high sweep angles...it also means extra sweep capability in other television sets, for extra safety factor, fewer complaints and service callbacks.

Type 6DQ6-B is more dependable in every way...huskier, runs cooler. Check the construction features above! Same improvements apply to new G-E companion types 12DQ6-B and 17DQ6-B. Fully interchangeable with prototypes. See your G-E tube distributor! *Distributor Sales, Electronic Components Division, General Electric Company, Owensboro, Kentucky.*

*Progress Is Our Most Important Product*

**GENERAL  ELECTRIC**

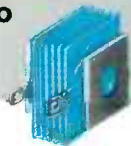
311-301

# 4 NEW TARZIAN "condensed-stack" SELENIUM RECTIFIERS cover 50 to 500-ma range

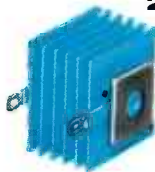
Model 50-75



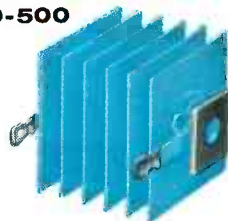
Model  
100-150



Model  
200-250



Model  
300-500



4 new types replace 20 standard units; technicians can reduce rectifier stocks

Sarkes Tarzian now offers four "condensed-stack" selenium rectifiers that replace the twenty types that formerly made up the 50 to 500-milliamperere line. This development was made possible by cumulative improvements in Tarzian's selenium rectifier production processes which have substantially reduced watt losses...by as much as 50%.

Now you can cover your selenium rectifier needs with four models. The small size of Tarzian "condensed-stack" units further eases your application and inventory problems. For more information contact your Sarkes Tarzian distributor, or write to Section 4455A, Semiconductor Division, Sarkes Tarzian, Inc., Bloomington, Indiana.

## "CONDENSED-STACK" CHARACTERISTICS

Model	Current Range, ma	Volts	Cell size (In. sq.)	Length (Inches)
50-75	50 to 75 ma	130	11/16	29/32
100-150	100 to 150 ma	130	1.0	13/16
200-250	200 to 250 ma	130	1 1/4	1 1/4
300-500	300 to 500 ma	130	1.6	1-15/16



**SARKES TARZIAN, INC.**

SEMICONDUCTOR DIVISION  
BLOOMINGTON, INDIANA

In Canada: 700 Weston Rd., Toronto 9, Ontario  
Export: Ad Auriema, Inc., New York City

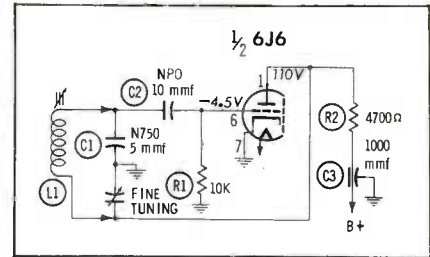


Fig. 4. Colpitts-type oscillator circuit used in a typical television tuner.

this case, you can assume that the internal capacitance between sections of the oscillator-mixer tube is adequate to provide the required oscillator injection.

### Blocking Oscillator

The blocking oscillator circuit in Fig. 5 is similar to the Armstrong design, the major differences being the absence of a tuning capacitor across the grid winding and a much lower frequency of oscillation. The capacitor across the primary winding doesn't tune the plate circuit, but rather limits the kickback-pulse voltage generated by the collapsing magnetic field which occurs after the saturation point is reached.

In operation, tube conduction causes a positive-going signal voltage to be induced in the grid winding; this makes the grid positive and causes tube current to increase further. The tube conducts more and more until T1 primary is saturated (additional current causes no further expansion of the magnetic field). At this point, the field surrounding T1 secondary collapses, causing grid current to flow and C1 to charge in the polarity indicated. Because of the relatively low-impedance charge path, and the absence of a positive feedback, the tube is driven rapidly into cutoff. C1 then begins to discharge across R2 in series with hold control R1, and grid voltage rises in accordance with

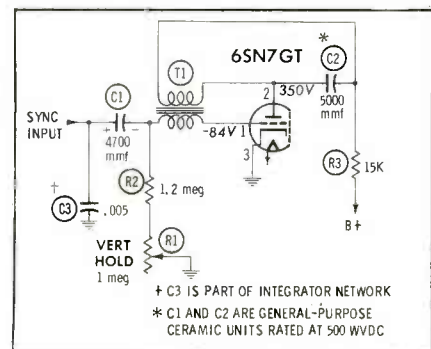


Fig. 5. Blocking oscillator circuit for vertical sweep section of TV set.

the exponential discharge curve. When it reaches tube cutoff level, the cycle starts over again. The grid signal produced is the familiar saw-tooth waveform shown in Fig. 6.

The recommended troubleshooting procedure for the circuit in Fig. 5 consists of:

1. Checking B+ on the plate of the tube.
2. Checking negative voltage on grid of tube.
3. Checking the change of grid voltage with a change of hold-control setting.
4. Continuity check of blocking transformer; also test for leakage between windings.
5. Value test of 1.2-meg resistor R2 and hold control.
6. Substitution of 4700-mmf capacitor C1.

If plate voltage is present on the tube, and the transformer has continuity and no leakage, there should be a negative voltage on the control grid. A low value of voltage here indicates either a lack of feedback or a defect in the RC grid network. The trouble is most often a loss of capacitance in the 4700-mmf unit.

Low grid voltage is always accompanied by low plate voltage because, with insufficient bias, the tube draws excessive current. Note: Low plate voltage can also *cause* low grid voltage, rather than *result* from it. For instance, if the plate-load impedance increases in value, the reduction in plate current will lead to a reduction in plate-to-grid feedback.

#### Multivibrator Circuit

A variation of the basic multivibrator circuit, known as the cathode-coupled version, is used in the vertical sweep sections of many TV receivers. Essentially, this circuit consists of a two-stage resistance-coupled amplifier with a common cathode load (see Fig. 7). Because of its application, circuit operation is such that the input stage conducts most of the time while the output stage conducts only a very short part of the time. With different component values, it could be the other way around, or both stages could be made to conduct an equal amount of time. The main thing to remember is that only one stage can conduct at a time.

# What's the latest score on cartridges?

<input checked="" type="checkbox"/>	<b>1<sup>ST</sup></b>	ceramic cartridge was invented by Sonotone...
<input checked="" type="checkbox"/>	<b>13</b>	years ago. Today, over...
<input checked="" type="checkbox"/>	<b>65</b>	different manufacturers have specified Sonotone for...
<input checked="" type="checkbox"/>	<b>662</b>	models of high-quality phonographs. Altogether over...
<input checked="" type="checkbox"/>	<b>9,000,000</b>	Sonotone Ceramic Cartridges have been used for original and replacement purposes. ('Nuff said!)

## Sonotone <sup>®</sup> CORP.

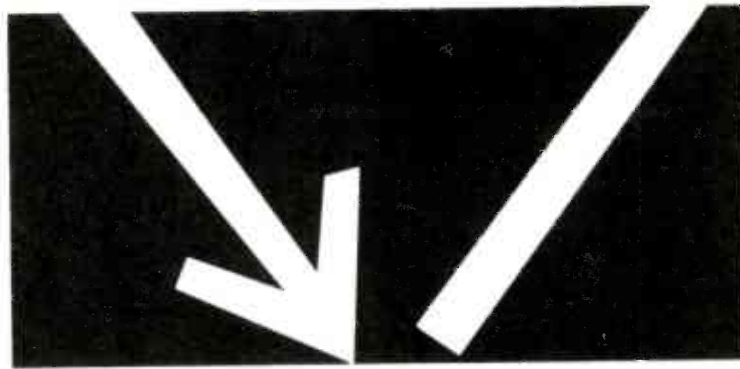
Electronic Applications Division, Dept. C10-20

ELMSFORD, NEW YORK

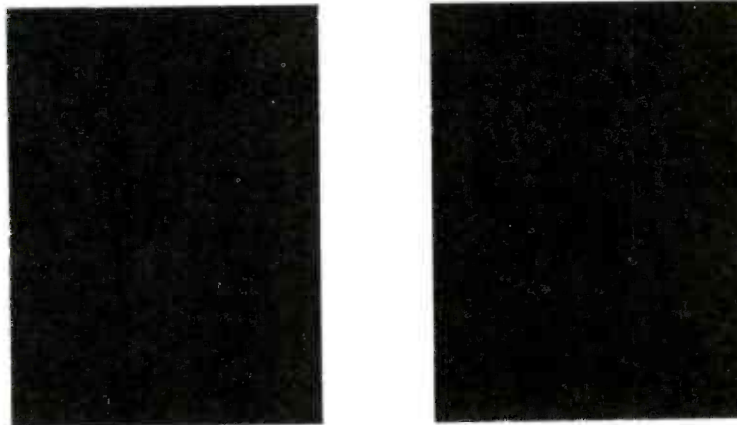
In Canada, contact Atlas Radio Corp., Ltd., Toronto

Leading makers of fine ceramic cartridges, speakers, microphones, electronic tubes.





## HOW MUCH DO YOU KNOW ABOUT TRANSISTORS?



Attend the

### Delco Electronics—One Week —Advanced Training School

No tuition charge  
No laboratory fees  
Textbooks supplied

Bring yourself up to date on transistors and other modern electronic equipment with personalized instruction at the Delco Electronic training school to be held soon at a General Motors Training Center near you. Classes are conducted by graduate engineers with special training in your field.

The Delco Radio diploma, awarded only to those who successfully complete the courses, will mean a great deal to you—and to your customers.

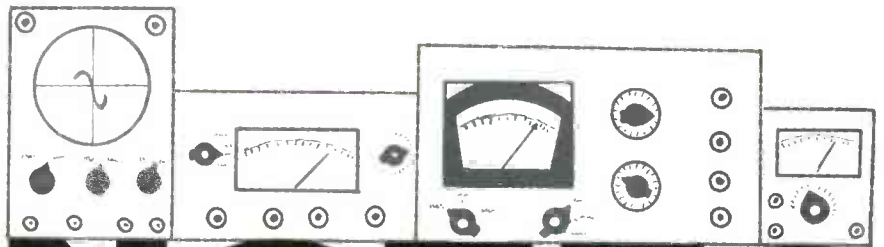
The Delco Electronics—One Week—Advanced Training Schools will be conducted in the General Motors Training Centers indicated below. One of them is near you. Register now through your local Delco Electronic Parts Distributor or write directly to Delco Radio Division, General Motors Corporation, Kokomo, Indiana, Attention: Service Manager.

### COURSES OF STUDY OFFERED AT NO COST TO YOU:

- ① Transistor Fundamentals—complete coverage of transistor theory without the use of mathematics.
- ② Transistor Circuit Trouble-shooting—lecture and lab work analyzing defects in transistor circuits.
- ③ Hybrid-type Automobile Radios—low voltage tube and output transistor circuits. Lecture and lab.
- ④ Trouble-shooting procedures for dead or weak low voltage auto radios—factory developed techniques that are foolproof.
- ⑤ Lecture and lab practice on “Signal Seeker” and “Wonder Bar” auto radio tuners and trigger circuits.
- ⑥ Guide-Matic Headlamp Control (Autronic Eye)—lecture and lab.
- ⑦ Twilight Sentinel Automatic Headlight Switch—lecture and lab.
- ⑧ Garage Door Operators—lecture and lab work including the new Delco Radio all-transistor control units.
- ⑨ Auto Portable Radios—lectures on circuitry of both 1959 and 1960 auto portable radios.

# DELCO RADIO

DELCO ELECTRONICS TRAINING SCHOOL SCHEDULE						
DATE	REGION 1	REGION 2	REGION 3	REGION 4	REGION 5	REGION 6
1-11	Philadelphia	New Orleans	Chicago			
1-18				St. Louis	Dallas	Salt Lake City
1-25		Atlanta	Detroit			
2-1	Union			Omaha	Memphis	
2-8						Los Angeles
2-15	Pittsburgh	Jacksonville				
2-22	Pittsburgh		Cincinnati			
2-29				Kansas City Kansas City	Dallas	Portland
3-7	Tarrytown	Charlotte				
3-14			Cleveland			
3-21				Omaha	El Paso	
3-28	Boston	Atlanta				Los Angeles
4-4	Boston		Chicago	Minneapolis Minneapolis		
4-11					Houston Houston	San Francisco
4-18	Union	Washington Washington	Milwaukee			
4-25				Omaha		Portland
5-2			Cincinnati			
5-9	Buffalo				Okla. City	
5-16		Atlanta	Detroit	St. Louis		
5-23						Los Angeles
6-6	Tarrytown		Chicago		Dallas	
6-13		New Orleans				San Francisco
6-20	Philadelphia			Denver		
6-27			Cleveland		Memphis	Salt Lake City



# NOTES ON TEST EQUIPMENT

by Les Deane

## Sweep Out?

Like gold, TV trouble is where you find it; but if you suspect it's somewhere between the sync section and the deflection yoke, an instrument like the Dyna-Sweep Circuit Analyzer shown in Fig. 1 will come in handy. Produced by B & K Mfg. Co. of Chicago, the Model 1070 provides a multitude of test signals for troubleshooting sync circuits as well as both vertical and horizontal sweep systems. The portable instrument is self-contained and comes completely equipped with test leads and special HV indicator.

### Specifications are:

1. **Power Requirements** — 110/120 volts, 50/60 cps; power consumption with no load approx. 20 watts; ON indicator on front panel; 1-amp line fuse provided.
2. **Output signals**—vertical and horizontal blanking pulses (to simulate composite video); composite sync pulses of either polarity adjustable in amplitude; grid-drive pulse for vertical output stage; plate-drive signal for vertical output transformer; test signal for vertical yoke windings; grid-drive pulse for horizontal output stage; plate-drive signal for horizontal output transformer; pulse signal for checking flybacks and yokes.
3. **Signal Frequencies**—60-cps vertical signals obtained from AC line; 15,750-cps horizontal signals ob-

tained from internal oscillator with frequency control on rear of case.

4. **Special Tests** — leakage and continuity checks for horizontal output transformers; neon indicator, calibration control, and two test jacks provided on panel.
5. **Other Panel Features**—boost and high voltage indicators, sync level control, function selector, ground jack, and 7 individual jacks for output signals.
6. **Size and Weight**—9½" x 7" x 5"; 8½ lbs.

The only way to really analyze a new instrument like the 1070 is to actually perform all of the tests it offers on typical television chassis. So, after reading the instruction manual from cover to cover, I did just that.

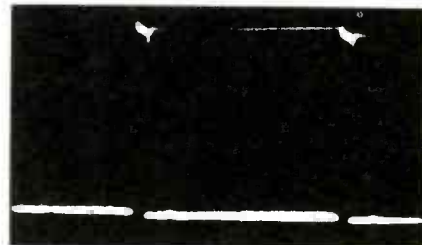
The first troubleshooting procedure involved a check on TV sync operation. Tuning the set to an unused channel, I connected a test lead from the VIDEO SIGNAL jack on the Dyna-Sweep to the grid of the video amplifier, and a ground lead between the two pieces. At this point, the instrument's output signal consists of both horizontal and vertical blanking bars at a fixed amplitude of about 100 volts p-p. Provided there are no troubles beyond the video detector, you should be able to obtain a blank raster on the TV screen after adjusting hold controls. If, however, poor synchronization is originating somewhere in the sync or oscillator sections, either one or both blanking bars will be visible on the screen. Vertical blanking may be running up or down, and horizontal blanking may be slanting diagonally in either direction.

The Dyna-Sweep also furnishes a composite sync signal (see Fig. 2A & B) for stage-by-stage testing of the entire sync system. Either signal polarity is available, and the output level is variable from 0 to 50 volts p-p. Incidentally, I found this signal strong enough for direct application to the vertical integrator network or to the input of a horizontal phase-detector stage.

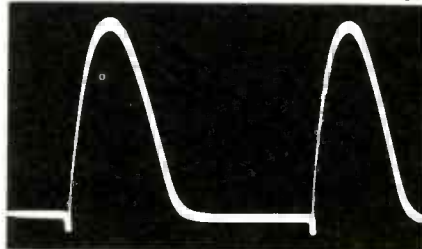
As noted in the specifications, the instrument will also supply drive signals for both grid and plate of each sweep

amplifier. In brief, this means that the receiver's vertical or horizontal output stage can be completely bypassed. The vertical grid-drive signal is pictured in Fig. 2C. Its fixed amplitude is approximately 140 volts p-p; however, the deflection it produces will usually be nonlinear, and the pattern frame will naturally be out of sync.

The horizontal grid drive (Fig. 2D) has a fixed output level of about 160 volts p-p. If the output and high voltage sections of the receiver are operating properly, a raster of sufficient width should be obtained when this signal is applied to either the output grid or the plate circuit of the oscillator. When I



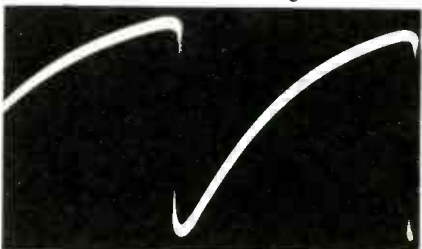
(A) Sync signal at 30-cps scope sweep.



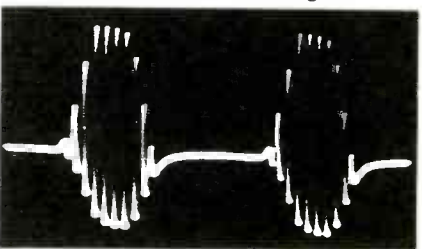
(B) Sync signal at 7,875-cps scope sweep.



(C) Vertical drive signal.



(D) Horizontal drive signal.



(E) Flyback/yoke test signal.

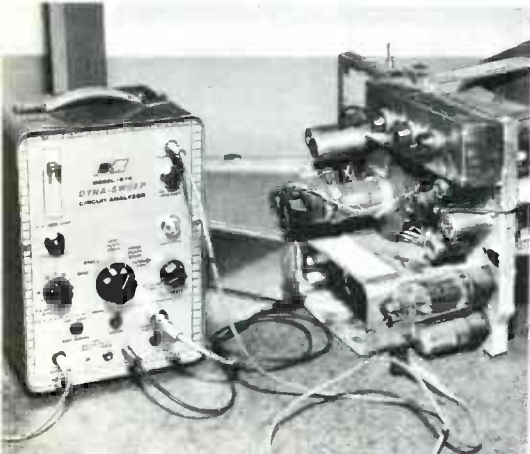


Fig. 1. The 1070 is a signal generator for checking sync and sweep circuits.

Fig. 2. Output waveforms of signals from the Dyna-Sweep Circuit Analyzer.

... the smartest move you can make is to ...

**pick a pak of**

**the**

**BIG**

**SIX**



**Outstanding in all areas....**

Available Now From Your  
Distributor. Order Yours Today!



# RELIABLE REPLACEMENT



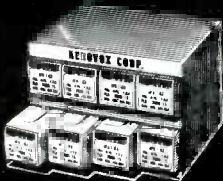
## TWIST-PRONG ELECTROLYTICS

A satisfactory repair job means a satisfied customer. To keep your customer happy and to prevent costly call-backs you must depend on a reliable replacement. Aerovox AFH Twist-Prong Electrolytics can always be depended on to give long-life and excellent service because they're made better . . . high-purity aluminum foil construction throughout, 85°C operation, improved hermetic sealing and rugged prongs and mounting terminals.

Available in the widest selection of exact-duplicate replacements including printed-wiring and selenium rectifier types. Your local Aerovox Distributor stocks the replacement you need when you need it. Call on him today for all your capacitor requirements.

### BUY THEM BY THE KIT . . .

Your Aerovox Distributor offers you special "Stack-A-Lytic" kits (AK-400 and AK-401) with a selection of 8 or 16 popular TV replacements with a FREE handy metal storage rack with stacking features.



**AEROVOX CORPORATION**  
DISTRIBUTOR DIVISION  
NEW BEDFORD, MASS.

performed this test in the lab, I found that the resulting sweep covered the screen of both a 90° and 110° CRT with pretty fair linearity. I could not coax the picture to sync completely; however, by adjusting the frequency control on the back of the 1070, I could cause the pattern to shift back and forth very slowly.

The plate-drive signals, available at a separate jack on the instrument, are high voltage pulses which will produce sweep without any assistance from the respective output stage in the receiver under test. I was rather curious to see how the Model 1070 developed these plate drive signals—especially those for supplying energy directly to the flyback transformer.

On examining the schematic, I found a single 6BQ6 output tube employed in the plate-drive circuit. The grid signal for this tube is selected by the function switch on the front panel. In the VERT. PLATE DRIVE position, a 60-cps signal from the AC line is amplified, shaped and applied to the output grid. In the HORIZ. PLATE DRIVE position, a 15,750-cps sawtooth signal from an internal oscillator is coupled to the output tube grid. Plate voltage is supplied to this output tube via the plate drive lead connected to the receiver under test. Thus, if B+ is absent at the output transformer, no plate-drive signal will be developed.

The *Dyna-Sweep* also features a separate output jack labeled VERT. YOKE TEST SIGNAL. The signal available at this point is a 60-cps sine wave derived from the 6.3-volt filament supply within the instrument; its amplitude is more than enough to produce sweep when applied directly across the vertical windings of the yoke. Deflection will not be linear, of course, due to the sine-wave makeup of the test signal.

Horizontal output transformer and

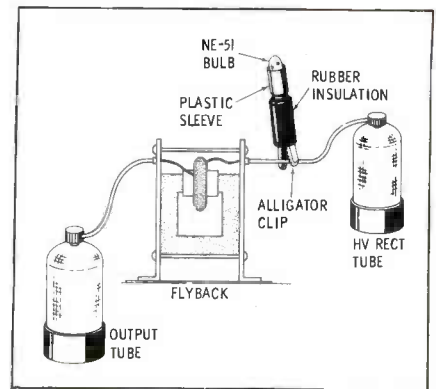


Fig. 3. Neon indicator supplied with Model 1070 clips to set under test.

yoke windings can be tested for shorted turns by using another special output feature of the *Dyna-Sweep*. Using a shielded cable, a test signal resembling that shown in Fig. 2E is applied to the transformer or yoke. This signal, at a peak-to-peak level of about 90 volts, represents a burst of oscillation occurring at a 60-cps rate. One can detect as little as a single shorted turn by pulsing the inductor and observing the neon indicator on the instrument's front panel. In conjunction with this test, the analyzer also provides leakage and continuity checks.

A small clip-on indicating lamp is supplied with the Model 1070 to indicate whether or not the set is producing high voltage. It is clipped to the insulated portion of the HV rectifier plate lead as illustrated in the drawing of Fig. 3. If the lamp glows, it indicates that RF pulses of sufficient magnitude are present to drive the high-voltage network. This simple test is made first with the rectifier plate cap disconnected, and then with the cap in place. When not in use, the indicator is held to the panel of the instrument by a special clip.

## Loan-Out Tube Tester

The instrument pictured in Fig. 4 is a Model 78 tube tester recently introduced by Seco Mfg. Co. of Minneapolis. This inexpensive unit represents a simple, expedient method for checking tubes at the counter, on the bench, or in the customer's home.

This portable, easy-to-operate unit was especially designed for Seco's *Take a Tube Tester Home* program for "do-it-yourselfers." The promotional packet for servicemen includes advertising aids, loan agreement forms, etc. The customer takes the tester home, checks his tubes, and returns it. The whole idea is to encourage the consumer to buy tubes, etc. at the service shop instead of the drug store.

Specifications are:

1. Power Requirements — 110/120 volts, 60 cps; power consumption less than 7 watts standby; ON-OFF switch and line voltage adjust provided on panel.
2. Tube Tests — cathode emission

automatically indicated on REPLACE-?-GOOD and relative numerical scales of panel meter; shorts and leakage, as well as grid emission, indicated on GOOD-?-REPLACE scale; filament continuity check also provided.

3. Other Features — 2 3/4" meter with

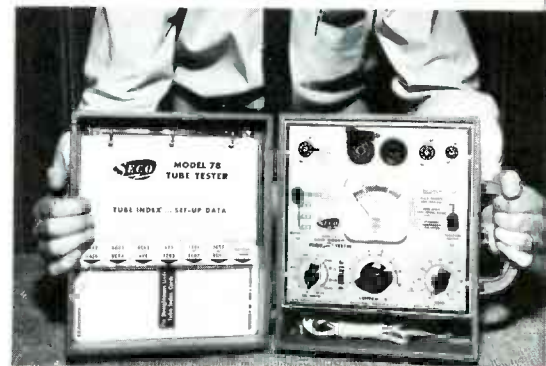
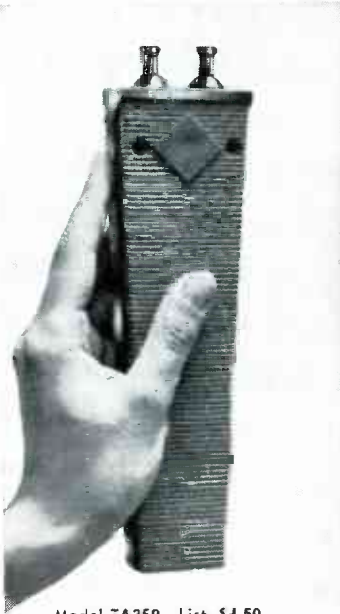


Fig. 4. Seco's Model 78 tube tester is designed for loan or rent to customers.



50% OF ALL TV SETS MADE TODAY ARE PORTABLE AND TOTE-ABLE TYPES. THIS WILL ADD UP TO \$3,500,000 IN EXACT REPLACEMENT ANTENNA VOLUME IN 1960 FOR FORWARD-THINKING DISTRIBUTORS AND DEALERS WHO PREPARE FOR IT TODAY! . . . WITH THE JFD EXACT REPLACEMENT ANTENNA MERCHANDISING PLAN.



Model TA359 List, \$4.50  
Exact Replacement for RCA,  
Motorola, Magnavox, 1956-7-8  
Portable TV Sets



Model TA352 List, \$5.75  
Exact Replacement for GE  
Designer and Hotpoint "Flair"  
1958 Portable TV Sets



Model TA369 List, \$8.25  
Exact Replacement for RCA  
1960 Portable TV Sets

WHERE WOULD YOU GET ANY  
AND EVERY ANTENNA REPLACEMENT  
FOR PORTABLE AND TOTEABLE SETS?

# JFD\*

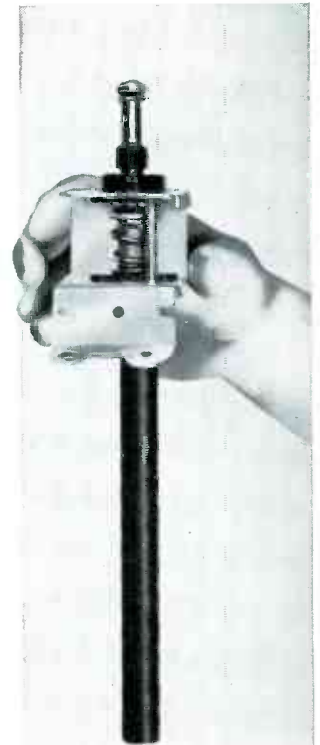
## OF COURSE!

Only when you buy a JFD Exact Replacement Antenna do you get the original unit that JFD supplies to manufacturers for their TV portable or "tote-able" sets. And when you install a JFD Exact Replacement Antenna you make a full profit on the sale and the installation—bring customers back to your shop because only you are equipped to replace a broken antenna.

Only \$11.95 puts you back in profitable indoor antenna business. That's all it costs for the No. PA500 JFD Exact Replacement Antenna Merchandising Kit that gets you started in this new multi-million dollar service market.

**Remember, next to receiving tubes, the antennas of portable and "tote-able" sets require the most frequent replacement.**

**See your JFD distributor today for your PA 500 kit and any and every antenna replacement need.**



Model TA370 List, \$6.25  
Exact Replacement for  
Admiral 1959-60 Portable  
TV Sets



Model TA360 List, \$7.65  
Exact Replacement for GE,  
Hoffman, Hotpoint & Emerson  
1957-8 Portable TV Sets

\*Beginning with set 467 in December, JFD Exact Replacement Antennas will be listed in SAMS PHOTOFAC T folders for your service reference.

Pioneers in electronics since 1929  
**JFD ELECTRONICS CORPORATION**

6101 Sixteenth Avenue Brooklyn 4, New York

**JFD CANADA LTD.**  
51 McCormack Street  
Toronto, Ontario, Canada

**JFD INTERNATIONAL**  
15 Moore Street  
New York, N.Y.

**PROTECTION  
where it counts!**

**AMPHENOL**  
**MARINE CORE**

## TWIN LEAD

Are you in a problem area? AMPHENOL's new Marine Core Twin Lead is winning new friends daily by solving reception problems all over America!

In salt-laden air along the coasts, in ultra fringe areas, in cities with heavy industrial contamination and in locations with heavy precipitation, Marine Core gives protection where it counts, consistently bringing in good pictures.

If you have reception problems try Marine Core—find out for yourself how really good it is!

Marine Core is available in 50, 75, 100 and 500 foot coils and in 1000 foot reels. Order by part number 214-103 from your Authorized AMPHENOL Distributor.

**AMPHENOL**

**DISTRIBUTOR DIVISION**  
BROADVIEW, ILLINOIS

Amphenol-Borg Electronics Corporation

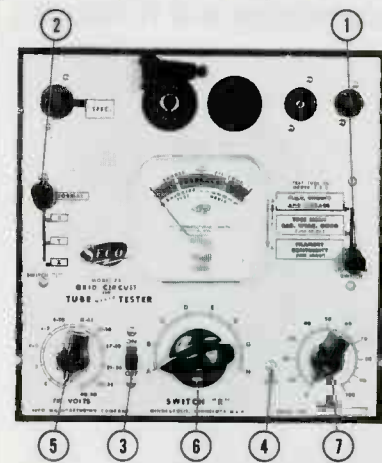


Fig. 5. Front panel of Model 78, numbered according to operational steps.

5-ma movement; heater selector provides voltages from 1 to 50 in 12 positions; pin straighteners, operating instructions, and set-up data located in detachable lid.

4. Size and Weight — 9" x 10½" x 5½"; 6 lbs.

Checking out one of these grid-circuit, tube-merit testers in the lab, I noticed it was very light in weight yet attractively styled in a fabric-covered case. The indicating meter sets in the center of a gold-anodized control panel with etched black lettering. Operating on a VTVM metering principle, the instrument features two DC-amplifier stages which isolate the tube under test from the measuring circuit and provide a wide range of test parameters.

In order to acquaint you with the Model 78, let's run through a typical tube test. A closeup of the unit's control panel is shown in Fig. 5; the various controls and switches are numbered so you can follow the procedure more closely.

Choosing a new 6BQ7A, I placed the function switch (1) in its center position and set switch "L" (2) in the position marked NORMAL. I then turned the instrument on with the small slide switch (3). While the unit warmed up, I located the setup information for the 6BQ7 and noted the location of the test tube socket to be used for this particular tube.

Using my fingernail in the screwdriver slot of the line adjust (4), I rocked the control until the meter pointer came to rest directly over the center line on the scale. I proceeded by switching the filament selector (5) to its "6-7" position, the large center knob (6) to position B, and the load control (7) to 40 on the 0 to 100 scale. I then plugged the tube in the proper test socket and flipped the function switch (1) to its lower position. This is a quick test for filament continuity, and the meter needle swung over to the green area on the right side of the scale.

Returning the function switch to its mid-position, the tube warmed up and the meter needle automatically indicated

the tube's merit by again swinging into the GOOD area. If cathode emission is low, the needle would have remained in the large red area of the scale marked REPLACE.

The next test step-checks the tube for shorts, leakage, and grid emission. Since a gassy tube will usually display symptoms of at least one of these defects, you might say that this is also a gas test. To complete the check, I merely flipped the function switch (1) to its top position and noted the meter reading. In this case, a satisfactory tube will register in the GOOD area on the extreme left side of the meter scale. During this test, the tube should be tapped gently to catch any intermittent shorts.

If a dual-purpose tube with two triode sections like the 6BQ7A passes the preceding tests, you then can check the other section (or sections) by following the additional instructions given in the setup data. In many instances, this will only require moving of switch (6) to another position. With the tester warmed up, I found that it actually took me less than 35 seconds to completely test a 6BQ7 in the Model 78. This also included the time spent in looking up the control settings listed in the charts.

Tube charts and operating instructions for the instrument are built into the detachable lid as shown in Fig. 6A. Under the loose-leaf charts, you'll also find the two pin straighteners shown in Fig. 6B, which are plastic units for both 7- and 9-pin miniature tube types.



Fig. 6. Features inside detachable lid of Seco grid-circuit and merit tester.

Choose ...

**XCELITE**

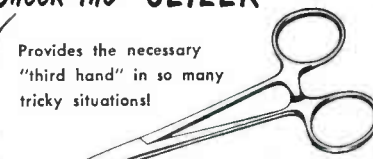
Hand Tools ... the Professionals do!

You need the BEST TOOLS to do the BEST JOB . . .

Your Radio, TV and Electronic  
Parts Distributor has them!

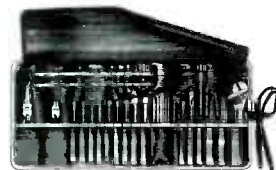
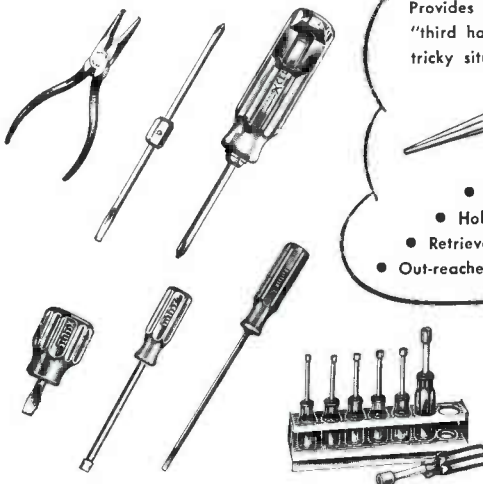
Check the "SEIZER" ✓

Provides the necessary  
"third hand" in so many  
tricky situations!



No. 42H

- Clamps on as a Heat Sink.
- Holds wires etc. while soldering.
- Holds dial cords when stringing them.
- Retrieves small items from awkward places.
- Out-reaches and out-holds needle nose pliers.



Select from the Complete Line of Quality Tools and Handy Kits . . .

**XCELITE, INCORPORATED**

ORCHARD PARK, NEW YORK

Canada: Charles W. Pointon, Ltd., Toronto

**XCELITE**

Quality Hand Tools

PREFERRED BY THE EXPERTS

"LESS WORK HOURS —  
MORE MONEY  
with E-Z-HOOK!"

Jed Motz  
Audio Engineer, Cincinnati, Ohio

"In my business of designing and building Hi-fi equipment, I've saved many hours of work using E-Z-Hook Test Connectors.

NO MORE SOLDERING or unsoldering wires when I use E-Z-Hook Sub Connectors to connect component parts in experimental setups and bread-boarding. They connect and disconnect so easily and I'm always sure of quick, positive connections.

WHEN CHECKING out circuits, I save lots more time, too, with E-Z-Hook Tips and Clips. Hooking up the Scope, Meters, Speakers, etc., with these self-holding connections, leaves my hands free. And, since they can't pull off, I don't have delays and aggravations caused by loose intermittent test connections that used to jump off and short. Believe me, the hours I saved put dollars in my pockets."

EXCLUSIVE  
E-Z-HOOK  
DESIGN!



EASY TO USE! GUARANTEED!

The self-adjusting stainless steel hook and nylon insulator clamps firmly in even hard-to-reach places. Eliminates loose intermittent connections and adjacent shorts.

AT YOUR FAVORITE PARTS DISTRIBUTOR  
From 49¢ up



ORDER THROUGH YOUR  
PARTS DISTRIBUTOR

E-Z-HOOK TEST PRODUCTS  
Dept. K 1536 Woodburn Ave.  
Covington, Ky.

Canadian Rep. Len Finkler Ltd., Toronto, Ont.

3¢ will start you  
on a new road to  
additional profits  
and happy customers  
with speaker repair.



Attach this coupon to  
a Post Card and mail.  
We will send you the  
complete story.

Your Name \_\_\_\_\_

Company \_\_\_\_\_

Street \_\_\_\_\_

City \_\_\_\_\_

Send to **WALDOM ELECTRONICS INC.**  
4625 WEST 53RD STREET, CHICAGO 32, ILL

## TV TUNERS REBUILT

All MAKES & MODELS

VHF  
or  
UHF



VHF or UHF  
TUNER  
OVERHAULED  
**\$9.95**  
NET

90 DAYS  
WARRANTY

COMBINATION  
UHF/VHF  
UNITS  
**\$19.90**

Fast Service, 48 hours on many types

Prices include labor and minor parts only, defective tubes and damaged major parts are extra at net prices.

Forward tuner complete with tubes, shield cover and any damaged parts. State fault.

QUOTE MAKE AND MODEL

F.O.B. CHICAGO OR TORONTO  
We will ship C.O.D.

### CASTLE TV TUNER SERVICE

5710 N. WESTERN  
CHICAGO 45, ILL.  
U.S.A.

136 MAIN ST.  
TORONTO 13  
CANADA



NEW!

## RESIST-O-PANEL

FREE! with any of 4 Handy-Pak  
Carbon Resistor Assortments

10 Values

**\$7<sup>20</sup>** to **\$14<sup>40</sup>** Dealer Net

Requires  
no bench  
space

Contains  
10 Handy-  
Paks with  
space for  
10 more

Wall  
Brackets  
Included



Order from  
your IRC  
Distributor

INTERNATIONAL RESISTANCE COMPANY  
DISTRIBUTOR SALES DIVISION  
414 N. 13th STREET • PHILADELPHIA 8, PA.

## Hi-Fi Troubleshooter

With the public more hi-fi minded today than ever before, the average serviceman is finding that he needs specialized test instruments to properly evaluate the operation of audio circuits in high fidelity and stereo apparatus. In answer to this growing demand, Winston Electronics of Miami, Florida, has recently developed the Hi-Fi Stereo Analyzer pictured in Fig. 7. The *Win-Tronix* Model 800 combines several test instruments into one compact and versatile unit for quickly analyzing all audio characteristics.

Specifications are:

1. *Power Requirements* — 110/120 volts, 60 cps; power consumption 35 watts; ON indicator provided on front panel.
2. *Audio Generator*—sine-wave output in 3 ranges from 20 cps to 25 kc; amplitude variable from 0 to 5 volts (rms), output monitored by built-in meter; output impedance approx. 300 ohms; output jack and separate attenuator provided on panel.
3. *Audio Wattmeter*—amplifier output power up to 30 watts monitored on internal meter; non-inductive loads of 4, 8, 16, and 600-ohms, plus high-impedance, with provisions for external loads up to 150 watts; meter ranges from 0 to .15, 1.5, 15, and 150 milliwatts, and from 0 to 1.5, 15, and 150 watts; db scale also provided on meter.
4. *Distortion Meter* — bridge-T network and built-in VTVM for measuring harmonic distortion with 400-cps test signal; modulation detector and VTVM for measuring intermodulation distortion with combination 60-cps and 3-kc signal mixed in ratio of 3 to 1; 4 meter ranges from 0 to 3%, 10%, 30%, 100% provided.
5. *Audio VTVM* — 10 rms ranges from 0 to .01, .03, .1, .3, 1, 3, 10, 30, 100 and 300 volts AC; 10 db ranges from -40 to +50, zero db equals -1 mw of audio power across 600 ohms; input impedance 1 megohm; frequency response 10 cps to 100 kc  $\pm 1$  db.
6. *Size and Weight*—13½" x 8½" x 7¼"; 11½ lbs.

If you've ever attempted any hi-fi servicing, you'll know it often takes more than just a few voltage and resistance measurements to pinpoint a deficiency even your own "TV-distorted" ears won't detect. When looking for a certain type of distortion, for example, you'll undoubtedly need an accurate audio generator, a VTVM, and an oscilloscope, but still you may not be able to test the unit properly.

Putting the Model 800 to work on a number of audio amplifiers in our lab, I was able to measure both input and output signal voltages or power as well as determine frequency response and the



Fig. 7. Win-Tronix Analyzer is combination of audio-system test instruments.

amount of harmonic and intermodulation distortion present. This is all accomplished by panel switching and the use of only two test cables. The front panel of the Analyzer is shown in Fig. 8; notice that all controls and switches are clearly labeled. The 200-ua meter has two scales at the top—one with a full-scale calibration of 3 and the other of 10. These are used in conjunction with various voltage, percentage, and power ranges of the instrument. The lower meter scales are for calibration purposes and db ranges.

Since many of you may be a little rusty on the fundamentals of harmonic and intermodulation distortion, I thought it worthwhile to define them briefly. Distortion in an audio system is actually a lack of fidelity caused when the frequency content (or shape) of an output signal differs from that of the input. Nonlinearity in one or more amplifier circuits results in such differences—called harmonic or intermodulation distortions.

Harmonic distortion occurs when harmonics of the input signal are produced during amplification and appear in the output. The Model 800 detects this type of distortion by applying a given test signal to the input of a system, trapping it out after amplification, and then measuring the remaining signal as a percentage of the total output. When I tested a number of high-quality amplifiers in the lab, the highest "HD" reading I obtained was .8% (in all cases, very close to the manufacturers' specifications). In general, harmonic distortions



Fig. 8. Front panel of Model 800.

of 1% or less will not produce noticeable trouble symptoms.

Intermodulation distortion occurs when two or more frequencies of an input signal beat together and produce sum and difference frequencies. These unwanted signals also produce amplitude distortion by adding to or subtracting from the normal level of the desired signal. However, this AM distortion will usually be negligible, especially if the amplifier has a low "HD" characteristic.

The Model 800 detects this form of distortion by applying two given test signals of different frequencies to the amplifier input. The signals are mixed, but in an amplitude ratio of about 3 to 1. Similar to the "HD" measurement, the instrument then filters out the original input signals after amplification and samples the remaining signal as a percentage of the total output.

From my experiments in the lab, I found the "IM" reading to average between 1 and 2%—less than the generally accepted maximum of 3 to 5%, but approximately equivalent to the manufacturers' specifications for the amplifiers tested. Conventional radio and television receivers, incidentally, may have a normal "IM" characteristic of as high as 30 to 40%.

In order to describe the basic circuitry of the *Win-Tronix Analyzer*, I prepared a block diagram (shown in Fig. 9). The sine-wave audio generator circuit employs both sections of a 12AT7 and one triode section of a 12AU7 to form a Wien-bridge audio oscillator. Frequency is controlled by a 3-position bandswitch and dual potentiometer. The output of the generator circuit consists of a cathode follower stage using one half of a 12AU7 and a calibrated output attenuator network.

Entering the instrument from the input jack, the signal under investigation is applied to an internal-external load circuit. From here, the signal may be fed to the meter circuit for direct power and voltage measurements or through a switch-in filter and detector network to measure distortion characteristics. The triode section of a 12AU7 makes up the distortion product detector, while the VTVM circuit employs both sections of a 12AT7. A 6X4 rectifier is featured in a well-filtered low-voltage supply which provides all operating voltages for the entire instrument. ▲

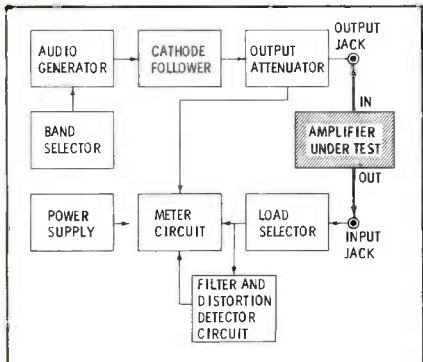


Fig. 9. Simplified diagram of the Model 800 Analyzer showing major sections.

# DOUBLE PROFITS

with these two ILLINOIS "HOT" LINES



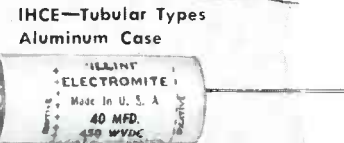
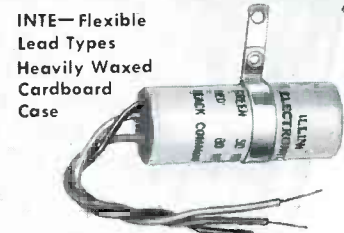
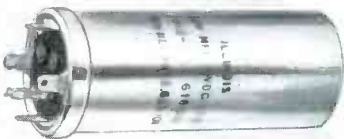
You really make extra profits with ILLINOIS UMP Twist Prong Capacitors which are especially designed for TV replacement. Each capacitor is fully guaranteed for one year . . . and is needed and in demand for replacement use NOW!

**UMP**

**ELECTROMITE**



Here are popular, fast moving capacitors which mean repeat business for you. They withstand extreme moisture and temperature conditions. Made of highest quality and unconditionally guaranteed for one year, these attractively-priced capacitors are packaged in eye-appealing boxes.



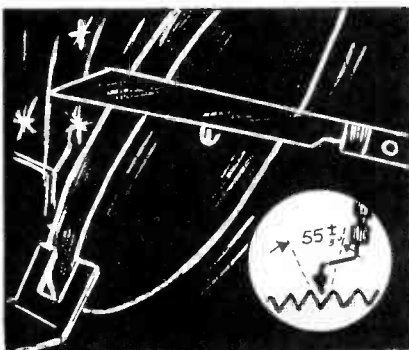
ILLINOIS "UMP" and "ELECTROMITE" Capacitors are available from leading electronic parts distributors.

Write for our complete catalog.

**ILLINOIS**

**CONDENSER COMPANY**  
1616 NORTH THROOP STREET  
CHICAGO 22, ILL. EV 4-1300

Export Department: 15 Moore Street, New York 4, New York



## AYE, THERE'S THE RUB . . .

It's become a classic . . . what hand polishing of the diamond radius in the Duotone Needle can do for hi-fi and stereo. Smooth to  $\pm .0001$  tolerance whereas ordinary needles produced by automation seldom do better than  $\pm .0007$ . Often the latter have no polish at all, leading to excessive record wear. Aye, but there's the rub! Other classic features in the Duotone Diamond Needle: 1. A guaranteed whole diamond (not a welded chip that can break off). 2.  $55^\circ (\pm 5)$  to the stylus angle every time (others varying to  $85^\circ$  often skip in the groove). 3. Quality controlled by 500 power microscopic inspection.

**DUOTONE**

DIAMOND NEEDLE

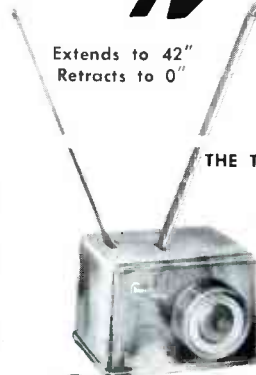
Keypart, New Jersey

In Canada: Chas. W. Pointon, Ltd., Toronto

**Channel King**

**INDOOR TV ANTENNA**

Extends to 42"  
Retracts to 0"



THE TRULY UNIQUE AND  
ADVANCED  
INDOOR ANTENNA

**HIGH  
PROFIT  
SALES**

- Ⓚ Hands NEVER touch Antenna arms
- Ⓚ SINGLE DIAL adjusts arms and signal
- Ⓚ FAST, positive wider range tuning
- Ⓚ UNBREAKABLE, flexible stainless steel arms
- Ⓚ COMPACT, attractive appearance

See your Distributor . . . Or write for Literature and Specification Sheets

✓ Attention Reprs. . . Some Choice Areas Open.

**MARJO TECHNICAL PRODUCTS COMPANY**

1152 E. Henry Street, Linden, N. J.



MODEL 12-C11

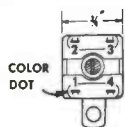
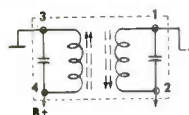
# new MILLER 455 kc IF transformer

— an exact replacement for  
G. E. RTL-143 and RTL-163  
— at your MILLER distributor

Here's the IF transformer used in a broad line of G.E. clock and table radios—available from any Miller distributor. It comes to you complete with schematic and base layout, to speed installation. List price: \$2.30

This unit is one of many miniature IF transformers designed for replacement in "personal" radio receivers. The line includes:

MODEL	ITEM
12-H1	262 KC Input I.F. Trans.
12-H2	262 KC Output I.F. Trans.
12-C1	455 KC Input I.F. Trans.
12-C2	455 KC Output I.F. Trans.
6203	4.5 Input or Interstage
6205	4.5 Ratio Detector



Write for the Miller general catalog, and the TV replacement guide, or get them at your distributor.

EXPORT REPRESENTATIVE:  
Roburn Agencies, Inc., N.Y. 13, N.Y.

CANADIAN REPRESENTATIVE:  
Atlas Radio Corp., Ltd., Toronto 10, Ont.

**J. W. MILLER COMPANY**

5917 S. Main St., Los Angeles 3, Calif.

## Color TV

(Continued from page 30)

across secondary of oscillator output transformer. If using scope, you should see waveform of type indicated in Fig. 3.

(5) Using scope, check signals in burst amplifier circuit. The output signal fed to the color sync circuits should look like Fig. 4; note that it consists almost entirely of 3.58-mc color-burst information obtained from the "back porch" of the horizontal sync pulses. Test points and waveforms on the input side of the burst amplifier vary considerably among different models of color sets, but the burst stage (or stages) *must* receive the following two signals in some form: Chroma information from video or band-pass amplifier; keying pulses from horizontal output transformer. In some sets, chroma and pulse signals are both applied to the control grid of the burst amplifier; thus, the resultant waveform will look somewhat like an AGC keying-pulse signal with a small amount of burst information superimposed on it.

(6) Scope-check for color burst signal (Fig. 4) reaching chroma-sync phase detector, and then use VTVM to check for DC bias output from this stage to grid of reactance tube. (To prevent throwing circuit out of color sync, measure voltage on other side of series resistor in grid circuit).

(7) Check input waveform to color killer—a keying-pulse signal from flyback transformer, usually positive in polarity and applied to



(A) Input to bandpass amplifier—mostly chrominance, some Y signal.



(B) Pure chrominance signal fed from bandpass amplifier to demodulators.



(C) Luminance or Y signal (composite video) at grid of video output tube.

Fig. 2. Color-bar signal waveforms.

## 900 ION TRAPS



## REPLACED IN TWO YEARS!

AMAZING? Yes! Especially when you consider they were all replaced through the efforts of just one shop — American Radio & Television Co. of Detroit.

RESULTS: Not only did they improve picture tube performance in 100% of their test cases, they took in \$7100.00 while doing it!

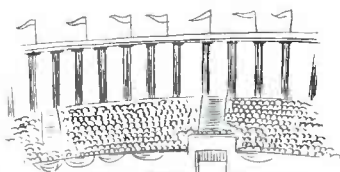
Are their customers happy? You bet they are, and yours will be, too, the day you begin stocking and selling ION, Berns' new beam bender.

Furthermore, with Berns' ION, there's no danger of cutting CRT necks, corner shadows are easy to eliminate, pictures are brighter, sharper.

Berns' ION installs easily, adjusts for perfect beam alignment. Front magnet sets rough adjustment, rear magnet used for final adjust. Gives precise magnetic strength for any CRT. You buy it for only \$1.95, sell for \$7.95 . . . you make \$6.00 profit.

See your distributor, or write to:

**BERNS** Mfg. Co.  
9853 Chalmers,  
Detroit 13, Mich



"I once took a JENSEN NEEDLE out of his paw."

plate of killer tube. Also measure DC voltage input from color sync or oscillator circuit, as well as DC voltage output from killer to band-pass amplifier or to color demodulators.

### II. Weak Color—Monochrome Pix & Sound Normal

#### Cause

Trouble area very broad, since defect may be in any circuit handling color signal. This includes entire signal path from antenna to CRT.

#### Procedure

(1) Disconnect antenna and apply output of color-bar generator (or rainbow generator) to receiver. If sufficient and proper color is not obtained, receiver is defective; proceed to step (3). Sufficient color indicates antenna trouble.

(2) Carefully check antenna lead-in for defects (short, open or improper impedance) or improper installation. Install a suitable broad-band antenna and new lead-in if the situation requires such action.

(3) Check all tubes handling chroma signal.

(4) Apply color-bar generator signal to receiver antenna terminals and signal-trace waveforms (using scope with proper probes) through receiver to point where amplitude of chroma falls off. Use VTVM for voltage and component checks to pinpoint trouble.

### III. Wrong Colors—Monochrome Pix & Sound Normal

#### Cause

Defect in chrominance-demodulator or subcarrier-oscillator sections.

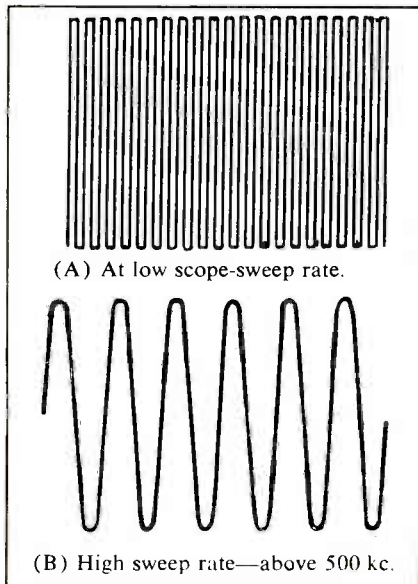
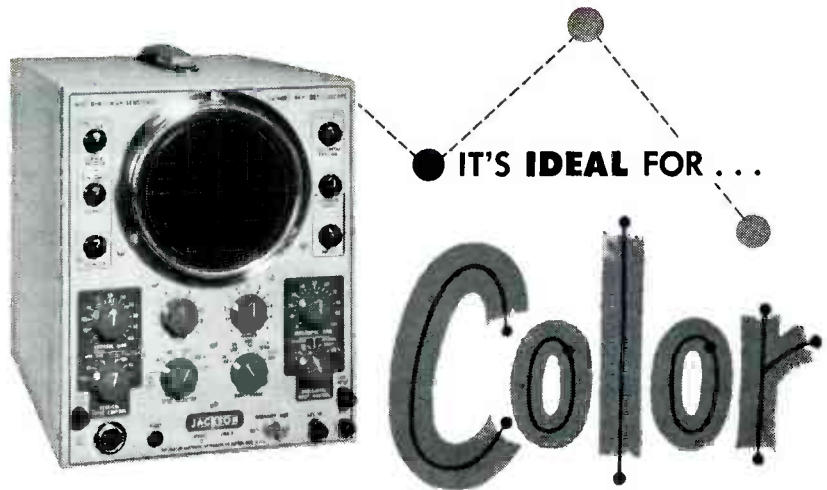


Fig. 3. Output of color oscillator.



## JACKSON CRO-2 FIVE-INCH OSCILLOSCOPE

And, this Jackson scope has been good for color even before color standards were approved. For Jackson "Service-Engineering" wisely provided many years ago this wide-band, high sensitivity oscilloscope to answer the need for a good television service instrument that would not become obsolete. Provided with probes the superb Jackson CRO-2 is the ideal service oscilloscope, used by servicemen and manufacturers. If you're thinking of buying a 'scope, check these features.

**Wide Band Amplifier**—Flat within 1 db from 20 cycles thru 4.5 MC. This feature is absolutely essential for evaluating color burst signal and Chrominance signal.

**Vertical Deflection Sensitivity**—Two ranges with three positions for each range. Has fully compensated attenuators. Excellent transient response. Each unit completely tested for "hilt" and "overshoot."

**Sensitivity Ranges**—With a band width of 20 cycles thru 100 KC, the sensitivity ranges are .018, .18, 1.8 RMS volts per inch. The wide band position 20 cycles thru 4.5 MC has sensitivity ranges of .25, 2.5, 25 RMS volts per inch.

**Internal Horizontal Sync.**—Positive or negative signal is available to provide excellent stability due to using the best available component of the waveform, such as the leading edge of the horizontal sync. pulse of the standard TV signal. Reversing pattern vertically will not interfere with sync.

**Horizontal Sweep Expansion**—Four times screen width—up to 20 inches of equivalent width. This feature is excellent for enlarging any small portion of the total waveform. For example, the color TV sync. pulse can be spread to easily observe the 3.58 MC color burst signal so that the individual cycles can be clearly viewed.

**Horizontal Deflection Sensitivity**—Push-

pull horizontal amplifiers have a sensitivity for all applications of 0.40 RMS volts per inch.

**Vertical Input Impedance**—1.5 megohms, shunted by 20 mmf. Direct to plates balanced 6 megohms, shunted by 11 mmf.

**Horizontal Input Impedance**—1.1 meg. **Linear Sweep Oscillator**—Saw tooth wave 20 cycles thru 50 KC per second in 5 steps. Sine wave sweep of 60 cycles also available. Provision for external sync.

**Input Calibration**—A standard voltage is provided to determine unknown voltages. Permits peak-to-peak measurements.

**Vertical Polarity Reversal**—By merely flipping a switch you can reverse the polarity of voltage to the vertical plates.

**Return Trace Blanking**—A new amplifier-timer combination for blanking return traces, providing a clearer, sharper image at all times. Prevents confusion in analysis.

**Synchronizing Input Control**—Four input control positions, Internal Positive—Internal Negative—External—60 cycle.

**Deflection Plate Connections**—Direct connections thru capacitors for AC only to deflection plates of CR tube by means of terminal block at back of instrument.

**Intensity Modulation**—Either 60 cycle internal intensity modulation or external intensity modulation through binding posts.

**Accessories**—Demodulation Probe, Model CR-P available for using scope as signal tracing instrument, Low Capacity Cathode Follower Probe, Model 10LCP with 2 to 1 attenuation ratio and not more than 8 mmf effective input capacitance. High Voltage Low Capacity Probe Model 3LCP with 10 to 1 attenuation ratio for use up to 1,000 volts.

Model CRO-2 Oscilloscope . . . \$225.00, net  
Model DEM-P Probe . . . . . \$ 9.95, net  
Model LC2-1P Probe . . . . . \$ 19.95, net  
Model LC10-P Probe . . . . . \$ 7.95, net



THE JACKSON ELECTRICAL  
INSTRUMENT COMPANY

"Service Engineered" Test Equipment

16-18 S. Patterson Boulevard, Dayton 2, Ohio • In Canada: The Canadian Marconi Company

#### Procedure

(1) Check hue control for proper setting and correct operation over its range.

(2) Make visual check for open filament in one picture-tube gun. If one filament appears unlit, measure total AC filament voltage and compare reading with published rating.

(3) Check tubes involved; weak subcarrier oscillator is a frequent source of this trouble.

(4) Check grid, cathode, and accelerating-anode voltages on color picture tube (accelerating anodes are pins 3, 7, and 11 on large-



Fig. 4. Separated color-burst signal at secondary of the burst transformer.

screen tubes).

(5) Check subcarrier-oscillator operation (See Symptom I, step 4). Make certain oscillator output is sufficient.

(6) Scope-check operation of chroma demodulators and amplifiers (see Fig. 5); measure DC voltages; check all transformers and chokes for opens or shorts.

#### IV. Color Blurred—No Monochrome Pix—Sound Normal Cause

Color picture tube is receiving chroma only; defect is in video detector or amplifiers (Y channel).

#### Procedure

(1) Check video detector and amplifier tubes.

(2) Scope-trace luminance (Y) signal from video detector through video amplifier(s) and delay line to cathode of picture tube. This signal is ordinary composite video (Fig. 2C).

#### V. No Color Sync—Monochrome Pix & Sound Normal Cause

Defect in chroma-sync phase detector, subcarrier oscillator, or reactance tube.

#### Procedure

(1) Check tubes in circuits involved.

(2) Short reactance-tube grid to ground; if symptom is unaffected, trouble is in reactance-tube or subcarrier-oscillator sections. If color shift slows down or is otherwise altered, defect is in phase detector; proceed to step (4).

(3) Check subcarrier-oscillator operation (See Symptom I, step 4). Check DC voltages in reactance-tube and subcarrier-oscillator circuits.

(4) Scope-check for sync burst on phase-detector diodes and 3.58-mc signal supplied from subcarrier oscillator. Check DC voltages in phase-detector circuit (sometimes called phase discriminator).

#### VI. Pix Bloomed—Sound Normal Cause

A defect in the low-voltage rectifiers, video amplifiers, color demodulators, color amplifiers, or horizontal output section has caused a drop in high voltage or a shift in bias voltages on the picture tube.

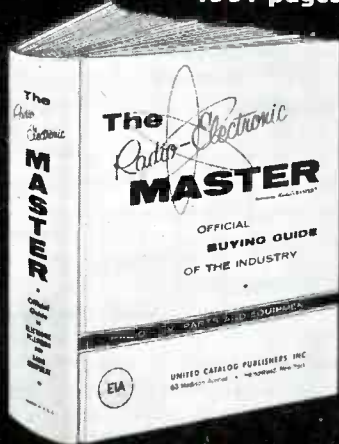
#### Procedure

(1) Check (by substitution) all tubes involved.

(2) Check high voltage and bias voltages on grids and cathodes of picture tube. Readjust high voltage as directed in service instructions if incorrect. Determine cause for discrepancies in bias voltages.

(3) Check DC voltages in color demodulators, video amplifiers, and other circuits involved; follow through on any discrepancies, no matter how insignificant they may seem to be.

1551 pages



World's **LARGEST** Electronic Catalog

**\$3.50**  
at parts distributors  
\$4.50 in Canada

# 1960 RADIO-ELECTRONIC MASTER

now available at your distributor

NEW...STREAMLINED...28 EASY-TO-USE PRODUCT SECTIONS COVER ALL LATEST PRODUCTS

*Printed Circuit Components • Stereo equipment • Color TV service instruments • miniature and sub-miniature components • Automatic test equipment • Remote control radio equipment • Silicon rectifiers • New transistor types .... Plus every new product for servicing, experimenting, design, industrial and military applications.*

**FASTER...EASIER...MORE PROFITABLE SERVICE OPERATION**

Covers all items necessary for radio-TV-audio servicing. Offers thousands of products for extra income in hi-fi, sound and industrial servicing. Buy, sell and bill direct from The MASTER...it shows list prices!



*No matter what product or component you require...*

**YOU'LL FIND IT FASTER IN THE**

# 1960 MASTER

RADIO ELECTRONIC MASTER, 55 Sewell St., Hempstead, N.Y.

**FREE...FROM YOUR DISTRIBUTOR**

24-page Foreign Tube Interchangeability Guide or write direct enclosing 25¢ for handling



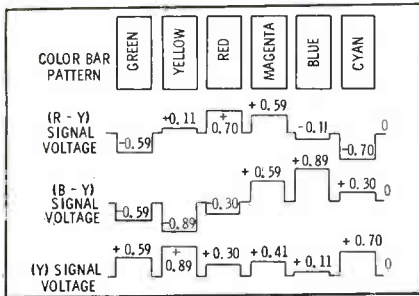


Fig. 5. Signal-voltage levels corresponding to bars in NTSC color pattern.

### VII. Intermittent Misconvergence or Blooming

#### Cause

High voltage unstable due to line-voltage fluctuation or low line voltage, misadjustment, or a defect in low-voltage rectifiers, high-voltage rectifiers, high-voltage regulator, or horizontal sweep section.

#### Procedure

(1) Check line voltage; install line-voltage regulator if required. (For some installations, this is desirable even if not absolutely necessary.)

(2) Temporarily replace all tubes involved, substituting one at a time until intermittent condition is remedied.

(3) Check high-voltage connectors for proper contact. Clean out any dust that may have accumulated in the high-voltage cage. Check for a dirty or intermittent high-voltage adjustment by rotating control over its range while observing meter indication; if meter jumps or swings sharply, control may be defective.

(4) Readjust horizontal sweep section according to service instructions.

(5) Measure and/or monitor DC voltages in stages involved.

### VIII. Color Purity Poor—Operation Otherwise Normal

#### Cause

Picture tube or mounting hardware magnetized, or purity-control devices misadjusted.

#### Procedure

(1) Check position (adjustment) of color purity magnet (or coil), field equalizing magnet (or coil), and position of yoke.

(2) Degauss picture tube and mounting hardware; readjust purity, following service instructions.

### IX. Convergence Poor—Operation Otherwise Normal

#### Cause

Poor high-voltage regulation, incorrectly adjusted or defective static or dynamic convergence controls or circuits; misadjusted blue beam lat-

eral control, or picture tube itself not capable of being acceptably converged (rare, but does occur occasionally).

#### Procedure

(1) Check convergence amplifier tubes, if used.

(2) Check high voltage for proper adjustment and regulation; check convergence assembly for proper placement on picture tube neck.

(3) Adjust horizontal linearity, vertical size, and vertical linearity controls for correct picture height and width. Perform static and

dynamic convergence adjustments as outlined in service instructions.

(4) Scope-check waveforms in convergence circuits for conformity to waveshaps in the service data.

(5) Check convergence coils and controls for shorts or opens.

Always keep in mind that the first step in troubleshooting color circuits, or any other circuits for that matter, is to test the tubes—preferably by substitution. It is surprisingly how often this uncovers an obscure fault that would otherwise consume a considerable amount of servicing time. ▲

## Transistor Radio Servicing CAN be Highly Profitable



The ONLY Complete Transistor Radio Service Lab  
Everything you need for less than \$50

### Check Transistors, Diodes, Rectifiers . . .



#### SCENCORE TRC4 TRANSISTOR CHECKER

Accurately checks all transistors in hearing aids, radios and power transistors in auto radios. Tests for opens, shorts, leakage, current gain. Measures forward-reverse current ratio on all crystal diodes. Measures forward and reverse currents on selenium rectifiers. With set-up chart for accurate checking of each transistor. Size, 5x4½x2½". With batteries. DEALER NET. . . . . 17<sup>95</sup>



### Replace Batteries During Repair . . .



#### SCENCORE PS103 BATTERY ELIMINATOR

All-new "Transi-Pak," twin to TRC4 Checker above. Provides variable DC voltage to 24 volts; 1.5-volt biasing tap (a "must" for servicing Philco and Sylvania radios). Metered current output, to 100 ma. Handles 200-ma peaks. Two 200-mfd electrolytics provide proper filtering and low output impedance. No hum or feedback problems. Ideal for alignment using station signal; adjust IF slugs for max. current, also ideal for charging nickel-cadmium batteries. Size, 5x4½x2½". 17<sup>95</sup> DEALER NET. . . . .



### Find Defective Stage in a Minute . . .



#### SCENCORE HG104 HARMONIC GENERATOR

New signal generator designed primarily for fast signal-tracing of transistor radio circuits. No need to unsolder all transistors. Provides RF, IF and audio signals *simultaneously*, drastically cutting service time. Traces from speaker to antenna. Clear 1000 cycle note signal is heard in speaker from all good stages. Signal weakens or stops at defective stage. Equally as effective for testing TV, hi-fi and other audio circuits also. Size, 3½x4½x1¾". 9<sup>95</sup> With batteries. DEALER NET. . . . .



Turn page for other



Time Savers

See your Parts  
Distributor  
NOW!

# SCENCORE

ADDISON 2, ILLINOIS

## Citizens Band

(Continued from page 37)

Citizens band radio equipment.

The person filing need not prove that such a service is necessary to his business. It may, in fact, be used for purely personal matters not related to business. However, this does *not* mean that Citizens radio may be used for "DXing," casual visiting, and other activities more properly confined to the amateur bands. (Note: Excessive "on-the-air" testing of transmitters is also frowned upon; this is becoming quite a problem in CB service.) The

Class D Citizens band, in particular, has become so crowded in some areas that it is essential to keep communications brief and to the point. A time-saving *voice code*, widely used in radiotelephone work, is outlined in Table III.

The minimum age of 18 does not necessarily apply to every operator of every station in a group licensed as a "system." The prime requirement is that the operation of every station in a particular system be under control of the licensee. This means, among other things, that the licensee must make certain the sta-

tions in his system are not operated for illegal purposes, or in any manner contrary to law. A summary of the highlights of FCC rules for Class D is given below.

- Obtain and study FCC Rules — Part 19 (Rules Governing Citizens Radio Service).
- File for station license on Form 505 available from the FCC or through supplier of Citizens band equipment. No examination is required.
- Any citizen of the United States over 18 years of age may apply for a station license. Persons under 18 years of age may use a station under supervision of licensee.
- No restrictions on use of equipment except where contrary to existent Federal, state or municipal laws. May be operated for business or personal use.
- Conelrad regulations apply.
- Protection from interference is not guaranteed by FCC.
- Station log is not required.
- Transmit station call sign every 10 minutes while transmitter is in use.
- Communications for hire not allowed.
- Greatest antenna height is 20' above ground, or above structure (such as a building) on which antenna is mounted.
- The FCC license given you can be revoked.
- Prior to November 15, 1959, all transmitter adjustments or tests requiring radiation of energy and affecting proper operation of any station had to be made by (or under immediate supervision and responsibility of) a person holding a first- or second-class commercial radiotelephone operator's license. Effective this date, Part 19 of FCC Rules was amended to state that a person adjusting Class C or D transmitters need not have such a license, *provided that all of the following conditions are met:*

- (1) Operating frequency of equipment must be controlled by a crystal capable of maintaining frequency within the specified limits.
- (2) Transmitter must be factory-assembled or else built from a kit containing all necessary components and complete instructions for assembly.
- (3) Frequency-determining circuits must be preassembled, pretuned to a suitable frequency, and sealed at the factory. If the seal is broken, certification by the manufacturer (see point 5) is voided.
- (4) Design of the transmitter must be such that normal tests and adjustments

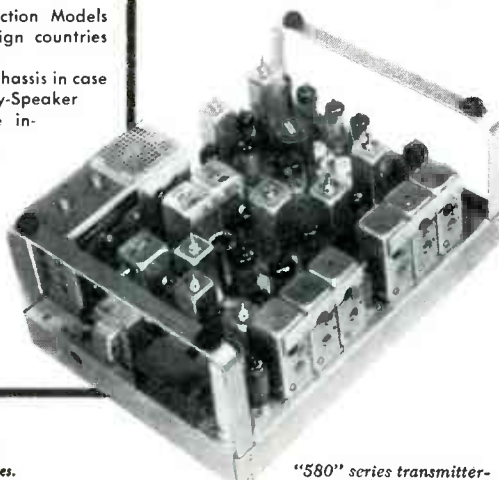
## DESIGNED FOR THE NEW BUSINESS RADIO SERVICE

### COMCO'S ALL NEW "580 FLEETCOM" VHF-FM MOBILE RADIO



The new "580" is compact, light weight, has high performance, and features an original concept in Mobile equipment packaging by combining the control head, speaker, and transistorized power supply in one small easily mounted case assembly.

**\$398** f.o.b. factory



"580" series transmitter-receiver chassis.

### FEATURES

- ★ HIGH PERFORMANCE... meets "split channel" technical requirements, all FCC and FCDA requirements.
- ★ FULL POWER OUTPUT... 35 Watts in 25-50 Mcs. 25 Watts in 144-174 Mcs.
- ★ BUILT-IN RELIABILITY... Preproduction Models field tested in 5 states and 3 foreign countries before starting production.
- ★ SMALL AND LIGHT WEIGHT... Chassis in case 13"x9<sup>3</sup>/<sub>16</sub>"x5<sup>1</sup>/<sub>2</sub>". Control-power Supply-Speaker case 5"x5"x3<sup>3</sup>/<sub>16</sub>". Complete Mobile installations 24 lbs.
- ★ EASY TO INSTALL... "Two-unit" package so small most installations are under dash.
- ★ EFFICIENT... Transistor power supply gives high efficiency. Total standby drain 5.25 amp.
- ★ INTERCHANGEABLE CHASSIS... Mobile transmitter-receiver chassis instantly interchangeable with base stations in simplex systems.

**ATTENTION DEALERS!**  
Write for available territories.

DESIGNERS AND MANUFACTURERS OF RADIO COMMUNICATIONS EQUIPMENT

## COMMUNICATIONS COMPANY, Inc.

FOUNDED 1938 CORAL GABLES, MIAMI 34, FLORIDA

### Table III—Radiotelephone Code

10-1	Receiving Poorly
10-2	Receiving Well (signal strength if requested)
10-3	Stop transmitting (off freq., overmod., etc.)
10-4	OK
10-5	Relay message
10-6	Busy
10-7	Out of service - leaving the air
10-8	In service, subject to call
10-9	Repeat; reception bad
10-10	Transmission completed, subject to call
10-11	Talking too rapidly
10-12	Officials or visitors present
10-13	Advise weather and road conditions
10-20	What is your location
10-21	Call -- station by telephone
10-23	Standby
10-24	Trouble at station
10-25	Do you have contact with --
10-30	Does not conform to rules and regulations
10-33	Emergency traffic at this station
10-35	Confidential information
10-36	Correct time
10-41	Tune to channel for test, operation or emergency service
10-60	What is next message number
10-62	Unable to copy phone, use CW
10-63	Net directed
10-64	Net clear
10-65	Clear for message
10-68	Repeat message
10-70	Net message
10-71	Proceed with transmission in sequence
10-84	What is your telephone number
10-92	Your quality is poor, transmitter apparently out of adjustment
10-93	Frequencies to be checked
10-94	Test intermittently with normal modulation for --
10-95	Test with no modulation
10-99	Unable to receive your signal

on the unit will not be expected to result in off-frequency operation, over-modulation, excessive harmonic radiation, etc.

(5) Manufacturer of the transmitter shall certify to purchasers that the unit complies with above requirements.

The intention of this amendment is to liberalize operating rules, while at the same time attacking the growing problem of incorrect operation of equipment by Citizens band users.

You can obtain the rules for the CB radio service by mail from the Superintendent of Documents, U.S. Government Printing Office, Washington 25, D.C. It is necessary that you read and know the rules *before* you apply for a station license. Fill in Form 505 with care, have it notarized and mail it to the Federal Communications Commission, Citizens Radio License Section, Washington 25, D. C. When your license is returned, you are ready to go on the air. The time required depends upon the FCC's backlog of pending applications.

### How Far Will Class D Units Transmit?

This is usually the first question asked by a prospective owner of CB radio. The answer is. "It depends."

The FCC limits Class D transmitters to a final-stage input power of 5 watts, and the distance over which reliable communications can be expected with this amount of power will vary greatly. The useful range depends on terrain and the amount of interference present, plus antenna design and loading. Other nearby stations, besides the one you are contacting, may be operating on the same channel; in this case, you should wait until the

other party is through with his conversation before attempting to use the channel. The Citizens band is like a telephone party line with many subscribers, and the same courtesy should prevail as for successful multi-party phone operation.

Class D channels are closely spaced; therefore, it is possible for transmitters on adjacent channels to cause some interference. This is particularly true if such transmitters are nearby and the station being contacted is located some distance away from you. The amount of adjacent-channel interference will

depend, in part, upon the selectivity of the receiver.

Where interference is not a factor, local-area or "ground-wave" range will vary from 1 to 30 miles. Signals at 27 mc tend to bend around obstructions somewhat more than FM or TV waves, and considerably more than the UHF signals used by the older 450-mc Class A or B Citizens band. Nevertheless, they do tend to follow a straight line-of-sight path to a considerable degree. Because of this, certain terrain obstructions will act to reduce signal strength. In car-to-car opera-

## Servicemen! SAVE TIME...SUBSTITUTE THE SENCORE WAY

The Fastest, Surest Method Known!

### Substitute for Capacitors, Resistors

#### SENCORE H-36—THE "HANDY 36"

36 most-often-needed resistors and capacitors, for fast, easy, direct substitution in all circuits. • Eliminates searching for replacement components for test purposes. • Avoids unnecessary unsoldering and soldering—no more solder mess. • Pays for itself the first month in time saved. • Flick of a switch instantly selects any one of . . .

24 RESISTORS from 10 ohms to 5.6 megohms  
10 CAPACITORS from 100 mmfd to .5 mfd  
2 ELECTROLYTICS, 10 mfd and 40 mfd  
DEALER NET. . . . . 1275

### Substitute for Electrolytic Capacitors

#### SENCORE ES102 ELECTRO-SUB

Usable from 2 to 450 volts, D.C.

Contains 10 electrolytics from 4 to 350 mfd. Select the correct value with the flick of a switch. Features automatic discharge, surge protector circuit. Prevents accidental "healing" of capacitor being bridged. Completely safe—no arc or spark when connecting or disconnecting. DEALER NET. . . . . 1595

### Substitute for Fuse Resistors During Repair

#### SENCORE FS3 "FUSE-SAFE" CIRCUIT TESTER

Instantly tells you whether or not it is safe to replace fuse resistors, fuses, or circuit breakers. Separate red and green scale for each commercially available fuse resistor used in radio and TV. Eliminates guesswork and wasted time. Also handy for wattage checks up to 1100 watts. DEALER NET. . . . . 895

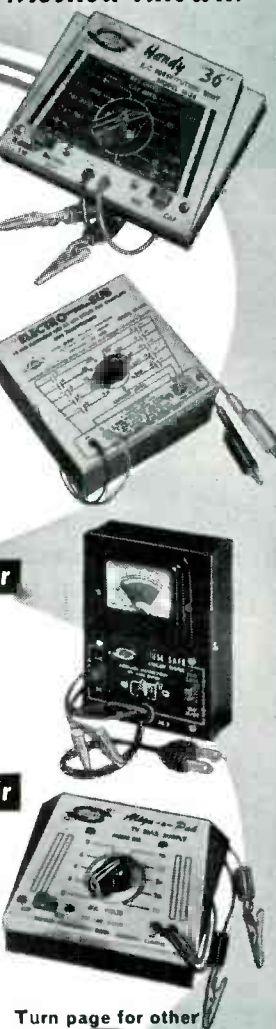
### Substitute for Bias Batteries During Repair

#### SENCORE BE3 "ALIGN-O-PAK"

Completely isolated DC supply, with less than 0.1% ripple. Eliminates messy batteries in TV service work. Handy for alignment, AGC trouble-shooting, or checking gated sync circuits. Just dial the voltage you need, 0-18 volts, positive or negative. Covers all voltages recommended by TV set manufacturers. Size, 3½x4½x1¾". For 110-120 volts, 60 cycle AC. DEALER NET. . . . . 785

### UNIVERSAL TV JUMPER CORD

Fits any set from back to chassis. Box has male and female plugs for additional power source, soldering, etc. DEALER NET 195



Turn page for other



### Have a New Mailing Address?

If so, notify us by the 15th of the month to assure uninterrupted delivery of PF REPORTER.

Please be sure to give us both your old and new address, including your postal zone number. (Or better yet, enclose a current mailing label with your new address.) Send to:

### PF REPORTER

Circulation Dept.  
2201 E. 46th Street  
Indianapolis 6, Ind.

See your Parts Distributor Now!

# SENCORE

ADDISON 2, ILLINOIS

tion, range may be as short as one mile under very unfavorable conditions. (These might be encountered when traveling in a deep canyon or on opposite sides of a steep hill.) On the other hand, two cars situated on hilltops may be able to communicate quite easily over distances of 30 miles or more.

The reliable range from a base station to a car in flat or gently rolling country is about two miles, when the base-station antenna is located on top of a one-story residential building. If the base station antenna is located on a hill, the re-

liable range over the same type of terrain will be increased to perhaps 7 or 8 miles. Over-water range (boat-to-boat or boat-to-shore) extends from 10 to 15 miles or more, if good antennas are used and there are no intervening land obstructions. Again, this depends upon the interference.

These 27-mc signals will occasionally be reflected back to earth from ionospheric layers in the atmosphere, so moderately strong signals may be received over distances of several hundred to several thousand miles. Such sky-wave signals

will tend to interfere with weak local signals and may reduce the effective range for local communication to less than the expected distances.

When the sky-wave reflections are from the F layers of the ionosphere, stations can be received with good strength at almost any distance beyond about 1200 miles. This condition usually occurs in the winter during the early-morning or late-afternoon hours, but it may also appear at other times and seasons. Such interference is more prevalent during years in which sunspot activity is greatest.

When the ionospheric reflections are of the sporadic-E type, the interfering signals will usually be confined to stations about 700 to 1500 miles away. The sporadic-E reflections occur at any time, but are not as frequent as the F-layer type of ionospheric activity.

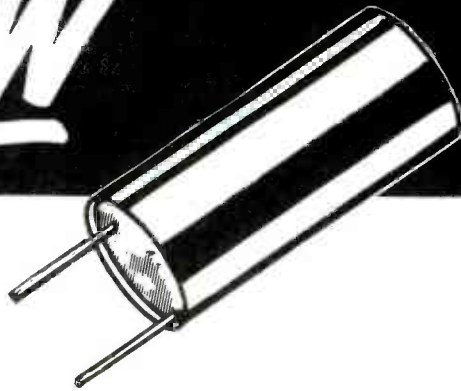
Class D equipment meeting the requirements of the FCC will not interfere with AM broadcast radio, but there may be slight interference to weak stations located at the high end of the FM broadcast band—if the FM receiver is close to the Class D transmitting antenna. Moving the antennas farther apart will usually eliminate this type of interference.

Class D Citizens band transmitters will not normally interfere with television reception, although it is possible that a slight amount of interference may exist on Channels 2 and 5 when the transmitting antenna and the television receiving antenna are located close together, and the received television signal is weak.

#### Range of Class B

The reception of the UHF signals employed in Class B service is usually limited to "line-of-sight" paths between transmitter and receiver, but experience has shown that signals often bounce from obstacles and fill in an otherwise dead spot. In most situations where an unobstructed line of sight can be drawn between two well-elevated antennas, reliable communication will be possible over considerable distances. However, any large hill or building astride the signal path will severely cut down the signal strength, ex-

# NEW



Type "SA" . . . small single section electrolytics for printed circuit boards . . . hermetically sealed in aluminum tubes covered with red kraftboard insulating jackets . . . extra heavy tinned terminals anchored for proper spacing by a high melting point wax . . . for 85°C operation . . . individually packaged. Recommended for TV, radio and industrial applications .

~  
"ENGINEERED FOR QUALITY"

GUARANTEED FOR ONE YEAR

~  
See Your Parts Distributor

**PLANET SALES CORPORATION**  
225 Belleville Avenue  
Bloomfield, N. J.

actly as the beam of a searchlight would be diffused or cut off by a similar obstruction. At close range (within a half mile or so), satisfactory communication can often be obtained despite blocking by building walls, contours in the land, and other objects.

As in the case of light rays, certain materials are "opaque" (act as practically complete shields) to UHF, while others allow the rays to pass with only moderate weakening. The materials which are good conductors of electricity will have the greatest screening effect. For example, metal (in the walls of a building), masses of earth, dense wet foliage, or window screens will cut down the signal much more severely than will dry wooden walls or window glass.

A quarter-wave "stick" antenna mounted directly on top of a Class B transceiver is sufficient for normal short-distance communication; however, to obtain maximum range, it is of utmost importance that antennas be mounted in as high and as clear a location as possible. A mast-mounted antenna like that shown in Fig. 1 may be used.

When operating over great distances or in unfavorable locations, the Class B operator will find that a very small change in antenna position may improve reception considerably, because of the influence exerted on the signal by reflections from nearby objects.

Greater range on the 465-mc band is possible by remote operation of the transmitter. This is de-

signed to eliminate the signal losses incurred by operating with a long lead between transceiver and antenna. A remote transceiver with built-in antenna can be placed up to 500' from the operator's control unit. This allows the transceiver to be mounted as high as possible for maximum performance, while still allowing the control unit to be situated in the most convenient location.

### Summary

The range of applications for

Citizens radio appears to be limited only by its short-distance transmission characteristics and the restrictions in number of channels available. As this radio service becomes more popular (and thus more congested), efficient and competent CB operation will become increasingly more important. With the information in this article, you are potentially well equipped to advise CB users on ways of getting maximum service out of their radio gear, as well as to make best use of it yourself. ▲

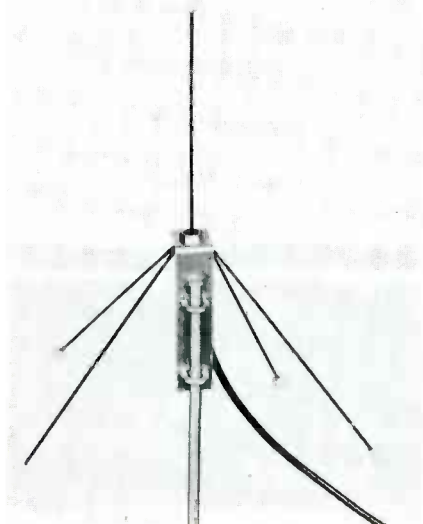


Fig. 1. Mast-mounted ground-plane antenna for Class B Citizens radio.

# Check TUBES, VIBRATORS THE SENCORE WAY

**FAST ACCURATE TROUBLE SHOOTING**



**America's Most Popular Tube Tester**  
more than 25,000 now in use

**SENCORE LC3 LEAKAGE CHECKER**

Whips those "tough dog" tube troubles . . .

Ask any serviceman who owns one . . . or try one for just one day of servicing in your shop. You'll see for yourself how much time the LC3 can save you. Checks for leakage between all elements, whether caused by gas, grid emission or foreign particles. Also checks leakage on all capacitors with voltage applied—including electrolytics. Provides instant filament checks in "Fil-Check" position—no need for a second filament checker. One spare pre-heating socket and new roll chart prevent obsolescence. New charts provided—no charge. Leakage sensitivity, 100 megohms, control grid to all other elements; 50,000 ohms, heater to cathode. Size, 7x6x3½". Wt., 3 lbs. For 110-120 volts, 60 cycle AC. DEALER NET **28<sup>95</sup>**



**NOW . . . checks 172 tube types—more than any other checker of this type.**

**NEW . . . replaceable Roll Chart prevents obsolescence.**

---

**Check Filaments of All Receiving Tubes and Picture Tubes**



**FC4 FILAMENT CHECKER**

For fast, easy checking of all tube filaments, without pulling chassis. Neon light goes out if tube filament is good. Also acts as continuity and voltage tester. Neon lamp glows when 115 v. AC is applied by cheater cord, providing a check on power to TV set. Size, 3¼x4x1". **29<sup>5</sup>** With leads. DEALER NET . . . . .

**Check 3- and 4-Prong Vibrators . . . Faster, Easier**



**VB2 "VIBRA-DAPTOR"**

Plugs into any tube checker; ideal for use with LC3 above. To check 6-v. vibrators, set for 6AX4 or 6SN7; for 12-v. vibrators, set for 12AX4 or 12SN7. Two No. 51 lamps indicate whether vibrator needs replacing. Instructions on front panel. Steel case. Size, 1½x1½x3" **27<sup>5</sup>** DEALER NET . . . . .

**See your Parts Distributor NOW!**

Turn page for other



Time Savers

# SENCORE

ADDISON 2, ILLINOIS

## "Tough Dog"

(Continued from page 28)  
start of a new raster field; and, finally, more horizontal sync pulses (with video information below them) as the CRT beam begins another journey from top to bottom of the screen.

The height of the wide-open area beneath the vertical blanking pedestal represents 75% of the total signal amplitude, since the pedestal's position (black reference level) equals the 75% modulation level of the transmitted signal. Fig. 2, a more conventional view of the composite video signal for an entire

frame, reveals that the horizontal sync pulses also have blanking pedestals at the 75% level. These signal elements produced too faint a trace on the scope to be seen in Fig. 1; however, when crowded together as in Fig. 2, they produce a hazy line that interconnects the vertical blanking pedestals.

Details of a horizontal sync pulse are shown in Fig. 3. The wide portion, reaching up to the 75% level, is the blanking pedestal, while the narrower peak rising above this level is the sync pulse proper. A small spike, the color stripe signal, sits on the "back porch" of the

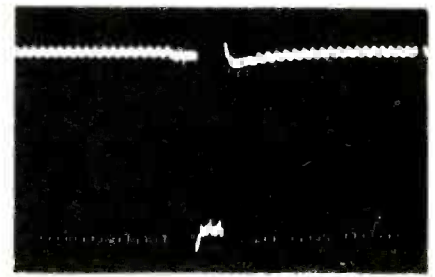


Fig. 5. Expanded view of vertical pulse at plate of sync-separator stage.

horizontal pulses. Included in the background is a hazy line traced by the vertical blanking pedestal, equalizing pulses, and serrated vertical sync pulses.

### Retrieve Them

It is the sync circuits' job to separate these pulses from the composite video signal, amplify them if necessary, and distribute them to their respective sweep circuits. Reviewing basic theory, we remember that sync pulse tips represent 100% modulation of the video carrier, or the maximum amplitude of the composite signal. Furthermore, the blanking level — the sync pulse "floor"—is fixed at 75% of maximum signal amplitude. Therefore, all that needs to be done to separate the sync pulses is to bias an amplifier stage so heavily that only the upper one-fourth of the signal is sufficiently positive to cause tube conduction. The only thing complicating this procedure is the variation of incoming signal amplitude from scene to scene and channel to channel. This problem is overcome by having the signal itself establish the bias amplitude through a grid-leak bias network. (In Fig. 4, a schematic of a typical sync section including two triode stages, the grid-leak components are C22 and R27.)

Proper bias level of a sync-separator stage is easily checked. Although service literature cannot possibly provide accurate voltages

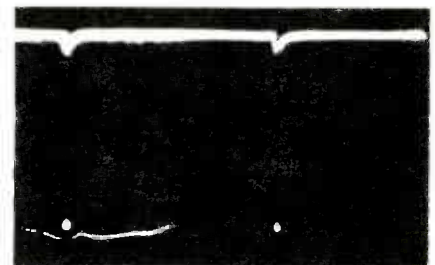


Fig. 6. Plate waveform of typical sync separator at sweep rate of 30 cps.

**DO YOURSELF A FAVOR...**  
*Cut your paper work in  $\frac{1}{2}$ !...*

**No. 125**  
5 7/8" x 9 3/4"  
\$3.25 per  
100 sets

**No. 120**  
4" x 8"  
\$2.95 per  
100 sets

**WINDSOR RADIO & TV SERVICE**  
4308 MILWAUKEE CHICAGO 41, ILL.  
N<sup>o</sup> 362

with modern one time carbon

## OELRICH SERVICE FORMS

• Triplicate set with hard third copy.

• Each with customer claim check section.

• Available unnumbered or numbered consecutively.

• Blank imprint for use with rubber stamp or with your 4 line imprint on special order.

The #120 and #125 Service Forms can do wonders for you to simplify and improve your billing and handling of service calls and shop jobs. The forms are impressive, expertly designed and are in use in thousands of shops throughout the U.S.A. They are carried in stock by parts distributors in every major city in all 50 states. You can buy them in any quantity from 100 up with blank heading for use with your rubber stamp or they are available with your imprint on special order on a 10 day delivery schedule at a slightly higher price. Get started now with the Service Forms that mark you as a real professional.

take advantage of the special offer below:

**Try before you buy!...**

**SEND 50c FOR TRIAL SUPPLY**  
Offer good only with this coupon

Oelrich Publications • 4308 Milwaukee • Chicago 41, Ill.  
Please send trial supply of 20:  No. 120 Service Forms. 50c enc.  
 No. 125 Service Forms. 50c enc.  
Also send FREE catalog and name of distributor in my area.

NAME \_\_\_\_\_  
ADDRESS \_\_\_\_\_  
CITY \_\_\_\_\_ ZONE \_\_\_\_\_ STATE \_\_\_\_\_

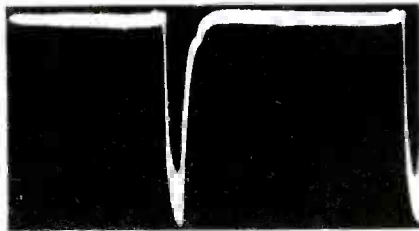


Fig. 7. Same waveform as in Fig. 6, with scope sweep reset to 7875 cps.

or waveform amplitudes for all conditions, the following rule of thumb generally holds true: When we measure the peak-to-peak amplitude of the blanking pedestal, or take three-fourths of the full peak-to-peak amplitude of the sync-input signal, we then know (within approximately  $\pm 10\%$ ) the value of DC bias voltage which should exist between grid and cathode when that signal is applied to the sync-separator grid. If some discrepancy is noted, we can immediately check the components involved in producing the bias—that is, the tube itself, the coupling capacitor, and the grid-leak resistor. Any malfunction in establishing the bias level will cause either a lowering of pulse amplitude, or the appearance of video information, in the signal at the plate. In either case, sync troubles are on the way.

Fig. 5 shows the details of the separated pulses, examined at the plate of the sync separator under the same conditions as for Fig. 1. The vertical and horizontal pulses are also shown in Figs. 6 and 7, respectively, as we normally view them. Notice that perfect separation has taken place, with the sync pulses amplified, inverted, and uncontaminated by video information.

### See That Hum

Going back to our original analogy—using the scope in troubleshooting sync as we would use our ears in audio—let us assume that 60-cps hum modulation exists in the signal as a result of heater-

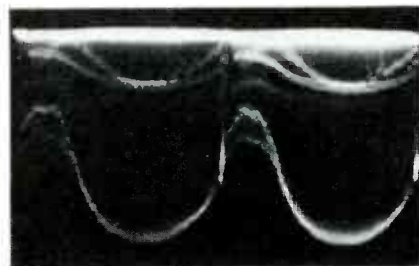


Fig. 8. Effect of 60-cps hum modulation on sync-separator plate waveform.

cathode leakage in the video output stage. (Remember, this stage directly supplies a composite video signal to the sync circuits.) Some settings of the contrast control give us an acceptable picture, but we are still bothered with vertical instability and a case of bends at the top of the picture. Instead of listening for the offending hum modulation, as we would in an audio circuit, we look for it with the scope—and we find it in the sync-separator plate waveform. Fig. 8 (taken at pin 1 of V6 in Fig. 4) shows how the



Fig. 9. Horizontal pulse amplitude fluctuates when 60-cps hum is present.

separated vertical pulse is compressed and distorted by hum. Also notice the varying height of the horizontal pulses. Fig. 9, a closeup of the horizontal-pulse signal, shows

# Pinpoint in Seconds...

## HORIZONTAL & VERTICAL SWEEP TROUBLES

**NEW**  
**SENCORE**  
 Time Saver

*The missing link in TV service...*

### SENCORE SS105 SWEEP CIRCUIT TROUBLE SHOOTER

**IT'S A...**

**UNIVERSAL HORIZONTAL OSCILLATOR.** For direct substitution. No wires to disconnect in most cases. Traces trouble right down to the defective component. Variable output from 0-200 volts, peak-to-peak.

**HORIZONTAL OUTPUT CATHODE CURRENT CHECKER.** A proven method that quickly checks the condition of the horizontal output tube and associated components. Adaptor socket prevents breaking wires. Easily replaceable Roll Chart gives all necessary pin, current and voltage data.

**UNIVERSAL DEFLECTION YOKE.** A new, simple way to determine yoke failure accurately—without removing yoke from picture tube. Merely disconnect one yoke lead and substitute. If high voltage (also bright vertical line) is restored, TV yoke is defective.

**DYNAMIC FLYBACK TRANSFORMER CHECKER.** Merely flip switch to "Flyback Check" and meter will indicate condition of flyback transformer, in degrees of horizontal deflection. Extremely sensitive and accurate; even shows up one shorted turn on flyback.

**VOLTMETER.** For testing bootstrap, screen and other voltages. Direct-reading voltmeter, 0-1000 volts.

**UNIVERSAL VERTICAL OSCILLATOR.** Checks oscillator, output transformer and yoke. Merely touch lead to component and check picture on screen.  
 Size, 7x6x3½". Wt. 4 lbs.  
 For 110-120 volts, 60 cycle AC.

**UNIVERSAL HORIZONTAL DEFLECTION YOKE SUB.**

**DYNAMIC FLYBACK TRANSFORMER CHECKER.**

**UNIVERSAL VERTICAL OSC.**

**UNIVERSAL VERTICAL DEFLEC. YOKE.**

HORIZ. OSC.	VERT. OSC.
HORIZ. O.P. STAGE	VERT. O.P. STAGE
HORIZ. FLYBACK XFORMER	VERT. O.P. XFORMER
HORIZ. DEFLEC. YOKE	VERT. DEFLEC. YOKE

See Your Parts  
Distributor  
NOW!

# SENCORE

ADDISON 2, ILLINOIS

DEALER NET <sup>42</sup>95

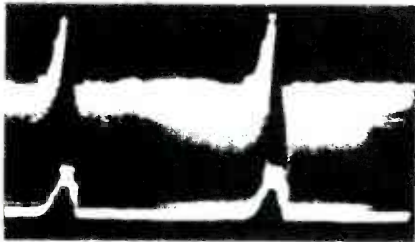


Fig. 10. With leaky input capacitor, video reaches separator plate (30 cps).

how the 60-cps hum causes the pulse amplitude to fluctuate. This "fuzzy" signal will cause trouble a little later when it reaches the horizontal AFC circuit.

### Leaky Coupler

Hum modulation isn't the only defect which shows up on a scope when you're tracing sync problems. One of the more common troubles is a defective coupling capacitor between the video-output and sync-separator stages. Figs. 10 and 11 show what happens to the output signal at the plate of a 3BU8-type sync separator when the input coupling capacitor C41 develops leakage on the order of 100K ohms. This fault provides a DC path to the B+ source through the video-amplifier

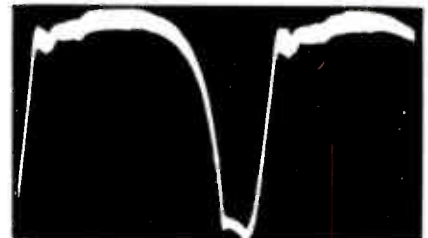


Fig. 11. Same waveform as in Fig. 10, but at scope sweep rate of 7875 cps.

plate circuit, upsetting the bias level on the control grid of the separator. The DC bias voltage is no longer numerically equal to 75% of the peak-to-peak signal voltage at the grid, with the result that video information appears in the output.

This trouble can be localized by a VTVM measurement of grid bias if we know (from measuring the signal amplitude) what the bias should be with a signal applied. It should be noted that the bias level can also be upset by a gassy tube.

### Separator Voltages

While we have already discussed bias voltages at some length, it would also be well to examine what happens to plate voltages. To be frank about it, so much happens that only one thing is sure: There should be *some* value of voltage present! Why is this so? To begin with, consider the voltages on a conventional triode-type separator circuit such as the one in Fig. 4. With no signal applied, almost no bias is developed; consequently, plate current is maximum. The definition of "maximum" is determined mainly by the value of plate-load resistance. Since load resistor R28 is 1.5 megohms, and 140 volts is the source potential, dividing the voltage drop across R28 by its value gives a current of 800 microamps when the tube is running wide open! Even with this small amount of plate current, the voltage drop across the large load resistor leaves only 20 volts at the plate. As soon as a signal is applied, bias develops; then the mere 800 microamps is cut drastically to an even lower value, and up soars the plate voltage toward source level. It becomes evident, therefore, that plate voltage measurements in this stage mean very little.

In Part II, we'll take up triode and pentagrid separators, as well as various sync amplifier circuits. ▲



## NOW! A QUALITY CLEANER-LUBRICANT FOR ONLY 98¢ Dealer Net

**JETKLEEN.** The most economical and effective cleaner-lubricant on the market. Jetklean provides quick, easy cleaning and lubrication of controls, contact points and tuners in one application.  
Dealer net: 6-ounce unit ..... 98¢

**QUIKLEEN.** The amazing new all-purpose cleaner that effectively and instantly cleans tuners, switches, band switches, volume controls and mechanisms. Contains no carbon tetrachloride . . . has no fire or flash point. Contains no oil, leaves no film.  
Dealer net: 16-oz. unit \$2.10 6-oz. \$1.10

**LUBEKLEEN.** For fast-action cleaning and top-quality lubrication of volume controls and tuners. Cleans and lubricates in one application! The lubricant contained is a premium-quality precision instrument oil with oxidation inhibitor added. The finest cleaner-lubricant on the market!  
Dealer net: 8-ounce unit ..... \$1.75

**QUIKFREEZE.** Cools components instantly to enable immediate detection of defective circuit components due to thermal intermittence. Saves important man-hours by pin-pointing trouble not otherwise discernable. May also be used for locating hairline breaks in most printed circuits. Spray suspected area. Breaks will normally become visible due to contraction caused by instant chilling.  
Dealer net: 8-ounce unit ..... \$1.50

For pin-point application, use Plytex EXACT-O-SPRAY needle.  
Dealer net: Each ..... 75¢

Plytex products are supplied through electronic parts distributors only.

**PLYTEX PRODUCTS, INC.**  
Electronic Chemicals in Aerosols  
Houston, Texas



## Hi Fi

(Continued from page 35)

is just ahead of the last injection point from which an audible signal can be produced in the loudspeaker.

Earphones can also be used to good advantage in signal tracing, no matter whether the trouble symptom is distortion, hum, noise, or loss of output. Use a regular program input—any one which causes the fault to appear—and use high-impedance headphones to listen to various points. Connecting a capacitor in series with the phones protects them, and also the serviceman, when tests are made at points where high DC voltage is present. With phones, you can work from either end of the system to localize the trouble source. Then the exact fault can be determined, either through visual checks or by measuring voltages and resistances.

Distortion exists in various forms, so before attempting to track it down, try and define its characteristics.

1. Frequency distortion occurs when the system is unable to handle all signal frequencies equally well. Usually the mid-frequency response is maximum, with decreased output for low and high frequencies. Assuming that the response had originally been satisfactory, the fault could be in any number of places. Component failure in feedback, equalizer, tone-control, amplifier, or crossover-network circuits could be to blame. Other possible causes are a worn stylus, dirty or damaged cartridge, or misadjusted speaker level in a multiple speaker system. Bear in mind that frequency response almost always seems poorer at lower volume levels than at high levels.

2. Hum and noise are usually distinguishable from other kinds of distortion, but they may originate from any of several sources. Hum may be caused by open ground connections, heater-to-cathode leakage in tubes, leakage across tube sockets, a misadjusted hum-balance control, interchassis ground loops, broken shielding, or faulty components in the amplifiers or power supply. Noise may be due to worn or dirty record surfaces, radio interference, or some fault in the audio-

amplifier system. In the latter category are noisy potentiometers and switches, loose connections, cold-solder joints, broken shielding, defective components, and noisy tubes. Sound from weak FM stations may be noisy because of incomplete limiting in the radio tuner. One more thing: Weak tubes in the tuner or amplifier may require the volume control to be advanced so far that excessive noise results.

3. Harmonic and intermodulation distortion occur when an amplifier generates additional frequency components not contained in the orig-

inal input signal, thereby changing the tonal characteristics of the signal. In general, both types of distortion are due to nonlinearity, primarily in the amplifier circuits. Specific causes are overloading of a stage, changes in feedback or bias circuits, unbalance in push-pull stages, a marked drop in B+, component failures, or deterioration of components (including tubes).

4. Transient distortion in a system makes it incapable of properly responding to sudden loud bursts of sound, either speech or music. If the power-output rating of an am-



### SENCORE RS106 RECTIFIER TROUBLE-SHOOTER

Instant, Direct Substitution for . . .

**SELENIUM RECTIFIERS.** Substitutes for all types used in Radio, TV and other electronic devices up to 500 ma.

**SILICON RECTIFIERS.** Types found in many new TV sets.

**SINGLE DIODES.** With exception of some used in high frequency circuits.

**DUAL DIODES.** Types used in sync Discriminator circuits. Third test lead is provided for center connection.

Sencore has simplified trouble shooting rectifiers and diodes with this unique substitution unit. The RS106 gives you a positive check everytime . . . Substitute for suspected rectifier or diode . . . watch picture or listen to sound and you'll know in seconds whether or not the rectifier or diode should be replaced. No guess work, no soldering mess, no time lost. The RS106 actually costs less than having loose rectifiers and diodes in the shop for testing and is worth many times more.

Ask your Distributor to show you the RS106.

• Rectifiers & Diodes at your finger tips for fast substitution

• Protected by 1/2 amp. Slow Blow Fuse.

**RS106**  
DEALER NET. **1275**

Now — with the RS 106, Sencore offers a complete lab for the substitution of resistors, capacitors, electrolytics, rectifiers and diodes for only \$41.45. Ask for the Sencore Substitution Lab containing the RS 106, Electro-Sub and Handy 36 (see other Sencore ads).

New Substitution  
**SENCORE**  
Time Saver

**SENCORE**  
ADDISON 2, ILLINOIS

plifier is inadequate for the application in which it is used, the system may not be able to handle transients because it is habitually operated at close to peak power levels. Transient distortion usually accompanies other types of distortion. Among other things, it can be caused by improper speaker damping (either too little or too much), peaks in response curves, weak tubes, and overloading in any form.

5. Pitch distortion, usually called flutter or wow, is caused by variations in the speed of the phono or

tape recorder. These variations change the pitch (frequency) of the reproduced sounds and are usually caused by some defect in the drive mechanism, motor, drive wheels, rollers, etc.

### Remedying the Trouble

It is impractical to carry *everything* that might be needed to complete a hi-fi service call, such as items of special test equipment. Also, it is desirable to create as little bother and confusion as possible in the home. Nevertheless, a large

percentage of hi-fi servicing calls (like TV calls) can be completed in the home. And most of this work can be done without specialized test equipment. Among the general procedures which can be carried out in the home are tube replacements, checking and repairing of interconnecting cables and plugs, cleaning or replacing dirty or worn controls and switches, and correcting any defects which show up in a visual check of the equipment. In addition, a number of special operations can be performed on each individual unit in the system.


**Replacement** with an advance-engineered CBS-Ronette cartridge restores true fidelity to your customer's hi-fi or stereo . . . makes it sound even better than new.

Only 27 CBS-Ronette cartridges — all with jeweled styli — replace over 500 others. And a complete cross-reference chart makes choice of cartridges quick and easy. In addition, CBS-Ronette provides exact replacements for the more than 6,000,000 CBS-Ronette cartridges now in use in the U.S.A.

Give your customers better than new performance. Tell your distributor you want CBS-Ronette, the cartridge proved superior by world-wide use in original equipment.

**TRUE SOUND  
COMES THROUGH  
...BETTER**

WITH A



**Ronette**

CARTRIDGE

Ask for Catalog PF-285

**CBS ELECTRONICS**, Danvers, Mass., U. S. A.  
A Division of Columbia Broadcasting System, Inc.

*Receiving, industrial and picture tubes • transistors and diodes • audio components • and phonographs*

### Tuners

Most of the tubes used in AM-FM radio tuners are also used in television, and servicing techniques used in TV are also applicable to tuner work. Tube replacement, signal tracing, and visual observation of components, as well as voltage and resistance measurements, are all used to advantage in tuner repair.

### Phono

It is a good idea to carry a good musical recording with you — one with which you are familiar — plus any test records you may have. By using the same disc all the time, you will have a more reliable standard against which to judge performance of each of the systems you service. For best results, your favorite test recording should contain various types of music, including percussion (bells, drums, and cymbals), strings, and brass; it should also have good, clear tones at both high and low frequencies. Specially-prepared test records give valuable data on system operation, are relatively inexpensive, and are convenient for use on home calls.

Many turntable problems involve rubber components in the drive mechanism. Cleaning rubber parts with alcohol gets rid of grease accumulation, a common cause of slippage. Dressing the surfaces with fine sandpaper or an emery board also cleans the rubber; in addition, it roughens the surface to give better traction. Cleaning the inner drive surface of the turntable also provides better operation. Dried-out or cracked rubber components should be replaced. Most distribu-

# BEST BUYS IN TEST INSTRUMENTS



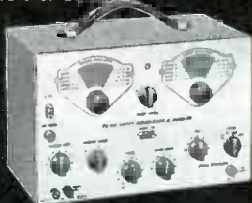
- Praised by the experts
- Lifetime service guarantee
- Ruggedized mechanical design for utmost accuracy & stability
- Only the latest, finest quality parts used



Color & Monochrome • DC to 5 MC Lab & TV 5" Oscilloscope #460

Wired \$129.50 Kit \$79.95

Features DC amplifiers; flat from DC to 4.5 mc, usable to 10 mc.



TV-FM Sweep Generator & Marker #368

Wired \$119.95 Kit \$69.95

Entirely electronic sweep circuit with accurately biased inductor for excellent linearity. Extremely flat RF output.

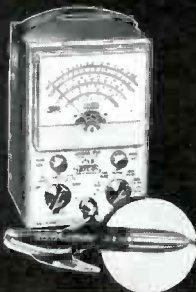
Dynamic Conductance Tube & Transistor Tester #666

Wired \$109.95 Kit \$69.95

Tests all receiving tubes (picture tubes with adapter), n-p-n and p-n-p transistors.



Add 5% in the West



Peak-to-Peak VTVM #232 & Uni-Probe (pat. pend.)  
Wired \$49.95 Kit \$29.95

Uni-Probe — exclusive with EICO — only 1 probe performs all functions: half-turn of probe tip selects DC or AC-Ohms.

In stock at over 1500 distributors in the U.S. and Canada

**IMPORTANT NOTE:** All EICO kits built according to our instructions, and all EICO factory-assembled equipment, conform to the high standards and specifications published in EICO literature and advertisements. All EICO factory-assembled equipment is completely and meticulously hand-wired throughout — no printed circuitry; each factory-assembled unit is 100% final-tested throughout for each feature and function — no "spot" or "partial" checking. In EICO's final-test techniques, nothing is left to chance.

EICO, 33-00 Northern Blvd., L.I.C. 1, N. Y.

tors carry assortments of drive components which should take care of almost all needs.

Be sure to carry a stroboscope disc for checking turntable speeds, as well as a pressure gauge or gram scale for checking and adjusting stylus tracking force. The stylus can also be checked for alignment, and the damping blocks in the cartridge can be re-cemented if loose. The cartridge, if dirty, can be cleaned with solvent and a very small brush. A small mirror (like those used by dentists) is a big help in checking and repairing cartridges. The condition of the stylus can be observed by using a small microscope. Replacement styli for most of the popular makes should be carried; you may also find it advisable to carry several of the most popular types of complete cartridges.

## Preamps

The main problems associated with preamps are hum, noise, and microphonics, especially in the first stage where signal level is extremely low. Also, because of the low levels, various types of external interference can occur—for example, pick-up of radio or power-line signals. Improper grounding of power-line circuits in a building occasionally causes trouble. Symptoms like this would be present in the home but not in the shop — another good reason for localizing the trouble "on the spot."

## Power Amplifiers

Naturally, the output quality of the system depends to a great extent on the power amplifier, especially the final stage. Other than the usual component, voltage, and resistance checks, there are several other items which deserve attention. Most units contain a balance control, the purpose of which is to balance the two sections of the push-pull output stage. When properly adjusted, it minimizes hum and harmonic distortion. The setting of this control should always be checked, even though it may have been properly adjusted when the amplifier was first installed. The need for occasional adjustment should be expected because tubes and other components will age unevenly.

Output tubes draw heavy current

# BEST BUYS IN CUSTOM

STEREO HI-FI...



- Praised by the experts
- Lifetime service guarantee
- Modern "low silhouette" horizontal chassis
- Easy console installation



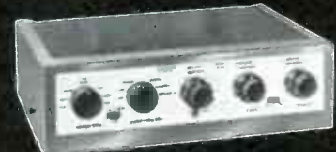
FM Tuner HFT90 Wired \$65.95\* Kit \$39.95\*  
Cover \$3.95. \*Less cover, FET included.  
"One of the best buys." — AUDIOCRAFT

AM Tuner HFT94 Wired \$65.95 Kit \$39.95  
Includes cover & FET.  
"One of the best... Ideal for those wishing to add AM to their systems." — HI-FI SYSTEMS

FM/AM Tuner HFT 92 Wired \$94.95  
Kit \$59.95 Includes cover & FET



Stereo Dual Amplifier — Preamplifier HF81  
Wired \$109.95 Kit \$69.95  
"Outstanding quality... extremely versatile."  
— ELECTRONICS WORLD LAB TESTED



Stereo Dual Preamplifier HF85  
Wired \$64.95 Kit \$39.95  
"Outstanding buy." — THE AMERICAN RECORD GUIDE

Stereo Dual Power Amps  
28-Watt Model HF86 70-Watt Model HF87  
Wired \$74.95 Kit \$43.95 Wired \$114.95 Kit \$74.95



3-Way High Fidelity Speaker System  
Semi-Kits HFS-3 & HFS-5

- Complete with factory-constructed enclosure
- Easy to assemble — no gluing or woodworking
- HFS-3 unfinished birch, \$72.50; walnut, mahogany or teak, \$87.50
- HFS-5 unfinished birch, \$47.50; walnut, mahogany or teak, \$59.50
- Other speaker system semi-kits from \$39.95.

In stock at over 1500 distributors in the U.S. and Canada

EICO, 33-00 Northern Blvd., L.I.C. 1, N. Y. PF-2  
Show me how to save 50% on top quality:  Hi-Fi  
 Test Instruments  Ham Gear. Send free catalog and name of neighborhood EICO supplier.  
 Send free STEREO Hi-Fi Guide.

Name.....  
Address.....  
City..... Zone..... State.....  
Add 5% in the West

# There's More Profit in this Proud Name



"Bargain basement" needles can ruin not only your customer's cherished records, but your reputation as well. Selling cut-rate inferior merchandise at little or no profit is short-sighted when you can move up to *quality* and *high profit* with the respected Clevite "Walco" line.

Clevite "Walco" is a name with a tradition of superiority — one your customers trust through long experience and world-wide acceptance. Every stylus is made to exacting tolerances . . . meticulously inspected to meet rigid standards that assure the ultimate in faithful sound reproduction — and Clevite "Walco" Styli are backed by a written guarantee.

Clevite "Walco" Diamond and Sapphire Needles, chosen as original equipment by America's leading phonograph manufacturers, are *exact* replacements that will perform perfectly in your customer's equipment. So, for "customer insurance" and a better profit potential, sell up to quality needles, *sell up to Clevite "Walco"*.

See your distributor or write Clevite "Walco" today.



60 Franklin Street, East Orange, N. J.

and may burn out prematurely if bias is misadjusted. In some localities, extreme line-voltage variations may also cause tube-burnout problems. In either case, if these tubes are not lasting as long as they should, a slight increase in bias may remedy the trouble without increasing distortion.

Speakers usually do not give much trouble; but if they have been moved about, their connections may have become loose or open. Signal tests with meters, phones, or scope can be made at the speaker terminals to check operation of the crossover network as well as the speakers. In this respect, however, don't forget to consider each speaker's contribution to the over-all frequency coverage; the crossover network separates the total signal into various frequency bands, and therefore the individual speakers will not respond to the entire audio spectrum equally.

#### Removal to Shop

The foregoing test procedures have been presented as a basic guide to hi-fi servicing in the home, but they are just as useful for working on any equipment that happens to be brought into the shop. If repairs cannot be completed in the home, bringing an entire "package"-type hi-fi unit into the shop would offer few problems beyond those presented by a large TV console; however, it would obviously be better to bring in only the subassembly suspected of being defective. With systems made up of separate components, the technician usually has little choice in the matter, since it is often virtually impossible to bring in the entire system. With this fact in mind, a tremendous asset to shop servicing is a complete audio system with provisions for easily inserting a unit to be analyzed. This system need not be the best, but it should be accurate and thoroughly familiar to the technician. Once the component to be repaired has been connected into this substitute audio setup, where do you go from there? How closely can you analyze the performance of the unit with your regular TV test equipment? The answer to this question will be explored in the April installment of this column. ▲

**"Eliminates Soldering"**

PERFECT *Audio*

**"PIN-PLUG" CRIMPER**

SLIP WIRE IN "PIN-PLUG," INSERT IN TOOL, AND SQUEEZE . . . JOB IS DONE.

AU-2

Useful in making hi-fi, audio and sound, radio, phono, and TV equipment connections.

only **\$1.25**

C-rings 1c each

Get the tool that makes solid electrical pin-plug connections without soldering or destroying pin form. Use one end for pin crimping, the other to push on C-ring clamp for braided-shield ground connection. Nothing like it anywhere.

3 models: PT-1 for 3/32" pin diameter; AU-2 for 1/8" pin diameter and installing C rings; LC-3 for 5/32" pin diameter.

Available at your parts distributor.  
Another fine product from:

**BERNS** Mfg. Co.  
9853 Chalmers, Detroit 13, Mich

**INJECTORALL**

THE NEEDLE DOES THE JOB!

**TUNER CLEANER AND LUBRICANT**  
with . . .  
**INJECTOR NEEDLE**

The leak-proof steel Injectorall Needle lubricates where you need it . . . you can reach hard-to-get at Wafers without pulling Tuners apart, or even removing Chassis.

**INJECTORALL CO.** Brooklyn 14, New York

## Emerson 700B

(Continued from page 39)

Fig. 4. It's low in amplitude—20 volts against the normal 30—and does not show the distinct saw-tooth shape that would indicate normal feedback from the oscillator through C65. The DC plate voltages on pins 2 and 5 of V17 are 90 and 88 volts, respectively, though they each should be more than 200. Both grids have odd-ball voltages as well. However, the incoming pulse signal from the horizontal sync amplifier looks good on either side of C64. This fact, along with other observations of the AFC stage, leads you to suspect that the trouble is confined wholly to the oscillator.

Since C71 helps control the operating frequency of the oscillator and C72 is part of the tank circuit of L21, these components draw your attention first. Disconnecting and checking both on a capacitance checker, you are presented with the sad news—both are good. Next you try checking or substituting C73, C65, C66, C2B, and R94, to no avail. Since C74 was previously disconnected to permit injecting a substitute signal into the horizontal-output grid circuit, you can assume normal condition of all components beyond C74. Still searching for the reason behind the lost oscillator-plate voltage, you have but two likely choices remaining: Either horizontal frequency coil B1 is defective, or waveform coil B2 is at fault. Sure enough, a coil and fly-back checker indicates shorted turns in B1.

### Repairs After "Fixing"

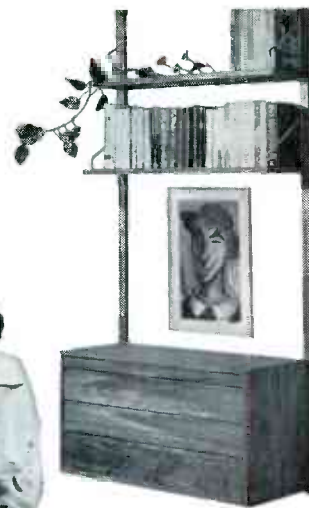
In an old receiver, it's always good insurance to check the resistance of selected controls—particularly potentiometers connected between any high B+ source and ground. If this appears to be a silly precaution, think of the cost of a free callback the following day just to reset or perhaps change the vertical linearity control. In these older receivers, I might add, we're consistently finding more and more half-watt variable control potentiometers that have risen to two or three times their normal values because of the current steadily passing through them year after year.

You're also wise to check some

## MORE! FOR THE



## DIFFERENCE



FLUXVALVE "V-GUARD" "H-GUARD" UNIPOISE PAC (TM)

Royal System Wall Cabinets designed by Paul Cadavus.

Here is more for the best of everything in quality record reproduction—the more that makes the difference! more output!... more channel separation!... more response... more record life! In short—more to enjoy because there's more quality for more listening pleasure. Without question, Pickering's Collectors' Series 380 is the finest—with more features and more flexibility than any other stereo pickup in the world.

For example, the 380 is fully encapsulated in radiation-proof precious mu-metal for absolutely hum-free performance in any record player regardless of type—make—model. The only true way to judge a high fidelity component is to compare it with another... measure its performance with the most vital instrument of all... the ear. For—those who can hear the difference choose PICKERING\*.

### COLLECTORS' SERIES 380.

OUTPUT: 15 mv per channel. CHANNEL SEPARATION: 30-35 db. FREQUENCY RESPONSE: + 2 db 20-20,000 cycles. SIGNAL TO NOISE RATIO: -65 db below reference. TRACKING FORCE: "A" type stylus—2-5 grams; "C" type stylus—3-7 grams.

Model 380E Collectors' Ensemble includes the Stanton Stereo FLUXVALVE with 3 "V-GUARD" styli for stereo, microgroove and 78 rpm records. \$60.00

Model 380A includes Stanton Stereo FLUXVALVE with D3807A "V-GUARD" stylus for transcription arms. \$34.50

Model 380C includes Stanton Stereo FLUXVALVE with D3807C "V-GUARD" stylus for auto-changer arms. \$29.95

\*PICKERING—for more than a decade—the world's most experienced manufacturer of high fidelity pickups



Only the Stanton Stereo FLUXVALVE features the safe, comfortable, easily replaceable stylus assembly.

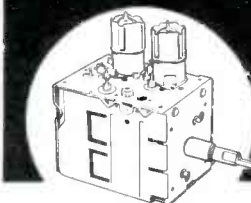
FOR THOSE WHO CAN HEAR THE DIFFERENCE



# Pickering

PICKERING & CO., INC., PLAINVIEW, NEW YORK

## TARZIAN Offers 48-Hour, Direct Factory Service on Tuner Repairs



only  
**\$8.50**

Price Effective Jan. 1, 1960

That's right. Net, \$8.50 per unit and \$15 for UV combinations, including ALL replacement parts. 90-day warranty against defective workmanship and parts failure. Tuners repaired on approved, open accounts. Replacements offered at these prices\* on tuners not repairable:

VHF 12 position tuner . . . . .	\$22.00
VHF 13 or 16 position . . . . .	23.00
VHF/UHF combination . . . . .	25.00
UHF only . . . . .	15.50

\*Subject to change



Tarzian-made tuners are easily identified by this stamping on the unit. When inquiring about service or replacements for other than Tarzian-made tuners, always give tube complement . . . shaft length . . . filament voltage . . . series or shunt heater . . . If frequency, chassis use this address for fast, 48-hour service: for service. Contact your local distributor or identification and allow a little more time

## SARKES TARZIAN, Inc.

Att.: Service Mgr., Tuner Division  
East Hillside Drive  
Bloomington, Indiana



"He got the idea from a science fiction movie."

for power tools to your liking

# SAY



ONLY  
**\$44.95**

½ H.P. SOUPED-UP SABRE SAW  
MODEL 909 ONLY

Only portable electric saw that can cut 4x4's at 45°, 6" board or log, yet cut any pattern, too! Cuts up to ½" steel, 2" pipe. Complete with rip guide, circle cutter, 45° tilting base plate and 7 blades.

Say WEN for Drills, Solder Guns, Sanders  
5810 NORTHWEST HIGHWAY, CHICAGO 31

**SMILES!**



**SMILES!**



**SMILES!**

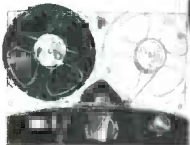
... when you recommend and install

**WEBSTER COMPONENTS**

Ahhh... smiles of sweet satisfaction when your customers hear the difference with Webster Stereo Components. Here's new depth, new realism, for both stereo and monaural tapes—exceptional reproduction!

Smiles for you, too, because Webster's components are profit-packed!

360/362  
TAPE DECKS



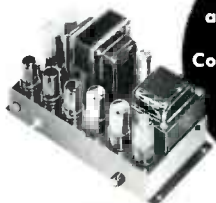
Record and playback 4- and 2-channel stereo and monaural tapes. Simple controls, horizontal or vertical mounting, 3 3/4 and 7 1/2 ips. Inline head.

GL20-20  
DUAL CHANNEL  
PREAMP-  
AMPLIFIER



Full 40 watt amplification without drop or distortion. Combined control, preamp and amplifier center for all program sources. 20 watts each channel.

GL12HF  
AMPLIFIER



Basic 12 watt amplifier to convert hi-fi to stereo. Compact. 1 high impedance input; 4, 8, 16 impedance outputs.

ELECTRONICS DIVISION

**WEBSTER ELECTRIC**  
RACINE - WIS

franklin adv. Y142

of the half-watt fixed resistors in circuits that have been repaired, as well as any others that you think may have been subjected to unusual current flow. Furthermore, it's a good idea to check selected capacitors, such as C59 (Fig. 1), which will kill or disturb multivibrator operation if bad, and C57 and C58, which affect the timing of the multivibrator.

Making a spot check of fixed resistors in the horizontal AFC-oscillator circuit, you discover that AFC cathode resistor R89 has changed from 82K to 130K, and that oscillator plate-supply resistor R94 is 97K instead of 68K. As an added precaution, you also check mica coupling capacitor C74. As usual for this unit, it is good.

**Touch-Ups**

You're ready to fire up the Emerson again. A nice, full raster appears, but the horizontal oscillator is far off frequency. So you adjust B1 until a single picture appears, denoting a return to a normal sweep rate of 15,750 cps. Then you connect the oscilloscope through a low-capacitance probe to the junction of L19 and L21 and turn the iron core of B2 until the rounded and sharp peaks of the waveform (W13 in Fig. 2) are equal. As a final check, you rotate the horizontal hold control throughout its range to be sure the picture remains locked in. You also switch to a different channel and back to make certain that the AFC circuit is capable of "snapping" the picture into sync.

Next, you try turning all controls in the set to see that they respond smoothly and are neither dirty or intermittent. They all perform satisfactorily except R6, the 2-meg focus

The makers of the "Executive Line" announce the latest technical advance in the britener field!

ANOTHER



EXCLUSIVE



**HEART-O-GOLD briteners**

The NEW Bonded transformers of anchor briteners give:-

- Longer life
- Truer performance
- Less service troubles
- Better TV pictures

See your Jobber today



**ANTRONIC CORPORATION**  
2712 WEST MONTROSE CHICAGO  
DESIGNERS AND MANUFACTURERS  
**anchor** ELECTRONIC PRODUCTS

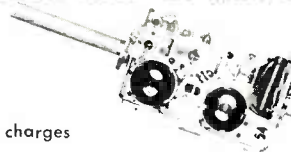
**FOR ANCHOR ELECTRONIC PRODUCTS:**

- in western Canada —  
**SYBELL SALES CO.**  
276 Arthington, Winnipeg 10
- in eastern Canada —  
**CROSS-CANADA ELECTRONICS**  
67 Ontario, Kitchener, Ontario
- in Foreign Countries —  
**BARRIE BYRD SERVICES**  
1724 La Salle, Chicago 14, Ill.

PHONE  
ED 9-9653

**\$7.50**

plus parts,  
C.O.D. and postage charges



90 DAY  
WARRANTY

**Precision Tuner Service**

ALL TYPES T.V. TUNERS REPAIRED AND ALIGNED TO FACTORY SPECIFICATIONS ON CRYSTAL-CONTROLLED SWEEP GENERATORS  
24-HOUR SERVICE ON MOST TUNERS

**UHF - VHF COMBINATIONS — \$13.50**

See your local distributor or send to:

P.O. Box 272, 601 N. College  
BLOOMINGTON, INDIANA

State make and model. Send  
all parts, tubes and shields

control. You find that it has developed a high-resistance connection between the resistive element and the lug going to ground, with the result that the lines on the raster are not sharply defined. Changing this control restores good focus.

Your next chore is to clean the contacts in the turret-type tuner and "respring" the finger-type fixed contacts to insure positive connections.

Now you go back with the oscilloscope and look at the waveforms your careful repairs have produced. W7, at the junction of R71 and R3 in the vertical multivibrator circuit, is 18 volts peak to peak—more than adequate. Using the DC vertical input of the scope, as I suggested in this column last August, you can see that the instantaneous voltage of W7 rises above zero only when a positive retrace pulse occurs in the waveform. This is as it should be.

W8, at the grid of V16, is now more than 70 volts in amplitude. The average DC level of this waveform is only slightly less than zero volts. A highly negative DC voltage is not needed on the grid, since most of the bias for the vertical output tube is provided by developing a positive voltage across cathode resistors R7 and R78.

At the grid of the horizontal AFC stage, you now see a waveform (W11) of about 35 volts peak to peak, also arranging itself closely around the zero DC level. W14, the sawtooth-shaped drive signal at the grid of the horizontal output tube, is more than 80 volts in amplitude. This voltage also goes more positive than zero during the latter part of the trace; however, just as in the vertical output tube, an even greater positive voltage is developed in the cathode circuit to furnish proper DC bias for the tube.

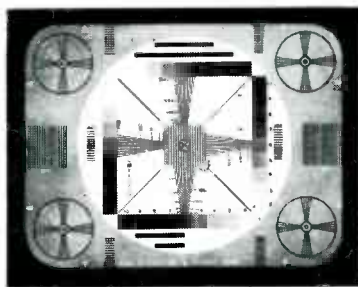
You know now that your waveform shapes and AC voltage amplitudes are close to what they should be and that the DC voltages are reasonably correct. You have completed the job with honors, and you can now return the set to the owner, unless you suspect it still has some borderline fault you haven't detected. If you are still in doubt, a quick "look-see" at the remaining waveforms as they appear on the schematic will help you decide if the job is really complete.

As you look through the rest of the receiver, don't let the sync circuits confuse you. As Fig. 5 reveals, the Emerson 700B has a "frill" you don't often see these days—two sync-separator circuits (one for vertical sync, one for horizontal). The 60- and 15,750-cps sync pulses are separated, clipped, and amplified independently in order to achieve the cleanest possible sync signals for triggering the sweep oscillators.

Another circuit that may seem a little strange to you is the low-volt-

age power supply with its twin 6AX5GT rectifier tubes. This B+ circuit was described in some detail in this column last October.

If the final test of the outgoing receiver shows any discrepancies, there's nothing else to do but get to the bottom of any remaining trouble. Callbacks—while they admittedly can't all be avoided—are mighty expensive luxuries for anybody, particularly if a mere twenty minutes of extra "preventive maintenance" could have made this receiver a really clean set. ▲



## TV TIPS FROM TRIAD

NO. 6 IN A SERIES

Joe, the Junior PTM, said, "How can you afford to stock TV parts, Bill?" He waved his arm around Bill's well-equipped shop.

"Some parts help me save time," replied Bill, "and I figure that time is about all I have to sell. Take this job I am working on: Sound ok, no boost or high voltage. So far I have eliminated such items as the fuse, tubes, drive, open cathode or screen circuits, and a half dozen other items without finding the cause. That leaves two possibilities: defective flyback or yoke. Since I can test both by substituting either one, I will naturally sub the easier item — which is the yoke."

"Don't you have to have thousands of yokes on hand to do that?" asked Joe.

"No, the yoke you use for substitution must be known to be good, and be within twenty percent of the inductance of the original. It doesn't have to be installed on the picture tube for the test. Less than a dozen yokes provide for nearly all tests, and in a majority of cases also serve as the replacement."

"You learn something new every day," Joe said.

\* \* \*

**MORAL:** If you would like to know more about testing flybacks by substituting yokes, ask your Triad Distributor or write the factory for PTM #3. If you are interested in which yokes make good test units ask for the YP-8 Yoke Pack information sheet. **Triad Transformer Corporation**, 4055 Redwood Avenue, Venice, California.

# PRODUCT REPORT

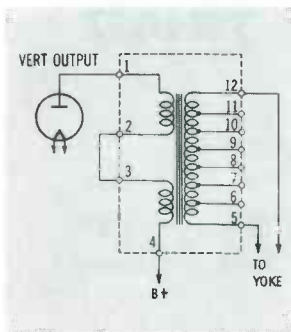
For further information on any of the following items, circle the associated number on the Catalog & Literature Card.

## Complementary PNP-NPN Transistors (43M)



Push-pull Class B amplifiers using power transistors in complementary pairs (one PNP, one NPN) have several advantages over conventional circuits; for example, no input and output transformers are needed. CBS has introduced eight new complementary pairs of transistors, which are finding use in process-control amplifiers, output stages of PA systems and mobile two-way radios, and a variety of other industrial and military applications.

## Vertical-Output Transformer (44M)



A dual primary winding and a secondary with six intermediate taps are incorporated in the Stancor *Multi-Ratio* vertical-output transformer (Part No. VO-109). This unit can be connected in a number of different configurations—including both isolated-secondary and autotransformer hook-ups—to achieve various turns ratios from 5:1 up to 50:1. The connections shown in the schematic would result in a 10:1 ratio. Suggested net price is \$5.52.

## Antenna Mixing Networks (45M)



Designed along the lines of the antenna mixing networks employed in master antenna systems, but simpler and more economical, Jerrold low-loss TX Series devices are useful in solving many home TV-FM reception problems. They can mix output signals from cut-to-channel and broadband antennas into a common downlead, take only a specific channel signal from a broadband antenna circuit, mix or separate VHF-TV and FM radio signals, and combine the outputs from as many as nine single-channel antennas.

## All-Transistor PA Amplifier (46M)



A new 10-transistor Webster Electric amplifier for mobile public-address service can produce 22½ watts of audio output while drawing 3½ amps from a 12-volt battery. With no input signal applied, battery drain is less than ½ amp. The 4½' power cord plugs into a standard automobile cigarette-lighter receptacle. The unit is available as an amplifier alone (Model TP20M) or with top-mounted phono turntable and pickup (Model TP20MP).

## Kit of Electrolytics (47M)

The Pyramid *V. I. P.* kit is an assortment of 30 Type TD tubular dry electrolytic capacitors packaged in a leatherette attache case. Contents include five capacitors in each of the following values: 25 mfd at 25WVDC, 20 mfd at 150V, 150 mfd at 300V, 8 mfd at 450V, 20 mfd at 450V, and 50/30 mfd (dual) at 150V. Gold-plated, adhesive-backed initials (for personalizing the case) are available at 10¢ each.



## Headphones (48M)

Interchangeable plugs in a new Clevite "Brush" headset adapt the unit for either stereo or monophonic reception. Among other features of these phones are soft ear cushions and a virtually flat frequency response to beyond 10,000 cps. The "Brush" line also includes general-purpose headsets, a model for laboratory use, a lorgnette-style set, and a single-ear unit. All are marketed by Clevite "Walco."



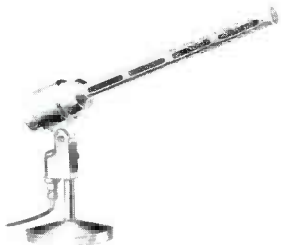
## High-Voltage Tester (49M)

The high AC pulse voltage at the plate cap of horizontal-output or high-voltage rectifier tubes can be measured with the VG-1 *Voltage Gauge* made by B & M Electronic Mfg. Co., Fort Wayne, Ind. One end of the gauge is attached to the tube cap with a metal clip, and the calibrated plastic rod is pushed inward until the neon bulb imbedded in the end of the rod lights. At this point, the voltage is indicated directly in kv on the scale.



## Spot-Pickup Microphone (50M)

The highly directional characteristics of the Electro-Voice Model 644 *Sound Spot* dynamic microphone enable it to pick up sound from an unusually long distance without loss of "presence." Exceptionally good rejection of random noise, reverberation, acoustic feedback, and wind noise is also provided. The *Sound Spot* has a frequency response of 40 to 12,000 cps and offers a choice of low (150-ohm) or high Z.



## Plug-In Tube Saver (51M)

The *TV Life Saver*, a new plug-in version of the Wuerth *Tube-Saver*, protects television and hi-fi sets from excessive surges of line current during warm-up time. The device plugs into the AC wall receptacle and receives the line cord of the set being protected. Two sizes are furnished—a smaller one for equipment drawing 100 to 275 watts, and a larger one for 250- to 400-watt loads.

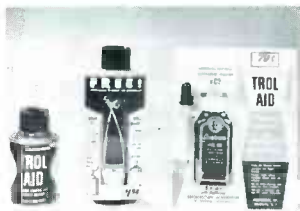


## Receiving Tubes (52M)

Sylvania has announced nine new types of tubes for the replacement market: 6DQ6B horizontal output tube with improved ratings for 110° service; 2-, 3-, and 6EA5 sharp-cutoff tetrode RF amplifiers; 5- and 6FV8 general-purpose triode/pentodes; 6FV6 tetrode RF amplifier; 12DQ7 power pentode for video-amplifier service; and 12AE6A dual diode/triode for use as a detector and amplifier in hybrid auto radios.



### Control Cleaner (53M)



Chemtronics (Brooklyn, N. Y.) *Trol-Aid*, a contact and control cleaner with lubricating action, is packed in three different types of containers—an 8-oz. aerosol can with wall mount and flexible “hose” applicator for \$1.98, a 3-oz. “caddy-size” aerosol can for 98c, and a 2-oz. bottle with break-resistant dropper-type applicator for 79c.

### VHF Amplifier (54M)



A new three-tube TV-FM amplifier, Blonder - Tongue Model HAB, lends itself to use as either a distribution amplifier for small master antenna systems or a single-set booster for extreme fringe areas. The “front end” employs a high-gain, low-noise frame-grid tube. Power supply is 110-120 VAC; dimensions of the grey steel cases are 6" x 5 3/8" x 4 3/8"; list price is \$62.50.

### Power Output Tube (55M)



A new Type 7581 beam-power pentode made by General Electric can replace Types 5881, 6L6 and KT66. An especially interesting feature for mobile applications is the “rounding off” of the envelope top just above the upper support wafer, which serves to prevent tube elements from “rattling” up and down (and causing microphonics) when subjected to vibration. In general, the electrical ratings are similar to Type 6L6GC.

### FM Antenna for Autos (56M)



Standard whip antennas on automobiles can be adapted for FM radio reception by installing a Clear Beam *Halo* unit. The loop at the top is attached to a hollow support column, which is designed to fit snugly over the existing antenna—thus permitting installation without any need for drilling holes or using special tools. The loop is aluminum, and the support element is nickel-plated brass.

### Zener Diodes (57M)

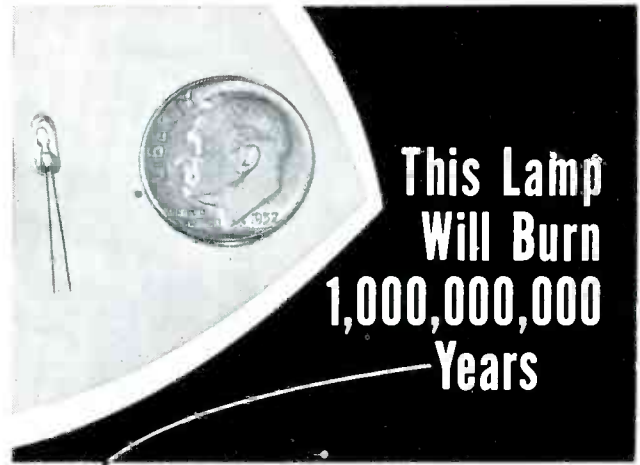


Silicon zener diodes, rated at 10 watts and encased in a three-layer seal, have been introduced by International Rectifier Corp. for commercial applications. This new series supplements the previously-available lines of 1-watt and 500-mw diodes. Cost per unit is relatively low—approximately \$5.40. All standard EIA values from 5.6 to 27 volts are supplied in all three wattage ratings.

### Small 4-Watt Controls (58M)



Clarostat Type 45 wire-wound potentiometers have a power rating of 4 watts at 40° C. A new method of internal construction makes it possible to enclose these units in 1 1/8" diameter cases instead of the 1 23/32" cases normally used with 4-watt controls. Resistance values from 1 to 10K ohms are obtainable at ±10% or closer tolerances.



**This Lamp  
Will Burn  
1,000,000,000  
Years**

This tiny lamp, produced initially by Chicago Miniature Lamp Works for certain special applications in aviation, will burn for a billion years, according to calculations based on accelerated life tests.

No such fantastic claims are made for the Chicago Miniature Lamps you obtain from your parts jobber,—but the meticulous attention to quality standards, the precision used in every manufacturing process of every Chicago Miniature Lamp, is reflected in their performance.

*You cannot purchase better than a Chicago Miniature Lamp—always ask for them!*

Send for Free Miniature Lamp Data Booklet



**CHICAGO MINIATURE LAMP WORKS**

1518 No. Ogden Ave., Chicago 10, Ill.  
*Miniature Lamps for every requirement*

### SAMS PHOTOFAC INDEX



sent direct  
to your shop

**FREE**

SEND FOR IT!

Yes, now you can have the valuable SAMS MASTER INDEX to PHOTOFAC FOLDERS and Index Supplements sent direct to your shop at no cost to you! Just mail coupon below and you'll be sure to receive regularly your handy guide to the world's finest service data covering over 33,000 TV, Radio, Amplifier, Tuner Tape Recorder and Changer models. Send for it—it's FREE!

**MAIL  
COUPON**

Howard W. Sams & Co., Inc.

Put me on your mailing list to receive the Sams Photofact Master Index and Supplements

I'm a Service Technician: \_\_\_\_\_ full time; \_\_\_\_\_ part time

My Distributor is: \_\_\_\_\_

Shop Name: \_\_\_\_\_

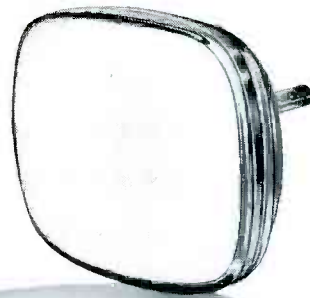
Attn: \_\_\_\_\_

Address: \_\_\_\_\_

City \_\_\_\_\_ Zone \_\_\_\_\_ State \_\_\_\_\_



*Straight facts  
on  
replacement  
picture tubes...*



# RCA Monogram is second only to RCA Silverama

1. MONOGRAM is RCA's economy line of brand-name replacement picture tubes—equal in performance to any so-called “first-quality” picture-tube lines that also contain used materials.
2. RCA Monogram is surpassed only by the *guaranteed all-new* RCA Silverama—the picture tube that commands premium price and profits.
3. Only RCA, of the three largest-selling brands of replacement TV picture tubes, offers you this double line for two distinct sales needs: RCA Monogram for the budget-minded... and premium RCA Silverama for those customers who demand the very best.
4. Most important, there are big new profit possibilities for dealers on the Monogram Picture Tube line. Get the exciting facts from your RCA distributor today!



**RADIO CORPORATION OF AMERICA**  
Electron Tube Division

Harrison, N. J.

® Silverama

# In Electronic Circuits . . .

## ALL AROUND PROTECTION

### NEW MICROFUSE

THE PIGTAIL VARIETY (278000) SERIES

THE PLUG-IN VARIETY (272000) SERIES

THE SUB-MINIATURE FUSE HOLDER (No. 281001)

### New Indicating 3AG Fuse Posts



It GLOWS when the FUSE BLOWS

Labels around the circle include: THROUGH PANEL MOUNTING, SCREW TERMINAL MOUNTING, SOLDER TERMINAL MOUNTING, 4AG FINGER OPERATED POST, TERMINAL CLIP, FUSE CLIP EARLESS, FUSE CLIP, LC FUSE HOLDERS, MOUNTINGS FOR RECTIFIERS, 3AG FUSES, 3AG SLO-BLO, 3AB FUSE U/L, LC FUSES 250V TYPE C, LC FUSES 125V TYPE C, LC SLO-BLO 125V TYPE N, 8AG INSTRUMENT FUSES, 8AG U/L FUSES, AIRCRAFT FUSES, 4AG SLO-BLO, IN LINE FUSE RETAINERS, 3AG POST SCREWDRIVER OPERATED, 3AG POST FINGER OPERATED, 3AG POST MINIATURE, CAN COVER MOUNTING.

It's **LITTELFUSE** First!  
 DES PLAINES, ILLINOIS