

MARCH, 1959

35 CENTS



**RF**  
PHOTOFACT

# REPORTER

Including **Electronic Servicing**



## This Month's Highlights

**Getting Acquainted  
With Communications  
Receivers**

**The Silicon  
Power-Rectifier Story**

**Making Use of Your  
Sweep Generator**

IA SH 635 1260  
WM M DAVIS  
118 RIVERSIDE AVE  
CANON CITY COLO



### NEW WALSCO C-RING TOOL

For easy removal and insertion of "C" washers and retaining rings. Use everywhere.  
No. 585 ..... List \$3.15



### WALSCO TEL-A-TURN TOOLS

For set alignments, count turns automatically to right or left.

- No. 2586—T.F. aligner, #4 & #6 studs . . . List \$1.65
- 2587—Screwdriver & 7/64" blade . . . List \$1.65
- 2588—Hex aligner, .100" & .125" . . . List \$1.65



### WALSCO TEKNI-LABELS

Wide variety of titles and designs for quick labeling of electronic equipment. Choice of 9 different assortments, each with hundreds of decals.



### WALSCO BATTERY PLUGS

Plugs to fit all popular batteries. 18 different types including regular, snap connectors, female plugs.

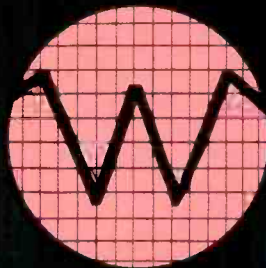

# WALSCO ELECTRONIC

## PRODUCTS

No. 1472  
No. 1462



No. 1432

## THE ONLY COMPLETE LINE OF REPLACEMENT PHONO AND RECORDER DRIVES AND BELTS

Take care of all your phono drive replacements with the WALSCO line . . . largest and most complete line on the market.



No. 1447

## ALWAYS QUALITY- RIGHT... PRICED RIGHT!

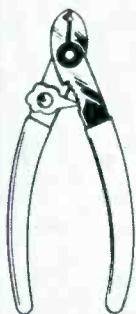

### WALSCO STRIP-ER- CLIP

Strips and clips all wire from 14 to 26 gauge. No accidental nicks or cuts.  
No. 595 . . . List \$2.30



### WALSCO STICKLEBACK TOOLS

Drill, saw, file and rout faster and easier with these remarkable tools made from tough alloy steel. Choice of 6 drill routers, 4 drillsaws, rasp and combination.



### WALSCO SOCKET PROTECTORS

Prevent excess wear and tear on tube checker sockets and other equipment.

- No. 1946—7-pin mini . . . List \$3.25
- 1947—8-pin octal . . . 3.25
- 1948—9-pin mini . . . 3.25

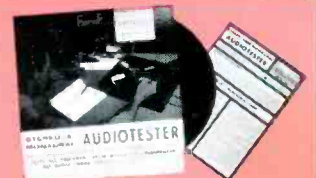

### NEW WALSCO "AUDIOTESTER" TEST RECORD

High fidelity LP record for checking playback equipment from needle to speaker. Mono bands on one side, stereo on reverse.  
No. 300— . . . . . Audiophile Net \$3.98

## WALSCO CHASSIS PUNCHES

featuring exclusive WalSCO L.T.\* design



Round



Square



Keyed



"D"

\*"Low-Torque" Electro-Coating requires 50% less punching effort.

## FREE!

Send for your copy of the new Color TV Tool Manual and WalSCO Catalog 59. Send postcard today!



## WALSCO ELECTRONICS MFG. CO.

Division of Textron Inc.

Western Plant: Los Angeles 18, Calif.  
Main Plant: ROCKFORD, ILLINOIS, U.S.A.

### YOU CAN GET WHAT YOU WANT FROM WALSCO!

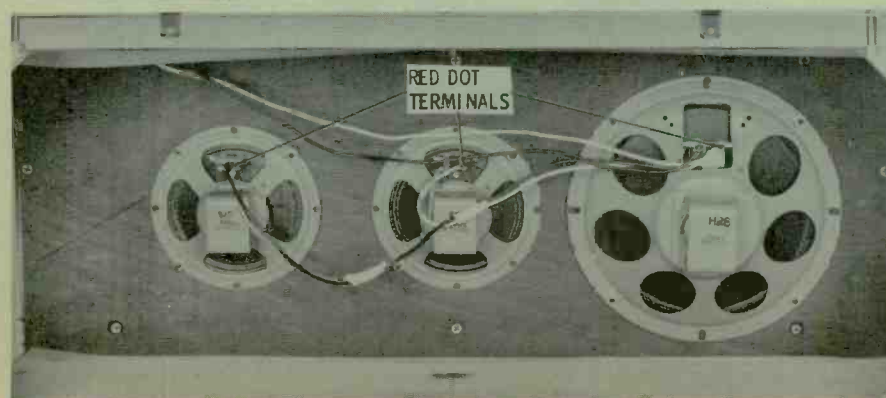
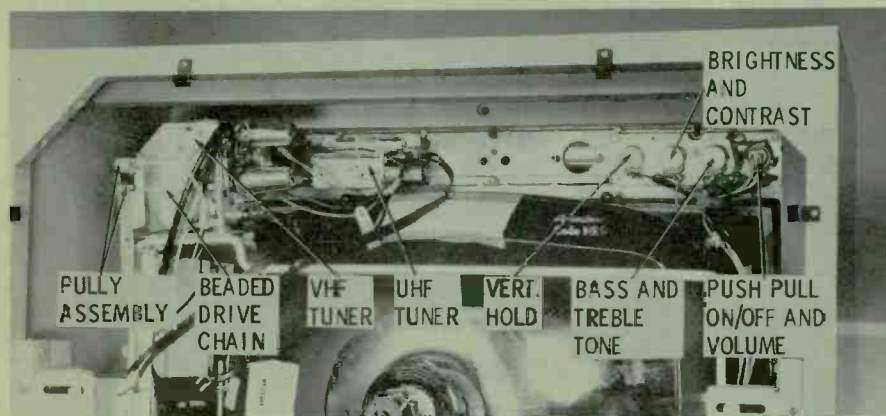
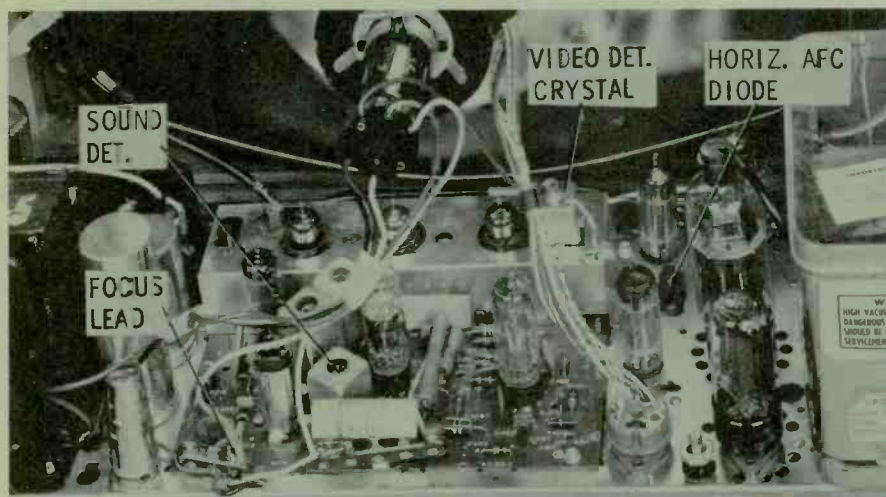
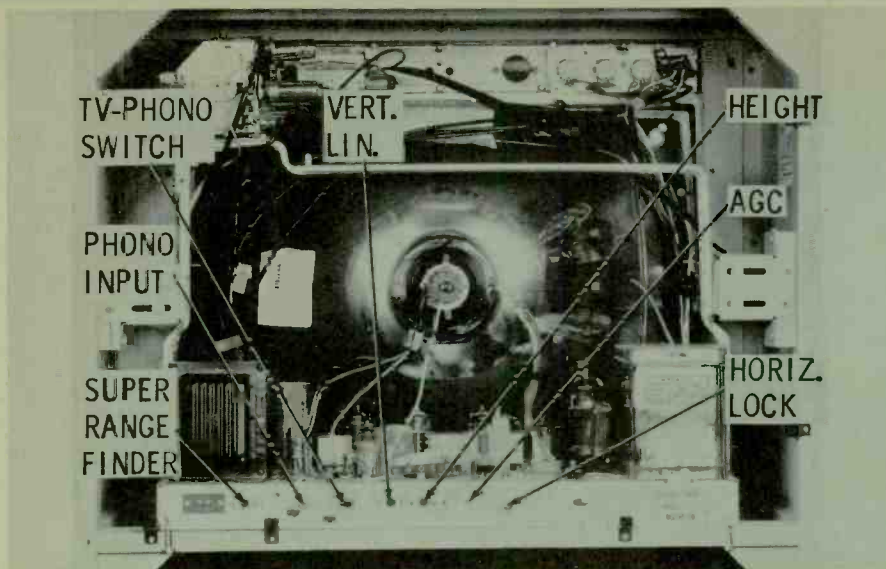

**Admiral Model CH21UH33  
Chassis 20UB6C**

This *Fidelity 500* console has a swivel-type base and features a 21" 110° picture tube with operating controls lining the top front edge of the cabinet.

Removing the rear cover by releasing nine slide-type clips, you'll find a horizontal chassis with VHF and UHF tuners mounted near the top of the cabinet. A phono input jack, TV/phono switch, and all service adjustments are positioned across the rear apron as shown. The *super range finder* control is used to improve sync stability in those areas where ignition systems, switches, motors, etc. cause undesirable interference. The transformer powered chassis uses two low-voltage rectifiers — a 5U4GB and a 5Y3GT connected in parallel. As far as the tube lineup goes, you might remember to check your caddy for a 6DB5, since this tube is employed in the vertical multivibrator-output circuit.

On top of the chassis in the center section, you'll find a printed wiring board housing the IF, sound, video, and sync circuitry. At the left rear corner of the board, there is a three-connection terminal strip used for selecting the correct focus potential for the picture tube. The B+ fuse near the high-voltage cage is a 1-amp slow-blow unit connected in series with the ground return lead of the power transformer. The only other fuse in the set is a 1" piece of #26 copper wire which protects the tube heater circuits. This fuse is soldered between two terminals of a seven-connector strip under the chassis below the power transformer.

Both tuners plus the front panel controls are mounted above the picture tube as shown in the photo of the top section. Operating channel numbers for the VHF tuner are automatically projected on a small window-like screen located in the upper right front corner of the set. The channel indicator drum is driven by a special pulley and beaded chain arrangement. You'll be interested to learn that the entire front escutcheon and chassis is removed through the front of the cabinet. To free the assembly, merely disconnect the speaker leads and remove four metal screws holding the side braces and three bottom chassis bolts.

The speaker system is made up of an 8" woofer and two 5" mid-range units. The two 5" speakers, having a voice coil impedance of 6 to 8 ohms each, are connected in series. This series combination then parallels the 3- to 4-ohm impedance of the 8" unit. Remember that the speaker connections are coded for proper phasing.

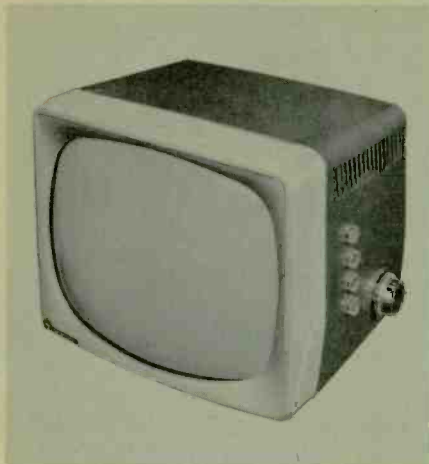

**Motorola Model 17T32BZ  
Chassis TS-430**

You'll recognize this 17" portable by its metal cabinet with side controls and VHF cascade tuner. The "hot" chassis is a conventionally-wired vertical type mounted around a 90° picture tube. With the back removed, all tubes are accessible, including several newer types such as the 8EB8 video amplifier and noise inverter, the XL34/8BQ5 audio output, the 12AF3 damper, and the DY87/1S2A high-voltage rectifier. The slow-blow fuse, located above the high-voltage cage, is a 1.6-amp LC type protecting the B+ supply. Two 350-ma seleniums are the heart of this supply, which is also protected by a 7.5-ohm surge-limiting resistor. The noise gate control should be adjusted for stable sync with the set in its permanent site.

The filament resistor shown is electrically connected in the series-string heater circuit. It controls warm-up time of the tubes and should normally measure 175 ohms cold and 16 ohms hot. To check or replace this component, you'll find it on a terminal board just to the right of the yoke. It's easy enough to get at if you remove the plug from the yoke socket.

To pull the chassis for bench servicing, remove the push-on type knobs, yoke plug, picture tube socket, and speaker leads. Take out two bottom chassis bolts and the two metal screws holding the top chassis braces. After tilting the chassis back slightly, disconnect the high-voltage lead and lift the entire assembly out of the cabinet. Before deciding to remove the chassis, remember that the manufacturer has placed a special test receptacle on the chassis pan above the yoke. This socket provides access to several test points, and permits adjustment of the horizontal oscillator frequency. AGC voltage measurement or clamping, and measurement of B+ voltage without the necessity for chassis removal.

The safety glass, mask, and front bezel are all one assembly and may be removed as such for cleaning purposes. The only problem involved in this operation is the removal of two metal screws under the front of the cabinet. These screws have a somewhat peculiar head (see photo). Known as *holt head* screws, they can be removed by using a special "L" shaped tool (Motorola part #66T-742501). After removing the two screws, pull the lower portion of the assembly away from the cabinet; then lift to release the upper edge and remove.

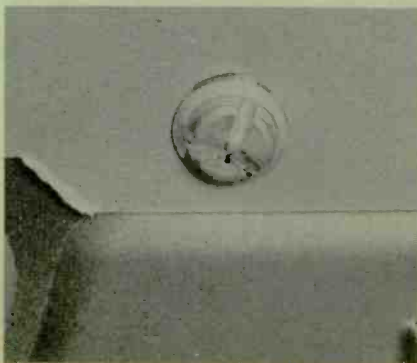
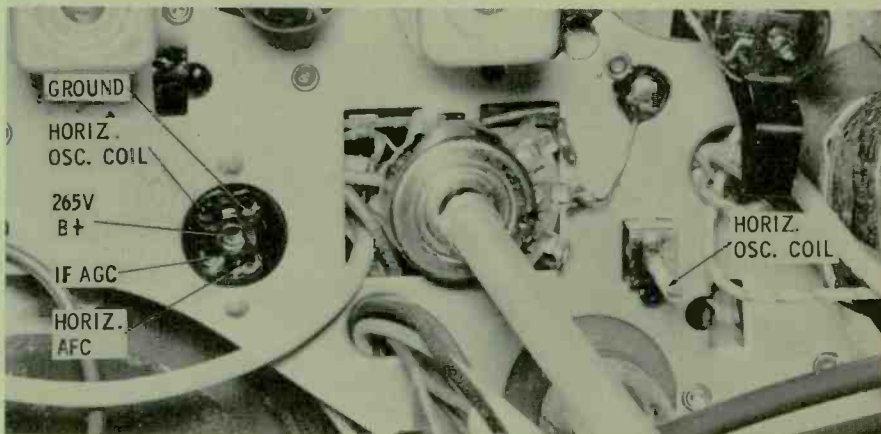
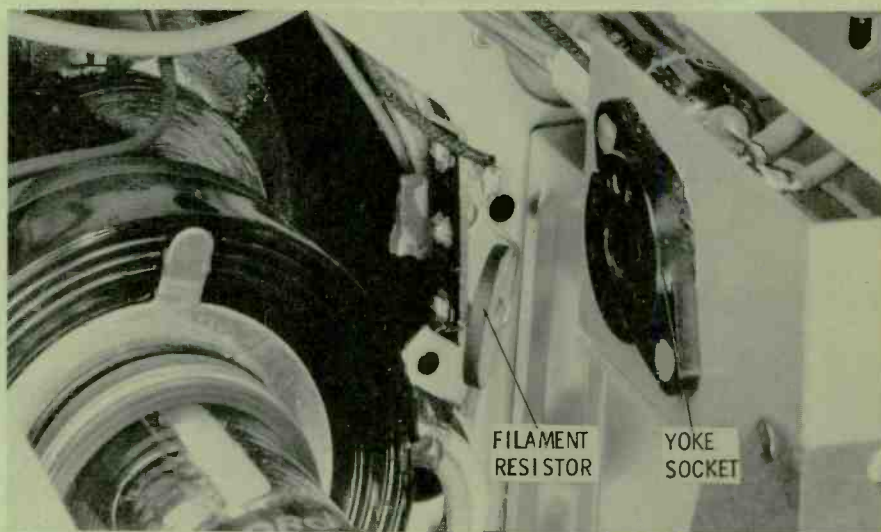
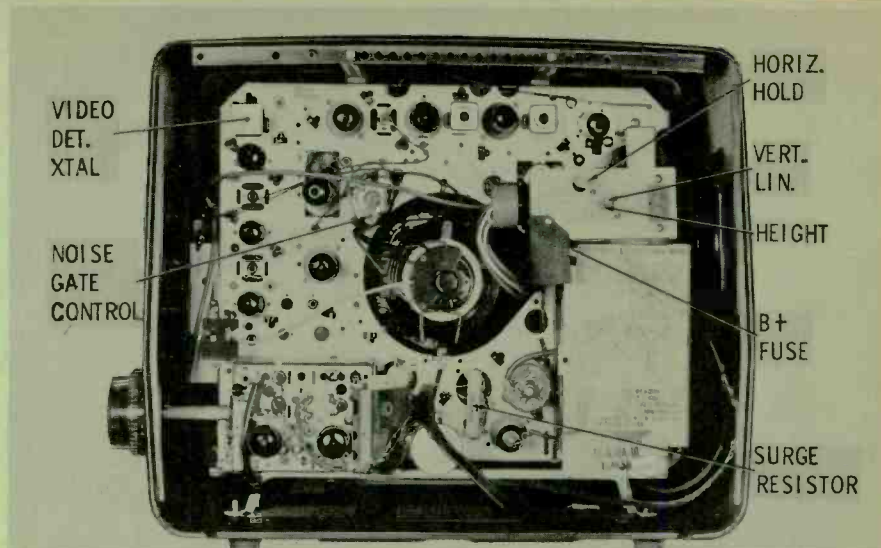

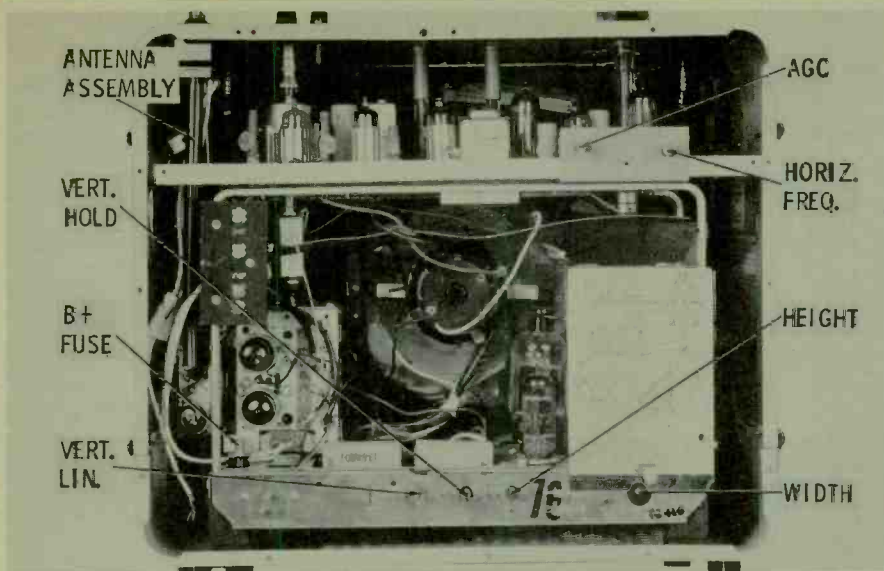

**Sylvania Model 17P110SU  
Chassis 1-537-5**

Here is another new 17" portable with operating controls across the top of its metal cabinet, and a built-in retractable antenna which extends to form full-size rabbit ears. The tuner is designed for both VHF and UHF reception, and the chassis drives a 17BWP4 110° picture tube.

Removing the back cover, you'll find a double-decked horizontal assembly with the lower metal chassis conventionally wired and the upper deck consisting of a single printed board. Although the "hot" chassis makes use of a familiar tube lineup, remember to carry a type 10DE7 for the vertical oscillator-output section. Picture-tube focusing is adjusted by positioning a jumper located on the base. It should connect from pin 6 to pin 5 or 7, whichever produces the sharpest picture. The B+ fuse is a 2.5-amp fast-blow unit protecting all circuits except the filament hookup.

For greater ease in servicing, remove two 1/4" hex-head screws holding the chassis at the lower rear of the cabinet. Pull up on the top control knobs (some of which are held to the cabinet by retainers) and disconnect the picture tube socket and high-voltage lead. The chassis assembly can then be tilted back as shown. You'll find several combination component units on the printed board—also a dual-type selenium diode in the horizontal AFC circuit.

Taking a look at the wiring side of the lower chassis, you'll see that the set is powered by a pair of 450-ma selenium rectifiers. The surge-limiting resistor wired in series with the rectifiers is a 4.7-ohm, 15-watt unit. The large 20-watt job in the opposite corner of the chassis is in series with the filament circuit and has a value of 45 ohms. A length of #24 fusible wire protects the entire receiver, including the filament string, against over-loads.

To clean the safety glass and screen on this portable, you must remove the chassis and picture tube. The chassis will come completely out after the yoke-retaining spring and speaker leads have been removed; however, the top of the cabinet must be removed to get to the picture tube. This is accomplished by removing two screws under the top handle, sliding the side trim strips forward as shown, and removing the three Phillips-head screws under each strip. After taking the top of the cabinet off, remove the bracket and then the picture tube.

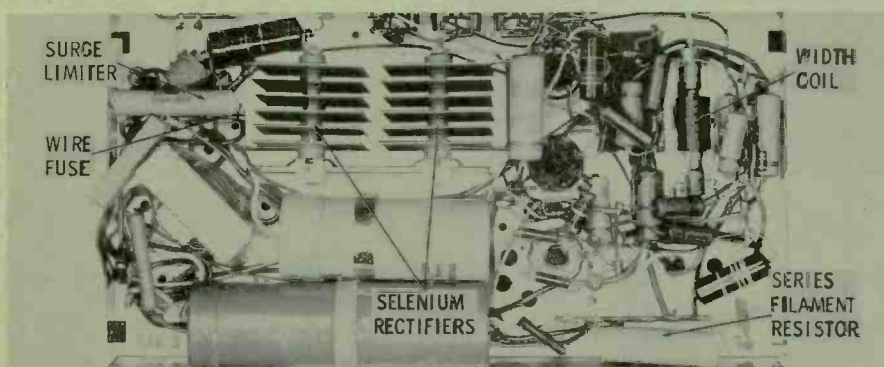
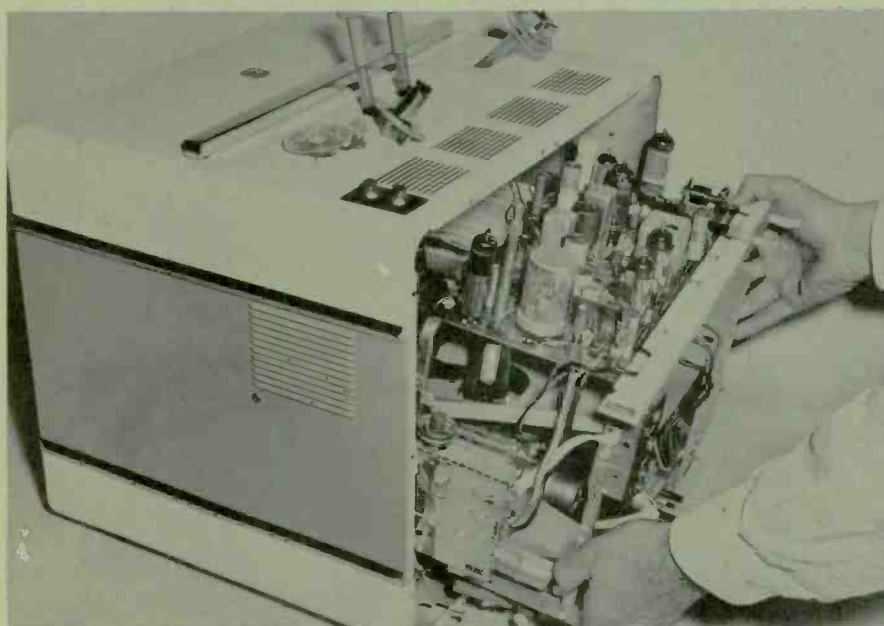

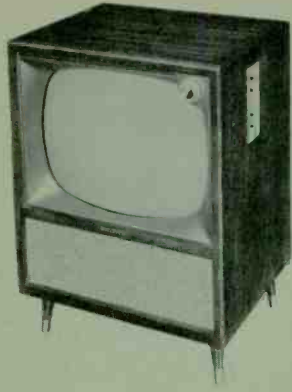

**Trav-Ler Model 721-K-751  
Chassis 943-38**

When you make a call to service this new console model, you'll find that the channel selector and fine tuning dials are the only adjustments on the front of the set. All other operating controls are vertically grouped on the right side of the cabinet. The set has a VHF tuner and drives a 5" speaker and a 21" 90° picture tube.

The small vertically-mounted chassis surrounds the neck of the picture tube and is supported in the center of the seemingly large cabinet by several metal brackets. The tuner mounts separately at the top of the cabinet and connects to the main chassis through two plug-in cables. All tube filaments in this receiver are connected in series, including two 5B8's serving the IF, sync, and vertical circuits and a 12CA5 in the audio output stage. A 12-ohm, 7-watt resistor, in series with the filament string, is located behind the interlock bracket. The fusible resistor protecting the selenium-rectifier power supply is a 4.7-ohm plug-in unit.

Since the instrument uses one of the new Standard Coil *Fire Ball* tuners, oscillator frequencies are not adjustable from either the front or back of the set. Instead, you must remove the small metal plug from the control side of the cabinet as shown and, using a long narrow alignment tool, touch up the adjustment for each channel as the tuner disc is rotated. In the photo showing this operation, the rear cover of the tuner has been removed to give you an idea of the small coil form you must hit when poking through the hole in the cabinet.

The operating controls located on the side of the cabinet include volume with on-off switch, contrast, brightness, and vertical hold. These four controls mount on a single metal panel, but since all leads are permanently attached to their respective circuits, the panel must be removed when pulling the chassis. After taking off the control knobs, all that holds the panel is two Phillips head screws. When replacing the panel, be sure to position the small washers correctly.

Although this is a new set, it won't be long before you'll be called upon to clean the safety glass and CRT. When you are, remember that the glass comes out the front after removal of the push-on type knobs for the channel selector and fine tuning plus four screws holding the top metal trim strip.

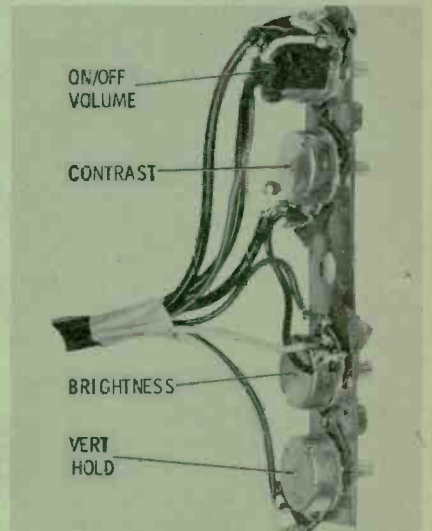
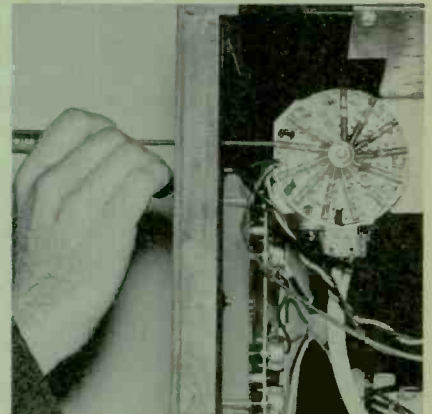
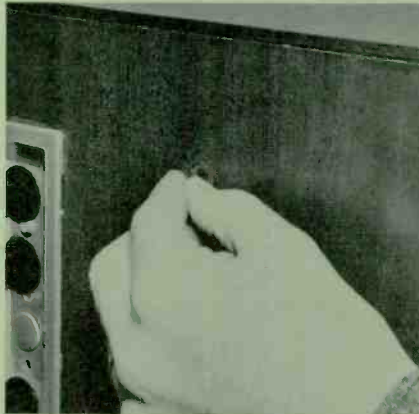
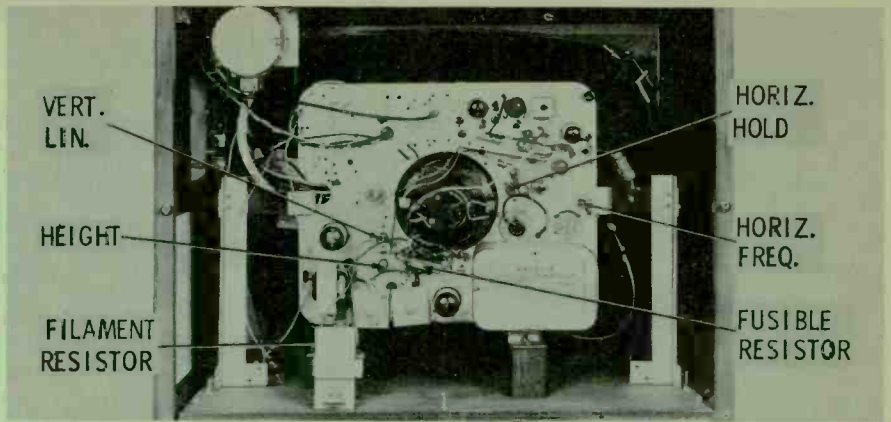

*Mr. Service Dealer...*

# YOUR PHILCO DISTRIBUTOR IS HEADQUARTERS FOR A COMPLETE SELECTION OF GENUINE PARTS

**Bendix**

Automatic Electric Washers • Automatic Electric Dryers • Duomatic Washer-Dryer Combinations • Automatic Gas Dryers • Gas Duomatic Washer-Dryer Combinations.

**CROSLEY**

Radio • Television • Refrigerators • Ranges • Freezers • Air Conditioners • Automatic Dishwashers.

**PHILCO-Bendix**

Automatic Electric Washers • Automatic Electric Dryers • Duomatic Washer-Dryer Combinations • Automatic Gas Dryers • Gas Duomatic Washer-Dryer Combinations.

**PHILCO**

Radio • High Fidelity • Stereophonic High Fidelity • Television • Refrigerators • Electric Ranges • Freezers • Air Conditioners • Automatic Electric Washers • Automatic Electric Dryers • Duomatic Washer-Dryer Combinations • Automatic Gas Dryers • Gas Duomatic Washer-Dryer Combinations.

*Don't Settle for Less than Genuine Replacement Parts*



**COMPLETE PARTS CATALOGS**—All models of all products listed above are completely covered in separate Philco catalogs on Electronics, Appliances and Home Laundry. See your Philco Distributor today for this valuable information.

**PHILCO®**  
*Accessory Division*

#### WORLD WIDE DISTRIBUTION

Service Parts • Power-Packed Batteries • Universal Components • Long-Life Tubes • Heavy Duty Rotors • Star Bright 20/20 Picture Tubes • Long Distance Antennas • Appliance Parts • Laundry Parts • Universal Parts and Accessories.

**PHILCO . . . Famous for Quality the World Over**

# NEW DIFILM<sup>®</sup> BLACK BEAUTY<sup>®</sup> MOLDED CAPACITORS

# BEAT THE HEAT AND HUMIDITY!

Now Sprague's new DIFILM BLACK BEAUTY MOLDED CAPACITORS have taken the steam out of heat and humidity problems. These capacitors are so good you can *boil 'em* for 24 hours without affecting their performance.

Unlike straight polyester film tubulars, these capacitors operate in a 105°C environment *without derating*.

And the heart of these new DIFILM capacitors can't be beat. It's a dual dielectric which *combines the best advantages of both Mylar\* polyester film and the highest grade of paper dielectric*. A rock-hard solid impregnant fills voids and pin-holes in the film.

Talk about *reliability!* . . . these capacitors have it. DIFILM capacitors are actually low cost versions of the Sprague capacitors now being used in every modern military missile. The basic reliability and outstanding performance of missile-type Sprague capacitors are all yours in this outstanding new development. Why take chances when you can get the best—DIFILM BLACK BEAUTY MOLDED TUBULARS . . . at regular prices.

*For the complete DIFILM BLACK BEAUTY story, write for Bulletin M-759 to Sprague Products Company, 105 Marshall St., North Adams, Mass.*

\*DuPont trademark

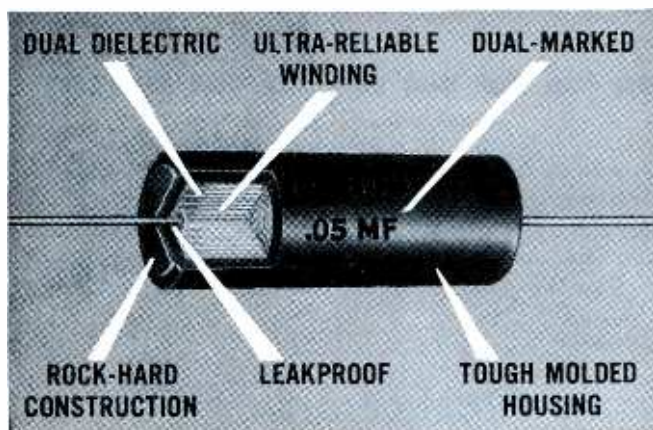

Look for the RED markings on the black case.

**The major capacitor improvements  
come from**



**SPRAGUE RESEARCH IS CONSTANTLY PRODUCING NEW AND BETTER CAPACITORS FOR YOU**



**publisher**  
Howard W. Sams  
**general manager**  
Mal Parks, Jr.

**editor**  
Verne M. Ray  
**associate editors**  
Leslie D. Deane  
Thomas A. Lesh  
Calvin C. Young, Jr.

**consulting editors**  
William E. Burke  
Robert B. Dunham  
George B. Mann  
C. P. Oliphant  
Paul C. Smith

**art director**  
Don W. Bradley

**editorial assistant**  
Georgeanna Caldwell

**adv. production**  
Carol B. Gadbury

**circulation fulfillment**  
Pat Tidd, Mgr.  
Ann Mathews, Ass't.

**photography**  
Robert W. Reed

**advertising sales offices**  
**Midwestern**  
PF REPORTER  
2201 East 46th Street, Indianapolis 6, Ind.  
Clifford 1-4531

**Eastern**  
Paul S. Weil and Donald C. Weil  
30-01 Main Street, Flushing 54, New York  
Independence 3-9098

**Western**  
The Maurice A. Kimball Co., Inc.  
2550 Beverly Blvd., Los Angeles 57, Calif.  
Dunkirk 8-6178; and 681 Market Street,  
San Francisco 5, Calif. Exbrook 2-3365

**Address all correspondence relating to circulation and editorial to PF REPORTER, 2201 East 46th Street, Indianapolis 6, Indiana**

Copyright 1959 by Howard W. Sams & Co., Inc. No part of the PF REPORTER may be reproduced without written permission. No patent liability is assumed with respect to use of information herein.

As a magazine devoted to public service to the entire electronics industry, it is the obligation of PF REPORTER with Electronic Servicing to present to its readers all legitimate advertising in this field. Acceptance of advertising does not in any manner signify the products, policies and services so advertised have been approved, endorsed, or recommended by this magazine.

## NEXT MONTH

### Bench-Servicing New Sets

The advanced design of some late model TV's can be helpful in expediting repairs, especially if you have the right approach. In the next issue, we'll show you "how," with one of the Philco "Predicta" series chassis.

### Printed-Circuit Component Combos

In addition to describing several of the most common circuit configurations, we'll tell you how to detect defective components, and provide you with cross-reference data for units available from major replacement-part manufacturers.

### Room Air-Conditioner Maintenance

If you liked the air-conditioning article in last August's issue, you'll be happy to learn that we've obtained the services of the same expert to prepare a two-part servicing series—the first appearing in April, the second in June.



**PF**  
PHOTOFACT

# REPORTER

including *Electronic Servicing*

VOLUME 9, No. 3

MARCH, 1959

## CONTENTS

<b>Previews of New Sets</b>	1
Data for in-the-home servicing of '59 sets	
<b>Video Speed Servicing</b>	5
Service hints for GE and RCA TV chassis	
<b>Letters to the Editor</b>	14
<b>Shop Talk</b>	18
How to expedite TV trouble analyses with signal-substitution techniques.	
<b>Getting Acquainted With Communications Receivers</b>	24
Facts to help you take the step toward some real radio servicing.	
<b>Servicing New Designs</b>	26
Blonder-Tongue's "Audio Baton"; "hot-rod" tuner by Sarkes Tarzian; CBS "two-way" stereo system.	
<b>Making Use of Your Sweep Generator</b>	28
Here's how to make this instrument pay its own way.	
<b>Servicing Industrial Electronics</b>	30
An analysis of circuits used to automatically control DC motor speeds.	
<b>The Silicon Power Rectifier Story</b>	32
To get the most from these unique components, profit by what we've learned in our labs.	
<b>Tips for Techs</b>	34
<b>Quicker Servicing</b>	38
First-hand experiences in phono-cartridge replacement, record-changer servicing, and AFC semiconductor-diode substitution.	
<b>The Troubleshooter</b>	44
<b>Notes on Test Equipment</b>	50
Triplett's 3414 tube tester; Philco's 7200 signal generator.	
<b>Dollar &amp; Sense Servicing</b>	58
<b>Product Report</b>	78
<b>Free Catalog &amp; Literature Service</b>	80

## ABOUT THE COVER

No matter where you go anymore, you can be in touch with the rest of the world by radio, which might be a simple commercial broadcast receiver, a short-wave set, or a "ham" outfit.

Even in a private plane, chances are a modern "birdman" won't "get away from it all"—most of them are equipped with two-way mobile units. If you're interested in communications work, turn to page 24 and get acquainted with the subject.



USE HANDY CARD AT BACK TO ENTER YOUR SUBSCRIPTION

[www.americanradiohistory.com](http://www.americanradiohistory.com)

Here's **Jensen's**  
**All New H-223F Coaxial...**  
**the Loudspeaker with *Better* Bass!**

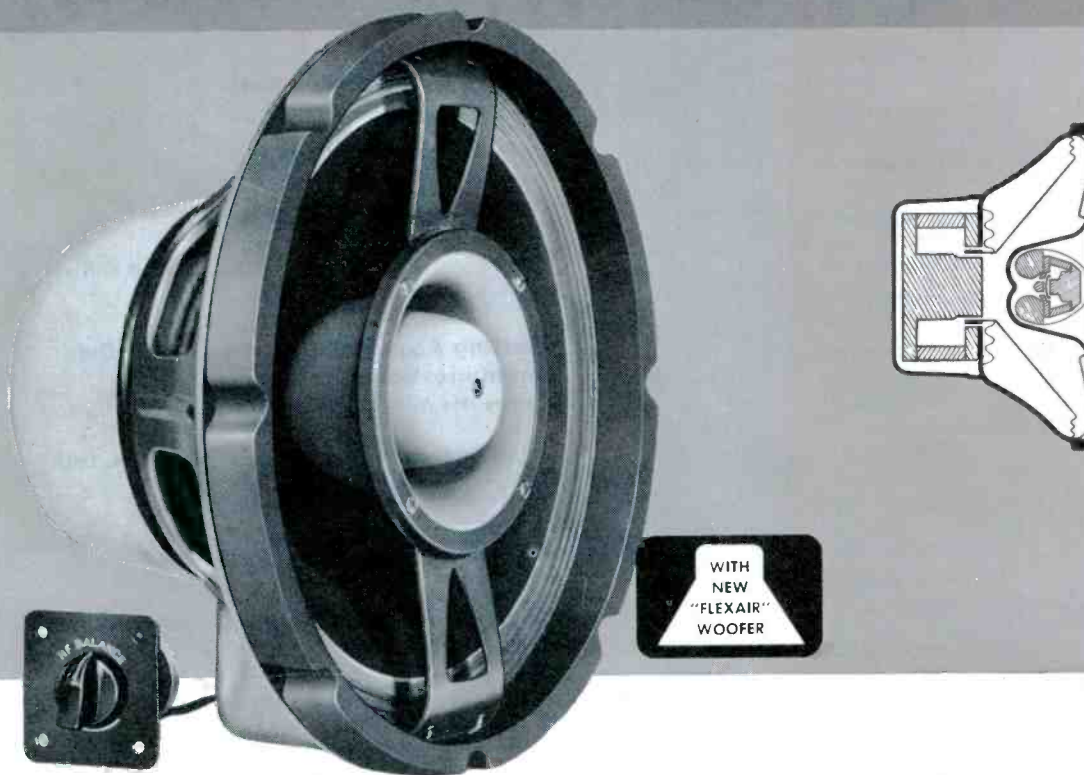

BURTON BROWNE ADVERTISING

*True 2-way Coaxial performance*  
**NOW** with *air-suspension* woofer!

Here's another Jensen first . . . more bass than ever before . . . not in just a woofer . . . not in a factory-enclosed system . . . but in convenient unitary coaxial form, ready to install as you wish. Gives you the range down to 20 cycles with the new Flexair woofer (1" movement with lowest distortion ever) . . . and smoothly up to 15,000 cycles from new compression driver tweeter. Ideal for mono hi-fi, stereo add-on (even with a big system) or paired for a new stereo set-up. Twelve inch size can go in a "bookshelf" or larger enclosure. Net only \$72.50. Write for free brochure KA.

\* Flexair and Bass-Superflex are trademarks of Jensen Mfg. Co.

**World's Favorite  
 Coaxial H-222**

You'll be delighted (as many thousands are) with the efficiency . . . full frequency range . . . easy installation in most any cabinetry . . . of the famous 12" H-222. Wonderful for mono or stereo hi-fi. Performs like much more than its modest cost of \$62.50.

**Jensen** MANUFACTURING COMPANY  
 6601 S. Laramie Avenue • Chicago 38, Illinois

DIVISION OF THE MUTER COMPANY / In Canada: J. R. Longstaffe Co., Ltd., Toronto  
 In Mexico: Radios Y Television, S. A., Mexico, D. F.

**FLEXAIR PLUS BASS-  
 SUPERFLEX MEANS  
 FAR BETTER BASS!**

New Jensen developed suspension allows Flexair\* woofer cone to move one full inch with extreme linearity.

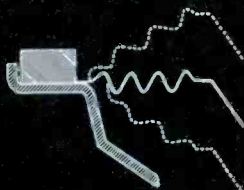

Air Suspension principle is brought to a new peak of performance with Jensen Bass-Superflex\* tube-loaded vented enclosure.

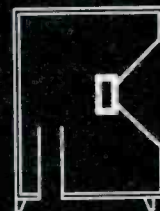

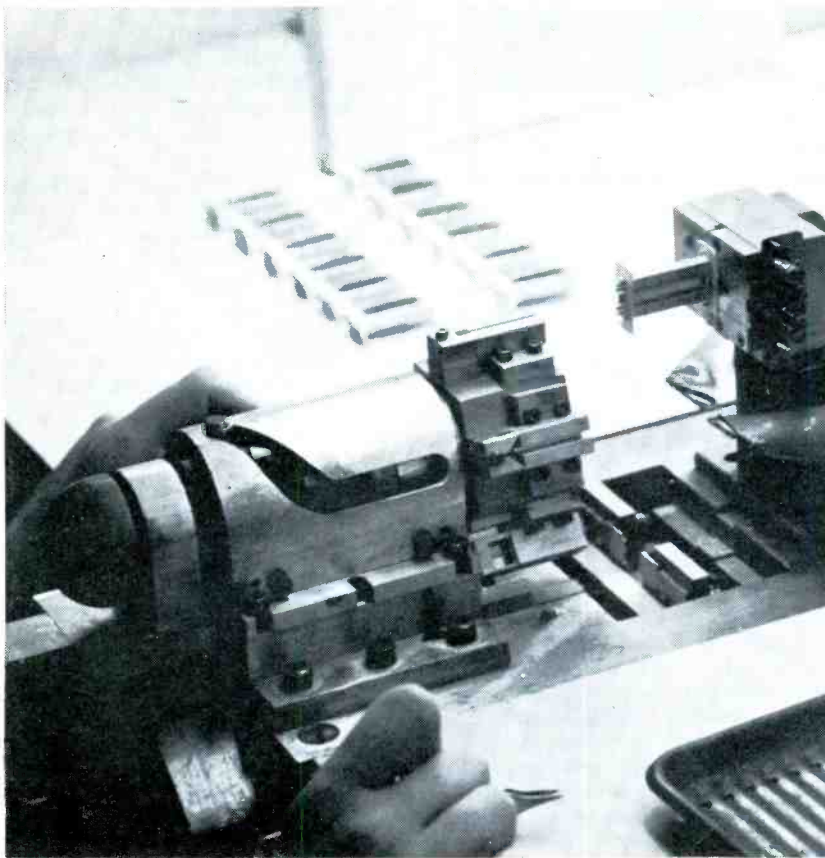

Large illustration shows operator completing the critical assembly work on a 6V6GTA mount in new CBS-Hytron automatic rotary assembly machine. Strip photos (top to bottom) catch six progressive steps: cathode positioned for insertion into bottom mica . . . cathode being inserted . . . A grid, B grid, and beam plate ready for assembly . . . top mica being added to complete the mount cage.



## Automatic tube assembly can cut your call-backs

"Quality always equal . . . or better" is not just a catch phrase at CBS-Hytron. It stems from a determination to prevent troublesome, expensive call-backs. And it is based on building in quality, not trying to test it in.

Here automatic assembly builds in better performance. Operator feeds in each part; presses foot pedal; machine moves part forward and precisely into position. No handling contaminates, distorts or misassembles the parts. Potential failure headaches for you are automatically avoided.

Take advantage of CBS-Hytron quality. You, too, will find it is always equal . . . or better . . . at all times more trouble-free. Ask for CBS-Hytron.



*More reliable products  
through  
Advanced-Engineering*

**CBS-HYTRON**, Danvers, Massachusetts  
A Division of Columbia Broadcasting System, Inc.

by every test



**ATR**  
is BEST!



**ATR AUTO RADIO VIBRATORS**  
Have Ceramic Stack Spacers

**A COMPLETE LINE OF VIBRATORS**

Designed for Use in Standard Vibrator-Operated Auto Radio Receivers. Built with Precision Construction, featuring Ceramic Stack Spacers for Longer Lasting Life. Backed by more than 27 years of experience in Vibrator Design, Development, and Manufacturing.

Free  
"A" Battery Eliminators, DC-AC Inverters, Auto Radio Vibrators



NEW MODELS  
NEW DESIGNS  
NEW LITERATURE

See your jobber or write factory

**AMERICAN TELEVISION & RADIO Co.**  
Quality Products Since 1931  
SAINT PAUL 1, MINNESOTA—U. S. A.

## Letters to the EDITOR

Dear Editor:

Quite a few of us who work on communications radios would like to see more articles and servicing hints on these units. I, for one, have gone into this type of work exclusively; and I find it very interesting and profitable.

My subscription to PF REPORTER has just expired. Since I no longer do TV repair, and most of your articles deal with TV alone, I can no longer benefit by renewing my subscription—even though your magazine is very good in its field.

CHARLES BARBIER

Linden, Texas

*Don't rush off! We've already started a series on communications equipment. The initial article was a picture story on "Installing Two-Way Radio Gear" in January, and we're following through with a coverage in this issue entitled "Getting Acquainted With Communications Receivers." You can expect additional articles in this field later in the year.—Ed.*

Dear Editor:

Tell "The Troubleshooter" that it is quite possible for Mr. Wisniewski (Dec. issue) to get a signal down to his cabin over a thousand feet of lead-in, sans boosters.

I have two installations outside of town here; one has 1076', the other 1155' of 350-ohm open-wire lead-in, with nary booster on either of 'em. In fact, they are fed by a four-antenna setup using couplers at the top. We get Channels 4, 6, 7 and 11 on these; low channels are practically snow-free, but high channels are sporadic due to the greater loss at higher frequencies.

We took measurements at both top and bottom, and found that the total loss is negligible. We have about 150-250 uv at the top and seldom less than 125-150 at the sets. The lines have been in service for four years now, with no trouble at all.

JACK DARR

Mena, Ark.

*Thanks for bringing us flatlanders up to date, Jack. Your report will doubtless encourage others to try probing for signals up on the mountains.*

*In case some of you failed to recognize the celebrated Mr. Darr, suggest you catch his byline over one of the outstanding features in this issue.—Ed.*

I'd like to put in a word for the "weaker sex." My husband and I operate A Clear Fic TV Service. It doesn't take a strong arm to chase an open or short. A 5' 6", 130-lb. woman can—and does—handle 24" TV chassis. I have had doors slammed in my face several times—"Who

ever heard of a woman fixing a TV set?" (Always by a woman!)

Most technicians we have employed do not seem to resent taking directions from a woman, or asking for help and consultation. We even have a few competitors (male) who come to us for help.

Keep up the good work. We appreciate your not wasting much space on such "drivel" as how to use a screwdriver.

RUBY D. SCRAGG

Charleston, W. Va.

*There was a time when women didn't vote, either! We're dedicating a forthcoming article on TV tuner alignment to you, Ruby. Screwdrivers won't even be mentioned.—Ed.*

Dear Editor:

Please tell me how I can find out when my subscription expires. Does the code in the address portion of the mailing label contain this information?

HARVEY BAXTER

Pasco, Wash.

*Yep, Harvey, it does. The numerals to the extreme right on the top line tell the whole story. For example, 162 means that your subscription expires with the January, 1962 issue. 1163 would mean an expiration date of November, 1963, etc.—Ed.*

Dear Editor:

One of my customers discovered one morning that the safety glass on her RCA Model 21D641 had cracked to bits during the night. No one had been near the set, and I am at a loss to account for this breakage. I would like to know if this type of trouble has been encountered before and if you have any explanation for it.

WALTER MORAN

DesPlaines, Ill.

*The glass was probably under stress because of some abnormality in the way it was mounted in the cabinet. In the case you describe, expansion or contraction due to changes in temperature evidently increased the strain to the point where the glass gave way.*

*We recently had a similar accident on a new receiver that was being prepared for PHOTOFAC analysis. As shown in the photo, the safety glass shattered when the*

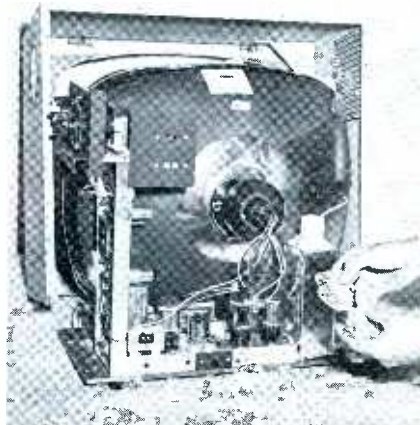

Simply by checking  
all the tubes in the TV set with **B&K DYN-A-QUIK**

# YOU CAN INCREASE YOUR INCOME

## FAST AND ACCURATE

- Tests complete set in minutes
- Wins customer's confidence
- Saves costly call-backs
- Sells more tubes on-the-spot
- Avoids substitution testing
- Makes more money every day

**\$50\***  
**PER WEEK**

\*ACTUAL EXPERIENCE SHOWS  
TV SERVICEMEN AVERAGE

**2 extra tube sales  
PER CALL**

**5 calls per day in  
5 days equal \$50**

## MEASURE TRUE DYNAMIC MUTUAL CONDUCTANCE

Thousands of technicians are doing a better servicing job and are making more money today with the famous B&K DYN-A-QUIK. Completely tests each tube in seconds, with laboratory accuracy, in home or shop. *Measures true dynamic mutual conductance.* Shows tube condition on "Good-Bad" scale and in micromhos. No multiple switching or roll chart. Quickly detects weak, short-life, or inoperative tubes. Shows customer the true condition and life-expectancy of tubes in the set; sells more tube replacements per call. Assures customer satisfaction and protects the service guarantee.

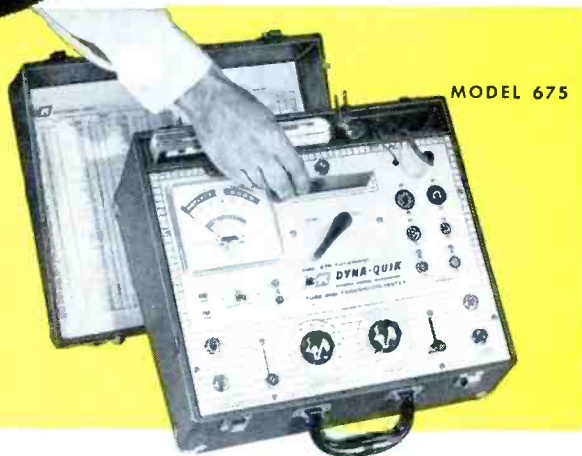

MODEL 675

## Model 675 AUTOMATIC Simplified, Portable, DYN-A-QUIK TUBE AND TRANSISTOR TESTER

With only 60 indexed phenolic Dyna-Cards, you can test over 500 tube types. Dyna-Card automatically sets socket connections for quick, accurate tube test. Checks over 99% of the tubes most widely used in television receivers, plus popular home and portable radio tubes. Easily kept up-to-date by adding new Dyna-Cards. Tests each section of multiple tubes separately for Gm, Shorts, Grid Emission, and Life. Tests each tube for Gas Content and Grid Emission simultaneously with Short Check. Provides instantaneous Heater Continuity test. Transistor Section checks junction, point contact, and barrier transistors, germanium and silicon diodes, selenium and silicon rectifiers.

Net, **\$169<sup>95</sup>**



MODEL 650

## Model 650 DYN-A-QUIK Fastest, Most Complete, Portable TUBE AND TRANSISTOR TESTER

Checks over 99% of the tubes most widely used in television receivers, plus popular home and portable radio tubes. Tests over 500 tube types. Lists over 125 most commonly used tube types, with settings, on socket panels for maximum operating speed. Complete listing in fast telephone-index type selector. Tests each section of multiple tubes separately for Gm, Shorts, Grid Emission, and Life. Tests each tube for Gas Content. Provides instantaneous Heater Continuity check. Includes 16 spare sockets and sufficient filament voltages for future new tube types. Transistor Section checks junction, point contact and barrier transistors, germanium and silicon diodes, selenium and silicon rectifiers.

Net, **\$169<sup>95</sup>**

Manufacturers of Tube Testers, Cathode Rejuvenator Tester, Television Analyst, Dyna-Scan, Transistor Tester, and other specialized instruments.



See your B&K Distributor or  
Send now for Bulletin ST21-R

**B & K MANUFACTURING CO.**  
3726 N. Southport Ave. • Chicago 13, Illinois

Canada: Atlas Radio Corp., 50 Wingold, Toronto 10, Ont.  
Export: Empire Exporters, 458 Broadway, New York 13, U.S.A.

Everyone's a winner in PERMA-POWER'S

## "FLIGHT TO LAS VEGAS" promotion

YOU GET THIS HANDY UNITED AIR LINES FLIGHT BAG

ABSOLUTELY *free!*

WHEN YOU BUY 24



AT THE REGULAR PRICE

and you get a chance at a wonderful trip for two to fabulous Las Vegas!



Never before in Britener history a marvelous offer like this!

This would be a marvelous opportunity even if it didn't include the chance of winning an all-expense trip for two to fabulous Las Vegas. This good-looking United Air Lines Flight Bag is really a handy dandy . . . perfect for carrying tools, supplies—wonderful for traveling—just right for the beach. You'll use it everywhere (if the wife or children don't get it away from you first!) And you get it absolutely free when you buy 24 PERMA-POWER VU-BRITES at the regular price.

And you get a bonus, too!

Attached to each Flight Bag is a "baggage ticket." This is your entry blank in PERMA-POWER'S contest. Send it in . . . and you may be the lucky technician who flies in luxurious comfort to the famous Flamingo Hotel for four days, three nights. Marvelous food—stupendous entertainment—swimming—excitement—you'll get them all in this wonderful all-expense trip for two to Las Vegas, the most exciting resort in the country. And every day of your stay there'll be a stack of silver dollars waiting to cover incidental expenses.

These are units you would buy anyway!

You know how frequently you install briteners to bring back a picture to a weakening pix tube. By buying a supply of 24, you save extra trips to your distributor because you'll have an adequate inventory on hand. The UAL Flight Bag is a big plus that costs you nothing, saves you lots . . . and you buy nothing that you wouldn't be buying anyway!

Don't say "Brightener," say PERMA-POWER!

The PERMA-POWER VU-BRITE is the sales leader and the price leader for brightening TV pix tubes. It's engineered for quality . . . and fully guaranteed. PERMA-POWER VU-BRITE increases filament voltage to a full 8 volts; works on electrostatic or electro-magnetic focus picture tubes. Model C-401 for parallel wired sets; Model C-402 for series wired sets.

Get your UAL Flight Bag today!

It's free with your purchase of 24 PERMA-POWER brighteners . . . and your distributor will give you full details about PERMA-POWER'S fabulous Las Vegas contest. Don't delay . . . contest closes May 15, 1959.

**PERMA-POWER COMPANY** 3102 N. ELSTON AVE., CHICAGO 18, ILL.

## Letters

(Continued from page 14)

cabinet was removed from the set. This metal cabinet does not have a rigid structure when separated from the baseboard (which remains with the chassis). The stress produced by lifting the cabinet off the chassis was evidently the proverbial "straw."—Ed.

Dear Editor:

Unless I am completely confused, the formulas on page 57 of the January issue are written erroneously. They were stated as follows:

$$W = \frac{Z \text{ at Ampl. Tap}}{Z \text{ at Speaker} \times \text{Ampl. Watts}}$$

$$W = \frac{500}{5000 \times 25}, \text{ or } 2.5 \text{ watts}$$

In order to work out to the correct answer (2.5 watts), the formulas would have to read as follows:

$$W = \frac{Z \text{ at Ampl. Tap}}{Z \text{ at Speaker}} \times \text{Ampl. Watts}$$

$$W = \frac{500}{5000} \times 25, \text{ or } 2.5 \text{ watts}$$

STAN FARMER

Grand Junction, Colo.

Come out from under that line, you Ampl. Watts! You got the proofreader in hot water again.—Ed.

Dear Editor:

While writing to extend my subscription, I just thought I'd add a note of thanks for putting in a full list of tubes for the new Philco portable TV set (Previews, December issue). It would help a lot if a complete tube lineup could be given for all new sets.

WALTER OVERBAY

LaFollette, Tenn.

Tube types such as 6DQ6's and 12AU7's should be included in any reasonably well-stocked tube caddy, so there's no reason for us to list them. But we will continue to mention the new or unusual tubes that are not likely to be on hand.—Ed.

Dear Editor:

Being a newcomer to the field of electronics, I have not as yet found any set procedures for doing business, but try to adapt my servicing to the needs of the customer and his problems. This principle applies to selling accessories and other extra items to the customer. I do not believe in selling the customer something he will not get any immediate use out of. I try to give the customer the best service within the limits of his ability to pay, without interfering too much with his financial problems. I may never become rich, but I will have the satisfaction of doing a job to the best of my ability and possibly encouraging people to become steady customers.

EDWARD W. ATKINSON

Detroit, Mich.

With this recipe, you can't help building up a loyal following of customers. Keep your ideals high, but don't let them interfere too much with your financial problems!—Ed.

# Use Delco Radio Service Parts!

2N278—Highest power transistor used in auto radios.

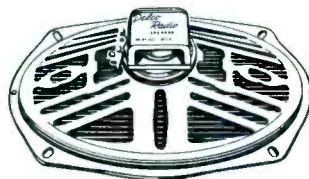

SPEAKERS



IRON CORES



RESISTORS



CAPACITORS



CONTROLS



TUBES



COILS



VIBRATORS

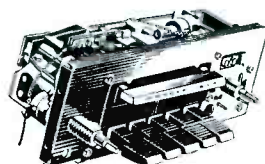

TUNER PARTS

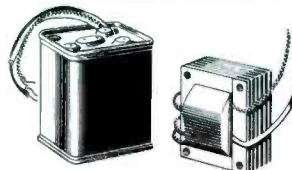

TRANSFORMERS

*Your Delco Radio Electronic Parts Distributor carries the complete line, giving you fast, dependable service on the items you'll need for Delco Radio—and other radio—service work. Delco Radio also provides:*

- Wide selection of special application parts
- Complete technical training program
- Effective warranty program
- Dealer identification signs

Get the facts today on this truly profitable dealer setup, and grow with General Motors!

Available everywhere through Electronic Distributors associated with . . .



## DELCO RADIO

DIVISION OF GENERAL MOTORS, KOKOMO, INDIANA

# ShopTalk

MILTON S. KIVER

Author of . . .  
*How to Understand and Use TV Test Instruments and Analyzing and Tracing TV Circuits*

The technique of signal injection or substitution is highly useful in troubleshooting radios. Unfortunately, many servicemen have not used it to the best advantage in expediting TV repairs. This is due, in part, to the more complex nature of a television receiver and the fact that several different types of signals are required. Also, part of the answer undoubtedly lies in the fact that many technicians are unfamiliar with signal-injection methods in

some sections of a television receiver, notably the horizontal and vertical sweep systems.

Because this approach holds such excellent promise of reducing servicing time, it would be worthwhile to take a long, searching look into the method. This will be done in the paragraphs to follow, restricting the equipment needed to that which might ordinarily be found around the average shop.

In signal-injection servicing, you

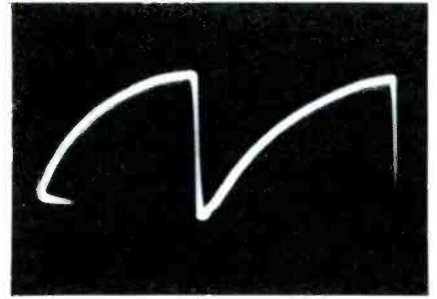

Fig. 1. Typical driving signal for control grid of horizontal output amplifier.

apply a suitable signal to a section of the receiver under test and observe the effect on an output device, such as a loudspeaker or a picture tube. You ordinarily start at a point close to this output indicator, and work toward the front end of the set until indications become abnormal. When this happens, you have located the circuit harboring the defect.

Instead of dealing with those sections of a television receiver where signal injection is ordinarily employed—the audio and video amplifiers—let's apply this technique where it is seldom used, the horizontal and vertical deflection systems.

In the horizontal system, there is an AFC circuit, an oscillator, an output amplifier, a high-voltage rectifier, and a damper stage. If the oscillator fails to function, the screen becomes dark. The same symptoms, however, can be caused by defects in the output amplifier or damper stages. Thus, it would be helpful to be able to check out individual sections of the system. With signal injection, this can be done. For example, if the proper signal is applied to the control grid of the output amplifier, you should be able to tell how well the system is functioning from this point to the deflection yoke.

A suitable test signal for this purpose is depicted by the waveform in Fig. 1. Different circuits may require different peak-to-peak amplitudes of this signal, but the shape of the wave is fairly standard.

Now, the question is: "Where is such a test signal obtained?" Well, there are some excellent instruments commercially available; indeed, you may consider your shop well equipped if it includes some of this modern signal-tracing equipment. Another answer, surprising to many (and yet not really surprising), is

• Please turn to page 72

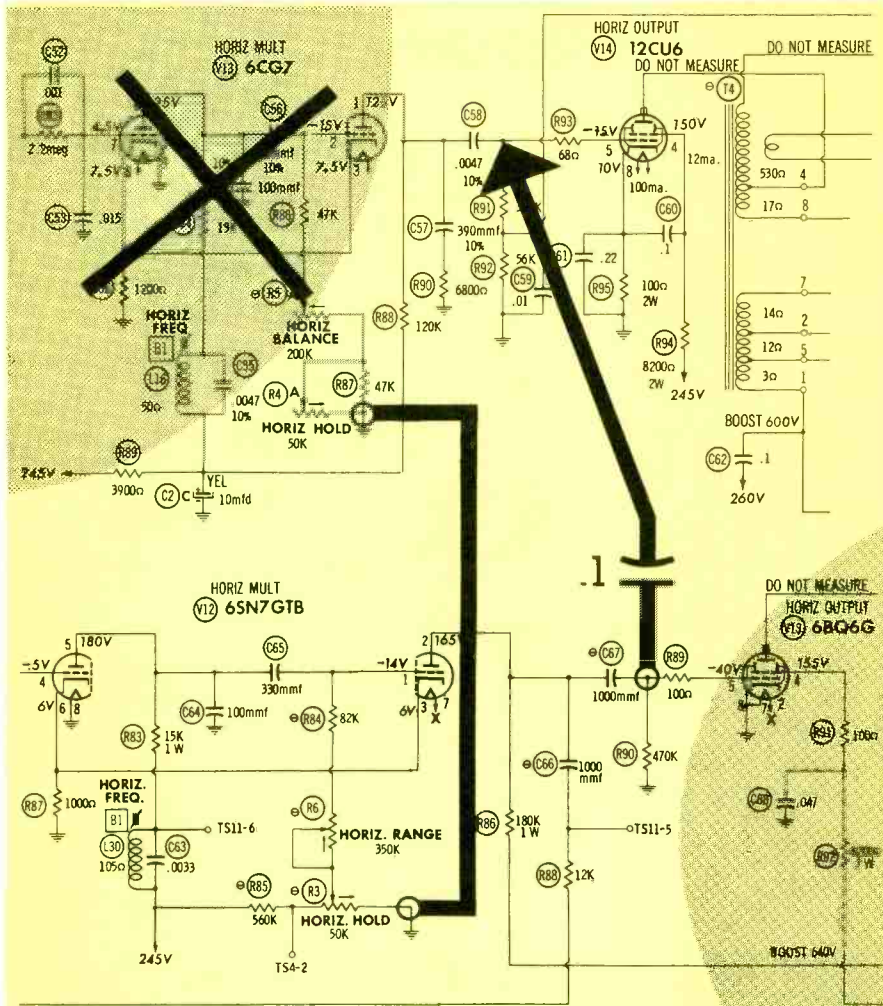

Fig. 2. Oscillator of one TV set used to drive the sweep amplifier of another.



Make a bee line  
for your  
**AUTHORIZED  
SYLVANIA  
DISTRIBUTOR**



-where "first line" dealers  
are buzzing about

**LOWEST COSTS IN**  
*"Silver Screen 85"*

**HISTORY!**

Here's good news, extra profit news, for "first line" dealers who sell up to Silver Screen 85. During the current promotion new low costs make America's most popular picture tube your most profitable first-quality replacement.

Call your Sylvania Distributor right away! Ask him for details about his plan. Then sell up to extra profits on every Silver Screen 85 you install.

**Authorized  
SYLVANIA  
Distributor**

SILVER SCREEN 85 PICTURE TUBES  
RECEIVING TUBES  
INDUSTRIAL PRODUCTS



**SYLVANIA**

SYLVANIA ELECTRIC PRODUCTS INC.  
1740 Broadway, New York 19, N. Y.  
In Canada: Sylvania Electric (Canada) Ltd.  
P. O. Box 1190, Station "O" Montreal 9

LIGHTING • TELEVISION • RADIO • ELECTRONICS • PHOTOGRAPHY • CHEMISTRY-METALLURGY

March, 1959/PF REPORTER 19

# WHEN CUSTOMERS ASK—IS RCA provides you

**ALL-NEW**

## RCA Silverama<sup>®</sup>

SILVERAMA is RCA's premium picture tube—that means *tops* in the industry! Manufactured with all-new glass and parts, it's the finest picture tube made—for the customer who prefers and *expects* the very best.

Command premium price and profits! Sell RCA SILVERAMA with *assurance* that you are delivering a completely all-new picture tube.

### A CHOICE OF RCA PICTURE TUBES TO MEET THE DEMAND OF TWO MARKETS

If your customers want the best that money can buy, offer them RCA SILVERAMA...the picture tube that's ALL-NEW through and through. If they want the economy of a rebuilt tube, offer them RCA MONOGRAM...there's no finer rebuilt made. Either way, you provide the *quality* assurance of the RCA name...a real quality choice for your customers...a real opportunity for you to simplify both your buying and selling by offering the best in TV picture tubes.



**GET FULL DETAILS FROM YOUR AUTHORIZED RCA DISTRIBUTOR TODAY**

**IT NEW OR REBUILT?**

**with a positive answer!**

**FACTORY-REBUILT**

## RCA Monogram

RCA MONOGRAM...no finer rebuilt picture tube made. Factory-rebuilt by RCA to quality standards, this tube assures dependable performance and fewer call-backs. It is backed by a brand name *you sell* with confidence—a brand name your customers *buy* with confidence.

Yes, top rebuilt quality at economy prices makes RCA MONOGRAM your best buy for picture tube replacements where price is the primary consideration.

**BACKED BY THE GREATEST  
PRE-SELLING CAMPAIGN  
IN PICTURE TUBE HISTORY!**

To make sure your customers know the full story...and all the advantages of using either RCA SILVERAMA or RCA MONOGRAM for replacement in their TV set, there's a big, big advertising program scheduled by RCA.

Hard-hitting ads that pre-sell for *you* are appearing in LIFE, SATURDAY EVENING POST and TV GUIDE. You'll see hard-selling commercials on top TV shows. You'll hear regularly-scheduled radio commercials. And your RCA distributor can supply you with everything you need...from window displays to your own ad mats.



**RADIO CORPORATION OF AMERICA**  
Electron Tube Division  
Harrison, N. J.

Dealer JOHN G. ALTMeyer Says...

# "Mallory Components are Best

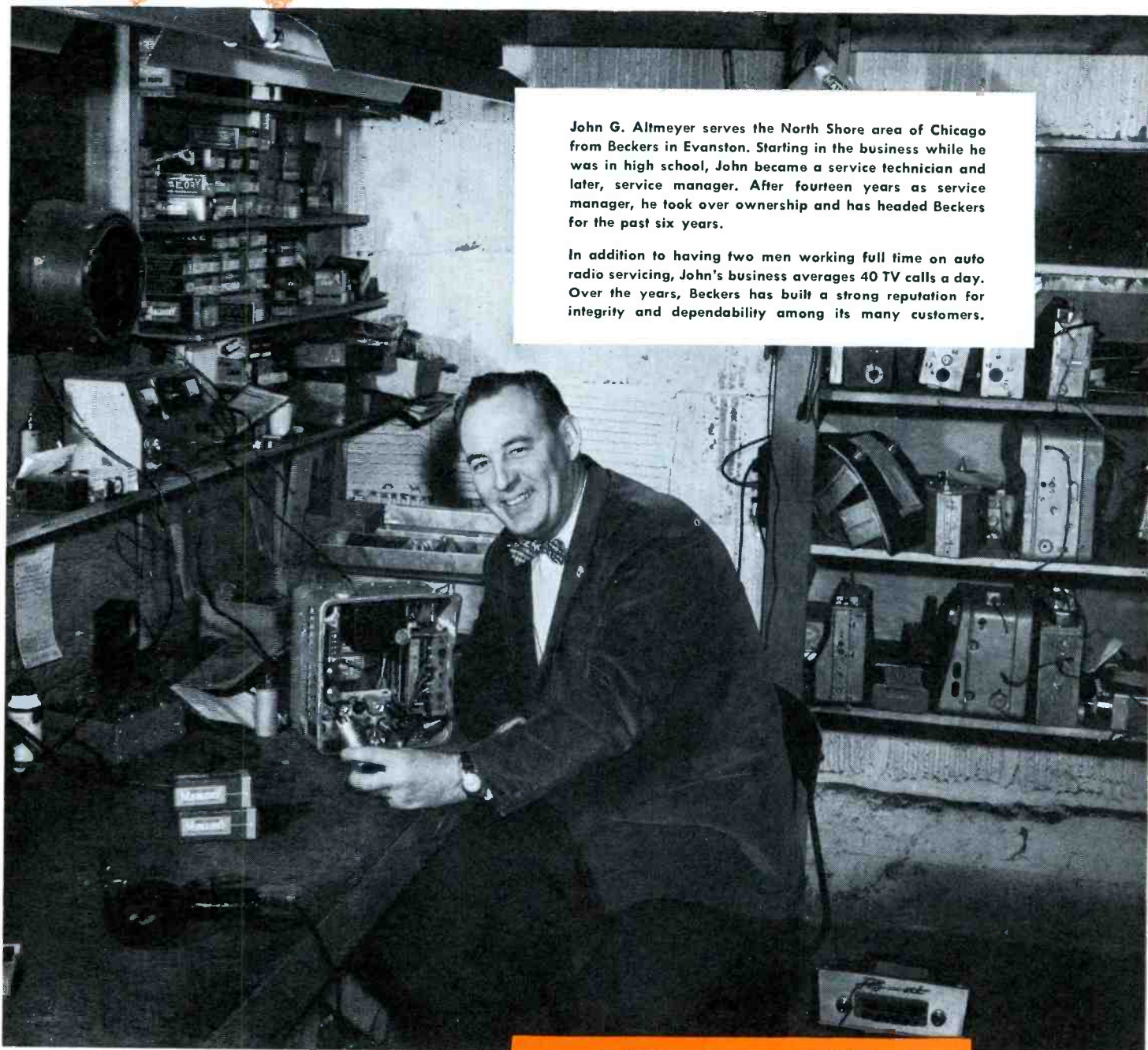

John G. Altmeyer serves the North Shore area of Chicago from Beckers in Evanston. Starting in the business while he was in high school, John became a service technician and later, service manager. After fourteen years as service manager, he took over ownership and has headed Beckers for the past six years.

In addition to having two men working full time on auto radio servicing, John's business averages 40 TV calls a day. Over the years, Beckers has built a strong reputation for integrity and dependability among its many customers.

P. R. MALLORY & CO. Inc.  
**MALLORY**  
P. R. MALLORY & CO. Inc., INDIANAPOLIS 6, INDIANA

# for Modern Equipment 'Trouble Spots'”

“Modern car radios—for example—need quiet vibrators . . . that’s why we replace with Mallory.

Today’s automobiles are engineered for a quieter, more pleasurable ride. A noisy vibrator in a car radio stands out immediately. Our servicemen use Mallory Vibrators for all replacements. We’ve found that they’re quieter and more dependable. The Mallory buttonless contact design adds to their longer, trouble-free life.”

Whatever component you need for servicing—capacitors, controls, resistors, silicon rectifiers or batteries—you get the highest quality at sensible prices from Mallory. It’s the widest line of parts in the industry . . . and every model is service-engineered to assure you that each job is right the first time, every time.

## Stop Callbacks with These Quality Mallory Products . . .



**Gems**—5 rugged, moistureproof, Mallory “Gem” tubular capacitors in an easy-to-use dispenser that keeps your stock fresh and clean—easy to find—no more kinks in lead wires. They’re your best bet for outstanding service in buffer, bypass or coupling applications.



**RMC Discaps**®—are a product of the world’s largest producer of ceramic disc capacitors. Long the original equipment standard, Mallory RMC Discaps are now available for replacement. They come in a handy 3” x 5” file card package . . . easy to stock, simple to use.

® Trade Mark of Radio Materials Company, a division of P. R. Mallory & Co. Inc.



**FP Electrolytics**—The Mallory FP—the original 85°C capacitor—now has improved shock-resistant construction and leakproof seal. Its etched cathode construction—standard in all FP’s—assures hum-free performance. High ripple current ratings fit the toughest filter circuits.

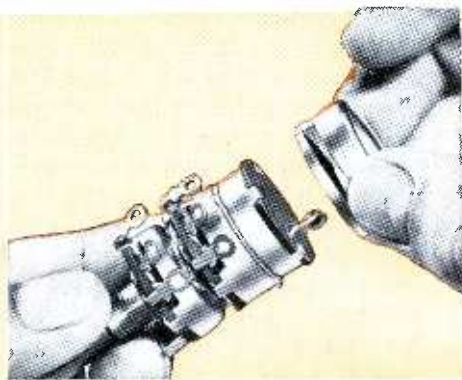

**Sta-Loc\* Controls**—New Sta-Loc design enables your distributor to custom build, in just 30 seconds, over 38,000 combinations—eliminates waiting for out-of-stock controls. You can replace the line switch by itself, without unsoldering control connections.



**Gold Label\* Vibrators**—On critical auto radio servicing, use the Mallory Gold Label Vibrator. It gives longer, trouble-free service life. Mallory Gold Label Vibrators feature Mallory exclusive buttonless contact design.

\*Trade Mark

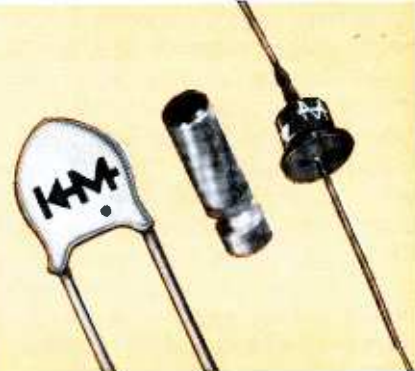

**Silicon Rectifiers**—New Mallory design gives far longer life, lower forward voltage drop, and reverse leakage current than conventional types . . . exceed the requirements of military humidity tests. In convenient kits for replacement of selenium rectifiers in radio and TV.



# Getting Acquainted With COMMUNICATIONS RECEIVERS

## *How they differ from standard sets, and hints on checking their performance*

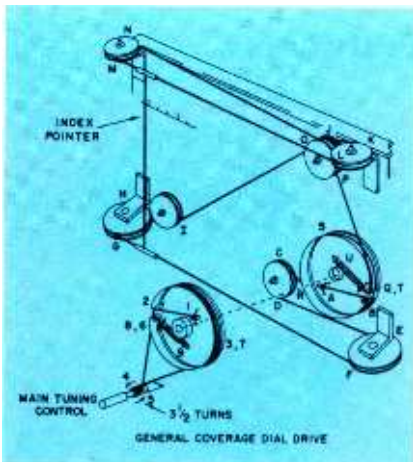

Fig. 1. General coverage dial drive system used in Hallicrafters SX-71 receiver.

The servicing of communications-type receivers can be quite a profitable business. Although the maze of controls on their front panels makes them appear quite complicated, actually they're not. Circuitry is conventional, and the added features can simplify servicing, rather than make it more difficult. No special test equipment is needed; the shop signal generator and oscilloscope can be used to supply the precise alignment frequencies required, if they are checked against frequency standards. Only the alignment and recalibration of communication receivers demands a certain degree of special skill, and this is not difficult to attain. Service techniques are the same as those used on home and auto radios, but should command a premium price, because of the extra time required.

The basic difference between communications receivers and "home sets" lies in the frequency coverage. In small sets this will extend from the broadcast band up to about 18 mc, in medium-sized sets

up to 40 mc, and in the more elaborate sets, up to 45mc, with the addition of the 144-mc band or the 40-mc "ham FM" band. Some highly specialized sets, such as the Collins 75-A series, and various Hammarlunds, do not include the standard broadcast band at all, covering only those frequencies used by amateurs, up to the 2-meter band (144 mc).

These frequencies are divided into several bands. A National NC-99, for instance, uses four bands: 550-1750 kc, 1.4 to 4.8 mc, 4.7 to 16 mc, and 14.5 to 41 mc. Other receivers divide the frequency coverage differently, but the principle is the same.

### Special Features

Special controls are added to a standard radio circuit to make a communications set. These, along with explanations of their purposes, are listed in Table I. All communications sets have some of these, and some have them all; they are always very plainly marked.

Most of these sets are housed in metal cabinets; fiberboard back covers are usually used. In many designs, the chassis does not come out of the cabinet; the large number of controls mounted on the front panel makes such removal difficult. Two methods of access will be found. Hallicrafters and some others fasten the front panel directly to the chassis pan. The cabinet is a metal sheath fastened to the front panel by small screws. With these removed, the cabinet may be slipped

off the back. Others fasten cabinet and front panel solidly together, and access to the underside of the chassis is gained by removing a bottom cover plate, which may be of fiber or metal.

Dial drives (see Fig. 1) are often quite elaborate due to the long dial scales used; the bandspread dial will have its own cable drive system. In some sets, these are quite difficult to repair or replace because they are concealed between the panel and a backing plate. Others are not quite so inaccessible. The larger sets use gear trains, and direct mechanical drive for both main tuning and bandspread. Fortunately, these give very little trouble.

### Circuit Features

Electrically, these sets are similar to the standard home radio; however, most use at least two stages of IF amplification and a tuned RF-amplifier stage. Some use pentagrid tubes for combination oscillator-converter stages, while others use a triode oscillator such as a 6C4 or 6J5 with a 6AU6 or something similar as mixer. IF amplifier tubes are remote-cutoff pentodes (6BA6, 6BD6, etc.), and all but the smallest sets use power transformers and rectifier tubes. Some of the small sets are AC/DC types, using the familiar lineup of series-string tubes (12BA6, 12BE6, etc.). Filtering and decoupling is much more elaborate; many sets use separate screen-dropping resistors and bypass

• Please turn to page 61

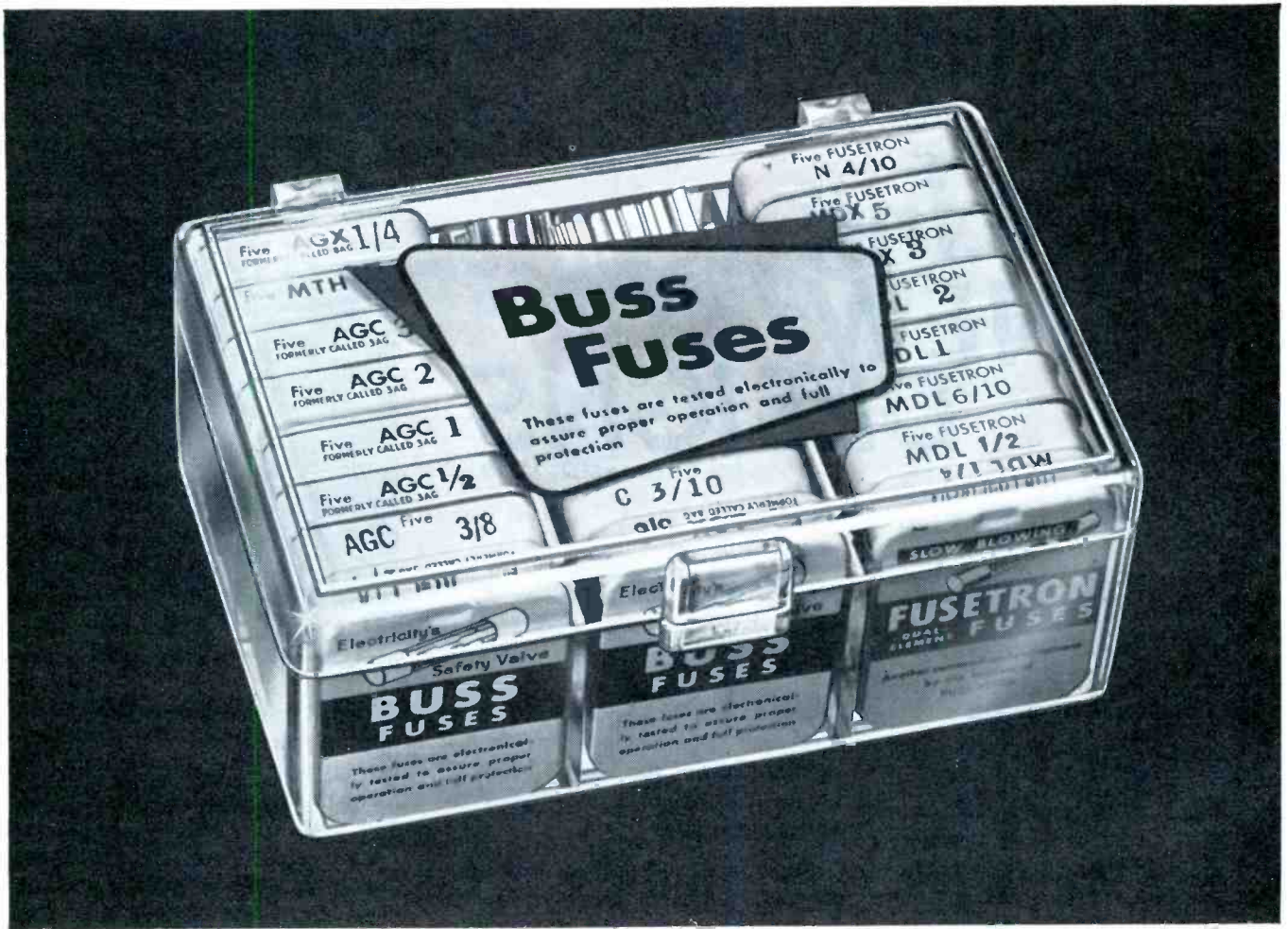

## A CONVENIENT WAY TO HAVE THE RIGHT FUSE WHEN YOU NEED IT

### BUSS fuse TV service kit assortment

Call-backs because you lacked the right fuse are costly — so why not carry an assortment of fuses that will supply the fuse you need.

Fuses are selected for the BUSS Fuse Kit on the basis of popular demand, which practically assures you of having the right fuse for any job.

The fuse boxes will not spill, scatter or be lost, as the kit keeps the boxes neatly arranged.

Your inventory problems are simplified too. One order takes care of your fuse requirements for some time. The clear plastic box enables you to tell at a glance what sizes need to be reordered.

Order the BUSS Fuse TV Service Kit from your distributor today.

#### BUSS fuses have ready customer acceptance

Over the past 43 years, millions upon millions of BUSS fuses have provided dependable electrical protection in homes, industries and on farms. Using BUSS, the Known brand of fuses, saves you time and helps you build your reputation for service and reliability.

*For more information on BUSS and FUSETRON Small Dimension fuses and fuseholders, write for bulletin SFB.*

**BUSSMANN MFG. DIVISION, McGraw-Edison Co.**

University at Jefferson, St. Louis 7, Mo.



BUSS makes a complete line of fuses for electronic, commercial, industrial, automotive, farm and home use.

# servicing NEW DESIGNS

by Thomas A. Lesh



Fig. 1. Audio Baton has separate gain controls for nine different octaves.

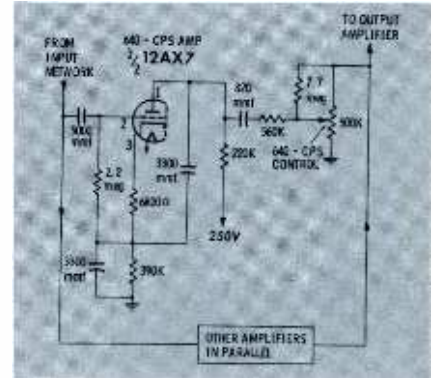

Fig. 2. 640-cps amplifier in Audio Baton is one of eight parallel circuits.

## Tone Control De Luxe

Although we are used to thinking of high-fidelity sound in terms of flat frequency response from 20 to 20,000 cps, the response curve of a hi-fi amplifier must often be deliberately *unflattened* to compensate for frequency distortion which may be introduced by the signal source. Controls for this purpose are usually included in preamplifier circuits. Frequency-response adjustment in its simplest form requires only a tone control—or perhaps separate bass and treble attenuators. More advanced types of frequency compensators are the equalization switches (with posi-

tions labeled RIAA, LP, etc.) that level out small, characteristic irregularities in the signal outputs obtained from particular types of recordings.

Such controls work well for specific purposes, but there is a limit to what they can accomplish. A greater range of frequency compensation is possible with the Blonder-Tongue Model B-9 *Audio Baton* (Fig. 1), which allows the user to produce practically any frequency-response pattern he chooses. This instrument receives the output of a hi-fi preamplifier and splits it among eight parallel amplifier stages, each of which is

designed to pass only a narrow portion of the audio spectrum. The various amplifiers are tuned to the following frequencies: 40, 80, 160, 320, 640, 1280, 2560, 5120, and 10,240 cps. Note that each frequency is twice as high as the previous one; this means that each circuit will amplify a different octave in the musical scale.

You may be wondering why *nine* frequencies were listed for only eight amplifiers. This is explained by the fact that one circuit contains a crossover network so that it can handle both the 40- and 10,240-cps bands. The other seven

• Please turn to page 65

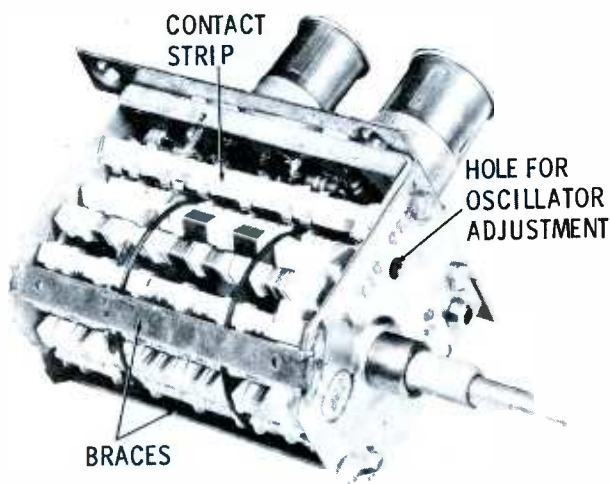

(A) Front cover and fixed contacts.

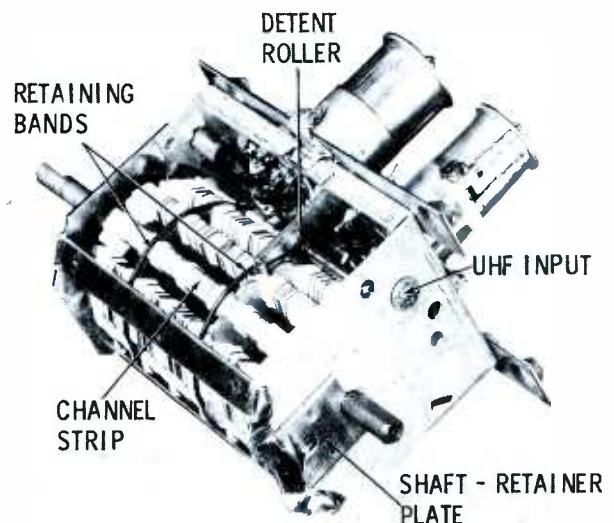

(B) Rear cover and detent mechanism.

Fig. 3. Sarkes Tarzian "Hot Rod" tuner.



# WANTED

## DEAD OR ALIVE

This tube is dangerous. He is used and worn. He will burn up your customers.

He could, if you gave him a chance, steal your business from you.

He has been cited as subversive by the entire Electronics Industry.

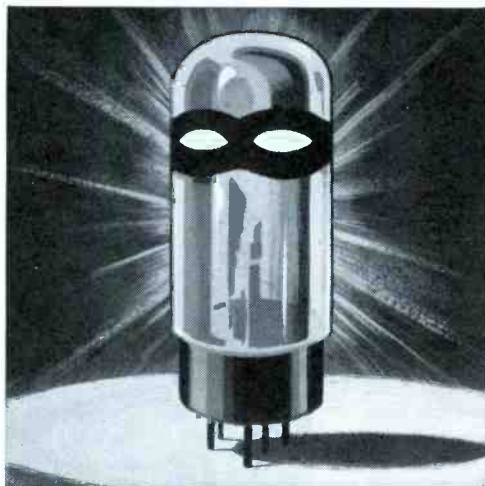

He has wrecked profits and held up business.

He is unwanted by consumers everywhere.

Your Philco Distributor has been deputized to smash him on sight.

He will go out in a set like a thief in the night.

## “TUBE” COUNTERFEITS

# 5¢ REWARD



You will receive 5c credit toward new Philco receiving tubes for all worn-out tubes you bring in. We'll smash 'em right before your eyes. Join with Philco to smash the racketeers.

SEE YOUR  
**PHILCO® Distributor**

# making use of your

# SWEEP GENERATOR

**EDITOR'S NOTE:** This article is based on material from the book *101 Ways to Use Your Sweep Generator* by Robert G. Middleton, published by Howard W. Sams & Co., Inc.



The electronic service shop of today just isn't modern without a good-quality sweep-frequency generator. Of more importance is the fact that the electronic serviceman of today just isn't modern without knowledge of the instrument's use. If your generator is collecting dust in some dark corner, and not working to pay you back for its cost, practice using it in these major applications. Before you know it, you'll wonder how you ever got along without this invaluable piece of equipment. More than that, you'll have customers clamoring for your services, because sets returned from your shop will never have performed better!

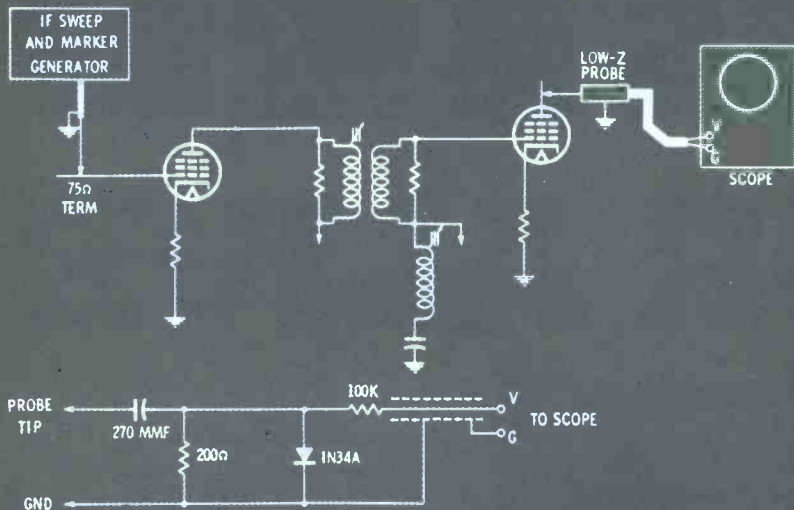

## To Measure Gain of IF Stage

**Other Equipment:** Low-impedance demodulator probe and oscilloscope.

**Connections Required:** Insert a .01-mfd capacitor in series with the "hot" generator lead. Apply an IF sweep signal to the grid of the tube preceding the tuned circuit under test. Connect a low-Z demodulator probe to the plate of the tube following this circuit. This "swamps out" the resonant response of the succeeding circuit and reduces its gain to approximately unity. Feed the probe output to the vertical-input terminals of the scope.

**Procedure:** Apply the probe at the input of the stage under test (at sweep-generator output termination), and then at the plate of the following (second) stage.

**Evaluation of Results:** The ratio between the pattern heights observed during the two tests denotes the approximate gain of the stage. The measurement is in error only by the amount the low-Z probe fails to reduce tube gain to unity. This small difference can be disregarded in practical work.

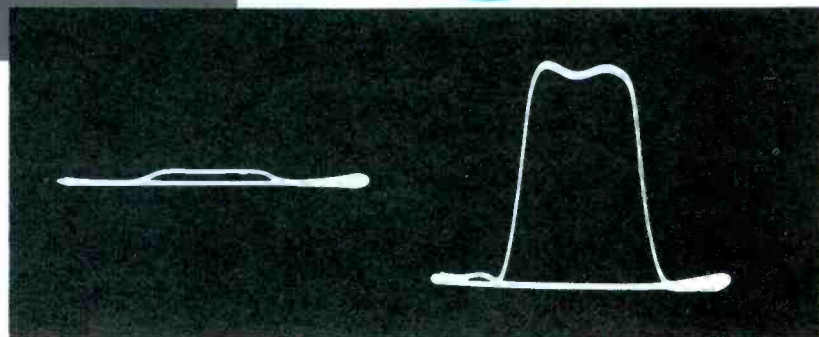

## To Check Response of Chroma Amplifier

**Equipment:** Video-frequency sweep generator, optional video marker, demodulator probe, and oscilloscope.

**Connections Required:** Connect the sweep-output cable to the grid of the chroma amplifier, and the demodulator probe across a low-impedance element in the output of this stage. Feed the output of the demodulator probe to the vertical-input terminals of the scope. Connect the horizontal-input terminals of the scope to the horizontal-sweep jack on the generator.

**Procedure:** Adjust the generator frequency to correspond with center frequency of the chroma amplifier. Adjust sweep width to about 3 mc and marker frequencies to the specified limits for chroma response, noting their positions on the curve.

**Evaluation of Results:** Consult receiver service notes for specified curve shape. Some chroma amplifiers are designed for flat response from about 3.1 to 4.1-mc; however, others are peaked at the high end and may have greater bandwidth, such as 2.1 to 4.1-mc.

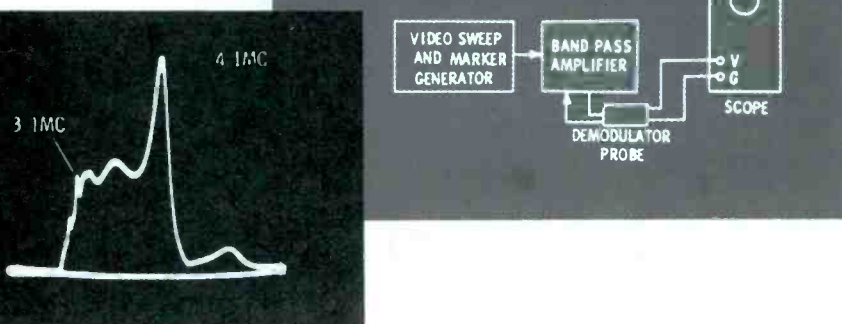

## To Obtain Response Curve of TV Tuner

*Other Equipment:* 50K-ohm isolating resistor, 75- to 300-ohm impedance-matching pad, DC bias box, and oscilloscope.

*Connections Required:* Connect the output cable from the sweep generator to the antenna-input terminals of the tuner through the matching pad. If the set has a transformerless power supply, use a line-isolating transformer. Connect the negative lead from the bias box to the RF AGC bus; connect the positive lead to the chassis and adjust bias potential to about 1.5 volts. Connect the horizontal-input terminals of the scope to the jack on the sweep generator labeled *Phase 60 Cycle*, *CRO Sweep*, or *Horiz. Sweep*. Connect the vertical-input terminals to the looker point on the tuner through the 50K isolating resistor. Ground the scope to the receiver chassis.

*Procedure:* Using maximum available sweep width (10 to 15 mc), tune the sweep generator to the center frequency of the channel under test. Use maximum generator output at the outset, and adjust the scope for full vertical gain. Set the scope controls for external sweep, unblank scope retrace, and adjust the generator phasing control so that the trace and retrace patterns coincide. Blank the retrace, and adjust generator output and scope gain to obtain a pattern of nominal height and width. Consult the receiver service data for tuner alignment adjustments.

*Evaluation of Results:* Curve should appear as illustrated and remain stable when touching any of the instruments or test cables. To avoid "stub" distortion, connect the output of the sweep generator to the antenna terminals as shown, and not directly to the tuner terminals. If the generator is connected to the tuner terminals, the dangling 300-ohm lead acts as an open stub and causes response-curve distortion on some of the channels.

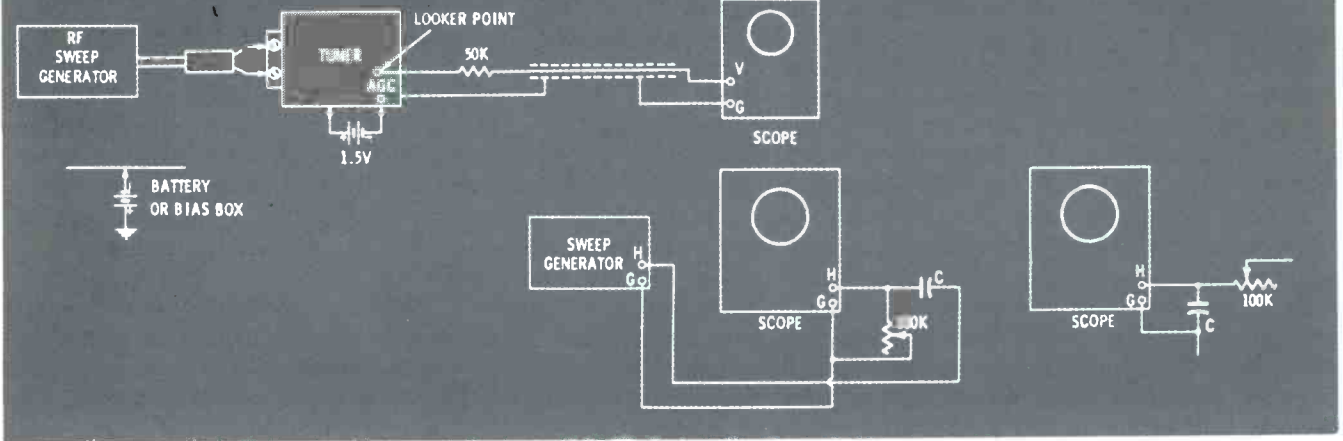

## To Sweep-Align Sound IF and Ratio-Detector Circuits

*Other Equipment:* 50K-ohm isolating resistor, .01-mfd capacitor, and oscilloscope.

*Connections Required:* Using a .01-mfd capacitor in series with the "hot" generator lead, apply sweep (4.5-mc center frequency and 500-kc swing) and 4.5-mc marker signals to the grid of the sound take-off stage as shown. Connect the scope through the 50K isolating resistor to the output of the de-emphasis network.

*Procedure:* Adjust the generator controls to obtain an S-curve display on the scope screen. Adjust the sound-IF transformer slugs and the ratio-detector primary slug for maximum height. Adjust the ratio-detector secondary slug for S-curve symmetry. The 4.5-mc marker must appear in the center of the S-curve; make the necessary touch-up adjustments to place this marker correctly. To make the 4.5-mc marker more visible during the sweep alignment procedure, disconnect the stabilizing capacitor. In waveform A, the marker appears expanded on the curve because sweep width is relatively narrow. An increase in sweep width improves marker definition.

*Evaluation of Results:* When you have achieved an S-curve having optimum amplitude and symmetry, with the 4.5-mc marker riding exactly at the point where the curve crosses the base line, you have completed alignment of the sound system. This should produce not only maximum fidelity but also maximum noise immunity.

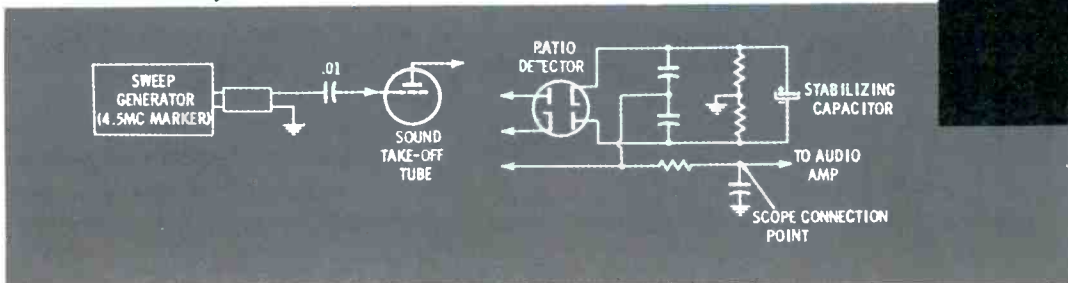
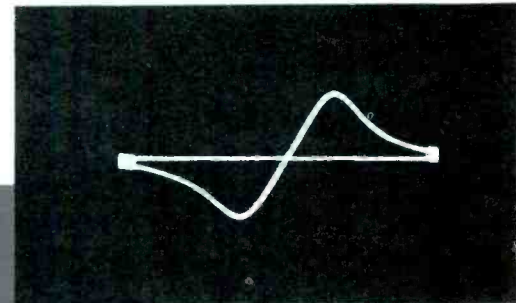
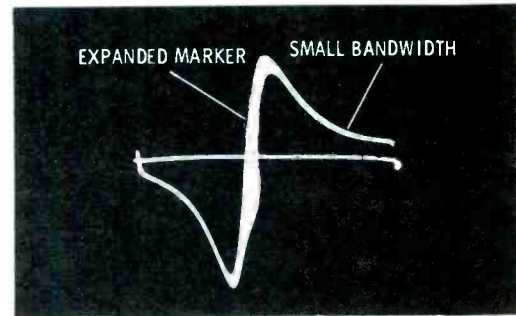

FORWARD AND  
REVERSE RELAYS

CONTROL  
TUBES

ARMATURE  
THYRATRONS

by Melvin Whitmer

# AUTOMATIC MOTOR-SPEED CONTROL SYSTEMS

Rotary machinery is required in the manufacture of practically all products. For example, the television industry requires rotary motion for the manufacture of control shafts, assembly parts, picture tubes, and coils. Another example is the automotive industry, where rotary power is necessary for lathes, grinders, borers, and milling machines. This power is supplied by electric motors—the muscles of modern industry.

Constant machine speed is often vital. Consider the milling machine, which requires constant cutting speeds to provide close tolerances and smooth finishes for the completed product. The cutting tool may vibrate or chatter at some speeds; therefore, cutting speeds are carefully selected for optimum performance. Since motors tend to change speed in inverse proportion to the cutting loads placed on the tool, however, automatic speed-control systems must be used.

AC motors are used where speed control is not required. Their speed of rotation depends primarily on the

number of armature poles and the frequency of the applied voltage, and neither of these can be conveniently varied. Thus, if AC motor speed is to be controlled, it must be done mechanically, such as varying clutch slippage or brake load.

DC motor speeds, however, depend on magnetic field flux and armature voltage, both of which are controllable electronically. Since DC-motor field flux is proportional to field current, reducing field current reduces field flux, which in turn increases motor speed. Reducing armature current reduces armature voltage, and a reduction in armature voltage reduces motor speed. These controllable features make DC motors ideal for use where constant speed control is required.

Most electronically-controlled DC motors are shunt-connected; i.e., the armature and field windings are in parallel across the supply. Also, each has a rectifier of its own (see Fig. 1). Shunt-wound motor speed is self-regulating to about 5% of the difference between no-load and full-load speeds. With a series mo-

tor, however, armature and field windings are connected in series, and speed is not self-regulating. This is due to the fact that a change in load will change both armature and field current.

## Motor Reactions

Motor speed for a given armature voltage is limited by an opposing voltage (counter electro-motive force or CEMF) induced in the armature. This induced voltage increases as more magnetic lines are cut in a given time, and thus varies with motor rpm. Fig. 2 illustrates the effect of CEMF, which is simulated by the battery in series with the armature. The voltage applied to the armature is the rectified voltage minus the CEMF. Previously, motor speed was described as a function of armature voltage; now, the speed is shown to be determined by CEMF. These statements are not contradictory; armature voltage does control speed, but CEMF subtracts from armature voltage. As motor speed increases, CEMF also increases, reducing the effect of

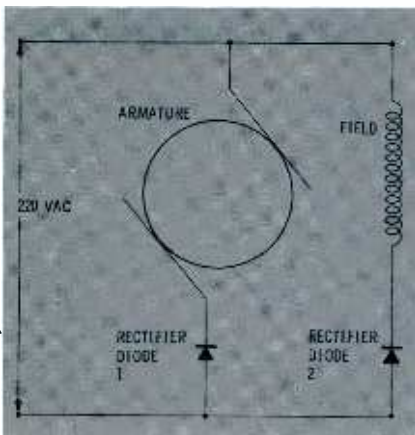

Fig. 1. Diagram for a shunt-wound DC motor. (Note separate rectifiers.)

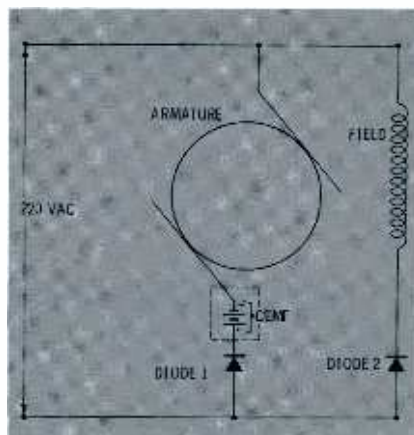

Fig. 2. Polarity of counter electromotive force opposes the armature voltage.

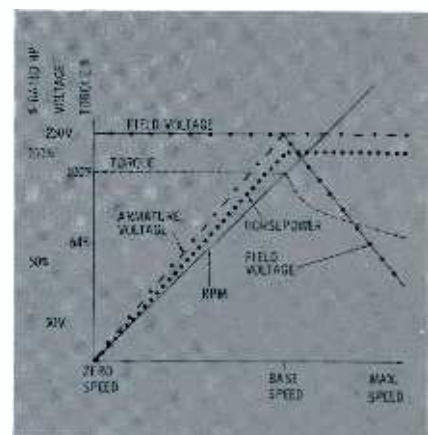

Fig. 3. Relationship between motor voltages and torque, speed, horsepower.

armature voltage and thus limiting armature current. This action provides the maximum limit for any given values of armature voltage and field current.

The speed range of a motor may be controlled from zero to rated base speed by electronically regulating the armature supply voltage. Base speed is reached when CEMF, added to the voltage required to replace frictional losses or load, equals the supply voltage. Lower speeds are obtained by reducing armature supply voltage.

Increasing motor speed over rated base speed is accomplished by reducing the field voltage and, consequently, field current. Reduced field voltage alters the CEMF supply voltage relationship by reducing the number of magnetic lines in the armature path. Thus, high speeds are attained by reducing the CEMF produced by the field flux. The maximum speed obtainable by field reduction is limited by the minimum safe field voltage (usually 50V).

What has just been said boils down to this. Three types of operation are possible with electronic motor controls: constant torque, constant speed, and constant horsepower. The error voltage in each type of operation is obtained by sensing a different motor property; i.e., constant-torque control senses armature current, constant-speed control senses armature voltage, and constant horsepower control senses both armature current and voltage.

The motor voltages, torque, speed, and horsepower are graphically represented in Fig. 3. Note that armature voltage increases linearly up to base speed, while field voltage remains constant. Above

base speed, field voltage reduces linearly, while armature voltage remains constant.

The torque or turning force of the motor can be constant up to base speed. Torque is proportional to field flux times armature current. Since the field voltage is at full value, and therefore constant below base speed, the only variable is armature current. Constant torque is available below base speed by controlling armature current. Over base speed, field flux decreases because the speed is obtained by reducing the field voltage; thus, torque can no longer be held constant above base speed.

Horsepower is limited by maximum armature current and voltage, and therefore can be constant only at base speed or higher.

### Torque Control

Fig. 4 shows a simple way of controlling armature current. Torque control R3 shifts the phase of thyatron grid voltage with respect to the phase of the plate voltage. Setting R3 for maximum resistance produces the phase shift of 160° shown by W3. This is the minimum torque point, permitting the thyatrons very short conduction periods. When R3 is minimum, phase shift is minimum (15° as shown by W2). This permits maximum thyatron conduction time.

Once the torque control has been set, sensing resistor R5 maintains the torque at that level. Armature current is the only variable item, and an increase in current will cause an increased voltage drop across R5. Since this voltage is between the thyatron cathodes and grids it acts as bias. Thus, a greater voltage

across R5 increases bias, decreasing conduction, and reducing armature current. If armature current decreases, voltage across R5 decreases. This allows greater thyatron conduction time, which increases current through the armature.

### Speed Control

Speed control requires a constant armature voltage; therefore, a sampling of the armature voltage, as shown in Fig. 5, is obtained across R2 of the voltage divider R1 and R2. A change in voltage across R2 alters the conduction of V3, and current through the DC control winding of the saturable reactor SR1 shifts the phase of thyatron grid voltage.

Desired speed is adjusted by R3 and maintained by the voltage across R2. For example, a decrease in armature voltage causes an increase in the conduction of V3 and decreases the phase shift of the thyatron grid waveform. This increases the conduction time of V1 and V2. The increased armature current returns the armature voltage to its original value.

Transformer secondary S2 of T1, V5, C1, R4 and V4 form a regulated power supply for the sensing and control tube V3. R3 is in the negative leg to provide grid bias for V3 when the motor is standing still.

### Horsepower Control

The product of armature current and armature voltage is the input horsepower of a motor. When constant horsepower is desired, both these properties must be sensed and

• Please turn to page 75

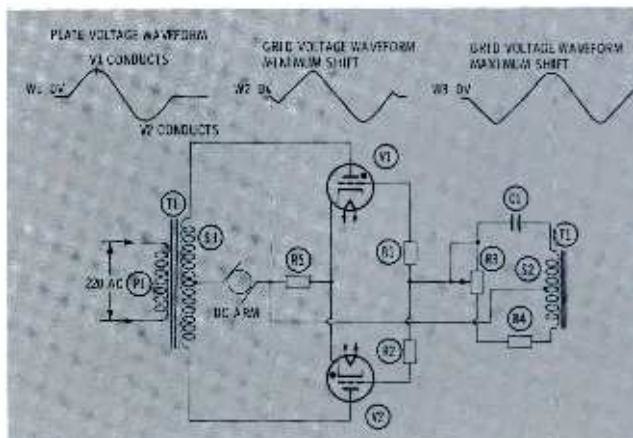

Fig. 4. Schematic of a torque-control system and waveforms illustrating grid-voltage phase shift produced by adjustment

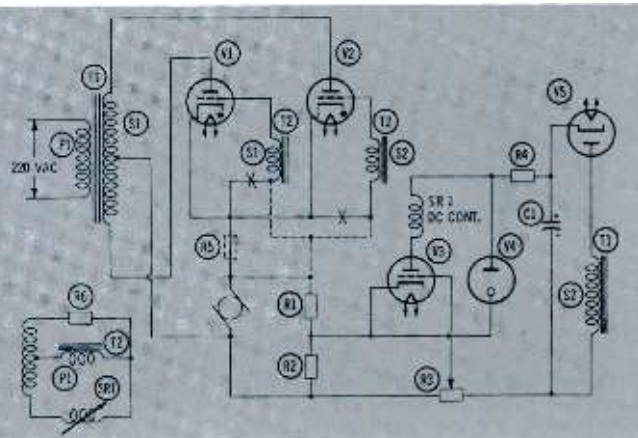
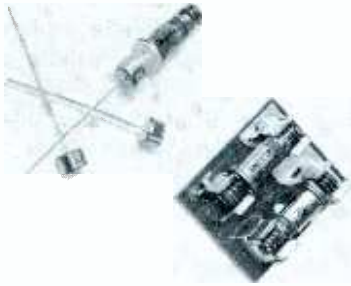
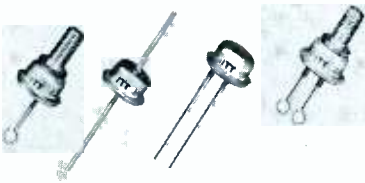

Fig. 5. Schematic of speed-control system with changes shown for converting it into a horsepower-control system



**AUDIO DEVICES**—Model A-750 units may be either clip, stud, or pigtail mounted. Pertinent ratings are PIV 400 volts; DC output .5 amps; forward drop @ full load 1.5 volts; reverse current @ PIV .5 ma; minimum surge resistance 4.7 ohms.



**ITT (FEDERAL)**—Type HE-504, a general-purpose junction diode, has pigtail leads. Ratings are: PIV 400 volts; DC output .5 amps @ 100° C; forward drop @ full load 1.2 volts; reverse current @ PIV .3 ma; minimum surge resistance 5 ohms.



**INTERNATIONAL RECTIFIER**—Type SD-500 is available in kit for clip-in installation. Ratings are: PIV 400 volts; DC output .5 amps; forward drop @ full load 1.3 volts; reverse current @ PIV .7 ma; minimum surge resistance 4.7 ohms.



**P. R. MALLORY**—Type PSR 4050 is also available in pigtail equivalent TSR4050. Pertinent ratings are: PIV 400 volts; DC output .5 amps; forward drop @ full load .5 volts; reverse current @ PIV .5 ma; minimum surge resistance 5 ohms.

# The Silicon Power

*Here's how it performs when placed in*

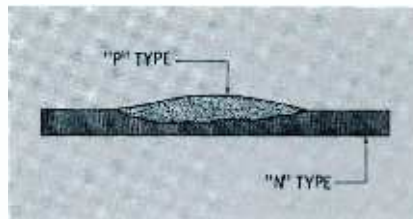

Fig. 1. Basic construction of the silicon junction used in power rectifiers.

The silicon rectifier used in TV power supplies is either a small cartridge- or hat-shaped device that clips into a mounting fixture, or has pigtailed and solders into the circuit. Its small size belies its ability to handle large currents; current capacity is even more amazing when you consider that the rectifier portion of the unit is less than 1% of the total assembly size. By far, the largest portion of the unit is devoted to sealing the rectifier junction against moisture, and terminals which can be connected into a circuit.

Electrically, a silicon rectifier is a junction diode consisting of a slice of "N" type silicon to which a thin layer of "P" type material has been diffused or alloyed (see Fig. 1). The property of such a junction is such that a positive potential at the "P" side causes current to flow very readily, while a negative potential at this point results in almost no

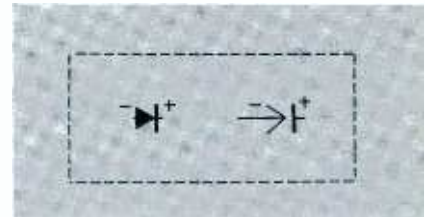

Fig. 2. Symbols normally used to identify semiconductor rectifier elements.

current flow. Forward resistance of the junction is quite low, less than 1 ohm at rated voltage. Reverse resistance, on the other hand, is extremely high, usually as much as 100 megohms. Generally speaking, forward voltage drop will vary between .5 and 2 volts at rated current flow. This small forward voltage drop represents practically all of the power loss; in fact, losses due to inverse current are so minute they can be discounted.

In case you're wondering how a silicon rectifier, small as it is, can have such a high current rating, consider that the current density of a silicon junction is so great that one square inch of effective barrier layer is sufficient to handle 600 to 900 amperes. This means that the junction area for 500 ma need be only 1/1200 to 1/1800 of a square inch. Further, a barrier layer only  $10^{-3}$  cm thick will block a 1000-volt poten-



**RCA**—Types 1N1763 and 1N1764 are hermetically-sealed pigtail units. Ratings are: PIV 400 and 500 volts; DC output .5 amps; forward drop @ full load .9 volts; reverse current @ PIV .1 ma; minimum surge resistance 5.6 ohms.



**RADIO RECEPTOR**—Type PT-5 silicon rectifiers are available in pigtail style only. Ratings are PIV 400 volts; DC output .5 amps; forward drop @ full load 1.5 volts; reverse current @ PIV .5 ma; minimum surge resistance 5 ohms.

# Rectifier Story

*proper service—by Calvin C. Young, Jr.*

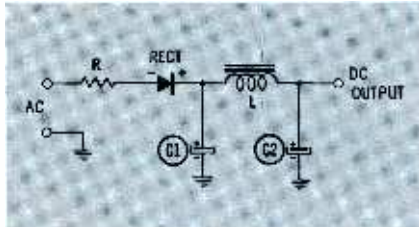

Fig. 3. Half-wave rectifier circuit is the simplest possible configuration.

tial. TV rectifiers are usually rated at 400 PIV; thus, the thickness of the junction needed is only about .0005 cm.

Rectifier action occurs within the solid mass of the fused junction, and the properties of this junction do not vary appreciably with age. For this reason, output voltage in circuits employing silicon rectifiers remains relatively constant. This is why conversion to silicon units in older TV sets alleviates the problem of eventual low B+ voltage and corresponding sweep troubles. Such conversion, however, is practical only if the serviceman is thoroughly acquainted with the facts and takes the necessary steps to insure lasting success. Read on for the facts!

Power rectifiers are usually coded with the semiconductor diode symbol (Fig. 2), or with a plus sign or encircling band near one terminal to designate the cathode. The terminal



RAYTHEON — Types 1N1763 and 1N1764 are pigtail units with PIV 400 and 500 volt ratings respectively; DC output .5 amps; forward drop @ full load .9 volts; reverse current @ PIV .1 ma; recommended surge resistance 10 ohms.

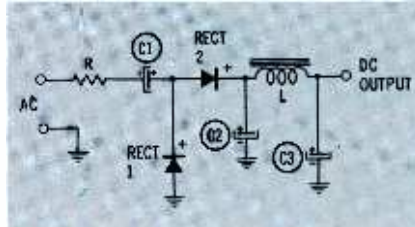

Fig. 4. Output of full-wave doubler circuit equals twice the peak line voltage.

or lead nearest the plus sign, band, or bar portion of the symbol should be connected to the DC side (output) of the rectifier system. Don't become confused because you feel that the cathode should be negative with respect to the anode. Plus symbols on rectifiers designate the element to be connected to the positive terminal of the filter.

## How to Install Silicons

Silicon rectifiers rarely, if ever, require replacement. Should you find a defective one, make sure you check for an abnormal circuit condition that might have caused the failure. Naturally, you must use units of equivalent characteristics for all replacement purposes. Silicon units can be used to replace other semiconductor rectifiers if certain facts are taken into consideration.

• Please turn to page 76

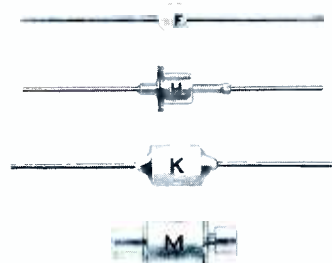

SARKES TARZIAN — Model M-500 has the same ratings as pigtail style 40M, most significant of which are: PIV 400 volts; DC output; .625 amps forward drop @ full load 1.1 volts; reverse current @ PIV .3ma; minimum surge resistance .5 ohms.

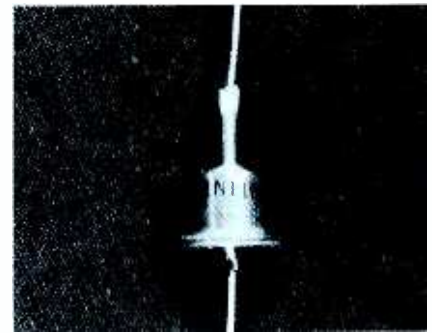

WESTINGHOUSE — Type 1N1169 is a pigtailed unit designed to operate directly from a 130V AC line, PIV is 400 volts; DC output .5 amps; forward drop @ full load .9 volts; reverse current @ PIV 3.5 ma; minimum surge resistance 4.7 ohms.



TUNG-SOL — Type 1N2078 pigtail style is designed for 100°C ambient temperature service. Ratings are: PIV 400 volts; DC output .625 amps; forward drop @ full load 1.1 volts; reverse current @ PIV .25 ma; minimum surge resistance 5 ohms.



TEXAS INSTRUMENTS — Types 1N2070 and 1N2071 are pigtail units with PIV ratings of 400 and 600 volts respectively; DC output .75 amps; forward drop @ full load .6 volts; reverse current @ PIV .2 ma; minimum surge resistance 4.7 ohms.

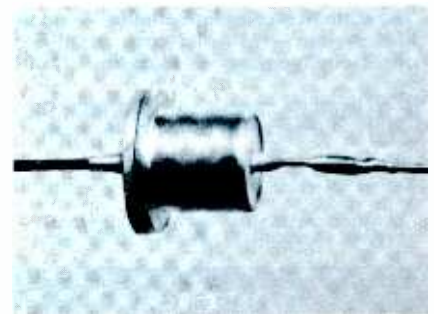

SYLVANIA — Type SR-500 silicon rectifiers are available in pigtail style only. Pertinent ratings are: PIV 400 volts; DC output .5 amps; forward drop @ full load 1.3 volts; reverse current @ PIV 1 ma; minimum surge resistance 10 ohms.

another



hi-fi profit-maker

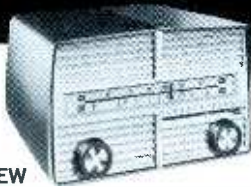

NEW

### FM-AM TUNER

**Model T-88** Provides amazing sensitivity on FM and AM in even the most difficult areas. Plugs into phono, TV or hi-fi system—an extra plus FM sale for you. **List 64.50**

### POWERFUL FM-AM RADIO

**Model R-98** Complete FM-AM radio with unexcelled quality on both FM and AM even in difficult reception areas. **List 64.50**

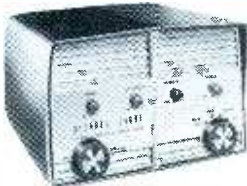

NEW

### DELUXE HI-FI AMPLIFIER

**Model A-1** Four unique frequency controls provide a degree of tonal selectivity unobtainable anywhere at any price in the hi-fi amplifier field. Built-in preamplifier with full function selection. **List 77.50**



### TWIN SPEAKER SYSTEM

**Model SS-2** Two matched 4-inch speakers in an acoustically matched enclosure. Ideal low cost multiple speaker system, or for stereo. **List 15.95**

**You can sell a complete Blonder-Tongue hi-fi system — FM-AM Tuner, Amplifier and Twin-Speakers—for less than \$160!**



**BLONDER-TONGUE LABORATORIES, INC.**  
9 Ailing Street, Newark 2, New Jersey

Canada: Telequipment Mfg. Co. Ltd., London, Ont.

Export: Morhan Export Corp., N. Y. 13, N. Y.

hi-fi components • UHF converters • master TV systems • industrial TV cameras • FM-AM radios

another



hi-fi profit-maker

# TIPS

# for TECHS



### Reputation-Saver Iron Rest

Have you ever accidentally burnt a hole in a customer's rug by having your hot soldering iron unsuspectingly slip from its rest. One such accident as this can spoil a serviceman's good reputation in a matter of minutes! To prevent such an unpleasant incident from happening, carry a large paper clamp, like the one shown, in your tool kit. Slipped over the barrel of the iron it makes an ideal rest — one that your iron just can't slip out of.

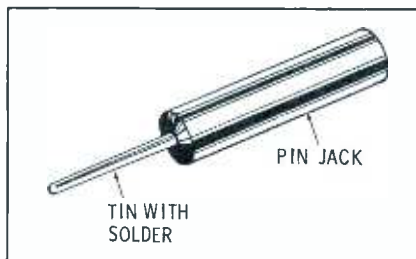

### Tightening Pin Jacks

If the jack pins on the ends of your test leads fit loosely in your VTVM, ohmmeter, or other test instruments, the readings are likely to fluctuate when the leads are handled. To prevent misleading meter readings, tin the pins with a very thin layer of solder. This is better than hammering the ends out of round.

### Electric Drill Holster

Need some sort of holster to keep your electric drill out of the way, yet still conveniently within reach? A bottomless tin can of appropriate size, fastened with wood screws to one end of your service bench, is just the thing for this purpose. Mount the can horizontally, but slant it down at a slight angle so the drill won't accidentally slide out.



### Insulate Your Prod Tips

Ever have your test prod slip and accidentally short a wire to chassis ground or to another wire while you were taking voltage measurements? This kind of accident can easily be prevented by slipping a piece of tight-fitting spaghetti over the tip as shown. If you work with a nervous hand or are using prods with long thin tips, this hint is well worth remembering — especially when you are working on transistorized equipment.

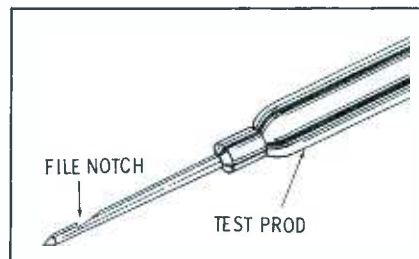

### Notched Prod Tip

If you work with an unsteady hand, you realize just how difficult it is to hold test prods in contact with bare wires and terminals. It's much easier to do this if you file a small slanting notch in the tip of each test prod. This permits you to hook the prod over the wire or terminal and hold it steady.

### Time-Saving Dial Markers

Want to save yourself some time whenever you have to set up the controls of your signal generator or other test instrument? Then don't hunt all over the dial to find such common frequencies as 456 kc, 4.5 mc, 10.7 mc, etc. Mark the dial at these often-used frequencies with tiny arrows or dots cut from plastic tape of different colors.



# AN OPEN LETTER TO TELEVISION SERVICE DEALERS

By Gordon E. Burns, Manager, Distributor Sales,  
Electronic Components Division, General Electric Company

Both to you as an independent service dealer, and to General Electric as a TV manufacturer, the goodwill of set owners is a requisite for success. It is the day-in, day-out work of the independent technician which is the cornerstone of owner satisfaction.

The following quotation emphasizes this. It is from a recent announcement by the manager of product service, General Electric Television Receiver Department:

"The independent service industry has filled an important part of our television marketing activity since the introduction of our first television receivers. Our customers have in the past, and certainly will continue in the future, to depend on the independent service dealer for the vast majority of service rendered on G-E television receivers. It is impractical that we provide all these services through our own resources. Consequently, we must develop communications and relationships with independent service organizations so that we may work together for our mutual benefit and for the benefit of the consumer."

On this solid foundation of G-E service policy, independent service dealers may look forward to building a bigger business, a better business... one to which the public will give increased confidence and respect.

General Electric's service policy and plans feature these significant points:

1. General Electric recognizes that television customer satisfaction depends basically on the work of independent servicemen.
2. Cooperative efforts of set dealers, independent service dealers, and various components of the General Electric Company will offer to G-E set owners the most complete and reliable service in the industry.
3. Improved public opinion of the TV service industry can be built on the philosophy quoted above—thus counteracting derogatory publicity servicemen have received.
4. Flexibility to meet local situations is assured as TV set distributors have authority to alter details of service agreements locally within the framework of this philosophy.
5. "Impracticality" of dotting the country with factory-owned service centers is recognized.
6. Technical assistance and flow of service information will be improved by service schools, courses, cooperative forums and meetings in activities encouraged by this policy.

*Gordon E. Burns*

*Progress Is Our Most Important Product*

GENERAL  ELECTRIC

2-111-203

## Auto Radio Control Replacement is Child's Play

with new **Centralab**  
Exact Replacement Controls



Now one source can fill all your needs for auto radio-replacement controls. CENTRALAB has a new line of exact replacements for every popular radio in use today. This is the first time in history that you have been able to get the auto radio control you need—from a control manufacturer.

It's easy to handle more auto radio repair business—and handle it profitably—when you install exact replacement controls bought from your *regular* supplier. No need to run all around town looking for the right unit—you can now be sure that your CENTRALAB distributor has it!

Besides controls, the line also includes six exact replacement on-off switches (SP Series) for push-button radios, used in Plymouth, Dodge, DeSoto, Chrysler, Ford, Mercury, Lincoln and Hudson.

A complete and thorough guide listing all auto radio controls in use today, and their CENTRALAB equivalents, is now available. Pick up your free copy from your distributor—or write direct to CENTRALAB.



# Centralab

A DIVISION OF GLOBE-UNION INC.  
942C E. KEEFE AVE.  
IN CANADA: 804 Mt. Pleasant Rd. • Toronto 12, Ont.

CONTROLS • ROTARY SWITCHES • CERAMIC CAPACITORS  
PACKAGED ELECTRONIC CIRCUITS • ENGINEERED CERAMICS

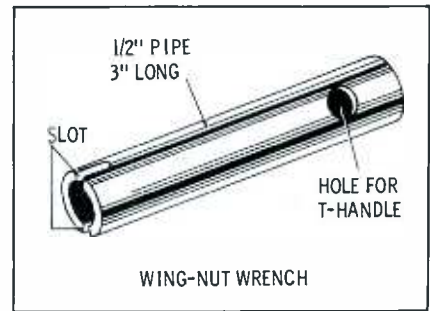

### Wing Nut Wrench

Ever find it difficult to loosen one of those wing nuts on a TV antenna or lightning arrester after it has been exposed to the weather for awhile? You probably had to use a pair of pliers on the nut, and chewed it up in the process. To prevent such woes, make the simple wing-nut wrench detailed in the drawing. It's merely a short length of 1/2" pipe, slotted at one end to fit over the wing nut. A hole drilled through the pipe near the other end lets you insert a metal rod to give the wrench a T-handle for more leverage.

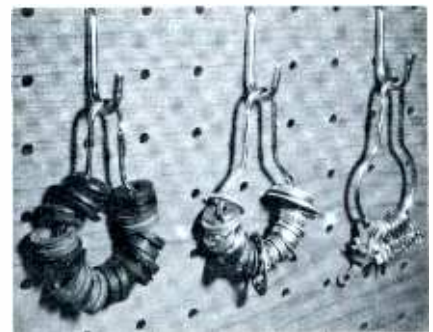

### Ring Racks for Grommets

Keep your supply of rubber grommets strung on a shower-curtain ring as shown for quick selection of a needed size. Hang the ring on your toolboard near the service bench within sight. You can also store nuts, washers, and soldering lugs in where the grommets will always be the same way.

### Hint for Easy Part Replacement

When you have to replace a defective iron-core transformer or other part having a number of color-coded leads, here's how to eliminate the necessity of sketching a wire placement diagram. When you remove the defective part, clip off the color-coded leads so that about an inch is left on each terminal or tie-down point. Then, when you have the new component mounted, all you'll have to do is unsolder and remove the leftover ends of wire, using the color code as a guide for soldering the new leads to the proper terminals.

**SERVICEMEN!**

Now for less than \$25.00

# You can stock PNP TRANSISTORS

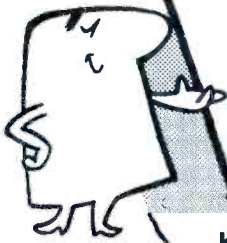

Your Favorite Local  
**WORKMAN TV INC.**  
PARTS DISTRIBUTOR

KNOWS THE EVERYDAY TYPES YOU NEED

- ASSOCIATION CODING FOR EASY IDENTIFICATION (BE6-MIXER OSC, POWER 40-40 WATTS etc.)

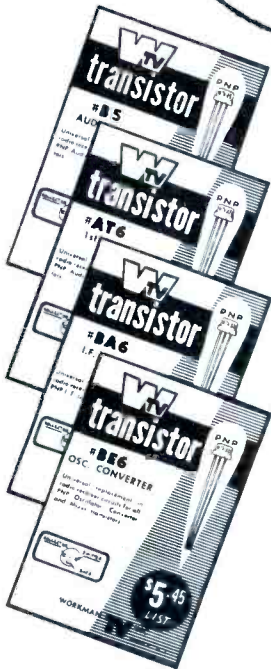

## Only 8 TRANSISTORS

By WORKMAN TV INC.

WILL TAKE CARE OF OVER 200 PNP ENTERTAINMENT TYPE TRANSISTORS USED IN EVERY DAY SERVICE WORK.

Including **AUTO RADIOS!**

- UP TO DATE CROSS REFERENCE SHEET INCLUDED.

*Complete Stock only...*

# \$24.95

Prices higher in Canada

If you HURRY you will receive

# Free!

with this order a 224 PAGE BOOK worth \$2.90 on "SERVICING TRANSISTOR RADIOS"



PUBLISHED BY GERNSBACK LIBRARY, INC., N. Y., N. Y.

Take Advantage of this Limited **FREE** Offer of a book on "SERVICING TRANSISTOR RADIOS"

8 TRANSISTORS IN A PLASTIC BOX

- 1 EACH OF POWER 40
- 1 EACH OF POWER 25
- 1 EACH OF POWER 12
- 1 EACH OF POWER 6
- #BE6
- #BA6
- #AT6
- #B5

*only* **\$24.95**

Prices higher in Canada

Please Ship.....

\_\_\_\_\_ TRANSISTOR SPECIALS @ \$24.95 each deal PLUS a **FREE** Book on "SERVICING TRANSISTOR RADIOS".

Name \_\_\_\_\_

Address \_\_\_\_\_

City \_\_\_\_\_ State \_\_\_\_\_

DETATCH & MAIL COUPON or Dont Wait---Drive down and pick up this deal at your local

## WORKMAN TV INC. PARTS DISTRIBUTOR



# QUICKER SERVICING

By Calvin C. Young, Jr.

## Tips on Phonos

In recent months, I have encountered several phonographs plagued by troubles other than complete failure. These troubles were not easy to find, even though the actual solution was very simple. Take the case where the unit seemed to be okay mechanically, yet sound was distorted. Since volume was adequate, the cartridge was not suspected. The stylus was removed and checked under a microscope and found to

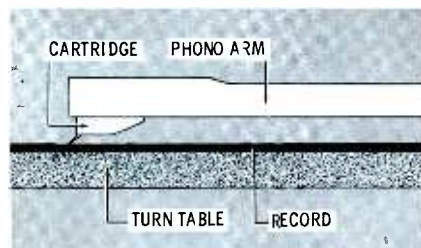

Fig. 1. Crystal cartridge has a bent stylus, which results in distorted sound.

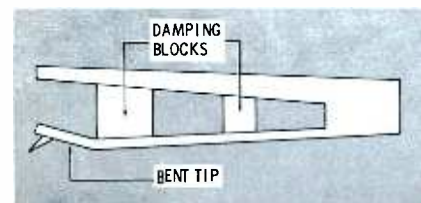

Fig. 2. Bent tip of this stylus permits cartridge body to drag on the record.

be only slightly worn—not enough to cause the distortion. The stylus was reinstalled and checked visually as it rested in the record groove. Only then did I notice that it did not engage the groove at a normal angle (see Fig. 1). In fact, it seemed to be bent. The needle was straightened with a pair of needle-nose pliers, and the distortion was no longer evident. Being the nosy sort, I naturally wondered why and how the needle had become bent. My trusty gram scale provided the answer—15 grams of weight, about double what it should have been for this cartridge. Adjustment for the correct weight and installation of a new needle completed the repair. The bent stylus had caused the distortion because it could not engage the grooves at the correct angle and therefore, could not follow the more minute modulations.

## Okay on 33 and 45, Erratic on 78

Just about every serviceman in the business knows that a changer will balk during the 33-rpm change cycle if it is going to balk at all; thus, it is not unusual to check cycling on 33-rpm and assume operation will be okay for the other

speeds. In this particular case, the customer was a consistent user of 78-rpm records, so operation was checked on 78-rpm. It proved to be erratic, although everything was fine at 33- and 45-rpm speeds.

The source of the trouble was finally located while viewing the underside of the unit and switching the mechanism back and forth between 78 and 45. The rubber grommets, through which the motor assembly mounted, had hardened and developed elliptical center holes. When the unit was shifted to 78-rpm, the rapid movement of the mechanism caused the motor assembly to shift around in the enlarged grommets. Forty-five cents worth of new grommets cured the trouble.

## Scraping Noise — Low Output

Because of the scraping noise, the first thing checked was the area where the stylus engaged the record. I noticed at once that the cartridge seemed to drag on the record. A check of the stylus, a diamond, revealed that it was bent at the tip. This case involved a cartridge which, even under normal conditions, doesn't have very much clearance. Because the stylus was a diamond and because it wasn't at all worn, it was very carefully straightened. Luckily, the bend was at the extreme tip (Fig. 2), and the repair was successful. Remembering the previous case, stylus pressure was checked to determine the initial cause of the trouble, but this time it was found to be correct. Questioning the customer disclosed that the arm had been roughly treated during a holiday party. (Whoopee!)

## Magnetic Cartridges and Stereo

Hum can well be a problem when installing magnetic cartridges in phonographs or turntable assemblies

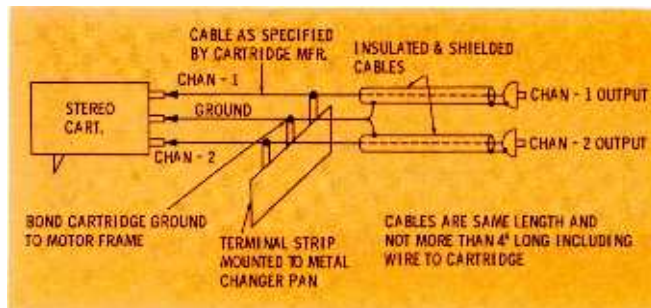

Fig. 3. Hookup details for a three-wire stereo cartridge; amplifier and AC supply are contained on a single chassis.

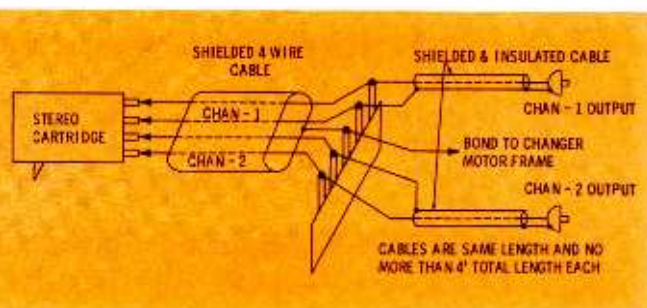

Fig. 4. Hookup details for a four-wire stereo cartridge; the amplifiers are powered separately from the AC supply.

# The **SIMPSON 260** TRADEMARK outsells all other VOMs combined!



Buy the VOM that's famous for  
ruggedness and dependability

**260**  
VOLT-OHM-MILLIAMMETER  
AC-DC

---

**\$43<sup>95</sup>**

Complete with Leads and  
Operator's Manual

Proof that the 260\* is your *best investment* comes from hundreds of thousands of users who have made it the leading VOM over the years. But convince yourself! Take a 260 apart. Check the workmanship and materials. Examine the components. Analyze the circuits. Then put it through its paces in actual day-in-day-out service. You'll soon discover why the 260 is the world's best seller. See your Electronic Parts Distributor for the preferred VOM.

**D.C. Voltage** (20,000 ohms-per-volt):  
0-250mv; 0-2.5 v; 0-10 v; 0-50 v; 0-250 v;  
0-1000 v; 0-5000 v.

**A.C. Voltage** (5000 ohms-per-volt): 0-2.5v;  
0-10 v; 0-50 v; 0-250 v; 0-1000 v;  
0-5000 v.

**A. C. Voltage** (with 0.1 uf internal series  
capacitor): 0-2.5v; 0-10v; 0-50v; 0-250 v.  
**Volume Level in Decibels** (Zero DB equal

to 1 milliwatt across a 600-ohm line): -20  
to +10 DB; -8 to +22 DB; +6 to +36  
DB; +20 to +50 DB.

**D.C. Resistance:** 0-2000 ohms (12 ohms  
center); 0-200,000 ohms (1200 ohms  
center); 0-20 megohms (120,000 ohms  
center).

**Direct Current:** 0-50 ua; 0-1 ma; 0-10  
ma; 0-100 ma; 0-500 ma; 0-10 amp.

\*Trademark

**Simpson** ELECTRIC COMPANY

5209 W. Kinzie St., Chicago 44, Ill.  
Phone: EStebrook 9-1121  
In Canada: Bach-Simpson Ltd.  
London, Ontario

**Plus Profits** for You... now at your

# PHILCO DISTRIBUTOR

Add to your volume and profit... with  
Philco's full line of universal products  
for the Hi-Fi and  
Tape Recorder  
enthusiast



## NEEDLES

- DIAMOND
- SAPPHIRE
- OSMIUM



## ANTI-STATIC SPRAY

Minimizes surface noise  
and insures needle  
glide.



## 45 RPM INSERTS

Custom-built for  
long wear.



## RECORD BRUSHES

Eliminates harmful dust  
from precious  
records.



## FULL-FIDELITY TAPE

Extra strength and  
extra length.

Further evidence of Philco's  
PROGRAM OF COMPLETENESS  
to America's Service Dealers.



COMPLETE PHILCO NEEDLE CATALOG  
Cross references are complete  
... Illustrations are big ...  
Makes selling easy.



WORLD WIDE DISTRIBUTION: Service Parts • Power  
Packed Batteries • Universal Components • Long-Life  
Tubes • Heavy Duty Rotors • Star-Bright 20/20 Picture  
Tubes • Long-Distance Antennas • Appliance Parts  
• Laundry Parts • Universal Parts and Accessories.

for stereo playback—that is, unless adequate precautions are taken.

The primary consideration is whether or not the amplifier chain employs more than one power supply. If the entire amplifier is contained on a single chassis and employs a single supply, a three-terminal cartridge can be used to good advantage. The correct hookup in this case is illustrated in Fig. 3. Hum can be further reduced by seeing that the polarity of the AC source is the same for both changer and amplifier. If, after determining the polarity connections that produce zero or minimum hum, the changer is plugged into the AC receptacle on the amplifier, the correct relationship will always be maintained.

If two separate amplifier systems are employed, the hookup shown in Fig. 4 will produce minimum hum level; it will also provide isolation if one of the amplifiers uses an AC-DC type circuit. Again, hum can be minimized by getting all of the various units plugged into the AC line in phase. Experiment a little and find the AC connection that produces minimum hum. Better yet, measure between the changer and the two amplifier systems to make sure there is no potential difference between the chassis or metal cabinets of the various units. Besides reducing the hum level, this procedure will eliminate (before it begins) any tendency toward motorboating due to the presence of a ground loop in the system of interconnecting cables.

### Replacing Horizontal AFC Diodes

When vacuum tubes are used in the horizontal AFC system, the serviceman has no difficulty determining if they are the root of his trouble; he simply installs an exact replacement from his stock of tubes. However, when dual selenium or silicon diode units are used, he normally doesn't have substitutes on hand. In fact, an exact replacement may not be too easy to come by in some

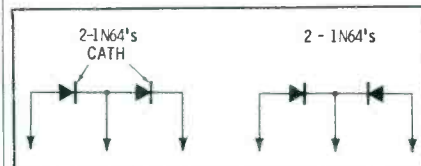

Fig. 5. Matched 1N64's connected in series and with common cathodes.

**PHILCO®** Famous for Quality the World Over

# the BIG NAME

in radio and TV  
replacements



good  
and  
fast!

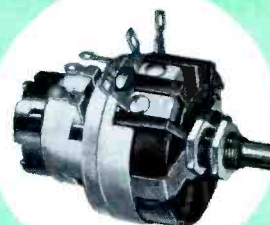
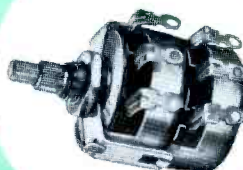
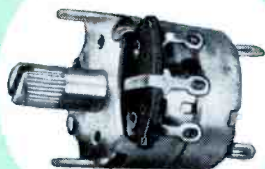

Right from the carton — right for the set! That's the way RTV<sup>®</sup>  
components work — no fuss, no muss — every RTV is right in every  
respect. Over 550 "RTV" models assure the right  
replacement for practically every radio or television control.

# 550

more good reasons  
for always saying



CLAROSTAT MFG. CO., INC., DOVER, NEW HAMPSHIRE



"RUSH CALL, GUS! DISC JOCKEY NEEDS A NEW STEREO CARTRIDGE... FANS ARE GIVING HIM THE NEEDLE!"

Never a worry in the world when you install a Webster cartridge. Even "amateur" hi-fi and stereo fans recognize professional quality reproduction when they hear it!

Recommend and install Webster cartridges every time... then you and your customers will make beautiful music together.

**REPLACE WITH WEBSTER STEREO...IT PAYS!**

stereo-ceramic...

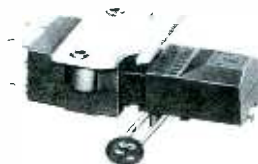

**SC-3D Stereo turn-under**  
— with .7 mil diamond  
and 3 mil sapphire styli.  
\$25.00\*



**SC-2D Stereo single needle**  
— with .7 mil  
diamond stylus.  
\$22.50\*



**MC-2 78 rpm single needle**  
— with 3 mil  
sapphire stylus.  
\$7.50\*

\* List prices — standard discounts apply.

**ELECTRONICS DIVISION**

**WEBSTER ELECTRIC**  
MELROSE 3-3511  
RACINE · WIS

our **50**th year

franklin adv. Y 132

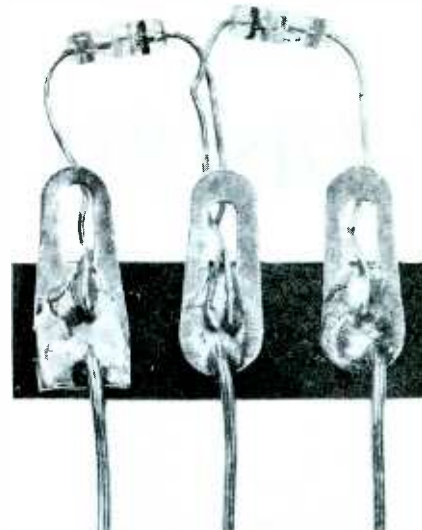

Fig. 6. 1N64's fastened to three-lug terminal strips as troubleshooting aids.

cases. This problem has so plagued me recently that I was determined to find an answer.

The solution I came up with—one which should work every time—involves the use of a matched pair of 1N64 video-detector diodes. These units are now a part of my standard troubleshooting equipment; in fact, I have two matched pairs made up into both series and common-cathode configurations (see Fig. 5). They are fastened to three-lug terminal strips (Fig. 6), with the mounting leads brought out the eyes of each lug. This permits them to be used repeatedly without danger of their being damaged by excess heat. Coded markings on the reverse side of the assemblies prevent them from being installed incorrectly. Once the need for a new AFC diode assembly has been determined, the test assembly can be removed and a set of exact replacement or recommended equivalent units installed to complete the repair.

If the pulse voltages in the AFC circuit are greater than the rating of the 1N64 diode, the 1N34A, a 75-volt diode, can be used instead.

Every so often you will encounter a receiver where the 1N64's will work but the recommended replacements won't. This is due to the fact that the original unit and the 1N64's feature a low forward resistance, while the replacement units have a relatively high forward resistance. In such a case, either use 1N64's for the replacement or obtain an original manufacturer's part. ▲



*Silicon Rectifier...* ... 1N2078

**NEW Tung-Sol 1N2078 designed and made for simple, speedy TV replacement!**

Tung-Sol's new 1N2078 diffused junction silicon rectifier possesses distinct advantages the service industry will welcome. Optimum physical and electrical characteristics combine to make 1N2078 convenient to handle and install, and assure your TV and radio service customers the high-grade performance they want and appreciate.

**Small size, easy to install.** Tung-Sol's 1N2078 is smaller than most semiconductor devices, at no sacrifice in efficiency. Long

flexible leads can be quickly soldered to existing connections with no additional hardware. This is especially suited to printed circuitry.

**Long life.** Negligible voltage drop that remains stable over lengthy operation promotes long life. 1N2078 virtually unaffected by high current surges . . . maintains high B+ over full-length operation.

**Special insulated case.** Special case insulates against chassis shorts to further ease replacement. Also, 1N2078 dissipates its own heat . . . needs no heat sink . . . yet never requires derating. Only leads get hot.

You can replace any other device and, in some cases, rectifier tubes, with the new, high-quality Tung-Sol 1N2078. For complete information . . . to stock up, contact your distributor or: Tung-Sol Electric Inc., Newark 4, New Jersey.

**1N2078 Maximum ratings (100°C) capacitive load:**

(Similar types available with Peak Inverse Voltages ranging from 50 up to 500)

Peak Inverse Voltage . . . . .	400 Volts
Continuous D. C. Reverse Working Voltage . . .	400 Volts
Average D. C. Output Current . . . . .	500 mAdc
Peak Recurrent Forward Current . . . . .	5 Amps.
½ Cycle Surge Current . . . . .	30 Amps.
Full Load Voltage Drop @ 25°C . . . . .	1.1 Volts
RMS Input Voltage . . . . .	130 Volts
Minlimum Series Resistance (for capacitive filter)	5 ohms, 10 watt





*Servicing is easy and profitable with...*

# RCA VoltOhmysts

*✓ Built, tested and calibrated to High RCA Standards*

## POPULAR

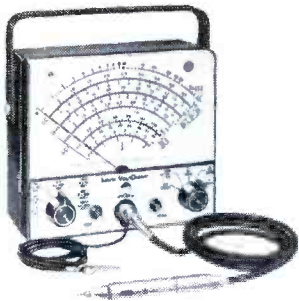

RCA WV-98A Senior VoltOhmyst® Improved circuitry makes the "Senior" RCA's most popular VTVM—provides 3% accuracy full scale on both ac and dc measurements with less than 1% tracking error. Direct reading of peak-to-peak voltages means faster trouble-shooting. Large, full-vision meter (26 sq. in.) is a breeze to read. Features high input resistance (11 megohms on all dc voltage ranges), rugged die-cast aluminum case, electronically protected meter, 200-microampere meter movement, precision multiplier resistors with  $\pm 1\%$  accuracy—and many, many more!

**\$79<sup>50</sup>\***

## PROFESSIONAL

The "Master" has accuracy and stability necessary for many special industrial or lab applications as well as for permanent mounting in your service shop. Big 7½" mirror-backed meter reduces meter pointer parallax. Peak-to-peak voltage scales are ideal for recurrent-pulse and complex-wave measurements, even with dc present. Measures dc current from 10 microamperes to 15 amperes.



RCA WV-87B Master VoltOhmyst Measures dc voltages accurately in high-impedance circuits, even with ac present. Reads rms values of sine waves. Frequency response: flat at power-line frequencies up to 1500 volts.

**\$137<sup>50</sup>\***

## PRACTICAL

ALL NEW addition to RCA VoltOhmyst family! Incorporates features that make it the most practical factory-wired instrument available at this low price.



RCA WV-77E VoltOhmyst NEW—sleeve on handle stores probes and cables! NEW—fuse in the resistance-divider network for the "OHMS" function prevents accidental burnout! NEW—special circuit minimizes effect of residual gas in bridge tube! NEW—color-coded scales for easier, faster readings! NEW—ultra-slim probes, extra-flexible cables!

**\$49<sup>95</sup>\***

(also available in kit form—\$29.95\*)

\*User Price (Optional)

**SPECIAL OFFER!** Now—for a limited time—get new booklet "Servicing is Easy with an RCA VoltOhmyst" (\$1.00 value)—FREE with the purchase of any of the above instruments!

For individual technical data bulletins on any of these instruments, see your nearest RCA Test Equipment Distributor, or write RCA Commercial Engineering, Section C-33-W, Harrison, New Jersey.



**RADIO CORPORATION OF AMERICA**  
Electron Tube Division  
Harrison, N. J.

RCA TEST EQUIPMENT—preferred by professionals!

AVAILABLE AT YOUR RCA TEST EQUIPMENT DISTRIBUTOR

For Quality of international reputation  
Economies that guarantee extra profits

FAMOUS

# HITACHI

## RECEIVING TUBES

Exclusively through **E.U.C.**

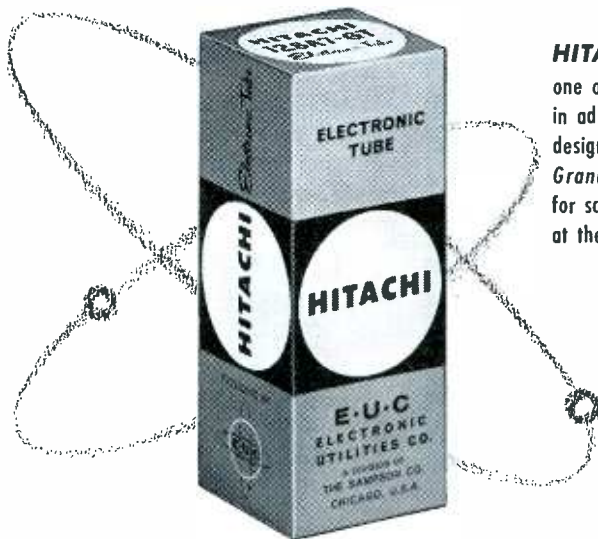

**HITACHI, LTD.,**  
one of the world's leaders  
in advanced electronics  
design and manufacture...  
*Grand Prix Award winners,*  
for scientific equipment,  
at the Brussels World's Fair.

HITACHI TUBES, CHOICE AS ORIGINAL  
EQUIPMENT BY MANUFACTURERS IN THE U. S.  
AND ABROAD

**SELL—SERVICE—SATISFY**—with dependable, EUC-guaranteed Hitachi tubes. Performance-proved around the world, Hitachi tubes are made the quality-controlled American way to fully meet *top American standards*. And, important cost savings assure you of profits not normally obtainable with tubes of this high calibre. Most popular types available.

**Behind the EUC symbol...** Electronic Utilities Co., a division of The Sampson Company, makes these tubes and other selected electronic components from abroad available to original equipment manufacturers and replacement parts distributors... on a *localized, prompt-delivery* basis. In addition, EUC has its own resident representatives and engineers abroad, maintaining quality of product in strict accordance with U. S. requirements.

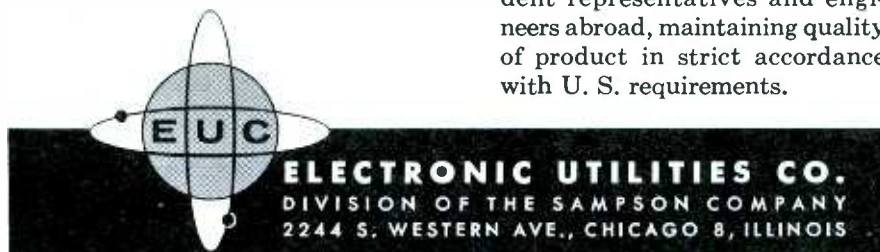

See your EUC Distributor now, or write for CATALOG NO. 558-R



A complete line of Quality Electronic Components:

Capacitors • Miniature Transistor Transformers • Variable Condensers  
Carbon Resistors • Tone Arms and Cartridges • Transistor Radio Earphones

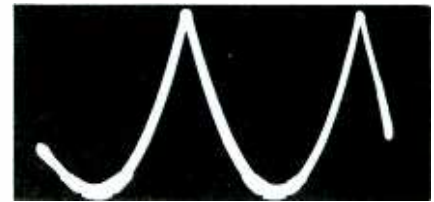

**Not Enough Height**

The picture on an Admiral Chassis 20Y4E covers only about half of the screen in the vertical direction, with the scan ending about 6" above the lower edge of the screen. The scanning lines are crowded together toward the bottom of the raster. The height control has no effect on vertical deflection, but the linearity control seems to be working more or less normally. All voltages and resistances in the vertical section are well within normal tolerances, according to the PHOTOFACT Folder for this set.

DONALD E. COLE

Lowell, Ore.

*DC voltage readings are probably not telling you the whole story. Even if these are all okay, a great deal can still be wrong with the AC signal voltages. You should be able to pinpoint the trouble rapidly with an oscilloscope.*

*Start by looking at the signal on the cathode of the 6S4A vertical output tube. It should be very low in amplitude (about 3 volts p-p) and should have roughly the same parabolic shape as shown in the sketch. If the height of this waveform is much greater than the specified value, degeneration will take place in the output stage. This effect will reduce the amplitude of the signal at the plate, thus accounting for the loss of height. Degeneration would also tend to oppose your attempts to increase vertical sweep by turning up the height control. The most probable cause of an abnormally strong cathode signal is an open electrolytic filter capacitor in the cathode circuit.*

*It's also conceivable that your trouble is due to a fault in the signal at the output-tube grid. Check the waveform at pin 3 of the 6S4A. If this signal doesn't have the correct shape and amplitude, or if you can't vary its amplitude by turning the height control, you can at least assume that your trouble lies somewhere ahead of the output-tube grid.*

*An easy way to check height-control action is to monitor the DC plate voltage of the 6BH8 vertical oscillator while you turn the control. If the plate voltage changes over a range of 200 volts or more from one extreme of rotation to the other, the control is probably all right.*

*If the waveforms are good at both cathode and grid, proceed under the assumption that the output-tube plate circuit (including output transformer and yoke) is not functioning properly.*

### Gym Acoustics

The PTA of a local school has asked me to look into an acoustical problem posed by the echo-ridden school gym, which is the only large space available for meeting purposes. I have checked the cost of acoustical ceiling tile and find

# ownership of a **PHOTOFACT** SERVICE DATA LIBRARY SPELLS SUCCESS FOR SERVICE TECHNICIANS

here's actual proof from the men who know



"Cuts service time in half. There's no way to accurately judge the great amount of time saved by PHOTOFACT in locating replacement parts and the many other services furnished by PHOTOFACT."

—Julius L. Burke,  
Dallas, Texas

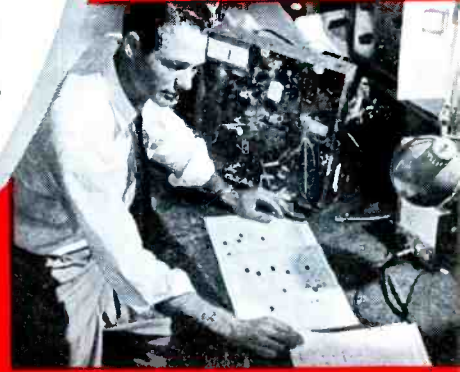

Mr. Burke at his bench consulting a time-saving, tell-all Standard Notation Schematic—an exclusive PHOTOFACT feature.

## HERE'S MORE PROOF...FROM COAST-TO-COAST

"Since I have used PHOTOFACT my business has increased about 50%, and they have taught me a lot about service work."

—Leland Moyer, Fort Plain, N. Y.

"PHOTOFACT is a great aid to expedite servicing and a handy complete reference material."

—E. A. Allen, Coffeeville, Ala.

"I couldn't do any business without PHOTOFACT. I just wish I could have afforded all of them before."

—Albert Bishop, Brevard, N. C.

"With my Sams PHOTOFACT Library I feel I can lick most any problem I'm likely to run into, in an efficient, profitable manner."

—Herbert L. Till, Iuka, Miss.

"It would be very difficult to service some sets without Sams PHOTOFACT; they make the tough ones easy to service."

—W. D. Johnson, Tavares, Fla.

"It is used for every bench job we work on."

—Edison R. Haviland,  
Garfield Heights, Ohio

"PHOTOFACT means faster and better service."

—Ray W. Nichols, Seymour, Ind.

"I believe PHOTOFACT is the only way for fast service on TV. I couldn't give good service without them."

—Henry Ingham, Tetum, Texas

(These are just a few of hundreds of "Success with PHOTOFACT" letters in our files)

**OWN A PHOTOFACT LIBRARY —**  
see your Sams Distributor today or write  
to Howard W. Sams for full details

**NEW EASY-BUY PLAN!** It's the money-saving way to build your complete profit-making PHOTOFACT Library!

NO INTEREST—NO CARRYING CHARGE—AS LITTLE AS \$10 DOWN

**FREE!** Valuable steel file cabinets for PHOTOFACT monthly subscribers and Library purchasers.



Valuable booklet show you how PHOTOFACT boosts your profit-capacity

**FREE!**

Send for it!



**HOWARD W. SAMS & CO., INC.**

2201 E. 46th St., Indianapolis 6, Ind.



- Send me Free booklet "Your Guide To Maximum Profits"  
 I'm a Service Technician:  full-time;  part-time

My Distributor is: \_\_\_\_\_

Shop Name \_\_\_\_\_

Attn. \_\_\_\_\_

Address \_\_\_\_\_

City \_\_\_\_\_ Zone \_\_\_\_\_ State \_\_\_\_\_

that it will be too expensive for the PTA to carry. A public-address system would undoubtedly be of help; however, I fear that it will not overcome the problem to a satisfactory degree.

Do you know of any method by which the acoustics of this type of room can be improved at moderate expense? The gym is 60' x 54', with bleachers along one of the longer sides. Ceiling height is 23', and each wall includes at least three windows.

ALBERT W. CORBIN

Lafayette, Ind.

*It doesn't seem economically practical to alter the acoustics of the gymnasium, considering your present budget. The best way to live with the situation would be to prevent sounds from becoming loud enough to produce undesirable re-*

*flections. This can be done most efficiently by using a P.A. system with a number of low-powered speakers placed at intervals around the edge of the gym. Each one covers a small area and relieves the necessity of either human or electronic "shouting." You will have to experiment with speaker placement to find locations that minimize echoes, but about twelve 12" speakers and a 50-watt amplifier should do the job. Be sure all speakers are properly phased and also matched to both the distribution line and the amplifier.*

### Pulling

I'm having quite a headache with two Admiral TV's, a Chassis 19C1 and a

Chassis 19A2. Both are pulling horizontally. I don't have a scope, which is a strike against me to start with. When I disconnect the sync input by removing the sync separator tube or by disconnecting the input coupling capacitor, I can lock in the picture well enough with the hold control to see that the trouble is cleared up. I can also tell that the raster edges are not affected by the pulling.

JEWELL C. MILLER

Taylor, S.C.

*There are two possible sources of trouble. One is an AGC defect leading to overload of an amplifier stage, and the other is improper operation of one or more video or sync stages. As you realize, locating the defective stage without a scope will be strictly a hit-or-miss proposition; but you might start by substituting all video and sync coupling capacitors. Clamping the AGC line with a variable negative DC voltage supply should tell you if the trouble is originating in this portion of the receiver.*

### Testing Low-Voltage 'Lytics

I would like some pointers on testing the low-voltage electrolytic capacitors found in transistor radios. Would it make any difference whether I use a VOM or a VTVM to make tests?

EDWIN J. MANIKOWSKI

Chicago, Ill.

*Opens and shorts are the only faults that will be reliably indicated by ohmmeter checks, whether made with a VOM or a VTVM. Be sure you know what voltage is present across the meter probes on all scales, so that you will not unknowingly exceed the voltage rating of a capacitor during a test.*

*Several other testing methods are preferred over ohmmeter checks. The best technique is substitution, and next best is measurement with a capacitance bridge that employs a suitably low test voltage. Also useful are in-circuit tests using a scope, which are made as follows:*

*For electrolytic bypass and filter capacitors, place the scope probe on the "hot" side of the unit. If you see a signal, the unit is open.*

*For coupling capacitors, touch the scope probe to the input terminal and adjust the scope to produce a viewable signal. Then shift the probe to the output side of the component. If the signal level is unchanged, the capacitor is OK. Loss of signal generally indicates an open condition, and reduced signal amplitude is a sign that the capacitance value may have decreased.*

*The voltage ranges of a VTVM can also be used for in-circuit tests. When normal voltage is present across a capacitor, you can assume an absence of shorts or leakage. A low reading indicates the possibility of leakage, and zero voltage means that there may be a short. Of course, other circuit defects besides bad capacitors could be producing the abnormal voltage readings, but the capacitors are the most likely culprits.*

**ADDS INCOME 2 WAYS**

**1. Tests and Repairs Picture Tubes**  
(110° Tubes and Color Tubes too, with new C40 Adapter)

**2. Makes New Tube Sales Easier**

**CATHODE REJUVENATOR TESTER**

**CRT 400 PROVES REAL MONEY-MAKER**

Thousands of servicemen today make money and keep customer good-will by checking and correcting b&w picture tube troubles with the famous B&K CRT 400, right in the home without removing tube from set. Restores emission and brightness. Repairs inter-element shorts and open circuits. Checks leakage. Indicates picture quality customer can expect. Life Test checks gas content and predicts remaining useful life of picture tube. Makes new picture tube replacement sales easier!

**Model 400 (without adapter) . . . . . Net, \$59<sup>95</sup>**

**NEW MODEL C40 ADAPTER DOUBLES VALUE OF B&K CRT**

Designed for use with all B&K Models 400 and 350 CRT's. Makes it easy to test and rejuvenate TV color picture tubes and 110° picture tubes. Isolates and detects difficult color troubles. Tests and rejuvenates each gun of the color picture tube separately the same way as a black & white tube.

**Model C40 Adapter . . . . . Net, \$9<sup>95</sup>**

See your B&K distributor, or write for Bulletin ST21-R

Makers of CRT, DYNA-QUIK, DYNA-SCAN and CALIBRATOR  
**B & K MANUFACTURING CO.**  
3726 N. Southport Ave. - Chicago 13, Illinois

# why SYLVANIA TV

with the new

## “LIFETIME ENGRAVED CIRCUIT”

means years of dependable  
operation ...  
more satisfied customers

### 1. DEMONSTRATED DURABILITY

One end of the rugged “LIFETIME ENGRAVED CIRCUIT” is being bent continually up and down a distance of over 3 inches. This has now gone on over a million times! Yet, the amazing LIFETIME ENGRAVED CIRCUIT keeps a clear and steady picture on the screen. There have been NO instances of loose or weakened connections, breakage, or failure of any kind!

### 2. LONG TUBE LIFE

Longer tube life is assured in all SYLVANIA sets by a “controlled warm-up” system. All tubes in series have the same warm-up time (approximately 11 seconds) despite varying heater voltages because tube heater resistance is carefully selected and manufactured. There is no danger of harmful surges and overheating damaging the lower voltage tubes.

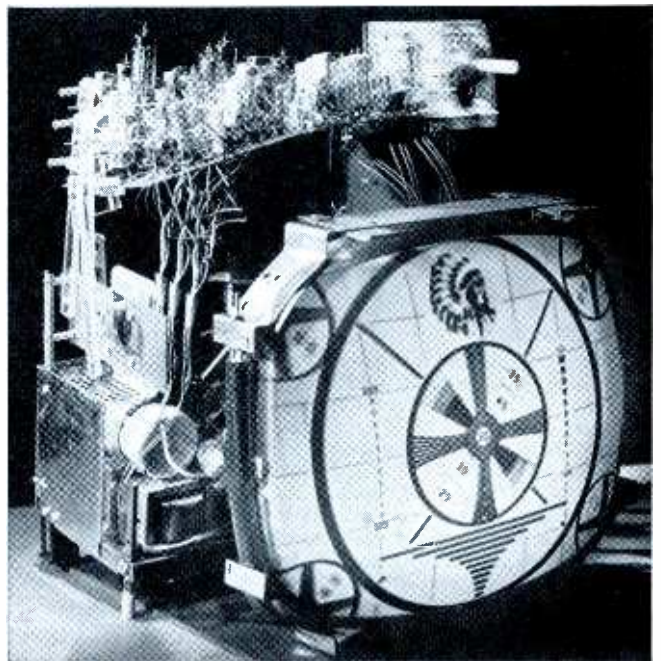

An actual unretouched photo of one of the toughest tests ever given an operating chassis—note clear picture.

### 3. COOLER OPERATION

Old-fashioned transformers, with bulky fins to transfer heat to the interior of the cabinet, raise the temperature of the low voltage power supply as much as 60° hotter than the new semiconductors used with the LIFETIME ENGRAVED CIRCUIT. A cooler operating chassis means greater life for all components.

**Recommend SYLVANIA TV**

**—every set has a “LIFETIME ENGRAVED CIRCUIT”**

# NOTES on test equipment

by Les Deane

informative reports from the lab

## Signals for Servicing

The instrument in Fig. 1 is an RF signal generator manufactured by the Accessory Division of Philco Corp., Philadelphia. Featuring portability, uniform output, and stable operation, the Model 7200 is especially designed for used in signal tracing and aligning radio and TV receivers.

Specifications and features are:

1. Power Requirements—110 to 120 volts AC, power consumption 25 watts.
2. RF Output — six frequency ranges from 100 kc to 300 kc, 300 kc to 900 kc, 900 kc to 3,000 kc, 2.7 mc to 11 mc, 10 mc to 38 mc, 38 mc to 140 mc, and a second harmonic band from 140 mc to 280 mc; all signals modulated or unmodulated; 70-ohm shielded cable provided.
3. AF Output — 400-cycle tone, maximum output signal at least 3V p-p; RF modulation switch provided.

4. Output Level — variable by four-step multiplier and separate attenuator control.
5. Accuracy — RF calibration  $\pm 1\%$  from 100 kc to 280 mc.
6. Size and Weight — 8 15/16" x 12 1/2" x 5 13/16"; 10 lbs.

When examining this instrument in the lab, the three things that impressed me most were its light weight, large easy-to-read dial, and simplified operating procedure. From the close-up of Fig. 2, you can see that the dial has six separate scales—one for each band of frequencies. In addition, an outer scale is marked off in degrees from 0 to 190. This scale calibration is used in conjunction with the vernier markings on the end of the pointer to quickly and accurately determine the precise setting for frequencies that fall between the main dial calibrations.



Fig. 1. Philco's RF generator is well-suited for radio and TV alignment work.

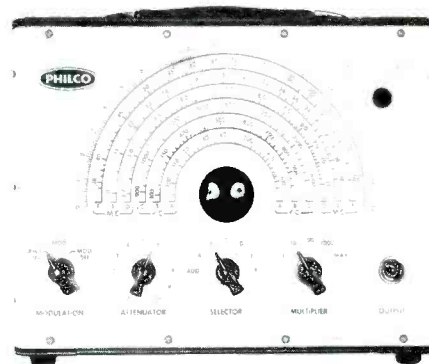

Fig. 2. The Mod. 7200 features an easy-to-read dial, 100-kc to 280-mc range.

Only four adjustments are found on the front panel. In addition to turning the power on and off, the MODULATION switch on the left enables the operator to include 400-cycle audio modulation or leave the output unmodulated. The ATTENUATOR is a potentiometer located in the cathode-follower output stage. This control, with a relative calibration of from 0 to 10, varies the signal level for all positions of the output multiplier.

The SELECTOR switch (center) has seven positions (A through F) covering the six RF bands and a position marked AUD for an output containing only the 400-cycle audible signal. The knob marked MULTIPLIER is an output attenuator switch located in series with the output jack. Its steps are: X1, X10, X100, and X1000, plus a MAX position for delivery of a full output signal.

Before actually making use of the generator, I checked its accuracy so I would know whether or not to rely on the frequency markings of the dial. As a frequency reference, I used a military-type generator which had recently been calibrated against WWV. Employing a set of headphones as shown in Fig. 1, I was able to zero beat the two generator frequencies and thus spot-check dial markings of the Model 7200.

As the experiment turned out, I found that for all scales the pointer was never off more than the width of the lines marking each graduation. What did this indicate? Well, to me it meant that the instrument was as accurate as one would ever need for use as a marker generator in sweep alignment work, as well as for conventional radio and TV alignments using a VTVM.



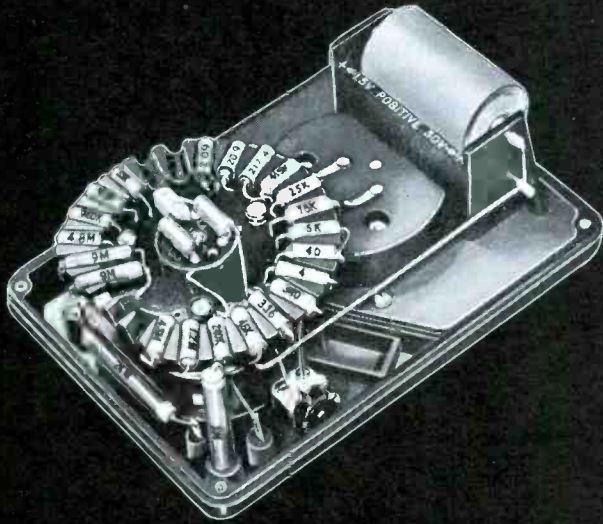

# new... most easy to read

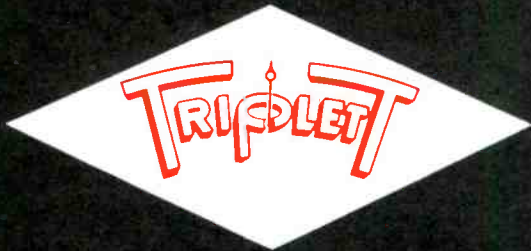

- Clear, unbreakable, shadowless front for instant wide vision.
- 5 to 500,000 cps on A.C.
- Continuous resistance reading from 0.1 ohms to 100 megohms.
- Polarity reversing switch.
- Only one (king-sized) switch selects both circuit and range—minimizes wrong settings, burnouts.

Only Triplet affords you such a wide choice of VOMs. Whatever your application—broad or limited—there is a Triplet VOM particularly suited for it.

# the mighty nine + two

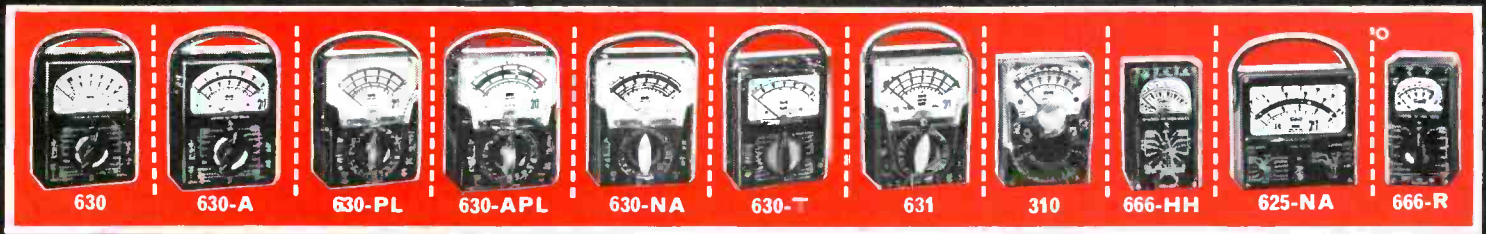

# You learn more from SAMS BOOKS

OVER 1,200,000 IN USE

JUST OUT!



## "101 Ways to Use Your Oscilloscope"

by Bob Middleton

A practical and invaluable guidebook for anyone using oscilloscopes. Covers all standard uses of this instrument as well as many uncommon ones. Describes connections required, equipment

needed, proper test procedures and evaluation of results for each scope use. Over 400 illustrations of waveforms and test setups are included. Invaluable for technicians, engineers, students and experimenters. 180 pages, 5 1/2 x 8 1/2". Only ..... \$2.50  
(Companion to Middleton's "101 Ways to Use Your Sweep Generator")

## "Tape Recorder Manual" - Vol. 3



Complete analysis of 22 tape recorders produced in 1957-58, including Ampex, Geloso, Knight, RCA, Revere, Silvertone, Webcor, Wilcox-Gay, Wollensak. Includes general description, operation data, troubleshooting and maintenance facts, parts lists, diagrams, etc. Has special editorial section on basic types of tape transport mechanisms; with cumulative index. 160 pages, 8 1/2 x 11". Only ..... \$2.95

..... \$2.95

## "Servicing Hi-Fi" Series



**SERVICING HI-FI AM-FM TUNERS.** Complete service data analysis of 18 AM-FM tuners produced in 1957-58. Thorough coverage: diagrams, photo views, troubleshooting, parts lists, etc. Includes special editorial section "Highlights on FM", covering FM signal, AFC circuits, alignment. 160 p., 8 1/2 x 11". Only ..... \$2.95



**SERVICING HI-FI PREAMPS AND AMPLIFIERS.** Covers 33 leading models made in 1957-58. Full technical analysis of each model (schematic, photos, charts, parts lists); special section on "Service Facts About Preamps and Amplifiers." 160 p., 8 1/2 x 11". Only ..... \$2.95

## HOWARD W. SAMS & CO., INC.

Order from your Sams Distributor today, or mail to Howard W. Sams & Co., Inc., Dept. C-39 2201 E. 46th St., Indianapolis 6, Ind.

Send me the following books:

- "101 Ways to Use Your Oscilloscope" (TEM-2)
- "Tape Recorder Manual" (TR-3)
- "Servicing Hi-Fi AM-FM Tuners" (HF-3)
- "Servicing Hi-Fi Preamps & Amplifiers" (HF-4)

\$..... enclosed.  Send Free Book List

Name.....

Address.....

City..... Zone..... State.....

(outside U.S.A. priced slightly higher)

Proper use of a generator in performing an alignment is described in most service literature, so to give you a better idea of this instrument's capabilities, I'll describe its use in signal tracing a typical AM radio. Without mentioning specific trouble symptoms, let's suppose you wanted to trace a radio signal from antenna to speaker. During actual troubleshooting, you would normally trace from speaker to antenna.

Starting with the last stage, let's apply a test signal to points A through E in Fig. 3A. Since this section of the receiver deals only with audio frequencies, we use the 400-cycle signal generated by the Model 7200. To obtain this output, we merely turn the instrument on and flip the selector switch to the

position marked AUD. With power applied and volume control at maximum, you should be able to hear the 400-cycle note in the speaker, provided of course, the stages are functioning properly.

When signal tracing, always keep the generator output as low as possible; also, use a capacitor (.05 to .1 mfd) in series with the probe for DC isolation. Although the speaker serves as a natural indicating device, you can employ an oscilloscope or VTVM in addition if desired.

Moving toward the front end of the set, let's next test those stages shown in Fig. 3B. Like most radios, the intermediate circuits are tuned to 455 kc; therefore, we will use an output signal from the generator of

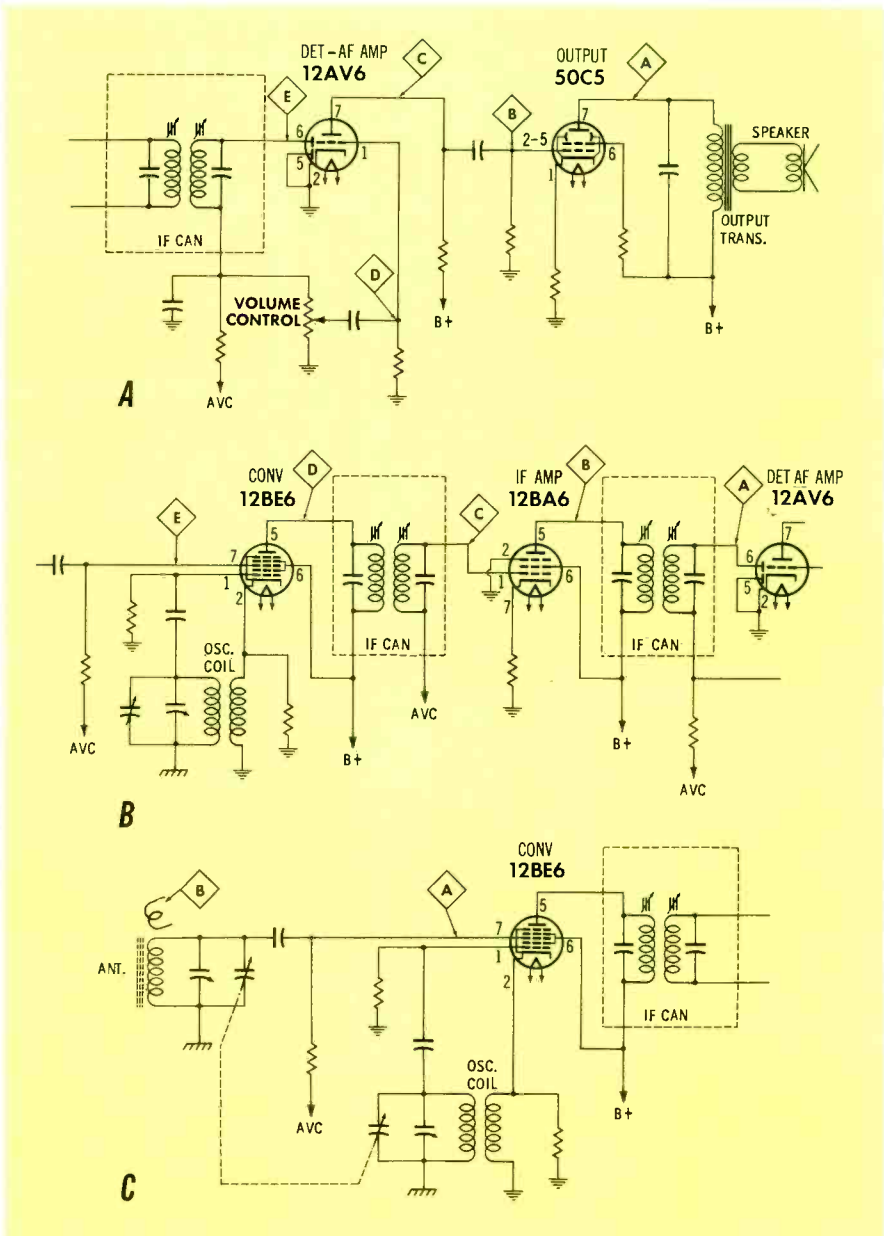

Fig. 3. Circuitry of typical AM stages.

# GUIDE

# AUTRONIC-EYE<sup>®</sup>

## TRAINING COURSES

## MEAN MORE

## BUSINESS FOR YOU!



**Courses for experienced service technicians provide latest repair information—enable you to do the job faster and more efficiently.**

Quick, accurate circuit diagnosis and repair to factory specifications boosts your profits. That's why so many qualified auto technicians attend these Guide training courses at no cost other than transportation and living expenses.

The Guide Lamp diploma, awarded only to those who successfully complete the course, is proof that you're equipped to give more and better service to more people—and that means business.

If you're an auto radio service dealer, come yourself, or send your technicians. There's one of 30 GM Training Centers near you. Apply through your local United Motors Service Division Distributor or write

GUIDE LAMP DIVISION • GENERAL MOTORS CORP. • ANDERSON, INDIANA

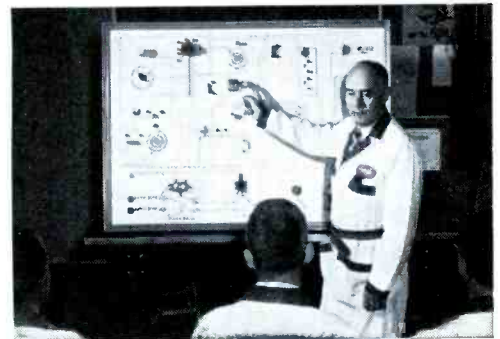

Jumbo-size operational panel of Guide's Autronic-Eye Circuit puts all parts out front for better, more efficient instruction.



Thirty modern GM Training Centers offer newest equipment and latest service techniques. There's one nearby . . . no matter where you live.

**BLINKY MEANS  
BUSINESS!**

**FAST!  
ACCURATE!**

**SECO Test Equipment**

**Saves time . . . makes  
more money for you!**

WRITE TODAY FOR COMPLETE  
SPECIFICATIONS AND FEATURES!

- Outstanding Reliability and Performance!
- Unique, Time-Saving Features!
- Low First Cost Makes You Money From the Start!

**107 TUBE TESTER—**

Outstanding performance and accuracy—provides 3 important tests: amplifier types tested for gain by Dynamic Mutual Conductance method—power types tested for cathode current by Cathode Emission method—all types tested for shorts and grid error by Grid Circuit Test developed and patented by Seco. Dynamic Mutual Conductance Test pre-wired to eliminate elaborate set-up. Cathode Emission Test done by free point pin-selector method—will not be obsolete. Completely self-contained in portable carrying case. Furnished with handy flip chart for fast tube set-up data.

MODEL 107 . . . . . \$139.50 NET



**GCT-8 GRID CIRCUIT TUBE TESTER**

—Perfect companion to any tester—checks critical “control grid” condition of vacuum tubes fast, accurately. Electron eye tube indicates faults at a glance. As many as eleven simultaneous checks—automatically.

MODEL GCT-8—Kit . . . . . \$19.95 NET

MODEL GCT-8—Wired & tested. . . . . 29.95 NET



**208V TVM**—“Fool-proof”—many new features! Easy-to-read 4½” 200 microamp meter mounted on sloping panel—7 DC, 7 AC, 7 ordinary Ohm ranges, plus RETMA (EIA) Ohm scale to check standard color-coded resistance values and tolerance limits.

Specially designed “shift-lever” type function switch identifies and automatically connects proper probe. With stand, 40’ leads, and common lead with clip.

MODEL 208 . . . . . \$74.50 NET

Leather, felt-lined carrying case. \$9.95 NET



**PS-2 BATTERY ELIMINATOR**—Compact unit takes place of battery normally used to operate and service low-powered transistorized equipment. Supplies clean, filtered DC—can’t be damaged

by a short. Quickly spots faulty batteries by substitution. Output continuously variable from 0 to 15 V.—ideal for experimenters. Complete with jacks, leads, and clips.

MODEL PS-2 . . . . . \$13.95 NET

**FB-4 FLYBACK CIRCUIT AND INDUCTANCE ANALYZER**—Quick “yes” or “no” answer on condition of flyback transformer and yoke—100% accuracy!

MODEL FB-4 . . . . . \$38.95 NET

**NEW! HC-6 CURRENT CHECKER**

Provides positive, on-the-spot method of checking TV horizontal output circuits—fast, accurate way to adjust horizontal drive and linearity. Easy to use—can be placed in circuit in seconds—compact size. Complete, ready to use.

MODEL HC-6 . . . . . \$12.95 NET

Get the complete story on Seco’s exciting line of test equipment. See your distributor—or write for complete information today!

**SECO MANUFACTURING CO.**  
**SECO** 5016 Penn Avenue So.  
Minneapolis, Minn.

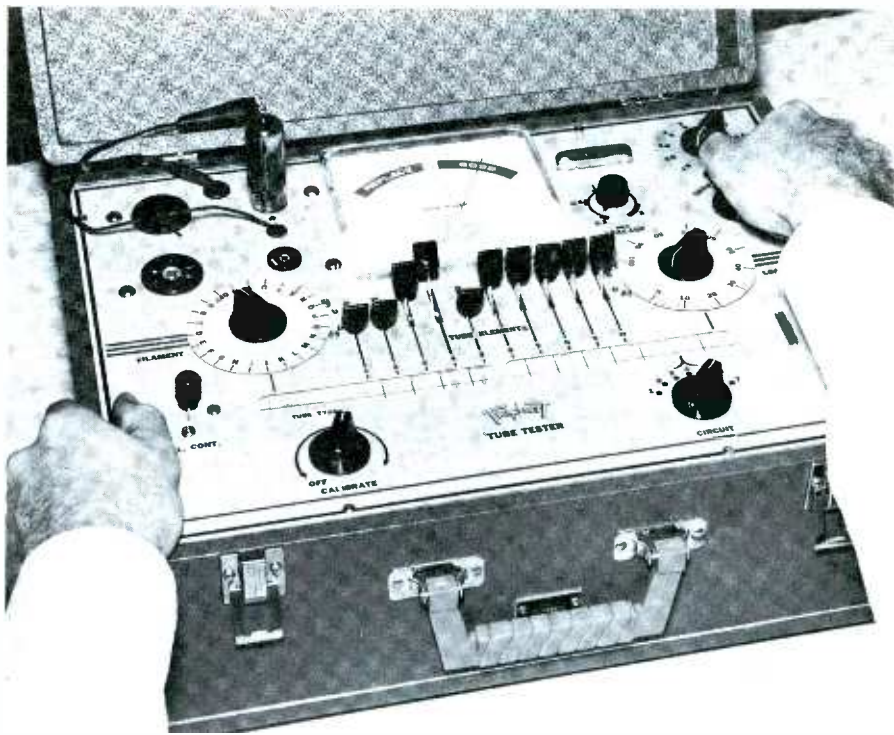

Fig. 4. The new Triplet tube tester is designed for fast, accurate service.

this precise frequency. Since we wish to obtain an indication from the speaker, however, the IF output should be modulated by the 400-cycle audio frequency. The Model 7200 is thrown into action by placing the modulation switch in the MOD position, flipping the selector switch to band B, and turning the dial pointer to 455 on scale B. Adjusting the output level, you can then apply the signal to points A through E to see if it passes from converter to detector.

The last phase of our signal tracing procedure calls for a check of the receiver’s RF circuitry. Since AM radios seldom cover a range greater than 520 to 1620 kc, we’ll need a generated test signal somewhere in this RF band. Selecting a

frequency of, say 1400 kc, the generator’s selector switch is placed in position C and the dial pointer turned to 1400. Here again, we use 400-cycle modulation and apply the signal to points A and B (see Fig. 3C). The tuning capacitor of the radio should be adjusted (almost fully open) until the test tone is heard in the speaker.

Injection of the signal at point B, which may be a rod- or loop-type antenna, is not accomplished by a direct connection, but by radiation. Make a loop of the output cable and place it close to the antenna. If the antenna, RF, and oscillator circuits are working okay, the detected audio modulation should be heard in the speaker. Remember, the output signal level should only be as

**SENCORE “Distributor of the Month”**

**SREPCO, INC.**

We are pleased to select SREPCO, INC., of Dayton, Ohio, as the March Distributor of the Month.

President “Lindy” Fansio and Vice-Pres. “Rube” Ruble ramrod this aggressive, expanding organization. They are doing an outstanding job of promoting and selling the SENCORE line . . . and they see the results. “Rube” says, “SENCORE offers a complete line of reasonably priced test equipment. The fine acceptance and wide use of all items by the service-technician is proof of the value of the line.”

**Save Time with SENCORE**

Leading Distributors Feature SENCORE

**SERVICE Instruments Corp., 121 Official Road • Addison, Ill.**

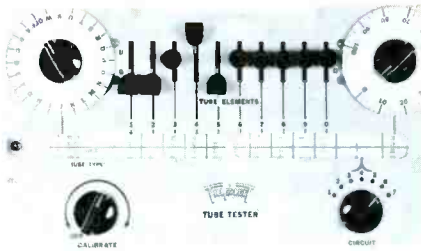

Fig. 5. Section of Model 3414 panel showing roll chart and adjustments.

high as needed for a clear indication; it will normally require reduction as you probe from the speaker toward the antenna.

**Replace — ? — Good**

One of the latest contributions to the service industry from Triplet Electrical Instrument Co. of Bluffton, Ohio, is the new tube tester shown in operation in Fig. 4. Designated the Model 3414, the instrument makes use of a modified plate conductance test to duplicate operating characteristics for the tube under test as closely as possible. With a relatively simple setup procedure, this instrument provides fast and accurate tube testing.

Specifications and features are:

1. Power Requirements—100/130 volts, 50/60 cps; line calibration control provided.
2. Value Test—all tubes including gas-filled rectifiers, ballast, and the newer series-string types; indications given directly on REPLACE—?—GOOD scale of large 4" meter; relative percent scale also provided.
3. Filament Test—special push-type switch on front panel for quickly checking filament continuity; 23 individual filament voltages available.
4. Shorts Test—shorts of 300K ohms or less are indicated from glow of neon lamp on front panel; element selector switch provided.
5. Leakage Test—leakage between elements indicated by glow of neon lamp; control on front panel selects leakage resistance range of from .3 to 3 megohms.
6. Picture Tube Test—cathode emission may be checked in shipping carton or

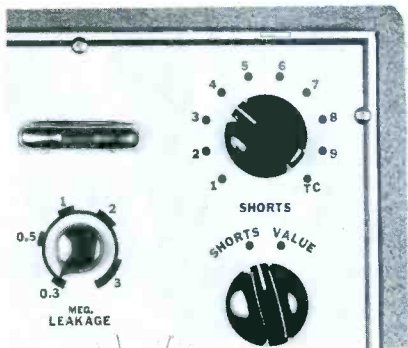

Fig. 6. Portion of Triplet panel showing the shorts and value switches.

General Instrument has  
the **RIGHT RECTIFIER**  
for every TV set





Silicon  
RECTIFIERS

Selenium  
RECTIFIERS



Don't be fooled by an "all or nothing at all" approach. Selenium and Silicon rectifiers both have a place in today's TV sets . . . and General Instrument supplies the very best!

Radio Receptor "Safe Center" selenium rectifiers have proved their reliability and long life in millions of circuits through the years. When your replacement calls for *selenium* there is no better rectifier.

AUTOMATIC PT5 Silicon rectifiers are the first choice of leading TV set manufacturers switching to silicon in their new models. When replacing or converting to *silicon*, install the PT5 for maximum performance and picture brightness.

Both these outstanding rectifiers are brought to you by GENERAL INSTRUMENT, your finest source of semiconductor components!

*General Instrument Distributor Division*  
**RADIO RECEPTOR COMPANY, INC.**  
*Subsidiary of General Instrument Corporation*  
240 Wythe Avenue, Brooklyn 11, N. Y. EVergreen 8-6000



# SAVE TIME

in removing printed  
circuit components

## Ungar®

### DE-SOLDERING KIT

Don't ruin printed boards. Avoid de-lamination. Avoid contamination. Components are removed quickly, easily, safely with Ungar's new 8-pc. De-Soldering Kit. Order from your parts jobber. Ungar Electric Tools, Inc., 4101 Redwood Ave., Los Angeles 66

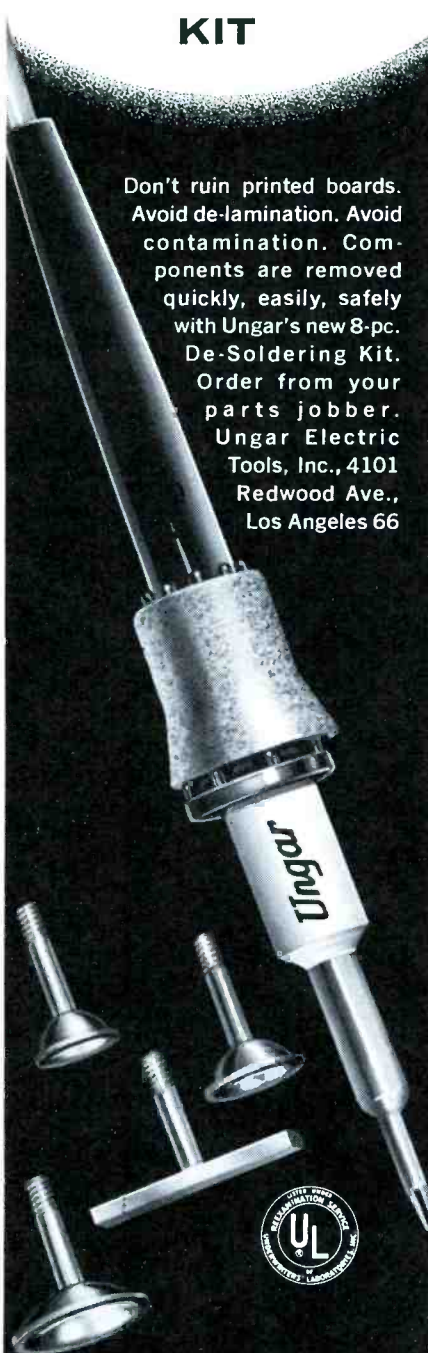

Ungar Electric Tools, Inc.

in receiver; special adapters "CB" for 110° tubes and "BV" for all other types available as accessory items.

7. Other Tests—pilot lamps, miniature base bulbs, and continuity checks for ballast tubes; optional accessories include adapters "BR" for acorn tubes, "BW" for round subminiatures, and "BP" for 7-pin subminiature types.
8. Size and Weight—case 15 $\frac{1}{8}$ " x 11 $\frac{1}{8}$ " x 6 $\frac{1}{2}$ "; 12 lbs net.

Trying out the Model 3414 in our test equipment lab, I found it to be a relatively easy and accurate tester to use. Upon opening the detachable lid, I noticed that there were only four test sockets on the entire panel. For simplification, the manufacturer has omitted the seldom-used acorn and subminiature types; adapters are available, however, should you need to check these special types.

The filament voltage selector is marked off in alphabetical steps representing 23 different values from .65 to 117 volts. The roll chart has a complete list of over 400 tubes in a single column, and in front of each type is a letter corresponding to the correct filament setting. The face of the large 500-microamp panel meter is graduated in three sections—red (REPLACE), yellow (?), and green (GOOD). It also has linear scale markings of zero to 100 and a center indication for line voltage calibration.

About the best way to familiarize anyone with a new tube tester is to explain the setup procedure for testing a typical tube. With the Model 3414, this first calls for inserting the power cord into an AC outlet and adjusting the CALIBRATION control until the meter pointer rests directly over the "CAL" mark.

Suppose we select one of the recent series-string TV tubes, such as a 6BA8A, for our guinea pig. This tube, a pentode-triode, often serves as video amplifier and sync sepa-



"He's a stickler for a truly level turntable."

# SAVE TIME

in replacing printed  
circuit components

## Ungar®

### SOLDERING TOOLS

Interchangeable Ungar Tips and Tiplets make soldering easier, faster and more efficient in close, tight spots. Write for free catalog and new soldering booklet. Ungar Electric Tools, Inc., 4101 Redwood Ave., Los Angeles 66, California



Ungar Electric Tools, Inc.

rator. Setting up the tester for this tube, I quickly turned the roll chart to the 6BA8 listing. In general, tubes with various suffixes such as "A" can be tested by using the setup for the type number without that suffix.

Following instructions on the roll chart, I placed the filament selector in its "J" position and flipped the proper element levers up or down as called for (see Fig. 5). Turning the CIRCUIT switch to No. 6 and setting the LOAD control to 16, I made a quick check for filament continuity by pressing the "FIL. CONT." button just left of the roll chart window. The neon lamp in the upper left section of the panel lit, thus indicating that the heaters were okay.

When the tube was warmed up, I checked for interelement shorts by noting the neon lamp as I rotated the SHORTS switch pictured in Fig. 6. I discovered that numbers on this switch correspond to pin numbers of the tube socket. After the shorts test gave the tube a clean bill of health, I proceeded to make the conductance test. I held the spring-loaded SHORTS/VALUE switch (Fig. 6) in its VALUE position and noted the condition of the tube by the meter reading. Since the tube was new, it naturally gave a reading in the green area labeled GOOD. Following instructions listed under TEST 2, I checked the other section of the tube and found it equally good.

Before calling my examination complete, however, I checked some tubes with known faults and found that the Triplet tester detected each one quite satisfactorily. ▲

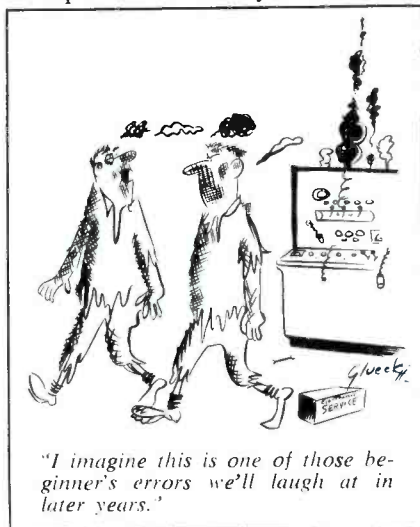

"I imagine this is one of those beginner's errors we'll laugh at in later years."

## best buys in custom hi-fi... **EICO**

- praised by the experts
- beautifully styled
- priced right for you
- lifetime guarantee



**FM Tuner HFT90**  
with precision "eye-tronic" tuning  
Wired \$65.95\* Kit \$39.95\*  
Cover \$3.95.  
\*Less Cover, FET included  
"One of the best buys you can get."—AUDIOCRAFT.

**STEREO Dual Amplifier-Preamplifier HF81**  
Wired \$109.95 Kit \$69.95  
"Excellent"—SATURDAY REVIEW, and HI-FI MUSIC AT HOME.



**STEREO Dual Preamplifier HF85**  
Wired \$64.95 Kit \$39.95

**Omni-directional Speaker System HFS2**  
completely factory-built: 36" h, 15 1/4" w, 11 1/2" d.  
Mahogany or Walnut \$139.95. Blonde \$144.95  
"Eminently musical!"—HIGH FIDELITY  
"Fine for stereo!"—MODERN HI-FI  
Also: **Bookshelf 2-Way Speaker System HFS1**  
complete with factory-built cabinet, \$39.95



Plus: POWER AMPLIFIERS (14, 22, 30, 35, 50 and 60-watts) from \$23.50.  
INTEGRATED AMPLIFIERS (12, 20, 32 and 50 watts) from \$34.95.

## best buys in test instruments... **EICO**



**COLOR & Monochrome DC to 5 MC Lab & TV 5" Oscilloscope #460**  
Wired \$129.50  
Kit \$79.95



**TV-FM Sweep Generator & Marker #368**  
Wired \$119.95  
Kit \$69.95

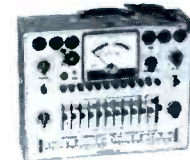

**DYNAMIC CONDUCTANCE Tube & Transistor Tester #666**  
Wired \$109.95  
Kit \$69.95

IN STOCK at over 2000 neighborhood distributors coast to coast  
Send for free catalog



**PEAK-to-PEAK VTVM #232 & Unit-Probe**  
Wired \$49.95  
Kit \$29.95  
(PAT. PEND.)

EICO, 33-00 Northern Blvd., L. I. C. 1, N. Y. PF-3  
Show me how to save 50% on top-quality:  Hi-Fi  
 Test Instruments  Ham Gear. Send free catalog and name of neighborhood EICO supplier.

NAME \_\_\_\_\_  
ADDRESS \_\_\_\_\_  
CITY \_\_\_\_\_ ZONE \_\_\_\_\_ STATE \_\_\_\_\_

ADD 5% IN THE WEST



For the tough  
old "DOGS"

Always rely on **DOSS**

For better, faster  
servicing get the **NEW**

D-200 Video Master



- Super sensitive, hi gain (built in I.F. stage) demodulator probe
- Separate, turntable controls for both 20 and 40 mc TV bands
- Allows signal viewing at any point in I.F. stages, including tuner output
- Excellent frequency response

NOW ONLY \$24.95

Fill in this handy order blank. Order will be credited to your distributor.

**DOSS**

**ELECTRONIC RESEARCH, INC.**  
820 Baltimore K. C. 5, Missouri

**ORDER NOW ON A 30 DAY  
MONEY BACK GUARANTEE**

If for any reason I am not satisfied with my D-200 VIDEO MASTER, I may return it within 30 days for full refund.

- Enclosed is remittance of \$24.95  
 Please ship C. O. D.

NAME .....

ADDRESS .....

CITY ..... STATE.....

*Dave Rice's*

**OFFICIAL**

**ORDER BOOK**

for every TV-Radio  
service call

**CONVENIENT!  
EASY TO USE!**

Simplify your record-keeping with these convenient triplicate forms. They serve as order form, invoice and office record, with spaces for complete information on every job. Separate listings for receiving tubes, picture tubes, parts, serial numbers, labor and tax charges, etc. 75c a book, \$6.50 for money-saving dust-proof box of 10.



**Dave Rice's Official Pricing Digest**

Shows flat-rate and hourly service charges based on regional and national averages, plus up-to-date list or resale prices on over 63,000 components. \$2.50 per copy.

In stock at your distributor

**ELECTRONIC PUBLISHING CO. INC.**

180 North Wacker Drive Chicago 6, Illinois



**Time Tip—II.** You see this motto almost everywhere these days:

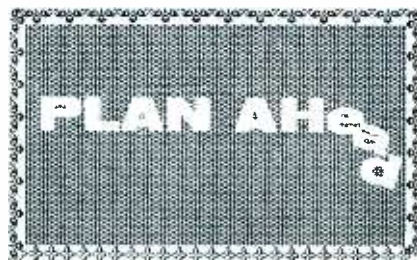

—so a lot of people must agree that the human race deserves some kidding on this subject!

The ability to look farther than the end of one's nose when a work schedule is being planned is the "success secret" of the man who can turn out a tremendous amount of productive work with minimum strain. Granted, it's hard to remember a whole flock of details that are not related to the job at hand, but it's worth the effort because *planning banishes waste motion.*

Save wear and tear on yourself by forming the habit of taking a few seconds to figure out your next moves. For instance, when you need a special replacement part for a bench job, don't just take off for the distributor's store. By being aware of your routine stock needs, you may be able to make several more purchases on the same trip and thus save yourself an extra trip.

The routing of service vehicles is a prime example of an activity calling for foresight in planning. Check to see if calls to the same general area can be scheduled one after the other; if so, you'll be relieved of time-consuming criss-cross trips. Also, lay out routes with an eye to avoiding traffic tangles and parking restrictions which regularly occur at certain places and times. Here's a case where planning pays off in better dispositions as well as in more productive schedules.

**Light on the Subject.** The service industry's shortcomings continue to be scrutinized by popular magazines. Among the latest articles are "Exposing the TV Repair Racket" (*TV Guide*, Jan. 3, 1959) and "Home Appliances: Poor Service—Whose Fault?" (*Changing Times*, *The Kiplinger Magazine*, Oct., 1958). Titles of this sort are enough to make any serviceman flinch, but they should be regarded mainly as attention-grabbers—roughly in the same category as "What Does Elvis Really Think About Girls?" These two articles themselves are presented in an encouragingly fair and objective manner.

Their most important feature, from the technician's point of view, is the advice they give the public on how to avoid gyms. Each magazine offers a sort of check-list designed to help readers recognize ethical TV repairmen.

*TV Guide* asks the set owner point-blank: "Do you realize that you're inviting a padded TV repair bill if you patronize firms which advertise house calls for \$2 or less? Do you realize that a big TV repair bill does not automatically mean you've been taken?"

"Repairs should be guaranteed," states *Changing Times*. "Some servicemen guarantee their work 90 days. In other cases the guarantee is for three days on a house call, 30 days on a shop job, parts 90 days except picture tube, which should be one year . . . Note that the warranty on radio and TV sets does not usually include labor or service charges for replacing defective parts."

Both articles emphasize that the man who makes a service call should present an itemized, signed bill that includes an explanation of labor performed.



Various suggestions are given for determining if a repairman is operating a legitimate business. For instance, *TV Guide* asks, "Does he receive checks made out to his firm's name?" *Changing Times* warns readers, "Beware of ads that give a telephone number but no address."

In general, the honest serviceman should have no trouble in living up to the standards set forth in these articles. A supposed "expose", therefore, turns out to be a welcome bit of favorable publicity.

**\$ & ¢**

**Crystal Ball.** Will you still be in the radio-TV service business in 1965? This question isn't meant to alarm you—only to make you think about future developments and the way they may affect your livelihood.

The TV industry is so dynamic that its course cannot be plainly charted in advance. Nevertheless, several trends are now afoot which will strongly influence the service field in the near future.

1. Mass production of transistorized TV sets is just over the horizon. While there are several economic and technical problems, engineers are working hard to solve them. Sets could be commercially available at almost any time.

2. A counter-trend, seemingly keeping pace with the gains being made by transistors, concerns a number of recent improvements in vacuum-tube designs. Most startling of the tube innovations is a cold-cathode type. Like a fluorescent lamp, this tube requires a brief "flashing" to start conduction; but, once the process has been started, the cathode continues to emit electrons indefinitely without being heated. This design is reportedly being adapted to cathode-ray tubes as well as radio-TV receiving tubes. Elimination of heaters would not only reduce current consumption of receivers but would also eliminate a major cause of tube failure. Furthermore, less heat would be generated inside set cabinets—so components other than tubes might also be less likely to fail.

Of course, less spectacular improvements are also being made in tubes. Lint- and dust- free, highly-

**CAPACITORS**

**you can depend upon!**

**PRECISION DESIGNED for Long Life and Trouble-Free Service!**



**ELMENCO Miniaturized MYLAR\* - PAPER TUBULARS**

- High Temperature Operation
- Superior Moisture Resistance
- High Insulation Resistance
- All Values  $\pm 10\%$  Tolerance
- Printed Circuit Application

**ELMENCO**

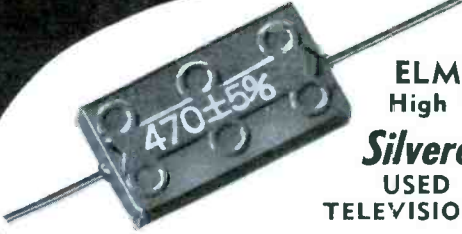

**ELMENCO High Voltage Silvered Mica USED IN ALL TELEVISION CIRCUITS**

CAPACITY, TOLERANCE AND VOLTAGE-IMPRINTED ON EACH UNIT  
Standard Tolerance  $\pm 5\%$

**ARColytic**  
HIGH QUALITY ELECTROLYTICS  
UNCONDITIONALLY GUARANTEED FOR ONE YEAR



Available at every REPUTABLE distributor throughout the country!  
\*DuPont Registered Trademark



**ARCO**  
ELECTRONICS INC.  
64 White Street  
New York 13, N. Y.  
DALLAS • LOS ANGELES

automated factories and tighter quality control are resulting in more reliable tubes with longer life.

3. No matter whether tubes or transistors win greater acceptance, the industry definitely appears to be working toward a situation where tube failures will account for a lower percentage of TV service calls. In fact, it's highly probable that each set will need fewer calls per year.

4. Does this mean less service work in the future? Not necessarily! There is a counter-trend in this area, too—a tendency toward more

sets in use. The total will not increase, as in the past, by opening up new areas to TV broadcasting; instead, the *concentration* of receivers will increase in all parts of the country. More households will have two or three TV sets apiece, and the number of households also will increase sharply during the next decade. The nation's whole economy is getting ready for a boom that is just now beginning, as the huge "baby crop" of the 1940's starts to pair off and set up house-keeping.

How will these various trends

balance each other? Your guess is as good as ours. One thing is sure, though—some far-reaching changes lie ahead. Now is a good time to consider how you will fit into the service world of the 1960's and to begin making plans accordingly.

## \$ & ¢

**Make-Do.** The hermit crab is a smart little animal. Instead of going to all the trouble of growing his own shell, he hunts around for an empty snail shell that fits him—and moves in. When he outgrows it, he trades it in on a bigger one.

And what does this bit of nature lore have to do with the electronic service business? Simply this: You can often profit by imitating your little ten-legged friend and taking over a building that has been cast off by another business concern. Certain types of existing buildings can be turned into excellent service shops at a fraction of the investment required to put up a new building.

As a case in point, automobile service stations are sometimes vacated because of stiff competition between oil companies. We know of one man who has remodeled such a station into a drive-in auto radio shop. The building is modern in appearance; the only reason it doesn't meet present-day standards as a gas station is that it lacks an indoor grease rack. However, it does have a single stall which provides a place to pull in one car at a time for all-weather radio repair work. Plenty of space is available on one side for a complete service bench. With gas pumps removed, the lot has room for enough cars to provide a full day's work for a one- or two-man shop. This organization's service truck has a soft life; it spends its nights in a heated garage at no extra cost to the owner!

**SAVE TIME with**

**SENCORE**

*Transi-Pak*

A "Twin" to the  
**SENCORE**  
TRC4 Transistor  
Checker

See other SENCORE ads in this issue.

**A Low Cost TRANSISTOR RADIO BATTERY ELIMINATOR**

Here is a complete isolated power supply especially designed to replace batteries during repair time of all transistor radios.

- ★ Supplies up to 200ma
- ★ A must for Philco and Sylvania radios
- ★ Insures proper operating voltage and current for transistor radios



**MODEL PS-103**  
**\$17.95**  
DEALER NET

**SERVICE Instruments Corp.**  
121 Official Road, Addison, Ill. AT LEADING PARTS DISTRIBUTORS

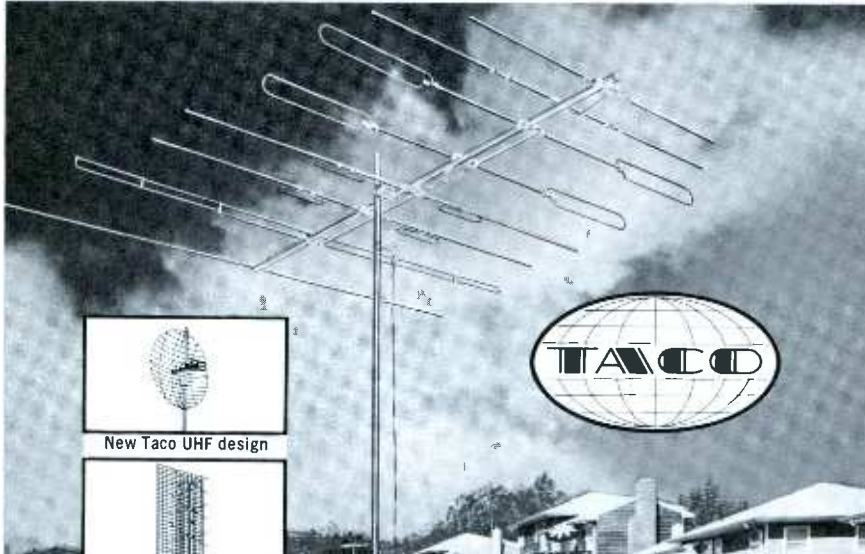



New Taco UHF design





Popular Taco Bowtie

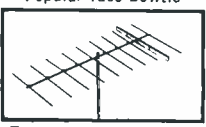

Taco area-ized antennas

## Use the best— TO BE THE BEST—

Back up your skills and reputation with the best—always use a Taco antenna to assure top-notch performance and lasting satisfaction. You'll find Taco antennas go up easier and work better—and you make more money!

*Write for complete details*

THE  
**TV-riffic**  
ANTENNAS

TECHNICAL APPLIANCE CORPORATION, Sherburne, New York.

### Planning To Move?

If so, notify us by the 15th of the month to assure uninterrupted delivery of PF REPORTER.

Be sure to include both your old and new address. (Or better yet, enclose a current mailing label with your new address.) Send to:

**PF REPORTER**

Circulation Dept.  
2201 E. 46th Street  
Indianapolis 6, Ind.

## Communications Receivers (Continued from page 24)

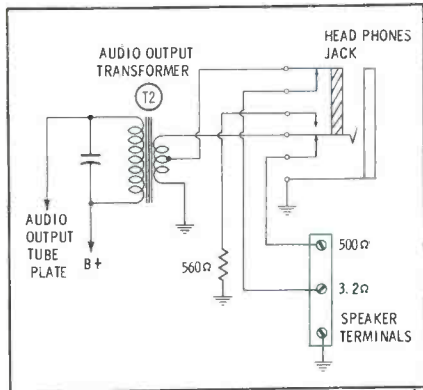

Fig. 2. Output transformer has 3.2- and 500-ohm taps for speakers, headphones

capacitors for each IF stage. AVC filtering is more complete, too, 3-section filters being quite common. Supply voltages are also held to close tolerances.

Audio stages are conventional, until you get to the output transformer. This is usually a special unit with two secondaries (a typical circuit is shown in Fig. 2), a 3.2-ohm for the speaker and a 500-ohm for the earphones. Some circuits use standard output transformers, feeding the phones from the 1st audio amplifier tube plate circuit through a large capacitor.

### Servicing

The serviceman's most important asset when working on a set such as this is complete service information. Even the most experienced technician cannot do his best without it. Multiple trimmers and padders, critical voltages, and settings of various controls all make it mandatory that you have full information at your fingertips. In the next installment, we'll give you emergency methods for locating trimmers, performing alignments, etc., but for the fastest work (and the most profit) on each job, get the service data and use it!

The first step in the service procedure should be a thorough check of all tubes and operating voltages. Check all RF amplifier and oscillator tubes for gas and interelectrode leakage. In the high-gain stages used in these sets, even a slight trace of gas can upset performance. Replacement is the best test for rectifier tubes, and even a small resultant increase in supply voltage would indicate the need for a new tube.

# TOBE SERVICE CAPACITORS



## Designed exclusively for service

Tobe Service Capacitors are the only capacitors literally "designed from the ground up" to meet the exacting requirements of modern radio and TV servicing. Before a capacitor was ever produced, Tobe engineers determined the ideal characteristics—then borrowed from their 36 years experience in the design and manufacture of high-quality commercial and industrial types. Result: capacitors like the plastic-sleeved streamlined "Jets" that stand up in the toughest circuits.

You owe it to yourself to try Tobe Service Capacitors on your next job. The line is complete—and they cost no more! See your Tobe Distributor today for full details or write Tobe Deutschmann Corporation, Distributor Division, 2900 Columbia Ave., Indianapolis 5, Ind.



**TOBE**  
RADIART  
CAPACITORS

*Old Hands at Dependability*

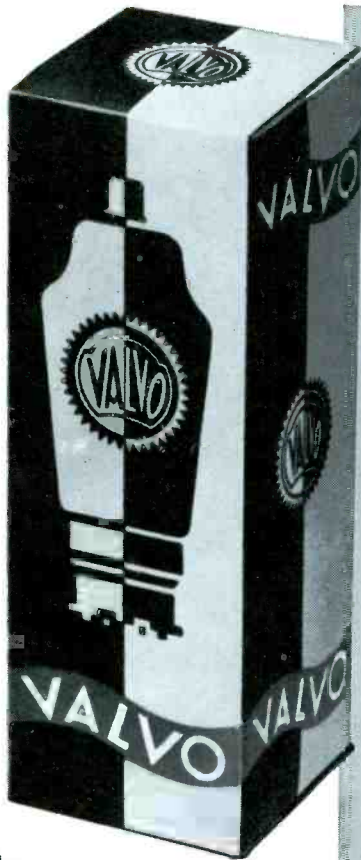

An  
exclusive  
service  
by  
**Amperex®**  
distributors:

## VALVO RECEIVING TUBES

*for replacement in  
European radios*

Many European radios and hi-fi components now popular in this country utilize the European-made VALVO tubes, which have thus far had no American distribution. As a special service to the trade, VALVO tubes are now being stocked by all franchised Amperex distributors. Replacement of the original tubes with completely identical types will assure optimum results in the repair and servicing of these European sets.



ask **Amperex**  
for the name and address  
of your nearest distributor

**Amperex Electronic Corp.**  
230 Duffy Avenue Hicksville, L.I., N.Y.

### Auxiliary Controls Found on Communications Receivers.

CONTROL	USE
Bandswitch	Usually marked A, B, C, D, etc. with the corresponding scales either colored or lettered to match.
Bandspread	Basically a set of trimmers on the main tuning capacitor. In most sets, consisting of a single rotor blade for each section of the gang (RF, osc. ant., etc.). Used to spread a given band of frequencies over a larger area of the dial for easier tuning.
BFO ON-OFF	Turns a special oscillator on or off. Set 1,000 cycles away from the IF frequency and used to add an audible signal to otherwise inaudible CW signals.
BFO Pitch	A tuning control for the BFO. It varies its tone 400-500 cycles to let the operator select the most pleasing tone.
ANL (Automatic Noise Limiter)	A diode, with associated circuitry connected so as to shunt large-amplitude noise pulses to ground. Several different circuits are used, all with same purpose.
Standby-Receiver	A switch that turns the plate voltage off when a nearby transmitter is used to prevent blocking of the receiver. (Must be "ON" before the receiver will work.)
Antenna Tuning	A trimmer across the antenna coil used to make it resonant at the frequency being received; increases volume.
RF Gain (sensitivity)	Usually a variable resistor in the cathode circuit of the RF amplifier used to vary the gain of RF, sometimes IF stages.
AF Gain (volume)	A standard audio-grid gain control, usually about .5 meg.
Phones	An earphone jack to allow the use of standard earphones with the receiver. In older sets, sometimes found on the rear chassis apron as two small pin-jacks.
Spkr-Phones	A selector switch for speaker or phones; be sure it is in "spkr" position.
Xtal Filter (shorp, broad, etc.)	A switch controlling a special bandpass filter, usually between the 1st and 2nd IF stages. A crystal cut exactly to IF frequency is used as a very selective filter circuit.
Xtal Phasing	A small trimmer connected across the crystal itself to vary selectivity of the circuit; in effect, it "tunes out" the capacity of the crystal holder.
"S" Meter	Used as a tuning meter to indicate the actual carrier strength of received signals. Sometimes a milliammeter in series with plates of AVC-controlled tubes, sometimes as an AVC-voltage indicator.
AVC On-Off	Just what it says. In many sets, AVC may be turned on or off to get the best reception on a given signal.
IF Bandwidth	Found only on the larger and more elaborate sets, it controls the actual bandpass of the IF transformers. In Hammarlund SP200LX, for instance, this is a long shaft which moves small brass cores in or out of each IF transformer to vary the inductance of the coils, hence the bandpass.

Operating voltages should be carefully checked against those shown on the schematic. Don't assume that all stages have correct screen voltages simply because one has! Quite often, a shorted tube has

overheated a screen-dropping or bias resistor, changing its value. Even though the tube has been replaced, the resistor hasn't—result, a stage with incorrect operating voltages.

**SAVE  
TIME  
with**

**SENCORE**

See other SENCORE ads in this issue.

**SENCORE**

*Handy "36"*

**R C-Substitution Unit**

"36"—Most Often Needed Components at YOUR Fingertips!

**3 Pole, 12 position switch individually selects one of the "36" components for direct substitution.**

Contains:

- ★ 12—1 watt 10% resistors from 10 ohms to 5600 ohms
- ★ 12—½ watt 10% resistors from 10K ohms to 5.6 megohms
- ★ 10—600 volt capacitors from 100-mmfd. to .5 mfd.
- ★ 1—10 mfd., 450V Electrolytic ★ 1—40 mfd., 450V Electrolytic

★ For Shop, Lab, or outside service

Service Instruments Corp., 121 Official Road, Addison, Ill.



ONLY  
**\$1295**

Model H-36 DEALER NET

Completely Isolated Available at all Parts Distributors

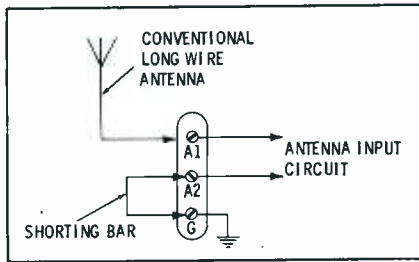
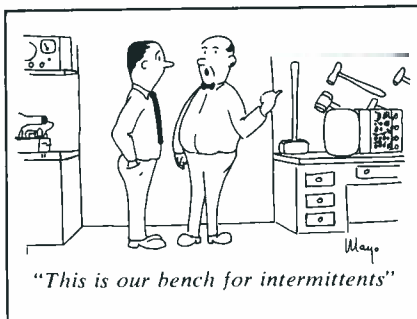

Fig. 3. TV antenna can be connected to A1-A2 after removal of shorting bar.

With these tests complete, give the set an "on-the-air" performance check. With the complete shielding of the metal cabinet, you'll need an outside antenna to get anything except powerful local stations. The bench TV antenna should serve very well. Most sets have provisions for attaching a dipole antenna, a three-terminal strip with shorting bar (see Fig. 3). The "clothespin" connector of the TV antenna can be clipped to these.

Check the broadcast band carefully to see that each station comes in on its assigned frequency. The dial scales of these sets are capable of being read with a good deal of accuracy. This calibration check is a very good indication of the possible need for realignment. Next, check the SW bands for activity. The low band may not have many stations on it (1.4 to 4 or 5 mc), but you should hear enough noise to tell whether it's "alive" or not. On the higher bands, check points are provided by the U. S. Bureau of Standards station, WWV (in Hawaii, WWVH). This station broadcasts extremely accurate RF carriers at 2.5, 5, 10, 15, 20, and 25 mc. These are modulated by a 440-cycle audio tone (which, incidentally, is what musicians call "Middle A," concert pitch, and can be used for tuning pianos, etc.) together with a one-per-second "tick" signal. Time announcements are given in both International code and voice at quarter-hour intervals. There are many other services



Limited time only! **Weller**<sup>®</sup>  
**INTRODUCTORY  
 OFFER!**



Buy both soldering tools and

**SAVE**  
**\$200** "special" model 8240K

**NEW DUAL HEAT SOLDERING GUN FOR YOUR KIT—**  
 Model 8200 with triggermatic control that switches instantly to high (125 watt) or low (90 watt) heat as your job requires. Tip life is increased because high heat is used only when necessary. Newest design gun with high efficiency, copper iron-plated tip. Spotlight. Reg. \$5.95 list.

**NEW TEMPERATURE-CONTROLLED IRON FOR YOUR BENCH—**Model TC-40. 40 watts. Built-in Magnastat temperature control at tip. Constantly maintains the proper soldering temperature—prevents overheating. Saves up to 50% on current used, gives 50% longer tip life. Ideal for printed circuit work. Reg. \$6.75 list.

A \$12<sup>70</sup> value • Special price \$10<sup>70</sup>

On sale for a limited time at your Electronic Parts Distributor.

**WELLER ELECTRIC CORP. • 601 Stone's Crossing Rd., Easton, Pa.**

*Have you ordered your copies of*

# Homeowner's TV Antenna Handbook

*...the low-cost consumer booklet that does your antenna installation and repair service merchandising for you.*

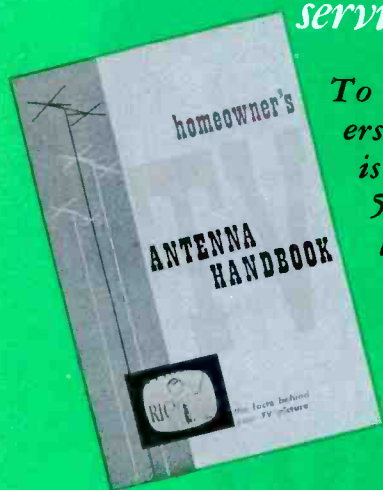

*To assist you in making your customers antenna conscious, PF REPORTER is offering quantities of this 8-page, 5½" by 8½" booklet at extremely low prices. Leaving one on each service call, or mailing a copy to everyone on your customer list, will prove more effective in gaining antenna business than anything you've ever tried.*

## Schedule of Prices

QUANTITY	PRICE
1 to 50	4¢ each
51 to 100	3½¢ each
101 to 500	3¢ each
501 to 1000	2½¢ each
over 1000	2¢ each
Unprinted 6" x 9"	
Mailing Envelopes	1½¢ each

4-line imprinting available for extra charge of \$4.00 for up to 1,000 copies; \$2.50 for each additional 1,000 or fraction thereof. All Orders Sent Postpaid.

Readers Service Dept., PF REPORTER  
2201 E. 46th St., Indianapolis 6, Ind.

Please enter my order for \_\_\_\_\_ copies of "Homeowner's TV Antenna Handbook." Add \$4.00 for imprinting up to 1,000 copies, \$2.50 for each additional 1,000 or fraction thereof.  Also send \_\_\_\_\_ mailing envelopes @ 1½¢ each. My check or money order for \$\_\_\_\_\_ is enclosed.

Please imprint (maximum 4 lines) my copies as follows. Allow at least 1 week for processing.

Name \_\_\_\_\_

Company \_\_\_\_\_

Address \_\_\_\_\_

City \_\_\_\_\_ Zone \_\_\_\_\_ State \_\_\_\_\_

## It's Antenna Check-Up Time

*Order your supply of booklets now to avoid disappointment. Just fill in the coupon below and send it along with a covering check or money order.*

offered by this station. A bulletin listing them is available from the Superintendent of Documents, Washington, D.C., and should be in every service shop.

When testing the higher bands, check frequencies at 5, 10 and 15 mc since they are the ones most commonly heard during daylight hours. See that they fall exactly on the proper calibration mark on the scale. If they don't, you can be very sure that the set is out of alignment, as the test signals are accurate to within one part in several million—but watch out for pointer error! If all signals show the same degree of miscalibration—one division, for instance—then the error could be in the positioning of the dial pointer on the cable rather than misalignment.

If these stations are not heard, and the general performance of the receiver is weak or noisy and seems to lack sensitivity, then a thorough alignment is probably in order. If the set uses the newer iron-core IF transformers, actual or unassisted alignment drift is very rare. Older sets, using mica compression trimmers, are subject to drift due to humidity changes, etc. However, "screwdriver drift" is the most common cause of IF misalignment.

Calibration of the main dial is another story. Practically all sets use compression trimmers in the oscillator circuits, and a small amount of drift is normal. Calibration of any set should be checked at least once a year, and a new set should be checked after it has been in use for about two months. The difference in climatic conditions, average humidity, etc., between the locality where it is used and the factory will cause a slight change in its calibration. Practically all of the better sets, if properly aligned, are capable of holding dial calibration accurately for long periods. In areas of excessive humidity changes, precautions such as spraying with a plastic protective coating may be taken to minimize the effects of this drift.

Complete alignment of a communications receiver is another story. The job is a rather painstaking process, but one which pays off in results and profits. We'll deal with this subject in the next installment. ▲

## New Designs

(Continued from page 26)

amplifiers are all similar to the circuit in Fig. 2 except for variations in parts values.

Nine front-panel controls permit either an increase or a decrease of as much as 13 db in the gain of individual circuits. Mounted in a vertical slot above each control is a red marker which moves up or down on a rainbow-hued db scale to indicate the control setting.

The outputs of the parallel amplifiers are mixed together, and the resulting wide-range signal is applied to a two-stage amplifier. Finally, the output is fed through a volume control to the power amplifier of the hi-fi system.

The *Audio Baton* takes its name from its unique ability to make specific instruments seem to stand out from or recede into an orchestral background. These effects are created by varying the gain of a narrow band of frequencies rich in the harmonics generated by the instrument. As an example of what can be done, the 1280-cps control can be advanced to hear a trumpet or banjo more clearly. The generally "muddy" sound of records which were made before the hi-fi era can be improved if the middle frequencies (especially those around 640 cps) are attenuated. In addition, even an untrained ear can detect a tremendous difference in sound clarity when the 2560-cps knob is rotated. Its action is similar to that of the "presence" control found in some hi-fi units.

When the front-panel volume control is set at maximum and the individual octave controls are all in the zero-db position, the *Audio Baton* will normally have no effect on either the volume or frequency response of audio signals fed through the instrument. Therefore, the easiest way to check its performance is to set the controls as described and then to analyze the operation of the system *with* and *without* the *Baton*. (The latter test should be made by plugging the pre-amplifier directly into the power amplifier. The front-panel BATON IN/OUT switch will not furnish an accurate check because it only disables the parallel amplifiers and does not bypass the two-stage output amplifier.)

# THE TREASURE CHEST THAT'S NEVER EMPTY



**FILLED WITH "GOOD-AS-GOLD" C-D CAPACITORS.** Here's the smart, modern way to keep your working capacitor stock shipshape. Each chest comes with a fast-moving assortment of C-D "Preferred" type twist-prongs, "Blue Beavers," and Mylar Tubulars—buy them and you get the chests **FREE**. Speed up your work...establish customer confidence with Consistently Dependable C-D capacitors from your own Treasure Chests. See them at your distributor or write for Bulletin to Cornell-Dubilier Electric Corporation, South Plainfield, New Jersey.



Consistently Dependable  
**CORNELL-DUBILIER**  
SERVICE CAPACITORS

# NEW!

**Acme Electric**  
TRANSFORMERS

## AUTOMATIC VOLTAGE STABILIZER



Compact in size, attractive in appearance. This unit rated at 200 va has capacity large enough to accommodate television receivers up to 24". Operation is noiseless and completely automatic. Fluctuation of incoming voltage over a range from 95 to 130 volts is automatically corrected ( $\pm 2\%$ ) within 1/30th second when operated within its normal rated capacity of 200 va. When TV set is turned off, a built-in relay automatically disconnects primary circuit, thus stopping coil magnetism. When TV set is turned on, relay automatically connects primary circuit. Furnished complete with heavy duty primary cord and built in secondary receptacle.

Write for bulletin VA-322.

PO-3226

**ACME ELECTRIC CORPORATION**

943 WATER ST.

CUBA, N. Y.

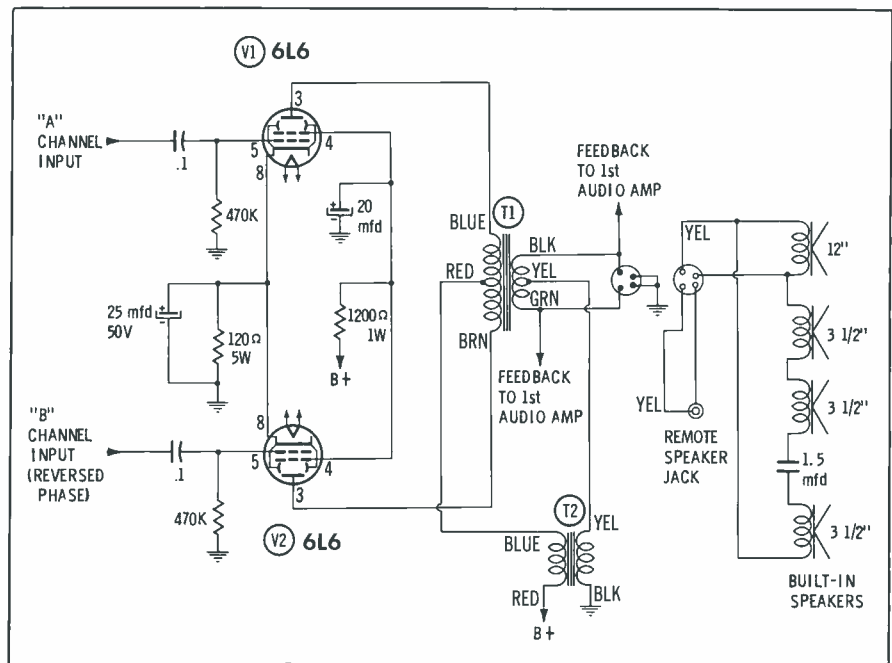

Fig. 4. Simultaneous parallel and push-pull amplifier has two input signals.

### New Turret Tuner

An unusual Sarkes Tarzian turret tuner called the "Hot Rod" (Fig. 3) is being used in the newest Muntz TV sets. Electrically, this tuner is a more or less conventional tetrode type equipped with a 2CY5 RF amplifier and a 5CG8 oscillator/mixer. The name "Hot Rod" refers to the unit's most distinctive physical feature—a group of ceramic rods that serve as combination channel strips and coil forms.

The various tuning coils for a particular channel are wound side by side on a rod, and the coil ends are attached to metal contacts which are embedded in the ceramic material. A complete set of rods is then mounted on a frame to form a turret assembly. Connections be-

tween the channel strips and the tuner body are made through spring contacts mounted on a stationary ceramic rod.

The front end of each rod is enlarged into a "hammerhead" that contains an oscillator adjustment slug. These adjustments can be made through a hole in the front cover of the tuner (see Fig. 3A), but keep in mind that a slender adjustment tool must be employed.

The mysterious-looking button on the back of the tuner is actually a contact designed to receive the output of an optional UHF tuner.

It may occasionally be necessary to disassemble a "Hot Rod" to replace a damaged channel strip or to perform some other servicing operation. The procedure is as follows: Unsolder the braces at the bottom; remove two screws from

## REPLACEMENT SPEAKERS

Stick with the "man who brung" you . . . order replacement speakers and specify OXFORD . . . the world's largest producers of SPEAKERS. Our seven factories are supplying the majority of original equipment manufacturers, assures you of exact replacements.

Leading distributors carry OXFORD . . . so should you.

# OXFORD

COMPONENTS, INC.  
556 West Monroe Street  
Chicago 6, Illinois

OXFORD Export: Roburn Agencies, New York • In Canada: Atlas Radio, Toronto  
BRANDS: Supreme Transformers, Hudson Lamps, Tempa Hi-Fi, Oxford Speakers & Rear Deck Kits.



the front cover; unsolder the shaft-retainer plate on the back cover; then, lift out the turret and front cover as a unit. To remove an individual rod from the turret, lift up on the plastic retaining bands (which are somewhat elastic) and simply slide the rod outward from the turret assembly. When putting the tuner back together, be sure the detent roller (Fig. 3B) is properly seated.

### A Two-Signal Amplifier for Stereo

Before stereo came along, you could usually figure out the block diagram of a hi-fi power amplifier from its tube complement. If you saw a pair of beam-power tubes side by side, you could reasonably assume that the amplifier had a push-pull output stage. Matters are a little more complicated in the popular-priced stereo field, however. A chassis equipped with two beam-power tubes may be wired in any one of three ways:

1. *Push-pull stage feeding one speaker system.* In this case, the phonograph may have been sold as "ready for stereo" and may still be basically a monophonic unit. If the system is already fully equipped for stereo, the second-channel amplifier will be found on a separate chassis.

2. *Separate single-ended amplifiers feeding different speaker systems.* This arrangement is widely used, especially in the more compact "package" stereo units now on the market.

3. *A brand-new "Two-way" stereo circuit* developed by CBS Laboratories. A quick once-over would give you the impression that this is an ordinary, monophonic push-pull circuit, but closer study reveals the rather startling fact that it provides two separate output signals to two different sets of speakers. This amplifier was designed to obtain many of the advantages of dual push-pull amplifiers while using very little more circuitry than would be required by a pair of single-ended stages.

The "two-way" layout first appeared in a line of Columbia stereo phonographs. Fig. 4, a schematic of the version found in Models 634 and 680, shows how closely the new circuit resembles a typical



There's no mystery here, Watson!

It's a perfect

**ASTRON**  
electrolytic  
capacitor

"Perfect" is the word for the serviceman's designed Astron line of capacitors. The popular Astron Twist Prong is a good case study. The clues are here. Judge for yourself!

- A selection of single, dual, triple and quadruple capacitance-voltage combinations designed for practical replacement requirements.
- Ideal for replacement in television, radio and other high quality electronic equipment where high ripple and high surge voltages are encountered.
- Hermetically sealed. Designed for 85° C operation.
- Quick, easy, firm mounting through chassis slots or slotted plates for insulated or grounded connection. Mounting prong ring serves as common negative terminal.
- Terminal coding clearly stamped on container.
- Individually packaged with mounting plates for your convenience.

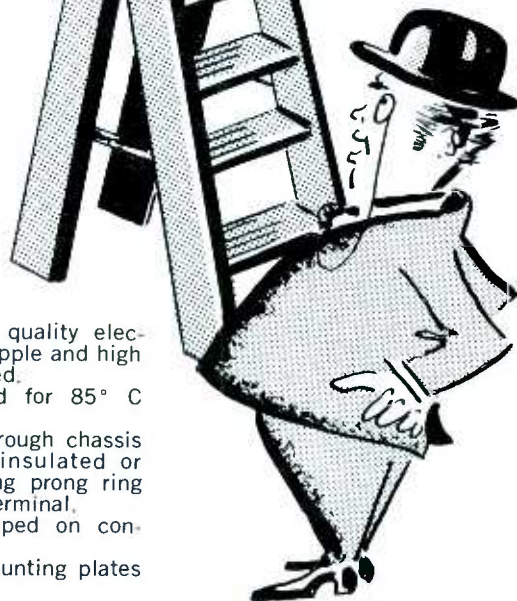

SEE US AT  
BOOTH NO. 2716  
IRE SHOW

**ASTRON**

C O R P O R A T I O N

255 GRANT AVENUE, EAST NEWARK, N. J.



At Your Service...  
at big savings

# arkay

Hi-Precision  
**TEST INSTRUMENTS**  
Kits and Wired

Designed and engineered in the Arkay tradition of highest professional quality at lowest cost.

**NEW!** ARKAY VT-10 6-INCH  
MULTI-PURPOSE  
VACUUM TUBE VOLTMETER



Advanced design and precision features make the Arkay VT-10 a truly sensational buy, unmatched at this price. You get exclusive larger 6-INCH 400 ua meter movement, within 2% accuracy, and edge-lighted for easier reading. 1% precision multiplier resistors are used throughout the range switch. There are 7 AC (RMS) and DC ranges, 0 to 1500 volts; also 7 AC (peak-to-peak) ranges, 0 to 2000 volts. Resistance of 0 to 1000 megohms, db and other essential ranges also included. Circuitry features 12AU7 for DC ranges, 6AL5 for AC, meter diodes rectifiers, and transformer operated selenium rectifier. Handsome durable plastic case.

Easy-to-build Kit **\$25.95**  
Wired and tested \$47.95



**ARKAY AV-20 6-INCH AUDIO VTVM PRE-AMPLIFIER**  
An Audio Vacuum Tube Voltmeter of extreme sensitivity, engineered for accurate measurements of RMS voltages.

Easy-to-build Kit **\$29.95**  
Wired and tested \$49.95



**ARKAY AW-30 6-INCH DIRECT READING AUDIO WATTMETER**  
Measures Audio Power Output with speed and precision. 0 to 500 watts in 6 ranges. For laboratory and general use.

Easy-to-build Kit **\$29.95**  
Wired and tested \$49.95



**ARKAY CAP-40 6-INCH DIRECT READING CAPACITY METER**  
1% precision calibration capacitors and 6-inch 200 ua meter movement provide accurate readings. 0 to 1 mfd. in 6 ranges.

Easy-to-build Kit **\$29.95**  
Wired and tested \$49.95



**ARKAY MT-50 6-INCH 20,000 OHMS PER VOLT METER**  
A completely portable multimeter of high accuracy. Sensitivity is 20,000 ohms per volt DC, 5,000 ohms per volt AC.

Easy-to-build Kit **\$29.50**  
Wired and tested \$42.95

All prices 5% higher west of Mississippi

See ARKAY completely wired Test Instruments at your dealer. Write for detailed specifications and catalog. Dept. PF

arkay

PAGE

88-06 Van Wyck Expressway Richmond Hill 18, N.Y.

push-pull amplifier. Note, however, that an extra output transformer T2 is connected to a center tap on each side of the main transformer T1. Another unexpected feature is that V1 and V2 receive completely different input signals—one from each element or coil in the stereo cartridge. Compare this with the usual push-pull arrangement, where one tube gets an upside-down version of the same signal being applied to the other tube.

Before we try to find out how the stereo signals percolate through this amplifier, we'd better take some simple test signals and study the operation of the circuit in slow motion. To start with, let's try two sine waves which are 180° out of phase but otherwise identical. When these signals are applied to the grids of V1 and V2, out-of-phase signals will appear at the plates of the tubes; that is, the plate current of one tube will be increasing while that of the other is decreasing. Now, since the plate current of both tubes will flow toward the center tap on the primary of T1, current will pass in opposite directions through the two halves of the primary. Out-of-phase currents, flowing in opposing directions, produce magnetic fields that reinforce each other. In other words, push-pull operation has been obtained as far as T1 secondary is concerned.

The plate currents of the two tubes, still out of phase, will both flow in the same direction through the primary of T2. Consequently, the magnetic fields due to these currents will cancel and no output will be obtained from this transformer.

Now let's apply identical, in-phase signals to the grids of V1 and V2, thus causing the plate currents of the tubes to vary in step with each other. Since equal signal currents will flow in opposite directions through the two halves of T1, two opposing magnetic fields will be produced and no output signal will be generated. On the other hand, an output will appear in the secondary of T2 because of the reinforcing fields developed by the two in-phase currents passing in the same direction through the primary. It should now become evident that any in-phase input signals will be amplified by the two tubes working in parallel.

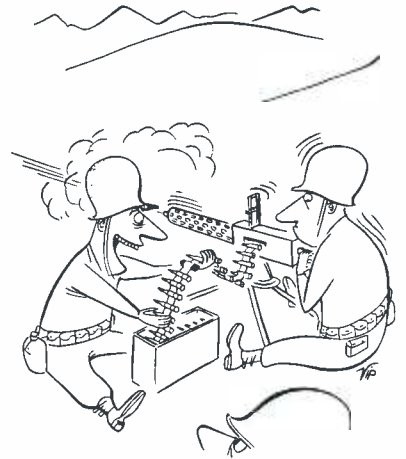

"Hold it, Ed! One of these cartridges is a JENSEN."

**IF YOU MUST SPEND YOUR MONEY**  
Why not get something for it?  
get **QUIETROLE**

**QUIETROLE**  
TRADE MARK U.S. PAT. OFF.

Costs little more than the poorest substitutes. Why take less than the BEST...

No Product can match its merit...  
None can equal its quality...

It's the answer to noisy controls and switches

QUIETROLE is the original product of its kind

MFG BY **QUIETROLE** Company  
SPARTANBURG, South Carolina  
IN CANADA: ACTIVE RADIO and TV DISTRIBUTORS  
• 58 Spadina Ave., Toronto 28, Ontario

Of course, the signals that actually pass through the A and B channels of a stereo amplifier are not identical, so you can't classify them exactly as "in phase" or "out of phase." These two signals, taken together, form a complex combination of signal elements that may be in phase at one instant and out of phase at the next. The circuit will therefore operate as a simultaneous push-pull and parallel amplifier, and outputs will be obtained from both T1 and T2. These resultant signals are not equal to the original A- and B-channel inputs, but they can be combined or "matrixed" (like color-difference signals in color TV) to recover the original signals.

By now, we should be about ready to trace the path of the stereo signals through the two-way amplifier. Let's start at the stylus. In the Westrex 45/45 system now being used as a standard for stereo recording, lateral "ripples" will be cut into the record groove when identical program material is present in both the A and B channels. (This will happen when the source of sound is midway between the two microphones used in the stereo recording setup.) When amplitude or phase differences exist between the A and B signals, the groove will be cut to some extent vertically as well as laterally. In cases where the signals are equal in amplitude but exactly 180° out of phase, the cutting will be done entirely in the vertical direction.

Conventional 45/45 stereo cartridges are wired so that pure lateral motion of the playback stylus in the record groove will cause a pair of in-phase signals of equal amplitude to be delivered to the amplifier by the A and B elements of the cartridge. Likewise, pure vertical motion will result in a pair of out-of-phase signals. To make a cartridge suitable for use with the two-way amplifier, however, it is necessary to reverse the leads of one element so that the lateral motion of the stylus will produce out-of-phase signals. When this hookup is used, a monophonic record (which contains pure lateral modulation) will furnish outputs that will drive the two-way amplifier in push-pull. A stereo recording will also produce some vertical stylus motion, and this



## The Greater Vibrator

Radiart Vibrators are unaffected by bounce, jounce, heat, cold, moisture. There's a replacement type for every 6- and 12-volt application. Ask your Radiart Distributor for a free Radiart Vibrator Replacement Guide or write The Radiart Corporation, 2900 Columbia Avenue, Indianapolis 5, Indiana.



**RADIART**  
TOBE  
**Vibrators**



For the tough  
old "DOGS"

Always rely on **DOSS**

For better, faster  
servicing get the

**NEW**

D-400 Hi Leak Analyzer



- Extremely sensitive, quick check for all bypass condensers (0 to 1.0 mfd)
- Identifies leakage up to 500 meg-ohms
- Checks for open conditions
- Checks leakage in tubes, I.F. transformers, flybacks and others
- Built in indicator, completely portable

NOW ONLY \$12.95 net

Fill in this handy order blank. Order will be credited to your distributor.

**DOSS**

**ELECTRONIC RESEARCH, INC.**  
820 Baltimore K. C. 5, Missouri

**ORDER NOW ON A 30 DAY  
MONEY BACK GUARANTEE**

If for any reason I am not satisfied with my D-400 HI LEAK ANALYZER, I may return it within 30 days for full refund.

- Enclosed is remittance of \$12.95  
 Please ship C. O. D.

NAME \_\_\_\_\_

ADDRESS \_\_\_\_\_

CITY \_\_\_\_\_

STATE \_\_\_\_\_

**NEW!** ON THE SPOT CHECK  
OF HORIZONTAL  
OUTPUT CIRCUIT!

—ends most common  
cause of callbacks!



**SECO HC-6  
CURRENT  
CHECKER**

- PLACE IN CIRCUIT IN SECONDS — NO DISCONNECTING OF CATHODE
- FAST, ACCURATE WAY TO ADJUST HORIZONTAL DRIVE AND LINEARITY

This new, low-cost current checker provides a positive, on-the-spot method of checking and adjusting TV horizontal output circuits — eliminates one of the most common causes of callbacks. Can be placed in circuit in seconds — without disconnecting cathode — immediately indicates whether horizontal output tube cathode current is within manufacturer's recommended limits. Insures proper picture focus, width, and stability with minimum cathode current — helps prevent premature failure of horizontal output transformer and in some cases failure of power transformer and rectifiers. HC-6 is valuable as a fast, accurate indicating device when adjusting horizontal drive and linearity. A "must" on all TV horizontal tube, transformer, or yoke replacement jobs — may also be used to balance hi-fi audio output tubes. Compact — inexpensive — easy to use — the HC-6 is a time-saving, money-making addition to your service kit. Complete, ready to use.

**\$12.95  
NET**

See your distributor . . . or write to:



**SECO MANUFACTURING CO.**  
5015 Penn Ave. S., Mpls., Minn.

will cause a certain amount of in-phase information to arrive at the grids of the amplifier tubes. As far as this component of the signal is concerned, the tubes will be driven in parallel.

Loosely speaking, then, we might say that the similarities between the A- and B-channel signals will receive push-pull amplification — and the differences between them (which determine the stereophonic effect) will receive parallel amplification.

Let's stop and think this statement over. Looking at it in another light, only that part of the signal which is necessary to create a stereo effect will appear at the output of T2. A couple of highly significant facts have been discovered about this component of the stereo program. For one thing, bass notes tend to be nondirectional and to affect both stereo channels about equally — so we won't find much low-frequency information in the difference signal. Furthermore, the power required for undistorted reproduction of the difference signal has been found to be considerably less than that required for the similarity signal. This is good news, because the amplifier tubes will not perform as well in parallel as they will in push-pull. Being single-ended, the parallel circuit has built-in limitations from a standpoint of both low-frequency response and maximum undistorted power output.

Here's a nice little bonus obtained from a two-way operation: The relatively poor low-frequency response at T2 will help us minimize turntable rumble and other low-frequency interference, which chiefly affects the vertical modulation of the record groove and thus appears mainly across T2.

Since the output signals of the two-way circuit are effectively equal to the sum and difference combinations of the two original stereo signals, you can't recover these A and B signals by simply connecting speakers to the secondaries of T1 and T2. Instead, the outputs have to be blended to achieve the desired effect. This is done as shown in Fig. 5. Note that the output for each set of speakers is obtained from T2 in series with half of T1.

**XCELITE PLIERS**

have a . . .

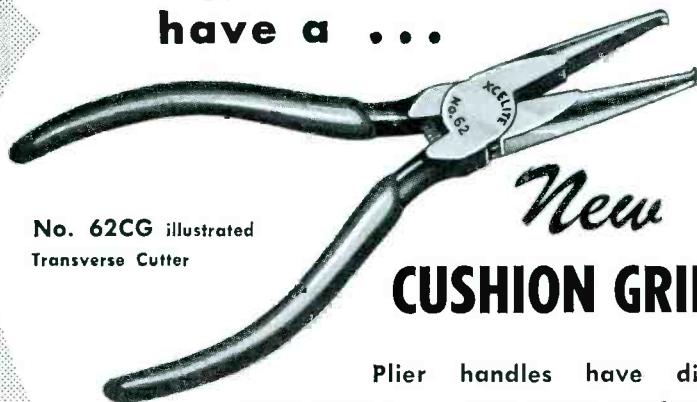

No. 62CG illustrated  
Transverse Cutter

*New*  
**CUSHION GRIP!**

Plier handles have dipped  
plastic coating . . . permanent, comfortable.

Heads polished and buffed to a "mirror finish".

All pliers available . . . See Your Distributor!

*Gives pliers a "Feel" that inspires Craftsmanship!*

**XCELITE, INCORPORATED**  
ORCHARD PARK, NEW YORK  
Canada: Charles W. Pointon, Ltd., Toronto

**XCELITE**  
*Quality Hand Tools*  
PREFERRED BY THE EXPERTS

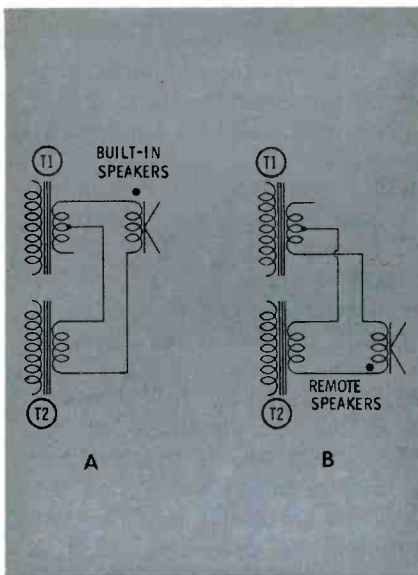

Fig. 5. Method of connecting speakers to transformers of a two-way amplifier.

The system is wired so that the signals will be taken in the same polarity from T2 but in opposite polarities from T1. The A and B components of the T1 and T2 outputs then combine in two different ways to re-create the original inputs.

### Installation Hints

There are several things to keep in mind when installing or servicing a hi-fi unit that employs a two-way amplifier. One point to remember is that the cartridge must be wired so as to produce a 180° phase inversion in one of its output signals. Some cartridges are available already wired for two-way service; for example, Columbia uses a special SC-2 Series *Constant Displacement* stereo cartridge in place of the standard SC-1 Series. In case a properly-wired cartridge cannot be obtained, a conventional four-wire unit can be rewired in the field.

Another important point is that the 180° phase inversion is still present in one of the signals recovered in the speaker circuit. Accordingly, the speaker system installed with a two-way amplifier should be carefully checked to see if it is properly phased. If not, the input leads for one set of speakers can be interchanged.

Finally, since this circuit depends on cancellation of push-pull signals in T2 and of parallel signals in T1, the output tubes must be closely matched in their characteristics—even more so than in an ordinary push-pull amplifier. ▲

**ANOTHER HUNTER FIRST!**

**THE ATOM**

**3 NUT DRIVERS in 1**  
IN 3 POPULAR SIZES  
1/4" · 5/16" · 3/8"

**FREE!**  
32 PAGE TOOL CATALOG

**SLUG RETRIEVERS...**

**Magic-Tip SCREW HOLDING SCREWDRIVERS**

**NOW IN 14 PROVEN SIZES!**

**HUNTER TOOLS**

9851 ALBURTIS AVE.  
SANTA FE SPRINGS, CALIFORNIA

**For the tough old "DOGS"**



**Always rely on DOSS**  
For better, faster servicing get the **NEW**

**D-600 Electrolytic Substitute**



- Tests all electrolytic capacitors "in circuit"
- Will not heal defective capacitors
- Neon indicator simplifies testing
- D-600 can be "switched" in or out of circuit
- Can be carried on the job, completely portable

NOW ONLY \$8.95 net

Fill in this handy order blank. Order will be credited to your distributor.

**DOSS ELECTRONIC RESEARCH, INC.**  
820 Baltimore K. C. 5, Missouri

**ORDER NOW ON A 30 DAY MONEY BACK GUARANTEE**

If for any reason I am not satisfied with my D-600 ELECTROLYTIC SUBSTITUTE, I may return it within 30 days for full refund.

- Enclosed is remittance of \$8.95  
 Please ship C. O. D.

NAME \_\_\_\_\_  
ADDRESS \_\_\_\_\_  
CITY \_\_\_\_\_ STATE \_\_\_\_\_

**Can you Fix this radio?**

You're going to get more and more calls to service transistor radios. It's easy to learn how to handle them with this new G/L Technicians' Club book. It gives you complete practical data on transistor radio servicing—from theory to advanced techniques. Includes troubleshooting charts. Increase your income. Get this book now! It retails for \$4.60—but here's

**HOW TO GET THIS BOOK FOR ONLY \$3.35**  
Through the G/L Technicians' Book Club you can get this book and others equally valuable for only \$3.35—a 27% saving!

**NO-RISK COUPON**

Gernsback Library Inc. PR-39  
154 West 14th St., New York 11, N. Y.

Enroll me in the G/L Technicians' Book Club. Send me my copy of **SERVICING TRANSISTOR RADIOS**.

Send me more information on the G/L Technicians' Book Club.

Name \_\_\_\_\_ please print  
Street \_\_\_\_\_  
City \_\_\_\_\_ Zone \_\_\_\_\_ State \_\_\_\_\_

**SERVICING TRANSISTOR RADIOS**  
By Leonard D'Airo  
224 pages. Deluxe gold-stamped hard cover.  
List price \$4.60



Model 810

### 3 TESTERS IN 1

- ★ Tuned Receiver
- ★ AM Generator
- ★ Transistor Tester

Specifically designed with all necessary features for complete troubleshooting of transistor radios. Almost all portables made today are transistorized. With the 810 you can profit immediately from service in this large, new field. The instruction book included contains an easy-to-learn course in transistor radio servicing. Now, any serviceman can quickly troubleshoot and profitably repair transistor radios.

**TUNED RECEIVER**—200 to 500 KC for troubleshooting IF. 550 to 1600 KC for troubleshooting RF. A cathode follower input probe minimizes loading. Loudspeaker indicator for signal tracing.

**AM SIGNAL GENERATOR**—200 to 575 KC for IF alignment. 550 to 1600 KC for RF alignment. 400 cycle audio output for signal injection.

**TRANSISTOR TESTER**—Test circuit for checking transistors—leakage and gain.

The 810 will pay for itself in a short time . . . and give you many years of accurate, dependable service.

**\$109<sup>90</sup>**  
**NET**

Now is the time to...  
**TRADE UP TO A HICKOK**

Ask for a demonstration of the new 810 from your Authorized Hickok Distributor.

**THE HICKOK ELECTRICAL INSTRUMENT CO.**  
10514 Dupont Ave. • Cleveland 8, Ohio

## Shop Talk

(Continued from page 18)

to use another receiver in good working condition. This is an excellent signal source, not only because almost every service shop has one, but also because you know, from the operation of this other set, that the signal is doing its job properly. A completely operating set is desirable, but not absolutely necessary. Any receiver whose horizontal deflection system is functioning normally will do fine, irrespective of how the rest of the set is doing. Thus, even some of the sets waiting to be repaired can serve as signal sources.

The method of applying the test signal is quite simple. With both sets turned off, connect one horizontal amplifier control grid to the other through a .1-mfd capacitor. To complete the circuit, both chassis are connected together. (Note the schematic presentation of this hookup in Fig. 2.) An isolation transformer should be used wherever a receiver has no power transformer. If both receivers are transformerless, two isolation transformers will be needed.

To prevent confusing results, it is generally best to kill the oscillator in the set being tested. This can be done in several ways. If the tube filaments are parallel-wired, the oscillator tube is simply removed from the circuit. If the filaments are series-wired, it is frequently possible to kill the oscillator by connecting a short circuit between grid and cathode of the section developing the deflection sawtooth. (In a multivibrator, this is the section closest to the output amplifier.) For oscillators controlled by pulse-

width AFC systems, the latter generally is not feasible. Here, a grid or plate lead should be temporarily unsoldered.

With the proper connections made and the equipment in operation, driving pulses will be fed to the receiver under test. Observe the results on the screen of this set; a raster will be seen if the circuit is functioning. How much of the screen is covered by the raster will depend on the amplitude of the driving waveform. If this pulse is less than normally applied to the grid of the horizontal amplifier, less sweep will be developed. If it is greater in amplitude than the stage usually receives, greater sweep will be produced, but generally not too much greater than normal. In neither case will the driven amplifier be damaged because of the change that takes place in bias conditions and because of the relatively short time of the actual test.

As an illustration, the following test was performed on two chassis. One was a Zenith and the other an Emerson. The Zenith circuit ordinarily developed a driving signal with a peak-to-peak amplitude of 150 volts; in the Emerson set, the wave normally applied to the control grid of the horizontal output amplifier was 100 volts peak-to-peak.

First, the oscillator in the Emerson set was disabled and the 150-volt signal from the Zenith receiver was applied to the Emerson circuit. Normally, the grid bias (with respect to chassis) on the output stage was -15 volts, while the cathode had a positive 10 volts. This represents a 25-volt bias between grid and cathode. With the larger driving signal, the grid voltage rose to -19

**SAVE TIME with**

**SENCORE**

See other SENCORE ads in this issue.

**Model ES-102**  
**ONLY \$15<sup>95</sup>**  
DEALER NET

Look that up for the individual capacitors. Carry it anywhere—measures only 4 3/4" H x 4 3/4" W x 2 1/4" D

**New!**

**SENCORE Electro-Sub**

Check all **ELECTROLYTIC CAPACITORS** in Seconds!

Merely select the electrolytic and substitute it. 10 big electrolytics from 4 to 350 Mfd. to safely substitute in: any circuit from 2 to 450 volts.

- ... COMPLETELY SAFE—no arc or spark when connecting or disconnecting.
- ... AUTOMATIC CAPACITOR DISCHARGE—within seconds after releasing test switch by, unique surge protector circuit.
- ... NO CAPACITOR HEALING—surge protector circuit prevents accidental healing of capacitor being "bridged" in service work.

SERVICE INSTRUMENTS CORP. 121 Official Rd. • Addison, Ill.



**SUITS NEED PRESSING—  
MERIT DEFLECTION YOKES  
DO NOT!**

Merit deflection yokes are cosine wound TO FORM, not pressed. Pressing can lead to distortion and poor focusing. Pressing after winding frequently causes breakdown.

**MERIT COILS AND TRANSFORMERS  
HAVE "BUILT-IN" ADVANTAGES.**



Each Merit yoke is  
100% LIVE TESTED

COMPARE IT WITH  
**MERIT**  
MERIT COIL AND TRANSFORMER CORP.  
MERIT PLAZA • HOLLYWOOD, FLORIDA

**SUBSTITUTE PARTS  
WITH-OUT SOLDERING**  
Quickly with Easily

Has 1001 Uses!

**NEW** E-Z-Hook "SUB" Connectors

Connect a speaker, or

Substitute a

- transformer
- capacitor
- resistor, or tube

In Seconds!!

★ Makes connections instantly!  
★ Won't pull off!  
★ Insures positive contact!  
Saves time, money and parts in servicing, experimenting, instructing and production.

**E-Z-HOOK SUB**  
No. 71-1...SUB... Only 69¢ ea.  
Six Colors! - for Easy Lead Identification

**E-Z-HOOK TEST PRODUCTS**  
SAFE - FAST - SURE

ORDER THROUGH YOUR PARTS DISTRIBUTOR  
**E-Z-HOOK TEST PRODUCTS**  
Dept. F, 1536 Woodburn Ave.  
Covington, Ky.

volts and the cathode voltage became 12 volts. This represents a total bias of -31 volts. Thus, the stronger drive was partially counteracted, minimizing over-drive. When the reverse arrangement was tried, the voltage difference between grid and cathode became less.

It is desirable, of course, to use driving signals close in amplitude to those normally applied to the output stage. Obviously, if you use the deflection wave from a set having a 10" screen to drive a set having a 24" screen, the disparity may be great enough to provide misleading results. However, the method is flexible enough so that a difference in peak-to-peak amplitude of even 30 to 40 volts will still enable you to obtain a useful indication.

While the test pulse is active, you can measure the boost B+ voltage. (Never measure this directly at the damper tube but at a point where it has been filtered. The filter may be a simple shunt capacitor, or a combination of shunt capacitor and series coil.) Some deviation from the normal value may be encountered, but the decrease (generally) should be within 10% of the indicated value.

Incidentally, while we are on the subject of boost B+, there is a feeling among some servicemen that an absence of boost voltage will prevent the oscillator from functioning normally when it is used in part to power this circuit. As long as B+ voltage is still present, the amplitude of the grid-driving signal will still be sufficient to produce horizontal sweep. This means that, if we completely removed the boost B+ voltage from the oscillator and used only the regular B+ to power this stage, essentially a full raster would be obtained on the screen. We are assuming, of course, that the proper boost B+ is being developed for the rest of the flyback system.

If an image contains horizontal distortion, you can use the signal-injection method to determine whether the distortion is being developed in the output circuit or at some prior point. Develop an image using a substitute signal wave and note whether or not the distortion is still present. If it is, the trouble is being caused by some component between the point of signal application (i.e., the control grid of the

**Resistor Stock In  
HANDY BOOK FORM  
with unique IRC**

**RESIST-O-PEDIA**

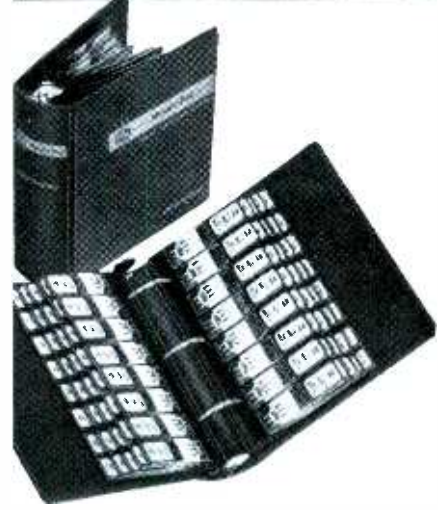

Brand new approach to convenience. Wide assortment of carbon composition resistors in handy book form. Attractive blue and yellow hardback binder 9 x 8 1/4 x 2 7/8" size... 3-ring "fingered" inserts hold Handy-Paks of IRC resistors. Provides a compact, easy to use, visible inventory. RESIST-O-PEDIA included free with any of—

- 3 POPULAR ASSORTMENTS**
- #44—462 1/2-watt resistors, 77 values \$55.44
  - #48—308 1-watt resistors, 77 values \$55.44
  - #51—195 2-watt resistors, 65 values \$46.80
- Dealer Net Price

**IRC HANDY-PAK \***  
Slimline plastic sleeve protects modern, reusable package. Opens at either end, closes to hold remaining resistors. Stock and complete identification always visible.

ORDER FROM YOUR IRC DISTRIBUTOR

Other new IRC "extra-value" assortments are described on the following pages.

\*PATENT PENDING

**IRC**

**INTERNATIONAL RESISTANCE CO.**  
401 N. Broad St., Philadelphia 8, Pa.

**BERNS** PERFECT  
PIN-CRIMPER

**"A Handy 3-in-1 Tool"**

only \$1.25

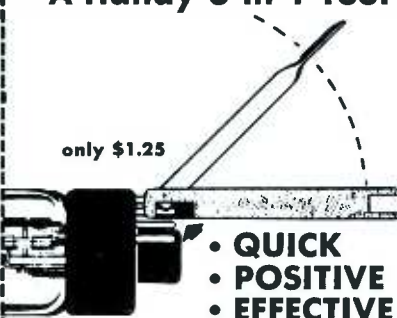

- QUICK
- POSITIVE
- EFFECTIVE

ELIMINATES SOLDERING socket pins of picture tubes or any other tube. Pin keeps its original form.

USE WRENCH to change channels.

USE BLADE as screwdriver.

IT'S DANDY . . . IT'S HANDY  
"you'll like it"

Available at your parts distributor or write us.  
Another fine product from:

**BERNS** Mfg. Co.  
9853 Chalmers,  
Detroit 13, Mich

**New TV SERVICE CRADLE**  
SPEEDS REPAIRS • BRINGS  
BIGGER SERVICE PROFITS



- Increases Production.
- Frees Bench For Test Equipment, Tools, Schematics.
- Precision Built.
- Moveable, Lightweight.

**PAYS FOR ITSELF WITH LABOR SAVINGS ON FIRST FEW JOBS**

TEL-A-TURN ends in-repair damage, propping and struggling with hard to handle TV chassis. Holds sets up to 200 lbs. and 9" to 25" wide. Places every component in sight and reach. Built-in speaker, outlets, cheater cord, pilot light and switch. Stand and bench models. Ideal too for servicing record changers, amplifiers and other electronic equipment. See TEL-A-TURN at your jobber or write today for free details. Dept. PF-39

**ROGERS** MANUFACTURING CO.  
LINDSEY, OHIO, U.S.A.

output amplifier) and the deflection yoke. If the distortion is not present, it is originating ahead of this point.

What is true of the horizontal system is also true of the vertical section. The same procedure is employed here, and the same precautions are taken to prevent any oscillator signal from reaching the grid of the output amplifier while it is being tested. Incidentally, a popular vertical system employs the output amplifier as the second half of the vertical multivibrator. With the signal-injection method, we can quickly determine which portion of this circuit is at fault.

In either system, vertical or horizontal, once you have determined that the output amplifier is functioning normally, you can concentrate on the oscillator. Just knowing which section of the horizontal system contains the defect will simplify the service problem considerably.

Another useful application of substitute signals is to localize sync troubles. The first inclination of a serviceman faced with this problem is to scope the pulse coming into the vertical oscillator by way of the integrating network. For a clear-cut indication, this necessitates removal of the vertical oscillator tube. Even with this precaution, it is possible to overlook some disturbance in the signal, or some distortion which will hamper positive triggering of the oscillator. A procedure that has been used successfully is to disable the last sync amplifier, either by removing the tube or by shorting grid to cathode, and then supplying a vertical sync pulse from another receiver. If lock-in is achieved with the pulses applied directly to the oscillator circuit, try injecting the

proper signal at the input of the integrating network. If the same result is obtained, you know the integrating circuit is functioning properly. This is a good check on this network, and is simpler to perform than substituting another integrator.

Vertical jitter lends itself particularly well to this approach. When faced with this trouble, you have to determine whether it is being caused by amplitude variation in the incoming pulses, or whether it is due to a signal (generally horizontal sync pulses) reaching the vertical oscillator through some extraneous coupling or by way of the B+ line. With an injected pulse, you can check out the incoming vertical pulses quite simply. If the jitter remains, the cause is elsewhere.

Several precautions should be observed when injecting pulses into the vertical oscillator. First, make certain that pulse polarity is correct. Blocking oscillators require positive pulses, but multivibrators may take either positive or negative pulses, depending on their point of application. Second, try not to overdrive the oscillator, although considerable leeway is permissible. Third, tune both sets to the same channel, and further make certain no other vertical sync pulses are reaching the circuit.

It is possible to inject video signals from one receiver into another—again, if proper attention is paid to signal polarity. When doing this, a 10K-ohm series resistor should be used to minimize the effect of the additional load on the circuit supplying the signal. Signal injection also works well in the RF and IF sections, although special commercial generators are more desirable for really effective results. ▲

**SENCORE**

**Save Time with**

**LEAKAGE CHECKER**

Check these outstanding New Features

The LC3 provides all these new improved features in addition to those employed in earlier leakage or "grid circuit" testers. A must for any TV service technician.

- ★ Checks 156 different tube types—more than any other "grid circuit" type checker. Includes UHF and latest type tubes.
- ★ Checks picture tubes without removing tube from cabinet or chassis.
- ★ New Roll Chart prevents absenteeism—just dial the tube type and save time. Chart is easily replaced at no extra cost.
- ★ Provides instant filament checks on "Fil-Check" position—no need to carry a second filament checker.
- ★ Capacitor checks simplified.
- ★ Two spare preheating sockets to cut down testing time.

In stock at your local parts distributor.



Model LC-3  
**\$2895**

DEALER NET  
Really Whips  
Tough Dogs

Service Instruments Corp., 121 Official Road, Addison, Ill.

See other SENCORE ads in this issue



## TV TUNERS REBUILT

All MAKES & MODELS

VHF  
OR  
UHF



EXCHANGED  
OR  
OVERHAULED  
**\$9.95**  
NET

90 DAYS  
WARRANTY

COMBINATION  
UHF/VHF  
UNITS  
**\$19.90**

ALIGNED TO ORIGINAL STANDARDS

Price includes worn parts only, defective tubes and damaged major parts are extra at net prices.

Forward tuner complete with tubes, shield cover and any damaged parts.

QUOTE MAKE AND MODEL

F.O.B. CHICAGO OR TORONTO  
We will ship C.O.D.

### CASTLE TV TUNER SERVICE

1723 W. LUNT AVE. 152 MAIN ST.  
CHICAGO 26, ILL. TORONTO 13, ONT.

**U.S.A. CANADA**



## you'll find TV installation items faster in the '59 MASTER

Complete descriptions, illustrations, prices for more profitable TV-radio-audio-industrial servicing. You can buy, sell and bill direct from the MASTER—world's largest electronic catalog at your jobber... only **\$3.50**. \$4.50 in Canada

FREE—24-page **PANEL LAMP CHART** at your jobber, or send 10c to:

**THE RADIO-ELECTRONIC MASTER**  
65 Sewell Street Hempstead, N.Y.

## Industrial Electronics

(Continued from page 31)

controlled. Figs. 4 and 5 are compatible; therefore, the circuit of Fig. 5 would include resistor R5 shown in dotted lines, and the grid returns of V1 and V2 would be placed at the bottom of R5 for constant horsepower control.

The control supplied by R5 must be less than the control supplied by the voltage-sensing network; thus, armature current will not be as closely regulated as armature voltage.

### Commercial Motor Controls

The foundation of all motor controls is the relationship of a motor effect to an electrical effect. The exact relationship depends on the characteristic to be controlled. For example, the three control functions just described are often paired together in commercial units to serve several functions. The current-sensing resistor R5 of Fig. 4 may also operate an acceleration-control tube, or the armature-voltage sensing circuit of Fig. 5 may serve as an over-voltage limiter.

### Motor Control Maintenance

Tubes should be changed every 2,000 hours of operating time. A log of all repairs should be kept near the machine or in the shop records. The complete motor control can be analyzed with a multimeter (not a VTVM) and an oscilloscope. The simple meter is preferred since a VTVM's accuracy can be affected by magnetic fields and noise pickup. The oscilloscope can be a narrow-band unit, since the sharpest pulse in motor control circuits rarely contains frequencies above 500 kc, and voltages in these circuits are ample for even scopes with the lowest sensitivity.

The motor itself requires regular brush replacement and commutator cleaning (do not use emery cloth). Complete repair of DC motors, however, should not be undertaken without greater preparation in motor operating theory. A few short hours spent studying this interesting field will ready you for motor-control equipment repair. ▲

End "Cigar Box  
Confusion"  
with a new IRC

## RESIST-O-CHEST



All-metal resistor file included free with new IRC RESIST-O-CHEST Assortments. Compact 5% x 3 3/8 x 6 1/4" size; handsomely finished in blue and yellow with hinged lid. Metal separators keep Handy-Paks in proper order. Identification of complete stock always visible.

### SELECT FROM 6 ASSORTMENTS

- #42—204 1/2-watt resistors, 34 values \$24.48
- #43—462 1/2-watt resistors, 77 values \$55.44
- #46—136 1-watt resistors, 34 values \$24.48
- #47—308 1-watt resistors, 77 values \$55.44
- #49—102 2-watt resistors, 34 values \$24.48
- #50—195 2-watt resistors, 65 values \$46.80

Dealer Net Price



### IRC HANDY-PAK \*

Exclusive IRC convenience. Uniform package for 6 half-watt, 4 one-watt, or 3 two-watt carbon composition resistors. Reusable package with resistors protected by plastic shield.

ORDER FROM YOUR IRC DISTRIBUTOR

See more new IRC  
Assortments on the  
adjacent pages.

\*PATENT PENDING



INTERNATIONAL RESISTANCE CO.  
401 N. Broad St., Philadelphia 8, Pa.

## Silicon Rectifiers

(Continued from page 33)

There are three popular semiconductor rectifier circuits employed in TV receivers. Among these are the half-wave, half-wave doubler and full-wave doubler. The first (Fig. 3) is the most basic and employs a minimum of components. Output voltage for this circuit is a function of four variables—applied voltage, load, filter capacity, and rectifier efficiency. We are concerned here with only the latter.

If forward resistance of a rectifier

is 10 ohms and filter capacity is 100 mfd, we can compute the time needed for the capacitor to charge to 63% of applied voltage as follows:

$$T = 10 \times 100 \times 10^{-6} = .001 \text{ seconds.}$$

If forward resistance of the rectifier is reduced to .5 ohms,

$$T = .5 \times 100 \times 10^{-6} = .00005 \text{ seconds.}$$

A reduction in the value of T means that there will be more RC periods during half-cycles of applied voltage, and the filter capacitor can assume its charge more rapidly. Actually, because of the lower loss across the rectifier, maximum charg-

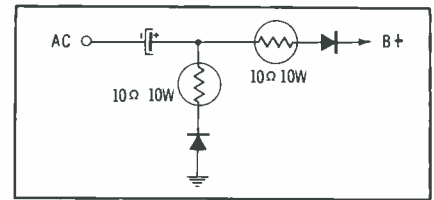

Fig. 5. 10-ohm resistors in series with silicon units prevents excessive B+.

ing potential is somewhat greater. In the average set, filter voltage can be expected to rise by as much as 15 volts after converting to a silicon rectifier, if all other component values remain the same. In some cases, such B+ increase may be desirable; in other instances, however, increased voltage can cause premature or repeated failure of various circuit components. In almost all cases, a nominal voltage increase in a set using the simple half-wave circuit will be a blessing. A 20-watt unit for R (Fig. 3) should provide adequate surge protection for the rectifier and still permit an output voltage increase of about 10 volts. Since the 10-ohm, 20-watt resistor won't blow readily, thus acting as a fuse, insert a 1.6- to 2-amp slow-blow fuse in series with the resistor.

The most popular rectifier circuit using semiconductors is the half-wave doubler shown in Fig. 4. When installing silicon units in this configuration, there are two circuit additions which should be made. These are simple, and consist of inserting a 10-ohm, 10-watt resistor in series with each rectifier as shown in Fig. 5. The added resistors take the place of the internal resistance of the replaced rectifier, and prevent B+ from increasing, as it otherwise would. Omission of the resistors can result in B+ increasing by as much as 30 volts. This, in turn, can cause the series capacitor C1 and/or the source capacitor C2 to fail prematurely. In addition, the extra 30 volts may result in repeated failure of cascade RF amplifier tubes, horizontal output and damper tubes, and closely-rated capacitors, such as the 400-volt units sometimes used as B+ boost filters.

Last in the circuit parade, we find the full-wave doubler shown in Fig. 6. It hasn't been used too much in black and white TV; however, it is achieving wide acceptance in color TV because the DC output voltage is almost 4% higher than the half-wave doubler can supply.

To avoid color troubles such as



STANCOR transformers can take the heat!

You get safe, breakdown-free transformer operation...even up to 221° F!

Under normal operating conditions, STANCOR transformers are designed to "run cooler" and, at the same time, withstand the heat of overload conditions or high surrounding temperatures . . . because all STANCOR iron core transformers are built to meet EIA Class A operating requirements of 221° F (105°C) temperatures. This important, additional margin of safety is part of the conservative design of all STANCOR transformers.

The ability to withstand heat is just one of the many extras built into every STANCOR yoke, flyback, power or audio transformer.

**CHICAGO STANDARD TRANSFORMER CORPORATION**

3503 WEST ADDISON STREET • CHICAGO 18, ILLINOIS

Export Sales: Roburn Agencies, Inc., 431 Greenwich St., New York 13, N. Y.

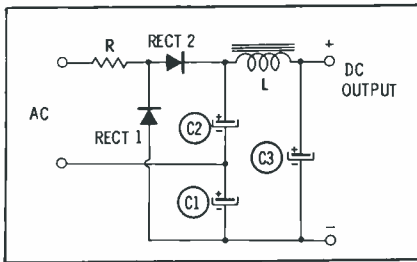

Fig. 6. Full-wave doubler is often used in color sets for higher B+ output.

changes in purity, convergence, high voltage, picture size and linearity, focus, and bandpass characteristics, install 10-ohm, 20-watt resistors when converting to silicon in higher-current color sets. Original surge-limiting resistors and fuses should be left in the circuit.

### What to Expect From Converted Circuits

Barring shorted B+ filters or other causes of excessive current, silicon rectifiers should last the life of the set. In portable receivers using a single half-wave rectifier, the installation of a silicon unit, with its reduced forward loss and correspondingly lower heat generation, should actually result in a reduction of ambient temperature and thus increased life expectancy of other components.

The installation of series resistors in doubler circuits makes up for internal losses of the original rectifier, and the net result is little or no change in ambient temperature. However, a reduction in temperature, while desirable, isn't as important as maintaining circuit balance and dependability.

### Final Considerations

Silicon rectifiers designed for TV use are generally rated at 280 volts rms input, 400 PIV, and 500 ma

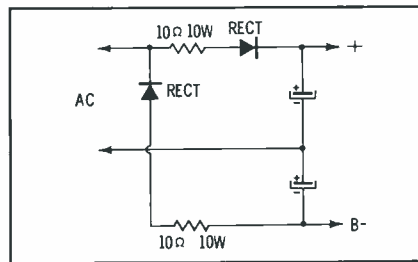

Fig. 7. Add 10-ohm resistors in full-wave doubler to prevent excessive B+

forward current with an ambient temperature of 100°C. To operate these units in circuits requiring a greater PIV rating, the required number of rectifiers can be connected in series. Current rating for a series assembly is the same as for a single unit. Greater current capacity at the single-unit PIV rating can be obtained by connecting the required number of units in parallel. A small resistor (about 1-ohm, 1-watt) should be placed in series with each rectifier to make sure the load will be distributed equally. Generally speaking, it isn't desirable or practical to parallel more than two units. The same restriction does not hold for series connection, however, where the practical limit is about 10 units. This is due in part to the high cost of a single rectifier with a comparable voltage rating.

Since TV sets are designed to operate under 85°C, the ambient temperature rating of a silicon rectifier is more than adequate for any convenient mounting location—even under the chassis. Ease of installation is further enhanced by the availability of kits which include the necessary mounting hardware. Once installed, silicon-rectifier replacement is no more difficult than replacing a fuse. Of course, fuses are designed to blow, whereas silicones are built to take it! ▲

Resistor Companion  
for your Tube Caddy  
... new IRC

# RESIST-O-CADDY



Ideal for in-home servicing... pliable plastic pouch folds to 6 3/4 x 3 3/8 x 1 1/2", and fits easily in tube caddy or tool chest. Stocked with either most popular values of 1/2-watt or 1-watt resistors. Individual pockets keep IRC Handy-Paks secure and orderly. Accurate resistor inventory is always visible. Your Handy-Pak RESIST-O-CADDY comes free with either of these—

### 2 "BEST SELLER" ASSORTMENTS

- #41—120 1/2-watt resistors, 20 values \$14.40
  - #45— 80 1-watt resistors, 20 values \$14.40
- Dealer Net Price



### IRC HANDY-PAK \*

New resistor convenience available only from IRC Distributors. Carbon composition resistors in slimline, reusable plastic package. Easier to use. Stock and complete identification always visible.

ORDER FROM YOUR IRC DISTRIBUTOR



More IRC "extra-value" resistor assortments are shown on the preceding pages.

\*PATENT PENDING



INTERNATIONAL RESISTANCE CO.  
401 N. Broad St., Philadelphia 8, Pa.

SAVE  
TIME  
with

**SENCORE**

**New! Improved!**

**TRANSISTOR  
CHECKER**

*America's newest, most popular test instrument*

Simple to Operate. Controls are accurately set for each transistor by referring to replaceable set-up chart on rear. Test leads or socket provides for fast hook-up.

**NOW CHECKS:**

- ★ Transistors for opens, shorts, leakage and current gain. Only tester that tests power transistors as used in car radio outputs.
- ★ Crystal Diodes checks forward to reverse current ratio on all diodes.
- ★ Selenium Rectifiers checks forward and reverse currents.

**Service Instruments Corp., 121 Official Rd., Addison, Ill.**

See other SENCORE ads in this issue.

**MODEL TRC4**

**\$17.95**

DEALER NET

Cannot become obsolete. Approved by leading manufacturers.

The **NEW** **YEATS "Shorty"**  
**STATION WAGON & PANEL PICK-UP**  
**appliance dolly**



**YEATS Model No. 5**  
 Aluminum alloy  
 Height 47"  
 Weight 32 lbs.

Only 47" tall, this new YEATS dolly is designed for TV and appliance men who make deliveries by station wagon or panel truck. No need to detach appliance for loading into the "wagon" or pick-up... the YEATS "Shorty" will slide into your vehicle with ease.

Has aluminum alloy frame with padded felt front, quick fastening (30 second) strap ratchet, and endless, rubber belt step glide. New YEATS folding platform attachment, at left, saves back-breaking work handling TV chassis or table models. Call your YEATS dealer today!

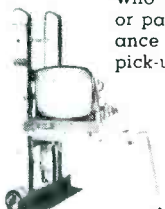

Folding platform is 13 1/2" x 24 1/2" —attaches instantly. (Platform only) \$9.95.

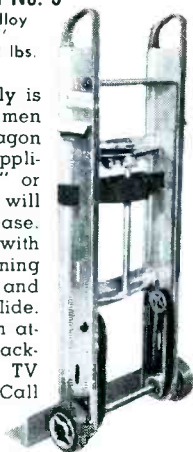

Furniture Pad

SEND postcard for full information on our complete line TODAY!

**"Everlast" COVERS & PADS**

YEATS semi-fitted covers are made of tough water repellent fabric with adjustable web straps and soft, scratchless white flannel liners. All shapes and sizes—Write.



TV Cover

**YEATS** appliance dolly

sales co.  
 Milwaukee, Wis.

2103 N. 12th St.

**P R O D U C T**  
**r e p o r t**

For further information on any of the following items, circle the associated number on the Catalog & Literature Card.

**Microphone Merchandiser (No. 48B)**

A counter display including six different tape-recorder microphones is now being offered to dealers by American Microphone. The assortment includes dynamic, crystal and ceramic mikes in both the lightweight 203 style and the push-button 204 style. List price of the display package (Order No. 3926) is \$99.65, complete with metal rack.



**Packaged Circuits (No. 49B)**

Eight different types of *PEC* packaged electronic circuits have been made available by Centralab for replacement applications. These units, numbered PC-336 through PC-343 inclusive, are used in numerous receivers built by Philco, RCA, Motorola, Packard-Bell, and General Electric.

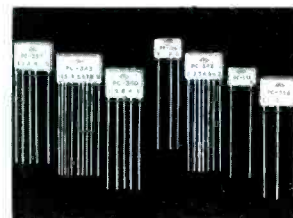

**Stereo Cartridge (No. 50B)**

A moving-magnet type of stereo cartridge, the Shure Custom Stereo Dynetic Model M7D, has an audiophile net price of \$24 including replaceable .7-mil diamond stylus. Specifications include a tracking force of 4 to 7 grams; load impedance of 47K ohms; four terminals; and output of 5 mv per channel at 1,000 cps and 5 cm/dyne.



**Baffle-Speaker Assemblies (No. 51B)**

Four models of Argos baffles are now available with speakers already installed. Models WB-8AS and WB-12AS are wall baffles containing 8" and 12" speakers, respectively. The same two sizes of speakers can be obtained in slanting corner baffles, Models SCB-8AS and SCB-12AS. Magnet weight is 4.64 oz. for the 8" speakers and 6.8 oz. for the 12" units.

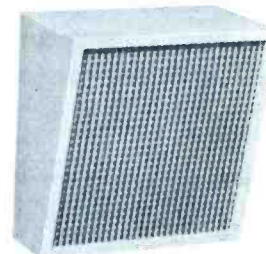

**Stereo Preamp (No. 52B)**

Two illuminated VU meters indicate the output signal levels in both channels of the Pilot Model 216 stereo preamplifier, as adjusted by either the main volume and balance controls or special tape-recording level controls. Among other features are a 5-position loudness contour control, choice of 12 inputs, and automatic shut-off switch for the entire audio system. Price is \$189.50.



**SAMS PHOTOFAC INDEX**

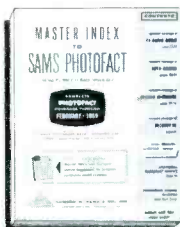

sent direct  
 to your shop

**FREE**

SEND FOR IT!

Yes, now you can have the valuable SAMS MASTER INDEX TO PHOTOFAC FOLDERS and Index Supplements sent direct to your shop at no cost to you! Just mail coupon below and you'll be sure to receive regularly your handy guide to the world's finest service data covering over 33,000 TV, Radio, Amplifier, Tuner Tape Recorder and Changer models. Send for it—it's FREE!

**MAIL COUPON**

**Howard W. Sams & Co., Inc.**  
 2201 East 46th St., Indianapolis 6, Ind.

Put me on your mailing list to receive the Sams Photofact Master Index and Supplements

I'm a Service Technician: \_\_\_\_\_ full time; \_\_\_\_\_ part time

My Distributor is:

Shop Name: \_\_\_\_\_

Attn: \_\_\_\_\_

Address: \_\_\_\_\_

City \_\_\_\_\_ Zone \_\_\_\_\_ State \_\_\_\_\_

### Amateur Transmitter (No. 53B)



The Johnson *Viking Challenger* amateur CW and phone transmitter covers all amateur bands from 80 through 6 meters. Tube complement includes a 6AU6 oscillator, 6DQ6 A buffer, two 6DQ6A's in final amplifier, 12AX7 speech amplifier, 6AQ5 screen modulator and CW clumper, and 5U4GB rectifier. Power line and meter circuit include L-section TV1 filters. Amateur net price is \$114.75 (kit) or \$154.75 (wired).

### Phono Pin Plug (No. 54B)

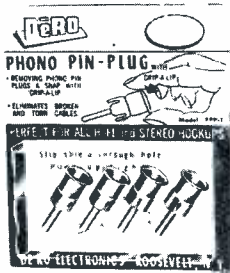

An outward flange at the open end of the De Ro Model PPP-1 *Grip-A-Lip* phono pin plug provides a firm grip for the fingers and thus makes the plug easier to remove from a socket. Another design feature of this plug simplifies the attachment and soldering of the cable shield. Display packs, wrapped in transparent plastic, are priced at 69c for a pack of 4 plugs and 99c for 8.

### Vacuum Tube Voltmeter (No. 55B)



The edge-lighted 6" meter face of the Arkay VT-10 VTVM has peak-to-peak AC, db, and zero-center DC scales in addition to those for ohms, DC, and rms AC. Every function has seven ranges, the highest being 1500V DC and rms, 2000V P-P, and  $R \times 1$  meg, respectively. The plastic case includes a recessed handle at the rear. Available in kit form at \$25.95, or factory-wired at \$47.95.

### Indoor Antenna (No. 56B)



"Diamond Phasing Loops," clamped to the main elements of the RMS Model F-38K *Focus* indoor antenna, extend the electrical length of the elements on channels 2-6. They also act as phasing stubs and permit the antenna to function as a  $1\frac{1}{2}$ -wave dipole on channels 7-13 when the elements are fully extended. A base-mounted 12-position switch varies the antenna's field pattern. List price is \$14.95.

### Mobile FM Receivers (No. 57B)



Two new crystal-controlled Monitoradio FM receivers are suitable for mounting in cars and trucks with 12-volt electrical systems. Model MC-40 can be fixed-tuned to any frequency in the 30-50 mc band, while Model MC-160 is for use in the 152-174 mc band. Both radios feature double conversion, squelch, and 4" PM speaker. Cabinet size is  $4\frac{1}{2}$ " x  $6\frac{1}{2}$ " x  $8\frac{3}{4}$ ", weight is 9 lb., and current drain is 3.9 amp.

From the pioneer  
in ceramics for electronics

# STEREO

the new single  
ceramic element  
Stereophonic  
cartridge



Approx.  
three times  
size

### DYNAMIC BALANCING MAKES THE DIFFERENCE

DYNAMIC BALANCING during manufacture provides full stereo reproduction. SINGLE ELEMENT DESIGN offers balanced outputs; excellent separation of 20 db over full audio-frequency range, with equal outputs from both channels. Compatible with stereo and monophonic discs.

#### SPECIFICATIONS

**RESPONSE:** 20 to 16,000 cps. **OUTPUT VOLTAGE:** 0.5 vrms. at 1 KC each channel. **COMPLIANCE:**  $3 \times 10^{-6}$  cm/dyne, vertical & lateral. **RECOMMENDED LOAD:** 2 megohms. **RECOMMENDED TRACKING PRESSURE:** 5-6 grams. **CHANNEL SEPARATION:** 20 db. **STYLII:** dual tip; 0.7 mil diamond or sapphire, and 3 mil sapphire. **MOUNTING DIMENSIONS:** EIA Standard  $\frac{7}{16}$ " &  $\frac{1}{2}$ " centers.

For additional information, see your Authorized ERIE Distributor



Acme Electric Corp. .... 66  
 American Television & Radio Co. (ATR) ..... 14  
 Amperex Electronic Corp. .... 62  
 Arco Electronics, Inc. .... 59  
 Arkay Radio Kits, Inc. .... 68  
 Astron Corp. .... 67  
 B & K Mfg. Co. .... 15, 48  
 Berns Mfg. Co. .... 74  
 Blonder-Tongue Labs ..... 34  
 Bussmann Mfg. Co. .... 25  
 CBS-Hytron ..... 13  
 Castle T V Tuner Service ..... 75  
 Centralab, A Div. of Globe-Union, Inc. .... 36  
 Chicago Standard Transformer Corp. .... 76  
 Clarostat Mfg. Co., Inc. .... 41  
 Cornell-Dubilier Electric Corp. .... 65  
 Delco Radio Div., General Motors Corp. .... 17  
 Doss Electronic Research, Inc. .... 58, 70, 71  
 EICO ..... 57  
 E-Z-Hook Test Products ..... 73  
 Electronic Publishing Co. .... 58  
 Electronic Utilities Co. (Div. of the Sampson Co.) ..... 46  
 Erie Resistor Corp. .... 79  
 General Cement Mfg. Co. .... 2nd Cover  
 General Electric Co. .... 35  
 Gernsback Library, Inc. .... 71  
 Guide Lamp Div., General Motors Corp. .... 53  
 Hickok Electrical Instrument Co. .... 72  
 Hunter Tool Co. .... 71  
 International Resistance Co. (IRC) ..... 73, 75, 77  
 Jackson Electrical Instrument Co. .... 80  
 Jensen Industries, Inc. .... 68  
 Jensen Mfg. Co. .... 12  
 Littelfuse, Inc. .... 4th Cover  
 Mallory & Co., Inc., P. R. .... 22-23  
 Merit Coil & Transformer Corp. .... 73  
 Oxford Components, Inc. .... 66  
 Perma-Power Co. .... 16  
 Philco Corp. Accessory Div. .... 9, 27, 40  
 Quietrole Co. .... 68  
 RCA Electron Tube Div. .... 20-21, 45, 3rd Cover  
 Radiart Corp.—Div. of Cornell-Dubilier Electric Corp. .... 69  
 Radio Receptor Co., Inc. .... 55  
 Rogers Mfg. Co. .... 74  
 Sams & Co., Inc., Howard W. .... 47, 52, 78  
 Seco Mfg. Co. .... 54, 70  
 Service Instruments Corp. (Secore) .... 54, 60, 62, 72, 74, 77  
 Simpson Electric Co. .... 39  
 Sprague Products Co. .... 10  
 Sylvania Electric Products, Inc. (Tube Div.) ..... 19  
 Sylvania Electric Products, Inc. (Television Rec. Div.) ..... 49  
 Technical Appliance Corp. (TACO) ..... 60  
 Tobe Deutschmann Corp. .... 61  
 Triplett Electrical Instrument Co. .... 51  
 Tung-Sol Electric, Inc. .... 43  
 Ungar Electric Tools, Inc. .... 56  
 United Catalog Publishers, Inc. .... 75  
 Webster Electric Co. .... 42  
 Weller Electric Corp. .... 63  
 Workman TV, Inc. .... 37  
 Xcelite, Inc. .... 70  
 Yeats Appliance Dolly Sales Co. .... 78

latest **JACKSON** tube test data

TUBE TYPE	MODEL 648 CIRCUIT	PLATE TEST	MODEL 115/715/561					
			FL.	X.	PLATE	YZ	E.	SHORTS
4EW6	4.2	AC1284 567* 45XZ	4.2	-	32	24MR	-	28
6CN6	6.3	1237 AB869 25W	6.3	-	12	81LS	-	4
6DA6	6.3	A1256 B979* 22XZ	6.3	4	14	5LOS	-	30
6EW6	6.3	AC1284 567* 45XZ	6.3	-	32	24MR	-	28
EL95	6.3	237 AC156 40W	6.3	5	12	21MS	-	6
TUBE TYPE	SEC.	A.	B.	C.	D.	E.	CATH.	SHORTS
4EW6	P	4.2	3	X	156	2	28	
6CN6	P	6.3	2	-	450	8	4	
6DA6	P	6.3	4	16X	278	3	30	
6EW6	P	6.3	3	X	156	2	28	
EL95	P	6.3	3	7	156	2	6	

Latest Chart Form 648-21, 115/715/561-11, 49-4

ANTENNA SYSTEMS

- 1B. **ANTENNA DESIGNS** — New 4-page folder including dealer price list.
- 2B. **CLEAR BEAM** — Complete information on how you can profit by stocking and selling antenna kits.
- 3B. **CORNELL-DUBILIER** — Catalog and brochure entitled, "All About Antenna Rotors." See ad page 65.
- 4B. **PF REPORTER** — Sample copy of "Homeowner's TV Antenna Handbook" and information on how to use it to improve your antenna business. See ad page 64.
- 5B. **TACO** — Catalog sheets on new products, and "PACKETTE" program for antenna installers. See ad page 60.

AUDIO AND HI-FI

- 6B. **ARKAY** — 16-page booklet entitled "Let's Talk About Stereo" gives practical information about stereo, including recommended home installations. See ad page 68.
- 7B. **BLONDER-TONGUE** — New folder, "The Hi-Fi Money-Making Method of the Month," offers TV servicemen useful sales hints for increasing efficiency and profits. See ad page 34.

CARTRIDGES

- 8B. **CBS-HYTRON** — Bulletin E-325, "Why a Ceramic Cartridge?" See ad page 13.
- 9B. **ERIE RESISTOR** — Literature on STERIEO, the single ceramic element cartridge. See ad page 79.
- 10B. **ELECTRO-VOICE** — Bulletin #254, facts about the new monaural and compatible stereophonic - monaural Power Point phono cartridge.
- 11B. **GENERAL ELECTRIC** — 16-page booklet entitled "Application Considerations in the Use of Stereo Cartridges." See ad page 35.
- 12B. **JENSEN INDUSTRIES** — 1959 cross-reference booklet on phono needles. See ad page 68.

CAPACITORS

- 13B. **ARCO** — Complete information on DP-600 Tubular stock package and DP Tubular buffer kit #16. See ad page 59.
- 14B. **SPRAGUE** — M726 "Cerami-Chart," large wall chart of standard ceramic capacitor color codes with circuit application data for various types. See ad page 10.
- 15B. **TOBE DEUTSCHMANN** — Catalog #5701 on replacement capacitors and filters. See ad page 61.

COMPONENTS (MISC.)

- 16B. **ANCHOR PRODUCTS** — Catalog sheet listing replacement auto-radio switches.
- 17B. **CLAROSTAT** — New brochure entitled "Potentiometer Definitions." See ad page 41.
- 18B. **IRC** — Catalog on S505 "Handy-Pak" carbon composition resistors. See ads pages 73, 75, 77.
- 19B. **MALLORY** — Capacitor catalog, form #9-140; silicon rectifier catalog, form #9-152. See ad pages 22-23.
- 20B. **J. W. MILLER** — Data sheet gives schematic and base layout on IF transformer replacement for two GE models.
- 21B. **PERMA-POWER** — Envelope stuffer #D-197 and literature describing and illustrating "Vu-Brite" promotion. See ad page 16.

FUSES

- 22B. **BUSSMANN** — Bulletin SFH-6 describes new space-saving fuse and fuseholder combination for circuit protection at 300 volts or less. See ad page 25.

POWER SUPPLIES

- 23B. **ACME** — Bulletin VA-322 explains the importance of automatic voltage stabilization to quality TV reception. See ad page 66.
- 24B. **ATR** — Descriptive literature on battery eliminators, DC-AC inverters, tube protectors, and other products. See ad page 14.

SERVICE AIDS

- 25B. **E-Z-HOOK** — Convenient reference sheet titled, "How to Build the Five Most Useful Scope Probes," with schematics, mechanical component layouts, etc. See ad page 73.
- 26B. **ROGERS MFG.** — Literature on the new "Tel-A-Turn" TV Service Cradle, designed to speed up repair time, eliminate struggling with heavy, hard-to-handle TV chassis, and permit better access and vision to all components. Full chassis rotation, self-locking in any position. See ad page 74.
- 27B. **SERVICE INSTRUMENTS** — Mailer describing 10 most popular Sencore time-savers. See ads pages 54, 60, 62, 72, 74, 77.
- 28B. **YEATS** — Flyer describing padded TV delivery covers. See ad page 78.

TECHNICAL PUBLICATIONS

- 29B. **GERNSBACK PUBLICATIONS** — Descriptive literature on Gernsback Library books. See ad page 71.
- 30B. **PHILCO** — "1959 Service Dealer Handbook" covers the business side of service and provides a day-by-day business record. See ads pages 9, 27, 40.
- 31B. **HOWARD W. SAMS** — Descriptive literature on all Howard W. Sams books covering servicing of TV, radio, hi-fi, etc. Includes data on latest books, "101 Ways to Use Your Oscilloscope" and Volumes 3 and 4 of the "Hi-Fi Servicing" series. See ads pages 47, 52, 78.

TEST EQUIPMENT

- 32B. **AEROVOX** — Literature on Model 97 LC CHECKER for in-circuit capacitor tests.
- 33B. **B & K** — Bulletin ST21-R gives helpful information on new point-to-point signal-injection technique with Model 1075 TV "Analyst"; other bulletins describe "Dyna-Quick" Models 500B, 650, and automatic 675 portable dynamic mutual conductance tube and transistor tester, plus Model 400 CRT cathode rejuvenator tester. See ads pages 15, 48.
- 34B. **DOSS** — Literature on new type transistor checker; also on CRT checker. See ads pages 58, 70, 71.
- 35B. **EICO** — 20-page 1959 2-color catalog describes 65 models of professional test instruments, hi-fi and "ham" gear in both kit and factory-wired form—shows how to save 50%. See ad page 57.
- 36B. **HICKOK** — New Test Equipment Catalog No. 38 describes latest radio-TV and communications testers. See ad page 72.
- 37B. **JACKSON** — Catalog sheet 655-59-10M on hi-fi, stereo, and audio test equipment. See ad page 80.
- 38B. **SECO** — New 2-color folder showing complete line of test equipment and service aids. See ads pages 54, 70.
- 39B. **SIMPSON** — Brochure #2060 covering complete line of test equipment for the radio and TV industry. See ad page 39.
- 40B. **TRIPLETT** — Data sheet on Model 690-A transistor tester. See ad page 51.

TOOLS

- 41B. **BERNS** — Circular on Perfect Pin Crimper. See ad page 74.
- 42B. **UNGAR** — Booklet detailing proper selection of soldering tools; catalog of soldering and desoldering tools. See ad page 56.
- 43B. **WELLER** — New Dual-Heat Soldering Gun Bulletin describes design and high-efficiency tip of model 8200K 90-125 watt iron. See ad page 63.
- 44B. **XCELITE** — Latest catalog on complete line of tools for the electronic serviceman. See ad page 70.

TUBES

- 45B. **SYLVANIA** — European-American Receiving Tube Replacement Guide. See ads pages 19, 49.
- 46B. **TUNG-SOL** — 30-page flip-style chart supplies electrical and physical characteristics for most important industrial, special-purpose and military tubes. See ad page 43.
- 47B. **WESTINGHOUSE** — Colorful comic book, "A Rescue Job for Tony," describing details of tube manufacturing.

# FREE

With Your Purchase of RCA Receiving Tubes

NEW  
ALL-METAL  
RCA  
TREASURE CHEST



RCA's "TREASURE CHEST"—the handy way to have more than 260 RCA receiving tubes with you at all times, and all in one easy-to-carry, durable *steel* carrying case! This All-Metal RCA Treasure Chest can carry a wide selection of tube types and sizes, with all type numbers in full view when the case is opened. It has a handsome finish, is well braced and strongly hinged. Measurements—21 $\frac{3}{4}$ " x 16" x 8 $\frac{3}{8}$ ".

ALL-NEW  
RCA SERVICE INFO KIT



**RCA SERVICE PARTS INFO KIT!** Valuable servicing data in one easy-to-use package for work right on the job! Contains: (1) the New Service Parts Directory for RCA Victor 1955, 1956 and 1957 TV Receivers—features service information on more than 250 color and black-and-white TV receiver models, circuit diagrams, parts lists, top-and-bottom chassis views and comprehensive index; (2) New RCA Victor Radio and Record Service Parts Directory—features major replacement parts for TV and radio receivers, phonograph cartridge guide and comprehensive index.

**TO GET THE NEW RCA ALL-METAL TREASURE CHEST AND THE RCA SERVICE PARTS INFO KIT ASK YOUR RCA TUBE DISTRIBUTOR FOR FULL DETAILS... TODAY!**



A BIG HAND  
From RCA to You...  
In Honor of 5th Annual  
**NATIONAL TELEVISION  
TECHNICIANS' WEEK**  
March 23-28



**RADIO CORPORATION OF AMERICA**  
Electron Tube Division  
Harrison, N. J.

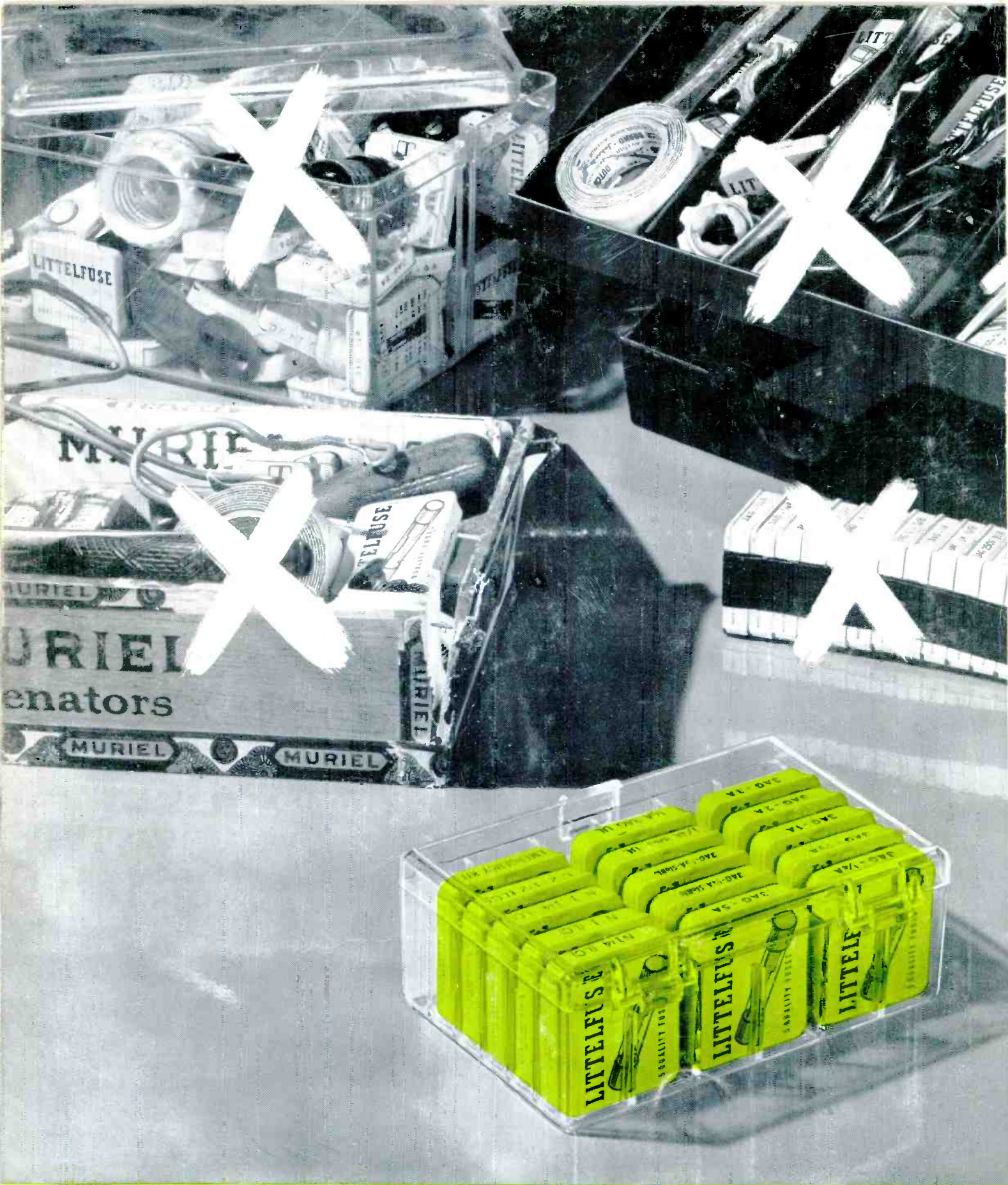

Burton Browne advertising

## THERE'S ONLY ONE RIGHT WAY

A fuse caddy for your tube caddy: 18 individual compartments for fingertip selection. The fuse caddy is complete with the 15 boxes of fuses required to service 93% of all TV sets. Three spare compartments are provided for additional fuses of your own selection.

**LITTELFUSE** Des Plaines, Ill.