

AUGUST • 1958 25 CENTS

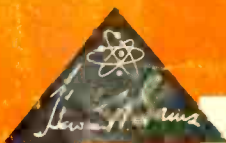

PF
PHOTOFACT

REPORTER

FOR THE ELECTRONIC SERVICE INDUSTRY



Troubleshooting Transistor Radios — page 14

Small Appliance Servicing — page 12

Vertical Retrace-Line Elimination — page 10

Servicing the Summer Air-Conditioner — page 28

2 88 098
A.L. BROWDY
1000 N. CAHUENGA BLVD.
HOLLYWOOD 28, CALIFORNIA

IF DRIFTING * DOESN'T BOTHER YOU ...

VITREOUS ENAMEL
POWER RESISTORS
MAY DO



But only **IRC's**
RESISTEG Coating
can assure stability
under load life

Circuits can be tricky enough without hanging out a welcome sign for drift and resistance change under load life. That's just what you do when you settle for less than IRC Resisteg Coated Power Wire Wound Resistors.

Vitreous enamel coatings beg trouble

ORDER TODAY FROM YOUR IRC DISTRIBUTOR!



IRC RESISTEG Coated Resistors have less drift and resistance change under load life; vitreous enameled resistors are not equal in stability.

when they are cured. At their curing temperatures of 1200°F. or over, turns may shift position or, if pre-stretched to compensate for shifting, may acquire a work-hardened after-effect.

So why risk your service reputation? IRC Resisteg Coated units have about half the resistance change of vitreous enameled resistors, require no derating. End the drift in resistors and prevent a drift in your trade at the same time!

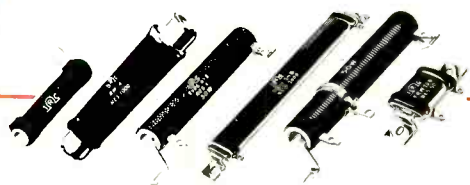

Wherever the Circuit Says



**NEW
COMPLETE**

**DIRECT
VIEWING**





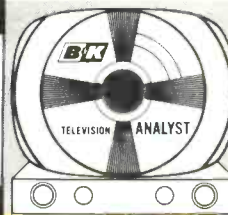
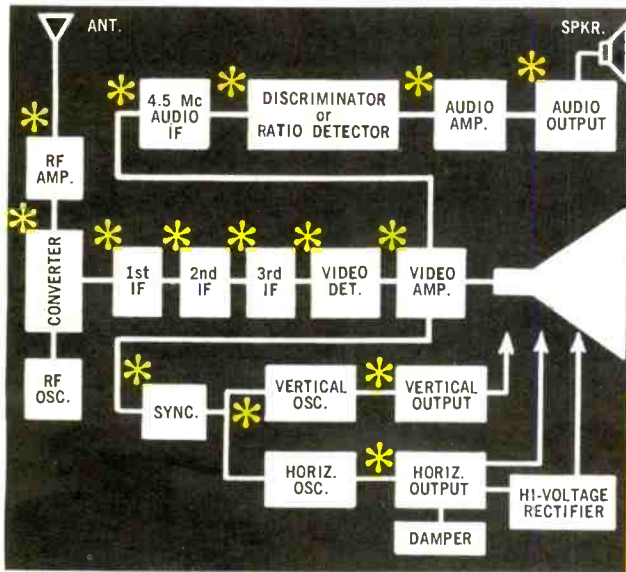

TELEVISION ANALYST

**test each stage
SEPARATELY**



and watch the
← result on the
TV set itself

**UNIQUE NEW SIGNAL-INJECTION TECHNIQUE
Saves TV Trouble-Shooting Time and Work**

-  **R.F.** Supplies complete r.f. and i.f. signals with video and audio modulation to quickly trouble-shoot each stage in each of the sections of the TV receiver. Enables you to check the r.f. sensitivity and AGC settings of TV receivers.
-  **VIDEO** Reproduces a complete test pattern on the screen of the TV picture tube and injects signals into each video stage of the TV receiver for fast, visual trouble-shooting and correction—anywhere, anytime. Makes it easy to check bandwidth, resolution, shading and contrast capabilities of the TV set.
-  **SYNC** Provides composite signal, sync positive and negative.
- SWEEP CIRCUIT DRIVING PULSES** Provides separate vertical and horizontal driving pulses for trouble-shooting deflection circuits.
- INTERMITTENTS** Test signal injection also aids in locating intermittent troubles.
-  **AUDIO** Provides a 4.5 mc sound channel, FM modulated with approximately 25 kc deviation. (This audio carrier is modulated either from a built-in 400 cycle tone generator, or from your own external audio source.) Injection of the 400 cycle tone signal simplifies trouble-shooting of the audio section.
-  **COLOR** Enables you to trouble-shoot and signal trace color circuits in color TV sets.
Generates white dot and crosshatch patterns on the TV screen for color TV convergence adjustments.
Generates full color rainbow pattern of orange, red, magenta, blue, cyan, green to test color sync circuits, check range of hue control, align color demodulators, etc.
-  **SET ADJUSTMENT** Enables you to check and adjust the vertical and horizontal linearity, size and aspect ratio of television receivers.



NEW



**MODEL
1075**



QUICK, DIRECT, COMPLETE TV TROUBLE-SHOOTING

Now, by point-to-point signal injection and test pattern reproduction, you can easily trouble-shoot and signal trace *any stage throughout the video, audio and sweep sections of black & white and color TV receivers.* With the remarkable new Model 1075 B&K TELEVISION ANALYST, you can quickly isolate and diagnose TV troubles (including intermittents). By use of the generated test pattern, you can *actually see* the condition directly on the picture tube of the television set itself. No external scope is needed. The TELEVISION ANALYST is practically a *complete TV service shop in one instrument!* Net, \$259⁹⁵



See your B&K Distributor or write for Bulletin AP 12 R

B & K MANUFACTURING CO.
3726 N. Southport Ave. • Chicago 13, Illinois

Canada: Atlas Radio Corp., 50 Wingold, Toronto 10, Ont.

Export: Empire Exporters, 458 Broadway, New York 13, U.S.A.

MINIATURE ELECTROLYTICS

FOR MINIATURE SETS

designed for transistorized radios, hearing aids, wireless microphones, miniature tape recorders, auto receivers, and similar miniature electronic products.

FOR POINT-TO-POINT WIRING AND FLAT MOUNTING ON PRINTED WIRING BOARDS

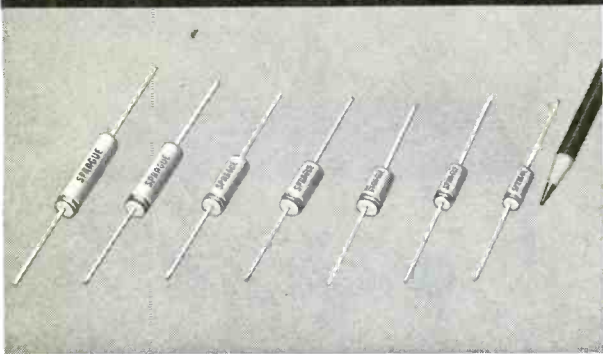

Sprague's new and improved 85°C Littl-lytic* Capacitors are the *tiniest* reliable electrolytic capacitors made to date . . . and their performance is better than ever. Their remarkable dependability is the result of a new manufacturing technique in which *all the terminal connections are welded. No pressure joints . . . no "open circuits" with the passage of time.* Littl-lytics are hermetically-sealed and aluminum-encased. And check this for low leakage current: for a 2 μ f, 6 volt capacitor . . . only 1.0 μ a max.; for a 300 μ f, 6 volt capacitor . . . 3.5 μ a max.! There are no transistor burn-out troubles when you use Littl-lytics. Available in the largest list of ratings in the industry! Request Bulletin M-753.

FOR UPRIGHT MOUNTING ON PRINTED WIRING BOARDS

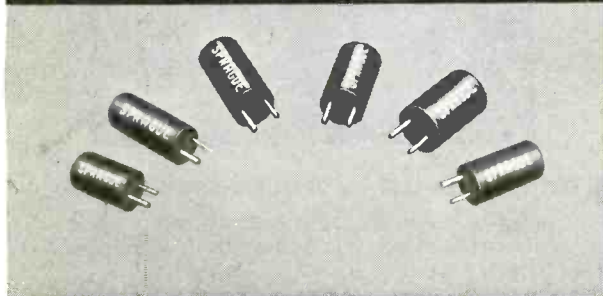

Space-saving Verti-lytic* Capacitors are designed for easy manual upright mounting on printed wiring boards. Keyed terminals assure fast mounting and correct polarity. Their low leakage current and high purity aluminum foil construction provide top performance and excellent protection against expensive transistor burn-outs. Sturdy premolded phenolic shell with resin end-fill gives excellent protection against drying-out of the electrolyte or the entry of external moisture. The phenolic case eliminates the necessity for any additional insulation. Request Bulletin M-757.

Be sure to see these new and improved 'lytic capacitors at your distributors. Check Sprague's other transistor capacitors while you're at it. You'll find that Sprague has the most complete ratings in the industry. Ask your

distributor for your copy of Sprague's Bulletins M-753 and M-757, or write Sprague Products Co., Distributors' Division of Sprague Electric Company, 105 Marshall Street, North Adams, Massachusetts.

*Trademark

don't be vague . . . insist on

SPRAGUE®

world's largest capacitor manufacturer

SPRAGUE RESEARCH IS CONSTANTLY PRODUCING NEW AND BETTER CAPACITORS FOR YOU

PUBLISHER
Howard W. Sams
GENERAL MANAGER
Mal Parks, Jr.

EDITOR
Verne M. Ray

ASSOCIATE EDITORS
Leslie D. Deane
Thomas A. Lesh
Calvin C. Young, Jr.

CONSULTING EDITORS
William E. Burke C. P. Oliphant
Robert B. Dunham George B. Mann
Paul C. Smith

ART DIRECTOR EDITORIAL ASSISTANT
Don W. Bradley Pat Moriarity

PHOTOGRAPHY CIRCULATION
Robert W. Reed Pat Tidd

ADVG. PRODUCTION
Carol B. Gadbury

ADVERTISING SALES OFFICES

MIDWESTERN
PF REPORTER,
2201 East 46th Street, Indianapolis 5, Ind.
Clifford 1-4531

EASTERN
Paul S. Weil and Donald C. Weil,
39-01 Main Street, Flushing 54, New York.
Independence 3-9098.

WESTERN
The Maurice A. Kimball Co., Inc.
2550 Beverly Blvd., Los Angeles 57, Calif.
Dunkirk 8-6178; and 681 Market Street,
San Francisco 5, Calif. EXbrook 2-3365.

Published monthly by Howard W. Sams & Co.,
Inc., at Indianapolis 5, Indiana.
Entered as second class matter October 11,
1954, at the Post Office at Indianapolis, Indiana,
under the Act of March 3, 1879.

Copyright 1958 by Howard W. Sams & Co., Inc.
No part of the PF REPORTER may be repro-
duced without written permission. No patent
liability is assumed with respect to the use of
information contained herein.

Subscription prices in U.S.A. and possessions:
1 yr., \$3.00; 2 yrs., \$5.00; 3 yrs., \$7.00. In
Canada and Pan America: 1 yr., \$3.60; 2 yrs.,
\$6.00; 3 yrs., \$8.50. Foreign subscriptions:
1 yr., \$6.00; 2 yrs., \$11.00; 3 yrs., \$15.00.
A limited quantity of back issues are available
at 35c per copy.

next month

STARTING IN SEPTEMBER

A special fact-filled 8-page bonus section, comprised of two extra monthly departments containing data unduplicated anywhere else!

Four full pages of this special section will be devoted to photos and preliminary service data on the newest sets, providing you with all the advance data you need to service the set in the customer's home (particularly helpful if you've never seen the unit before).

The other four pages include trouble symptoms for various makes of TV receivers, complete with schematics of the circuits involved and explanations of the reasons for improper operation, plus what can be done to restore normal operation.

This new bonus section doesn't replace any of PF REPORTER'S regular departments or features—you'll be getting them all — plus this 8-page editorial section (containing no ads) each and every month starting in September.

VOLUME 8, No. 8



AUGUST, 1958

PF REPORTER

FOR THE ELECTRONIC SERVICE INDUSTRY

CONTENTS

This Month's Cover	57
Letters to the Editor	4
Across the Bench	8
How an expert puts new life into old sets.	Stan Prentiss
Vertical Retrace-Line Elimination	10
Improve picture quality with a retrace-blanking circuit.	Jesse Dines
Small-Appliance Servicing	12
A profitable sideline.	
Advanced Troubleshooting Techniques for Transistor Radios	14
Time-saving hints for servicing printed-circuit portables.	Calvin C. Young, Jr.
Dollar & Sense Servicing	16
Thomas A. Lesh	
The Troubleshooter	18
Quicker Servicing	22
Servicing the Summer Air-Conditioner	28
Principles of operation along with trouble analysis procedures.	Joseph Derman
Audio Facts	38
Fundamentals of horns; analyzing stereo preamp design.	
Notes on Test Equipment	44
Les Deane	
Product Report	60
Free Catalog & Literature Service	64

SUBJECT REFERENCE INDEX

AUDIO

Horn-type loudspeakers, horn structure	38
driver units	40
Stereo preamps	42

BUSINESS

Dressing for calls	16
Labor charge for "dogs"	16
Smoking on home calls	16

CIRCUITS AND DESIGNS

Air-conditioners, refrigeration system	28
electrical system	31
Low Eg2 picture tubes	22
Vertical retrace blanking	10

COLOR TV

Dot generator pattern stability	21
---------------------------------------	----

COMPONENTS AND MATERIALS

Newly introduced	60
------------------------	----

SERVICING

Air-conditioners, troubleshooting analysis	34
B+ supply, excess current drain	8
Demagnetizing tools	25
Horizontal sweep, jitter	18
loss of	20
weaving	18
Old receiver, revitalizing	8
Police radio interference	21
Transistor radios, alignment	15
component replacement	57
power supply on bench	14
voltage measurements	14
Video amplifier overloading	18

TEST EQUIPMENT

Absorption analyzer, Kingston Model EA-1	47
Oscilloscope, Simpson Model 466 ..	50
Transistor tester, Triplett Model 690	44
Tube tester, Hickok "Cardmatic"	48

USE HANDY CARD AT BACK TO ENTER YOUR SUBSCRIPTION

TRANSFORMER NEWS FROM TRIAD

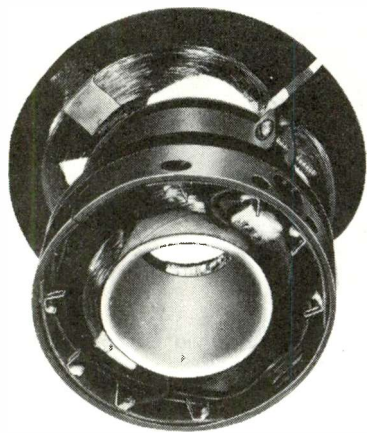

SAF-T-LINER®
PROTECTS YOU IN NEW,
BETTER YOKE

A special insulating sleeve is now permanently positioned on the inside of most Triad yokes. This Saf-T-Liner® protects the service man against shock when a metal width sleeve is used on the neck of the tube, and also protects the yoke from damage when being installed. This is still another advanced feature that guarantees Triad's unsurpassed excellence in the TV replacement field.

NEW YOKE PACK

Solve the majority of your deflection problems and yoke stocking problems with TRIAD'S new yoke pack.

This steel cabinet contains 8 of the most popular yokes, 25 network kits and 2 accessories. Write today for folder YP-8 New Triad Yoke Pack.



TRIAD TRANSFORMER CORPORATION
 4055 REDWOOD AVE. | 812 E. STATE STREET
 VENICE, CALIFORNIA | HUNTINGTON, INDIANA

A SUBSIDIARY OF LITTON INDUSTRIES

Letters to the
EDITOR

In the May "Troubleshooter" column, Mr. Norris Asche mentions installing a *retrace suppression* circuit in a set. This is new to me, and I would like to know more about it. Is it a standard circuit or must it be custom-designed for each application?

ERNEST E. BIEN

Sharon Hill, Pa.

Perhaps you know this circuit by the name of retrace-blanking network. Turn to Jesse Dines' article in this issue for a complete explanation.—Ed.

Dear Editor:

I am building a preamplifier like the one described in your June, 1955 issue. The article refers to a previous issue, which I would like to acquire if possible.

In the diagram given on page 25 of the June, 1955 issue, one side of the equalization selector switch is not connected and there is some doubt in my mind as to where I should connect C8, C9 and C10.

On the same schematic, could you recommend a value for R38 that would equalize a General Electric VR11 cartridge for proper RIAA response?

LOUIS ROSSI

Oakland, Calif.

The preamplifier described in June, 1955 is a modernized version of one first introduced in our July-August, 1952 issue. The original unit had a 6X4 rectifier and AC-powered tube heaters, but otherwise was practically the same as the later design.

The open contact on the equalization switch should connect to the junction of R16 and R20. The value of R38 for equalization of the VR11 cartridge is 6.8K ohms.—Ed.

Dear Editor:

There is a standard procedure which most top TV men use for approaching any service problem. It's hard to diagram, but it's there and makes them professionals. Can you emphasize this approach in some of your articles? Even the worst problem is simple—if you don't panic.

KEAT N. THOMPSON

Gainesville, Fla.

What you have in mind is evidently the same thing Art Margolis was talking about in "A System for Starting on Dogs" (February, 1958 issue) or which Stan Prentiss outlines in this issue. To give it a fancy name, it's an analytical approach. The expert keeps track of every step in his work and has a definite purpose for every action he takes. This method keeps him from going around in circles when trying to lick a tough problem. Most of

the material in PF REPORTER is intended to help the reader in using this approach.—Ed.

Dear Editor:

In your June "Letters" column, you advise that reprints of the "Tube Substitution Guide" presented in "Quicker Servicing" are available on request. Would appreciate your sending me a copy.

I have a TV technician friend in Sydney, Australia who I'm sure would also like a copy. May I have an extra to send to him.

G. R. MILLER

San Carlos, Calif.

Okay, Miller, two copies are on their way—yours is the best excuse yet for getting an "extra."—Ed.

Dear Editor:

Thank you for reinstating "Audio Facts." Let's have more articles on "old-fashioned" audio, now that it has been rejuvenated by hi-fi. Incidentally, what can be "hi-fi" about lipstick? Such a brand name is now on the market. Sounds as if everyone is jumping on the bandwagon!

WILLIAM E. STEPHENS

Jackson, Mich.

It might not be "true hi-fi," but it's loud.—Ed.

Dear Editor:

I've been a subscriber for over a year now, and learn something helpful from every issue. My favorites are "Notes on Test Equipment" and "The Troubleshooter."

There is something else I would like to have you include, however, and that is a preview of what is new in each year's designs. It would give us an opportunity to know about new sets before we are called upon to service them.

DAVID R. LYBROOK

Bakersfield, Calif.

Perhaps you saw "Previews of 1958 TV Sets" in our November, 1957 issue. Starting next month, there'll be an 8-page BONUS section in EVERY issue—including 4 full pages of "Previews" which will provide you with preliminary data to help you service new sets when you first encounter them in the customer's home. Okay, Dave?—Ed.

Dear Editor:

Jesse Dines' article "Analyzing the Vertical Circuit" in your June issue is one of the most comprehensive I have read in many a day. It is written with the serviceman in mind, but even an "egg-head" could learn much from it. Let's have more articles by Jesse.

EUGENE P. CURTIS

Portland, Ore.

You guys really flooded the mails in response to this article. See page 10 of this issue for another Dines' original.—Ed.

NO MUSS—NO FUSS!

CLAROSTAT® WIRE-WOUND CONTROLS.....

Give you exactly what you want!

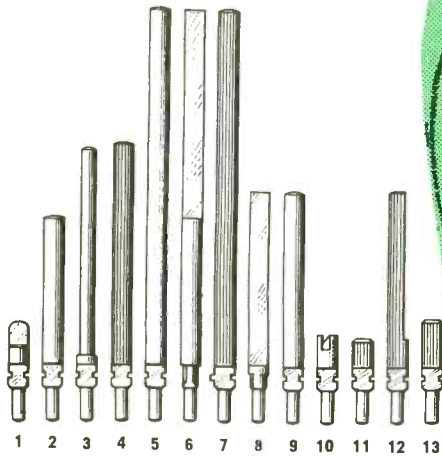

- | | |
|--------------------------------------|---|
| 1 3/8" long male for female fitting. | 8 3" flatted shaft. |
| 2 2" round shaft. | 9 3" round shaft. |
| 3 3" round shaft, 3/8" dia. | 10 1/2" double-flatted Philco-type shaft. |
| 4 3" knurled split shaft. | 11 1/4" fine knurled shaft. |
| 5 5" round shaft. | 12 3" knurled flatted shaft. |
| 6 5" flatted shaft. | 13 1/2" fine knurled flatted shaft. |
| 7 5" knurled split shaft. | |

With every CLAROSTAT "Pick-A-Shaft"® control, you get the shaft of your choice. Thirteen types meet just about every shaft requirement. A light tap and the "Pick-A-Shaft" shaft locks into position, securely and permanently.



CLAROSTAT MFG. CO., INC.

Headquarters for RESISTORS, CONTROLS, and RESISTANCE DEVICES

DOVER, NEW HAMPSHIRE, U.S.A.

In Canada: CANADIAN MARCONI CO., LTD., Toronto 17, Ont.

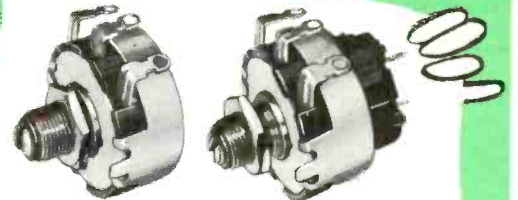

Series A 43: 2-watt wire-wound controls, 5 ohms to 10K ohms. Available with factory-attached switch, as Series A 43S (right).



Series A 58: 3-watt wire-wound controls, 1 ohm to 50K ohms. Available with factory-attached switch, as Series A 58S (right).



Series A 10: 4-watt wire-wound controls, 1 ohm to 100K ohms. Available with factory-attached switch, as Series A-10S (right).

Have you seen the latest Clarostat catalog? If not, be sure to ask your Clarostat distributor for a copy of **Cat. No. 58.**

*They're New...
Smart... Attract Customers.*



A. ILLUMINATED SIGN-A-RAMA. Visible for blocks. Brightly lit with six flashing lamps. Double-faced, large—48" by 24"—gives top identification to your store or shop. Mounting hardware is included.

B. ILLUMINATED SPECIAL-MESSAGE SIGN. Carries your name, or tells any brief message you select. Ideal for windows or interiors. 37" by 14". Uses two 30-watt bulbs. Kit of letters and numerals is included.

C. DISPLAY BACKDROP. Arrange this handy back-up display to meet your advertising needs. Material is flexible, can be curved or will mount flat. For window trim, walls, or counter fronts. Two 36" x 24" designs per strip.

D. GIANT TUBE CARTON. Eye-arresting... indicates the quality components you install and sell.

E. DOOR, WINDOW DECAL. Neat, attractive, new dry-apply type. 12" diameter.

GENERAL ELECTRIC'S COLOR-KEYED SHOP SIGNS!

Color-keyed to the G-E tube carton—symbol of quality!



Here is your chance to give your shop-front and windows eye-appeal with "sell". Colors of all eleven new General Electric signs and displays match handsomely the famous G-E tube carton. Quality appearance is keyed to high quality of product—a message every passerby is sure to read.

Attractive and modern, General Electric's color-keyed signs and displays also stand for leadership. They identify your shop as a source for television repairwork done to professional standards, backed by up-to-the-minute facilities.

All your display needs are met by smart new G-E designs—from an eye-catching, easy-to-apply door or window decal, to metal and illuminated outdoor and indoor signs... plus colorful utility items like the electric clock and thermometer.

These brand-new signs and displays are waiting for you now at your General Electric tube distributor's. Ask him how to obtain them! *Distributor Sales, Electronic Components Division, General Electric Company, Owensboro, Kentucky.*

◀ **SERVICE CLOTHING**, smartly styled, also is available. Garments are color-keyed to new G-E signs and displays—give that professional look. Durable, launder easily.

◀ **SERVICE CASES** in three useful sizes—small, medium, and large—match color-theme of General Electric displays. Now you can carry with you neatly, compactly, everything you need for making home service calls!

Progress Is Our Most Important Product

GENERAL ELECTRIC

11-11-102



METAL FLANGE SIGN. A display workhorse. Double-faced. Mount it anywhere! Compact—15" by 12"—handy for building corners, delivery entrances, and other side locations.



ILLUMINATED CLOCK, electric. Both useful and advertises your business. Easily read—16" diameter—with long-life bulbs. Hang on a wall, or mount on a counter (easel is provided).



COUNTER-WALL-WINDOW SIGN. Illuminated. Use it anywhere in your shop! Wrap-around cover has the attractive display on both sides. 15" by 11½" by 5".



OUTDOOR-INDOOR THERMOMETER. Tells temperature accurately. Every viewer will see your advertising message. Replaceable front. 12" diameter.



HANGING METAL SIGN. For shop front or service entrance. Message both sides, plus your nameplate. Large—48" by 36"—easily seen. Hanging hardware is included; lights are available.



METAL TACK-ON SIGN. Narrow, smart dimensions—14" by 42". Fasten against building, or mount as a free-standing display.

across the BENCH

Old TV's Never Die by Stan Prentiss

While these original words referred to "old soldiers," they apply equally to old television receivers, which also "fade away." Cathode-ray tubes grow weak, capacitors and resistors age, tubes accumulate interelement leakage and lose emission, and the wrinkles of age multiply. But unlike "old soldiers," a good television receiver can be given new life, so that it will perform as good as (or even better than) it did when first installed.

There is a Difference

Of course, there is a difference among "old" receivers. Regardless of the competence of the manufacturer, there seem to be good years and poor years for his products, depending on a multiplicity of factors. Engineering, research, materials, labor, etc., all play a respective part, and the result may not be known until the product has proved itself with the passage of time. One of these is used in the following example of what can be done with an old set.

Admiral 36X36

The sensitivity of this receiver is nothing to brag about by today's standards, but its reliability for day-in, day-out operation is hard to beat.

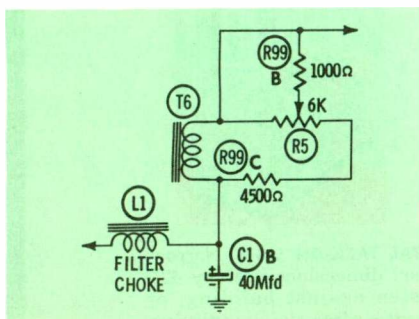

Fig. 1. Focus control in Admiral 36X36 is used to vary resistance across coil.

It was introduced about 7 years ago (1951) as a composite of, and improvement on, several predecessors which were themselves durable workmen. 1951 was a little early for employment of the cascode tuner; however, a good Standard Coil pentode type was used. Three stagger-tuned IF stages support the tuner, and the audio section (with a big, beautiful 6V6 providing 5 watts of potential output) is supplied with signal from the IN64 video detector diode. An old reliable 6AC7 (you'll find plenty of originals still in these sets) provides a positively-polarized video signal (sync positive) to the cathode of the picture tube.

The vertical sweep generator is of the blocking-oscillator type with a 6S4 tube and circuit of conventional design. The horizontal section is composed of the familiar phase-detector AFC system, where a pulse-developed sawtooth from the high voltage transformer is compared with pulses from the sync chain to generate a control voltage for the input grid of the horizontal multivibrator. A 200-volt positive spike from the same high voltage transformer terminal drives the AGC keyer tube, which regulates the bias for the RF and the first two IF amplifiers. The sync chain is standard and requires no particular explanation other than to remind the technician that for waveform viewing in the sync separator, clipper, and inverter stages, oscilloscope sweep selections correspond to either the horizontal or vertical scanning frequencies, depending upon the objective sought.

The Trouble

Recently, I had occasion to examine one of these sets. Upon arrival

in the customer's home, I detected a sputtering noise, which obviously came from the back of the receiver. There was neither sound nor picture and the odor reaching my nostrils told me I'd better turn off the power. Unfastening the rear cover and re-connecting the AC line cord revealed a sparking low-voltage rectifier tube and a curl of smoke ascending from the front of the chassis.

"We have been told," said the customer, "that the main transformer is shorted and that repairs will cost at least \$70. This is an old set, and even though it's always performed well, we just don't want to spend that much money to have it repaired."

This is sort of a routine attitude among many owners of older receivers. Either they have already spent a considerable amount of money on the set, or they are apprehensive about spending more than its apparent value justifies. In this instance, however, there obviously remained an element of doubt. "We have been told," the woman said, and along with the statement was a rather evident desire to have the old receiver back in operating condition if such was possible at a reasonable fee. Here were all the psychological elements necessary to promote a profitable repair plus an opportunity to magnify an already good reputation with a new client (yes, client—"one who employs the services of any professional man"). In short, a chance for more business!

What Might Have Been Done

Under this set of circumstances there are two usual alternatives: either you courteously remove the receiver from its cabinet and make some preliminary tests to try and determine the extent of the necessary repairs, or you agree with the supplied diagnosis and offer to sell the customer a new receiver.

That last alternative would have backfired immediately. The customer wanted both assurance and insurance. The first thing that had to be done was to convince them of my ability as a television technician; the second was to repair the receiver at a logical, if not reasonable, price. To the customers, in this instance, a reasonable price would naturally be anything *under* the previously

• Please turn to page 52

NOW... AN *Electro-Voice*[®] PUBLIC ADDRESS SPEAKER FOR ANY APPLICATION

For SUPERIOR SOUND ... CONTROLLED COVERAGE

See Electro-Voice public address projectors. They offer perfect voice penetration and full-range "musicasting." They're weatherproof, splashproof and blastproof.

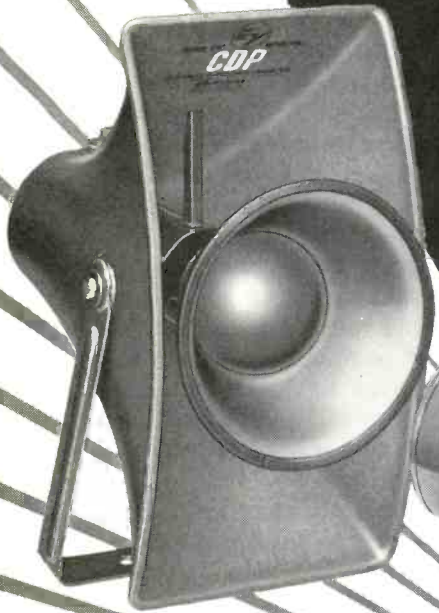

\$75.00
LIST

Model 848LT Long Throw CDP* (With 1000-cycle concentrating horn). For projecting intelligible, extended-range sound over great distances.

Model 844 30-Watt Paging Unit. Compact, economical unit for quality, high-efficiency voice reproduction.

\$34.50
LIST



\$80.00
LIST

The New Electro-Voice Musicast... rugged, weatherproof high-fidelity speaker system for high-quality music reproduction.

*CDP (Compound Diffraction Projection) Design Patent 169,904. Additional Patent Pending.



Model 848 30-Watt CDP. For wide-angle coverage and extended range. Standard of the industry.

\$75.00
LIST



Model 847 25-Watt CDP. Smaller version of Model 848.

\$46.33
LIST



Model LS-12. For interior installations requiring full-range response.

\$32.50
LIST



Model LS-8. Smaller version of Model LS-12.

\$30.00
LIST

THESE ELECTRO-VOICE MICROPHONES ARE
ESPECIALLY OUTSTANDING FOR PUBLIC ADDRESS

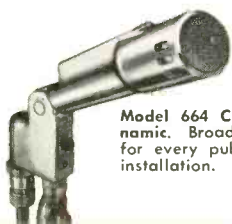

\$85.00
LIST

Model 664 Cardioid Dynamic. Broadcast-quality for every public address installation.



\$49.50
LIST

Model 951 Cardioid Crystal. Excellent, wide-range, all-purpose microphone.

The Sound of Electro-Voice... Assures Superior Installations, Customer Satisfaction, Your Reputation!

Electro-Voice[®] ELECTRO-VOICE, INC.
BUCHANAN, MICH.

In Canada: E-V of Canada Ltd., 73 Crockford Blvd., Scarborough, Ontario
Cables: ARLAB

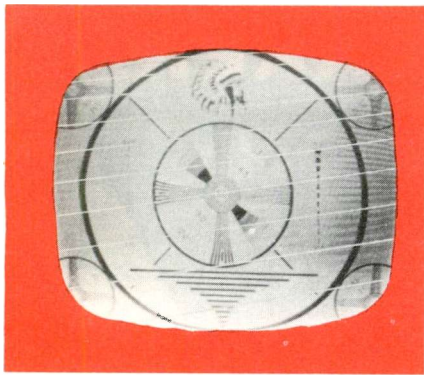

Fig. 1. Retrace lines on a picture are very disturbing, but can be eliminated.

vertical RETRACE-LINE elimination

By Jesse Dines

Bring Those Old Sets Up To Date
By Installing Blanking Circuits.

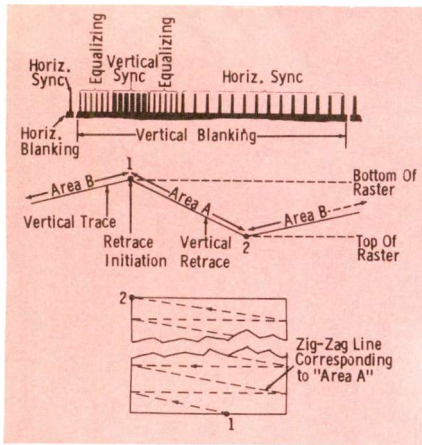

Fig. 2. A comparison of signals and beam action during vertical retrace.

Occasionally, you may come across a receiver whose raster has visible vertical retrace lines such as pictured in Fig. 1. These retrace lines are annoying to the viewer, especially when they can be seen in the picture background. In most cases, the receiver is operating in accordance with the manufacturer's specifications; yet, if you can modify the design to obtain complete retrace blanking, your customer will most certainly be grateful.

Cause of Retrace Lines

Before discussing retrace elimination circuits, let's first see what causes retrace lines. Examine the composite video signal shown in Fig. 2A, in which the various components are labeled. A waveform of the current which produces vertical raster deflection is shown in Fig. 2B. The vertical trace portion of the sweep current causes the picture tube beam to be deflected from top to bottom in less than 1/60 of a second, completing one field. The vertical retrace portion, which is initiated when the vertical oscillator triggers, deflects the electron beam back to the top in something like 1200/1400 microseconds (depending on the receiver). This time is designated as "Area A" in Figs. 2B and 2C. Fig. 2C shows how the retrace lines form a zig-zag pattern because horizontal scanning continues during vertical retrace.

Now let's change our trend of thought slightly and see what happens under conditions of normal and abnormal brightness control settings. Typical Eg- I_p curves for a picture tube and changes in bias caused by video signal excursions are shown in

the illustrations of Fig. 3. Operating levels for various control settings are shown so that the picture tube has (A) normal bias, (B) too little bias, and (C) too much bias. The bias normally developed is effectively the average AC potential of the video signal, and average beam current corresponds to this DC level.

In Fig. 3A, the brightness control is set so that picture tube bias is an arbitrary 30 volts. Note that the 40-volt cutoff point occurs at the black level (at sync tips). In this case, blanking pulses effect picture tube cutoff and retrace lines are not visible.

In Fig. 3B, insufficient bias is produced by the brightness control setting; thus, sync and blanking pulses fall short of cutoff, black portions of the video signal will appear as grays. All portions of the image will be brighter than normal, and may even have a "washed out" appearance. Inasmuch as the picture tube is not cut off during vertical retrace, the undesired lines will appear. At this point, perhaps you can see that vertical blanking would permit good picture viewing with a higher average brightness level by preventing

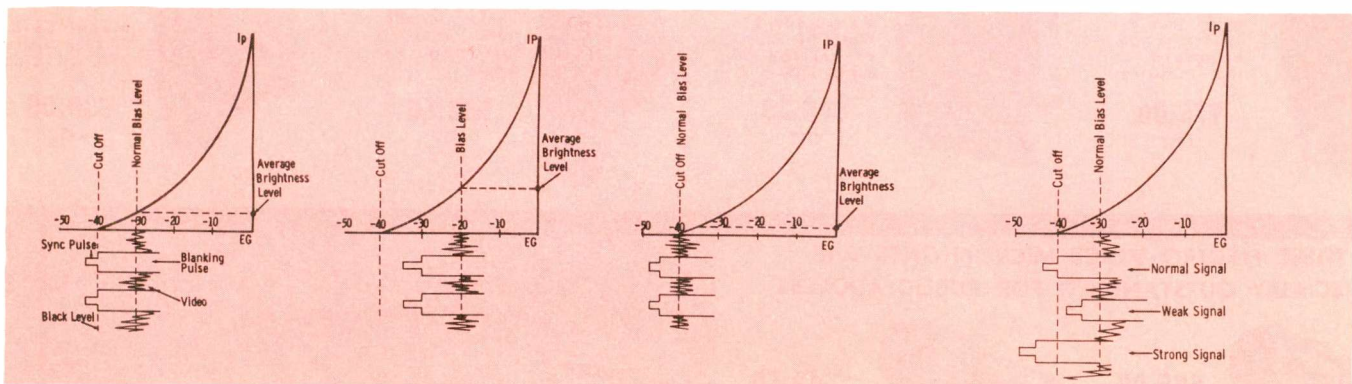

(A) Normal bias. (B) Too little bias. (C) Too much bias.

Fig. 3. Picture tube Eg I_p curves showing how bias affects image reproduction.

Fig. 4. Picture tube Eg I_p curve showing effects of changes in video signal level.

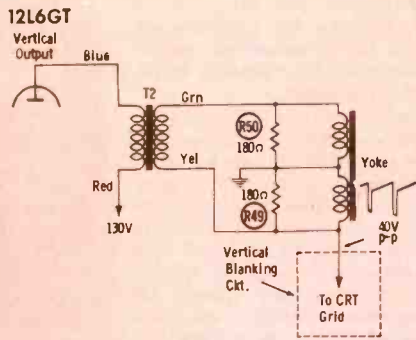

(A) Truetime Model 2D3770A

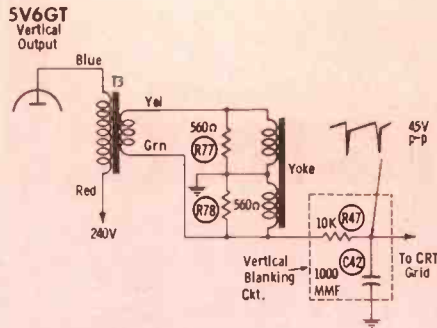

(B) Emerson Chassis 120257-D

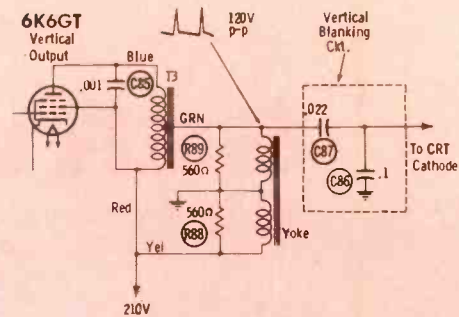

(C) RCA Chassis KCS88J

Fig. 6. Typical vertical blanking circuits incorporated in modern receivers.

retrace lines from being seen.

In a similar analogy, a signal with insufficient amplitude (due to a weak signal or a misadjusted contrast control) may also result in visible retrace lines (see Fig. 4). Note that the effects of a normal signal, weak signal, and strong signal are similar to those indicated in Fig. 3A, B, and C, respectively.

Obtaining the Spike

To insure vertical blanking, a portion of the vertical sweep energy can be shaped and fed to either the grid or cathode of the picture tube. If pulses are fed to the cathode, they must be positive in polarity; if fed to the grid, they must be negative.

In either case, the picture tube will be biased to or beyond cutoff during the proper interval.

The spike acts in conjunction with the vertical blanking portion of the composite video signal to drive the

picture tube into cutoff. To avoid adverse loading of the video amplifier, it is usually a good idea to feed the spike to the undriven picture tube element. Thus, if the video amplifier feeds the grid, connect the spike voltage to the picture tube cathode and vice versa.

Fig. 5 represents typical voltage waveforms found in the vertical sweep circuit. It can be seen that a negative-going spike is present in the plate circuit of the vertical oscillator tube and one of positive polarity at the plate of the output stage. Note that a negative spike appears across resistor R1 and a sawtooth across capacitor C1 in the sawtooth-forming network of the vertical oscillator; hence, a blanking signal from the junction of R1-C1 would be applied to the picture tube grid. Note, too, from Fig. 5, that the spike voltage obtained from the output

• Please turn to page 58

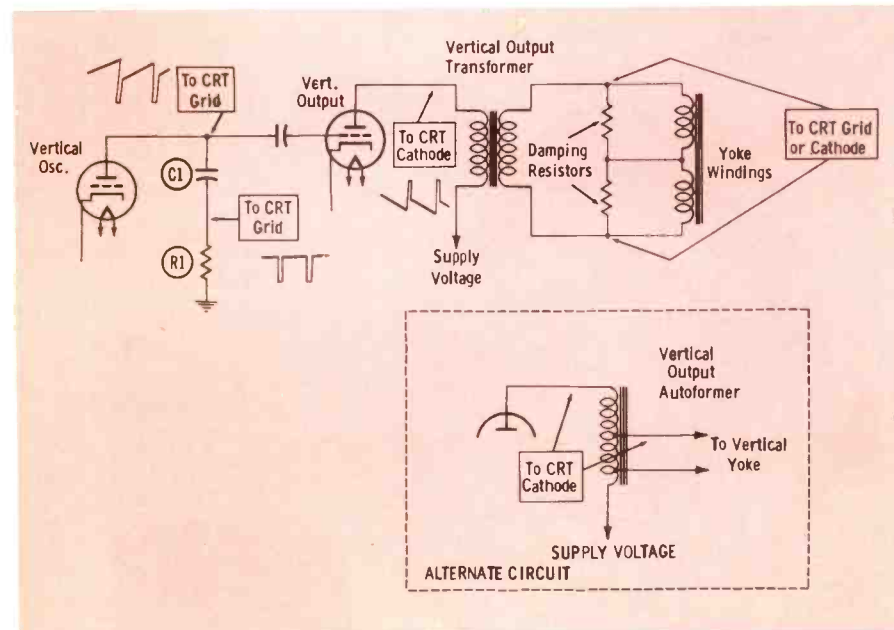
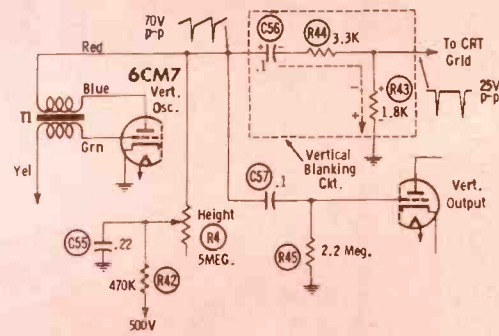
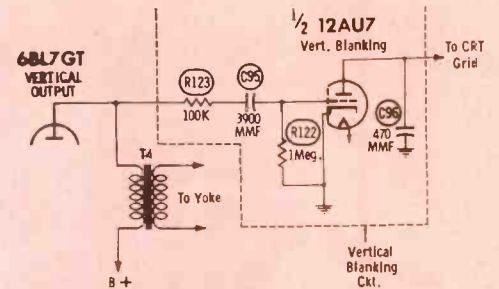

Fig. 5. Partial schematic of vertical section shows blanking take-off points.



(D) Airline Model GRX4020A



(E) GE Model 24C101

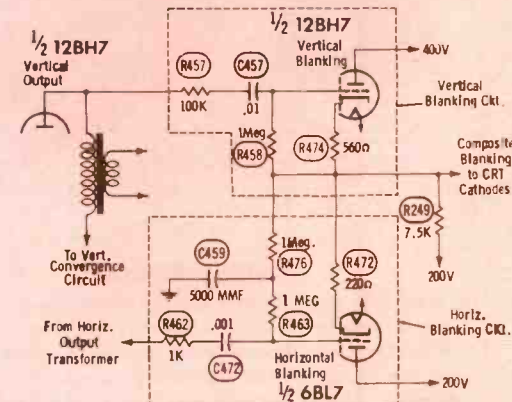

(F) GE Model 15CL100

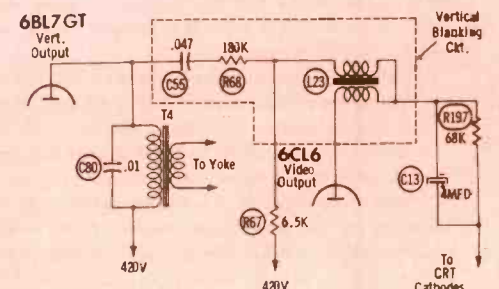

(G) Raytheon Chassis 21CT1C

SERVICING SMALL APPLIANCES

If you can repair radio and television receivers, you can also fix small appliances, for you already have the basic essentials necessary—electronic background, tools, and test equipment.

Naturally, you should feel your way slowly at first—but when you see how profitable it can be (perhaps helping you through a temporary slump), you may want to go ahead and invest in special test instruments such as surface- and water-temperature meters, a tachometer to check the speeds of motor-operated devices, etc. One problem, of course, is getting replacement parts and adequate service literature. You might plan ahead, however, and contact as many distributors and appliance manufacturers as possible before a particular need arises. The items pictured and described here are just a fraction of the many appliances found in the average home. And to help you get started in repairing them, we've provided you with pertinent data and servicing tips.

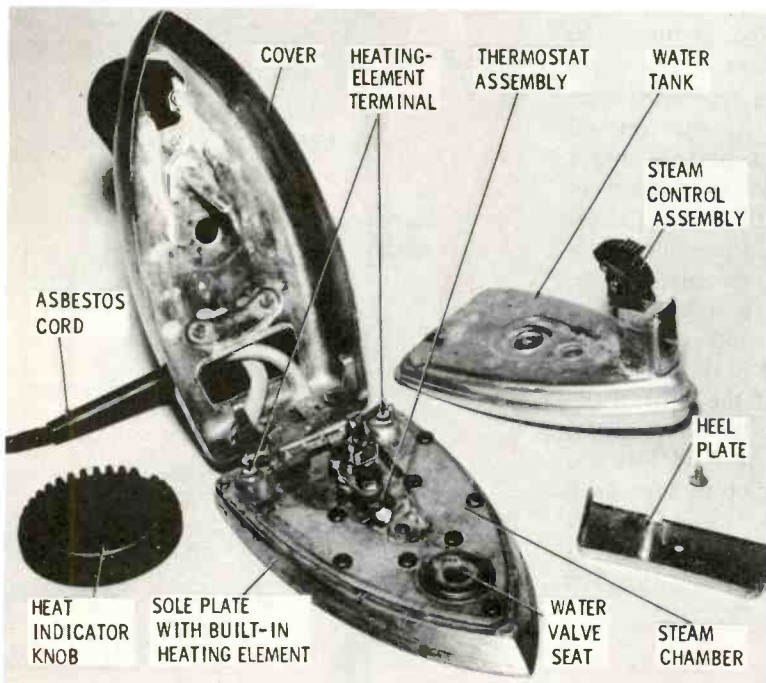

Irons

The electrical circuit of an iron is relatively simple, consisting basically of only a heating element attached to an AC cord. Automatic and steam irons, of course, have certain features such as variable heat controls, but these are not at all complex. Most of the troubles encountered will be either shorts or opens. Little need be said about the continuity tests for locating these sort of troubles.

You will probably find that the toughest job is taking the iron apart. For this reason, obtain all the disassembly information you can from manufacturers and their distributors.

Don't waste valuable time repairing parts such as open heating elements, defective thermostats, or leaky water tanks, which are more easily replaced.

If ordinary tap water has been used in a steam iron, its steam passages, valve, and port holes may become congested with lime and other chemical deposits. Before disassembling the iron, try cleaning it with a small amount of white vinegar. Let the iron "steam" until the vinegar starts to boil; remove the plug and let it sit for twenty minutes; then flush with pure distilled water.

Coffee Makers

Normally, you will encounter two general types—the percolator and the brewer. Either, however, may come in automatic or non-automatic designs. When servicing non-automatic percolators, check the heat fuse which protects the unit against damage when the pot boils dry. Always test for shorts before replacing this fuse. Inside the percolator is a stem with a coffee basket at the top, and a hood or valve at the base. Check to see that the valve is clean and that it seats firmly over the heating element.

Automatic percolators, such as shown, will feature a thermostatically-controlled timing unit of some sort: If this proves to be at fault, replace the entire assembly.

In the automatic brewer, more than one heating element may be employed. Heat controls automatically switch operation from a high-heat to a low-heat element. The first causes the water to boil, and steam pressure forces it up into the brewing basket. When pressure drops, the brew returns to the bottom section, and the second element keeps it at serving temperature. Adjustment of these controls should be in accordance with the manufacturer's recommendations.

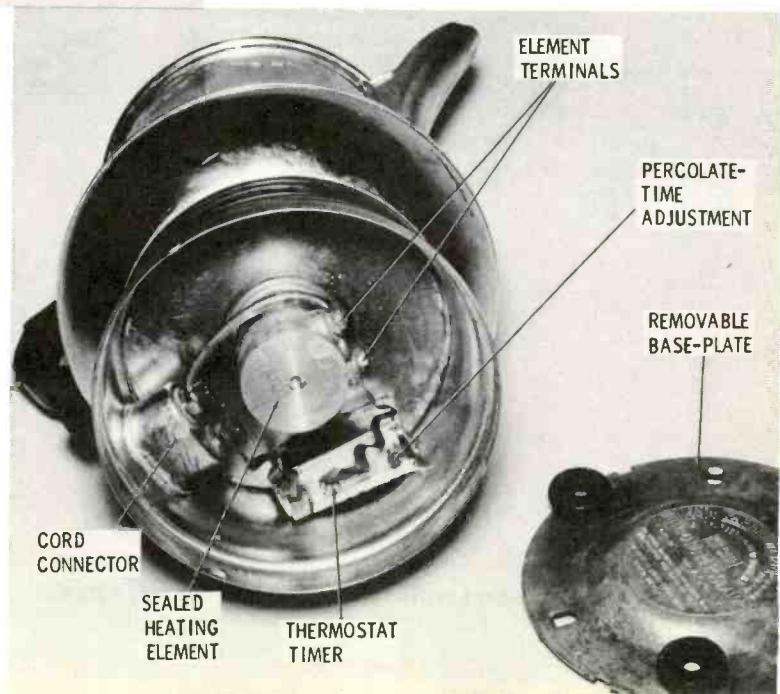

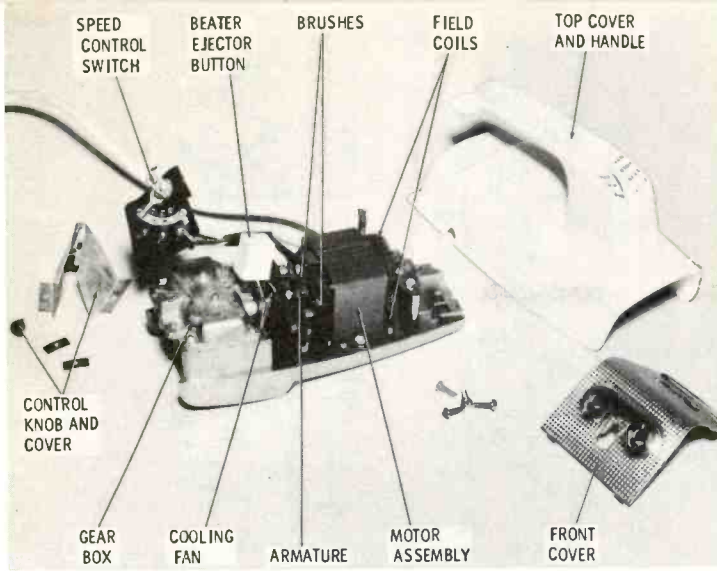

Toasters

All toasters operate on the same basic principle wherein a thermostat opens a switch when a certain temperature is reached. To accomplish this, the unit may employ a clock-timer, a direct thermostat, an adjustable timer, or a combination timer and thermostat.

Removing the outer covering of a toaster may be a little tricky—but with experience, you'll find it no more difficult than disassembling a TV high-voltage cage. Remember, however, not to go any further than necessary when taking a unit apart. The heating elements are relatively delicate, so go easy when probing around for trouble.

The most common troubles found in toasters are damaged carriages or cocking mechanisms, dirty or gummed-up parts, and misadjusted thermostats. In some cases, the heating elements may be broken or burned in two. If at all possible, replace the element rather than try to repair it. In older units for which replacements are hard or impossible to obtain, however, use a mending sleeve to repair the open element.

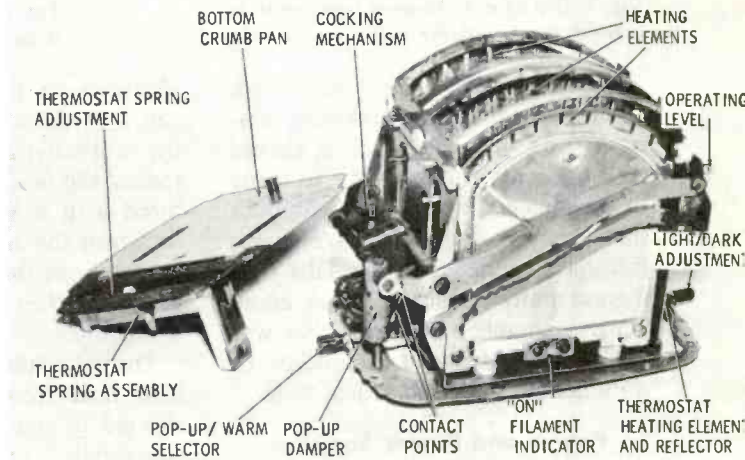

Space Heaters

Small space heaters are nothing more than a heat-producing grid with a fan or reflector to direct the air or heat waves. Aside from fan trouble, it is not unusual to find a faulty switch or a burned connection. The switch may regulate current through the heating element and/or control the speed of the fan motor.

Make sure all electrical connections are tight. At high currents such as found in heaters, a loose contact will usually develop enough excessive heat to completely burn off a terminal or its mounting board.

As with any other appliance, the test procedure should include a thorough inspection of the line cord. Since the cord undergoes more abuse than any other component, it naturally becomes a common source of trouble. If you question its current-carrying capabilities for any reason, replace it.

If you are unable to obtain a new heating element of the resistive-wire type for a particular heater, a temporary repair of an open can be made by placing the wire ends together, putting a small amount of borax on the joint, and welding the junction by turning the unit on.

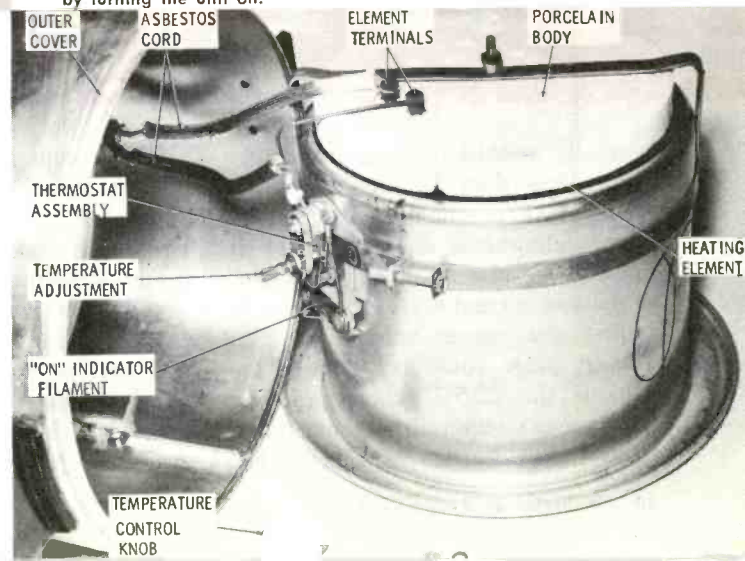
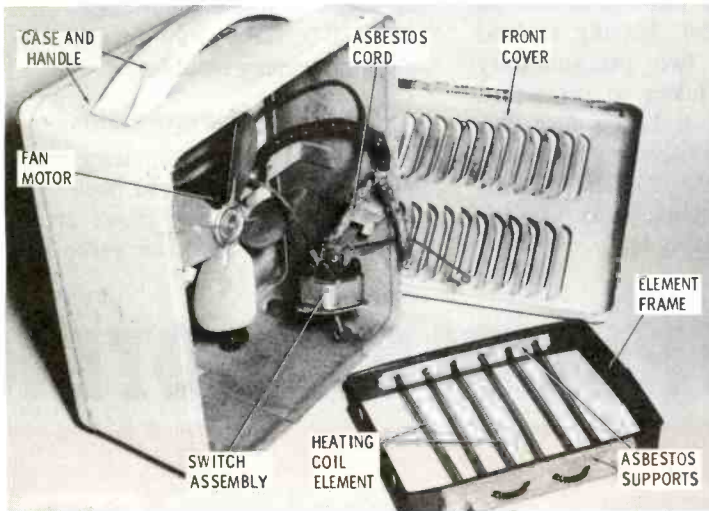

Cookers

This group of appliances includes roasters, casseroles, broilers, deep fryers, hot plates, etc. When a unit of this type will not heat, check first for continuity through the power cord and heating element.

If the cooker has a thermostat, its operation and adjustment should be checked according to manufacturer's specifications. Always be sure that the heat-conducting portion of the thermostat is making good contact with the inner heating surfaces of the cooker. Also, check to see that the heating element is correctly positioned, a factor which has a definite effect on thermostat operation.

Most small appliances will have either painted, chrome, or porcelain-enamel finishes; therefore, take care in handling them by padding your workbench and using a cloth or piece of cardboard between your tools and such vulnerable surfaces.

Mixers

In nearly all domestic food mixers and blenders, a series-type commutator motor is used. Check the motor for overheating, irregular speed, excessive arcing at commutator, loose bearings, or armature binding. If the motor chatters, chances are that the bearings are badly worn and should be replaced. One can check the speed control and field coils for opens or shorts by making a simple ohmmeter test.

When checking the gear box for worn or damaged gears, always be on the lookout for oil leaks. If you disassemble the motor and gear case, it's a good idea to replace all oil retainers to insure a leak-proof seal. If the mixer motor refuses to run and the power cord is okay, check the switch assembly, solder connections and leads, motor brushes, field coil and armature.

Use factory-replacement parts whenever possible. If you estimate that the cost of parts and labor will exceed the price of a new appliance, consult the customer before going ahead with the repair.

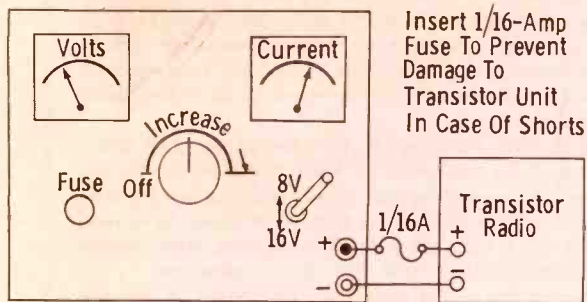

Fig. 1. Use of a 1/16-amp fuse helps to protect the transistor radio under test.

Previously, we have said much about basic transistor servicing concepts, and many technicians should now be ready for exposure to some of the more advanced techniques that can be employed. We have, through experience in our labs with a great many transistor radios, come across a number of points that will enable the advanced technician to do a better repair job in less time.

Power and Power Supplies

One of the first obstacles you will encounter is how to power the transistor radio during necessary test procedures. The newer models of battery eliminators, designed for servicing transistorized auto radios, were checked as possible power sources. A scope analysis of output current ripple content with the drain

obtained on the 8-volt range. Because of the low voltage ratings of the electrolytics used in transistor radios, the output voltage was monitored with a VOM and a red line drawn at the rated voltage point on the meter of the power supply. Current was then monitored with the VOM.

During a subsequent test, the positive lead from the power supply shorted to one lead of a miniature electrolytic, ruining the capacitor and blowing a 1" section of foil on the printed board. Having learned the hard way, two precautionary measures were taken to prevent a recurrence: (1) a 1/16a fuse was inserted in the positive lead from the power supply (Fig. 1), and (2) insulated alligator clips were installed on the power supply leads.

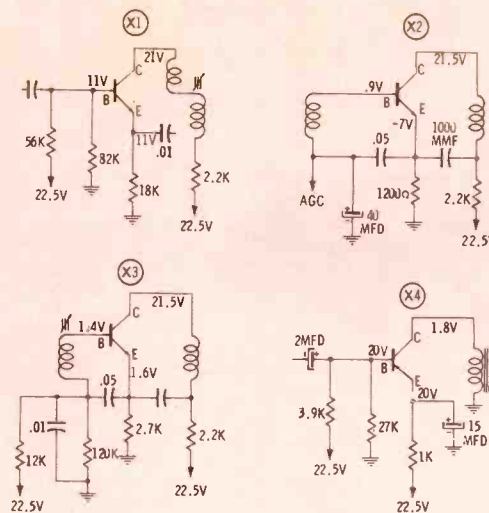

Fig. 2. Partial schematic shows voltage-divider networks and dropping resistors which can be used to locate test points.

check the battery current drain? First of all you tune off station, then adjust the volume control to maximum and note the reading on the current meter. If current is much higher than normal (more than 10-15%), the set probably has a leaky capacitor or a transistor that is biased improperly. If current is too low, then one stage isn't working due to an open capacitor, open resistor, broken connection, high value resistor, open transformer, etc. As you can see, a simple current check puts you well on the way toward the solution to many troubles.

Voltage Measurements

Various articles on servicing transistorized equipment have been very consistent in stating, "Don't check resistances in a transistor radio un-

ADVANCED TROUBLESHOOTING

TRANSISTOR

normally required by a transistor radio (less than 10 ma) revealed that, for all practical purposes, the battery eliminator was as good as a battery. We also found that because of the low current drain of transistor radios, the output voltage on the 16-volt range could be adjusted to provide the 22.5V (even more in some cases) required by some transistor radios. Further, 9 volts can be

This setup, although a workable one, is rather bulky and presents certain dangers to the equipment under test. A power supply designed for use with transistor radios is much smaller and eliminates these dangers. In addition, accurate voltage and current meters are often provided on such instruments, which makes checking for proper current drain much easier. How do you

less you remove the transistor from the circuit under test." This author suggests you take it a step further; forget about resistance and check voltage instead. After all, a resistance check is made under dynamic conditions and will therefore provide more data in less time. Because the voltages employed in a transistor radio are necessarily low, and minute variations are often very signifi-

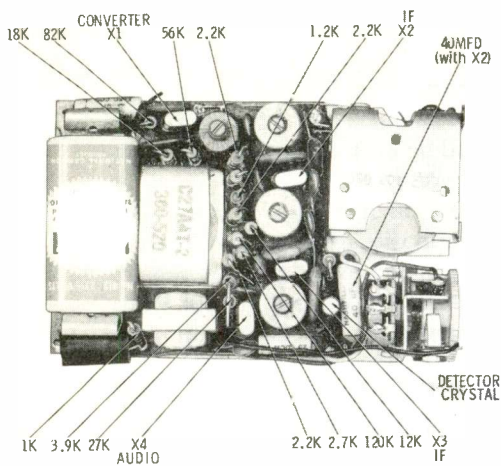

Fig. 3. Sample layout of radio showing locations of transistors, helpful guides.

cant, the meter employed must be quite accurate. A recently-calibrated VTVM fills the bill very nicely.

Before you can measure voltages, you have to locate the desired check points on the printed wiring board. Rather than spend a lot of time trying to trace the crazy maze of silver ribbons, consult the schematic and the pictorial component-identification sections of the service literature and systematically locate the chosen test points. (ED. NOTE: Beginning with Set No. 414, PHOTOFACT folders will identify various circuit connections by keying them to the schematic.) In Fig. 2, we have shown a partial schematic of the four stages employed in a typical transistor radio. In each stage, the resistors (easiest components to identify) can be used as "land-

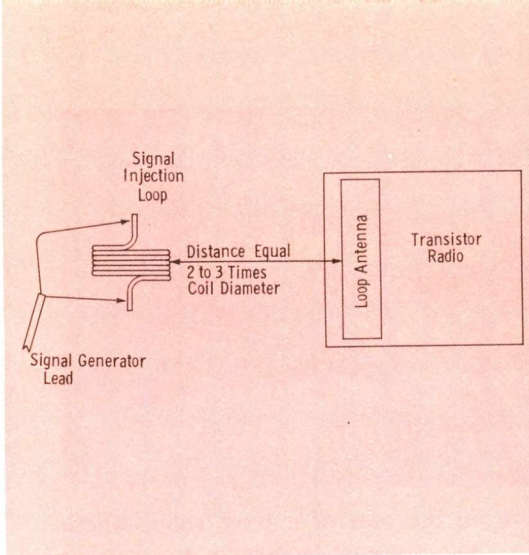

Fig. 4. How to radiate signal into the loop antenna of a transistor radio.

Once you have determined where to make the checks, it is a simple matter to check the voltages present at the elements of the transistors. A rapid check of a transistor circuit consists of measurements at the base and emitter. These voltages should be nearly equal as indicated in Fig. 2. Any significant difference between the voltages on these elements is an indication of some malfunction in that stage. The readings given in the service literature provide an accurate reference point in each case.

Alignment

The alignment of a transistor radio is not a hit or miss proposition; it is an exact science. The instructions given in service literature provide an accurate guide for the actual procedure; however, you must have

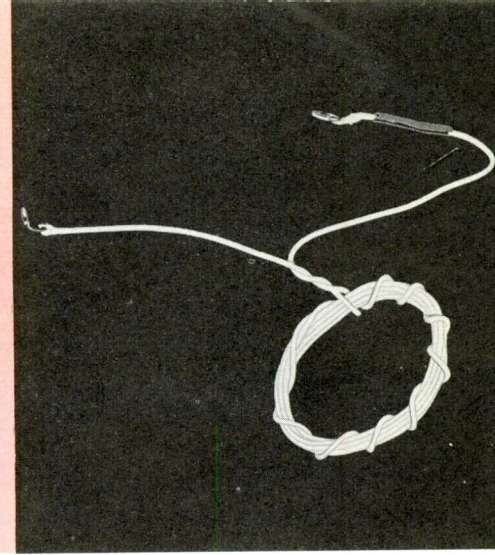

Fig. 5. Sample of signal injection coil made from 15 turns of number 26 wire.

not detune or unnecessarily load the input circuit. A commonly recommended procedure for signal injection involves radiation of the signal into the loop antenna of the receiver. This should be done as illustrated by the drawing in Fig. 4. Notice that the injection coil is positioned at right angles to the loop, and at a distance of about two or three coil diameters. The exact distance must be determined by trial and error since it is affected by radiation characteristics of the coil, signal generator output voltage, and sensitivity of the loop antenna circuit. A good workable injection coil (Fig. 5) is comprised of 15 turns of No. 26 insulated wire wound into a coil 1½" in diameter. The last turn should entwine the others to hold them together. (Always connect the ground lead of the generator to this end of the coil.) In lab tests we found that getting the injection coil too near the loop resulted in an apparent detuning of the circuit whenever a hand was brought close enough to the trimmers to make adjustments. Moving the injection coil farther away from the loop minimized this effect. Along with signal injection, we should consider the output indicator; a VTVM connected across the end terminals of the volume control is the most satisfactory.

Oscillator Tracking

In an examination of several radios, two differences between transistor oscillator circuits and their vacuum-tube counterparts were noted. One is that an adjustable oscillator coil is always employed, and the other is that the sections of the

• Please turn to page 55

TECHNIQUES FOR RADIOS

marks." If you study the parts layout (a sample showing transistor locations is shown in Fig. 3) and positively locate stages 1, 2, 3, and 4, you can associate the resistors with the adjacent transistor and identify the desired test points. Make yourself a little chart if you can't remember them. A few minutes spent in this manner can save much time in the over-all job.

a great deal of personal knowledge about circuit operating theories and designs if best tracking and sensitivity are to be achieved.

Signal Injection

One of the first problems that arises in any alignment procedure is how to inject the generator signal into the receiver circuits. The problem is a dual one; the signal must be coupled into the receiver, yet it must



Consumer Education. Did you see "The Facts About the Cost of TV Repairs" in the June 28th edition of TV Guide? About 6,500,000 television set owners in the U.S. did! It warrants mention because it's just the sort of thing that helps clear up some of the mysteries the general public has about the TV repair business. Howard W. Sams & Co. has obtained permission from TV Guide to make reprints available for your benefit. If you'd like to distribute them to your customers, order from Dept. C.S., 2201 E. 46th St., Indianapolis 5, Ind., enclosing 25c per hundred to cover cost of handling and mailing. A sample of the reprint will be sent on request.

\$ & ¢

Right Dress. "Servicemen should dress for a service call as though they were taking the lady customer out for dinner and a Broadway premiere. Suppose he does get a little dirty, poking around in the TV. She will think of Sir Walter Raleigh flinging his beautiful cape into the mud to provide a clean place for the feet of a queen. And who would quibble over a few dollars with so gallant a man?"

This tongue-in-cheek commentary from TEAM NEWS (published by The Electronic Association of Missouri) contains more than just a grain of truth. Neatness in dress is definitely appreciated by the customer, and making a good impression is worth the small effort it takes.

Whether you dress in sports clothes or in a uniform depends on the impression you want to create in the mind of the customer. A uniform suggests a businesslike, efficient organization. This is exactly the feeling you want to get across

in the case of a large shop, where the customer-technician relationship is fairly impersonal. Here, you actually try to create a "personality" for the shop itself, distinct from that of the technician. The uniform becomes a shop trademark, and the customer thinks, "Here comes A-1 TV" instead of "Here comes Charlie Brown."

The only trouble with a uniform is that some customers will associate it with gas-station attendants or route salesman, and mentally classify the technician as such. This is a handicap if you are trying to impress the customer with the fact that you are rendering professional services. Technicians in small shops, who depend most heavily on personal contact with customers, would especially benefit from upgrading their appearance by dressing up a little. Slacks and a well-pressed sport shirt are sufficient in many communities, but a dress shirt and tie may be preferred in some locations.

At any rate, dirty work pants and a wrinkled shirt will do nothing toward improving your standing with the customer — or toward raising your own impression of yourself.

\$ & ¢

Dogged Perseverance. When a technician is hot on the trail of a defect in a "dog" TV set, time flies by unnoticed. It's easy to work through an entire half day or longer without realizing how much time has been spent on the job.

When you finally lay down your test probes and pick up a pencil to figure out the bill, how much compensation do you expect for putting in those long hours? You could charge your regular hourly rate for labor, but this could result in a bill of \$25 or more for replacing a few

small parts. At this point, it becomes hard to convince even your most understanding customers that you have earned your fee.

On the other hand, you could go to the opposite extreme and charge a flat rate for every type of repair — no matter how long it took you to complete it. The danger in this practice is the temptation to tell yourself, "I was too dumb to cure this trouble sooner, so it wouldn't be fair to charge for all the time I spent poking around in the set."

Charging some of your time to experience is all right, up to a point, but a technician is entitled to somewhat more than the average labor charge when he has to spend an unusual amount of time on a difficult bench job. After all, he must call on all his reserves of skill and patience to cure a trouble that is hard to find. To keep charges on long jobs from going sky-high, however, it may be necessary to average out the fees for different calls to some extent. That is, you should be sure that you allow enough profit on "easy" jobs to make up for losses on the inevitable "dogs."

\$ & ¢

Test Your Tact—VI. When you run into an unexpected problem on a house call, it's only natural to stop for a moment and collect your thoughts before taking further action. If you are one of the many people who automatically reach for a cigarette at such a time, do you stop to find out whether the customer is willing to let you smoke in his home?

Before you ask, you would be wise to scout around the room for ashtrays. If they are lacking, you're probably better off not even to mention the subject of smoking. Fight off that "nicotine fit" until you can get out of the house! On the other hand, used ashtrays are a signal that the customer will probably OK your request for a few puffs.

By the way, how good are you at keeping ashes under control? It's a good trick even when your mind is not preoccupied with some technical problem. Unless your nicotine habit is absolutely uncontrollable or the customer offers you a cigarette, your best bet is to wait until you get outside for that satisfying puff.

**NEW,
LOW
PRICE**



HICKOK

high-speed
**PORTABLE
CARDMATIC
TUBE TESTER**



MODEL
121

SPECIFICATIONS

- 320 heater voltages.
- 140 fixed bias potentials.
- 640 plate voltages.
- 640 screen voltages.
- 100 self-bias settings
- 1000 quality-value sensitivity ranges

Instant shorts indication.

ALL AUTOMATICALLY!

Active card magazine holds over 600 cards instantly available with time saving automatic filing feature.

SEE THE 121 TODAY!

\$249.50
(Includes 300 cards) NET

Fully Automatic

Tests any tube in 8 to 12 seconds . . . including handling of tube test data card.

Here is the new, low cost version of the famous Hickok Cardmatic so popular with leading lab engineers. Especially designed for high speed service work, this new 121 is high quality in a lightweight portable . . . and the price is low too.

The Hickok Cardmatic switch sets up all tests automatically and eliminates fussing around with adjustments. You can accurately check a tube for dynamic mutual conductance, controlled emission, cutoff point "Knee" point, shorts, leakage, gas and voltage drop . . . and rectifier tubes at their rated loads. Any way you look at it, this new automatic tube testing machine will be helpful to you in your work. It will pay for itself in a very short time . . . and give you many years of accurate dependable service.

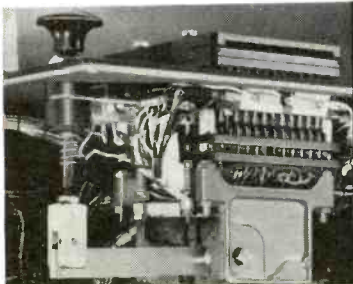

The new 121 incorporates a fully automatic mechanism actually incorporating 187 individual switches providing an almost unlimited number of voltage combinations to any tube element. This mechanism has been life tested in a cycling process over 100,000 times—without fail, and has proven superior to all other switching arrangements.

**Now is the time to . . .
TRADE UP TO A HICKOK**

Ask for a demonstration of the new 121
or write for descriptive literature.

THE HICKOK ELECTRICAL INSTRUMENT CO.

10566 Dupont Avenue • Cleveland 8, Ohio

the troubleshooter

answers your service problems

Overloading

Since the flyback transformer on a Sparton Chassis 22V214 was replaced with a Merit HVO-9 and MWC-1, the set has had a tendency to overload on strong signals. The "no-signal" voltage at the grid of the AGC keying tube is only 90 volts, and the pulses at the plate of this tube have a peak-to-peak value of only slightly more than 400 volts instead of the 500 volts shown on the schematic. Is there some modification necessary in this AGC circuit because of the change in the flyback?

W. H. Guss

Roswell, N. Mex.

All voltages in the flyback circuit may be somewhat lower than they were before you replaced the transformer. As long as you still have sufficient width and brightness, however, you shouldn't need to be concerned with any alterations of the flyback circuit. The 400-volt pulses at the plate of the AGC tube are ample for normal operation.

On the other hand, an AGC grid voltage of only 90 volts is definitely too low to permit normal conduction of the keying tube. In this set, boost partly determines the voltage on the grid by means of the connection through R54; therefore, a decrease in boost voltage would cause a corresponding increase in bias on the AGC tube. Unless boost is so low as to hinder the operation of the sweep oscillators, though, I'd say it would be best to let it seek its own level. You can probably raise the AGC grid voltage by reducing the value of R54.

Low grid voltage on the AGC tube could also be caused by insufficient voltage in the plate circuit of the video output tube. (The latter condition in itself would cause overloading.) At least 120 volts should be present at the junction of R46 and R47 in the video circuit.

Intermittent High Voltage

I've had five different calls to restore high voltage on a Crosley Chassis 473, and I restored operation in a different manner each time. The last two times, substitution of the damper tube did the trick; on another occasion, the horizontal oscillator tube had to be changed. One time I restored high voltage simply by bringing the set to the shop. How can I prevent this symptom from coming back?

GEORGE PATTERSON

Irwin, Pa.

This appears to be one of those ultra-exasperating intermittent conditions where the trouble won't stay around long enough to let you locate the source. A visual check of the horizontal and high-voltage circuits would be advisable, since the trouble could be something as simple as an intermittently open anode lead. I suggest a thorough check of the damper tube socket pins and connections.

If physical checks and tube substitutions don't result in a permanent cure, wait until the set acts up again; then check some of the waveforms in the circuit. The drive signal at the output-tube grid should be viewed first. Distortion of this waveform indicates trouble in the discharge-tube, oscillator, or AFC stages, and normal appearance indicates trouble in the output, damper, or high-voltage stages. Keep narrowing down your search until the trouble is found. Don't let the

set go back to the customer without trying your best to find a lasting remedy; nothing will hurt your business worse than repeated calls for the same complaint.

Horizontal Weave

A Packard-Bell Model 2710 has an intermittent horizontal wobble. When the set is first turned on, a bend appears in the picture and weaves slowly from top to bottom. The raster is not distorted, and I can remove the bend by reducing the contrast setting to a low value. The picture settles down to normal after five or ten minutes of operation, but the weaving reappears once or twice each evening.

R. J. GRANT

Culver City, Calif.

This trouble sounds very much like 60-cps hum interference in the video signal. Weaving occurs in such cases because the interfering signal is out of phase with the vertical sweep signal. Since the set in question has a full-wave power supply that produces 120-cps ripple, the most likely source of the spurious 60-cps signal is the heater circuit. Leakage from heater to cathode of some tube is frequently to blame.

You mention that the contrast control setting affects the bends. This could be a good, time-saving clue to the location of the defect. Your set has two stages of video amplification, with the sync and AGC take-off points in the first stage and the contrast control at the cathode of the second stage. This means that the contrast control should have no effect upon the operation of the sync or AGC sections of the receiver, and we can deduce that the trouble is probably not in either of those sections.

The most obvious suspect is the video output stage or the DC restorer that follows it. Try substituting (not just checking) the tubes in these circuits. If that does not cure the trouble, do some signal tracing with a scope. A humped appearance of the waveform (at a sweep frequency of 30 cps) corresponds to a bend in the picture.

Horizontal Jitter

A Packard-Bell Model 21VT1 recently gave me quite a battle. The picture would vibrate horizontally at a fairly rapid rate. Vertical interlace also seemed to be affected at times. I did everything I could think of, and followed the suggestions of several others, but got no results. Then, for no special purpose, I checked a 10-mfd capacitor in the vertical output stage with my capacitor checker. (This component is connected to the bottom of the vertical output transformer and also through 12K ohms to B+ boost.) It showed a power factor of 20, so I slipped a new one in—and cured the trouble. Now I'm wondering why.

WADE L. NELSON

Highgrove, Calif.

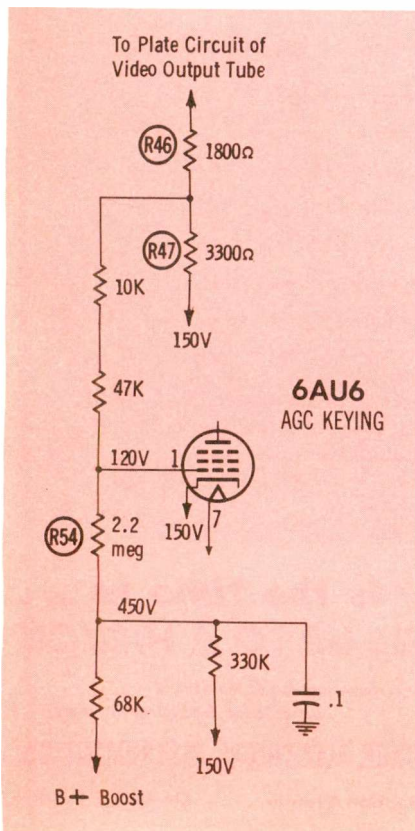

MR. INDEPENDENT SERVICE DEALER:

how many of
your tube dollars
are helping
your "competitors"?



Not a single one of them, if you standardize on Raytheon TV and Radio Tubes because Raytheon does not make TV and Radio sets — does not have a factory controlled TV and Radio Service organization — does not compete with you for profitable service business.

On the contrary, Raytheon's sole aim is serving you, the Independent Service Dealer — by making available to you the finest quality TV and Radio Tubes money can buy — tubes that are perfect for replacement work because they are designed to

provide quality performance in all makes and models of sets.

Independent Raytheon Tube Distributors from coast to coast are as near as your phone — ready to fill your tube needs — eager to supply you with the hundreds of shop and sales aids Raytheon makes available to you to help make your job easier, more efficient and more profitable.

You win all ways when you ask your Raytheon Tube Distributor for Raytheon TV and Radio Tubes — the tubes that are Right . . . for Sound and Sight!



RAYTHEON MANUFACTURING COMPANY

Receiving and Cathode Ray Tube Operations

NEWTON 58, MASS. 55 Chapel Street
CHICAGO, ILL. 9501 Grand Ave. (Franklin Park)
ATLANTA 6, GA. 1150 Zonolite Rd. N.E.
LOS ANGELES 7, CALIF. 2419 So. Grand Ave.

Raytheon makes all these } Receiving and Picture Tubes, Reliable Subminiature and Miniature Tubes, Semiconductor Diodes and Transistors, Nucleonic Tubes, Microwave Tubes.



**Replace
with the
TV
manufacturers'
choice...**



- Easy pigtail installation
- Hermetically sealed
- No pressure contacts used
- No heat sinks required

**AUTOMATIC PT5
SILICON
RECTIFIER**

General Instrument Distributor Division
RADIO RECEPTOR COMPANY, INC.
Subsidiary of General Instrument Corporation
240 Wythe Avenue, Brooklyn 11, N. Y. EVergreen 8-6000



This electrolytic capacitor serves mainly to decouple the vertical output stage from the B+ boost line. The original unit was probably just defective enough to allow a spurious signal to appear across it at a 60-cps rate. Such a signal, when fed back to the horizontal output circuit by way of the boost line, would probably account for the jitter you observed. Congratulations on making full use of your capacitor checker. A thorough test appears to have paid off in this case.

Bad Horizontal Drive

A DuMont Chassis RA-340 had sound but no picture, and the plate of the 6CD6 horizontal output tube was red hot. When I advanced the horizontal drive control, the picture came in. Everything returned to normal except that a drive bar appeared near the center of the screen. The customer noticed this and called me back to remove it; however, I could not do so without bringing back the original trouble. I wonder if the control might be bad, or if there might be some other trouble with the circuit?

MICHAEL J. SHIVEY, JR.

Cleveland, Ohio

Since you are unable to get a strong enough drive signal without distortion, something is apparently wrong with the second section of the horizontal multivibrator or the coupling circuit between the multivibrator and output stages. There might possibly be open spots in the drive control, but I would sooner suspect trouble in some other component. Here are a couple of other possible defects:

1. The second section of the multivibrator tube could be too weak to supply a normal drive signal.
2. C99 could be leaky, thereby reducing the plate voltage at pin 1 of the multivibrator tube and thus reducing output signal amplitude.

If you can find no defects in the multivibrator plate circuit, check the grid and screen circuits of the output tube for possible troubles.

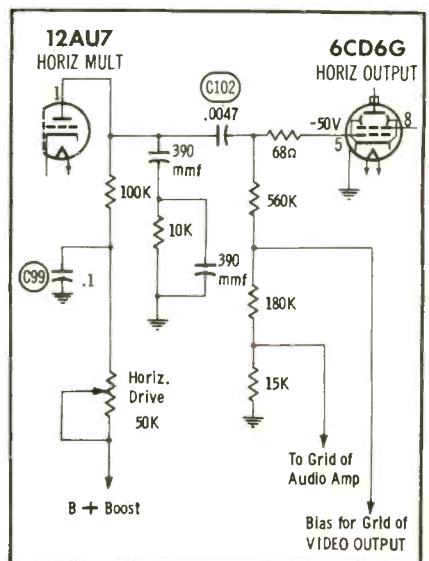

Police Radio Interference

The local State Highway Patrol radio station interferes with reception on a Motorola Model 21K53MA. Each time a call is sent out, the TV sound is distorted and the picture tears. Both local stations (Channels 7 and 9) are affected by this interference. Frequency of the Patrol transmitter is 42.62 mc.

I. C. WYATT

New Bern, N. C.

Since the interference falls right in the video IF band, it'll be fairly tough to get rid of without seriously reducing picture fidelity. About all you can do is to trap out as much of the interfering signal as possible. You might first install a high-pass filter between the antenna and the terminals on the tuner. If the interference is still objectionable, you might try installing an extra 41.25-mc sound trap (or another unit with very high Q) and retune it to exactly 42.62 mc. A series resonant circuit from the grid of the first IF to ground might do the trick, but if it doesn't give good results in this location, you might try moving it to one of the other IF grid circuits. More than one trap might be needed.

By keeping the Q of the trap extremely high, you will minimize the loss of video information. Fortunately, the portion of the IF band in the vicinity of 42.62 mc corresponds to the higher video frequencies; this means that adding the extra trap should not cause picture degradation other than the loss of a certain amount of fine detail.

Wobbly Dots

I have an RCA WR-36A white dot generator and an Admiral C322C2 color TV. When I try to perform convergence with any of the four patterns provided by the generator, the pattern wobbles in time with vertical retrace lines that run up or down on the screen. The lines can be temporarily stopped by adjusting the hold control on the TV or the vertical bar control on the generator, but they cannot be held stationary. They are very bothersome in most convergence work because their speed and direction of motion is constantly changing. How can they be eliminated or controlled?

L. U. KING, JR.

Corning, Ark.

This generator provides two methods of synchronizing the pattern with the TV receiver's sweep oscillators. In the "Line" position of the sync switch, synchronization depends on power line frequency. The vertical hold control of the receiver must usually be adjusted in order to lock in the pattern. If stable sync cannot be achieved by this method, try placing the sync switch in the "External" position and feeding sync pulses from the TV set to the generator. The latter method, which is more positive-acting, is easy to use by following the explicit directions given in the instruction manual.



RCA WV-98A Senior VoltOhmyst...time-proved performance, "workhorse" of the VoltOhmyst line. Improved circuitry provides faster, more accurate servicing. Large, wide-vision meter (6½" w) with easiest-to-read scales ever designed into a VTVM. Features: direct peak-to-peak readings of complex waveforms, accuracy of ±3% full scale on both ac and dc voltage measurements. Complete with sturdy, single-unit WG-299C DC/AC Ohms Probe and Cable, ground cable, alligator clip, insulator clip, instruction booklet. \$79.50*.

RCA WV-77C Junior VoltOhmyst...value plus efficiency! Designed to check avc, oscillator and other high-impedance circuits as well as audio and rf circuits. Five ranges each for dc and ac voltage and resistance measurements. Sturdy, 200-microampere meter movement electronically protected against burnout on all functions. Complete with WG-299C DC/AC Ohms Probe and Cable, ground cable, alligator clip, insulator clip, instruction booklet. \$59.50.

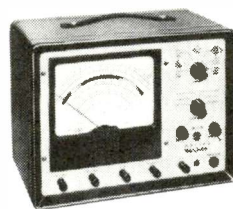

RCA WV-87B Master VoltOhmyst...features a 7½-inch meter with mirror-backed scale. Its easy-to-read peak-to-peak voltage scales are particularly useful for TV, radar, and other types of pulse work. Current ranges from 0.01 ma to 15 amperes. Complete with WG-299C DC/AC Ohms Probe and Cable, current cable, ground cable, alligator clip, instruction booklet. \$137.50*.

the most important shop instrument you can own...

RCA VoltOhmyst®

A VTVM is the most valuable, most used instrument in any radio and TV service shop. When you buy one it is practically a lifetime investment. You'll find RCA VoltOhmysts first choice among wise servicemen. Factory calibrated and factory-guaranteed, RCA VoltOhmysts are your assurance of lasting accuracy and dependability...dollar for dollar, the very finest made!



RCA WV-74A High-Sensitivity AC VTVM...this ALL NEW AC vacuum-tube voltmeter is equipped with a large (7-inch) meter, features wide frequency response (within ½ db from 20 cps to 500 kc) and high sensitivity (10 mv rms full scale). Built-in amplifier with gain of approximately 38 db and output impedance of 400 ohms can be used as a preamplifier for numerous applications. Complete with low-capacitance probe having input resistance and capacitance of 10 megohms and 13 µf. \$99.50*.

CHOOSE THE VoltOhmyst THAT SUITS YOUR NEEDS

Features	Master VoltOhmyst WV-87B	Senior VoltOhmyst WV-98A	Junior VoltOhmyst WV-77C
Measurements:			
Voltage:			
DC	0.02 to 1500V	0.02 to 1500V	0.05 to 1200V
AC (rms)	0.1 to 1500V	0.1 to 1500V	0.1 to 1200V
AC (peak-to-peak)	0.2 to 4200V	0.2 to 4200V	—
Resistance	0 to 1000 meg.	0 to 1000 meg.	0 to 1000 meg.
Current	10 µa to 15 amp.	—	—
Accuracy (full scale):			
Voltage:			
DC (+)	±3%	±3%	±3%
DC (-)	±3%	±3%	±5%
AC	±3%	±3%	±5%
Current	±3%	—	—

*User Price (optional)



AT YOUR LOCAL RCA DISTRIBUTOR'S!

RADIO CORPORATION OF AMERICA
Electron Tube Division
Harrison, N. J.



QUICKER SERVICING

By Calvin C. Young, Jr.

New-Type CRT

A recently-introduced picture tube design that features low-voltage operation of grid number two (low Eg2) can be a source of trouble to the serviceman who encounters one without warning. As of June, 1958, there were seventeen low-Eg2 tubes registered with EIA, including five 14" types, six 17" types, four 21" types, and two 24" types. All of these units feature 90° deflection, 12L basing configuration, and low-voltage electrostatic focusing. Six of them are designed to operate with a potential difference of 110 volts between G1 and G2—the others with only 50 volts difference. Referring to EIA basing diagram 12L in Fig. 1, note that G1 and G2 as mentioned here are the control grid (pin 2) and accelerator grid (pin 10), respectively.

After mentioning some of the major reasons for the development of this tube, we will examine in detail the principles that make this type of operation possible. Recently, there has been some discussion of picture tubes which can be driven directly by the video detector circuit, completely eliminating the need for a video output stage. That there has

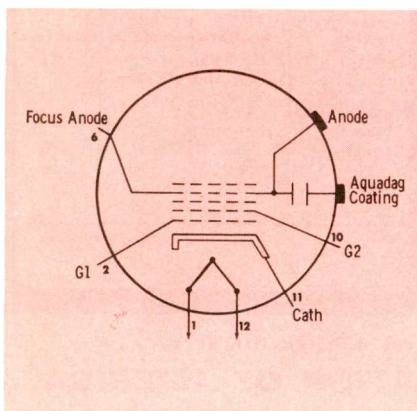

Fig. 1. EIA picture tube basing configuration 12L applies to low-Eg2 types.

been progress in this direction is borne out by the introduction of the low-Eg2 tube, because it requires less video drive to achieve the same contrast ratio produced by earlier tubes operating with 300 volts or more on G2. This means that it is now possible to obtain a higher contrast with the same video drive, or the same contrast ratio with less drive, a very important consideration for portable TV receivers having contrast ratios which leave something to be desired. Another important feature is that G2 can be powered directly from the low voltage supply, even in a set that employs a half-wave power supply having a maximum DC output of only 125 to 135 volts.

With these advantages in mind, let's see how the low-Eg2 tube operates. In theory, it can be compared to a pentode receiving tube, where plate current is relatively independent of plate voltage as long as it exceeds the screen voltage. Plate current is a direct function of screen and bias voltages, the latter having the greater effect.

In a picture tube, G2 can be compared to the screen grid of a pentode and the ultor anode to the plate. The additional focusing and acceler-

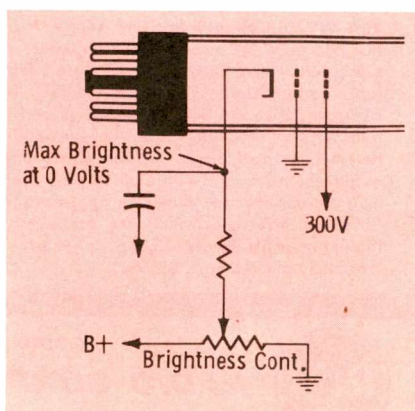

Fig. 2. Basic CRT circuit showing bias arrangement for maximum brightness.

ating anodes used in the gun structure do not affect this comparison since their function is to concentrate the electrons into a narrow, rapidly-moving beam.

Having established the mode of operation, let's proceed to see how the low-Eg2 tube applies these principles. Consult the schematic of a basic picture tube gun structure in Fig. 2 and note that for a standard CRT, the first anode (G2) operates at about 300 VDC, the control grid at ground potential (OV), and the cathode receives the video driving signal. In addition, the brightness control is connected into the cathode circuit to provide variable bias. The video driving signal (for cathode drive) is positive-going, and maximum brightness is obtained when the cathode voltage equals the control grid voltage. In this configuration, the positive-going video signal increases instantaneous bias and causes a corresponding change in the instantaneous brightness level. Because the setting of the brightness control determines the fixed bias on the picture tube, maximum illumination is a function of the brightness-control setting when all other voltages remain unchanged. Maximum contrast, however, is a function of the amplitude of the video drive signal, increasing in more or less direct proportion until saturation and cutoff levels are reached. To summarize, we can say that maximum usable brightness and contrast levels are obtained when the DC bias is such that the video blanking pedestal causes raster cutoff and maximum white produces a condition of zero bias.

Looking at a tube manual, we find that raster cutoff for a 14NP4 occurs between 33 and 77 volts, while cutoff for the equivalent low-Eg2 tube (a 14AEP4) is obtained somewhere between 37 and 55 volts. If these tubes are operated at their recommended G2 values of 300 and 110 volts respectively, and are cathode driven, the video drive requirements for raster cutoff are 48 and 42 volts, respectively. From this comparison alone, it can be seen that the low-Eg2 tube type requires less video drive to produce the same contrast ratio.

To understand how this increase in efficiency is possible, let's examine the basic circuits of the two tubes

Sylvania comparisons point out—

The big difference in Picture Tubes!

Here's the inside story on why local "off-brands" don't measure up to Silver Screen 85® standards

If you're like most dealers, you know off-brand tubes don't have the same quality standards as first-line tubes. To help you see how big the difference is, Sylvania purchased a nationwide sample of sixty 21YP4A's made by 19 different local tube makers. These tubes were put through the same production tests that all Sylvania tubes must pass.

Not a single local off-brand passed all 54 mechanical and electrical tests! Many of these were minor defects making little or no difference in whether or not the tube "lit up." But look how loose manufacturing controls can affect the important features of light output, focus, and life!

LIGHT OUTPUT

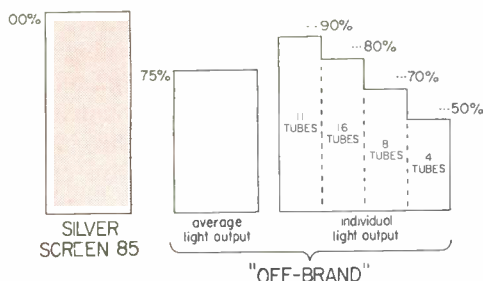

So far, 39 off-brand tubes have been compared with the *minimum* light output of Silver Screen 85. Five additional tubes couldn't even be tested. Eleven tubes were less than 90% as bright as the minimum for Silver Screen 85; 16 were less than 80%; 8 were less than 70%; and 4 were *less than 50%* as bright. Since most Silver Screen 85 tubes average as much as 125% of minimum standards, the difference becomes even greater. Small wonder that Silver Screen 85 is the easy way to more satisfied customers.

FOCUS

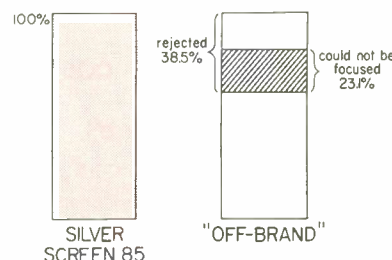
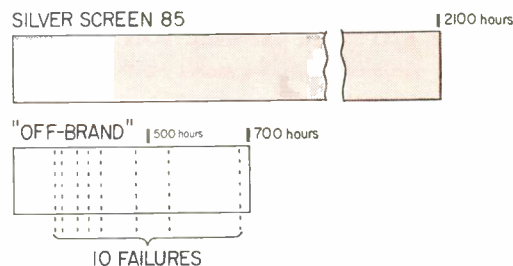

Chart 2 shows how these same 39 tubes stacked up to registered limits on focus voltage. 38.5% were rejected under these limits. Over half of all those rejected could not be focused in a TV receiver. Small wonder then that "Silver Screen 85" pictures are sharper, brighter, clearer.

LIFE TEST



Nineteen off-brand tubes were placed on Sylvania's standard 2000-hour life test. Chart 3 tells you how fast these tubes developed slow-heating cathodes. Over half, or ten units, failed to go beyond the 700-hour mark. Small wonder then that Silver Screen 85 gives you less troublesome callbacks.

Of all the off-brand tubes tested, Sylvania engineers estimate that 43% probably would not have operated properly in a TV set. Why gamble your reputation, customer satisfaction, and success. It's just *good business* to sell up to "first line" picture tubes; Silver Screen 85 picture tubes.



SYLVANIA

SYLVANIA ELECTRIC PRODUCTS INC.
1740 Broadway, New York 19, N. Y.
In Canada: Sylvania Electric (Canada) Ltd.
University Tower Bldg., Montreal

Add **ELECTROSTATIC PICK-UP**
TO **YOUR SCOPE**



MODEL PO-1

ONLY \$197.50

WITH THIS **NEW** LOW COST
KINGSTON
ABSORPTION ANALYZER

If you are one of the thousands who wish they had seen a Kingston Absorption Analyzer before buying a scope... this is for YOU! This NEW Kingston Model PO-1 coupled with your scope gives you all the features of the Kingston Model VS-5 except portability. With its "magic" electrostatic pick-up you can trace signals in any equipment having wave-forms, without any physical connection... without loading the circuit under test. The tuned circuits and preamplifier of the PO-1 increase the sensitivity of your scope 10 to 100 times, depending on the circuit tested.

CHECK TV FROM TOP-SIDE WITHOUT PHYSICAL CONNECTION

With your own oscilloscope, the Model PO-1 speeds TV checking by making every tube a reference point from which wave-forms may be displayed on the scope.

FOR SOUND and COMMUNICATION EQUIPMENT

Without a scope, the Model PO-1 speeds and simplifies trouble-shooting of all kinds of audio equipment including Hi-Fi, tube and transistor radios, record players, tape recorders, communication equipment and public address systems. And you can hear the audio at each check point.

NEW — KINGSTON PULSE GENERATOR \$29.95



Designed to be used with the Kingston Absorption Analyzer for easily locating open

filaments in series string receivers. Injects signal into receiver through line cord receptacle, which may be electrostatically traced to the defective stage.

Write today for Catalog

KINGSTON
ELECTRONIC CORPORATION
MEDFIELD, MASSACHUSETTS, U.S.A.

as shown in Fig. 3. In both A and B you will notice that the video drive signal is 42 volts. (This value was used for comparison purposes since the 48-volt signal required by the 14NP4 would be excessive for the 14AEP4 tube.) If we assume that a bias of 10 volts is required to achieve optimum video drive, the potential on the cathode will increase by 32 volts with the presence of the blanking pulse. For the 14NP4, this means that the cathode will be, at that instant, 32 volts closer to G2, or that the difference between cathode and G2 will be reduced from 290 volts to 258 volts.

Now if we consider the other case, where the grid has a potential of 25 volts and the cathode 35 volts (again providing a 10-volt bias), we have a difference of 100 volts between the cathode and G2. With 42 volts of video drive, application of the blanking pulse will reduce the voltage between cathode and G2 to 68 volts. It can be further seen that the change from 100 to 68 volts is greater percentage-wise than the change from 290 to 258, even though the change was 32 volts in both cases. Viewed in this light, the increased efficiency (reduced video drive required for same contrast ratio) is easily understood. Low-Eg2 operation is possible because of the improved electron gun assembly. We say improved rather than new because the electron gun used in low-Eg2 tubes has the same general configuration as the standard picture tube.

What This Means to Technician

Aside from the improved performance features of low-Eg2 tubes, there are at least two other associated factors that will be of interest and concern to you. First and foremost is testing of the new tube. Naturally, you wouldn't expect to test it with 300 volts on G2. (The absolute maximum voltage rating between G2 and G1 on the 14AEP4 is 220 volts and is as low as 68 volts on some tubes in this same general class.) However, as one might suspect, with certain modifications to the test setup procedure, existing CRT testers can be employed. At least one manufacturer of test equipment, when contacted about this, revealed that revised instructions on

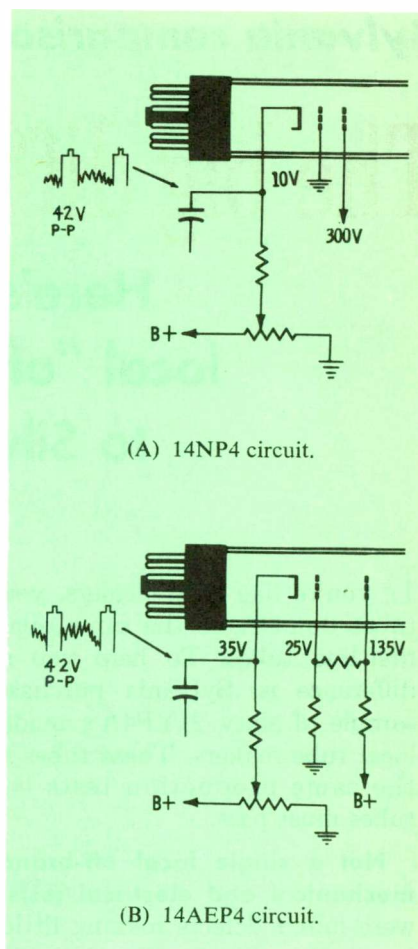

Fig. 3. Comparison of bias arrangements, standard and low-Eg2 circuits.

testing low-Eg2 tubes were being sent to owners of their brand CRT tester. However, the instructions carried a warning to the effect that testing low-Eg2 tubes in any but the prescribed manner could ruin the tube. With this in mind, it is suggested that you contact the manufacturer of your test instrument for instructions on testing these new type tubes. Further, do not test these tubes until you have received instructions, studied them, and are absolutely sure you understand just what to do.

Also of interest is the fact that the new tube will replace its standard equivalent with only minor circuit changes. If a receiver circuit includes cathode drive and a cathode brightness control, the low-Eg2 tube can be installed by simply changing the voltage on G2 to the correct level. Fig. 4 is a basic circuit diagram of a low-EG2 tube. Note that the control grid is operated at a positive potential derived from the same resistive voltage-divider network which supplies G2. This is done be-

cause the potential difference between G1 and G2 must remain fixed. Notice also that a vertical-retrace blanking signal is coupled into the control grid circuit. The pulse must be negative-going and have an amplitude of about 80V p-p.

For the signal condition shown, 50V p-p, the picture tube is being operated with 10 volts of bias between the cathode and the control grid. This is necessary to prevent excessive contrast, and indicates that a 40V p-p signal would, in all likelihood, produce adequate contrast.

It should also be apparent from Fig. 4 that the values of R40, R41, and R42 are such that they carry a current of about 1 ma (270 volts across 263,000 ohms produces .975 ma). This means that if you make a similar resistor choice, the voltage drop can be determined without effort. For instance, if your power supply produces 135 volts and you need 50 volts between G1 and G2, use a total of 135,000 ohms for the three resistors and values of 25K for R40, 50K for R41, and 60K for R42. You may want to select the nearest EIA standard values — say 22K, 56K, and 56K, respectively. The same principle can be applied to any supply voltage; however, do not supply this network from B+ boost.

Magnetize or Demagnetize Tool Instantly

The Perma-Power "Magneformer" (Fig. 5) should be a boon to the service shop. Tools become magnetized when removing or installing permanent-magnet focus assemblies

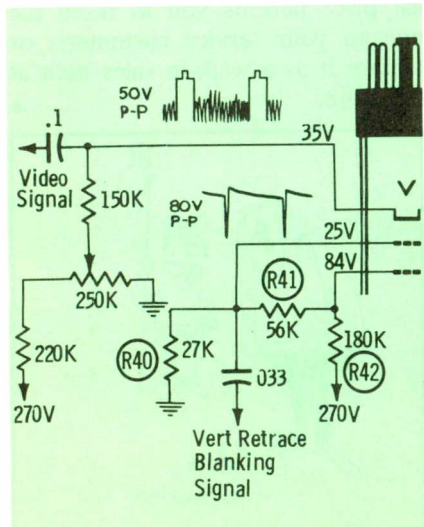

Fig. 4. Practical voltage-divider circuit for low-Eg2 operation of picture tube.



"HE'S BEEN THAT WAY EVER SINCE YOU PUT IN THAT WEBSTER STEREO CARTRIDGE."

The new stereo records will turn *your* customers' heads too, when you install a new Webster Stereo-Ceramic cartridge. It not only plays the new stereo discs, but standard LP's and those treasured 78's as well... all with exceptional fidelity. One universal mounting bracket fits any standard arm. And it's easy to install — never a call back. New stereo discs are being released daily. Be prepared — see your jobber.

REPLACE WITH WEBSTER... IT PAYS!

stereo-ceramic ...



SC-TD Stereo turn-under — with .7 mil diamond and 3 mil sapphire styli. \$29.50*



SC-1D Stereo single needle — with .7 mil diamond stylus. \$24.50*



MC-1 78 rpm single needle — with 3 mil sapphire stylus. \$7.50*

* List prices — standard discounts apply.

ELECTRONICS DIVISION

WEBSTER ELECTRIC



RACINE · WIS

franklin adv. Y-128



For my Money
XCELITE Tools are
 the Finest!

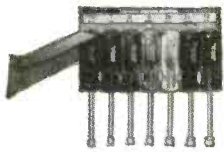

... Superbly made and designed for Radio, T.V. and Electronic Technicians. See your Distributor ... only one quality ... the finest — whether you choose individual items or the handy kits ...

Use the Tools the Professionals use!

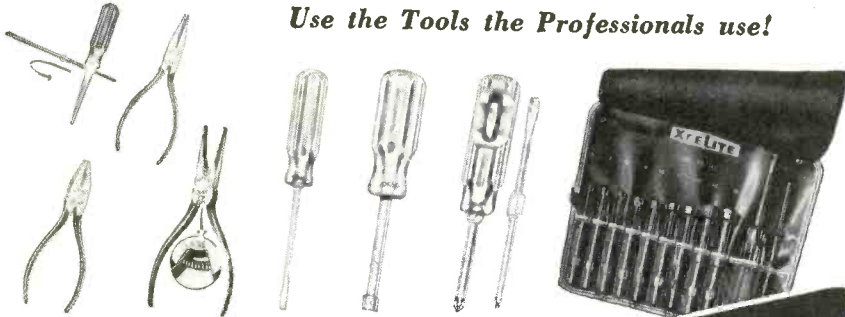

XCELITE, INCORPORATED
 ORCHARD PARK, NEW YORK
 Canada: Charles W. Pointon, Ltd., Toronto

XCELITE
Quality Hand Tools
 PREFERRED BY THE EXPERTS

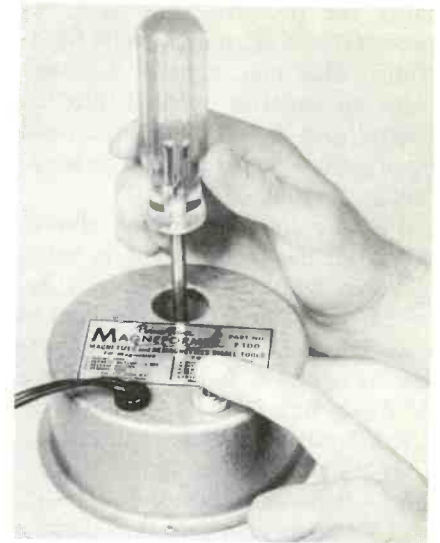

Fig. 5. "Magneformer" can be used to magnetize or demagnetize hand tools.

and are then forever sticking together or collecting small metal filings, washers, screws, nuts and other such items. At other times, it is desirable to have a magnetized screwdriver or nut driver to hold a screw or nut in starting position.

To magnetize a tool, you simply insert it into the unit as shown in Fig. 5 and depress the button for 10 seconds or longer. After releasing the button, the magnetized tool can be removed. To demagnetize a tool, the button is depressed first, and the tool is inserted and removed slowly. The button can be released when the tool is well away from the unit.

The "Magneformer" can be left plugged into the AC line because it consumes current only when the button is depressed. Price of the Model F-100 is \$4.50 to servicemen at electronic parts distributors. A \$7.50 list price permits you to resell the unit to your service customers, or feature it as a walk-in sales item at the store. ▲

WRIGHT WIRE STRAND PERFORMS LIKE A KING AND IS NON-SNARLING



Wright TV Guy Wire Strand is your guard against irritating snarls. Each concentric coil measures two feet. You save money in guying antennas. Greater flexibility, heavily galvanized continuous connected coils. Prompt delivery from stocks in Worcester, Chicago, New Orleans, Dallas, Los Angeles, San Francisco and Portland, Oregon.

Non-Snarling Pre-Measured Wire Strand Sold only through Wholesale Distributors.

G. F. WRIGHT STEEL & WIRE CO.
 235 Stafford St. Worcester, Mass.



"I should have stayed at the shop and fixed that sync circuit."

FREE from HOWARD W. SAMS!...valuable all-steel file cabinets with your purchase of **PHOTOFACT**—the world's finest TV-Radio Service Data



FREE! FOR REGULAR PHOTOFACT SUBSCRIBERS

You get your File Cabinets FREE if you are a regular subscriber to PHOTOFACT Folders and buy all new Sets as issued each month. Your Folders come to you in special envelopes, each including a "Bonus Certificate." Sixty (60) of these entitle you to a single-drawer File Cabinet ABSOLUTELY FREE...



FREE! FOR PHOTOFACT LIBRARY PURCHASERS

Get FREE File Cabinets as you complete your profit-building PHOTOFACT Library... here's how:

FREE!

Single-Drawer File Cabinet with your purchase of 60 Sets of PHOTOFACT Folders. Cabinet Worth... \$895



FREE!

Two single-drawer File Cabinets with your purchase of 120 Sets of PHOTOFACT Folders. Cabinets Worth... \$1790



FREE!

Three single-drawer File Cabinets with your purchase of 180 Sets of PHOTOFACT Folders. Cabinets Worth... \$2685



FREE!

Four single-drawer File Cabinets with your purchase of 240 Sets of PHOTOFACT Folders. Cabinets Worth... \$3580



NEW EASY-BUY PLAN

It's easy to complete your present PHOTOFACT Library or start a PHOTOFACT Library. Use the EASY-BUY PURCHASE PLAN:

- NO INTEREST
- NO CARRYING CHARGE
- AS LITTLE AS \$10 DOWN
- UP TO 24 MONTHS TO PAY

Get the world's finest TV-Radio Service Data... get FREE File Cabinets with your PHOTOFACT purchases...take advantage of the Easy-Buy Plan. See your Sams Distributor today, or write to Howard W. Sams for full details.

get the full details of the HOWARD W. SAMS money-saving way to build your complete profit-making PHOTOFACT Library!

HOWARD W. SAMS & CO., INC.
2201 E. 46th St., Indianapolis 5, Indiana



Send details on your FREE File Cabinet offer and EASY-BUY Plan.

I'm a Service Technician: full time; part time

My Distributor is: _____

Shop Name: _____

Attn.: _____

Address: _____

City _____ Zone _____ State _____

servicing the summer AIR-CONDITIONER

Maintenance Data for Radio-TV Servicemen by Joseph Derman

Summer air improvement, both in the home and in public places, has almost become a necessity. The TV set owner may already have an air-conditioner, or if not, is very likely considering the purchase of one. Shopping centers, movies, offices, and other such areas are employing air-conditioning equipment at an ever-increasing rate. Since the popularity of air-conditioners during the warm season naturally complements other types of service during the balance of the year, the electronic service technician would do well to weigh the possibilities of servicing air-conditioning equipment. This article will familiarize the reader with air-conditioners based on the principles of mechanical refrigeration, and will then examine some major troubleshooting and testing techniques.

Mechanical refrigeration is basically the same process, whether applied to the air-conditioner, the household refrigerator, the freezer, or any other kind of cooling device. It can be defined as the controlled evaporation and condensation of a suitable liquid (refrigerant) in a properly designed system.

We are all familiar with the cooling effect developed by the evaporation of a drop of alcohol from the skin. In normally encountered temperatures and pressures, alcohol will evaporate and become a gas, thereby causing an amount of heat energy to be expended. Since, in this case, the skin provides the required energy, it becomes cool.

The air-conditioning unit (Fig. 1) accomplishes cooling in much the same way. A measured amount of a special liquid is permitted to evaporate,

thus extracting heat from the space to be conditioned. The component in which this actually takes place—the evaporator—resembles the radiator of an automobile. It is composed of a system of copper tubing equipped with fins to provide a large area of contact between the evaporating liquid in the tubing and the surrounding air. A blower brings room air into the air-conditioner to aid in the evaporation process and thus cool an increased quantity of air.

For obvious reasons, it is desirable to reuse the refrigerant liquid. The air-conditioner does this as shown in Fig. 2. The evaporated liquid (gas) from the evaporator is drawn into the compressor where it is compressed in order to raise its temperature. In this condition of elevated temperature and high pres-

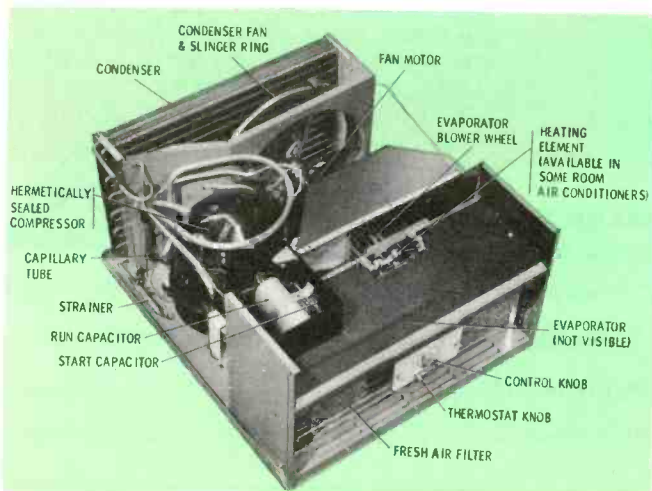

Fig. 1. Component layout in typical window air-conditioner.

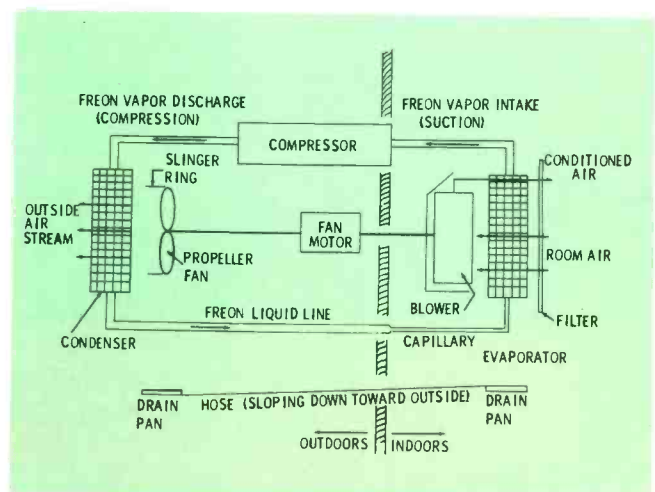
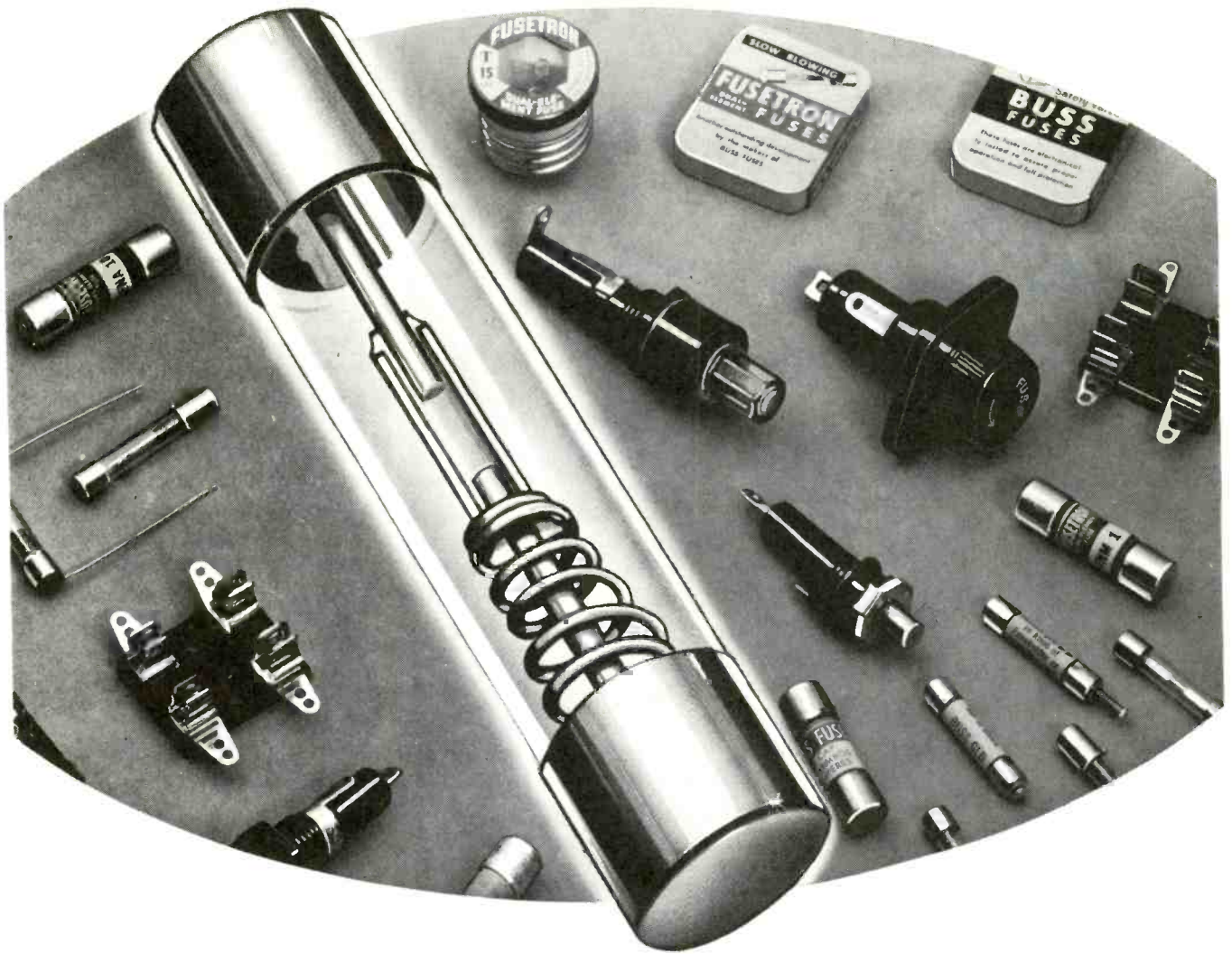

Fig. 2. Block diagram of air streams and refrigerant system.



Save Time and Trouble by Standardizing on BUSS Fuses

YOU'LL FIND THE RIGHT FUSE EVERYTIME . . . IN THE COMPLETE BUSS LINE

By using BUSS as your source for fuses, you can quickly and easily find the type and size fuse you need. The complete BUSS line of fuses includes: single-element (both quick blowing and for normal circuit protection) and dual-element (slow blowing) types . . . in sizes from 1/500 amp. up — plus a companion line of fuse clips, blocks and holders.

BUSS TRADEMARK

IS YOUR ASSURANCE OF FUSES OF UNQUESTIONED HIGH QUALITY

Over the past 43 years, millions upon millions of BUSS fuses have operated properly under all service conditions.

Thus, BUSS fuses have earned a reputation for accurate and dependable electrical protection.

To make sure this high standard of dependability is maintained . . . BUSS fuses are tested in a sensitive electronic device. Any fuse not correctly calibrated, properly constructed and right in all physical dimensions is automatically rejected.

LET BUSS FUSES HELP PROTECT YOUR PROFITS . . . The dependability of BUSS fuses helps you avoid 'kicks' and complaints that the fuses you sold or

installed failed to protect or blew needlessly. This safeguards you against costly adjustments and 'call-backs'. It pays to refuse to take a chance with anything less than BUSS quality in fuses.

For more information on BUSS and FUSETRON Small Dimension fuses and fuseholders . . . Write for bulletin SFB.

Bussmann Mfg. Division McGraw-Edison Co., University at Jefferson, St. Louis 7, Mo.

BUSS fuses are made to protect — not to blow, needlessly



BUSS MAKES A COMPLETE LINE OF FUSES FOR HOME, FARM, COMMERCIAL, ELECTRONIC, AUTOMOTIVE AND INDUSTRIAL USE.

CORNELL-DUBILIER VIBRATORS



Built to last... a type for every radio

The C-D brand name on a vibrator is your guarantee of dependable performance, long trouble-free service. Because C-D vibrators are built to last, you can use them with full confidence. That's why it pays to reach for a C-D when a replacement is called for.

Remember, too, that there's a C-D vibrator type for every make and model car on the road. And the C-D VIBRATOR REPLACEMENT GUIDE makes it quick and easy for you to select the exact type required. Ask your local C-D distributor for a free copy of VIB-3, or write to Cornell-Dubilier Electric Corp., South Plainfield, N. J. Dept. PR 88



CORNELL-DUBILIER VIBRATORS

Old Hands at Dependability

sure, the gas is forced into the condenser which is located outside the conditioned space. The construction of the condenser is similar to that of the evaporator and facilitates another heat transfer. The heat of the compressed gas is liberated to the outdoor air, causing the gas to liquefy. The liquid is now ready to start another cycle of evaporation, compression and condensation. To control the rate of entry of the refrigerant into the evaporator, most manufacturers of window units use a capillary tube comprised of a few feet of small-bore copper tubing, in series with the refrigerant circuit.

The air streams (both inside and outside the room) contribute to the efficiency of the refrigerating process. The blower pulls room air through the filter as well as through the evaporator and then directs it back into the room. Since the filter removes dust, pollen, etc., the air is cleaned in addition to being cooled. Dehumidification, or the removal of moisture from the air, also occurs at the evaporator because air supports less moisture as it cools. The moisture that condenses out of the evaporator fins and tubing is collected and piped from a pan under the evaporator to another pan beneath the condenser fan.

Removal of moisture from the room being conditioned is important because the body cannot dispose of its perspiration readily in an atmosphere of high humidity. Evaporation of perspiration (and consequent body cooling) increases as moisture in the atmosphere decreases.

The function of the propeller fan is to bring outdoor air through the condenser in order to cool it and thereby aid in the condensation of the refrigerant. To increase the effectiveness of the condensing action, most manufacturers make use of the condensate (water) that is collected at the evaporator. This is usually done by equipping the propeller fan with a lip at the tips of the fan blades. As the fan rotates, this "slinger ring" scoops up the condensate and sprays it against the condenser to aid in cooling the fins and tubing.

The evaporator, compressor, condenser and capillary tube constitute a hermetically-sealed system. An accurately-measured amount of re-

CORNELL-DUBILIER CAPACITORS

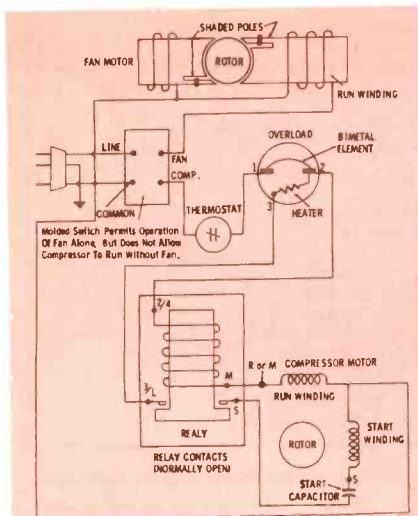

Fig. 3. Basic schematic of air-conditioner with thermostat, element overload, current relay, and shaded-pole fan motor.

frigerant, usually *Freon*, flows through this system and undergoes the changes in states described. Because the Freon circuit must be kept absolutely free of impurities, including moisture, repairs to this system must be performed in a specifically prescribed manner, preferably in a shop equipped to handle this type of service. Further considerations are beyond the scope of this article.

The other major portion or division of the air-conditioner is the electrical system, which includes the motors and the control elements. Modern air-conditioners use induction motors to drive both the compressor and the fans. This type of motor is widely used for alternating current applications because it is rugged and simple in construction.

In the induction motor, AC power is applied to the stator or stationary windings. The rotor, or moving element, is set into motion by the rotating magnetic field set up around the stator. When used on single-phase power such as is available in most dwellings, the induction motor requires special starting circuits.

A shaded-pole motor is employed as a fan motor in some air-conditioners. As can be seen in Fig. 3, a single, closed-turn of cooper (called a shading winding) is embedded in each pole of the stator. Power is applied to the main or run winding, and the rotor is set into motion by the rotary torque created by the phase difference between the magnetic fields of the main winding and the shaded pole. At rated speed, the



The extra values are "on the house"

Want more capacitor for your dollar? Here's how:

Cornell-Dubilier has originated a "preferred-type" program on twist-prong electrolytics. Now, a relatively few types fill over 90% of all replacement requirements. You need less — to do more. Fewer types means improved production efficiency, lowered costs — savings to you. How is it done? Instead of producing hundreds of types with odd and critical capacitance and voltage ratings, each "preferred type" carries the *highest* value and rating called for in each category. In most cases you get *more* capacitor *at lower cost* — plus added safety factor, improved performance and "call-back" protection. It's on the house! To get more capacitor for *your* dollar, ask your C-D Distributor about *Preferred Type* Twist-Prong Electrolytics or write Cornell-Dubilier Electric Corporation, South Plainfield, New Jersey.



CORNELL-DUBILIER CAPACITORS

Consistently Dependable



America's Fastest-Growing
Service Capacitor Line...



NEW!

TOBE MYLAR* MOLDED TUBULAR CAPACITORS

- *Molded of DuPont Mylar*, one of the finest insulation materials ever developed.
- *Thermoset Case Construction* secures leads and sections firmly to withstand extremes of handling, vibration, shock and soldering temperatures.
- *High Insulation Resistance*: Average megohm values per unit 10,000 at 25°C. Small capacitance variation with thermal change.
- *Temperature Operating Range*: -55° to +130°C.
- *Moisture Resistant*: Exceeds JAN-C-91 requirements.
- *Non-Inductive*: Extended foil construction insures low resistance connections and low RF impedance.

DESIGNED FOR SERVICE DEALERS

NEW TOBE MYLAR* CAPACITOR KIT

FREE KIT CONTAINS
80 CAPACITORS

ONLY

\$15⁸⁴



Compact, clear-plastic dispenser contains an assortment of 80 Tobe Mylar capacitors in the most popular sizes, ratings and quantities for quick, efficient servicing. Covers over 60 different ratings at 200, 400 and 600 working volts and from .0001 to 1.00 mfd. Dealer pays only for the Tobe Mylar capacitors, kit is free.

Today, order
your Tobe Mylar
Kit from your
Tobe Distributor



TOBE
RADIART
CAPACITORS

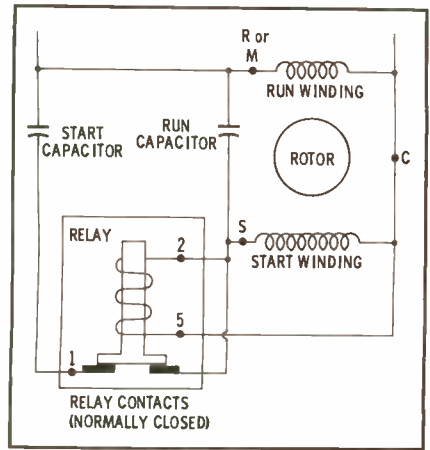

Fig. 4. Start-capacitor contacts will open when motor comes up to rated speed.

shading winding becomes ineffective and the main winding alone is sufficient to maintain rotation. A single-speed fan motor will have one stator winding; two-speed fans require two stator windings.

Considerably greater motor torque is required to operate the compressor than can be developed by the shaded-pole type of motor; consequently, an induction motor of the capacitor-start type is generally found in a motor-compressor system (see Fig. 3). The necessary torque for rotor starting is established by the phase difference between the current in the main winding and that in the start circuit (start winding and start capacitor).

An ohmmeter can easily be used to distinguish one winding from the other. The run winding, which is designed for continuous operation, consists of a relatively-small number of turns of heavy gauge wire; but the start winding, operated only for the short period during starting time, is made up of a larger number of turns of thin gauge wire. The resistance of the start winding, therefore, is generally greater than that of the run winding.

The stator windings (that is, the run and start windings) are an integral part of the sealed motor-compressor unit. Only the terminals — "C" (common) "S" (start), and "R" or "M" (run or main) — are accessible on the outside of the compressor. Both start and run capacitors are external to the compressor. The use of the start capacitor is an improvement over earlier types of induction motors because it provides for greater starting torque. The running capacitor is a recent develop-

*DuPont trademark

TOBE DEUTSCHMANN CORPORATION, NORWOOD, MASSACHUSETTS

ment that helps to improve the power factor of the air-conditioner load.

It is the usual practice for the start circuit to be disconnected as soon as the motor reaches about 85% of rated speed. Disconnect devices used in air-conditioning, called starting relays, are available in either current or voltage types.

In the current relay (Fig. 3), the initial surge of current to the main winding closes the normally-open contacts and inserts the starting circuit. As the speed of the motor increases from stalled (stationary) position to rated speed, current to the motor decreases. Then the relay contacts open and disconnect the start circuit. The run winding alone is sufficient for continued operation of the motor.

The voltage relay (Fig. 4) has contacts that are normally closed, which means that the start circuit is already connected before power is applied to the motor. As the rotor comes up to the normal speed, the relay is energized sufficiently to maintain the contacts in an open position, thus removing the start capacitor from the circuit.

Two control elements found in most air-conditioners are a thermostat and the thermal overload protection device. The thermostat is an automatic switch that turns the compressor on or off to maintain the temperature of the conditioned air within a preselected range. A gas-filled tube, suspended in the return stream of room air, actuates the make-and-break device that controls the operation of the compressor. The fan motor is independent of the thermostat.

The thermal overload is an automatic control designed to protect the compressor motor against excessive current. An important characteristic of induction-motor operation is that the current decreases from the maximum initial current surge to a much lower normal load current. If, for any reason, the motor does not turn over, the current drain will be excessive and the thermal overload will open the compressor circuit. In a short while, however, the overload unit will again permit the motor to go on. Motor operation will then continue normally if the cause of improper motor operation has been removed.

RADIART VIBRATORS



Consistently dependable power

Next time an auto-radio vibrator replacement is called for, try Radiart. There's a complete line for all 6-volt and 12-volt applications. And no waiting for the type you want, because your local Radiart Distributor maintains a full stock for your convenience. Ask him for your free copy of the Radiart Vibrator Replacement Guide, or write to Dept. S-1, The Radiart Corporation, Indianapolis 5, Indiana.



RADIART TOBE Vibrators

Old Hands at Dependability

... another
MALLORY
 service-engineered
 product



Your Distributor Has MALLORY-RMC Discaps® "On File"

Mallory-RMC Discaps, long the standard in original equipment, are now available for service work. These high quality ceramic disc capacitors are "on file" at Mallory Distributors... especially packaged for your convenience.

Discaps are packed 5-of-a-kind on a handy 3"x5" file-card. Knockout panels on the back of the package let you remove one capacitor at a time without disturbing the others or destroying the package.

Mallory-RMC Discaps are made by the world's largest manufacturer of ceramic disc capacitors—are available in popular ratings. You can depend on Discaps for the most critical applications.

Get these from your Mallory Distributor—today.



• Capacitors • Vibrators • Resistors • Controls • Switches • Filters • Rectifiers
 • Power Supplies • Mercury and Zinc-Carbon Batteries

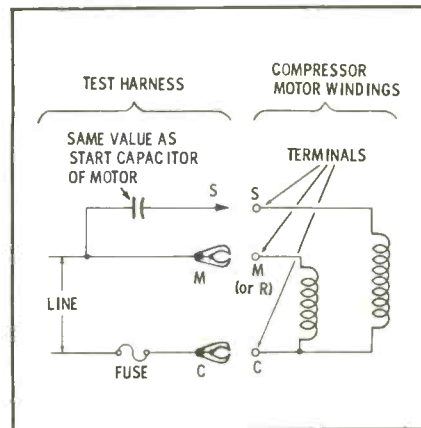

Fig. 5. Compressor-motor test harness includes substitute for start capacitor.

Troubleshooting Problems

When an air-conditioner service problem is being analyzed, the trouble should first be localized to the electrical, refrigeration, or air-circulation system. Then it can be further analyzed in the following manner:

Electrical Section

Symptom: Unit is inoperative because fuse has blown, or fuses blow repeatedly.

Analysis #1: Initial current surge of normally - operating induction motor is great enough to open an ordinary fuse.

Solution: Use a fuse of the thermal-delay type. This type of fuse is designed to pass the initial current surge for induction-motor starting and yet afford protection against a sustained short or current overload.

Analysis #2: Low line voltage at the unit prevents the compressor from starting. Under this condition, excessive current is drawn and even the thermal-delay type of fuse will blow.

Solution: The voltage applied to an induction motor should be within 10% of the rated value. Low line voltage may exist at the unit because of heavy power demand in the community, increased local demand on the same branch circuit for other appliances, or high IR drop between source of power and unit due to inadequate wire size or too great a distance. It is advisable to check the adequacy of available power by measuring the voltage across a 1000-watt resistive load at the outlet to be used by the air-conditioner. If other appliances are overloading the air-conditioner power circuit, they should be removed. Only #12

or larger wire should be used for extension cords when these are necessary.

Analysis #3: The compressor motor does not turn over and therefore draws high current.

Solution: Compressor failure may have many causes such as a defective winding (open or short), a short to chassis, or a defective start capacitor. Use an ohmmeter to check for winding continuity. (The run winding may have a resistance of approximately 3 ohms, while the start winding may have a resistance of approximately 15 ohms.) Test for a short between the compressor terminals (C, S, and M or R) and chassis. There must be no indication of continuity between the terminals and the compressor shell. Check the start capacitor with an ohmmeter. Use an exact replacement, if the capacitor is suspected of being defective.

Occasionally, one may encounter a "stuck" compressor which will not operate because of internal mechanical reasons. It had best be replaced.

Fig. 5 shows a test harness with which to check the compressor motor. To use it, disconnect other components and use a capacitor of correct value required to start the motor. With the "M" and "C" leads already connected, apply the start-capacitor lead for a few seconds only. The motor will start up if it is satisfactory. (Note: The above discussion emphasizes high current drain caused by compressor-motor failures because this motor requires as much as 10 times the rated current of the fan motor.)

Symptom: Compressor motor does not operate at all.

Analysis: Power may not be reaching the compressor, or the compressor may be defective.

Solution: Check voltage at outlet, switch, cord, etc. Use the compressor test harness. There's a possibility that the room temperature is not high enough to close the thermostat contacts. This condition can be verified by advancing the thermostat control so that the unit will "cut in" at a lower temperature, or by shorting across the thermostat with a jumper wire.

The thermal overload also may be defective. Use an ohmmeter to check for continuity across contacts and through the heater element of the

... another
MALLORY
service-engineered
product

MALLORY
Gold Label
VIBRATOR

Sign of a Job Well Done!

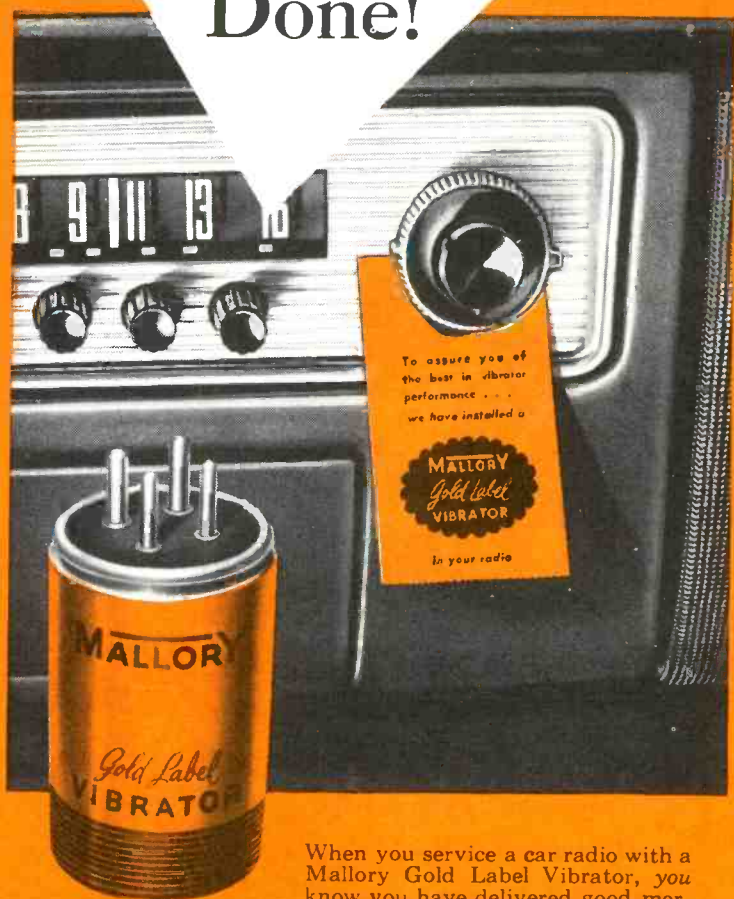

When you service a car radio with a Mallory Gold Label Vibrator, you know you have delivered good merchandise and exercised good judgement. You can remind the customer that his car radio has received this preferred treatment by hanging this attractive gold tag—supplied with each Gold Label Vibrator—on a knob of the radio. It's a reminder to your customer that his set has been serviced with the finest.

This helpful promotion is another good reason to be sure to always ask for Mallory Gold Label Vibrators... the standard of performance. Get them from your Mallory Distributor.

P. R. MALLORY & CO. Inc.
MALLORY

P. R. MALLORY & CO. Inc., INDIANAPOLIS 6, INDIANA

- Capacitors • Controls
- Vibrators • Switches
- Resistors • Filters
- Rectifiers
- Power Supplies
- Mercury and Zinc-Carbon Batteries

get this TV
COUPLER
FREE!



when you buy
1000 feet of
TWIN LEAD

IT'S THE
AMPHENOL

SPECIAL "1001 PACKAGE"

Here's a Special Offer that puts extra profits in your pocket! For a limited time, your AMPHENOL Distributor is stocking a special "1001 Package" — 1000 feet of AMPHENOL's popular 214-056 Twin Lead and 1 free 114-097 two set Color Coupler. You pay only for the Twin Lead, the Color Coupler is free!

If you already sell or use Color Couplers, you know how good a bargain this package is; if not, here is an opportunity to become acquainted with, and sell at a 100% profit, one of the finest two set couplers available!

See your AMPHENOL Distributor and order the special "1001 Package*" today!

*Part number is 214-056-02



AMPHENOL ELECTRONICS CORPORATION
chicago 50, illinois

overload control. *Important:* Do not operate the unit without an overload protector. Check the relay coil and contacts; if you replace the relay, also replace the start capacitor.

Symptom: Compressor cycles (goes off and on repeatedly).

Analysis: Automatic thermal overload makes and breaks the circuit—it is doing its job.

Solution: A condition such as unusual heat of the sun on the outside of the air-conditioner may increase the current through the overload until that unit is actuated. Place an awning over the air-conditioner in this case, being careful not to block outside circulation around the condenser. A partial short in the electrical system or a marginal low-voltage condition will contribute to increased current drain and therefore to a condition of overload.

Only a brief mention can be made of the operation of the fan motor and its blades. Both the blower wheel and the condenser fan must rotate freely and at rated speeds for adequate air-conditioner performance. Does the motor require maintenance, i.e., oil, etc.? Do the fans slip on their shafts? Does anything keep them from rotating freely? A slow or stopped condenser fan may reduce refrigerant condensation enough to raise the head pressure in the condenser side so as to cause current overload. The compressor is then forced to work harder against increased pressure.

Refrigerator System

Symptom: Evaporator coil freezes up.

Analysis: The reduction or loss of any considerable amount of *Freon* from the system results in evaporator pressures lower than the unit is designed for, causing excessive local cooling. The same condition of freeze-up can be caused by an obstructed air stream.

Solution: Examine the air stream (inside and outside) for dirt or any other obstruction. Replace or clean the filter. See whether the fan motor or fans are operating at reduced speeds. Check the line voltage. The unit will have to be pulled into the shop if a gas-leakage test or recharging is needed. Observe the manufacturer's warranty rules with respect to breaking into the sealed system.

Air Stream

Symptom: Ineffective cooling, freeze-up of evaporator, high wattage consumption, etc. (Wattage consumption must be checked against manufacturer's specifications.)

Analysis: The air stream at the evaporator and condenser must be free and unobstructed. Any interference with air flow prevents evaporation of the correct amount of *Freon*. The temperature of the room air must be warm enough to furnish the required energy for *Freon* evaporation; on the other hand, an excessive load (or room air much too hot) will interfere with operation because of too much *Freon* evaporation.

The condenser air streams must also be free-flowing and not too hot. Unusually high temperature may trigger the overload, reduce condensation of the *Freon* gas and cause high head pressure.

Solution: The filter must be clean, and the blower wheel and condenser fan must rotate freely and at proper speed. Oil and clean the fan motor as necessary. The outside louvers must be clear of obstruction, and the condenser fan and slinger ring must be adjusted to pick up enough condensate to hurl against the condenser. Check to see that the unit is tilted so that condensate can collect under the condenser fan.

This brief analysis will serve to illustrate that troubleshooting problems and servicing techniques in the air-conditioner field are not greatly different from those in other electronic work. The television technician should feel right at home in air-conditioner servicing, once he becomes familiar with this type of work. ▲

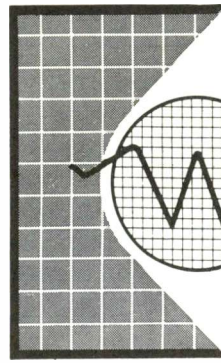
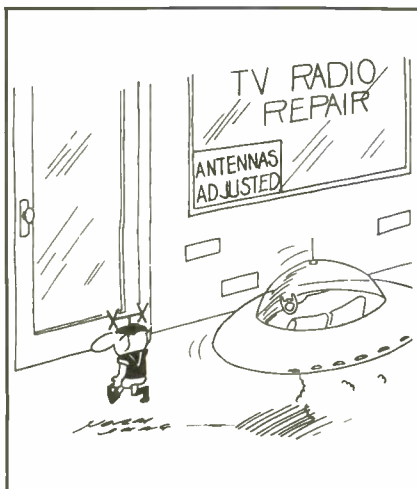

FREE! FREE!

Walsco PHONO DRIVE INVENTORY CASE with WALSCO PHONO DRIVES

Designed especially for servicemen, the Walsco Phono Drive Inventory Case has these important advantages for you:

- Keeps your stock up-to-date—instantly tells you when and what to re-order
- Covers 90% of all your replacement needs
- Compact enough to carry with you on house calls
- Contains an up-to-date cross-reference replacement chart—instantly tells you the right drive to use
- Keeps drives neat and orderly—makes it easy to find the right drive

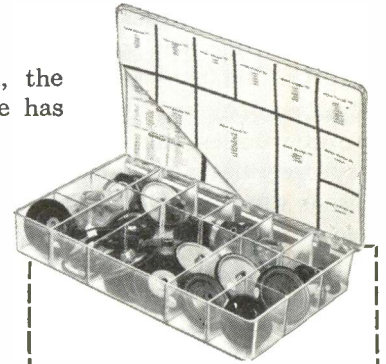

This indispensable kit is \$2.50 dealer net. It's free with your next phono drive order of \$10.00 or more.

EXTRA SALES and EXTRA PROFITS

... come your way when you sell your customer a new drive or belt. A phonograph or recorder that is old enough to need service of any kind needs a new belt or drive for good performance. Suggest it to your customer next time you service a phono or recorder—see how easy it is to get Plus Profits.

19 NEW DRIVES and BELTS

...make Walsco the most complete line ever

Nineteen new items, including replacements for Admiral, Collaro, Garrard, Monarch, Philco, RCA, Revere, Viking, and Webcor are now listed in the Walsco catalog, along with hundreds of other units for all standard phonographs and recorders. Tires, belts, idler wheels and pulleys, and many more to fill your every replacement need.

FREE: Walsco Identification Wall Chart—with actual size reproductions and detailed cross-reference listings of all replacement drives and belts—lets you instantly identify the one you need. See your Walsco distributor or write directly to Walsco.



Catg. No. 1479 (Garrard) \$2.25 List



Catg. No. 1490-01 (RCA) \$1.10 List



Catg. No. 1492-01 (Webcor) \$2.25 List

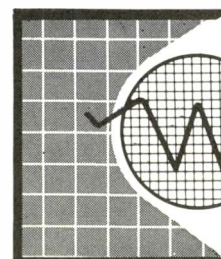

Walsco ELECTRONICS MFG. CO.
A Division of Textron Inc.
West Coast Plant: Los Angeles 18, California
MAIN PLANT: 102 W. GREEN ST., ROCKFORD, ILL., U.S.A.
In Canada: Atlas Radio Corporation, Toronto 10, Ontario

Horn-Type Loudspeaker Stereo Preamp Design

By Calvin C. Young, Jr.

In the two previous columns, we examined cone-type speakers in detail. The limited performance of the direct-radiating speaker at the low frequencies and its low efficiency over the entire range are two reasons why horn-type speakers are used in many commercial, PA, and hi-fi systems. In this article, we will examine the basic principles of horn-type speakers and see just how various aspects in their design affect operation.

Basic Horn Styles

A horn-type loudspeaker consists of a driver assembly (sound generator) and a tube of varying sectional diameter (horn). The most common styles of horns (Fig. 1) are conical, exponential, hyperbolic, and parabolic. The flare of a horn may be either single or compound (Fig. 2), depending on the propagation or distribution pattern desired. Generally speaking, a horn which has a compound flare (equal in all directions) will have a fairly uniform distribution pattern, while a horn having only a simple flare will have a wider distribution pattern along the smaller axis of the mouth opening.

High- and low-frequency horns may use any of the styles shown in Fig. 1; however, a low-frequency horn will be large (in length and mouth diameter), while a high-frequency horn will be relatively small. When we speak of a high- or low-frequency horn, we are speaking of the cutoff characteristic. A large horn can produce the higher audio frequencies; but, unless it is assisted in this respect, considerable distortion can be developed in the upper range. Good low-frequency performance demands a large mouth area and a small rate of taper. A recent engineering textbook states that a taper constant of .1 produces a horn which doubles in area each 7.5" and has

a cutoff frequency 100 cps lower because of the taper. Further, cutoff frequency decreases as horn length increases (assuming the same rate of taper). With this factor in mind, it is easy to visualize that a low cutoff frequency is obtained only with a long, gently-tapering horn which has a large mouth area.

It seems logical to assume that a high-frequency horn would be short and have a small mouth area, or that best high-frequency response would be obtained by eliminating the horn entirely. This is true — but only up to a point. Because of efficiency considerations, the horn cannot be completely eliminated. A horn-type unit is more efficient than a cone-type because its diaphragm works into the resistance of the horn throat; the cone-type (in free air) works only against mechanical inertia. In other words, a small diaphragm in a horn-type speaker acts against the large column of air contained within the horn, while a cone works only against the air it contacts. Thus, for the sake of efficiency, it is necessary to have a horn of some size even for the higher-frequency units.

The extreme lengths required for low-frequency horns are obtained through the use of folded designs. In this way, effective horn lengths of 9' to 12' can be contained in a unit only 3' to 4' long — or even shorter, depending on the number of folds. Folding a horn causes some loss in performance due to the difference in path lengths along the inside and outside turns. Losses can be held to a minimum by confining the bends to the sections where the horn area is small; however, bends cannot be used in horns designed to produce frequencies above about 5,000 cps.

Horns may be circular or square with no appreciable change in performance. If a square horn is used, however, corner fillets must be em-

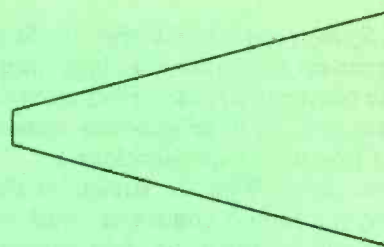

(A) Conical.

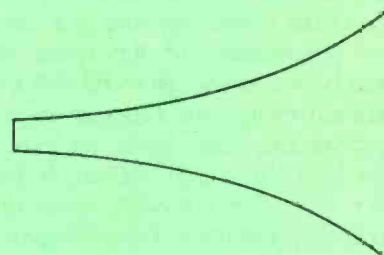

(B) Exponential.

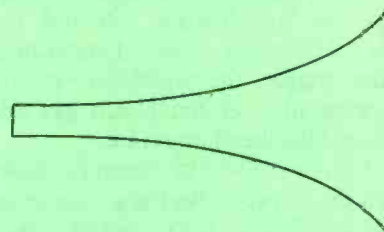

(C) Hyperbolic.

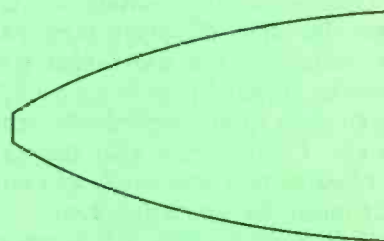

(D) Parabolic.

Fig. 1. Horn flare styles.

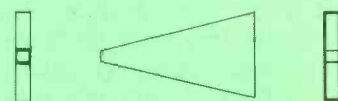

(A) Simple.

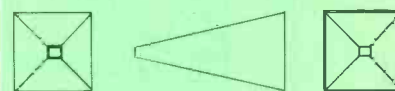

(B) Compound.

Fig. 2. Horn flares.

The foremost
name in
automotive
loudspeakers!

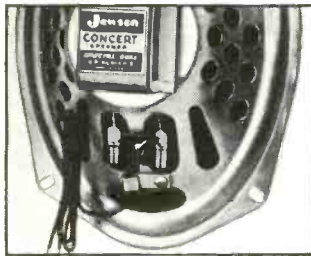
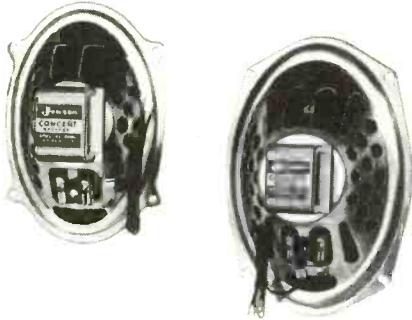

Three-way universal terminal-lead arrangement is especially convenient. Tip jacks fit Ford-Lincoln-Mercury rear seat pin terminals; twin lead for splicing to front seat plug cable; solder lugs for general use.

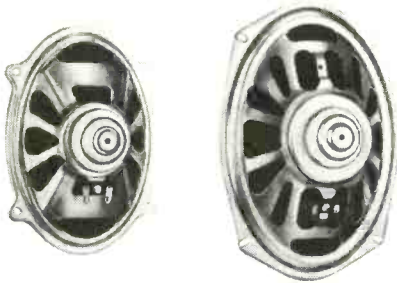

BURTON BROWNE ADVERTISING

PROVED IN **10,000,000**
CARS AND TRUCKS!

Jensen WORLD'S MOST RUGGED
AUTOMOTIVE SPEAKERS

CONCERT SPECIAL OVAL GROUP

Jensen designed this extra ruggedized Special Oval Group at the request of one of the largest automobile manufacturers. Millions of units with years of service in truck and passenger vehicles have established the complete dependability of these speakers for use as replacements wherever 6 x 9 and 5 x 7 units are required. Not to be compared with conventional ovals, they are up to 3 times as resistant to housing distortion due to mounting strains and vehicle vibration, maintain alignment indefinitely in specially oversized gaps, withstand severe overloads, are immune to weather and temperature changes. Efficient magnetic structure design, using DP-Alnico 5 magnets, has made possible shallow construction, virtually universal in complying with crowded installation conditions.

New high fidelity models will give superior wide range performance and added power handling capacity for a noticeable improvement in auto radio sound quality.

VIKING

For lowest cost, combined with rugged compactness, Jensen VIKING Series ovals fill the bill in automotive and other replacement services. Features include a completely enclosed magnetic structure, with precision locked-in alignment and new high efficiency DP-Alnico-5 magnet. Heavy gauge rigid housing. Solder lug terminals. One model in each 5" x 7" and 6" x 9" sizes handles 90% of your oval speaker requirements.

CONCERT SERIES—SPECIAL OVAL GROUP

Nominal Size Inches	Model No.	Magnet Weight* Ounces	Voice Coil			Dimensions, Inches			List Price
			Imped. Ohms	Power Watts	Dia. Inches	H. & W.	Depth	Baffle Opening	
5 x 7	P57-U	1.73†	3.2	8.0	1	5 x 7¼	2½	4¼ x 6½	\$7.20
5 x 7	P57-TX§	2.5‡	3.2	9.0	1	5 x 7¼	2½	4¼ x 6½	8.35
6 x 9	P69-U	1.73†	3.2	9.0	1	6¾ x 9½	3½	5¼ x 8½	7.80
6 x 9	P69-T	2.5‡	3.2	10.0	1	6¾ x 9½	3½	5¼ x 8½	8.65
6 x 9	P69-TX§	2.5‡	3.2	10.0	1	6¾ x 9½	3½	5¼ x 8½	8.95
VIKING SERIES									
5 x 7	57-J9	1.47	3.2	6.0	¾	5 x 7¼	2½	4¼ x 6¼	5.85
6 x 9	69-J9	1.47	3.2	7.5	¾	6¾ x 9½	2½	5¼ x 8½	6.50

§High Fidelity Model. *All Magnets DP Alnico 5.

†Performance Equivalent to RETMA 2.15 oz. ‡Performance Equivalent to RETMA 3.16 oz.



Send for your
free copy of
Data Sheet 167.

Jensen MANUFACTURING COMPANY
6601 South Laramie Ave., Chicago 38, Illinois

Division of The Muter Co. In Canada: J. R. Longstaffe Co., Ltd., Toronto
In Mexico: Radios Y Television, S.A., Mexico D.F.

NEW
IMPROVED
SENCORE
LC3
Leakage Checker

Another Sencore Time-Saver

Check these outstanding New Features

Now — For the first time ...

Checks 130 different tube types — more than any other "grid circuit" type checker. Includes UHF and latest type tubes.

Checks picture tubes without removing tube from cabinet or chassis.

New Roll Chart prevents obsolescence — just dial the tube type and save time. Chart is easily replaced at no extra cost.

Dynamic Filament checks including heater to cathode leakage & shorts — no need for a second filament tester.

Two spare preheating sockets to cut down testing time.

Capacitor checks simplified.

The LC3 provides all these new improved features in addition to those employed in earlier leakage or "grid circuit" testers. A must for any TV service technician.

SENCORE SERVICE INSTRUMENTS CORP.
 171 Official Rd. • Addison, Ill.

In stock at your local parts distributor

\$28.95
 DEALER NET
Really Whips Tough Dogs

Cut out this ad now for further information

ployed in the throat end to provide a smooth transition between the square section and the round diaphragm normally used in the driver unit. The relationship between the horn and the driver is shown in Fig. 3. Materials in common use for horns include wood, metal, and molded fiberglass. All of these materials must be used in sufficient quantity, and be adequately braced, to prevent the horn walls from vibrating and causing distortion.

In the early days of audio, before too much was known about horn action, conical horns were often employed. However, an exponential horn having the same length and effective mouth area as a conical design has been found to be superior in performance. This is due, at least in part, to the difference in throat impedance characteristics. The throat impedance of a conical horn rises from a low value of about .05 acoustical ohms at 200 cps to about .75 at 7000 cps; in an exponential horn, impedance rises from 0 to .95 acoustical ohms over the relatively small range of 300 to 700 cps.

The directional pattern produced by a horn is almost completely a function of mouth area and shape, and follows the same basic laws that determine directional patterns of cone-type units. Horn taper has only a minor effect. A horn designed for wide-range reproduction has a relatively large mouth, and as a result, will cause high frequencies to be beamed sharply. This effect can be eliminated by dividing the horn into a number of smaller horns supplied in parallel by the same driver unit. At the higher frequencies, each section of the multiple-section horn acts independently and provides a beam narrow enough to prevent interaction with its neighbors. As illustrated in Fig. 4, several narrow beams spread over a wide axis achieves a wide coverage because they add vectorially.

The shape of the horn mouth governs the pattern, in that wider sound distribution is obtained along the narrow axis of the mouth opening. This is why you see circular speakers mounted at ceiling level with the mouth pointed downward, and rectangular-shaped horns mounted with the widest mouth opening in a vertical direction. In either case, the idea is to get maximum area coverage.

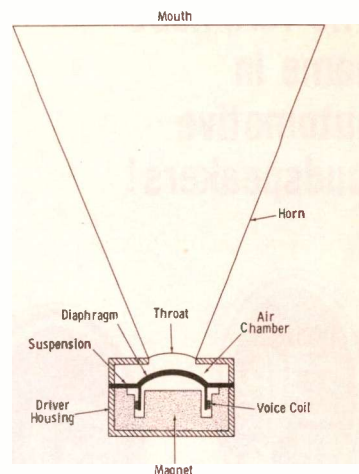

Fig. 3. Horn-type speaker showing relative position of throat and diaphragm.

Driver Units

If we consider the driver portion of a horn speaker as the sound generator, and visualize that it is in many ways very similar to a cone-type speaker, the driver unit will cease to be that mysterious metal thing on the rear end of a horn. While the power output of any horn is limited by its throat diameter (if a reasonable distortion figure is to be preserved), it is even more limited by the driver assembly. This factor is emphasized by the availability of hardware which permits two drivers to be coupled to a single horn for added power output.

Refer again to Fig. 3 and note that a basic driver consists of a magnet, voice coil, diaphragm, air chamber, and throat. There will be differences in the size, shape and movement of these parts and even additional components in certain cases, but the same basic configurations will apply, just as they do for cone-type speakers.

It was briefly mentioned earlier that a horn-type speaker was more efficient than a cone-type. Efficiency in a horn-type speaker is defined as the ratio of useful acoustical power output to electrical power input. Such factors as flux density, voice-

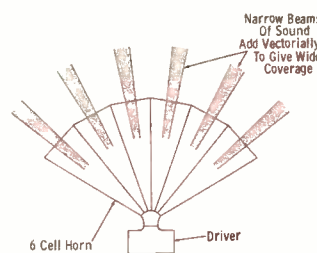

Fig. 4. Narrow beams from multicell horn blend for wide dispersal of highs.

ATLAS

\$129.95
 DEALER NET

- ★ **LOWEST PRICE** quality tube tester on the market
- ★ **GUARANTEED** non-obsolescence, patented memory bank instantly adapts ATLAS to test any new tube
- ★ **MOST BEAUTIFUL** looking addition to any store

SIMPLEST BY FAR TO OPERATE
PROVEN — TROUBLE FREE
SAFE — NO HIGH VOLTAGE ON PANEL

See your local distributor for further information—write

AFFILIATED television laboratories, inc.
 112-07 FRANCIS LEWIS BLVD., QUEENS VILLAGE 29, N. Y.
 HOllis 5-8000

coil mass, diaphragm mass, ratio of diaphragm area to throat area, dimensions of the air chamber, and voice-coil temperature all affect efficiency. The air chamber is an important part of a driver unit designed for a wide frequency range because it provides the necessary transition between the diaphragm and throat areas which are of different sizes. In order to prevent distortion, the dimensions of the air are small in any direction when compared to the wavelengths of the higher frequencies. Further, if the driver is intended for high frequency use, say 10 kc and up, the distance from the throat opening to the farthest point on the diaphragm must be less than $\frac{1}{2}$ wavelength at the highest frequency to prevent interference and radiation from the surrounding support or diaphragm suspension. This has led to the use of equalizing plugs between the driver throat and the horn itself. Instead of one circular opening, a plug provides additional passages between the diaphragm and the horn as illustrated in Fig. 5. All passages must be of equal length so that pressure variations will be in phase when they reach the throat of the horn.

The acoustical power output from a driver can be limited by the generation of spurious harmonics or subharmonics. These spurious generations can be caused by air overloads, excessive driving signal, varying voice-coil air-gap flux product, or nonfundamental vibration nodes of the diaphragm. This means that the maximum power rating for a horn speaker will be most often determined by the maximum tolerable distortion. Maximum permissible voice-coil temperature is another limiting factor, especially in high-frequency units.

Because the driver contains the moving portions of a horn-type speaker, it is the most likely source of distortion. Since diaphragm ex-

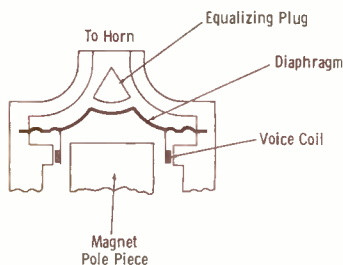

Fig. 5. Construction of horn driving unit showing location of equalizing plug.

BETTER BUSINESS is in the cards

with the
Centralab[®]
FR-22A
FASTATCH[®]
Control Kit



It's like playing with a stacked deck! The odds are 80 to 1 that you can draw the dual-concentric control you need from this kit. Avoid delays—avoid extra trips to your distributor. Over 120 different combinations can be assembled from this small stock!

You'll be flush with new profits when you pair these units . . . so ante up \$30.73 (Your resale price totals \$49.55!)—keep a full house always—and you can bet you'll end up a big winner.

Every control factory assembled and tested—all you do is snap them together.

Catalog 30 listing the full line of Centralab products is available free from your distributor, or write us for it.

Centralab products are listed in COUNTERFACTS and PHOTOFACTS.

Centralab  A DIVISION OF GLOBE-UNION, INC.
942 H. E. KEEFE AVE. • MILWAUKEE 1, WIS.
In Canada: 804 Mt. Pleasant Rd. • Toronto, Ontario

CONTROLS • SWITCHES • PACKAGED ELECTRONIC CIRCUITS
CERAMIC CAPACITORS • SEMI-CONDUCTOR PRODUCTS

MULTIPLE TV INSTALLATIONS MADE EASY!

PROFITABLE BUSINESS

- Hotels
- Motels
- Apartments
- Institutions
- Stores, etc.

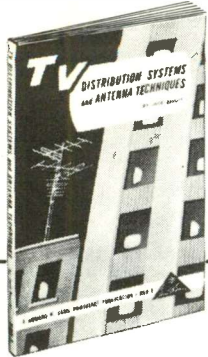

GET ALL THE KNOW-HOW IN THIS VALUABLE SAMS BOOK

"TV DISTRIBUTION SYSTEMS and ANTENNA TECHNIQUES" by Jack Beever



MAKES YOU AN EXPERT ON MULTIPLE TV INSTALLATION

Here's complete information on how to feed TV signals to multiple TV sets from a single antenna system. Describes equipment required to solve signal distribution problems; shows how to use equipment properly. Covers every type of multiple-set system from simple two-receiver service to large commercial installations. Full information on how to solve difficult "local" reception problems and how to get good fringe area results. Describes community antenna systems—planning, equipment, installation, legal problems, costs, maintenance, service charges—all the facts.

17 FACT-PACKED CHAPTERS:

You get detailed practical information on: selection, location and orientation of the antenna—recommended signal distribution systems and how to install them—requirements for coaxial cable, set outlets or tap-offs—available equipment for amplifying and filtering signals—modernizing or converting a system for UHF—how to maintain the system, what to charge—even how to prepare bids and estimates and make the sale! It's complete—it's practical—tells you everything you need to know to build a profitable business in multiple TV installations. Order today!

176 pages, 5 1/2 x 8 1/2" PRICE ONLY **\$295**

SEE THIS BOOK AT YOUR SAMS DISTRIBUTOR OR MAIL COUPON

FREE TRIAL COUPON

Howard W. Sams & Co., Inc., Dept. 3-H8
2201 E. 46th St., Indianapolis 5, Ind.

Send me Sams "TV Distribution Systems and Antenna Techniques" for 10 days FREE examination. In 10 days, I will pay for the book, plus few cents delivery cost, or return postpaid.

We pay delivery cost if you remit with this coupon; same return privilege.

Name

Address

City Zone State

(Outside U.S.A. priced slightly higher)

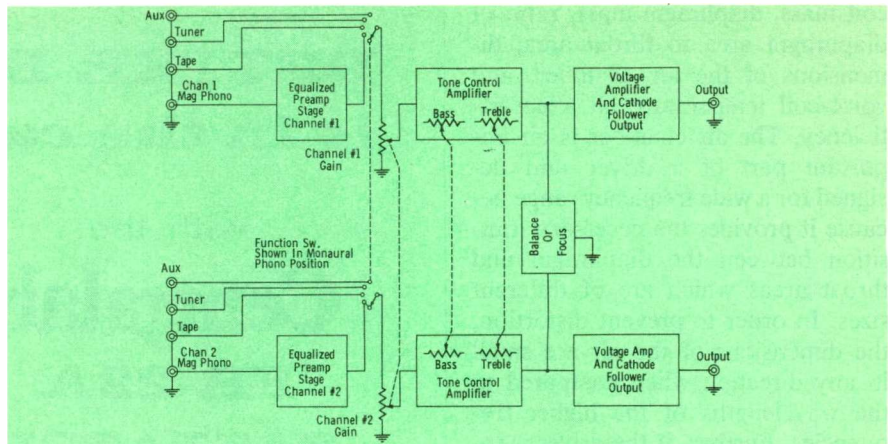

Fig. 6. Block diagram of basic stereo preamplifier showing pair of identical sound channels, ganged controls, balance network, and function-switch circuit.

curtion for constant power output is inversely proportional to frequency and the mechanical impedance of the system, the suspension system will cause the greatest amount of distortion at low frequencies. Considering this, it is apparent that a horn-type speaker should not be used in any manner other than the one for which it was designed. In other words, a low-frequency horn is good for low-frequency reproduction, a high-frequency unit for high frequencies, etc. Never apply large-amplitude, low-frequency signals to high-frequency horns (tweeters) or high-frequency signals to low-frequency horns (woofers). To do so is to invite disaster.

A Glimpse into Stereo Preamp Design

To say a preamp is a preamp and a stereo preamp is simply two preamps would be like saying any two babies are twins. Since we know a 6SN7 won't work as the final amplifier in a 100-kw transmitter stage, it can be realized that a stereo preamp isn't just two of everything. While two of everything *is* required, there are several other considerations which are of utmost importance to stereo operation. In the block diagram of Fig. 6, for example, you will notice such things as balance control, ganged controls, monaural phono position and two input jacks for each position on the function selector (except monaural phono). Ganged equalization switches that simultaneously provide the desired equalization to both preamplifier stages are also often provided.

Of particular interest is the fact that the function selector switches,

gain, treble, and bass controls of the two channels are ganged—making this portion of the stereo preamplifier no more complicated to operate than a single channel preamplifier.

The gain controls in Fig. 6 might be labeled volume or loudness in a commercial unit. The function would be the same, however — to vary the output signal of the two channels equally and simultaneously. The ganged bass and treble controls need no explanation other than that they provide simultaneous changes in bass or treble response for the two channels. The design of the circuit in each channel must consider this ganged operation and the components selected must be of close tolerance to insure a balanced operating condition.

The balance or focus control is peculiar to stereo preamps — monaural units don't have one. The function of this control is to provide precise balancing of the two output signal amplitudes. If for any reason, such as unbalanced gain in the preceding stages, the output signals are not identical in amplitude, the balance control can be adjusted to achieve the desired degree of equality. While the balance control is shown connecting the two channels, it does so only from a DC bias standpoint. It does not link the signals in the two channels, or in any way cause the two signals to be mixed.

The sample circuit in Fig. 7 shows how the balance control connects into the circuit to do its required job. As you can see, the control is in the common grid return, and varies the ratio of DC resistance in each grid

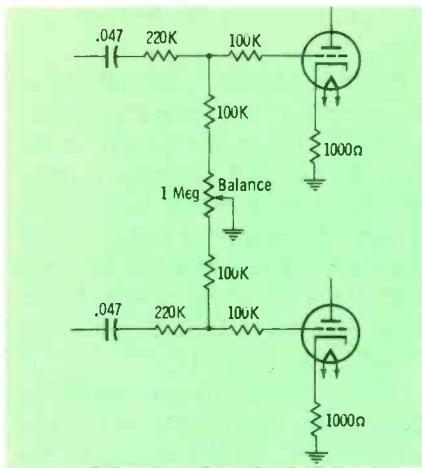
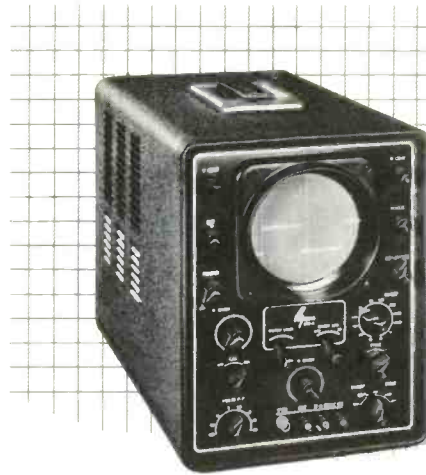

Fig. 7. Schematic of balance control network between stereo preamp channels.

circuit. Because of this feature, a stage of gain is provided after the balance control and just ahead of the usual cathode-follower output stage. This means that where some commercial preamp designs have employed only two dual-triode tubes (one tube as equalized preamp, 1/2 tube as tone-control amplifier and 1/2 tube as a cathode follower), many stereo preamps will employ three dual triodes in each channel. When this is done, one tube will probably be used for equalized preamp stages, one as a tone-control amplifier, and one as a voltage amplifier and cathode-follower output.

The major problem in stereo preamp design is construction of the unit so that it will provide identical performance on both channels without interaction between the two. This is achieved by the use of close-tolerance components, matched tubes, adequate filtering and decoupling between the two channels and the power supply, and careful layout of components so that ground loops will not be created. While these factors are most important on the manufacturing level, they also come into the picture whenever service is required. The serviceman should be careful to replace defective components with replacements having identical ratings and characteristics. Further, replacements should be installed exactly as were the originals; do not move ground connections, etc., even though it may be physically easier to connect a part differently. Also, any tube selected for use in a stereo preamp should be aged in the circuit for 24 hours before the unit undergoes a final check prior to its return. ▲



Hycon MODEL 622A
PROFESSIONAL

5" OSCILLOSCOPE
for color tv
and pulse work

A wide-band (to 6 mc) 'scope with high vertical sensitivity and low internal noise, equipped with triggered or recurrent sweeps and preset TV sweep frequencies.

5X expansion of horizontal, plus real sync stability, means you can examine a 6 mc sine wave using a direct probe.

Full details in Bulletin 622A

At your distributor

Model 622A..... \$426.00

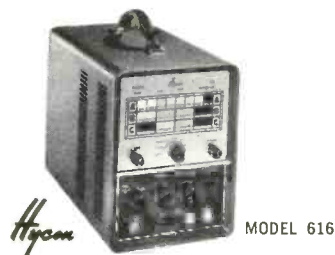

Hycon MODEL 616
Color Bar/Dot Generator
The complete color signal test instrument, and companion unit to Model 622A

At your distributor... \$485

Hycon
ELECTRONICS, INC.
A SUBSIDIARY OF HYCON MFG. CO.
370 South Fair Oaks, Pasadena, California

Here's How You Can Make MORE PROFIT on TV Repairs

**PAYS FOR ITSELF
IN A VERY SHORT TIME**

- The new Tel-A-Turn service cradle increases efficiency and output of any Electronic Technician.
- Simplifies part replacement, soldering, test probing.
 - Prevents breakage and damage to above-chassis components.
 - Ideal portable bench for "on-the-spot" work.
 - A self-locking worm and gear provides 360° chassis rotation for the most convenient position for servicing above or below-chassis components.
 - Quick-operating clamps hold chassis from 9" to 25" wide, and up to 200 pounds.
 - Adjustable swivel lamp permits placing light for best visibility.
 - A built-in PM speaker eliminates removing speaker from TV cabinet.
 - Two hot outlets are provided for soldering iron and test equipment.
 - Cheater cord, switch and pilot light provide safe, easy means of supplying and cutting off power to chassis under test.
 - Tel-A-Turn is mounted on ball bearing rubber casters for smooth, easy mobility.
 - Made of heavily ribbed cast aluminum. Weighs only 37 pounds.

"Here-at-Last", a practical service cradle for servicing Radio and TV chassis, Record Changers, Amplifiers and other Electronic Equipment. No service tool is more useful or profitable. Write Dept. PF-88 today for descriptive literature. Dealer inquiries invited.

ROGERS MANUFACTURING CO.
LINDSEY, OHIO-U.S.A.

notes on TEST EQUIPMENT

Informative reports from the lab

by Les Deane

New Transistor Checker

With the use of transistors continually increasing, the service technician needs a reasonably accurate means of evaluating their operating conditions. Having a transistor checker is imperative because one cannot merely look at a transistor and expect to see a lit filament, nor can he quickly substitute a replacement unit as he can with many vacuum tubes.

Featured in the photo of Fig. 1 is the Model 690 Transistor Tester recently produced by Triplett Electrical Instrument Co., Bluffton, Ohio. This battery-operated instrument is designed to measure leakage and gain characteristics of all low and medium power p-n-p and n-p-n type transistors.

Specifications and test features are:

1. *Power Requirements* — 1.5- and 30-volt self-contained batteries; universal replacements available.
2. *Panel Features* — leakage-gain meter; NPN/OFF/PNP selector switch; gain test button; calibration button and adjustment; one standard transistor socket and separate collector, base, emitter test jacks with external leads.
3. *Transistor Tests* — measures base-to-collector leakage current with open emitter element, current gain percent with grounded base element.
4. *Accuracy* — meter reading within 2% of full scale deflection on 0-500 DC μ a range.

Checking a transistor usually involves two separate operations, similar to the shorts and emission tests performed on vacuum tubes; name-

ly, these are tests for leakage and gain.

Following instructions outlined in the manual, I first turned the CAL. ADJUST control completely counterclockwise. This prevents pinning the meter needle in case the unit under test is excessively leaky. I next consulted a transistor guide to determine the type of transistor I was about to check. In this particular case, it was an n-p-n.

After connecting the transistor to each of the appropriate test leads, I flipped the selector switch to the NPN position. I then pressed the CAL button and increased the CAL. ADJUST control until the meter needle coincided with the CAL. SET mark at full scale. Releasing the button, I was then able to observe the leakage current on the lower scale of the meter. In this instance, the needle barely moved away from zero, staying in the green area labeled GOOD. Incidentally, the green area of both meter scales is divided into two sections — one of dark green for small-signal transistors and one of light green for medium-power units.

Following this satisfactory leakage indication, I proceeded to the second step, which was a check of current gain. Without disturbing the CAL. ADJUST, I depressed the GAIN button and noted results on the upper scale. This scale is calibrated in percentage of gain based on full-scale deflection of 100. If the needle comes to rest above the

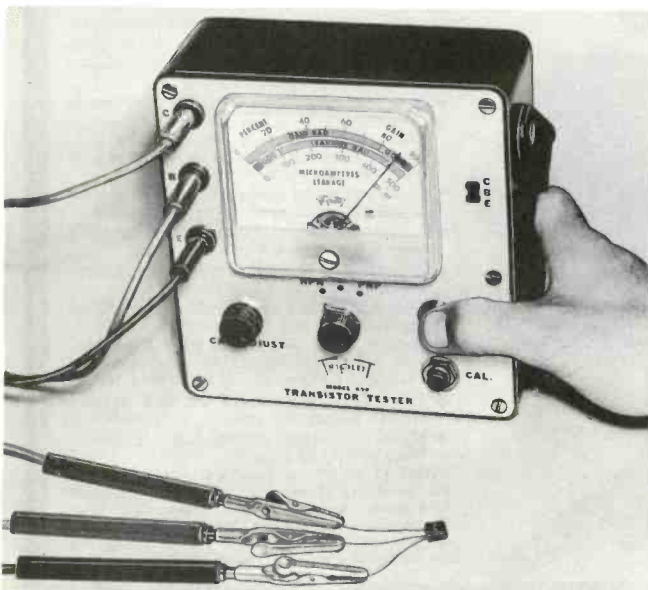

Fig. 1. New transistor checker by Triplett features panel test socket and detachable leads.

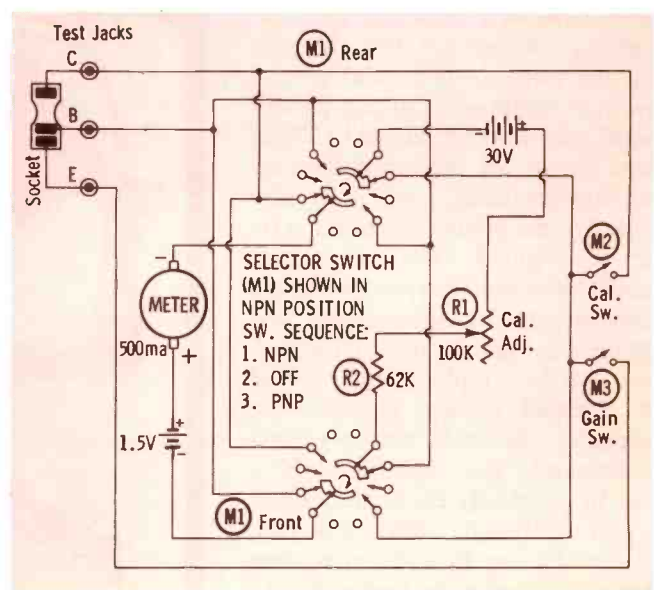
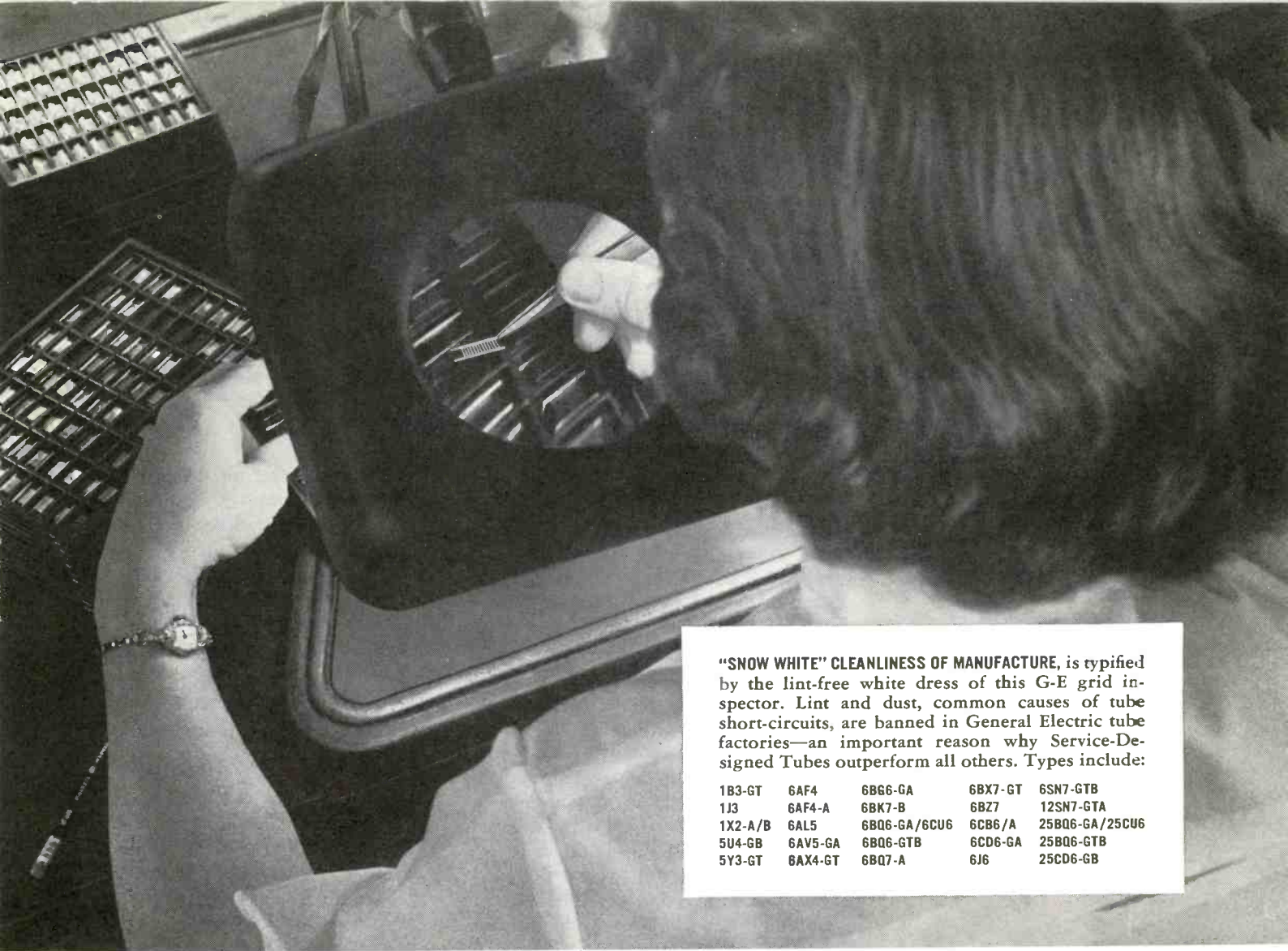

Fig. 2. Schematic of Model 690 shows meter and battery connections in various switch positions.



"SNOW WHITE" CLEANLINESS OF MANUFACTURE, is typified by the lint-free white dress of this G-E grid inspector. Lint and dust, common causes of tube short-circuits, are banned in General Electric tube factories—an important reason why Service-Designed Tubes outperform all others. Types include:

1B3-GT	6AF4	6B66-GA	6BX7-GT	6SN7-GTB
1J3	6AF4-A	6BK7-B	6BZ7	12SN7-GTA
1X2-A/B	6AL5	6BQ6-GA/6CU6	6CB6/A	25BQ6-GA/25CU6
5U4-GB	6AV5-GA	6BQ6-GTB	6CD6-GA	25BQ6-GTB
5Y3-GT	6AX4-GT	6BQ7-A	6J6	25CD6-GB

Individual grid inspection! 300 such quality checks mean fewer callbacks with G-E Service-Designed Tubes!

More than 300 inspections, checks, and tests are given General Electric Service-Designed Tubes before they are approved for shipment.

Prior to assembly, tube materials are exhaustively analyzed, weighed, and tested. Parts—like the grids shown above—are inspected for accurate workmanship. Pre-assembly checks on a 6BQ6-GA sweep tube, for example, total 215 . . . definite proof how wide is the range of General Electric's quality control!

A 6BQ6-GA still must pass 109 successive inspections during tube assembly—must undergo 13 final electrical and mechanical tests, every

tube, before shipment. Other General Electric Service-Designed types are given inspections and tests that are equally exhaustive.

Fewer servicing callbacks? You can rely on this, with testing so extensive and rigid. Yet Service-Designed Tubes cost no more. Phone your G-E tube distributor! *Distributor Sales, Electronic Components Division, General Electric Company, Owensboro, Kentucky.*

Progress Is Our Most Important Product

GENERAL  ELECTRIC
11-11-124

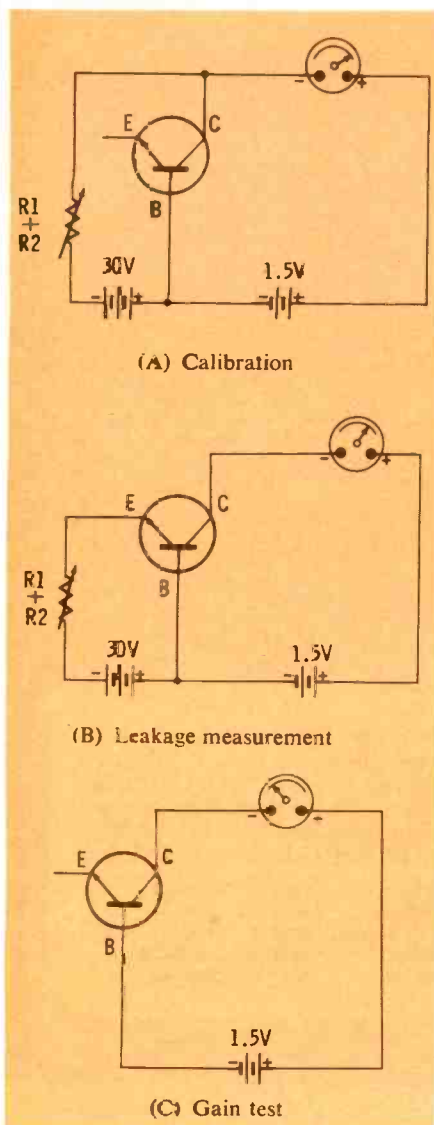

Fig. 3. Circuits for three-step operation of checking transistor in Model 690.

80% mark for medium-power transistors, the unit has sufficient gain. For small-signal units, however, the needle must register 90% or above. The particular transistor I tested produced a reading slightly above the 90% mark, indicating that its gain factor was such that the unit should function properly in its designed application.

So much for the mechanics of checking a transistor on the instrument. Now let's see how it actually does it. A complete schematic diagram of the Model 690 is given in Fig. 2. With the selector switch in the NPN position (as shown) and the CAL. switch (M2) closed, the transistor is first thrown into a circuit represented by the simplified schematic of Fig. 3A. The meter is then calibrated by adjusting R1 for full scale deflection.

After the calibration step, the CAL. switch is opened and the circuit loop containing the 30-volt battery is eliminated, leaving the simple arrangement shown in Fig. 3B. The current now flowing through the meter represents only base-to-collector leakage, which is indicated directly on a 0 to 500 μ a scale.

In the final test step, the GAIN switch (M3) is closed, thus connecting the 30-volt loop to the emitter (see Fig. 3C).

A portion of the emitter current must now flow in the base to provide transistor bias; therefore, the re-

maining current flowing in the collector (meter) circuit represents transistor gain. This, in turn, is indicated directly on the percent-gain scale of the instrument.

Waveform Analyzer

The instrument pictured in Fig. 4 may look like a small portable scope with a simplified front-panel arrangement; actually, it's much more than that. Properly identified as the Model EA-1 Absorption Analyzer, the unit is manufactured by Kingston Electronic Corp., Medfield, Mass.

The EA-1 will permit the observation of waveforms in electronic equipment by either direct connection, or through use of a special electrostatic pick-up which is sensitive to signal radiations emanating through the glass of a vacuum tube.

Specifications and features are:

1. *Power Requirements* — 110/120 volts, 60-cps; power consumption 55 watts; line fuse provided.
2. *Vertical Input* — neutrode Standard Coil tuner converting all RF frequencies between 3 and 240 mc to a 43-mc IF (12 snap-in tuner strips are included with instrument); sensitivity of from 200 to 600 μ v/inch over a frequency range of 20 mc to 250 mc; direct frequency response down not more than 50% from 20 cps to 300 kc with a sensitivity of 2 mv/inch.
3. *Horizontal Sweep Frequency* — 5 ranges from 20 cps to 45 kc continuously variable; external sweep input provided with a frequency response down not more than 50% from 20 cps to 70 kc and a sensitivity of 500 mv/in, external sync input and amplitude control provided.
4. *Front Panel Features* — beam intensity control and on-off switch, sweep-frequency vernier, sweep range selector, vertical gain control, band selector switch, and input circuit selector; vertical input jack, ground jack, external sync input jack, external sweep input jack, and sound jack for monitoring signal by phones.
5. *Rear Chassis Adjustments* — focus, sync amplitude, sweep width, vertical and horizontal centering.



Fig. 4. Kingston Absorption Analyzer picks up signal radiation, converts it to standard IF frequency, and feeds it to high-gain scope for waveform analysis.

R and D Labs
 Engineers...
 Servicemen...
 Hobbyists...



NEW Belden

WORKBENCH HOOK-UP WIRE DISPENSER KITS

Belden Dispenser Kits solve the problems of waste and inconvenience for all users of Hook-Up Wire and are available in the 14 most popular assortments of Vinyl, Vinyl-Nylon, Textile, and Teflon* insulated wire for every requirement.

Each kit contains an assortment of Hook-Up Wire colors and types plus a portable metal dispenser rack for workbench or wall mounting. The dispenser rack provides a complete, compact, and convenient wire department for every working area at the user's finger tips, simplifies user Hook-Up Wire stock maintenance, and helps keep wire clean and orderly while keeping the workbench neat and efficient. Available at all Belden jobbers.

* Du Pont trademark

One Wire Source for Everything Electrical and Electronic

Magnet Wire • Lead Wire • Power Supply Cords,
 Cord Sets and Portable Cord • Aircraft Wires
 Electrical Household Cords • Electronic Wires
 Welding Cable • Automotive Wire and Cable



08A01G8

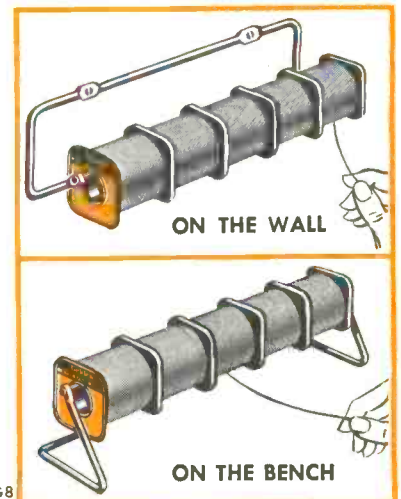



**SUITS NEED PRESSING—
MERIT DEFLECTION YOKES
DO NOT!**

Merit deflection yokes are cosine wound TO FORM, not pressed. Pressing can lead to distortion and poor focusing. Pressing after winding frequently causes breakdown.

**MERIT COILS AND TRANSFORMERS
HAVE "BUILT-IN" ADVANTAGES.**



Each Merit yoke is
100% LIVE TESTED

COMPARE IT WITH
MERIT
MERIT COIL AND TRANSFORMER CORP.
MERIT PLAZA • HOLLYWOOD, FLORIDA

TV TUNERS REBUILT

ALL MAKES & MODELS
THOUSANDS OF TUNERS IN STOCK

VHF
or
UHF

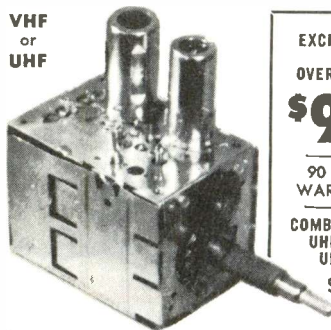

EXCHANGED
OR
OVERHAULED
\$9.95
NET
90 DAYS
WARRANTY
COMBINATION
UHF/VHF
UNITS
\$19.90

ALIGNED TO ORIGINAL STANDARDS

SAME DAY SERVICE

EXCHANGE TUNER SHIPPED SAME DAY
(OTHERWISE DEFECTIVE TUNER OVERHAULED AND
RETURNED: WITHIN 48 HOURS IN MOST CASES.)

Replacement tubes and smashed parts
are charged extra.

Forward Tuner with All Smashed Parts
Quate Make and Model

F.O.B. CHICAGO OR TORONTO

CASTLE TV TUNER SERVICE

1723 W. LUNT AVE.,
CHICAGO 26, ILL.,

152 MAIN ST.,
TORONTO 13, ONT.,

U.S.A.

CANADA

AMbassador 2-7505

OXford 4-5637

6. *Other Features* — two different sized ring pick-ups, one crescent probe, an envelope probe, coaxial cable and ground lead are supplied with the instrument; a direct probe with built-in step attenuator, a transistor radio probe, and a special envelope probe for 7-pin miniature tubes are also available as accessories.

Examining the Model EA-1 in the lab, I noted that it has all of the potentials for TV troubleshooting possessed by its predecessor, the Model VS4 (see this column in the July, 1957 issue). In addition to the many servicing features of the VS4, the new Analyzer can be used to analyze just about any piece of equipment having periodic or recurrent waveforms. Equipment for two-way communications, commercial or governmental aircraft, navigational or weather radar, public address systems, tape recorders, record players, hi-fi systems, electronic organs and counters all fall into this category.

I obtained one of the Transistor Radio Probes (Fig. 5) with the Model EA-1, and thought you would like to see how this accessory item is used in conjunction with the Analyzer to troubleshoot a typical transistor radio.

Following instructions, I first connected the probe to the Analyzer's input cable and attached the ground lead to the radio chassis under test. Next, I placed the input selector in the VERT. AMP position, meaning that the input signal would be applied directly to the vertical deflection system of the scope. Since I not only wanted to obtain the signal waveform but also an audible indication, I secured a set of ear phones and plugged them into the sound jack located in the lower-left section of the front panel.

Adjusting the gain to near maximum, I then turned the instrument on. After it had warmed up a moment, I touched the probe tip to the collector element of the RF transistor and varied the tuning gang until I picked up a strong local station. If the antenna input or RF stage had been defective, I would have not received a signal. I noted that weaker signals could also be picked up at this point by increasing Analyzer gain to maximum and placing my hand close to the receiver antenna.

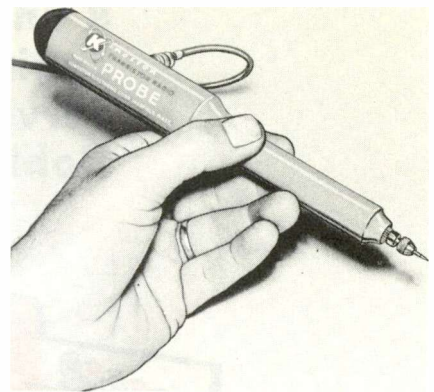

Fig. 5. Detector probe used with Model EA-1 to signal-trace transistor radios.

Progressing from one stage to another, I found that I could signal trace the entire radio by adjusting Analyzer gain for convenient viewing and listening level. Although ear phones are not always required in this operation, they come in handy when troubleshooting for a distorted condition. I found too that the sound may distort if the Analyzer gain is excessive; therefore, it may be necessary to reduce the setting as you proceed toward the output section of the receiver.

Automatic Tube Tester

What's an automatic tube tester? Well, the instrument shown in operation in Fig. 6 is a dynamic mutual conductance tester which approaches automation by instantly setting up various tube-test conditions with the simple insertion of a prepunched index card.

Designed especially for the serviceman, this new "Cardmatic" Model 121 is manufactured by Hickok Electrical Instrument Co. of Cleveland, Ohio.

Specifications and test features are:

1. *Power Requirements* — 105/125v AC, 50/60-cps; line voltage adjustment and overload indicator provided.
2. *Tube Tests*—leakage and shorts, quality (mutual conductance), gas and grid emission with built-in VTVM; twin-section tubes are tested automatically by pushing a button; special application tests provided for certain tubes.
3. *Panel Sockets* — 10 different types provided with 320 specific heater voltages available.
4. *Other Features* — space for over 600 index cards (approximately 325 furnished); detachable lid; case size and weight, 19¾" ×



Fig. 6. Hickok Model 121 "Cardmatic" is a dynamic mutual conductance tube tester which uses prepunched, coded cards to set up conditions automatically.

13 1/4" x 8", 34 lbs.

When checking out this piece of equipment, I was first concerned with testing a number of tubes to see how automatic the operation really was, and how speedily a tube could be checked. The thing that impressed me was that the "Cardmatic" is a dynamic type checker, yet can be set up as quickly, if not more so, than any other type on the market.

It actually takes longer to tell about it than to do it, but to familiarize you with the operation of the instrument, here are the detailed steps involved.

One unusual thing I noticed during the preliminary set-up was the three-prong "Underwriters - Type" plug on the end of the power cord. This is an added safety feature where the third prong connects to ground through the AC socket or a

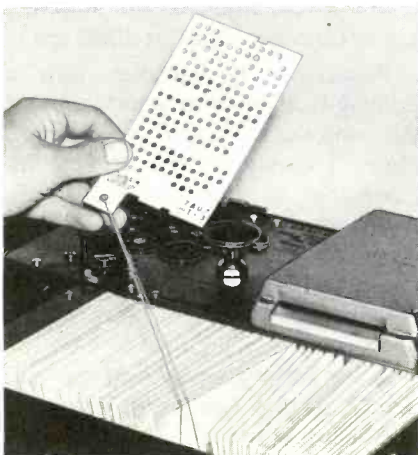

Fig. 7. Cards for Model 121 are on a cord and can be quickly returned to file.

socket adapter. After properly connecting the cord to a power source, I turned the instrument on by rotating the LINE ADJUST knob from its OFF position to the 115-volt point. Permitting the unit to warm up for about 25 seconds, I then zeroed the meter (VTVM) using the control provided on the front panel. With these steps completed, the Model 121 was now ready to check tubes.

Selecting a card from the index rack which corresponded to the tube I was checking, I inserted the tube into the correct socket and pushed the card into the automatic switch. Giving the tube about 5 seconds to warm up, I then pushed button #1 and set the line voltage so that the meter needle registered on the LINE TEST point. Releasing the button, I glanced at the 5 short lamps located between the meter and the switch. A short was not indicated, nor did any leakage show up on the meter, so I proceeded to push button #2. This is the quality test, and the condition of the tube is indicated immediately on the GOOD — REPLACE scale.

As a final test, I pushed button #3 which checks the gas content in amplifier tubes. Referring to the meter, I found that the needle remained in the green area marked GOOD on the gas scale. In my first few testing attempts, I was a little slow — for it took me a little less than one minute to complete the preceding test steps. After I be-

for servicing transistorized equipment

EICO®

LOW RIPPLE

battery eliminator & charger

#1060

Kit \$38.95
Wired \$47.95

- Percent ripple (proportional to current drawn) down to 0.3% @ 2 amps, only 1.5% @ 10 amps (12v range) for operating transistor, "hybrid", or any battery-powered equipment.
- Continuous voltage adjustment with Variac-type transformer.
- 2 ranges: 0-8V: 10 A cont., 20 A int.; 0-16V: 6 A cont., 10 A int.
- 6 exclusives: simultaneous monitoring by separate voltmeter & dual-range ammeter, automatic switching of ammeter to appropriate current range, tilted meter panel, all-steel rugged cabinet, optional wall-mounting feature, industry's lowest price.
- Pi-type heavy-duty filter circuit employing an oversized choke & dual 5000 mf-20 V electrolytic capacitor (10,000 mfd total) takes full continuous and intermittent current output. Heavy-duty selenium rectifiers.
- Fused primary; automatic reset overload relay for secondary.

See the 50 EICO models IN STOCK at your neighborhood distributor. Write for FREE Catalog. 

Prices 5% higher in West.
EICO, 33-00 Northern Blvd.,
L.I.C. 1, N. Y.

ask the
"Man-on-the-Roof"
why he prefers

South River

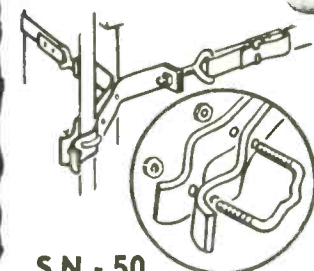

**SN - 50
CHIMNEY MOUNT
SNAP-IN TYPE**

with unique U-Bolt INSTEAD OF SCREWS for easy one hand "Spintite" fastening. Hot Dip Galvanized — 12 Ft. Straps, two to a set. Same Unique U-Bolts used on Snap-in Wall Brackets. Also Available with Stainless Steel Banding.

WRITE FOR NEW CATALOG

SOUTH RIVER
METAL PRODUCTS CO., INC.
South River, New Jersey

pioneer & outstanding producer of finest line of antenna mounts



CABLE TIES FOR ALL CABLE LACING PROBLEMS



RED
YELLOW
BLUE

Here's the new, easy way to bring wires into safe, neat cables. Ideal for color coding, circuit tracing. TIES are 4" long, make 1" cable. Locking loop holds securely. Tubes of 40.

No. 9362-1	Red	List \$1.63
No. 9362-4	Yellow	1.63
No. 9362-6	Blue	1.63

G-C CABLE CLAMPS



Nylon

Complete line of cable clamps in choice of sizes; lightweight, shock resistant, tough, approved for military applications.



Plastic

G-C TEFLON* TUBING

New G-C "spaghetti" with unsurpassed electrical properties. Chemically inert, weatherproof, low friction. Available 10-24 gauge, color (red, blue, natural), 10' and 100' lengths. *DuPont Trademark



FREE CATALOG... WRITE TODAY!

GENERAL CEMENT MFG. CO.

division of **TEXTRON INC.**
Western Plant: Los Angeles 18, Calif.
Main Plant: **ROCKFORD, ILLINOIS, U.S.A.**

looking for the right replacement?

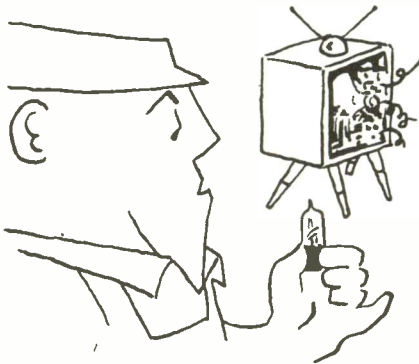

you'll find it
faster in the

MASTER

new **1958** edition — world's largest electronic catalog only **\$3.50** at your local parts distributor — now

THE RADIO-ELECTRONIC MASTER
60 MADISON AVE., HEMPSTEAD, N. Y.

came familiar with the instrument's card filing system, however, I found that I could check a typical IF tube (such as a 6CB6) in about 15 seconds. On one occasion, it took me only 6 seconds to discover a short in a 6W4 damper tube, so I'm sure that with experience one could learn to test a tube in the 8 to 12 seconds specified by the manufacturer.

The card filing system is shown in the photograph of Fig. 7. Note that the test cards are all attached to a single nylon cord. As a card is pulled from the tray, the cord also extends outward, being anchored to a reel mechanism similar to a window-shade roller. When a test is completed, the card is removed from the switch and is more or less free to follow the attached cord back to its original position in the tray. Detailed instructions for adding or removing test cards are given in the "Cardmatic" manual.

Scope Features Portability

The oscilloscope pictured in Fig. 8 is a product of Simpson Electric Co., Chicago. Designed for general-purpose applications, the Model 466 "Handiscope" features a 5-inch CRT with green calibrated mask. The instrument is suitable for just about any TV or radio troubleshooting job, and due to its size is easily transported.

Specification features are:

1. **Power Requirements** — 105/125 volts, 50/60 cps; power consumption 50 watts; line fuse provided.
2. **Vertical Input System** — frequency response 15 cps to 100 kc ± 1 db; down 6db at 250 kc, useful to 1 mc; sensitivity of .03 volts RMS/inch; maximum input voltage 400 volts p-p; input impedance on $\times 1$ position is 100K ohms shunted by 40 mmf; on $\times 100$ position 500K ohms shunted by 35 mmf; input cable supplied.
3. **Horizontal Input System** — frequency response 15 cps to 20 kc ± 1 db, down 6 db at 100 kc; sensitivity .7 volts RMS/inch; maximum input voltage 150 volts p-p; input impedance 250K ohms shunted by 40 mmf.
4. **Sweep Frequency System** — internal range of from 15 cps to 80 kc in six steps; external sweep position and variable

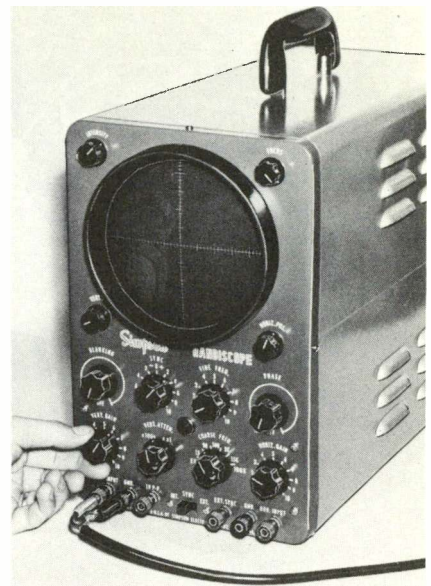

Fig. 8. Portability is main feature of Simpson 466 general-purpose scope.

phase provided.

5. **Synchronization System** — positive or negative sync voltage from vertical system or from external source.
6. **Z-Axis Modulation** — with normal intensity, approximately 20 volts RMS required to extinguish beam; input provided on rear panel.
7. **Voltage Calibration** — special jack provided on front panel; 1-volt peak-to-peak $\pm 10\%$.
8. **Size and Weight** — overall 7 $\frac{7}{8}$ " \times 12 $\frac{1}{4}$ " \times 16 $\frac{1}{8}$ ", 19 lbs. net.

Working on some audio equipment in the lab the other day, I used the Handiscope to check overall operating characteristics of a commercial amplifier chassis. Arranging the apparatus as illustrated in Fig. 9, I connected an audio generator to the input of the amplifier and set the frequency at 1000 cps.

Replacing the speaker with a dummy-load resistor which equaled the voice-coil impedance of 16 ohms, I connected the vertical input cable of the Handiscope directly across the resistive substitute. Naturally, I employed a resistor having a wattage value equal to or greater than the output power rating of the amplifier.

After turning everything on and permitting the equipment to warm up for a few minutes, I set the volume control of the amplifier to maximum and adjusted the sweep

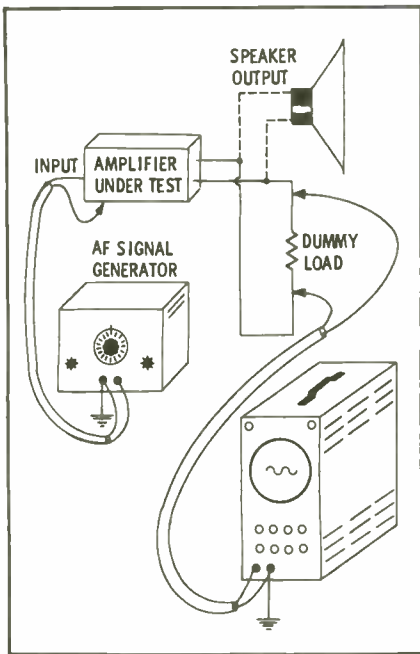

Fig. 9. How to use the "Handscope" to check for audio amplifier distortion.

of the scope to 500 cps—(half the repetition rate of the signal to be viewed so that two complete cycles of the sine wave would be reproduced). Next, I set the signal level of the generator slightly below the point which produced clipping of the sine wave peaks in the output. Under these conditions, the power dissipated in the load should equal approximately the rated power of the amplifier.

To check this point, I measured the AC output voltage across the dummy load and found it to be about 12.5 volts. Knowing that E^2/R equals power, I calculated the output to be roughly 9.8 watts. Since the amplifier under test was rated at 10 watts, this value seemed to be fairly satisfactory. Oftentimes you may find this power figure to be considerably lower than the rated value, or the shape of the output wave might look distorted. This, of course, would indicate trouble in the amplifier and would call for additional troubleshooting procedures. I found, for example, that changing the bias of a stage will usually result in unequal peaks within each cycle. An overload, on the other hand, will generally produce a flattening or clipping of peaks on both halves of the wave. The manual for the Simpson scope outlines several other interesting applications for the instrument and also contains servicing hints, schematic, and complete parts list. ▲

Where PERFORMANCE counts most!



you can depend on AEROVOX CAPACITORS

Set owners today expect and demand top quality service and repairs . . . they won't take less! So, don't gamble with your customers good-will . . . replace those defective or inferior capacitors with AEROVOX units of known and preferred quality. You give your customers the best when you use Aerovox Capacitors.

DURAMIC CERAMIC-CASED TUBULARS . . . Type P84CM paper capacitors are encased in dense steatite for performance above that of conventional paper units. New thermo-setting end seals for exceptional humidity protection. Firmly imbedded leads will not work loose or pull out.

DURANITE MOLDED TUBULARS . . . Type P88N units are molded in a blue permanent rock-hard casing that does not dry out or develop cracks or fissures. Moisture proof operation from sub-zero to 212°F.

VERTICAL MOUNTING TUBULARS . . . Type P151N capacitors are specifically designed for use in printed-wiring chassis. Assembled in molded phenolic case, Aerolene impregnated, thermosetting end-fill, sturdy wire leads for firm mounting.

Ask your local Aerovox Distributor for your copy of the latest Aerovox Catalog.

AEROVOX CORPORATION

DISTRIBUTOR DIVISION

NEW BEDFORD, MASS.

NEW! IMPROVED!

SENCORE
TRC4
TRANSISTOR
CHECKER

Another
Sencore
Time-Saver

America's newest,
most popular test
instruments

NOW CHECKS:

★ **Transistors**
for opens, shorts,
leakage and cur-
rent gain. In-
cludes new
gain test on
power transistors.

★ **Crystal Diodes**
checks forward to reverse
current ratio on all
diodes.

★ **Selenium Rectifiers**
checks forward and re-
verse currents.

Controls are accurately
set for each transistor
by referring to replaceable set-up chart on rear.
Test leads or socket provides for fast hook-up.
See your parts distributor.

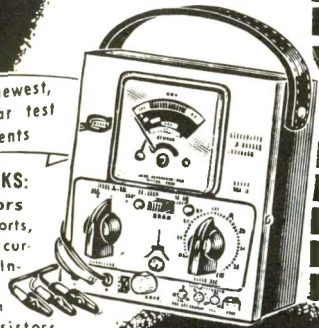

ONLY \$17.95
Dealer Net
SIMPLE TO
OPERATE
Cannot become
obsolete.
Approved by
leading
manufacturers

SENCORE Mfg. by **SERVICE**
INSTRUMENTS CORP.
171 OFFICIAL RD., ADDISON, ILL.

Cut out this ad now for further information

**Grips
the
screw!**

Drives it too!

**Quick-Wedge
SCREW-HOLDING
SCREWDRIVER**

2" to 14" blades, 4 bit sizes.
Available with shockproof
plastic covered tubing
Unconditionally guaranteed



ASK FOR IT AT YOUR DEALER

Kedman Co., 233 South 5th W.,
Salt Lake City, Utah

Across the Bench

(Continued from page 8)

quoted fee of \$70. (Consider for a moment what might have been your feelings under similar circumstances. If you asked yourself the question, "Do I do, or do I don't?" I hope your resolve was, and forever is, *do!* For only by doing are you learning, and learning promotes that great confidence and ability so necessary to a successful servicing business.)

Action

No, the solution wasn't easy. In order to establish customer confidence, it was necessary to exhibit on-the-spot technical skill. And to make sure the job was complete in all respects (there were evidences of fresh soldering at a number of connecting junctions), the receiver would most certainly have to be taken into the shop for the actual repair. In this instance, the receiver was removed from its cabinet and the speaker (a PM without mounted audio transformer) was disconnected. Next, the low-voltage rectifier tube was taken from its socket, and a quick continuity check was made from the 5U4-G socket terminals 2 and 8 to chassis ground. The reading was better than 20,000 ohms, which indicated that the filter capacitors were not shorted. Power was supplied to the receiver and AC voltage measurements were taken at pins 4 and 6 of the 5U4-G socket. The transformer was also felt for any evidence of excessive heat. At both points, a cool 320 volts AC registered on the meter, exactly the value listed for this particular receiver.

Results

The power transformer shorted? Hardly, under these excellent conditions. The customer was so informed and also told that since the short (with the rectifier tube in the circuit) would undoubtedly be difficult to find, the work should be performed in the shop where test aids and equipment were readily available. To this the customer promptly agreed and asked also that the picture tube be checked when the other repairs had been completed. During this time, while I had been making tests, there had been no mention of price. Neither was anything said now—a silent, mutual understanding had been reached. In the eyes of

the customer, I was competent and the bill would be paid.

In the Shop

Needless to say, this is where the fun began. A new 5U4-G was inserted in the tube socket and power was applied. The picture tube lighted momentarily and then the rectifier tube plates began to turn metallic red. The AC was immediately disconnected and a few futile resistance checks were made—no trouble was evident. Now this in itself was a substantial indication, for if no capacitor or transformer was shorting to ground, the only other probability was a tube that, when fired to full potential, would short internally. (All receiving tubes had, of course, been checked with a tester while the set was still in the home, but no shorts were discovered.) A quick look at the schematic seemed to implicate the horizontal output, horizontal multivibrator, damper, audio, and perhaps even the vertical output tubes. How to find the bad one was the problem. I could substitute all of them and come up with a quantitative but not qualitative solution. Since there was some limit on the price (and the CRT had not yet been checked), the qualitative approach was decided upon. The horizontal output tube was replaced first, but the rectifier tube still glowed red. Next, the 6V6 audio amplifier was substituted for; again, the low-voltage rectifier plates glowed angrily, answering my suspicions in the negative. Just by chance, I noticed the damper-tube plate exhibiting the same tell-tale red. Ah, here was the culprit at last. And sure enough it was, for substitution of this tube returned B+ voltages to normal, and the cathode-ray tube lighted again. The big problem had been licked—happy day! But hold up a moment—what about the little

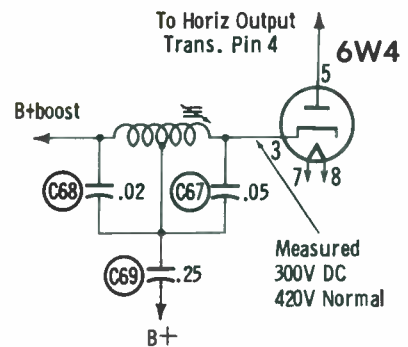

Fig. 2. Voltage on damper cathode measured 300 VDC instead of 420V.

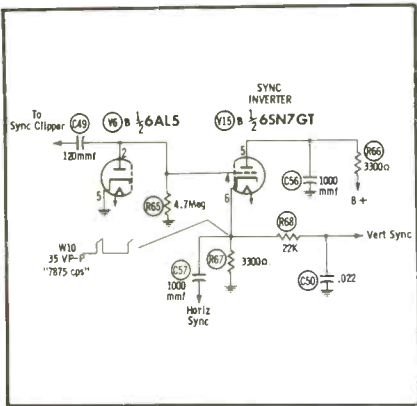

Fig. 3. W10 was incorrect because R67 was improperly wired into the circuit.

problems? And this is where so many television repair shops make their human, but fundamental, mistake. Hurray, they say, it works! But does it? Read on . . .

Much, Much More

What about the smoking condition observed when the receiver was allowed to run in the home? Isn't smoke usually the result of excessive current through a resistor? Notice in Fig. 1 that focus coil T6 and its associated control (R5, 6000 ohms) act as the B+ choke. The element in this potentiometer had been charred, indicated by the rough feeling which was evident when its shaft was rotated. R5 was replaced with an equivalent-value wire-wound control.

Now what about the B+ boost circuit? Could there be any defects that caused the damper tube to go bad? The voltage at pin 3 of the damper (Fig. 2) was down to 300 volts. More tubes? Hardly, the previous tube check was probably reliable. More likely, this fault could be attributed to the capacitors associated with the development of boost voltage. One of the three capacitors was found improperly connected and another, when placed across a capacitance checker and subjected to a potential of 500 volts, proved to be leaky. Just to be safe, all three (.02, .05 and .25 mfd) were replaced and boost returned to a normal 420 volts.

Next, the waveforms for sync tubes V6B, V14 and V15B were checked for shape and amplitude. Essentially, they were within tolerable limits—all, that is, except the 35-volt positive - spike waveform

Popular and Fast Moving . . .

"ILLINI ELECTROMITE CONDENSERS"

Time Tested Quality

Earn greater profits with this quality line of capacitors which are priced to sell. Available in variety of sizes with flexible leads or tinned pigtail leads. Attractively packed 10 to colorful display box. One full year unconditional guarantee. Write for catalog. SOLD THROUGH RECOGNIZED DISTRIBUTORS EVERYWHERE

Telephone: EVERglade 4-1300

ILLINOIS CONDENSER COMPANY

1616 N. Throop Street • Chicago 22, Illinois

Pure Rice's

OFFICIAL ORDER BOOK

for every TV-Radio service call

CONVENIENT! EASY TO USE!

Simplify your record-keeping with these convenient triplicate forms. They serve as order form, invoice and office record, with spaces for complete information on every job. Separate listings for receiving tubes, picture tubes, parts, serial numbers, labor and tax charges, etc. 75c a book, \$6.50 for money-saving dust-proof box of 10.

In stock at your distributor

ELECTRONIC PUBLISHING CO. INC.

180 North Wacker Drive Chicago 6, Illinois

TEST LEADS

KLIPZON & STANDARD

Complete line of quality test leads for every application. Choice of prods, tips and handles.

G-C UNIVERSAL TYPE TEST LEADS
50" leads with 6" unbreakable plastic handles. Heavy duty; complete set of tips.
No. 8463... List \$3.00

G-C MASTER LINE TEST LEADS
Heavy duty, 6,000 volts; solderless type. Well-insulated handles.
No. 5050... List \$1.85

G-C KLIPZON TEST PRODS & LEADS
4' leads with Tenite handles. Clip-on jaws of prods free both hands.
No. 5608... List \$3.25
FREE CATALOG... WRITE TODAY!

GENERAL CEMENT MFG. CO.

division of TEXTRON INC.
Western Plant: Los Angeles 18, Calif.
Main Plant **ROCKFORD, ILLINOIS, U.S.A.**

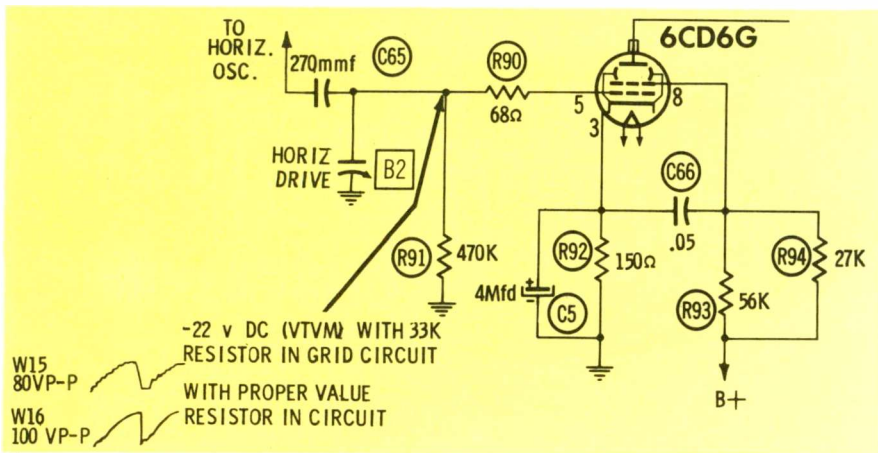

Fig. 4. Distortion of 6CD6 grid waveform was traced to incorrect value for R90.

W10 at the cathode of V15B in Fig. 3. Here, it was found that R67 had been connected *into* the circuit instead of from cathode to ground. By changing the circuit to conform with the diagram, the waveform specifications were satisfied.

Making a further check, the peak voltage at the grid of V19, the horizontal output amplifier, was measured. Here, the waveform amplitude was essentially correct, yet the shape was considerably distorted. The top was unduly flattened (W15 in Fig. 4) and there were transients along the leading edge. A glance at the input grid resistor provided the answer. The color code was three orange rings. No wonder the poor waveform appeared out of shape—the value for R90 (which is always low) given by the manufacturer was a mere 68 ohms, not the huge 33,000 ohms that was in the circuit. The resistor was immediately replaced, and not only did the wave-shape return to a modified sawtooth (W16 in Fig. 4), but it also increased in amplitude by 20 volts! Three weak tubes in the video IF strip (discovered during tests made in the home) were next replaced and the waveform at the plate of the video output amplifier came up from 60 volts to slightly more than 80 volts peak-to-peak.

Now, it was time to check the picture tube for a hint of the distortion that had been noted at the plate of the 6AC7 video amplifier. A CRT adapter used in conjunction with the tube tester quickly confirmed the suspicion that the picture tube was shorted.

Back to the Customer

After several additional voltage and oscilloscope waveform checks had been made to firmly resolve the satisfactory over-all operation of the receiver, the customer was called. All circuit defects and their repairs were carefully reported before news of the defective cathode ray tube was gently broken. The customer "never even blinked" as the saying goes.

"Replace it," the husband said, "and bring me the bill." We returned the repaired receiver to his home in fine operating condition with a new 17BP4-B brightly lighting the way. The bill? Labor was a flat \$20 . . . you figure the parts. ▲

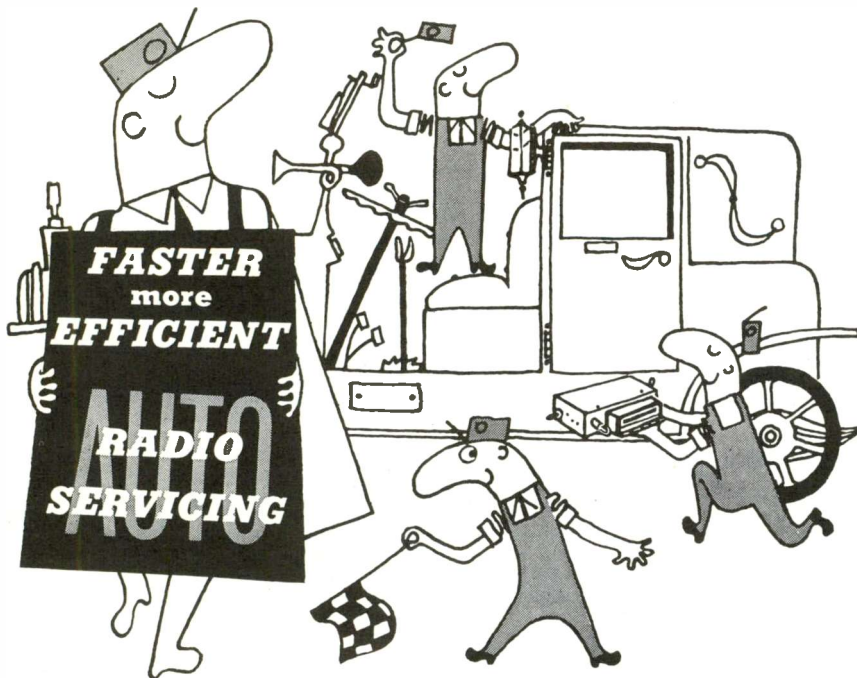

with the **NEW**

STANCOR®

AUTO RADIO

TRANSFORMER

Replacement Guide



FREE! The most complete auto radio guide ever published! This new Stancor service reference lists over 800 models of 39 auto radio manufacturers, including private label brands. They are indexed by manufacturer, model number and year—for quick location of the part you need—from Stancor's extensive line of exact replacement vibrators and audios . . . including replacements for the new transistor auto radios. Get your copy now from your Stancor distributor or by writing to Chicago Standard.

CHICAGO STANDARD TRANSFORMER CORPORATION

3503 ADDISON STREET • CHICAGO 18, ILLINOIS

Export Sales: Roburn Agencies, Inc., 431 Greenwich Street, New York 13, N. Y.



Troubleshooting Transistor Radios

(Continued from page 15)

tuning capacitor (Fig. 6) are generally equal in size and capacity. The latter is of particular importance since it makes differentiation between RF and oscillator sections a bit more difficult. The loop is always a handy guide in this respect because one end always connects to the RF section of the tuning gang. This will keep you from turning the wrong trimmers during the alignment procedure. The addition of the adjustable oscillator coil complicates tracking adjustments slightly because the coil must be set at the low end and the oscillator trimmer at the high end. This procedure must then be repeated at least twice to achieve optimum oscillator tracking.

RF Tracking

Alignment instructions normally specify that the RF trimmer should be adjusted at approximately 1500 kc, which usually results in acceptable tracking of the RF section. Generally, however, improvements in performance can be made even after it has been aligned as prescribed. Remember that transistor radios, like everything else, are mass-produced—a factor considered in their design. Here is a check which quickly indicates whether or not further improvement is possible: Bring your hand near the loop antenna of the receiver; if the desired sound increases in volume, improvement can be made. If the noise level goes up, but the desired sound remains steady, no improvement can be made.

If sound level increases, and you

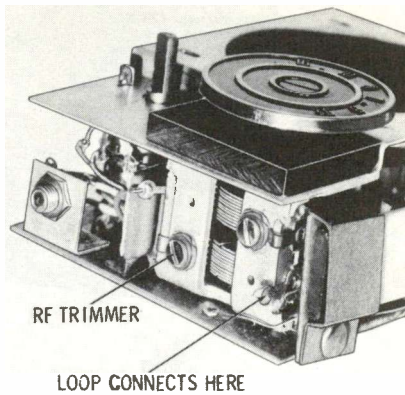
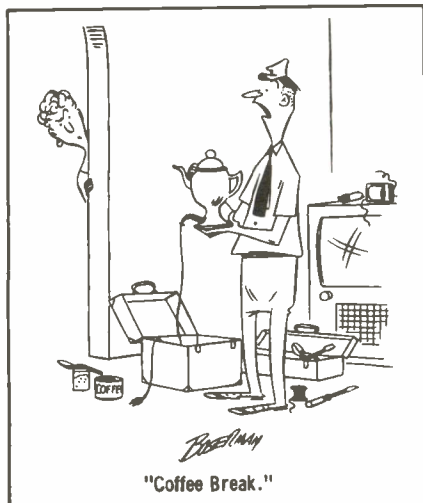
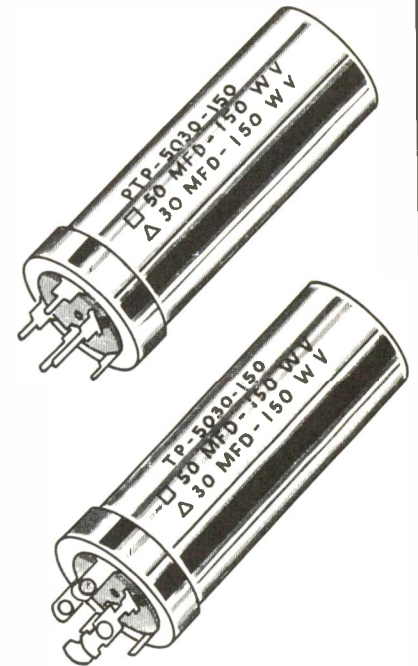

Fig. 6. Loop antenna hooked to tuning gang helps to identify the RF section.

wish to improve performance, unwind a couple of turns from the end of the larger loop winding (Fig. 7) and reverse-wind one turn. Set the signal generator frequency and the station indicator to about 1100 kc and adjust the RF trimmer to produce maximum VTVM indication. Repeat the hand test with the receiver tuned to a local station near the high end of the band. If maximum performance is now indicated, remove the reversed turn and an additional turn. After cutting off all excess wire, resolder the shortened coil to the tuning capacitor. Retune

Now . . .

Planet offers you
exact replacement
Twist Prong Can
Capacitors in both
Solder Lug and
Printed Board
Construction



Planet Twist Prong Can Electrolytics are the choice of many top TV and electronic equipment makers. These firms use Planet "TP's" because of uniform quality, workmanlike construction and freedom from field troubles. Now Planet is making these same values and sizes available to you, the men who service this equipment. Ask for Planet "TP's" by name at your parts distributor.

We will send you our catalog listing upon request.

PLANET SALES CORPORATION

BLOOMFIELD, NEW JERSEY

TRANSISTOR RADIO REPAIRS NOW EASY!



with this
NEW *Howard W. Sams* BOOK
"SERVICING
TRANSISTOR RADIOS"
COMPLETE ANALYSIS OF 70 POPULAR
TRANSISTOR RADIO MODELS

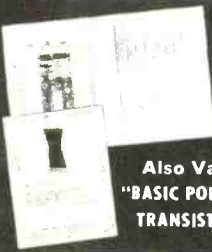

includes new
General Motors
(Delco)
Transistorized
Auto-Portable
Radio

Also Valuable Section—
"BASIC POINTERS ON SERVICING
TRANSISTORIZED RADIOS"...

COVERS LATEST MAKES AND MODELS

This book helps you earn big profits on Transistor Radio repairs—gives you complete, time-saving information—helps you become an expert on transistorized radios! Complete data on 70 latest models is based on actual lab analysis of each set. You get the famous Sams Standard Notation schematics—accurate, big, legible; full photo views of each chassis, with all components identified; complete alignment instructions; complete parts lists with full replacement data—everything you need to be successful in fast-growing transistorized radio servicing. Here's a "must" book for your bench. Order it now!
152 pages; 8½ x 11" **\$295**
PRICE ONLY.....

SEE THIS BOOK AT YOUR SAMS
DISTRIBUTOR OR MAIL COUPON

FREE TRIAL COUPON

Howard W. Sams & Co., Inc., Dept. 3-MH8
2201 E. 46th St., Indianapolis 5, Ind.

Send me Sams "Servicing Transistor Radios" for 10 days
FREE examination. In 10 days I will pay for the book, plus
few cents delivery cost, or return postpaid.

We pay delivery costs if you remit with this coupon;
same return privilege.

Name _____

Address _____

City _____ Zone _____ State _____
(Outside U.S.A. priced slightly higher)

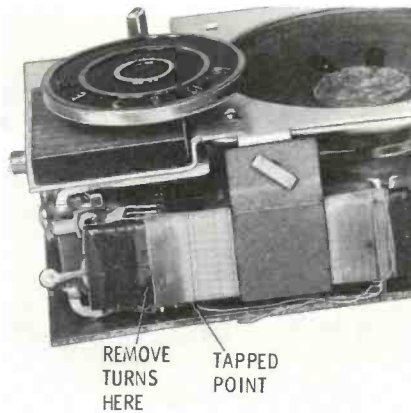

Fig. 7. Removing turns from this end of antenna loop helps improve RF tracking.

the RF trimmer to 1100 kc as before and repeat the hand check. Continue this process until optimum performance is indicated.

When optimum RF tracking is obtained, the RF trimmer capacitor will be about one-quarter turn from tight. Continue to remove turns from the loop and readjust the trimmer until this condition has been achieved. Once you have become familiar with this procedure, it can be completed in about 10 minutes. The improved performance of the radio will amaze you and overwhelm your customer.

Component Replacement

Many of the small, low-voltage replacement electrolytics have exposed metal cases. A single layer of plastic tape (Fig. 8) will prevent shorts or leakage that could damage other components or shorten battery life.

Because printed wiring and extreme miniaturization are employed

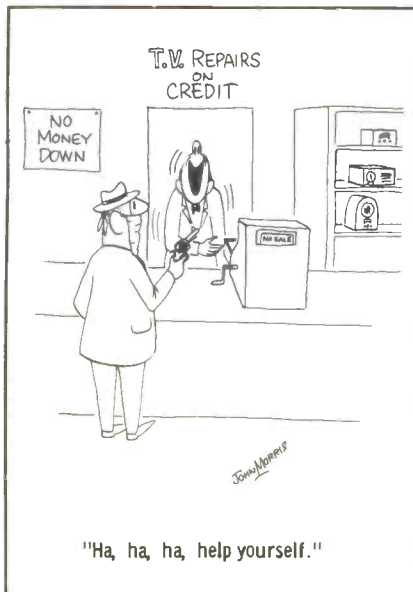

"Ha, ha, ha, help yourself."

WILL YOUR REPLACEMENT Fuse Resistor BURN OUT AGAIN?

Not if you use—
The NEW SENCORE
"FUSE-SAFE"
CIRCUIT TESTER

Another Sencore Time-Saver



Individual scale for each value fuse resistor — no interpretation, just read in red or green area.

★ Measures line current and up to 1100 watts of power at 115 volts using line cord and socket.

★ Two convenient current ranges — 0 to 2 amps and 0 to 10 amps. Test leads clip in place of fuse or fuse resistor.

★ 5 ohm, 10 watt resistor prevents TV circuit damage and simulates operating conditions.

As Recommended by Leading Manufacturers

Mfg. by **SENCORE** SERVICE INSTRUMENTS CORP.
171 OFFICIAL RD., ADDISON, ILL.

Cut out this ad now for further information

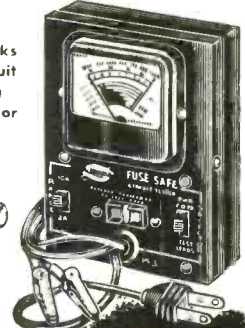

\$895 DEALER NET
MODEL FS-3
AC-DC or both as needed for Fuse Resistor Circuits

New!



Dynamic Picture Tube Tester Makes Skeptical Set-Owners Satisfied Customers!

Pix-Chex gives proof positive of picture tube failure to skeptical set-owners... and you! You prove your point when you point to your Pix-Chex indicator. Answers all questions for you and your customers yet easily fits your pocket... and your pocketbook!

- CHECKS EMISSION
- Checks picture tube in set, in the box or on the bench.
- Transformer powered.
- Checks grid-cathode short.

\$495 ONLY NET

- Checks heater-cathode short.
- Detects shorts up to 50,000 ohms.
- Checks filament.
- No gimmick rejuvenators.

Available at your jobbers



HALLMARK ELECTRONICS CORP.
3104 Spring Garden St.
Philadelphia 4, Pennsylvania
BA 2-4333

MAKE YOUR STANDARD TEST PRODS
TEN TIMES
 MORE EFFECTIVE *IN SECONDS*
 WITH THE **E-Z-HOOK TIP**
 CONVERTS YOUR STANDARD TEST PROD
 TO A SELF-HOLDING CONNECTOR

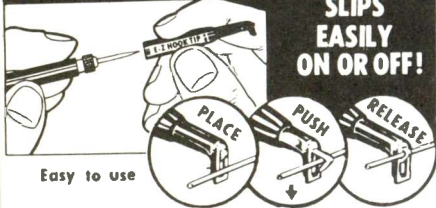

Easy to use

**SLIPS
 EASILY
 ON OR OFF!**

Here are the TEN E-Z-Hook Tip advantages:

1. Easy to attach — slips easily over test prod tip.
2. Stays on—special chuck holds tip firmly on prod.
3. Easy to connect or disconnect — patented design operates with light forward pressure.
4. Safer checks — hands stay clear of wiring.
5. Won't slip off — exclusive hook design clamps firmly around conductor.
6. Eliminates intermittents — spring pressure insures positive contact.
7. Eliminates adjacent shorts — insulated design gives maximum protection.
8. Connects anywhere — fits large or irregular shaped conductors.
9. Frees your hands — holds test prod for you.
10. Makes testing easier — saves time — eliminates aggravation.

No. 56-1 E-Z-HOOK Tip Only 89c ea.



ORDER THROUGH YOUR
 PARTS DISTRIBUTOR

E-Z-HOOK TEST PRODUCTS
 Dept. F 2, 1536 Woodburn Ave.
 Covington, Ky.

Canadian Rep.: Len Finkler & Co., Toronto, Ontario

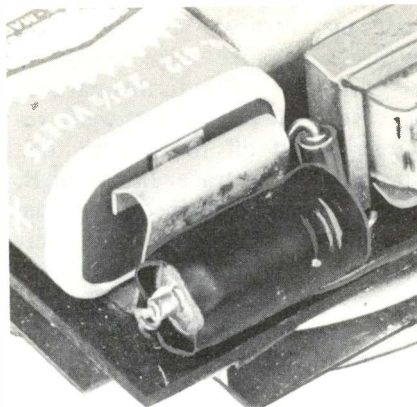

Fig. 8. Use of plastic tape to insulate the bodies of electrolytic replacements.

in most transistor radios, only resistors, electrolytics (single section), loop antennas and batteries are considered to be standard replacement items. You should have exact replacements or identical substitute units for tuning capacitors, volume controls, IF transformers, oscillator transformers, transistors, and audio transformers.

As a final test for a transistor radio you've just repaired, take it along with you on home service calls. Play it in the presence of your customers. You might drum up some additional sales and the radio will also receive the necessary air test. ▲

YOUR BEST BUY!

TV
 HEATERS - IN - SERIES

RESISTORS

LICK THAT
 CRITICAL PROBLEM

20 WATT—19, 21, 22, 25, 33
 35, 42, 44, 47, etc., OHMS

Your jobber has them or
 can get them for you.

**MILWAUKEE
 RESISTOR
 CO.**

700 WEST VIRGINIA STREET
 MILWAUKEE 4, WISCONSIN

ABOUT THE COVER

The beach is a wonderful place to spend an afternoon relaxing in the sun and reading your favorite magazine — but how can a guy enjoy himself with some dame pestering him all the time! (Who wants to play when there's a new issue of PF Reporter available.)

Seriously though, this month's cover photo is our idea of how a typical reader might spend some of his leisure summer hours—if he can bear to tear himself away from the bench, that is.

If you won't be taking a vacation this year because you're too busy, it could be our fault — in which case, we're sorry. We've spent all our time concentrating on ways to help you increase your business and completely forgot that you might be adverse to leaving these money-making ventures to enjoy a well-earned rest. We hope the cover scene will change your mind.

**FAST!
 ACCURATE!**

SECO Test Equipment

Saves time . . . makes
 more money for you!

WRITE TODAY FOR COMPLETE
 SPECIFICATIONS AND FEATURES!

- Outstanding Reliability and Performance!
- Unique, Time-Saving Features!
- Low First Cost Makes You Money From the Start!

107 TUBE TESTER—

Outstanding performance and accuracy — provides 3 important tests: amplifier types tested for gain by Dynamic Mutual Conductance method—power types tested for cathode current by Cathode Emission method—all types tested for shorts and grid error by Grid Circuit Test developed and patented by Seco. Dynamic Mutual Conductance Test pre-wired to eliminate elaborate set-up. Cathode Emission Test done by free point pin-selector method—will not be obsolete. Completely self-contained in portable carrying case. Furnished with handy flip chart for fast tube set-up data.



MODEL 107 \$139.50 NET

GCT-8 GRID CIRCUIT TUBE TESTER

—Perfect companion to any tester—checks critical "control grid" condition of vacuum tubes fast, accurately. Electron eye tube indicates faults at a glance. As many as eleven simultaneous checks—automatically.



MODEL GCT-8—Kit \$19.95 NET
 MODEL GCT-B—Wired & tested 29.95 NET



208V TVM — "Fool-proof"—many new features! Easy - to - read 4½" 200 microamp meter mounted on sloping panel — 7 DC, 7 AC, 7 ordinary Ohm ranges, plus RETMA (EIA) Ohm scale to check standard color-coded resistance values and tolerance limits. Specially designed "shift-lever" type function switch identifies and automatically connects proper probe. With stand, 40" leads, and common lead with clip.

MODEL 208 \$74.50 NET
 Leather, felt-lined carrying case. \$9.95 NET



PS-2 BATTERY ELIMINATOR—Compact unit takes place of battery normally used to operate and service low-powered transistorized equipment. Supplies clean, filtered DC — can't be damaged by a short. Quickly spots faulty batteries by substitution. Output continuously variable from 0 to 15 V.—ideal for experimenters. Complete with jacks, leads, and clips.

MODEL PS-2 \$13.95 NET

FB-4 FLYBACK CIRCUIT AND INDUCTANCE ANALYZER—Quick "yes" or "no" answer on condition of flyback transformer and yoke—100% accuracy! Resonant frequency and "Q" meter principle used—will not be obsolete. No disconnecting—no charting—checks complete horizontal coil circuit. Complete with self-contained power supply and matched 18" leads.

MODEL FB-4 \$38.95 NET

FP-1 FILAMENT CONTINUITY CHECKER AND 90 VOLT BIAS SUPPLY PACK—Checks continuity of TV and radio-type tubes—perfect for many bias substitution jobs.

MODEL FP-1 \$12.95 NET

Get the complete story on Seco's exciting line of test equipment. See your distributor—or write for complete information today!

SECO MANUFACTURING CO.



5015 Penn Avenue So.
 Minneapolis, Minn.

Vertical Retrace

(Continued from page 11)

transformer secondary (or the vertical yoke windings) may be of either polarity, depending on receiver design. Usually, the polarity of the secondary winding is not indicated schematically, and if unknown, a scope may have to be employed to determine which it is.

Vertical Blanking Circuits

Several typical retrace elimination circuits are shown in Fig. 6. In circuit A, there is a direct connection

This is the 2-Set TV COUPLER

Rated No. 1

• • • by a nationally known independent product quality rating group as the result of tests made on 10 leading two-set couplers for:

- IMPEDANCE MATCH
- SIGNAL TRANSFER
- TWO-SET ISOLATION

MOSLEY 902



List Price \$3.10

Rated **FIRST** in overall quality for weak signal reception means; the MOSLEY 902 Dual Match 2-Set TV Coupler can be sold and installed in practically any TV area with full confidence that your customers will be completely satisfied!

Available at Radio and Television Parts Distributors — coast-to-coast.

Mosley
Electronics, Inc.
8622 ST. CHARLES ROCK ROAD
ST. LOUIS 14, MISSOURI

from the vertical yoke windings (where a negative spike exists) to the grid of the CRT. In this particular case, 100-volt pulses were required to cut off the picture tube during vertical retrace. In circuit B, a spike is also obtained from the yoke, except that here an RC network is used instead of a direct connection. The schematic of Fig. 6C shows a circuit employing a vertical output transformer of the autotransformer type, with a capacitive-divider network to supply a positive spike from a tap on the transformer to the picture tube cathode.

In circuit D, blanking pulses are taken from the plate of the vertical oscillator tube. This blanking circuit happens to be part of the sawtooth-forming network of the oscillator. Its circuit explanation is as follows: C56 is the sawtooth-forming capacitor which provides a signal to drive the vertical output tube. During the vertical oscillator quiescent period (vertical trace time), C56 charges with the indicated polarity through resistors R4, R42, R43 and R44. The positive voltage drop across R43 does not cut off the picture tube beam, which is exactly what is desired during vertical trace time.

When the vertical oscillator conducts (during retrace time), C56 discharges through R43, R44, the vertical oscillator tube, and the primary of T1. The polarity across R43 is thus reversed, biasing the picture tube sufficiently to effect beam cutoff. (Note that the voltage produced is a 30-volt negative spike at the picture tube grid.)

In Fig. 6E, the vertical blanking circuit consists of several RC components and a vertical blanking tube. The tube is an ordinary triode amplifier which serves to amplify the blanking pulse before it is applied to the CRT grid. Ordinarily, the vertical output signal (or the high-side of the vertical output transformer primary) connects to the picture tube cathode (Fig. 5) since its spikes are positive; however, because the vertical blanking amplifier reverses the polarity of the spikes, its output is fed to the picture tube grid.

Example F in Fig. 6 illustrates the vertical blanking circuit used in a color set which, you'll notice, also employs a horizontal blanking circuit. Both circuits are cathode fol-

lowers. In the vertical blanking circuit, the high side of the vertical output transformer primary is fed to the grid of a blanking tube and the output is taken from its cathode. The cathode follower is used to prevent loading of the video amplifier. Because the output signal of the cathode follower is not reversed in phase from its input, the take-off voltage is fed to the picture tube cathode.

It was mentioned earlier that the vertical blanking circuit usually connects to the undriven picture tube element in order to minimize video amplifier loading. Nevertheless, the vertical blanking circuit of Fig. 6G and the video amplifier both feed the three cathodes of the color picture tube. Isolation between the two circuits is maintained, however, by use of isolation transformer L23.

Installing Blanking Circuits

If a receiver displaying retrace lines does not employ a blanking circuit and a fault in the video output or picture tube circuits is not the cause, any of the circuits shown in Fig. 6 may be used. It may be nec-

**FINEST TESTER-MERCHANDISER
EVER DEVELOPED**

Vis-U-All

self service
**TUBE
TESTER**

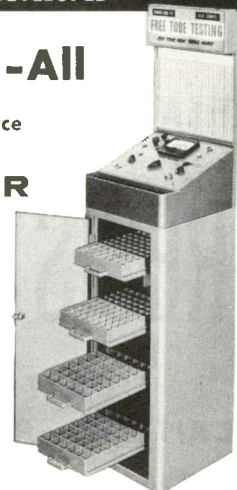

Model V 11

Counter model
also available

Features only six tube sockets for simple operation, yet tests over 600 types of radio-TV tubes. Occupies minimum floor space, only 15" x 15". Most obsolescence-proof, has master-switch dial control to accommodate new tubes. Attractively designed, ruggedly built. Big tube storage capacity. And it's only \$199.95!

See your distributor or write for full details.

VIS-U-ALL products company
303 Fuller N.E., Grand Rapids 3, Mich.

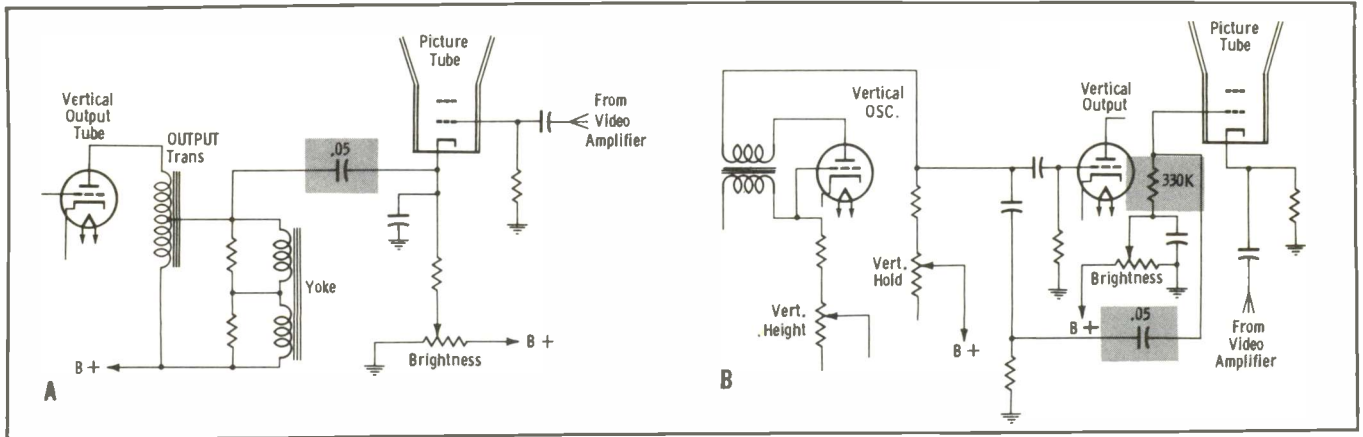

Fig. 7. Blanking pulse networks for picture tube cathode and picture tube grid.

essary in some cases to alter the values of resistors and capacitors in the circuit to conform with picture tube operating characteristics and p-p signal voltage in the vertical sweep circuit.

Fig. 7A shows a simple way to install a vertical blanking circuit. Simply connect a 0.05-mfd capacitor from the tap on the vertical output transformer or from the output tube plate directly to the picture tube cathode. If the peak-to-peak voltage of the spike is too high (say, over 100 volts), insert a 100K- to 220K-ohm resistor in series with the capacitor. If the connection is made to the secondary of an isolation-type transformer, then use a 10K-ohm resistor.

When the video amplifier drives the picture tube cathode instead of the grid, connect the 0.05-mfd capacitor as shown in Fig. 7B. In this circuit, the coupling capacitor connects from the junction of C1 and R1 of the sawtooth-forming network to the picture tube grid. If the picture tube does not contain a large-value resistor between the brightness control and grid, then insert a 330K resistor as shown. Otherwise, you may find the blanking signal being shunted to ground through B+ filters or a grid-bypass capacitor.

When choosing a point in the vertical sweep circuit from which to obtain a spike, try to use a voltage of about 30 to 50 volts p-p. Sometimes, however, a pulse voltage as high as 100 volts may be needed for adequate blanking. Check waveforms of the circuit to determine the peak-to-peak values if they are not known. When higher than needed, install a divider network similar to those shown in Fig. 6. ▲

independent
survey
shows



Why do electronic technicians prefer Quam speakers? In filling out their survey questionnaires, they mentioned such reasons as:

- Adjust-a-Cone Suspension
- High quality dependable performance
- Adjustable mounting bracket
- Better construction
- No call-backs

Thank you, Mr. Serviceman. We appreciate the vote of confidence.

QUAM
is
first
again!

Brand Name Surveys of Chicago, Illinois, asked 22,000 service technicians from coast to coast, "What brand of replacement speakers do you prefer?" Overwhelmingly, from Maine to California, the preference was for Quam. This is the fifth consecutive year in which Quam speakers have led the Survey.

Ask for Quam, the Quality Line, for all your speaker needs.

QUAM-NICHOLS COMPANY

234 EAST MARQUETTE ROAD • CHICAGO 37, ILLINOIS

CANADA:

A.T.R. Armstrong, Ltd., 700 Weston Road, Toronto 9, Ontario
D. Eldon McLennan, Ltd., 1624 W. Third Avenue, Vancouver 9, B.C.

LEADING SET MAKERS SPECIFY TUNG-SOL

HIGH IN PERFORMANCE

BLUE CHIP
QUALITY



TUNG-SOL®

Magic Mirror Aluminized
PICTURE TUBES

ELECTRON TUBE DIVISION  TUNG-SOL ELECTRIC INC.
NEWARK 4, NEW JERSEY

PRODUCT REPORT

Replacement Flybacks

Rogers has announced three new exact replacement flyback transformers for Bendix and Capehart TV sets. EFR 134 is equivalent to Bendix part number 265075-1, EFR 135 is a replacement for Bendix part 265078-3, and EFR 143 replaces Capehart part 850274B-1.



For further information, check 36U on Literature Card.

Indoor Antenna

Radion has announced a novel indoor antenna, the X-5, which consists of a four-conductor lead wire terminated in a rotary switch. A matching network in the switch housing is adjusted in order to vary the electrical length of the wire and thus adapt the antenna to various reception conditions. List price is \$4.95.



For further information, check 37U on Literature Card.

Self-Service Tube Tester

Vis-U-All is supplying a self-service tube tester to radio-TV service dealers. A floor model with tube storage cabinet (V11) and a counter model (V12) are both available. Either one occupies an area of 15" x 15". Revised tube charts are periodically provided by the manufacturer.



For further information, check 38U on Literature Card.

Test Leads

Alpha has designed a display rack for merchandising test leads. Each pair of leads is individually packaged in a plastic tube, and an assortment of 12 different combinations of test prods and meter tips is available. All leads are 50" long, contain a No. 18-gauge conductor, and have high-dielectric rubber insulation.



For further information, check 39U on Literature Card.

Selenium Rectifiers

IT & T Components Div. has announced a new line of Federal selenium rectifiers known as the "Golden Eight." Two styles of potted dual diodes are available for horizontal AFC applications, and there are six different B+ rectifiers with ratings that range from 65 to 600 ma at 130 volts.

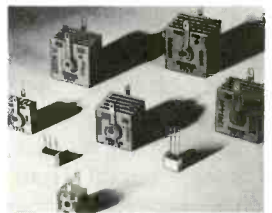

For further information, check 40U on Literature Card.

Neon Lamps

Circon has developed a new subminiature neon lamp, Type NE2R, for indicator, panel light, and computer applications. No external current-limiting resistor is required, since the necessary current-control network is built in. The standard version is for 110/125 VAC operation.

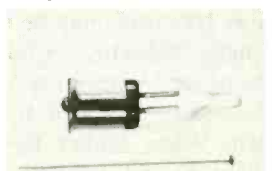

For further information, check 41U on Literature Card.

Chassis Punches

Walsco has introduced a new line of "L. T." (low-torque) chassis punches. A new "electro-coating" process, applied to the steel used in these punches, is claimed to reduce friction between parts so that 50% less torque is required to cut through metal. Available in the new line are all standard sizes of punches needed for cutting round, square, key, and "D" holes in chassis.

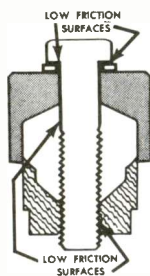

For further information, check 42U on Literature Card.

Miniature Multimeter

British Industries Corp. is importing the English-made AVO "Multiminor," a miniaturized volt-ohm-milliammeter that measures DC voltages from 2 mv to 1 kv at 10K ohms per volt; AC voltages from 200 mv to 1 kv; DC current from 2 ua to 1 amp.; and resistance from 5 ohms to 2 megohms.



For further information, check 43U on Literature Card.

Transistorized Inverters

Universal Transistor Products Corp. is marketing an extensive line of completely transistorized DC-to-AC static inverters featuring extremely small size and light weight. Some units develop 115 VAC at 60 cps from a 6- or 12-volt source and therefore would be suitable for operating test equipment or small P. A. systems from an auto battery. Others have 24- to 28-volt input for mobile and aircraft applications.

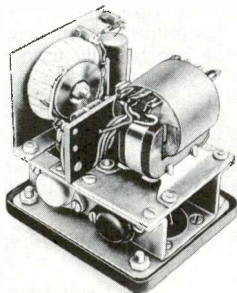

For further information, check 44U on Literature Card.

Multi-Set Couplers

TACO has introduced a new line of balanced resistive couplers for connecting two or more TV sets to the same antenna with minimum interference between the receivers. Indoor two-, three-, and four-set types have list prices of \$2.95, \$3.50 and \$4.25 respectively. Also available are weatherproof two- and three-set couplers.

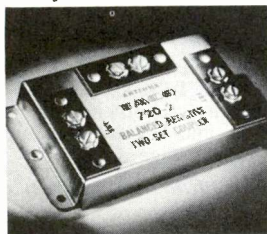

For further information, check 45U on Literature Card.

Circuit Tracer

Hunter Tool Co. is supplying a pocket-sized "Circuitracer" probe for general circuit testing. A lamp in the body of the probe glows to indicate the presence of voltage across the two terminals of the tester. By adding a battery in series with the lamp, the user can trace continuity in circuits with the power off. List price is \$4.95.

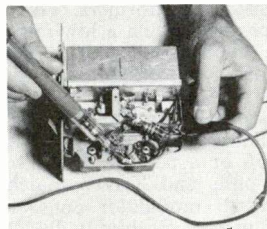

For further information, check 46U on Literature Card.

Printed Circuit Soldering Kit

Ungar has introduced a new No. 270 "De-Soldering Kit" that includes several specially-shaped tips to simplify removal of components from printed wiring boards. One tip is bar-shaped for unsoldering several connections in a straight line; another is cup-shaped for unsoldering a tube socket in one operation; and still another is slotted for straightening component leads while they are being unsoldered.



For further information, check 47U on Literature Card.

LEADING
INDEPENDENT
SERVICE
DEALERS
CHOOSE
TUNG-SOL



TUNG-SOL®
RECEIVING TUBES

ELECTRON TUBE DIVISION TUNG-SOL ELECTRIC INC.
NEWARK 4, NEW JERSEY

For Fast, *SAFE*, Easy Printed Circuit Repair



5 assorted
tips for every
de-soldering
operation

Ungar®

DE-SOLDERING KIT

#270 Popular lightweight pencil handle with 5 assorted tips for every de-soldering operation. Slotted tip that melts solder and straightens bent or folded tube tabs. Bar tip for straight line de-soldering. 3 different size cup tips that de-solder tube tabs and center pin in one simple operation. In goldtone metal case. List \$5.95 each.



Morris Weisenberg, Chief Technician
Universal TV Co., Los Angeles, Soys...

**"We Save 70% of Time and Temper
In De-Soldering Printed Circuits..."**

"As one of the largest service organizations, with a fleet of 28 trucks, saving time for our 45 personnel is important. In the past, we found that regular soldering irons and tips, when used for de-soldering, would break off lugs or ruin the printed board.

Ungar's De-Soldering Kits permit the easy, quick removal of multi-lug components without disturbing printed wire continuity. Any part is speedily removed without damage."

Write for complete details and new catalog

Ungar Electric Tools, Inc.

4101 Redwood Avenue, Los Angeles 66, California

Stereo Conversion Kit

Walco has announced a kit for converting moderately-priced phonographs for stereo operation. Included are a 4-watt push-pull amplifier, two tone controls, a 6" speaker and cabinet with baffles, and a four-wire stereo cartridge. List price is \$59.95.

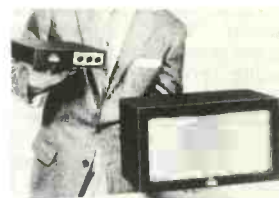

For further information, check 48U on Literature Card.

110° Check Tube

CBS-Hytron has introduced an 8" test picture tube, Type 8JP4, with 110° deflection and aluminized screen. The base is of the small-button (miniature-pin) type but can be converted to the shell type with an adapter. Other accessories are a patterned plastic mask and a carrying carton.

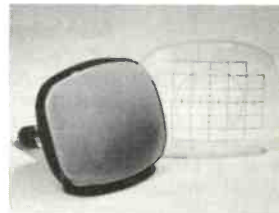

For further information, check 49U on Literature Card.

Yoke Replacement Kit

Triad is offering a "Yoke Pack" containing a replacement stock of most-often used 70° and 90° yokes and accessories. Included are 8 yokes, 25 network kits, yoke clamp CL-1, and centering cover YC-1. Space is provided at the top for storing the Triad 1958 instruction-book catalog.

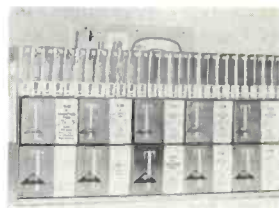

For further information, check 50U on Literature Card.

Ceramic Capacitor Kits

Centralab offers four new kits of "Hi-Kap" ceramic capacitors packed in steel file cabinets. Kit DCK-200 contains 200 tubular ceramic units, DDK-200 includes 200 standard disc types, TCK-80 contains 80 temperature-compensating capacitors, and HVK-150 includes 150 high-voltage discs.

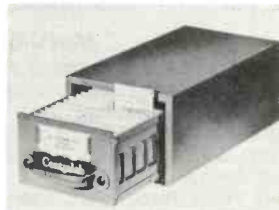

For further information, check 51U on Literature Card.

Transistor Transformers

Chicago Standard Transformer Corp. announces three new transistor transformers. TA-5 is designed to match a low-impedance microphone to the input circuit of a 2N156 or similar transistor; TA-16 is a driver transformer for class-B audio amplifiers employing a single 2N156 or a pair of 2N278's in push-pull; and TA-17 matches a class-B modulator consisting of a pair of push-pull 2N278's to a class-C load.

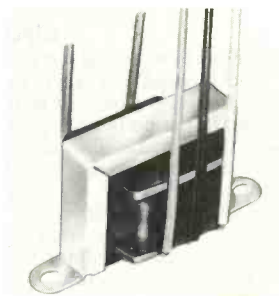

For further information, check 52U on Literature Card.

Mylar Dielectric Capacitors

Aerovox has made available a new "Aerofilm" series of bypass capacitors (Type V84C) with Mylar dielectric and white ceramic cases. These units are claimed to have smaller size, lower power factor, and higher insulation resistance than previous types of molded-tubular bypass capacitors.

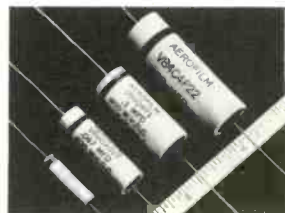

For further information, check 53U on Literature Card.

Wall Receptacles

R-Columbia has introduced a "Switchmatic" wall receptacle for making antenna connections to TV sets. Several of these units can be interconnected and attached to one antenna in such a manner that the unused portion of the system is automatically disconnected when a TV set is plugged into any one of the outlets.

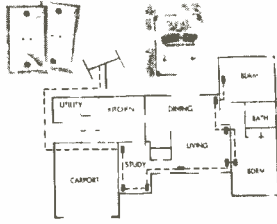

For further information, check 60U on Literature Card.

Tab Mount Controls

Clarostat is now supplying Series B47 tab-mount controls to the radio-TV replacement market. A selection of 25 different resistance values is available. Each control has a 1" phenolic shaft that is both knurled and slotted.

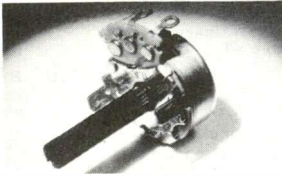

For further information, check 54U on Literature Card.

Hook-Up Wire Kits

New hook-up wire dispenser kits are being offered by Belden. 14 different stock combinations are available; some kits have eight or ten 25-ft. spools of wire with different colored insulation, while various other kits have five 100-ft. spools. Each kit includes a dispenser rack that can be mounted either on the bench or on the wall. A choice of cellulose acetate, vinyl thermoplastic, or Teflon insulation is available.

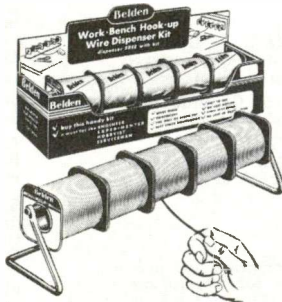

For further information, check 55U on Literature Card.

Replacement Yokes

Ram has announced availability of two new replacement yokes for 110° TV receivers. Type Y-110 is for Admiral 16F1 and related chassis, RCA Victor chassis KCS107 and -109, and Packard-Bell chassis 98D3. Type Y-111 is equipped with a damping network and plug for use with RCA Victor chassis KCS108, -113, -116, and -118. List price is \$22.50 each.

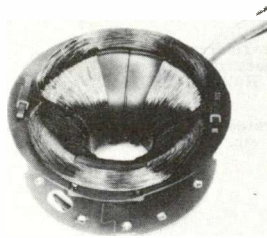

For further information, check 56U on Literature Card.

Stereo Preamp

Grommes new Model 208 provides balanced outputs and necessary equalization through the use of gauged controls. When monaural material is being played, only one of the preamp channels is used to drive both power amplifiers in the system. Net price is \$99.75.

For further information, check 57U on Literature Card.

Antenna Base

South River has announced a new "Bantam" TV tower weighing 3 lbs. and constructed of hot-dip galvanized tubular steel. This tripod-shaped unit is recommended for supporting an antenna on a 5' or 10' aluminum mast without guy wires. Thus loaded, the "Bantam" has withstood extensive wind resistance tests at velocities up to 90 mph.

For further information, check 58U on Literature Card.

P-N-P Transistors

Workman TV has announced a line of 19 p-n-p general-purpose audio and AF transistors, including power output and high-frequency types. The price list (Form No. CS-41) includes a complete cross reference between Workman transistors and comparable types bearing standard "2N" type numbers.

For further information, check 59U on Literature Card.

When Converting Your Phono to Stereo Use ...

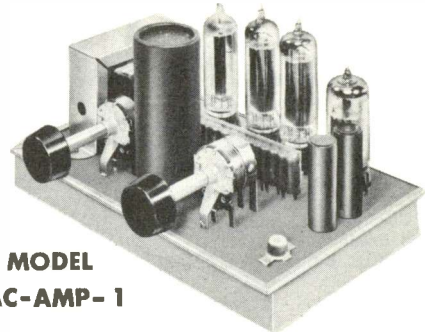

MODEL
PAC-AMP-1

The ERIE AUDIO-AMPLIFIER KIT

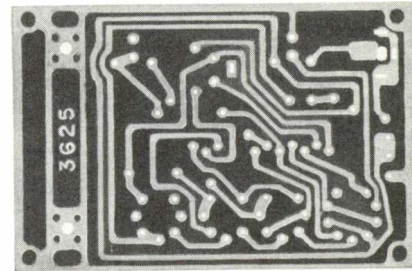
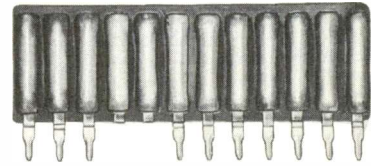

featuring "PAC" and an ERIE Printed Wiring Board

With these Plug-in Components:

- ERIE "PAC" (Pre-Assembled Components)
- ERIE PRINTED BOARD
- OUTPUT TRANSFORMER
- FILTER CAPACITOR
- VOLUME CONTROL and SWITCH
- TUBE SOCKETS
- CAPACITORS
- TONE CONTROL
- TUBES

SPECIFICATIONS FOR ERIE STANDARD AUDIO-AMPLIFIER

- Frequency Response: 30 cycles to 12,000 cycles ± 0 , -3.5 db.
- Sensitivity: 0.56 volt RMS (input at 1 KC) for 2 watt output.
- Power Output: 2 watts • Input Impedance: 2 megohms.
- Output Impedance: 4 ohms • AC Power Consumption: 17 watts.
- Overall Dimensions: 6 $\frac{1}{2}$ " L x 4 $\frac{3}{4}$ " W x 3 $\frac{3}{8}$ " H.
- Shipping Weight: 2 lbs.

See and hear it at your local distributor
or write for nearest source.



Advertiser	Page No.
August, 1958	
Aerovox Corp	51
Affiliated TV Labs	40
Amphenol Electronics Corp.	36
B&K Mfg. Co.	1
Belden Mfg. Co.	47
Bussmann Mfg. Co.	29
Castle TV Tuner Service	48
Centralab, A Div. of Globe-Union, Inc.	41
Chicago Standard Transformer Corp.	54
ClaroStat Mfg. Co., Inc.	5
Cornell-Dubilier Electric Corp.	30, 31
EICO	49
Electronic Publishing Co.	53
Electro-Voice, Inc.	9
Erie Resistor Corp.	63
E-Z-Hook Test Products	57
General Cement Mfg. Co.	50, 53
General Electric Co.	6-7, 45
Hallmark Electronic Corp.	56
Hickok Electrical Instrument Co.	17
Hycon Electronics, Inc.	43
Illinois Condenser Co.	53
International Resistance Co. (IRC)	2nd Cover
Jackson Electrical Instrument Co.	64
Jensen Mfg. Co.	39
Kedman Co.	52
Kingston Electronic Corp.	24
Littelfuse, Inc.	4th Cover
Mallory & Co., Inc., P.R.	34, 35
Merit Coil & Transformer Corp.	48
Milwaukee Resistor Co.	57
Mosley Electronics, Inc.	58
Planet Mfg. Co.	55
Quam-Nichols Co.	59
RCA Electron Tube Div.	21, 3rd Cover
Radiart Corp. — Div. of Cornell-Dubilier Electric Corp.	33
Radio Receptor Co., Inc.	20
Raytheon Corp.	19
Rogers Mfg. Co.	43
Sams & Co., Inc. Howard W.	27, 42, 56
Seco Mfg. Co.	57
Service Instruments Corp.	40, 52, 56
South River Metal Products Co.	49
Sprague Products Co.	2
Sylvania Electric Products, Inc.	23
Tobe Deutschmann Corp.	32
Triad Transformer Corp.	4
Tung-Sol Electric, Inc.	60, 61
United Catalog Publishing, Inc.	50
Ungar Electric Tools, Inc.	65
Vis-U-All Products Co.	58
Walco Electronics Mfg. Co.	37
Webster Electric Co.	25
Wright Steel & Wire Co., G.F.	26
Xcelite, Inc.	26

(Advertisement)

latest JACKSON tube test data

MODEL 648		MODEL 115/715/561	
TUBE TYPE	FIL. D.	FIL. D.	PLATE
7054	12.6 A1234	B579 2BWX	12.6 7 12 5LOS
7055	12.6 235	7 65X	28 5Q
7056	12.6 C123	4 65X	28 6Q
7057	12.6 AC1234	567* 16WY	26 3JKMQ
7057	12.6 A123	A45 41V	17 2LR
7057	12.6 A127	A89 41V	17 4NR
TUBE TYPE	SEC.	A. B. C.	MODEL 49
7054	P	12.6 4 9X	D. CATH. SHORTS
7055	D	12.6 3	1 2376
7055	D	12.6 3	2X. 5 47
7056	P	12.6 3	7X. 1 47
7057	T	12.6 4	X 1567 2 30
7057	T	12.6 4	X 12 3 30
7057	T	12.6 4	X 67 8 30

Latest Chart Form 648-19, 115/715/561-10, 49-4

ACCESSORIES

1U. **E-Z-HOOK** — A convenient reference sheet titled, "How to Build the Five Most Useful Scope Probes," with schematic, mechanical component layout, etc. See ad page 57.

AUDIO EQUIPMENT

2U. **CENTRALAB** — 20-page booklet on a quickly-installed hi-fi compensated volume control that improves the response of radios and phonographs by automatically increasing the volume of frequencies normally lost by ordinary volume controls. See ad page 41.

CABINETS

3U. **OXFORD** — New bass-reflex cabinet catalog illustrates vertical and horizontal positioning and includes data on 3-speaker system with 3-way crossover network. Also catalog on *Tempo* high fidelity speakers.

CAPACITORS

4U. **CORNELL - DUBILIER** — Bulletin XTR-MOT on motor start-run capacitors. See ads pages 30, 31.

5U. **SPRAGUE** — "ABC's of Ceramic Capacitors," a comprehensive brochure on theory and applications. See ad page 2.

6U. **TOBE DEUTSCHMANN** — Capacitor catalog #5701. See ad page 32.

CONTROLS

7U. **CLAROSTAT** — Information on precision potentiometers for prototype work, series 42-900 — 5K to 100K, 3 watts. See ad page 5.

8U. **IRC** — Industrial volume controls, Bulletin DC4C-(50640). See ad 2nd cover.

FUSES

9U. **BUSSMANN** — Quick reference catalog to all types of fuses used in the electronic industry — Bulletin SFUS. See ad page 29.

10U. **LITTELFUSE** — Illustrated price sheet on fuses, fuse-holders, etc. See ad 4th cover.

MICROPHONES

11U. **ELECTRO-VOICE** — Catalog No. 126 on public-address and general-purpose microphones. See ad page 9.

RESISTORS

12U. **MILWAUKEE RESISTOR** — Literature on 51-piece assortment of most wanted 5-10-15 watt replacement wire-wound resistors. See ad page 37.

SALES PROMOTION

13U. **VIS-U-ALL** — Auto-radio service merchandising manual. See ad page 58.

SERVICE AIDS

14U. **ANCHOR** — Colorful catalog sheet on complete *Britener* line, plus several new TV service aids.

15U. **GENERAL CEMENT** — General catalog No. 158 on complete line of products. See ads pages 50, 53.

16U. **HALLMARK** — Catalog sheet and price list on CRT tester. See ad page 56.

17U. **SERVICE INSTRUMENTS** — New complete catalog of all Sencore units. See ads pages 40, 52, 56.

SPEAKERS

18U. **QUAM-NICHOLS** — 1958 speaker catalog listing 111 replacement speakers for outdoor and high-fidelity applications. See ad page 59.

TECHNICAL PUBLICATIONS

19U. **HOWARD W. SAMS** — Descriptive literature on new book, "Servicing Transistor Radios" — plus new 1958 Book List including the latest technical publications on TV, radio, electronics, audio, hi-fi, etc. See ads pages 27, 42 56.

TEST EQUIPMENT

20U. **AFFILIATED TV LABS** — Catalog sheets, literature and sales plans for servicemen on complete line of self-service tube testers. See ad page 40.

21U. **B&K** — Bulletin AP12-R gives helpful information on new point-to-point signal-injection techniques with Model 1075 TV "Analyst"; other bulletins describe "Dyna-Quick" Models 500B, 650, and automatic 675 portable dynamic mutual conductance tube and transistor testers plus Model 400 CRT cathode rejuvenator tester. See ad page 1.

22U. **EICO** — New 1958 16-page catalog shows you how to save 50% on test instruments and hi-fi equipment in both kit and factory-wired form. See ad page 49.

23U. **HICKOK** — 4-page, 2-color brochure on new "Portable Cardmatic Tube and Transistor Tester." See ad page 17.

24U. **JACKSON** — Folder covering entire line of "Service Engineered" test equipment. See ad page 64.

25U. **KINGSTON** — New 12-page catalog describes the complete line of Absorption Analyzers including the new Model PO-1 with a wide variety of direct and electrostatic probes, in addition to Model AC-1 Series-String Pulse Generator, Model BB-1 Variable DC source, and Model PM-1 Probe-Master. See ad page 24.

26U. **RCA** — Form 3F767, flyer on Model, WV-84B ultra-sensitive DC microammeter. Form 3F764, RCA test-equipment line flyer. See ads page 21, 3rd cover.

27U. **TRIPLETT** — Circular on universal VOM-VTVM.

TOOLS

28U. **KEDMAN** — Catalog sheet describing 4 screwdriver displays and specifications of 14 kinds of screwdrivers in the company's line. See ad page 52.

29U. **XCELITE** — Complete tool catalog. See ad page 26.

TRANSFORMERS & COILS

30U. **CHICAGO STANDARD** — 100-page TV Transformer Replacement Guide, cross-referenced for over 7,000 chassis of 98 manufacturers. See ad page 54.

31U. **MERIT** — "Service Technician's Handbook" lists part numbers and prices of products in company's line. See ad page 48.

TUBES

32U. **GENERAL ELECTRIC** — Receiving-tube interchangeability chart. Lists 122 television and radio types which can directly replace 180 others. (ETR-1749). See ads pages 6-7, 45.

33U. **RAYTHEON** — Revised 14-page Television Picture Tube Characteristics booklet includes data on aluminized black-and-white and color tubes, face-plate deflection angle, bulb dimension, ion-trap information, and basing diagrams. See ad page 19.

VIBRATORS

34U. **RADIART** — 1958 Vibrator Supplement Guide. See ad page 33.

WIRE

35U. **COLUMBIA WIRE** — New 4-page supplement to Catalog No. 107.

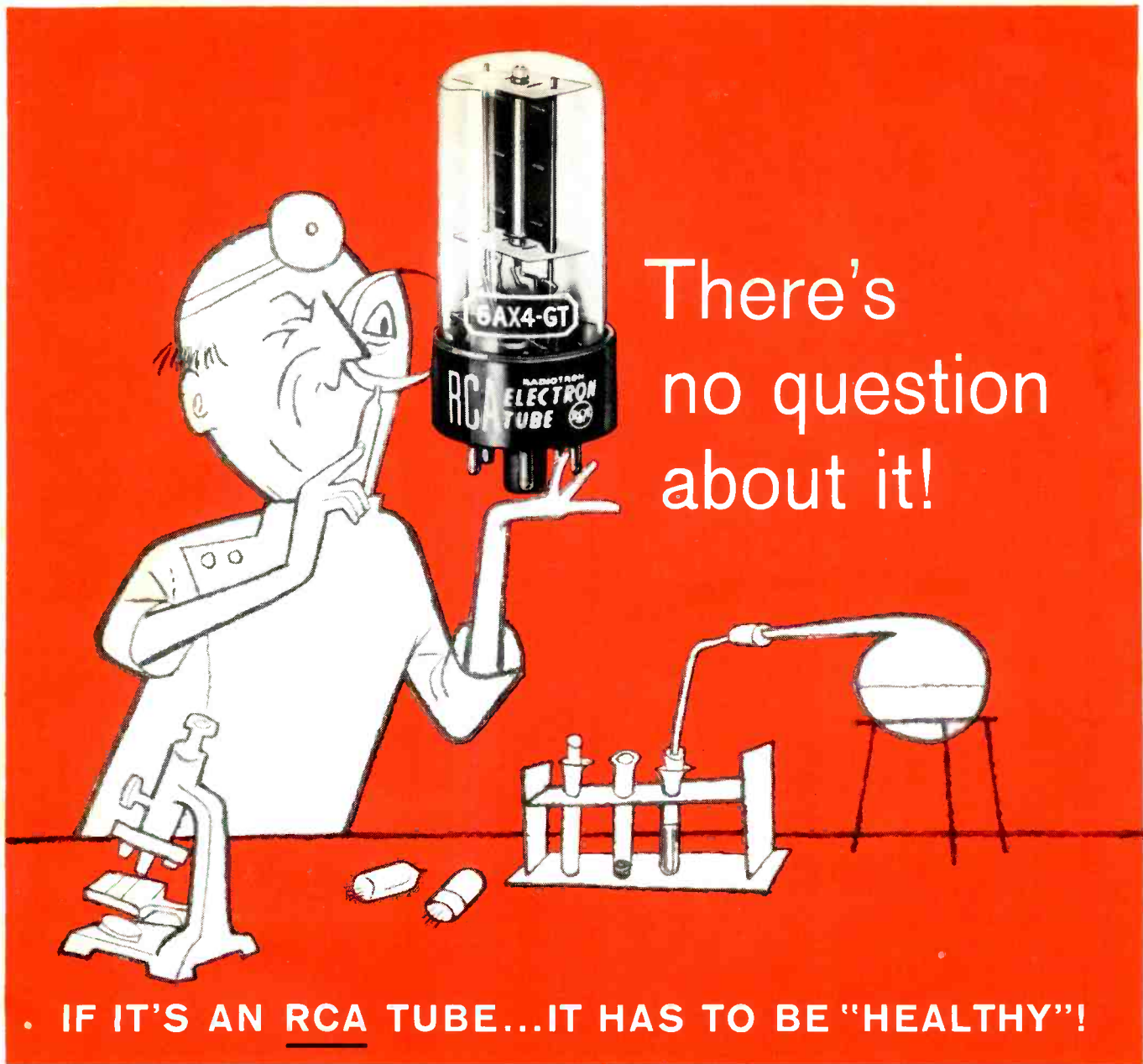

There's
no question
about it!

IF IT'S AN RCA TUBE...IT HAS TO BE "HEALTHY"!

RCA specializes in the production of "healthy" tubes. Take the RCA-6AX4-GT, for example. It features important built-in safety factors that minimize internal breakdowns and "arc-over", reducing early-hour failures—while providing reliable performance in TV damper circuits. Here are some of the ways RCA builds this "good health" into the 6AX4-GT:

Heater wire has been specially developed to improve welds, thereby reducing early-hour failures due to an open circuit at the weld point. Heater-spacer assemblies are pre-fired to eliminate leakage-producing contamination during tube production. And micas are specially sprayed to control plate-to-cathode leakage.

These are some of the reasons why many designers and manufacturers of TV sets specify RCA's 6AX4-GT—the very same reasons why you should always ask your RCA Tube Distributor to "Ship RCA Only"!

**RCA Technical
Booklet Available**

RCA Receiving Tubes and Picture Tubes for AM, FM, and Television Broadcast (1275-H) ... includes socket information and useful data for more than 700 tube types. Ask your RCA Tube Distributor for your copy today!



RADIO CORPORATION OF AMERICA

Electron Tube Division

Harrison, N. J.

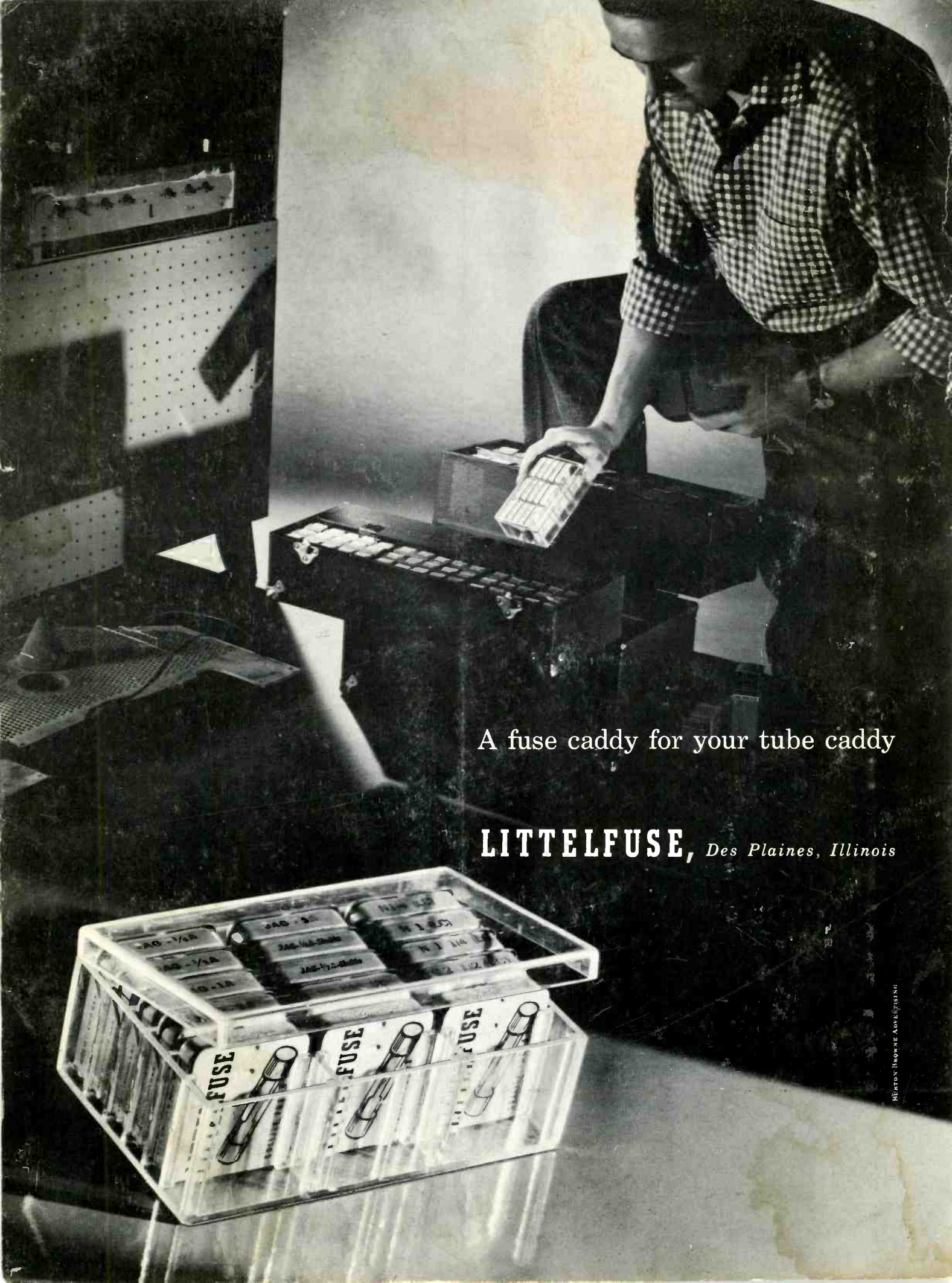

A fuse caddy for your tube caddy

LITTELFUSE, *Des Plaines, Illinois*