



JULY 25 CENTS

RF REPORTER

FOR THE ELECTRONIC SERVICE INDUSTRY



This Month's Highlights

The Modern Vertical Sweep Circuit
(see page 18)

Color Servicing Simplified
(see page 28)

TV Waveforms
(see page 14)

Transistor Application Chart No. 2
(see page 34)

PLUS SUPPLEMENT No. 102-F TO SAMS MASTER INDEX

558

1
5
RICHARD GAHL
4660 L ST
OMAHA 7, NE8



FUSE
RESISTOR

IRC 629
FR 5.6

Stock No.
FR5.6

5.6 ohms



FUSE
RESISTOR

Stock No.
FR5.6

5.6 ohms

IRC "Skin-Packed" Fuse Resistors

CONVENIENT TO BUY—Your IRC Distributor has IRC fuse resistors now on perforated display cards. You can buy one, a dozen or more—each on an individual "skin-packed" card section.

- Improved plug-in type for fast, easy replacement in the newer TV receivers. Terminal pin holes facilitate attaching leads where necessary.
- Featuring sturdy terminal pins—both attached inside a rugged ceramic case.
- "Skin-packed" cards protect each fuse resistor from dirt and handling.
- Available in 2 types—FR5.6 at 5.6 ohms and FR7.5 at 7.5 ohms to meet popular TV requirements.
- Type and range clearly identified on both fuse resistor and "skin-packed" card.

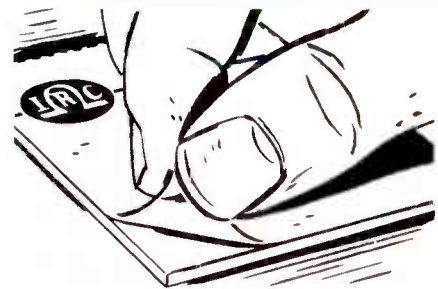

EASY TO STOCK—Heavy card helps prevent breakage or damage... "skin-packing" keeps every fuse resistor factory-fresh. Just peel off plastic skin, and you're all set.

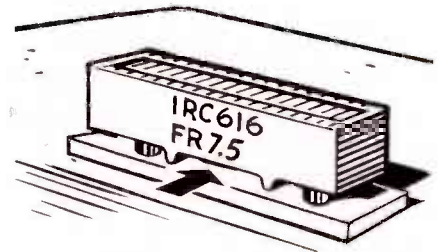

HANDY TO USE—Sturdy terminal pins. Simply plug fuse resistor into receptacle. Projections on bottom of case leave air space so receptacle won't overheat.

ORDER NOW FROM YOUR IRC DISTRIBUTOR

Wherever the Circuit Says



INTERNATIONAL RESISTANCE CO.

Dept. 361, 401 N. Broad St., Phila. 8, Pa.

In Canada: International Resistance Co. Ltd., Toronto, Licensee

MODEL 280SW (shown right)

- Double stacked array PLUS high frequency elements.
- All Aluminum Construction.
- Mounts on any mast up to 1 3/4".
- QUICK-RIG design for speedy one man installation.
- Complete with stacking bars.

MODEL 180SW same as 280SW only not double stacked.

MODEL 180 QUICK-RIG 8 element "Lazy-X" Conical.

MODEL 280 QUICK-RIG double stacked "Lazy-X" Conical.

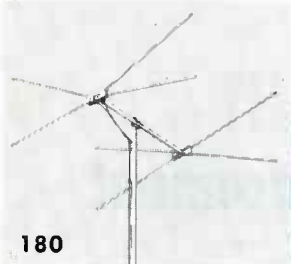

180

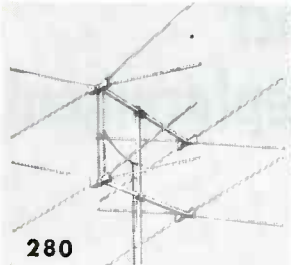

280

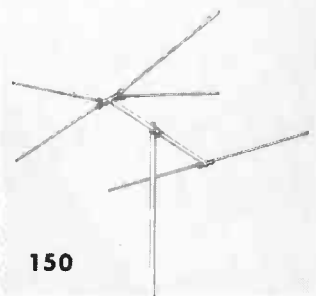

150

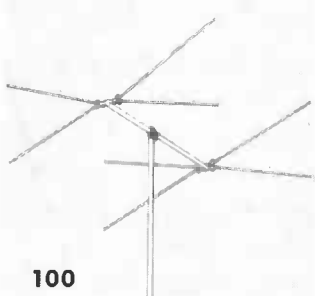

100

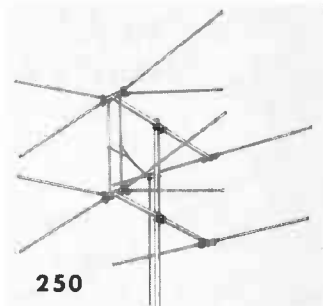

250

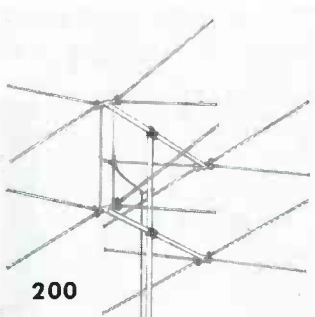

200

Proven Unquestionably . . .
the best performing at
the lowest possible price!

RADIART . . . the name you can depend upon for QUALITY and VALUE . . . offers a COMPLETE . . . and NEWLY ENGINEERED line of superbly performing TV antennas at an economy price. Carefully tested under all conditions . . . each of these new models is guaranteed to be the best performing at the lowest possible price.

- LZX 100 single array
- LZX 101 single array, unassembled
- LZX 200 8 element conical completely assembled, stacked array
- LZX 201 8 element conical unassembled, stacked array
- LZX 150 single array
- LZX 151 single array, unassembled
- LZX 250 6 element conical assembled, stacked array
- LZX 251 6 element conical unassembled, stacked array



THE RADIART CORPORATION / CLEVELAND 13, OHIO

MF C	50+30 MF 150 WVDC	15+15 MF 300 WVDC	40/25 MF 250/25 WVDC	40+40 MF 150 WVDC	60/350
	SPRAGUE	SPRAGUE	SPRAGUE	SPRAGUE	
	TWIST-LOK* LYTIC TVL-2510 20+10 MF 150 WVDC	TWIST-LOK* LYTIC TVL-2575 40+40 MF 300 WVDC	TWIST-LOK* LYTIC TVL-2515 20+20 MF 250 WVDC	TWIST-LOK* LYTIC TVL-2579 60+60 MF 300 WVDC	
	SPRAGUE	SPRAGUE	SPRAGUE	SPRAGUE	
	TWIST-LOK* LYTIC TVL-2438 60+60 MF 150 WVDC	TWIST-LOK* LYTIC TVL-2435 50+50 MF 150 WVDC			
	SPRAGUE	SPRAGUE			
	TWIST-LOK* LYTIC TVL-2430	TWIST-LOK* LYTIC TVL-2435			

for the **RIGHT**
'LYTIC replacement

...use an exact
SPRAGUE replacement



YOU GET EVERYTHING IN A SPRAGUE TVL! *Every* TVL for *every* voltage rating is made with the more expensive high-purity etched-foil anode construction using ultra-stable film formation techniques. Cathodes are etched to meet high ripple requirements. Sprague TVL's give maximum trouble-free service—NO HUM—as well as long shelf life. And they perform just as well in the cold North as they do in the sub-Tropics. Yet this premium quality costs you no more!

That's why Sprague Twist-Lok® electrolytic capacitors are the first choice of leading radio-TV set makers and independent service technicians alike. Insist on TVL's for more exact ratings . . . quality that meets original equipment specifications . . . and all the latest results of capacitor research. WRITE FOR NEW CATALOG C—112

don't be vague...insist on

SPRAGUE®

world's largest capacitor manufacturer

SPRAGUE RESEARCH IS CONSTANTLY PRODUCING NEW AND BETTER CAPACITORS FOR YOU

Sprague Products Company • Distributors' Division of the Sprague Electric Company • North Adams, Massachusetts.

PUBLISHER
Howard W. Sams

GENERAL MANAGER
Mal Parks, Jr.

EDITOR TECHNICAL EDITOR
Glen E. Slutz Verne M. Ray

ASSOCIATE EDITORS

Leslie D. Deane Thomas A. Lesh
Calvin C. Young, Jr.

CONSULTING EDITORS

William E. Burke C. P. Oliphant
Robert B. Dunham George B. Mann
Paul C. Smith

ART DIRECTOR EDITORIAL ASSISTANT
Glenn R. Smith Gwen Bigham

PHOTOGRAPHY CIRCULATION
Robert W. Reed Pat Tidd

ADVERTISING SALES OFFICES

MIDWESTERN

PF REPORTER,
2201 East 46th Street, Indianapolis 5, Ind.
Clifford 1-4531

EASTERN

Paul S. Weil and Donald C. Weil,
39-01 Main Street, Flushing 54, New York.
Independence 3-9098.

WESTERN

The Maurice A. Kimball Co., Inc.,
2550 Beverly Blvd., Los Angeles 57, Calif.
Dunkirk 8-6178; and 681 Market Street,
San Francisco 5, Calif. EXbrook 2-3365.

Published monthly by Howard W. Sams & Co., Inc., at Indianapolis 5, Indiana.

Entered as second class matter October 11, 1954, at the Post Office at Indianapolis, Indiana, under the Act of March 3, 1879.

Copyright 1957 by Howard W. Sams & Co., Inc. No part of the PF REPORTER may be reproduced without written permission. No patent liability is assumed with respect to the use of information contained herein.

A limited quantity of back issues are available at 35c per copy.

next month

FM FOR THE TV MAN

A photo story showing the steps, equipment and tools needed to align FM tuners properly.

SERVICING TV TUNERS

First in a series of articles giving a comprehensive coverage of the more popular circuits used in TV tuners—plus servicing tips.

HOW A RAINBOW GENERATOR SIDELOCKS IN COLOR SYNC

Describes a popular type of color pattern generator and its applications in color TV servicing.

LET'S PULL LESS CHASSIS

A collection of one serviceman's experiences on home calls, with many tips on how to avoid taking a set back to the shop unnecessarily.

VOL. 7 · No. 7



JULY · 1957

PF REPORTER

FOR THE ELECTRONIC SERVICE INDUSTRY

CONTENTS

Letters to the Editor	6
Shop Talk	11
Impedance-matching arrangements in transistor circuits.	<i>Milton S. Kiver</i>
What's New In Batteries	13
A rundown on the numerous new developments in this important component.	<i>Thomas A. Lesh</i>
TV Waveforms	14
Interpreting oscilloscope displays of various signals	
Individualized Service Pays Off	16
How the "personal touch" pays off in Canton, Ohio.	
The Modern Vertical Sweep Circuit	18
A 6CM7 dual-triode functions as both multivibrator and output amplifier.	<i>Leslie D. Deane</i>
Dollar & Sense Servicing	21
Quicker Servicing	22
Color Servicing Simplified	28
An analysis that will help you isolate color TV troubles.	<i>John Markus</i>
Transistor Application Chart No. 2	34
64 radio models were analyzed to develop this list of transistor types and their uses.	<i>Calvin C. Young, Jr.</i>
Notes on Test Equipment	36
TV Sets May Lose Another Stage	58
The "Pure Signal" CRT eliminates the video amplifier.	
Product Report	66
Supplement to SAMS Master Index	69

SUBJECT REFERENCE INDEX

BUSINESS MANAGEMENT	TELEVISION
Report on operation of a large TV service company	Vertical sweep circuit, operation of
16	18
COLOR TV	Waveforms—what they show
Servicing procedure, step-by-step	14
28	TEST EQUIPMENT
COMPONENTS	B & K "Dyna-Scan" Models 1000 and 1050
Batteries in transistor radios	36
Batteries	B & M Model 50-A Inductive Winding Tester
Alkaline-cell	48
Atomic	Kingston Model VS-4 Absorption Analyzer
Mercury	40
Picture tube driven by video detector	Precision Model 230 Multi-Bias Supply
58	48
SERVICING	Simpson Model 362 Low-Range Ohmmeter
Front door to shop, electrically operated	44
17	THEORY
Half-wave power supplies in TV sets	Detectors in transistorized radios ..
22	Impedance matching in transistor IF stages
Procedures in color TV service ...	11
28	Vertical multivibrator, analysis of ..
Solder-Matic attachment for solder guns	18
22	TRANSISTORS
	Detectors
	55
	Impedance matching between IF stages
	11
	List of types used in radios
	34

USE HANDY CARD AT BACK TO ENTER YOUR SUBSCRIPTION



Is a Degree Essential for an Electronic Engineering Career?



"Student" Fred Gunther in the IBM school

Fred Gunther has no degree. Yet, today, at IBM, Fred is a Technical Engineer working on America's biggest electronics project. His story is significant to every technician who feels that lack of formal training is blocking his road to the top.

Let's go back to 1950 and watch Fred Gunther, at 18, as he goes about the business of determining his life's work. Fred spent almost a year trying his hand at various jobs. None of these turned out to be the one that Fred wanted to devote his life to. So, still undecided about his career, Fred entered the Navy for a four-year hitch.

Fred learned something very valuable in the Service, as have many other men who eventually discover the electronics field. His aptitude tests revealed him as an excellent electronics prospect, and he received ten months' training in electronics fundamentals and radar. Upon his discharge in 1955, he was an Electronics Technician, First Class.

Something even more important to Fred's career occurred during his Service hitch. He began to hear such terms as "automation" . . . "data processing" . . . "electronic computer." "Then, one evening, while glancing through the paper," he recalls, "I spotted a story about *Project SAGE*."

What is Project SAGE?

SAGE means Semi-Automatic Ground Environment. It is part of America's radar warning system—a chain of defense that will ultimately ring our country's entire perimeter. At the heart of this system are giant electronic computers, which digest data filtered in from Texas towers, picket ships, reconnaissance planes, ground observers. The computers analyze this information for action by the Strategic Air Command and other defense units. These computers are the largest in the world. Each contains perhaps a million parts—occupies an entire city block. They are built for the Project by IBM.

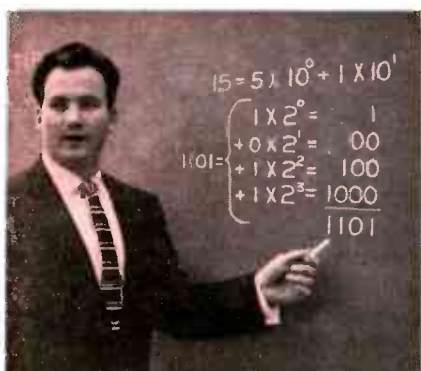

Answering instructor's questions

Fred joins IBM

SAGE fascinated Fred, for it embodies the most advanced electronic concepts. And, when he learned that IBM would train him for six months, at full salary, plus a living allowance, to become a Computer Units Field Engineer, he seized the opportunity. Fred started his new electronics career in the IBM school, with twenty other technicians. He attended classes 8 hours a day. Courses consisted of some 20 subjects—computer circuitry and units, maintenance techniques—everything he would need to become a full-fledged Computer Units Field Engineer.

Assigned to McGuire AFB

His six months' training completed, Fred was assigned in May, 1956, to McGuire Field, where the first of the giant SAGE computers is located. Here he assisted in the cable installation for this vastly complicated electronic giant. He helped to set up the computer, interconnect its many sections, check it out and make it ready for operation. Fred spent five months

at McGuire, but his education was not yet completed.

Becoming a Computer Systems Engineer

"I like to think it was due to my interest and grade of work," Fred says, "but at any rate, last October I was invited to return to Kingston for further training—to become, in fact, a Computer Systems Engineer. Naturally, I was proud and pleased, for this training would give me a much greater range of understanding... make me more valuable to the company and myself... and give me a chance to assume actual engineering responsibility." Fred completed the



At the operating console of the computer

Computer Systems course. After several months of outstanding work in his new capacity, he received a *third* promotion—to Technical Engineer—in a field engineering liaison group.

What does the future hold?

What does the future hold for Fred Gunther, now that he has become a Technical Engineer? "It's hard to even set a goal in a field as rapidly moving as this," Fred says, "but with my IBM training back of me, the future sure looks good. I've advanced from Radar Technician to Computer Units Field Engineer to Computer Systems Engineer to Technical Engineer in two years—and received a valuable electronics education besides!"

How about YOU?

Since Fred Gunther joined IBM Military Products and the Project SAGE program, opportunities are more promising than ever. This long-range program is destined for increasing national importance, and IBM will invest thousands of dollars in the right men to insure its success.

If you have 2 years' technical schooling—or equivalent experience—IBM will train you for 6 months as a *Computer Units Field Engineer*.

If IBM considers your experience equivalent to an E.E., M.E., or Physics degree, you'll receive 8 months' training as a *Computer Systems Engineer*.

After training, you will be assigned to an area of your choice within the United States. You receive *salary*, not wages, plus overtime pay. In addition, every channel of advancement in the entire company is open, and IBM is a leader in a field that is sky-rocketing in growth. And, of



Home to the family, Pemberton, N. J.

course, you receive the famous IBM company-paid benefits that set standards for industry.

• • •
WHY NOT WRITE—today—to:
Nelson Heyer, Room 9607
Military Products Division
IBM Corp., Kingston, N. Y.?

You'll receive a prompt reply. Personal interviews arranged in all areas of the United States if your résumé of experience and education indicates you have the qualifications.

IBM

MILITARY PRODUCTS

- DATA PROCESSING
- ELECTRIC TYPEWRITERS
- MILITARY PRODUCTS
- SPECIAL ENGINEERING PRODUCTS
- TIME EQUIPMENT

Letters to the

EDITOR



**"YOU'LL FIND OUR SERVICE CHARGE
QUITE MODEST — HOWEVER THERE'S A
5 BUCK CHARGE FOR BREATHING DOWN
MY NECK!"**

You can stop neck breather downers by using Webster cartridges and arms. Customers will know you know your job because everyone recognizes Webster quality. That means more money for you, too, because there's no call-backs . . . no dissatisfaction.

BUY WISELY...BUY WEBSTER!

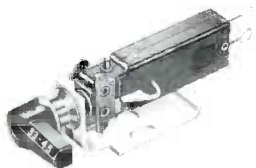

Model A X—two needle,
3 speed replacement cartridge

ELECTRONICS DIVISION

WEBSTER  ELECTRIC
RACINE · WIS

Dear Editor:

I took in an old Garod Model 1650T on a trade, thinking I would put it in condition and then sell it. It turned out to be a dog. It has a case of "horizontal jitter" on channel 2—usually, channels 4, 6, 7 and 9 are OK except for an occasional program. Any ideas you might come up with would be appreciated.

J. W. MARKWELL

Denver, Colorado

The source of this horizontal jitter may be the AGC circuit. If insufficient AGC voltage is fed to the tuner under a strong signal condition, the resultant strong IF signal can overload the third IF stage and possibly cause this trouble.

Another possibility is that a 60-cps signal is being coupled to the input grid of the horizontal multivibrator. An open .05-mfd capacitor from this grid to ground could be the culprit. In any case, clamping the AGC line with a variable bias supply will indicate whether or not the AGC is causing trouble. If adjustment of the bias causes normal operation on channel 2, check the AGC circuit thoroughly.—Editor

Dear Editor:

I have tried several circuits for vertical retrace blanking in an Admiral Chassis 21G1 and have met with failure in all of them. They either don't work out or cut off the set completely. Can you help me?

C. J. HULL

Long Beach, Calif.

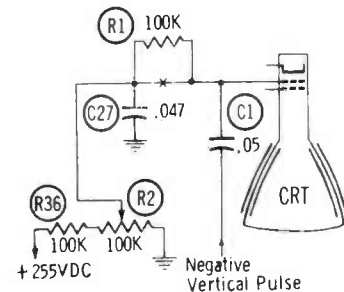

Reader Hull's trouble is trying to install a retrace blanking circuit in Admiral Chassis 21G1 probably stems from the fact that the control grid of the picture tube is bypassed with a .047-mfd capacitor (see schematic). He should try inserting a 100K-ohm resistor, R1, between the control grid and this capacitor and then couple a negative vertical pulse through a .05-mfd capacitor, C1, to the grid.—Editor

Dear Editor:

I do not understand the automatic noise inverter circuit—its function or its purpose—and I have not been able to find a clear description of it. Naturally, I do not need a complete detailed explanation—just something to get me out of the dark.

EDWIN M. MENEKEN

San Francisco, Calif.

The purpose of the automatic noise inverter circuit is to cancel any noise pulses which could otherwise cause sync instability in noisy locations. With reference to the accompanying schematic, any noise pulse that appears across the video detector load also appears on the grid loads of the sync

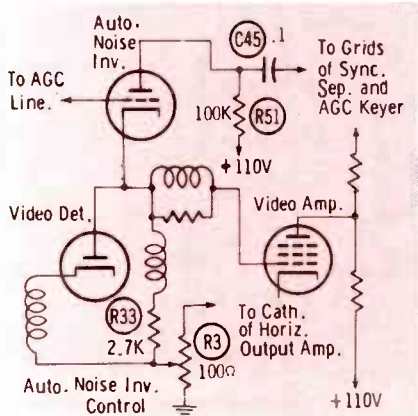

separator and AGC keyer. Since the cathode of the ANI tube is connected to the video detector load and the ANI tube is biased to conduct on noise pulses only (AGC on grid and ANI control in cathode circuit), any noise pulse from the video detector will be amplified and coupled to the sync-separator and AGC-keyer grids. Since this amplified pulse is about equal in amplitude but opposite in polarity to the noise pulse coupled through the video amplifier, it is cancelled out—result, noise-free operation.—Editor

Dear Editor:

Would you please give me an idea of what's wrong with a Magnovox 21", Chassis CTA427CE, 300 series, in which the yoke has been replaced.

The raster is very ragged on both sides. With a signal applied, the edges are more ragged. The contrast control will vary it. When I pull the video amplifier tube the raster clears up. I have relocated the leads and also shielded them, with no luck.

JIM McCUE

Jim's Radio & TV Servicing
Baker, Oregon

Sounds very much like you have horizontal AFC trouble. Check voltages and signals applied to the 6AL5 AFC diode as well as the tube itself. You'll probably find the trouble is due to a leaky coupling capacitor either ahead of or following this stage.—Editor

July, 1957 • PF REPORTER

DEPENDABILITY



above all others

Topliners are built for dependability. Wind, snow, ice . . . the Topliners take them all in stride. Superior mechanical design, careful assembly plus the right choice of materials results in an antenna that far exceeds "staying ability" of any other antenna. When you install a Topliner—relax . . . you can stake your reputation on its performance, dependability, and appearance.

TAACED

Topliners

Trade-mark

TECHNICAL APPLIANCE CORPORATION, SHERBURNE, N. Y.

IN CANADA: Hackbusch Electronics, Ltd., Toronto 4, Ont.

MODERNIZE!



*"What a bright picture!
Thanks, Mr. Serviceman,
for rejuvenating our old
TV set"*

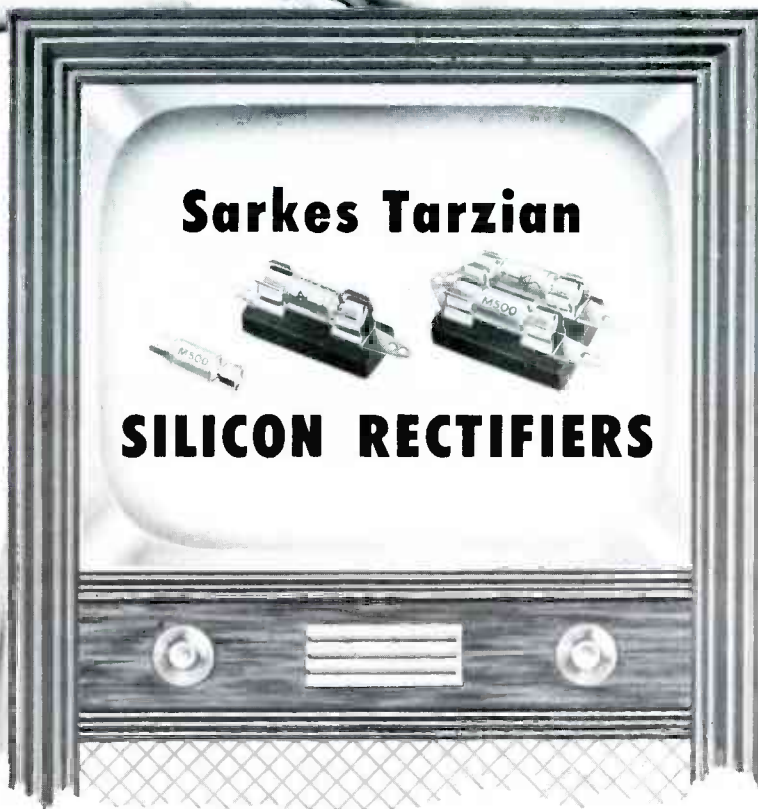

Sarkes Tarzian

SILICON RECTIFIERS

REJUVENATE

old TV sets with the "Miraculous M-500" Sarkes Tarzian Silicon Rectifier... Your customers will appreciate it... See your distributor or write for complete information.

Sarkes Tarzian Inc., RECTIFIER DIVISION

DEPT. PF2, 415 NORTH COLLEGE AVE., BLOOMINGTON, INDIANA

IN CANADA: 700 WESTON RD., TORONTO 9, TEL. ROGERS 2-7535 • EXPORT: AD AURIEMA, INC., NEW YORK CITY

Dear Editor:

I have a question about Figs. 3C and 3D in the article "Semiconductor Diodes" which appeared in the May issue. The circuits appear to be clamper or DC restorer circuits, therefore the output in each case should be nearly the input sine wave with a different voltage reference. Do these diodes have some properties that make me wrong?

ROBERT S. POWELL

Victorville, Calif.

If the time constant of R_L and C were long in comparison to the input signal frequency, the capacitor would become charged and you would get a clamping effect. In the shunt-type video detec-

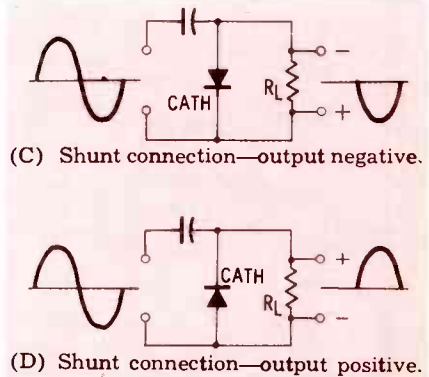

Fig. 3. Semiconductors as rectifiers.

tors of Figs. 3C and 3D, however, the RC time is short enough so that the capacitor discharges between voltage peaks, and rectification occurs.—Editor

Dear Editor:

Just a line to let you know that we liked your series of articles entitled "Resonant Circuits," and found them very helpful. Articles like these are good refreshers for the man in the field who sometimes can get so tied down to the routine of servicing that he forgets original theory. Since your magazine is really for servicemen and not trying to cater to the hobbyist, short-wave enthusiast, gadgeteer, etc., I hope that other articles on the theoretical aspects of electronics will be forthcoming. I happen to believe that your level of presentation is appropriate—about enough math that would be learned in a two-year technical course—and I hope that your other readers will agree.

FRANK YORK

Stalb Electronics
St. Albans, N. Y.

Dear Editor:

In reference to the vibrator cross-reference chart on page 76 of the May issue, the Delco 8550 is a discontinued type, superseded by the Delco 8555 which is 2 $\frac{7}{8}$ " high.

MERLE F. BARKER

Barker Electronics Service
Concordia, Kansas

ASTRON *"Staminized"* CAPACITORS HAVE . .

Long life

**NO CALL-BACK CONSTRUCTION
ASSURED BY 10 INDIVIDUAL
PRODUCTION TESTS**

plus **100% FINAL INSPECTION**

Long life in capacitors is important to you as a serviceman. Complete confidence in the components you use is a necessity, because your business is built on reputation.

Astron considers the serviceman's reputation to be prime importance. That is why each capacitor is manufactured under Astron's "Staminized" system.

Astron's "Selected Purchasing" guarantees that only the very finest of raw materials are chosen. Astron's special production techniques are supplemented by continuous inspection under strict quality controls. Production tests are made right on the production line . . . 10 separate tests in all. **A 100% final inspection is made before any capacitor can be shipped.**

You can put your trust in Astron . . . your assurance of top performance . . . every time.

There is an Astron "Staminized" Capacitor built especially to fill the specific, exacting replacement requirements of any job you tackle.

Remember, your reputation is our business, too. Build it, guard it, protect it . . . Buy Astron!

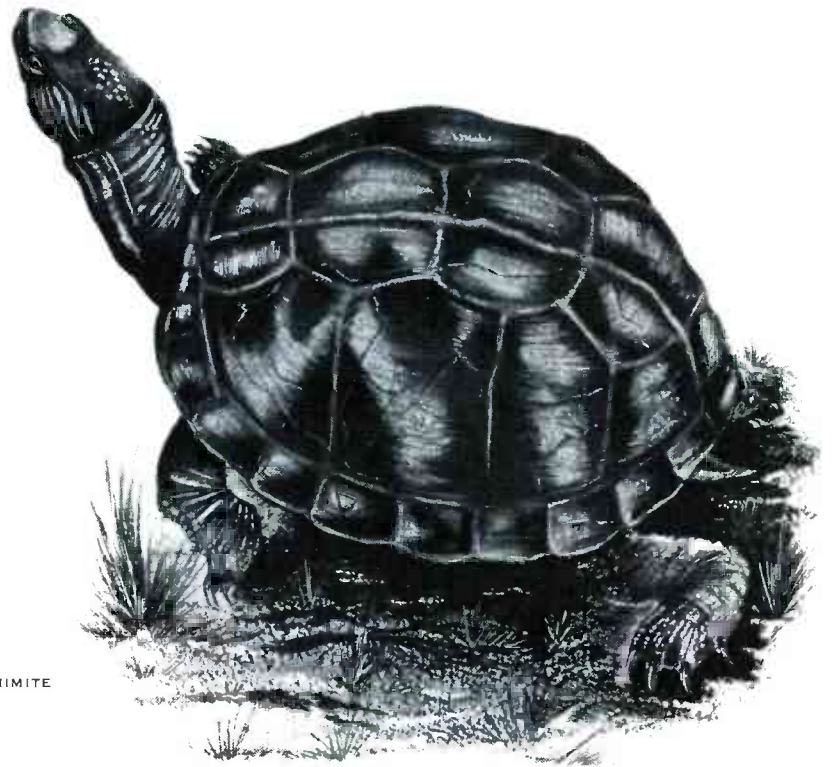

*Trade-Mark



BLUE-POINT[®] MOLDED PLASTIC PAPER TUBULAR

Free Servicing Aid . .

Save time, use handy Astron pocket-sized Replacement Catalog and Pricing Guide (AC-4D) . . Write today!



ASTRON

C O R P O R A T I O N

255 GRANT AVENUE

EAST NEWARK, N. J.



Export Division: Rocke International Corp., 13 East 40th St., N. Y., N. Y.

In Canada: Charles W. Pointon, 6 Alcina Ave., Toronto 10, Ontario

Mr. Independent Service Dealer...

IF YOU'RE FEELING THE SQUEEZE of
Rising Costs • National Service Company Competition • Lack of Manpower



Better look into the



BONDED ELECTRONIC TECHNICIAN PROGRAM

Today, more than ever before, qualifying as a Raytheon Bonded Electronic Technician will help you in many ways:

First, your service work is backed by a Bond issued through one of America's largest insurance companies. This bond means you can charge and get a proper price for your work because the bond creates customer confidence in your shop.

Second, you get the services of Western Union "Operator 25," who, in answer to requests, is sending customers to Raytheon Bonded Dealers from coast to coast.

Third, you get the backing of national advertising which sells your *bonded* service as the customers' best buy!

Fourth, you become a member of a national group of service dealers who can feature the national sym-

bol of superior TV-radio service . . . the Raytheon Bonded Decal. *Yet you retain your own independence.*

Fifth, you'll find technicians prefer to work for Raytheon Bonded Dealer organizations because these companies have earned the respect of their customers.

Your Raytheon Sponsoring Bonded Tube Distributor will be glad to explain the program to you.

TV-Radio service is your business . . . serving you is ours



RAYTHEON MANUFACTURING COMPANY

Receiving and Cathode Ray Tube Operations

Newton, Mass. • Chicago, Ill. • Atlanta, Ga. • Los Angeles, Calif.

Raytheon makes all these { Receiving and Picture Tubes, Reliable Subminiature and Miniature Tubes, Semiconductor Diodes and Transistors, Nucleonic Tubes, Microwave Tubes.



Excellence in Electronics



ShopTalk

MILTON S. KIVER

Author of . . .
How to Understand and Use TV Test Instruments and Analyzing and Tracing TV Circuits

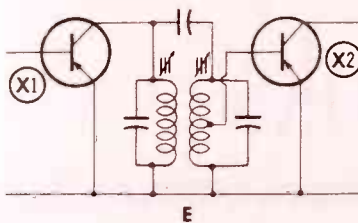
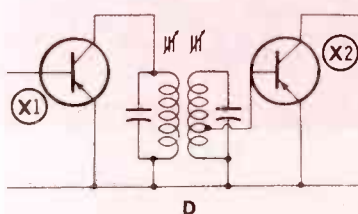
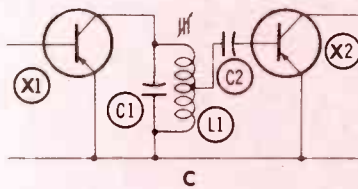
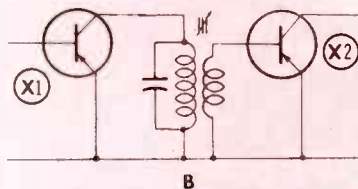
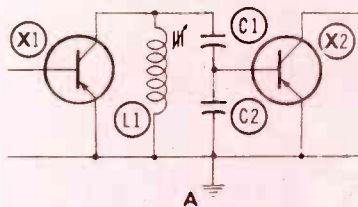

Fig. 1. Various methods of coupling high-frequency transistor stages together.

Impedance Matching in IF Transistor Stages

Transistor high-frequency stages follow the same general design as low-frequency amplifier circuits—i.e., matching is still required in the output and input circuits, the grounded-emitter arrangement is still the most popular, and the transistor is still biased in the same fashion and generally with the same voltage values. Differences that do occur stem from different coupling methods, the frequency of use of neutralization, and the insertion of AVC bias to regulate automatically the gain of one or more stages. Each of these aspects will be considered in the ensuing discussion.

A number of methods of coupling high-frequency transistor stages together are shown in Fig. 1. In Fig. 1A, L1, C1, and C2 form a resonant circuit. However, by properly proportioning C1 and C2, we can readily match the higher output impedance of X1 to

the lower input impedance of X2. (It is understood that the output capacitance of X1 and the input capacitance of X2 will be included in and form part of the resonant circuit.)

In Fig. 1B, transformer coupling is employed, using a tuned primary and an untuned secondary. The tuned primary possesses a relatively high impedance and matches the output impedance of X1. At the same time, the untuned secondary impedance is low and is suitable for matching the input of X2. In Fig. 1C, we achieve the same step-down effect by using only a single tuned coil. X2, via C2, taps down on L1 where the impedance presented to X2 matches its low input impedance.

If greater selectivity is desired, two tuned circuits can be employed in the manner shown in Fig. 1D. Again, the lower input impedance of X2 is met by tapping down on a tuned coil. Another variation is shown in Fig. 1E.

The use of the foregoing inter-stage coupling circuits in the IF system of a transistor receiver is shown in Fig. 2. Each IF transformer consists of a tuned primary and an untuned secondary. The transistors are of the p-n-p variety, requiring negative voltages on the base and collector and relatively positive voltages on the emitter. If we check the voltage distribution system, we will find that this scheme is carried out. In all other respects, the circuit follows conventional transistor practice, with perhaps the exception of C2 which serves as a neutraliz-

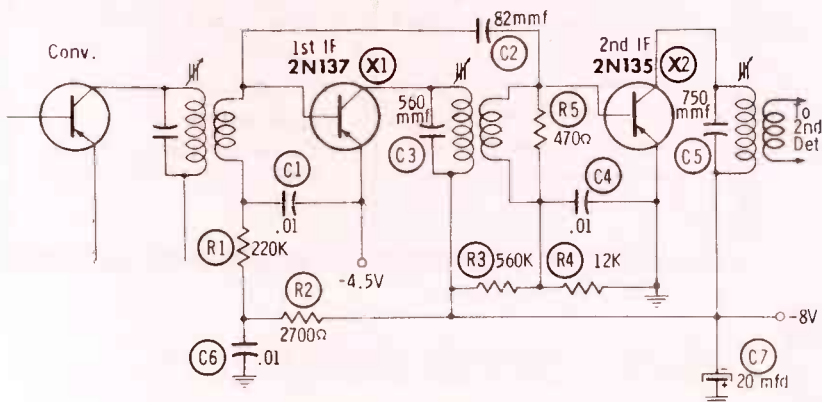

Fig. 2. A two-stage IF system employed in GE Models 675 and 676 transistor radios.

• Please turn to page 52



... by and for the technician, \$1.50 net



... by and for the engineer, \$7.60 net

Two new CBS handbooks

The new CBS Technician's Handbook and Engineer's Handbook are complete. They contain data for receiving, special and picture tubes as well as crystal diodes and transistors. Designed for on-the-job use, they are single, compact, handy volumes that lie flat. They feature modern styling for quick, easy reference. Supplementary services are available. Ask to see these Handbooks at your CBS Tube distributor's. You will want them both.

CHECK THESE FEATURES

Technician's Handbook

- Comprehensive data for all popular types
- Reference data for seldom-used types, grouped by application
- All popular special-purpose tubes and semiconductors
- 450 pages
- Handy 5¼ by 9 inches
- Rugged plastic binder
- Appendix especially prepared for service technicians

Engineer's Handbook

- Complete RETMA engineering design data
- Seldom-used types tabulated for quick reference
- 300 two-color design curves
- 650 pages, two colors
- Handy 8¼ by 9¾ inches
- 16-ring metal binder
- Appendix includes description of terms, symbols, characteristics ratings, etc.

Reliable products
through Advanced-Engineering



tubes • semiconductors

CBS-HYTRON, Danvers, Massachusetts
A Division of Columbia Broadcasting System, Inc.

Within its familiar-looking outer shell, the common dry battery is changing to keep pace with other advances in electronics. New combinations of chemicals and new manufacturing techniques are lengthening cell life and packing more power into less space. It is common knowledge that the battery stock requirements of parts distributors and service shops have already been affected by the increasing popularity of transistorized portable radios. In addition, subminiature low-current batteries of radical new design are becoming practical for use in specialized electronic equipment. And units like the tiny atomic battery in Fig. 1 furnish clues to possible future developments in radio power supplies.

Transistor Radio Batteries

A considerable variety of batteries are being employed in transistor radios to obtain different voltage and current outputs, as well as to meet physical size limitations in various receivers. Some sets utilize standard flashlight batteries in sizes AA, C or D. As a rule, 4 or 6 such cells are stacked in series to obtain 6- or 9-volt output. Numerous special types of transistor-radio batteries are also on the market; Fig. 2 will give the reader an idea of the range of sizes available in 9-volt batteries alone. Several widely-used batteries made especially for transistor use are listed in Table I, which is a cross-reference chart of comparable type numbers for different brands. Either flashlight-type batteries or the units listed in the table will be found in the vast majority of transistor radios now in use.

Types marked * are not of conventional dry-cell construction, but are mercury batteries. In these, mercuric oxide is used as a depolarizing substance at the cathode in place of the manganese dioxide found in the conventional LeClanche cell, and the electrolyte is an alkali (potassium hydroxide) instead of the usual ammonium chloride. A zinc anode is used in both types of cells.

An outstanding characteristic of mercury batteries is their long life. Other features are compactness and the ability to withstand rough treatment and extremes of temperature. Furthermore, mercury batteries have very good voltage regulation. Output voltage does not decline gradually during use—instead, it tends to remain constant until the battery is nearly used up, and then it decreases abruptly.

The ingredients in mercury batteries are relatively costly, especially the mercury. In miniaturized transistor circuitry requiring small batteries with low current drain, however, the importance of this cost

• Please turn to page 63

TABLE I—Some Popular Transistor Radio Batteries

VOLTAGE	TYPE NO.				
	Burgess	Eveready	Mallory	RCA	Ray-O-Vac
4	—	*E233	*RM233R	*VS400	—
9	D6	276	M1603	VS306	1603
9	P6	226	M1600	VS300	1600
9	2N6	246	M1602 or *TR246R	VS305	1602
9, 6 & 3 (tapped)	D6P1	2506	M1601	VS301	1601
22½	U15	412	M215 or *RM412R	VS084	215

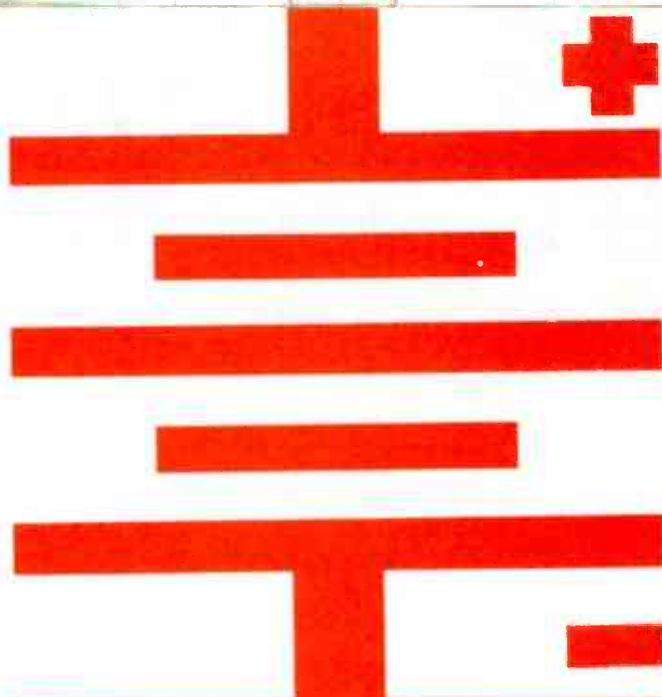

what's new in BATTERIES

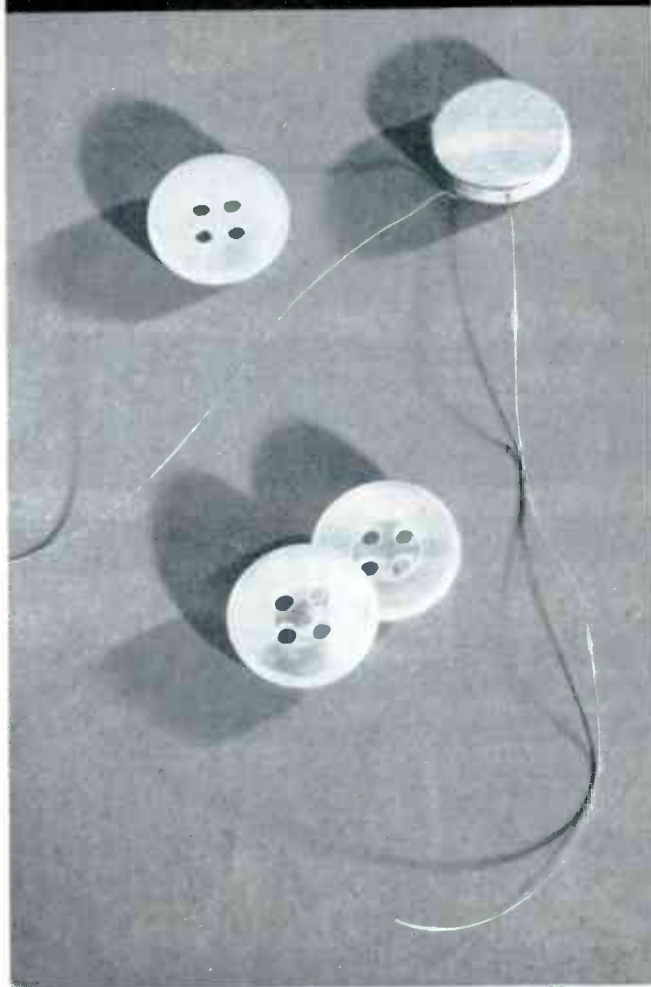

—Photo courtesy Walter Kidde Nuclear Labs., Inc.

Fig. 1. This button-sized battery makes electricity from the nuclear energy of a radioactive isotope.

TV WAVEFORMS

—the Scope Sees All

The oscilloscope can be extremely useful in helping the technician troubleshoot a TV chassis, providing he is able to accurately interpret what he sees in the waveforms! In this respect, many of us are rather limited to determining whether or not a signal is present at a certain point and comparing it with that

shown in service literature.

Fortunately, this information is often sufficient to permit isolation and location of the troublesome component, but when you run across a really tough service job, a greater comprehension of those lines and wiggles on your scope screen can be of much help.

The waveforms presented in

this analysis were obtained at key check points in a normally-operating receiver of conventional design. Since the type of oscilloscope used can make a great deal of difference in the appearance of waveforms, an average instrument having fairly-good wide-band response was used to obtain these pictures.

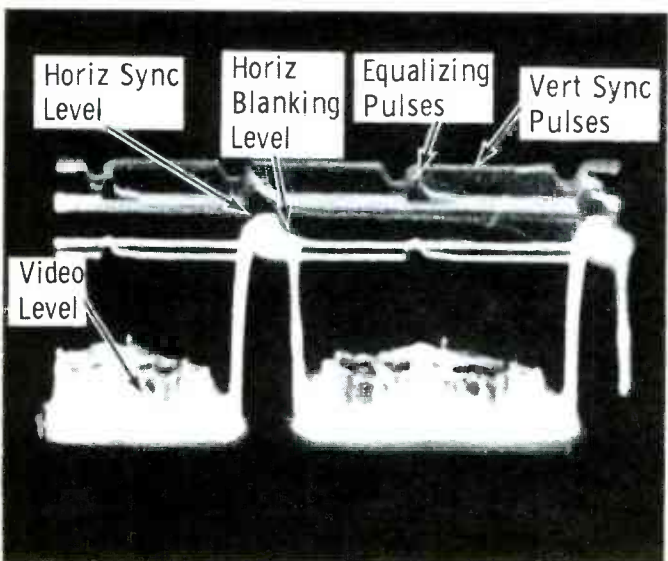
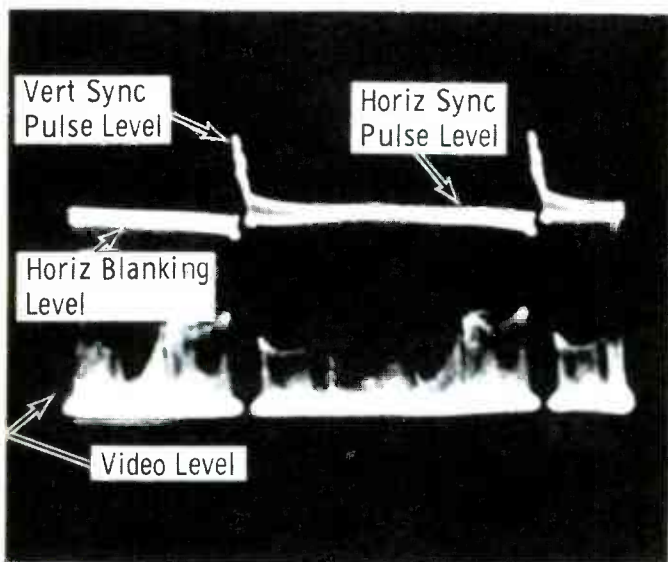

1. VIDEO AMP PLATE AT 30 CPS

This waveform represents all of the signal information in a vertical field; however, much of the detail is not evident because the horizontal trace of the scope is very slow in comparison to some of the rapid changes in signal voltage. Note, for example, the dark area below the blanking level. We know that the signal must rise to the blanking level and return to the video level during horizontal retrace or about 250 times during the scanning of a vertical field—yet this voltage variation is apparently unrecorded.

If we stop to consider that the rise or fall of this voltage occurs in less than .5 microsecond and that the time represented between the vertical pulses is over 15,000 microseconds, we find that some of the voltage excursions during the horizontal retrace periods are relatively instantaneous. The scope sweep rate and beam intensity are set to view recordings of slower voltage changes; thus, the more rapid changes do not permit the scope beam to energize the phosphor into fluorescence.

You may have wondered about the difference in the vertical and horizontal sync pulse levels. This is due to the input capacity of the scope, attenuating higher frequencies more than lower frequencies.

2. VIDEO AMP PLATE AT 7,875 CPS

The horizontal trace speed of the scope is much faster than in waveform 1, and the rise and fall of the signal between video and blanking levels is very evident. Furthermore, the video information is more detailed because it is a recording of the signal voltage changes during line-scanning periods. Still, each individual signal variation during a line-scanning period is not discernible because the voltage changes for every other successive line are superimposed on each other. If we could turn the scope beam on every 1/30 of a second for a period of only 1/7,875 of a second, and off at all other times, the voltage variations during the same two horizontal lines would continually be recorded. If the transmitted picture were steady (no motion), each voltage variation would appear in detail.

The extraneous signals dimly reproduced at the top of the waveform are portions of the sync, equalizing and blanking signals which occur during the vertical retrace period. These are recorded only once during approximately 125 traces of the scope.

3. SYNC AMP PLATE AT 30 CPS

Notice the relative increase in the amplitude of the sync pulses. This is significant because it indicates that the sync amplifier is operating over the correct portion of its characteristic curve; and for a given change in grid voltage, the sync pulses produce greater variations in plate current than do the video portions of the signal.

Immediately following the vertical sync pulse, there is a short period when the amplitude of the horizontal pulses are greater. This is the period during vertical blanking prior to the presentation of video information. Naturally, the average voltage level at the sync amp grid is greater; hence, the tube is working higher on its operating curve, and a greater variation in plate current is obtained for a given change in grid voltage.

4. SYNC AMP PLATE AT 7,875 CPS

With the writing speed of the scope increased considerably, we are again able to see the rapid voltage changes which occur during horizontal blanking. These could not be seen when the same signal was viewed at 30 cps with a normal beam-intensity setting.

Some interesting traces can be seen at the top of this waveform. They are produced only periodically by the voltage levels present during the vertical blanking interval. Signals partly in evidence are the vertical-pulse serrations and the equalizing pulses.

5. SYNC SEPARATOR PLATE AT 30 CPS

Only the sync pulses are present in this waveform because the separator tube is driven to saturation during the video portion of the signal. Notice how the sync level fades out into the dark area, indicating that the pulses have steep leading and trailing edges which are not recorded because of the relatively slow trace speed of the scope. The wide, bright trace at the clipping level indicates that the scope beam spends more of its time here than at the sync level. This is as it should be since sync and blanking represent only brief time elements in the composite signal.

6. SYNC SEPARATOR PLATE AT 7,875 CPS

With the sweep frequency of the scope increased, only horizontal sync pulses can be seen; however, an increase in the intensity of the beam might produce traces of the equalizing and vertical sync pulses which occur in a group only once during approximately 125 sweeps of the scope beam.

Here again, the beam is tracing at the clipping level most of the time, which accounts for the brightness of the scan between pulses. The tips of the pulses are bright because voltage change is slower during their reproduction.

7. PULSE-WIDTH AFC GRID AT 7,875 CPS

This waveform is created by the addition of a positive sync pulse and a sawtooth signal derived from a feedback circuit. The receiver must be tuned to an incoming signal and the picture horizontally synchronized. The horizontal sync pulse will then appear on the steep slope of the sawtooth signal, which is derived by integration from the horizontal sweep output circuit. When the scanning frequency is lowered slightly, more of the pulse will appear at the sawtooth peak. When the frequency is increased slightly, the pulse will slide down on the steep slope. If the horizontal oscillator is not synchronized, the pulse will be in motion, riding up and down along the sawtooth wave.

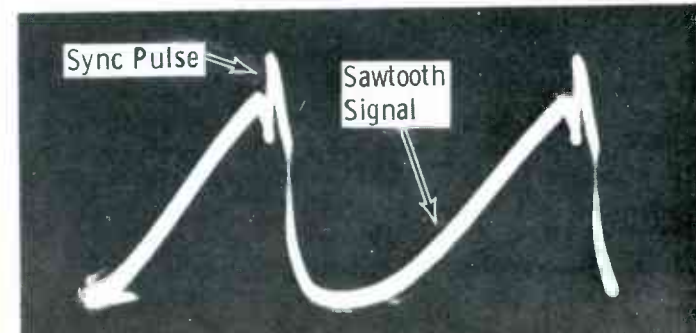
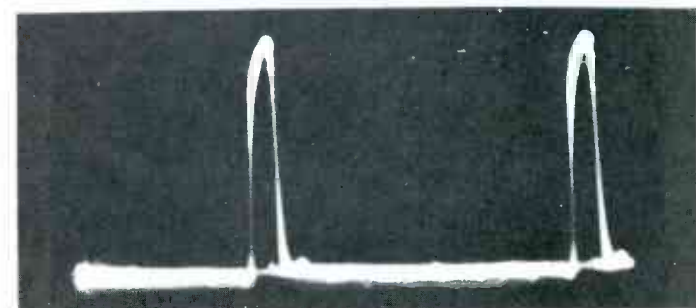
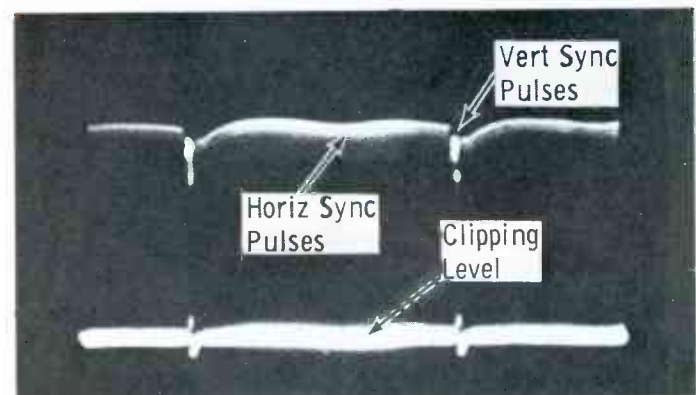
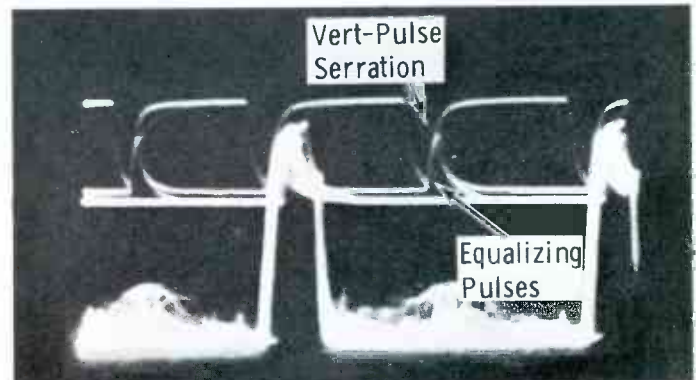
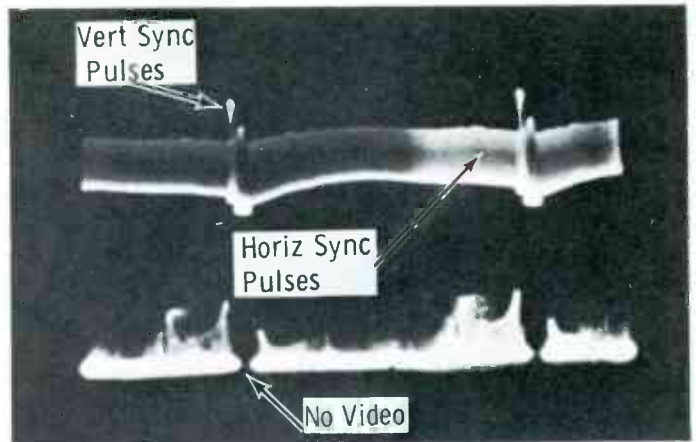



Plenty of elbow room for technician Jim Schiffner—like other T-M men, he has a bench to himself.

Individualized Service Pays Off

by Thomas A. Lesh

...for Television Maintenance Co. of Canton, Ohio

The "personal touch," one of the strongest assets of the small TV service shop, is many times left by the wayside as the business grows. Not so with Television Maintenance Co. of Canton, Ohio, however, who has found that a policy of paying individual attention to customers has enabled the company to grow from a one-man operation into a thriving enterprise that keeps 10 TV technicians busy.

What do we mean by "individual attention?" Well, for example, T-M makes every effort to have its technicians "follow through" on each call. Whenever

practical, the man who brings a set into the shop also does the bench work, returns the set to the home, and takes care of any callbacks that may occur. Thus, he is familiar with the whole case history of a given trouble, and the customer has no occasion to go through a recital of what "that other man" did to the set.

As another method of personalizing its operation, a large proportion of T-M's total advertising budget goes into direct mail. George F. Ebel, dynamic young owner of the company, says, "About a week after we make a call, we send a card to the cus-

tomers asking if our service was satisfactory. Then we follow up with another card that thanks them for calling us. Finally, we mail promotional pieces to the customer's next-door neighbors, inviting them to use our service, referring them to the job we did for folks they know."

That T-M's personalized policy has paid off is perhaps best indicated by the fact that it has occupied its present plant on the north edge of Canton for only a few years; three other locations have been outgrown since the business was founded in 1948. The logical outgrowth of such frequent moves is a well-planned and efficient servicing facility. T-M's main building houses the TV shop, a parts stock room, and offices. Some space is also used for appliance servicing, a sideline which

keeps two men busy full time. "They used to have more work space here," says Mr. Ebel, "but we've cut down on it because most of the appliance work is done right in the home."

An independent affiliated company sells and installs hi-fi and commercial sound equipment; this activity is quartered in a two-story house across the street from the main building. The audio operation is entirely separate from the TV service business except that shop facilities are shared. A fleet of 12 spanking-white trucks completes the physical plant.

While elaborate assembly-line arrangements do not fit into the individualized routine of the shop, nevertheless TV sets do move in a one-way flow—in the front door, through the shop, into a back room for final checkout and out the back door.

To permit easy entry, the front door is motorized. As the technician approaches the building carrying a heavy chassis, he nudges a control button and the overhead door rolls up. It stays open long enough to let the man in, and then automatically rolls back down. Turning off the power causes the door to be locked. Another unique facility in T-M's layout is a hose attached to an air compressor, which is inside the entryway and is used to blow dirt off a chassis before it is brought into the shop.

The air-conditioned shop itself is divided into bays with individual benches for technicians. Each bench is equipped with a permanently-mounted mirror and a hardware drawer for storage of miscellaneous screws, washers, and the like. A separate outside antenna is provided for every bench; this is necessary because Canton receives only fringe-area signals from Cleveland, about 50 miles away.

Each man furnishes his own tools. There is a company-supplied VTVM on each bench, but other pieces of test equipment—tube testers, scopes, signal generators, and a color bar-dot generator—are kept on shelves in a central location and are drawn as needed.

A fair-sized stock of frequently-used tube types is kept in a rack

• Please turn to page 59



H. B. Carter demonstrates the electrically-operated front door of the service shop. After he enters, door will close automatically.



Stock man Russ Schaefer checks T-M's large tube inventory.



Hazel Jones has customers' service records within easy reach on this "lazy Susan."



the MODERN VERTICAL SWEEP CIRCUIT

6CM7

A MULTIVIBRATOR TEMPERED WITH A CHARACTERISTIC OF BLOCKING OSCILLATORS



by Leslie D. Deane

On investigating the vertical sweep systems of today, one may find somewhat of a new look in this section of the TV receiver. With economy in mind and new tube types in continued development, TV manufacturers are favoring the use of a modified plate-coupled multivibrator which utilizes a principle common to blocking-oscillator operation. Using only one tube, this arrangement functions as a sawtooth generator and also as an output amplifier.

The schematic of Fig. 1 represents a circuit found in one of the latest portable TV receivers. First, let's consider the relatively new tube used in this vertical oscillator-output system. The 6CM7 is a 9-pin miniature tube especially designed for application in 600-ma series-string receivers. It houses two dissimilar triode sections, making it ideal for use as a combination vertical multivibrator and deflection amplifier. In this particular example, the circuit is operated from the boost B+ supply and delivers its energy to an autotransformer which is coupled to a conventional 90° deflection yoke. Later, we shall see that T1 functions as part of the oscillator circuit in addition to serving as a coupling unit.

As in all multivibrators, oscillation takes place as a result of alter-

nate conduction of the two sections of the tube. The circuit is free-running and will oscillate at its natural frequency without the necessity for external triggering. To synchronize the oscillator action with a signal from the transmitter, however, positive-going sync pulses are coupled to the system through capacitor C1.

Considering only the basic action of the circuit, we find that V1A acts somewhat as a switch which automatically charges and discharges the sawtooth-forming capacitor C4. During vertical trace time, V1A is nonconductive and capacitor C4 charges. The positive-going signal voltage developed across the combination of C4, C3 and R6 is then coupled to the grid of V1B where it causes a sawtooth deflection current in the plate circuit and through the yoke.

When retrace starts, V1A conducts and capacitor C4 discharges so that a sharp negative voltage is applied to the grid of V1B and cuts it off. The circuit is designed so that V1A conducts only during the retrace period or approximately $\frac{1}{15}$ of the vertical cycle.

Examining the circuit in more detail, let's see what actually happens from the moment the set is turned on. With cathodes heated and plate voltage applied, both tubes will start to conduct. For the circuit to oscillate, however,

one section must conduct while the other is cut off. Let us assume that this is initially accomplished by the following action.

As B+ is applied to the circuit, capacitors C5 and C6 attempt to charge to their associated plate potentials. Due to the relatively lower resistance in the charge path of C6 and the higher plate voltage on V1B, the initial capacitor-charging current through R1 will exceed that through R7. The current through grid resistor R1 causes the grid voltage of V1A to rise in a positive direction slightly before the grid voltage of V1B. The positive-going voltage on the grid of V1A increases plate current through the tube and more voltage is dropped across resistors R4 and R5, thus lowering the plate potential. This negative-going signal is coupled through C5 to the grid of V1B, causing its conduction to diminish and its plate voltage to increase. As the plate voltage of this tube rises, capacitor C6 couples the positive voltage back to the grid of V1A, causing it to conduct still more. The variation in plate current flow between the two triode tube sections is amplified by this continued action until V1A becomes highly conductive and V1B is completely cut off. This is the action which occurs between points a and b on the waveforms of Figs. 2, 3 and 4.

A relatively large value of in-

ductance is present in the plate circuit of V1B in the form of the vertical output transformer T1. When the output triode is cut off, current ceases to flow through T1 and the magnetic field produced by this current collapses. The voltage induced across the inductance by this collapsing field is very high and accounts for the high value (approximately 1,400 volts) of the pulse at point b in Fig. 2. Since V1B is cut off, its plate voltage drops back rapidly toward point c in Fig. 2, after the magnetic field has collapsed.

A portion of the high pulse developed across the top section of T1 is divided between R8 and R1. Note the resulting positive swing in the grid waveform of Fig. 3. Grid current flows in V1A during this pulse and charges C6 in the polarity shown in Fig. 1. Then, when the plate voltage on V1B drops down to point c in Fig. 2, the charge on C6 adds to this negative voltage swing and causes the grid voltage on V1A to drop all the way down to point c in Fig. 3. This negative grid voltage cuts off V1A.

To explain the waveshape of Fig. 4 between points b and c, we must say that the charge on C4 and C3 is immediately dissipated when V1A conducts, so that very shortly after time b, when the grid starts in a negative direction and the plate current begins to fall off, the plate voltage rises once again. However, it only reaches point c by the time the tube cuts off. From point c to point d, capacitors C4 and C3 charge slowly through the path consisting of the power supply, R11, R5, and R4. This accounts for the sloping rise of V1A plate voltage during this period.

The almost linear shape of Fig. 4 between points c and d produces a steady increase in V1B grid voltage and consequently in V1B tube current. This is the reason for the steady decrease in V1B plate voltage shown between points c and d in Fig. 2.

We now have V1A cut off and V1B conducting, which is the reverse of the initial circuit action. At this point, you might wonder why V1A has not started to conduct again. Looking at the grid waveform in Fig. 3, one could er-

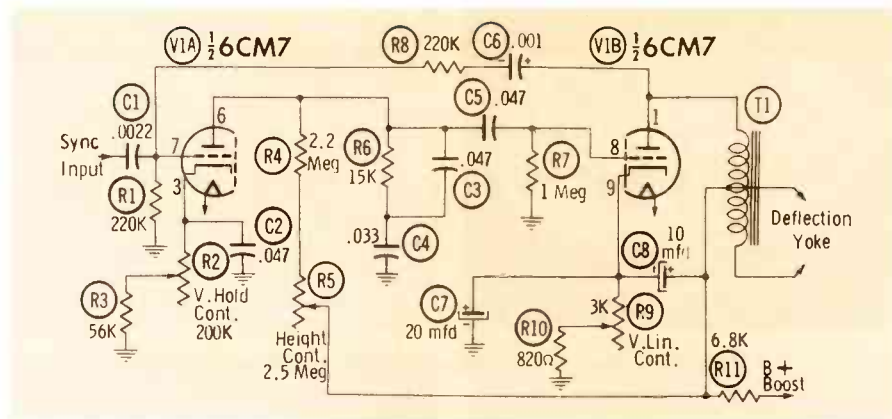

Fig. 1. Vertical oscillator-output system employed in a modern TV receiver.

roneously assume that a zero-bias condition exists shortly after time c. Actually, the level portion of the trace between points c and d represents a bias level just a few volts more than is required for cutoff. The exponential rise beginning at point c represents the decrease in the discharge current of C6. During the remainder of the trace period, C6 continues to discharge down through R1 at a lesser but steady rate because of the linear decrease in V1B plate voltage. The steady rate of discharge through R1 holds V1A cut off during trace time. Other factors contributing to the maintenance of cutoff in V1A are the low plate voltage during the early part of the trace period and the charge on C2 as a result of earlier tube conduction.

All inductors have a saturation point; that is, a point at which additional current will not cause further expansion of the magnetic field. This is what happens with respect to a blocking oscillator transformer, and in this case, with T1. Current through V1B increases linearly until T1 becomes saturated. When this occurs, V1B plate voltage will no longer decrease and C6 will cease to discharge through R1. With bias removed, V1A starts to conduct and the whole cycle of events is repeated.

The frequency of oscillation in this particular circuit is primarily determined by the charge and discharge of capacitors C4 and C3 as well as the inductance of T1. The vertical synchronizing pulses coupled to the grid of V1A by way of C1 tend to force the oscillator into sync with any incoming signal from a TV station. Actually,

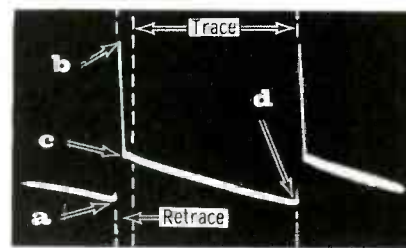

Fig. 2. Plate waveform of V1B.

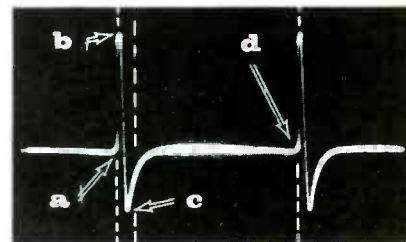

Fig. 3. Grid waveform of V1A.

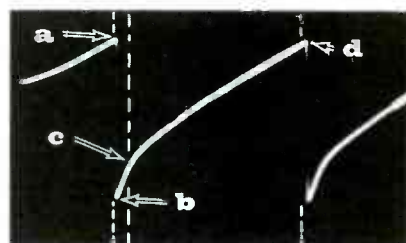

Fig. 4. Plate waveform of V1A.

several sync pulses may occur before the sweep oscillator can lock in with the transmitted signal.

Any faulty component in the wave-shaping network formed by components R6, C3 and C4 can produce an insufficient or non-linear vertical sweep. Close examination of various plate and grid waveforms in this section of the receiver can often pin-point troubles of this nature. Once the technician realizes which components affect various portions of a given waveform, he can often save himself valuable trouble-shooting time. ▲



SPEAKERS

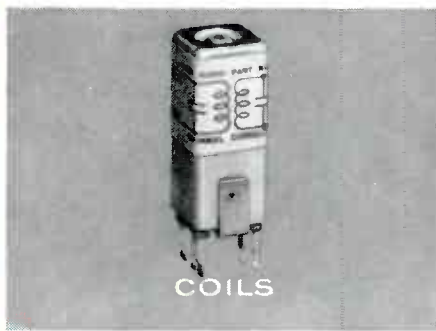

COILS



TRANSFORMERS



CONTROLS



TRANSISTORS



VIBRATORS



TUBES

From
DELCO
RADIO:



IRON CORES

a complete line of replacement parts



CAPACITORS



RESISTORS

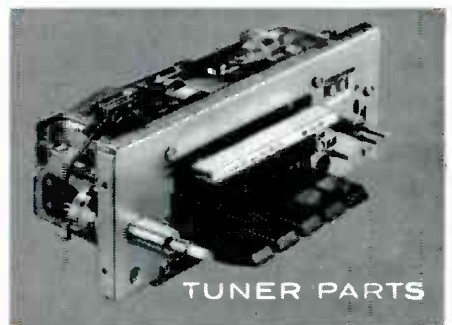

TUNER PARTS

for your Delco Radio service work!

It's one-stop service from the world leader in auto radio! Your Delco Electronic Parts Distributor gives you fast delivery on all items, *plus* a truly profitable Delco Radio independent dealer program that includes:

1. A technical training program conducted by factory engineers.
2. An attractive warranty policy.
3. Plenty of attractive dealer identification.

Delco Radio also offers a wide selection of Special Application Parts for your convenience and profit. Get the facts today.

DELCO

WONDER BAR
RADIO

DIVISION OF GENERAL MOTORS, KOKOMO, INDIANA



A GENERAL MOTORS PRODUCT — A UNITED MOTORS LINE
Distributed by Electronics Distributors Everywhere

Showmanship. Throughout history, people have been impressed by showmanship. And today, of course, this is more true than ever. This love of the unusual can be made to pay off in servicing work, too.

A distinctive working uniform improves the impression you make as you come into a home. Your attitude toward the customer's set counts a lot—do you glance at the set as if it were just another piece of junk, or do you convey the impression that here is a masterpiece of modern technical ingenuity that is fully worthy of your expert knowledge?

Make a show of spreading your work cloth out on the floor and laying out your tools on it, carefully spaced in a planned sequence. Provide small plastic dishes on this cloth for the knobs and screws that you carefully remove from the customer's set. Put each tool back in place on the cloth when finished, so that the customer can't miss this impressive layout.

Try putting on a good show along these lines, with technical dignity and yet enough planned showmanship to interest even your own wife and children, and note the effect at bill-presenting time. The extra minutes the whole show takes per call can be made to pay off many times over in direct returns from the jobs, as well as in free good will and customer satisfaction.

\$ & ¢

Tips. To tip or not to tip—that is the question for many of us today. To take or not to take a tip is the companion question that occasionally confronts a serviceman. There are no fixed rules to guide you here, other than your own good common sense.

Many wealthy people are accustomed to tipping frequently, particularly when they are appreciative of fine work. The money involved in the tip means little to them, whereas refusal of the tip may embarrass them. Here it would seem best to accept the tip with an appropriate expression of thanks and the hope that you may serve him again some time.

When a customer seems a bit doubtful whether or not to give a tip, then gives one, you will probably be better off to refuse it



BY JOHN MARKUS

Editor-in-Chief, McGraw-Hill Radio Servicing Library

gracefully with thanks. This should hold true for most of your customers, to whom the repair bill is generally a major expense. Refusing the tip here paves the way for future work. The important thing is to avoid embarrassing your customer. One way is to make a definite statement, "Our business has a firm policy of not accepting tips because we are doing professional type work."

\$ & ¢

\$599. It is not too well known that the owner of a business may hire his own children and list their pay as a business deduction on his income-tax return. Naturally, there are conditions. First of all, the total paid to the child in a given year must be under \$600 in order to be eligible for the standard deduction for the support of that child. Second, the hourly rate paid to the child must be comparable to that which you might otherwise have paid someone else to do the same work. The child must be old enough to do such work satisfactorily and you must have evidence that you actually hired and paid him. Keep a record of the exact hours worked, the nature of the work and the hourly rate decided on for that work. Make your payments to the child by check at the end of the week or month, just as you would for any other employee.

Jobs your children can do include sweeping the floor, washing the windows, sweeping the sidewalk, shoveling snow, answering the telephone, keeping your library of service manuals in order, addressing envelopes for promotional mailings, stuffing and sealing envelopes, typing business letters for you, sending out bills, polishing cabinets, checking your inventory of tubes and parts, dusting the cobwebs off the ceiling, and the like.

Epidemic. Each fall brings with it an epidemic of capacitor failures in television and radio sets. The cause is lack of use during summer heat and humidity while the owners are away on vacation.

Here is an opportunity for a special offer that will help counteract the fall rush. Offer special rates for storing all of the customer's radio and television sets in your shop during their vacation. Promise to return them in guaranteed operating condition on whatever day they specify. In your promotion, list the services you will perform on the sets, such as testing tubes, checking performance, checking alignment, cleaning thoroughly, and polishing the cabinet. Include in your offer a plan for operating each set at least half a day before making delivery, for the purpose of a thorough final checkup of performance and the replacement of any parts which may go bad. You can work up an attractive rate schedule of fixed charges or quote on an individual basis, as you prefer.

\$ & ¢

By the Way. In Memphis, Mrs. F. M. Cooper didn't like to fiddle with TV dials. Her solution? Nine TV sets, each tuned to one of the channels serving her area. Now she moves from room to room to see the show she wants.

In Tucson, one street beggar has replaced his harmonica with a tiny transistor radio hung around his neck.

In Minneapolis, a new supermarket has thirty radio-equipped carts to occupy the attention of customers waiting in line at check-out counters, and to keep their children out of mischief. Present sets use miniature tubes, but owner Bob Tait plans to change soon to transistor radios.



QUICKER SERVICING

by Calvin C. Young, Jr.

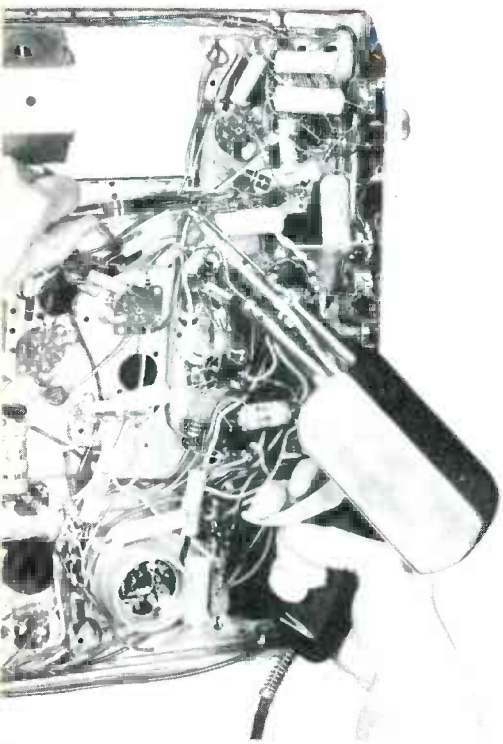

Fig. 1. Solder-Matic gun attachment, a third hand for the technician.

Third Hand for Technician

If asked what would help him most in servicing TV receivers, a busy technician might well reply, "A third hand!" While it is highly unlikely that any of us will ever grow an extra five digits, it is possible to obtain many of the advantages that they would afford. Take the job of soldering, for instance. Ordinarily you need one hand to hold the solder gun, one hand to hold the component lead, and a third hand to apply solder.

The Solder-Matic attachment shown in use in Fig. 1 functions as this third hand. Its use permits a technician to apply solder at the tip of the solder gun using the same hand that holds the gun. As the trigger on the unit is pulled, solder is fed from a spool within

the attachment through the tube alongside the barrel of the gun. The amount of solder applied to the tip depends on how far the trigger is pulled. If only a small quantity of solder is required, it is necessary to pull the trigger only a short distance.

This handy attachment is available for use with all Weller and Wen solder guns, and is a product of the Atlas Mfg. Co., Inc., of Montgomery, Alabama.

Half-Wave Power Supply in TV Receivers

Although identical in configuration to the circuit employed in an AC-DC radio, which every tech-

nician should be familiar with, the power-supply circuit in a TV receiver uses components of considerably different values because of the higher current requirements. The following case history should emphasize the importance of a detailed analysis of the action of each component used in this TV circuit.

Open Fusible Resistor

On the initial home service call to repair a 17" portable TV receiver, the technician noticed at once that the tube filaments were all lit. The set employed a single series-filament string and an AC-DC power supply. He reasoned that since the complaint was no sound or picture, the trouble was in the power supply. The plug-in type fusible resistor was in plain sight, and shorting across this unit restored the set to operation. Since the defective resistor was marked with only the manufacturer's part number, and neither the value or rating of the part was given on the tube placement chart, the technician decided to install a 7.5-ohm, 5-watt plug-in resistor that he happened to have in his service kit. After installing the resistor and applying power, the sound and picture came on, but after only a few seconds the 7.5-ohm resistor began to smoke. At this point, the customer was informed that the receiver would have to be taken into the shop for further analysis.

In the shop, all of the tubes were tested on a high-quality tester and found to be good. From the service literature, the fusible resistor was identified as a 4.7-ohm, 5-watt unit. The technician decided to try a new unit of the proper value on the off-chance that an abnormal AC-line condition in the home had caused the initial failure. The set was then placed on life test, but after a short period of operation the fusible resistor failed again.

Having already ruined two fusible resistors costing about 40¢ each, the technician decided that a service procedure which didn't include the fusible resistor would have to be instituted. A VOM set to the 1,000-ma range and a ½-amp fuse were connected in series in place of the fusible resistor

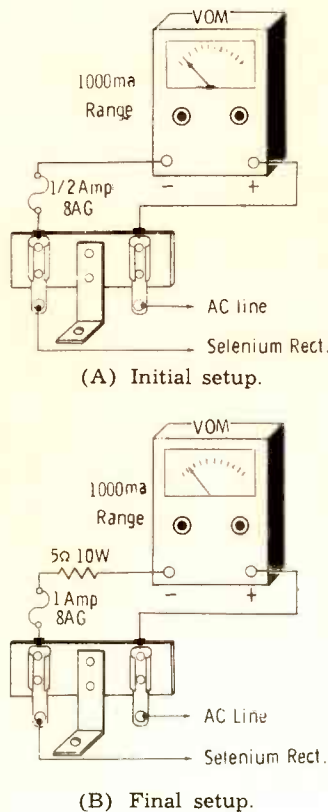
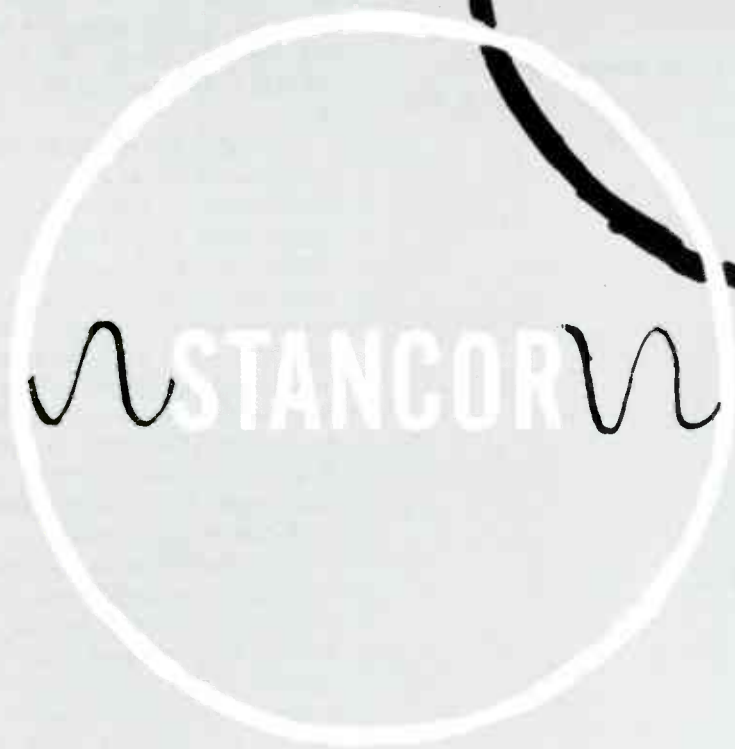

Fig. 2. Test setups used to check current through half-wave power supply.

for ENGINEERED
exact
replacements
look to



Stancor exact replacement transformers are engineered—not copied. With manufacturers' original prints used as a basis for physical exactness, the circuit and operating requirements are carefully analyzed by the Stancor engineering staff. Where necessary, heavier wire, more insulation, protective coatings, corona rings, or heavier shielding are used to assure you of "better-than-new" performance. Even where the original may have been easily overloaded—it won't happen again with the Stancor replacement.

Chicago Standard has the largest engineering staff of any replacement transformer manufacturer—your assurance of a carefully and correctly designed transformer.

A free copy of the latest Stancor catalog and TV Guide is available at your distributor or direct from Stancor.

CHICAGO STANDARD TRANSFORMER CORPORATION

3503 ADDISON STREET

CHICAGO 18, ILLINOIS

Export Sales: Roburn Agencies, Inc., 431 Greenwich St., New York 13, N.Y.

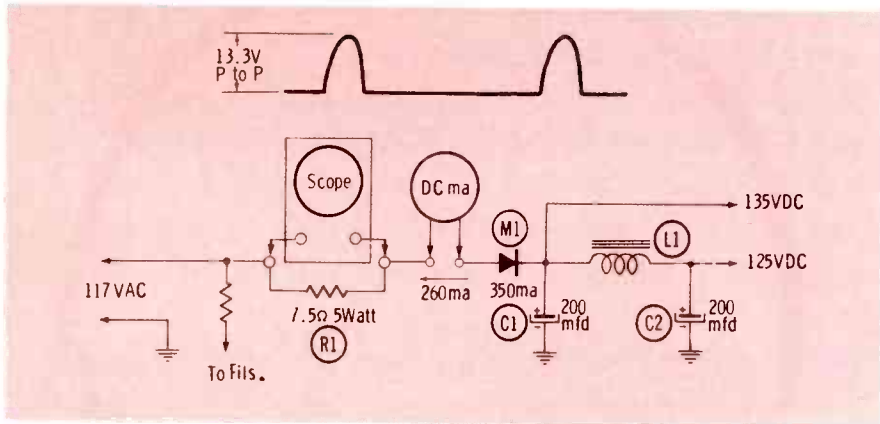

Fig. 3. Typical half-wave power supply in AC-DC television set.



STOP CB* WITH C-D

*STOP CALL BACKS by always using C-D "CUBS"®—the tubular that has proven itself the champ in the service field. They out-perform any other replacement because they're the only molded tubular with built-in extras that insure call-back-free servicing. C-D "CUBS" are made exclusively for the service trade.

SPECIAL! "CUB SERVICE KIT" in all-plastic dispenser. You pay only for the capacitors. Ask your distributor salesman to show you the new C-D "CUB SERVICE KIT" or write for details Cornell-Dubilier Electric Corporation, South Plainfield, N.J. stop callbacks...insist on

CORNELL-DUBILIER CAPACITORS

SOUTH PLAINFIELD, N. J.; NEW BEDFORD, WORCESTER & CAMBRIDGE, MASS.; PROVIDENCE & HOPE VALLEY, R. I.; INDIANAPOLIS, IND.; SANFORD, FUQUAY SPRINGS & VARINA, N. C.; VENICE, CALIF.; & SUB.: THE RADIANT CORP. CLEVELAND, O.; CORNELL-DUBILIER ELECTRIC INTERNATIONAL, N. Y.

(Fig. 2A) to determine just what current was actually flowing in the circuit. The fuse blew the instant power was applied.

Since the fusible resistor had lasted for over an hour and since, according to the service literature, only 320 ma was supposed to flow in the circuit, the technician wondered why the ½-amp fuse had failed so rapidly. Thinking this over carefully, he reasoned that no short circuits were present and that the initial surge of current required to charge the filter capacitors had caused the fuse to blow.

Accordingly, a 1-amp 8AG instrument fuse and a 5-ohm, 10-watt resistor were connected in series with the VOM (Fig. 2B). Again, power was applied. This time the picture and sound came on, and after the initial surge of about ½ amp, a steady reading of 350 ma was obtained on the meter. This represented an increase of less than 10% over the current drain specified in the service literature, so it didn't give any real clue to the trouble.

Since no other symptoms were available, the technician began to substitute tubes which were known to use appreciable current (audio, video, vertical, and horizontal output tubes) while monitoring the current drain on the supply. This procedure failed to reduce the average current flow, so the original tubes were reinstalled.

Because there were no other symptoms to investigate, the technician next began a close visual inspection of the tubes while lightly tapping each tube with the eraser end of a pencil. Tapping the 12D4GT damper tube produced sparks between the internal elements, and the technician reasoned that at last the source of the trouble had been located. When the fusible resistor reached normal temperature (after a period of operation), the current peaks produced by the arcing within the damper tube caused the resistor to open up.

The trouble outlined in the preceding case history was finally located by visual means, a time-consuming operation at best. What if the trouble had been caused by something which couldn't be seen?

Temperatures are rising



...and so are profits with

RCA Batteries!

There's a mighty big market for RCA Battery sales with all America, young and old, heading for the great outdoors with millions of portable radios in tow!

This is far and away your best battery selling season. NOW is the time to cash in on high turnover, easy-to-take profits with RCA Batteries. Stock 'em, display 'em, sell 'em! Available from your local distributor—so do it now!



RADIO CORPORATION of AMERICA

COMPONENTS DIVISION

CAMDEN, N. J.

RCA BATTERIES...THE BRAND THAT COMMANDS PUBLIC DEMAND!

... another
P. R. MALLORY & CO. Inc.
MALLORY
service-engineered
product

Months under Water...

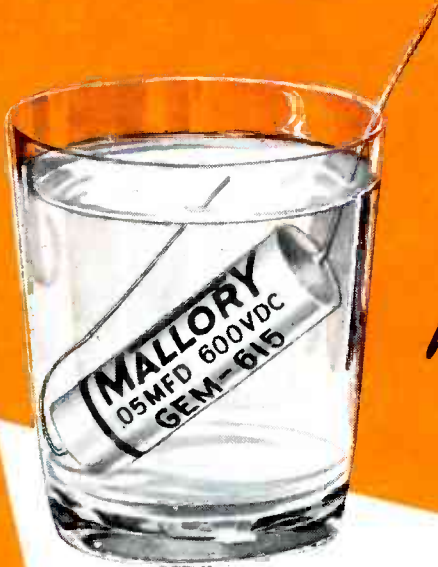

prove
MALLORY
"GEMS"

moisture proof

To demonstrate how well Mallory "Gem" tubular capacitors resist moisture, we put some in plastic tubes filled with water. Months later, their internal resistance remains unchanged... proving there has been no moisture absorption.

Sure, you don't expect to submerge the capacitors you install. But when you're looking for top performance, even under the toughest humidity—always ask for Mallory "Gems."

Get your stock today from your Mallory distributor. He carries them in all popular ratings for by-pass and coupling applications.

P. R. MALLORY & CO. Inc.
MALLORY

P. R. MALLORY & CO. Inc., INDIANAPOLIS 6, INDIANA

- Capacitors
- Vibrators
- Resistors
- Power Supplies
- Mercury and Zinc-Carbon Batteries
- Controls
- Switches
- Rectifiers
- Filters

Can you efficiently locate and repair troubles in which a half-wave AC-DC power supply is involved? After studying the following circuit analysis, ask yourself these same two questions again. You may be surprised.

Circuit Analysis

A circuit using typical component values is shown in Fig. 3. Notice, as mentioned earlier, that the circuit has the same configuration as the power supply often present in an AC-DC radio. Let's study the function of each of its components. The input capacitor C1 charges to approximately the positive peak value of the line voltage when rectifier M1 first conducts, while inductor L1 and capacitor C2 act as a filter to smooth out the AC ripple. Resistor R1 acts as a surge limiter to protect the rectifier from the initial current surge when the receiver is first turned on, and because of its special construction, it also acts as a slow-blow fuse and protects the circuit components from overloads.

Notice the oscilloscope waveform across R1. The pulses occur during rectifier conduction and keep C1 charged. By adding the amplitude of these pulses (13.3 volts) to the voltage drop across the rectifier (approximately 5 volts) and subtracting this amount from the theoretical voltage level which C1 can charge to (1.414 times 117 volts or about 165 volts), we end up with a little more than the 135 volts shown on the schematic. This discrepancy is due to the fact that the calculated voltage does not take into consideration the discharging of C1 through the load.

Now let's make further use of the waveform and find the peak current through the rectifier—and it is a peak current, because the rectifier only conducts on positive peaks to keep the input capacitor charged. Using Ohm's Law, we find that the peak current is 13.3 divided by 7.5 or 1.77 amps. Surprised? Well, this isn't out of line, and it won't damage the rectifier because a 350-ma selenium rectifier has a peak-current rating of 3.5 amps. This peak current occurring each $\frac{1}{60}$ of a second recharges the input capacitor C1 in

the amount drawn by the load.

Have you wondered about the shape of the signal across R1? The drawing in Fig. 4 explains it, but let's put it into words anyway. As the AC voltage on the input (anode) side of the rectifier declines from its positive peak, the load can obtain current only from C1, so its charge is reduced accordingly. Because of the large time constant, however, this reduction is only a few volts. Of course, the rectifier will not conduct again until the anode voltage rises above the voltage across C1. You could say that the rectifier is biased by the voltage on C1; thus, the rectifier doesn't begin to conduct until the input voltage has nearly reached the peak of

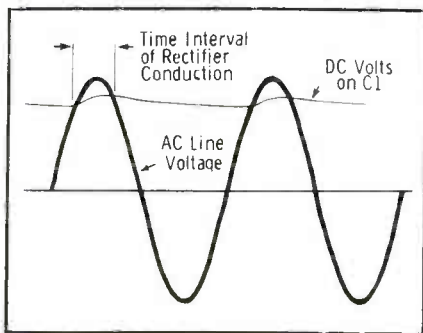
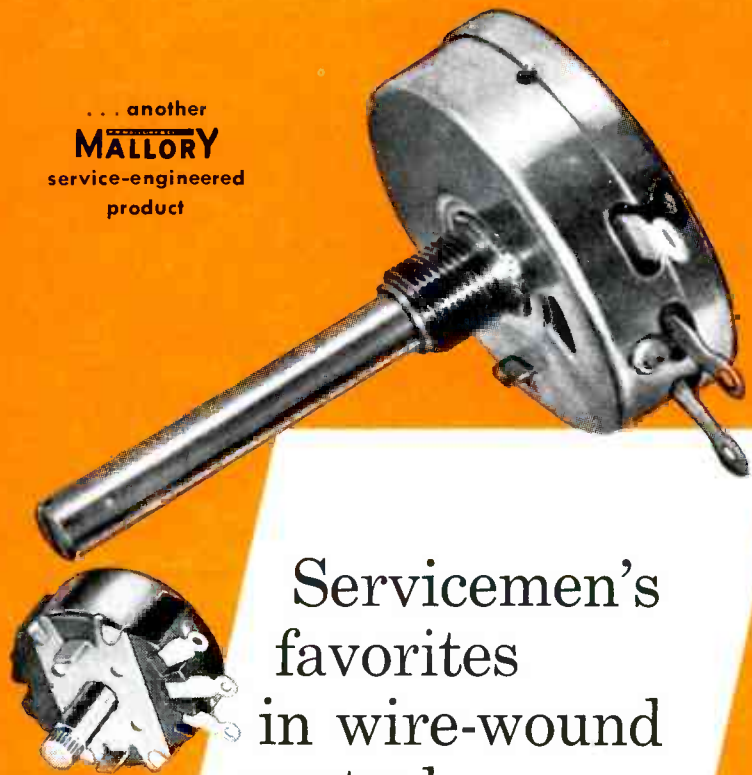

Fig. 4. Conduction of rectifier on AC peaks to charge input capacitor.

its positive swing. Essentially then, the waveform obtained across R1 represents the current through the rectifier, indicating current pulses of short duration separated by longer periods of nonconduction.

Now let's apply some of this theory to a couple of often-encountered troubles: leaky capacitors and defective rectifiers. If the capacitors develop leakage, they won't hold a charge as well and the peak current through the rectifier will increase. Result—an open fusible resistor and a service call. Should the voltage drop across the rectifiers increase because of age, the output voltage goes down and the sweep circuits will not supply enough energy to fill the screen. Or, if the forward-to-backward resistance ratio of the seleniums goes down appreciably, the filter capacitors will begin to discharge across the rectifier as well as through the load, and again the DC voltage will decrease. ▲

... another
MALLORY
service-engineered
product



Servicemen's favorites in wire-wound controls

You're sure of giving your customers the best when you use Mallory wire-wound controls. The choice of servicemen and manufacturers everywhere, they have set the standards of the industry for value and performance.

They're conservatively rated—to assure you of cool operation without need for using over-sized units.

They're compact—fit readily into crowded chassis locations.

They're long lasting—give years of stable, dependable service.

They're uniform—made to strict specifications to meet or exceed original equipment requirements.

Mallory 2-watt and 4-watt controls are available in resistance values and tapers to match every replacement need. Your local Mallory distributor has a complete stock—see him today!

P. R. MALLORY & CO. Inc.
MALLORY

- Capacitors
- Vibrators
- Resistors
- Power Supplies
- Mercury Batteries
- Controls
- Switches
- Rectifiers
- Filters

P. R. MALLORY & CO. Inc., INDIANAPOLIS 6, INDIANA

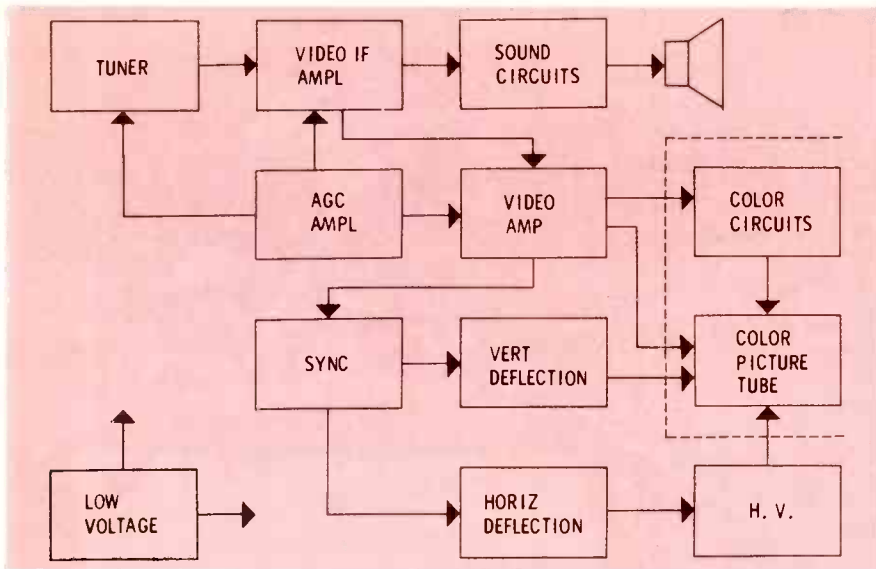

Fig. 1. Block diagram of color receiver with color circuits identified.

Due to the nature of the composition of the transmitted color signal, monochrome and color transmissions, when analyzed from a service standpoint, are identical to a considerable degree and differ only in that an additional signal is required for color reproduction. When a color receiver is analyzed from a circuitry standpoint, the majority of the circuits will be found identical to those employed in monochrome receivers. The block diagram in Fig. 1 illustrates this point.

Notice that the blocks located to the left of the dotted line in Fig. 1 are representative of the circuits found in a monochrome receiver. If the block labeled "color circuits" were removed and the word "color" deleted from the picture tube block, a typical monochrome receiver would be illustrated. The block diagram of Fig. 1 shows the essential difference between monochrome and color receivers and clearly indicates that a color receiver is basically monochrome circuitry with a different picture tube and additional circuits to process that portion of the composite signal peculiar to color transmissions. The circuits of any color receiver, past or present, regardless of manufacturer, can be arranged as a block diagram similar to Fig. 1.

Fig. 2 represents a more detailed block diagram of a current-production, 1957 color receiver, RCA's CTC5A chassis. This diagram was purposely arranged to illustrate more exactly the differ-

ences between monochrome and color receiver circuitry. Notice the similarities, however, between Figs. 1 and 2. The seven blocks at the top of Fig. 2 are the color circuits, which handle or process only the color signals (color burst and chrominance signals). The remaining 23 blocks constitute the circuits necessary to reproduce a black-and-white picture.

Further analysis of the color receiver reveals that a 4-part division can easily be accomplished and will be a definite aid when trouble shooting. The 4-part division—raster, picture, sound and color circuits—are illustrated in Fig. 2 by dotted-line separations. Each section functions in a prescribed manner and contributes in a definite way to the picture appearing on the face of the picture tube or to the sound produced by the speaker.

The percentage figures shown were derived by dividing the number of tubes in each part by the total number of tubes in the receiver. The raster (40%), picture (30%) and sound (10%) circuits account for 80% of the circuits in a color receiver. Thus, 80% of the circuits are equivalent monochrome circuits and only 20%, the color circuits, are new and different or unfamiliar to the service technician.

You can utilize this fact when attempting to isolate trouble in a color receiver. By analyzing the face of the color picture tube and the sound from the speaker in conjunction with the four part

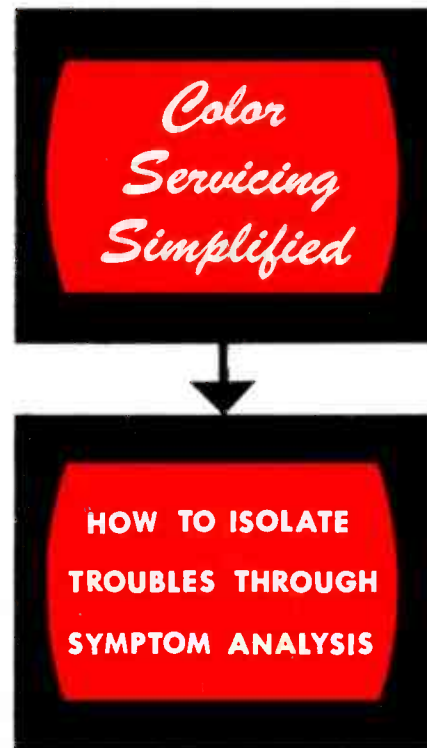

by Ken Kleidon

division of a color receiver, any defect can be quickly localized. Since 80% of the circuits in a color receiver are necessary to reproduce a black-and-white picture, the majority of the service problems encountered will be identical to those experienced in monochrome receiver servicing. This fact illustrates an important servicing consideration in that the first requirement of a color receiver is to reproduce a good black-and-white picture before a normal color picture can be achieved. The monochrome circuits must be functioning normally before proper color reproduction can be obtained.

The general trouble-shooting procedure detailed below follows an almost forgotten practice for localizing troubles. This procedure, if followed in sequence, will help you to locate a malfunctioning stage quickly and efficiently. It is based on the assumption that the receiver was once functioning normally, and it is applicable approximately 95% of the time. The exception is a condition when seemingly normal pictures can be reproduced in black-and-white but not in color. Defects in the RF, IF and first video amplifier stages could possibly cause such a condition.



Dependable Electrical Protection

BUSS FUSES OPERATE PROPERLY

Under all Service Conditions . . .

HERE'S WHY . . . To assure unfailing dependability, BUSS fuses are electronically tested. A sensitive device automatically rejects any fuse not correctly calibrated, properly constructed and right in all physical dimensions.

Because of this careful testing, you can rely on BUSS fuses to provide maximum protection against damage due to electrical faults. And just as important, BUSS fuses eliminate useless, irritating shutdowns due to faulty fuses blowing needlessly.

As a result, BUSS fuses help protect your reputation for quality and service and . . . BUSS fuses also help servicemen avoid costly,

unnecessary call-backs.

With a complete line of fuses available in all types and sizes, it is just good business to standardize on BUSS fuses.

BUSS FUSES HAVE READY CUSTOMER ACCEPTANCE . . .

Over the past 42 years, millions upon millions of BUSS fuses for home, industrial and automotive use have firmly established BUSS as the Known brand. Sales are easier to make and with never a 'come-back'.

For more information on BUSS and FUSE-TRON Small Dimension fuses and fuseholders . . . Write for bulletin SFB. Bussmann Mfg. Co. (Div. of McGraw-Edison Co.), University at Jefferson, St. Louis 7, Mo.

BUSS fuses are made to protect - not to blow, needlessly



Makers of a complete line of fuses for home, farm, commercial, electronic, automotive and industrial use.

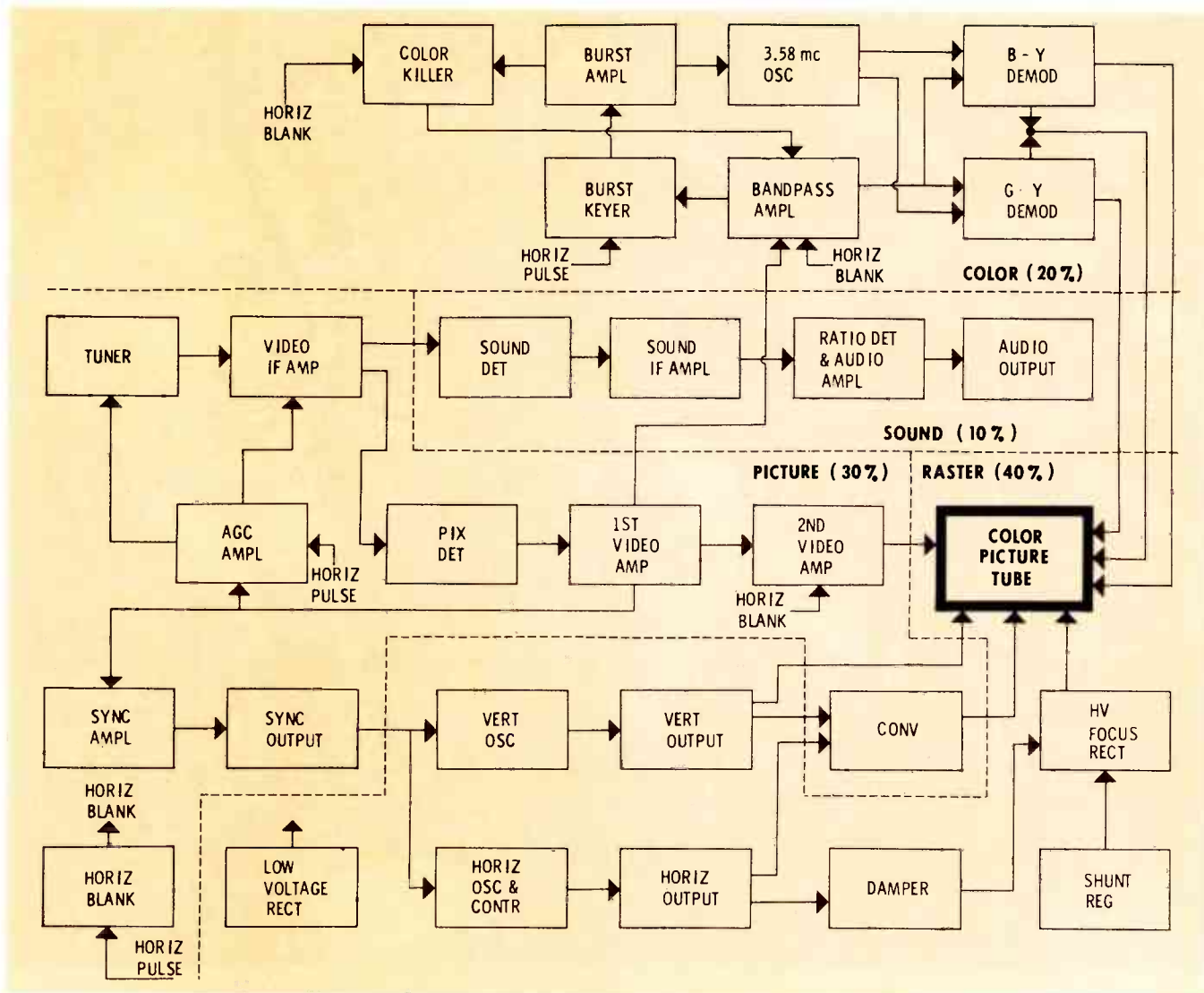

Fig. 2. Block diagram of color receiver with circuitry divided into four parts.

Trouble-Shooting Procedure

Step 1. Tune Receiver to an Inactive Channel

If the raster circuits are functioning normally, the picture tube will portray a grey raster which fills the screen both horizontally and vertically and has adequate brightness. If a normal raster is not obtained, refer to Chart I. Proceed to Step 2 if the raster circuits function as outlined.

Step 2. Tune Receiver to an Active Monochrome Channel

If, in addition to the raster circuits, the picture circuits are functioning normally, the picture tube will portray a stationary picture with sufficient contrast, detail and acceptable convergence. If a normal picture is not obtained, refer to Chart II. Proceed to Step 3 if the picture circuits function as outlined.

Step 3. Turn Volume Control to 50% of Rotation

If the picture appears normal and there is no sound, distorted sound, weak sound or a hum or buzz, check the sound detector, sound IF amplifier, ratio detector, audio amplifier and output tubes and associated circuitry. If normal

sound is obtained, proceed to Step 4.

Step 4. Connect Color Bar Generator to Antenna Terminals.

Turn sound carrier on and adjust fine tuning for minimum 920-kc beat interference. Refer to Chart III for typical color circuit troubles.

Chart I—Raster Circuits

1. If no raster appears, turn the volume control to maximum and listen to the speaker.
 - A. *No Speaker Response.* Check power applied to the receiver, safety interlock connections, B+ and filament fuses, and the low-voltage power supply.
 - B. *Rushing Noise from Speaker.* Measure picture-tube anode voltage with a suitable meter and high-voltage probe.
 - (1) *Normal High Voltage.* Check the anode and base connections to the picture tube. Check CRT cathode, grid and screen circuits.
 - (2) *Low High Voltage.* Check horizontal oscillator and output, damper, regulator, high-voltage and focus rectifier tubes and associated circuitry.

NEW!

CATCHES ALL LEAKY CAPACITORS

IN-CIRCUIT
... CHECKS
ALL COUPLING
CAPACITORS
FOR
LEAKAGE

OUT-OF-CIRCUIT
... CHECKS
ALL CAPACITORS
FOR LEAKAGE
AND
CAPACITANCE

Simpson

MODEL 383A

CAPACOHMETER

IN-CIRCUIT

CAPACITOR LEAKAGE TESTER



Here is the first *complete* "testing package" for all paper, mica, and ceramic capacitors. With this *one* instrument—the Simpson Capacohmeter—you can: (1) detect most borderline capacitors *in-circuit* by means of the exclusive Simpson *Pulse Test*; (2) measure leakage of defective capacitors, including coupling capacitors, in ohms; (3) determine the capacitance directly, of good capacitors, from 10.0 uuf to 10.0 uf.

With *this* instrument, most tests can be made *in-circuit*. All tests are made under load conditions. There is no fussing with bridge circuits and balancing controls. Readings are indicated on a large 4½" meter with better than 10% accuracy. But that's not all. You can use the Simpson Capacohmeter to test for leaky wiring, sockets, and transformers . . . to measure distributed capacitance of wiring to ground . . . to "high-pot" good components . . . and many other tests which you will discover.

Model 383A with leads and Operator's Manual . . . **\$89⁹⁵**

See your Jobber, or Write

SIMPSON ELECTRIC COMPANY

5200 W. Kinzie St., Chicago 44, Illinois

Phone: EStebrook 9-1121

In Canada: Bach-Simpson Ltd., London, Ontario



WORLD'S LARGEST MANUFACTURER OF ELECTRONIC TEST EQUIPMENT

FOR TOP-O'-CHASSIS SERVICING

locates defective stage in
less than 5 minutes for average
TV receiver.



NEW FROM
Wintronix
MODEL 850
**INDUCED WAVEFORM
ANALYZER**
complete with
"Phantom Probe"
and attachments

ONLY
\$169⁹⁵

Localize troubles in TV, radios, amplifiers, etc., right from the top of the chassis . . . and without making a single direct connection to the circuit! The new Wintronix Model 850 does all this by the modern, easy-to-use Induced Waveform method. Helps you quickly spot those often overlooked tube and circuit defects that mean callbacks or extra troubleshooting.

Simply connect the output of the Model 850 to any 'scope, then slip the Phantom Detector Probe successively over each tube in the receiver under test. By viewing the waveform of the received signal (from b'dcast station or generator) at each stage, you quickly localize troubles to the offending stage. Works equally well for RF, IF, video, sync, and audio circuits. Also makes Color TV troubleshooting easier and faster.

See and try the new Wintronix Induced Waveform Analyzer at your local Wintronix dealer or write for free literature.

WINSTON
ELECTRONICS INC.,
4312 Main St., Phila. 27, Pa.

2. If the face of the picture tube indicates a raster of a sort, check the circuit indicated for the particular condition in the following list.
 - A. *Color-Tinted Raster.* Readjust screen and background controls as outlined in the service instructions. If a black-and-white raster cannot be achieved, check picture tube components in the cathode, grid, screen and brightness control circuits. If one color is missing, check appropriate electron gun circuitry.
 - B. *Raster Impurity.* Recheck purity adjustments as outlined in the service instructions. If acceptable purity cannot be achieved, check DC convergence adjustments, purity magnet and picture tube. Picture tube may require degaussing.
 - C. *Insufficient or No Vertical Sweep.* Check vertical oscillator and output tubes and associated circuitry.
 - D. *Insufficient Horizontal Sweep.* Check horizontal size adjustment, horizontal oscillator, output and damper tubes and associated circuitry.
 - E. *Picture Blooming.* Check high voltage and focus rectifier, shunt regulator, damper and horizontal output tubes and associated circuitry.

Chart II—Picture Circuits

1. If no sound and no picture appears, the trouble is located between the antenna connections and sound take-off point. Check RF, IF and AGC circuits.
2. If the sound appears normal and there is no picture, the trouble is located between the sound take-off point and the picture tube. Check the picture detector and video amplifier circuits.
3. If a picture of some sort appears, check the circuit indicated for the particular condition in the following list.
 - A. *No Vertical Sync.* Check sync amplifier, sync output and vertical oscillator circuits.
 - B. *No Horizontal Sync.* Check sync output, horizontal oscillator and control circuits.
 - C. *No Horizontal or Vertical Sync.* Check sync amplifier and sync output circuits.
 - D. *Insufficient Picture Detail.* Check picture detector and video amplifier circuits.
 - E. *Poor Vertical Linearity.* Check vertical size and linearity control adjustments, vertical oscillator and amplifier circuits.
 - F. *Picture Overloading.* Check AGC circuit.
 - G. *Poor Convergence.* Readjust convergence controls as outlined in the service instructions. If acceptable convergence cannot be obtained, check convergence circuits.

NOTE: All the service conditions experienced when dealing with monochrome receivers are also possible with a color receiver. The same solution will generally apply because the monochrome circuits of a color receiver are similar to those of a monochrome receiver.

Chart III—Color Circuits

Observe the face of the picture tube and check the circuits indicated for the service conditions in the following list.

1. *No Color.* Check adjustments of color, fine tuning and color killer threshold controls. Check bandpass (chrominance) amplifier, burst keyer, burst amplifier and 3.58-mc oscillator circuits.
2. *Improper Colors.* Check color, hue and fine tuning control adjustments. Check bandpass amplifier, B-Y demodulator, G-Y demodulator and 3.58-mc oscillator circuits.
3. *No Color Sync.* Check 3.58-mc oscillator, burst amplifier, burst keyer and color sync stages. ▲

"CHOOSE YOUR PARTNER..."



WITH EVERY
CLAROSTAT
PICK-A-SHAFT* CONTROL
YOU GET YOUR CHOICE OF
SHAFT AT NO EXTRA COST!

Select the control you want — ½-watt composition-element, regular, tapped or dual; 2-watt wire-wound; 3-watt wire-wound; or 4-watt wire-wound. Then choose from any one of the 13 shaft types. There's one for every need.

Ask your Clarostat Distributor...

*Reg. U.S. Pat. Off.



for **P**erformance... **D**ependability... **Q**uality...

Controls and Resistors

CLAROSTAT MFG. CO., INC., DOVER, NEW HAMPSHIRE

In Canada: CANADIAN MARCONI CO., LTD., TORONTO 17, ONT.

checked, and a record made of the transistor type used in each stage. Finally, the results from all sets were combined to obtain stage-by-stage figures showing all transistor types in use and the total number of transistors of each type among the 64 sets. These numerical totals are given in the "No. of Units" column at the right of the type numbers in the chart. The tabulation is not a true "stock guide," since it does not take into account the production figures of different models of sets, but it does tend to indicate which types of transistors are finding widest usage in the field.

When a transistor type is employed in more than one stage, this fact is taken into account by listing the transistor more than once. The chart is as complete as possible, but no claim is made to have covered all production changes of every transistorized set; thus, a few transistor types besides those found in the chart may be found in the field.

The following abbreviations are used in the "Mfr." column:

Amp = Amperex
 Del = Delco
 GE = General Electric
 GT = General Transistor
 Mot = Motorola
 Ray = Raytheon
 Syl = Sylvania
 TI = Texas Instruments

Sometimes a single transistor design is available under two different type numbers. In such cases, both numbers are linked by "or" and listed together in the chart. Among RCA units, the solder-in 2N217, 2N218 and 2N219 are electrically equal to the plug-in 2N109, 2N139, and 2N140, respectively. Some Raytheon and TI transistors have both a standard RETMA "2N" number and a special number based on the manufacturer's own system.

"Special types" are transistors which, because of obsolescence or other reasons, may be hard to locate in the replacement market. We are informed that Regency still can furnish exact replacements for the special transistor types in its earlier models of radios. The IF units are shipped complete with a neutralizing capacitor which must be installed

along with the new transistor.

Many IF transistors are made in a series of closely related types such as TI types 2N145, -6, -7 and GE types 2N168A, -9A. Circuit design originally determines which member of a series is used, and an exact replacement is usually necessary.

In the chart, the term "AF driver" is defined as the stage following the second detector—it almost invariably drives a second or output audio stage. Either single-ended or push-pull output

circuits are employed. There is considerable variation in the power-handling capabilities of transistors used in AF stages, and listing them as "comparable" is stretching a point. Some units such as the 2N109 and 2N185 are able to operate either as low-level drivers or in class-B, push-pull stages with 150 to 250 milliwatts of output. Matched pairs of transistors usually are required for satisfactory class-B operation, except in the case of a few types such as the 2N186-8 series. ▲

ADD COLOR

RAINBOW DISPLAY

ORANGE
RED
MAGENTA
BLUE
CYAN
GREEN

ADD SOUND

FROM ANY SOURCE





EASILY MAKE the B&K Model 1000

DYNA-SCAN

a complete VIDEO & AUDIO GENERATOR

It's so simple and costs so little to add the Color-Scan or Audio-Scan, or both, to any Model 1000 Dyna-Scan. Makes the Dyna-Scan more useful and valuable than ever.

NEW MODEL C15 COLOR-SCAN

Adds crystal-controlled full color rainbow display (orange, red, magenta, blue, cyan, green). In conjunction with the White Dot and White Line patterns, it makes the Model 1000 a complete color test instrument. Enables you to test color sync circuits—check range of hue control—align color demodulators, etc. Easy to install on chassis. Just 4 wires to connect.

Net, **\$19⁹⁵**

NEW MODEL S16 AUDIO-SCAN

Adds FM sound transmission exactly like a TV station. 4.5 megacycles above video carrier, with modulation from any available audio source. Enables you to combine speech or music with the video display. Can be modulated with built-in 400 cycle tone generator for test signal or from external signal source such as microphone, tape recorder, FM-AM tuner, or audio oscillator. Can be used for aligning sound I.F. stages of intercarrier television set. Full 25 KC deviation similar to TV station. Has built-in audio amplifier and volume control. Input takes audio signals from .01 to 5 volts, low or high impedance. Simple to install on chassis.

Net, **\$29⁹⁵**



See your B&K Distributor, or write for Bulletin C15-S16-R

B & K MANUFACTURING CO.

3726 N. Southport Ave. • Chicago 13, Illinois

Canada: Atlas Radio Corp. 50 Wingold, Toronto 10, Ont.

Export: Empire Exporters, 439 Broadway, New York 13, N.Y.



Notes On

TEST EQUIPMENT

Latest Information on Application,
Maintenance and Adaptability
of Service Instruments

by Leslie D. Deane

Flying-Spot Scanner Serves as Portable Video Generator

The somewhat unusual instrument pictured in Fig. 1 is the Model 1000 "Dyna-Scan" developed and produced by B & K Mfg. Co. of Chicago. Utilizing small transparent slides, the instrument can deliver signals for the reproduction of any picture or pattern on the screen of a TV receiver.

Specifications and features are:

1. Power Requirements—117 volts, 60-cps AC supply, power consumption 150 watts.
2. Modulated RF Output—variable to a maximum of 50,000 microvolts, output impedance 75 ohms, coaxial cable provided.
3. RF Carrier—continuously tunable over all VHF channels—2 through 6 on fundamental frequencies, 7 through 13 on harmonics.
4. Output Signals—video modulated RF representing light variations of any 3" by 4" positive transparency; complete set of Indian head, white dot, and white-line crosshatch transparencies are supplied with instrument.
5. Calibration—built-in bar generator provides pattern on scanning tube for internal sweep adjustments.

When I examined this piece of equipment in the lab, I naturally wanted to try all of the test patterns on a properly operating TV

receiver first. Following the procedures outlined in the manual, I connected one end of the test cable to the RF OUTPUT jack

and the other to the antenna terminals of the receiver.

After turning on both the TV set and generator, and tuning both to the same unused channel, I adjusted the RF and VIDEO attenuators until I detected video on the screen of the receiver. With the TV's brightness and contrast controls set for normal operation, I then synchronized the picture by adjusting the HORIZONTAL control provided on the front panel of the "Dyna-Scan" and obtained a very presentable pattern.

By using the various test pattern transparencies, the service technician will find the Model 1000 useful for checking sweep size and linearity, contrast and AGC control settings, sync stability, picture resolution, and also the performance of antenna systems. In addition, the instrument



Fig. 1. B & K Model 1000 picture-pattern generator uses slide transparencies.

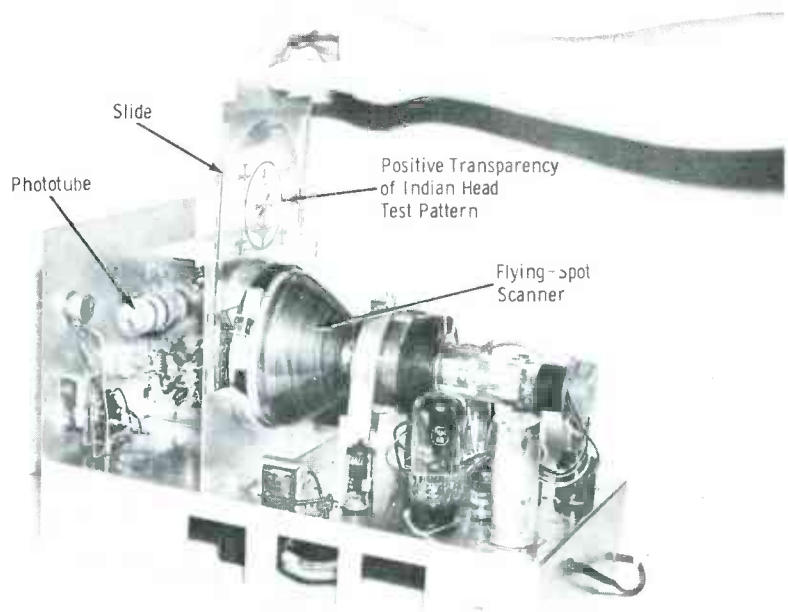

Fig. 2. "Dyna-Scan" chassis showing positions of scanner, slide and phototube.

to

do more

...today and tomorrow!



The first
low priced
tube tester
to provide
**DUAL SENSITIVITY
SHORT TEST**
Triplet Model
3413-B Tube Tester
\$79.50

BURTON BROWNE ADVERTISING

And here are just 2 answers that tell you why.

Question:

Why Will Triplet Model 3413-B "do more" tomorrow?

Answer:

Because it will test *any new tube*. Unlike testers with preset panels of test sockets which become obsolete with the release of a new tube, Triplet flexibility of switching allows a set-up to test any new tube.

Question:

Why Will Triplet Model 3413-B "do more" today?

Answer:

Because it combines provision for conventional short test (0.25 megohms) with high sensitivity leakage test (2.0 megohms)—will test series string tubes without adapter. At only \$79.50 today's and tomorrow's biggest value.

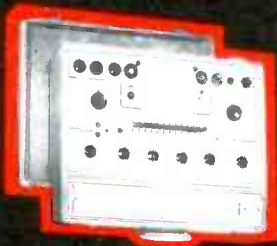

And for the ultimate in laboratory quality testing examine MODEL 3423 MUTUAL CONDUCTANCE TUBE TESTER \$199.50. Proportional Mutual Conductance testing of *all* radio and TV tubes plus selenium rectifiers, crystal diodes, pilot lamps, thyratrons, transistors, etc., by a new patented circuit.

At leading Parts Distributors everywhere, see the finest and most complete line of test equipment by

TRIPLET

Triplet Electrical
Instrument Company
Bluffton, Ohio

8 NEW B-T LABS PRODUCTS

... just a few of the many
new B-T precision
engineered products

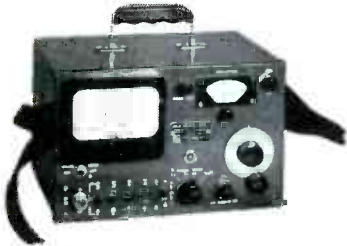

FIELD STRENGTH METER Model FSM-1

A portable precision instrument for accurate measurement of RF signals. Continuous tuning from 54 mc to 216 mc covering VHF-TV, FM, mobile, aircraft, ham, industrial and CD. Use of B-T UHF converter extends range to entire UHF band. **\$310 net**



3 MASTERLINE CRYSTAL-CONTROLLED CONVERTERS

Model MVC: Hi-to-Lo channel VHF converter.

Model MLC: Lo-to-Lo channel VHF converter.

Model MUC: UHF to VHF converter.

List \$300 Each

Extremely stable, self-powered with two matched 75 ohm outputs. All channel VHF mixing network. Flat within 1/2 db over full 6 mc output. For color and black and white TV.

4 INDOOR TV SYSTEM TAPOFFS

Easy to install, matched low cost tapoffs

Model TO1-75: single isolated tapoff for recessed mounting. For RG-11/U or RG-59/U, with 75 ohm jack. **List \$4.50**

Model TO1-300: has 300 ohm terminals. **List \$4.50**

Model TO2-75: two 75 ohm outlets from RG-11/U or RG-59/U cable. **List \$9.00**

Model TO2-300: two 300 ohm isolated outlets from RG-11/U or RG-59/U cable. **List \$9.00**

sold by electronic parts distributors
for further information use coupon below

BLONDER-TONGUE LABS, INC.

9-25 Alling Street, Newark 2, N. J.

PF-7

Please send me literature covering:

- Field Strength Meter Masterline Converters
 Indoor TV System Tapoffs

Name.....

Address.....

City..... Zone..... State.....

can be used to check and adjust static or dynamic convergence of color television receivers. Since the test setup is relatively simple and the servicing applications fairly obvious, I thought that readers may be interested in a brief description of the instrument's construction.

Pictured in Fig. 2 is the "Dyna-Scan" chassis removed from its cabinet. The instrument actually simulates a TV transmitter in that its RF output is modulated by both video and sync information. Thus, the composite signal is able to properly operate any conventional TV receiver. The 5BKPV-1 flying-spot scanner tube, pointed out in Fig. 2, resembles a small picture tube. Its high-voltage and sweep circuits are much like those found in conventional television chassis.

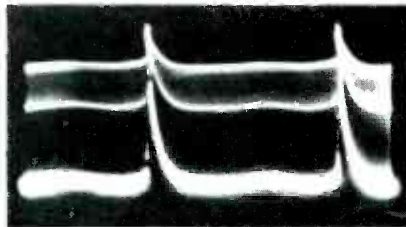

(A) With 30-cps sweep.

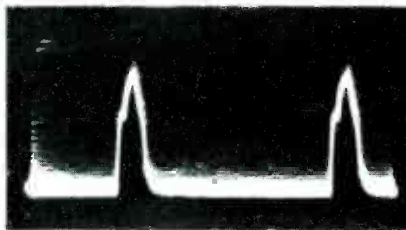

(B) With 7,875-cps sweep.

Fig. 3. "Dyna-Scan" sync signals.

In operation, the electron beam, or flying spot, sweeps the face of the tube which is blanked during each vertical and horizontal retrace interval. The raster light thus produced falls on a phototube placed directly in front of the scanner. The phototube, or photo-multiplier, converts this light energy to an electrical signal. When a positive transparency, such as that shown in Fig. 2, is placed between the flying-spot scanner and the phototube, the image appearing on the transparent slide is transposed from small variations of light to electrical impulses. Light will filter through the transparent areas but not through the opaque image, thus

producing a video signal voltage.

In addition to generating the video signal, the instrument also develops both vertical and horizontal sync pulses. This, of course, becomes part of the composite video signal and insures proper picture synchronization. The sync signals are derived from the sweep circuits of the 5BKPV-1. The waveform of Fig. 3A represents the vertical sync signal, while that of Fig. 3B represents the horizontal. These waveforms were obtained at the plate circuit of a TV video amplifier stage with the video control on the "Dyna-Scan" set to minimum.

Model C15 "Color-Scan" and Model S16 "Audio-Scan" accessory kits are available now to owners of the Model 1000 "Dyna-Scan." With the addition of these units, the instrument can be used as a color-rainbow and sound-carrier generator. I found that the kits consist of two small sub-chassis, which may be easily wired to the Model 1000 circuitry. All necessary items for changing the front panel features of the Model 1000 are furnished.

The one-tube color subchassis houses a crystal-controlled oscillator, enabling the modified "Dyna-Scan" to generate a color signal for a full rainbow display. For this feature, a separate video-color selector switch is installed on the front panel of the instrument.

The two-tube "Audio-Scan" unit incorporates an RF oscillator operating at 4.5 mc above the video carrier frequency. I also noticed that provisions are made for both internal and external modulation of this signal. An audio input jack is added to the front panel of the instrument as well as a volume control and audio modulation switch.

B & K has recently introduced



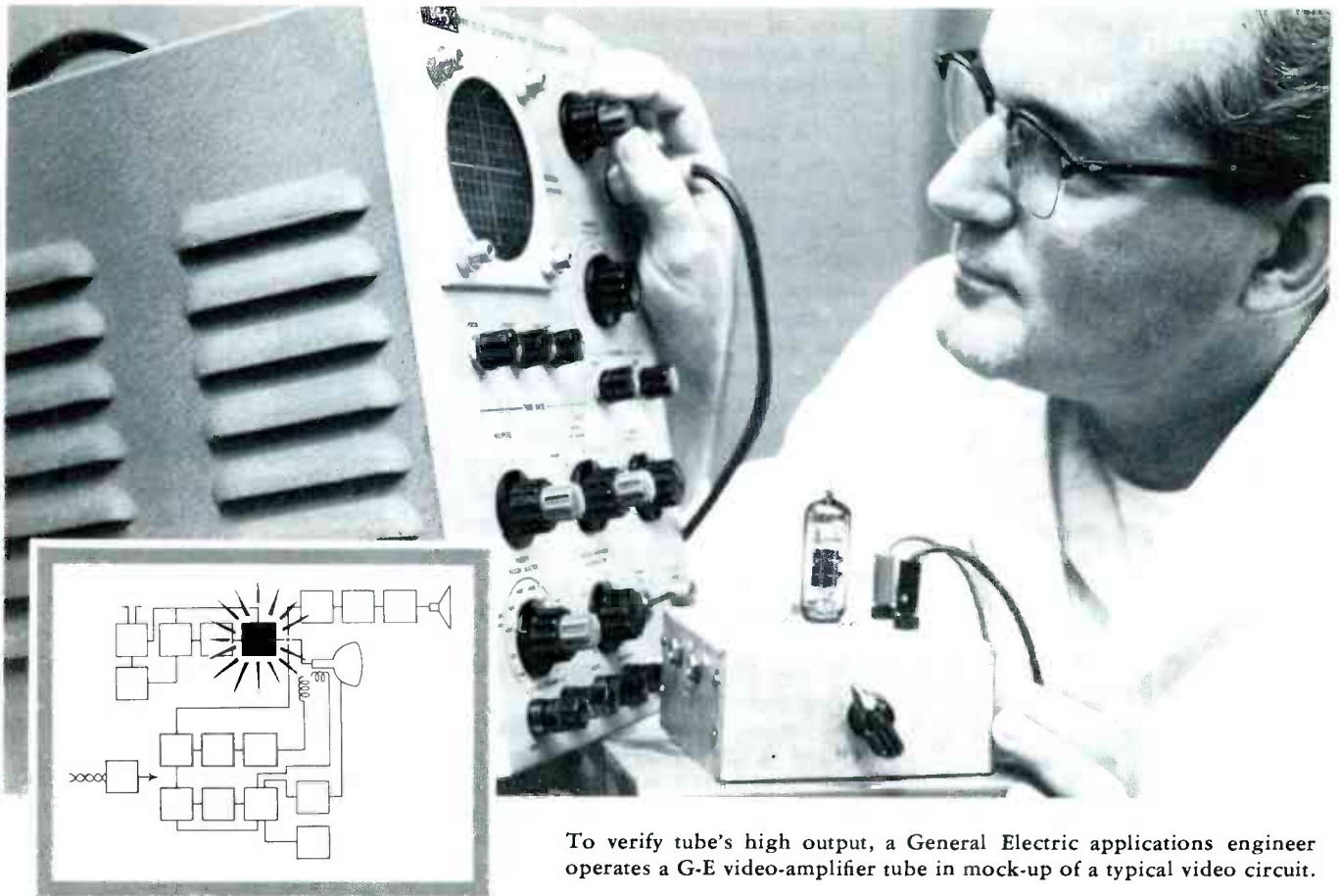

To verify tube's high output, a General Electric applications engineer operates a G-E video-amplifier tube in mock-up of a typical video circuit.

Install high-quality G-E video-amplifier tubes for maximum TV sharpness and contrast!

Plated grids and special-alloy cathodes keep down grid emission, increase video output!

● General Electric video-amplifier Types 6AU8-A, 6CX8, and 12BY7 feature plated grids and special-alloy cathodes. These reduce grid emission to an insignificant level, and mean sharp, full-detail TV pictures for your service customers.

Further, the new dual-function 6AU8-A includes new-design shields that bar cross currents between tube sections, effectively preventing picture distortion and erratic sync. Also, the tube's increased permeance and controlled knee location provide

more video output without white compression.

Similar high-quality characteristics mark *all* General Electric video-amplifier tube replacements. Stringent control of mica holes for support rods makes for tight-fitting tube elements and reduced microphonics. Rigid testing for zero-bias plate current encourages electrical uniformity . . . life tests promote full-length, top-value operation.

Always replace with high-quality G-E tubes! Your customers will enjoy better TV . . . your list of satisfied clients should grow steadily. *Distributor Sales, Electronic Components Division, General Electric Company, Schenectady 5, New York.*

Progress Is Our Most Important Product

GENERAL  ELECTRIC

161-1A6

**Cash in on
Profitable
Transistor Business!**

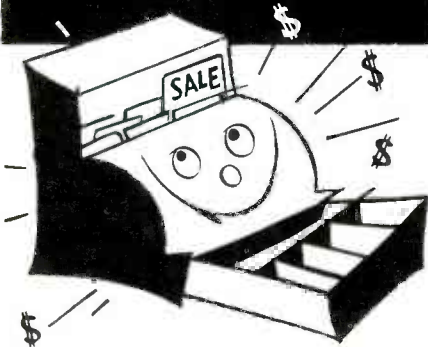

**STOCK
and
SELL**



TRANSISTORS

Thousands upon thousands of experimenters, hobbyists and engineers are using Raytheon Transistors for all kinds of circuits. And thousands upon thousands of transistor receivers are now in use and must be serviced.

You'll get a good share of both transistor sales business and receiver service work if you standardize on Raytheon Transistors, because Raytheon Transistors are (1) low priced (2) available for every application (3) stocked by Raytheon Suppliers from coast to coast.

Ask your Raytheon Tube Supplier for the new Raytheon Transistor Interchangeability Chart. It shows you just which ordinary transistors can be replaced by Raytheon Transistors. You'll find it most helpful. It's yours for the asking.



Excellence in Electronics
RAYTHEON MFG. CO.
Receiving and Cathode Ray Tube Operations
Newton 58, Massachusetts

the Model 1050 "Dyna-Scan." This piece of equipment incorporates both accessory circuits as factory built-in features.

A Special Type of Scope

The Kingston Electronic Corp. of Cambridge, Mass. has recently introduced a new special-purpose oscilloscope for the TV service industry. Pictured in Fig. 4, the instrument is identified as the Model VS4 Absorption Analyzer.

This portable unit is designed to permit waveform analysis from the tube side of the chassis. It makes use of capacitive pick-up rings which will electrostatically absorb a sample signal at the glass envelope of any specific tube throughout the chassis.

- Specifications and features are:
1. Power Requirements—110/120 volts, 60-cps AC supply, power consumption 55 watts.
 2. Vertical Input—cascode Stand-ard Coil tuner covering all commercial VHF channels, additional turret strips provide for 20-, 40-, 3.58-, and 4.5-mc operation; suitable deflection down to 200 microvolts with direct connection to antenna; direct frequency response down not more than 50% from 20 cps to 300 kc, sensitivity of 2 millivolts per inch.
 3. Horizontal Sweep Frequency—20 to 120 cps for viewing signals in vertical fields, 4,000 to 40,000 cps for horizontal scanning signals, sync control provided.
 4. Probe Pick-Ups—two rings and one crescent-shaped pick-up, large ring for GT type tubes and small ring for 7- and 9-pin miniature tubes, direct probe with built-in step attenuator also available as accessory.



Fig. 4. Kingston Absorption Analyzer has a unique pick-up device.

5. Front Panel Adjustments—beam intensity and on-off switch, sync control, vertical and horizontal sweep-frequency switch, vertical gain control, band selector, and input selector.
6. Rear Chassis Adjustments—focus, sync amplitude, sweep width, vertical and horizontal centering.

When checking out this instrument in our test equipment lab, I found it so different from other scopes that I was sure our readers would be interested in its operation. While reading over the instruction manual and examining the schematic, I noted the unusual vertical input circuit employed in the analyzer. I have shown this section of the instrument in block diagram form in Fig. 5.

As illustrated in the diagram, the probe pick-up and input cable first conduct the signal to the input selector switch. With this switch in the RF-IF or 3.58-4.5 mc position, input signals are coupled to a built-in tuner where they are

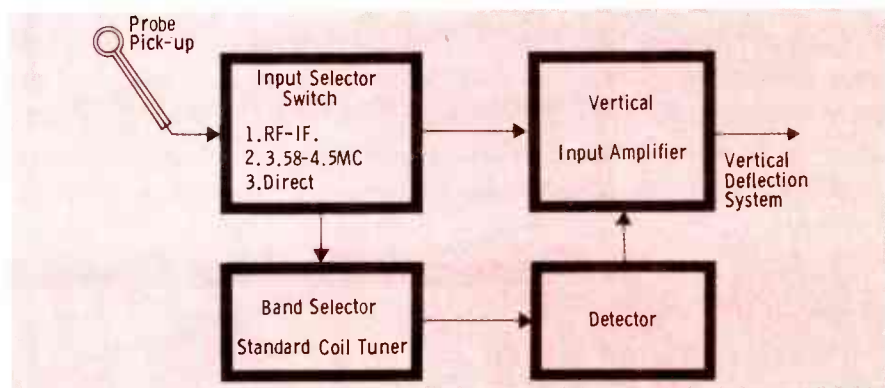

Fig. 5. Block diagram of vertical input system in Kingston instrument.

MAGIC NUMBERS

28 YEARS



P-275-Y

38

MAJOR REPLACEMENT FIELDS
OF APPLICATION

46 ITEMS



P-15-N

COMBINATION TO REPLACEMENT PROFIT

THE NEW

Jensen

CONCERT SERIES

Through the complete range of the Jensen Concert Series from the 2 3/4 inch miniature P-275-Y for transistorized pocket radios to the heavy duty 5 inch P-15-N you find the dependability and high order performance that are traditional with Jensen. The newly augmented Concert Series affords you the widest available choice of sizes and ratings of loudspeakers for general applications and for replacement. All have the new high energy DP-Alnico-5 magnets.



NEW!

the special Oval Group in the Concert Series, designed originally by Jensen

for one of the largest auto manufacturers features triple-rugged heavy-gauge distortion-proof housing, space saving shallow construction, immunity to weather and temperature changes, resistance to even severe overload and true high fidelity wide range models which will noticeably improve auto radio sound quality. The new Ovals should be used wherever 6 x 9 and 5 x 7 units are required for replacement.

Ask your distributor or write for new Data Sheet 167 for complete listings and specifications.

Burton Browne Advertising

World's Quality Standard for more than a Quarter Century

Jensen

MANUFACTURING COMPANY
6601 South Laramie Ave., Chicago 38, Illinois
Division of The Muter Co. • In Canada: Copper Wire Products, Ltd., Toronto

Here's why



**tubular capacitors
give you better
performance
and longer life!**

All Aerovox P88N molded tubular capacitors are manufactured by a unique low-pressure, low-temperature molding process that insures perfectly centered sections with uniform wall thickness on every single unit. Only Aerovox gives you round, uniform, undistorted, coaxially-centered sections solidly imbedded in the right plastic for superb mechanical, electrical and climatic characteristics.

NOT THIS NOR THIS AND NEVER THIS

Off-centered section Distorted section Compressed section

BUT
Always
THIS

Perfectly centered, undistorted, unimpaired section protected by uniform and adequate plastic wall thickness.

That's the inside story why Aerovox Duranite capacitors are recognized for their top performance and utmost reliability and extra-generous service life. Your local Aerovox Distributor carries a complete stock of Aerovox capacitors to meet ALL your service needs. Drop in soon and ask for a copy of the latest Aerovox catalog or write



AEROVOX CORPORATION

DISTRIBUTOR SALES DIVISION,
NEW BEDFORD, MASS.

In Canada: AEROVOX CANADA LTD., Hamilton, Ont.
Export: Ad Auriema, 89 Broad St., New York, N. Y.,
Cable: Auriema, N. Y.

amplified and converted to a 25-mc carrier. Inputs in the 20-mc band, however, receive only amplification in the tuner section. From the tuner the signal is then applied to the internal detector stage.

On the other hand, with the input selector in DIRECT position, input signals are applied directly to the vertical input amplifier and on to the deflection system of the CRT.

To give you a better idea of the practical applications of this instrument, I thought you might like to follow through with me on a waveform analysis of a typical monochrome receiver.

My first step was to fire up one of our TV test chassis (a conventional series-filament receiver), set the tuner on a local channel, and adjust all controls for normal picture and sound. After connecting one of the probe rings to the cable leading from the analyzer, I turned the unit on. I next removed the antenna leads from the set and connected them directly to the inner and outer metal bands of the pick-up ring. I then placed the instrument's input selector switch in the RF-IF position and set the band selector to the proper channel number. Following instructions, I flipped the sweep switch to the "V" (vertical) position and adjusted the gain control until the pattern reached a convenient viewing level. By varying the sync control, I was able to reproduce the composite video signal shown in Fig. 6. (All waveforms presented in this discussion were taken right from the face of the analyzer by a 35mm camera.)

This first test proved very interesting. I realized that by monitoring the TV signal at this point, the service technician could easily locate antenna or lead-in troubles, orient an antenna, and in some cases detect man-made interferences.

Placing the antenna leads back on the receiver and connecting the instrument's ground lead to the TV chassis, I next decided to take a peak at the signal present in the video IF stages. The TV chassis used in this experiment employed a 20-mc IF system; therefore, I positioned the analyzer's turret

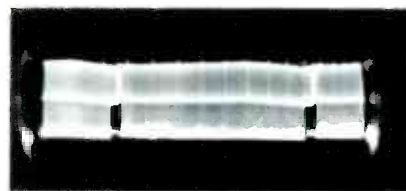

Fig. 6. TV signal picked up directly from antenna transmission line.



Fig. 7. Signal observed with ring probe over tube in video IF strip.

tuner or band selector on the channel number containing the special 21- to 27-mc coil strip.

Leaving all other adjustments as they were for the first test, I placed the small probe ring over the 2nd IF amplifier tube. Although I made no direct connection to the circuit, I was forced to reduce the setting of the gain control because of the strong input signal picked up by the probe. When I synchronized the pattern at a 30-cycle sweep rate, I was able to view the waveform pictured in Fig. 7.

By adjusting the width control, located on the rear of the analyzer chassis, I noticed that the pattern could be expanded considerably. This is an important feature, especially if a more detailed examination of the composite signal becomes necessary. Analyzing waveforms in this section of the receiver will naturally aid the technician in his troubleshooting procedure. He should be able to determine the relative gain of each stage, and to see any indications of hum, oscillation, or symptoms of sync clipping which usually result in overloading at the video stages.

Proceeding with our spot check of waveforms throughout the receiver, let's make our next stop at the input to the picture tube. Here, my first step was to place the input selector switch on DIRECT and to flip the sweep switch to the "H" or horizontal position. The instruction manual recommends that the sweep selector be kept in this position when signal tracing in the video-detect-



If it's worth Engineers' time . . .



. . . It's worth Engineered Cable



Belden

**INTERCOMMUNICATING
AND
SOUND SYSTEM CABLES**

Indoor-outdoor, phones
or speakers—there is a
Belden engineered cable
to meet your needs for
a permanent, trouble-
free installation.

"Items from the
Complete Belden Line"

*The TV station, the systems for
music, paging, and intercom-
munication in the new
Prudential Insurance Company
of America's Building in Chicago
have been—wired by Belden.*



Belden

**WIREMAKER FOR INDUSTRY
SINCE 1902
CHICAGO**

8-8

Magnet Wire • Lead and Fixture Wire • Power Supply Cords, Cord Sets and Portable Cord • Aircraft Wires
Welding Cable • Electrical Household Cords • Electronic Wires • Automotive Wire and Cable

THE HANDIEST TESTER YOU CAN HAVE IN YOUR KIT



THE ACME ELECTRIC T-8394 VOLTAGE ADJUSTOR

Smart service men, who like to save time and make more money by doing so, are using the Acme Electric T-8394M Voltage Adjustor on every service call. With this unit, varying voltage conditions ranging from 95 to 125 volts input can be simulated. Under these varying voltage conditions defective components that function properly at normal voltage, but cause trouble at low voltage or over voltage can be located and replaced.

And, in thousands of instances, service customers have insisted on buying this handy unit from the service man so that they may maintain a normal voltage at the set and enjoy top TV reception.

Furnished complete: primary cord and plug; secondary receptacle; accurate meter indicates output voltage; control switch regulates secondary voltage. Compact, inexpensive.

See this at your dealers.

ACME ELECTRIC CORPORATION
94 WATER STREET CUBA, NEW YORK

Acme Electric
TRANSFORMERS

tor, video-output, and picture-tube stages. This is due to the low capacity of the pick-up probe which will normally compress the vertical sync signals and thus cause the composite waveform to appear somewhat distorted.

Continuing, I next made a small loop from a portion of the picture tube cathode lead and placed the pick-up ring over it. After adjusting gain and sync controls, I obtained the waveform shown in Fig. 8. The sweep frequency of the scope was 7,875 cps; therefore, the video information could be seen between the two horizontal sync pulses.

Using the larger ring for a GT tube type, I thought I might next look at the vertical oscillator waveform. With the input selector set on DIRECT and the sweep switch in the "V" position, I slipped the pick-up ring over the tube. I again adjusted the gain and sync controls and obtained a clear-cut pattern at a 30-cycle sweep rate (Fig. 9).

For my final waveform analysis, I decided to use the crescent-shaped pick-up and view the horizontal oscillator signal. Setting the sweep selector to the "H" position, I positioned the half-moon probe against the glass envelope of the horizontal oscillator tube. The unusual pattern pictured in Fig. 10 appeared on the scope. I first thought that the crescent pick-up might not be giving a true indication, but after substituting the ring type pick-up, I found this waveform to be perfectly normal. The instruction manual informed me that the waveform at this stage will depend entirely upon the type of oscillator circuit employed in the receiver.

In addition to checking video, sync, and sweep signals in a television receiver, the instrument will also detect troubles in the sound IF and audio stages. Sound modulation patterns from the antenna to the speaker can be observed in much the same manner as video. By placing high-impedance magnetic earphones in the sound jack located on the front panel of the unit, one can hear, as well as view, the audio modulation.

A complete gallery of normal waveforms for both monochrome

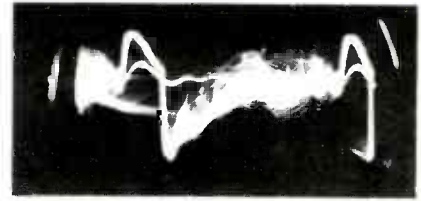

Fig. 8. Signal detected on cathode lead to picture tube.

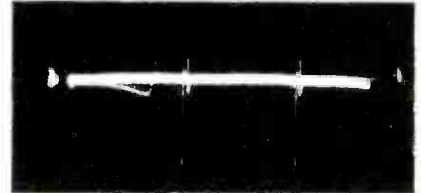

Fig. 9. Ring probe over vertical oscillator tube produced this waveform.

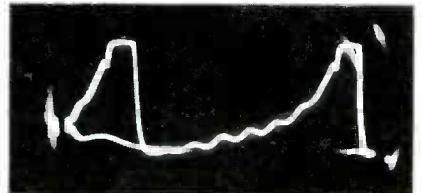

Fig. 10. Horizontal oscillator plate waveform as seen on Kingston Analyzer.

and color TV receivers is incorporated in the Kingston instruction manual. Once the technician becomes familiar with the waveform patterns produced by the analyzer, he should have little difficulty troubleshooting with this new instrument.

New Simpson Low-Range Ohmmeter

The instrument pictured in Fig. 11 is a recent product of Simpson Electric Co., Chicago, Ill. The Model 362 is a low-drain, two-range unit designed for measuring low-value resistances.

Specification features are:

1. Self-Power—one type "C" 1.5-volt flashlight cell, circuit current 5 ma.
2. Ranges—high, 0 to 25 ohms, scale markings every .5 ohm; low, 0 to 5 ohms, scale markings every .1 ohm.
3. Accuracy—3% of full-scale deflection using the expanded scale of a suppressed-infinity, shunt-type meter.
4. Calibration—front panel adjust control, two .08-ohm calibrated test leads provided.

After examining this piece of equipment, I was somewhat amazed to learn of the many applications such an instrument might afford the service techni-

ONLY UNIVERSITY OFFERS A COMPLETE RANGE OF DRIVERS

**Versatility and Adaptability
Unlimited... to Match Every
Soundcasting Requirement!**



Model PA-50



Model PA-HF



Model SA-30



Model SA-HF



Model MA-25

**ALL NEW DESIGN... ALL FROM
ONE RELIABLE SOURCE...
ALL BUILT TO UNIVERSITY'S
SUPERB QUALITY STANDARDS**

**Most Efficient
Widest Response
Highest Power
Greatest Output
Best Value
Always Dependable**

Model PA-50 — The ultimate in deluxe, advance-design. Features: extended high and low frequency range, highest continuous duty power capacity, Super W magnet, bi-sectional construction, greatest conversion efficiency, husky built-in multi-match transformer with terminals conveniently located at base of unit. Especially recommended for church chimes, carillons, organs; fast set-up time ideal for rental or semi-permanent systems; outstanding performance characteristics. The answer to the toughest sound problem. Nothing finer!

Response: 70 to 10,000 cps. Power Capacity: Full Range 50 watts, Adjusted Range 100 watts. Impedance: 16 ohms. Transformer Impedances: 100/165/250/500/1000/2000 ohms, 70 v. Line Power Taps: 50/30/20/10/5/2.5 watts. List Price: \$57.50.*

Model PA-HF — Without question the finest driver unit ever offered. For applications requiring the greatest power handling capacity, maximum sensitivity, widest range frequency response, plus rugged lifetime construction. Features completely die-cast aluminum housing. Water-tight voice terminals are located at base of housing for added convenience. Increased sound output cuts amplifier requirements in half!

Response: 70 to 10,000 cps. Power Capacity: Full Range 50 watts, Adjusted Range 100 watts. Impedance: 16 ohms. List Price: \$47.50.*

Model SA-30 — High efficiency and response of Model SA-HF, plus "battleship" construction for maximum durability against abuse or in hazardous environments. Completely die-cast aluminum housing and built-in matching transformer for connection to high impedance lines or "constant voltage" systems. Exclusive water-tight dural gland nut cable entrance. Shockproof bi-sectional speaker construction.

Response: 80 to 10,000 cps. Power Capacity: Full Range 30 watts, Adjusted Range 60 watts. Impedance: 16 ohms. Transformer Impedances: 45/165/250/500/1000/2000 ohms, 70 v. Line Power Taps: 30/20/10/5/2.5 watts. List Price: \$47.50.*

Model SA-HF — Often called "the workhorse of the sound industry." Meets most p.a. and industrial requirements. Response to 10,000 cycles and more efficient than the Model MA-25. Will deliver that extra punch needed to cut through heavy noise. Use for speech or high quality music. Tropicalized and hermetically sealed for continuous top tight performance even under adverse weather conditions.

Response: 80 to 10,000 cps. Power Capacity: Full Range 30 watts, Adjusted Range 60 watts. Impedance: 16 ohms. List Price: \$36.00.*

Model MA-25 — Use this rugged, weather-proof driver unit where response to 6500 cycles is adequate or to preserve "balance" when used with high cut-off frequency trumpets. Low in cost, high in quality, featuring high efficiency magnet, tropicalized 2" voice coil, "rim-centered" breakdown-proof bakelite diaphragm.

Response: 85 to 6500 cps. Power Capacity: Full Range 25 watts, Adjusted Range 50 watts. Impedance: 16 ohms. List Price: \$27.50.*

* Program response adjusted to horn cut-off.

WITH THESE TRUMPETS

USE ANY UNIVERSITY DRIVER FOR EFFICIENCY, ECONOMY AND ADAPTABILITY NEVER BEFORE POSSIBLE!



DIRECTIONAL-4 MODELS

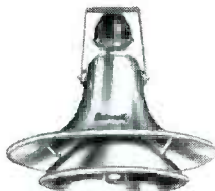

RADIAL-3 MODELS



SUPER POWER-2 MODELS



WIDE ANGLE-2 MODELS

**THE SUPER-POWER YOU WANT
... WHEN YOU WANT IT!**

With the 2YC ACCESSORY CONNECTOR, you can apply the output of any two drivers to the same trumpet... meet any budget limitation... and get exactly the frequency response, efficiency and power capacity you need. Up to 200 watts—using standard stock drivers!

RTA, WEA ADAPTERS... for fitting University drivers and trumpets with 1 3/8" — 18 threads to equipment having 1 7/16" — 16 threads.



LISTEN

University sounds better



FOR FURTHER INFORMATION WRITE UNIVERSITY LOUDSPEAKERS, INC., 80 SOUTH KENSICO AVENUE, WHITE PLAINS, N. Y.



American

Now . . . look to ELGIN for research, design and manufacturing leadership

American's FULL VISION—FULL SOUND audio equipment now comes to you from Elgin! Warehouse and service facilities are being maintained in California, of course; but manufacturing and product development have been moved to Elgin to work hand-in-glove with Elgin's well known styling and electronics research experts. You can expect the best . . . in appearance and performance . . . from American Microphones.

Does your equipment require a specially designed microphone? American is now better equipped than ever to help you!



1.



2.

an American Microphone for every use!



3.



4.



5.



6.



FOR BROADCAST QUALITY

1. DR330 Cardioid Dynamic and Ribbon Microphone meets strictest requirements of tv-radio broadcasting and motion pictures.

2. Presidential Series Dynamic Omni-Directional Microphone is rugged, compact, quickly converts to 6 oz. hand microphone.

FOR RECORDING AND GENERAL P. A. USE

3. D22 Dynamic Omni-Directional Microphone is a beauty queen—and dependable too. Quickly converts to hand use.

FOR TAPE RECORDERS

4. Versatile microphone is designed for hand or desk use, weighs only 2 ounces, yet gives outstanding performance.

FOR SOUND-POWERED TELEPHONES

5. No external power source required for this lightweight, sensitive unit. Rugged and extremely versatile.

FOR RUGGED, DEPENDABLE OUTDOOR MICROPHONES

6. A mobile microphone that resists moisture. Ideal for ship-to-shore and aircraft installation. High output, shock resistance.

ELECTRONICS DIVISION

ELGIN NATIONAL WATCH COMPANY

107 National Street, Elgin, Illinois

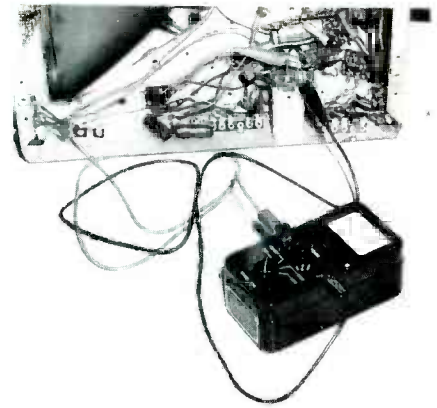

Fig. 11. Checking coil resistance with Simpson Model 362 low-range ohmmeter.

cian. Aside from its use in checking motor winding resistances, relay coils, and switch contacts, I found a number of instances where accurate low-range resistance measurements could be of a definite value in servicing both radio and TV receivers.

For example, let's see what inductive components could be measured with this type of unit. In the average TV receiver, the tuner, IF, filament choke, video peaking, trap, and certain AFC or oscillator coils all have relatively low DC resistance values. If these coils have shorted turns or higher than normal contact resistances, an accurate ohmmeter check will often locate the trouble immediately.

Primary and secondary windings of typical video IF transformers normally average from .01 to .7 ohms. In modern receivers, a series peaking coil at the video detector stage will usually tip the scale at 1 to 4 ohms, while the shunt coils at this stage may run as high as 20 ohms. Peaking coils in the video output circuit, on the other hand, generally average from 5 to 15 ohms. Other components, where I found an accurate indication of DC resistance to be of significance, are high-voltage filament resistors; certain windings of the power, audio, and sweep transformers; surge-limiter resistors; speaker voice coils; tube filaments; and individual windings of the deflection yoke.

An accurate low-range ohmmeter, such as the Model 362, can also be used for tracing shorts in a complex wiring system, checking for positive contact between tube socket and pins, or for proper



20,000 megawatts

What's this "big feller" doing in a service ad?
The story behind it is important to you.

The "big feller" is known as a "low-inductance energy-storage capacitor." It's made by Tobe, and used in nuclear research. And get this . . . it has a rating of 100,000 volts. What's more, it is capable of delivering a peak power of 20,000 megawatts.

This is just one example of the many types of capacitors Tobe has been building for 35 years. This fact is important to you because the new quality line of Tobe service capacitors is built to the same high standards. The line includes all the popular types required to meet 90% of all replacement needs.

You'll be pleased when you switch to Tobe. So will your customers. See your Tobe jobber today for full details, or write Tobe Deutschmann Corp., Service Div., 2900 Columbia Ave., Indianapolis, Ind.

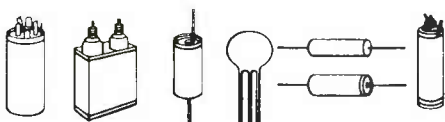

Specify



Capacitors • Pioneers Since 1922

**YOU CAN FORGET
ABOUT CHASSIS
"BITES"**



\$29.50

From Stock of
Your Jobber

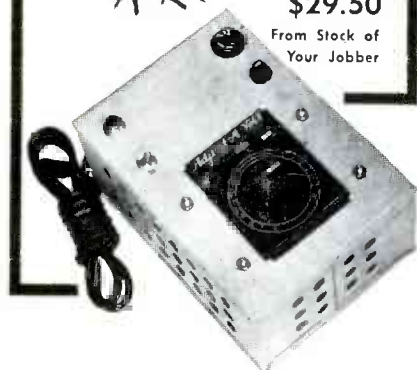

Adjust-A-Volt

LR-5 Variable Transformer

No wonder thousands of servicemen rely on the LR-5! It's standard equipment on many test benches because it combines the features of both a variable and isolation transformer.

Because of its isolated primary winding you can handle any TV or radio set without jitters... it takes the "bite" right out of the job! Intermittent operating sets can be checked with it by dropping line voltage to 105V or lower, to detect a faulty oscillator. You can also use it to cook a set at 130-140V, to break down an intermittent part.

Use the Adjust-A-Volt LR-5 on any job where a variable or isolation transformer is needed... you'll like it! Built for long life and dependability, this husky 1/2 KVA electro-statically shielded unit is supplied in a grey, wrinkle finish case, equipped with pilot light and convenient fuse.

Write for our catalog. It describes our complete line of isolated primary and other types of variable transformers.

**STANDARD
ELECTRICAL PRODUCTS CO.
2240 E. THIRD ST., DAYTON, OHIO**

ground connections throughout the receiver. Measuring precision resistors and shunts in other test instruments is still another application for this instrument.

Bench Bias Supply Eliminates Makeshift Battery Hookups

The accessory instrument shown in operation in Fig. 12 is the Precision Model 230 Multi-Bias Supply. Especially designed for alignment purposes, the unit is manufactured by Precision Apparatus Co., Inc., of Glendale, Long Island.

Specification features are:

1. **Power Requirements**—115-volt, 50/60 cycle AC only, power consumption 11 watts.
2. **Filtered DC Output**—three outputs variable from 0 to -15 volts with a maximum internal impedance of 975 ohms each, one output variable from 0 to -150 volts with a maximum internal impedance of 37,500 ohms.
3. **Current Rating**—drain on combined output supplies 5 ma maximum.
4. **Voltage Regulation**—OA2 regulator tube and internal calibration adjustment for voltage-dropping network.
5. **Test Leads**—4 black leads for negative bias jacks and 1 red lead for common or +GRD jack.

The most important use I found for this piece of equipment is in color television alignment work. Having four separate output supplies, the unit can simultaneously provide required bias voltages to several circuits in these more complex receivers. For example, I recently had the opportunity to use the instrument during the alignment of an RCA Model 21-CD-7895U color receiver. In the pre-alignment instructions, the manufacturer recommends that a variable DC bias supply be connected to the chroma AGC line. During the video IF alignment, two additional bias voltages are required for RF and IF bias.

Most bias voltages specified in alignment procedures will range between 0 and -15 volts DC. The burst keyer circuits in certain color receivers, however, require bias voltages as high as -100 volts.

Another interesting feature about the Model 230 is its use in

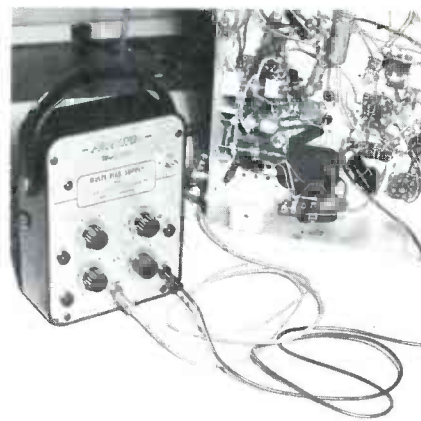

Fig. 12. Several bias voltages are available from the Precision Model 230.

extending the highest ohms ranges of typical multimeters. Connections for this application are described in the instruction manual. The manual also mentions the instrument's use as a low-current bias supply for breadboard circuits. With this in mind, I decided to check this feature by using the unit to power a small transistor radio. I realized, of course, that the total current drain must not exceed 5 ma. After measuring the current requirements of several transistor radios, I found that I could power the smaller 3- and 4-stage receivers with the Model 230. Transistor radios drawing less than 2.5 ma, such as Regency Model TR-1 and Sutton Model TR3-B, can be operated successfully.

The Little Black Box

The small test instrument being held in Fig. 13 is the Model 50-A Inductive Winding Tester. The unit is being produced by B & M Electronic Mfg. Co. of Fort Wayne, Ind., and is designed to operate in conjunction with both the vertical and horizontal deflection systems of any ordinary oscil-

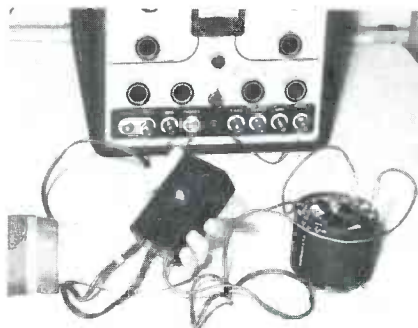
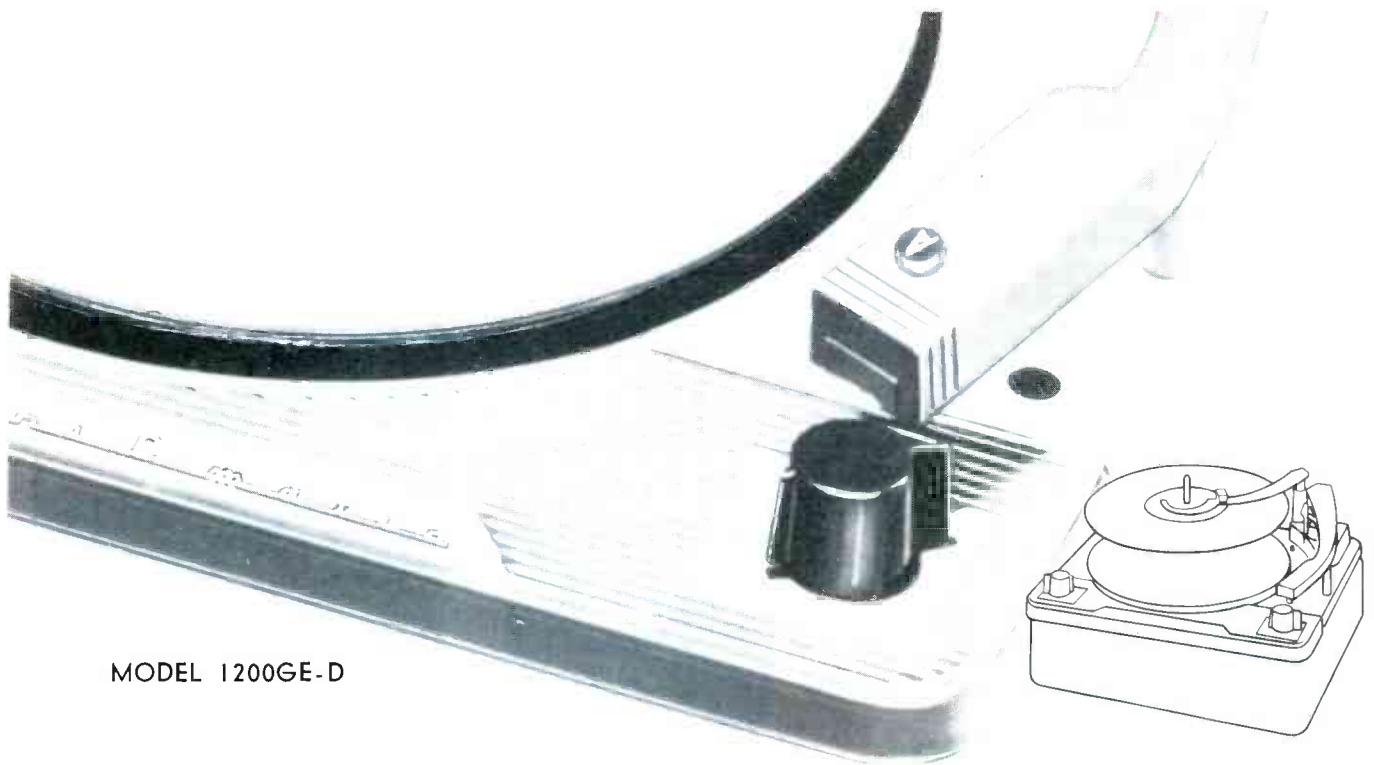

Fig. 13. B & M coil checker being used with scope to test yoke winding.



MODEL 1200GE-D

V-M / GE-D

Which Means: America's Best-Selling Record Changer Sells Better Than Ever With a GE Cartridge and a *Diamond Needle!*

It isn't often that a model designation rates headlines, but the cryptic symbol up there means that you can make plus profits selling the V-M 4-speed automatic record changer at its sparkling best—mounted on a metal base pan, equipped with a four-pole motor, muting switch and sporting a General-Electric variable reluctance cartridge and a 1-mil DIAMOND needle! (There's a 3-mil sapphire, too.) Model 1200GE-D Audiophile Net is only \$54.00** **INCLUDING DIAMOND NEEDLE!**

Other plus-features: Patented drive motor, low-torque jam-proof mechanism,

Tri-O-Matic* spindle, rubber turntable mat. A model to suit every need. As you know, most of the finest American-built phonographs* are equipped with the V-M 1200 series 'Super-Fidelis' 4-speed changer with exclusive 'Siesta-Matic' protection feature.

Hurry! Call your V-M Distributor and order NOW!

*We'll gladly send you a long list of famous phonograph makers who use the V-M changer as original equipment. Just drop us a line.

***Slightly higher in the West*

the **Voice**  of **Music**®
 V-M CORPORATION BENTON HARBOR, MICHIGAN

WORLD'S LARGEST MANUFACTURER OF PHONOGRAPHS AND RECORD CHANGERS

loscope. Operating from a 110/120 volt, 60-cycle AC supply, the Model 50-A will aid the technician in checking for an open winding, shorted turns, or leakage between core and winding in the following inductive components:

1. Flyback transformers.
2. Deflection yoke windings.
3. Blocking oscillator transformers.
4. Vertical output transformers.
5. Audio interstage transformers.
6. Audio output transformers.
7. Power transformers.
8. Filament transformers.

9. Windings of small motors and generators.

10. Automobile spark coils.

Consulting the instruction booklet, I learned that by connecting the proper leads from this instrument to the vertical input, horizontal input and ground terminals of a conventional scope, various inductances connected between the test leads will cause spiral-like patterns to be produced on the screen of the scope.

Naturally, I was curious to see how this unit worked, so I decided to try it out on a TV sweep com-

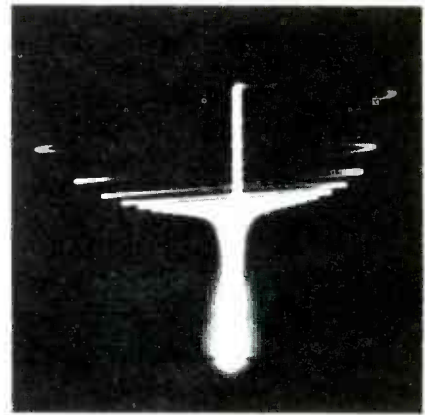

(A) With normal yoke winding.

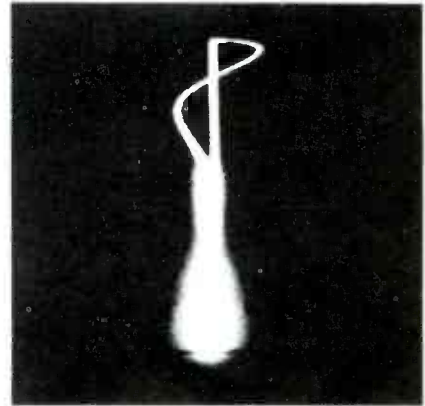

(B) With shorted yoke winding.

Fig. 14. Displays produced by B & M unit.

ponent such as a deflection yoke. Selecting a yoke of known good quality, I proceeded to connect the instrument's three-wire cable to one of our scopes in the lab. I then applied power to the box and placed the two "Minigator" clip leads across the entire vertical winding of the yoke.

After adjusting the scope as recommended, I obtained the unusual pattern pictured in Fig. 14A. According to the instruction booklet, this was a full spiral cone, indicating the winding was intact and free from shorts and leakage.

To get an idea of the type of pattern a defective winding might produce, I obtained a yoke with a shorted vertical winding. The results of this test can be seen in Fig. 14B. Here, it was obvious that the spiral-like oscillations were lost—thus denoting a lack of inductance and a faulty winding. Once the technician becomes acquainted with the various patterns obtained in checking different inductive components, he will have little difficulty interpreting his findings with the little black box! ▲

NEW! REVOLUTIONARY!

BULLET

SWIVEL ANTENNA

by TENNA

★ **MOUNTS ANYWHERE!**

The "mast section" of the "Bullet" swivels to permit either top cowl, top fender, side cowl, side fender or rear deck mounting. Available with vertical masts for front mounting and graceful sweep-backs for rear mounting. Extra mounting pads furnished for curved surfaces.

Brilliantly chrome plated from base to tip. The Bullet adds a sparkling touch of beauty to even the most beautiful of today's beautiful cars. Packaged in lovely black and gold display carton. All 15' cables listed below are equipped with 75MMF ceramic condensers to provide finest reception.

2 Models
Vertical and sweep back

Both swivel to meet **EVERY MOUNTING NEED!**

FRONT FENDER, VERTICAL

TRUNK DECK, SWEEP-BACK

FRONT FENDER, SWEEP-BACK

SIDE FENDER, SWEEP-BACK

REAR FENDER, SWEEP-BACK

MODEL	DESCRIPTION	CABLE
JA-1	Single Rear, Active	15'
JA-2	Single, Dress-Up	None
JA-3	Dual Rear, Active	15'-6'-3"
JA-4	Dual, One Active	15'
JA-5	Front, Vertical	4'
JA-6	Front, Sweep-Back	4'

THE TENNA MANUFACTURING CO.
CLEVELAND 25, OHIO

FREE



BARBEQUE GRILL with "FASTEST FIFTY" TUBES!

this portable, foldaway Charcoal Grill is just the thing for enjoying delicious grilled steaks, hamburgers and hot dogs all year round! Use in fireplace, back yard barbeque or at the beach. Gives big 17½" cooking area. Built of strong, sturdy steel yet weighs only 5 lbs.

\$4⁹⁸ Value

Westinghouse RELIATRON® Tubes Special Offer *with Fifty Fastest-Moving, High-Profit Tubes*



Starting June 1, 1957, for a limited time, with your order of the "Fastest Fifty" Westinghouse Tubes, you get a free barbeque grill packed right in the special container! What's more, you get the fifty tubes with the fastest turnover and highest profit. Westinghouse RELIATRON Tubes—the tubes that are still standing up under the grueling Locked TV "Torture Test"—proving they work better and last longer to reduce call-backs!

PLACE YOUR ORDER WITH YOUR WESTINGHOUSE DISTRIBUTOR TODAY!

HERE'S WHAT YOU GET
in the special "Fastest Fifty" Tube Kit of RELIATRON Tubes . . .

QUANTITY	TYPE NO.
5	1B3GT
5	5U4GB
6	6AU6
3	6AX4GT
6	6BQ7A
3	6BZ7
7	6CB6
7	6SN7GTB
5	6U8A
3	12AU7A

YOU CAN BE SURE...IF IT'S Westinghouse

Shop Talk

(Continued from page 11)

ing capacitor to feed back signal voltage from the base of one stage to the base of the preceding stage. This neutralization counteracts the voltage which feeds back from the

Now the collector and base receive positive voltages while the emitter is made relatively negative. In the circuit shown, R4 with R5 and R9 with R10 form voltage dividers to provide the required bias voltages for the bases of X2 and X3. R8 and R14, in the col-



"Mother. He . . . he loves the phonograph more than he does me . . . since we got the JENSEN NEEDLES!"

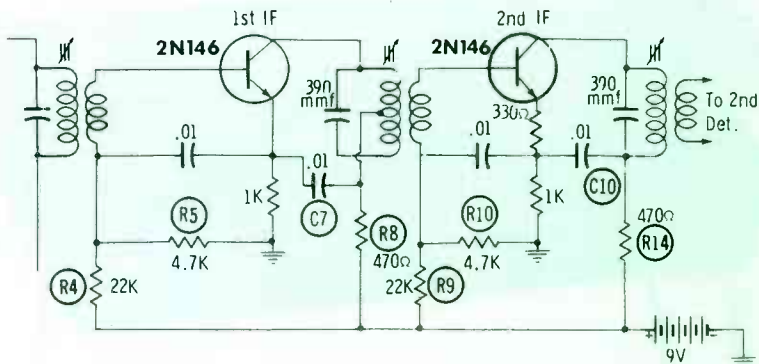

Fig. 3. IF system in Motorola Model 56T1 portable receiver.

lector to the base of X2 via internal transistor capacitances and which could lead to regeneration if not checked.

Another IF system, this one using n-p-n transistors, is shown in Fig. 3. With the change in transistor type comes a reversal in the polarity of the biasing voltage.

lector circuits of X2 and X3, respectively, serve more as decoupling resistors than voltage dropping resistors. Together with suitable bypass capacitors C7 and C10, they prevent signals from reaching the common B+ line.

It is interesting to note that in each stage of Fig. 3, the point

the specs are the proof . . .
the BEST BUYS are **EICO**
for COLOR & Monochrome TV servicing

NEW
Dynamic
Conductance
Tube &
Transistor
Tester
#666
WIRED \$109⁹⁵
KIT \$69⁹⁵

COMPLETE with steel cover and handle.

SPEED, ease, unexcelled accuracy & thoroughness. Tests all receiving tubes (and picture tubes with adapter). Composite indication of Gm, Gp & peak emission. Simultaneous sel of any 1 of 4 combinations of 3 plate voltages, 3 screen voltages, 3 ranges of continuously variable grid voltage (with 5% accurate pot). New series-string voltages: for 600, 450, 300 ma types. Sensitive 200 ua meter. 5 ranges meter sensitivity (1% shunts & 5% pot). 10 SIX-position lever switches: freepoint connection of each tube pin. 10 pushbuttons: rapid insert of any tube element in leakage test circuit & speedy sel. of individual sections of multi-section tubes in merit tests. Direct-reading of inter-element leakage in ohms. New gear-driven rollechart. Checks n-p-n & p-n-p transistors: separate meter readings of collector leakage current & Beta using internal dc power supply. Deep-etched satin aluminum panel; rugged grey wrinkle steel cabinet. CRA Adapter \$4.50

See the 50 EICO models of tests instruments and hi-fi equipment IN STOCK at your neighborhood distributor. Write for FREE Catalog PF-7

Prices 5% higher on West Coast

EICO BROOKLYN 11, N. Y.

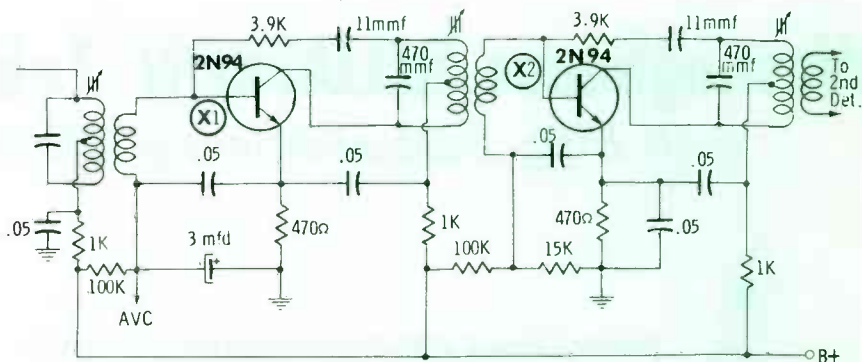

(A) Zenith Royal 500.

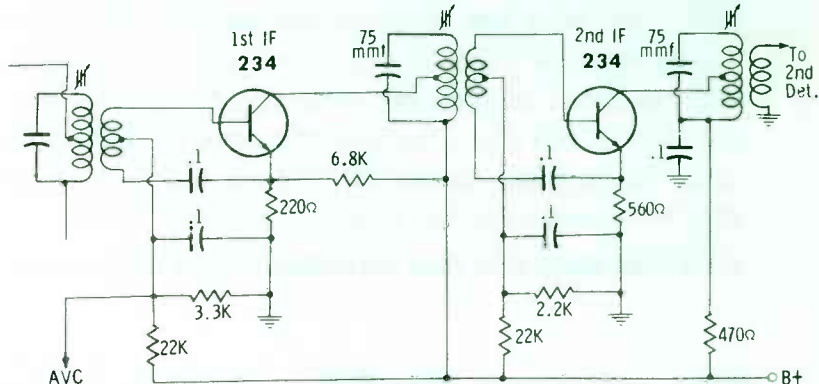

(B) RCA Model 7BT-9J.

Fig. 4. IF sections which use tapped transformers to provide impedance matching.

how long would it take you to solve this service problem?

SYMPTOM: Smeared Picture (showing black streaks trailing from blacks)

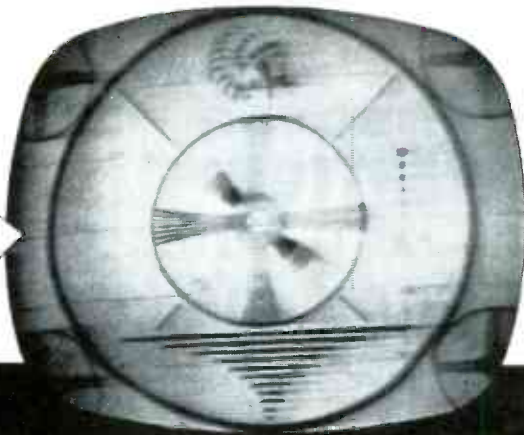

PHOTOFACT helps you lick problems like this
in just minutes for only
***2½¢ per model!**

Let's take a look at this problem: A smeared picture such as illustrated above is caused by excessive low-frequency response coupled with poor high-frequency response. Look for the following possible causes:

1. Defective video amplifier, video output, or Picture tube
2. Low value of coupling capacitor C51 or C53
3. Low value of grid resistor R46 or R52
4. Open cathode bypass capacitor C50 or C52
5. Open series-peaking coil L23 or L21
6. High value of plate resistor R44, R48 or R49

With the applicable PHOTOFACT Folder at your fingertips, you trouble-shoot and solve this problem in just seconds. Here's how:

Check the Video Detector (V7) and the Video Amplifier (V8). Just refer to the Tube Placement Chart (you'll find it in every PHOTOFACT TV Folder) for quick location of these tubes.

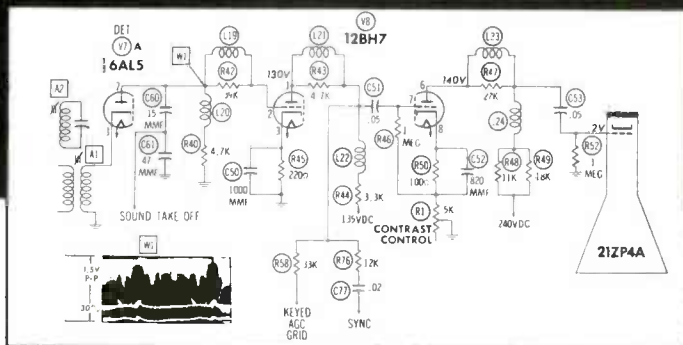

(Based on an actual case history taken from the Howard W. Sams book "TV Servicing Guide")

Tubes okay?—then: Check the waveform at pin 7 of V7. The correct waveform is shown right on the PHOTOFACT Standard Notation Schematic. Waveform correct?—then: Check the voltages in the Video amplifier and Video output stages to determine which part is defective. The correct voltages appear right on the exclusive Standard Notation Schematic, along with resistances (shown in easy-to-read chart form). Exclusive PHOTOFACT chassis photos with "call-outs" keyed to the schematic help you locate the faulty parts in just minutes.

Whatever the trouble, you'll locate it faster and easier with a PHOTOFACT Folder by your side. Be sure to use the complete Replacement Parts List to select the proper replacement for the repair.

Use the servicing method you prefer—checking of waveform, voltage or resistance—you'll find all the information you need at your finger-tips in PHOTOFACT. For only *2½¢ per model, PHOTOFACT helps you solve your service problems in just minutes—helps you service more sets and earn more daily!

*Based on the average number of models covered in a single set of PHOTOFACT Folders.



MONEY BACK GUARANTEE!

Got a tough repair? Try this—at Howard W. Sams' own risk: see your Parts Distributor and buy the proper PHOTOFACT Folder Set covering the receiver. Then use it on the actual repair. If PHOTOFACT doesn't save you time, doesn't make the job easier and more profitable for you, Howard W. Sams wants you to return the complete Folder Set direct to him and he'll refund your purchase price promptly. GET THE PROOF FOR YOURSELF—TRY PHOTOFACT NOW!

FREE



FOR SERVICE TECHNICIANS ONLY

Fill out and mail coupon today for Free subscription to the Sams Photofact Index — your up-to-date guide to virtually any receiver model ever to come into your shop. Send coupon now.

HOWARD W. SAMS & CO., INC.

Howard W. Sams & Co., Inc.
2201 E. 46th St., Indianapolis 5, Ind.
 Put me on your mailing list to receive the Sams Photofact Index and Supplements. My (letterhead) (business card) is attached.
 I'm a Service Technician: full time; part time
My Distributor is: _____
Shop Name _____
Attn: _____
Address: _____
City _____ Zone _____ State _____

NEW CONNECTOR INVENTION

SAFE! FAST! SURE!

E-Z-HOOK TIP

CONVERTS YOUR STANDARD
TEST PROD TO A SELF-HOLDING
CONNECTOR IN SECONDS!

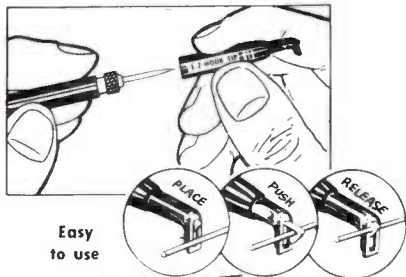

Easy
to use

* SAFE!

Fully Insulated
Small and Compact
Keeps Hands Clear of Wiring

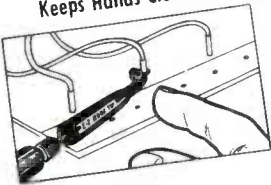

* FAST!

Frees Your Hands
Easy to Connect or
Disconnect

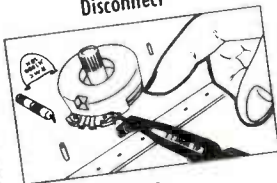

* SURE!

Won't Slip Off
Insures Positive Connections
Fits Irregular Shaped Conductors

For your special test
Probe assemblies

Use the NEW
E-Z-HOOK Custom PROBE

- ① Saves time and money
- ② Has the E-Z-Hook connector
- ③ Built-in terminal board



GET THEM AT
YOUR
PARTS DISTRIBUTOR

TODAY

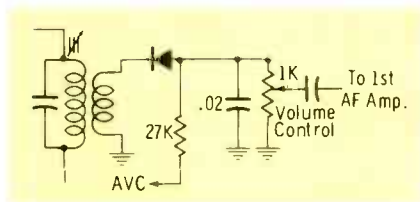

Fig. 5. Typical crystal diode detector employed in transistor radio receivers.

where the collector voltage line connects to the IF transformer is not at the bottom of the transformer winding but instead is a short distance up from the bottom. This, again, is an impedance modifying or matching stratagem, only now the matching takes place in the transistor output circuit rather than the input circuit of the following stage. It means that the transformer primary impedance is higher than the output impedance of the transistor. By means of the

4A, is employed in the Zenith Royal 500 receiver. Note that tapped primary windings are used in order to have each tuned circuit match the impedance of its associated collector while, at the same time, provide the desired degree of selectivity. Neutralization between the collector and base is achieved by using an 11-mmf capacitor in series with a 3900-ohm resistor. The emitter of each transistor contains a 470-ohm DC stabilizing resistor and a bypass capacitor to prevent signal degeneration. In the first stage, the emitter resistor appears, at first glance, to be unbypassed although actually it is, by means of the .05- and 3-mfd capacitors acting in series with each other. Finally, AVC voltage is brought to the base of X1 from the diode second detector (not shown).

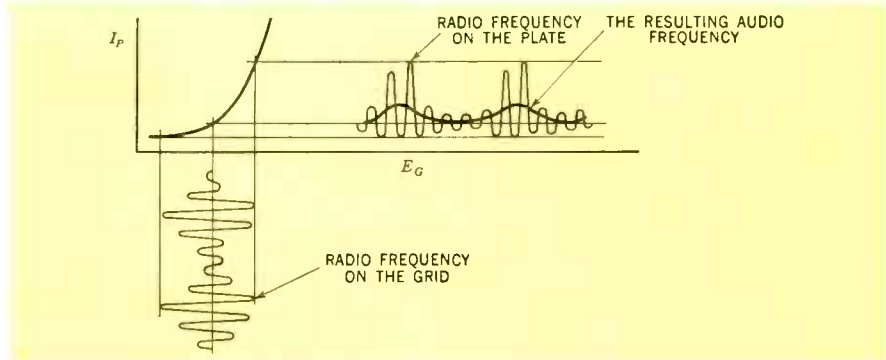

Fig. 6. Class-B detector rectifies and amplifies the signal.

tap, the transistor and transformer are matched, yet the transformer is allowed to retain its selectivity.

No neutralizing circuit is employed here because the transistors used have been constructed so that negligible feedback effects occur at 455 kc. Also, to aid in maintaining stability, unbypassed resistors are employed in the emitter leg of each transistor. No AVC network is shown for each of the preceding two diagrams, but AVC is employed. This will be discussed more fully later.

Two additional IF circuits are shown in Fig. 4. The first one, Fig.

The second IF system, shown in Fig. 4B, appeared in the RCA Model 7BT-9J receiver. It, too, utilizes a tapped primary on each IF interstage transformer although here the tap connection goes to the collector, rather than to the B+ (or B-) line as in the previous circuits. The result, nevertheless, is the same.

One novel feature found in the RCA circuit is the use of a center-tapped secondary on each IF transformer. This provides the associated transistor with a balanced or push-pull input whereby one polarity signal is applied to the

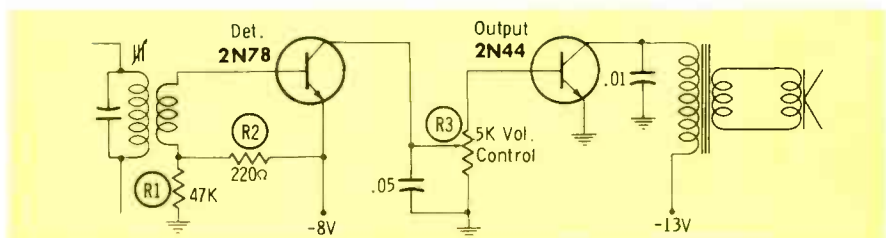

Fig. 7. A 2N78 n-p-n transistor functions as the second detector in GE Model 675.

base and the opposite polarity signal goes to the emitter. Although this arrangement may not provide any greater signal, it is beneficial in reducing the tendency of the stage to oscillate due to collector-to-base feedback. This is because any voltage fed back from the collector to the base is split in two. Part of the voltage takes the path from the base through the upper half of the input transformer to ground. The other path is through the base-emitter impedance and the lower half of the input transformer to ground. If the turns in both sections of this tapped winding are properly proportioned, the effects of the two currents will cancel, thereby effecting neutralization. Such split input systems yield 4 to 8 db less gain per stage than RC neutralization methods. They tend, however, to be superior insofar as interchangeability of transistors is concerned.

This split input system was used only in one model of this manufacturer's line. In later sets, it was dropped and designers used transistors in which the feedback between the input and output circuits at 455 kc was not significant enough to warrant a special neutralizing network.

Second Detectors

Two types of second detectors have been used in transistor receivers—the simple germanium diode and a transistor operating class B. The first circuit offers the advantages of economy and simplicity, but provides no gain (actually, there is some loss). The second method is more complex and more costly, but it does give about 10 db of gain and hence serves to increase the sensitivity of the receiver. Both methods are employed in current models although it is possible that if high-frequency transistors of greater gain can be developed, the simple diode may eventually replace the transistor in the second detector.

A diode second detector in a transistor receiver (Fig. 5) is quite similar to the same stage in vacuum-tube receivers. The incoming signal appears across the secondary of the final IF transformer, is rectified by the diode, and audio signal is developed across the load resistor. This re-



METER OVERLOAD PROTECTION AND OVERLOAD SIGNAL LIGHT. It is fused to prevent most common burn-outs and instrument damage. The 666 has complete meter movement overload protection. An overload signal light warns the operator of overloads, or incorrect polarity.

RAPID, RELIABLE AND ACCURATE MEASUREMENTS

43 Unduplicated Ranges.
Long (4 $\frac{7}{8}$ ") Scales are Color-Coded for clarity.
Illuminated Dial for easier reading.

AC CURRENT RANGES (from 1.5 MA to 15 Amps) **MEAN FEWER INSTRUMENTS TO CARRY**

RELIABLE PERFORMANCE

Doubly Shielded 45 UA movement assures continuous accuracy.
Permanent Accuracy 3% DC, 4% AC.
Sensitivity: 20,000 Ohms/Volt DC, 2,000 Ohms/Volt AC.

CONVENIENT TO CARRY

This instrument, with its unbreakable steel case, fits into the provided handsome leather carrying case which has space for all accessories.
Lightweight: 4 lbs. 4 oz.
Compact: 3 $\frac{3}{4}$ " x 6 $\frac{5}{8}$ " x 7 $\frac{1}{2}$ ".

Complete with Probes, Power Cord, Batteries and Leather Carrying Case at your Parts Distributor. **\$64.50**

PHASTRON INSTRUMENT AND ELECTRONIC COMPANY

151 Pasadena Avenue, South Pasadena, California

EXPORT: Ad. Rurima, Inc., 69 Broad St., New York 4, N.Y.

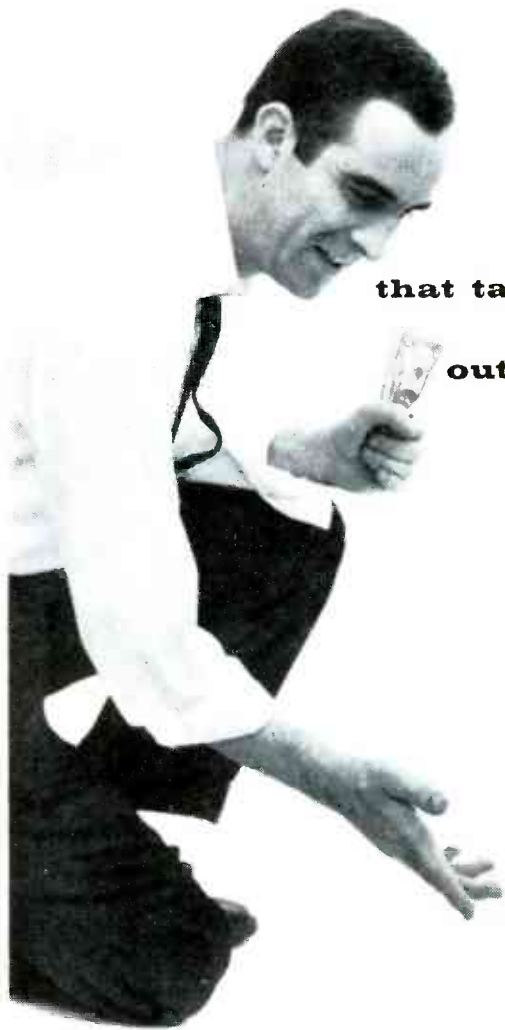

Here's the number

that takes the "gamble"
out of your service
reputation



Centralab PK-300 dual-speaker switch kit

Surely your reputation means more to you than the pennies you save by installing an inferior dual-speaker switch. Then, why gamble? Especially when it costs so little more to go first class with the PK-300 switch kit.

The PK-300 is your "seven-come-eleven" combination that keeps customers sold. Here's real quality — a switch with silver-plated, double-wiping contacts — a dial plate that's etched to stay legible long after conventional painted types have worn off.

So don't settle for just any switch kit for your auto-radio and other dual-speaker jobs. Pick up a PK-300 kit at your Centralab distributor. Write for Catalog 30.

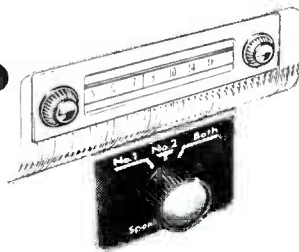

PK-300 switch kit includes:

1. Dual-speaker switch
2. Etched mounting bracket and dial
3. Split-knurled pointer knob
4. Self-tapping screws
5. Easy-to-follow instructions

Centralab A DIVISION OF GLOBE-UNION INC.
942G EAST KEEFE AVENUE • MILWAUKEE 1, WISCONSIN

P-1658

sistor generally has a low value in order to match the low input impedance of the following transistor. Note that because the resistor value is low, the shunting capacitor must be higher in value in order to do an effective job as an RF bypass.

Some receiver designers place a small DC forward bias on the second detector diode in order to bring the unit's operating point into a more linear region of its characteristic curve. The result is less distortion, particularly when the input signal is small.

The diode can also be employed to provide an AVC voltage for the converter and IF stages. Either a negative or a positive control voltage can be obtained by connecting the diode correctly.

The use of a transistor detector operating class B is something which is a throw-back to the early days of radio when vacuum-tube class-B detectors using triodes were quite common. Such detectors could offer amplification which, in those days, was badly needed. The practice was discontinued when sufficient amplification could be provided ahead of the detector, permitting the designer to use a diode as the detector. Diodes were cheaper and did not introduce as much distortion as class-B operated triodes.

In transistor circuits, amplification is greatly needed and class-B detectors are a help in this direction. Furthermore, AVC systems in transistor circuits require power from the controlling source, and a class-B stage is better able to provide it than a diode. (In vacuum-tube circuits, the AVC voltage is applied to the grid of a stage and since no current flows in this circuit, little or no power is needed for the controlling function. In a transistor circuit, on the other hand, power is needed because the transistor is a current-operated device. This means that to alter the operating condition of a transistor, current must flow from the controlling circuit to the transistor and this requires power.)

Another factor in favor of a transistorized class-B detector is the linearity of transistor characteristics down to very low values of bias voltages. In this

respect, transistors are considerably superior to tubes and a well designed class-B transistor detector will introduce as little distortion as a vacuum-tube diode and often less.

For those readers who may not be familiar with class-B detectors, operation is as follows. A class-B detector is a tube (or a transistor) which is biased close to cutoff. When the incoming signal is applied to the tube or transistor, current will flow during the positive half cycles and only partially during the negative half cycles. (The most negative segments of the negative half cycles will drive the device beyond cutoff as shown in Fig. 6.) The result is a rectified signal, and if we remove the IF carrier, we will obtain the desired audio intelligence.

The circuit of a transistor class-B detector is shown in Fig. 7. R1 and R2 form a voltage divider which provides only a slight voltage between emitter and base of the n-p-n 2N78 transistor. The collector current, under these conditions, is quite minute, bringing its voltage close to zero. When a signal is received, current does flow, producing a voltage drop across R3. This voltage drop consists of two parts—an average DC value dependent on the strength of the received carrier and an audio component that represents the transmitted intelligence. Since electrons flow from the collector, the top end of R3 will be negative with respect to ground. This polarity is in the right direction to bias the 2N44 power output stage into conduction. Hence, the signal will be amplified and transferred on to the speaker.

On strong signals, the arm of the volume control will be near ground while on weak signals it will be high on R3. In this way, the bias on X2 can be chosen for best operation.

Another class-B second detector circuit is shown in Fig. 8. This, too, is an n-p-n transistor biased by the voltage drop across the 1K-ohm resistor (R1) situated between the base and the emitter. Under no-signal conditions, the collector current is quite low. When the signal is received, the collector current increases, causing the voltage drop across R2 to

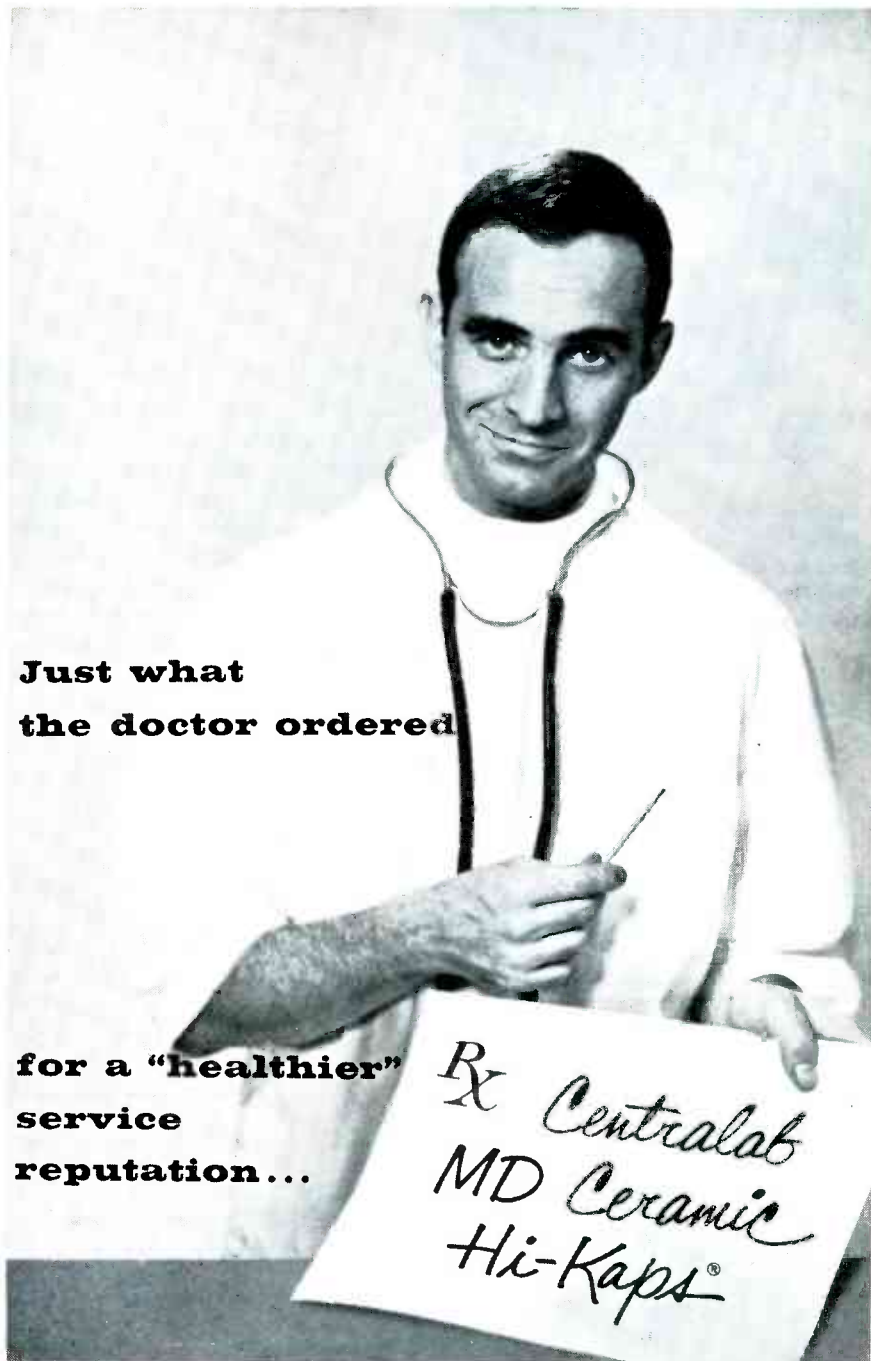

**Just what
the doctor ordered**

**for a "healthier"
service
reputation...**

Check these "undoctored" facts yourself to learn why CRL MD (molded disc) ceramic capacitors outlast and outperform conventional "mud" discs—yet cost the same. You'll find that CRL molded discs give you:

1. *Three times* the voltage breakdown — 3000 V.D.C. breakdown to ground.
2. *Eight times* the lead strength—greater than the breaking strength of the No. 22 tinned-copper wire itself.
3. *Ten times* the humidity resistance — .005% or less moisture absorption by the molded casing.
4. *Many times* the resistance of ordinary discs to physical shock and vibration.

The results: more satisfied customers . . . more business for you . . . and a self-assurance that you gave the best.

Pick them up at your CRL distributor who handles these and thousands of other quality components described in Centralab Catalog 30, which is available on request.



Centralab
CRL

® Centralab Trademark

A DIVISION OF GLOBE-UNION INC.
942G EAST KEEFE AVENUE • MILWAUKEE 1, WISCONSIN
IN CANADA: 804 MT. PLEASANT ROAD • TORONTO, ONTARIO

D-1758

Individualized Service

(Continued from page 17)

mounted on one wall of the shop, and the technicians use these freely for substitution checking without having to go through the formality of signing them out. Likewise, a selection of resistors and capacitors is kept in drawers in the shop for use as needed. These handy stocks are periodically replenished from the main stocks, which are kept in a locked room adjacent to the TV shop. The stock man, Russ Schaefer, keeps track of parts-room inventories and issues major parts as needed through a window which opens into the shop.

You might expect that a considerable degree of specialization among the men would develop in a shop as large as T-M, but such is not the case. One man, who is especially adept in dealing with hi-fi calls, works with audio equipment about half the time, but he is considered the only real specialist. "We sometimes give the difficult bench jobs to the senior men," explains service manager Bill Schroeter, "but there are no full-time bench men. In fact, I sometimes go out on house calls myself."

It's the service manager's job to check over a set on which bench service has been completed and to OK it for return. Then, in the back room, the set is operated continuously for a test period to be sure that the repair is holding up. The receiver is finally set on a shelf near the back door, awaiting return to the customer.

The same technician handles a home call at both the pickup and delivery end whenever possible. "If the man who is to return a set has a day off," says Mr. Ebel, "we often hold the set for an extra day so that he can return it. Of course, we will send the set back with another man if the customer is in a hurry for it."

This desire to maintain "same man" service also helps to determine the routing of the service trucks, although an attempt is made to plan routes efficiently so that all calls for one truck will be in the same general neighborhood. Calls are made all over Stark County, in which Canton is located. Mr. Ebel points out, "We

July, 1957 · PF REPORTER

SAVE with SECURITY

Because Wright Wire Strand comes to you pre-measured and uncoils without snarling, it gives to you unique economy. Quality wire, perfectly stranded and heavily galvanized, the bright Wright way. SAVE with Wright.

Prompt deliveries from stocks in Worcester, Chicago, Atlanta, New Orleans, Houston, Dallas and Los Angeles.

G. F. WRIGHT STEEL & WIRE CO.

249 Stafford St. • Worcester, Mass.

"G" PRESENTING THE *New* GRIP SPINTITE® WRENCHES

FINEST QUALITY
STEEL SHANK
AND SLEEVE
•
BRIGHT PLATED
FINISH
•
STRONG
PLASTIC HANDLE

WITH THE EASY "FINGER-CONTROL"
GRIP AND RELEASE ACTION
FOR THOSE
HARD-TO-GET-AT PLACES —

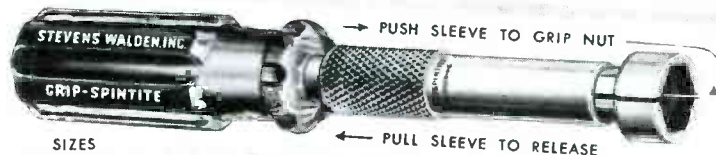

BY THE MAKERS OF
THE ORIGINAL
SPINTITE
WRENCHES
OVER 150 STYLES
AND SIZES

ONE HAND OPERATION—

- GRIPS nuts or bolts of any material
- HOLDS firmly in any position
- TIGHTENS nut or bolt securely
- RELEASES at the pull of the fingers

Write for
catalogue

STEVENS WALDEN Inc.

500 SHREWSBURY STREET — WORCESTER, MASSACHUSETTS
MAKERS OF WORLD-FAMOUS HAND TOOLS FOR OVER 50 YEARS

SENCORE
Another Sencore Time-Saver
Handy "36"
R-C Substitution Unit



"36"
Most Often Needed Components At YOUR Fingertips!

3 pole, 12 position switch individually selects one of the "36" components for direct substitution.

Contains:

- ★ 12-1 watt 10% resistor from 10 ohms to 5600 ohms
- ★ 12-1/2 watt 10% resistors from 10K ohms to 5.6 megohms
- ★ 10-600 volt capacitors Completely isolated from 100-mfd. to .5mfd.
- ★ 1-10mfd., 450V Electrolytic
- ★ 1-40mfd., 450V Electrolytic
- ★ For Shop, Lab, or outside service

AVAILABLE AT ALL PARTS DISTRIBUTORS!

SENCORE SERVICE
INSTRUMENTS CORP.
 171 OFFICIAL RD., ADDISON, ILL.

ONLY \$1275 DEALER NET

POPULAR SENCORE PRODUCTS

- Transistor Tester
- Leakage Checker
- Filament Tester
- Voltage Regulator
- Bias Supply

Cut out this ad now for further information.

THE QUICK EASY WAY TO FIGURE SERVICE CHARGES ...

Dore Riee's **OFFICIAL PRICING DIGEST**
 Spring-Summer Edition

Flat rate and hourly service charges, based on and showing regional and national averages, plus up-to-date list or resale prices on over 60,000 components. Arranged alphabetically by manufacturers and products, numerically by part number. Compact, convenient size fits in tube caddy, toolbox or pocket. \$2.50 per copy from your distributor.



ELECTRONIC PUBLISHING COMPANY, INC.
 180 NORTH WACKER DRIVE
 CHICAGO 6, ILLINOIS

can make suburban calls just as fast as many calls in town, because the trucks can make better time over the country roads." Calls in neighboring counties are made at an extra charge of 20 cents for each one-way mile traveled outside the county line.

Work hours are from 9 a.m. to 5:30 p.m. Monday through Saturday, with each man getting one day off during the week. T-M does not keep a technician on hand during the evening hours just to wait for calls. In Mr. Ebel's opinion, people go through the listings in the telephone book "shopping" for prompt service much less often than is generally thought. Many customers are willing to wait overnight for service which they believe will be competent. So, T-M employs a girl until 10 p.m. nightly to answer the telephone, taking orders for calls to be dispatched promptly in the morning. "She has proven more satisfactory than either a night technician or an answering service," says Ebel.

Nearly half of T-M's television repairs are performed for dealers, and numerous traded-in sets are taken into the shop for re-conditioning. Before being repaired, they are placed in a special section of the back room where an automatic timing device puts them through a series of on-off cycling tests to hasten any breakdowns which might be about to occur.

As the size of any business increases, written records become more and more necessary, but management has to be on guard to keep the important activities from bogging down with paper work. T-M has tried to streamline its records wherever practical.

Uniquely, for a shop of its size, T-M lacks complicated inventory-control procedures. Actually, the men have as easy access to common parts as the operators of 1- and 2-man shops. In Mr. Ebel's experience, record-keeping which accounts meticulously for the whereabouts of every last component is not needed in a shop the size of T-M, since "the cost of extra help to maintain records would more than offset any savings which might be gained." A complete parts inventory, taken approximately every two months, shows whether the consumption

of any item is getting out of line and indicates when certain stocks need to be replenished.

Complete records are kept, however, on past and present customers through the use of service-record cards on which all work done on each set is briefly described. These cards are filed in a somewhat unusual manner—according to the customer's home telephone number. "This works the best of the many systems we've tried," Mr. Ebel explains. After experimenting with various ways of storing the card files, T-M has settled on a "lazy Susan" arrangement. Files are placed in open file drawers on a table with a circular swivel top. The table is located next to the telephone desk, so that the office girl can readily find any card while she is taking an incoming call.

Further records are kept by means of a three-part invoice which is filled out for each job. The original white copy is given to the customer, a yellow copy is placed in "permanent" office files and kept several years, and a pink copy is used for various purposes, depending upon the situation. Technicians draw parts from the stock room against the pink sheet, and this copy is also used to remind the office force to order special parts or to contact the customer for some particular reason. The pink copies are finally filed according to date—a stack of these sheets represents a day's work for the whole shop. They are kept for a relatively short time, until callbacks, installment payments, etc., are taken care of; and then the whole stack is thrown away.

To help determine labor

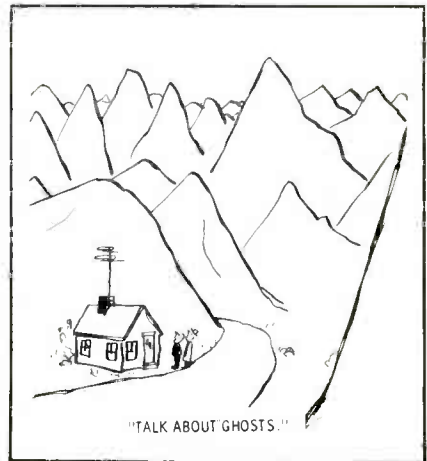

charges, a series of code numbers on the invoice are checked off by the technician to indicate how much labor time has been spent on the call for service in the home, service in the shop, and transportation. In a space on the invoice marked "Delivery Report," the technician notes the condition of the set at the time he returns it to the customer.

Another piece of paper work used by each technician on home calls is the "Daily Time and Sales Report" which is a daily log of the number of calls made, time spent on each call, number of miles the truck was driven, proportion of time spent each in travel and on servicing, and total sales figures including parts and labor.

Just about the most complicated form used at T-M is the six-part purchase order which is used occasionally when a needed part is not immediately available from regular distributors. Two of these copies are sent to the customer to explain the delay in service, thus eliminating the need for his calling about his set or appliance (still another example of individualized service). A statement on one of these customer copies reads as follows:

"Dear Customer:

The above is an exact copy of the original purchase order used to obtain a special part for your appliance. Although our stock is the largest in Stark County, the many thousands of parts used in modern appliances necessitate occasional special orders.

We take pride in the speed with which these orders are handled. In most cases our own trucks make trips to out-of-town distributors, resulting in quicker service than parcel post. In any event, the most rapid method is used.

It is NOT necessary for you to contact us regarding this order. As soon as the part is received, you will be called to arrange delivery. Thank You.

PARTS DEPARTMENT"

So much for the technical side of T-M's business. Now, some of Mr. Ebel's views and policies on such management aspects of a service business as personnel relations, advertising, service charges and credit to customers.

On personnel—"To minimize turnover among experienced technicians, hire very carefully in the first place." This sensible attitude seems to be at the root of T-M's success, personnel wise. Salaries and fringe benefits are competi-

XCELITE Hand Tools
PREFERRED BY THE EXPERTS

NOW...
Your Most-Needed
XCELITE TOOLS

... ALL
IN ONE
CONVENIENT
KIT!



No. 99 SM Service Master Kit

Yes, *now* — you can handle 99% of your service calls with the convenient 99 SM Service Master Kit. You get *all* these famous quality XCELITE tools — plus this handsome, durable, non-scratch roll kit — at a real saving compared to buying the tools separately:

<p>No. 52C Long Nose Pliers. No. 55C Diag. Pliers. Stubby 99-3 Handle with three Nutdrivers (1/4", 3/8" and 1/2").</p>	<p>No. 46C 6" Chrome-Plated Adjustable Wrench. Regular 99-1 Handle with: Nine Nutdrivers, one Phillips and two Regular Screwdrivers.</p>	<p>99-X10 Extension Shaft (new item — adds 6"). Two Chrome-Plated SUPREAMERS (3/8" and 1/2").</p>
--	--	---

Get the 99 SM From Your Supplier Today!

XCELITE, INCORPORATED

Dept. G.,
Orchard Park, N. Y.

In Canada — Charles W.
Pointon Ltd., 6 Alcina Ave.,
Toronto, Ont.

For Originality
LOOK TO XCELITE

DON'T GUESS ABOUT HI-FI!

Ever wonder which phase inverter is best? Or whether fixed or self bias gives less distortion in the power output stage? Stop guessing — hi-fi expert Norman H. Crowhurst gives you the right answers to these and many other questions in his new book **UNDERSTANDING HI-FI CIRCUITS**. Eleven big chapters cover output and input stages, feedback, equalization and many other problems. Every true hi-fi fan should own this book.



NOW YOU CAN BUY THIS DELUXE \$5.00 BOOK FOR ONLY \$3.75

Through the unique no risk G/L Audio Hi-Fi Book Club you can buy **UNDERSTANDING HI-FI CIRCUITS** — and other equally valuable books at a wholesale price! Read how to save 25% on each book!

HOW THE G/L AUDIO HI-FI BOOK CLUB WORKS

To enroll simply fill out the coupon below. Select **UNDERSTANDING HI-FI CIRCUITS** or either of the other two books already published. **SEND NO MONEY NOW**. You examine the book free in your own home. If you like it, send us your remittance. If not, simply return the book in the container in which it came. A new book is published about every four months — and sent to you automatically with the same no risk free examination privilege. You agree to take a minimum of four books during your entire membership. You may cancel anytime after that.

These are all outstanding books written by recognized hi-fi experts. Their knowledge and experience can save you money — add to your pleasure. Each book is superbly printed and exquisitely bound in gold-leaf stamped cloth covers — books you'll be proud to display on your bookshelf. Take advantage of this unusual opportunity today. Mail in your enrollment form now.

THESE BOOKS ALREADY PUBLISHED

- BASIC AUDIO COURSE—Hoefler
- MAINTAINING HI-FI EQUIPMENT—Marshall

FOR FUTURE PUBLICATION

- High Quality Audio Amplifiers
- The Audio Data Book
- Loudspeaker enclosures
- Audio Hints
- Constructing Audio Amplifiers
- Loudspeakers—and Speaker Systems.

NO RISK COUPON

GERNSBACK LIBRARY INC. PR-77
154 West 14th St.
New York 11, N. Y.

Begin my enrollment with the book checked below

Understanding Hi-Fi Circuits

Basic Audio Course

Maintaining Hi-Fi Equipment

Send me more information about the G/L Audio Hi-Fi Book Club

Name.....
(Please print)

Street.....

City..... State.....

tive; 75% of the expense of a Blue Cross plan is paid for by the company, and a profit-sharing plan has been worked out. Green uniforms are furnished by the company and kept laundered by the men themselves. T-M has settled the coffee break problem by having a caterer bring in a thermos jug of coffee every morning so that employees could take their break whenever they got the time. A large round table in one corner of the office serves as a meeting place for both coffee breaks and conferences.

Every Friday morning, before the crew sets out on calls, about a half hour is spent in a discussion of company policies—for instance, customer relations. In the past, technical information on new products has generally been presented at Wednesday night meetings, on the men's own time. The most ambitious training program to date was a series of weekly lessons on color TV, conducted for three months by Bill Schroeter, who had attended a factory training course on color. Each man per-

formed a convergence adjustment as a "final exam," and the highest scorer received as a prize the color set which had been used during the course.

About advertising—"Besides direct mail, we have found that spot announcements on a local radio station have been most effective." T-M does very little other advertising besides the direct-mail and radio campaigns—to a great extent, word-of-mouth advertising has contributed to new business.

As for service charges—"We need to make a \$5 labor charge on calls, plus the actual list prices on parts, to obtain a reasonable profit margin. Our customers generally accept this charge as fair." T-M technicians replace some parts, such as selenium rectifiers and picture tubes, on the basis of an "installed" price which covers the cost of both the part and the labor involved. Parts carry a standard RETMA-type guarantee—they are replaced if they fail within 90 days of the installation. T-M makes no labor or parts charge for such guarantee work.

And how about credit?—"No credit is refused over the phone." If someone asks for credit when first phoning in for service, he is invited to come in and fill out a credit application in person. Since this would delay the service call, the customer often decides to go ahead and pay cash. If a technician completes a call and is then asked to grant credit, he is instructed to tell the customer, "Your invoice is marked C.O.D., but if you'll fill out this credit application, I'll call the shop and perhaps credit can be arranged." Besides the application, the customer is asked to sign an installment note in which he promises to pay for the call by a certain date. The shop approves the credit (rather than telling the technician to "unfix" the set and walk out!), and the note gives the company a legal means of enforcing collection if this should become necessary.

In the final analysis, of course, it's up to the owner of every independent TV repair shop to develop business methods which are best suited to his own operation. This, young George Ebel has done—and to a highly successful degree. ▲

OXFORD HI-FIDELITY SPEAKERS

Optimum Range at Minimum Cost!

Engineered for finest performance at minimum cost, OXFORD HI-FI SPEAKERS have a flat response throughout the audible range and are capable of handling the range of power inputs necessary for finest high fidelity reproduction.



COAXIAL SPEAKERS

C12J408 12"
Frequency response:
40-15,000 cps.

C15L608 15"
Frequency response:
30-15,000 cps.



EXTENDED RANGE SPEAKERS

HFBJB 8"
HF10JB 10"
HF12JB 12"
HF12LN 12"
HF15LN 15"
Frequency responses:
70-10,000 cps.

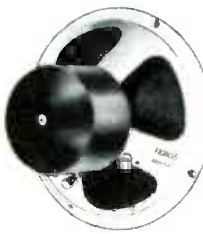

FULL RANGE SPEAKERS

F8J408 8"
Frequency response:
50-13,000 cps.

F12J408 12"
Frequency response:
50-12,000 cps.

F12L608 12"
Frequency response:
40-10,000 cps.



TWEETERS

T3C208 3"
Frequency response:
1,800 to 15,000 cps.

T5C208 5"
Frequency response:
1,100 to 15,000 cps.

Finer HIGH FIDELITY SPEAKERS engineered for best reproduction designed to sell.

Illustrated literature is available

OXFORD Components, Inc.

Subsidiary of Oxford Electric Corp.

556 West Monroe Street • Chicago 6, Illinois

Export: Roburn Agencies, New York City In Canada: Atlas Radio Corp., Ltd., Toronto



What's New In Batteries
(Continued from page 13)



—Photo courtesy Ray-O-Vac Co.

Fig. 2. 9-volt batteries are popular as transistor power supplies.

factor is minimized and the features of mercury units become especially valuable.

A compromise between mercury and conventional batteries, the "alkaline cell" type, has recently replaced the LeClanche formula in several established types of RCA and Ray-O-Vac batteries. An alkali is used as an electrolyte, but little or no mercury is included in the depolarizer. Alkaline cells, too, have long life and relatively constant voltage output, but they do not rank quite as high as mercury cells in these respects. On the other hand, neither do they cost as much as the mercury type—a typical alkaline battery is only about 1½ times as expensive as a LeClanche battery. Since the advantages of the new formula are greatest when battery size is smallest, alkaline batteries are being manufactured mainly for applications such as pocket-sized radios, where miniaturization is important.



Fig. 3. Alkaline-cell batteries. 9-volt unit (at left) contains 6 large cells; 15-volt unit has 10 small cells.

Two sizes of alkaline cells and the batteries in which they are used are shown in Fig. 3. The round battery is a 9-volt unit containing 6 of the large-diameter cells, and the oblong battery is rated at 15 volts and contains two stacks of 5 small cells each. Notice that each cell resembles a pair of bottle caps pressed together. Between these caps are a depolarizer pellet, an absorbent disc saturated with an electrolyte, and a zinc anode pellet, all stacked together and sealed inside a plastic ring. Leakage is not a particular

problem because the cell tends to dry up as it is used.

From a mechanical standpoint, the alkaline cell is an example of "flat-cell" construction, which means that the electrolyte is sandwiched between two disc-like electrodes. Contrast this arrangement with the common flashlight cell, in which one electrode is a can containing the electrolyte, and the other is a central rod. Since the flat cell lends itself well to stacking of several units, it is becoming popular for some types of multi-cell batteries. For exam-



TV HARDWARE

with Di-Chromate Finish

EVERYTHING YOU NEED... QUALITY MADE FOR PROFITABLE INSTALLATIONS!

 ROOF MOUNTS	 STANDOFFS	 ARRESTORS
 TOWERS	 CHIMNEY MOUNTS	 LINE CLIPS
 ALL ACCESSORIES		<div style="border: 2px solid black; padding: 5px;"> <p>Di-Chromate Finish Prevents Roof Streaks</p> <p>All Telco TV Hardware is built and finished to last regardless of the rigors of weather, climate or usage. Quality features at a price that makes your TV installations profitable. Insist on TELCO for all your hardware needs.</p> </div>

YOUR JOBBER HAS COMPLETE TELCO HARDWARE STOCKS... SEE HIM AND SAVE!

TELEVISION HARDWARE MFG. CO.

Division of G-C • Textron Inc.
 400 South Wyman Street • Rockford, Illinois



WHY BEAT YOUR BRAINS OUT?

Merit exact replacement coils and transformers are always available at your nearest parts jobber—and they slide into chassis and circuit like a banana on ice!



MERIT

MERIT COIL AND TRANSFORMER CORP.

4427 N. CLARK ST., CHICAGO 40, ILLINOIS



Fig. 4. Miniature 22½-volt battery contains a stack of cells individually sealed in transparent envelopes and bonded together with conductive wax.

—Photo courtesy: Burgess Battery Co.

ple, U, Y, and P series of Burgess batteries are being assembled from a new type of flat Le-Clanche cell called a "wafer cell." Fig. 4 shows individual and stacked wafer cells, plus a finished 22½-volt battery. Each cell is machine-wrapped in a .0015"-thick envelope of transparent "Pliofilm" and heat sealed. Conductive "silver wax," placed on the outside of each electrode, forms a secure inter-cell connection when

the cells are pressed together into stacks.

The flat-cell batteries are of the same size as the units which they replace, but they contain a greater volume of active ingredients because the cell walls are thinner. As a result, the newer batteries have longer useful life.

Specialized Batteries

Several miniature batteries based on new combinations of chemicals have recently been in the news. One fact about these components which needs to be emphasized is that they have extremely low output current—usually less than 1μa. Believe it or not, such devices have practical uses. The most important application at present is in Geiger counters and other radiological equipment.

What can you do with a fraction of a microampere? For one thing, you can maintain a potential in a circuit that has very high impedance. You can also place a "trickle charge" on a capacitor and keep it fully charged. The stored energy is discharged intermittently as a "one-shot" pulse of current used for a photoflash, pre-ionizing trigger, or other applications.

Several types of solid-electrolyte batteries are included among the new low-current units. These consist of tiny, extremely thin cells, many of which are stacked in series to produce potentials as high as 90 volts in a container of the size shown in Fig. 5. Steady output current is approximately .01μa, although intermittent bursts of current in the order of 10 μa

The NEW YEATS "Shorty" STATION WAGON & PANEL PICK-UP appliance dolly



YEATS Model No. 5
Aluminum alloy
Height 47"
Weight 32 lbs.

Only 47" tall, this new YEATS dolly is designed for TV and appliance men who make deliveries by station wagon or panel truck. No need to detach appliance for loading into the "wagon" or pick-up... the YEATS "Shorty" will slide into your vehicle with ease. Has aluminum alloy frame with padded felt front, quick fastening (30 second) strap ratchet, and endless, rubber belt step glide. New YEATS folding platform attachment, at left, saves back-breaking work handling TV chassis or table models. Call your YEATS dealer today!



Folding platform is 13½" x 24½"
—attaches instantly. (Platform only) \$9.95.



Furniture Pad

SEND postcard for full information on our complete line TODAY!

"Everlast" COVERS & PADS

YEATS semi-fitted covers are made of tough water repellant fabric with adjustable web straps and soft, scratchless white flannel liners. All shapes and sizes—Write.

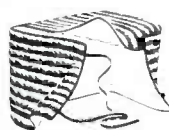

TV Cover

YEATS appliance dolly

2103 N. 12th St.

sales co.
Milwaukee, Wis.



—Photo courtesy National Carbon Co.

Fig. 5. Over 100 cells are stacked in this 90-volt solid-electrolyte battery.

can be tolerated.

Other than their subminiature size, a highly important feature of solid electrolyte batteries is their shelf life, which is measured in decades instead of months. They are ideal for use in military and other equipment that may be stored for years in a standby condition. Since the all-solid composition of the new batteries completely eliminates liquid or gaseous leakage, they can even be sealed into modular subassemblies of equipment.

Among the companies making solid-electrolyte batteries are General Electric, National Carbon

Co. (Eveready), and Ray-O-Vac Co. Each brand has a distinct chemical composition. For example, the GE units have a silver anode, cupric bromide and carbon cathode, and silver bromide electrolyte. Eveready types have vanadium pentoxide in the cathode and employ silver iodide as an electrolyte.

New types of low-current batteries do not necessarily have unusual ingredients, however. A standard zinc-carbon formula, highly refined, is utilized in a tiny Eveready battery which furnishes power for a new Hamilton electric wrist watch. This 1.5-volt battery in its gold-plated case weights only $\frac{1}{20}$ oz. and is $\frac{1}{8}$ " thick and 0.440" in diameter. At a current drain of about 60 μ a, it can operate the watch continuously for a year.

An "atom-powered" electric watch will also be feasible in the near future, powered from a battery that makes use of a by-product of nuclear fission. A practical cell developed jointly by Elgin National Watch Co. and Walter Kidde Nuclear Labs., Inc., contains a radioactive isotope known as Promethium 147. Beta particles emitted by this substance are absorbed by a phosphor which is mixed with the isotope, and the nuclear energy is converted to light energy. Two or more silicon photocells pick up the light from the glowing phosphor and produce electric current. Total battery output is from $\frac{1}{4}$ to 1 volt, depending upon the photocell connections. Power furnished by a fresh battery of this type is about 20 microwatts, but due to the decay of the radioactivity in the promethium, output declines to about 5 microwatts after 5 years.

The phosphor used is not a standard white or green type; instead, it emits red and infrared light, to which the photocells are most sensitive. The isotope and phosphor are contained in a transparent plastic container which passes light but prevents most of the radioactive particles from reaching the photocells. By encasing the battery in a shield of a heavy metal such as tantalum, it is made safe for use in portable equipment. Even when thus shielded, the nuclear battery is

only 0.2" thick and 0.6" in diameter.

Photocells can also make electricity from an "old reliable" source of nuclear energy, the sun. Solar batteries large enough to power small transistor radios have already been produced. From the standpoint of low cost and sustained current ratings, however, conventional batteries still have a big advantage; so don't expect them to disappear from the scene. On the contrary, they are becoming more extensively used than ever before. ▲

note:
Estimated 13/4 million portable TV sets to be sold in '57!

Here's Your MARKET...

for the
MOSLEY Flush Mount TV Socket

LOW LOSS
NEAT
EFFICIENT

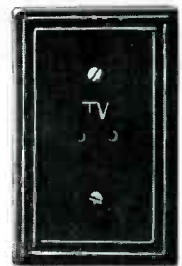

MODEL F-1PK

• The tremendous demand for portable TV sets opens another BIG market for good set-to-antenna plug-in outlets. MOSLEY Flush Sockets meet this need—supplying attractive, convenient, customer-approved wall outlets for every installation requirement.

Without MOSLEY TV Outlets, portable TV—in most areas—ceases to be portable!

Let MOSLEY TV Outlets spark YOUR Portable TV Sales!

For a complete line of up-to-date TV Accessories and Electronic Components send for our "57" catalog.

Mosley Electronics, Inc.

8622 ST. CHARLES ROCK ROAD
 ST. LOUIS 14, MISSOURI

(Advertisement)

latest **JACKSON** tube test data

TUBE TYPE	MODEL 648		PLATE TEST		MODEL 115/715/561		FIL.	X.	PLATE	YZ
	FIL. D.	CIRCUIT	E.	TEST	FIL.	PLATE				
6DA4	6.3	234	6	15W.	6.3F	-	8			4S
6DA7	6.3	126	AC34	23Z	6.3	-	20			2LR 4NR
6DE7	6.3	126	A45	33VW	6.3	3	20			2LR 4NR
25EC6	25.	124	AB389	16W.	25.	-	8			8MPS.
TUBE TYPE	SEC.	A.	MODEL 49		CATH.		D.	SHORTS	E.	
			B.	C.						
6DA4	D	6.3	7	-	5	3			4	
6DA7	T	6.3	4	X	13	9			30	
6DE7	T	6.3	4	-	67	8			9	
6DE7	T	6.3	4	2X	13	9			30	
25EC6	P	25.	2	-	580	3			9	

Latest Chart Form 648-18, 115/715/561-9, 49-3

FOR A brighter TV picture



Rely on the tube that has always been specified by leading independent set makers.

Blue Chip Quality

TUNG-SOL[®]
 Magic Mirror Aluminized
PICTURE TUBES

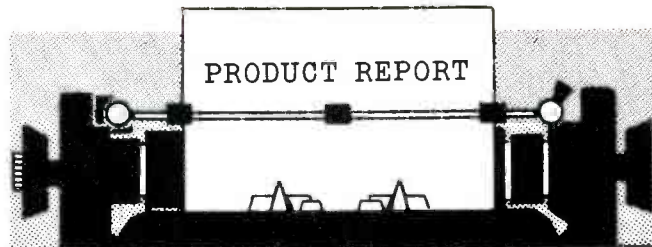
TUNG-SOL ELECTRIC INC., Newark 4, N. J. Sales Offices: Atlanta, Ga.; Columbus, Ohio; Culver City, Calif.; Dallas, Tex.; Denver, Colo.; Detroit, Mich.; Irvington, N. J.; Melrose Park, Ill.; Newark, N. J.; Seattle, Wash.



Record Spray Treatment



Permo, Inc., 6415 N. Ravenswood Ave., Chicago, Ill., is now distributing "Fidelitone Lubri-Stat," a preparation which is sprayed on phonograph records to prevent the buildup of static electricity — and also to coat the record grooves with a film of lubricant, thereby reducing record and needle wear.

Elliptical Hi-Fi Tweeter



Sonotone Corp., Elmsford, N.Y., announces that their T-64 Linear Standard Elliptical Cone Tweeter is now available as a separate unit at \$7.50 (\$8.50 in the Far West). This is the same 4" x 6" tweeter unit originally used in the Sonotone CA-15 coaxial speaker.

Frequency range of the speaker is 800 to 17,000 cps, and voice-coil impedance is 15 ohms.

New Feature in "Pricing Digest"

A guide to TV and radio service charges for parts and labor—on both a nationwide and a regional basis—is a regular new feature incorporated in the Spring-Summer edition of "Dave Rice's Official Pricing Digest," issued by Electronic Publishing Co., Inc., Chicago, Ill.

The book, which sells at \$2.50, also includes suggested list or resale prices on more than 65,000 electronic components. Price changes have taken effect on over one-third of these items since the last "Pricing Digest" was issued.

Replacement Flybacks



Chicago Standard Transformer Corp., 3501 W. Addison St., Chicago, Ill., has released 8 new exact replacement flybacks for recent models of TV receivers.

Stancor part HO-264 replaces Philco part 32-8709-1; HO-265 replaces Admiral part 79C70-1; and HO-266 replaces Magnavox part 360659. The following 5 Stancor transformers replace original Zenith parts as noted: HO-267 for S-20099; HO-268 for S-23049; HO-269 for S-22720; HO-270 for S-18125; and HO-271 for S-23438.

Miniature Electrolytics

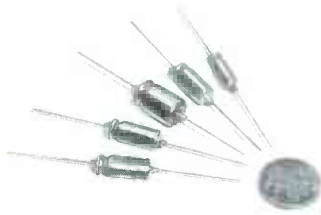

P. R. Mallory & Co., Inc., 3029 E. Washington St., Indianapolis, Ind., has announced a new low-cost "TT" line of subminiature, aluminum-cased electrolytic capacitors intended for replacement use in miniaturized electronic equipment such as transistor radios.

More than 30 types, with capacitance values from 1 to 110 mfd at working-voltage ratings from 1 to 50 volts, are included in the "TT" line. The permissible operating temperature ranges from -20 to +65° C. The smallest unit in the line measures $\frac{3}{16}$ " in diameter and $\frac{1}{2}$ " in length.

Inverter Power Supply



The "Sportsman Senior Powercon" (Model 12SS14) made by Cornell-Dubilier Electric Corp., South Plainfield, N.J., is a self-contained inverter power supply capable of operating portable

TV sets and other equipment having a continuous power rating of up to 140 watts. The energy source is a standard 12-volt automobile battery, which will operate a 140-watt load for 3 hours and which is rechargeable at the user's convenience by plugging the unit into an AC power line. A vibrator converts the DC from the battery into 110-volt, 60-cps AC. Weight of the inverter (including battery) is 60 lbs., size is 14" x 9 $\frac{1}{2}$ " x 9 $\frac{1}{2}$ ", and list price is \$79.50.

Long-Life Tube



Amperex Electronic Corp., 230 Duffy Ave., Hicksville, L.I., N.Y., has added a Type E88CC 6922 frame-grid miniature twin triode to its 10,000-hour guaranteed line of

tubes. This high-transconductance, low-noise tube is used principally in cascode circuits, IF amplifiers, mixers, and phase inverters, and as a multivibrator and cathode follower in computers.

Midget Soldering Iron

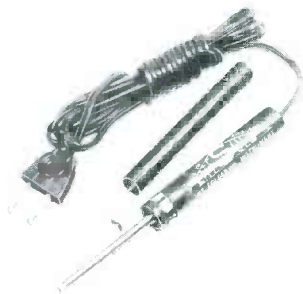

A tiny British-made soldering iron for precision work in miniaturized equipment is being distributed in this country by Meadow Sales Corp., 2714 W. Montrose Ave., Chicago, Ill. Model SL-10 is 6" long, weighs $\frac{1}{2}$ oz. and is equipped with a heat-proof cover so that

it can be stored without waiting for the tip to cool. Rated at 10 watts, the iron operates on 110/120 volts AC or DC.

FOR A brighter

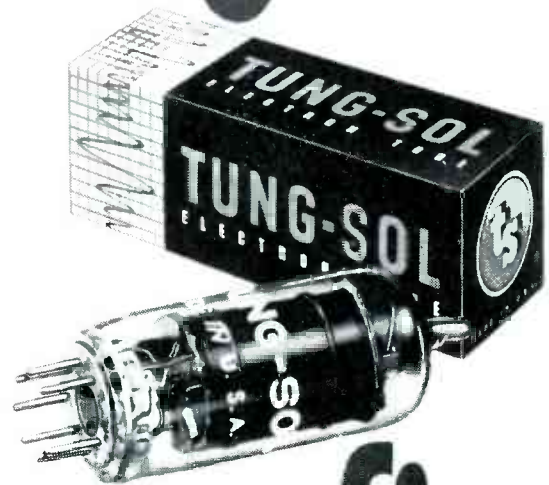

profit picture

Rely on the tube that has always been a favorite with leading independent service dealers.

Blue Chip Quality
TUNG-SOL[®]
RECEIVING TUBES

TUNG-SOL makes All-Glass Sealed Beam Lamps, Miniature Lamps, Signal Flashers, Picture Tubes, Radio, TV and Special Purpose Electron Tubes and Semiconductor Products.



PF REPORTER

INDEX TO ADVERTISERS

July, 1957

Advertisers	Page No.
Acme Electric Corp.	44
Aerovox Corp.	42
Astron Corp.	9
B & K Mfg. Co.	35
B & M Electronic Mfg. Co.	58
Belden Mfg. Co.	43
Blonder-Tongue Labs.	38
Bussmann Mfg. Co.	29
CBS-Hytron	12
Centralab, Div. of Globe-Union, Inc.	56, 57
Chicago Standard Transformer Co.	23
Clarostat Mfg. Co., Inc.	33
Cornell-Dubilier Electric Corp.	24
Delco Radio Div., General Motors Corp.	20
EICO	52
Electronic Publishing Co.	60
Elgin Nat'l. Watch Co. (Electronics Div.)	46
E-Z Hook Test Products	54
General Cement Mfg. Co.	63
General Electric Co.	39
Gernsback Library, Inc.	61
International Business Machines Corp.	4-5
International Resistance Co.	2nd cover
Jackson Electrical Instr. Co.	65
Jensen Industries, Inc.	52
Jensen Mfg. Co.	41
JFD Mfg. Co.	58
Littelfuse, Inc.	4th cover
Mallory & Co., Inc. P. R.	26, 27
Merit Coil & Trans. Corp.	64
Mosley Electronics, Inc.	65
Oxford Components, Inc.	62
Phaotron Co., Inc.	55
RCA Components Division	25
RCA Electron Tube Division	3rd cover
Radiart Corp.—Cornell- Dubilier Electric Corp.	1
Raytheon Mfg. Co.	10, 40
Sams & Co., Inc., Howard W.	53
Sarkes Tarzian, Inc.	8
Service Instruments Corp.	60
Simpson Electric Co.	31
Sprague Products Co.	2
Standard Electrical Products Co.	48
Stevens-Walden, Inc.	59
Technical Appliance Corp. (TACO)	7
Tenna Mfg. Co.	50
Tobe Deutschmann Corp.	47
Triplett Electrical Instr. Co.	37
Tung-Sol Electric, Inc.	66, 67
University Loudspeakers, Inc.	45
V-M Corp.	49
Webster Electric Co.	6
Westinghouse Electric Co.	51
Winston Electronics, Inc.	32
Wright Steel & Wire Co., G. F.	59
Xcelite, Inc.	61
Yeats Appliance Dolly Sales	64

PF REPORTER

CATALOG and LITERATURE SERVICE

valuable manufacturers' data available to our readers at no charge.

- 1G. AMPHENOL**
Data sheet on lightweight, low-cost polyfoam coaxial-cable equivalents of RG-11/U and RG-59/U.
- 2G. BELDEN**
Electronic wire and cable catalog #857. *See ad page 42.*
- 3G. B & K**
Bulletin 1050 describes the new "Dyna-Scan" audio, video, color-display generator. Also Bulletins C15 and S16 on the "Color-Scan" and "Audio-Scan" accessory kits for owners of Model 1000. *See ad page 35.*
- 4G. B & M**
One sheet flyer describes the functions of the Inductive Winding Tester. *See ad page 58.*
- 5G. BLONDER-TONGUE**
Form TO-47 lists TV cable tap-offs. Form MC-5-27 on crystal-controlled converters. *See ad page 38.*
- 6G. BUSSMANN**
Television fuse chart Form TVC Shows components protected and proper fuse for all TV and auto radio sets. *See ad page 29.*
- 7G. CHICAGO STANDARD**
Stancor TV transformer replacement guide and catalog library. *See ad page 23.*
- 8G. CLAROSTAT**
Radio & TV replacement controls. RTV-IZE, Form No. 753393. *See ad page 33.*
- 9G. CONTINENTAL CARBON**
New literature on carbon film resistors B-307 and miniature controls (variable resistors) B-361.
- 10G. CORNELL-DUBILIER**
Form XTR200D-3M—data on mica capacitors. *See ad page 24.*
- 11G. ELGIN**
New data sheets on broadcast and general purpose microphones. *See ad page 46.*
- 12G. EICO**
12-page catalog shows how to save 50% on electronic test instruments and hi-fi equipment in both kit and factory-wired form. *See ad page 52.*
- 13G. E-Z HOOK**
A convenient reference sheet titled "How to Build the Five Most Useful Scope Probes" gives the schematic, mechanical component layout, and a brief description of five scope probes you'll find most useful in your servicing. *See ad page 54.*
- 14G. GERNSBACK**
Descriptive literature on Gernsback library books. *See ad page 61.*
- 15G. IRC**
New replacement parts catalog DLR-57 (form S-035-1). *See ad 2nd cover.*
- 16G. JACKSON**
Condensed catalog sheet listing all products. *See ad page 65.*
- 17G. JENSEN INDUSTRIES**
1957 "Jenselector" and wall chart for easy identification of correct needle for you and your customer. *See ad page 52.*
- 18G. LITTELFUSE**
Price sheets showing pictures, descriptions, part numbers and list prices of company's products. *See ad 4th cover.*
- 19G. MERIT**
Auto radio replacement guide and catalog No. 3-1957. *See ad page 64.*
- 20G. PERMA-POWER**
Descriptive technical bulletin on TV picture tube restorers, describing cathode and grid defects and cures.
- 21G. PHAOSTRON**
Illustrated catalog lists complete line of custom panel meters. Includes comparison chart of Phaotron instruments vs. other brands plus dimensions and features. *See ad page 55.*
- 22G. RADIART**
Rotor catalog F-904 covering all CDR rotors. *See ad page 1.*
- 23G. RCA ELECTRON TUBE DIV.**
KB-106 RCA picture tube characteristics and replacement directory, 1275-G RCA receiving tube booklet. *See ad 3rd cover.*
- 24G. SPRAGUE**
Form M-726 ceramic capacitor wall chart gives technical data and application notes on various types of ceramic capacitors, as well as color coding information. *See ad page 2.*
- 25G. STANDARD ELECTRICAL**
22-page catalog describing complete line of "Adjust-A-Volt" variable transformers. Also catalog page on PA-1 "Adjust-A-Volt." *See ad page 48.*
- 26G. TACO**
Summertime "Business Building" program for dealers. *See ad page 7.*
- 27G. TELEMATIC**
Free 16-page booklet entitled "Hints for Speedier Servicing." Goes into full detail about the common faults found in CRT and SYNC circuits, how to recognize them and fix them quickly.
- 28G. TRIPLETT**
Literature describing clamp-on ammeter and complete volt-ohm-milliammeter. *See ad page 37.*
- 29G. XCELITE**
New illustrated general catalog covers nutdrivers, screwdrivers, pliers, reamers and combination kits. *See ad page 61.*
- 30G. YEATS**
Literature describing appliance dollies, appliance covers and furniture pads. *See ad page 64.*

JULY 1957

SUPPLEMENT to SAMS MASTER INDEX No. 102

File this Supplement with your 36-page SAMS MASTER INDEX. Together, they give you complete PHOTOFACT coverage.

This Supplement is your handy index to new models covered in the latest PHOTOFACT Sets 346 through 365. It's your guide to the world's finest service data coverage of the current output of the new TV and Radio receivers, as well as models not previously covered in PHOTOFACT. It keeps you right up to date.

ALWAYS USE YOUR LATEST ISSUE OF THIS SUPPLEMENT WITH THE SAMS MASTER INDEX . . . TOGETHER, THEY ARE YOUR COMPLETE INDEX TO OVER 28,000 MODELS.

For models and chassis not listed in this Supplement, refer to SAMS MASTER INDEX No. 102. If you haven't a copy, send for it today. It's FREE . . . just write to HOWARD W. SAMS & CO., INC., 2201 East 46th Street, Indianapolis 5, Indiana.



FILE WITH YOUR SAMS MASTER INDEX No. 102, DATED FEBRUARY, 1957

IMPORTANT: THIS SUPPLEMENT REPLACES JUNE SUPPLEMENT No. 102-E

Discard prior supplement, since this issue includes all previous listings plus latest models

Set Folder No.	Model No.
ADMIRAL	
402	354-2
402, 4G2A	346-2
4H2	354-2
5N3, 5N3A	357-2
5W3	352-2
6R2, 6R2A	356-1
Chassis 14UY3B, C	351-1
Chassis 14Y3C, BK, C	350-1
Chassis 17Z3D, DB, DBM, DBN, DC, DCB, DF, DF8, DT, DTB	363-2
Chassis 18Y4EFA, LSA, PSA	360-2
Chassis 18Z4ES, ESA, ESB, FS, FSA, FSB, LSA, PSA	360-2
Chassis 19Y4R5	361-2
Chassis 19Y4RF	361-2
Chassis 20S24EF, PS	359-1
Models C23A1C, C23A2C, C23A3C (See Ch. 17Z3D)	
Models C23A6A, C23A7A (See Ch. 18Y4EFA)	
Models C23A11, C23A12, C23A13 (See Ch. 17Z3D)	
Models C23A11B, C23A12B, C23A13B, (See Ch. 17Z3D)	
Models C23A26, C23A27 (See Ch. 17Z3D)	
Models C23A26B, C23A27B (See Ch. 17Z3D)	
Models C23B16C, CB, C23B17C, CB (See Ch. 17Z3D)	
Models C23A2, C23A3 (See Ch. 19Y4RF)	
Models C32A6, C32A7 (See Ch. 18Z4ES)	
Models C32A6A, C32A7A (See Ch. 18Z4ESA)	
Models C32A16, C32A17, C32A19 (See Ch. 18Z4ES)	
Models C32A16A, C32A17A, C32A19A (See Ch. 18Z4ESA)	
Models C32A6, C32A7 (See Ch. 18Z4ES)	
Models C323B2, C323B3 (See Ch. 20S24EF)	
Models C323B2E, C323B27 (See Ch. 20S24EF)	
Models HC2276, HC2277 (See Ch. 5N3A)	
Models HC406, HC4407 (See Ch. 6R2A)	
Models HP2235, HP2238 (See Ch. 4G2)	
Models T23A1, T23A2, T23A3 (See Ch. 17Z3D)	
Models T23A1B, T23A2B, T23A3B (See Ch. 17Z3D)	
Models T23A6, T23A7 (See Ch. 17Z3D)	
Models T23A6B, T23A7B (See Ch. 17Z3D)	
Models T23E1A, T23E2A, T23E3A (See Ch. 18Y4PSA)	
Models T101, T102, T103, T104, T105AL, T106AL, T107AL (See Ch. 14Y3B)	
Models T140, T141, T142, T143, T144AL, T145AL (See Ch. 14Y3PC)	
Models T23A1, T23A2, T23A3 (See Ch. 19Y4RF)	
Models T23A1A, T23A2A, T23A3A, T23A3A, T23A3A, T23A3A (See Ch. 18Z4PSA)	
Models T1010, T1011AL, T1012AL, T1013AL (See Ch. 14Y3B)	
Model T1410 (See Ch. 14Y3C)	
Models T2301DRA, T2302DRA, T2303DRA (See Ch. 18Y4LSA)	
Models T2302D5A, T2303D5A (See Ch. 18Z4LSA)	
Models TS101, TS102, TS103, TS104, TS105AL, TS106AL, TS107AL (See Ch. 14Y3B)	
Models TS140, TS141, TS142, TS143, TS144AL, TS145AL (See Ch. 14Y3C)	
Models TS323B1, TS323B2, TS323B2B, TS323B3, TS323B3L (See Ch. 20S24FS)	
Models TS1010, TS1011, TS102AL, TS1013AL (See Ch. 14Y3B)	
Model 4D18D (See Ch. 4G2)	
Model 4D28D (See Ch. 4G2)	
Model 4E21 (See Ch. 4E2)	
Models 4F22, 4F24, 4F26, 4F28 (See Ch. 4E2)	

Set Folder No.	Model No.
ADMIRAL—Cont.	
Model 4G22D (See Ch. 4G2)	
Models 4H24, 4H24, 4H26, 4H28 (See Ch. 4H2)	
Models 5B42, 5B43 (See Ch. 5W3)	
Model 5B48 (See Ch. 5W3)	
Models 5H44, 5H47, 5H49 (See Ch. 5W3)	
Models 5M36D, 5M37D (See Ch. 5N3)	
Models 5M56D, 5M57D (See Ch. 5N3)	
Models 5M66D, 5M67D (See Ch. 6R2)	
Models 5W32, 5W33, 5W34 (See Ch. 5W3)	
Models 5W38, 5W39 (See Ch. 5W3)	
AIRLINE	
BR-1100A, BR-1102A (Similar to chassis)	343-14
BR-4024A	365-2
BR-4124A (Similar to chassis)	365-2
FJB-6525A (Similar to chassis)	325-4
FJB-6526A (Similar to chassis)	325-4
FJB-6527A (Similar to chassis)	325-4
FJB-6528A (Similar to chassis)	298-4
FJB-6599A (Similar to chassis)	298-4
GAA-861A, GAA-862A, GAA-863A (See Model GAA-951A—Set 344-2)	
GAA-864A, GAA-864B (See Model GAA-954A—Set 333-2)	
GAA-865A, GAA-866A (See Model GAA-951A—Set 344-2)	
GEN-1090A	350-2
GEN-1103A	349-2
GEN-1655A, GEN-1656A, GEN-1657A, GEN-1658A, GEN-1660A, GEN-1661A	358-1
GRX-1089A (See Model GSI-1079A—Set 294-2)	
GRX-1650A, GRX-1651A	359-2
GRX-4020A, GRX-4120A	347-1
GSL-1650A, GSL-1651A	359-2
GTC-1085A, GTC-1086A	356-2
GTM-4031A, GTM-4032A	364-18-5
GTM-4131A, GTM-4132A	364-18-5
WG-1637A	363-3
WG-4026A, B, WG-4027A	359-3
WG-5030A, WG-5032A, B, C, WG-5035A, B, C	351-2
WG-5038A, B, WG-5039A, B	359-3
WG-5130A, WG-5132A, B, WG-5135A, B	351-2
ALLSTATE	
6263-1 (Ch. 528.6263-1) (See Model 6263—Set 269-3)	
6268 (Ch. 528.6268)	365-3
6269 (Ch. 528.6269)	365-3
6269-1 (Ch. 528.6269-1)	365-3
6295-7 (Ch. 528.6295-7)	365-3
Model 6295-6—Set 229-2	
6295-8 (Ch. 528.6295-8) (See Model 6295-6—Set 229-2)	
Ch. 528.6263-1 (See Model 6263-1) (1955)	
Ch. 528.6295-7 (See Model 6295-7)	
Ch. 528.6295-8 (See Model 6295-8)	
Ch. 528.6268, 528.62681 (See Model 6268)	
Ch. 528.6269, 528.62691 (See Model 6269)	
AMBASSADOR	
17T761E, M, 17T762, 17T763 (Ch. A2005)	352-3
Ch. A2005 (See Model 17T761E)	
AMERICAN TELEVISION	
American Television 1955 (F55, G55)	361-16-5
American Television 9081A (1955)	360-16-5
American Television 1956 (F-56)	353-20-5
American Television 1956 (Late)	353-20-5

Set Folder No.	Model No.
A.M.I. (Automatic Musical Instruments)	
PBA (Mark 1)	361-3
ANDREA	
TP-BW (Ch. P-8W)	363-4
21B-V21 (Ch. VP21) (See Model Ch. P-8W) (See Model TP-8W)	
ARVIN	
2563 (Ch. 1.40300)	356-3
2564 (Ch. 1.40400)	356-3
3561 (Ch. 1.40600)	358-2
5561 (Ch. 1.40800)	351-3
9562 (Ch. 1.40900)	348-1
Ch. 1.40300 (See Model 2563)	
Ch. 1.40400 (See Model 2564)	
Ch. 1.40600 (See Model 3561)	
Ch. 1.40800 (See Model 5561)	
Ch. 1.40900 (See Model 9562)	
AUTOMATIC	
TT600	349-3
BENDIX	
KM17CD (Ch. T17-1) (See Photofact Servicer Set 320)	
KS21C (Ch. T17) (See Photofact Servicer Set 320)	
SKM17C (Ch. T17-1) (See Photofact Servicer Set 320)	
STM17C (Ch. T17-1) (See Photofact Servicer Set 320)	
TM17CD (Ch. T17-1) (See Photofact Servicer Set 320)	
TS17C (Ch. T17-1) (See Photofact Servicer Set 320)	
TS21C (Ch. T17) (See Photofact Servicer Set 320)	
Ch. T17 (See Model KS21C)	
Ch. T17-1 (See Model KM17CD)	
BROCINER	
Mark 30A	347-2
Mark 30C	346-3
BUICK	
981707	347-3
981708	346-4
CAVALIER	
603	353-2
CBS-COLUMBIA	
U23C39, B (Ch. 921-93) (See PCB 179—Set 346-1 and Model 23C49) (See 292-3)	
U23C49L (Ch. 921-93) (See PCB 179—Set 346-1 and Model 23C49) (See 292-3)	
U23T19, B (Ch. 921-93) (See PCB 179—Set 346-1 and Model 23C49) (See 292-3)	
U23C39, B (Ch. 921-94) (See PCB 179—Set 346-1 and Model 23C49) (See 292-3)	
U23T19, B (Ch. 921-94) (See PCB 179—Set 346-1 and Model 23C49) (See 292-3)	
Ch. 921-93 (See Model U23C39)	
CHEVROLET	
987573	365-4
987575	362-1
987577	364-1
987599	363-5
3725156	352-17-5
COLUMBIA RECORDS	
420	354-3
522, 524, 527	352-4
526	356-4
528	355-1
530	358-3
CORONADO	
RA12-8121-A	346-5
RA48-832A	355-2
RA48-832A	356-5
TV1-9399A, TV1-9400A	353-3
TV1-9404A, TV1-9405A, TV1-9407A, TV1-9408A, TV1-9409A, TV1-9410A, TV1-9411A	361-4

Set Folder No.	Model No.
CORONADO—Cont.	
TV2-9426A, TV2-9427A, TV2-9428A, TV2-9429A, TV2-9430A, TV2-9431A, TV2-9432A, TV2-9433A	364-2
TV3-9397A	359-4
CRESCENT	
A-642	359-5
A-644	363-7
A-740	355-3
A-4600	355-3
F-637, F-639	355-3
F-737, F-739	355-3
M-633	355-3
M-732, M-734	355-3
CROSLY	
AC-108, AC-110M (Ch. 487) 351-4	
AC-118, AC-114M (Ch. 488) 351-4	
AH-108 (Ch. 487) 351-4	
AH-118 (Ch. 488) 351-4	
AT-108, AT-110M (Ch. 487) 351-4	
AT-118, AT-114M (Ch. 488) 351-4	
BC-128Z, M, MZ, BC-138, M, BC-14M, BC-15M (Ch. 489, 490)	352-5
BT-12BZ, M, MZ, BT-138, M (Ch. 489, 490)	352-5
H-210BU (Ch. 431) (See PCB 182—Set 353-1 and Model G-210BU—Set 263-6)	
H-210MU (Ch. 431) (See PCB 182—Set 353-1 and Model G-210MU—Set 263-6)	
H-211TOU (Ch. 431) (See PCB 182—Set 353-1 and Model G-211TOU—Set 263-6)	
Ch. 487 (See Model AC-108)	
Ch. 488 (See Model AC-118)	
Ch. 489, 490 (See Model BC-128Z)	
DEWALD	
K-544	347-4
DUMONT	
RA370, RA371	364-3
RA-372, RA-373	358-4
RA-380, RA-22-5	356-19-5
RA-392, RA-393	356-19-5
1110, 1120, 1130, 1140, 1150	354-4
Derbyshire (See RA370)	
Shelby (See RA370)	
Wilshire (See RA370)	
Windsor (See RA370)	
ELECTRO-VOICE	
A13CL	353-4
A20CL	360-3
A30	354-5
PC2	351-5
EMERSON	
834-A (Ch. 120308-A) (See PCB 182—Set 353-1 and Model 834-B—Set 310-3)	
839-B (Ch. 120270-B) (See PCB 182—Set 353-1 and Model 834-B—Set 310-3)	
841-A (Ch. 120291-A) (See PCB 182—Set 353-1 and Model 834-B—Set 310-3)	
844 (Ch. 120309)	353-5
847 (Ch. 120328)	353-5
855 (Ch. 120314)	354-6
1200 (Ch. 120306CM, EM) 360-4	
1201 (Ch. 120307RM) 360-4	
1202 (Ch. 120306CM, EM) 360-4	
1203 (Ch. 120307RM) 360-4	
1204 (Ch. 120306CM, EM) 360-4	
1205 (Ch. 120307RM) 360-4	
1206 (Ch. 120306CM, EM) 360-4	
1207 (Ch. 120307RM) 360-4	
1208 (Ch. 120306CM, EM) 360-4	
1209 (Ch. 120307RM) 360-4	
1210 (Ch. 120306CM, EM) 360-4	
1211 (Ch. 120307RM) 360-4	
1212 (Ch. 120315-E) 365-16-5	
1213 (Ch. 120352-G) 365-16-5	
1228 (Ch. 120351-E) 365-16-5	
1229 (Ch. 120352-G) 365-16-5	
1232 (Ch. 120331-H) 354-7	
1233 (Ch. 120332-R) 354-7	
1238 (Ch. 120351-E) 365-16-5	
1239 (Ch. 120352-G) 365-16-5	

Set Folder No.	Model No.
EMERSON—Cont.	
1244 (Ch. 120351-E) 365-16-5	
1245 (Ch. 120352-G) 365-16-5	
1246 (Ch. 120351-E) 365-16-5	
1247 (Ch. 120352-G) 365-16-5	
1254 (Ch. 120341-H) 365-16-5	
1255 (Ch. 120342-E) 365-16-5	
1264 (Ch. 120341-H) 365-16-5	
1265 (Ch. 120342-R) 365-16-5	
1272 (Ch. 120351-E) 365-16-5	
1273 (Ch. 120352-G) 365-16-5	
1274 (Ch. 120351-E) 365-16-5	
1275 (Ch. 120352-G) 365-16-5	
20345 (Ch. 120345-E, V) 363-21-5	
20385 (Ch. 120345-E, V) 363-21-5	
20405, 20425 (Ch. 120346-V) 363-21-5	
2056 (Ch. 120343-E) 363-21-5	
2057 (Ch. 120344-G) 363-21-5	
2058 (Ch. 120343-E) 363-21-5	
2059 (Ch. 120344-G) 363-21-5	
2060 (Ch. 120343-E) 363-21-5	
2061 (Ch. 120344-G) 363-21-5	
2062 (Ch. 120343-E) 363-21-5	
2063 (Ch. 120344-G) 363-21-5	
Ch. 120291-A (See Model 841-A)	
Ch. 120306CM, EM (See Model 1201)	
Ch. 120307RM (See Model 1201)	
Ch. 120308-A (See Model 844-A)	
Ch. 120309 (See Model 834-C)	
Ch. 120314 (See Model 855)	
Ch. 120328 (See Model 847)	
Ch. 120331-H (See Model 1232)	
Ch. 120332-R (See Model 1233)	
Ch. 120341-H (See Model 1254)	
Ch. 120342-E (See Model 1255)	
Ch. 120343-E (See Model 2056)	
Ch. 120344-G (See Model 2057)	

Set Folder No. No.

RCA VICTOR—Cont.

Table listing RCA Victor models and their set/folder numbers. Includes models like 24D7566, 24D7568, 24D7587, etc.

REGENCY

Table listing Regency models and their set/folder numbers. Includes models TR-5, TR-6.

ROLAND

Table listing Roland models and their set/folder numbers. Includes models AC2, 4P1, 4P2, etc.

SCOTT (H. M.)

Table listing Scott (H. M.) models and their set/folder numbers. Includes models 210-E, 311, 330, etc.

SENTINEL

Table listing Sentinel models and their set/folder numbers. Includes models 73 Series, 74 Series, etc.

SETCHEL-CARLSON

Table listing Setchel-Carlson models and their set/folder numbers. Includes models P-62, P-71, etc.

SILVERTONE

Table listing Silvertone models and their set/folder numbers. Includes models PC-5161, PC-5171, etc.

Set Folder No. No.

SILVERTONE—Cont.

Table listing Silvertone models and their set/folder numbers. Includes models PC-7100A, PC-7110, PC-7112A, etc.

SONORA

Table listing Sonora models and their set/folder numbers. Includes models 502, 518, 523, etc.

SONORA—Cont.

Table listing Sonora models and their set/folder numbers. Includes models 613, 615, 622, etc.

SPARTAN

Table listing Spartan models and their set/folder numbers. Includes models 19 Series, 21 Series, etc.

STELMAN

Table listing Stelman models and their set/folder numbers. Includes models 3A14-1, 3A15, etc.

STROMBERG-CARLSON

Table listing Stromberg-Carlson models and their set/folder numbers. Includes models AP428, SR-406, etc.

STUDEBAKER

Table listing Studebaker models and their set/folder numbers. Includes model AC2786.

SYLVANIA

Table listing Sylvania models and their set/folder numbers. Includes models 14P101 Series, 17P101, etc.

Set Folder No. No.

SONORA—Cont.

Table listing Sonora models and their set/folder numbers. Includes models 613, 615, 622, etc.

STELMAN

Table listing Stelman models and their set/folder numbers. Includes models 3A14-1, 3A15, etc.

STROMBERG-CARLSON

Table listing Stromberg-Carlson models and their set/folder numbers. Includes models AP428, SR-406, etc.

STUDEBAKER

Table listing Studebaker models and their set/folder numbers. Includes model AC2786.

SYLVANIA

Table listing Sylvania models and their set/folder numbers. Includes models 14P101 Series, 17P101, etc.

SYLVANIA—Cont.

Table listing Sylvania models and their set/folder numbers. Includes models 21C405, 21C406, etc.

TELEFUNKEN

Table listing Telefunken models and their set/folder numbers. Includes model 'Opus 7'.

TRAV-LER

Table listing Trav-Ler models and their set/folder numbers. Includes models 55C46, 517-106, etc.

TRUETONE

Table listing Truetone models and their set/folder numbers. Includes models D2781A, D2782A, etc.

TRUETONE—Cont.

Table listing Truetone models and their set/folder numbers. Includes models D2781A, D2782A, etc.

Set Folder No. No.

V-M

Table listing V-M models and their set/folder numbers. Includes models 156, 556-A, 625, etc.

WEBCOR

Table listing Webcor models and their set/folder numbers. Includes models GT1651, 1653, etc.

WEBCOR—Cont.

Table listing Webcor models and their set/folder numbers. Includes models 1755, 1762, etc.

WELLS-GARDNER

Table listing Wells-Gardner models and their set/folder numbers. Includes models 37A10-551-5, 37A10-562, etc.

WELLS-GARDNER—Cont.

Table listing Wells-Gardner models and their set/folder numbers. Includes models 321A63-8-622, 321A63U-8-622, etc.

WESTINGHOUSE

Table listing Westinghouse models and their set/folder numbers. Includes models H-14T170, H-14T172, etc.

WESTINGHOUSE—Cont.

Table listing Westinghouse models and their set/folder numbers. Includes models H-17T175, H-17T176, etc.

WESTINGHOUSE—Cont.

Table listing Westinghouse models and their set/folder numbers. Includes models H-21K111, H-21K112, etc.

WESTINGHOUSE—Cont.

Table listing Westinghouse models and their set/folder numbers. Includes models H-21K113, H-21K114, etc.

WESTINGHOUSE—Cont.

Table listing Westinghouse models and their set/folder numbers. Includes models H-21K114B, H-21K116, etc.

WESTINGHOUSE—Cont.

Table listing Westinghouse models and their set/folder numbers. Includes models H-21K118, H-21K119, etc.

WESTINGHOUSE—Cont.

Table listing Westinghouse models and their set/folder numbers. Includes models H-21K119A, H-21K119B, etc.

WESTINGHOUSE—Cont.

Table listing Westinghouse models and their set/folder numbers. Includes models H-21K119C, H-21K119D, etc.

WESTINGHOUSE—Cont.

Table listing Westinghouse models and their set/folder numbers. Includes models H-21K119E, H-21K119F, etc.

WESTINGHOUSE—Cont.

Table listing Westinghouse models and their set/folder numbers. Includes models H-21K119G, H-21K119H, etc.

WESTINGHOUSE—Cont.

Table listing Westinghouse models and their set/folder numbers. Includes models H-21K119I, H-21K119J, etc.

WESTINGHOUSE—Cont.

Table listing Westinghouse models and their set/folder numbers. Includes models H-21K119K, H-21K119L, etc.

WESTINGHOUSE—Cont.

Table listing Westinghouse models and their set/folder numbers. Includes models H-21K119M, H-21K119N, etc.

Set Folder No. No.

WESTINGHOUSE—Cont.

Table listing Westinghouse models and their set/folder numbers. Includes models H-21TR182A, H-21TR183A, etc.

WESTINGHOUSE—Cont.

Table listing Westinghouse models and their set/folder numbers. Includes models H-21TR183A, H-21TR184A, etc.

WESTINGHOUSE—Cont.

Table listing Westinghouse models and their set/folder numbers. Includes models H-21TR184A, H-21TR185A, etc.

WESTINGHOUSE—Cont.

Table listing Westinghouse models and their set/folder numbers. Includes models H-21TR185A, H-21TR186A, etc.

WESTINGHOUSE—Cont.

Table listing Westinghouse models and their set/folder numbers. Includes models H-21TR186A, H-21TR187A, etc.

WESTINGHOUSE—Cont.

Table listing Westinghouse models and their set/folder numbers. Includes models H-21TR187A, H-21TR188A, etc.

WESTINGHOUSE—Cont.

Table listing Westinghouse models and their set/folder numbers. Includes models H-21TR188A, H-21TR189A, etc.

WESTINGHOUSE—Cont.

Table listing Westinghouse models and their set/folder numbers. Includes models H-21TR189A, H-21TR190A, etc.

WESTINGHOUSE—Cont.

Table listing Westinghouse models and their set/folder numbers. Includes models H-21TR190A, H-21TR191A, etc.

WESTINGHOUSE—Cont.

Table listing Westinghouse models and their set/folder numbers. Includes models H-21TR191A, H-21TR192A, etc.

WESTINGHOUSE—Cont.

Table listing Westinghouse models and their set/folder numbers. Includes models H-21TR192A, H-21TR193A, etc.

WESTINGHOUSE—Cont.

Table listing Westinghouse models and their set/folder numbers. Includes models H-21TR193A, H-21TR194A, etc.

WESTINGHOUSE—Cont.

Table listing Westinghouse models and their set/folder numbers. Includes models H-21TR194A, H-21TR195A, etc.

WESTINGHOUSE—Cont.

Table listing Westinghouse models and their set/folder numbers. Includes models H-21TR195A, H-21TR196A, etc.

WESTINGHOUSE—Cont.

Table listing Westinghouse models and their set/folder numbers. Includes models H-21TR196A, H-21TR197A, etc.

WESTINGHOUSE—Cont.

Table listing Westinghouse models and their set/folder numbers. Includes models H-21TR197A, H-21TR198A, etc.

WESTINGHOUSE—Cont.

Table listing Westinghouse models and their set/folder numbers. Includes models H-21TR198A, H-21TR199A, etc.

WESTINGHOUSE—Cont.

Table listing Westinghouse models and their set/folder numbers. Includes models H-21TR199A, H-21TR200A, etc.

NOTE: PCB Denotes Production Change Bulletin. • Denotes Television Receiver. 5 Denotes Schematic Coverage Only.

Set No.	Folder No.	Model
WESTINGHOUSE—Cont.		
Ch. V-2356	(See Model H-21KR190)	
Ch. V-2356-204	(See Model H-21KU128)	
Ch. V-2356-205	(See Model H-21KU124)	
Ch. V-2356-405	(See Model H-21KU185)	
Ch. V-2356-406	(See Model H-21KR188)	
Ch. V-2356-605	(See Model H-21KU186)	
Ch. V-2356-606	(See Model H-21KR188)	
Ch. V-2357	(See Model H-24KR1278)	
Ch. V-2357-205	(See Model H-24KU126A)	
Ch. V-2370-24, -42	(See Model H-17T175)	
Ch. V-2380-201	(See Model H-17T175)	

WHITLEY
"Mursonde" AP1000 360-13

Set No.	Folder No.	Model
ZENITH		
HF772E, H, R	(Ch. 7Z20)	360-14
HFY10L, Y, HFY12E, R	(Ch. 3Y04)	346-20
HFY15E, R	(Ch. 3Y05)	349-15
HFZ18R, HFZ19E	(Ch. 3Z21)	346-21
HFZ22E, H, R	(Ch. 7Z20)	360-14
Royal 800	(Ch. 7Z741)	351-21
Y2359E, EU	(Ch. 2Y20, U)	(See PCB 186—Set 361-1 and Model Y2671R—Set 330-12)
YPBL		360-15
Z508B, L, W	(Ch. 5Z05)	353-17
Z510G, R, W	(Ch. 5Z10)	359-17
Z511R, Z512F, G, Y	(Ch. 5Z01, 5Z02)	361-15
Z515, W, Y	(Ch. 5Z06)	362-16

Set No.	Folder No.	Model
ZENITH—Cont.		
Z519P, R, V, W, Y	(Ch. 5Z07)	353-18
Z524W, Y	(Ch. 5Z04)	355-17
Z550C	(Ch. 5Z08)	353-19
Z615P, G, R, W	(Ch. 6Z05)	363-20
Z732C, R, Y	(Ch. 7Y03Z)	(Also see PCB 182—Set 353-1 and Model Y733G—Set 339-17)
Z1817GZ, LZ, Z1819JZ	(Ch. 15Z31)	355-18-5
Z2223CZ, EZ, RZ, YZ	(Ch. 17Z31)	355-18-5
Z2229RZ, Z2230EZ, RZ	(Ch. 19Z32)	357-14-5
Z2243EZ, RZ, Z2244EZ, RZ	(Ch. 17Z32)	355-18-5
Z2249EZ, RZ, Z2251EZ, RZ	(Ch. 17Z32)	355-18-5
Z2257EZ, MZ, RZ	(Ch. 19Z32)	357-14-5
Z2359EZ, RZ, Z, Z2360RZ	(Ch. 2Z230)	358-14-5
Z2282EZ, RZ	(Ch. 17Z32)	355-18-5
Z2675EZ, RZ	(Ch. 17Z33)	357-14-5
Z3000EZ, RZ	(Ch. 17Z32Q)	355-18-5
Z3001EZ, RZ	(Ch. 17Z34Q)	355-18-5
Z3004EZ, RZ	(Ch. 17Z32Q)	355-18-5
Z3008EZ, RZ	(Ch. 17Z34Q)	355-18-5
Z3010EZ, MZ, RZ, YZ	(Ch. 19Z32Q)	357-14-5
Z3012HZ, RZ, Z3014HZ, RZ	(Ch. 2Z230Q)	358-14-5
Z4000EZ, RZ	(Ch. 17Z33Q)	357-14-5
Z4006EZ, RZ	(Ch. 17Z33Q)	357-14-5
Ch. 3Y04	(See Model HFY10L)	
Ch. 3Y05	(See Model HFY15E)	

Set No.	Folder No.	Model
ZENITH—Cont.		
Ch. 5Z01, 5Z02	(See Model Z511R)	
Ch. 5Z04	(See Model Z524W)	
Ch. 5Z05	(See Model Z508B)	
Ch. 5Z06	(See Model Z515)	
Ch. 5Z07	(See Model Z519P)	
Ch. 5Z08	(See Model Z550C)	
Ch. 5Z10	(See Model Z510G)	
Ch. 5Z21	(See Model HFZ18R)	
Ch. 6Z05	(See Model Z615P)	
Ch. 7Y03Z	(See Model Z732C)	
Ch. 7Z20	(See Model HF772E)	
Ch. 7Z741	(See Model Royal 800)	
Ch. 15Z31	(See Model Z1817GZ)	
Ch. 17Z31	(See Model Z2223CZ)	
Ch. 17Z32	(See Model Z2243EZ)	
Ch. 17Z32Q	(See Model Z3000EZ)	
Ch. 17Z33	(See Model Z2675EZ)	
Ch. 17Z33Q	(See Model Z4000EZ)	
Ch. 17Z34Q	(See Model Z3001EZ)	
Ch. 19Z32	(See Model Z2229RZ)	
Ch. 19Z32Q	(See Model Z3010EZ)	
Ch. 2Y20, U	(See Model Y2359E)	
Ch. 2Z230	(See Model Z2359Z)	
Ch. 2Z230Q	(See Model Z3012HZ)	

RECORD CHANGERS

Set No.	Folder No.	Model
GARRARD		
RC120, RC120/4, RC121, RC121/4		355-4

Set No.	Folder No.	Model
HOFFMAN		
990002	(See PFF 355-4)	

Set No.	Folder No.	Model
MAGNAVOX		
522533	(See PFF 353-16)	

Set No.	Folder No.	Model
PHILCO		
M-39		362-6

Set No.	Folder No.	Model
RCA		
RP-205 Series		358-10

Set No.	Folder No.	Model
SILVERTONE		
567.40000, 567.40001, 567.40002, 567.40003		365-13
567.40006		365-13
567.40009		365-13
567.40100, 567.40101, 567.40102, 567.40103		365-13
567.40108, 567.40109		365-13
567.40100, 567.41001, 567.41002		365-13
567.41007, 567.41008, 567.41009, 567.41010, 567.41011		365-13
567.41013, 567.41014, 567.41015, 567.41016, 567.41017, 567.41018, 567.41019		365-13
567.41100, 567.41101, 567.41102, 567.41107		365-13
567.41109, 567.41110, 567.41111		365-13
567.41113, 567.41114, 567.41115, 567.41116, 567.41117, 567.41118, 567.41119		365-13

SPARTAN
522553 (See PFF 353-16)

Set No.	Folder No.	Model
V-M		
1200A		353-16

RECORDERS

Set No.	Folder No.	Model
COLUMBIA RECORDS		
560, A		363-6

Set No.	Folder No.	Model
CRESCENT		
TR-672, TR-673		356-6

Set No.	Folder No.	Model
EKOTAPE		
250, 251, 252, 253, 254, 255, 260, 261		347-5

Set No.	Folder No.	Model
ELLAMAC		
"Language Master"		350-3

Set No.	Folder No.	Model
MAGNECORD		
S-368		364-5

Set No.	Folder No.	Model
REVERE		
T-10 (T-70167)	(CM-5)	193-9
T-700 (T-70163)	(CM-5)	193-9
TR-20 (T-77167)	(CM-5)	193-9
TR-800 (T-77163)	(CM-5)	193-9
TRS-25 (T-77257)	(CM-5)	193-9
TRS-26 (T-77267)	(CM-5)	193-9
TRS-27 (T-77257)	(CM-5)	193-9
TRS-850 (T-77153)	(CM-5)	193-9
TRS-852 (T-77253)	(CM-5)	193-9
TRS-862 (T-77263)	(CM-5)	193-9
TS-15 (T-70157)	(CM-5)	193-9
TS-16 (T-70267)	(CM-5)	193-9
TS-17 (T-70257)	(CM-5)	193-9
TS-750 (T-70153)	(CM-5)	193-9
TS-752 (T-70253)	(CM-5)	193-9
TS-762 (T-70263)	(CM-5)	193-9

Set No.	Folder No.	Model
SILVERTONE		
7074	(Ch. 567.34006, 567.35011)	350-17
7080, 7081	(See Model 7074—Set 350-17)	
Ch. 567.34006	(See Model 7074)	
Ch. 567.35011	(See Model 7074)	

Set No.	Folder No.	Model
V-M		
710, 711		349-13
750		349-13

Set No.	Folder No.	Model
WEBCOR		
2718		357-11

Set No.	Folder No.	Model
WEBSTER ELECTRIC		
(See Ekotape)		

Set No.	Folder No.	Model
WILCOX GAY		
651, 674		348-17

NOTE: PCB Denotes Production Change Bulletin. Ⓢ Denotes Television Receiver. S Denotes Schematic Coverage Only.

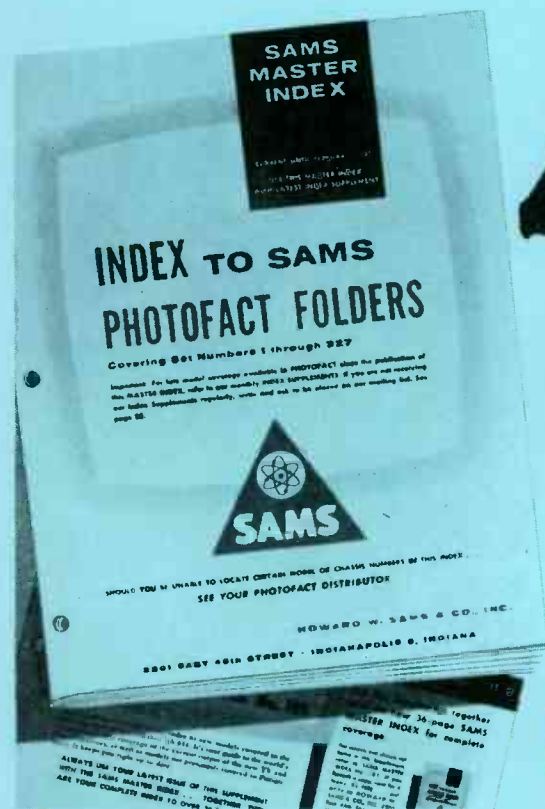

Free!

to Service Technicians Only

THE NEW SAMS INDEX TO PHOTOFAC FOLDERS

it keeps you up-to-the-minute on receiver coverage

Mail coupon today for your free subscription to the Sams Photofact Index

HOWARD W. SAMS & CO., INC.

Howard W. Sams & Co., Inc.
2203 E. 46th St., Indianapolis 5, Indiana

Send me your FREE Master Index to PHOTOFAC Folders (twice yearly), and put me on your mailing list to receive all Index Supplements. My letterhead and/or business card is attached.

I am a Service Technician: full time; part time.

My Distributor is: _____

Shop Name _____

Attn: _____

Address _____

City _____ Zone _____ State _____

free!
TO SERVICE TECHNICIANS

TAKE THE RIGHT STEP TO TIME-SAVING PROFIT-BUILDING BUSINESS: Sign up with your Parts Distributor to get PHOTOFAC Folder Sets automatically each month.

DO IT NOW!

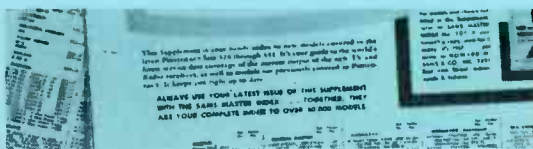

Just Arrived!

THE MOST USEFUL, PRACTICAL AID TO COLOR-TV SERVICING IN THE INDUSTRY

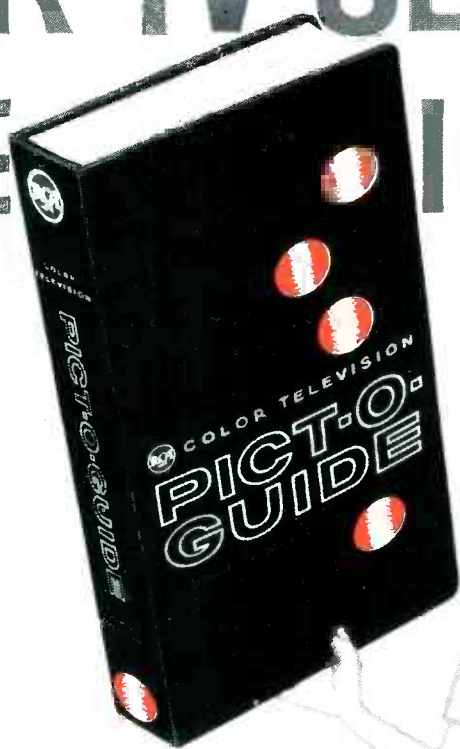

- Speeds up, simplifies installation, adjustment, and servicing of color-tv receivers
- Saves time in localizing color-tv troubles
- Profusely illustrated in full color, and monochrome
- Sturdily bound in lie-flat, multiple-ring covers

FREE OF EXTRA CHARGE WHEN YOU BUY RCA TOP-QUALITY RECEIVING TUBES!

Here's *practical* information on Color TV. Clearly written by John R. Meagher, RCA's nationally recognized authority on TV servicing and originator of the famous RCA Pict-O-Guide for black-and-white TV. It's profusely illustrated with full-color photos taken from an operating color-TV receiver.

Step-by-step instructions and diagrams provide many labor- and time-saving short-cuts for *profitable* color-TV servicing.

Build up your share of the dynamic color-TV service market with the new PICT-O-GUIDE. Get your copy from your RCA tube distributor...today!

NEW COLOR-TV PICT-O-GUIDE CONTAINS SECTIONS ON:

- Color Mixing • RCA Compatible Color TV System
- Purity • Convergence • Gray-Scale Tracking • Color Operating Controls • Antenna Considerations • RF-IF • Bandpass Alignment • Color Test Equipment • Color-Bar Patterns • Troubleshooting • Signal Tracing • Interference • "Green Stripe" Test Signals



RECEIVING TUBES

RADIO CORPORATION OF AMERICA

Electron Tube Division

Harrison, N. J.



BORTON BROWNE ADVERTISING

Everyone Looks First to LITTELFUSE

Whenever there is
a new fuse need
for service...

It is *always* Littelfuse that gives you the complete package for your requirements.

Now—the LC fuse caddy for your tube caddy—an assortment of 15 LC fuse types to cover over 94% of all service requirements for this new fuse which is rapidly becoming the TV fuse

Part No. 094041



NEW LC FUSE CADDY

