

OCTOBER • 1955

25 CENTS

*Lawrence W. Sams*



# REPORTER

for the *Electronic Service Industry*

SERVICING

AUDIO

TEST  
EQUIPMENT

RADIATION  
DETECTORS



20 7 WATT RESISTORS

SELECTED POPULAR VALUES



# RESIST-O-CARD

**\$6.20**  
NET

NEW TYPE PW-7 WIRE WOUND POWER RESISTORS • FULL 7 WATT RATING

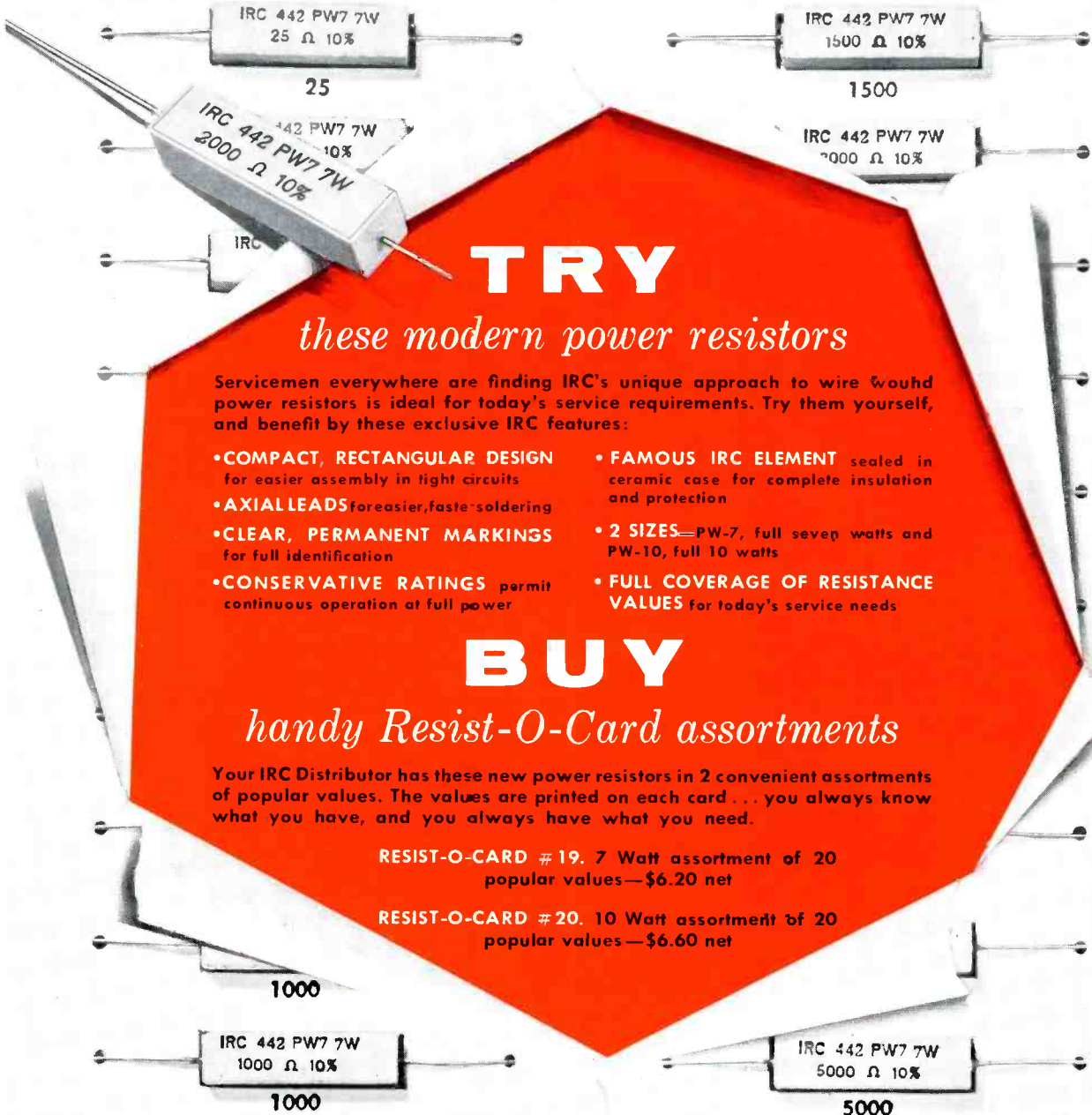

## TRY

*these modern power resistors*

Servicemen everywhere are finding IRC's unique approach to wire wound power resistors is ideal for today's service requirements. Try them yourself, and benefit by these exclusive IRC features:

- **COMPACT, RECTANGULAR DESIGN** for easier assembly in tight circuits
- **AXIAL LEADS** for easier, faster soldering
- **CLEAR, PERMANENT MARKINGS** for full identification
- **CONSERVATIVE RATINGS** permit continuous operation at full power
- **FAMOUS IRC ELEMENT** sealed in ceramic case for complete insulation and protection
- **2 SIZES**—PW-7, full seven watts and PW-10, full 10 watts
- **FULL COVERAGE OF RESISTANCE VALUES** for today's service needs

## BUY

*handy Resist-O-Card assortments*

Your IRC Distributor has these new power resistors in 2 convenient assortments of popular values. The values are printed on each card . . . you always know what you have, and you always have what you need.

RESIST-O-CARD # 19. 7 Watt assortment of 20 popular values—\$6.20 net

RESIST-O-CARD # 20. 10 Watt assortment of 20 popular values—\$6.60 net



### INTERNATIONAL RESISTANCE CO.

Philadelphia, Penna.

FOR 10 WATT POWER RESISTOR REQUIREMENTS SPECIFY IRC ASSORTMENT #20. ASSORTMENT #20 INCLUDES 20 PW-10 RESISTORS IN SELECTED VALUES—\$6.60 NET.

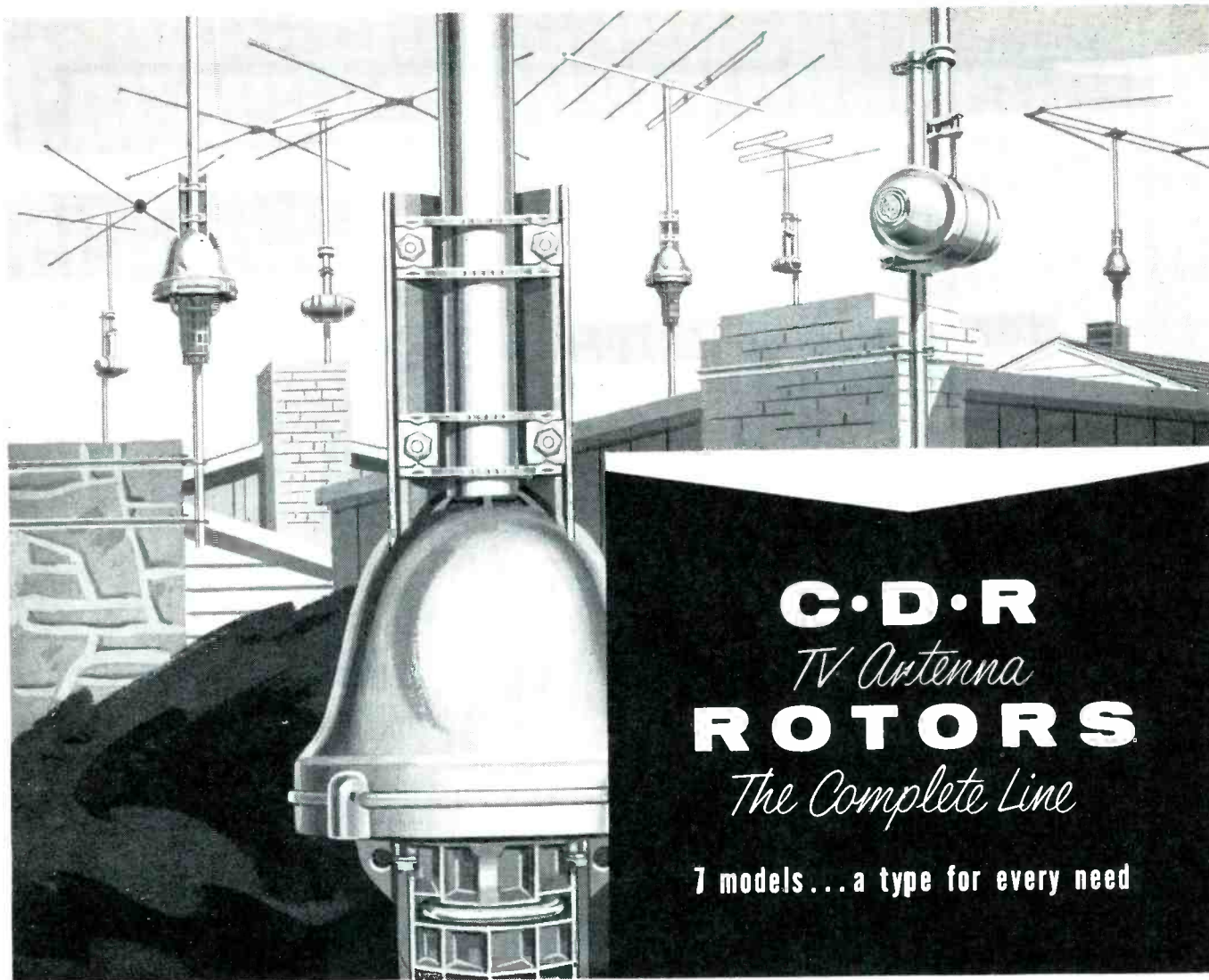

**C·D·R**  
*TV Antenna*  
**ROTORS**  
*The Complete Line*

7 models... a type for every need

featuring **C·D·R automatic ROTORS**

Here they are . . . the fastest selling line of rotors . . . complete in every detail . . . including three models in completely AUTOMATIC rotors! The AR-1 and AR-2 and the AR-22 which is the automatic version of the famous TR-2. ALL FIELD TESTED AND PROVEN BY THOUSANDS OF SATISFIED USERS!

TR-2 The heavy duty rotor with plastic cabinet featuring "compass control" illuminated perfect pattern dial . . . uses 8 wire cable.

TR-12 Complete rotor INCLUDING thrust bearing. Handsome modern cabinet with meter control dial, uses 4 wire cable.

TR-4 The heavy duty rotor complete with handsome new, modern cabinet with METER control dial, uses 4 wire cable.

TR-11 Same as model TR-12 without thrust bearing.



PRE-SOLD to millions with the greatest concentration of TV Spots in our history.

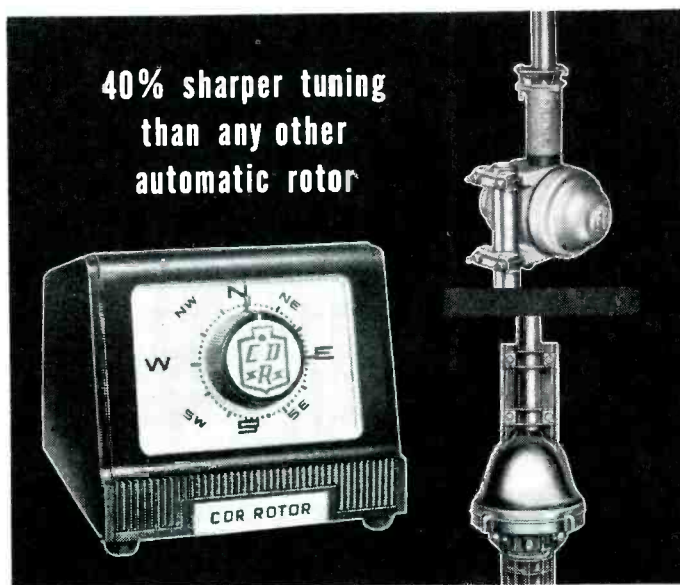

40% sharper tuning than any other automatic rotor



**CORNELL-DUBILIER**  
 SOUTH PLAINFIELD, N. J.



**THE RADIART CORP.**  
 CLEVELAND 13, OHIO



THERE WAS SO MUCH SNOW BEFORE WE PUT IN SPRAGUE CAPACITORS WE THOUGHT DAVY CROCKETT WAS AN ESKIMO.

## Don't Be Vague... Insist on SPRAGUE

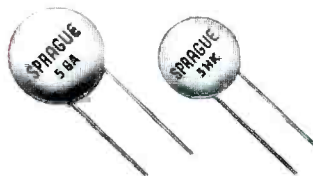

### Insist on Sprague CERAMICS

Tiny, tough, dependable . . . in every application . . . whether discs, plates, buttons, or door knobs. And there's a Sprague ceramic capacitor to meet every service need. You give your customers dependable service, guard yourself against costly call-backs, when you use only Sprague Ceramic capacitors.

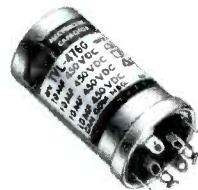

### Insist on Sprague TWIST-LOK<sup>☆</sup> 'LYTICS

Sprague TVL's fill the top performance bill in the toughest TV circuits. High temperatures, surge voltages, ripple currents won't faze them. Like all Sprague capacitors, Twist-Lok 'Lytics are your first line of defense against expensive call-backs.



### Insist on Sprague ATOMS<sup>®</sup>

The smallest TV 'lytics made—and the only small ones for 85°C (185°F) up to 450 volts d-c. Guaranteed for low leakage and long shelf life, they withstand high temperatures, high ripple currents, high surge voltages. From crowded TV chassis to jam-packed portables, Sprague Atoms fit 'em all.

Accept no substitutes. There is a Sprague Distributor in every sales area in the United States. Write for the name of your nearest source of supply today.

☆ Trademark

# SPRAGUE

Get your copy of Sprague's latest radio and TV service catalog C-610. Write Sprague Products Company\*, 105 Marshall St., North Adams, Mass.

\*Distributors' Division of Sprague Electric Company

**WORLD'S LARGEST  
CAPACITOR MANUFACTURER**



JAMES R. RONK  
Editor

LESTER H. NELSON  
Managing Editor

W. WILLIAM HENSLER  
Technical Editor

GLEN E. SLUTZ  
Asst. Technical Editor

Editorial Staff

GWEN BIGHAM  
WILLIAM E. BURKE  
HENRY A. CARTER  
LESLIE D. DEANE  
ROBERT B. DUNHAM  
PHYLLIS J. HURLEY  
THOMAS A. LESH  
GEORGE B. MANN  
GLENN M. McROAN  
EVELYN S. MOUSER  
MARGARET NEFF  
C. P. OLIPHANT  
VERNE M. RAY  
PAUL C. SMITH  
CALVIN C. YOUNG, JR.

ANTHONY M. ANDREONE  
GLENN R. SMITH  
Art Directors

ROBERT W. REED  
Photography

ARCHIE E. CUTSHALL  
DOUGLAS G. BOLT  
Production

★  
**HOWARD W. SAMS**  
Publisher

Business Department:  
Donald B. Shaw, V. P.  
Treasurer

F. T. Dobbs, Secretary  
Joe H. Morin, Sales Mgr.  
Ann W. Jones, Advertising

Eastern Representatives  
Paul S. Weil and  
Donald C. Weil  
39-01 Main Street,  
Flushing 54, New York  
Independence 3-9098

Western Representatives  
Maurice A. Kimball Co., Inc.  
2550 Beverly Blvd.  
Los Angeles 57, Cal.  
DUnkirk 8-6178

681 Market St.  
San Francisco 5, Cal.  
EXbrook 2-3365

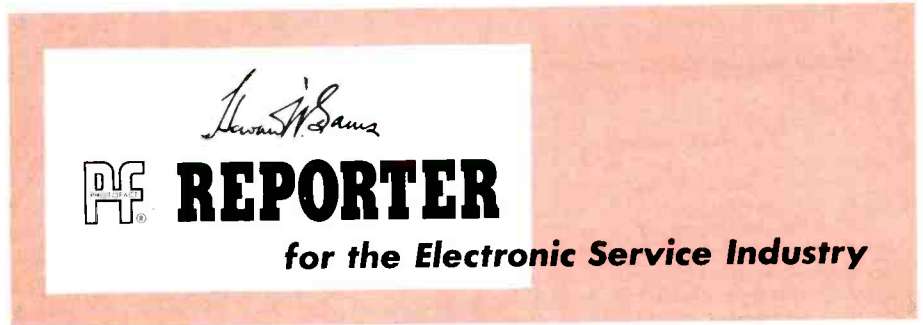

VOL. 5 • NO. 10

OCTOBER • 1955

## CONTENTS

Examining Design Features	Leslie D. Deane	9
Servicing Modular TV Receivers (Part II)	William E. Burke and W. W. Hensler	10
Radiation Detectors	William E. Burke	12
In the Interest of Quicker Servicing	Calvin C. Young, Jr.	15
Troubles in Video IF and Detector Systems (Part II)	Leslie D. Deane and Calvin C. Young, Jr.	17
Audio Facts	Robert B. Dunham	20
Shop Talk	Milton S. Kiver	23
Notes on Test Equipment	Paul C. Smith	24
Circuits in Ampex Model 600 Tape Recorder	Robert B. Dunham	27
Dollar and Sense Servicing	John Markus	29
A Sales Item for TV Technicians	Robert B. Dunham	33
A Stock Guide for TV Tubes		41
PHOTOFACT Colorblock Reference Chart No. 9		Insert

## SUBJECT REFERENCE

AUDIO	Radiation Detectors	55
Ampex Model 600 Tape Recorder, Circuits in	Solderless Connections	15
Jensen TV Duette	Symptoms and Troubles in Video IF and Detector Systems	17
Listening Room, Characteristics of		21
COLOR TV	TELEVISION	
Adjusting and Servicing with RCA Model WR-61 Color-Bar Generator	General Electric Model 14T007, Description of	9
GENERAL THEORY	TEST EQUIPMENT	
Geiger Counter, Description of	B & K Model 350 Cathode Rejuvenator Tester	24
Scintillation Counter, Description of	General Electronics Model KE-1 CRT Rejuvenator	24
RADIO	Triplet Model 310 VOM	25
Arvin Model 950T, Description of	Triplet Model 630-NA Multimeter, Overload Protection in	82
SERVICING	Win-Tronix Model 160 White Dot-Linearity Generator	83
Horizontal-Linearity Adjustment in the Home	TUBES	
Keystone Effect	6CM7 Dual Triode	71
Modular TV Receivers		
Precautions in Replacing Components		

Copyright 1955 by Howard W. Sams & Co., Inc.  
No part of the PF REPORTER may be reproduced without written permission. No  
patent liability is assumed with respect to the use of information contained herein.

The PF REPORTER is published monthly by Howard W. Sams & Co., Inc., 2201 East 46th Street, Indianapolis 5, Indiana. The PF REPORTER is on sale at 25¢ a copy at 1401 jobbers of Electronic Parts throughout the United States and Canada. (In Canada 30 cents.) When available, back numbers may be obtained by sending 35¢ for each copy desired. Entered as second class matter October 11, 1954, at the Post Office at Indianapolis, Indiana, under the Act of March 3, 1879.

SUBSCRIPTION DATA: For those desiring the convenience of delivery to their homes or shops, each issue of the REPORTER will be mailed direct, promptly upon publication. Rates: U. S. and its Possessions, one year \$3.00. Canadian subscriptions, one year \$3.60. All other countries \$12.00 per year in American money.

# FIELD REPORT NO. 5

Jack Livesay  
Livesay's Music Co.  
Roanoke Rapids, N. C.



We have an eighty-five foot test tower located at our Store for the purpose of comparing the different types of antennas on the market today. The reason we have selected the JFD Star-Helix all channel antenna above all others is that it has the best frequency response and highest gain on channels 2 through 13. Since the birth of the JFD Star-Helix we have installed over 600 Star-Helix and have never had a call back due to the fault of the antenna.

Paul Morrone  
Morrone TV  
Creston, Ia.



Most of my customers are out in the fringe area. We need a lot of gain to pull in the signal, most of all on channel 13. I used every new antenna that came out that was a fringe antenna, but nothing worked until I used the Super-Star Helix made by JFD. The Super-Star Helix is for me now. It's made me a lot of new customers.

Oliver Ewbank  
Plaza Television  
Topeka, Kan.



When the Star-Helix came out, we checked its performance as we do with all new antennas. The exceptional results of those tests have since been verified many times by users who are getting the sharpest, cleanest pictures possible. We know of numerous instances where the Star-Helix delivered excellent pictures at locations where three or four other antennas had failed.

Sam M. Patrick  
Patrick TV & Radio Inc.  
Orlando, Fla.



The JFD Star-Helix is the best antenna I've tried—and I've tried them all—that pulls in clear pictures on channels 8 and 13 from Tampa over 100 miles away. Also channel 4 from Jacksonville which is over 150 miles away. I also know that my Star-Helix customers are ready for Top-notch color reception when it comes their way.

Harry H. Rogers  
Rogers Radio & TV  
Lenox, Ia.



Channel 13 from Des Moines has been a big problem out my way. The other channels came in good but 13 was nothing but ghosts and interference. JFD made the Super-Star Helix and I tried it and now 13 comes in as bright as all the other channels. Now I'm using it in all of my installations.

John D. Sorrentino  
East New York Appliance  
Brooklyn, N. Y.



It sure surprised me. It's the first time I ever got compliments on the looks of my antenna installation. That trim inline build of the JFD Fire-Ball sure looks as good as it works. I don't have to worry about break-down from high winds or ice-loading either. It's got my vote.

## Across the U. S. A. TV Dealers Acclaim these Antennas ...

Whether you buy the ultra-sensitive Star-Helix or the new Super-Star Helix or the remarkable Fire-Ball, you know the JFD antenna you install protects your reputation.

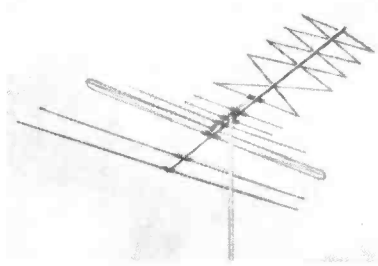

### JFD STAR-HELIX

SX711 single \$25.50  
SX711S stacked \$52.50  
SX711S-96\* 96" stacked \$55.00

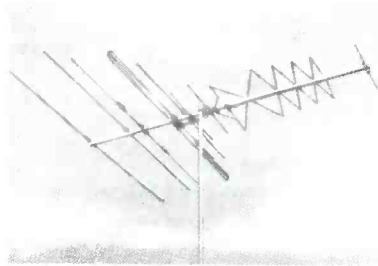

### JFD SUPER-STAR HELIX

SX13 single \$35.00  
SX13S stacked \$72.50

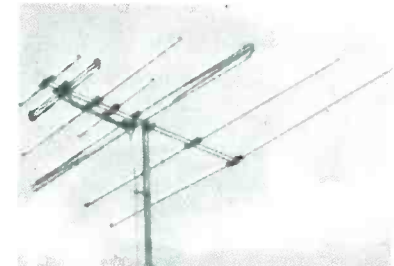

### JFD FIRE-BALL

FB500 single \$17.35  
FB500S stacked \$36.65  
FB500S-68† 68" wide stacked \$36.65  
FB500S-96\* 96" wide stacked \$38.60



"Go Forward with JFD Engineering."  
MANUFACTURING Co. Inc., BROOKLYN 4, N. Y.  
INTERNATIONAL DIVISION, 15 MOORE ST., N. Y.



†for areas with co-channel and cross-channel interference

\*for added channel 2-6 gain





# 4,000 GOOD REASONS FOR BUYING

ASK YOUR DISTRIBUTOR  
for the new Clarostat Catalog No. 55 listing the most  
complete line of essential controls and resistors. And ask for the  
right placements for stay-put, profitable, good-will jobs.

Clarostat Mfg. Co., Inc., Dover, New Hampshire. In Canada: Canadian Marconi Co., Ltd., Toronto 17, Ont.



*All New!*  
**RCA WO-91A**  
**5" 'SCOPE FOR**  
**BLACK and WHITE**  
**and COLOR TV**

**Only \$229<sup>50</sup>**  
 User Price (Optional)

**RCA WO-91A 5" OSCILLOSCOPE**  
 Complete, ready-for-use, including new  
 WG-300A low-capacitance, dual-purpose  
 probe, shielded input cable and  
 instruction book.

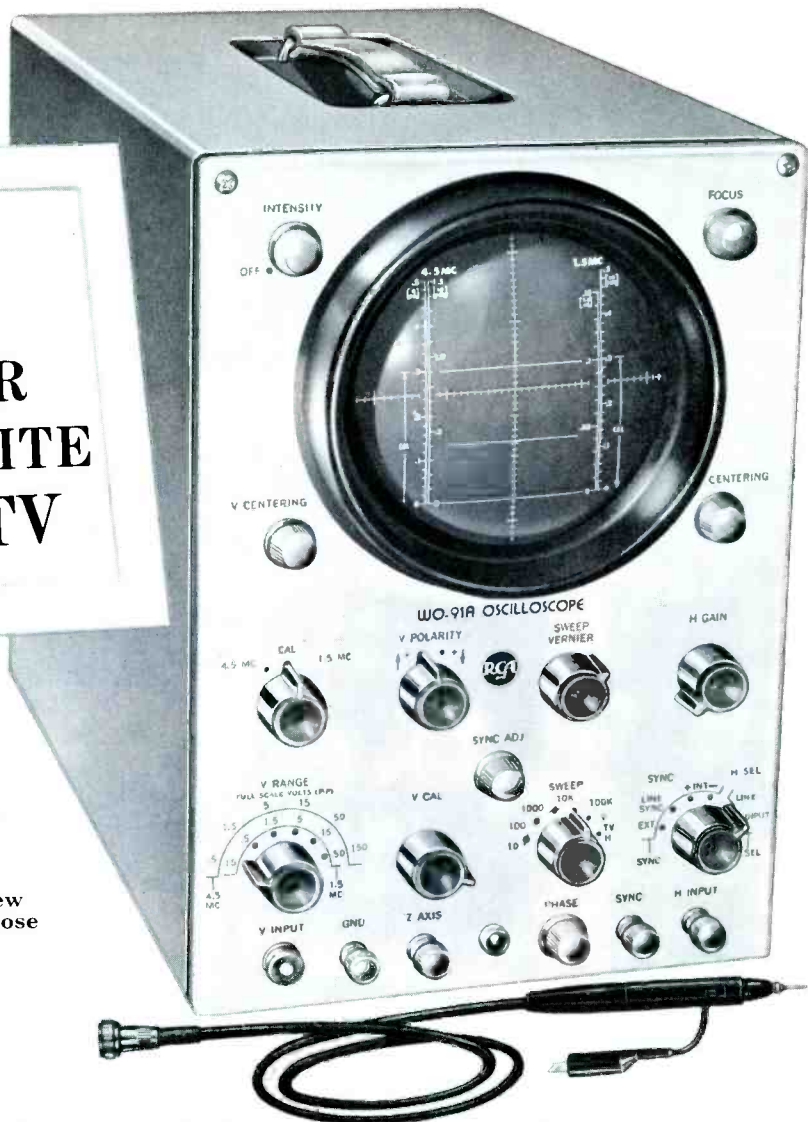

Now—AN ALL-NEW OSCILLOSCOPE with features usually found only in more expensive instruments. It has all the 'scope functions you need to do both black-and-white and color TV service work . . . speedily and with top-grade results! Check a few of these work-simplifying features . . . "low-capacitance/direct" probe . . . preset "V" and "H" sweep positions . . . automatic probe-disconnect calibration control. And look at the added features of this instrument:

- *Dual-band response. Response flat to 4.5 Mc in wide-band position.*
- *Voltage-calibrated, frequency-compensated, 3-to-1 step attenuator for "V" amplifier.*
- *Simplified, semi-automatic voltage calibration for simultaneous voltage measurement and waveshape display.*
- *VTVM-type graph scales marked in peak-to-peak volts—read voltage amplitude directly from screen.*
- *Vertical-polarity reversal switch for "upright" or "inverted" trace display.*
- *Sturdy one-piece low-capacitance/direct probe minimizes circuit loading.*
- *Z-AXIS input facilities permit direct modulation of the cathode-ray tube grid.*
- *Preset "V" and "H" sweep positions for speedy, automatic lock-in at "vertical" and "horizontal" frequencies.*
- *"Plus" or "minus" internal-sync selector.*
- *Shielded vertical-input connector and shielded cable for minimizing hum and stray field pick-up.*
- *Positive-lock internal sync.*

**FREQUENCY RESPONSE:** Wide-band position, within-1 db from 10 cps to 4.5 Mc; Narrow band position, within-1 db from 10 cps to 0.5 Mc; within-6 db at 1.5 Mc.

**SENSITIVITY:** 0.05 volt peak-to-peak per inch (0.018 volt rms) in narrow-band position; 0.15 volt peak-to-peak per inch (0.053 volt rms) in wide-band position.



**RADIO CORPORATION of AMERICA**  
 TEST EQUIPMENT  
 HARRISON, N. J.

See the ALL-NEW  
 WO-91A at your  
 RCA Distributor.  
 Order now for  
 early delivery.





**QUALITY CONTROL MANAGER** of Leading Set Maker: "In a recent life test, every Raytheon Cathode Ray Tube tested passed the 1000 hour test with colors flying".



**HEAD OF A LEADING ELECTRONICS DISTRIBUTION CO.:** "Demand for Raytheon Aluminized Picture Tubes is increasing daily. Their superb quality and performance is rapidly making Raytheon first choice. We carry more Raytheons than any other brand".

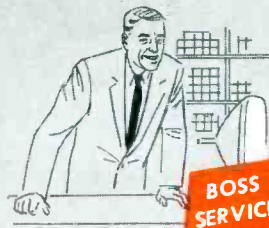

**BOSS OF TV-RADIO SERVICE SHOP:** "My men prefer to replace with Raytheons. They know that Raytheon Picture Tubes will make them look good".

**RAYTHEON**



Everyone's putting in a good word for **ALUMINIZED PICTURE TUBES** with **LUMILAC\***



**TV SET MANUFACTURERS INSPECTION EXPERT:** "Raytheon Picture Tubes have lowest line returns in the industry".



**SET OWNER:** "My TV set is better than new, since the service man put in a new Raytheon Picture Tube".

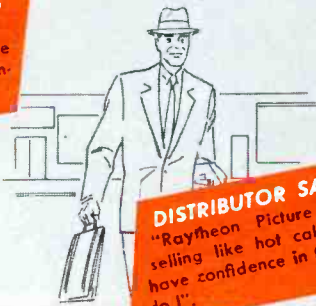

**DISTRIBUTOR SALESMAN:** "Raytheon Picture Tubes are selling like hot cakes. Dealers have confidence in them and so do I".



**LIFE TEST ENGINEER:** "Since the introduction of LUMILAC, Raytheon Aluminized Tubes have outperformed all others for brightness and life".

Excerpts from correspondence in Raytheon's files.

**LUMILAC** — a lacquer especially blended and used exclusively by Raytheon — is the secret of the superiority of Raytheon Aluminized Picture Tubes. It produces a smooth unbroken surface for the pure aluminum coating, yet leaves no gas-producing residues which could impair cathode emission and shorten tube life.

**RAYTHEON**

*Excellence in Electronics*

**RAYTHEON MANUFACTURING COMPANY**

Receiving and Cathode Ray Tube Operations  
Newton, Mass., Chicago, Ill., Atlanta, Ga., Los Angeles, Calif.

RAYTHEON MAKES ALL THESE:

RECEIVING AND PICTURE TUBES • RELIABLE SUBMINIATURE AND MINIATURE TUBES • SEMICONDUCTOR DIODES AND TRANSISTORS • NUCLEONIC TUBES • MICROWAVE TUBES



# NO DUST CATCHERS

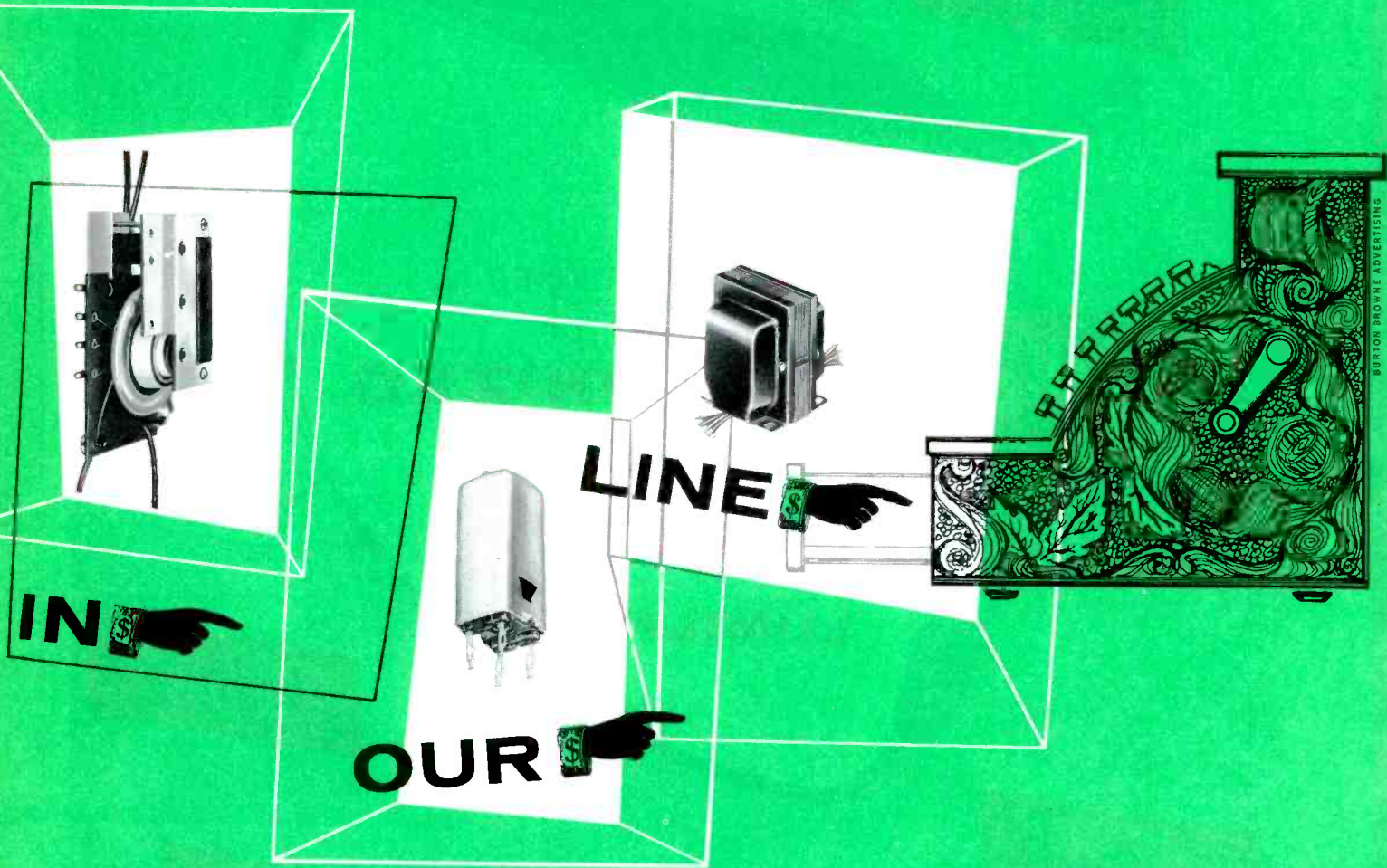

BURTON BROWNE ADVERTISING

... 101 new items added in the last 300 days keep Merit's line of coils and transformers *the most complete* replacement line in the TV-Radio field ... and that's why more and more servicemen come to Merit for their "Single Source"!

Merit products are listed in Howard Sam's Photofacts and Counter Facts.



MERIT COIL & TRANSFORMER CORPORATION  
4427 North Clark Street, Chicago, Illinois



## New GE Portable Television Receiver

This year has seen a definite trend toward the production of light-weight portable television receivers by many of the leading manufacturers. The General Electric Model 14T007 is a recent example of this new look in TV design.

The metal cabinet shown in the heading is only 10 1/4 inches high, 13 1/4 inches wide, and 16 inches deep; and this set weighs approximately 35 pounds. These physical features permit the unit to be moved very easily. The receiver has a complement of thirteen tubes, exclusive of the 14QP4 picture tube. The tubes are of the new 600-ma series-heater type; and all have approximately the same warm-up time, which tends to eliminate troublesome burnouts. One of the first features that becomes apparent upon examining the vertically mounted chassis is the extensive use of printed wiring. All the printed-wiring is laid out in two sections which are phenolic mounting boards attached to the main chassis. The side of each of these two sections on which the components are placed can be seen in the photograph of Fig. 1, and the plated-wiring side of one board is shown in Fig. 2.

In general, the basic circuitry is somewhat simplified and uses only two video IF amplifiers, a 1N64 crystal diode for video detection, and a single triode stage in the sync section.

The combination vertical-multivibrator and output circuit incorporated in this receiver differs from that found in previous designs. A schematic diagram of this circuit is illustrated in Fig. 3. The use of a 12BH7A as a vertical multivibrator eliminates the necessity of a separate vertical-output tube because the sweep output obtained from this stage is sufficient to drive the vertical-deflection coils without additional amplification.

One noticeable departure from the conventional vertical multivibrator circuit is the electrical location of the vertical-linearity and height controls. The electrical location of these controls is schematically illustrated in Fig. 3. In the majority of receivers employing this type multivibrator, the height control is usually found in the plate circuit of the first triode section and the linearity control is found in the grid or cathode circuit of the output section.

The physical design of these two controls is another feature which

# Examining DESIGN Features

by Leslie D. Deane



is relatively new to the industry. The controls are small carbon potentiometers mounted on a single insulated strip, and they employ short shafts made of plastic material. These have a slot at the end for use in making screwdriver adjustments. Neither control is incased, thus exposing the glider contacts and resistive elements, as shown in Fig. 4.

The horizontal-sweep system consists of the triode section of a 5AN8 tube used as a horizontal-phase detector, a 7AU7 tube used as a horizontal multivibrator, and a 12BQ6GA

tube used as an output stage. A small cage houses the flyback transformer and the 1X2A high-voltage rectifier tube. A 12AX4GTA tube serves as a damper for the flyback circuit and also supplies the necessary boost voltage.

Included with this new chassis is a deflection yoke of small design. This yoke was originally developed and introduced by General Electric. Bulky support brackets are not necessary with this style of yoke because

\* \* Please turn to page 70 \* \*

Fig. 1. The New GE Vertical Chassis Partially Removed From the Cabinet.

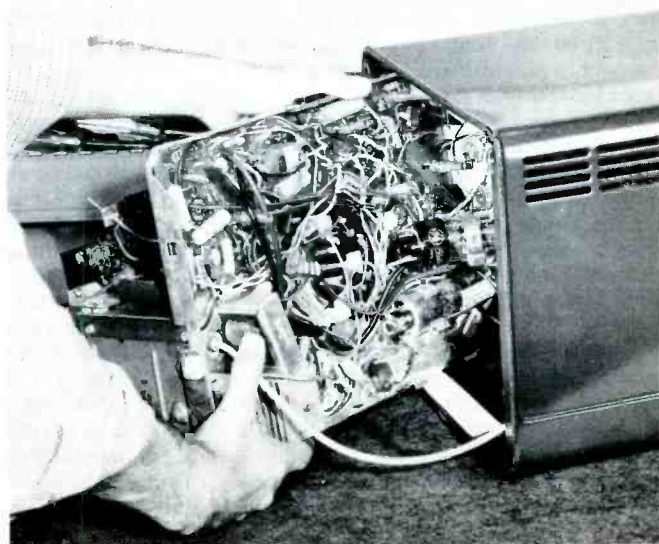

# SERVICING MODULAR TV RECEIVERS

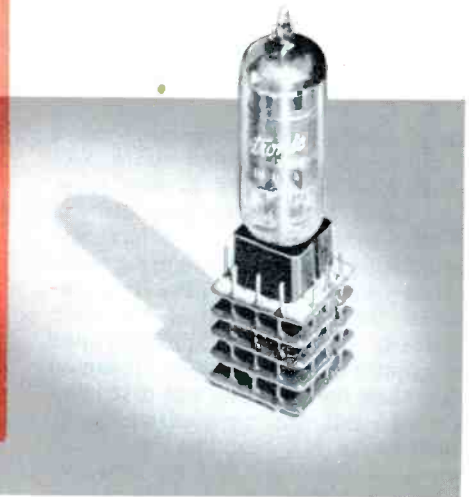
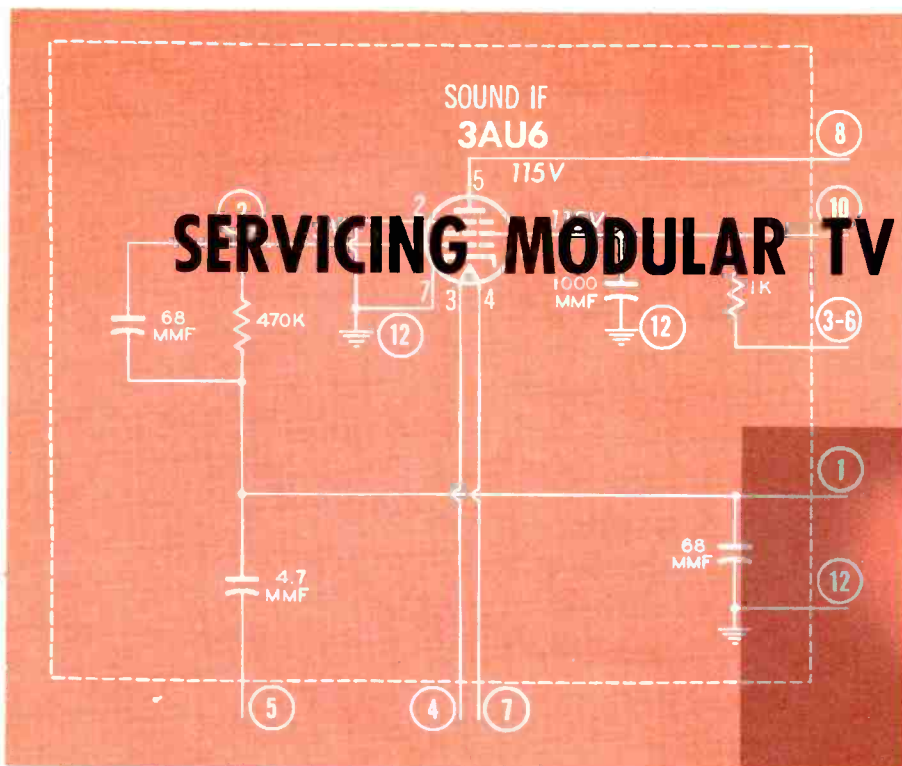

## PART II Recommended Procedures for Trouble Shooting

by William E. Burke and W. W. Hensler

(Editor's Note: Part I of this two-part coverage of the new modular type of construction in TV receivers appeared in the August 1955 issue of the PF REPORTER. In that part, modules were described and the methods of removing and replacing them were discussed.)

The success or lack of it that is experienced when servicing any TV receiver depends greatly upon the frame of mind of the technician doing the work. A sad experience with a particular chassis may have a tendency to cause a technician to develop a sort of defeatist attitude every time he comes in contact with the same chassis. A similar feeling may be experienced when a new type of receiver employing new circuits or mechanical features is encountered. The thought of having to "dope out" a new circuit or to become accustomed to a strange chassis layout can be rather disheartening. In such a frame of mind, no one can be expected to work at top efficiency.

The first time a technician is called upon to service a modular receiver, he is very likely to be more than just disheartened — he will probably have the feeling of "Where can I start?" unless he has advance information on this particular design. It is the purpose of this article to point

out certain advantages that a modular design presents from a servicing standpoint. As would be expected, there are also several disadvantages; and they will be discussed along with recommended measures for overcoming them.

### Advantages

The following discussion will point out six advantages that a technician will enjoy when he services a modular TV receiver.

Although the number of resistive, capacitive, and inductive elements contained in a single module will vary from unit to unit, an actual count of elements contained in all the modules in a representative receiver has shown that 139 parts are contained within 17 modules. This averages slightly more than eight elements per module. More important, though, is the fact that instead of 139 components, among which the defective component must be located, there are actually only 17. Fig. 1 shows two chassis. One has been constructed with modules and the other with conventional components. Note the great difference in the number of components used in the two chassis. The recommended procedure for determining which module is defective will be discussed later.

### 2. No Need to Find the Specific Element That Failed.

During a servicing job, there is a tendency for the technician to bypass certain steps by making a measurement to ascertain the condition of a specific component. Such practice has been brought about by the fact that some components require more frequent replacement than others, and it is natural for the technician to jump to conclusions as to which component is bad. Using such a procedure, the technician first determines which stage is defective. After accomplishing this and before taking a single voltage measurement, he may try to test components that are frequent offenders in that stage. Although such practice is fruitful in a great many instances, there are still times when a more thorough servicing procedure is required to locate the defective part.

When servicing a modular receiver, the technician needs only to locate the defective stage, which in most cases is contained within a single module unit. The additional step of locating the defective element in that stage is not necessary.

### 3. Entire Stage Is Replaced When New Module Is Installed

When servicing a receiver that is wired conventionally, certain pre-



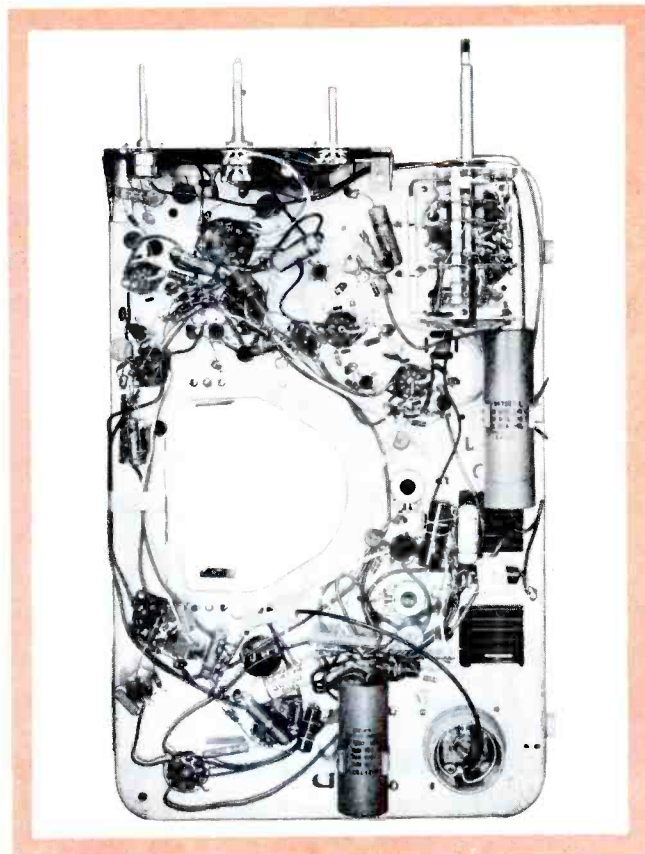
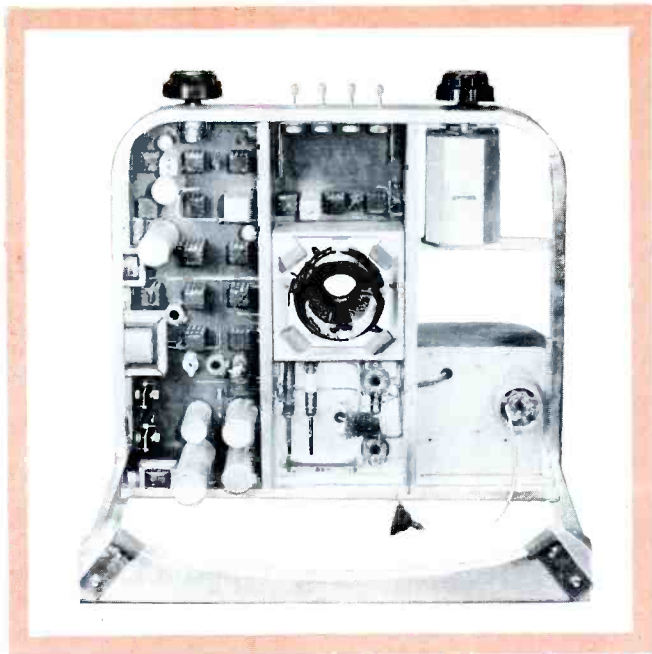

**Fig. 1. Above is a Modular Receiver, and at the Right is a Conventional Receiver. Note the Greater Number of Components in the Conventional Receiver.**

cautions must be taken after a defective component is located. Replacement of only that part may not completely repair the receiver because other components may also have been damaged. For example, a coupling capacitor may initially have become leaky. The resultant increase in current in the associated tube may have caused damage to the plate load or decoupling resistor. Unless both the resistor and the capacitor are replaced, the receiver will not be satisfactorily repaired.

The replacement of a module in a modular receiver will bring about replacement of all elements in the stage represented by the module; thus, there is no need to spend time determining how many elements in the stage require replacement. There is consequently no cause for apprehension concerning the proper operation of the circuit after the repair is completed.

#### **4. Parts Replaced Can Be Positively Identified.**

The list of parts used in a typical repair job on a conventional receiver might include one capacitor and one resistor. The customer has no way of knowing which resistor or capacitor was replaced; and in fact, it would do no good in most cases to explain to a customer that the bypass capacitor and decoupling resistor in one of the video IF stages had been replaced. If

(shortly after a service call) there occurred a failure that produced the same or similar symptoms and if a capacitor and resistor appeared again in the list of parts replaced, the customer might suspect that he would be paying for the replacement of the same parts.

In the case of a modular receiver, a module which has been replaced can be positively identified on the customer's receipt as the "Vertical-Output Stage," or the like. In fact, the technician can (if it is his policy to do so) place a specific guarantee on that

part for a certain length of time; and the receipt can so indicate.

Positive identification of the replacement module can be made in several ways. One method was suggested in the previous paragraph. Another might be that of using indelible ink to write the date of installation on the top of the unit. Fig. 2 shows a module which has been so marked.

Still another method for identification of replacement modules could be made possible at the manufacturers' level by using a special mark or paint on replacement units. No definite plan along this line has been expressed by any manufacturer, but it is mentioned here as a suggested method of marking the modules.

#### **5. No Lead-Dress Problems.**

When some conventionally wired circuits are serviced, precaution must be taken not to move certain components or the operation of a circuit might be affected. Such is not the case with modules. All of the elements are in fixed positions within the module. Whatever distributed capacitance that may exist between the various elements cannot be changed; and in fact, such capacitance may be included as an electrical part of the design of the stage.

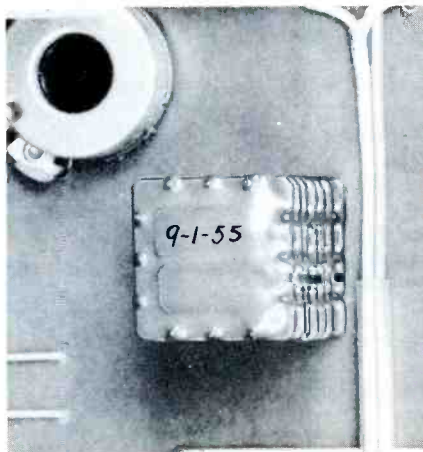

**Fig. 2. A Module Which Has Been Identified As a Replacement by Writing the Date of Installation on the Unit.**

\* \* Please turn to page 42 \* \*

# RADIATION DETECTORS

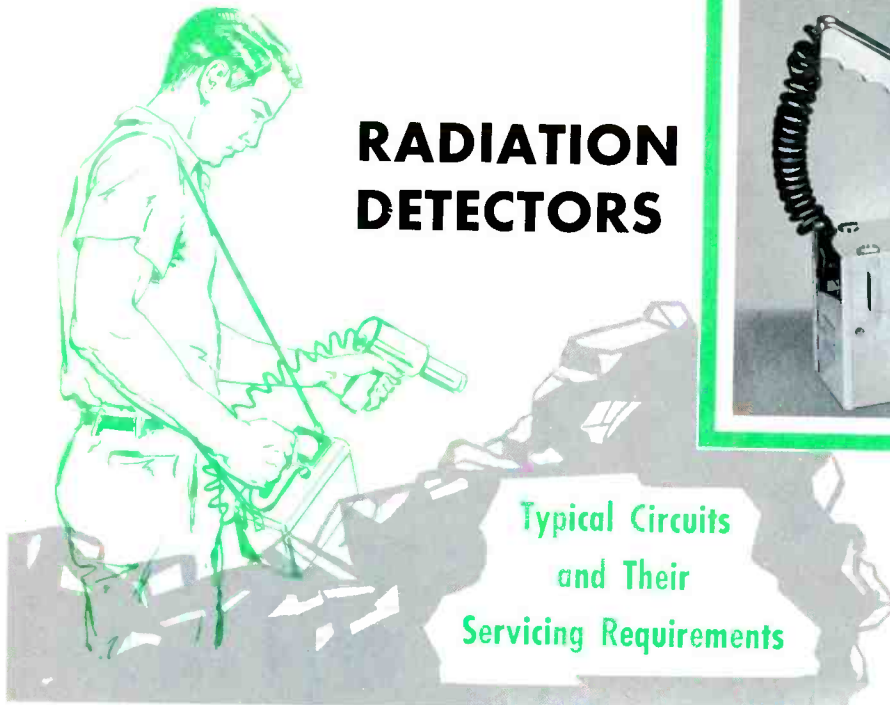

Typical Circuits  
and Their  
Servicing Requirements



by William E. Burke

used to measure the output of such a supply, the voltmeter loads the supply to such an extent that the output voltage drops to practically zero. Even a VTVM will introduce an error of ten to twenty per cent in the reading. An electrostatic voltmeter draws no current from the voltage source and measures the true voltage.

Of the many different types of radiation instruments, only the Geiger counter and the scintillation counter will be covered in this article. The circuits in the electronic sections of these two types are very similar to the circuits with which the service technician is familiar and should be fairly easy to repair.

## Geiger Counter

The Geiger counter derives its name from the Geiger-Müller type which is used in the instrument. The tube has an outer metallic envelope and an insulated electrode consisting of a wire through the center of the tube. In operation, the

### EDITOR'S NOTE

During the past year, we have had considerable correspondence with Mr. Paul Sperling of Precision Radiation Instruments, Inc.; and the subject of his correspondence has been the need in the service industry for information about the various devices which have been developed for detecting radioactivity. Mr. Sperling feels that the increasing use of Geiger and scintillation counters by uranium prospectors will result in more and more radio and TV service technicians being called upon to service these types of instruments.

In order to help the service industry in this matter, Precision Radiation Instruments, Inc., has made available to us representative samples of their products. We, in turn, have examined and tested these sample units. The following article presents the basic operation of the two most popular types of radiation detectors and the equipment and procedures which are needed for servicing them. It is hoped that, after reading this article, the reader will be able to judge whether or not he should actively enter this specialized branch of servicing.

The application and study of atomic energy and the use of radioactive devices have become very important in today's world. Equally important is the detection of radiation from such devices. Measurements must be made by engineers and scientists in the course of their work. Medical personnel must also make measurements in order to safeguard adequately the health of everyone associated with atomic energy.

There have been many types of instruments devised for the purpose of detecting and measuring radiation, and most of these depend upon electronic principles for their operation. These electronic instruments present a new and potentially large source of income for the service technician who is willing to learn their basic principles. The test equipment in the average service shop is suitable for working on radiation instruments, and an electrostatic voltmeter is the only extra piece of equipment which will be necessary.

The power supplies in most radiation instruments generate very high voltages and have extremely small current-generating capabilities. When an ordinary voltmeter is

Fig. 1. Precision Model 107C Professional Geiger Counter.





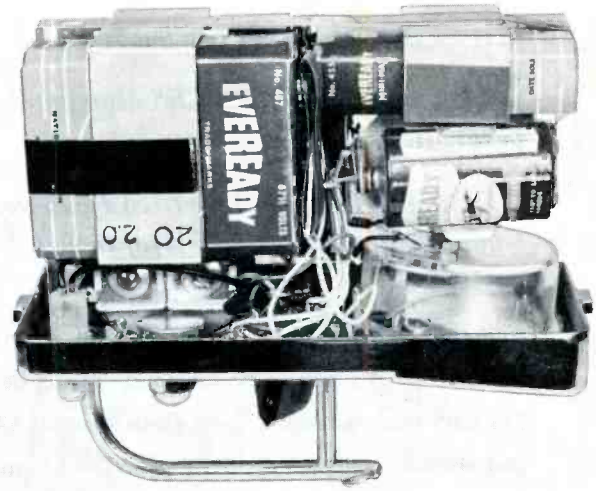
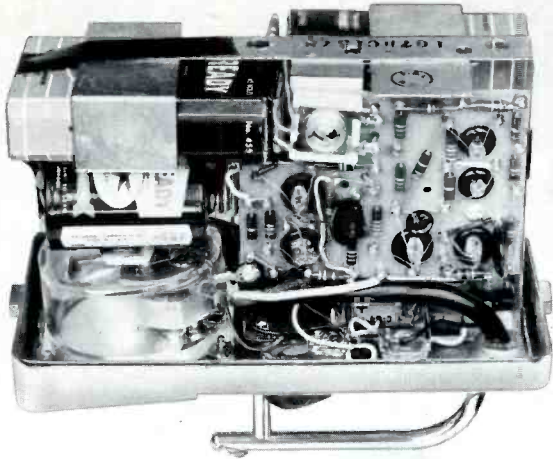

Fig. 2. Internal Construction of Model 107C.

central electrode is biased with a highly positive voltage.

The tube is filled with an easily ionized gas, and ions are formed when radiation strikes the tube. The positive ions are attracted to the envelope, and the negative ions are attracted to the positive electrode. This movement of ions constitutes a pulse of current which occurs each time that a particle of radiation enters the tube. After each particle enters, the gas quickly deionizes and readies itself for the next.

The pulses of current develop voltage pulses across a high resistance which is in series with the positive electrode. These voltage pulses are counted by the Geiger counter, and the information is presented to the user either visibly or audibly as an indication of the amount of radiation to which the tube is exposed.

Geiger tubes are made in a great variety of shapes and sizes, but the most important feature of any tube is its operating voltage. Operating potentials for Geiger tubes may vary from 300 to 1,500 volts or higher. Any one tube, however, is designed to operate at a certain voltage; and any deviation from this voltage will adversely affect the operation of the tube. For this reason, high voltage is supplied by batteries or by electronically regulated power supplies.

A typical Geiger counter is shown in Fig. 1. It is the Model 107C manufactured by Precision Radiation Instruments, Inc., of Los Angeles, Calif. Two interior views of the instrument are shown in Fig. 2, and the schematic is shown in Fig. 3. The 1B85 Geiger tube is supplied with 900 volts by the power supply consisting of V1 and V2.

Resistor R1, capacitor C1, and the neon bulb M1 form a relaxation oscillator. The battery charges C1 through R1 until the voltage across the capacitor reaches the ignition point of M1. M1 conducts and reduces the charge on C1 to the extinguishing point of M1. The charging action begins again, and this cycle is repeated.

The sharp negative pulses of voltage across C1 are coupled to the grid of V1. The pulses are of sufficient amplitude to drive the grid of V1 to cutoff and the plate current through V1 stops. The sudden changes of current through L1 produce pulses of extremely high voltage at the plate of V1. These pulses are applied to V2 which is connected as a shunt type of diode rectifier. The negative DC output voltage is

\* \* Please turn to page 53 \* \*

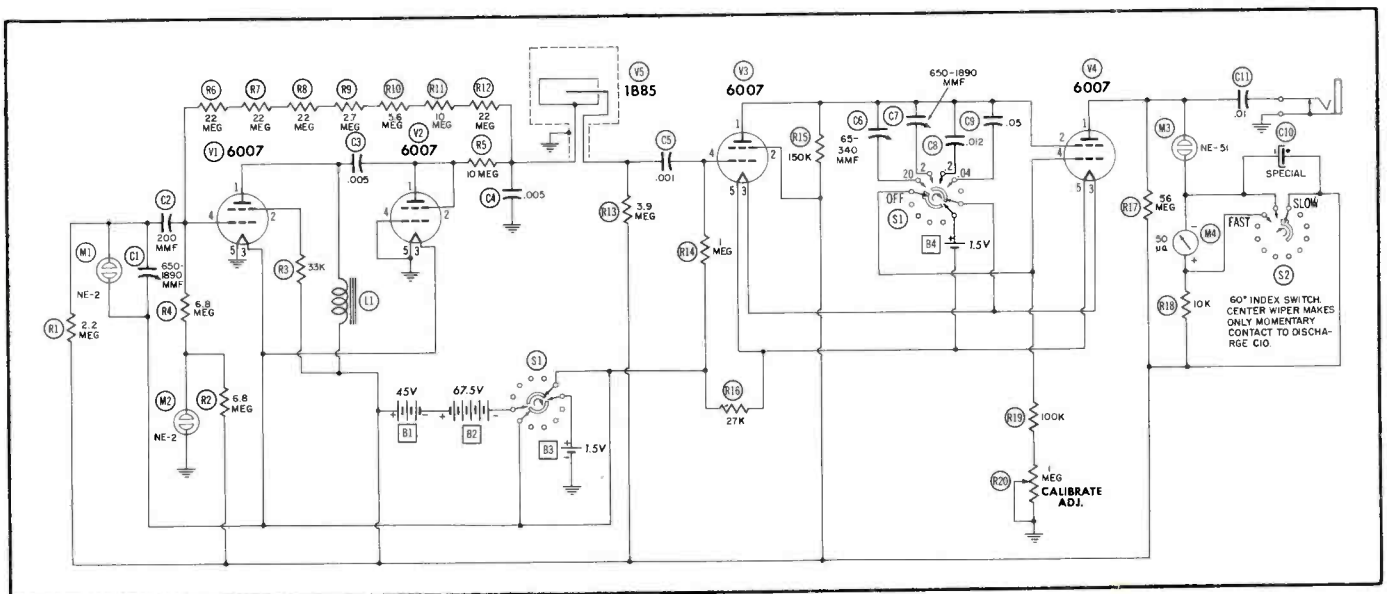

Fig. 3. Schematic Diagram of the Model 107C.

**She:** *But, how do I know this is a good tube?*

**You:** *Because, this is a CBS aluminized Mirror-Back picture tube. There aren't any better.*

**She:** *And I see it has the Good Housekeeping Guaranty Seal, too. That's proof enough for me.*

Customer confidence really counts when it comes to the big tube. That's when CBS tube advertising helps you most. For CBS tubes have the Good Housekeeping Guaranty Seal and are nationally advertised to 76.9% of your customers . . . the women of America. And 53% of these women are influenced in their purchases by that seal of approval. You protect yourself and gain your customer's good will when you install a new CBS aluminized Mirror-Back picture tube.

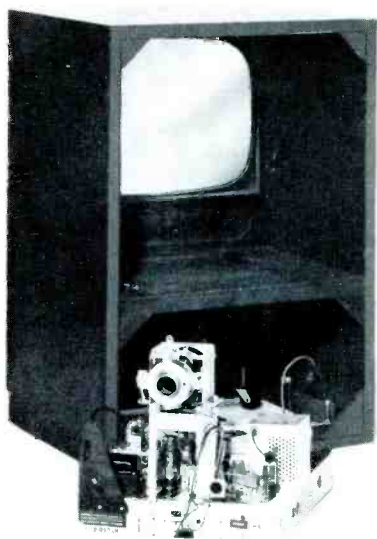

Show her the CBS carton with the Good Housekeeping Guaranty Seal.



**CBS-HYTRON**, Danvers, Massachusetts . . . A DIVISION OF COLUMBIA BROADCASTING SYSTEM, INC.



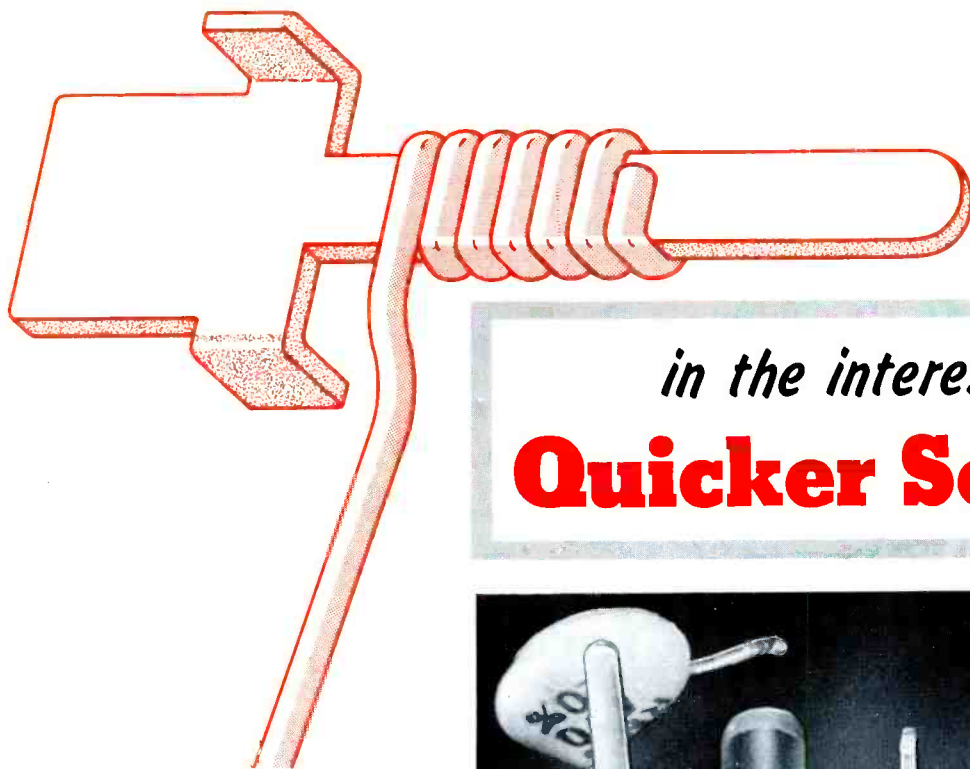

*in the interest of...*  
**Quicker Servicing**

by Calvin C. Young, Jr.

**Solderless Connections**

RCA Victor television receivers that employ either the Chassis KCS95 or a chassis with a higher number have certain electrical connections of the new solderless type. Fig. 1 shows this type of connection used in connecting together the various subassemblies. Wiring to the various potentiometers also uses this solderless connection. Examination of a chassis shows that solderless connections are used only for connecting wires. All component leads are soldered even when solderless connections have been made at the same terminal.

These solderless connections are made by wrapping 6 or 7 turns of wire tightly around a terminal or stake. They are made using a power tool, and they feature both a strong mechanical bond and a good electrical connection. This is made possible by the fact that the power tool spins the wire onto the terminal with sufficient force that the terminal bites into the softer wire. The wire is held onto the terminal by the tension of the several turns. Consult the drawing in the heading for details of this type of connection. Should it be required to remove a wire from one of these solderless connections, the connection should be soldered when the wire is replaced.

Since these connections are machine wrapped, little trouble from

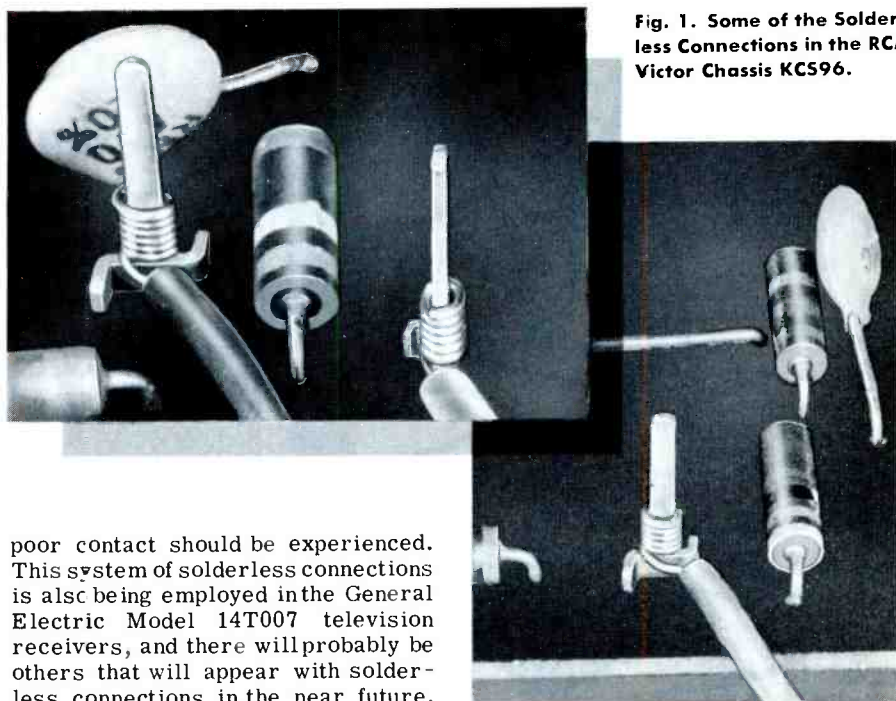

Fig. 1. Some of the Solderless Connections in the RCA Victor Chassis KCS96.

poor contact should be experienced. This system of solderless connections is also being employed in the General Electric Model 14T007 television receivers, and there will probably be others that will appear with solderless connections in the near future.

**Selenium Rectifiers**

We wish to call the attention of all service technicians to the continuing need for the salvaging of discarded selenium rectifiers. Each replaced selenium rectifier regardless of make or size should be returned to your local distributor. The manufacturers of selenium rectifiers and the United States Department of Commerce urge you to co-operate in this endeavor in order to conserve the dwindling supplies of selenium of high purity.

**Keystone Effect**

Most service technicians have at one time or another encountered the trouble known as keystone effect which is usually caused by a defective damping component within the yoke or by a defective yoke.

Since keystone effect is caused by a defective yoke in practically all cases, there is a tendency on the part of service technicians to change the yoke immediately whenever a keystone effect is noticed. There are occasions, however, when such a procedure will accomplish nothing but will waste time, effort, and energy.

A receiver with such a trouble recently appeared in the shop and — as you might guess — substitution of the yoke had no effect upon the trouble. As a matter of general troubleshooting procedure, the tubes in the horizontal- and vertical-sweep sections were checked by substitution — again without effect. In this instance, the keystone effect appeared on the left side of the picture; so it seemed

\* \* Please turn to page 35 \* \*

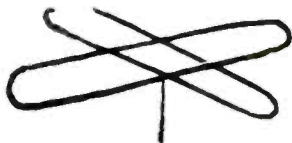

*the famous Indian philosopher . . .*

**CHIEF TV-in-TEPEE  
once said**

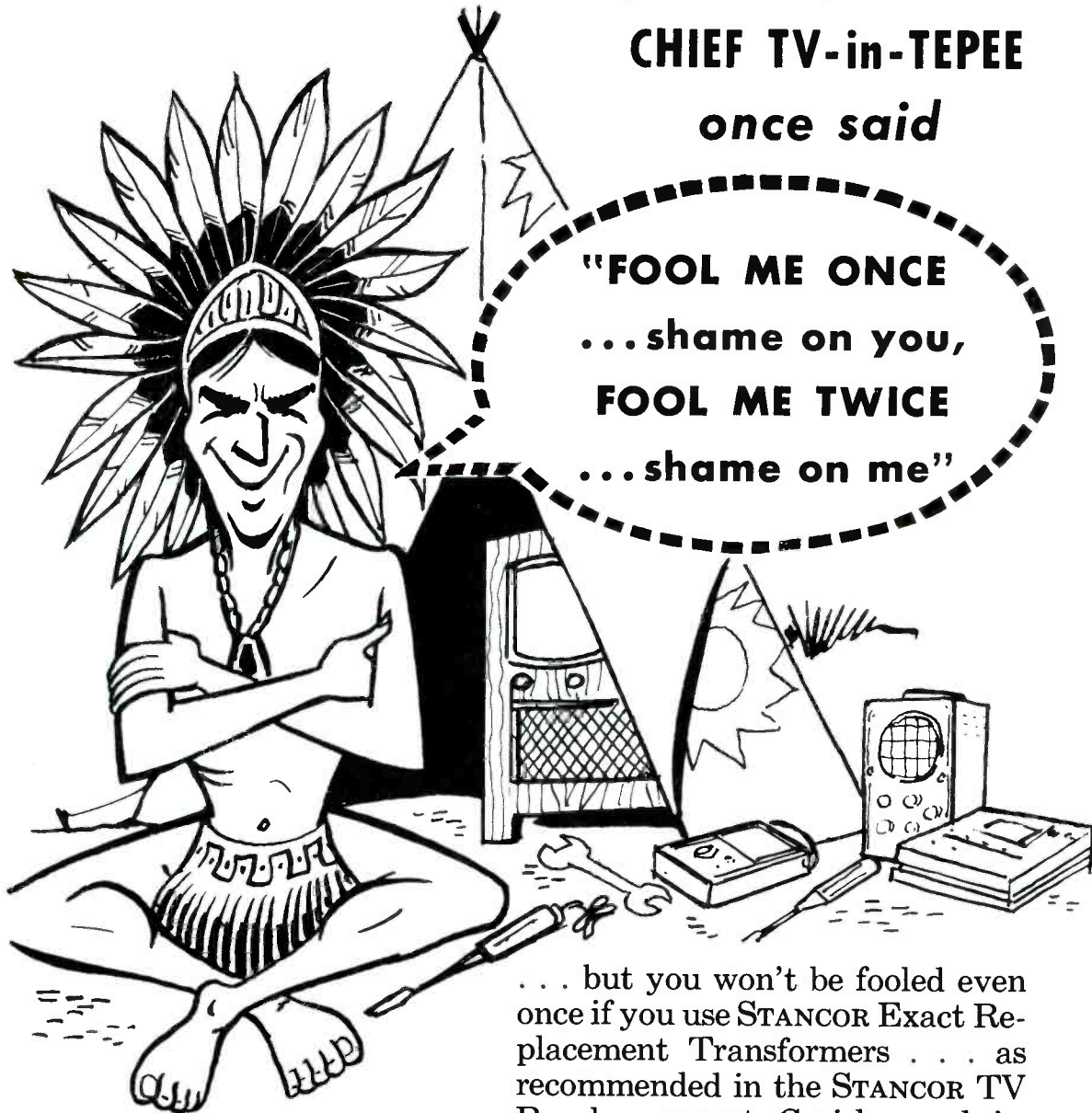

**"FOOL ME ONCE  
. . . shame on you,  
FOOL ME TWICE  
. . . shame on me"**

EXPORT SALES:  
Roburn Agencies, Inc.  
431 Greenwich St.  
New York 13, N. Y.



**CHICAGO  
STANDARD  
TRANSFORMER  
CORPORATION**

. . . but you won't be fooled even once if you use STANCOR Exact Replacement Transformers . . . as recommended in the STANCOR TV Replacement Guide and in Counter-Facts . . . because every unit is a **VERIFIED** exact replacement, designed from the original manufacturer's specifications and tested by actual installation and operation in the recommended chassis.

**FREE**—54 page STANCOR TV GUIDE. Lists over 8000 TV models and chassis and over 150 exact replacements. Available from your STANCOR distributor or from Chicago Standard.

3594 ELSTON AVENUE • CHICAGO 18, ILLINOIS



# TROUBLES in VIDEO IF and DETECTOR SYSTEMS

## PART II

### A Servicing Guide Arranged by Symptoms

BY LESLIE D. DEANE  
and CALVIN C. YOUNG, JR.

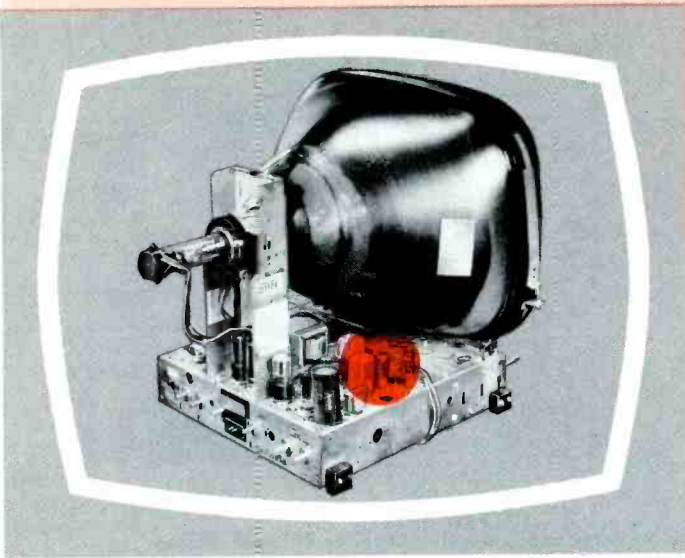

Part I of "Troubles in Video IF and Detector Systems" appeared in last month's issue of the PF REPORTER, and five of a total of twelve listed symptoms were discussed in detail. In this issue, the remaining seven symptoms will be covered.

The total list of common symptoms reads as follows:

1. Raster, no picture, and no snow.
2. Snowy picture.
3. Ringing in picture.
4. Poor vertical synchronization.
5. Pulling in picture.
6. Lack of picture contrast.
7. Intercarrier buzz.
8. Negative picture.
9. Hum in picture.
10. Intermittent troubles.
11. Smeared picture.
12. Overloading in picture.

The schematic diagrams in Figs. 1 and 2 show two popular types of video IF and detector systems. During the discussions about the various symptoms, references to components in these circuits will be made from time to time.

### COMMON SYMPTOMS (continued)

#### 6. Lack of Picture Contrast.

Lack of contrast or a weak, washed-out picture is illustrated in Fig. 3. This symptom is generally caused by failure within the video-amplifier or video-output stages; therefore, these stages should be eliminated as a source of the trouble

before an attempt to trouble shoot the video IF or detector stages.

Possible causes of a lack of picture contrast are:

- a. Last video IF tube weak.
- b. Detector tube weak.
- c. Detector crystal faulty.
- d. Low plate or screen voltage in last video IF stage.
- e. Improper bias in last video IF stage.

Generally speaking, when there is lack of contrast that can be traced to trouble within the IF or detector stages, it will be caused by a lack of signal output from the detector stage. When very little snow or noise accompanies the lack of contrast in the picture as in Fig. 3, the trouble is located near the output portion of the video IF and detector circuit.

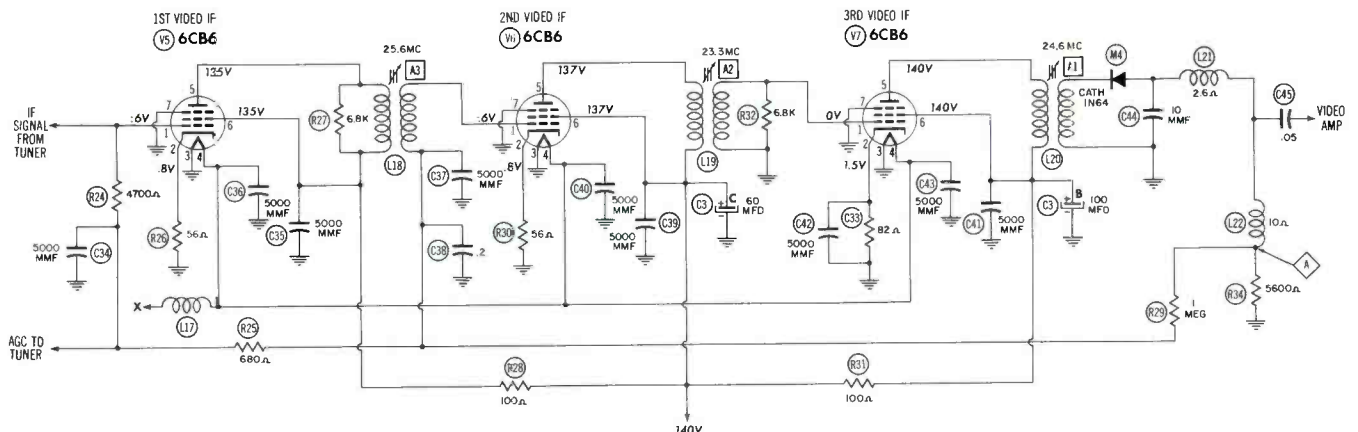

Fig. 1. Video IF and Detector System Which Employs a Crystal Detector and Transformer Coupling Between Stages.

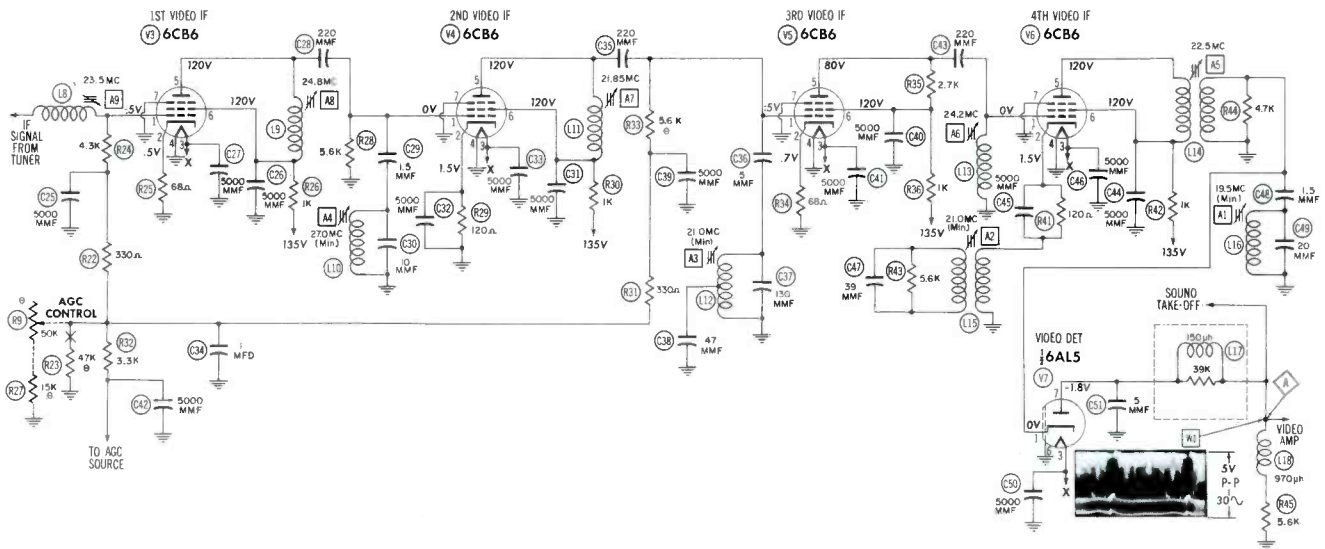

Fig. 2. Video IF and Detector System Which Employs a Diode Detector and Capacitive Coupling Between Stages.

### 7. Intercarrier Buzz.

Another symptom which is sometimes encountered in TV servicing is a type of audio buzz in receivers employing an intercarrier sound system. The sound frequency used in these receivers results from a heterodyning action between the AM (video) carrier and the FM (sound) carrier. The heterodyning action produces a difference frequency of 4.5 megacycles. Only the FM signal is required by the sound circuit; however, AM variations are always present. If they are of high amplitude, the limiter or sound detector will be unable to suppress them, and buzz will result. In order to minimize any influence which the AM variations may have on the audio output, the receiver manufacturer aligns the video IF response of an intercarrier set so that the sound carrier will fall about 95 per cent down on the response slope.

Most defects which cause inter-carrier buzz will be found in the

sound IF and detector systems of receivers; however, they may occasionally turn up in the video IF and detector systems.

Possible causes of intercarrier buzz are:

- a. Poor alignment of video IF strip.
- b. Faulty video-detector tube or crystal.
- c. Excessive signal fed to sound IF system.
- d. Misadjusted trap in video IF strip.

Dust, humidity, and aging of components can affect receiver alignment. Correct adjustment of the fine-tuning, AGC, and contrast controls may eliminate or lessen the effect of intercarrier buzz.

If the buzz is present on one operating channel only or is present

after one camera is substituted for another during a program or a commercial, the fault may be in the transmitter. The equipment at the station may be causing the video carrier to be overmodulated. Transmission defects such as this cannot be corrected at the receiver.

### 8. Negative Picture.

A negative or reversed picture is shown in Fig. 4. The blacks show up as white, and the whites show up as black.

A faulty picture tube or a trouble within the video-amplifier stages are familiar causes of a negative picture. Troubles within the IF section can also cause a negative picture. A negative picture that originates from trouble within the video IF system will generally be caused by overloading of the last IF stage or of the detector stage, but the actual source of the trouble may be in any of the stages.



Fig. 3. Lack of Picture Contrast.

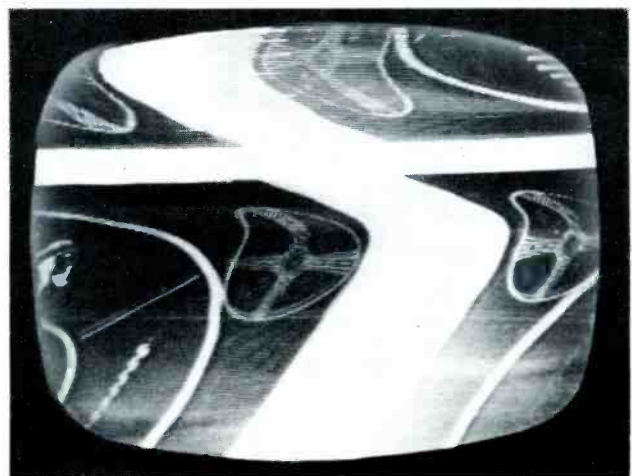

Fig. 4. Negative Picture.



Possible causes of a negative picture are:

- a. Weak or gassy tubes in the IF or detector stages.
- b. Low plate and screen voltage in an IF stage.
- c. Incorrect bias in an IF stage.
- d. Leaky coupling capacitor between IF stages. (See C28, C35, C43 in Fig. 2.)
- e. Faulty detector crystal. (See M4 in Fig. 1.)

A thorough understanding of what occurs in the IF strip under different operating conditions is very helpful in locating the source of negative-picture trouble. If a grid draws current, the signal can be compressed or even inverted, depending on how much grid current is drawn. In Fig. 5, waveforms taken at the input to the video detector are shown. Fig. 5A shows a normal waveform. The waveform in Fig. 5B shows the sync pulses compressed because of grid current. Fig. 5C shows the sync pulses actually reversed in polarity. These three waveforms were taken using a crystal-demodulator probe of the high-impedance type such as that shown in the schematic in Fig. 6.

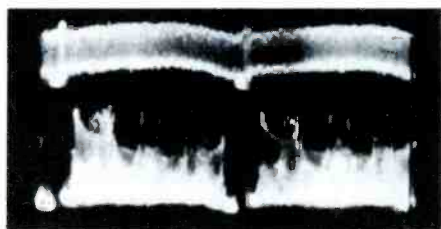

(A) Normal Waveform.



(B) Waveform Showing Sync Compression.



(C) Waveform Showing Sync Inversion.

**Fig. 5. Waveforms Taken With Demodulator Probe at Input to Video Detector.**

The distorted waveforms in Figs. 5B and C were caused by grid current drawn in the last IF stage. (Refer to the schematic shown in Fig. 2). Grid current is caused to flow when the bias of a stage is such that the incoming signal drives the grid positive and can be a result of improper bias or excessive driving

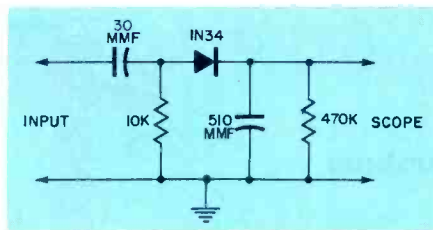

**Fig. 6. Crystal-Demodulator Probe of the High-Impedance Type.**

signal. Since (in most cases) the last stage will be the direct cause of the negative picture and since this stage is seldom controlled by AGC, it is usually an excessive driving signal that causes grid current to flow in this stage. The excessive driving signal may, however, be the result of low bias applied to the other IF stages. A good example of this situation may be obtained by adjusting the AGC control on a receiver to produce a negative picture. When this is done, a check of the AGC voltage will reveal a very low value. This low value of AGC voltage causes excessive gain in the stages controlled by the AGC voltage and in turn causes the last stage to be overdriven and to draw grid current. A gassy tube is another possible cause of excessive gain in the IF strip.

Because of the nature of pentode amplifier tubes, low plate and screen voltages in one stage will cause a loss of amplification in that stage. In some cases, this loss can result in low output from the detector and low AGC voltage. When the low AGC voltage is applied to the IF strip, there is a substantial increase in

signal applied to the stage with the low B+ voltage. Overdriving of that stage results. This is an example of the manner in which a negative picture may be caused by a chain of events and reactions.

#### 9. Hum in Picture.

Alternating voltages of 60 cycles and 120 cycles per second are present in the filament circuits and in the power supplies of most television receivers. Troubles can occur and allow these voltages to modulate the video signal. When this happens, the picture will show the presence of hum in the form of one or more horizontal light or dark bars on the screen. The photograph of Fig. 7 shows a pattern with distortion produced from a 60-cycle modulation of the video signal. Heater-to-cathode leakage in a tube is a common cause of this distortion.

If the hum interference is introduced into a stage prior to the sync take-off point, a bending at the edges of the raster may accompany the bars in the picture. Hum bars may often be accompanied by sound distortion and poor synchronization.

When a hum signal of sufficient amplitude is applied to the input of the picture tube, the tube becomes controlled by this voltage and brightness modulation will result. In the case of a strong 60-cycle signal, one half the raster will be dark and the other half will be bright. The phase of the hum signal determines where the dark portion will appear on the screen. If the phase of the hum changes with respect to the vertical-sweep rate, the dark portions will not remain stationary but will move in a vertical direction. The gradual changes of intensity from light to dark and from dark to light, as shown in Fig. 7, indicate that the hum voltage is a sine wave.

\* \* Please turn to page 64 \* \*



**Fig. 7. Hum Bars Caused by 60-Cycle Modulation.**

# Audio-Facts



by Robert B. Dunham



## The Listening Room

The amount of pleasure and satisfaction to be derived from listening to a home music system depends upon some important factors. The quality of each individual piece of equipment, the program material being reproduced, and the characteristics of the room in which the listening is being done have been some of those mentioned in these columns.

Certain subjects have been discussed in detail, but very little has been explained about how and why the listening room influences the quality of reproduction to be obtained from an audio system. The listening room plays a more critical part in determining how much enjoyment will be obtained from a music system than is realized by many audio enthusiasts. If the room is nothing else but a place where you can listen to music in some degree of seclusion without being disturbed or without disturbing others who do not wish to listen, a suitable room certainly serves a worth-while purpose. Probably because it is so important, an appropriate room with characteristics that permit a sound system to perform at its best can be one of the most difficult things for a system owner to acquire.

After an audio system has been built up and developed to the point where it is capable of excellent reproduction of music, the need for a suitable listening room becomes increasingly apparent.

The writer was impressed very much with the results of some ventures along this line while he was in Germany during World War II. Having been interested in music and audio for some years preceding the war, the writer and two associates managed to construct an amplifier and assemble a reasonably good music system. This activity was aided and abetted by the fact that we were in a radio broadcasting outfit and worked with studio and recording equipment.

A German-made turntable, arm, and magnetic pickup when used with an amplifier and a couple of good 15-inch speakers produced very good results in our shop and laboratories when we played such excellent records as the Gramophone, Telefunken, Electrola, Odeon, and Siemens.

When we moved this music system to the stage of a theater located in the immediate area, a great improvement in the reproduction from these same records could be heard and the music seemed to come to life. The theater which was actually an auditorium in a very large building was complete with upholstered seats. Its suitability as a place in which to play records can be recognized by the fact that it was designed and used for symphony concerts and other musical events. It was of no consequence that the rear portion of the stage had been bombed because we had that part boarded over and covered with tarpaulins. What did count was that when we played our records they sounded so different. The defects and limitations seemed to disappear, and the reproduction became balanced and very effective. The sensation of hearing a live performance was so real that it made a lasting impression.

Apparently, because the auditorium was large and possessed very good acoustics, the music could be played at a level that approached the level at which it was played when the recordings were made. The fact that the human ear tends to level off its response to all frequencies as the level of loudness increases, as well as some other factors to be discussed later, no doubt had a lot to do with the effectiveness of the sound. The theater was also soundproof; consequently, no sound could leak through from the outside to disturb the music

and no music could leak out to disturb any one on the outside.

### Experiments in Church Auditorium

The writer's experience in the theater in Germany has been duplicated to an extent by some experiments made during the past three years with home audio systems in a church auditorium.

What could be called normal home music systems were used in these experiments or trials. Amplifiers (either of the Williamson, modified Williamson, or equivalent types), preamplifier and control units, transcription type turntables, and high quality magnetic pickups in transcription arms were used to drive various types of loudspeaker systems. The primary purpose of the experiments was to try out different types of loudspeaker enclosures, but the quality of reproduction in the large auditorium stole the show and made the outstanding impression.

All operations were carried out with no audience present; consequently, the acoustics of the auditorium were inclined to be very "live" because of the empty upholstered seats. Reproduced music sounded real and alive. Response appeared to be very well balanced, and the bass and treble tones were clean and effective. Low pedal notes seemed to vibrate the balcony, and the tones from the high-pitched instruments seemed to float in the air. No emphasis or boost of the high frequencies was required or desired. Record noises were not accentuated or disturbing. When certain loudspeaker systems were used, some directional effects were noticed in the sound produced by extreme high frequencies. Music sounded pleasing; and although



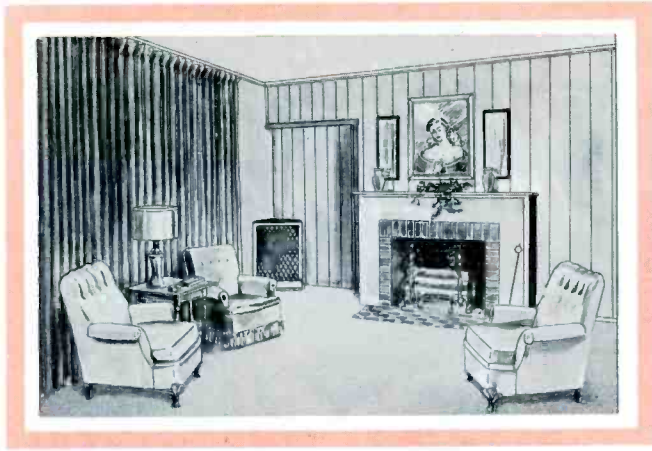

Fig. 1. Listening Rooms. Example of "dead" Listening Room (left), Example of "live" Listening Room (right).

played at a level higher than would be used in the average home, it did not seem too loud.

Most speaker systems produced very satisfactory results. Some simple horn type enclosures that seemed to be somewhat inadequate in reproducing the lower bass frequencies in smaller rooms proved to be very satisfactory when operated in the church auditorium.

Why did the systems sound better in the auditorium? Apparently, it was for the same reasons that the records had sounded so well in the German theater.

This does not mean that a large room is the answer to all of the problems encountered when trying to obtain the best reproduction of music with an audio system. Room size is not the complete and final answer. In fact, large rooms and auditoriums present their own special problems. They have to be very carefully designed and engineered. Sometimes very drastic measures have to be taken to modify the acoustics of a large room in order to obtain satisfactory reproduction of speech and music.

Because of certain fundamental reasons, a large room usually can be properly fitted and modified so that its acoustics are suitable for good musical reproduction; but it is nearly impossible to accomplish much in that respect with a very small room. This is particularly true if loud music is played. Although some of the reasons have to do with the characteristics of the human ear, many of them are acoustical because we are concerned with the behavior of the sound waves produced by the loudspeaker in the confinement of the room.

We cannot go into a long discussion on acoustics because the subject of the generation, transmission, and

reception of sound waves is long and complex; but we can cover some of the practical considerations concerning the important characteristics of listening rooms.

### Characteristics of Listening Room

The most important physical characteristics of a room are:

Size — volume.

Shape — cube, oblong.

Nature of inner surfaces — hard smooth ceiling, irregular walls, covered floor.

The volume and shape of a room have a great influence upon the number and frequencies of the resonances and of the standing waves developed in the room. All rooms are resonant at some frequency, but the resonant frequency decreases as the size of the room increases. Standing waves, which are evident as points in the room where tones are reinforced or cancelled when the sound waves bounce off the reflecting surfaces, are intensified by the parallel walls of square or rectangular rooms. Resonances and standing waves cause certain tones to be emphasized and therefore destroy tonal balance.

The amount of reverberation or echo generated in a room is determined mostly by the texture and shape of the inner surfaces such as, for example: flat smooth walls that reflect sound, carpeted floor that absorbs sound, walls or ceiling with irregular surfaces that break up or disperse echoes, or a square or rectangular room in which the sound waves bound and rebound from the surfaces of the parallel walls.

### Effects of Small Room

Further explanation regarding the acoustics of a room can be gained

from a discussion of the effects of a small listening room upon the reproduction of music.

A small room cannot accommodate a symphony orchestra giving a concert in person. Neither can it accommodate the sound of a symphony orchestra reproduced at full original sound level from a record. The sound would be so loud that it would be overpowering and fatiguing. A recording of a solo played by an instrument such as a guitar could be reproduced in the small room and made to sound like the original. The record could be reproduced at the same level used when the recording was made, because the guitar would sound pleasant and not too loud when played in the small room.

Sounds must be reproduced at their normal level if they are to sound natural. Any deviation, too loud or too soft, changes the character and tonal balance of the sound. This is particularly true with complex sounds such as music. The value of a conductor to a musical ensemble is due to his ability to produce the correct tonal balance and dynamic effects from the ensemble under his direction in addition to his more obvious purpose of keeping time.

Since many recordings of music cannot be reproduced loud enough in a small listening room, the reproduction cannot sound exactly the same as the original. This does not necessarily mean that the record cannot be played and listened to with pleasure, because we can listen to reproduced music and enjoy it although it does not sound as effective as the original performance would have sounded.

The resonant frequency of a small room is high, and high resonant frequencies can produce many disturbing peaks. These peaks, along

\* \* Please turn to page 81 \* \*

*Costs no more than ordinary  
Aluminized Picture tubes...*



Your best buy in television picture tubes is the Du Mont Twin-Screen Hi-Lite. It offers you greater brilliance, clarity and sharpness that makes your best work better.

The Twin-Screen Hi-Lite is a product of *cathode-ray* tube specialists. All engineering talents and knowledge at the Du Mont Tube Division are devoted

solely to the design and development of superior cathode-ray tubes.

Use a Du Mont Twin-Screen Hi-Lite picture tube on that next replacement job and see for yourself why leading TV receiver manufacturers specify them. They are available in all popular types for all popular sets.

**DU MONT**®

Cathode-ray Tube Division, Allen B. Du Mont Laboratories, Inc., Clifton, N. J.



# ShopTalk

MILTON S. KIVER

President, Television Communications Institute

## Precautions in Replacing Components

It is always nice to have on hand an exact replacement part, one that perfectly duplicates the defective component in the set. This ideal situation, however, is not always attainable; and so, the service technician from time to time is faced with the question, "What else can I use in place of this part?" or, "How much leeway do I have in substituting other values?"

There are some fairly obvious answers to these questions and some answers that are not so obvious. The horizontal-output transformer, the yoke, or a video IF transformer — to mention a few of the more obvious items — must be replaced by units closely matching the original; otherwise, the technician may find himself with a redesign problem on his hands. On the other hand, the values of coupling capacitors or grid resistors in the AF section of a TV receiver are not unduly critical, and a fairly wide range of component sizes may be employed.

Specific data covering the value limits of every component in a television receiver would require a minute examination of each set on the market. There are, however, a number of general rules that can serve as a guide for most television receivers, and it is these rules which we will consider here.

In the RF section, not only is component value important but so also are part placement and part size (physical). The latter two features must be given careful consideration because they directly influence the stray capacity in the circuit and will have a very noticeable effect on tuner operation. Lead dress is also important, which is the reason that service technicians are always cautioned against disturbing the existing

layout whenever repair work is done on a tuner. With respect to physical size, if exact dimensions cannot be duplicated, it is generally more desirable to use a smaller replacement part than a larger one.

Another factor that must be considered is whether a capacitor is a unit with temperature compensation or is simply a general-purpose unit. If it does provide temperature compensation, use a replacement having the same temperature coefficient, the same or closer tolerance rating, and the same capacity as the original unit. In general, capacitors used for such applications as for AGC filtering and decoupling and for cathode, filament, screen, and RF bypassing are general-purpose units without any special temperature characteristics. Tolerance in these units is not particularly critical. On the other hand, when capacitors are used for RF, oscillator, or IF coupling; are used for oscillator feedback; and are used as fixed trimmers and fixed padders; then value, tolerance, and temperature compensation should be duplicated as closely as possible.\*

In the IF system, most of the foregoing considerations still prevail. Lead dress is important, and component values should be matched closely; however, because the operational frequency is lower, some leeway in component values is frequently permissible. Filament-bypass capacitors, for example, normally vary in value between 1,000 and 5,000 micromicrofarads; and any value within this range would generally be suitable. Plate decoupling resistors, nominally around

\*A more extensive discussion of temperature compensation in capacitors will be found in the author's, "TV Service Data Handbook," published by the Howard W. Sams & Co., Inc.

470 ohms for most IF tubes, could be raised 40 to 50 per cent with only slight loss of stage gain. Shunting resistors (across interstage tuning coils, as in Fig. 1) could have their values altered one to two thousand ohms with very little effect on overall response ordinarily. It is suggested that if a change in value is

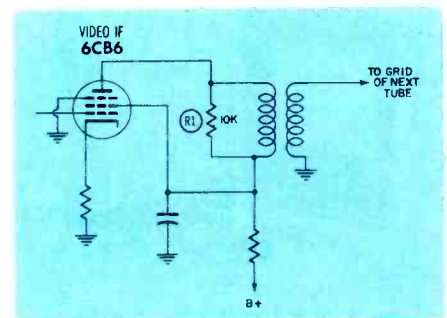

Fig. 1. Schematic Diagram Illustrating a Loading Resistor Across an IF Transformer.

made, the response curve should be checked. This should be performed not only with normal negative bias but also with zero bias. It will be found that although the response curve will change somewhat as the bias is reduced to zero, the change should be comparatively small. This indicates a small amount of regeneration. A curve which changes markedly indicates a large amount of regeneration.

Sometimes the service technician will encounter a situation which, to him, does not make sense. For example, in the DuMont video IF section shown in Fig. 2, two voltage-dropping resistors instead of one are employed in the screen-grid circuit of each tube. If one of these resistors requires replacement and an exact replacement is not on hand, the technician might be tempted to substitute a single resistor with a

\* \* Please turn to page 74 \* \*

# Notes On

# TEST EQUIPMENT

## Presenting Information on Application, Maintenance, and Adaptability of Service Instruments

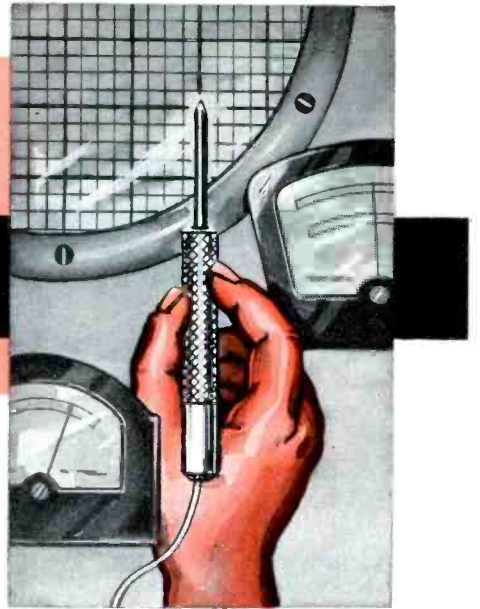

by Paul C. Smith

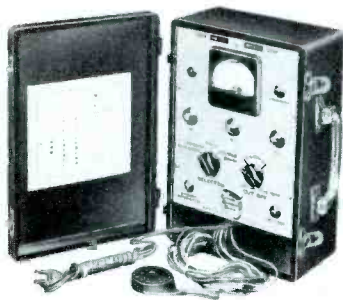

Fig. 1. B & K Model 350 Cathode Rejuvenator Tester.

### B & K Model 350 Cathode Rejuvenator Tester

There have been a number of instruments that have appeared on the market in the last year or so for testing and rejuvenating picture tubes. The one shown in Fig. 1 is a product of the B & K Manufacturing Co., Chicago, Illinois.

The Model 350 Cathode Rejuvenator Tester has provisions for making the following quality tests of a picture tube: emission, shorted or open elements, cutoff characteristic, and expected life. The manufacturer states that, in addition to these tests, the instrument can be used to repair such common faults as weak emission, open cathode tabs, and shorts between elements in cathode-ray tubes.

The instrument is easily portable, having a weight of 5 pounds and measuring 11 1/2 by 7 1/2 by 5 inches.

An open or shorted condition of a picture tube can be determined by

a comparison of the neon indicators on the panel of the instrument with a chart which is supplied with the instrument. Any of the neon indicators can be either lighted, half lighted, or unlighted. When the SELECTOR switch is placed in the CONT-SHORT position, note the pattern formed by the neon indicators. This pattern will be found in the chart opposite the condition which it indicates.

The test for the cutoff characteristic of a picture tube is performed by rotating the CUT OFF control and by noting at what position of the control the meter needle drops to zero. This test is a measure of the ability of the picture tube to produce a picture of acceptable contrast.

The life test is performed by pressing a button to remove the filament voltage from the picture tube and by observing the rate at which the meter needle drops to zero. This test is based upon the assumption that a tube which is gassy or lacking in cathode-emitting material will cause a more rapid drop of the meter needle than a normal tube. Either one of these defects reduces the life expectancy of the tube.

The aforementioned life test requires some judgment on the part of the operator. This judgment can be acquired by experience in testing a number of tubes of known quality.

When the operator uses the instrument to restore the cathode emission of a tube, he has a choice of three different potentials that may be applied — low, medium, or high.

These are obtained by turning the selector switch to either the DYN-LO, DYN-MED, or DYN-HI position. The operator will normally start with the low position and switch to the higher positions if there is difficulty in getting results at the low position.

### Central Electronics Model RE-1 CRT Rejuvenator

Central Electronics, Inc., Chicago, Illinois, is the manufacturer of the Model RE-1 cathode-ray tube tester and rejuvenator shown in Fig. 2. This tester has provisions for checking tube elements for shorted or open conditions and for checking the emission properties. It can also be used to make tests for the cutoff level and expected life of tubes.

Its repair functions include removal of heater-to-cathode shorts and restoration of the tube emission. Although the instrument has no direct provision for removing shorts between grid No. 1 and the cathode, the



Fig. 2. Central Electronics Model RE-1 CRT Rejuvenator.



instruction leaflet recommends that rejuvenation should be tried in such cases because the foreign particle causing the short may be burned away during the rejuvenation process.

Shorted or open tube elements are indicated by the pattern made by the neon lamps on the instrument panel. This method has become popular among the manufacturers of this type of instrument. A comparison chart mounted in the cover of the Model RE-1 lists the possible conditions indicated by the various patterns obtained, together with recommendations for dealing with each condition.

One of the initial steps in taking an emission reading is to set the meter needle to a reference mark on the dial. This is accomplished through the use of a control on the instrument panel. If the meter needle cannot be made to coincide with the reference mark, this indicates that the cutoff characteristic of the tube is not what it should be; therefore, the tube should be considered as a possible reject.

The rejuvenation procedure is such that the operator of the instrument can follow the change in tube condition and stop the procedure when the optimum amount of rejuvenation is achieved. To rejuvenate a tube, the operator first turns the selector switch to the REJUV. position. Rejuvenation will not start until a toggle switch, also marked REJUV., is thrown to the ON position. Progress of rejuvenation is indicated by the movement of the meter needle across the dial scale.

As the meter needle moves up the scale, the operator should employ a rapid on-off switching action with the toggle switch, stopping the rejuvenating action as near to the peak of the upswing as possible. If the action is allowed to continue further than this, too much emitting material may be lost from the cathode surface and the tube would be weakened.

If the rejuvenation action is slow in starting, several aids to starting it may be used. Tapping the neck of the tube lightly may be tried first; and if that fails, the heater voltage can be raised by pressing the HEATER INCREASE button. If the rejuvenation action is still slow in starting, both the HEATER INCREASE and the REJUV. INCREASE buttons may be pressed simultaneously.

A test for life expectancy of the tube after rejuvenation can be performed. The operator proceeds as though an emission test were being made. The READ EMISSION button

is pressed and held for an emission reading, and then the heater voltage to the cathode-ray tube is removed by operating a toggle switch on the instrument. The rate at which the meter needle falls to zero gives some idea of the expected life of the tube.

The instrument is supplied with one plug-in cable for the standard 12-pin picture tubes. Other plug-in cables are available as accessories for the testing of oscilloscope tubes, 7-inch picture tubes, and color picture tubes.

The size of the instrument is 11 by 12 by 5 inches.

### Triplet Model 310 VOM

The Triplet Model 310 volt-ohm-milliammeter shown in Fig. 3 is a pocket-sized tester offering features commonly found in much larger testers. Among these are a sensitivity of 20,000 ohms per volt on DC ranges and the use of a range switch for the selection of all ranges except the highest AC and DC ranges.

One of the first physical features to be noticed by an observer is the small size of the meter. It is 2 3/4 by 4 1/4 by 1 3/16 inches. This small size is apparent in Fig. 4 which also shows another interesting property of the meter. Notice in the two photographs that the tip can be removed from the end of the common test lead and inserted into a jack at the top of the instrument case. The meter itself becomes the ground probe, and it is held in one hand with the tip pressed against a convenient ground point on the set being checked. The other hand is free to manipulate the test probe. When the meter is used in this fashion, the two test leads can be plugged together to form one long lead for taking measurements at widely separated points.

Another feature of the Model 310 is the bar-ring movement which is used in the meter. This movement is self-shielded and remains relatively unaffected when measurements are taken in the presence of strong magnetic fields.

The meter case is of molded black plastic with a transparent plastic window. The weight of the instrument complete with batteries is approximately 14 ounces.

Voltage ranges on the Triplet Model 310 are: DC volts from 0 to 3, 12, 60, 300, and 1200 at 20,000 ohms per volt; AC volts from 0 to 3, 12, 60, 300, and 1200 at 5,000 ohms per

\* \* Please turn to page 82 \* \*



Fig. 3. Triplet Model 310 VOM.



(A) Tip From Ground Lead Being Inserted Into Instrument Case.

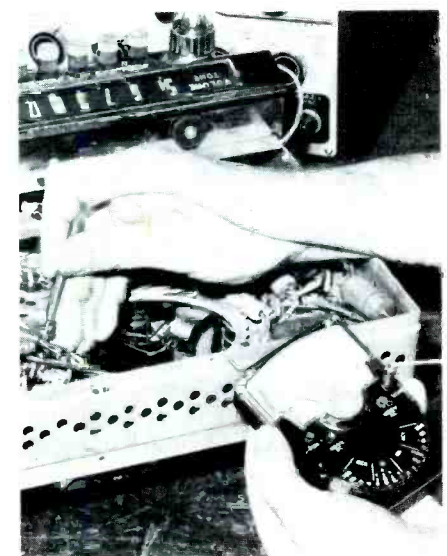

(B) Tip Inserted and Serving As Ground Probe.

Fig. 4. A Novel Feature of the Triplet Model 310 VOM.

# THEY'RE HOT!

## WARD Dura-ramic

TRADE MARK

### REINFORCED FIBERGLAS CAR AERIALS in SIX COLORS

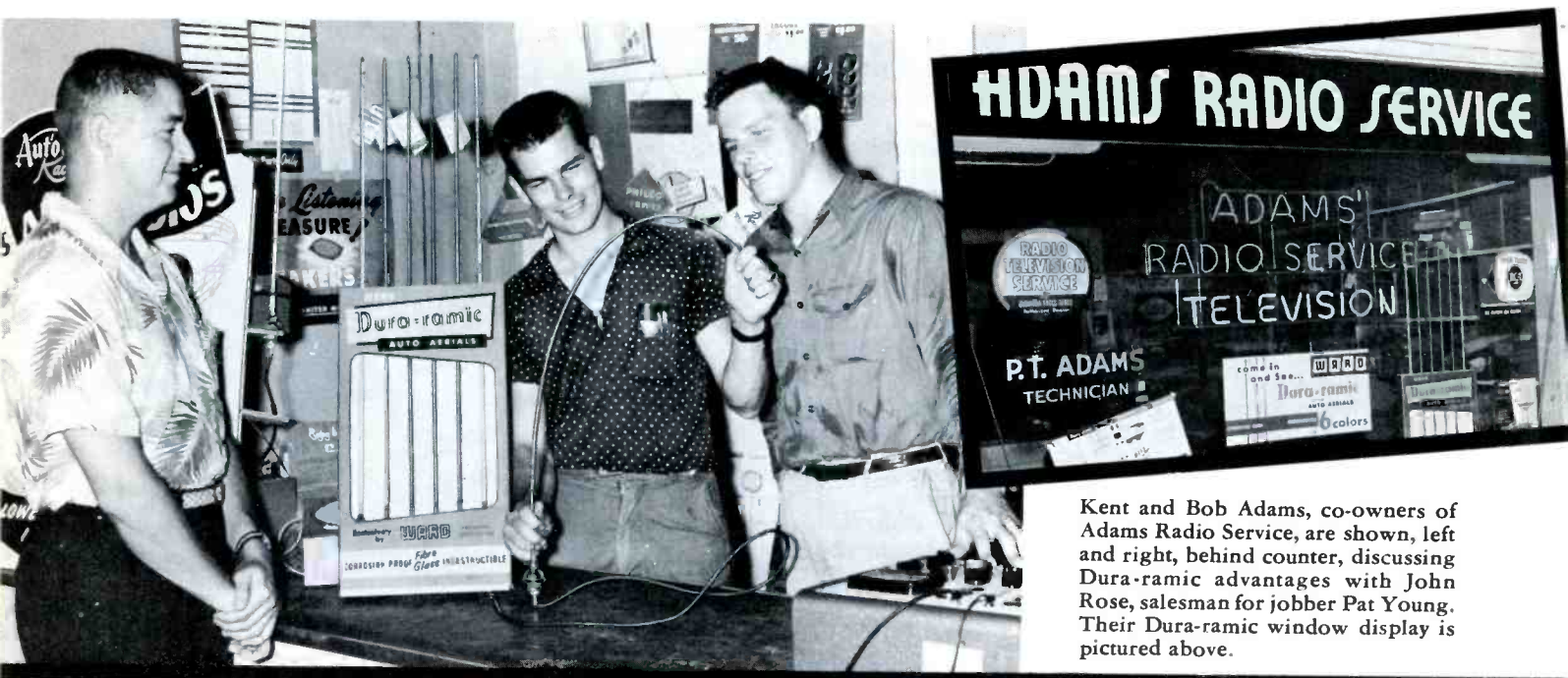

Kent and Bob Adams, co-owners of Adams Radio Service, are shown, left and right, behind counter, discussing Dura-ramic advantages with John Rose, salesman for jobber Pat Young. Their Dura-ramic window display is pictured above.

## ADAMS RADIO SERVICE FINDS ALMOST EVERY CAR OWNER A PROSPECT FOR DURA-RAMIC

Are you, too, cashing in like Adams Radio Service, on the big sales appeal of the new, noncorroding Ward Dura-ramic car aerial?

Dealers all over the country are finding that Dura-ramic car aerials, in six popular colors, are one of their hottest items today. If you are not now taking advantage of the big trend to color and the flexible, durable reinforced Fiberglas construction of the Dura-ramic, you are missing one of the biggest profit opportunities in your busi-

ness at the present time.

Adams Radio Service, Cleveland, is only one of many Dura-ramic dealers who are making important *added* profits from the sale of this sensational, new car aerial.

It will pay you, too, in big, new profits to talk, push and sell Dura-ramics. Ride the wave of color popularity in cars! Sell Dura-ramics!

Write today for name of your nearest electronics wholesaler.

# WARD

## PRODUCTS CORPORATION

DIVISION OF GABRIEL CO.

1148 EUCLID AVENUE • CLEVELAND, OHIO



# CIRCUITS

## in AMPEX

### Model 600

### TAPE RECORDER

The Eighth in a  
Series of Articles Devoted to  
the Principles of  
Magnetic Recording

by Robert B. Dunham

Basic principles and important characteristics encountered in magnetic recording and playback have been discussed in the preceding articles in this series, but very little has been said about the electronic circuits required to handle the signal and to take care of other functions. Some space has been devoted to discussing tape-transport mechanisms because of the very important part they play in recording and playing back the tape.

The quality of recording and playback depends to a great degree upon the precision with which the mechanical section of the recorder moves and handles the tape, but the electronic section must also do its part and do it well. By electronic section, we refer to the portion of the recorder which contains the amplifiers, bias and erase oscillator, control circuits, power supply, or other allied circuits. These circuits are usually assembled on one or more chassis and are separate from the transport-mechanism assembly.

The electronic section of the Ampex Model 600 magnetic tape recorder serves as a very good example to show the principles of magnetic tape recording put into actual practice. The Model 600 is a portable recorder; therefore, the electronic chassis is small and compact. See Figs. 1, 2, 3, and 4. Although simplified to a certain extent, the circuit

(shown in Fig. 5) is complete; and no sacrifice of capabilities or performance has been made. The Model 600 is a professional type of recorder and produces results of professional quality.

The schematic diagram can be traced and examined very readily because conventional circuits are employed. Complicated switching arrangements and multipurpose stages, which are often used in portable equipment to reduce physical size and weight, are not employed in the Model 600. Separate record and playback channels (used in conjunction with a bias and erase oscillator section and a power supply) require very little switching and changing of circuit function when operating modes are changed.

#### RECORDING CHANNEL

The recording channel makes use of two microphone-preamplifier stages, three amplifier stages, and a bias and erase oscillator. Two separate and independent inputs (marked MICROPHONE and LINE INPUT) are provided. Each input circuit is provided with an input-level control for convenience in mixing or other procedures when recording. The control associated with the microphone input is called the MIC REC LEVEL (microphone recording level) control; and the control associated with the line input is called the LINE REC LEVEL (line recording level) control. The recording channel can be studied in more detail in some of the sections which follow.

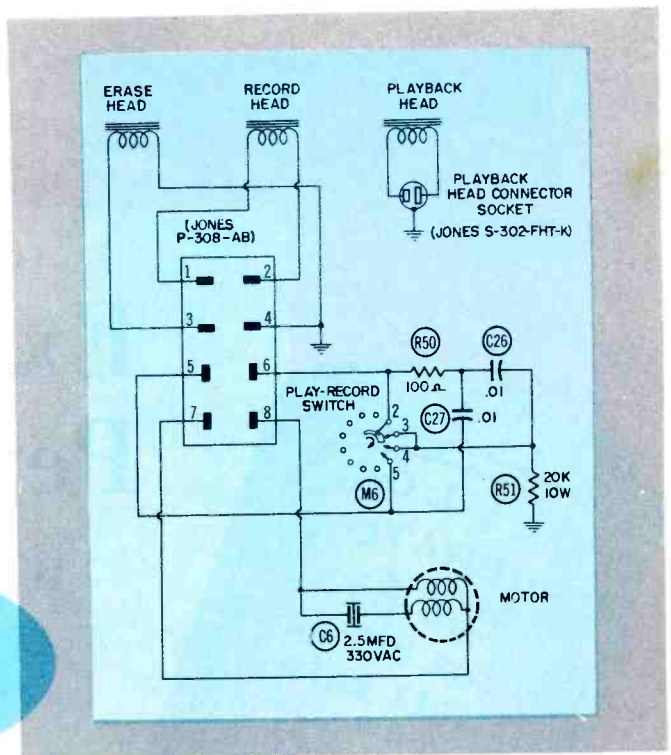

#### Microphone Channel

A professional type of microphone receptacle (the Cannon XL-3-13N) is provided on the front panel for use with a high-impedance microphone. One precaution is very appropriate at this time — a high quality microphone must always be used when high quality results are desired.

Provisions are made for modifying the input circuit for use with a low-impedance microphone. A cutout in the chassis is fitted with a removable cover plate, as shown in Fig. 3, and will accommodate a standard microphone transformer. Ampex supplies a kit for this purpose; or instead, a standard transformer like the UTC Type A-11 can be installed. The terminal strip (shown in Figs. 4 and 5) and the cover plate are removed and discarded, thus permitting the transformer to be installed according to the instructions supplied by Ampex.

The 5879 tube V1 in the microphone-input stage is a low-noise pentode developed for use in low-level stages. Hum, noise, and microphonism can be very troublesome in such stages because of the low level of the input signal and because of the amount of amplification in the following stages.

The signal from the input stage is fed to the grid (pin No. 2) of V2A in the second stage through the micro-

\* \* Please turn to page 58 \* \*

P. R. MALLORY & CO. INC.  
**MALLORY**  
APPROVED PRECISION PRODUCTS

P. R. MALLORY & CO. INC.  
**MALLORY**  
APPROVED PRECISION PRODUCTS

P. R. MALLORY & CO. INC.  
**MALLORY**  
APPROVED PRECISION PRODUCTS

# Extra Vibrator Performance... without Extra Cost

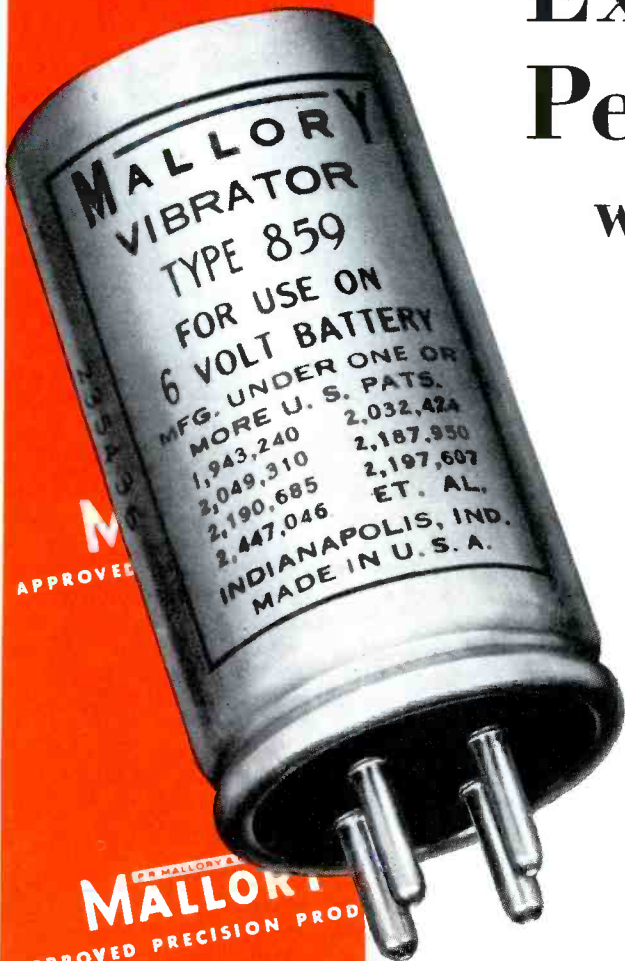

IN THE MALLORY 25th ANNIVERSARY VIBRATOR,\* mechanical hum has been squelched right at its source. In any mounting position . . . prongs up, side-wise, or prongs down . . . this is the quietest vibrator ever. And it costs no more than the previous Mallory vibrators which it replaces!

**TOP ELECTRICAL PERFORMANCE**—for hundreds of hours. These test oscillograms show how Mallory vibrators are adjusted to excellent wave form, and continue to produce this performance for hundreds of hours. Note that even after long service, the 'scope shows complete freedom from hash, off-frequencies or variations in amplitude . . . no evidence of contact chatter or bounce.

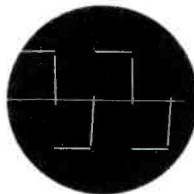

Ideal vibrator wave form

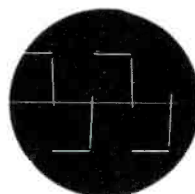

New Mallory vibrator



Mallory vibrator after hundreds of hours of service

In every respect, the new Mallory vibrators live up to the reputation for long, dependable service which has made Mallory vibrators the leading choice of servicemen and manufacturers.

Your Mallory distributor carries the new models, with part numbers identical with those you've been using. Call him soon . . . and order your supply of the quietest vibrators you've ever used.

\*Patent Applied For

P. R. MALLORY & CO. INC.  
**MALLORY**  
APPROVED PRECISION PRODUCTS

P. R. MALLORY & CO. INC.  
**MALLORY**  
APPROVED PRECISION PRODUCTS

APPROVED PRECISION PRODUCTS

APPROVED PRECISION PRODUCTS

P. R. MALLORY & CO. INC.  
**MALLORY**

CAPACITORS • CONTROLS • VIBRATORS • SWITCHES • RESISTORS  
RECTIFIERS • POWER SUPPLIES • FILTERS • MERCURY BATTERIES  
**APPROVED PRECISION PRODUCTS**

P. R. MALLORY & CO. Inc., INDIANAPOLIS 6, INDIANA





# Dollar and Sense Servicing

by *John Markus*

*Editor-in-Chief, McGraw-Hill Radio Servicing Library*

**NWF.** According to Electrical Merchandising, full-scale merchandising of radios has paid off for Elmer Ross, a small dealer from San Mateo, California. Radio now accounts for one sixth of sales volume, yet television sales have not suffered. The initials NWF (not worth fixing) on many repair job tickets help their service reputation. One person out of ten buys a new set, and all respect the frankness of the firm.

Sales techniques include putting radios up front in the store, using special window displays, putting portables out where prospects can get that feel of ownership (didn't pay out, though — losses through theft ate up profits — so back behind glass are the portables), and heavy use of classified ads. On tough customers, they make a practice of switching salesmen for the closing because a different personality often clicks.

Four types of gift-wrapping paper are kept on hand — a service particularly appreciated by professional and business men. A headache-creating record department is tolerated because of the traffic it brings for exposure to radios and phonographs on the floor.



**PENNY'S WORTH.** Although not good for much more than paying sales taxes these days, a penny still gets you 15 minutes of viewing on the average TV set. Whether it's worth the penny is another thing, depending largely on who in the family does the tuning.

This figure is arrived at by assuming an average of 6 hours viewing a day on a \$240 set that is junked in 5 years; with \$20 a year for service; \$13 for electrical power; and \$6 for installation, antenna, and miscellaneous. The total is \$87 a year.

**TAPEWORM.** Self-adopted name for a tape-recording enthusiast, who may or may not be a member of International Tape Worms, P. O. Box 215, Cedarhurst, L. I., N. Y.



**FOLLY.** Too many shops put a bright new display in the front window and then forget to wash the window. Water and a rubber squeegee are all it takes. Do yours need it?



**LIFESAVER.** Latest item for boats is a portable radio transmitter that floats and sends out SOS signals. Chances are it'll have enough reserve buoyancy to keep your nose above water too, if the lifeboat goes down. Synthetic rubber gaskets around the antenna and controls keep air in and water out.



**HAMS.** By charging hams and smoke with opposite polarity, packing plants are now getting as much smoke into a ham in 4 minutes as they formerly did when the hams traveled for 12 hours through smoke-filled tunnels. Of course, tubes do the rectifying to give the DC voltage that does the charging. Don't sell electronics short.



**NECESSITY.** A recent decision of the California legislature now prevents creditors from taking the family TV set in a bankruptcy action. The sets now come under the category of sundry items of furniture and personal belongings that can't be taken away because their seizure would work a hardship on the family.

**PIG-TAILOR.** This is the newly coined name for a device that tailors the pig-tail leads of resistors and capacitors to the lengths and shapes required for easy insertion in etched-wiring boards. It's fastened to a bench and is operated by hand or foot, and the operator loads the components into the device one at a time.

The Pig-Tailor made by Bruno-New York Industries Corporation is just one of many ingenious new machines going into radio and TV plants in this year of transition to mechanized production. One of the fastest, made by IRC, can cut off resistor leads at the rate of 500 per minute.

The mechanisms in the Admiral and United Shoe automatic-assembly machines likewise cut and form leads; then they insert the parts in etched-wiring boards and clinch the leads underneath to complete the assembly job.

A Melpar machine under development goes one step further by using a heated clinching anvil to solder the leads to the etched wiring at the same time. Truly, the transition to automation in the electronics industry is a fascinating period in history — one which, years in the future, you can look back on and say, "I was there."



**PHANTOMS.** With etched-wiring boards, the parts are on one side and the wiring on the other, much to the frustration of technicians. As an aid to trouble shooting its five printed-circuit assemblies, RCA prints the etched-wiring pattern in phantom on the back side right over the layout diagram for each board. For this they deserve congratulations. A contrasting color would be a bit easier to trace than the gray wiring though. Which manufacturer will get our plaudits for going to color on these?



have you got  
"the LOWS"?

"The Lows" is a dread disease, always found in dealers carrying low-priced antennas, accessories and twin-lead. Symptoms are alarming. Such dealers have acute pocketbook pallor and sad faces. "The Lows" is a contagious business disease. Customers buying from dealers with "Lows" can be easily spotted by their belligerent air of dissatisfaction.

The cause of "The Lows" is easily found. Low priced merchandise. For low price means low profit (hence the dealer's blues) and low quality (hence the customers' complaints).

Fortunately the remedy is simple—sell quality products at a fair profit margin. Dealers who have switched to selling AMPHENOL antennas, accessories and twin-lead have instantly improved their condition. They have found the AMPHENOL line to be the high profit line, with good mark-ups on every item. They have found the AMPHENOL line to be the high quality line, with resultant customer satisfaction.

Be immune to this dread disease—"The Lows".



help your business grow PROFITABLY . . .

**SELL AMPHENOL**

AMERICAN PHENOLIC CORPORATION *chicago 50, illinois*  
In Canada: AMPHENOL CANADA LTD., *Toronto*

**DOORMAN.** For apartments having pushbuttons that open the main door of the building, why not set up an industrial TV camera to view the area just outside the door? Its output can be fed to each TV set in the building on some vacant channel. Then, when the doorbell rings, the housewife can tune her TV set to that channel to see who's there before pressing the button that opens the door.

For lonely people, this front-door channel may prove more attractive than all the others to watch who's visiting the other people in the building. The idea is worth a bit of exploring in your town since it could mean some highly profitable installation work.



**DREAMING.** Only an advertising man (A. C. Fatt of Grey Advertising Agency) could dream up this for 1970. A new product, perhaps a drug or cosmetic, is introduced to 100,000,000 people with 6 to 12 minutes of commercials that demonstrate the product and create an almost irresistible desire to possess it. The viewer then reaches forward to push a button or two on the "Sellelevision" panel of her life-size-screen, three-dimensional color set to register her code number in the store, to indicate the size or color desired, and to indicate if it is charge or COD.



**A DECADE.** In the past ten years, around 39,000,000 TV sets were sold to the public and about 4,000,000 of these were scrapped; and this makes about 35,000,000 TV sets in use today. Around half of these are 21-inch sets, 37 per cent are 16- to 17-inch sets, 12 per cent are 15-inch sets or smaller, and about 1 per cent have screens larger than 21 inches. Of the 28,000 color sets produced, 8,000 are in use. The pattern for tomorrow is thus clearly evident — 21-inch sets will dominate sales. Sales for the first half of this year back this up — 83 per cent of the 3,182,000 sets sold were 21-inch sets, according to TV Factbook.

With the public satisfied with 21-inch sets in black and white, even though bigger tubes are available, it looks as if color is restarting on the right foot with a tube of comparable size. This is a good selling point to customers who fear that the color sets available this fall will become obsolete too soon.



**ELECTRONIC CHEATING.** Even a bridge game on a lonely beach, blocks away from onlookers, isn't immune to cheating in this day of electronics when stakes run from a dime to a dollar a point. The cheaters themselves suggest the location, and the complacent sucker is placed with his back to a nearby hotel. He loses his shirt.

Details weren't revealed by columnist Hy Gardner in his writeup of gambling, but the gist of the trick is this: A confederate with a powerful telescope in the hotel sees every card as it is drawn by the sucker. The cheater in the game wears a metal belt appropriately wired for pulse reception, probably with an output gadget that pricks his tummy gently each time a pulse is received. The telescope operator pulses a radio transmitter in some prearranged code. This need not be much more elaborate than some of the conventions used legally in the game, since plenty of cheating can be done just by knowing the opponent's face cards and trump count.

The moral of this story is to stay away from gambling with strangers regardless of location.



**LEARNING.** Talking cards are a feature of a new language training aid soon to be placed on the market by McGraw-Hill Book Company. On each card is printed one word and its meaning, along with a picture where appropriate. At the bottom of the card is cemented a length of ordinary magnetic recording tape. The user studies the card, then places it on the playback machine where motor-driven rollers zip the card through a playback head at the correct speed in order to reproduce the correctly spoken word on the tape.



**NECKING CHASSIS.** Right on top of the neck of the picture tube is where you'll find the chassis on some of the new General Electric TV sets. It's on a slant with the front edge just about touching the cone of the picture tube. Loosen the mounting screws and the chassis slides right down into your lap.

With the industry rapidly changing over to etched-wiring boards that permit a flock of new mounting tricks, there's no telling where we'll find the chassis next.

\* \* Please turn to page 52 \* \*

October, 1955 - PF REPORTER

TOP  
Quality

full  
Profit

Easy-  
to-Sell

AMPHENOL



genuine  
TWIN  
LEAD



ANTENNA KITS  
VHF/UHF

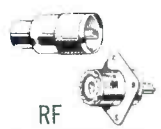

RF  
CONNECTORS



Qwik  
MICROPHONE  
CONNECTORS

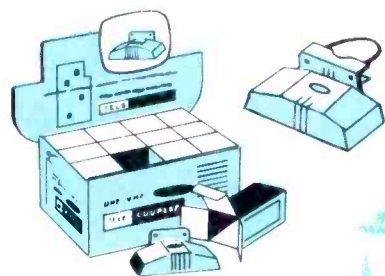

ACCESSORIES



LIGHTNING  
ARRESTORS



COAXIAL  
CABLE

AMPHENOL products, like those pictured above, are the simple remedy for "The Lows." Your order blank is your prescription form. Help your business grow profitably, sell AMPHENOL!

AMPHENOL

AMERICAN PHENOLIC CORPORATION  
chicago 50, illinois  
In Canada: AMPHENOL CANADA LIMITED. Toronto



# SYLVANIA SILVER SCREEN 85

more profit for you in  
"Silver Screen 85's"

Stepped-Up  
Selling Power



Sylvania puts you in the driver's seat and backs you with more promotional horsepower than ever before. This Fall, it's *all out on all fronts* to make your selling job easier and your servicing job more profitable. Here's how:

**Stepped-up TV power**—"Beat the Clock's" fabulous prize contest makes all your customers and prospects potential prize winners. 10 new prizes, 10 new winners every week. Week after week you'll win new customers who come to you for their free entry blank. And as a Sylvania Dealer only you can supply them with an official entry blank.

**Stepped-up magazine power**—Sylvania's selling the "Silver Screen 85" in the biggest consumer magazine campaign of 1955. Full schedules in *This Week* and *TV Guide* will presell your customers on the three outstanding features of the "Silver Screen 85" picture tubes. 11 million readers are reached by *This Week* through the combined distribution of 35 great American newspapers. Over 3 million TV viewers use *TV Guide* every week for TV news and program listings.

**Stepped-up promotional power for you.** A complete package of Sylvania promotion material is available so you can fill in the important final link in this promotional chain reaction. Window and counter displays, new direct-mail material, the important "Silver Screen 85" booklet, and new ad mats are included to help you capitalize on the prize contest and national magazine program.

**Stepped-up profits for you.** Sylvania supplies selling power that adds up to more profit for you. Think with Sylvania—work with Sylvania—promote with Sylvania—and you can't help but profit with Sylvania.

SYLVANIA ELECTRIC PRODUCTS INC.  
1740 Broadway, New York 19, N. Y.

In Canada: Sylvania Electric (Canada) Ltd.  
University Tower Bldg., Montreal

LIGHTING • RADIO • ELECTRONICS  
TELEVISION • ATOMIC ENERGY



# SYLVANIA®

...fastest growing name in sight



TV service technicians usually concentrate on service and installation and give very little attention to selling anything other than parts or items for service and replacement purposes. Because of this, many service and sales organizations lose opportunities to cash in on the contacts made by their service technicians. When making service calls, a technician encounters many situations in which certain items not directly connected with servicing can be sold. He certainly has a chance to see if a customer has a need for an article.

Of course, such small items as indoor TV antennas have been sold by technicians, but there seems to be little activity on the part of most technicians to promote the sale of more expensive items. The ideal situation would be one in which the item could be carried in the service truck so that a demonstration could be given when the occasion arises.

The TV Duettes which have recently been introduced lend themselves very well to this procedure. They are manufactured by the Jensen Manufacturing Company. Two views are shown of the TV Duette in use. Note that the construction of the unit is such that in addition to serving as a two-way speaker system, it can also be used as a table for a table-model TV receiver or as an end table.

An opportunity to sell a TV Duette may present itself when a service technician who is making a call in a home sees that the customer could use an appropriate table for his table-model receiver. Of course, a TV Duette is much more than a table; but the fact that it is in this form can be used as an opening wedge to sell not only a table but a high quality speaker system.

Several features make the TV Duettes particularly suitable for home demonstrations. They are small enough to handle and to set up easily. The receiver may be placed on top of the TV Duette, and the three-wire cable should be connected to the voice coil of the original speaker in the TV receiver. The connections are shown in the circuit diagram of Fig. 1. A three-position switch located in the lower right-hand corner of the front grille on the TV Duette permits instantaneous switching either to the Duette or to the original speaker in the receiver. This switch enables the technician to demonstrate the improvement in sound quality when the TV Duette is switched into the circuit.

Since most table-model receivers use small speakers located on the side or top of the cabinet be-

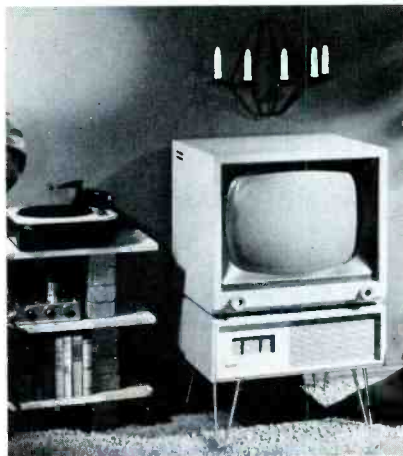

## A SALES ITEM for TV TECHNICIANS

### A Dual-Speaker Enclosure for TV Table Models



cause of space limitations, the quality of the sound produced suffers more than most viewers realize. When the TV Duette is switched into the circuit, the wide range of sound coming from the front of the cabinet makes a very noticeable and convincing improvement.

Two terminals are provided on the back of the TV Duette to permit the amplified output from a phonograph, tuner, or recorder to be reproduced by the TV Duette when the switch is turned to the third position. The switching circuit is shown in Fig. 2.

The TV Duettes are made in two models as follows:

1. The Model DU-500 rated at 20 watts. It comes in blonde oak with

brass hairpin legs or in ribbon-striped mahogany with wood legs.

2. The Model DU-400 rated at 15 watts. It comes in a Korina blonde finish on plywood with wood legs or in ribbon-striped mahogany finish on plywood with wood legs.

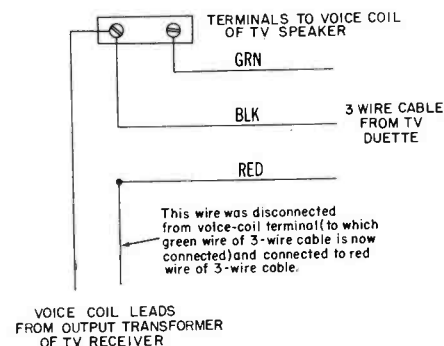

Fig. 1. Changes Required When Connecting the TV Duette to Receiver.

The TV Duettes operate on the same principles as the portable DU-202 Duettes described in the Audio Facts column of the October 1954 PF REPORTER. They are two-way systems using a 6-inch by 9-inch woofer in both models. The woofer in the Model DU-500 has greater power-handling capabilities than the woofer in the Model DU-400. The

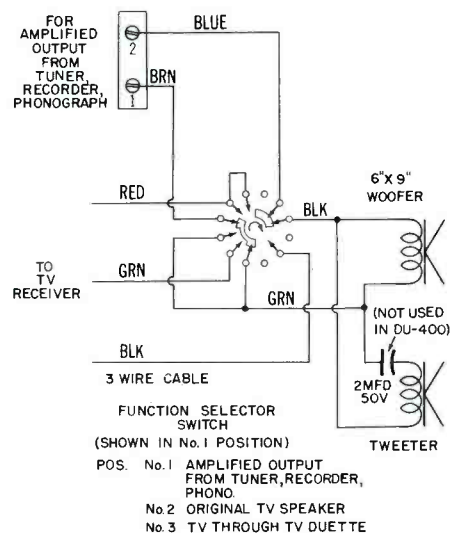

Fig. 2. Switching Circuit in the TV Duette.

former employs a horn-loaded tweeter, and the latter employs a 3-inch cone type of tweeter. Service dealers can obtain these units from Jensen wholesalers at a substantial discount from users' net price, and it is therefore possible to sell them in competition with any other sales outlet.

ROBERT B. DUNHAM

# EXCLUSIVE "PHASE-REVERSER" GUARANTEES

## THE NEW WALSCO WIZARD

### THE MOST ADVANCED, MOST POWERFUL

### SUPER FRINGE ANTENNA

### IN THE WORLD

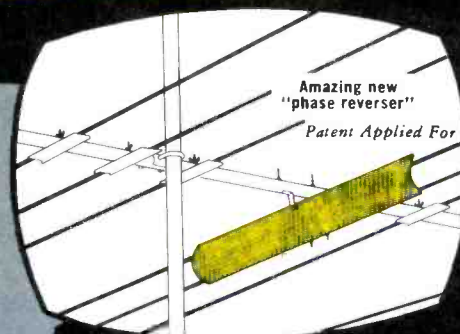

*here's positive proof!*

Actual comparison of fringe antenna performance

Channels	Gain (db) Single Bay						
	2	4	6	7	9	11	13
Walsco Wizard Imperial	6.1	6.9	8.2	11.9	11.6	10.8	12.6
Antenna "A" With 3 Phase Reversing Dipoles	6.3	6.6	8.1	10.5	10.2	10.6	12.4
Antenna "B" - Yagi Type with Phasing Loops	5.1	5.5	6.8	7.5	9.6	8.8	11.2
Antenna "C" - Yagi Type with Loading Coils	5.9	6.9	8.6	9.1	8.6	9.6	7.8

The new Walsco Wizard performs as 3 separate antennas combined in one to give the very finest, all-channel picture reception ever seen on any television screen. Extra dipoles, complicated harnesses, or phasing stubs are completely eliminated. And the Wizard is the easiest to assemble and install.

Walsco guarantees the Wizard for 3 years.

Model	Price
Wizardette #4110	\$14.90 list
Wizard #4220	19.50 list
Wizard Imperial #4230	34.90 list

**ASK YOUR JOBBER FOR FULL INFORMATION AND TECHNICAL BROCHURE ... OR WRITE DIRECT TO WALSCO.**



3602 Crenshaw Blvd.,  
Los Angeles 16, California

IN CANADA: Atlas Radio Corp., Ltd.



## Quicker Servicing

(Continued from page 15)

that the trouble was located in the horizontal-sweep section of the receiver. A picture of a test pattern under this condition is shown in Fig. 2.

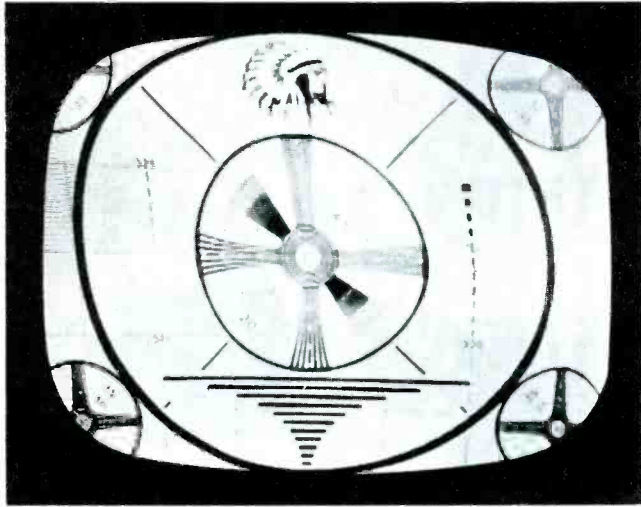

Fig. 2. Test Pattern Showing Trouble at Normal-Brightness Level.

Notice the slight pull in the picture as well as the keystone effect at the left of the picture. Because the yoke had been replaced and the trouble remained, there was some doubt that the usual trouble which produces keystone effect was present. Not knowing just where to start, the technician first checked the operation of the setup and operating controls. Adjustment of the brightness control

toward a lower brightness setting produced the effect shown in Fig. 3. It may be seen that the trouble is more pronounced at this setting of the brightness control. A check on the adjustment of the other operating controls showed that their operation was normal.

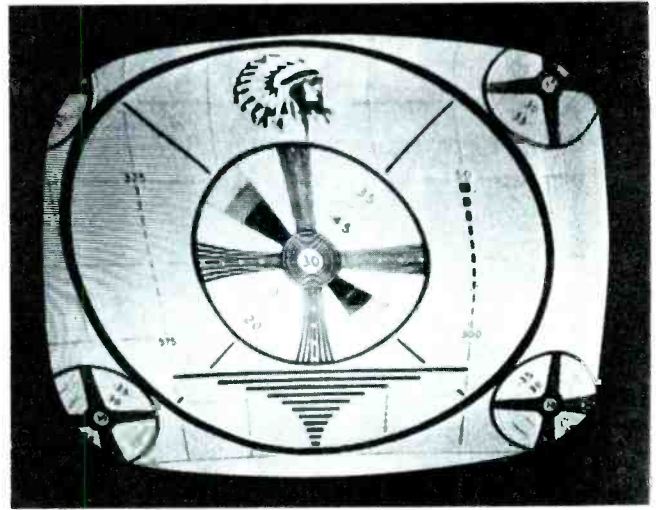

Fig. 3. Test Pattern Showing Trouble at Low-Brightness Level.

A check of the adjustment of the setup controls — height, vertical linearity, width, horizontal linearity, and horizontal drive — likewise revealed normal operation.

A check of the raster under no-signal conditions showed that the keystone appearance was in the raster. This check definitely established the fact that the trouble

was located in the sweep section. A partial schematic diagram of the receiver in question is shown in Fig. 4.

The author checked the grid waveform in the horizontal-output stage, and the waveform shown in Fig. 5 was found. Notice that this

waveform, which represents the drive voltage, is normal. Since the oscilloscope was already set up to operate at one half the horizontal-sweep rate, the cathode was also checked without changing this rate. The waveform shown in Fig. 6 was found at the cathode. Notice the wide portion of the sweep. This shows the presence of an undesired signal. In order to determine the nature of the undesired signal, the cathode was next checked at one half the vertical rate. The waveform shown in Fig. 7 was found. It was then apparent that the trouble was being caused by 60-

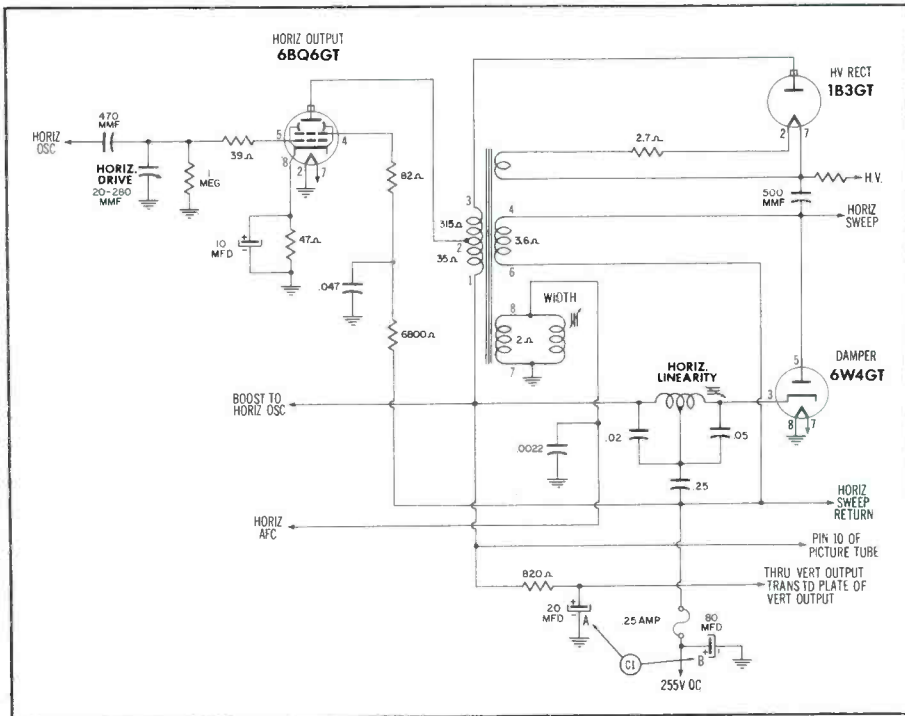

Fig. 4. Partial Schematic Diagram of Receiver in Which the Trouble Appeared.

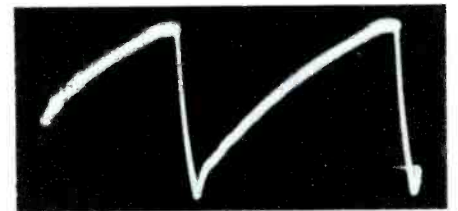

Fig. 5. Normal Grid Waveform in Horizontal-Output Stage, Taken at 7,875 CPS.

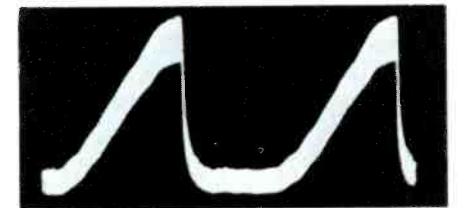
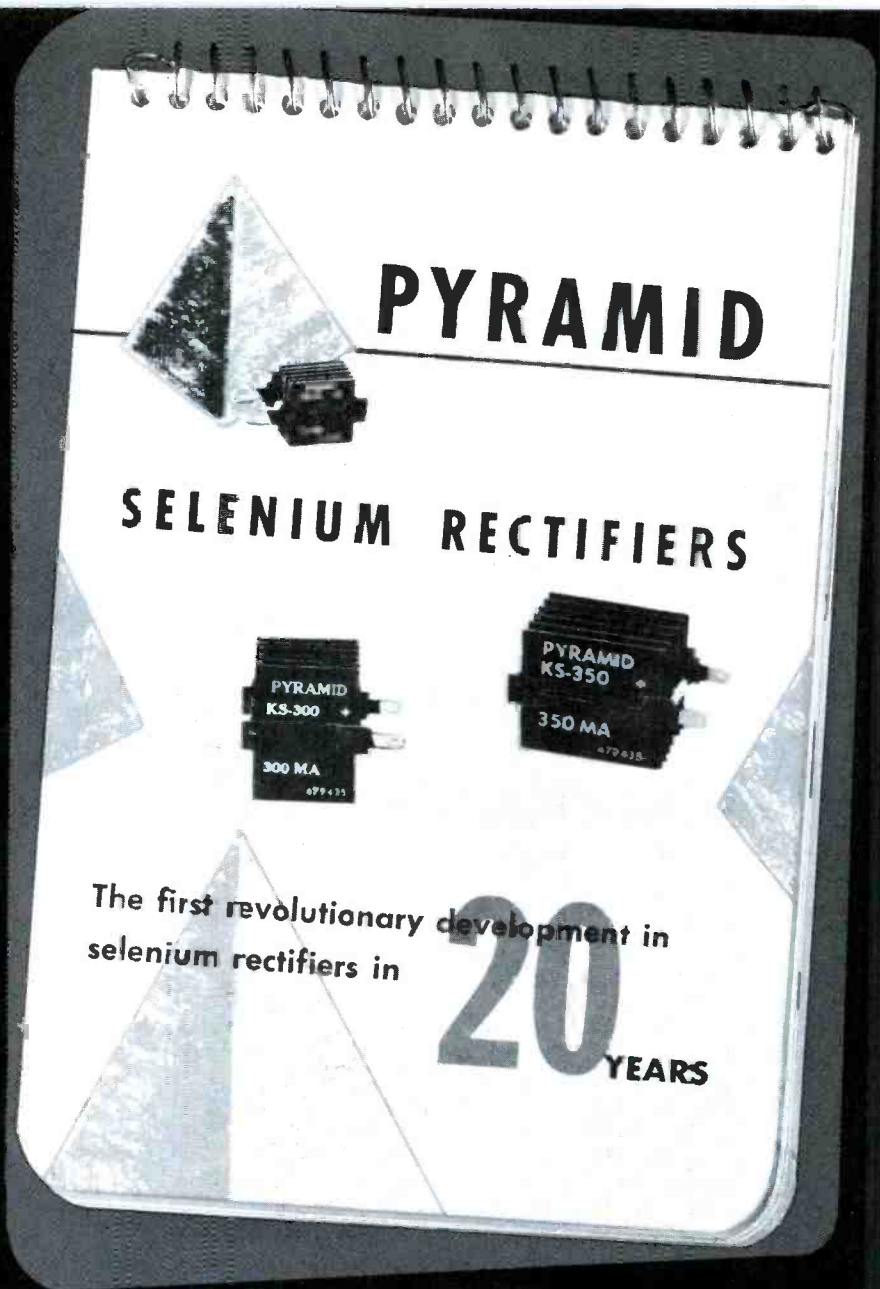

Fig. 6. Distorted Cathode Waveform in Horizontal-Output Stage, Taken at 7,875 CPS.

*ask your jobber  
for the whole story  
of the...*

**1st NEW DESIGN**  
of selenium rectifiers  
*in over 20 years*

because the new Pyramid  
Kool-sel design is so revolutionary  
and because its features  
themselves sell so immediately  
Pyramid has prepared this  
hand-sized flip chart, which  
tells at a glance all about such  
features as No Center  
Mounting and the Secret  
Barrier Layer of Pyramidium  
and explains the principles  
that make Kool-sel rectifiers  
superior to any on the market.



DISTRIBUTOR DIVISION

**PYRAMID**

ELECTRIC COMPANY

1445 Hudson Blvd. • North Bergen, N.J.

Burton Browne / New York



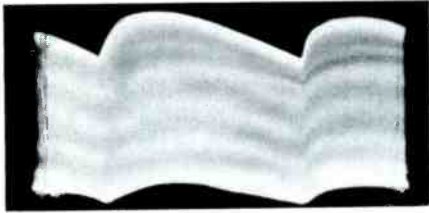

**Fig. 7. Distorted Cathode Waveform in Horizontal-Output Stage, Taken at 30 CPS.**

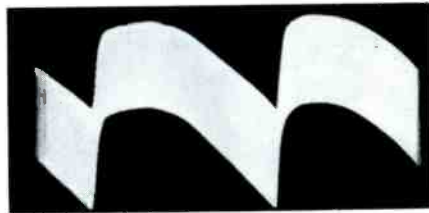

**Fig. 8. Distorted Screen-Grid Waveform Taken at 30 CPS.**

cycle modulation of the horizontal sweep.

To help in isolating the trouble, the waveform at the screengrid of the horizontal-output stage was also checked at one half the vertical rate. The waveform in Fig. 8 was found.

Examination of the schematic diagram revealed that the screen grid of the horizontal-output stage was supplied from the 255-volt point of the power supply. It also revealed that the filter capacitor at this point and the decoupling capacitor for the vertical-output plate were sections of a multiple filter capacitor. A check of this unit showed it to be defective, and replacement of the defective unit cured the trouble.

In this particular case, the receiver did not use a metal picture tube which could have become magnetized and thus cause a similar effect; nor did this receiver have the speaker or other magnetic unit mounted near enough to the picture tube to cause a symptom of this type. These are mentioned because under some conditions they could cause a symptom similar to the one discussed here.

### Horizontal-Linearity Adjustment in the Home

The adjustment in the home of the horizontal linearity of a receiver has posed somewhat of a problem. This is due in part to the short duration of the test pattern which is usually transmitted before the regular programming begins each day. Then too, generators which will produce a crosshatch or linearity pattern that is suitable for horizontal adjustments are somewhat expensive.

There is one method that can be used to adjust some TV receivers to a point of acceptable horizontal linearity. This method consists of adjusting the width and horizontal-drive controls properly, removing the fuse from the horizontal-output stage, and connecting a 150-ma DC meter in place of the fuse. The meter should be connected in the manner shown in Fig. 9. The proper polarity must be observed in order to avoid damage to the meter. After the meter is properly connected into the circuit, the set should be turned on and the horizontal-linearity control should be adjusted to produce a minimum reading on the meter.

A No. 47 pilot lamp can be used in place of the meter. The linearity coil should be adjusted to produce minimum brightness of the pilot lamp. Fig. 10 shows a pilot lamp which has been adapted by the addition of two wires with alligator clips. It is shown connected across the fuse for use in adjustment of the horizontal linearity. This method can easily be used on TV receivers that have fuse holders of the clip-in type in the horizontal-output stage.

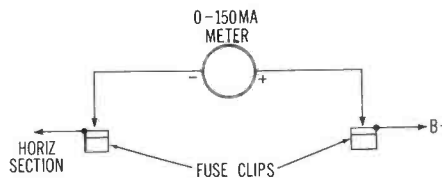

**Fig. 9. Connection of a Milliampere Meter Used to Adjust Horizontal Linearity.**

### Vertical-Sync Trouble

Sometime ago, a receiver was encountered in which the picture had a tendency to break out of synchronization vertically and roll several frames; then the picture would appear to be locked in. A thorough and exhaustive check of the sync,

video, and vertical-oscillator stages was made. Substitution for all components which were off value by 10 per cent or more failed to give even a hint of the possible cause of this erratic action.

A further examination of the service literature revealed a production-change bulletin which supplied the solution to the problem. Refer to the partial schematic of the IF strip of this receiver shown in Fig. 11. The plate of the first IF stage was connected to only a 120-volt source through the plate-load circuit; and as a result, a strong incoming signal had sufficient amplitude to cause the tube to be overdriven. Thus the vertical sync pulses were slightly clipped or compressed. On strong local signals, the vertical sync pulse was compressed enough that the vertical oscillator could occasionally break away from the control of the sync pulses. This condition was caused by the fact that the video signal approached the amplitude of the sync pulses and that this video signal would actually trigger the vertical oscillator.

To remedy this condition, the plate of the first IF tube was connected to 220 volts instead of to 120 volts; and this connection is illustrated by the dotted line in Fig. 11. The other changes (shown by dotted lines) were also a part of the production change and were made to help improve sync stability.

Although this problem concerned one specific TV model, its implications apply directly to synchronization trouble which may develop in any TV receiver.

A quick check that will help to reveal trouble of this nature is to check the video signal at the video-detector load. If this signal reveals any distortion in the sync-pulse

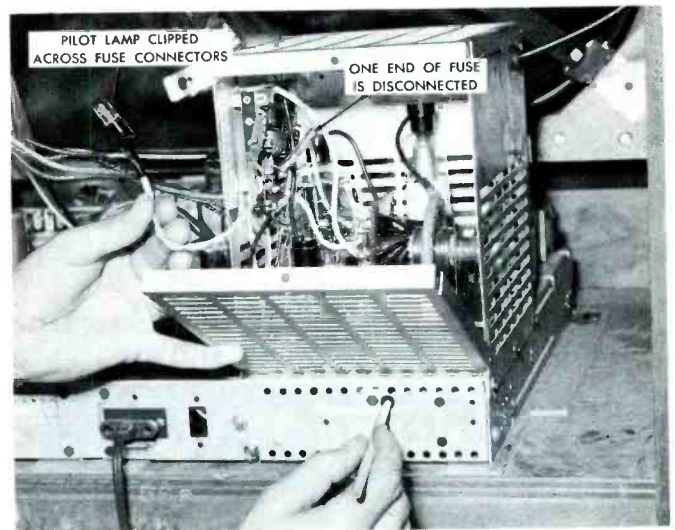

**Fig. 10. Pilot Lamp Being Used to Adjust Horizontal Linearity.**



# ALL-ALUMINUM Conical ANTENNAS



WITH THE NEW AND AMAZING

## "Presto"

### INSTANT MOUNT ASSEMBLY

Opens as easily,  
quickly as an umbrella!

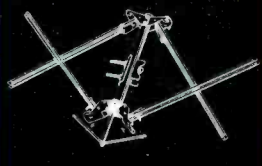

REMOVE FROM BOX • OPEN ELEMENTS • AND PRESTO, IT'S READY!

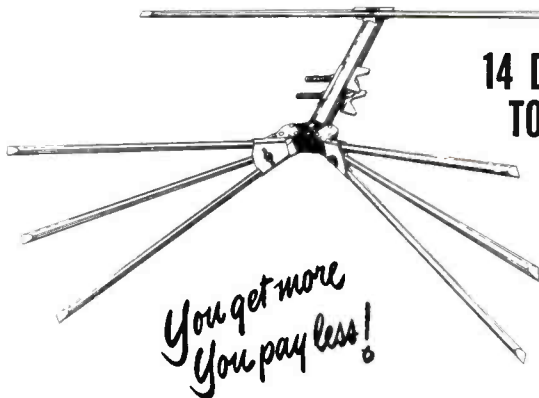

14 DIFFERENT MODELS  
TO CHOOSE FROM!

*You get more  
You pay less!*

MODEL  
T-771  
**5<sup>00</sup>**  
LIST

### Here's what you get!

Complete line of 14 full size, all aluminum conicals with Instant Mount assemblies to fill every installation need • Completely preassembled and ready for the mast • Molded plastic insulator of high impact polystyrene • Seamless aluminum boom • Doweled elements • Highest electrical efficiency • Traditional TENNA quality at lowest prices.

### ...and here's all you pay!

MODEL	ELEMENTS	LIST	MODEL	ELEMENTS	LIST
T-801	4×2	\$4.17	T-851	4×2+Dir. Bar	\$4.72
T-791	4×2+Stubs	4.44	T-781	6×2+Dir. Bar	5.56
T-811	4×4	5.00	T-751	4×4+Dir. Bar	5.56

ALSO AVAILABLE IN STACKED MODELS.

WRITE FOR NEW CATALOG SHOWING LATEST MODELS.

**Tenna** Manufacturing Co.

7580 GARFIELD BLVD. • CLEVELAND 25, OHIO

region, clamp the AGC line using a variable negative DC supply and vary the bias. At the same time, observe the waveform at the video-detector load and note any change or elimination of distortion in the sync-pulse region. If the distortion is varied when the AGC voltage is varied, check the screen grids of the IF amplifiers for the presence of a video signal.

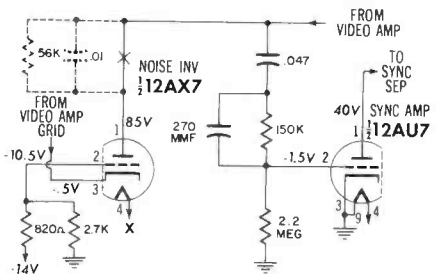
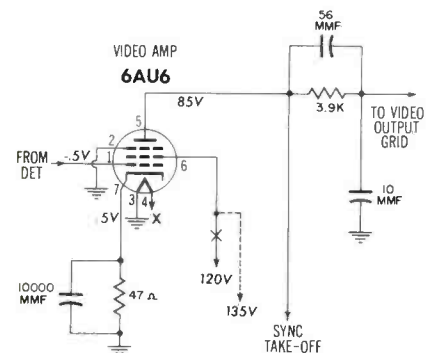
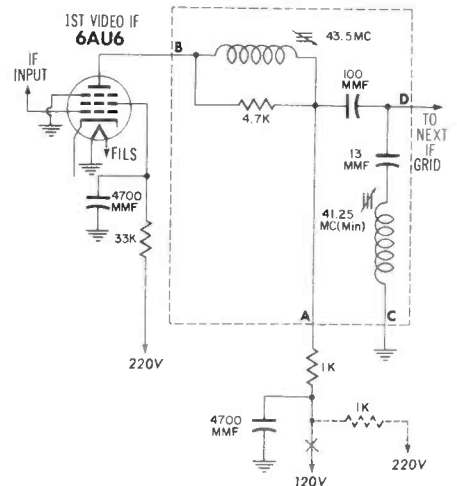

Fig. 11. Partial Schematic Diagram of Receiver in Which the Vertical Sync Was Poor.

If one is found on one or more of the screen grids, check the voltages applied to the IF amplifier stages. A comparison between the voltages thus recorded and normal operating voltages should help to reveal the source of the trouble. An open screen-bypass capacitor could also set up a condition that would affect the vertical synchronization.

CALVIN C. YOUNG, JR.



# Sangamo wire lead mica capacitors



## Now packaged for your convenience!

Save time—do away with the cluttered mess of tangled wire leads. Use Sangamo Mica Capacitors, now mounted on space-saving cards.

These high quality mica capacitors are the finest available anywhere—at any price. They are fabricated with carefully selected premium grade India Ruby mica and are molded in Humidite for unequalled moisture resistance.

You can depend on these wire leads for completely trouble-free TV replacements.

Each card of five capacitors has rating and wvdc clearly marked. Each card shows the new RTMA Standards and the new MIL-C-5-A color code.

Stock up now—see your Sangamo distributor, or write us.

*High quality wire lead micas  
for troublefree TV replacements*

**SANGAMO**  
ELECTRIC COMPANY  
MARION, ILLINOIS



# RCA

# SELENIUM

# RECTIFIERS

Now, RCA offers you a top-grade line of selenium rectifiers for general replacement use in TV, radio receivers, and phonographs. Advanced design, select raw materials, and superior workmanship give you a *dependable line of selenium rectifiers for virtually all service jobs.*

### Advanced Design for Dependable Performance and Long Life

Note the wide-open plate spacing for elimination of solid center "hot spot." Design utilizes corrugated spacers for excellent heat dissipation and rigid construction for rugged service.

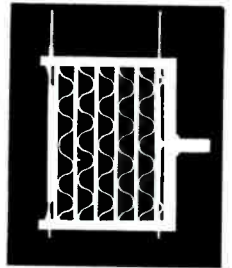

**NEW**—smaller size . . . for any given current, they are smaller than other types.

**NEW**—quicker installation . . . integral mounting stud.

**NEW**—wide-open design . . . insures maximum heat dissipation, cooler operation . . . no center "hot spots."

**NEW**—rigid construction . . . for rugged service.

**RCA SELENIUM RECTIFIERS**—a comprehensive line—for consistently good performance, easier installation, longer life and customer satisfaction. ORDER FROM YOUR RCA DISTRIBUTOR TODAY!

**-one comprehensive line for virtually all replacement requirements!**

WIDE SELECTION OF 12 TYPES		
Max. Output ma	Max. Input volts	RCA Type
65	130	205G1
75	130	200G1
100	130	206G1
150	130	201G1
200	130	207G1
250	130	208G1
300	130	202G1
350	130	209G1
400	130	203G1
500	130	204G1
400*	130	210G1
500*	130	211G1

\*Special thin types for use where available space will not permit the use of type 203G1 or 204G1.



**RADIO CORPORATION of AMERICA**  
ELECTRONIC COMPONENTS  
HARRISON, N. J.



# A STOCK GUIDE FOR TV TUBES

The following chart has been compiled to serve as a guide in establishing proper tube stocks for servicing TV receivers. The figures have been derived by combining (1) a production factor (the number of models and an estimate of the total number of receivers produced by all manufacturers) and (2) a depreciation factor (based on an average life of six years for each receiver, and the figures are reduced accordingly each two months).

1. The figures shown are based on a total of 1,000 units. This was done in order to eliminate percentage figures and decimals. The figure shown for any tube type then represents a percentage of all tubes now in use. For example, a figure of 100 would imply that that particular tube type constitutes 10 per cent of all tube applications.

2. Some consideration should be given to the frequency of failure of a particular type of tube. A tube used in the horizontal-output stage will fail much more frequently than a tube used as a video detector. Thus, even though

the same figure may be given for both tubes, more of the horizontal-output type should be stocked.

3. The column headed '46 to '55 is intended for use in those areas where television broadcasting was initiated prior to the freeze. Entries in this column include all tubes used since 1946 except those having a value of less than one, which is the value of the minimum entry in this chart. The '52 to '55 column applies to the TV areas which have been opened since the freeze. Since the majority of receivers in these areas will be of the later models, only the tubes used in these newer sets are considered in this column. The minimum value of one also applies to this column.

4. The listing of a large figure for a particular tube type is not necessarily a recommendation for stocking that number of tubes. The large figure does indicate that this tube is used in many circuits and emphasizes the necessity for maintaining a stock sufficient to fill requirements between regular tube orders.

	46-55 Models	52-55 Models		46-55 Models	52-55 Models		46-55 Models	52-55 Models		46-55 Models	52-55 Models
cOA2	-	-	6AL7GT	5	-	c6BK5	3	3	6SQ7GT	2	2
c1AX2	-	-	c6AM8	-	-	6BK7	3	5	#6T4	-	-
c1B3GT	41	44	#6AN4	-	-	c6BK7A	2	2	c6T8	13	14
1X2	4	1	c6AN8	1	2	c6BL7GT	4	7	c6U8	9	11
1X2A	3	5	c6AQ5	13	14	c6BN6	4	5	6V3	2	3
c1X2B	1	-	6AQ7GT	2	2	*6BQ6GA	-	-	c6V6GT	19	18
c*3A2	-	-	6AS5	2	3	6BQ6GT	18	25	6W4GT	26	28
c3A3GT	-	-	c6AS6	-	-	*6BQ6GTB	-	-	6W6GT	7	11
*3AL5	-	-	*6AS8	-	-	6BQ7	5	12	6X5GT	1	-
*3AU6	-	-	6AT6	4	3	c6BQ7A	6	6	c6X8	6	7
*3AV6	-	-	*6AT8	-	-	c6BY6	-	-	6Y6G	2	1
*3BC5	-	-	c6AU4GT	-	-	c6BZ7	7	2	*7AU7	-	-
*5AM8	-	-	6AU5GT	3	4	c6C4	10	9	7N7	2	-
*5AN8	-	-	c6AU6	122	116	c6CB6	107	137	c12AT7	14	13
*5AV8	-	-	*6AU8	-	-	c6CD6G	9	10	c12AU7	45	32
*5AW4	-	-	6AV5GT	2	3	6CF6	1	1	*12AU7A	-	-
c5U4G	47	48	c6AV6	15	17	c6CL6	1	2	c12AV7	3	3
*5U4GA	-	-	c6AX4GT	11	10	*6CM6	-	-	12AX4GT	2	4
*5U4GB	-	-	6AX5GT	1	2	c6CS6	2	2	*12AX4GTA	-	-
5V4G	6	-	*6AX8	-	-	c6DC6	-	-	12AX7	5	5
5Y3GT	3	2	c6BA6	13	10	*6DE6	-	-	12AZ7	-	2
6AB4	3	2	6BC5	9	7	*6DG6GT	-	-	*12B4	-	-
6AC7	7	7	c6BC7	-	-	6J5	3	3	c12BH7	10	13
c#6AF4	3	3	c6BD4	-	-	6J5GT	1	-	*12BH7A	-	-
6AG5	28	8	6BE6	6	7	6J6	31	29	c12BY7	6	7
6AG7	2	2	c6BG6G	11	6	6K6GT	15	9	12BZ7	2	-
c6AH4GT	3	4	6BH6	6	-	c6S4	8	10	*12CA5	-	-
c6AH6	7	8	6BJ6	1	-	*6S4A	-	-	*12CU6	-	-
6AK5	3	3	c6BJ7	-	-	6SH7GT	2	-	12SN7GT	5	4
c6AL5	71	73				6SL7GT	3	2	25BQ6GT	3	4
						c6SN7GT	69	75	25L6GT	5	5
						c6SN7GTA	5	5	25W4GT	1	1
						*6SN7GTB	-	-	5642	1	2
						6SQ7	2	2	c*6505	-	-

# A stock of these tubes should be maintained in UHF areas.  
\* New tubes recently introduced.  
c These tubes have been used in color television receivers.

**TEPEE TV.** Many moons ago, Chief White Eagle of the Iroquois Tribe at Caughnawaga, Quebec, had gone into the forest and cut a number of stout saplings. Stripping the branches from the young trees, he had lashed them together in his yard in the shape of a cone 40 feet high. Then he had peeled the thick white bark from the trunks of many birch trees and covered the framework with the bark to form a huge tepee. It stood for many seasons there by the highway, a landmark for motorists.

Then two years ago, Chief White Eagle saved up enough wampum to buy an RCA Victor 20-inch TV set. The flickering magic of the white man provided good entertainment for the chief, his wife, and five daughters as they watched programs from Montreal.

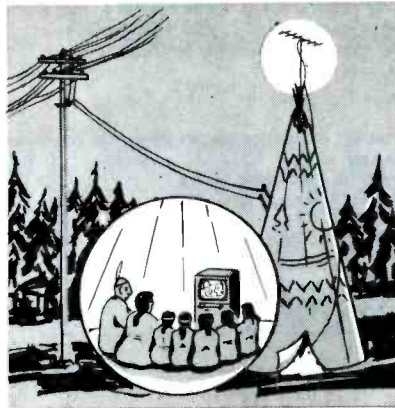

But being curious, the chief wanted to receive the new TV stations that came on the air at Burlington, Vermont and Plattsburg, N. Y.

Looking for a high place to erect his antenna, the chief's gaze fell on the top of the tepee. That was it! Being among other things a skilled bridge worker, the chief scaled the tepee in no time flat and put up his antenna.

And now, when night comes on and the fire burns low and the wind sighs across the marshlands, Chief White Eagle and his family sit before their set while the tepee reaches up into the sky to bring in the signals from across the border.

MARKUS · · Dollar and Sense Servicing

## Servicing Modular TV Receivers

(Continued from page 11)

### 6. Uniform Layout of Parts.

In a conventional receiver, the wiring has height, width, and depth. Not only can the components be placed at any point on the chassis, but they can be arranged in layers. Often, it is necessary to move some components and leads in order to make certain measurements or to replace components.

When a receiver incorporates both modules and a printed-wiring board, the chassis is reduced to a single plane as far as servicing requirements are concerned. All measurements can be made on the surface of the board because the leads of the elements in the module are brought out at the base of the module and in turn are soldered to the surface of the printed-wiring board. After a service technician becomes familiar with a particular chassis, any measurement in other receivers having this same chassis can be made quickly because the leads will be placed in

precisely the same position in every receiver.

So much for some of the advantages of a modular receiver. Let us take a look at the disadvantages and see what can be done to overcome them.

### Disadvantages

#### 1. Inability to Identify Tube-Pin Numbers Readily.

A service technician who has been in the business for some length of time may have noticed that he knows the base connections of the more popular tubes by memory. In the case of a seven-pin miniature tube, he knows that pin No. 5 is the plate connection, that pin No. 6 is the screen-grid connection, that pin No. 1 is the control-grid connection, and so on. This knowledge helps him in his servicing.

In the case of a modular design, however, the pin connections are not brought out in any particular order. For example, Fig. 3A shows the wiring side of a module stage. Note that the pin numbers do not correspond with the riser numbers. Nor will the pin connections in other modules be the same as those shown here.

Although this problem would seem very serious at first glance, let us consider what can be done to identify pin numbers. In Part I in the August 1955 issue of the PF REPORTER, the numbering system of the riser wires was explained. A plan for indicating the numbers of riser wires on the schematic diagram was also discussed. If the technician refers to a schematic diagram on which these riser wires are so indicated, the number of the riser wire that is attached to a given pin can be determined.

Another method of making measurements at the tube terminals is made possible through the use of a socket adapter. Fig. 3B shows such a unit in position. When this unit is used, the pin numbers must be counted in a counterclockwise manner because the tube socket must be viewed from the top instead of the bottom.

It would seem that the use of an adapter would be the most satisfactory method, but there are certain drawbacks that should be pointed out. In order to use an adapter, it is necessary to remove the tube from the socket and to insert it in the adapter. After the measurements are made, the tube must be removed from the adapter and reinserted into the regular socket. During this procedure, there is a chance that the tube may be broken or that the tube pins may become bent.



**WINEGARD**  
*Pixies* **MEAN**  
*Profits* **FOR YOU!**

**TODAY'S TOP ANTENNA VALUE . . . BY FAR!**  
3 great WINEGARD PIXIE models. Pixie POWERHOUSE (Illustrated) perfect for weak signal areas. Pixie PRINCESS designed for normal fringe areas and Pixie PAL for close-in suburbanites.

**NEW TWIN-LOCK HARDWARE with STAINLESS STEEL SNAPS**  
Here it is! The finest, lightest and yet strongest hardware you'll find on any TV antenna, regardless of price. No nuts or bolts to tighten—elements simply lock in place automatically.

**FABULOUS NEW DICON ELEMENT!** Another WINEGARD Original! A composite of the best features of both the conical and folded dipole in one simple element! The Dicon is one element mechanically . . . three elements electrically!

**ULTRA-SENSITIVE ELECTRO-LENS FOCUSING\*** Both Pixie POWERHOUSE and PRINCESS antennas have exclusive Winegard Electro-Lens Focusing! It absorbs the full signal, intensifies it and focuses it on the driven element for brilliant, clear-as-life pictures.

\*Patent No. 2700105

**Originals by**  
**WINEGARD**  
List prices: POWERHOUSE (LP-5) \$19.95; PRINCESS (L-5) \$13.65; PAL (P-5) \$8.85.

Special PIXIE PROMOTION PROGRAM until Jan. 1. FREE PIXIE BUCKS.

**ASK YOUR JOBBER OR MAIL COUPON TODAY**

**WINEGARD COMPANY**  
3000 Scotten Boulevard, Burlington, Iowa

Please Rush Detailed Technical Information On Operation Of Dicon Element

Please Send Information On How I Can Get Pixie Bucks

\_\_\_\_\_ FIRM NAME \_\_\_\_\_

\_\_\_\_\_ ADDRESS \_\_\_\_\_

CITY \_\_\_\_\_ STATE \_\_\_\_\_

\_\_\_\_\_ SIGNATURE \_\_\_\_\_



# Walco IDENT-I-GRAF

*Positive Needle Identification*  
... ALL YOU NEED IS  
**Phono Manufacturer's Name!**

PHONOGRAPH MANUFACTURER	SPEEDS	NUMBER OF NEEDLES USED	PICTURE KEY	CARTRIDGE	WALCO NUMBER
ANSLEY	33-78 33-45-78 33-45-78 33-45-78 33-45-78 33-45-78 33-45-78 33-45-78				
BENDIX	33-78 33-45-78 33-45-78 33-45-78 33-45-78 33-45-78 33-45-78 33-45-78				
BIRCH	33-78 33-45-78 33-45-78 33-45-78 33-45-78 33-45-78 33-45-78 33-45-78				
HOFFMAN	33-78 33-78 33-78 33-45-78 33-45-78 33-45-78 33-45-78 33-45-78				
HUDSON	33-45-78 33-45-78 33-45-78 33-45-78 33-45-78 33-45-78 33-45-78 33-45-78				
MAGNA-VOX	33-78 33-78 33-45-78 33-45-78 33-45-78 33-45-78 33-45-78 33-45-78				
MAJESTIC	33-45-78 33-45-78 33-45-78 33-45-78 33-45-78 33-45-78 33-45-78 33-45-78				
STEWART WARNER	33-78 33-78 33-45-78 33-45-78 33-45-78 33-45-78 33-45-78 33-45-78				
STROMBERG CARLSON	33-78 33-78 33-45-78 33-45-78 33-45-78 33-45-78 33-45-78 33-45-78				
SYMPHONIC NETTE	33-45-78 33-45-78 33-45-78 33-45-78 33-45-78 33-45-78 33-45-78 33-45-78				
SYMPHONIC	33-45-78 33-45-78 33-45-78 33-45-78 33-45-78 33-45-78 33-45-78 33-45-78				

**INSTRUCTIONS**  
Find phonograph manufacturer in large window at left. Move slide to set phonograph speeds at arrow. Check cartridge manufacturer. Read correct WALCO replacement number in same window.

**YOURS FREE!**  
... with your **FIRST** order of **WALCO NEEDLES!**

You'll get this sensational Walco Ident-I-Graf which enables you to identify needles quickly and easily by cartridge number or . . . by phonograph manufacturer alone!

- PLUS**—the remarkable Walco Magnetic Message Center that helps you remember all your important calls, dates and appointments.
- PLUS**—the Walco Inventory Control Cabinet that gives you a fingertip index on what needles you have, what needles you've sold and what needles you *need*.
- PLUS**—UP TO \$120 IN FREE NEEDLES!
- PLUS**—America's finest, fastest-selling line of phonograph needles!

Why sell any other needle when Walco gives you so much to sell . . . so much to sell with. Ask your distributor or fill in the coupon for complete details on how you can become a Walco dealer.

**CHECK COUPON** FOR A FULL SIZE PRINT OF CHERI, THE CURRENT WALCO CUTIE.

**Walco** ELECTROVOX CO., INC. Dept. PF-10  
60 Franklin Street, East Orange, N. J.

**CARTRIDGE ILLUSTRATIONS**

4 SHURE  
5 SHURE  
6 ASTATIC  
9 SHURE  
11 ELECTRO-VOICE  
12 ELECTRO-VOICE  
17 WEBSTER-CHICAGO  
18 G-E  
23 WEBSTER-CHICAGO  
24 SONOT  
29 WEBSTER-CHICAGO  
30 SONOT

ELECTROVOX CO., INC. Dept. PF-10  
60 Franklin St. East Orange, N. J.

Gentlemen:  
I like your deal. Please send me complete information on how I can become a Walco dealer.  
Please send me a Full Size print of Cheri

NAME: \_\_\_\_\_  
COMPANY: \_\_\_\_\_  
ADDRESS: \_\_\_\_\_  
CITY & STATE: \_\_\_\_\_

**New!** SELENIUM

TV REPLACEMENT RECTIFIER

**Bonus Pack!**

4 TV Replacement Rectifiers...  
a PAIR and a SPARE PAIR in every pack!

You can't miss with International's New "BONUS PACK"! You'll get the *best* in TV replacement rectifiers. Each BONUS PACK contains a pair for immediate use, and a spare pair for your next job—PLUS a Nylon TV Alignment Tool worth \$1—ABSOLUTELY FREE!



GET THE BEST...SPECIFY

# International

THE WIDEST RANGE  
OF QUALITY REPLACEMENT  
RECTIFIERS IN THE  
INDUSTRY

Makes a World of Difference



**Here's Why International Rectifiers Are Your Best Bet!**

**HIGH QUALITY** International, through its advanced designs and precision production, consistently meets—or exceeds—the highest government and trade standards for all types of rectifiers. These high standards are maintained on *all* International products, assuring *you* a better product.

**THE WIDEST RANGE IN THE INDUSTRY!**... more than 10,000 types! International TV-Radio rectifiers are available in *all* sizes and types. This complete line of selenium and germanium products also includes industrial rectifiers, replacement diodes and a wide range of photo-cells and sun batteries.

**SPECIFY INTERNATIONAL RECTIFIERS** for long, dependable performance. Best for you... Best for your service customers!

Ask your distributor for details about International's "Bonus Pack" today!

## International Rectifier

C O R P O R A T I O N

1521 EAST GRAND AVENUE • EL SEGUNDO, CALIFORNIA • OREGON 8-6281  
IN CANADA: Atlas Radio Corp., 50 Wingold Ave. W., Toronto, Ontario  
WORLD'S LARGEST SUPPLIERS OF INDUSTRIAL METALLIC RECTIFIERS



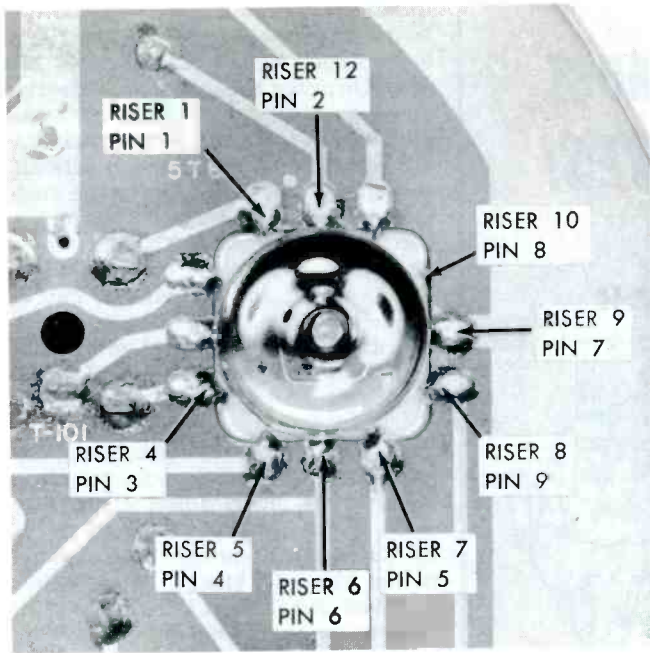

**Fig. 3A.** Note That the Pin Numbers Do Not Correspond with the Riser Numbers.

There is also a possibility that in some circuits the presence of the adapter may disturb the operation of the circuit. Because the schematic diagram must be consulted to determine what voltage should be present at a given tube terminal, the riser number can be noted at the same time. A given riser is actually easier to locate than a given terminal on a tube socket. The module unit is larger than the average tube socket, and there is a mark on the chassis for identification of the numbering system of the risers. So with everything taken into account, making measurements in a modular chassis will probably be no more time consuming than in a conventionally wired receiver.

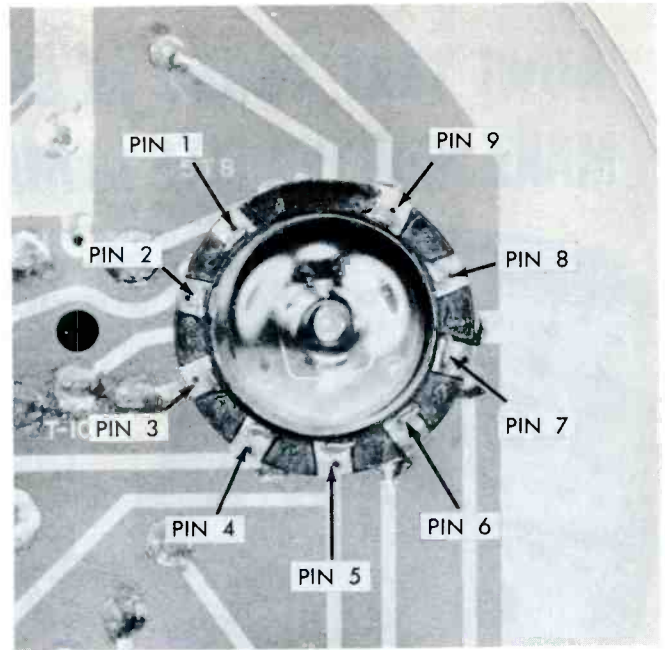

**Fig. 3B.** A Tube-Socket Adapter Inserted to Facilitate Measurements at the Tube Pins.

## 2. Lack of Attachment Points for Clip Leads.

There is another problem which is peculiar to a modular receiver employing a printed-wiring board. In Fig. 4A, a technician is trying to attach a test lead to a riser wire. Because of the fact that very little wire protrudes from the module, it is very difficult to get the test clip to support the weight of the test lead. This problem can be overcome by using a short piece of wire and soldering it into the circuit so that it can be used as a test point. See Fig. 4B. Be sure to use a minimum of heat when soldering the wire to the printed-wiring board. In most cases, the wire will

not need to be removed after the servicing job is completed.

The sample modular receiver which was used to determine the problems encountered in servicing this type of set is not a production model. It is very probable that a receiver manufacturer may incorporate such test points in his receivers. If this is done, there should be no problem concerning attachment points for test leads.

## 3. False Indications Arising Because of Interaction Between Stages.

In any receiver, interaction between stages may make it difficult

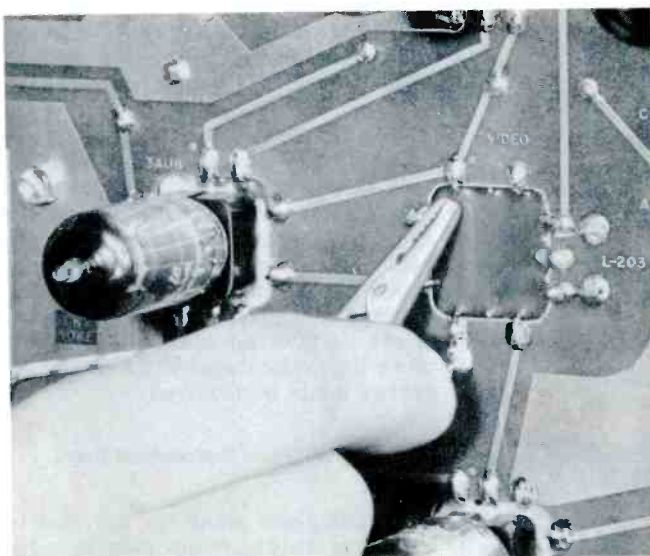

**Fig. 4A.** Test Clip Is Difficult to Attach to Terminal Because of Short Length of Riser Wire.

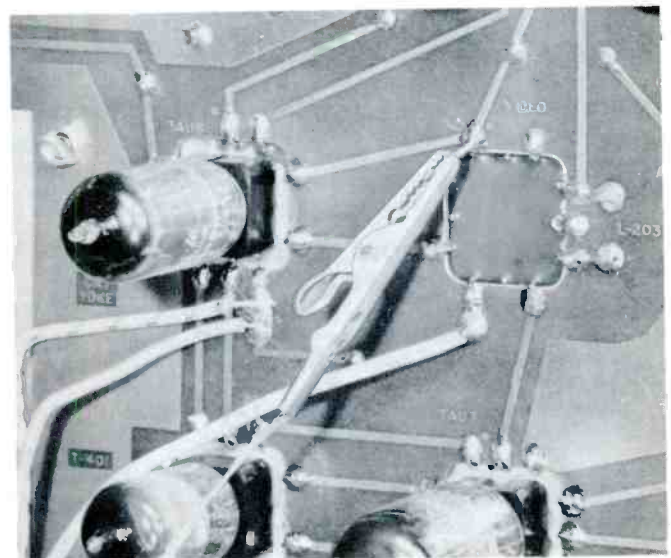

**Fig. 4B.** The Addition of a Short Piece of Wire Makes Possible a Connection to a Test Point.

# NOW! TEST TUBES IN SECONDS! MAKE NEW PROFITS *in MINUTES!*



on every  
service call



**B&K** NEW PORTABLE  
**DYNA-QUIK** MODEL 500  
DYNAMIC MUTUAL CONDUCTANCE TUBE TESTER

ONLY  
**\$109<sup>95</sup>**  
NET

Now you can easily cut servicing time—make more on-the-spot tube sales—prevent costly call-backs—and give a better service guarantee! **DYNA-QUIK**—the new top quality, low cost, portable tester quickly locates all weak and in-operative tubes—and easily does the complete job with laboratory accuracy right in the home! You create greater customer confidence because your customer sees for himself the true tube condition. Easy to operate—in just a few minutes you can quickly check all the tubes in a TV set. You can depend upon **DYNA-QUIK** because it tests under the dynamic heavily loaded conditions that are the actual operating conditions of the set. At such low cost **DYNA-QUIK** quickly pays for itself—and continues to make money for you every day!

### **DYNA-QUIK DOES IT FASTER, EASIER, MORE ACCURATELY**

- Makes complete tube test in as little as 12 seconds per tube—faster than any other tester!
- One switch tests everything! No multiple switching—no roll chart.
- Laboratory accuracy right in the home! Large 4½" plastic meter has two scales calibrated 0-6,000 and 0-18,000 micromhos.
- Shows customer true tube condition and life expectancy on "Good-Bad" scale!
- Automatic line compensation! Special bridge continuously monitors line voltage.
- 7-pin and 9-pin straighteners mounted on panel!
- Never Obsolete! New overlay panels with up-to-date markings available from factory, when required.

## TESTS 99%

OF ALL TUBES\*  
in use today for:

**DYNAMIC  
MUTUAL CONDUCTANCE  
SHORTS  
GRID EMISSION  
GAS CONTENT  
LEAKAGE  
LIFE EXPECTANCY**

\*Including new 600 mil series tubes.

### **PORTABLE—CAN BE USED ANYWHERE**

Handsome, rugged, luggage style carrying case, covered in durable, black leatherette. Removable slip-hinged cover. Size: 15½ x 14½ x 5¾ in. For 105-125 volts, 60 cycle, A.C. Net wt. 12 lbs.

**SEND FOR BULLETIN 500**

Made by the makers of  
the famous CRT 350



**B & K MANUFACTURING CO.**  
3726 N. SOUTHPORT, CHICAGO 13

to determine which stage is defective. In a conventional receiver, individual components can be disconnected and tested in order to isolate the defective stage or component. Although some elements in a module can be individually tested, the task is rather difficult; therefore, every effort should be made to make sure that a module is defective before it is removed. The removal of a module entails the clipping of the riser wires, and the module can no longer be used. If a module that is operating normally is mistakenly removed, both time and material have been wasted.

To illustrate a case in which this might happen, let us suppose that a receiver is overloading. The AGC stage might be suspected since it will be supplying improper AGC voltage to the video IF stages. The trouble, however, might be in the video amplifier stage; and unless the proper measurements of the signals being fed to the AGC stage are made, improper diagnosis might result. The technician may remove the AGC module and replace it only to find that the trouble still exists. There are other stages in which a similar situation might present itself; but through proper voltage and waveform measurements, there should be little difficulty in determining which stage is not operating properly. The main thing to remember is to refrain from making a snap decision without considering all of the defects which could be present in other stages.

#### **4. Good Elements in a Module Must Be Replaced Along with Bad Ones.**

The replacement of a modular stage actually results in the replacement of several elements. Although there are definite advantages in doing this, it may seem that such a replacement would be more expensive and thus objectionable to the customer. If, however, the program outlined for the merchandising and distribution of replacement modules works out as planned, the prices of module units will be very modest. In fact, there will be very little additional charge over that normally charged for the replacement of two or three components. As mentioned previously, the replacement of the complete stage offers definite advantages and should more than offset what little additional charge might be involved.

#### **5. Unavailability of Replacement Units.**

Complete plans for the distribution of replacement module units have not yet been decided because the use of modules is a new technique. It is very probable that set manufacturers



will distribute the replacement modules for their receivers through their regular channels. It is also very probable that the manufacturers of replacement parts will also make available module units for the various receivers.

Aerovox Corporation has already announced that certain modules will be available from them. Although it is not known at this time the exact nature of their line of replacement modules, it appears that they will soon be setting up a merchandising program for modules. After several receiver manufacturers incorporate module units in their receivers, the replacement-parts industry will show increased interest and several parts manufacturers may produce complete lines of replacement units.

### Techniques of Servicing

In order to illustrate the techniques of servicing modular receivers, let us simulate some troubles and go through the process required to isolate the faulty module. As when servicing the ordinary type of receiver, always substitute new tubes for the ones in the suspected stages before starting any other servicing. Keep in mind that some circuits are interacting and that trouble in one section may produce symptoms which might appear as trouble in another section. By sound reasoning, reduce the number of suspected modules to a minimum.

#### Trouble No. 1

For trouble No. 1, suppose that a modular receiver has a raster and sound but no picture. These symptoms indicate that the trouble is in the video amplifier or in its associated circuits. The schematic diagram of this part of a modular receiver is shown in Fig. 5. Each of the modules can be identified by the letter in the upper left-hand corner of the box (drawn in dotted lines) enclosing the schematic diagram of each module. These letters have been arbitrarily assigned to the modules. In actual practice, the modules will probably be identified by part numbers in much the same manner that other components are identified.

An oscilloscope is the best instrument to use to isolate trouble of this nature. Since the cathode of the picture tube receives the video signal, this point was checked first; and no signal was found. The input signal to module J was checked at riser No. 10, and again no signal could be found. The input to module G was checked, and a video waveform was found at this point; therefore, the signal was being lost in module G.

**JUST ONE WILL DO...  
SO WHY BUY TWO?**

## AEROVOX TWIST-PRONG ELECTROLYTICS

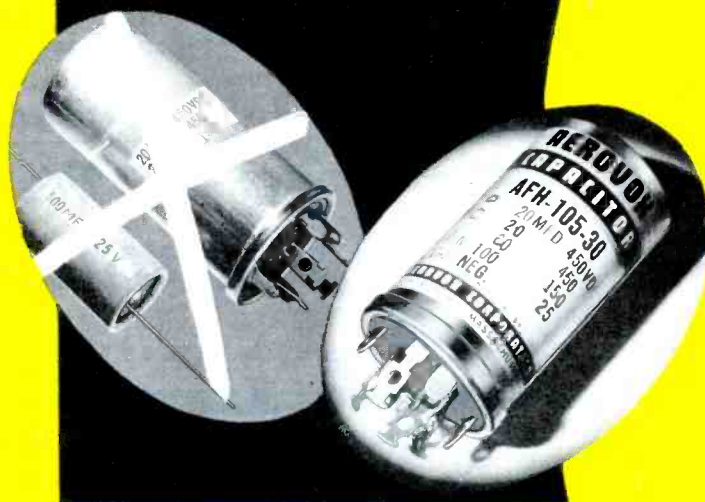

Voltages, capacitances, sections—in several hundred different combinations—go to meet today's twist-prong electrolytic capacitor replacement needs.

Such variety compounds the replacement headaches. Too bad the combinations are not kept to a minimum. But just so long as set designers insist on odd combinations, the replacements will have to include those combinations.

And so Aerovox faces the job squarely. Aerovox provides the biggest listing of twist-prong (Type AFH) electrolytics—by actual count, 290 to 345 more numbers than offered by any one of five competing brands. That is why Aerovox meets those replacement needs with single, economical, readily-installed units in place of multiple-unit makeshifts. And at considerably less cost!

Yes, ONE Aerovox will do... so why buy TWO from incomplete listings?

Ask your Aerovox distributor for copy of this handy pocket-sized AFH selector. Or write us.



## AEROVOX CORPORATION

DISTRIBUTOR SALES DIVISION,  
NEW BEDFORD, MASS.



In Canada: AEROVOX CANADA, LTD., Hamilton, Ont.  
Export: Ad. Auriema, 89 Broad St., New York, N. Y. • Cable: Auriema, N. Y.



**TELCOE-Z "SWINGIN" STAND-OFF**

Wood screw type, 3 1/2"; UHF-VHF.

No. EZ-8027 \$4.80 / C

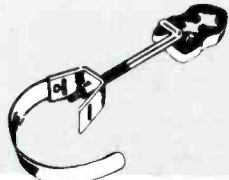

**TELCO E-Z "KANT-STRIP" STAND-OFF**

"Swing In" type; 3 1/2"; 9" strap.

No. EZ-8253 \$0.13

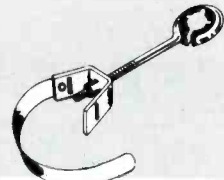

**TELCO "KANT-STRIP" STAND-OFF**

Round insulator; 3 1/2"; 9" strap.

No. 8253 NET \$0.11

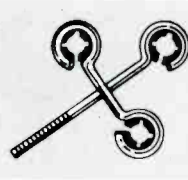

**TELCO 3-WAY STAND-OFF**

For 3-line use; 7 1/2"; wood screw.

No. 8397 NET \$0.21



**TELCO NUT-TYPE STAND-OFF**

Welded 10-23 nut; 3 1/2"; 9" strap.

No. 8253-N \$0.12

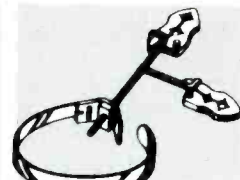

**TELCO E-Z NUT-TYPE STAND-OFF**

Tougher, inline duplex; 7 1/2"; 9" strap.

No. EZ-8258-N \$0.24



**TELCO CHIMNEY QUICK MOUNT**

Easy to install, complete.

No. 8005 NET \$1.35

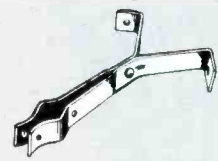

**TELCO SNAP-IN CHIMNEY MOUNT**

Fits masts to 1 3/4"; complete.

No. 8610 NET \$1.71



**TELCO PEAK MOUNT**

Masts to 1 3/4"; 30" lower support.

No. 8625 NET \$2.37

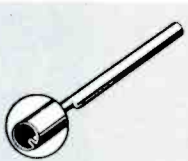

**TELCO GALVANIZED ANTENNA MASTS**

1 1/4" OD x 5"; crimped end.

No. 9013 NET \$0.78

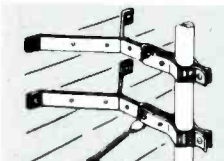

**TELCO DELUXE SNAP-IN WALL MOUNT**

Extra sturdy; 12" clearance.

No. 8312 NET \$2.10



**TELCO UNIVERSAL LIGHTNING ARRESTOR**

Easy to install; UL approved.

No. 8642 NET \$0.75



**TELCO UHF-VHF GLOBE-TENNA**

Handsome 12" globe plus built-in antenna.

No. A-9265 \$11.97

*Ask For These*

# SERVICE AIDS

*...at Your Jobber*



**TELCO UHF-VHF LIGHTNING ARRESTOR**

Universal type; UL approved.

No. 9242 NET \$0.42

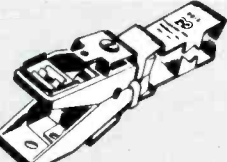

**TELCO 3-WAY TV LINE KLIP**

For straight, side or plug-in.

No. 9015 NET \$0.12

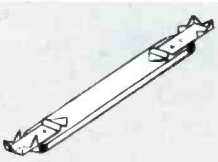

**TELCO LOW-LOSS LINE KLIP**

All one piece, plastic, metal ends.

No. 9055 NET \$0.15

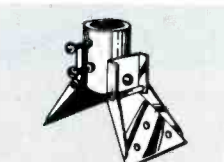

**TELCO HINGED TYPE RIDGE MOUNT**

Fits masts to 1 1/2"; assembled.

No. 9021 NET \$1.17

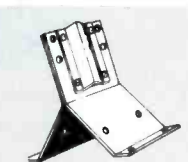

**TELCO ALL-PURPOSE MAST BRACKET**

Fits masts to 1 3/4"; use everywhere.

No. 8575 NET \$1.65

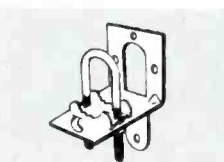

**TELCO MAST HANDY MOUNT**

For masts to 1 1/2"; extra support.

No. 8800-U \$0.33

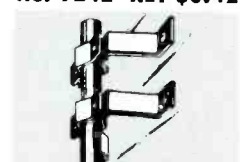

**TELCO SPECIAL WALL MOUNT**

For close-in (4") mounting.

No. 9241 NET \$0.45

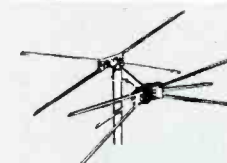

**TELCO MASTER-LINE VHF CONICAL ANTENNA**

Single bay, 10 element; all-channel.

No. A-8700 \$4.20

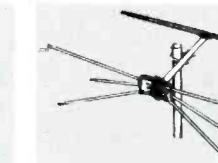

**TELCO RANGER COLOR CONICAL ANTENNA**

Single bay, 8 element; VHF-UHF.

No. A-110 NET \$3.45

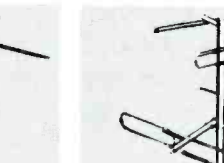

**TELCO HI-LOW DIPOLE ANTENNA**

VHF, covers channels 2 to 13.

No. A-250 NET \$4.41

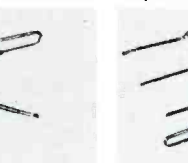

**TELCO 5 ELEMENT VHF YAGI ANTENNA**

12 models, custom cut to each.

No. A-302 Ch. 2 \$7.35  
No. A-313 Ch. 13 4.35

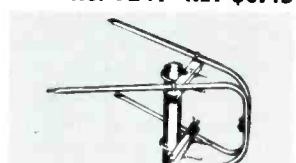

**TELCO UHF-VHF DOUBLE V ANTENNA**

Covers channels 2 through 83.

No. A-9017 \$3.15

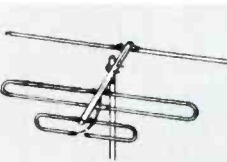

**TELCO VHF INLINE ANTENNA**

Channels 2-13; 3/8" seamless elements.

No. A-9046 NET \$5.97



**TELCO INDOOR UHF-VHF ANTENNA**

DeLuxe brass, nickel-plated elements.

No. A-8160-TP \$2.97

**FREE!**

Your copy of the complete, illustrated TELCO Catalog. Send postcard today.



# TELEVISION HARDWARE MFG. CO.

Division of General Cement Mfg. Co.

919 TAYLOR AVENUE • ROCKFORD, ILLINOIS



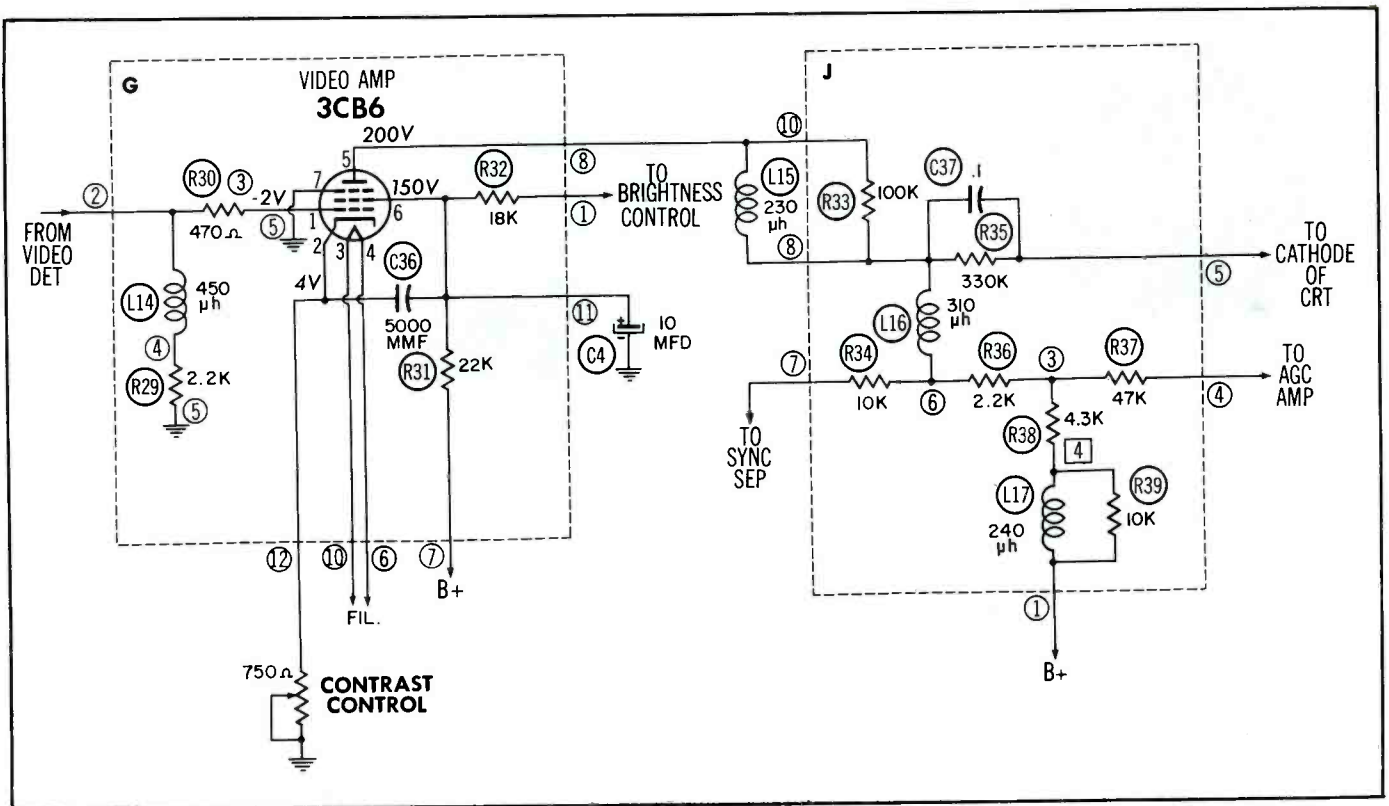

Fig. 5. A Video-Amplifier Stage and Coupling Circuit Incorporated in Two Modules.

A first assumption might be that module G is faulty and should be changed. Some additional checks should be made, however, since there are two components which are mounted externally to this module yet are associated with it. These components are the capacitor C4 which is connected

to riser No. 11 and the contrast control which is connected to riser No. 12.

Both of these components were checked and found to be satisfactory. A check at riser No. 7 showed that B+ voltage was being applied to the screen circuit. Normal plate voltage was

present at riser No. 8. The module was definitely faulty; and when it was changed, proper operation of the receiver was restored.

**Trouble No. 2**

The second trouble was evident as a complete loss of synchronization,

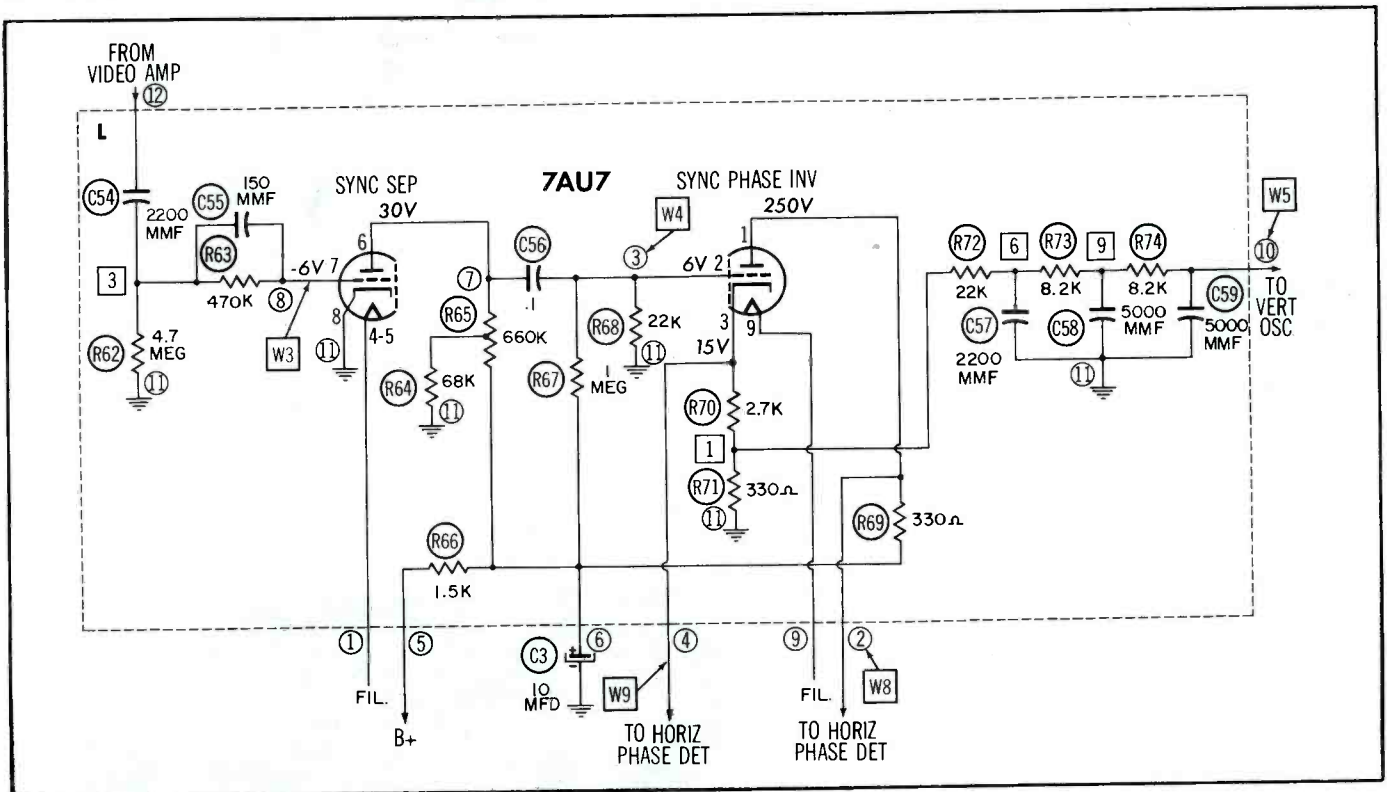

Fig. 6. A Complete Sync Circuit That Is Contained in One Module.

# Hycon

...where  
accuracy  
counts

## MODEL 617 3" OSCILLOSCOPE



The general purpose scope that gives you most for your dollar... has *flat face* CRT for usable trace edge to edge. It combines laboratory accuracy with ruggedness and compactness that makes it ideal for field service...

**VERTICAL AMPLIFIER**  
Frequency Response: 6 cps to 4.5 mc  $\pm 1$  db  
Sensitivity: .01 v/in rms  
Input Impedance: 1 megohm, 35 mmf ( $\pm 2$  mmf) over entire range of attenuator

**HORIZONTAL AMPLIFIER**  
Frequency Response: 6 cps to 500 kc  $\pm 3$  db  
Sensitivity: .075 v/in rms  
Input Impedance: 1 megohm

**SWEEP RANGES**  
15 cycles to 100 kc

Television V & H frequencies  
60 cycle, variable phase

**CALIBRATION**  
Internal 60 cps square-wave 0.05 to 150 volts peak-to-peak  $\pm 5\%$

**SYNCHRONIZATION**  
Internal, external, positive, negative or AC line

**POWER REQUIREMENTS**  
115 volts, 60 cycles, 100 watts

**SIZE...WEIGHT**  
8 $\frac{1}{2}$ " x 11" x 10 $\frac{3}{4}$ "... 22 lbs.



## MODEL 616 COLOR BAR/DOT GENERATOR

...for adjusting and testing color receivers and transmitting equipment by manufacturer, station or serviceman. Features: Seven output forms of bars, dots, cross-hatch, phase and color-difference signals, including NTSC color bars. Panel presentation shows actual color and sequence of generator output...

**SIGNAL OUTPUTS:**  
Composite video... either phase... adjustable 0 to 1.5 volts peak-to-peak across 75 ohms  
RF... 10,000 microvolts fixed level... optional channel 3 or 4... crystal controlled... modulated sound carrier  
Sync in or out

**TYPES OF SIGNAL:**  
Vertical bars... variable from 15 to 20  
Horizontal bars... variable from 10 to 15  
Cross-hatch... variable as above

Dots... variable as above  
Color Bars:  
"A"... NTSC colors (Phase accuracy  $\pm 5^\circ$ ... luminance and chrominance amplitude held to  $\pm 10\%$ )  
"B"... G-Y at  $90^\circ$ ... R-Y... B-Y... Black... R-Y and B-Y within  $\pm 1^\circ$  of quadrature  
"C"... Black... I... Q... Black... I and Q within  $\pm 1^\circ$  of quadrature

**PHYSICAL CHARACTERISTICS:**  
Power: approximately 125 watts  
Size: 8 $\frac{1}{2}$ " x 11" x 10 $\frac{3}{4}$ "  
Weight: approximately 22 lbs.



## MODEL 622 5" OSCILLOSCOPE

A new oscilloscope concept... *automatic triggered sweep*. Simplifies adjustments, makes synchronization positive. Special CRT has flat face for usable trace edge to edge. One of today's most advanced TV servicing aids...

**VERTICAL AMPLIFIER**  
Frequency Response: 6 cps to 6 mc  $\pm 3$  db; down less than 0.5 db @ 4 mc  
Sensitivity: 10 mv rms (28 mv peak-to-peak) per inch  
Input Impedance: 1 megohm, 40 mmf ( $\pm 2$  mmf) over entire attenuator range

**HORIZONTAL AMPLIFIER**  
Frequency Response: 1.5 cps to 500 kc  $\pm 3$  db  
Sensitivity: 75 mv rms (210 mv peak-to-peak) per inch  
Input Impedance: 100k, 25 mmf

**SWEEP CHARACTERISTICS**  
Usable writing speed... 0.03 sec/in to .3  $\mu$ sec/in

Ranges...  
a. 10 cps to 300 kc  
b. Preset V & H television @ 7875 and 30 cps  
c. 60 cps, variable phase line  
Type... automatic triggered or straight triggered (by switching)

**SYNCHRONIZATION**  
Internal, external, positive, negative or AC line

**CALIBRATION**  
Internal 60 cps square-wave .05 volts peak-to-peak  $\pm 3\%$

**POWER REQUIREMENTS**  
115 volts, 60 cycles, 175 watts

**SIZE...WEIGHT**  
13 $\frac{3}{8}$ " x 10 $\frac{1}{2}$ " x 18 $\frac{3}{4}$ "... 32 lbs.

## MODEL 614 VTVM



Convenience at unprecedented low cost sums up this rugged, serviceable instrument. It's lightweight, versatile. Probes stow inside case, ready for instant use...

**RANGES**  
DC: 0-1.5, 5, 15, 50, 150, 500, 1500 volts  
AC: 0-1.5, 5, 15, 50, 150, 500, 1500 volts rms (with associated peak-to-peak scales)  
Ohms: 0-1000 megohms in seven ranges

**INPUT IMPEDANCE**  
11 megohms

**FREQUENCY RESPONSE**  
Direct Probe: 30 cps - 3 mc

Crystal Probe: 50 kc - 250 mc

**INDICATOR**  
6 $\frac{1}{2}$ " meter

**ACCURACY**  
DC and ohms: 3%... AC: 5%

**POWER REQUIREMENTS**  
115 volts, 60 cycles, 6 watts

**SIZE...WEIGHT**  
8 $\frac{1}{2}$ " x 11" x 7 $\frac{1}{2}$ "... 10 lbs.

You can find Hycon electronic test instruments at your local parts jobber.

# Hycon Mfg. Company

2961 EAST COLORADO STREET  
PASADENA 8, CALIFORNIA



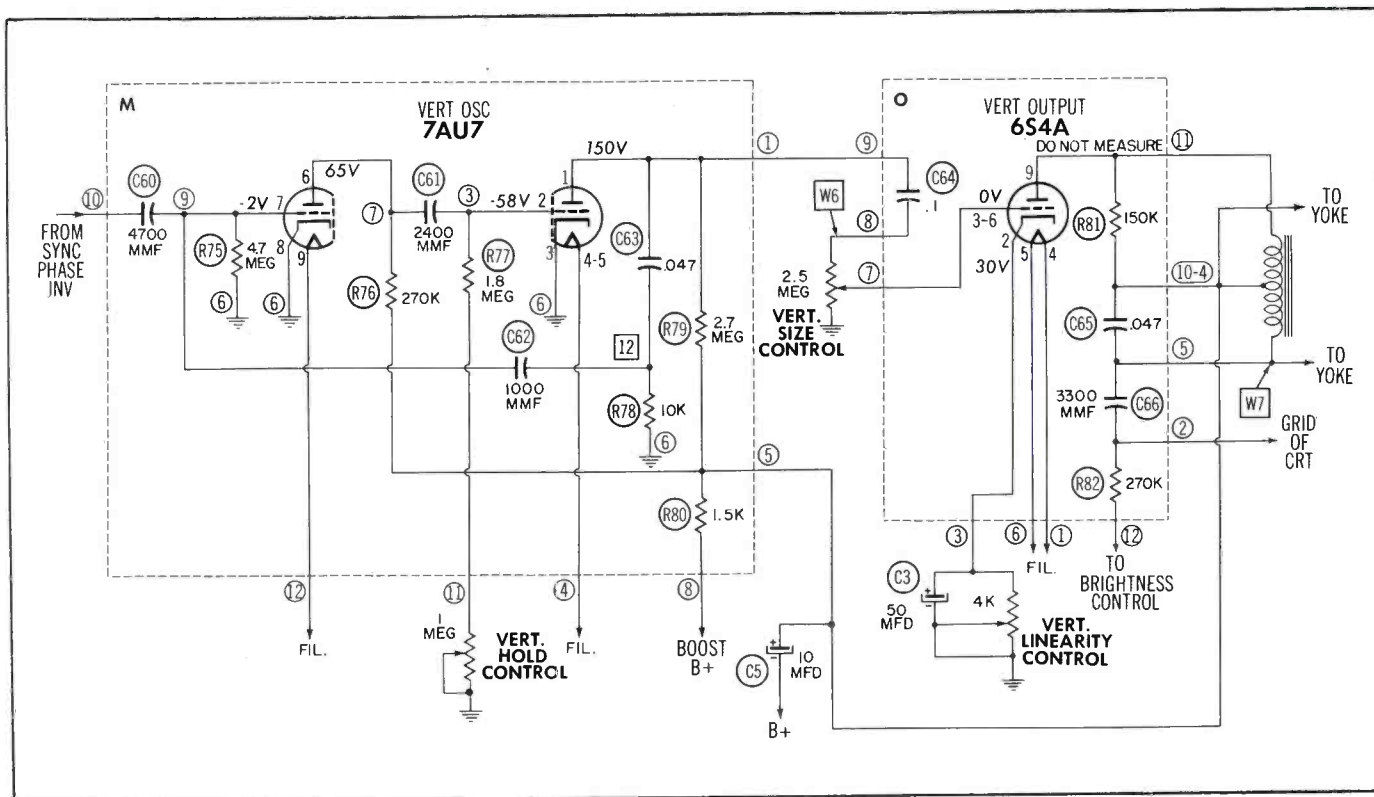

Fig. 7. The Vertical-Oscillator and Vertical-Output Stages of a Modular Receiver.

both vertically and horizontally. The sync circuit for this receiver was contained in one module, and the schematic diagram of this module is shown in Fig. 6. An oscilloscope was used to determine whether or not the composite video signal was being applied to riser No. 12. Another check

the capacitor had to be replaced. The receiver operated properly after they were replaced.

### Trouble No. 3

The third trouble was nonlinearity of the vertical sweep. The schematic diagrams of the vertical-oscillator and vertical-output modules are shown in Fig. 7. An oscilloscope was used to check the linearity of the input waveform to the output module. This check was made at riser No. 8 of module O, and it revealed that the signal was low in amplitude. Compare the two waveforms in Fig. 8. Waveform A represents the signal that was present at riser No. 8, and waveform B is a normal signal. The loss in amplitude is evident.

the type of construction with which most service technicians are familiar. Basically, however, the procedures for trouble shooting are not changed for the modular receiver — just the mechanics involved in following the procedures are different. It is probable that the first one or two

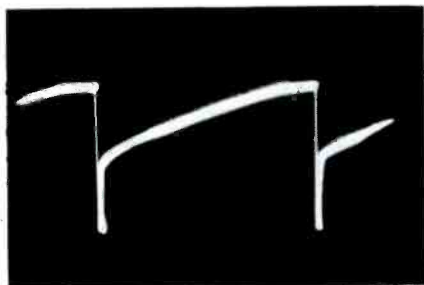

Fig. 8A. Vertical-Drive Signal in a Defective Receiver.

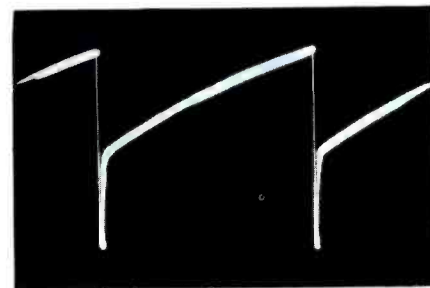

Fig. 8B. Vertical-Drive Signal in a Receiver That Is Operating Normally.

showed B+ voltage at riser No. 5. During the process of checking capacitor C3 which was connected to riser No. 6, it was found that there was no voltage on this riser. The capacitor was found to be shorted.

As a precautionary measure, the value of resistor R66 which was inside the module was checked by measuring between risers No. 5 and No. 6. The resistor was found to be open, and this meant that the module as well as

The distortion in the waveform just mentioned could be caused by a trouble in module M or in module O. Since capacitor C64 is the only module-O component which could cause the distortion in this case, it was checked first and proved to be all right. The B+ voltage at riser No. 5 of module M and the boost voltage at riser No. 8 were checked and were found to be satisfactory; therefore, module M had to be faulty. It was replaced, and proper operation of the receiver was restored.

modular receivers brought in for service will require a technician to spend a little extra time; nevertheless, after this first exposure to modules, the technician will soon find that servicing modular receivers is no more difficult than servicing conventional receivers.

### Summary

Modular construction in TV receivers is new and different from

WILLIAM E. BURKE

and

W. W. HENSLER

## Dollar & Sense Servicing

(Continued from page 31)

**SYNTHESIZER.** From our phonograph now comes true electronic music — "Oh, Holy Night" in the style of an organ and created by a team of engineers under the direction of Dr. H. F. Olson at RCA's famous Princeton laboratory. The music is on a new, experimental 12-inch microgroove RCA Victor record (LM-1922) along with six other familiar selections created synthetically note by note for each instrument. The music is excellent with one exception — being an engineer, we just don't care for another engineer's conception of the music of "Home, Sweet Home." Sure do like "Nola" in the style of an imaginary piano, though, and the Foster medleys in the style of a hillbilly band.

On the other side of the record is a step-by-step explanation of how each type of musical sound is synthesized, starting with a piano. We plunked the proper key on our piano as each synthetic note was called off and played, but the piano notes were consistently high. This means that the record-changer motor needs to be oiled or replaced, unless perchance the local power company's generators were running a bit slow

under their peak evening load on that hot and humid summer day.

After demonstrating pitch, the narrator on the record in turn describes and demonstrates loudness, timbre, and time, along with growth, duration, decay, portamento, waveform, vibrato, and all the other characteristics that make up sounds. The individual sounds are then put together step by step until suddenly it becomes music. Truly it is a fascinating short course in music and should have wide appeal in schools in addition to showing off the capabilities of a high-fidelity system (didn't hear a thing from ours when the record put forth a pure 32,703-cps note).

To create the music, engineers punch holes in wide paper tape to give coded instructions for each of the ten tone characteristics desired at each instant. The tape is then run through the machine, and the resulting electrical output is fed to the cutting head of a recorder.

An early attempt at synthesizing the human voice, also included on the record, shows that man still has a long way to go in creating artificially the sounds we humans make with our mouths.

Chief practical use for the RCA electronic music synthesizer is expected to be in creating great new music having new fields of tone and rhythm. Operation of the machine demands diligence, patience, and a high degree of musical ability; hence, it is expected to provide new jobs for composers, arrangers, and artists who may have passed their prime as concert performers. No manual dexterity is needed.



**THE EYE.** To see reactions of passengers riding in a new operator-less elevator, an industrial TV camera was concealed in the roof of the elevator. Delegates to a Cincinnati convention of building owners and managers watched the results on closed-circuit receivers.

To see if TV can replace spotting planes or helicopters in locating traffic jams, Detroit is trying out closed-circuit equipment for scanning traffic on its express-highway system. The cameras feed monitor receivers through Bell System circuits.

John Markus



## Here is your answer to small parts storage problems

Superior features keep Equipto all-steel units out front! 54 different type small parts can be stored in this single drawer unit by using the two adjustable dividers in each drawer. Spacious drawers have king-size handle and slide easily on embossed runners. Enclosed sides and bottom prevent escape of parts and jamming of drawer. Tank-strong construction. Rugged shelf beneath each row of drawers. For use individually, in stacks, under counters, or in shelving. Available in 8 to 108 drawer units. Olive green baked enamel. Write today for full details.

**Equipto**

Division of  
Aurora Equipment Company

830 Prairie Avenue, Aurora, Illinois  
Steel Shelving . . . Parts Bins . . . Drawer Units

**XCELITE Hand Tools**  
PREFERRED BY THE EXPERTS

SLICK AS A WHISTLE

and twice as tough!

XCELITE CHROME-PLATED PLIERS

You've got drop forged strength—proper design and workmanship—plus a "honey" of a finish that will STAY bright—when you have a set of these chrome-plated pliers! And there's an XCELITE plier for most any job you do—in chrome or standard finish. Why not ask your supplier to show 'em to you—see if they aren't the slickest work-savers you've seen yet!

XCELITE, INCORPORATED  
DEPT. Q  
ORCHARD PARK, N. Y.

No. 51C  
LONG NOSE  
SIDE CUTTER

No. 58C  
RADIO-TV  
PLIER

No. 66C  
6-IN.  
DIAGONAL  
PLIER

For Originality  
LOOK TO XCELITE



## Radiation Detectors

(Continued from page 13)

filtered by R5 and C4 and is applied to the envelope of the Geiger tube.

Regulation of the output voltage of the power supply is accomplished by the feedback network consisting of resistors R6 through R12, R4, and the neon bulb M2. This network determines a voltage which is a small percentage of the output voltage. This small negative voltage is applied as a bias to the grid of V1. There is also a small positive voltage applied to the grid of V1, and this is regulated by the firing voltage of the neon bulb M2.

When the output voltage of the supply rises, the negative voltage on the grid also rises. The conduction of V1 is lowered, and the output voltage is lowered to the proper point. If the output voltage of the supply were to decrease, the negative voltage on the grid would decrease; tube conduction would increase; and the output voltage would increase to the proper point.

The current pulses produced by the Geiger tube flow through R13 and generate voltage pulses which are applied to a single-shot multivibrator circuit composed of V3 and V4. The multivibrator generates one output pulse for each input pulse, and the output pulses are of constant amplitude. In effect then, the Geiger-tube pulses (which can vary in amplitude because of variations in the high voltage) are traded for pulses of constant amplitude. In this way, the meter produces equal deflection for all pulses; and the accuracy of the Geiger counter is improved.

The output circuit of the multivibrator contains the meter M4 and the neon bulb M3 which is on the front panel and which flashes in the presence of radiation. The pulses appearing at the plate of V4 are coupled through M3, and they charge C10. The meter reads the charge on C10 and gives an indication of the amount of radiation.

The time-constant switch S2 inserts a resistor in series with the meter when the switch is in the SLOW position. The meter then indicates the average value of the charges applied to C10. When the switch is in the FAST position, the meter indicates the instantaneous value of the charge on C10. The time-constant switch S2 indexes at 60 degrees. When the switch is actuated, the center wiper makes only momentary contact in order to discharge C10.

## Just off the press!

Centralab Pocket-Edition  
Control Guide No. 2

**Handy, revised workbook  
lists new Centralab wirewound  
dual control replacements**



Brand-new, revised edition.  
Handy size, 3 $\frac{3}{4}$ " x 8 $\frac{1}{4}$ ".

Lists Centralab replacements by  
manufacturers' part numbers —  
for TV, radio, audio, auto radio.

Saves you time and money — yet costs less  
than a package of cigarettes!

Order a copy for yourself and each of your  
men. Get from your Centralab distributor —  
or order direct from

# Centralab

A Division of Globe-Union Inc.

942J E. Keefe Ave., Milwaukee 1, Wisconsin

- Enclosed is \$1.00 for the next five editions  
of the pocket control guide.  
 Enclosed is 20 cents for the current edition  
only. (Paste coins securely to cardboard.)

Name \_\_\_\_\_  
Company \_\_\_\_\_  
Address \_\_\_\_\_  
City \_\_\_\_\_ Zone \_\_\_\_\_ State \_\_\_\_\_

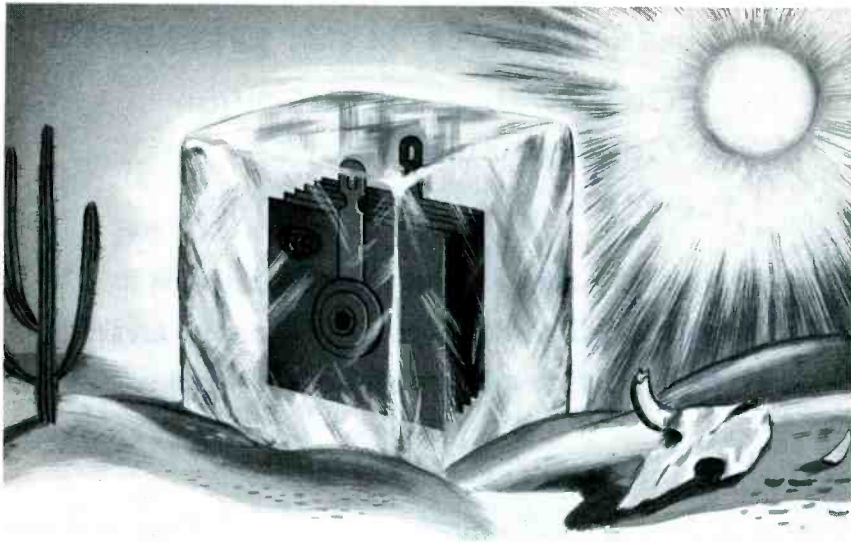

***They beat the heat in the  
sizzling southwest!***

**RADIO RECEPTOR**

**selenium rectifiers with  
"safe centers"**

Intense heat, humidity and blazing sunshine down in south Texas are *murder* on ordinary rectifiers. That's what servicemen at J. B. Penny Co., Inc., of Houston find every day when they check over ailing radio and TV sets. There's a simple solution, though. Replacements are invariably Radio Receptor rectifiers with the famous "Safe Centers."

"We've been using Radio Receptor rectifiers for over two years," says Mr. Penny, "because they take our extremes of temperature and humidity in stride, where other brands won't stand up. In our shop, selenium rectifiers are always replaced with Radio Receptor units."

The "Safe Center" feature in RRco. rectifiers means cool January performance right through the hottest months of summer. It eliminates arc-over danger, short circuits and heating at the center contact point — *Complete* protection during mounting and when in use.

You can bet on those bright green RRco. rectifiers for a sure thing, next time you need replacements. Insist on them when you order from your jobber.

**For latest information on the Radio  
Receptor rectifier line write today  
to Dept. PF.**



*Semi-Conductor Division*  
**RADIO RECEPTOR COMPANY, INC.**

*In Radio and Electronics Since 1922*

SALES OFFICE: 251 WEST 19th STREET, NEW YORK 11  
WAtkins 4-3633 • Factories in Brooklyn, N. Y.



**Fig. 4. Precision Model 111B De Luxe  
Scintillator.**



**Fig. 5. Internal Construction of Model 111B.**



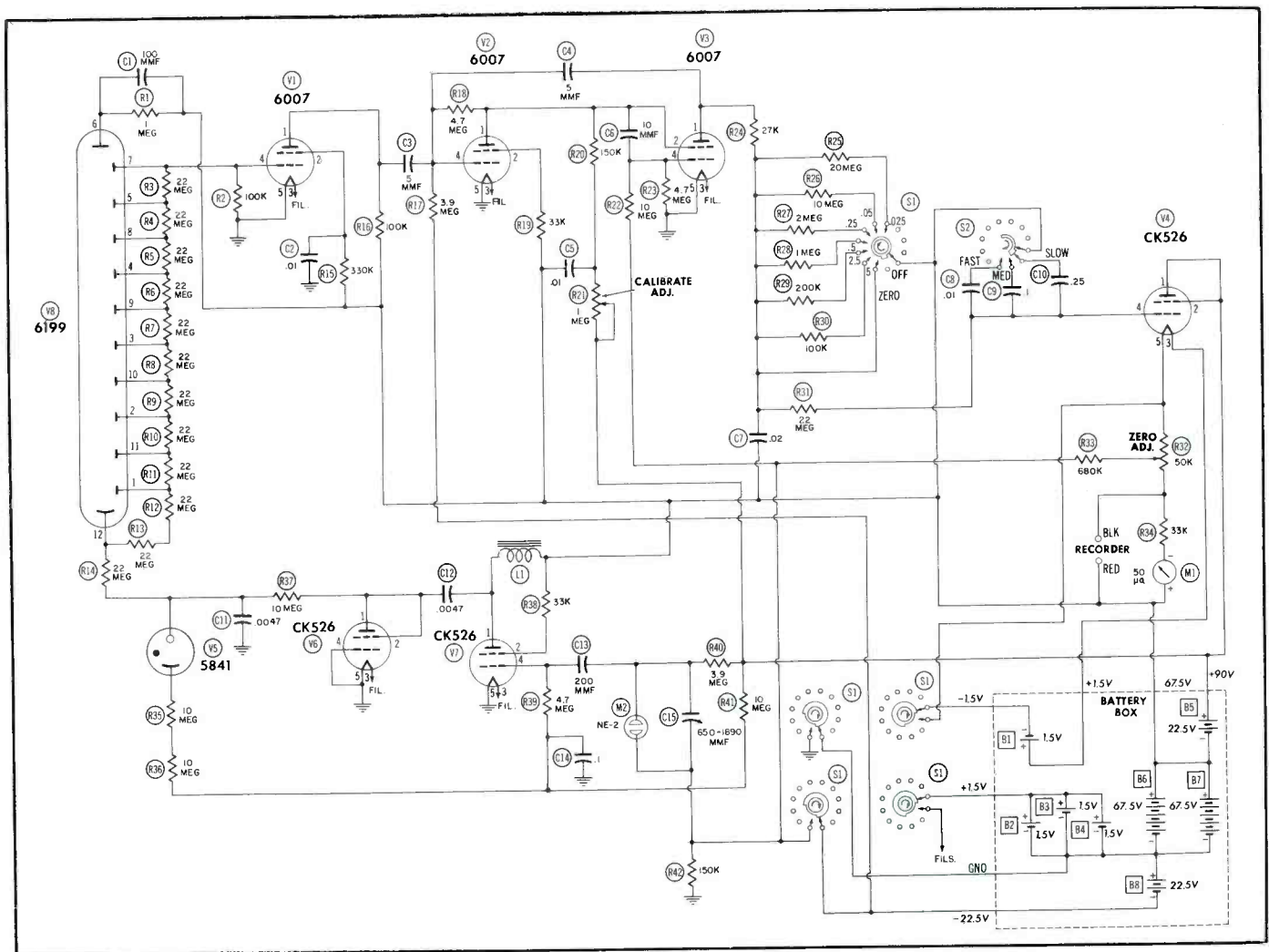

Fig. 6. Schematic Diagram of the Model 111B.

### Scintillation Counter

The operation of a scintillation counter depends upon the fact that radiation will produce minute flashes of light within some crystalline materials. The most active material for the crystal is sodium iodide to which has been added a small amount of thallium so that the fluorescence will be shifted into the spectral region which is most easily detected by a photomultiplier tube.

The crystal in a scintillation counter is optically coupled to a photomultiplier tube. Such a tube consists of a cathode, one or more dynodes, and a plate. The material of which the cathode is made is photosensitive — electrons are given off when light strikes the material. The electrons are accelerated and focused into a beam and are attracted by the positive charge on the first dynode.

The dynodes are made of a material having high secondary-electron emission. For each electron striking the dynode, two or more electrons are emitted. The electron

beam is directed from dynode to dynode and gains electrons from each one. The plate of the tube collects all of the electrons and applies them to the external circuit. In modern photomultiplier tubes having ten dynodes, amplification factors of one million to one are possible.

The photomultiplier tube is sensitive to electrostatic and electromagnetic fields and to external light. For this reason, the tube and crystal are covered by a metal shield which is thin enough to admit the radiation.

One pulse is produced in the external circuit for each particle of radiation which strikes the crystal, but these pulses have various amplitudes. Just as in the Geiger counter, the pulses are used to trigger a single-shot multivibrator. The meter measures the average rate of arrival of these pulses and produces a reading equivalent to the radiation intensity.

A typical scintillation counter is shown in Fig. 4. This is Model 111B manufactured by Precision Radiation Instruments, Inc. Two

internal views of the instrument are shown in Fig. 5, and the schematic diagram is shown in Fig. 6. The photomultiplier tube V8 is supplied with 1,000 volts by the power supply consisting of V6 and V7. The power supply is almost identical to that used in the Model 107C except that a cold-cathode, voltage-regulator tube V5 is used instead of the feedback network.

The output of the power supply is -1,000 volts. The ten dynodes are connected to a voltage divider (R3 through R13) so that each dynode is about 100 volts more positive than the one before it. The output signal from V8 is taken from the last dynode, is amplified by V1, and is applied to the single-shot multivibrator consisting of V2 and V3. Tube V4 is connected as a cathode follower and drives the indicating meter.

### Servicing

Since these instruments are battery operated, the batteries should be the first suspects when an instrument is inoperative. Of course, if the owner of the instrument says that he

has just changed the batteries, the instrument itself will have to be checked. Remove the instrument from its case, and check the filaments of all the tubes. If the tubes are of the subminiature type and are wired into the circuit, it will be necessary to unsolder one of the filament leads.

No matter what type of tubes are used in the instrument, do not attempt to measure filament resistance directly. Always connect a 1,000-ohm resistor in series with the meter leads. This resistor limits the

current through the filament and will prevent a burnout. The meter will indicate the value of this resistor and not the actual resistance of the filament, but this is unimportant because an indication of continuity is all that is necessary.

If the power supply is of the electronic type, check to see that the neon bulb (M1 in Fig. 3 or M2 in Fig. 6) in the relaxation oscillator is lit and that it is firing at the proper voltage. These bulbs deteriorate with age and occasionally require replacement.

Using an electrostatic voltmeter, measure the high-voltage output of the power supply. A conventional voltmeter or a VTVM will not give correct readings and should not be used.

Connect an oscilloscope across the load resistor (R13 in Fig. 3) of the Geiger tube. Expose the tube to radiation from the radioactive sample supplied with the counter, and check to see if voltage pulses are appearing across the load resistor. Conventional servicing techniques can then be applied to the multivibrator circuit.

Most Geiger tubes have a limit on their useful life, and it is usually expressed as a life of so many counts. This means that one tube will last long enough to count one hundred million particles and another may last to count ten billion particles. These counts are the usual limits for Geiger tubes. Some new Geiger tubes are designed to have a practically infinite life.

The photomultiplier tube and the scintillation counter can be checked by connecting an oscilloscope to the point from which the output signal is derived. This point would be at the last dynode in the Model 111B, but it could be at the plate in other counters.

If at all possible, the instruction book for the instrument undergoing repair should be consulted. This book will usually give hints on servicing procedures such as (1) adjusting the high voltage, (2) replacing the batteries, and (3) adjusting calibration. Each type of instrument requires different procedures, and no one procedure can be given here to cover all instruments.

In addition, the instruction book will usually contain the warranty and the conditions under which it applies. Many manufacturers will not guarantee the instrument if someone other than a factory-authorized repairman does the repair work. Such is the case with instruments manufactured by Precision Radiation Instruments, Inc. If any instrument is brought in for repair and it is found that the unit is still in warranty, the technician should point out that the instrument should be taken to a factory-authorized shop for repair. If the instrument is not in warranty, repairs can be made and charged for in the same manner as that for any piece of equipment.

#### General Discussion

There are many other possible types of power supplies which can be

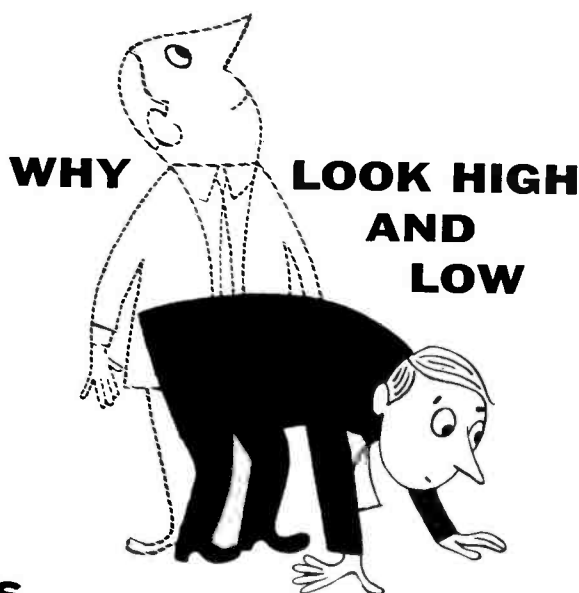

## C-D IS THE ONLY COMPLETE LINE OF ELECTROLYTICS

No matter what you need in electrolytic capacitors—C-D has it. Every type, shape and rating . . . all of consistent high quality proven by outstanding field performance. C-D capacitors are always reliable . . . and readily available—because Distributors *who know*, carry the complete Cornell-Dubilier line.

Free! TV Capacitor "Replacement Guide"—and C-D Twist Prong Cross Index from your C-D Distributor. He's listed in your local Classified Telephone Directory.

C-D's "UP" twist prong

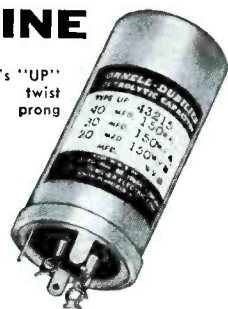

C-D's Blue Beaver

There are more C-D capacitors in use today than any other make.



CONSISTENTLY DEPENDABLE  
**CORNELL-DUBILIER CAPACITORS**

PLANTS IN SOUTH PLAINFIELD, N. J.; NEW BEDFORD, WORCESTER AND CAMBRIDGE, MASS.; PROVIDENCE AND HOPE VALLEY, R. I.; INDIANAPOLIS, IND.; SANFORD AND FUQUAY SPRINGS, N. C.; SUBSIDIARY: THE RADIART CORPORATION, CLEVELAND, O.



used in either the Geiger or scintillation counter. The most common of these is probably a battery supply. There are miniature 300-volt batteries which are used in a great number of such instruments.

Since the operating voltages of various Geiger tubes may range from 300 to 1,500 volts or higher, various combinations of batteries may be encountered. A 300-volt Geiger tube

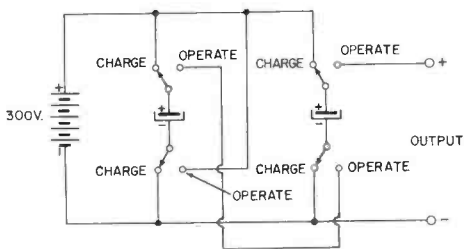

Fig. 7. Schematic Diagram of Voltage-Tripler Circuit.

will use one battery. A 900-volt Geiger tube could use three 300-volt batteries; or to reduce the weight of the instrument, one battery and two capacitors could be used.

The schematic diagram in Fig. 7 shows how this combination

could be wired. When the switch is in the charging position, the two capacitors are connected in parallel with the batteries and are charged to the voltage of the battery. In the operating position, the switch connects the battery and both capacitors in series and an output of 900 volts is obtained.

The Geiger tube will operate properly only as long as the applied voltage stays at the proper value. The charge on the capacitors diminishes as the Geiger tube operates, and the voltage to the tube also diminishes. For this reason, the counter will operate for only a short time for each movement of the switch.

Many instruments use a power supply consisting of a low-voltage battery, a vibrator, and a step-up transformer. The schematic diagram for such a supply is shown in Fig. 8. The high-voltage pulses produced when the contacts open are rectified and filtered. This voltage is then supplied to the Geiger tube.

In order to diminish the drain on the battery in a supply of this type, the filter capacitor C2 is usually of large value, and a push switch is connected in series with the battery lead.

The switch is depressed for a few seconds while the capacitor is being charged. The charge is sufficient to operate the counter for one or two minutes, and then the button is pushed again.

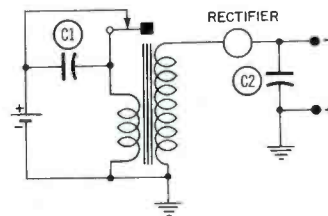

Fig. 8. Schematic Diagram of Vibrator Power Supply.

It is hoped that this article has brought out the similarities between the servicing of radiation-detecting instruments and the servicing of radio and television receivers. We think that the income that could be gained by entering the field will far outweigh the investment which would be necessary, particularly in those areas in which many radiation instruments are in use.

WILLIAM E. BURKE

*at your fingertips . . .*

CLEAR BEAM'S

**5**

**"EASY WAY" ANSWERS  
FOR TOUGH FRINGE  
INSTALLATIONS!**

**B CLEAR BEAM** ANTENNA CORP.

CANOGA PARK, CALIF. • CHICAGO, ILL.

Your Clear Beam distributor has all 5 antennas — contact him today!

It's an established fact (and you know it, too) that no one antenna can lick every fringe area problem.

In view of this, Clear Beam manufactures five different types of fringe antennas — each tops in its field!

All five Clear Beam fringe antennas provide easy installation, improved picture quality and happy customers.

One of the five is the tailor-made answer to your installation headaches — and a faster way to higher profits!

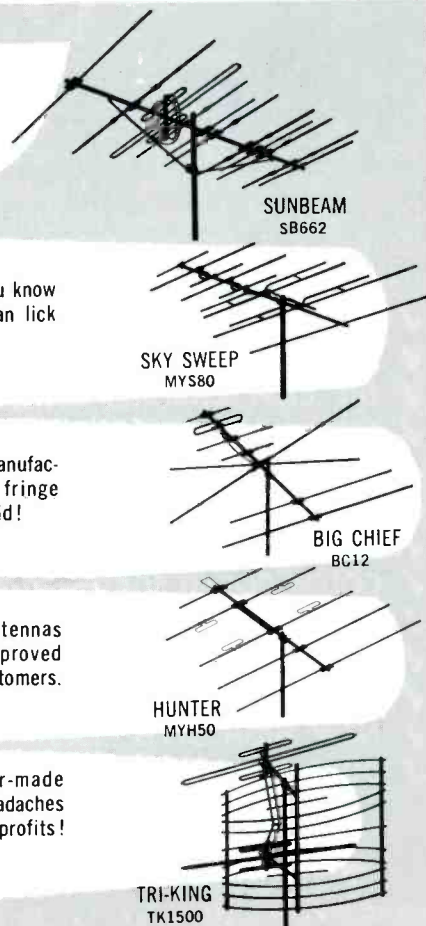

your KEY  
TO EXCELLENCE

phaostron

"777"

NEW!



The MODEL "777" VTVM is a completely self-contained, ready-to-use test instrument. Its accessories and the HF co-ax cable, DC Probe, AC line cord and instruction book **all fit** in the genuine California Saddle Leather carrying case that is furnished with the instrument.

- ✓ 42 UNDUPLICATED RANGES
- ✓ ILLUMINATED DIAL (5000 hour self-contained lamps)
- ✓ DIE CAST CHROME FINISHED BEZEL
- ✓ METAL CASE—unbreakable, ultra compact
- ✓ DOUBLY SHIELDED, time proven 200 microamp movement
- ✓ PERMANENT ACCURACY . . . 3% DC, 5% AC
- ✓ LARGE, EASY TO READ SCALES 4-7/8" LONG
- ✓ COLOR CODED SCALES: green-ohms; black-AC, DC; red-P. to P.
- ✓ 2 ZERO CENTER SCALES for FM DISCRIMINATOR ALIGNMENT
- ✓ SEPARATE RANGE and FUNCTION SWITCHES
- ✓ ONLY 2 JACKS for ALL MEASUREMENTS
- ✓ NEW HIGH STYLE, EASY-TO-USE CHROME BAR KNOBS
- ✓ DUAL PURPOSE HANDLE also serves as AC line cord reel

**\$69.95**

"777" VTVM complete with  
Coaxial Cables DC Probes and Leather Case  
at your PARTS DISTRIBUTOR

PHAOSTRON COMPANY • 151 PASADENA AVE. • SOUTH PASADENA, CALIF., U.S.A.

## Circuits in Ampex Model 600 Tape Recorder

(Continued from 27)

phone recording-level control R1 which is a 250K-ohm potentiometer. The signal is then applied through C8 and R15 to the grid (pin No. 7) of the recording amplifier V2B.

The 12AY7 tube V2 is a low-noise nonmicrophonic dual-triode tube designed for use in low-level stages.

### Line Input

The line input (the phono jack shown in Fig. 2) is for use with a signal from a source such as a tuner, phono preamplifier, crystal phono cartridge, TV receiver, or tape recorder that provides a signal that is flat and of comparatively high level (0.5 volt). The signal is fed through the line recording-level control R2 and through R16 to the grid (pin No. 2) of V2B.

Because of this arrangement, both of the signals will be applied to the grid (pin No. 7) of the recording amplifier V2B if signals are fed into the microphone input and into the line input. The amount and the proportion depend upon the settings of the recording-level controls R1 and R2.

### Recording Amplifier

The signal from the output of the recording amplifier V2B is fed to the remaining recording-amplifier stages; it is also fed to the output amplifier for monitoring when the MONITOR SELECTOR switch is in the TAPE position. REC. CAL (recording calibration) control R3 is a 250K-ohm potentiometer used in calibrating the VU meter so that identical readings will be obtained in both positions (INPUT or TAPE) of the monitor-selector switch.

In the discussion about the characteristics of magnetic recording, the fact was mentioned that high-frequency equalization is accomplished during recording by boosting the high frequencies a sufficient amount to compensate for the tendency of the recording process to roll off high frequencies. This equalization is supplied in the Model 600 by the network composed of R20, R21, R22, C11, and C12 in the grid circuit of V3A and by the network including C14, C15, and L2 in the cathode circuit of V3B. The networks develop the desired effect largely by reducing the low-frequency response the necessary amount. The amount of equalization can be varied by adjusting the recording-equalization trimmer capacitor C11.



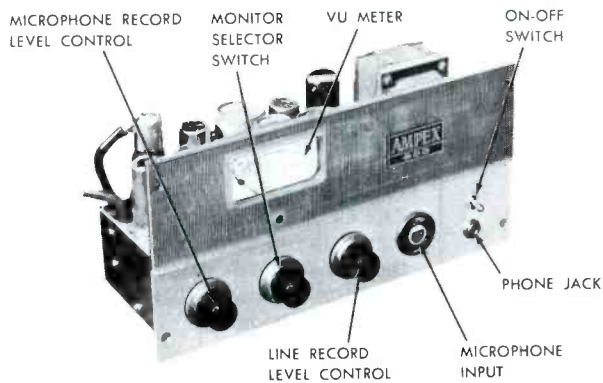

Fig. 1. Front View of Electronic Chassis of Ampex Model 600.

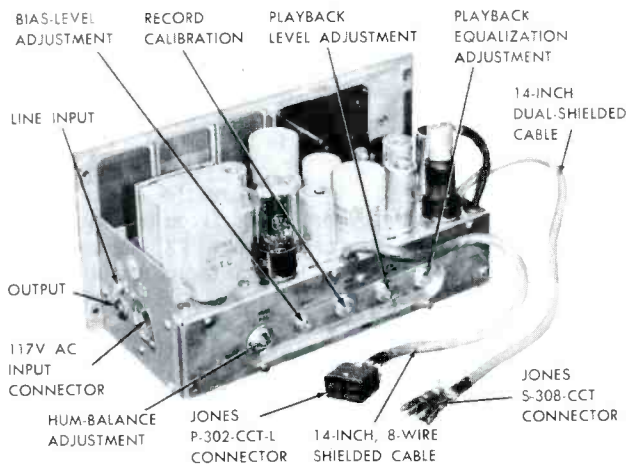

Fig. 2. Rear View of Electronic Chassis of Ampex Model 600.

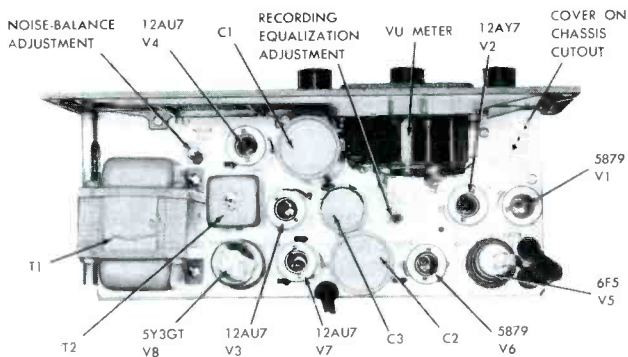

Fig. 3. Top View of Electronic Chassis of Ampex Model 600.

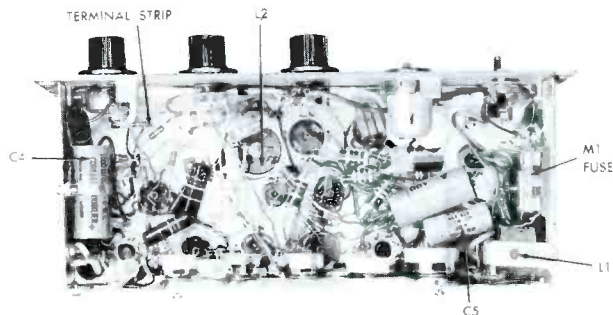

Fig. 4. Bottom View of Electronic Chassis of Ampex Model 600.

and NOW a **NEW**



**ERIE**  
**CERAMICON®**  
**TV SERVICE**  
*Kit*

ORDER  
*Now*  
from your  
**ERIE**  
**DISTRIBUTOR**

*Here's* **WHAT YOU GET**

- 1** 63 High Stability ERIE Disc or Tubular Ceramicons
- 2** 18 Popular Values
- 3** Handy, Convenient 18 Section Plastic Storage Case
- 4** Exceptional Value

*Here's* **WHAT YOU SAVE**

	REGULAR PRICE
63 Piece ERIE Ceramicon Assortment.....	\$15.00
18 Section Plastic Case.....	1.75
	<i>Total Value</i> \$16.75
<b>YOU PAY</b> .....	<b>\$10.65</b>
<b>YOU SAVE</b> .....	<b>\$ 6.10</b>

**ERIE**  
*Electronics*

ERIE ELECTRONICS DISTRIBUTOR DIVISION  
ERIE RESISTOR CORPORATION  
Main Offices: ERIE, PA.  
Factories: ERIE, PA. • LONDON, ENGLAND • TRENTON, ONTARIO

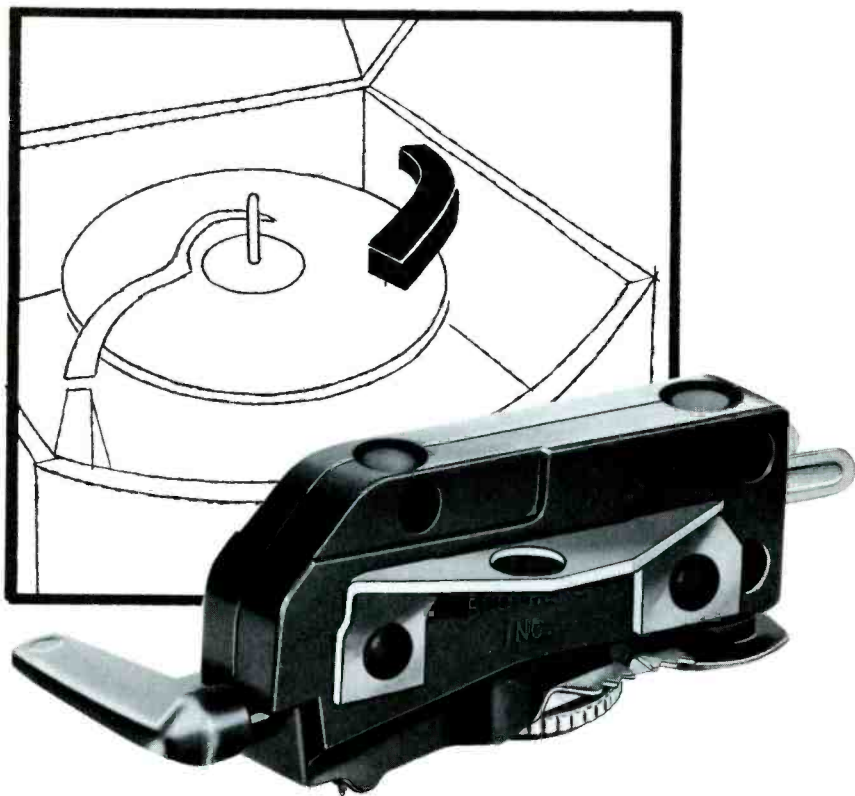

It's Dramatically New!

## SHURE 'TWIN-LEVER' Ceramic Phono Cartridge

The most important advance in phono replacement cartridges since the introduction of 3 speeds!

- To improve the quality of all conventional home phonographs!
- To replace 128 3-speed, plastic-cased, ceramic and crystal, turnover and single needle cartridges!

We make these strong claims: the "Twin-Lever" is the finest replacement cartridge ever developed! It sets a new high, leaving all other replacement cartridges far behind its brilliant level of tone superiority . . . individual needle compliance for superior 78 rpm and microgroove response . . . unique needle shift design . . . amazingly simple needle replacement.

The "Twin-Lever" offers you maximum replacement coverage with minimum investment because it handles the replacements for practically all 3-speed phonos using plastic-cased cartridges. New business and greater profits can be yours — because this "Twin-Lever" cartridge costs only \$9.50 list — yet it can make conventional 3-speed phonos sound better than when they were new!

See your Shure Distributor today — he has the "Twin-Lever" in stock. And here's a tip: *buy more than you think you will need* — or you'll have to go back for more mighty soon. That's how good this cartridge is. And don't take our word for it — ask your first "Twin-Lever" customer what *he* thinks!

### MODEL WC10

List Price **\$9.50**

(including two synthesized sapphire-tipped needles)

### MODEL WC10D

List Price **\$34.00**

(including a 1-mil diamond-tipped needle and a 3-mil synthesized sapphire-tipped needle)



----- The Mark of Quality

The signal is fed from the plate (pin No. 1) of the recording amplifier V3B, through C16, through the No. 1 contact of the 8-contact Jones connector, and to the record head. Plate voltage is applied to V3B only when the play-record switch M6 on the tape-transport chassis is in the RECORD position. Obviously, no signal is fed to the record head when the play-record switch is in the PLAY position because V3B is inoperative in that position.

### Bias and Erase Oscillator

In order to supply bias and erase current, a 12AU7 tube V4 is employed as a push-pull oscillator operating at a frequency of about 100 kilocycles. The oscillator functions only when the play-record switch is in the RECORD position because plate voltage is not applied to V4 when the switch is in the PLAY position.

A portion of the output of the oscillator is fed from the secondary of the transformer T2, through C18, through C17, and then into the circuit (which also carries the signal) to the record head to serve as recording bias. The amount of bias applied to the record head is adjusted by the bias-level trimmer capacitor C17.

Erase current is supplied to the erase head from the secondary of T2, through C18, and through the No. 3 contact of the 8-contact Jones connector. The amplitude of the current flowing through the erase head is many times greater than the amount used as bias in the record head. C17 is very effective in reducing the amount fed to the record head for bias.

The noise-balance control R6, a 10K-ohm potentiometer, is adjusted to balance the push-pull oscillator so that a symmetrical waveform will be produced. As explained in the discussion on bias and erase in previous issues, the waveforms of the bias and erase currents must be symmetrical or the resulting DC component will magnetize the tape instead of leaving it in a neutral or demagnetized state. Tape should be in a demagnetized condition when a signal is recorded upon it because recording on a magnetized tape produces a noisy recording.

The operation and adjustment of the oscillator were discussed in the second article of this series which appeared in the December 1954 issue of the PF REPORTER.

### PLAYBACK CHANNEL

The playback channel makes use of two playback-amplifier stages and two output-amplifier stages. A Jones connector is mounted on the



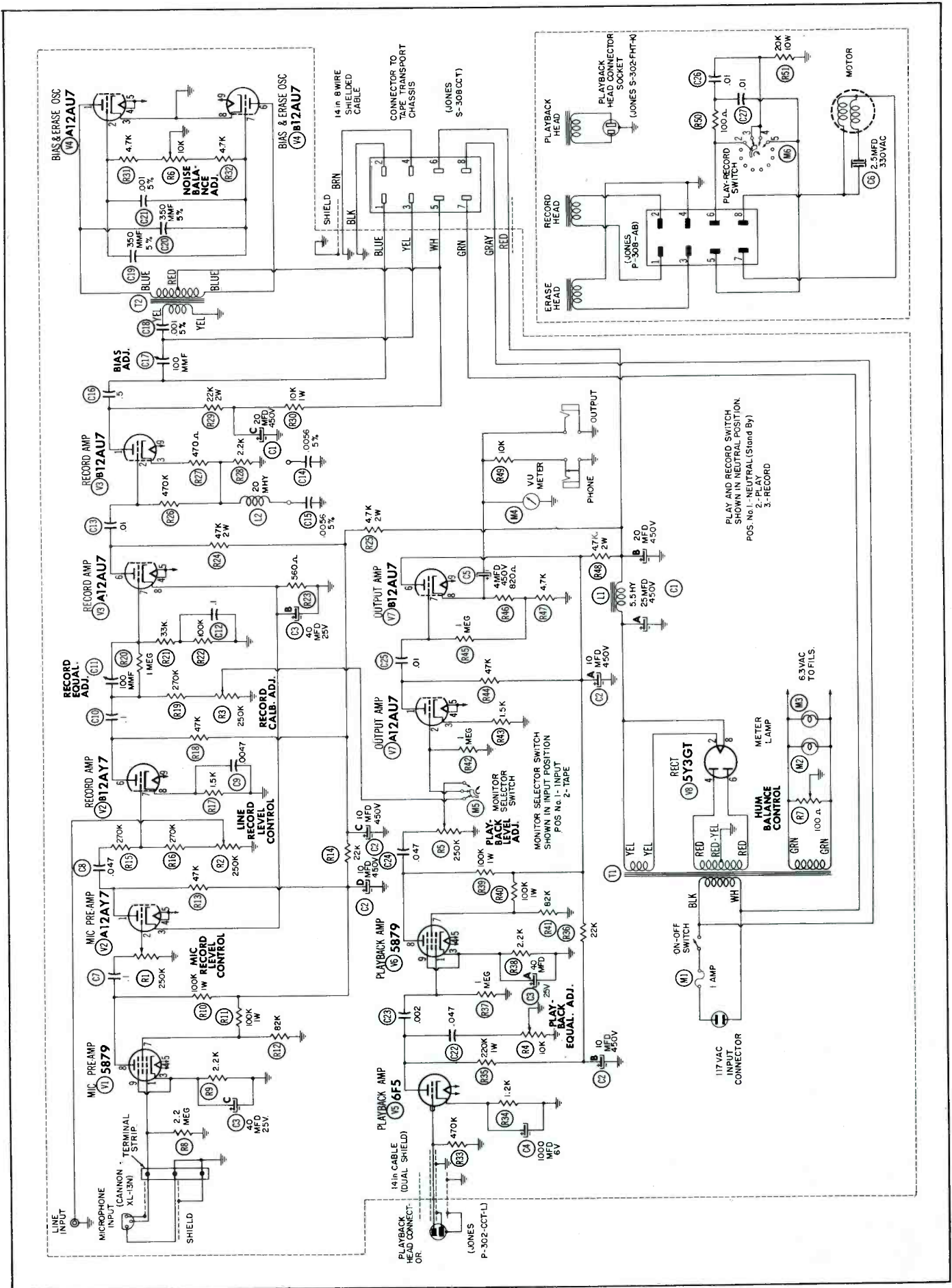

Fig. 5. Schematic Diagram of Ampex Model 600 Circuits.

# SAHARA PACK SURE STARTS!



New SAHARA-PACK dry-air canning process reduces moisture inside the vibrator during manufacture! No moisture is present to condense on tungsten points causing corrosion during shipping and storage! SAHARA-PACK eliminates early-life failures, assures low-voltage SURE STARTS!



# VOKAR

VOKAR VIBRATORS  
preferred by  
leading manufacturers  
of auto-radios.

VOKAR CORPORATION • DEXTER 1, MICHIGAN

underside of the head assembly (on the tape-transport chassis); consequently, very short leads can be run to the playback head. The Jones connector on the 14-inch dual-shielded cable is plugged into the connector on the head assembly in order that the signal may be fed from the playback head to the grid of V5. The 6F5 tube V5 used in the first playback-amplifier stage is a high-mu triode with a top cap connection to the grid. This connection permits isolation of the grid circuit from other signal and heater leads to avoid unwanted feedback and hum. The cathode-bypass capacitor C4 of this stage is large (100 microfarads) which size aids in maintaining a good low-frequency response.

In fact, it is interesting to note that cathode-bypass capacitors are employed in the majority of the stages throughout the circuit, but very little negative feedback is used.

C20 and R4 produce the low-frequency boost required in playback circuits by rolling off the high frequencies. This equalization is made variable by R4, which is a 10K-ohm potentiometer that serves as the playback-equalization control.

The second playback-amplifier stage uses a 5879 tube V6 which is the same type as that used in the first microphone-preamplifier stage V1.

A 250K-ohm potentiometer R5 is the playback-level control which is adjusted to feed the correct amount of signal through the monitor-selector switch to the grid (pin No. 2) of the first output-amplifier tube V7A. Control R5 (a "screwdriver" adjustment) is set to give the same playback level on the VU meter as the level used when the tape was recorded. This adjustment point is important because no panel control is provided for the adjustment of playback level. The playback-level control and the recording-calibration control are adjusted so that identical readings will be obtained on the VU meter for both positions of the monitor-selector switch while a recording is being made.

V7B in the second output-amplifier stage is operated as a cathode follower and is designed to work into an impedance of not less than 10,000 ohms. The output taken from the open-circuit jack can be connected to the inputs provided on most control units and amplifiers because their input impedances are usually much higher than 10,000 ohms. If it is necessary to feed the signal to a 600-ohm line, a suitable matching or bridging transformer or some type



of impedance-matching arrangement should be used.

The closed-circuit jack marked PHONES is used when monitoring. The channel to be monitored is selected by the use of the monitor-selector switch; and monitoring is accomplished through the use of high-impedance headphones, the VU meter, or any auxiliary equipment connected to the output jack. Since there are separate record and playback heads, the signal can be monitored while the recording is in progress if the monitor-selector switch is set in the TAPE position. When the monitor-selector switch is set in the INPUT position, the incoming signal that is being recorded, can be monitored.

If the ON-OFF switch is turned on so that the amplifier circuits are operating and the monitor-selector switch is set in the INPUT position, the incoming signal from either or both input channels can be monitored even though the recorder is not operating in the record or playback modes. This is a convenient feature, because all controls can be adjusted properly before the tape-transport mechanism is started in the recording mode.

**POWER SUPPLY**

A conventional power supply using a 5Y3GT rectifier tube is included on this compact chassis. Good design, proper layout of parts, and adequate filtering are responsible in large part for the quiet, hum-free operation of the recorder.

All tube filaments are heated with AC, but hum is no problem. The use of suitable types of tubes and the 100-ohm hum-balance control R7 reduces hum to such a low level that we have been unable to detect it in the Model 600 recorders we have used.

**ROBERT B. DUNHAM**

**don't stand on your head!**

let the **MASTER** show you the easy way... see pg. 70



# WIN-TRONIX

## Makes Sweep and Sync Circuit Trouble-Shooting Easy! **LOW-COST DYNAMIC SWEEP CIRCUIT ANALYZER**

for  
Black-and-White TV  
and color too!  
only

**\$69<sup>95</sup>**

dealer net

Model 820

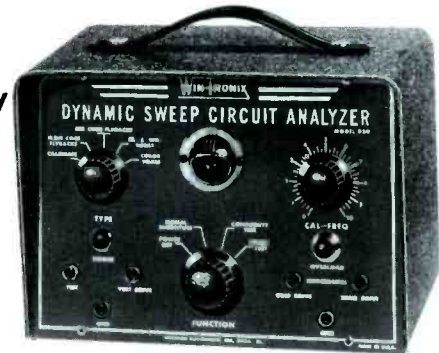

TWO INSTRUMENTS IN ONE

1. Horizontal and vertical sawtooth-square wave and sync pulse generator.
2. Complete compatible flyback and yoke tester.

**ISOLATE SWEEP/SYNC TROUBLES RAPIDLY IN FIVE EASY STEPS!!!**

**1. VERTICAL TROUBLESHOOTING**  
Inject 60 cps on vertical output grid from "vertical grid drive" jack.

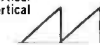

**2. HORIZONTAL TROUBLESHOOTING**  
Inject 15,734 cps on horizontal output grid from "horizontal grid drive" jack.



**3. HORIZONTAL TROUBLESHOOTING**  
Drive horizontal output xfmr directly from "xfmr drive" jack.



**4. COMPONENT TESTING**  
Test flyback transformer and deflection yoke in receiver with Model 820.

**5. SYNC CIRCUIT TROUBLESHOOTING**  
Inject vertical and horizontal sync pulses, stage by stage, in sync amplifiers, with accessory probes.

**SPECIFICATIONS**

Signal Outputs  
15,734 cps sawtooth and pulse adjustable.  
15,734 square wave adjustable.  
60 cps sawtooth locked to line.  
Overload indicator for safety and test.  
Oscillating neon indicator with D.C. amplifier for flyback/yoke test.  
Calibrated for color and black-and-white.  
Test leads supplied.  
Operates on 105-125 VAC.

**OTHER WIN-TRONIX LOW-COST TV TEST INSTRUMENTS—  
Buy Now for Bl. & Wh. Service—be ready for color!**

**WHITE DOT—Linearity Generator**



Model 160

**\$79.95**

**RAINBOW GENERATOR**



Model 150

Patent Pending **\$49.95**

**COMPATIBLE FIELD STRENGTH METER**



Model 330

**\$129.95**

**FLYBACK AND YOKE TESTER**



Model 810

**\$29.95**

- Compatible advanced design prevents obsolescence!
- Low cost with high quality!
- Portability!
- Standard warranty on all instruments!

**SEE YOUR PARTS JOBBER!  
WRITE FOR FREE LITERATURE!**

**COMPATIBLE CRYSTAL CALIBRATOR**



Model 120

**\$59.95**

# WINSTON ELECTRONICS, INC.

4312 Main St., Philadelphia 27, Pa.

the VOICE of AUTHORITY...  
**RAM** reports to Servicemen  
**on TV SWEEPS**

to help you do faster, easier, safer servicing

**Q.** How can I eliminate corona after flyback installation?

**A.** Eliminate all metallic sharp edges by resoldering to ball-shaped connections and apply anti-corona compound. Redress leads if necessary. Use conductive cement to eliminate poor RF grounding between core, mounting screw and TRUE ground connection.

**Q.** Can "ringing" still occur when an exact replacement yoke with recommended network is installed — and how do I correct this?

**A.** Yes, because the flyback and/or associated components have deteriorated from use and thus are no longer a perfect match to the original circuit. To minimize this condition, connect 5K carbon pot in series with capacitor connected across  $\frac{1}{2}$  of horizontal yoke winding. Vary until "ringing" disappears or is minimized. Measure resistance of pot and insert fixed resistor in its place.

**Q.** How can I increase width after flyback installation?

**A.** Add capacitor approximately 1000 v. rating across width coil. This lowers high voltage output. The higher the capacitance, the greater the width; this value can be increased until foldover results. Try capacitance range of .0001 to .001 mf. Other methods: replace horizontal output or low voltage rectifier tubes.

**Q.** What can I do to step up high voltage safely?

**A.** Move the low side of the 500 mmf HV capacitor, which is usually connected to ground, to plate of damper (or cathode, if it is autotransformer). Decrease flyback bias, increase horizontal drive, increase horizontal output screen voltage by reducing value of screen grid dropping resistor. CAUTION: Don't make any of these changes if horizontal output to cathode current exceeds the 85-100 ma recommended range (125 ma for "CD" types).

For over 10 years, Ram has specialized and pioneered in sweeps *exclusively*. Ram designs them, makes them, counsels TV set manufacturers on them, field-services them, educates Servicemen on them — leads the industry.

No one but Ram can bring you such proven data — in reports like these and in their Service Manual. In manufacturing know-how and field experience, you can depend on Ram for...

THE VOICE OF AUTHORITY IN SWEEPS

Watch for further late field reports.

FREE! Ram's 1955 Sweep Catalog & Service Manual. Write for Manual PF10



**RAM ELECTRONIC SALES CO.**  
 Irvington, New York

In Canada: Teleguide Mfg. Co., Ltd., Ontario  
 Export Dept.:  
 Dage Corp., 219 East 44th St., New York, N. Y.

## Troubles in Video IF and Detector Systems

(Continued from page 19)

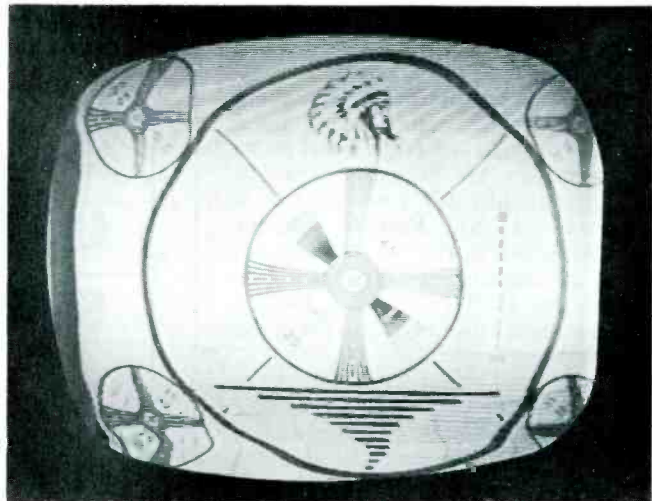

Fig. 8. Hum Bars Caused by Slight 120-Cycle Modulation.

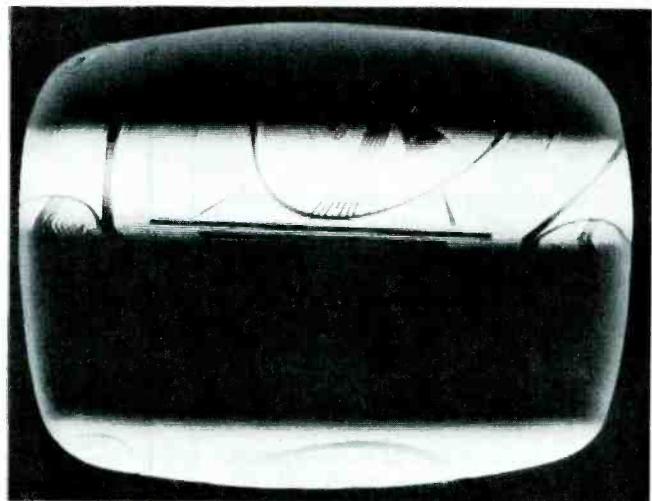

Fig. 9. Hum Bars Caused by Severe 120-Cycle Modulation.

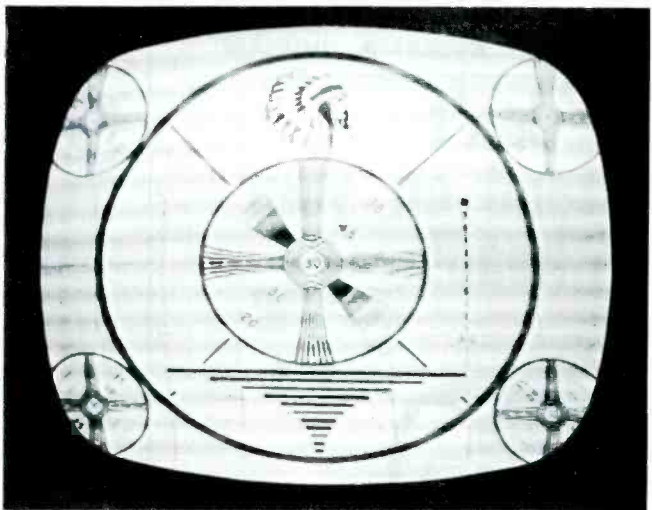

Fig. 10. Sound Bars in Picture.



The photograph of Fig. 8 illustrates picture bending and slight brightness modulation resulting from 120-cycle hum which produces two shaded areas and a two-cycle bend at the edge of the raster. This type of distortion usually originates from a ripple component of the B+ voltage from a full-wave power supply. The ripple voltage is capable of modulating the DC plate voltage supplied to the video section and can thus produce hum in the picture. Bending of the picture and raster can also occur if hum is picked up in the horizontal circuit and causes modulation of the sweep.

An oscilloscope is a valuable piece of test equipment when checking for the presence of 120-cycle ripple. A check of the B+ and AGC lines in the video IF section will reveal any unwanted signal that might be affecting the normal operation of these stages. If no hum is detected at these points, then the modulation is probably occurring in the sync or sweep circuits. The effect of a severe case of 120-cycle hum is shown in the photograph of Fig. 9.

There are other types of picture interference which may be mistakenly identified as hum. Fig. 10 shows a picture in which there are sound bars. These bars will vary in intensity and position according to the audio that is being transmitted. They are produced when the sound carrier receives too much amplification in the video IF stages. The sloping response in the IF stages causes the FM sound signal to be converted to an AM signal. The AM signal is coupled to the video detector, and the output of the detector contains audio frequencies which appear as bars in the picture. The most common cause for this condition is misalignment in the video IF strip.

Possible causes of hum in the picture are:

- a. Defective tubes.
- b. Open B+ filter or decoupling capacitor. (See C3B or C3C in Fig. 1.)
- c. Stray pickup caused by improper shielding in the IF and detector stages.

Heater-to-cathode leakage in one of the IF tubes will occasionally produce 60-cycle hum in both the picture and sound. If the defective tube is in the first video IF stage, the symptom will be more pronounced on account of the amplification of the following stages.

# Gives your customers brilliant results ...pays off for you!

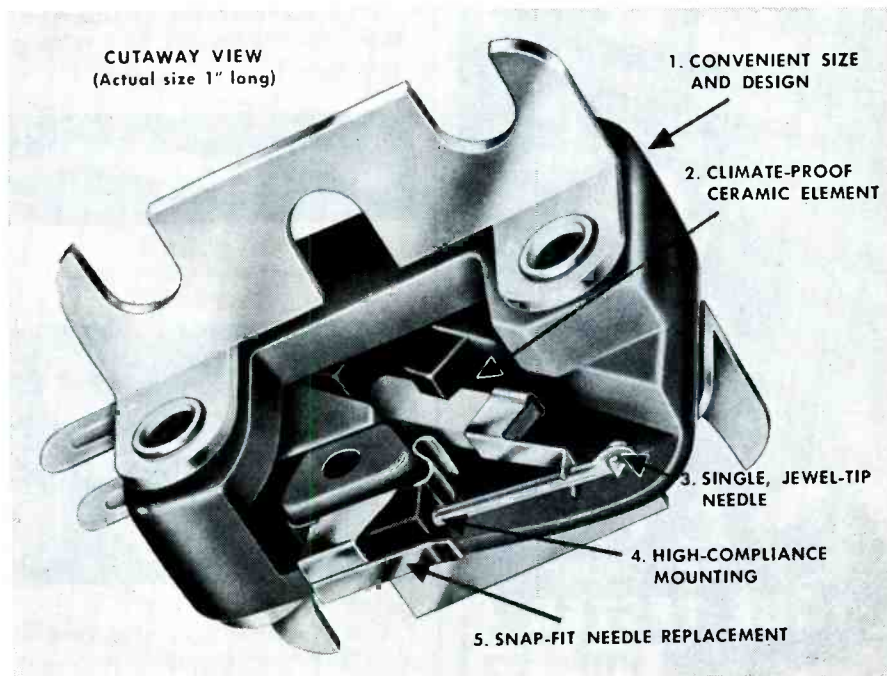

## New Sonotone 1P Cartridge

1. Easy to install. Just two models fit most arms now in use. Cartridge is less than 1" long, 8/10" wide with bracket. Time-saving hardware included.
2. Ceramic element gives flat response (see curve) — requires no preamplification or equalization. No deterioration problems as with other types...virtually immune to hum pickup.
3. Replaceable needle, diamond or sapphire. Models for 33-45 rpm, or 78 rpm.
4. Extreme lateral compliance and low-mass design give superior tracking, low wear.
5. Needles snap in, snap out easily.

### Tap the Huge 45 RPM Changer Market!

Install this new Sonotone 1P, and give your customers exciting, true, wide-range response. At one stroke, you make a good sale, cut installation time, avoid problems found with other types of cartridges...and build your reputation for quality work and professional advice. No other cartridge has all the advantages this 1P gives you! With sapphire, \$7.50; with diamond, \$25.00.

RESPONSE 30-15,000 ± 3 DB!

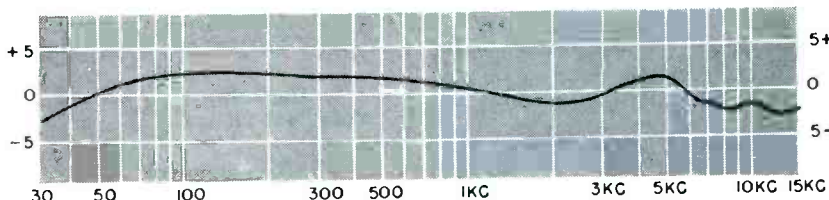

# SONOTONE CORPORATION

ELMSFORD, N. Y.

Write Dept. C P-105 for free Phono Modernization Manual

**INTRODUCING YOUR NEW PROFIT MAKER**

**SAVE SERVICE TIME SELL MORE TUBES**



**MODEL GCT-5**

# SECO

GRID CIRCUIT TUBE TESTER

**\$29<sup>95</sup>** Slightly higher West

Now quickly and accurately detect "positive grid" conditions in amplifier tubes used in circuits employing a high value of grid return resistance. EXCLUSIVE!



**"HARD TO FIND" TV TUBE FAULTS LOCATED FAST!**

- Poor picture contrast
- Grainy picture
- Twisting, bending or pulling of the picture
- AGC, RF, IF and Sync. Group tube faults
- Vertical jitter or bounce
- Sync. Buzz in the sound
- Any or all symptoms caused by sync. pulse compression.

Stop guessing and substitution checking, test and sell tubes with conviction on the first call, avoid embarrassing and costly callbacks.

Filament Selector Switch accommodates all the latest tubes for TV and INDUSTRIAL uses.



**Another Seco Exclusive FLY BACK INTERVAL & INDUCTANCE ANALYZER**

Checks horizontal circuits without disconnecting!

For specialized applications to meet your specific need, contact:

**SECO MFG. CO.**  
5015 Penn. Ave. So.  
Minneapolis, Minn.

An open electrolytic capacitor in the B+ circuit to the video IF section is a frequent cause of 120-cycle hum in the picture. The waveform of Fig. 11A illustrates a normal ripple voltage appearing on a B+ line in an IF section. Fig. 11B indicates the presence of excess 120-cycle hum and the video signal both of which may appear on the B+ line when the bypass capacitor for this line is open. The sweep rate of the oscilloscope for both waveforms is 60 cycles per second.



(A) With Normal 120-Cycle Ripple.

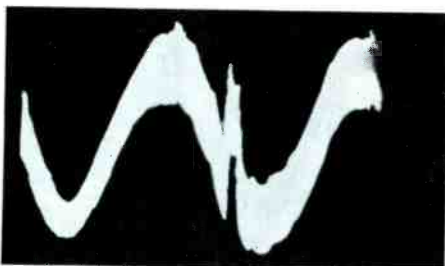

(B) With Excessive 120-Cycle Ripple and Video Signal Produced by Open Bypass Capacitor.

**Fig. 11. Waveforms of B+ Voltage Applied to IF Stages.**

**10. Intermittent Troubles.**

Because of their nature, intermittent troubles are probably among the hardest for the technician to locate. The symptom will often disappear when an attempt is made to connect the test equipment into the circuit in order to localize the trouble.

Possible causes of intermittent conditions in the IF strip are:

- a. Tubes.
- b. Crystal diodes.
- c. Loose connections.
- d. Cold solder joints.
- e. Changing resistor values.
- f. Capacitors open or shorted when heat rises.

Microphonism may be considered as one form of intermittent trouble and may be almost as difficult to locate as the other forms of intermittent trouble. Usually when microphonism is encountered, tubes are immediately suspected; but although tubes are the source of some of this,

# 25% more POWER

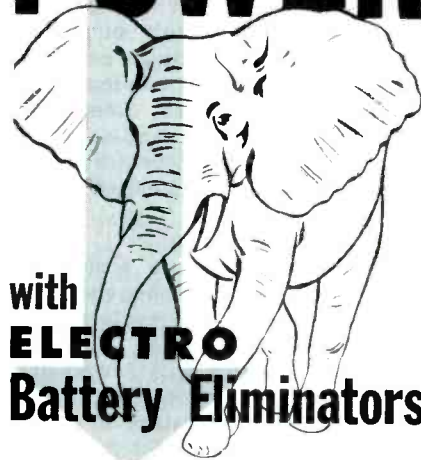

with **ELECTRO** Battery Eliminators



**6/12-volt DC Power Supply . . .**  
operates all 6 & 12-volt auto radios  
Same price range as Kits!

Heavy duty control transformer offers better regulation and withstands overloads for long service. Electro application of larger selenium rectifiers, combined with EPL patented conduction cooling increases rectifier power rating at lowest operating cost. Rugged, high quality construction, superior filtering, wide application. **\$39<sup>95</sup>**

**Only Electro offers actual proof with performance charts**

DC Output Voltage	Amperage Output		% AC Ripple
	Continuous	Intermittent	
0-8	0-10	20	5
0-16	0-10	20	5

**Model "NF" DC Power Supply 0-28 volts up to 15 amperes**

Less than 1% ripple at top load. Intermittent loads up to 25 amperes. Acclaimed in industry for its unmatched performance and construction at this **\$195<sup>00</sup>** price. *Certified performance.*



**SEND TODAY FOR DETAILED BULLETINS!**

See your Electro representative or write  
**ELECTRO PRODUCTS LABORATORIES**  
4501-PF N. Ravenswood Ave., Chicago 40, Ill.



there are other sources of such trouble. Resistors, crystal diodes, capacitors, and even IF coils or transformers have been sources of microphonic conditions. A gentle tap with a pencil eraser is helpful in locating a tube which is microphonic and may even help to locate a resistor or other microphonic component. Microphonism may result when sound waves from the speaker cause a component or a tube element to vibrate and produce a varying or intermittent pattern in the picture.

#### 11. Smeared Picture.

The symptoms shown in the pattern of Fig. 12 illustrate picture smear with loss of detail. Trouble in the video-amplifier stage is the most common cause of this condition; however, defective components or misalignment in the video IF or detector stages will sometimes affect the picture in this same manner. It may be noticed that the vertical wedges of the pattern appear weaker than the horizontal wedges. This is usually the result of poor high-frequency response. An excessive low-frequency response or phase shift will produce streaking and also the loss of the vertical wedges.

The low-frequency response of the receiver may be checked by observing the vertical blanking pulse on the screen. Turn up the brightness control, and misadjust the vertical-hold control until the blanking bar appears. The vertical sync pulse should be darker than the darkest picture element; if it is not, then the low-frequency response is poor. In many instances, the definition of the horizontal wedges can be improved by adjustment of the focus control; but very little effect will be noted on the vertical wedges.

#### Ask For Sprague By Catalog Number

Know what you're getting . . . get exactly what you want. Don't be vague . . . insist on

Sprague. Use complete radio-TV service catalog C-610. Write Sprague Products Company, 105 Marshall Street, No. Adams, Mass.

**DON'T  
JUST SAY  
CAPACITORS**

**SPRAGUE**  
WORLD'S LARGEST CAPACITOR MANUFACTURER

If misalignment is suspected in a receiver, it should be remembered that a poor frequency response can result from defective components or insufficient supply voltage. A complete voltage and resistance check should be made before attempting receiver alignment.

Possible causes of a smeared picture are:

a. Defective video IF or video-detector tube or faulty detector crystal.

b. Misalignment.

c. Open decoupling capacitor. (See C35, C39, or C41 in Fig. 1; C26, C31, C40, or C44 in Fig. 2.)

d. Open or leaky coupling capacitor. (See C28, C35, or C43 in Fig. 1.)

e. Video-detector load too high in value. (See R35 in Fig. 1; R45 in Fig. 2.)

f. Open cathode-bypass capacitor in final IF stage. (See C42 in Fig. 1; C45 in Fig. 2.)

**NO SPEAKER  
INSTALLATION  
PROBLEMS**

with

**QUAM**  
*Adjust-a-Cone*<sup>®</sup>  
**SPEAKERS**

QUAM speakers have transformer mounting brackets welded to the baskets.

There is a universal mounting bracket packed with every QUAM 3½", 4", 5", 5¼", 6½", 4" x 6" and 5" x 7" Adjust-a-Cone speaker, AT NO EXTRA COST.

In addition there are four threaded mounting holes in the pot . . . besides the usual mounting holes in the speaker basket.

A good hi-fi speaker need not be expensive.

Prove it to yourself by listening to QUAM extended range and coaxial speakers.

They can't be beat for small budget hi-fi installations.

Write for QUAM Hi-Fi Catalog No. 69.

**QUAM  
HI-FI  
SPEAKERS**

for fine audio  
reproduction  
at low cost

*ask for QUAM, the quality line, for all your speaker needs*

**QUAM-NICHOLS COMPANY**

234 EAST MARQUETTE ROAD • CHICAGO 37, ILLINOIS

**BEST CHOICE**

# BUD PRODUCTS

with *EXCLUSIVE FEATURES*

To get better results on the job or in the shop choose Bud Products. Their exclusive features mean time and money savings to you. All Bud Products are engineered and built better to give you outstanding performance and long lasting qualities. Check the exclusive features of the Test Leads and Test Prods illustrated below. Ask for them at your distributors.

## Super Test Leads

With vise-grip prods that screw into the plastic handles, eliminating the use of soldering iron or screw driver to replace broken or worn lead. Time is your most expensive commodity. This is where top quality pays off. Only the finest flexible, kinkless rubber covered wire is used.

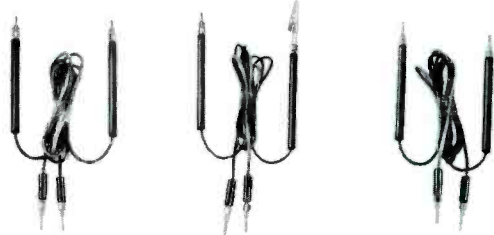

TL-178

TL-179

TL-180

TL-178 — 4" handles at one end of the wires with removable needle points and 1" handle with phone tips on other end. Dealer Net \$1.62.

TL-179 — 4" handles, one with removable needle point and other with phone tip and removable alligator clip. 1" handles have phone tips. Dealer Net \$1.62.

TL-180 — 4" handles with phone tips on one end. 1" handles have phone tips also. Dealer Net \$1.41.

## Test Prods with Plastic Handles

Prods are made of brass rods, nickle plated. All have plastic handles and feature the vise-grip method of assembly for speed and efficiency of wire replacement.

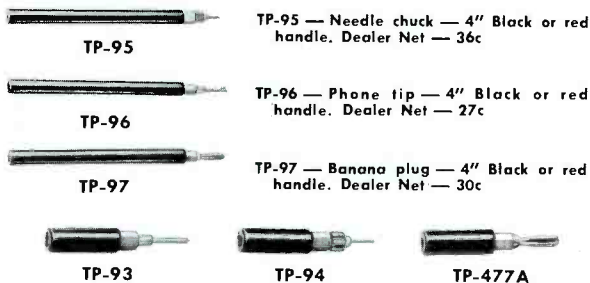

TP-95

TP-95 — Needle chuck — 4" Black or red handle. Dealer Net — 36c

TP-96

TP-96 — Phone tip — 4" Black or red handle. Dealer Net — 27c

TP-97

TP-97 — Banana plug — 4" Black or red handle. Dealer Net — 30c

TP-93

TP-94

TP-477A

TP-93 — Needle chuck — 1" Red or black handle Dealer Net — 21c

TP-94 — Phone tip — 1" Red or black handle Dealer Net — 18c

TP-477A — Banana plug — 1" Red or black handle Dealer Net — 18c

Remember!! — You save money by choosing the highest value. See these and other Bud Products at your distributors! If you don't know his name, write us.

**BUD RADIO, INC.** 

2118 East 55th St. • Dept. X • Cleveland 3, Ohio

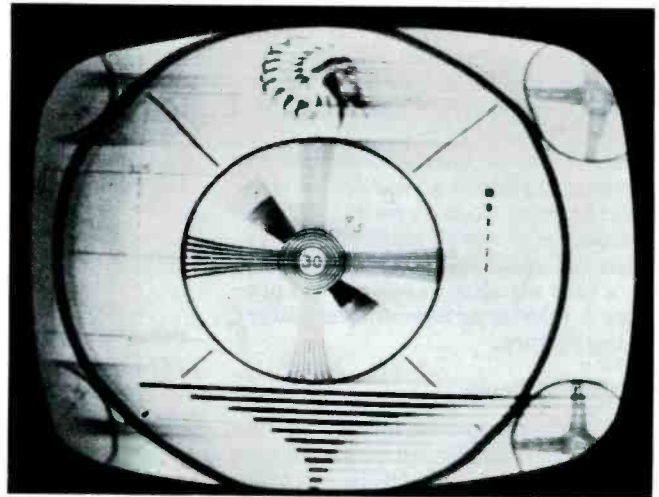

Fig. 12. Smeared Picture.

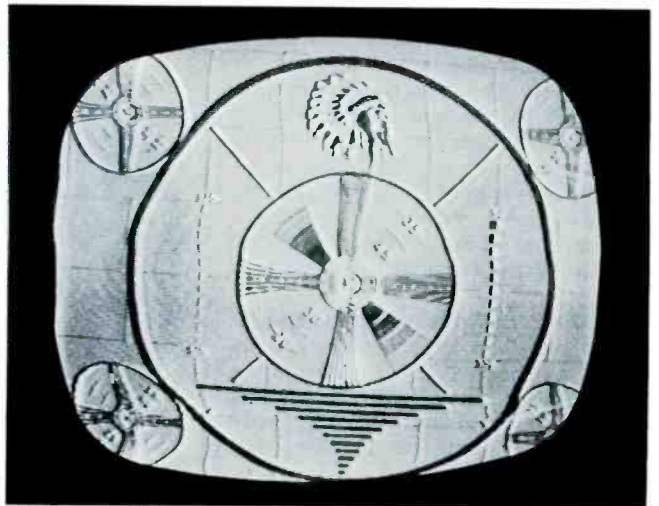

Fig. 13. Slight Overloading in Picture.

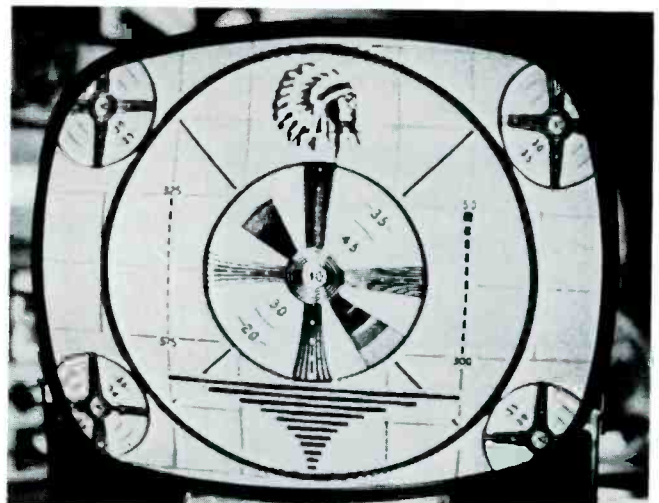

Fig. 14. Severe Overloading in Picture.

g. Improper placement of components or poor lead dress in the IF section.

h. Cathode resistor very high in value. (See R26, R30, or R33 in Fig. 1; R25, R29, R34, or R41 in Fig. 2.)

i. Shorted AGC filter. (See C38 in Fig. 1; C34 in Fig. 2.)



The oscilloscope is ideal for trouble shooting when a picture is smeared. It is capable of reproducing a curve which will indicate the frequency response of the video IF stages. Care should be taken when setting up the test equipment for alignment. An improper arrangement may result in regeneration which usually shows up as sharp, high peaks and instability in the response curve.

Misadjusted traps in the video IF or video-detector stages can produce smearing; therefore, they should be checked as part of the alignment procedure. Never ignore the possibility that a defective tube may be causing this symptom. A gassy IF tube usually results in improper grid bias which may cause a blurred or smeared picture.

**12. Overloading in Picture.**

Overloading in a picture comes about because of excessive amplification of the video signal. Shown in Figs. 13 and 14 are two degrees of picture overloading. The same trouble existed for both pictures, but the setting of the contrast control was varied. The picture shown in Fig. 14 was taken at a high-contrast setting, and the one in Fig. 13 was taken at a low-contrast setting.

Possible causes of picture overloading are:

- a. Defective tubes.
- b. Defective detector crystal. (See M4 in Fig. 1.)
- c. Improper AGC voltage.

(Advertisement)

MODEL 648		MODEL 715/115					
TUBE TYPE	FIL.	CIRCUIT D	PLATE TEST E	FIL.	X.	PLATE	YZ
6CN7	6.3	A128	A 79 5 80X 4	6.3	7	30 30 30	6NQ 20 3Q
25DNG	25.0	124	AB389 18V	25.0	-	15	8MPR
6660	6.3	A2347	AC156 50WZ	6.3	-	14	2IMS
6661	6.3	A2347	AC156 20WY	6.3	-	16	2IMS
6663	6.3	235	7 60X 4 60X	6.3	-	28 28	5Q 6Q

Latest Chart Form 648-13

CHART ERRORS ON MODEL 49		Latest Chart Form 715/115-8						
TUBE TYPE	SEC.	A	B	C	D	CATH.	SHORTS	E
6AR6	P	6.3	6	-	357	1	6	
14X7	T	12.6	1	-	23	4	11	
	D	12.6	1	-	5X	4	47	
	D	12.6	1	-	6X	7	47	

d. Improper plate or screen voltage.

e. Leaky coupling capacitor between IF stages. (See C28, C35, C43 in Fig. 2.)

f. Misalignment of IF strip.

When an overloading condition exists, there is a marked tendency for the synchronization to be unstable. This is caused by the fact that the video portion of the signal extends into the sync region. When this

happens, the video pulses tend to trigger the sweep oscillators, and the synchronization will be unstable.

To isolate this trouble to the IF strip, a check of the waveform at the detector output is very helpful because distortion at this point could indicate trouble in the IF strip.

**LESLIE D. DEANE**

and

**CALVIN C. YOUNG, JR.**

**OVER 1/2 MILLION  
WELLER SOLDERING GUNS**  
*have been bought by  
radio and TV servicemen*



**Weller... first to design and patent a soldering gun**

**Weller... first in performance and features**

**Weller... first in value — models as low as \$7.95**

*Weller* ask your distributor for a demonstration  
**ELECTRIC CORP.** 827 Packer Street  
Easton, Pa.

## Examining Design Features

(Continued from page 9)

the entire assembly, including the centering mechanism, clamps to the neck of the picture tube.

The two horizontal-deflection windings of the yoke are connected in parallel and require no damping or neutralizing components, but the vertical windings which are in series employ two 2,200-ohm damping resistors.

Another new development making its first public appearance in this receiver is the 14QP4 picture tube. It is a 14-inch rectangular tube employing electrostatic focusing. A small jumper connector, often referred to as a focus link, is located

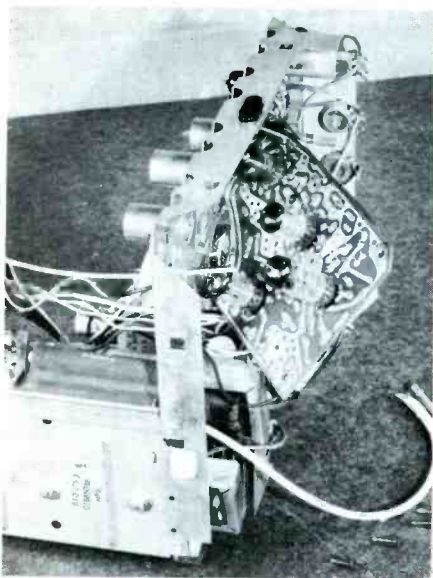
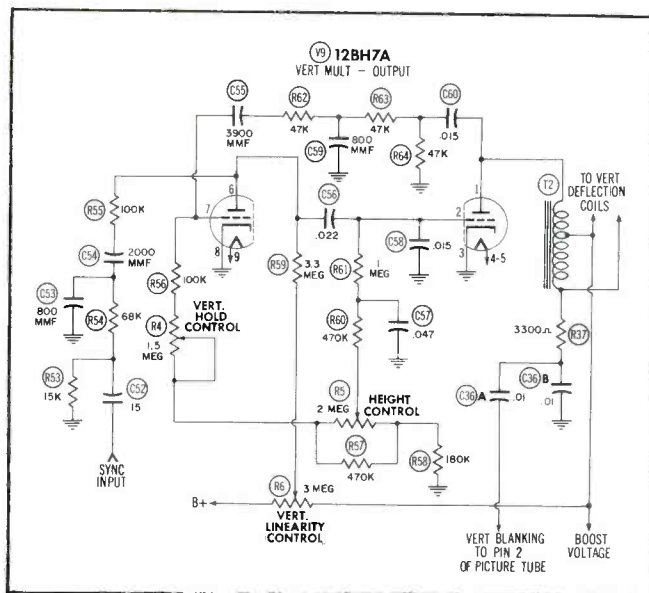

Fig. 2. Wiring View of Printed Circuit Board.

Fig. 3. Vertical-Sweep Circuit Employed in GE Model 14T007.



on the picture-tube base pins. This jumper is so designed that it will connect pin 6 to either pin 2 or pin 10 depending upon the potential required to produce adequate focus. The manufacturer has found that best focus is usually obtained when the jumper is connected between pins 2 and 6.

The entire receiver operates from a 140-volt B+ supply furnished by only one 350-ma selenium rectifier. One side of the AC power line is connected to the chassis; therefore, an isolation transformer should be used when servicing this receiver.

In order to aid the service technician in replacing component parts on the printed-wiring boards, the manufacturer recommends that the leads of the defective component should be clipped and that the replacement part should be soldered to the existing leads. If the leads are short,

the defective component may be cut in half and the body of the component may be broken away from the original



Fig. 4. Vertical-Linearity and Height Controls Incorporated in the New GE Design.

## The MASTER SETS YOU UP!

here's what's in it for you . . .

**BONANZA BUSINESS** Use The MASTER as your "geiger". Strike it rich with every repair. Take The MASTER right into your customer's home and sell direct from its pages. Watch it pay off!

**DOLLAR-WISE PURCHASING** Shop before you buy! Do it right at your own bench through the supermarket pages of the industry-wide MASTER. Compare specs and prices first—then buy and save.

- 100,000 items • Complete descriptions
- Specifications—Prices • 11,000 illustrations • 350 mfrs. • 8 x 11", 6 lbs.

**UNITED CATALOG PUBLISHERS, INC.**  
110 Lafayette St., New York 13

List \$7.50  
As low as  
**\$2.95**  
from parts  
distributors

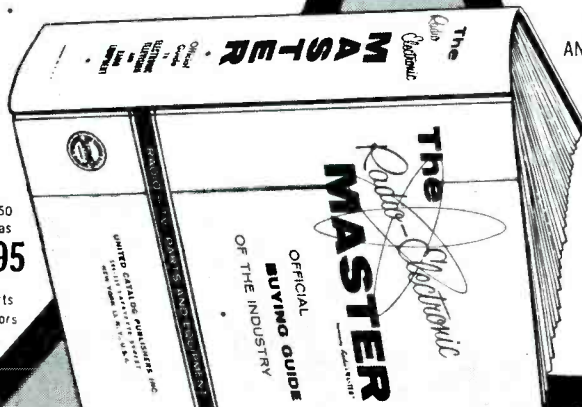

## 1956 edition

FULLY CATALOGS:

- TUBES — TRANSMITTERS
- TEST EQUIPMENT — COMMUNICATION
- RECEIVERS — TRANSFORMERS
- ANTENNAS — RESISTORS — COILS
- RECORDING & PA SYSTEMS
- CAPACITORS — HARDWARE
- RELAYS — TOOLS, ETC.

**1456 pages**  
**OFFICIAL**  
**BUYING GUIDE**  
**OF THE**  
**INDUSTRY**



leads to give the extra lead length needed. A small soldering tip should also be used in order to avoid overheating the printed-wiring board.

The new General Electric chassis employed in Model 14T007 is also being used in other models of the 1955 line of General Electric receivers. These models may include such accessories as a carrying handle, an electric clock, or provisions for UHF reception. All of these light weight models are portable and in the low-price range.

### A New Dual-Triode Tube

The Radio Corporation of America has recently released tentative data on a new 9-pin miniature tube. The tube is a 6CM7 medium-mu dual triode with two dissimilar sections in one envelope. This tube was primarily designed for use in the vertical-oscillator and vertical-amplifier circuits of television receivers. The unit has a 600-ma heater and may be used in receivers employing the new series-filament arrangement.

The tube diagram in Chart I illustrates the tube elements and their associated pin numbers. Pin No. 2 is not shown in the illustration because there is no internal connection made to this pin. The triode section A, shown in this chart, is designed for operation in a conven-

tional circuit of a vertical blocking-oscillator stage. The tube section B shown in this chart is a high perveance triode intended for use in a vertical-amplifier circuit. One desirable feature of this triode section is the fact that the grid remains at a relatively low temperature during operation and thus keeps grid emission low.

A more detailed description of the ratings and operational characteristics of this tube may be found in Chart I. The manufacturer states that this tube will give satisfactory performance in any equipment designed so that the maximum tube ratings will not be exceeded when the unit is operated from a 117-volt AC or DC power line which has variations that fall within  $\pm 10$  per cent of the nominal line voltage.

The heater element in the tube is designed to accommodate two separate cathodes which will normally be operating at different potentials depending upon the circuit requirements. The filament voltage required by the tube is 6.3 volts AC or DC at 600 milliamperes, and the average warm-up time is approximately 11 seconds. All tube elements are connected to the base pins in such a manner that the tube may be easily used with printed-wiring circuits. Proper operation can also be obtained with the tube mounted in any position.

CHART I

6CM7 MEDIUM-MU TRIODE Description and Rating			
<b>GENERAL</b>			
Heater for Unipotential Cathodes	6.3	Volts	
Heater Voltage, AC or DC			
Heater Current	.6	Amp.	
Direct Interelectrode Capacitances, approximate*			
	Section A	Section B	
	Vert. Osc.	Vert. Amp.	
Grid to Plate	3.8	3.0	$\mu\mu\text{f}$
Grid to Cathode and Heater	2.0	3.5	$\mu\mu\text{f}$
Plate to Cathode and Heater	0.5	0.4	$\mu\mu\text{f}$
<b>CHARACTERISTICS</b>			
<b>Typical Ratings</b>			
DC Plate Voltage	500	500	Volts
Peak Positive-Pulse Plate Voltage †	-	220 <sup>c</sup>	Volts ‡
Peak Negative-Pulse Grid Voltage †	200	200	Volts
Cathode Current			
Peak	70	70	MA
Average	15	20	MA
Plate Dissipation	1.25	5	Watts
Peak Heater-Cathode Voltage			
Heater Negative With Respect to Cathode	200	200	Volts
Heater Positive With Respect to Cathode#	200	200	Volts
<b>Maximum Circuit Values</b>			
Grid-Circuit Resistance			
(for Cathode-Bias Operation)	2.2	2.5	Meg.
(for Fixed-Bias Operation)	2.2	1.0	Meg.
(for Grid-Resistor Bias Operation)	2.2	-	Meg.
*Without External Shield.			
†Where the Duration of the Voltage Pulse Does Not Exceed 2.5 Milliseconds.			
‡The DC Cathode Potential Must Not Exceed 100 Volts.			
#Under No Circumstances Should This Value Be Exceeded.			
(Specifications courtesy of RCA.)			
<b>TUBE DIAGRAM</b>			
Section A OSCILLATOR		Section B AMPLIFIER	
<b>PHYSICAL DIMENSIONS</b>			

AMERICAN TELEVISION & RADIO CO. ST. PAUL, MINN.

**introduces the  
new**

**ATR TV**

*Full Door Console  
Receiving Sets*

UNSURPASSED  
IN BEAUTY

UNEQUALLED  
IN PERFORMANCE

UNMATCHED IN  
QUALITY  
CONSTRUCTION

exclusive  
profitable  
dealer  
franchises  
now available



*designed  
with the  
Serviceman  
in mind  
... easy to  
get at*



WRITE TODAY FOR COLORFUL  
BROCHURE SHOWING THE  
NEW LINE OF ATR TV SETS

ALSO MANUFACTURERS OF DC-AC INVERTERS,  
"A" BATTERY ELIMINATORS, AUTO RADIO VIBRATORS

**ATR** **AMERICAN TELEVISION & RADIO CO.**  
Quality Product's Since 1931  
SAINT PAUL 1, MINNESOTA - U. S. A.

# DOUBLE MANPOWER WITH SAME PAYROLL



**\$97<sup>50</sup>**

Dealer Net  
Less Batteries

by using a Radion  
**BATTERY OPERATED**  
Field Strength Meter  
on TV Antenna Jobs

Let one man do the work of two—in less time, with greater accuracy. He can take the meter on the roof, locate and orient the antenna by himself—even before running lead-in. On master antenna systems he checks each outlet, quickly, without guesswork. This efficiency reduces call-backs, builds confidence, makes larger profits.

If you are using two men on antenna jobs now, a Radion FSM No. 5000 can pay for itself in three weeks time. Ask your parts distributor or write for folder.



**THE RADION CORPORATION**  
Dept. R, 1130 W. Wisconsin Ave., Chicago 14, Ill.

A dimensional drawing of the 6CM7 tube is presented in Chart I, and all dimensions given are maximum.

### Arvin Model 950T Radio

The table-model AC-DC radio pictured in Fig. 5 is of the printed-circuit variety and is the Model 950T made by Arvin Industries, Inc. An interesting feature in this radio is the placement of the circuit board in the cabinet. It is mounted vertically and

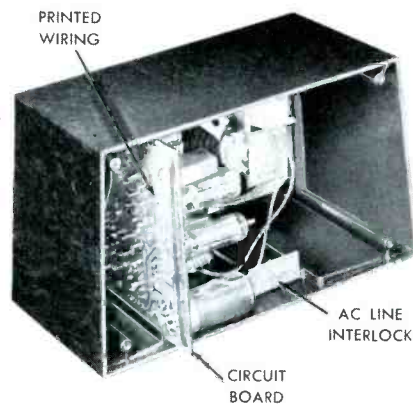

Fig. 5. Rear View of Arvin AM Receiver Model 950T.

slides into two molded grooves at the top and bottom of the cabinet. It is secured by one machine screw which is inserted through the front of the tuning capacitor. The head of the screw is covered by the tuning knob.

The replacement of components, other than individual resistors or capacitors, can present a problem in this type of design. The components on the circuit board are connected physically and electrically by a dip-solder process at the factory. All the components are placed in position, and then each board is dipped into a soldering pot or pan. In this way, all points are soldered at the same time. After each unit has been removed from the pan and allowed to cool, the components become firmly fixed in place.

This soldering process aids in the mass production of receivers but makes it more difficult to replace some of the components with a soldering iron. In order to remove the tuning capacitor, for example, five solder connections must be heated at the same time; otherwise, each terminal must be cleaned of all solder, one terminal at a time. The latter operation may be performed by applying the tip of the soldering iron to each connection; and when the solder is melted, quickly brush it off with a small wire brush. Heat

## 1st with all prices

Dave Rice's Official Pricing Digest answers a need long-felt by Servicemen—List or resale prices for every replacement part or component at your fingertips.

*Over 300 pages; covers more than 60,000 items*

Compiled like a telephone book (1) Alphabetical by Manufacturer (2) Alphabetical by Product Category (3) Numerical by Part Number. Price and identify any replacement item in seconds—as easy as 1-2-3.

## 1st handy sized reference in the industry

9 $\frac{3}{4}$ " long by 3 $\frac{3}{4}$ " wide . . . convenient for counter, pocket, tool box or tube caddy.



## 1st completely revised four times each year

Publication dates are October, January, April and July. Prices will be current on each publication date.

## 1st in savings

Time and money savings—no wasted effort—no calls to your distributor to check prices. No undercharges—no overcharges when you price your tubes and parts from the Official Pricing Digest.

## 1st issue October, 1955

PRICE \$2.50 PER COPY—will pay for itself many times over by giving you CORRECT PRICES where and when you need them.

*available exclusively thru your parts distributor*

See him now and place your order for the first issue.

*Electronic Publishing Co., Inc.*  
180 North Wacker Drive  
Chicago 6, Illinois



the connections only long enough to melt the solder in order not to damage the mounting board or the adjacent components.

After the solder has been cleaned from each connection, gently remove the defective part from the board. If a component to be removed has bent prongs, cut them off as close to the board as possible before heating the connections. Remove the surplus solder from all connecting points on the board, and clean the chassis area with carbon tetrachloride before installing the replacement part. Extreme care should be taken when inserting the new part. Do not use force to place the leads or prongs into position because this may separate the printed wiring from the mounting board. It is also wise to remove the tubes from the board when performing any soldering operation.

Replacing components such as resistors or capacitors which have long enough leads will not involve soldering of the printed-wiring connections. By clipping the leads near the body of the defective part, the replacement part may be soldered to the remaining leads. If the leads are too short, the component can be cut in half, as previously mentioned.

If the technician is called upon to service many of these dip-soldered units, it is recommended that he invest in a solder pot. There are a number of commercial solder pots on the market, and one that is 3 to 4 inches in diameter is usually sufficient. When using the dip-solder method, care must be exercised not to overheat the unit. Carefully immerse the wiring side of the board into the molten solder while pulling upward

on the defective component. All component connections are then heated simultaneously, usually within one or two seconds; and the component will be freed the moment the solder melts. The board should then be removed from the pot immediately.

Before replacing the new part, check the position of the leads or prongs and make sure that they will align with the openings in the board. After the defective component or components have been replaced, a complete check of the circuitry in-

involved should be made. This check may reveal a possible short circuit caused by an excessive deposit of solder.

The manufacturer of the Arvin Model 950T radio has also incorporated an interlock for protection against electrical shock. Note the male AC plug in Fig. 5. As in the majority of television receivers, the circuit of the power supply opens when the rear cover is removed.

LESLIE D. DEANE

For the  
**Finest TV Master or Community System**



**TRANSVISION**  
Master Systems  
have been proven  
**BEST IN PERFORMANCE**  
**LOWEST IN COST**  
in hundreds of important installations

**BEST IN PERFORMANCE**  
**BECAUSE Transvision Master Units have specialized Broadband and individual Channel Amplifiers for each purpose.**

**SOLD THRU SELECTED DISTRIBUTORS**

Write for the name of the one in your area.

**SPECIALIZED BROADBAND UNITS**

with 1 or 2 outputs—each with full power  
Built-in cable loss equalization on community broadband units. Largest line of strip amplifiers, channel changers, etc. Send us your problem.

Transvision offers you the choice of the best Broadband Amplifier — at lowest cost—for any particular community TV job.

**TRANSVISION  
FIELD STRENGTH METER**  
For Battery Operation and 110 V AC

Saves 50%  
of installation  
cost



Model FSM-5B, for Battery Operation and 110 V AC. Weight 22 lbs. **\$89** net



DISTRIBUTORS: Some areas still available. Write, wire, phone for complete program.

TRANSVISION, INC. • NEW ROCHELLE, N. Y.

TRANSVISION, INC., NEW ROCHELLE, N. Y. PF 10

- Please send name of your nearest Distributor.
- FREE copy of Pamphlet on TV Master Systems.

Name \_\_\_\_\_

Address \_\_\_\_\_

City \_\_\_\_\_ State \_\_\_\_\_

**ASK FOR SPRAGUE BY  
CATALOG NUMBER**

Know what you're getting... get exactly what you want. Don't be vague... insist on Sprague. Use complete radio-TV service catalog C-610. Write Sprague Products Company, 105 Marshall Street, North Adams, Massachusetts.

**DON'T JUST SAY  
CAPACITORS  
SAY**

**SPRAGUE**

WORLD'S LARGEST CAPACITOR MANUFACTURER

## Shop Talk

(Continued from page 23)

value equal to that of both individual resistors.

It is cautioned that this procedure should not be followed unless suggested by factory notice. The use of two resistors in this particular

circuit was not a matter of expediency but was carefully reasoned out by DuMont engineers. This video IF system operates at 45 megacycles; and at this frequency, the equivalent circuit of a resistor is not a pure resistance but rather that of a resistance and a capacitance in parallel. See Fig. 3. In the DuMont circuit, a 27,000-ohm, 1-watt resistor would have been required for dropping the

voltage; however, an ordinary 1-watt resistor has a shunting capacitance of approximately 3 micromicrofarads. At 45 megacycles, this capacitance presents an impedance of only 1,200 ohms. In effect, then, we are shunting the 27,000-ohm resistor with an impedance of 1,200 ohms and are reducing the total impedance of this network to a value less than 1,200 ohms. Under these conditions,

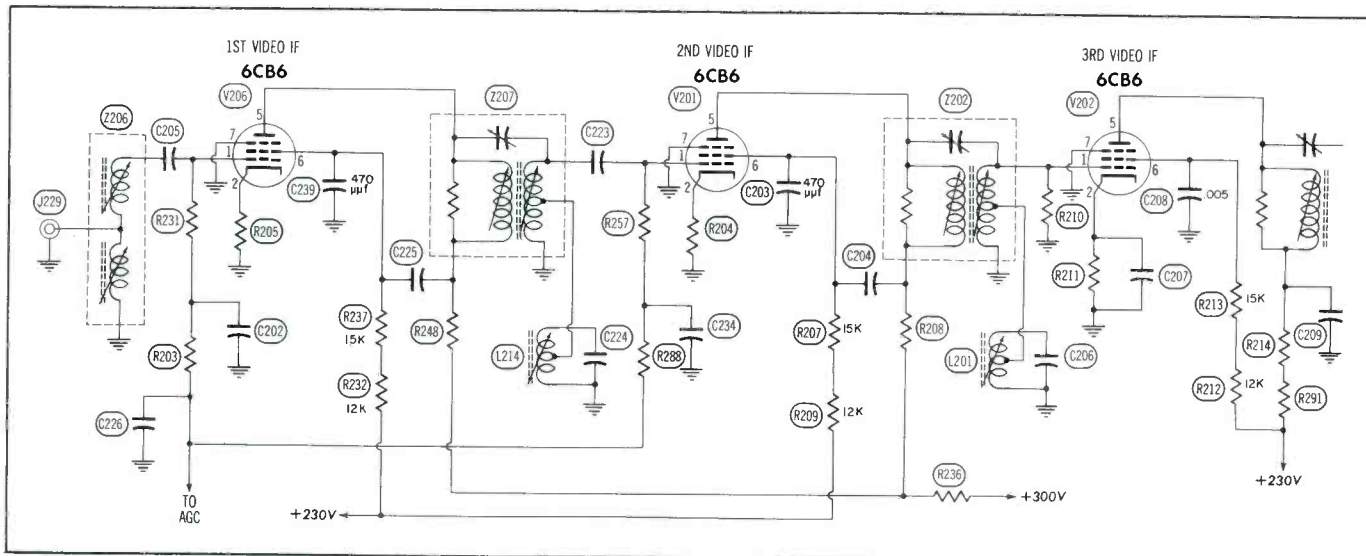

Fig. 2. Schematic Diagram Illustrating Two Resistors in Series to Reduce the Shunting Capacity.



## PORTABLE PARTS CABINET (or tackle box)

FREE with . . .

the purchase of thirty popular fast moving Planet Electrolytic Condensers. This welded all steel cabinet is rigidly constructed and tested to carry a 100 pound load safely. Hinged front locks in drawers when closed—serves as Handy Tray when open. Cabinet has solid steel back with 4 key holes for safe hanging and easy removal.

WATCH FOR IT AT YOUR PARTS JOBBER

## PLANET SALES CORPORATION

BLOOMFIELD, NEW JERSEY

For **SATISFIED CUSTOMERS**  
and **PROFITS too!**

INSTALL

# Mosley

TV ANTENNA  
ACCESSORIES

## Wall-Thru



Cat. No. 625  
List Price \$1.95

- New, improved tube is semi-flexible — bends without breaking for easy insertion into wall openings drilled out of line!
- Neat, Convenient, Efficient! Appeals to ALL TV Owners because it's Practical!
- A Sure-Fire Profit Maker For TV Installers!

Ask your Parts Jobber or write direct for your  
Free copy of the new MOSLEY Catalog 54-55.

## MOSLEY ELECTRONICS, Inc.

8622 St. Charles Rock Rd., St. Louis 14, Missouri



the decoupling effectiveness of the 27,000-ohm resistor would be greatly impaired.

To get around this situation, two half-watt resistors were employed. The internal shunting capacitance of a half-watt resistor is approximately 1 micromicrofarad. By using two such resistors in series, we place their individual shunting capacitances in series to give a total shunting capacitance of approximately one sixth that of a single one-watt resistor.

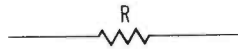

(A) At Low Frequencies.

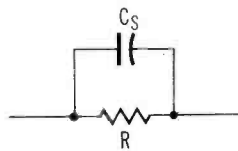

(B) At 45 Megacycles.

**Fig. 3. Equivalent Circuit of a Resistor.**

Suppose that a 27,000-ohm, 1-watt resistor were substituted for the two original resistors by some technician who is not aware of the significance of this design. What would happen? It is quite possible that regeneration would set in, particularly at low AGC voltages. The moral of the story, of course, is never to assume that apparent deviations from so-called conventional practice represent an oversight on the part of the receiver designers.

In the sound IF system, the operating frequency is only 4.5 megacycles in most receivers today; hence, even greater leeway in parts substitution is possible. Actually, the most critical stage in this section of the receiver is the FM detector. Always use an exact replacement for the detector transformer. If a part (resistor or capacitor) inside the transformer shield is to be replaced, use an exact duplicate and follow the layout carefully. Balance is an important feature of FM detectors, and anything that upsets that balance impairs the ability of the detector to reject AM interference. The two resistors of equal value across the detector output should be matched within 5 per cent or closer. This does not mean that resistors having 20-per-cent tolerance cannot be used. They can if they record similar values on an ohmmeter.

In the video-amplifier section following the video detector, a clear

understanding of the role played by the various peaking coils will show the technician what the effect of various substitutions will be. The network most widely used for high-

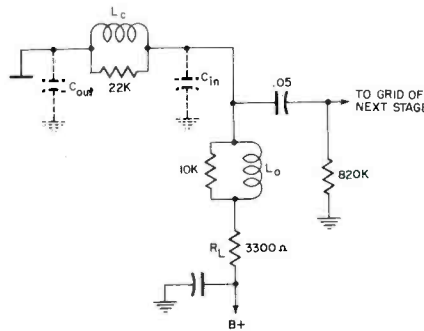

**Fig. 4. Schematic Diagram of High Frequency Compensation Network.**

frequency compensation is shown in Fig. 4.  $L_c$  is the series-peaking coil, and  $L_o$  is the shunt-peaking coil.  $C_{out}$  is the stray circuit capacitance existing to the left of  $L_c$ , and it includes the output capacitance of the tube plus whatever wiring and other circuit capacitance may be present in this portion of the circuit.  $C_{in}$  is the capacitance existing to the right of  $L_c$  and includes the input capacitance of the following tube plus whatever wiring and other stray capacitance may be present across this portion of the circuit.

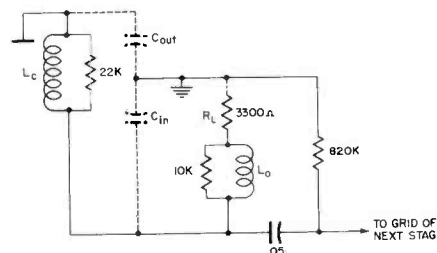
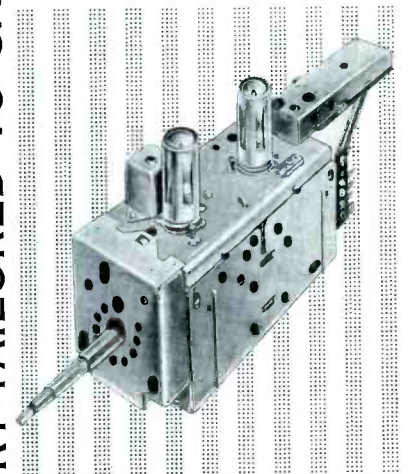

**Fig. 5. Equivalent Circuit of High-Frequency Compensation Network of Fig. 4.**

To appreciate better the role of these various components, let us redraw the circuit to the form shown in Fig. 5.  $L_c$  forms a resonant circuit with  $C_{out}$  and  $C_{in}$ ; whereas,  $L_o$  forms a second or auxiliary resonant circuit with  $C_{in}$ . Note that whatever voltage the grid of the following stage receives is thus determined by two principal factors: the voltage that is developed across  $C_{in}$  and the resonant frequency of  $L_o$  and  $C_{in}$ .

We are concerned with the high-frequency response of this coupling network. Generally, this pertains to those frequencies above 2 megacycles. For frequencies below 2 megacycles,  $C_{out}$  and  $C_{in}$  have little shunting effect; whereas,  $L_c$  is essentially a connecting wire. It is the value of  $R_L$

take  
Tuners  
for  
example



Today's exacting mechanical requirements for tuners make it essential that only exact replacements be used. RCA Tuners are factory-tailored for RCA Victor TV receivers . . . designed to save you time and money by fitting right, installing fast.

Your RCA Tube Distributor can supply you with an exact RCA replacement tuner for virtually every RCA Victor TV receiver currently in use.

So, cut down your call-backs, build up your profits, keep your servicing "on the go" with genuine RCA Tuners.

**RCA** RADIO CORPORATION  
of AMERICA  
SERVICE PARTS HARRISON, N. J.

536K Multimeter Kit \$12.90  
Wired \$14.90  
1000 ohms/volt



425K 5" Scope  
Kit \$44.95  
Wired \$79.95

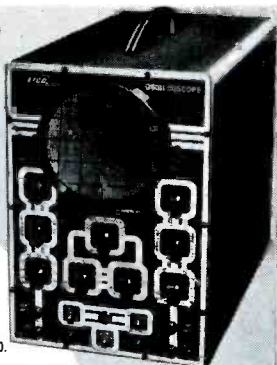

470K 7" Push-Pull Scope  
KIT \$79.95. WIRED \$129.50.

**YOU BUILD**

**EICO**

**KITS  
IN ONE  
EVENING-**

**but they  
last a lifetime...  
and you  
save 50%**

**38 Kits and 42 Instruments —  
the Industry's most complete  
line of MATCHED  
TEST INSTRUMENTS**

**½ - million EICO In-**  
struments are now in use  
the world over! That's the  
proof of EICO's leader-  
ship in Value.

For latest precision engi-  
neering, finest compo-  
nents, smart professional  
appearance, lifetime per-  
formance and rock-bot-  
tom economy — see and  
compare the **EICO**  
line at your Jobber  
before you buy any  
higher-priced equip-  
ment! You'll agree with  
over 100,000 others that  
only EICO Kits and In-  
struments give you the in-  
dustry's greatest values  
at lowest cost.

Prices 5% higher on West Coast.



1050K Battery Elim.  
Kit \$29.95. Wired \$38.95

625K Tube Tester  
Kit \$34.95  
Wired \$49.95



377K  
Sine & Square Wave Audio Gen.  
Kit \$31.95. Wired \$49.95



360K Sweep Gen.  
Kit \$34.95. Wired \$49.95



221K VTVM Kit \$25.95  
Wired \$39.95

565K Multimeter Kit \$24.95  
Wired \$29.95  
20,000 ohms/volt

Write NOW for FREE latest Catalog PF10

**EICO**  
Laboratory Precision at lowest cost

©1954

**ELECTRONIC INSTRUMENT CO., Inc.**  
84 Withers Street, Brooklyn 11, N. Y.

which largely determines the behav-  
ior of the circuit at lower frequencies.

In view of the foregoing circuit  
relationships, the following general  
statements can be made:

1. Increasing the value of  $L_C$   
(through substitution) will lower the  
resonant frequency of the circuit  
formed by  $L_C$ ,  $C_{out}$ , and  $C_{in}$ . This  
will cause the voltage across  $C_{in}$  to  
peak at some lower frequency with  
the result that a hump or a rise will  
appear on the response curve between  
the mid-point (about 2 megacycles)  
and the end of the curve. At the  
same time, the high-frequency  
response of the curve will drop.

2. Reducing the value of  $L_C$  will  
raise the resonant frequency of this  
network. This will shift the compen-  
sating effect out beyond the normal  
point (between 3 and 4 megacycles,  
according to the designer's speci-  
fications) and cause whatever compen-  
sation this circuit provides to appear  
later than it normally would. The  
result will be a sag in the response  
curve near the high-frequency end  
and a possible rise at the very end  
of the curve. (The distinctness with  
which these various peaks or sags  
stand out will depend on the Q's of  
the several resonant circuits.)

3. Increasing the value of  $L_0$   
serves to lower the resonant fre-  
quency of the resonant circuit formed  
by  $C_{in}$  and  $L_0$ . This will produce a  
rise in the response curve between  
the mid-band frequency and the end  
of the curve, and there will be a falling  
off at the high end of the curve. The  
exact point where the rise will occur  
will depend on the new value of  $L_0$ .

4. Decreasing the inductance of  
 $L_0$  will shift the compensation point  
of this network to a higher frequency.  
A dip or valley will appear at the high  
end of the curve where this circuit  
previously was effective, and a rise  
will appear at a higher frequency at  
which the network is now resonant.  
A simple way of looking at this action  
is to consider the circuit of  $L_0$  and  
 $C_{in}$  as a support for the high end of  
the response curve. If the support is  
moved farther out, the vacated posi-  
tion tends to sag because of lack of  
support.

5. Increasing the value of  $R_L$  will  
strengthen or raise the low end of  
the response curve. At the same  
time, the high end of the curve will  
tend to drop somewhat because the  
shunting effect of  $C_{in}$  will appear at  
a lower frequency. It is possible that  
the change will lead to the appearance  
of a dip near the high end of the curve  
just before the supporting effects of  
the peaking networks come into play.

**TROLMASTER**

**CLEANS  
AND  
LUBRICATES**

**TV-RADIO  
CONTROLS**

**IN**

**60**

**SECONDS**



Now you can completely  
clean and lubricate volume,  
tone, brightness and contrast  
controls without removing  
chassis or back from cabinet.

Simply remove knob at front  
of control, screw solvent-loaded  
TROLMASTER onto control,  
push the plunger in, remove  
TROLMASTER, work the control  
back and forth and the job  
is done—in 60 seconds or less!

TROLMASTER thoroughly  
cleans either single or dual  
controls. Constructed of solid  
brass, TROLMASTER will not  
corrode when used with any  
chemical normally  
used in the electronics industry. User's Net, **\$395**

**KLENTROL MAGIC SOLVENT**

Cleans, lubricates TV-Radio  
controls and tuner, push-  
button and switch contacts.  
Non-inflammable. Will not  
harm surfaces or finishes of  
wood, metal or acetate.

Recommended for use with  
TROLMASTER. Full Pint. User's Net, **\$195**

See your Distributor or write.

Manufactured by

**R-COLUMBIA  
PRODUCTS CO., INC.**  
HIGHWOOD, ILLINOIS



6. Decreasing the value of  $R_L$  will tend to flatten out the response curve and reduce its amplitude. Remember that  $R_L$  shunts the peaking circuits; and when its value is too low, everything is loaded down.

### REVIEW

Everyone who has had any contact with electronic circuits must at one time or another have heard the expression "load line." Not everyone has a clear idea of what a load line is, how it is employed, or what purpose it serves. Since there is nothing mysterious or profound about load lines, there is no reason why every service technician should not at least be on speaking terms with this subject.

An excellent article that discusses load lines at some length appeared in the June 1955 issue of Radio-Electronics magazine. The article is entitled, "What Is a Load Line?" and was written by Norman H. Crowhurst.

Radio-Electronics is published monthly by Gernsback Publications, Inc., 25 West Broadway, New York 7, N. Y. Subscription rates are \$3.50 per year for the United States, its possessions, and Canada. Single copies are 35 cents each.

The first things to understand are the different ways in which tube characteristics can be presented. One way, shown in Fig. 6A, has the grid-voltage values along the horizontal axis and the plate-current values along the vertical axis. If we consider just one curve on this chart, say the one marked 200, then for each value of grid bias, a certain specific amount of plate current will flow. The number 200 on this curve signifies that the plate voltage is 200 volts. If we change this to 150 volts, then a different amount of current will flow for the same grid bias. Hence, another curve must be drawn for the grid-voltage, plate-current relationship at this plate voltage. In all, five different curves are shown in Fig. 6A.

It is also possible to present the characteristics of a tube by means of the set of curves shown in Fig. 6B in which the plate voltage is plotted horizontally and the plate current is plotted vertically. Each curve is for a different fixed voltage on the grid. For example, if the grid is kept at -1 volt, then as we vary the plate voltage the plate current will vary. Curve No. 2 of this figure shows exactly what variation will take place. For another value of grid voltage, another set of conditions will exist and another curve will be required. In all, six curves are shown in Fig. 6B.

It should be noted in passing that the information given on one set of curves can be used to plot the other set of curves. This is understandable because we are dealing with the same tube in each instance.

All the curves in the graphs in Fig. 6 have been drawn for an unloaded amplifier. This is, there is no load resistor in the plate circuit. In a practical amplifier, however, there is a resistor in the plate circuit; and we come up against a situation which is actually not covered

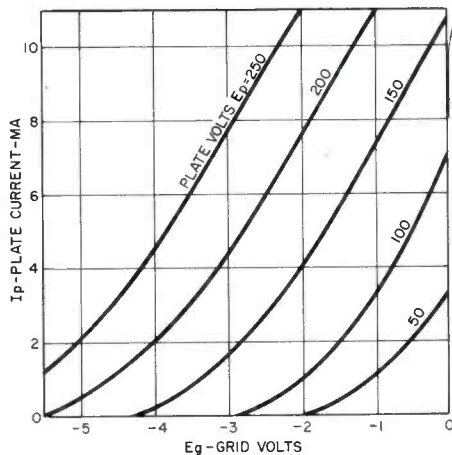

(A)  $E_g$  Versus  $I_p$  Group.

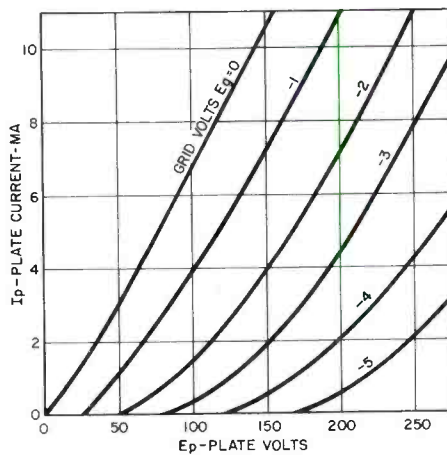

(B)  $E_p$  Versus  $I_p$  Group.

**Fig. 6. Two Ways of Representing the Characteristics of an Electron Tube.**

by any of the curves in Fig. 6. When there is a load resistor, then a change in grid voltage will cause both the plate voltage and the plate current to change. (Previously, only the plate current changed as we varied the grid voltage.) A load line is useful because with it we can determine the exact nature of the plate-voltage and plate-current changes with different applied grid voltages.

Let us assume that a load resistor of 25,000 ohms is placed in the plate circuit of the tube. If the grid voltage is such that no current passes

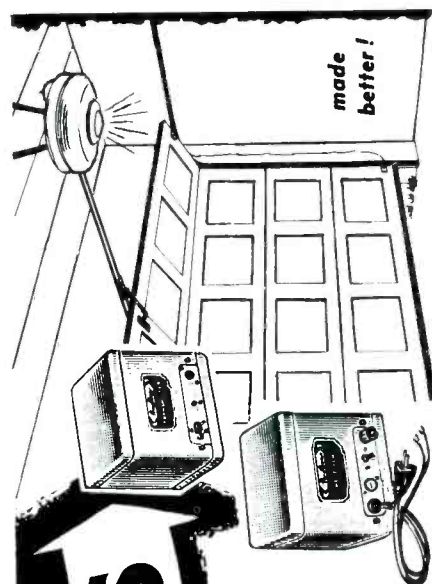

**NEW DESIGN means NEW SALES**

Now, the newest, finest Radio-Control Garage Door Opener styled in a modern spun-aluminum fixture that beautifies garage interiors. Convenience and safety features galore — New automatic shut-off, positive locking of door, FCC authorized radio frequency . . . and many more plus qualities! Write today for descriptive literature.

**Perma-Power's**

**NEW Garage Door Opener**

made by **Perma-Power Company**

4727 N. Damen Ave., Chicago 25, Ill.  
Manufacturers of electronic equipment since 1928  
EXPORT: Scheel International, Chicago, Ill.

**FIRST and FOREMOST!**  
The ORIGINAL and UNMATCHED

**CapaciTester**

The pioneer instrument for checking coupling condenser leakage in the circuit!

*TeleTest* anticipated your demand for a unit that would check leaky coupling condensers, under load, without removal from the circuit. With the remarkable and unparalleled CapaciTester, you not only can check any coupling condenser without clipping or unsoldering leads, but you can test for leakage between any points where it may occur! AND, with the added Wien bridge, you can measure capacities from 10 mmf. to 50 mfd.



Model CT-355

1-YEAR FACTORY SERVICE GUARANTEE

only \$44<sup>95</sup>

- Tests all coupling condensers for leakage, regardless of type or capacity.... IN THE CIRCUIT

- Will not damage condensers
- No calibration adjustments required
- Positive indication of relative leakage amount present



See your local jobber, or write TODAY:  
31-01 Linden Place, Dept. PF, Flushing 54, N. Y.

**NOT VERY BIG!**

in fact...the one truly miniaturized clip in this age of miniaturization! The new

**M U E L L E R**

**MINI-GATOR**

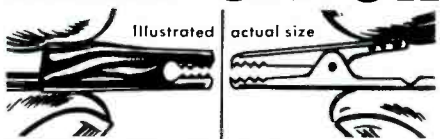

Separate skin-tight vinyl plastisol insulator covers right down to the nose. Will not tear. Slatted "lip action" tip permits full jaw opening without "boring" teeth.

Steel (cadmium plated) or solid copper. 1-1/16" long. Jaws open 3/16". Solder connection. Clinching ears for cord strain relief. For No. 20 or smaller wire.

Simply stated in Electronic terms, it's



(Mini-gator : Alligator :: Transistor : Tube)  
SIMPLIFIES TESTING OF ALL MINIATURIZED AND SUB-MINIATURIZED EQUIPMENT.

Provides the quick convenience of a test clip in spots that are otherwise inaccessible.

FREES THE HAND THAT HELD THE PROD!

WRITE TO FACTORY FOR **FREE SAMPLES!**  
*Mueller Electric Co* 1561Y E. 31st STREET CLEVELAND 14, OHIO

**Arvin TV PARTS**

See your parts Distributor

Write for free Radio & Television Service Parts Price Catalog SP900D

**ARVIN INDUSTRIES, Inc.**

Radio Division Service Department

ORINOCO PLANT COLUMBUS, INDIANA

through the tube, then the full B+ voltage will appear at the plate. Let us say this is 250 volts. This condition can be represented by point A on the graph of Fig. 7. On the other hand, if the grid voltage is adjusted so that 10 milliamperes of plate current will flow, there will be a drop of 250 volts across the 25,000-ohm resistor; and the plate voltage will have dropped to zero. This condition is depicted by point B in the figure.

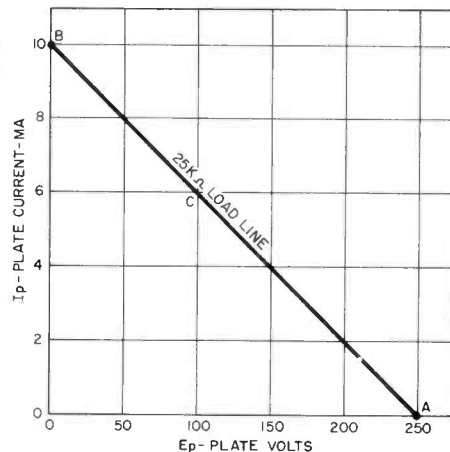

Fig. 7. Formation of a Load Line.

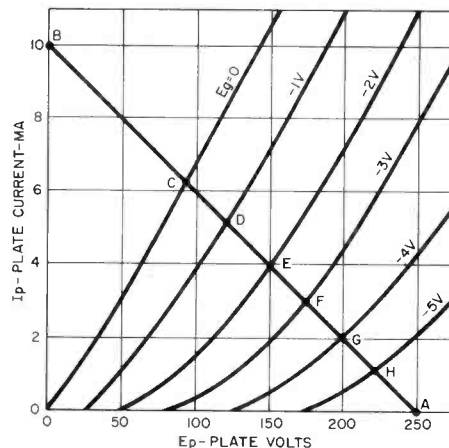

Fig. 8. The Load Line Combined with the  $E_p$  Versus  $I_p$  Curves of a Triode.

If the tube draws 6 milliamperes of current, the voltage drop across the load resistor will be 150 volts, leaving 100 volts for the plate. This is represented by point C. A line drawn through these points will be found to contain every possible voltage condition over a current variation of 0 to 10 milliamperes in the plate circuit of the tube. In short, as the grid voltage is varied, the plate current and voltage must be given by some point along this line because of the voltage drop across the 25,000-ohm resistor. That is why this is called a 25,000-ohm load line.

The load line is shown separately in Fig. 7; but it would actually be combined with the plate-voltage, plate-current group of curves of Fig. 6A. The result is shown in Fig. 8.



new  
AMERICAN  
"5-PAK"  
SERVICE  
KIT



sells  
**9 out of 10**

CRYSTAL  
PHONOGRAPH  
REPLACEMENT  
CARTRIDGE  
CUSTOMERS!

Here's everything you need . . . in one convenient package!

American's high quality "Clear as Crystal" replacement cartridges are packed in this reusable plastic box . . . ideal as a small parts container. The box contains five of the most popular types of replacement cartridges . . . meets 90% of your customers' requirements.

In addition, you get an authorized repair service decal . . . five identification cartridge labels for your name . . . and a handy crystal cartridge replacement chart.

The whole package costs less, because you get more. And, you give your customers more, too. Why not call your nearby American distributor today and order the new "5-PAK" for yourself.



370 South Fair Oaks Ave., Pasadena 1, Cal.  
AN ELGIN NATIONAL WATCH  
COMPANY AFFILIATE

We use these curves in preference to the grid-voltage, plate-current group of curves because this latter group represents the action of an amplifier without a plate load — a condition which will never be encountered in an actual amplifier.

Let us use the diagram of this load line in a typical application. Suppose that the DC grid bias is -2 volts and that a signal having a peak amplitude of 1 volt is applied to the tube. We can determine from Fig. 8 that when the signal is at its positive peak, the grid voltage will be  $-2 + 1$  or -1 volt. On the load line, this is point D where the plate current is 5 milliamperes and the plate voltage is 125 volts. On the negative half cycle of the signal, the total grid voltage becomes -3 volts. This is point F on the load line; and at this point, the plate current is 3 milliamperes and the plate voltage is 175 volts.

These facts will enable us to determine several things about this amplifier. The first one is its amplification factor under the grid-bias conditions specified. A change of 1 volt in the grid bias produces a 25-volt change in plate voltage. Since amplification factor is defined as the change in plate voltage for a change in grid voltage, the amplification factor of this stage is 25.

A second thing we can determine from Fig. 8 is that as long as we operate between points D and F of the load line, practically no distortion will be introduced by the amplifier. The curves within this region are evenly spaced and fairly linear — two conditions that will provide distortionless operation. (There are more precise methods for determining exactly how much distortion exists, but these are somewhat beyond the scope of this article.)

To appreciate how the mode of operation changes for different load resistances, consider Fig. 9 in which three load lines have been drawn.

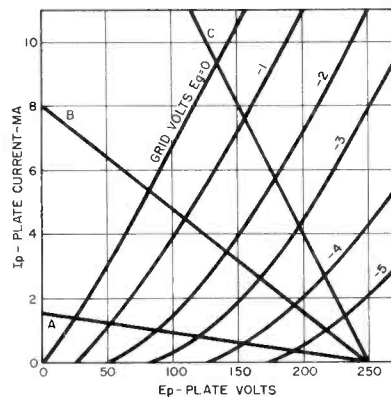

Fig. 9. Triode Characteristic Curves With Three Different Load Lines.

## Pay less

for the  
radio and TV controls  
you use most often

...get  
**Centralab's  
extra  
quality**



**Centralab  
Blue Shaft  
Radiohms**

Models B-60 and B-70  
—popular 1/2- and 1-meg.  
audio taper units

**only \$1 each**  
(with DPST switch \$1.50)  
suggested list price

Smooth, moisture-resistant, phenolic-base resistor elements. Electronically checked for accuracy and minimum noise.

Phosphor-bronze, *double-wiping* contacts. Controlled mechanical pressure and positive contact insure long life, noiseless operation.

Universal, fluted-mill, full-length shafts, 3" from end of bushing.

Packaged singly and in kits of 5, 12, and 22 controls.

Let Centralab's low price save you money. Let Centralab's exacting quality standards help eliminate call-backs. Stock up on B-60 and B-70 Blue Shaft Controls at your Centralab distributor.

# Centralab

Write today for  
Centralab Catalog No. 29.  
Address **CENTRALAB,**  
**A Division of Globe-Union Inc.**  
**942J E. Keefe Avenue,**  
**Milwaukee 1, Wisconsin**

ARE ANY  
OF THESE  
YOUR CUSTOMERS?

I have a speaker  
I'd like to keep.



I want to start  
a simple system  
and build on it.



I'd like to start  
from scratch.



I have a system  
I'd like to improve.



You can solve all  
their problems with **P•S•E**

**P•S•E** (University's Progressive Speaker Expansion plan) is the most revolutionary concept in speaker history. It's the best salesman you could possibly have. It makes selling your customers *easy* and *profitable*.

Here's how it works: University speaker components, enclosures and networks have been so uniquely designed that it is possible to start an excellent basic system, *at low cost*, and add to it later—while enjoying immediate listening satisfaction.

**P•S•E** makes it possible to build up to a great variety of magnificent sounding systems, most of which are not available competitively or commercially. Systems can be built in successive, inexpensive stages regardless of budget or space limitations.

Think of the sales angle! Now you can sell a speaker and assure your customer that *it will never become obsolete*. Now you can also improve his present speaker or system *without discarding what he has*.

The beauty of it all is that the first sale is not the last. He keeps coming back for more . . . and when you've completed his system, *he sends his friends*.

Simplified, easy to follow instructions called **TECHNIGRAMS** are available **FREE**. Fill out and mail coupon immediately for further information.



**University**

**LOUDSPEAKERS, INC.** Desk C3

80 South Kensico Avenue, White Plains, N.Y.

Please send me details showing how P•S•E can boost my profits immediately.

NAME \_\_\_\_\_

ADDRESS \_\_\_\_\_

CITY \_\_\_\_\_ STATE \_\_\_\_\_

Line A represents the highest load resistance, line B represents a somewhat smaller resistance, and line C represents the smallest load resistance. When resistor A is used, operation takes place near the curved portions of the  $E_p$  versus  $I_p$  curves, and distortion results. In the case of resistor C, the spacings between the  $E_p$  versus  $I_p$  curves at opposite ends of load line C are unequal, and distortion again results. The best compromise is provided by load resistor B. The curves in the section of the graph through which line B passes are linear and equally spaced from each other.

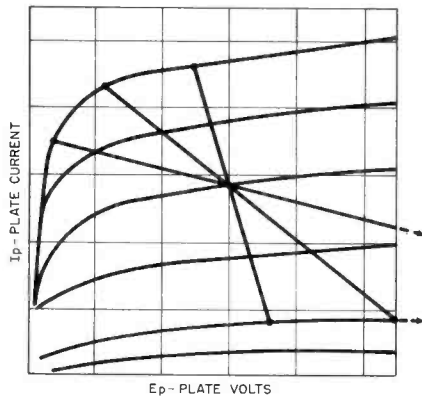

Fig. 10. Pentode Characteristic Curves With Several Possible Load Lines.

The foregoing discussion has dealt with triodes. For pentodes, the effect of a variation in load resistance is shown in Fig. 10. A low value of resistance, represented by a load line that crosses the  $E_p$  versus  $I_p$  curves almost vertically, results in comparatively low distortion. On the other hand, a high value of resistance, represented by a line that crosses the curves almost horizontally, produces a high degree of distortion. This is because all of the grid-voltage curves converge together at the left and are spread out at the right. The smaller the resistor, however, the lower the output voltage for a given grid-voltage swing; hence, the value to choose will be the one that will provide the greatest output for a predetermined amount of distortion.

There are many facets to this subject, and only a few have been touched upon. For those who wish to delve further into load lines, a full reading of Mr. Crowhurst's article is recommended and should be followed in turn by a book that appeared about 12 years ago. The title of the book is, "Graphical Constructions for Vacuum-Tube Circuits." The author is A. Preisman, and it is published by the McGraw-Hill Book Company.

MILTON S. KIVER

*Easier,  
Faster*

INSTALLATIONS WITH THE

*New* LA-75  
ARRESTER

LIST  
\$1.35  
Pat.  
Pending



ANOTHER

Radion

FIRST

ANOTHER

Radion

FIRST

ANOTHER

Radion

FIRST

Gone is the washer you had to lift—or take off. Instead, Radion's new L-shaped grip stands ready for instant action. Once you've used it, you won't want any other kind. Order today.

**THE RADION CORP.**

1130 W. Wisconsin Ave.,  
Dept. R,  
Chicago 14, Ill.



"It just isn't fair . . . she's using  
**JENSEN NEEDLES!**"



## Audio Facts

(Continued from page 21)

with the standing waves developed at higher frequencies in a small room, can result in a conglomeration of distracting sounds that fall within a critical range of frequencies.

Low tones can be attenuated to a very low level because a room is too small to handle the long wavelengths of the low frequencies.

If the room has many hard reflecting surfaces, the high tones can be distorted because of the echoes resulting from the excessive reverberation. If the room contains a lot of upholstered furniture, heavy drapes, and thick carpet, the music may sound "dead" and the higher frequencies may be attenuated. High-frequency tones with their short wavelengths are more readily absorbed than are the low frequencies with their long wavelengths. A happy medium must be reached for best results, because a room must not be too "dead" nor too "live." The amount depends upon the particular situation and to some extent upon the program material.

We are usually too close to the speaker in a small room. The sound is very directional, and we are aware of the fact that it is coming from the speaker. It is sometimes very difficult to diffuse sound in a small room, and therefore the sound bounces around and creates standing waves and distortions in the response. Most listening rooms in homes are too small; but they are also usually on the "dead" side, which is better than being too "live" in most cases. Fig.

1 shows examples of two listening rooms, one would be considered "live" and the other "dead."

### Compensating for Deficiencies of Small Room

The amount of compensation for the effect of the smallness of a listening room depends upon the program material being played and upon the listener. Adjustments must be made to make the recorded material sound the best to the listener.

The loudspeaker can be placed in a corner to reduce the effects of standing waves and to give better distribution of the sound, particularly of the high frequencies. Some loudspeakers seem to sound better than others when used at low loudness levels in certain rooms. This is one reason why it is worth while, when selecting a speaker, to give it a trial in the room where it will be used.

This statement might seem to imply that all equipment, including loudspeakers and recordings, practically always produces perfect results and that only the room gives trouble. This, of course, is not true. The equipment involved and the human ear both have their limitations.

For example, some records are recorded in very "live" studios; or reverberation effects may have been added during processing. These records should be played in a "dead" room; otherwise, the reverberation of the listening room will be added to that recorded on the record, and the listener is then subjected to a double dose of reverberation. On the other hand, a record recorded in a "dead" studio can sound better when played back in a "live" room.

It is practically impossible to duplicate a live performance with a home music system. Although this statement is true, it does not alter the fact that audio systems and records are made to be enjoyed. We do not wish to leave the impression that no one can listen to nor enjoy recorded music unless the system and room provide perfect reproduction. If that were true, we would certainly be limited in our listening. Being very much interested in music, the writer knows that he usually becomes so absorbed in listening to and enjoying the music that he is not bothered by some of the deficiencies of an inadequate system.

If we use some care and knowledge in adjusting and operating a home music system, it can be the source of a great deal of satisfaction and enjoyment even though the system and the listening room are not perfect.

ROBERT B. DUNHAM

Now you can buy the new lower-priced Columbia Permaline 300 ohm line with the new thinner insulation; with a black satin smooth finish which resists moisture, dirt, salt spray, etc.; contains carbon black for maximum resistance to sunlight; with high molecular weight polyethylene which will last longer than ever dreamed possible; moisture absorption about 0.03%; withstands —100°C; tensile strength of 2300 lbs. per square inch.

SEE FOR YOURSELF . . . write for free samples and specification sheet completely describing the remarkable qualities of this insulation. Available from leading jobbers



Columbia

WIRE & SUPPLY CO.  
2850 Irving Park Road, Chicago 18, Ill.

outlasts  
ALL others!  
Yet has  
thinner  
insulation

**DON'T** Just  
say capacitors

Ask For Sprague By Catalog Number

Know what you're getting . . . get exactly what you want. Don't be vague . . . insist on Sprague. Use complete radio-TV service catalog C-610. Write Sprague Products Company, 105 Marshall Street, North Adams, Massachusetts.

**SPRAGUE**<sup>®</sup>

WORLD'S LARGEST CAPACITOR MANUFACTURER

IT PAYS  
FOR ITSELF  
FAST!

WHEN YOU COMPARE  
YOU'LL CHOOSE THE BEST

the **VITAMETER**  
OVER 20,000 IN USE

IT'S  
PORTABLE

WEIGHT  
ONLY  
10 LBS.

The VITAMETER is precision designed and housed in rugged steel case to insure long and dependable service. It is light, compact, portable and therefore can be used on picture tube while it is still in the cabinet. Just plug in and attach instrument socket to C.R. Tube... easy to read indicators tells the whole accurate story at a glance. VITAMETER repairs tubes right-on-the-spot. NO GUESS WORK.

SEE YOUR DISTRIBUTOR OR WRITE

**ELECTRONIC TEST INSTRUMENT CORP.**  
13224 LIVERNOIS AVENUE DETROIT 38, MICHIGAN

AN INSTRUMENT DESIGNED  
TO MAINTAIN, IMPROVE  
and VITALIZE OPERATION  
OF CATHODE RAY TUBES

Unique reactivator function is accomplished by dynamic sweep between cathode and grid... removing gas ions and stale emitting material from surface of cathode tube.

the **VITAMETER**

- analyzes performance characteristics
- locate and remove inter-element shorts
- repairs open elements
- welds open filaments
- restores or improves emission quality
- estimates tube life expectancy

**\$6995** COMPLETE

## Notes on Test Equipment

(Continued from page 25)

volt. A separate scale is provided for the lowest range of AC volts. The ohms ranges are x1, x10, x100, and x1K. The milliamperes ranges are 0 to .6, 6, 60, and 600 milliamperes.

A leather carrying case is available as an accessory. A loop on the case permits it to be worn on the trouser belt for convenient, out-of-the-way carrying.

### Protection Against Overloading in Triplet 630-NA Multimeter

No matter how careful the technician may be in the use of his meter, eventually he may get the test prods across the wrong circuit points; and the resultant overloading may either bend the needle or damage the meter movement.

To prevent such a possibility the manufacturers may include some protective device in the design of their product, as Triplet has done in the Model 630-NA multimeter.

We were not aware of this feature at the time the article on the Model 630-NA was prepared for the July 1955 issue. Since that time, it was brought to our attention through a very convincing demonstration of the protection it affords to the meter movement. In this demonstration, the test prods of the meter were purposely inserted into the 110-volt power receptacle. There was no damage to the movement, even though the meter switch was set on a low range.

We do not recommend that owners of the Model 630-NA make the same test merely to satisfy themselves on the matter, but it is a comfort to know that such protection exists in the event that it is needed.

### Triplet Model 3432-A Signal Generator

A recent addition to the Triplet line of test equipment is the Model 3432-A signal generator shown in Fig. 5. This generator provides an RF signal that is variable from 160 kilocycles to 110 megacycles which are fundamental frequencies and from 68 to 220 megacycles which are harmonic frequencies.

The RF signal may either be modulated or unmodulated, and the percentage of 400-cps modulation may be varied by means of the front-panel AUDIO control. This control

PERMO'S  
**PROFIT EXTRAS**



—help  
fill out  
your wallet

PERMO  
*Phono Needles*

**PERMO, INC.**  
Chicago 26, Illinois

## ATLAS Cobra-Jectors

- wide angle dispersion
- indestructible fiber-glass
- all-weather construction



CJ-30  
Net \$24.00

Weatherproof  
universal line  
transformer,  
\$5.10 Net.



CJ-14  
Net \$16.80

Designed for wide angle coverage, paging, high efficiency intercom, sensitive talk-back. Tops in articulation. Convenient omnidirectional mounting bracket. In appearance, they're "beauts".

SPECIFICATIONS	CJ-30	CJ-14
Input pwr (cont.)	15 w	5 w
Input imp.	4 or 8 Ω	4, 8 or 45 Ω
Response (cps)	250-9,000	400-10,000
Dispersion	120° x 60°	120° x 60°
Bell Size	14" x 6"	9½" x 5½"
Over-all length	14"	8½"

Amazing "power packages"—use the  
Cobra-Jectors for the "tough" jobs.



WRITE FOR COMPLETE CATALOG  
**ATLAS SOUND CORP.**  
1448—39 St., Bklyn. 18, N. Y.  
In Canada:  
Atlas Radio Corp., Ltd., Toronto, Ont.



THE TAG TELLS THE  
TURNER STORY —  
**VALUE**



**TURNER MODEL 57  
DYNAMIC MICROPHONE**

RESPONSE:  
50-13,000 c.p.s.

LEVEL:  
-55 db.

IMPEDANCE:  
Wired for quick selection of high or low impedance.

CABLE:  
20-ft. 3-conductor shielded cable with Cannon XL-4 quick-disconnect plug.

CASE:  
Modern, slim, inconspicuous; satin black with chrome fittings.

MOUNTING:  
Hinged 60°-arc coupler. Standard 3/8" — 27 thread.

DIMENSIONS:  
8 3/4" long. Dia. 1 1/8".

WEIGHT:  
14 oz. less cable.

USE:  
TV, Broadcast, P.A.

PRICE:  
Exceptionally Low;

**\$57.00**

Desk Stand \$7.50 extra.

Rugged dependability, Modern styling,  
Sound performance at a value price—

**TURNER MICROPHONES**

**THE TURNER COMPANY**

949 17th Street, N.E.  
Cedar Rapids, Iowa



Fig. 5. Triplet Model 3432-A Signal Generator.

also varies the amplitude of the audio signal which is available at the jacks labeled A.F. OUTPUT. A modulating signal from an external source may be fed in at the jacks just mentioned in case a special modulating signal is desired.

The RF output signal is obtained from a cathode-follower stage which provides minimum loading on the RF circuits. A three-step R.F. SELECTOR switch is labeled LOW, MED, and HI for low, medium, and high levels of signal strength. Continuously variable attenuation for each of these three steps is obtained with the ATTENUATOR control.

The seven positions of the RANGE SELECTOR switch are marked as follows: A, 160 to 370 kc; B, 360 to 735 kc; C, 715 to 1875 kc; D, 1825 to 4950 kc; E, 4.85 to 13 mc; F, 12.5 to 35 mc; and G, 34 to 110 mc. The coverage of the last range is extended by harmonics from 68 to 220 megacycles. Notice that the ranges are overlapping so that complete coverage will be obtained over the entire range from 160 kilocycles to 220 megacycles.

Smooth tuning is obtained by the use of a planetary-drive dial having a tuning ratio of approximately 6 to 1. Each dial scale is spread over 160 degrees.

The instrument case is of metal; the size is 6 1/4 by 11 1/32 by 5 11/32 inches; and the weight is 12 pounds.

**Win-Tronix Model 160 White Dot-  
Linearity Generator**

The Win-Tronix Model 160 White Dot-Linearity Generator is a compact and portable source of signals for creating dot and bar patterns on TV receiver screens. This type of signal generator is useful for convergence adjustments of color

**DOUBLE HEADER...  
TOP SALES!**

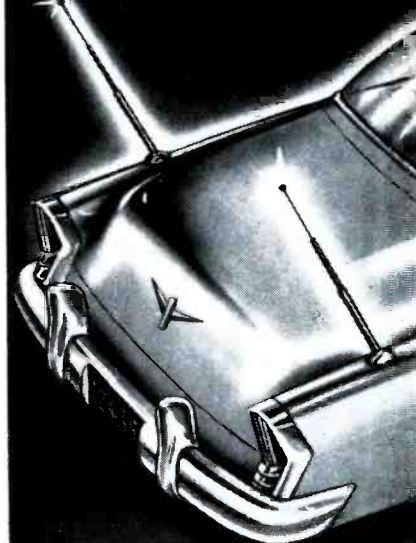

For a car that's really "dressed up to go places", the new "Double Header" twin antenna is a must! The latest selling sensation in automotive accessories, the "Double Header" is available in triple-plated chrome or 6 sparkling baked-on automotive colors. In self-displaying package units, these quality antennas are setting new sales records everywhere, a worthy companion to the famous Telescopic Auto "Baseball" Antenna, also available in chrome or color.

Whatever your antenna requirements — automotive, communications or special antennas — The Antenna Specialists Company will be pleased to serve you.

Write today for catalog sheets and complete specifications.



the  
**antenna  
specialists  
co.**

12435 Euclid Ave., Cleveland 6, Ohio

CANADA: ACTIVE RADIO & TV DISTRI.  
58 Spadina Ave. · Toronto  
EXPORT: C. O. BRANDES  
Cleveland, Ohio

# NEW!

**A more durable  
easier-to-use  
SERVICEMAN'S  
CARRYING CASE**

- more durable
- more compact

**TNT  
TUBE'N TOOL  
CARRIER**

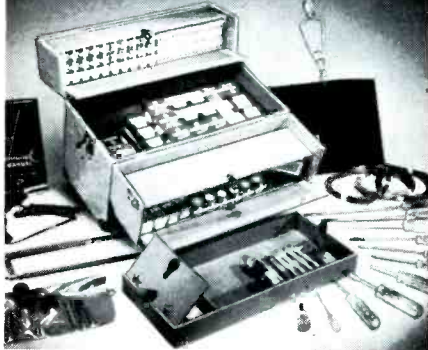

**Holds As Many As 250 Tubes  
and a Complete Set of Tools!**

"Terrific", say radio-TV servicemen. "Best-designed carrier ever made!" Extra rugged, extra roomy — holds all your tools and up to 250 tubes, standing upright for easy identification. Removable tray with compartment and side pockets keep everything in view. A real time and temper saver, built by men in the know, and priced to save you money. Model 55 19 3/4" x 9 3/8" x 14 1/4".



**Really Rugged!**

- Supports 350 lbs.
- Tough 1/4" plywood throughout
- Leatherette lined and covered
- Tough, top-grain cowhide corners
- Metal bottom studs
- Lifetime handle
- Positive draw bolt lock and key

Manufacturers  
of  
**LEATHER  
GOODS**  
Since 1926

Write for name of nearest distributor, also prices and specifications on other TNT Carriers.

**MASTRA COMPANY**  
2032 Euclid Ave., Cleveland 15, Ohio

receivers and for deflection adjustments of both monochrome and color receivers. It may also be used to advantage as a signal source for signal tracing.

The Model 160 generator is shown in Fig. 6. It is a product of Winston Electronics, Inc., Philadelphia, Pa.

The instrument provides an RF signal which may be fed into the antenna terminals of the receiver under adjustment. This signal is tunable from channel 2 through 6.

The function-selector switch has 7 positions. In clockwise order, these positions are labeled on the front panel in the following manner; POWER OFF, STANDBY, HORIZONTAL BARS, EXT MOD, VERTICAL BARS, DOTS X1, and DOTS X2. When the switch



**Fig. 6. Win-Tronix Model 160 White Dot-Linearity Generator.**

is in EXT MOD position, external modulation may be applied to the RF signal through the EXT MOD jack. The DOTS X1 and DOTS X2 positions provide a choice of large or small dots.

HORIZONTAL SYNC and VERTICAL SYNC controls are provided on the front panel for the purpose of stabilizing the dot or bar patterns on the receiver. Adjustment of these controls also affects the number of bars or dots obtained. An EXT SYNC jack is also mounted on the front panel. A test lead can be plugged into this jack, and the lead can be clipped on the insulated leads to the receiver yoke as an aid to horizontal synchronization.

In some cases, the operator will find that merely placing this test lead somewhere near the horizontal-deflection circuits of the receiver will result in enough signal pickup to synchronize the generator signal. We found in our laboratory tests that it was good practice to use the minimum amount of sync signal necessary for

good results. More than this amount may result in sync instability or jitter.

The instruction manual which accompanies the instrument contains a list of applications and a number of hints for obtaining the most satisfactory results from the generator.

The size of the Model 160 generator is 10 1/2 by 7 by 6 inches, and the weight is 6 1/4 pounds.

**PAUL C. SMITH**

**The  
Top  
Swivels  
It Never  
Leaves  
Your  
Palm**

**SWIVEL TOP  
SCREWDRIVER**

A New Principle! This economical Screwdriver saves time, saves effort. The swivel top permits you to maintain pressure on the screw without shifting your hand. Unbreakable handle made of Tenite 2, in amber with red swivel top. 14 popular sizes. 3/16" x 3" to 3/16" x 8"—plus No. 1, No. 2, and No. 3 Recess. Unconditionally guaranteed.

**SET YOUR  
SIGHT ON**

See Your  
Jobber

**AMALITE INC.**  
1884 PITKIN AVENUE, BROOKLYN 12, N.Y.

**stop  
knockin'  
yourself  
out!**

let the  
**MASTER**  
make life  
easier  
for you . . .  
see pg. 70





# PF REPORTER

## CATALOG and LITERATURE SERVICE

valuable manufacturers' data available to our readers

### 1K. AEROVOX (Aerovox Corporation)

Pocket-sized Aerovox Twist-Prong Capacitor Selector listing over 700 Type AFH twist-prong electrolytic capacitors to meet every current TV replacement need. In addition, booklet also lists over 200 tubular electrolytics. *See advertisement page 47.*

### 2K. AMERICAN MICROPHONE

(American Microphone, Div. of Elgin-Neomatic Inc.)

All new D-300 Dynamic Microphone designed for hand or stand use. Light weight, small and rugged for music or voice reproduction. Bulletin 300. *See advertisement page 79.*

### 3K. ASTRON (Astron Corp.)

Free sample of famous "Blue Point" molded paper capacitor. *See advertisement colorblock insert.*

### 4K. B & K (B & K Manufacturing Co.)

Bulletin No. 500 describing DYNALQUICK, Model 500, a new dynamic mutual conductance tube tester that completely tests, with laboratory accuracy, 99% of all tubes; and Bulletin 104 describing two new B & K Cathode Rejuvenator Testers—the CRT 400 and the CRT 200. *See advertisement page 46.*

### 5K. BUSSMANN (Bussmann Manufacturing Co.)

Bulletin SFB—a catalog of fuses used for protection of electronic devices. *See advertisement colorblock insert.*

### 6K. CBS (CBS-Hytron, A Div. of Columbia Broadcasting System, Inc.)

Crystal Diode Manual, 2nd Edition. *See advertisement page 14.*

### 7K. CHICAGO STANDARD (Chicago Standard Transformer Corp.)

Television Transformer Replacement Catalog Library, Auto-Radio Transformer Replacement Guide. *See advertisement page 16.*

### 8K. CLAROSTAT (Clarostat Mfg. Co., Inc.)

Series 43c Wire-Wound Controls, Rated 2-Watts, now up to 50,000 ohms. Form No. 753805. *See advertisement page 5.*

### 9K. CLEAR BEAM (Clear Beam TV Antenna Co.)

Clear Beam's Big 5 All Band Fringe Antennas. *See advertisement page 57.*

### 10K. CORNELL-DUBILIER (Cornell-Dubilier Electric Corp.)

Ceramic Capacitor Guide No. 616. *See advertisement page 56.*

### 11K. EICO (Electronic Instrument Co., Inc.)

Free 12-page catalog describing EICO's complete line Kits and Instruments—VTVMs, Scopes, Signal Generators, VOMs, Tube Testers, Battery Eliminators, etc. *See advertisement page 76.*

### 12K. ELECTROVOX (Electrovox Co., Inc.)

Walco dealer folder No. 6408, replacement needle wall chart No. 6186, and Walco Ident-I-Graf Bulletin (new system for quick needle identification using name of phono manufacturer as only reference). *See advertisement page 43.*

### 13K. ERIE (Erie Resistor Corp.)

Erie Catalog No. 55 (12 pages) describing various types of Erie capacitors, printed circuits, Teflon insulators, sockets, connectors and spagetti. *See advertisement page 59.*

### 14K. GENERAL CEMENT (General Cement Mfg. Co.)

New G-C Printed Circuit Service Manual. *See advertisement page 48.*

### 15K. IRC (International Resistance Co.)

Form S-031, Auto Radio Control Replacements. *See advertisement 2nd cover.*

### 16K. JFD (JFD Manufacturing Co., Inc.)

JFD Star-Helix, Fire-Ball, and Super Star Helix TV Antenna brochures. *See advertisement page 4.*

### 17K. MALLORY (P. R. Mallory & Co., Inc.)

Replacement Guide for Electrolytic Capacitors—all "can" types. *See advertisement page 28.*

### 18K. MOSLEY (Mosley Electronics)

Descriptive folder on new Mosley AC/TV wall plate outlets combining dual AC outlet and TV line and rotator outlets. *See advertisement page 74.*

### 19K. PERMA-POWER (Perma-Power Company)

Perma-Power bulletins covering TV Briteners, Service Aids and Remote Control Garage Door Openers. *See advertisement page 77.*

(Continued on next page)

## JUST CHECK AND MAIL THE CARD

1. Circle or check the corresponding numbers of literature you want to receive.

2. Fill in your complete name and address.

3. Detach and mail self-addressed card. No postage necessary.

Please send me the following literature checked below:

1K	2K	3K	4K	5K	6K	7K	8K	9K	10K	11K
12K	13K	14K	15K	16K	17K	18K	19K	20K	21K	22K
23K	24K	25K	26K	27K	28K	29K	30K	31K	32K	

Print plainly or type below

Name .....

Firm .....

Address .....

City ..... Zone ..... State .....

Has your address changed since you last wrote us  No  Yes

To guarantee receipt of literature please check one of boxes below:

Dealer with Service Shop  Independent Serviceman  Part Time Serviceman  Student

Other (Please explain) .....

**OFFER GOOD  
ONLY UNTIL  
DEC. 1, 1955**



# CATALOG and LITERATURE SERVICE

valuable manufacturers' data available to our readers

(Continued)



- 20K. PERMO (Permo, Incorporated)**  
Numerical listing of all Permo needles No. PPSL-7, Dealer Price Schedule No. DPS-7. See advertisement page 82.
- 21K. QUAM (Quam-Nichols Co.)**  
Catalog No. 75 describing new 2½" speakers. See advertisement page 67.
- 22K. R-COLUMBIA (R-Columbia Products Co.)**  
Bulletin No. 21 describing TROL-MASTER, a new tool that cleans and lubricates any TV or radio control. Kleontrol Magic Solvent, a non-inflammable fluid recommended for use with TROL-MASTER, is also described. See advertisement page 76.
- 23K. RADION (The Radion Corporation)**  
Model 600 Antenna Catalog. See advertisement pages 72, 80.
- 24K. RAM (Ram Electronics, Inc.)**  
Pocket Dealer Manual Composite Story. See advertisement page 64.
- 25K. SECO (Seco Mfg. Co.)**  
Seco TV Grid Circuit Tube Tester (GCTS) and FB-4 Flyback Interval and Inductance Checker. See advertisement page 66.
- 26K. SPRAGUE (Sprague Products Co.)**  
M-714 Catalog Sheet, illustrating and describing the new line of Sprague "Blue Jacket" vitreous enamel wire-wound resistors. Includes complete listings. See advertisement pages 2, 67, 73, 81.
- 27K. TURNER (Turner Co.)**  
Bulletin No. 968 . . . The Turner Model 58 lavalier microphone. See advertisement page 83.

## 28K. U. S. ELECTRONICS (United States Electronic Research and Development Corp.)

Complete description and specifications covering amazing new "laboratory-accurate" Tube Checker and companion picture tube Ren-O-Lyzer. Both designed for on-the-job use—will increase in-home service potential and reduce call-backs. Instruments are rugged, compact, light weight, and can be carried in tube caddy. (NOTE: Ads appeared in September issue of PF REPORTER. Listing was omitted through error.)

## 29K. WALSCO (Walsco Electronics Corp.)

General Catalog and informative literature on Walsco TV and FM antennas, electronic hardware and chemicals, TV alignment tools, phono and recorder drives, chassis punches, etc. See advertisement page 34.

## 30K. WELLER (Weller Electric Corp.)

New catalog sheet No. 006, describing new Weller soldering kit Model 810 OK. Covers kit contents, practical features and price. See advertisement page 69.

## 31K. WINEGARD (Winegard Co.)

Pixie Folder. See advertisement page 42.

## 32K. XCELITE (Xcelite, Incorporated)

Complete catalog on nut drivers, screwdrivers, pliers; supplementary sheets on new tool kits, chrome plated pliers, new reamers. See advertisement page 52.

INDEX TO ADVERTISERS  
October, 1955

Advertiser	Page No.
Aerovox Corp. . . . .	47
Amalite, Inc. . . . .	84
American Microphone Co., Affiliate Elgin Nat'l Watch Co. . . . .	79
American Phenolic Corp. . . . .	30, 31
American Television & Radio Co. . . . .	71
Antenna Specialists Co., The . . . . .	83
Arvin Industries, Inc. . . . .	78
Astron Corporation. . . . .	Colorblock Insert
Atlas Sound Corp. . . . .	82
B & K Manufacturing Co. . . . .	46
Belden Manufacturing Co. . . . .	Colorblock Insert
Bud Radio, Inc. . . . .	68
Bussmann Mfg. Co. . . . .	Colorblock Insert
CBS-Hytron . . . . .	14
Centralab, A Division Globe-Union, Inc. . . . .	53, 79
Chicago Standard Trans. Corp. . . . .	16
Claroostat Mfg. Co., Inc. . . . .	5
Clear Beam Antenna Corp. . . . .	57
Columbia Wire & Supply Co. . . . .	81
Cornell-Dubilier Electric Corp. . . . .	56
Allen B. DuMont Labs., Inc. . . . .	22
Electro Products Labs. . . . .	66
Electronic Instrument Co., Inc. (EICO). . . . .	76
Electronic Publishing Co. . . . .	72
Electronic Test Instr. Co. . . . .	82
Equipto Division, Aurora Equipment Co., Inc. . . . .	52
Erie Resistor Corp. . . . .	59
General Cement Mfg. Co. . . . .	48
Hycon Mfg. Co. . . . .	50
International Rectifier Corp. . . . .	44
International Resistance Co. . . . .	2nd Cover
Jackson Electrical Instrument Co. . . . .	69
Jensen Industries, Inc. . . . .	80
JFD Mfg. Co. . . . .	4
Littelfuse, Inc. . . . .	4th Cover
Mallory & Co., Inc., P. R. . . . .	28
Mastra Co. . . . .	84
Merit Coil & Trans. Co. . . . .	8
Mosley Electronics, Inc. . . . .	74
Mueller Electric Co. . . . .	78
Perma-Power Co. . . . .	77
Permo, Inc. . . . .	82
Phaoston Co. . . . .	58
Planet Mfg. Corp. . . . .	74
Pyramid Electric Co. . . . .	36
Quam-Nichols Co. . . . .	67
R-Columbia Products Co. . . . .	76
Radiart Corp. — Cornell-Dubilier Electric Corp. . . . .	1
Radio Corp. of America . . . . .	6, 40, 75, Third Cover
Radio Receptor Co., Inc. . . . .	54
Radion, Co., The . . . . .	72, 80
Ram Electronics Sales Co. . . . .	64
Raytheon Mfg. Co. . . . .	7
Sams & Co., Inc., Howard W. . . . . .	Colorblock Insert
Sangamo Electric Co. . . . .	39
Seco Mfg. Co. . . . .	66
Shure Bros., Inc. . . . .	60
Sonotone Corp. . . . .	65
Sprague Products Co. . . . .	2, 67, 73, 81
Sylvania Electric Products Inc. . . . .	32
Teletest Instr. Corp. . . . .	78
Tenna Mfg. Co. . . . .	38
Transvision, Inc. . . . .	73
Turner Co. . . . .	83
United Catalog Publishers, Inc. . . . .	63, 70, 84
University Loudspeakers, Inc. . . . .	80
Vokar Corp. . . . .	62
Walco-Electrovox Co., Inc. . . . .	43
Walsco Electronics Corp. . . . .	34
Ward Products Corp. . . . .	26
Weller Corp. . . . .	69
Winegard Co. . . . .	42
Winston Electronics . . . . .	63
Xcelite, Inc. . . . .	52

FIRST CLASS  
PERMIT No. 1076  
(Sec. 34.9, P. L. & R.)  
Indianapolis, Ind.

### BUSINESS REPLY CARD

No Postage Stamp Necessary If Mailed in the United States

3¢ POSTAGE WILL BE PAID BY

## PF REPORTER

Reader's Literature Service Dept.

2201 EAST 46TH STREET

INDIANAPOLIS 5, IND.

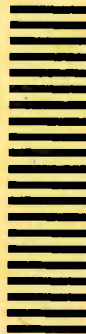

While every precaution is taken to insure accuracy, we cannot guarantee against the possibility of an occasional change or omission in the preparation of the REPORTER.



BLACK AND WHITE TV  
 COLOR TV  
 TRANSISTOR RADIOS  
 FM RADIOS  
 AM RADIOS  
 AUTO RADIOS  
 AMPLIFIERS AND TUNERS  
 RECORD CHANGERS

# WHAT'S YOUR SERVICE PROBLEM?

## PHOTOFACT HELPS YOU SOLVE IT

**FASTER, EASIER, BETTER, MORE PROFITABLY!**



### THE WORLD'S FINEST SERVICE DATA

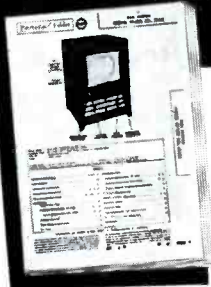

THESE GREAT FEATURES ARE EXCLUSIVE IN PHOTOFACT—THEY HELP YOU EARN MORE DAILY, HELP INSURE CUSTOMER SATISFACTION

PHOTOFACT Service Data is the only service information based upon first-hand examination of the actual production-run receivers and equipment. It is authentic, uniform data developed through actual study and analysis by service engineers in the Howard W. Sams Laboratories. PHOTOFACT is the only data prepared from the practical point of view of the Service Technician.

Thousands of Service Technicians use PHOTOFACT daily for time-saving, profit-boosting service operations. If you've never used PHOTOFACT, you've never realized your full earning power—you've never given such complete customer satisfaction. So get the proof for yourself. Try PHOTOFACT—use it on any job. Your Parts Distributor has the Folder Sets you need for any of the 17,000 TV and radio receivers, changers, recorders, etc., covered in PHOTOFACT. Once you use this great service, we know you'll want the complete PHOTOFACT Library.

**EASY-PAY PLAN TO FIT YOUR BUDGET**  
 Ask your PHOTOFACT Distributor... he'll show you how you can now own the PHOTOFACT Library through a unique Easy-Pay Plan that exactly fits your needs. Pays for itself as you EARN MORE.

### IT'S EASY TO SOLVE YOUR SERVICE PROBLEMS

See the PHOTOFACT Cumulative Index, page 88 and following  
 It is your guide to virtually any model ever to come into your shop; helps you locate the proper PHOTOFACT Folder you need to solve any service problem on any model. Once you have the make and chassis number, it takes just 60 seconds to find the applicable PHOTOFACT Folder.  
 Get the required Folders from your parts distributor and you are all set for faster, easier, better, more profitable work.

**HOWARD W. SAMS & CO., INC. • Indianapolis 5, Indiana**

### FULL SCHEMATIC COVERAGE

1. Famous "Standard Notation" uniform symbols are used in every schematic.
2. The same standard, uniform layout is used for each schematic.
3. Diagrams are clear, large, easy to read, easy to handle.

4. Wave forms are shown right on the TV schematics for quick analysis by scope.
5. Voltages appear on the schematics for speedy voltage analysis.
6. Transformer lead color-coding is indicated on the schematic.
7. Transformer winding resistances appear on the schematic.
8. Schematics are keyed to photos and parts lists.

### FULL PHOTOGRAPHIC COVERAGE

9. Exclusive photo coverage of all chassis views is provided for each receiver.
10. All parts are numbered and keyed to the schematic and parts lists.
11. Photo coverage provides quicker parts identifications and location.

### ALIGNMENT INSTRUCTIONS

12. Complete, detailed alignment data is standard and uniformly presented in all Folders.
13. Alignment frequencies are shown on radio photos adjacent to adjustment number—adjustments are keyed to schematic and photos.

### TUBE PLACEMENT CHARTS

14. Top and bottom views are shown. Top view is positioned as chassis would be viewed from back of cabinet.
15. Blank pin or locating key on each tube is shown on placement chart.
16. Tube charts include fuse location for quick service reference.

### TUBE FAILURE CHECK CHARTS

17. Shows common trouble symptoms and indicates tubes generally responsible for such troubles.
18. Series filament strings are schematically presented for quick reference.

### COMPLETE PARTS LISTS

19. A complete and detailed parts list is given for each receiver.
20. Proper replacement parts are listed, together with installation notes where required.
21. All parts are keyed to the photos and schematics for quick reference.

### FIELD SERVICE NOTES

22. Each Folder includes time-saving tips for servicing in the customer's home.
23. Valuable hints are given for quick access to pertinent adjustments.
24. Tips on safety glass removal and cleaning.

### TROUBLE-SHOOTING AIDS

25. Includes advice for localizing commonly recurring troubles.
26. Gives useful description of any new or unusual circuits employed in the receiver.
27. Includes hints and advice for each specific chassis.

### OUTSTANDING GENERAL FEATURES

28. Each and every PHOTOFACT Folder, regardless of receiver manufacturer, is presented in a standard, uniform layout.
29. PHOTOFACT is a current service—you don't have to wait a year or longer for the data you need. PHOTOFACT keeps right up with receiver production.
30. PHOTOFACT gives you complete coverage on TV, Radio, Amplifiers, Tuners, Phonos, Changers.
31. PHOTOFACT maintains an inquiry service bureau for the benefit of its customers.



**no!**

NOTHING BUT  
**"STAMINIZED" CAPACITORS**  
 WILL DO...

The consumer is king!  
 Catering to his wishes is the way to bigger servicing profits.

Set owners depend upon you as a "specialist" to install top-quality replacement parts that will give long, satisfactory service... for this reason, Astron developed "Staminized" capacitors... a special process imparts extra-ruggedness to each unit... it's the protection that lets you install with complete confidence.  
 This royal quality gained immediate and widespread acceptance among service technicians... it's why Astron "SM" Safety Margin Electrolytics can successfully withstand surge voltages and overloads without permanent damage... their reputation for durability is the sure key to increased consumer satisfaction and faster, more profitable servicing for you.

Easy-to-install, exact replacement Astron "SM" Electrolytics are available in a wide range of styles... one for every servicing requirement... meticulously assembled by contamination-free techniques for dependable 85°C operation, low leakage and long shelf life.

They're backed by the famous Astron guarantee—result of TEN individual production tests and 100% final inspection.

See your local jobber for Astron capacitors—Today!  
**FREE SERVICING AID**—Write for your copy of NEW handy pocket-sized replacement capacitor and pricing guide — Now!



ASTRON "SM" MINIMATE



ASTRON "SM" TWIST-PRONG



CROWN PRINCE OF MOLDED PLASTIC PAPER TUBULARS  
 ASTRON BLUE • POINT

**ASTRON**  
 CORPORATION



255 GRANT AVENUE, E., NEWARK, N. J.

\*Trademark

Export Division: Techno-International Corp., 1185 20th St., NEW YORK, N. Y. • Canadian: Charles W. Pettifor, 6 Aylmer Ave., Toronto, Ontario

**HELPS YOU EARN MORE DAILY**



# USING THE RCA MODEL WR-



Fig. 2. Pattern Produced by Depressing MOD. Button.



Fig. 3. Pattern Indicating Improper Setting of Hue Control.



Fig. 4. Pattern Produced by a Receiver.



Fig. 1. The RCA Model WR-61A Color-Bar Generator.

## GENERAL DESCRIPTION

The RCA Model WR-61A color-bar generator produces signals which can be used to test and adjust color receivers. The cabinet of the instrument is styled so that it matches other RCA equipment. Not only can the unit be used on the bench, it can also be used as a portable instrument. The controls are neatly arranged and clearly marked to facilitate the selection of the desired signals. Fig. 1 is a photograph of the RCA Model WR-61A color-bar generator.

## SIGNALS PROVIDED

The Model WR-61A produces either a video signal or a modulated RF signal. The video signal is available at either a positive or negative polarity. The instrument produces an RF signal for operation on channels 3 or 4 depending upon which crystal has been supplied with the unit. Operation on a different channel may be had by changing crystals and by recalibrating. The sound carrier is unmodulated and may be turned off by depressing the SOUND CARRIER OFF button on the front panel.

The color video signal produced by the Model WR-61A consists of a sync pulse and eleven subcarrier bursts. The waveform of this video signal is illustrated in Fig. 7. The phase of each of the subcarrier bursts is delayed 30 degrees from the preceding one. In operation, the receiver interprets the first subcarrier burst as the color-sync burst; and the remaining ten bursts produce ten color bars, each bar being representative of a color displaced by 30 degrees from its adjacent bar. Fig. 4 illustrates the pattern that is seen on a receiver that is operating normally. Note that the color bars vary in hue, starting with a yellow-orange on the left and ending with a green on the right.

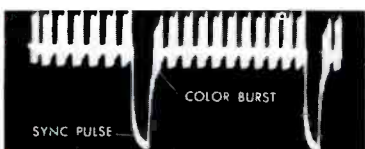

Fig. 7. Waveform of Color Signal.

The phase angle of the subcarrier and the color for each of the bars are identified on the color-phase diagram shown in Fig. 10 in which bar No. 1 is yellow-orange, bar 2 is orange, bar 3 is red, bar 4 is blue-red, bar 5 is magenta, bar 6 is blue, bar 7 is green-blue, bar 8 is cyan, bar 9 is blue-green, and bar 10 is green. Note that the third bar is an R - Y signal, bar 6 is a B - Y signal, and bar 9 is a minus R - Y signal. Bars 2, 5, and 8 are only three degrees off the I, Q, and minus I signals, respectively. Because of the fact that the hue control of a receiver covers a much greater range than three degrees, these three bars can be used to adjust circuits in receivers which demodulate on I and Q axes.

The five controls which are positioned horizontally across the panel of the instrument, starting from right to left, are labeled as follows: (1) OFF-STANDBY-ON, (2) BRIGHTNESS MOD., (3) SUBCARRIER MOD., (4) VIDEO, and (5) HOR. HOLD. The OFF-STANDBY-ON control is a three-position switch. When this switch is in the STANDBY position, power is applied only to the tube heaters. When the switch is turned to the ON position, B+ is applied.

The BRIGHTNESS MOD. control is used to vary the level of horizontal synchronization. Once this control is properly adjusted, it is not necessary to readjust it under normal conditions.

The SUBCARRIER MOD. control varies the amplitude of the color-burst signal and can be adjusted to reduce the amplitude of the signal so that the color-locking characteristics of the receiver under test can be checked.

The VIDEO switch, which is labeled (-) and (+), permits the selection of a video signal of either a negative or positive polarity. The video signal is available from a jack which is located below the VIDEO switch. This jack is labeled VIDEO OUT - LO and supplies a video signal suitable for injection into low-impedance circuits. A shielded cable is provided to make this connection. To the left of this jack is a binding post labeled VIDEO OUT - HI, and to the right is one labeled GND. The video signal of either polarity is taken from these terminals when connecting to high-impedance circuits.

The repetition rate of the horizontal sync pulses can be varied by adjustment of the HOR. HOLD control. The control should be set so that a 10-bar pattern like that shown in Fig. 4 is visible on the screen.

The control positioned near the top center of the panel is labeled METERING. This control is a three-position switch which serves as a means of supplying various signals to an external VTVM for setting modulation levels. The VTVM is connected to a binding post labeled METER. The modulation levels are adjusted by means of controls which are located inside the instrument. Once these controls are set, they seldom require readjustment. The METERING switch is normally set to the OFF position.

The R.F. OUT jack is located in the lower portion of the unit to the left of the METER terminal. A cable which has a balanced output is provided for connecting the RF signal to the receiver.

To the right of the METERING control is a push button labeled SOUND CARRIER OFF. The sound carrier may be turned off by depressing this button. By so doing, any 920-kc beat which might be present in the picture is removed.

To the left of the METERING control, there is another push button labeled MOD. When this button is depressed, 60-cycle modulation is applied to the signal and a brightened horizontal bar appears in the picture. This signal is helpful in testing the amplitude characteristics of a receiver. Fig. 2 illustrates the appearance of the pattern when the 60-cycle modulation has been applied. Note that, although the color in one portion of each bar is of a different saturation than the color in the rest of the bar, the hue is the same throughout the length of the bar. In a receiver that is improperly adjusted, the portion of each bar in the bright area will be of a different hue than that in the dark area of the same bar.

## CHECKING RECEIVER OPERATION

Connect the RF output of the generator to the antenna terminals of the receiver under test. Set the channel selector of the receiver to the proper channel, and adjust the fine-tuning control to tune in the pattern so that a minimum 920-kc beat is obtained. Adjust the HOR. HOLD control on the instrument in order to obtain ten bars in the picture.

Adjust the brightness, contrast, saturation, and hue controls of the receiver in an attempt to produce the proper pattern like that shown in Fig. 4. If the receiver produces a satisfactory pattern, its operation can be considered normal.

If a satisfactory picture cannot be produced, analyze the symptoms in order to determine what section is not operating properly. All color troubles will fall into these three categories: (1) loss of color, (2) wrong color, and (3) loss of color synchronization. After determining the proper category of the symptoms, substitute tubes in the stages involved. If no improvement is noted, proceed as outlined in the servicing section.

## SERVICING

The operation of the color stages can be checked with the signal available from the RCA Model WR-61A. In every case, it is assumed that the receiver operates normally when receiving a monochrome transmission.

### NO COLOR

If no color can be produced by injecting an RF signal at the antenna terminals, inject a video signal across the video-detector load. If color can be obtained by injecting the signal at this point, the trouble must lie in the IF stages or in the tuner. Do not overlook the possibility that the tuning range of the tuner might be

insufficient. Reconnect the RF output of the generator to the antenna terminals, and check the setting of the fine-tuning slug or trimmer. If color cannot be received even though the fine-tuning range is known to be correct, check the alignment of the tuner and IF amplifier.

If color cannot be received by injecting a video signal at the video detector, check the input of the signal at the demodulator stages. Fig. 8 illustrates the signal which should be present at the input of the demodulators. If the signal is not present, check the operation of the bandpass amplifier and locate the point at which the signal is being lost. If the receiver employs a color-killer stage, check to see that this stage is not cutting off the bandpass amplifier. If such should be the case, check the operation of the color-sync section as outlined under "Loss of Color Synchronization."

Color demodulation should take place if both the chrominance signal (Fig. 8) and the CW signal (Fig. 9) are present at the demodulators. If either is absent, locate the defective stage by signal tracing backward through the circuits. After the defective stage is located, voltage and resistance measurements will usually identify the defective component.

### WRONG COLOR

Defects associated with wrong color can be classified into two main categories: (1) complete or partial loss of one of the color-difference signals, and (2) a phase error either in the chrominance signal that is applied to the demodulators or in the CW reference signals that are applied to the demodulators.

The fact that there is any color produced indicates that the CW reference oscillator is operating and that the reference and chrominance signals are being fed to at least one of the demodulators. The first step is to determine whether or not both demodulator circuits are working. This can be done by noting the effects on the pattern as the hue control is rotated. In

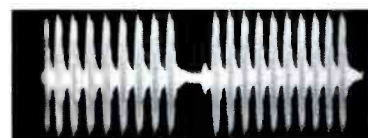

Fig. 8. Chrominance Signal at Input of Demodulators.



Fig. 9. CW Signal at Input of Demodulators.

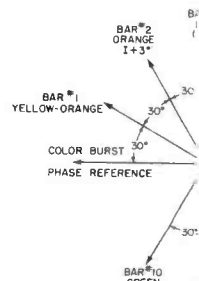

Fig. 10. Diagram Showing Chrominance Signal.



Fig. 11. Pattern Illustrating Chrominance Signal.



Fig. 12. Pattern Illustrating Chrominance Signal.



Fig. 13. Pattern Illustrating Chrominance Signal.



# 61A COLOR-BAR GENERATOR



Fig. 5. Pattern Indicating Loss of Q Signal.



Fig. 6. Pattern Indicating Loss of I Signal.

Receiver That is Operating Normally.

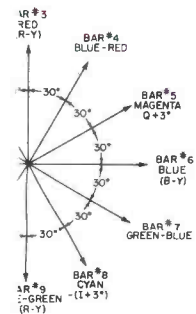

Fig. Phase Angles of the



Fig. Indicating Loss of Red Signal.



Fig. Indicating Loss of Green Signal.



Fig. Indicating Loss of Blue Signal.

receivers that are operating normally, the colors on the screen will vary through a wide range as the hue control is varied. Fig. 3 illustrates a picture which has improper colors. Note that the first bar is orange instead of the second bar. Such a condition indicates an error of 30 degrees in the demodulation process.

If only one of the color-difference signals is present, each of the color bars will remain predominantly at one of two hues. If the receiver demodulates on the I and Q axes and if the Q signal is being lost, all the color bars will appear predominantly an orange or a cyan color as they do in Fig. 5. If the I signal is being lost, the color bars will appear predominantly green or magenta as in Fig. 6. As the hue control is varied, the green and magenta bars will appear to vary in saturation and some of them may take on the opposite hue.

If the receiver demodulates on the R - Y and B - Y axes and if either of the demodulator sections fail, the following conditions exist. If the B - Y signal is lost, the bars will appear predominantly red or cyan. If the R - Y signal is lost, the bars will appear predominantly greenish-yellow or blue.

Another significant thing that will be noted when checking a receiver that has lost one of the color-difference signals is that some of the bars may lose all color at certain settings of the hue control. After it has been determined which signal is absent, a signal-tracing procedure should disclose the faulty stage.

Figs. 11, 12, and 13 are color patterns which result from the loss of the red, green, and blue signals, respectively. Although the loss of any one of these color signals would affect the operation of the color receiver during monochrome reception, the patterns are shown in order to provide a comparison with Figs. 5 and 6 which are patterns that result from the loss of a color-difference signal.



Fig. 14. Signal at Plate of I Demodulator Illustrates Proper Cancellation of Fifth-Bar Signal.



Fig. 15. Signal at Plate of I Demodulator Illustrates Improper Cancellation of Fifth-Bar Signal.

### Checking Demodulator Action

Defects associated with phase errors in the CW reference signals or in the chrominance signal can be located through the use of the signal produced by the generator. If (after adjustment of the contrast, brightness, hue, and saturation controls) the receiver cannot produce a pattern such as that shown in Fig. 4, check the operation of the demodulators. Inject a signal into the receiver; then using an oscilloscope, check the signal at the plate of the I demodulator.



Fig. 16. Signal at Plate of Q Demodulator Illustrates Proper Cancellation of Second-Bar Signal.



Fig. 17. Signal at Plate of Q Demodulator Illustrates Improper Cancellation of Second-Bar Signal.

Adjust the hue control to obtain a zero signal during the scanning time of the fifth bar. Fig. 14 illustrates the pattern that will be obtained under these conditions. Fig. 15 illustrates a pattern that will be obtained when there is incorrect setting of the hue control. As the hue control is rotated on either side of the correct setting, the polarity of the signal during the scanning time of the fifth bar will go alternately positive and negative. If the receiver under test employs an R - Y demodulator instead of an I demodulator, adjust the hue control for zero signal during the scanning time of the sixth bar instead of the fifth.

With the hue control set so that the I signal is at zero during the scanning time of the fifth bar, connect the oscilloscope to the plate of the Q demodulator. Without readjusting the hue control, check to see that there is zero signal during the scanning time of the second bar, as illustrated by the waveform in Fig. 16. The result of an incorrect condition is shown in the waveform of Fig. 17. If the receiver under test employs a B - Y demodulator instead of a Q demodulator, check for zero signal during the scanning time of the third bar instead of the second.

If the signal is not at zero during the scanning time of the second (or third) bar, an adjustment of the quadrature transformer must be made. (In some receivers, the order of checking the signals at the plates of the demodulators may be reversed. Consult the receiver service data to determine the proper order.)

After making the quadrature adjustment, set the hue control to its proper position by adjusting it for cancellation of the unwanted signal at the plate of one of the demodulators. If the colors obtained are not satisfactory, check the operation and alignment of the matrix in the manner specified in the receiver service data.

tion by adjusting it for cancellation of the unwanted signal at the plate of one of the demodulators. If the colors obtained are not satisfactory, check the operation and alignment of the matrix in the manner specified in the receiver service data.



Fig. 18. A Minus I Signal.



Fig. 19. A Minus Q Signal.



Fig. 20. A Minus R-Y Signal.

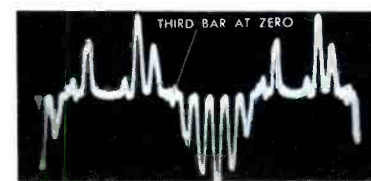

Fig. 21. A Minus B-Y Signal.

Figs. 18 through 21 illustrate color-difference signals that are obtained when using the RCA Model WR-61A color-bar generator. Fig. 18 shows a minus I signal, Fig. 19 shows a minus Q signal, Fig. 20 shows a minus R - Y signal, and Fig. 21 shows a minus B - Y signal. These waveforms can be referred to when checking demodulator operation, when adjusting the

matrix, and when checking the operation of the color-difference amplifiers.

### LOSS OF COLOR SYNCHRONIZATION

If the reference oscillator of the receiver does not synchronize with the color-burst signal, color demodulation takes place at a random rate. Under these conditions, diagonal or horizontal stripes of variegated colors appear in the picture. These stripes may or may not move, depending upon the operating frequency of the reference oscillator. When loss of color synchronization is experienced, trouble in the burst amplifier or color-synchronizing stages should be suspected.

Because of the fact that some color is produced, two things are known: (1) the color signal is being applied to the demodulators and (2) the CW reference oscillator is operating. The problem is to find out why the color burst does not synchronize the CW oscillator.



Fig. 22. Signal at Plate of Burst Amplifier.

Fig. 22 illustrates the waveform present on the plate of the burst amplifier. The large spike is caused by the keying pulse obtained from the horizontal-output stage. Note the color-burst position at the tip of the spike. If the color burst is not present, rotate the horizontal-hold control and note whether the color burst appears. When checking some receivers or when using an oscilloscope which has only medium gain at 3.58 megacycles, it may be necessary to increase the vertical gain of the oscilloscope to maximum in order to see the color burst. Position the pattern so that the tip of the spike is visible, and then check to see if the color burst is visible.

If the color burst is present in the output of the burst amplifier, trace the signal to the color-synchronizing section. The type of synchronizing circuit used in the receiver being serviced will dictate the servicing procedure that should be used in the color-sync stages; but in the majority of receivers, voltage and resistance checks will disclose the defective component.

## PHOTOFACT COLORBLOCK\* Reference Chart No. 9

A PHOTOFACT COLORBLOCK Which Outlines the Uses of the RCA Model WR-61A Color-Bar Generator in Adjusting and Servicing Color Receivers.

Prepared by the Editorial Staff of the PF REPORTER for the Electronic Service Industry—October, 1955



**WIRE  
AND  
CABLE  
FOR EVERY  
ELECTRONIC  
PRODUCT**

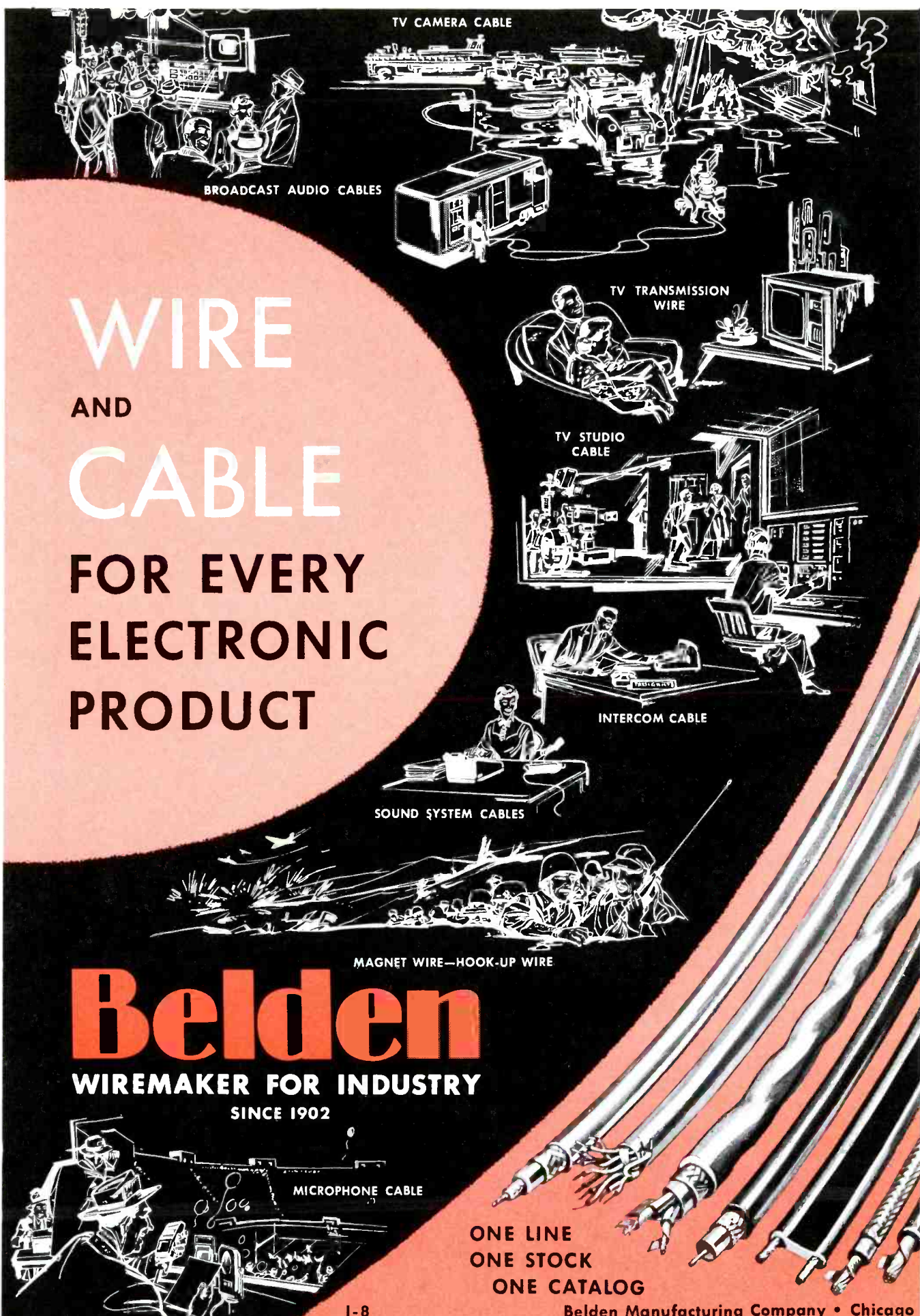

**Belden**  
WIREMAKER FOR INDUSTRY  
SINCE 1902



**ONE LINE  
ONE STOCK  
ONE CATALOG**  
Belden Manufacturing Company • Chicago

I-8

**Buss Fuses  
give you...**

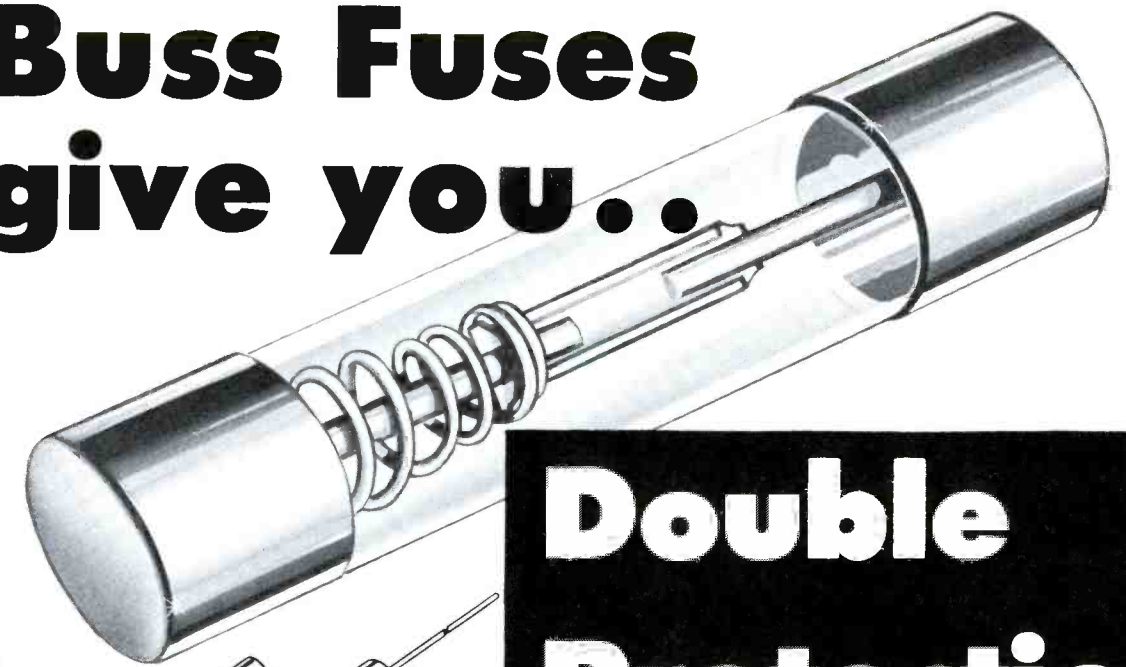

**Double  
Protection**

**.. Against loss of  
Customer Satisfaction**

To make sure of proper operation under all service conditions — every BUSS fuse normally used by the Electronic Industries is tested in a sensitive electronic device. Any fuse not correctly calibrated, properly constructed and right in all physical dimensions is automatically rejected.

That's why BUSS fuses won't blow when trouble doesn't exist. Useless shutdowns caused by poor quality fuses blowing needlessly are not only irritating to customers — but customers' confidence in your product or service could be jolted.

However, when there is an electrical fault BUSS fuses open to prevent further damage to equipment — saving users the expense of replacing needlessly damaged parts.

When you standardize on BUSS fuses, you are doubly safe.

MAKERS OF A COMPLETE LINE OF FUSES FOR  
HOME, FARM, COMMERCIAL, ELECTRONIC,  
AUTOMOTIVE AND INDUSTRIAL USE.

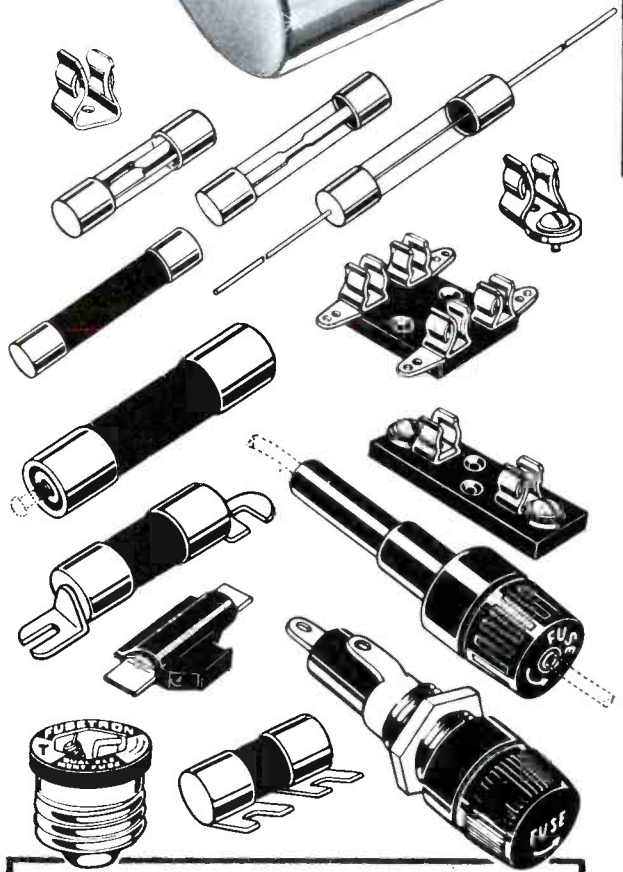

**BUSS IS THE PROFIT LINE  
TO HANDLE**

Millions upon millions of BUSS fuses used in home, farm and industry over the past 41 years have firmly established BUSS as the *Known* brand.

This means sales are easier to make and with never a "comeback".

And BUSS offers a complete line to meet all your needs.

Be sure to get the latest information on BUSS and FUSETRON small dimension fuses and fuse-holders . . . Write for bulletin SFB.

**BUSSMANN MFG. CO.** **FUSETRON** TRUSTWORTHY NAMES IN ELECTRICAL PROTECTION **BUSS** Div. McGraw Electric Co.  
University at Jefferson St. Louis 7, Mo.



# THE GREAT NEW NAME IN ALUMINIZED PICTURE TUBES!



**RCA**  
**Silverama**

your new  
replacement  
profit-maker

sizes to fit  
virtually all  
sets

heavily  
consumer  
advertised

**RCA "SILVERAMA" MEANS BRIGHTER, CLEARER, SHARPER TV PICTURES FOR YOUR CUSTOMERS—MORE REPLACEMENT BUSINESS, SALES AND PROFITS FOR YOU!**

It's the great, new replacement line of RCA aluminized picture tubes and RCA is telling the world, your city and neighborhood about it. Radio & TV announcements, national magazines, direct mail, posters, streamers, counter cards and other powerful sales aids will bring the remarkable story of RCA "SILVERAMA" right into your customers' homes—bring customers into your store! Order RCA "Silverama" Aluminized Picture Tubes now. Your customers will ask for them. Get on board this new profit-maker!

SEE YOUR RCA TUBE DISTRIBUTOR TODAY FOR FULL DETAILS ON THE EXCITING RCA SILVERAMA WINDOW DISPLAY CONTEST FOR SERVICE DEALERS!



National  
Radio &  
Television  
Week

September 18-24  
dedicated to better home entertainment



**RADIO CORPORATION of AMERICA**  
TUBE DIVISION  
HARRISON, N. J.



NOW in TV sets by . . .

soon in most other TV receivers!

## LIMITED CURRENT (L.C.) FUSES AND FUSE HOLDERS

... a new and profitable replacement market

A completely new approach to circuit protection to completely eliminate the possibility of over fusing circuits.

This has been accomplished by a combination of three different fuse lengths and seven different widths of bayonet locking tabs on the fuse caps. LC fuses may not be replaced by standard fuses.

The fuse post is made to accept only the size amperage range and type (regular or slo blo) in its range. For example: a 1 amp. slo blo fuse is 1¼" long with .115 to .120 width tabs. The holder used with this will only accept a slo blo fuse (N type) above ¾ to 1¼ amps.

The holder is a ruggedly designed unit, molded from high strength bakelite.

It snaps into a predetermined chassis mounting hole and locks into place by means of a quick snap-in type lock washer. It can be pressed into place by hand or simple tools.

The fuse locks into the holder by means of a bayonet lock which permits easy and quick insertion and removal of fuses—simple replacement.

Both solder connections are behind panel, making the installation of the unit simple and inexpensive.

SYLVANIA

Caphart

Emerson

STROMBERG-CARLSON

Bendix

SETCHELL-CARLSON

BURTON BROWNE ADVERTISING

# LITTELFUSE

DES PLAINES, ILL.