

AUGUST 1974

Howard W. Sams
INDEX

the monthly **REPORTER** for the Electronic Service Industry

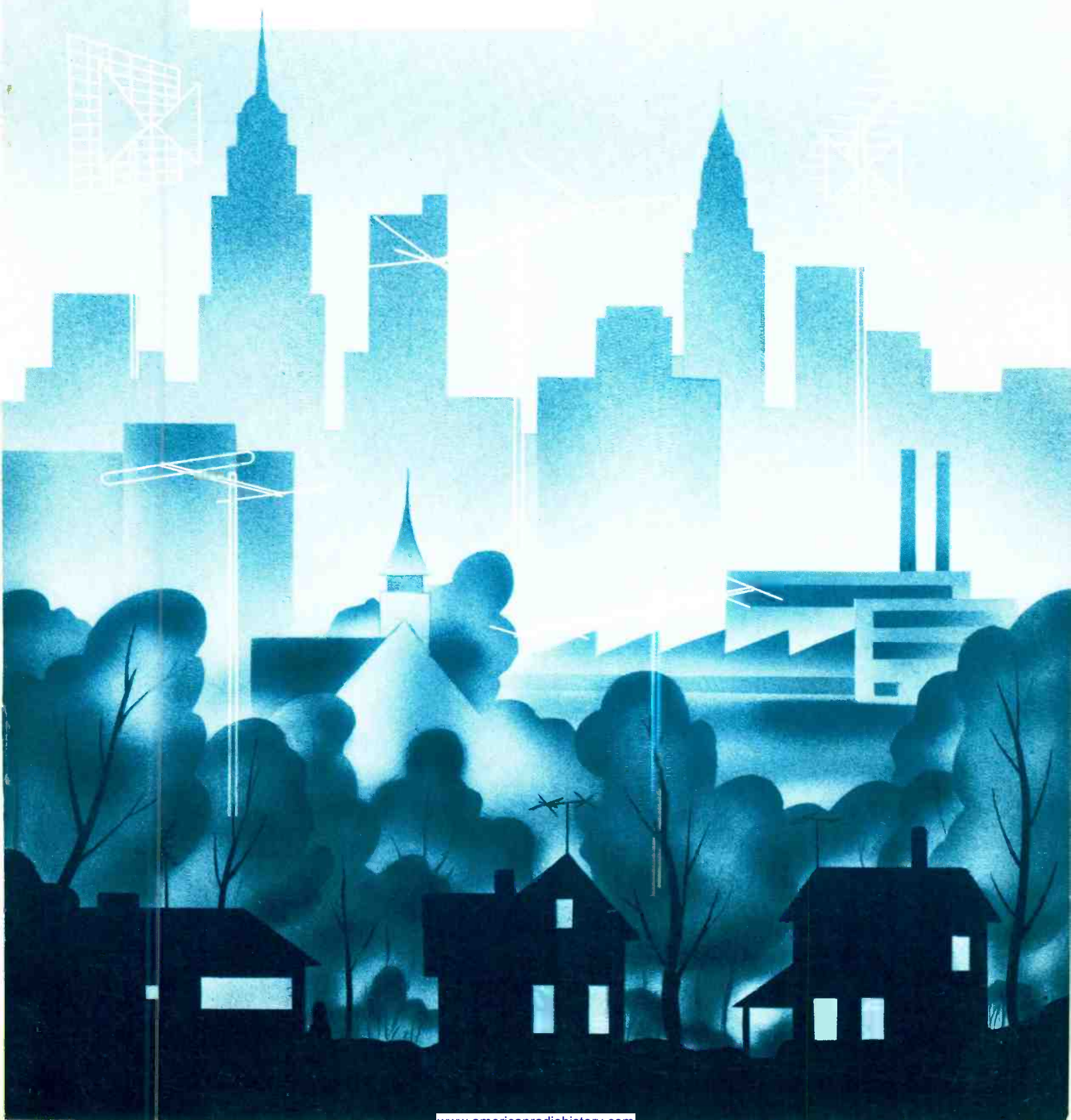

ASSURED ELECTRICAL ACCURACY BASED ON MANUFACTURERS' PROCUREMENT PRINTS

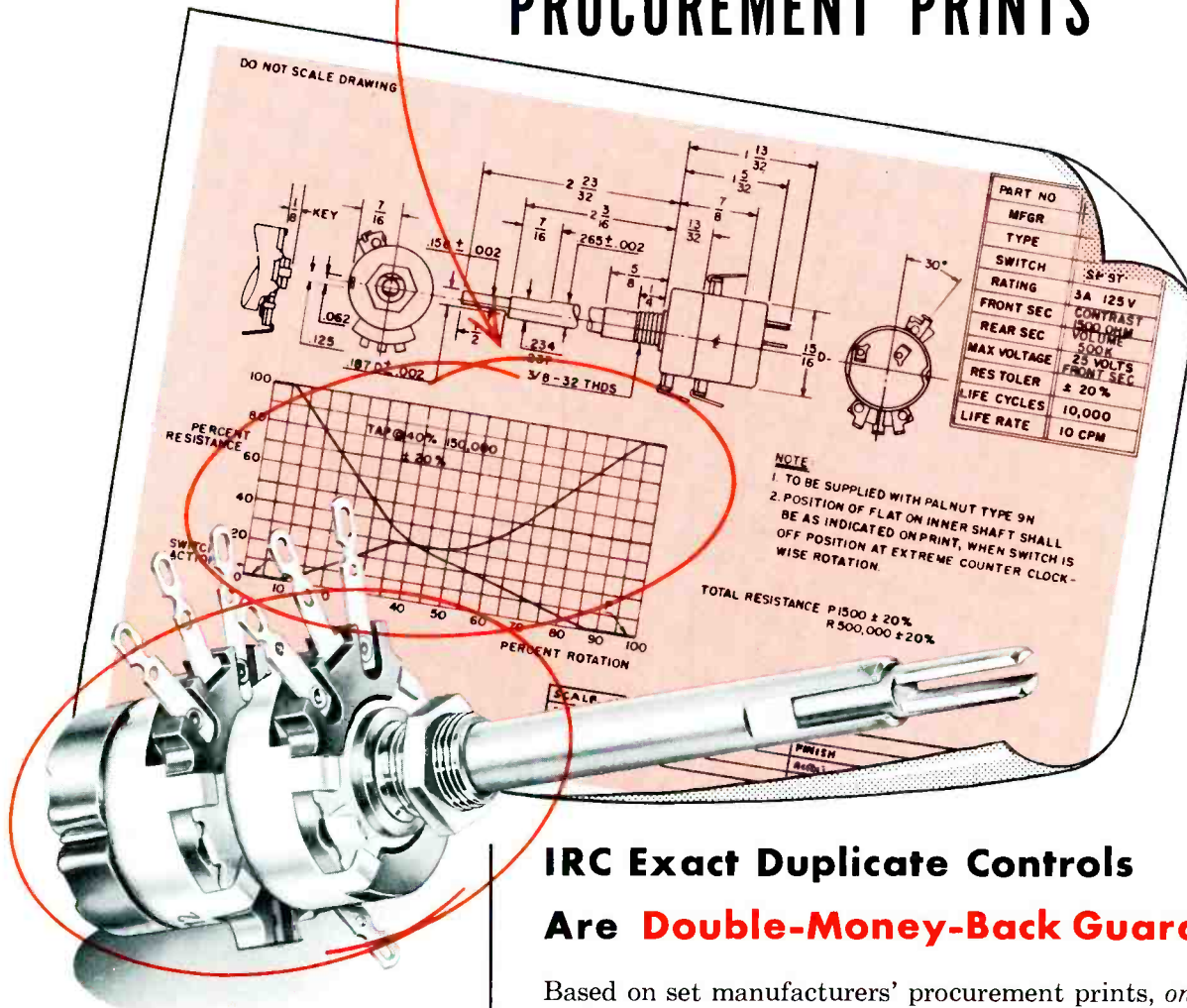

**ONLY IRC GUARANTEES
ACCURATE ELECTRICAL OPERATION
AND SATISFACTORY MECHANICAL FIT
OR DOUBLE-YOUR-MONEY-BACK**

Electrical specifications of this typical manufacturer's procurement print are exactly duplicated by IRC's QJ-412 control (shown). CONCENTRIKIT assembly includes P1-206 and R1-223 shafts with B17-109 and B13-133X Base Elements and 76-1 Switch.



Wherever the Circuit Says ~~~

IRC Exact Duplicate Controls Are Double-Money-Back Guaranteed

Based on set manufacturers' procurement prints, *only* IRC Exact Duplicate Controls are double-money-back guaranteed for accurate electrical operation. This firm guarantee applies to both IRC factory-assembled Exact Duplicates *and* universal CONCENTRIKIT equivalents.

Set manufacturers' electrical specifications are closely followed.

Resistance values are carefully selected to match.

Tapers are watched carefully; IRC doesn't arbitrarily substitute tapers to obtain wide coverage.

For exact duplicate controls of guaranteed accuracy, specify IRC. Most Service Technicians do.

INTERNATIONAL RESISTANCE CO.

423 N. Broad Street, Philadelphia 8, Pa.

In Canada: International Resistance Co., Ltd., Toronto, Licensee

NEW

**the Booster with Twice as much Gain
as Ever Before!!**

Regency

CASCADE TWO-STAGE

MODEL

DB-550

ONLY \$37.50 LIST



Burton brown advertising

DESIGNED SPECIALLY FOR USE WITH CASCADE FRONT ENDS!

REGENCY DIV., I.D.E.A., INC., 7900 PENDLETON PIKE, INDIANAPOLIS 26, INDIANA

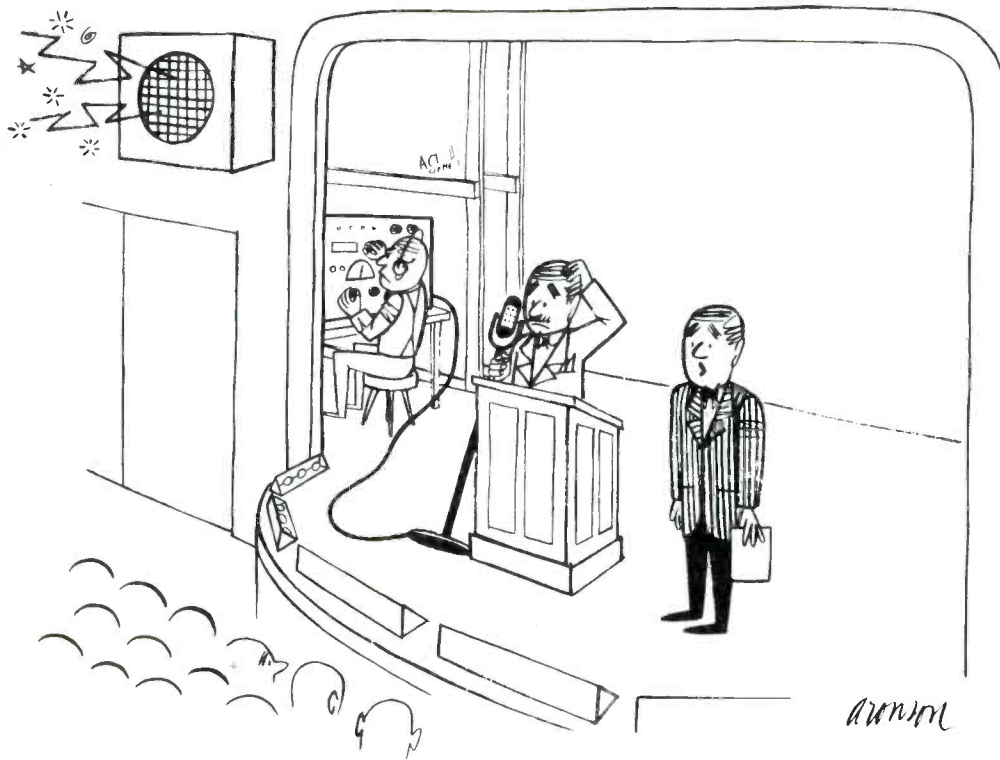

IS THERE A SPRAGUE CAPACITOR
IN THE HOUSE?

Don't Be Vague...Insist on SPRAGUE

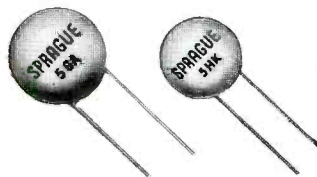

Insist on Sprague CERAMICS

Tiny, tough, dependable . . . in every application . . . whether discs, plates, buttons, or door knobs. And there's a Sprague ceramic capacitor to meet every service need. You give your customers dependable service, guard yourself against costly call-backs, when you use only Sprague Ceramic capacitors.

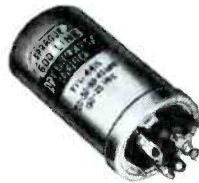

Insist on Sprague TWIST-LOK☆ 'LYTICS

Sprague TVL's fill the top performance bill in the toughest TV circuits. High temperatures, surge voltages, ripple currents won't faze them. Like all Sprague capacitors, Twist-Lok 'Lytics are your first line of defense against expensive call-backs.

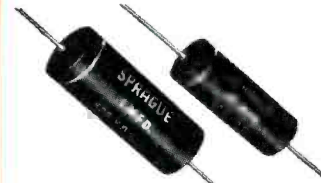

Insist on Sprague BLACK BEAUTY® TELECAPS®

The most imitated capacitor Sprague ever introduced. But you get Sprague *performance* only when you insist on Sprague Telecaps. Hundreds of millions are in use today as first choice of quality-conscious manufacturers and servicemen. It's the *premium* molded tubular *at no extra cost*.

Accept no substitutes
There is a Sprague
Distributor in every
sales area in the
United States. Write
for the name of your
nearest source of sup-
ply today.

☆ Trademark

SPRAGUE

Get your copy of Sprague's latest radio and TV service catalog C-609. Write Sprague Products Company*, 105 Marshall St., North Adams, Mass.

*Distributors' Division of Sprague Electric Company

**WORLD'S LARGEST
CAPACITOR MANUFACTURER**

JAMES R. RONK
Editor
 LESTER H. NELSON
Managing Editor
 W. WILLIAM HENSLER
Technical Editor

Editorial Staff

PHYLLIS J. AUKERMAN
 GWEN BIGHAM
 WILLIAM E. BURKE
 HENRY A. CARTER
 ROBERT B. DUNHAM
 JAMES M. FOY
 DON R. HOWE
 FRED McKINNEY
 GLENNA M. McROAN
 EVELYN S. MOUSER
 MARGARET NEFF
 C. P. OLIPHANT
 VERNE M. RAY
 GLEN E. SLUTZ
 PAUL C. SMITH
 CALVIN C. YOUNG, JR.
 ANTHONY M. ANDREONE
 GLENN R. SMITH
Art Directors

ROBERT W. REED
Photography

ARCHIE E. CUTSHALL
 DOUGLAS G. BOLT
 HARRY A. MARTIN
Production

★
HOWARD W. SAMS
Publisher

Business Department:

Donald B. Shaw, V. P.
Treasurer
 F. T. Dobbs, Secretary
 Joe H. Morin, Sales Mgr.
 Ann W. Jones, Advertising
 Shirley A. Owens, Literature
Service Mgr.
 J. C. Keith, V. P.
Charge of Circulation

Printed by
THE WALDEMAR PRESS
 Joseph C. Collins, Mgr.

Eastern Representatives
 Paul S. Weil and
 Donald C. Weil
 39-01 Main Street,
 Flushing 54, New York
 Independence 3-9098

Howard W. Sams
PF INDEX
REPORTER for the Electronic Service Industry

VOL. 4 • NO. 8

AUGUST • 1954

CONTENTS

Shop Talk	Milton S. Kiver	5
Color TV Training Series (Part III)	C. P. Oliphant and Verne M. Ray	7
Notes on Test Equipment	Paul C. Smith	11
Antenna Principles (Part II)	Don R. Howe	14
Examining Design Features	Don R. Howe	17
TV Colormath (Part IV)	Harold E. Ennes	19
Horizontal AFC Circuits (Part III)	William E. Burke	23
Audio Facts	Robert B. Dunham	25
In the Interest of Quicker Servicing	Henry A. Carter and Calvin C. Young, Jr.	27
Dollar and Sense Servicing	John Markus	31
A Stock Guide for TV Tubes		59
+More or Less—		72
PHOTOFACT Colorblock Reference Chart No. 2		Insert

SUBJECT REFERENCE

ANTENNAS			
Broadside Arrays	15	Mechanical Defects in Tuners	5
Collinear Arrays	15	Moving TV Receivers in Customer's Home	61
End-Fire Arrays	42	Plug-In Selenium Rectifiers	55
Lazy H Antennas	43	Solder Dispenser	62
V Antennas	14	Video Amplifiers	27
AUDIO		TELEVISION	
Electronic Crossover Network	25	Admiral Chassis 20A2	17
COLOR TV		Horizontal Discriminator	47
Bandwidths of Luminance and Chrominance Signals	63	Horizontal Reactance Tube	47
Chrominance Signal	9	Horizontal Sine-Wave Oscillator	23
Chrominance-To-Luminance Signal Ratio	21	TEST EQUIPMENT	
Color-Bar Pattern	64	Phase Relationship Check	13
DC Restorers	35	Current Measurement with Oscilloscope	51
Luminance Signal	7	Intensity Modulating the Oscilloscope	51
Receiver Matrix	19	Oscilloscope DC Amplifiers	11
Vector Relationships of Color Signals	68	RCA Model WR-36A Dot-Bar Generator	51
SERVICING		RCA Model WR-61A Color-Bar Generator	52
Electrical Defects in Tuners	57	RCA Model WR-86A UHF Sweep Generator	51

Copyright 1954 by Howard W. Sams & Co., Inc.
 No part of the PF INDEX may be reproduced without written permission. No pat-
 ent liability is assumed with respect to the use of information contained herein.

The PF INDEX is published monthly by Howard W. Sams & Co., Inc., 2201 East 46th Street, Indianapolis 5, Indiana. The PF INDEX is on sale at 25¢ a copy at 1093 jobbers of Electronic Parts throughout the United States and Canada. (In Canada 30 cents.) When available, back numbers may be obtained by sending 35¢ for each copy desired. Acceptance under Section 34.64 P. L. & R. authorized at Indianapolis, Indiana
SUBSCRIPTION DATA: For those desiring the convenience of delivery to their homes or shops, each issue of the INDEX will be mailed direct, promptly upon publication. The subscription charge is \$4.00 annually in the United States and U. S. possessions.

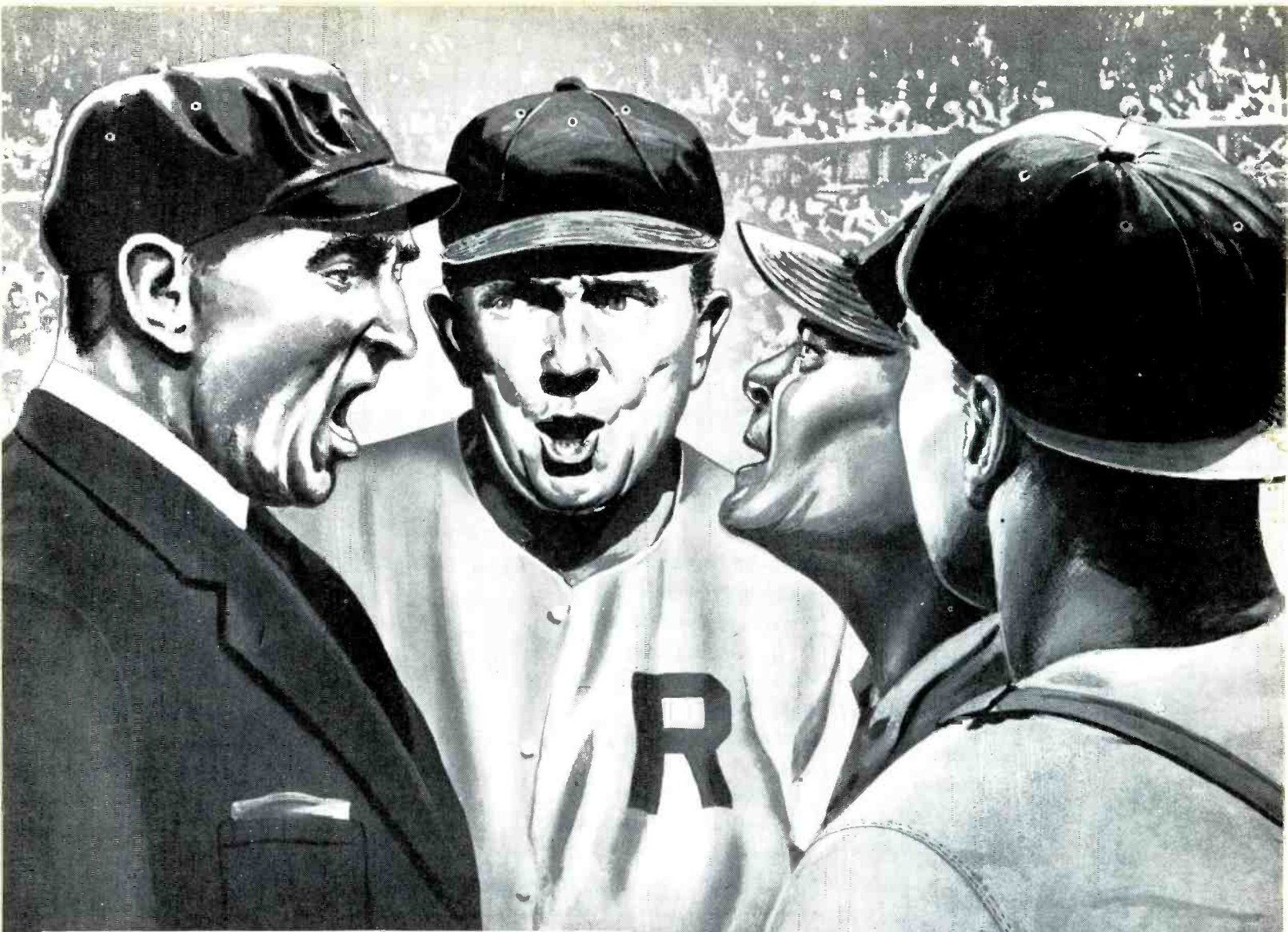

avoid "RHUBARBS"

The key to successful servicing is a satisfied customer. In television servicing, customer satisfaction is assured only when your highly technical knowledge is employed with components that meet or exceed performance expectations. Taking chances with components of questionable quality leads eventually to "rhubarbs" with dissatisfied customers. Nothing can be more harmful to the future of your television servicing business.

Always back up your quality work with dependable component parts. You can depend on Du Mont quality picture tubes to do more for your service.



Replacement Sales, Cathode Ray Tube Division
Allen B. Du Mont Laboratories, Inc., Clifton, N. J.

PIONEER IN BIG PICTURE TUBES • ORIGINATOR OF THE FAMOUS BENT-GUN AND SELFOCUS •
LEADER IN HIGH RESOLUTION • MAJOR SUPPLIER TO MOST FINE TELEVISION RECEIVER MANUFACTURERS

*Trade-mar

Shop Talk

MILTON S. KIVER

President, Television Communications Institute

The front-end tuner of a television set can present servicing problems which are, in many respects, unique to this section of the receiver. There are a number of reasons for this. For one thing, the highest RF circuits are contained in the tuner; and by the nature of their frequency, these circuits are very susceptible to change. Secondly, the limited space and compactness in these high-frequency television tuners make it difficult to change parts when this becomes necessary. Finally, many service technicians shy away from visual alignment of the front-end stages. To do the job thoroughly requires a fairly sensitive scope, an accurate marker or AM generator, and a sweep generator with a high output level over the VHF range. (UHF problems will not be considered in this article.) Such instruments are now available, which was not the case in the earlier days of television.

The servicing of a television tuner requires both an electrical and a mechanical approach; and one can be just as difficult as the other, although usually mechanical defects are more readily located and corrected than electrical ones. Under the mechanical heading, we might find one or more of the following defects.

MECHANICAL DEFECTS

1. Defective Detent Assemblies.

The detent mechanism is the name for that portion of the tuner which produces the mechanical lock in each switch position. The detent plate on a Standard Coil tuner is shown in Fig. 1. Mounted on the underside of the tuner frame is a strip of spring metal with a roller on the end of it. The roller presses against the ridged detent plate, and the only stable position for the roller is in one of the indentations between the ridges of the detent plate. The spring keeps the roller firmly in place. In this way, a

positive mechanical lock is achieved in each selector-switch position.

A detent mechanism that does not engage securely will cause noisy, erratic operation. Most of the time, the trouble is caused by reduced tension in the spring metal which presses the roller against the detent plate. A simple tightening of the screw that holds the metal strip in place will ordinarily suffice to reimpose the needed tension.

The Standard Coil tuner has been remarkably free of defective detents. Much more frequent has been the loss in tension of contact springs.

2. Insufficient Contact-Spring Tension.

Each of the channel strips on a Standard Coil tuner brings its coils and capacitors into contact with the rest of the tuner circuits by way of contact springs. Poor tension in these springs will lead to intermittent operation or noise and flashes of light. Repositioning of the springs will overcome this trouble.

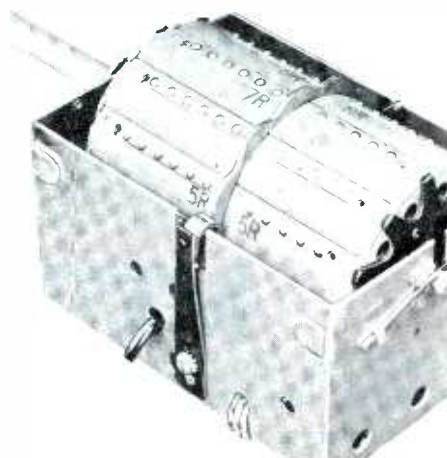

Fig. 1. The Detent Plate and Roller Which Provide Indexing on the Standard Coil Tuner.

3. Dust, Dirt, and Corrosion.

Dust, dirt, or corrosion on contact points may lead to a variety of effects such as noisy operation, weak pictures despite sufficient incoming signal, intermittent operation, and critical settings of the selector switch.

For as long as this writer can remember, the usual cleaner used for noisy controls was carbon tetrachloride which was about the only cleaning solvent available. But carbon tetrachloride did not seem to effect a permanent cure for the trouble, because the noise seemed to return in a short time. Today, there are better and more efficient cleaners which not only remove the dirt but also lubricate as well. These noncorrosive cleaning fluids are available through parts jobbers.

4. Cold Solder Joints.

An ailment that appears to be fairly widespread is that of cold solder joints. The effects of this defect can range from intermittent operation to weak, snowy pictures; noise; or oscillator drift. It is one of the more difficult troubles to find, and finding it requires a great deal of patience. In some of the best procedures given later, methods will be indicated whereby the defective stage can be isolated; and in this way, the source of the trouble is also isolated. The possibility of cold solder joints should be kept in mind whenever the foregoing symptoms are obtained. A little judicious touching up with a clean, hot soldering iron may then correct any cold solder joints that may exist.

5. Partial or Total Short Circuits.

Feed-through capacitors are widely employed in tuners for the purpose of bringing wires through metal plates which serve to shield

* * Please turn to page 57 * *

You always
win with...
**Mallory
Vibrators**



YOU AND YOUR CUSTOMERS WIN
every time you use a Mallory Vibrator on a service job
because the patented, tuned mechanism of the Mallory
Vibrator assures completely dependable performance.

HERE'S YOUR PROOF OF WINNING
PERFORMANCE . . . Mallory produced the first com-
mercial vibrators . . . produces more vibrators for set
manufacturers than all other makes combined. And sur-
veys show that Mallory Vibrators are preferred and used
by 5 out of 6 servicemen.

STICK WITH THE WINNER . . .
always ask for Mallory Vibrators by name. Use them for
all your car radio service jobs.

**Another
Mallory Winner!**

The new Mallory Vibra-
tor Guide is a complete
cross-reference and serv-
ice guide. It has always
been the accepted refer-
ence book for vibrator
selection. Get one from
your Mallory distributor.

P. R. MALLORY & CO. Inc.
MALLORY

CAPACITORS • CONTROLS • VIBRATORS • SWITCHES • RESISTORS
RECTIFIERS • POWER SUPPLIES • CONVERTERS • MERCURY BATTERIES
APPROVED PRECISION PRODUCTS

P. R. MALLORY & CO. Inc., INDIANAPOLIS 6, INDIANA

COLOR TV

TRAINING SERIES

PART III

MAKE-UP OF THE COLOR PICTURE SIGNAL

by C. P. Oliphant and Verne M. Ray

The preceding section (Part II) of this series covered the three major processes employed in the transmission of the composite color signal. These are the interleaving process, divided-carrier modulation, and the use of a color burst for purposes of color synchronization. In the following section, the actual make-up of the color picture signal will be discussed.

The color picture signal consists of two separate signals. These are a luminance signal and a chrominance signal. The luminance signal conveys the brightness information, and the chrominance signal conveys the color information. Both signals are made up of a mixture of three voltages which are representative of red, green, and blue. To show the mixing proportions of these signals, let us see how they are formed by the transmitter.

Shown in Fig. 3-1 is a drawing of the basic components of a tricolor camera which employs three camera tubes and two dichroic mirrors for the separation of light. To illustrate the operation, let us assume that the color camera is focused on a color scene. The light is broken up by the following method. All the light passes through the objective lens which is mounted on the turret, and it passes on through a pair of relay lenses. Then the light is operated upon by the dichroic mirrors. This type of mirror has the property of passing all the light of the spectrum except the primary color which it is designed to reflect. By the use of this type of mirror, the light can be separated into the three primary colors — red, green, and blue. Through correct placement of the mirrors, only two are needed in the color camera. The blue dichroic mirror is positioned at point A on the diagram. When light arrives at this point, all the colors of the light except blue are passed through the mirror. The blue portion of the light is reflected. The tilt angle of the mirror at point A is such that it directs the blue light to a front-surface mirror at point C. Then the blue light is reflected onto the face of the blue camera tube.

The light that was passed by the dichroic mirror at point A passes to the red dichroic mirror which is positioned at point B. This mirror is designed to pass all the light except the red frequencies. The red light is deflected to a front-surface mirror at point D where it is again deflected so that it falls on the face of the red camera tube.

Both the blue and the red portions of the incoming light have been removed, so only the green portion remains. This is allowed to fall directly upon the face of the green camera tube. In this manner, the light is broken up into the three primary colors.

At the output of the color camera, there are three voltages which are representative of the three colors. These voltages are designated as E_R , E_G , and E_B where R equals red, G equals green, and B equals blue. These voltages must be acted upon in such a way that a signal representative of the brightness and a signal representative of the color information are formed.

Luminance Signal

The luminance signal is the portion of the color picture signal that is utilized by monochrome receivers. For this reason, the luminance signal must represent the scene according to its brightness and must be free of any color information. It is very similar to the video signal specified for standard monochrome transmission.

The luminosity response of the eye to the three primary colors was considered when the specifications for the luminance signal were made. The response of the eye to these colors can be illustrated through the use of three projectors for colored lights — one projector is for red, one for blue, and one for green. If we take these three projectors and adjust them so that they emit equal amounts of light as measured by photoelectric means, the three lights will be found to produce white when they are superimposed upon each other. When they are separated, the green light will appear almost twice as bright as the red and from five to six times as bright as the blue. The red light will appear from two to three times as bright as the blue light, which will appear the dimmest. This means that the eye is most sensitive to green, less sensitive to red, and least sensitive to blue. This effect was described in the colorimetry discussion earlier in this training series.

The formation of the luminance signal is based upon this phenomenon concerning the sensitivity of the eye. From the outputs of the color camera, definite proportions of each of the color signals are taken at the transmitter to make up the luminance signal. These proportions are: 59% of the green signal, 30% of the red signal and 11% of the blue signal.

The luminance signal is frequently called the Y signal, and its voltage is designated as E_Y . The equation for E_Y is expressed as

$$E_Y = .30E_R + .59E_G + .11E_B \quad (4)$$

where E_R = the voltage of the red signal,

E_G = the voltage of the green signal,

E_B = the voltage of the blue signal.

As an example of the application of this equation, let us assume a televised scene consisting of a card which has four vertical bars. From left to right, the first bar is white, the second red, the third green, and the fourth blue. The scene lighting is adjusted so that each of the three color signals from the camera is one volt when the white bar is scanned. According to equation 4, the luminance signal is also one volt. During the scanning of the white bar, a bright, white bar would be produced on a monochrome receiver tuned to this signal. When the red bar is scanned, the blue and green color signals go to zero while the red signal remains at one volt. By equa-

Can You afford to take a Chance

ON ANYTHING LESS THAN BUSS QUALITY IN FUSES?

Hardly!

Dependable electrical protection . . . isn't that what you rightly expect of a fuse? For you rely on the fuse alone to safeguard your equipment when there is trouble in the circuit — and just as important, a fuse should never give a "false alarm" by blowing needlessly.

To make sure of proper operation under all service conditions, every BUSS fuse normally used by the Electronic Industries is tested in a sensitive electronic device that rejects any fuse that is not properly constructed, correctly calibrated and right in all physical dimensions.

And there's no need to sacrifice quality on any type of fuse, for BUSS offers a complete line of fuses to the Electronic Industries: — standard type, dual-element (slow blowing), renewable and one-time types . . . in sizes from 1/500 ampere up.

And in sales and service — your customer doesn't question quality when you furnish BUSS fuses. The BUSS trademark and the BUSS reputation for 'trouble-free' fuses have been firmly established over the past 39 years by the millions and millions of installations for home, farm, and industry. So be doubly safe — protect your profits and your reputation — standardize on genuine BUSS fuses.

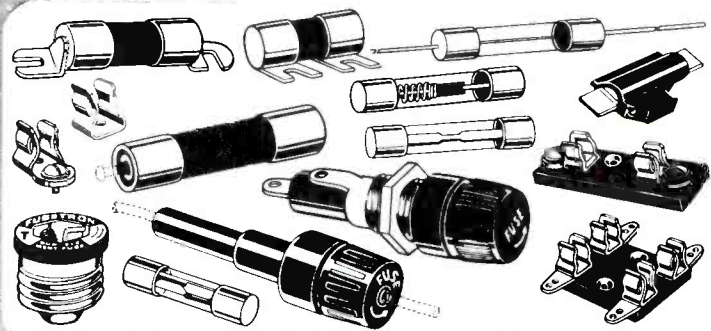
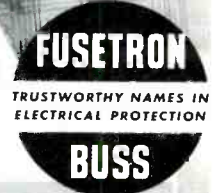

Bulletin SFB gives the facts on

**Buss Small Dimension
FUSES and HOLDERS**

Send today for your copy — it's FREE!



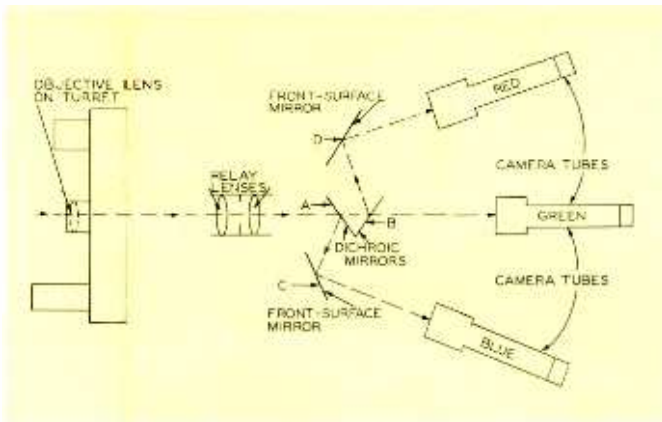

Fig. 3-1. Drawing of Basic Components of a Tricolor Camera.

tion 4, the luminance signal drops to 0.30 volt. A gray bar would appear on the monochrome receiver when this red bar is scanned. When the green bar is scanned, the luminance signal assumes a value of 0.59 and would produce a very light gray on the monochrome receiver. Scanning of the blue bar would cause the luminance signal to be 0.11 volt, and a dark gray shade would appear.

Chrominance Signal

The portion of the color picture signal which contains the color information is called the chrominance signal. This signal can be separated from the luminance signal and is utilized by the color receiver for the reproduction of the colors.

Since the brightness is transmitted by the luminance signal, it is not necessary to transmit brightness information again with the color information. Therefore, the luminance voltage E_Y is subtracted from each of the three output voltages of the camera. This results in three signals which represent red minus luminance, green minus luminance, and blue minus luminance. These signals are denoted as the color-difference signals $E_R - E_Y$, $E_G - E_Y$, and $E_B - E_Y$ in which E_Y equals the luminance signal (equation 4). Substituting for E_Y in the three color-difference signals, we can obtain an expression for each color-difference signal in terms of the three primary colors:

$$E_R - E_Y = .70E_R - .59E_G - .11E_B \quad (5)$$

$$E_G - E_Y = .41E_G - .30E_R - .11E_B \quad (6)$$

$$E_B - E_Y = .89E_B - .59E_G - .30E_R \quad (7)$$

See footnote¹ for derivation of these equations.

The $E_R - E_Y$ and $E_B - E_Y$ color-difference signals are the ones that are used to form the components I and Q of the chrominance signal. The color-difference signal

¹As an example of the manner in which equations 5, 6, and 7 are derived, let us consider equation 5. As previously stated, the color-difference signal is formed by subtracting the luminance signal from the color signal. In the case of equation 5, the color signal is E_R . From this we need to subtract E_Y . Equation 4 states that

$$E_Y = .30E_R + .59E_G + .11E_B.$$

Therefore,

$$\begin{aligned} E_R - E_Y &= E_R - (.30E_R + .59E_G + .11E_B) \\ &= E_R - .30E_R - .59E_G - .11E_B \\ &= .70E_R - .59E_G - .11E_B. \end{aligned}$$

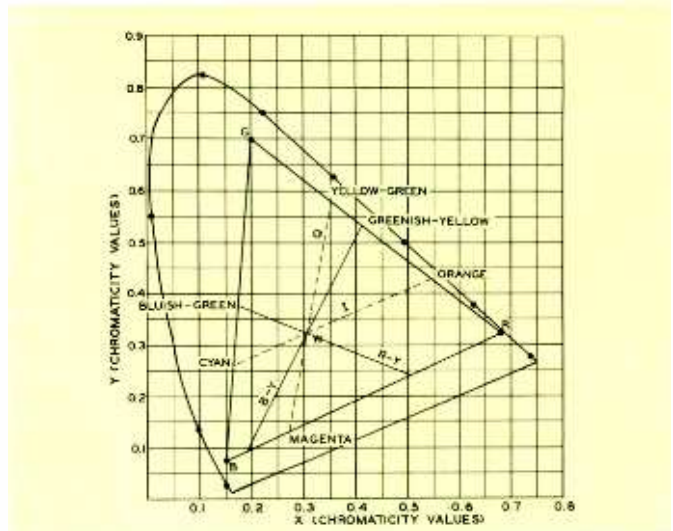

Fig. 3-2. The Axes of the Color-Difference Signals and the I and Q Signals on the Color Triangle.

$E_G - E_Y$ is not transmitted as such. It was found by proper mixing of $E_R - E_Y$ and $E_B - E_Y$ in the receiver that $E_G - E_Y$ can be recovered. The mixture is made up of $-.51(E_R - E_Y)$ and $-.19(E_B - E_Y)$. Thus

$$E_G - E_Y = -.51(E_R - E_Y) - .19(E_B - E_Y).$$

The mathematical proof for this equation is presented in the footnote.²

The color-difference signals are not transmitted as $E_R - E_Y$ and $E_B - E_Y$. They are used to form two other signals which modulate the color subcarrier. This is done because a more faithful reproduction of the colors can be obtained. These other two modulating signals are called the I (in phase) and Q (quadrature phase) color signals. They are formed by proportionately mixing the color-difference signals.

Shown in Fig. 3-2 is the chromaticity diagram and the NTSC triangle. The axes of the color-difference signals and the I and Q signals can be seen. Along these axes are the colors that are represented by these signals. Colors from red to bluish-green are depicted along the R - Y axis and from blue to greenish-yellow along the B - Y axis. By moving the axes to the I and Q positions, colors from orange to cyan are depicted along the I axis and from magenta to yellow-green along the Q axis. Better reproduction of color is achieved along the I and Q

* * Please turn to page 63 * *

²From equations 5 and 7 we know that

$$E_R - E_Y = .70E_R - .59E_G - .11E_B,$$

and that

$$E_B - E_Y = .89E_B - .59E_G - .30E_R.$$

By substituting these quantities in the equation being proved, we have

$$\begin{aligned} E_G - E_Y &= -.51(.70E_R - .59E_G - .11E_B) - .19(.89E_B - .59E_G - .30E_R) \\ &= +.41E_G - .30E_R - .11E_B. \end{aligned}$$

The value $.41E_G$ can also be expressed as $E_G - .59E_G$. Therefore,

$$\begin{aligned} E_G - E_Y &= E_G - .59E_G - .30E_R - .11E_B \\ &= E_G - (.30E_R + .59E_G + .11E_B) \\ &= E_G - E_Y. \end{aligned}$$



offers

50

SALES AND SHOP AIDS

to help YOU make more money!

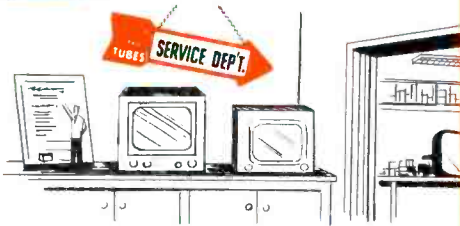

ILLUMINATED "SERVICE DEPT." SIGN

Dress up your shop with this easy-to-hang direction sign. Supplied ready to hang.



TUBE and TOOL CARRYING CASE

Holds 137 tubes and necessary repair tools — all tubes are in full view.



RAYTHEON ConvertTV Seats

Ideal for shop or home use, or as incentive gifts on TV set sales.



RAYTHEON BROWLITE

A new kind of flashlight that frees both hands for service work.



ILLUMINATED OUTDOOR SIGN

Double sided, — formed plastic face sign for outdoor use. 36" x 24". A real traffic stopper.



PRESSURE-SENSITIVE REPAIR STICKERS

Stick to any surface without moistening. Packaged in handy dispenser box.



OUTDOOR THERMOMETER

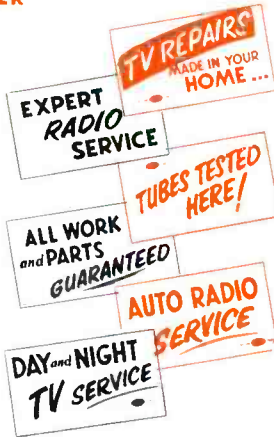
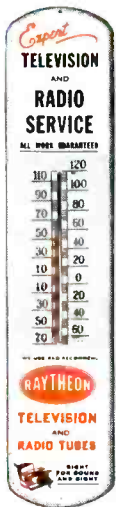

COLOR SPOT SIGNS

A brand new set of transparent window signs every service shop needs.



TRANSPARENT PLASTIC WINDOW STREAMER

TUBE SHELF IDENTIFICATION LABELS BOOK



Labels for over 480 current Raytheon Radio and TV tube type designations. Easy to apply.



WINDOW DISPLAYS

Bright, full color displays to sell your service. Both are varnished and easeled.



They're all in this FREE BOOKLET! It's yours for the asking

You'll find many more money-making sales stimulators and time-saving shop aids in this booklet — all designed to help you make more money by increasing service business and saving valuable time. Many are free and others are made available through your Raytheon Tube Distributor at less than cost. To get a copy of the booklet write to Raytheon Manufacturing Company, Receiving and Cathode Ray Tube Operations, 55 Chapel Street, Newton 58, Mass. Department



RAYTHEON MANUFACTURING COMPANY

Receiving and Cathode Ray Tube Operations
Newton, Mass., Chicago, Ill., Atlanta, Ga., Los Angeles, Calif.

Excellence in Electronics

RAYTHEON MAKES ALL THESE:

RECEIVING AND PICTURE TUBES • RELIABLE SUBMINIATURE AND MINIATURE TUBES • SEMICONDUCTOR DIODES AND TRANSISTORS • NUCLEONIC TUBES • MICROWAVE TUBES

Notes On

TEST EQUIPMENT

Presenting Information on Application, Maintenance, and Adaptability of Service Instruments

Some Unusual Scope Features and Applications

Certain features of an oscilloscope, or of any test instrument, are bound to be utilized more than others. The manner in which one service technician employs his test equipment differs from that of another technician, depending upon a number of factors. Individual temperament, understanding of the operation of the circuit being tested, and understanding of the equipment being used to make the test, all have some bearing upon the working methods of the technician.

Whether the technician utilizes only a few or all of the possibilities of any test instrument, we must conclude that since the manufacturer has considered any single feature worth incorporating in his product the technician will find it to his advantage to learn about its potentialities in servicing. Although a certain operation with a piece of test equipment may not find as much use as some others, there may be times when it is the best answer to a special problem.

In oscilloscopes, some features which may receive a little less attention than others are the provisions for DC amplification, for direct connection to the deflection plates, and for intensity modulation of the trace. The driven sweep and the provisions for current measurements are also neglected by many scope users. It is realized, of course, that many scopes do not have all these features and applications; for example, the DC amplifier and the driven sweep are refinements found only in some of the higher-priced scopes. However, when such provisions are available, they should be put to use.

DC Amplifiers

In general, the DC amplifier will be useful whenever it is desired to view an AC waveform superimposed upon a DC component. DC voltages alone can also be indicated, but these are usually more conveniently measured with the conventional voltmeter. TV circuits in which the technician might find the DC amplifier particularly useful for spotting improper operation are AGC returns, direct-coupled video amplifiers, sync circuits, and DC restorers.

As an example, assume that a service technician wishes to check the operation of a DC restorer. The DC-amplifier input of the scope is connected to the restorer output, and the video signal which is being applied to the picture tube is observed. This signal might appear as in Fig. 1A. The scope is synchronized to show two horizontal sync pulses with video information appearing between them. When a varying signal such as this is passed through an amplifier that is AC coupled only, the signal tends to align itself about the AC axis so that equal areas of the waveform appear above and below the axis.

Fig. 1A represents a signal containing information that is predominantly of a high brightness level; when the transmitted signal shifts to one representing darker objects or lower brightness levels, it appears as in Figs. 1B and 1C. Fig. 1B shows that with an AC-coupled amplifier the signal averages itself about the AC axis, and the picture information assumes a position which represents a brightness higher than the true level of the scene. A properly functioning DC restorer would restore the sync tips to the level shown in



by Paul C. Smith

Fig. 1A, and along with them the picture information would assume its true level. See Fig. 1C. Therefore, to check for proper operation of the DC restorer, it is only necessary to connect the DC amplifier of the scope to the modulated element of the picture tube and to observe the level of the sync tips as the transmitted scene changes from light to dark. The sync level should remain unchanged for proper operation. A large percentage of present-day monochrome TV receivers do not employ the DC restorer, but the technician will find it reappearing in the color TV receiver; consequently, the aforementioned application of the DC amplifier in an oscilloscope may prove useful.

Another point of application for the DC amplifier might be at the video detector of a receiver. A great many receivers have the video detector coupled directly to the grid of the first video-amplifier stage, and the instantaneous grid voltage produced by the video signal with respect to the cathode of the video amplifier is important when trouble shooting such stages for overloading or improper operation. A DC scope applied to these stages will aid in localizing such troubles.

Sync-separator circuits are also critical with respect to the magnitude of signal for proper operation. Too large a signal can easily result in unwanted video information being passed along with the desired sync signals. The DC scope again will prove useful in determining the instantaneous voltages of a signal at various points.

New service-aids to solve servicing puzzles

WALSCO

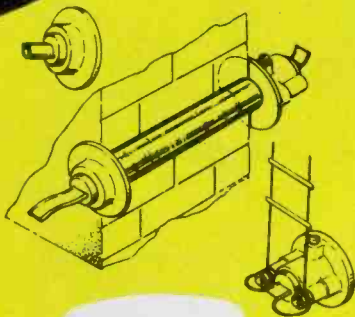

Walsco Universal Feed-Thru Bushing
Fits all standard types of coaxial, tubular and twin-lead wires. Can be terminated to open line, enabling you to bring 300 ohm twin lead through wall and into room. The bushing fits walls up to 14" thick.
Dealer net \$1.17 (Cat. no. 1551)

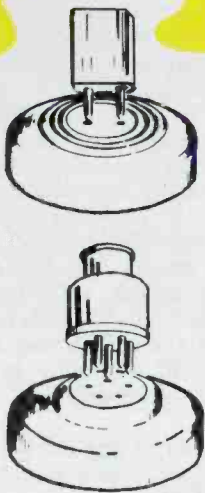

Walsco TV Lead-In and Rotor Receptacles
Used effectively as wall outlets for any type of lead-in or rotor cable. They also fit over and fasten to the inside flange of feed-thru. Matching plugs included.
2 prong (Cat. no. 1552) \$.63 dealer net
5 prong (Cat. no. 1553) \$.90 dealer net

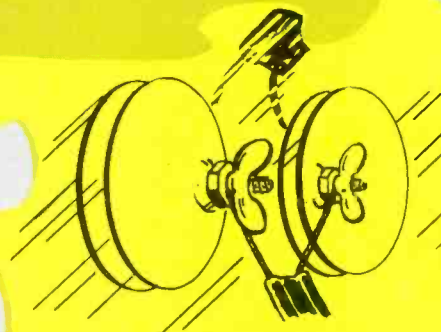

Walsco Window-Thru Bushing
A new, simple way to bring lead wires into the home without drilling holes, etc. Use effectively on both VHF and UHF. Walsco supplies the adhesive to cement capacitor discs to window pane. A quick, easy, weatherproof installation.
Dealer net \$.59 (Cat. no. 1555)



Walsco Electronic Chemicals in Spray Cans
Just spray it on! "Instant-spray" cans cut chemical application time in half. No messy applicators. Can't leak, break, spill or evaporate...it's air-tight. Insist on WALSCO chemical spray cans containing — Contactene, Tubecoat, Anti-Corona Lacquer, and Wrinkle Varnish.



WALSCO counter displays
featuring chemicals in spray cans are at jobbers everywhere.



 **Walsco**
ELECTRONICS CORPORATION

3602 Crenshaw Boulevard, Los Angeles 36, California

Canadian Factory Distributor:
ATLAS RADIO CORP., Ltd., 560 King St., West, Toronto 2-B

Export Distributor:
AD AURIEMA, Inc., 39 Broad St., New York 4, N.Y.

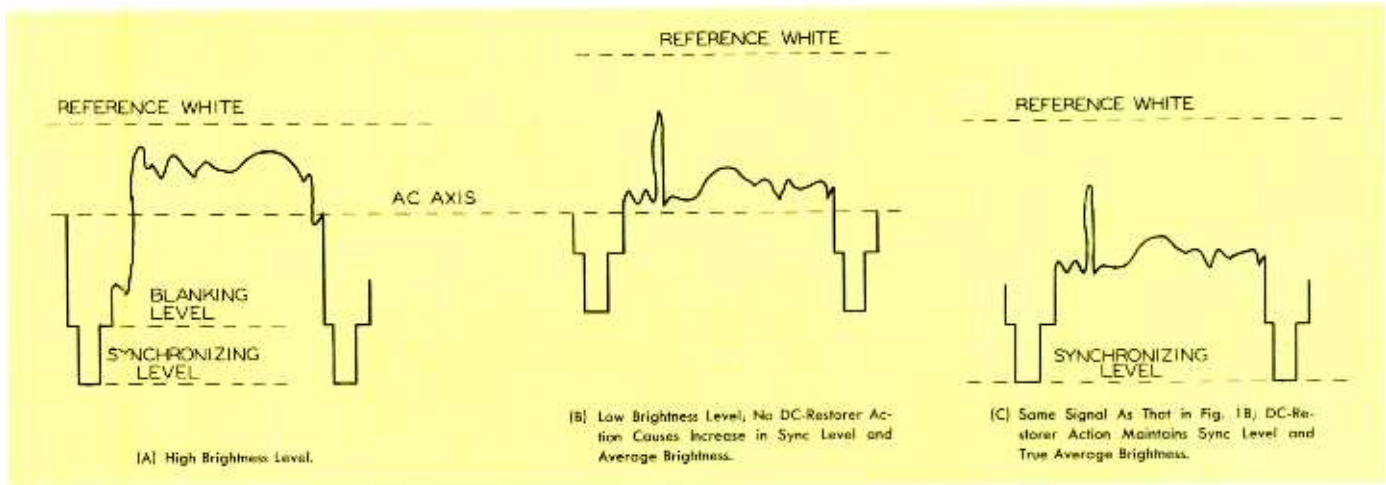

Fig. 1. Video Signals at the Picture Tube; Viewed on Oscilloscope Having DC Amplifiers.

The excellent low-frequency response of the DC amplifier is valuable in audio applications such as checking audio-amplifier response or checking the quality of the square-wave signal so often used in audio testing. Lack of phase shift at low frequencies allows the audio technician to determine that any square-wave tilt observed is due to the audio amplifier rather than to the square-wave source or to the scope amplifiers.

Direct Connections to Deflection Plates

Provisions for direct connections to the deflection plates are found on many scopes and offer two of the same advantages offered by the DC amplifier; namely, the measurement of DC levels and the elimination of phase shift. The deflection sensitivity with direct connections is less than that with the complete scope and is normally about 15 to 20 rms volts per inch. Therefore, a greater signal must be available for convenient deflection.

The technician is probably becoming more phase conscious from reading the numerous color TV articles in which the importance of phase relationships between the color sub-carriers is stressed. The oscilloscope is very easily adaptable for making phase comparisons between two signals of the same frequency. When one signal is fed directly to one set of deflection plates and the other signal is fed to the other set, the resultant trace on the scope screen becomes an indication of the phase relationship between the two signals and requires only proper interpretation on the part of the observer.

Fig. 2 will serve to illustrate the way in which two sine-wave signals applied to the horizontal- and

vertical-deflection plates result in a scope waveform which is indicative of the phase relationship between the two signals. The large circle indicates the face of the scope, and the X and Y axes have been drawn through its center. Voltages applied to the horizontal-deflection plates will produce a movement of the beam along the X-axis to the right or left of center, depending upon the polarity of the voltage. Voltages applied to the vertical-deflection plates produce movement of the beam along the Y-axis.

The two smaller circles represent sine-wave voltage generators for the vertical and horizontal signals and are divided from zero degrees to 360 degrees in steps of 22.5 degrees. The heavy arrows are vector representations of the maximum signal voltage of each generator and are made equal to each other for simplicity in illustration. The deflection factors of the vertical and horizontal plates of the scope are assumed to be equal for the same reason.

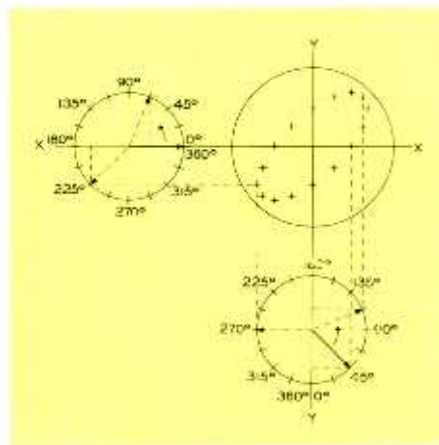

Fig. 2. Graphical Illustration of the Manner in Which Two Sine-Wave Signals of Identical Frequency But Different Phase Develop a Phase Indication on an Oscilloscope.

In the left-hand circle, a perpendicular to the X-axis from the point of the heavy arrow will represent the instantaneous magnitude of the sine-wave voltage applied to the vertical-deflection plates; and this value can be transferred graphically to the scope diagram to locate the vertical position of the beam trace at that instant. Other times during the cycle are indicated by dotted arrows. In like manner, the perpendicular to the Y-axis from the arrow point in the lower circle represents the horizontal-deflection voltage at any particular instant. This value is transferred graphically to the scope diagram to locate the horizontal position of the beam trace at that instant. For this illustration the two sine-wave vectors have been chosen so that the horizontal vector is 45 degrees ahead of the vertical vector. Since the frequencies of both signals are the same, this 45-degree difference is maintained throughout the complete cycle. The beam position on the scope is plotted for every 22.5-degree interval of the cycle, and the resultant graph gives a very good indication of the scope waveform obtained for a phase difference of 45 degrees between signals. It can be seen that the waveform is an ellipse. This waveform is the same as that obtained for a phase difference of 360 degrees minus 45 degrees (or 315 degrees) as will be seen if we consider the vertical vector to be lagging the horizontal vector.

If various phase differences are plotted in the foregoing manner, the waveforms on the scope will be found to be straight lines at phase differences of zero degrees and 180 degrees. The straight line at zero will be at right angles to the straight line at 180 degrees. Phase differences between 90 degrees and 270 degrees

* * Please turn to page 50 * *

Antenna Principles

by Don R. Howe

Part II More About Basic Antenna Types Used for TV Reception

In Part I of this series, which appeared in the April issue of the PF INDEX, we examined some of the basic types of antennas and how they were utilized to form more complicated arrays. Similar studies can be made of other basic types. The following article is devoted to such studies, with particular attention to the V-antenna and to the various phased systems of antennas.

V-Antennas

The V-antenna and derivatives of it are frequently employed for television reception. This type of antenna is capable of providing excellent results and is not critical in its adjustments. A commercial form of the V-antenna is shown in Fig. 1.

The first step in an analysis of the V-antenna is to consider the response pattern of a long-wire antenna. Fig. 2A shows this pattern when the long-wire antenna is two wavelengths long. It may be noticed that there are

four major lobes with axes that lie at an angle θ with respect to the antenna. If the antenna is operated at a frequency at which it no longer has a length of two wavelengths, the angle θ will vary accordingly.

When the antenna is one wavelength, the angle θ is approximately 54 degrees. As the frequency is raised, this angle decreases until at an antenna length of two wavelengths the angle is 36 degrees and at five wavelengths the angle is 22.5 degrees.

If two long-wire antennas are combined as shown in Fig. 2B, four of the major lobes tend to cancel one another. The resultant pattern is similar to the one in Fig. 2C. The antenna is bidirectional; and it possesses some degree of gain when its operation is compared to that of a standard half-wave dipole.

When two long-wire antennas are combined to form the V-antenna, as in Fig. 1B, the angle θ must be adjusted so that four of the major lobes lie parallel or in line with each other. The angle θ is therefore dependent upon the angle ϕ . Since the angle θ is a function of the electrical length of the antenna, the angle ϕ is also dependent upon the length of the antenna. For optimum performance, the angle ϕ should be twice the angle θ . If the antenna is one wavelength long, the angle of the V will be approximately 108 degrees. The angle will decrease to about 35 degrees when the antenna possesses a length of eight wavelengths. When this type of antenna is to be used for television

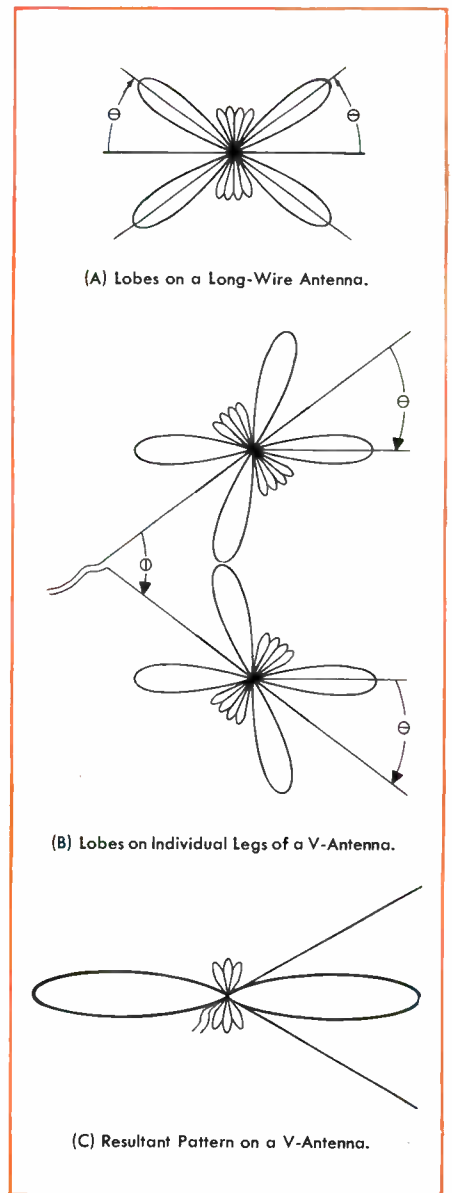

Fig. 2. Response Patterns Illustrating Lobe Addition in the V-Antenna.

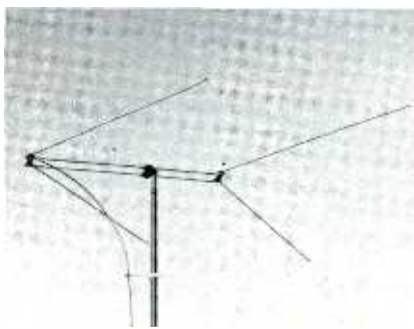

Fig. 1. A V-Antenna.

reception on several channels, the angle θ is usually adjusted for the center of the band.

It is generally desirable that a television antenna have unidirectional characteristics. In the case of the V-antenna, this may be accomplished by several methods.

The bidirectional response of the V-antenna may be attributed to the reflection of waves from the ends of the antenna back to the feed point. These reflected waves may be eliminated by terminating the ends of the antenna as shown in Fig. 3. The terminating resistances are equal to the characteristic impedances at the ends and will absorb the wave that would have been reflected. Because of this absorption, the maximum gain is in the direction of the open end of the V-antenna. This method is rather difficult to accomplish from the mechanical standpoint, and therefore it is not used appreciably.

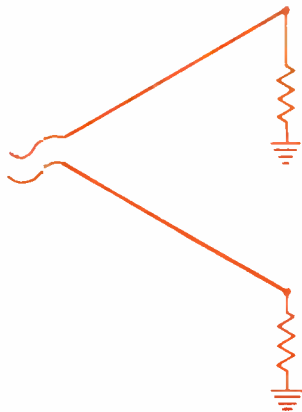

Fig. 3. Terminating the Ends of a V-Antenna.

Another method of obtaining unidirectional characteristics is by increasing the diameter of the legs. If the diameter of the conductors is an appreciable fraction of a wavelength (one-fortieth or more), the reflected wave will be considerably weaker than the outgoing wave, and the antenna will exhibit a unidirectional pattern. Because of the relatively small antennas required for the high frequencies in the television field, leg diameters of one-fortieth wavelength or greater become practical.

An additional V-antenna may be added to act as a reflector and to make the system unidirectional. The reflector should be spaced an odd number of quarter wavelengths from the front V and should be driven 90 degrees out of phase with the other V. See the photograph in Fig. 1.

The reflector may also be parasitic, receiving its excitation from the driven element. In this case, the quadrature phase relationship may be

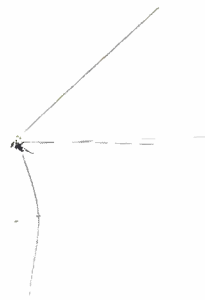

Fig. 4. A Conical V-Antenna.

accomplished by proper spacing and by attaching a tuning stub to the reflector. The use of reflectors with the V-antenna will result in a slightly reduced bandwidth.

As stated in Part I of this series, the conical antenna is a form of broadband dipole frequently used in television. The conical is often designed to include the principle of the V-antenna. In the conical V-type, the elements are bent forward to obtain increased directivity and gain while still retaining the broadband characteristics associated with the conical. The V-angle is usually kept rather large so that the decrease in bandwidth of the conical may be kept at a minimum. Fig. 4 shows a typical conical V-antenna.

Phased Systems

There are many types of antenna arrays that contain several driven elements, with each element possessing a certain phase relationship to the others. These antennas are grouped under the general heading of phased systems. To be more specific, these antennas are further divided into three categories: collinear arrays, broadside arrays, and end-fire arrays.

Collinear Arrays

This type of antenna consists of several elements placed end to end and having their currents in phase. Consider a long-wire antenna having a length of $1\frac{1}{2}$ wavelengths. The current distribution on this antenna would be similar to that shown in Fig. 5. By removing the center half-wave section, there would be two half-wave elements with their currents in phase.

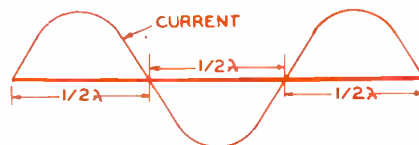

Fig. 5. Current Distribution in One-and-One-Half Wavelength Antenna.

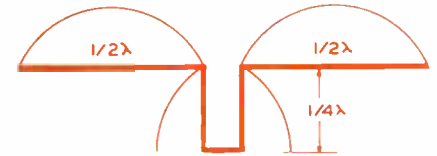
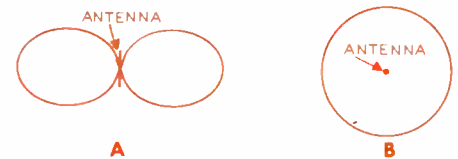

Fig. 6. The Basic Collinear Antenna.

This is done by replacing the center section with a quarter-wave matching stub, as shown in Fig. 6. The basic collinear antenna is formed in this way. The antenna is nondirectional in a plane perpendicular to the antenna, but it is bidirectional in a plane containing the antenna. The response patterns in these planes appear in Fig. 7.

The lengths of the half-wave elements used in the collinear antenna are not critical, but the lengths should all be the same.

The Q of an antenna is indicative of its broadband characteristics. A high Q produces a sharp response curve and indicates narrow frequency response. Conversely, a low Q pro-



(A) In a Plane Containing the Elements. (B) In a Plane Perpendicular to the Elements.

Fig. 7. Response Patterns of a Collinear Antenna.

duces a broad response curve and is therefore an indication of wide frequency response. The collinear antenna possesses a low Q; consequently, it is a good broadband antenna.

Increased gain and directivity are possible by the addition of half-wave elements, as illustrated in Fig. 8. Note that the transmission line is connected to a high-impedance point.

The collinear array may be made unidirectional by the addition of a reflector, usually of the screen type.

Broadside Arrays

A broadside array is formed when the driven half-wave elements

* * Please turn to page 42 * *



Fig. 8. The Addition of Elements to a Collinear Array.

The BACKSTOP

STOPS co-channel and adjacent-channel interference caused by rear signal pick-up!

- Highest front-to-back ratio ever built into an antenna!
- No rear pick-up; eliminates "venetian blinds"!
- Largest screen area: 70 square feet!
- Very high all-channel gain. Incorporates basic Champion design, including Tri-Pole, with additional elements!
- Completely preassembled!

Table of Front-to-Back Ratios (Relative Voltage)

Channels	Front-to-Back Ratios
2	9:1
3	10:1
4	11:1
5	20:1
6	18:1

Only Low Band channels shown, since co-channel interference is not encountered on High Band channels.

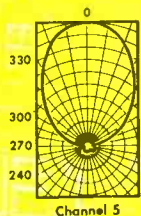

IMPORTANT . . . don't be misled by polar patterns representing relative POWER. Remember, power is the square of voltage. All Channel Master polar patterns are presented in relative VOLTAGE.

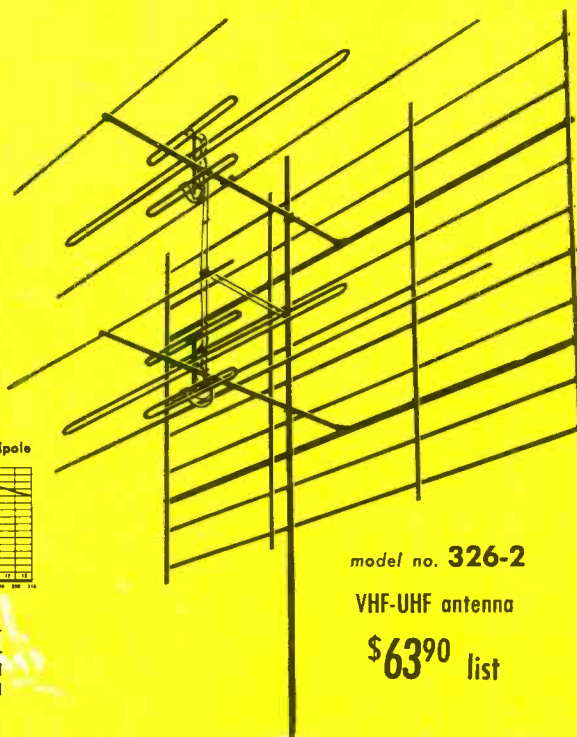
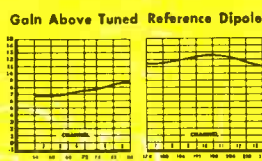

model no. 326-2

VHF-UHF antenna

\$63⁹⁰ list

2 radical new antennas by CHANNEL MASTER

The most beautiful antenna ever made! The only indoor antenna featuring powerful outdoor design principles — Bow-Tie and Screen.

Wonder Bow * VHF-UHF indoor antenna

DESIGNED FOR POWER!

On **UHF**: For primary and secondary areas. In many cases, performance is equal to actual outdoor installations. Good directivity on all channels.

On **VHF**: Ideal in areas of strong VHF signals.

STYLED FOR BEAUTY!

Designed by a well-known industrial designer, the WONDER BOW is proof that indoor antennas can be beautiful as well as powerful. Wins customer approval on beauty alone!

The first gain figures ever to be published for an indoor antenna!

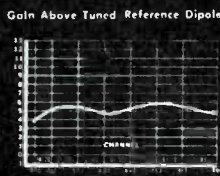

Gold and black
model no. 416

Silver and black
model no. 417

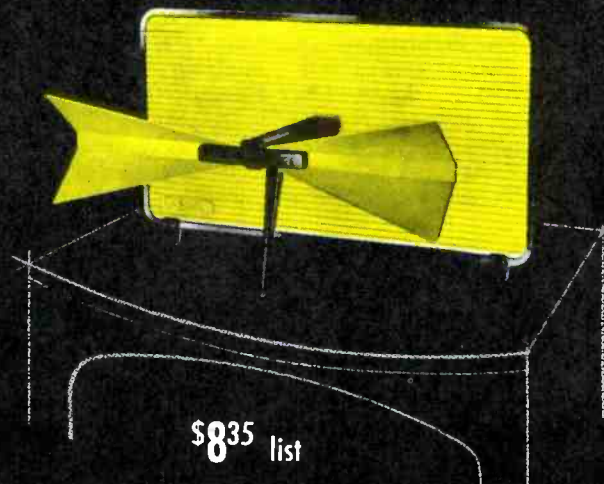

\$83⁵ list



CHANNEL MASTER CORP. ELLENVILLE, N. Y.

The World's Largest Manufacturer of TV Antennas

Write for complete technical literature.

Copyright 1954, Channel Master Corp.

*Pat. No. D-171560

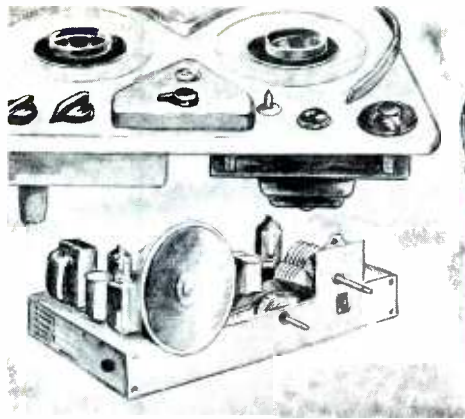

ADMIRAL CHASSIS 20A2

In line with our aim to describe the design features of television receivers produced by various manufacturers, we have selected the Admiral Chassis 20A2 for discussion in this issue. Although a general description is given of the complete receiver, particular emphasis is placed upon new circuits employed by this manufacturer.

The Admiral Chassis 20A2 which is equipped for VHF reception employs a total of nineteen tubes, exclusive of a 21-inch picture tube. The 21ZP4A picture tube is mounted on support brackets attached to the chassis. The chassis and picture tube are removed from the cabinet as a single unit and appear as shown in Fig. 1.

The ON-OFF switch, contrast control, channel selector, and the fine-tuning control are accessible from the front of the receiver. By lowering a hinged panel on the front of the cabinet, access is provided to the brightness, horizontal hold, vertical hold, and tone controls.

Tuner

The VHF tuner used in this chassis is designated the 94D46-4. It is a turret type of tuner using two removable strips for each channel. Although the tuner has an input design for use with 300-ohm line, coaxial cable with an impedance of 75 ohms may be used. In this case, the shield of the cable is connected to the chassis and the center lead is connected to one of the antenna terminals on the receiver. Both of the terminals should be tried, and the one providing the best reception should be used.

The RF amplifier is a 6BZ7 connected in a cascode circuit. The gain of this stage is controlled by the application of the AGC voltage to the grid of the first triode section. The output of the RF amplifier is inductively coupled to the mixer stage.

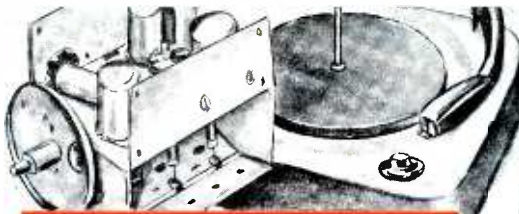

Examining DESIGN Features

The mixer and oscillator are triode sections of a 6J6. The frequency of the oscillator may be varied by adjusting the slug in the oscillator coil. This adjustment may be made without removing the chassis from the cabinet. Access to the slug is provided by removing the channel-selector and fine-tuning knobs.

During the complete alignment of the tuner, there are four adjustments to be made in addition to the twelve oscillator slugs.

Video IF

The IF signal from the output of the mixer is coupled to the grid of the 6CB6 first IF amplifier. The plate circuit of this stage contains a trap tuned to 27.25 megacycles. The IF signal is then transformer coupled to the grid of the second IF amplifier which is also a 6CB6. The transformer between these stages is peaked at a frequency of 25.3 megacycles. The amplified signal is then fed to the pentode section of a 6U8 which serves as the third stage of IF amplification. The IF transformer linking the second and third stages is peaked at 23.1 megacycles. The transformer

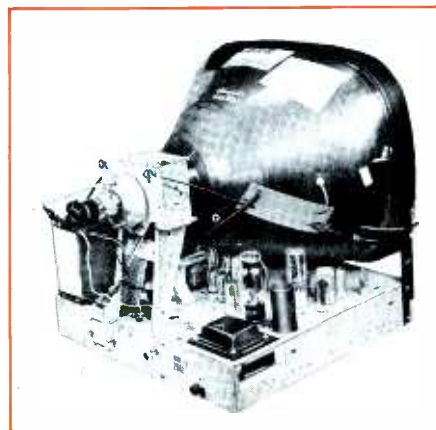
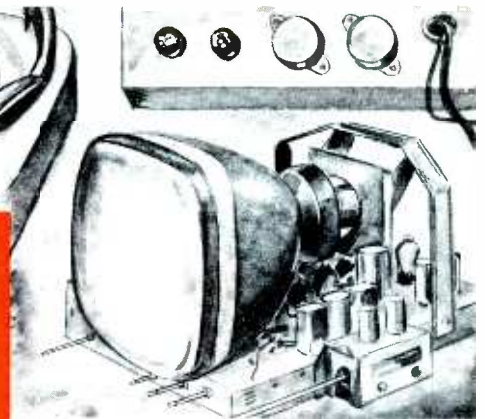

Fig. 1. The Admiral Chassis 20A2.



by DON R. HOWE

in the plate circuit of the third stage is peaked at 25.3 megacycles. The secondary is connected to a 6AL5 video detector and AGC tube. Overall gain of the video IF is controlled by the AGC voltage applied to the first and second stages.

Video

One diode section of the 6AL5 is used as the video detector with the IF signal being fed to the cathode. A video peaking coil is placed in series with the signal from the detector. The video signal is then fed to the grid of the 12BY7 video amplifier which has an additional peaking coil in its grid circuit. A series trap, resonant at a frequency of 4.5 megacycles, is also contained in the grid circuit of this tube. The desired contrast is achieved by varying the control in the cathode circuit of the 12BY7. An improved response of the video amplifier is obtained by the inclusion of two video peaking coils in the plate circuit. The resultant signal is then coupled to the cathode of the 21ZP4A picture tube. The cathode of the picture tube has its DC potential varied by means of the brightness control.

AGC

The AGC system in the Admiral Chassis 20A2 is shown in Fig. 2. From this circuit, it may be seen that the IF signal fed to the video detector is also coupled to one section of a 6AL5 for use in developing the AGC voltage. A two-megohm potentiometer in the plate circuit of the diode determines the amount of AGC voltage that is obtained. This control is labeled "DX Range Finder" and is located on the rear of the chassis.

When the DX Range Finder R2 is set for maximum resistance, which is the condition for strong signals,

* * Please turn to page 54 * *

Fits Anywhere!



15/16" COMPOSITION-ELEMENT

Series A47 and A47F

1/2 WATT CONTROLS

Choose your key to any replacement need — right size, right ohmage, right taper, right tap, right shaft, right switch — right at your finger tips. Minimum inventory with Clarostat 15/16" Ad-A-Switch* and Pick-A-Shaft* controls (taking attachable switches and shafts) provides for maximum variety of replacements. And all are stocked locally by distributors serving the service trade best. Literature on request.

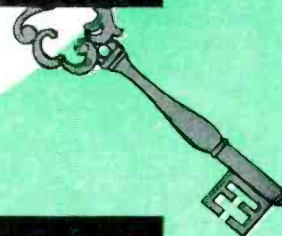
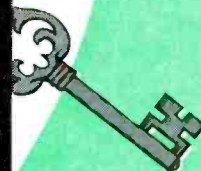
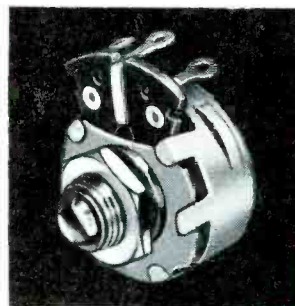

... PLAIN OR TAPPED

The completely redesigned Clarostat 15/16" dia. composition-element 1/2 watt control (Series A47) is small enough to fit into the tightest spots. 500 ohms to 10 megohms. Various tapers. Also tapped (Series A47F) 200 ohms to 2 megohms, with popular selection of taps.

... WITH SWITCH

And the desired switch is easily and quickly attached. Series SWE-12 S.P.S.T. (rated at 5 amps. 125 v.a.c.); Series SWE-20 D.P.S.T. (3 amps. 125 v.a.c.); Series SWE-21 Mod. D.P.S.T. (3 amps. 125 v.a.c./d.c., one-pole-on, one-pole-off, or with jumper for S.P.D.T.). Designed by Clarostat, made by Clarostat, for exclusive Clarostat use. No better switch has yet been offered.

... ANY SHAFT

For the mechanical requirements, choose the correct shaft from the 12 different "Pick-A-Shaft" types, or again the insulated or the high-voltage coupler types. Selected shaft inserts firmly and permanently in the selected control.

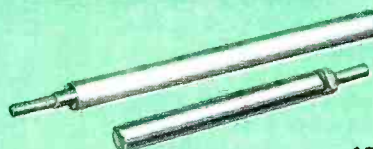

* Trade-mark

CLAROSTAT MFG. CO., INC., DOVER, NEW HAMPSHIRE

In Canada: Canadian Marconi Co., Ltd., Toronto, Ont.

COLORMATH

by HAROLD E. ENNES



PART IV

Receiver Matrix and Picture Tube

The matrix extracts the color-difference signals R - Y, G - Y, and B - Y from the filtered output of the I and Q demodulators. These signals, along with the luminance or Y signal, excite the color picture tube in instantaneous values so that the overall function matches the corresponding scanned point at the studio camera.

The I-Q matrixer at the sending end reduces the R - Y component to:

$$0.877 (R-Y), \text{ or } \frac{R-Y}{1.14}$$

Similarly, the B - Y component was reduced to

$$0.493 (B-Y), \text{ or } \frac{B-Y}{2.03}$$

In this manner, both I and Q channels contain some of both color-difference components so that only a two-phase color carrier is required for three chrominance primaries. It is the purpose of the matrixer in an I-Q demodulator type of receiver to recover $1.14(R - Y)$ and $2.03(B - Y)$. This means that the color-difference components will be recovered in their original forms before I and Q matrixing at the transmission end; therefore, R - Y gain will be 1.14 and B - Y

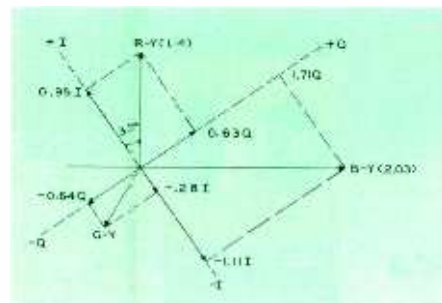

Fig. 12A. Matrix Functions Necessary to Extract the Color-Difference Signals From the I and Q Demodulators.

The Mathematical Foundations Upon Which the Color TV System Operates

gain will be 2.03. In narrow-band color receivers, the gain of the R - Y demodulator is 1.14 and the B - Y demodulator has a gain of 2.03. In the wide-band receiver, this is achieved in the matrixer operation.

This action is emphasized in Fig. 12A where we have simply taken the R - Y and B - Y components and multiplied them by 1.14 and 2.03 respectively. We may now note the values of I and Q necessary to extract the color-difference components existing before modulation. This is found to be:

$$R-Y = 0.95 (I) + 0.63 (Q) \quad (8)$$

$$B-Y = -1.11 (I) + 1.71 (Q) \quad (9)$$

We know that Y is:

$$Y = 0.30R + 0.59G + 0.11B. \quad (10)$$

Rearranging equation 10:

$$G-Y = -0.51 (R-Y) - 0.19 (B-Y). \quad (11)$$

This is the action performed in receivers in which the color-difference signals are directly demodulated in the matrix to extract the G - Y component. In terms of I and Q for the wide-band color receiver, substituting equation 8 and 9 into 11,

$$G-Y = -0.28 (I) - 0.64 (Q). \quad (12)$$

Equation 12 is also shown in Fig. 12A for matrix operation necessary to extract the G - Y color-difference signal.

Fig. 12B is a block diagram of a receiver matrixer. From equations 8, 9, and 12 we know that these color-difference signals plus the luminance

(Y) signal is equal to that particular color as:

$$R = 0.95 (I) + 0.63 (Q) + Y, \quad (13)$$

$$G = -0.28 (I) - 0.64 (Q) + Y, \quad (14)$$

$$B = -1.11 (I) + 1.71 (Q) + Y. \quad (15)$$

The matrixer takes the plus and minus signals from the I and Q phase splitters and proportions the signals according to equations 13, 14, and 15; that is, the Y signal with unity gain is mixed with the I-Q proportionment. Note that the green adder stage is fed by Y plus $-0.28 (I)$ and $-0.64 (Q)$. The blue adder stage is fed by Y plus $-1.11 (I)$ and $1.71 (Q)$. The red adder is fed by Y plus $0.95 (I)$ and $0.63 (Q)$. The adder outputs, containing green, blue, and red signals respectively, feed their individual amplifiers for driving the picture tube.

As a specific example, consider the reproduction of yellow, for which:

$$I = +0.32,$$

$$Q = -0.31.$$

Since yellow is a combination of red and green, we know that the red and green phosphors of the picture tube will be excited equally, whereas blue is biased off.

For yellow, the luminance signal is 0.89. Then to see the matrix operation on the red channel, substitute the values of I and Q for yellow into the red matrixer operation (equation 13):

$$R = 0.95 (0.32) + 0.63 (-0.31) + 0.89,$$

$$R = 0.3 - 0.19 + 0.89,$$

$$R = 0.11 + 0.89 = 1 \text{ (unity).}$$

RCA research is constantly at work INSIDE EVERY RCA TUBE



Same basic type number... better tube! RCA Receiving Tubes undergo continual improvement, to help you do a better job

Take an RCA Receiving Tube out of its famous red, white and black carton. Examine it! You're looking at a product of *constant development* by RCA Engineers — to give you superior tube performance and top tube value.

RCA is constantly improving tube design and making these advances without changing the basic type number. Yet RCA asks no premium for improvements! You get increased value with RCA Receiving Tubes!

Tubes shown here are typical examples of RCA's program of constant product improvement.

When you sell a replacement tube, your profit and reputation are at stake. That's why it pays to use the best in Receiving Tubes—RCA.

RCA-1B3-GT. This rectifier tube has been improved to handle the higher voltages required by "big-picture" TV sets. Tube safety factors have been increased through use of a special glass envelope and hydrogen firing of this envelope. **Result: Longer Life.**

RCA-6BQ6-GT. This horizontal deflection amplifier tube has been improved to minimize grid emission, stray emission, and TV picture "jitters." **Result: Superior Performance.**

RCA-6BQ7-A. Here's a miniature type twin triode with improved structure that does away with heater cathode trouble. Built to stand up in rf amplifier systems operating 24 hours a day. Replaces type 6BZ7 in practically every socket... **offers equal performance at a lower price! Result: Plus features, at no extra cost.**



RADIO CORPORATION of AMERICA
ELECTRON TUBES
HARRISON, N. J.



Then for green, substitute into equation 14 the values of I and Q for yellow:

$$G = -0.28(0.32) - 0.64(-0.31) + 0.89,$$

$$G = 0.09 + 0.20 + 0.89,$$

$$G = 0.11 + 0.89 = 1 \text{ (unity)}.$$

Then for blue, substitute into equation 15 the values of I and Q for yellow:

$$B = -1.11(0.32) + 1.71(-0.31) + 0.89,$$

$$B = -0.36 - 0.53 + 0.89,$$

$$B = -0.89 + 0.89 = 0 \text{ (biased off)}.$$

Thus, the result is equal excitation of red and green, whereas blue excitation is zero. This condition produces yellow.

Bear in mind that we have considered only hues at maximum saturation. We may now examine the more usual case concerning hues that are not at maximum saturation or where a mixture with white exists in the dye or pigments of the object being televised.

Since white is composed of all primary colors, any particular hue that is not at maximum saturation

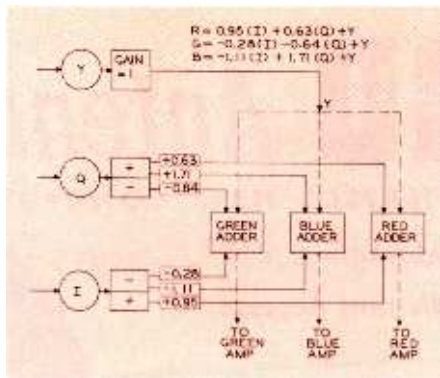

Fig. 12B. Matrix Action for Recovery of the Three Color Signals.

will have some of red plus green plus blue added to the dominant hue. Note particularly that addition of all colors by an equal amount will not change the dominant hue but will change its shade or color characteristic. This particular characteristic is termed the degree of saturation.

Fig. 12C illustrates the transmission of a red that is not at maximum saturation (red plus white). Let us assume that the degree of white mixture is such that 0.5 unit of each primary is added. See section 1 of Fig. 12C. Since Y is 30 per cent red,

59 per cent green, and 11 per cent blue, the luminance channel carries (in monochrome) 0.3R plus 0.295G plus 0.055B for a total of 0.65 volts. This is considerably more than a Y of 0.3 for a red of maximum saturation.

Note the formation of the color difference signals, as shown in section 2 of Fig. 12C.

$$R - Y = +0.35,$$

$$B - Y = -0.15.$$

Then the I-Q matrix results in:

$$I = +0.299,$$

$$Q = +0.106.$$

Compare this to the condition of maximum saturation in which I equals +0.60 and Q equals +0.21.

Interpretation of Saturation Occurs in the Chrominance-to-Luminance Signal Ratio

The ratios of the chrominance signals to the luminance signals and

* * Please turn to page 33 * *

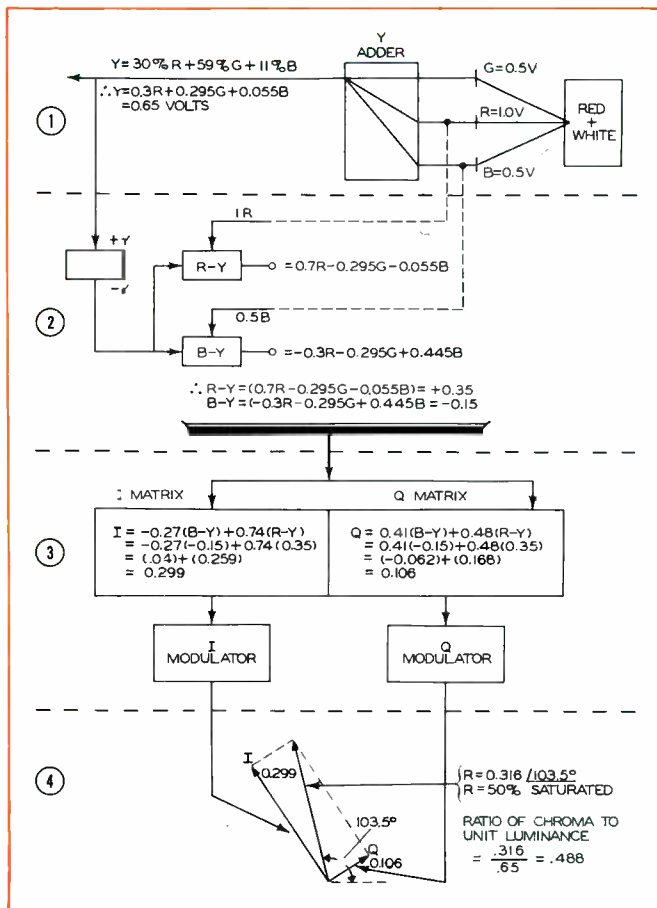

Fig. 12C. Ratio of Chrominance Signal to Luminance Signal for a Red of 50 Per Cent Saturation.

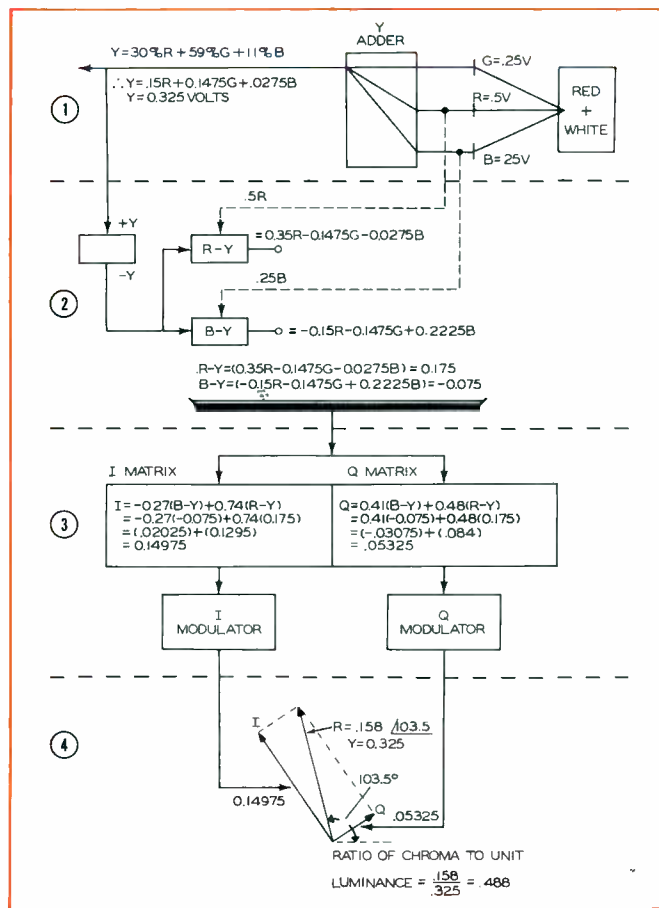

Fig. 12D. Ratio of Chrominance Signal to Luminance Signal for a Red of 50 Per Cent Saturation at Low Brightness Level.

WARD Antenna Rama

A DYNAMIC NEW CONCEPT

*in the Manufacture and Marketing of TV Antennas,
Auto Radio Aerials and Accessories*

LENGTH OF EXPERIENCE

Ward electronic engineers have pioneered many important advances in TV and Radio communications — advances which have set the pattern for others.

DEPTH OF PRICES

Whatever the budget may indicate, Ward offers the right answer with TV antennas, auto radio aerials and accessories at the right price . . . profitable for you, too.

BREADTH OF LINE

The new Ward line includes TV antennas, auto radio aerials, and accessories . . . engineered and styled for complete customer satisfaction.

HEIGHT OF QUALITY

Every TV and radio product which proudly bears the Ward name represents the finest material money can buy.

RANGE OF MODELS

That Ward dealers may best serve their patrons, Ward offers a wide selection of antennas and accessories to meet every need.

**LET SAM
WORK
FOR YOU!**



SALES PROMOTION

Eye catching displays, mailing pieces, catalog sheets.

ADVERTISING

National advertising plus local cooperation for you.

MERCHANDISING

Actual sales leads plus products and prices that make selling easy for Ward dealers.

WARD PRODUCTS CORP.

DIVISION OF THE GABRIEL COMPANY

1148 Euclid Ave., Cleveland 15, Ohio

Canadian Distributor: ATLAS RADIO CO., LTD., TORONTO, CANADA



HORIZONTAL

(Part III)

Control of the Sine-Wave Oscillator by the Reactance Tube and the Discriminator

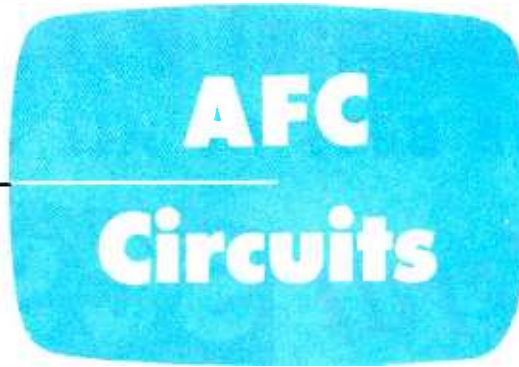

by William E. Burke

The May and June 1954 issues of the PF INDEX contained the first two of a series of articles designed to cover the various methods of automatic frequency control of the horizontal-sweep oscillator in television receivers. To continue the series, this article covers the sine-wave oscillator in combination with a reactance tube and a discriminator. A typical circuit is illustrated in the schematic of Fig. 8-18. As before, waveform numbers on the schematic identify points at which significant waveforms can be observed. The operation of the system may be explained through an analysis of these waveforms and the phase relationships between them.

The connection of the equipment for this analysis was given previously, but it will be repeated here for the convenience of the reader desirous of following the analysis by direct observation of the waveforms. In order to provide a suitable means of comparison between the various waveforms, the oscilloscope was synchro-

nized externally with the saw-tooth voltage which is present at the grid of the horizontal-output tube. A 500,000-ohm resistor was placed in series with this external sync connection so that the receiver operation would not be disrupted by loading of the circuit. By synchronizing the scope in this manner and by maintaining the frequency and amplitude of the horizontal sweep of the scope at constant values, we have shown all the waveforms with reference to approximately the same time base. Then, by placing associated waveforms one above the other, any change in either the frequency or phase of these waveforms is made apparent. In addition, an isolation probe was used in the vertical-input lead to prevent the input capacitance of the scope from affecting the receiver performance.

This system, like the other AFC systems, performs a comparison between the sync pulses and the horizontal-oscillator signal and produces a DC voltage which is repre-

sentative of any difference in either the frequency or the phase of the two signals. The DC voltage is applied to the reactance tube which then returns the frequency or the phase of the oscillator to the normal condition.

Oscillator

The horizontal oscillator, V2 on the schematic of Fig. 8-18, is connected in a modified Hartley oscillator circuit. The basic oscillator action can best be explained by starting at the instant that plate voltage is first applied to the circuit shown in Fig. 8-19. Since the grid is at zero voltage initially, plate current will immediately start to flow. The cathode current will flow through the lower portion of coil L1 and will build up a magnetic field around the entire coil. The coil is wound so that an increasing cathode current will produce a positive voltage at the top or grid end of the coil. A positive voltage on the grid of the tube will cause an increase in the flow of plate current which will, in turn, cause an increase in the positive grid voltage. This action is cumulative and ends when the plate current is at saturation.

As the plate current is approaching the saturation point, the rate of change of the current will decrease. The induced magnetic field in L1 will not build up so fast, and the positive grid voltage will not be so high as it was previously. When plate current saturation is attained, the current is at a steady value, and the magnetic field of L1 begins to collapse. Since the direction of the magnetic field then reverses, a negative voltage is applied to the grid. The plate current will begin to decrease, and this will increase the rate at which the magnetic field is collapsing. This action is also cumulative and ends when the magnetic field is built up

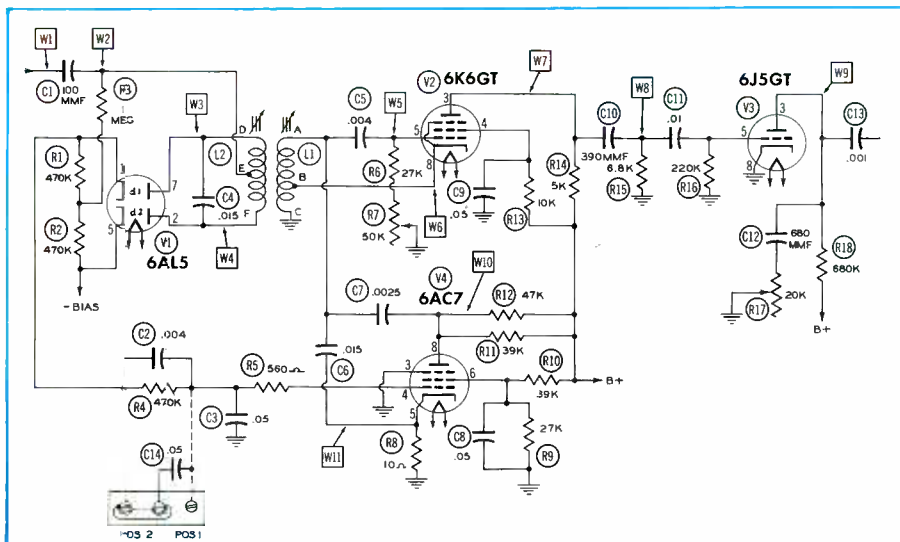

Fig. 8-18. Schematic of the AFC System Under Discussion.

* * Please turn to page 46 * *

Performance! Profits! Packages!

GET THE BEST IN ALL 3 WITH THE NEW

Federal S-C-S DIODES

"SINGLE-CRYSTAL STABILIZED"

Highest quality diodes for every replacement need...packed for economy buying...in the service industry's MOST USEFUL PACKAGE LINE!

Servicemen! Federal's "S-C-S" Germanium Diode Packaging Program is the hottest news in diode purchasing!

You get top performance and attractive profits in handy packages you can use for many practical purposes.

You can buy single units in cellophane-wrapped packages . . . you can buy 5-unit and 10-unit packages in the form of clear plastic cases with hinges and snap-lock. You can buy boxes of 50 single-unit packages . . . at a substantial saving!

Look for "S-C-S" Diodes in Federal's Store Dispensers!

When you're shopping at your Federal Distributor — look for these two types of dispensers: (A) counter dispenser with single-, five- and ten-unit packages; (B) wall dispenser with single-unit packages. Serve yourself . . . save time! Watch for them in stores . . . in golden yellow and brilliant red!



10-UNIT PACKAGE

—economy-size clear plastic hinged utility case.

5-UNIT PACKAGE

—clear plastic hinged utility case.

SINGLE-UNIT PACKAGE

—cellophane-wrapped.

50-UNIT PACKAGE

—large-economy-size, combination dispenser-container . . . a real money-saver!



CHECK the quality and performance features of Federal's new design achievement in diodes! You'll agree that Federal is your best bet for profitable, customer-satisfying diode servicing!

Federal

Telephone and Radio Company

A Division of
INTERNATIONAL TELEPHONE AND TELEGRAPH CORPORATION
COMPONENTS DIVISION, 100 KINGSLAND ROAD, CLIFTON, N. J.

In Canada:
Federal Electric Manufacturing Company, Ltd., Montreal, P.Q.

Export Distributors:
International Standard Electric Corp., 67 Broad St., N. Y.

Federal "S-C-S" Diodes ARE TOPS!

SINGLE-CRYSTAL GERMANIUM—the finest for reliable performance
MOISTURE-PROOF—vacuum-sealed, all-ceramic construction
EVERY DIODE TESTED for all characteristics
COMPLETELY INSULATED CASE
POLARITY clearly identified
HEAT SINKS protect during soldering
SMALL SIZE ($\frac{1}{4}$ " diameter, $\frac{1}{2}$ " long)
FLEXIBLE LEADS for easy mounting
NO FILAMENT—no heater power drain or hum
LOW SHUNT CAPACITY (average 1 mmf.)
SELF-HEALING for temporary overloads
NO CONTACT POTENTIAL
WITHSTAND adverse temperature and humidity cycling
INSURE many thousands of hours of dependable performance

PACKAGES YOU CAN USE!

Be sure to save Federal's 5-unit and 10-unit packages of clear plastic. They're hinged . . . they snap-lock . . . they open easily. Excellent for storing small parts . . . carrying in pocket or kit or filing in shop cabinets. They're a plus value you get with Federal quality-controlled "S-C-S" Diodes!

Ask your
Federal
Distributor
or write to
Dept. R-3118 B

Audio-Facts



by

Robert B. Dunham

Electronic Divider Unit

The primary reason for having a high-fidelity system is the desire to obtain the best possible sound reproduction. High quality equipment is used throughout the system because every part must operate properly. Distortion or undesired results produced by any weak link will be made more noticeable in the reproduced sound because of the faithful reproduction afforded by the rest of the system.

Eventhough the best turntables, pickups, tuners, preamplifiers, amplifiers, and loudspeakers are employed, certain conditions which are very difficult to correct are sometimes encountered. For example, when an excellent amplifier is connected to an equally excellent loudspeaker system, the capabilities of these units may not be fully realized because of the circuits necessary to channel the correct frequencies to the appropriate loudspeaker.

Most high quality sound systems include a loudspeaker system which is composed of two or more speakers and a divider network, as discussed in "Audio Facts" in the PF INDEX for May-June 1953. The correct combination of amplifier, divider network, and loudspeakers can reproduce sound of such high quality that many people may consider it unnecessary to try to improve upon it; but most high-fidelity enthusiasts are striving for perfection, and any reasonable thing

An Electronic Crossover Network for Driving Two Amplifier-Speaker Combinations

which will improve the quality of the sound is considered worth while.

The electronic divider unit shown in Figs. 1 and 2 eliminates the need for the usual divider network located in the power-output circuit; and for this and other reasons, it can provide improved operation and better sound. The reasons for this improvement as well as some of the problems of the design and construction of the unit are interesting, and they touch upon many fundamental points.

By using this small unit, which usually connects into the circuit between the output of the preamplifier and the input of the power amplifier, some definite advantages can be gained. The manner in which the system operates when this unit is used can be seen in the block diagram in Fig. 3 and in the schematic in Fig. 4.

One requirement for a two-channel system is the use of an additional amplifier. This is not so much of a problem as it might seem to be, because many audio enthusiasts have on hand an extra amplifier that is suitable for this application. Al-

though it must be good, it does not necessarily need to be a powerful unit.

In most systems employing two amplifiers, the more powerful one handles the low frequencies; whereas, a lower-powered unit operates at the high frequencies where the power requirements are not so heavy. This is due in part to the fact that loudspeakers which operate as midrange and high-frequency tweeters are more efficient than low-frequency woofers. Amplifiers from 20 to 25 watts or higher are often used in the low-frequency channel, while an 8- to 10-watt amplifier is employed in the high-frequency channel.

Conventional Divider Networks

To go into some of the whys and wherefores, we will first consider the usual divider network.

The capacitors used in a divider network must usually be quite large in capacity to accomplish division of the signal at the low crossover frequency normally used. The coils need not be large with regard to inductance, but they must be large physically because they have to be wound with large-sized wire to keep the resistance low and the losses down in the power-handling circuit.

A divider network depends chiefly upon the personal preferences

* * Please turn to page 37 * *

The Complete Line

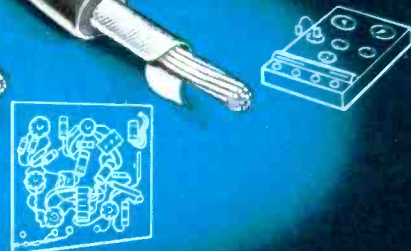
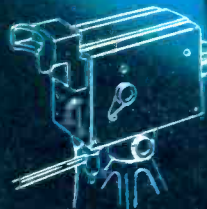

Aptitude-Tested
**ELECTRONIC
WIRES
and
CABLES**

Belden makes a complete line of Aptitude-Tested electronic wires and cables. You can select the right wire for every application, because all performance values are shown. See your Belden Catalog.

Belden Manufacturing Company
Chicago, Illinois

Belden

**WIREMAKER
FOR INDUSTRY**

In the Interest of . . .

Quicker Servicing

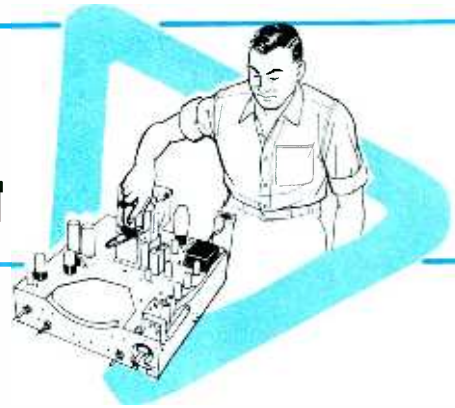

IN THE SHOP

From a compilation of the troubles which frequently occur in video amplifier stages and those which are difficult to trace in these stages, we have selected several problems for discussion. The symptoms, the reasoning used by the service technician, the trouble-shooting approaches, and the solutions are described for every case. To facilitate this discussion, we are adapting these problems to the particular circuit drawn in Fig. 1. This circuit can be considered representative of a great many video-amplifier designs, and we trust that the reader will find the problems and their solutions generally applicable to all television receivers.

Problem No. 1

When the set came on, it was immediately noted that a complete loss of sync had occurred. No amount of control adjustment would cause the picture to lock in, even momentarily.

It was a natural thing to try substituting new tubes in the sync circuit first. The hope for a quick repair was soon squelched however; for as soon as the set came on, the trouble was still present. (This is as good a time as any to caution the service technician always to try the tubes in a chassis when it is brought into the shop for bench work even though the tubes may have been previously tried in the home. Occasionally, a lot of valuable time is lost in hunting for a trouble source other than tubes simply because a tube in the service kit happened to be bad and the bench man depended entirely on its reliability. For this reason, rechecking tubes by substitution is always a good policy. The short time consumed in doing this will pay off in the long run.)

When the substitution of the sync tubes failed to correct the symptom, it was decided that the best course to follow next was to use the scope and see where the signal was being lost.

The scope lead was first placed on the grid of the sync separator as a check of whether or not the signal was getting that far. It was not; there was no signal of any kind on the sync-separator grid. From there, the lead was moved to the junction of R12 and C11. Still no signal was observed. Moving the scope lead to the other side of the resistor R12 (that is, to the junction of R12 and L5) resulted in the appearance of a good signal. This narrowed the possibilities to only two components. Either R12 was open or C11 was shorted. Further tests using an ohmmeter showed C11 to be shorted. A new capacitor returned the set operation to normal.

Notice that the oscilloscope was particularly useful in the solving of this problem. Moreover, by intelligent interpretation of the symptoms, the technician was able to narrow the field of suspects to two components by means of only three tests with the scope. His approach to this problem was efficient and resulted in a quick solution.

Let us see the manner in which he tackled a little more difficult problem.

Problem No. 2

The high-frequency response in the TV receiver was very low. In fact, it was so low that it caused the picture to appear blurred. This is a trouble which may be caused by a great many things. Bad tubes, a shorted or open peaking coil, an open bypass capacitor, and even poor alignment may cause poor frequency response. Since this trouble had occurred suddenly, the technician did not suspect the alignment, because misalignment is something that does not usually occur overnight but instead happens over a long period of time. It could occur after a component substitution which might alter certain circuit constants and thereby affect the resonance of a stage in the IF

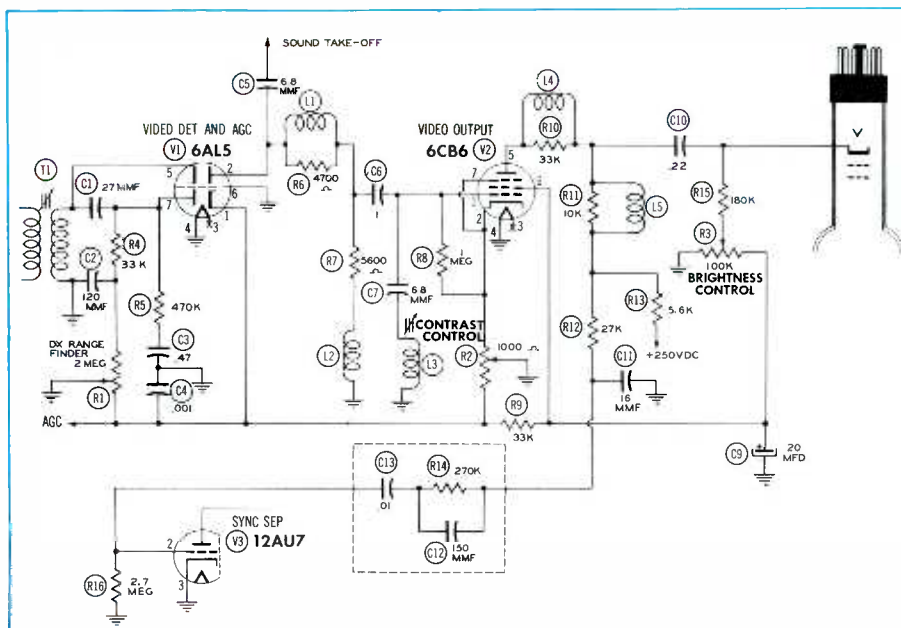
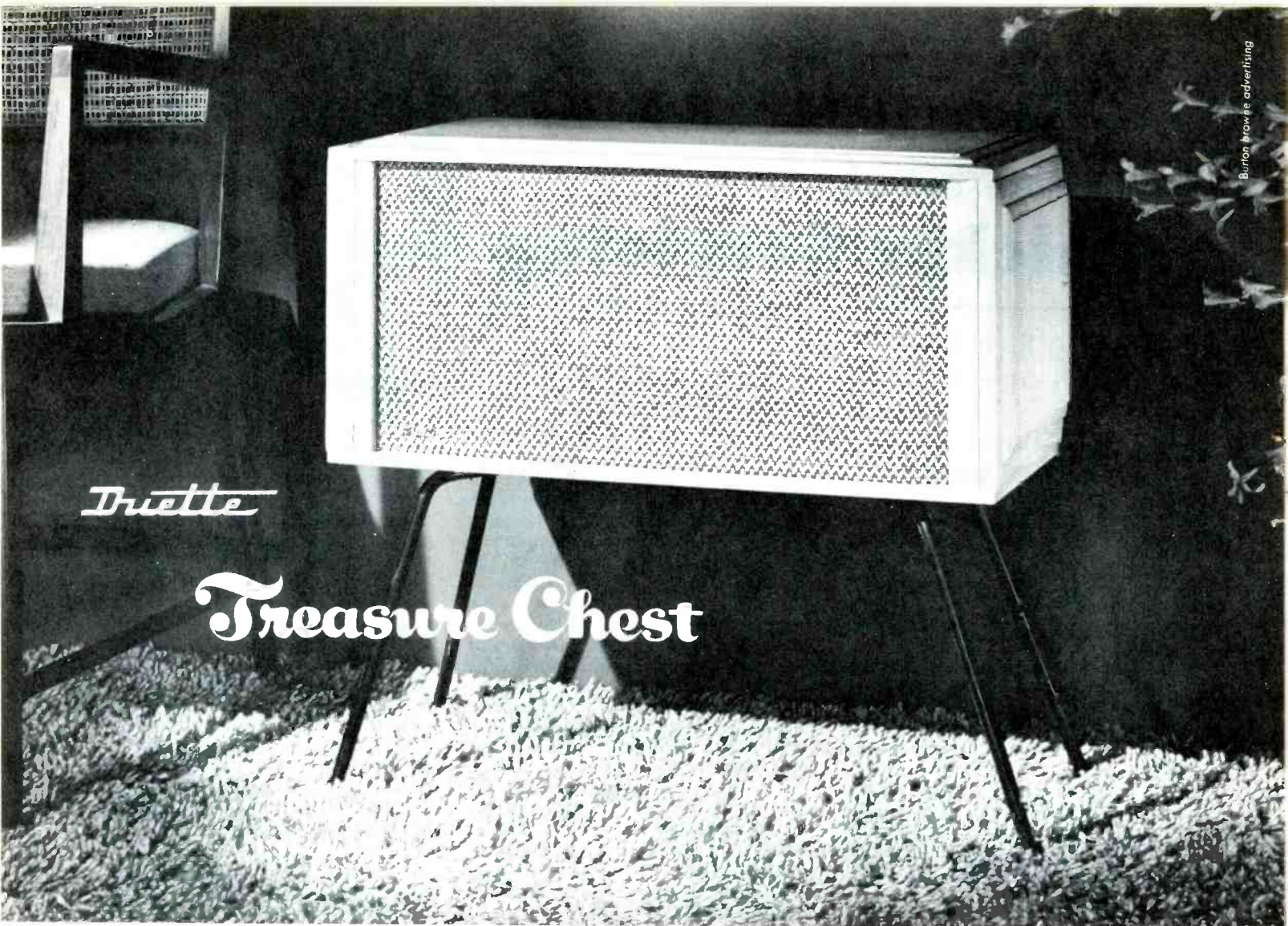

Fig. 1. A Video-Output Stage.



Duette

Treasure Chest

FIRST to give you the real high fidelity of a two-way speaker system in a small package—the Jensen "Duette" won your acclaim.

Now the Jensen Duette "Treasure Chest" model is an elegant compliment to your decor whether traditional or modern. The handsome versatile chest design is available in either selected mahogany or blonde oak veneer with genuine matching hardwood trim.

The "Treasure Chest" Duette fits on your book shelf or in a small table area. Measures only 11" by 23 1/4" by 10". The "Treasure Chest" may be made into a graceful free-standing piece by the addition of modern wrought iron legs—available separately.

Duette "Treasure Chest" gives the full performance of the true two-way system with its special 8-inch woofer and compression driver tweeter in an unusually compact scientifically designed acoustic enclosure. Ideal for

small space hi-fi system, excellent as an improvement addition for true hi-fi from existing radio, TV, phonograph or tape recorder. Capable of adequate bass reproduction even at low listening levels. Clean, smooth response with the unmistakable presence of the true two-way reproducer.

The Jensen "Treasure Chest" Duette in either blonde oak or mahogany is an extraordinary value at **\$76⁵⁰ net.**

ST-862 Wrought iron leg set, \$4.25

Also see the "Duette DU-201" in Dupont Fabrikoid finish at a new low price **\$62⁵⁰ net.**

And the "Duette Portable" in black leatherette carrying case at only **\$77⁵⁰ net.**

Jensen has been the world's quality standard in loudspeakers for more than a quarter of a century.

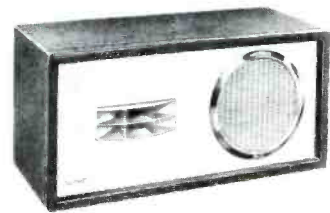

DUETTE DU-201



DUETTE PORTABLE

Jensen MANUFACTURING COMPANY

Division of The Muter Company
6601 South Laramie Avenue • Chicago 38, Illinois
In Canada: COPPER WIRE PRODUCTS, LTD., Licensee

strip. The technician knew that this had not been done.

This left tubes, peaking coils, and bypasses as possible suspects. A quick recheck of tubes in the tuner, the IF, the video detector, and the video output stages failed to remedy the situation. Since most of the peaking coils and other components which affect the frequency response are found in the output of the video detector and in the grid and plate circuits of the video output tube, these were thought to be the most appropriate places in which to start checking components.

The components most likely to cause trouble of a frequency-response nature are L1, L2, C9, L4, L5, and C10. In such a case, voltage measurements help to narrow the possibilities. Therefore, the next step was to measure grid, screen, and plate voltages on the video output tube. The grid voltage was satisfactory and so was the screen voltage; however, the plate voltage, instead of having a normal 200 volts, had only 70 volts. This measurement indicated that one of the coils in the plate circuit had probably opened and increased the plate-load resistance to an abnormal value. A check with an ohmmeter showed L5 to be open.

The trouble-shooting procedure employed by the technician with this problem may not have been the quickest method; however, it was thorough. Possibly a more experienced man might have suspected an open peaking coil when he first viewed the picture. By a quick ohmmeter check of the peaking coils in the set, he would have located the defective unit. On the other hand, if he had discovered that his diagnosis was wrong and that the trouble was caused by some other component, it is probable that he would have resorted to the basic procedure followed by the other technician.

Problem No. 3

This set had raster and sound but no picture. These symptoms strongly indicated that the trouble was probably somewhere after the point of sound take-off.

The first step, as usual, was to recheck the video output tube by substitution. This was no help.

The next step was to trace the signal with the scope and locate the point where the signal was being lost. (Incidentally, we have received numerous letters from our readers, inquiring whether it is advisable to keep the scope turned on all day during working hours or to keep it on only

during the time it is actually being used. It is our opinion that the scope should be on at all times while work is being done. We say this because of the time lost in waiting for the scope to warm up every time it is needed. If it is used as much as it should be, this lost time can amount to hours over a year's period. There is very little wear on a cathode-ray tube if the intensity is not kept too high.)

The scope lead was first placed on the grid of the video output tube in the receiver, and no signal was indicated. This meant that one of two things was causing the difficulty. Either the signal was being grounded by some physical means such as a wire touching the chassis or the coupling capacitor C6 had become open and was thereby preventing the signal from reaching the grid. A resistance check from grid to ground disproved the first possibility. Replacement of C6 then fixed the set so that it was as good as new.

This was another case in which the scope proved to be very helpful. One measurement served to isolate the source of trouble to a very small area in the receiver. It is doubtful that the technician could have achieved a more rapid solution to this problem.

Problem No. 4

The set had sound but no visible raster, yet when it was turned on and allowed to warm up and then turned off, a residual spot appeared. This indicated that there was high voltage present, but it was not conclusive proof that the voltage was sufficiently high to produce a raster. Therefore, the voltage was measured with a high-voltage probe on the voltmeter. The voltage was found to be sufficient.

This knowledge completely eliminated the high-voltage section as a possible source of the trouble. The only remaining possibilities were a bad picture tube or else a condition of beam cutoff due to insufficiently positive grid voltage or excessively positive cathode voltage.

The voltmeter was put to use in measuring the grid and cathode voltages. The grid voltage was normal, but the cathode voltage was much too high. The voltage on the cathode was 185 volts and provided a positive indication that the coupling capacitor C10 was either leaking or shorted. The ohmmeter bore out this theory with a resistance reading of 1,200 ohms across this capacitor.

In this case, the technician noted a symptom which helped him very much toward finding the trouble. He

saw a residual spot when he switched off the set. This led him to make a rapid check of the high voltage, and he eliminated the sweep and high-voltage sections from consideration. A high-voltage check is usually a primary measurement in cases of missing rasters.

Problem No. 5

This proved to be quite an interesting case. The set had a raster but no picture, and the sound was quite distorted.

All the appropriate controls which should have had an effect on the picture were adjusted, but to no avail, until the DX Range Finder (AGC adjustment) located on the rear of the chassis was reached. This caused the picture to show up, but it was very weak and the contrast control had no effect.

Since the range finder caused the picture to appear, it was believed that the trouble must lie somewhere in the AGC circuit. So a new AGC diode (6AL5) was tried in the set, but it failed to help. Just to be on the safe side, a new video output tube was then tried. It too failed to effect a change for the better.

The next step was to check through the circuit. Because the AGC circuit operates with relatively low voltages, it was believed that resistance measurements would be more significant than would voltage readings.

Examination of the circuit showed that a resistance measurement at pin No. 1 (cathode) of the AGC diode should read between zero and 1,000 ohms because of the current path through the contrast control in the cathode circuit of the video output tube, the tap of which is connected to ground. However, such was not the case. Instead, it measured 2,500 ohms regardless of the contrast-control setting. This was a direct indication that the path from the cathode of the diode to ground through the contrast control was broken. This, coupled with the fact that the contrast had no effect on the picture, showed that the trouble was in the control.

Further examination of the control located a cold solder connection at the center lug. This caused the cathode current of the video output tube to travel through the entire control and through part of the range finder.

The technician could have solved this problem more quickly if he had

* * Please turn to page 60 * *



more servicemen prefer

STANCOR

REPLACEMENT TRANSFORMERS

than all other brands combined*

because they like the . . .

- ease of installation
- completeness of the Stancor line
- availability of accurate replacement information
- rugged, breakdown-proof construction
- quick delivery from distributor's stock

Stancor transformers
are listed in Photofact Folders and Counterfacts

Brand Name Surveys, Chicago, Illinois;
brand preference survey of electronic re-
placement components, May, 1954.
Answered by servicemen from all over
the U. S.

FREE NEW STANCOR GENERAL CATALOG
listing over 500 transformers for TV, radio,
high fidelity, communications and other
electronic applications. Available from
your local Stancor distributor or by writ-
ing Standard Division, Chicago Standard
Transformer Corporation.



CHICAGO STANDARD TRANSFORMER CORPORATION

3594 ELSTON AVENUE • CHICAGO 18, ILLINOIS

EXPORT SALES: Roburn Agencies, Inc.
431 Greenwich Street, New York 13, N. Y.



Dollar and Sense Servicing

by *John Markus*

Editor-in-Chief, McGraw-Hill Radio Servicing Library

YOUR FUTURE. During the last war, a surprisingly high percentage of those who contributed to the development of radar, sonar, and all the other electronic developments came from the ranks of radio service technicians. What qualifications made these men capable of doing work more creative and more complex than they had ever done before? As summarized by some of the men who did the hiring, here are some of the qualifications:

1. Aptitude for science — as indicated in youth by eager reading of the popular scientific magazines; in high school by high grades in math, physics, and science; and later, by a desire to pursue scientific subjects further.

2. Ability to analyze — to reason logically when solving a problem or forming a decision. This ability is rarely developed in youth; instead, it is acquired largely through long practice and experience. (Yes, trouble shooting in radio and television develops it beautifully.)

3. Originality — which involves going beyond routine procedures to find new technical methods and easier ways of doing things. Men with strong originality find the challenge to improve things irresistible. Improving a repair when parts are unavailable is one sign of originality.

4. Curiosity — wanting to know why as well as how. Intelligent curiosity has been responsible for the great inventions of the past and will bring us the new things of tomorrow as well. One indication of healthy curiosity in youth is an appetite for reading scientific articles and a natural impulse to take apart any new machine or device to see how and why it works. Asking intelligent questions is another good sign. Still another is interest enough to set up a small laboratory or workbench at home.

5. Openmindedness — which means willingness to listen to new thoughts

without prejudice. This quality is difficult to achieve while young, and it is equally difficult to retain in old age; yet it alone often determines ultimate success or failure in a technical field. Openmindedness must be cultivated, and this is done with more and more effort as one grows older.

The foregoing five qualities, far more than the amount of formal education, have determined the success of service technicians in highly secret military electronic work. Today the formal college degree is back on the list of job requirements for most engineering firms, but there is still a good chance of advancing into engineering work for service technicians who possess at least four of these qualities already and are willing to cultivate the hidden fifth quality in themselves.



VERTICALS. The vertical chassis that surrounds the neck of a TV tube has been in the minds of engineers for several years, chiefly because of its space-saving features. It may even have been on some production lines — we can't rightly remember, and there are now so many PHOTOFACT Folders that it'd take us a day to go through them all — but this year is really the commercial debut of the verticals.

Crosley came out first this year with a 17-inch set selling at about \$140, and it clicked marketwise. Then came Raytheon's Challenger line with a 17-incher starting at \$140 and a 21-incher starting at \$170, both in a vertical chassis design. The Raytheon cabinet is scarcely half an inch wider than the 17-inch picture tube, and controls are on top of the set.

For technicians the verticals are a boon, because tubes all face the

rear and are easily accessible when the back cover is removed. Whether the verticals will mean more trouble and hence more service business remains to be seen.



RADIATION. The RETMA recommendation for halting spurious TV radiation involves building all sets with the 41.25-mc IF stages on which the FCC's entire UHF allocation plan is based and then building the rest of the set so that its radiation limits will keep the commission happy. At 100 feet, these limits range from 50 microvolts per meter below 130 mc to 500 microvolts per meter above 470 mc.

Community TV antenna systems get much stiffer limits under a recent ruling. They must be down to 10 microvolts per meter at 10 feet in order to protect persons living near the cables who prefer to receive free signals directly on their own antennas. Existing systems have until June 30, 1955 to comply. The new rule does not apply to multiple-outlet antenna systems confined to single buildings, such as apartments and hotels.



TALLEST. From the ground to the tip of its channel-8 antenna will be 1,873 feet, if WSLA gets approval of plans for its tower in Selma, Alabama. It'll be a guyed job, tallest structure in the world, and ready late this year if plans go through.

The tallest towers so far authorized are the 1,572-foot job now going up jointly for KWTW on channel 9 and educational KETA on channel 13 in Oklahoma City; and the 1,521-foot runner-up is in Dallas, Texas, for KRLD-TV and WFAA-TV.

* * Please turn to page 44 * *

SUPER-PERFORMANCE

...THAT COSTS NO MORE!

MAKE THE SCREEN TEST!

1. Measure the space between reflector elements of any other big screen antenna.
2. Note that the TRI-KING has closer spacing between reflector elements for improved performance. The TRI-KING's element spacing is the proven maximum for a full $1/10$ wave length.

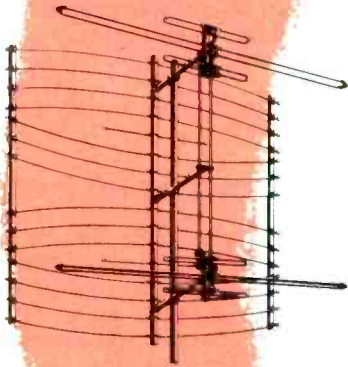

SUPER
TRI-KING
Model
TK1800

WIND TUNNEL TESTED to exacting aircraft standards. Test results prove that a full size TRI-KING antenna can withstand 30% higher wind velocities than any other large screen antenna.

ORDER NOW - IMMEDIATE DELIVERY!

CLEAR BEAM PRICES

Model TRI-KING	List Price
TK1500	\$44.50
Super TK1800	\$52.95

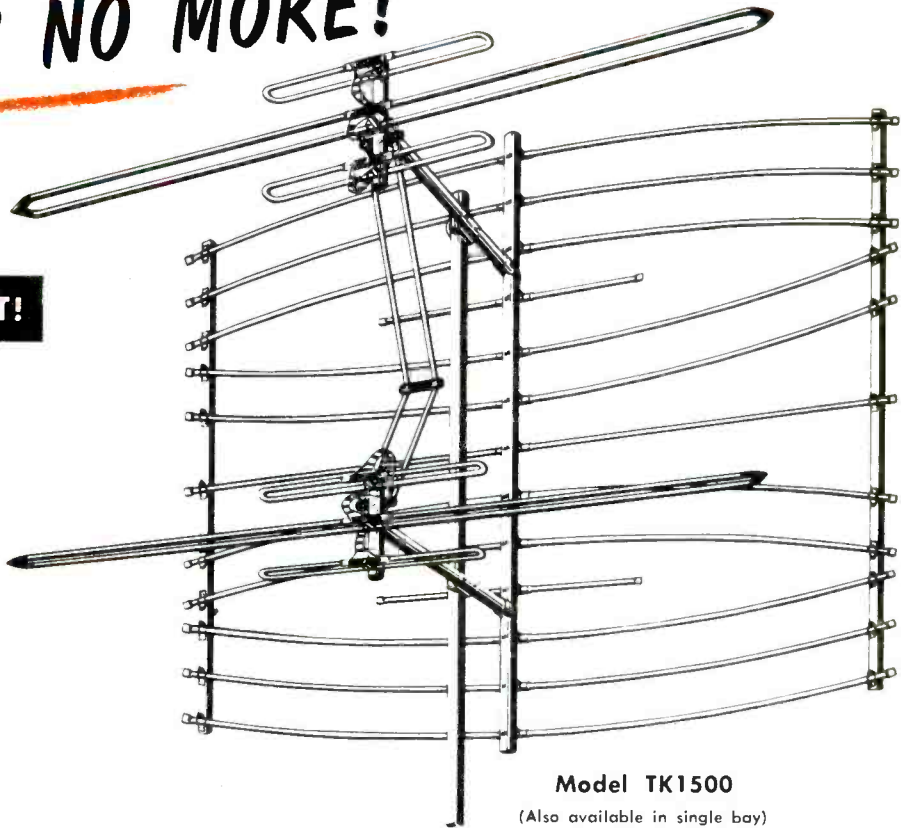

Model TK1500

(Also available in single bay)

CLEAR BEAM'S TRI-KING

Patent Applied For

POSITIVE GHOST REJECTION! Clear Beam proudly announces the new TRI-KING, combining for the first time a Radar-type reflector screen with the improved TRI-KING dipole assembly. A real champion with many Clear Beam features including rugged, quality construction and Quik-Rig assembly that outsells all other big screen antennas. Sold on a money back guarantee.

WRITE FOR COMPLETE INFORMATION TODAY

Clear Beam Antenna Corp.



100 PROSPECT AVENUE • BURBANK, CALIFORNIA
THornwall 2-4886 • Victoria 9-2141

WAREHOUSES IN: San Francisco • Portland • Seattle • Chicago • Kansas City • Detroit • Dallas • Baltimore

TV Colormath

(Continued from page 21)

the levels for the various signals for red at maximum and 50 per cent saturation levels are given in the following:

	VALUES FOR RED Saturation	
	At Max.	At 50%
Signal I	0.60	0.299
Signal Q	0.21	0.106
Signal Y	0.3	0.65
Chroma amplitude	0.632	0.316
Ratio of chrominance to luminance	2.1	0.488

This points up the importance of proper gain adjustments in luminance and chrominance channels of a receiver. If the ratio of luminance channel gain to over-all chrominance gain exceeds normal, hues are washed out. Incorrect gain of an individual color channel will cause contamination of hues.

To illustrate the fact that the chrominance-to-luminance signal

ratio remains constant with only a change in brightness, consider the case shown in Fig. 12D. The only difference between the conditions of transmission for this case and the conditions shown in Fig. 12C is that the brightness level has been reduced. Note that the green, red, and blue voltages are one-half of those shown in Fig. 12C. By following the calculations for the values of I and Q, it can be seen that the values of R - Y, B - Y, I, Q, and Y are also one-half of the corresponding signals in Fig. 12C. Since the chrominance amplitude and the luminance amplitude are both halved, their ratio (.488) remains the same.

Fig. 12E illustrates the ratio of the chrominance-to-luminance amplitude when a green of 50 per cent saturation is being transmitted. The ratio in this case is .38. For maximum saturation, the ratio is .059 or 1. If the brightness level were reduced, the Y signal and the chrominance signal would decrease proportionately. Thus, the chrominance-to-luminance signal ratio remains unchanged. It might be well to point out that in both Fig. 12C and Fig. 12E, conditions were given for hues of 50 per cent saturation; but the ratios of the chrominance signals to the luminance signals were different.

The basic color picture tube of the three-gun variety is shown by Fig. 12F. Each picture element is actually composed of three individual phosphor dots, each emitting its respective primary color under excitation from the associated electron gun. This immediately sets a limit on the practical amount of definition of fine detail for monochrome. Only one picture element and its individual hole in the aperture mask is shown.

The three beams from the electron guns must be fixed in relation to the aperture holes and individual primary phosphor dots. This is initially fixed by the beam-positioning magnets.

The color-purifying coil maintains proper position along the neck of the tube. With adjustment of the coil position and the amount of current, the beam from the red gun falls only on red phosphors, the beam from the green gun only on green phosphors, and the beam from the blue gun only on blue phosphors. This particular adjustment in conjunction with beam-positioning magnets establishes correct center-of-screen color purity. Proper alignment for adequate color purity under deflection of the beams in areas removed from the central screen area is more complex, being a combined function of dynamic convergence and focus.

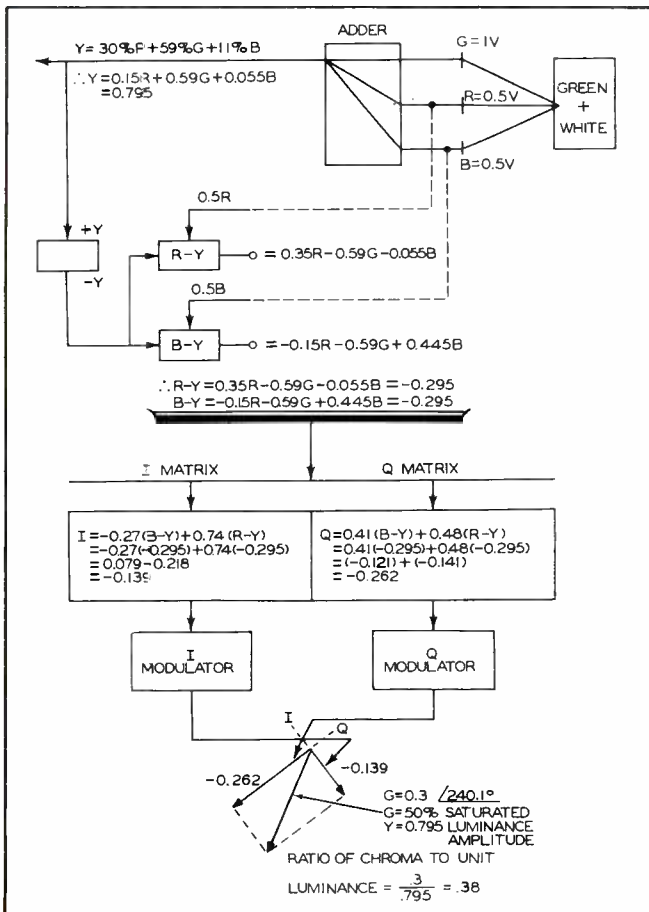

(left)

Fig. 12E. Ratio of Chrominance Signal to Luminance Signal for a Green of 50 Per Cent Saturation.

(below)

Fig. 12F. Fundamentals of a Three-Gun Color Picture Tube Showing Typical Voltages.

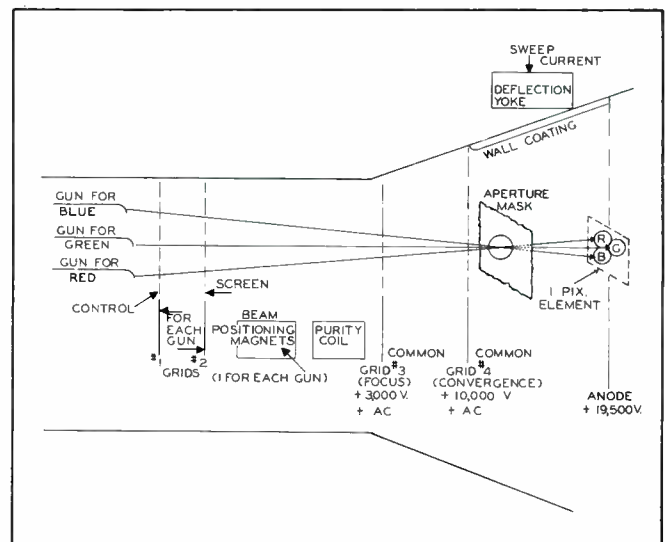

Announcing—

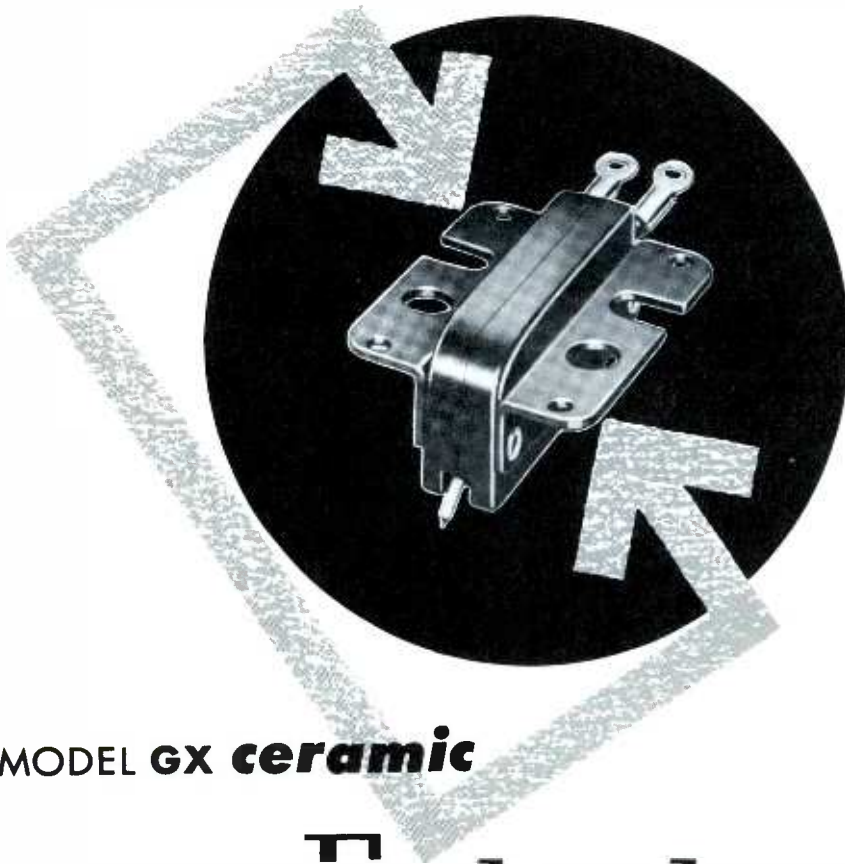

MODEL GX **ceramic**

WEBSTER ELECTRIC
Featheride[®]
 REPLACEMENT CARTRIDGE
 for 33 1/3 and 45 rpm use

• Here is WEBSTER ELECTRIC's answer to the wide demand for a high quality, small-sized, durable **ceramic** replacement cartridge. The new Model GX defies any weather and climate—its ceramic construction enables it to withstand extremes of temperature and humidity.

It is designed especially for fast on-the-spot replacement in any standard RMA 1/2" mounting, such as the Columbia 33 1/3—also in all RCA 45 record players (1/2" to 5/8" mounting).

Stock and sell this new **ceramic** member of the famous Featheride family for added sales and profits. Write today for full information.

WEBSTER  **ELECTRIC**
 RACINE WISCONSIN

"Where Quality is a Responsibility and Fair Dealing an Obligation"
 WEBSTER ELECTRIC COMPANY, RACINE, WISCONSIN - EST. 1909

The typical potential of the high-voltage anode at the time of this writing is a well-regulated 19,500 volts. The inside coating on the tube envelope is electrically connected to this anode as well as to the aperture mask.

The beams must be brought to convergence at the aperture mask. The convergence electrode (grid No. 4) has a potential of approximately 10,000 volts DC. Actually, there are three variables for proper electron-lens action to bring about accurate convergence. Since the potential of the mask is fixed by the anode voltage (19,500 volts in this example), the potential of the convergence electrode is varied to cause beam convergence. Also the potential of the focus electrode (grid No. 3) is varied to influence the field in this area of beam traversal.

To maintain color purity under deflection, grids 3 and 4 also receive AC voltages. This is termed dynamic convergence to distinguish from static DC voltage convergence. Under beam deflection, the distance which the beam travels from the mask to the screen obviously lengthens, resulting in convergence errors. The AC voltages are derived from the horizontal- and vertical-sweep sections, and they are shaped into parabolic waves which correct convergence in synchronization with the swept beams. The six following controls are involved:

- Horizontal dynamic-convergence amplitude.
- Horizontal dynamic-convergence phase.
- Vertical dynamic-convergence amplitude.
- Vertical dynamic-convergence shaping.
- Focus.
- DC convergence.

Grid No. 1 is the control grid, and grid No. 2 is the accelerating electrode. Each gun has individual grids 1 and 2. Potentials in these grids are determined by operating technique, as described in the following.

The individual phosphors comprising a picture element have different luminosity efficiencies. For equal beam currents, light energies produced by the phosphors are approximately as follows:

- Blue 1.0,
- Green 0.7,
- Red 0.3.

DATA ON THE MODEL GX

TYPE • Single-needle ceramic cartridge for 33 1/3 and 45 rpm use

OUTPUT • Develops 0.6 volt at 33 1/3 rpm
 ... 0.8 volt at 45 rpm

TRACKING PRESSURE
 7.0 gr.

CUTOFF FREQUENCY
 10,000 C.P.S.

NET WEIGHT • 5.0 gr.

NEEDLE • Single
 1-mil Osmium

Thus, the blue phosphor has the highest efficiency, green less, and red the least. This calls for one of two general techniques in operating the color picture tube:

1. Equal signal drives and unequal DC supply voltages on grids 1 and 2.

2. Unequal signal drives with approximately equal grid DC supply voltages.

For the first method, the DC supply voltages for grids 1 and 2 for each gun are adjusted so that the currents for the red, green, and blue guns are approximately as follows:

Red-gun current . . . 1.0,

Green-gun current . . . 0.7,

Blue-gun current . . . 0.3.

Note that the opposite ratio is proper for correction of the efficiencies given in the prior list.

In the first method, ratios may not be maintained over the entire amplitude range of signal excursions. The second method seems more precise at the present time. For the technique of the second method, the voltages of grids 1 and 2 are approximately equal for all guns, while the No. 1 grids receive unequal signal drives. It should not be assumed, however, that the exact ratios listed apply in this mode of operation. Because of the curvature characteristic of the voltage current, the following approximate signal-voltage ratios result in optimum color reproduction:

Red-signal volts . . . 1.0,

Green-signal volts . . . 0.8,

Blue-signal volts . . . 0.7.

It is to be expected that characteristics of individual color picture tubes will introduce variables which will influence actual ratios required for optimum performance.

DC Levels

In order that the brightness control and the gain controls of the color channels of a receiver can be properly adjusted the video amplifiers must be linear and the DC levels of the luminance and chrominance signals must be maintained.

For optimum chrominance reproduction, the color system is highly interdependent in action. Signals carrying basic hue information must be maintained in accurate phase

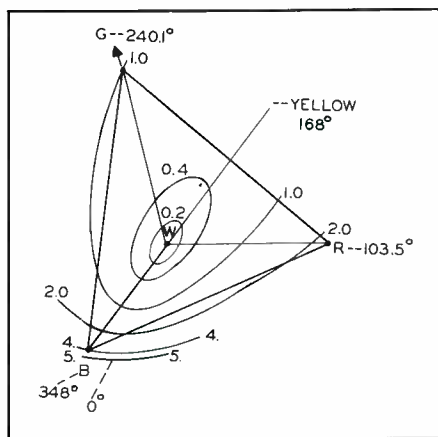

Fig. 13A. Constant Color-Carrier Amplitudes Per Unit Luminance.

relationships through the product demodulators, and they require proper local phasing. Saturation information is contained in the ratio of chrominance-to-luminance, gamma-controlled amplitudes.

Fig. 13A is the familiar color triangle with the phase relationships and saturation information for red, green, blue, and yellow. The ratio of chroma amplitude to unit luminance is indicated by the curved lines for gamma-controlled signals as they are radiated from the transmitter.

For example blue at maximum saturation has an amplitude of 0.447; unit luminance for pure blue is 0.11. Therefore, the ratio of unit luminance to blue is 0.447 to 0.11 or about 4. This is indicated on the diagram of Fig. 13A. Red at maximum saturation has a ratio of 0.632 to 0.3 or about 2.1. We also know that as white is

mixed with red (see the line between R and W in the diagram of Fig. 13A), this ratio changes in accordance with the degree of white mixture and with the gamma correction of the signals in order to compensate for different phosphor characteristics.

Assume for the moment that only the luminance channel used a DC restorer circuit at the picture tube. Then as the primaries at the triangle points are moved in on their respective axes toward white (less saturation), the ratios of signal amplitudes would depart from system requirements. Obviously each primary-color channel as well as the luminance channel must resort to DC restoration to maintain an adequate function in signal ratios.

Fig. 13B illustrates the need for DC restoration. In Fig. 13B, section 1, is shown the transfer of a video signal through conventional RC-coupled stages. Since signal transfer occurs only about the DC or average-signal axis, the blanking level will change between light and dark picture content and the background brightness will change from line to line without regard to the scene being reproduced. The blanking level of lines containing dark information may not reach kinescope cutoff. As a result, retrace lines appear on the screen. Fig. 13B, section 2, illustrates proper DC restorer action with which the reader should be familiar.

Let us see what happens in color systems if DC restorer function is disabled. In Fig. 13B, section 3, are illustrated the cases of red at minimum and maximum saturation.

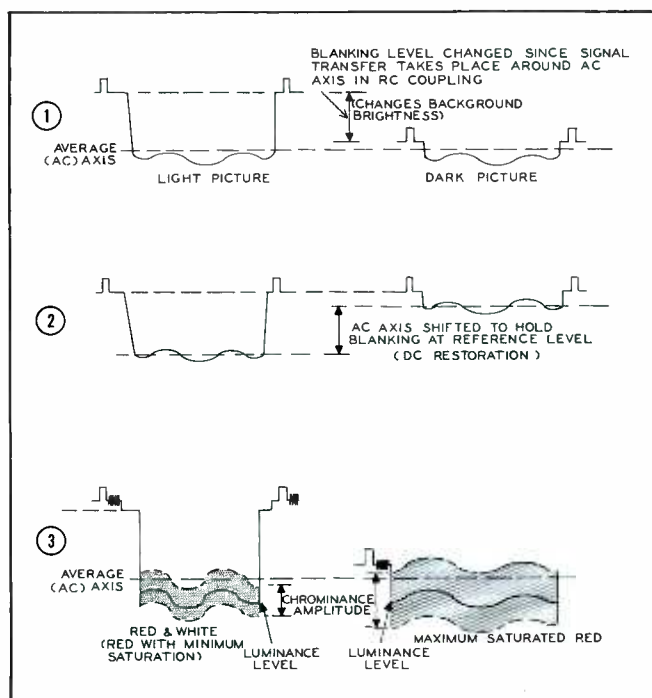

Fig. 13B. Illustrating the Effects of Improper DC Restoration.

If you own Jackson Test Equipment

*You're all set
for Color*

Jackson "Service-Engineering" has always meant designing with the future in mind. And compatible color proves the point. For, if you bought Jackson TV test equipment within the past few years, you'll find it's now as good for color as for black-and-white.



Jackson CRO-2 Wide Band Oscilloscope

Flat within 1 db to 4.5 mc. Ideal for displaying 3.58 mc color burst signals. New Low Capacity probe available has only 2 to 1 attenuation ratio, not more than 8 mmf effective input capacitance.

Jackson TVG-2 Television Signal Generator

Complete sweep and marker generator with separate crystal calibrator. Sweep width adjustable from 0 thru 18 mc. Sweep frequencies for IF or color video alignment. Built-in oscilloscope timing.



Jackson 707 Dynamic[®] CRT Analyzer

The CRT analyzer that completely and accurately tests *all* TV picture tubes, magnetic or electrostatic, black-and-white or color. Provides complete tests for shorts, beam current, grid condition and gas.



Jackson 648 Dynamic[®] Tube Tester

Features Sequence Switching for Super-speed set-up and tests. Saves valuable minutes in checking TV sets. Dynamic test method gives accurate, under-load test conditions. Life-line indicator, many other features.



New! Jackson Color-Bar/White Dot Generator

If your shop is Jackson-equipped, here's the *only* new instrument you'll need for color. Provides single color bars, or multi-bar pattern, as well as white dots for convergence checks. For use with present 3-gun color tubes or any new development using NTSC standards.

*"Service Engineered"
Test Equipment*



16-18 South Patterson Blvd., Dayton 2, Ohio—In Canada: The Canadian Marconi Company

Red at maximum saturation has a vector sum of 0.632 for chroma and of 0.3 for luminance; whereas, the illustrative example (Fig. 12C) of red plus white resulted in a chroma of 0.316 and a luminance of 0.65. In section 3 of Fig. 13B, the amplitudes of the signals (except for the blanking pedestals) appear to be almost the same. This malfunction results from the failure of the DC restorer circuits. Although some conventional monochrome receivers have been designed without DC restoration, such design would be disastrous for color receivers.

At the transmission end, each color channel in the gamma-correction preamplifiers is DC controlled in relation to the entire scene. Thus, the level is initially set at a point where both luminance and chrominance components are present. It is then only necessary, since Y is inserted at the matrix section, that each grid of the color picture tube in I-Q receivers should be DC restored. In receivers employing the color-difference system of detection, the Y channel is DC restored separately from the three color-difference channels.

In practice, when the DC restorers are properly adjusted, TV reference white will occur on the raster during the transmission of a white signal. If a signal which ought to reproduce white should be tinged with some predominant hue, that particular DC restorer needs readjusting, other factors being normal.

As mentioned previously, passage of the color sync burst through the bandpass amplifier is capable of influencing DC restorer action. The reason for this is that the restorer potential is apt to be affected by presence of the burst. This is particularly true for the blue grid, because the luminance signal for blue is often very close to the blanking level. Remember that the DC restorer usually refers to sync tip level. Since the color-burst pulses extend into both video and sync regions, the blue restorer would be set up so that it averages the sync in the Y channel and the color-sync envelope. The same is true in general for the red and green restorers.

Harold E. Ennis

Audio Facts

(Continued from page 25)

of the designer, constructor, and user. There are many types and varieties of conventional divider networks. One classification is the constant-resistance type, another is the filter type. Either type may be series or parallel connected and may have quarter, half, or full sections. All types are designed to match the impedance of the loudspeakers with which they will be operated. This means that compromises must be made, because the impedance of a loudspeaker varies with the frequency and with the enclosure in which it is installed. Because of this, there will be an impedance match only over a comparatively small band of frequencies.

It is rather general practice to design and produce amplifiers with low output impedances and good damping factors in order that the bad effects due to the unstable electrical load presented to a loudspeaker at varying frequencies will be minimized. When a divider network is inserted in the circuit between the amplifier output and the loudspeakers, the desired damping is largely lost. Instability and a "muddy" sound result.

In loudspeaker systems, the tweeters and midrange units are usually much more efficient than the woofers. Therefore, variable resistors (potentiometers or pads) are normally inserted in a divider network to attenuate the signal fed to the high-frequency unit or units to balance the sound output. If the amplifier

must be operated at a high level to drive the woofer, it is possible that a high percentage of distortion will be developed and will be found especially noticeable at the higher frequencies. The variable resistors will present some loss in the circuits at all times. This loss can be detrimental when added to the insertion loss of some divider networks.

Incidentally, this serves to illustrate the importance of a matched system where everything works just right together; and it also tends to explain why certain outfits produce such satisfactory sound.

Why Use the Electronic Unit?

When the electronic divider unit is connected into a sound system, as shown in Fig. 3, some definite conveniences and advantages are realized.

When frequency division is accomplished ahead of the amplifier, the output transformer is connected directly to the appropriate loudspeaker. No network is present in the output circuit to disturb the loudspeaker damping action of the amplifier or to present insertion loss.

The proper impedance tap on the output transformer can be used to match the impedance of the loudspeaker. This allows any combination of loudspeakers with widely varying impedances to be used in the system. With the conventional network, the impedances of the loudspeakers cannot differ more than a ratio of two to one if any kind of predictable results are to be obtained.

Being able to use loudspeakers of widely varying impedances is a worth-while advantage; but the ease with which the sound output can be balanced without undesirable effects, when an inefficient loudspeaker is paired with a very efficient one, is also to be appreciated.

No doubt there is a lot to be said in favor of the manner in which one amplifier handles only the low frequencies and the other handles only the high frequencies to reduce distortion.

In most cases when working with a good loudspeaker system, a low crossover frequency not higher than 800 cps is used. The advantages to be gained by connecting the electronic divider network ahead of the amplifier are more apparent in the range of frequencies from 800 cps down.

At the higher crossover frequencies such as 4,000 cps, which is that recommended for many ultra-high-frequency tweeters, the undesirable effects of a conventional divider network are not so apparent. Therefore, it is convenient to make use of a high-frequency divider network in a multiple loudspeaker system, as shown in Fig. 3.

The story of the way in which a piece of equipment produces such excellent results can be very impressive, but the real test for a unit such as this is how the system sounds in actual operation. Tests proved that there is no problem in obtaining good, clean, balanced sound output when using the electronic divider unit with

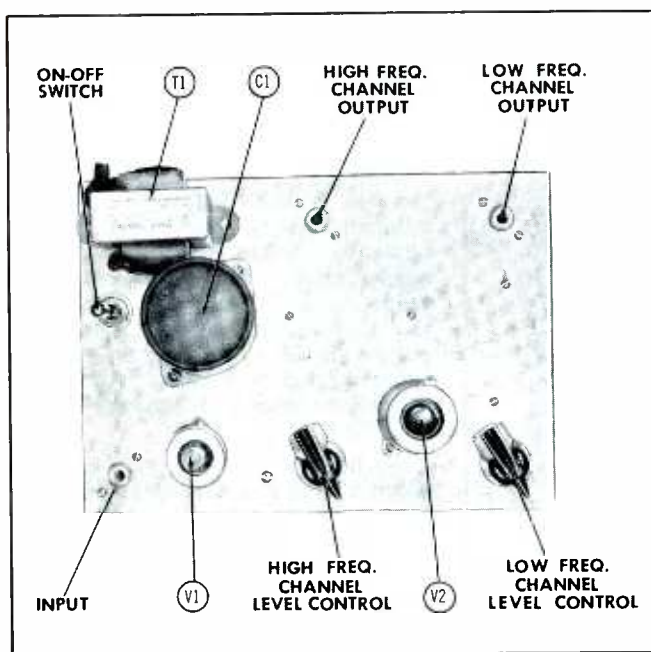

Fig. 1. Top View of the Electronic Crossover Network.

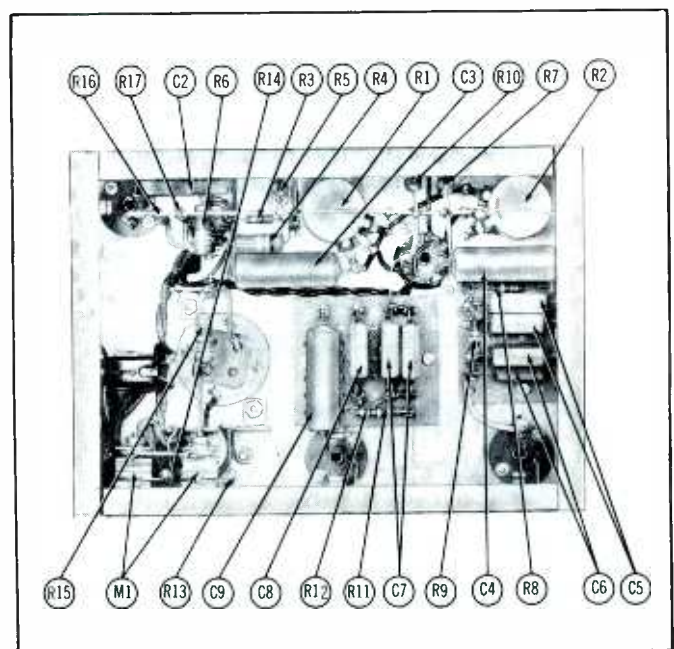
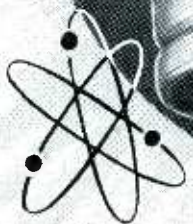

Fig. 2. Bottom View of the Electronic Crossover Network.

ATR

INTRODUCES



The World's Finest
Communication
VIBRATORS

featuring:

- CERAMIC STACK SPACERS
- 1/4" DIAMETER POWER CONTACTS
- DRIVER-TYPE COIL CONSTRUCTION
- SPECIAL REED HINGE and WIRING
- POWER CAPABILITY UP TO 15 AMPERES

A COMPLETE LINE OF REPLACEMENT

ATR VIBRATORS

FOR AUTOMOTIVE, HOUSEHOLD and TWO-WAY COMMUNICATION SETS

ATR VIBRATORS are proven units of the highest quality, engineered to perfection. They are backed by more than 23 years of vibrator design and research, development and manufacturing.
 ATR pioneered in the vibrator field.



FREE - Just off the Press!
 1954 ATR VIBRATOR
 MASTER MANUAL

See your jobber or write factory today for complete information

ATR

AMERICAN TELEVISION & RADIO Co.
Quality Products Since 1931
 SAINT PAUL 1, MINNESOTA - U. S. A.



loudspeakers of widely varying impedances and efficiencies and with good amplifiers of high and low power output. This flexibility of operation resulting in excellent sound reproduction can be appreciated by any one who has tried to design, construct, or select a conventional divider network for use with certain combinations of loudspeakers and a single amplifier.

It is easy to recognize why the electronic divider unit has been found so convenient and useful for experimenting and making tests.

Design of Unit

The first requirement when designing the electronic divider unit was that there had to be high-pass and low-pass networks with which to separate the signal into a high-frequency channel and a low-frequency channel. Among other design problems which had to be considered was that the input and output characteristics should permit the unit to be connected properly into the system. It was also thought best to design the unit so that it would compensate for losses due to filters and not allow the unit to present an insertion loss to the system.

To put some gain into the unit to eliminate insertion loss required the use of tubes which in turn call for a power supply. Such pieces of equipment are much more convenient to use if they are self-powered, consequently a small power supply was included in the circuit. The complete unit was then constructed on a chassis which measured 5 inches by 7 inches by 2 inches and which was considered small enough to make it a practical and worth-while piece of equipment.

Circuit and Construction

The schematic in Fig. 4 and the photographs show the final form of the unit. Most of its features are very evident in the illustrations, for it is basically simple in both design and construction. We will give an explanation and description of some of the main points without getting involved to the extent that would be required for a thorough discussion of such matters as filter networks.

Starting at the input, we find capacitor C2 which is included for DC isolation. A divider network composed of R3, R4, and R5 is provided so that the grid of the high-mu triode V1 will not be overloaded by a comparatively large signal. A high-mu triode (6AV6) was used because tests revealed that, at the plate voltage available, a 6C4 or 6AB4 developed a

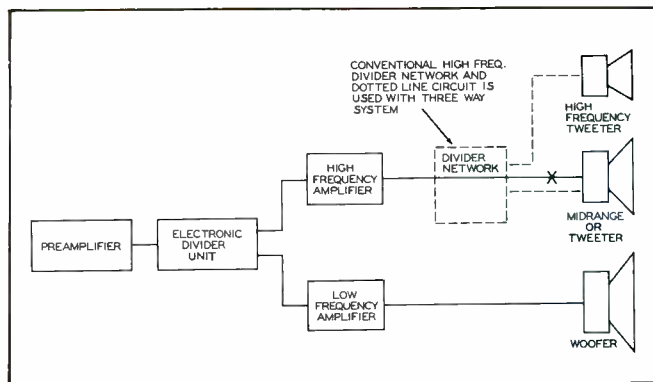

Fig. 3. Block Diagram of a System Using the Electronic Crossover Network.

prohibitive amount of distortion. The low- μ tubes also drew enough plate current to reduce the voltage applied to the plate. The 6AV6 operates very satisfactorily and with a low percentage of distortion. A pentode was not considered for this application because the extra circuit components involved did not fit in with the desire to keep the circuit simple and the power supply small in size as well as low in voltage and current output.

The two sections of tube V2 (which is a 12AU7) operate as cathode followers and permit the use, with no detrimental loading effects, of the level controls R1 and R2 in parallel. This has been found to be a very satisfactory location for the level controls.

By means of the low-pass filter network in one cathode-follower output and the high-pass network in the other cathode circuit, good isolation of the two channels is achieved as well as satisfactory loading effects on the networks. The value selected for cathode resistors R7 and R10 was found to give best operation. The desire for simplicity also influenced the design of the filter networks. A crossover frequency of 600 cps was selected because it is so commonly used, although any suitable frequency can be used. The important thing is that the crossover from one loudspeaker to the other should occur smoothly. Each filter network should attenuate on the same curve so that the output to one loudspeaker is going down at the same rate that the output to the other loudspeaker is coming up. Such operation results in a level output with no disagreeable peaks or dips.

It might be well to mention that when working with filter networks such as these, the crossover frequency is considered to be the frequency at which the reactance of the capacitor is equal to the value of the resistor employed. The correct values of capacitance and resistance for any desired frequency can be calculated or found by use of the tables and charts in most all handbooks and textbooks.

In an effort to limit the size and the inductive effects of the capacitors that were used in the filters, micas were used. If capacitors with lower values (which would call for an increase in the values of the resistors) are inserted in the filters, results are not so satisfactory as when larger sizes are used.

Low-Pass Filter

C4 in the low-frequency channel serves as a DC-blocking capacitor, and R8 and R9 with C5 and C6 make up the low-pass filter. Note that in order to obtain a satisfactory slope in attenuation, R8 was selected with one-half the value of R9 and C5 with twice the value of C6. Standard values of capacitance and resistance are shown, and critical tests revealed that they produced the desired curve.

For critical work, the resistors and capacitors should be selected very carefully for the crossover frequency to be used. This should be done not because the exact crossover frequency is so important but because the same curves should be followed by each section in order to obtain the smooth crossover in response mentioned previously.

High-Pass Filter

In the high-frequency channel, C7 and C8 with R11 and R12 form the high-pass circuit; and C9 is a DC-blocking capacitor. Note that in this filter, the same ratio of capacitance and resistance is maintained as in the low-pass filter and for the same reason.

Standard values of capacitance and resistance were also selected for the high-pass filter, with the same satisfactory results as were obtained in the low-pass filter. The same care and precautions are to be taken when making up a high-pass filter as those mentioned concerning low-pass networks.

The high- and low-frequency channels were designed to operate properly when connected to the normal high-impedance input of the usual amplifier.

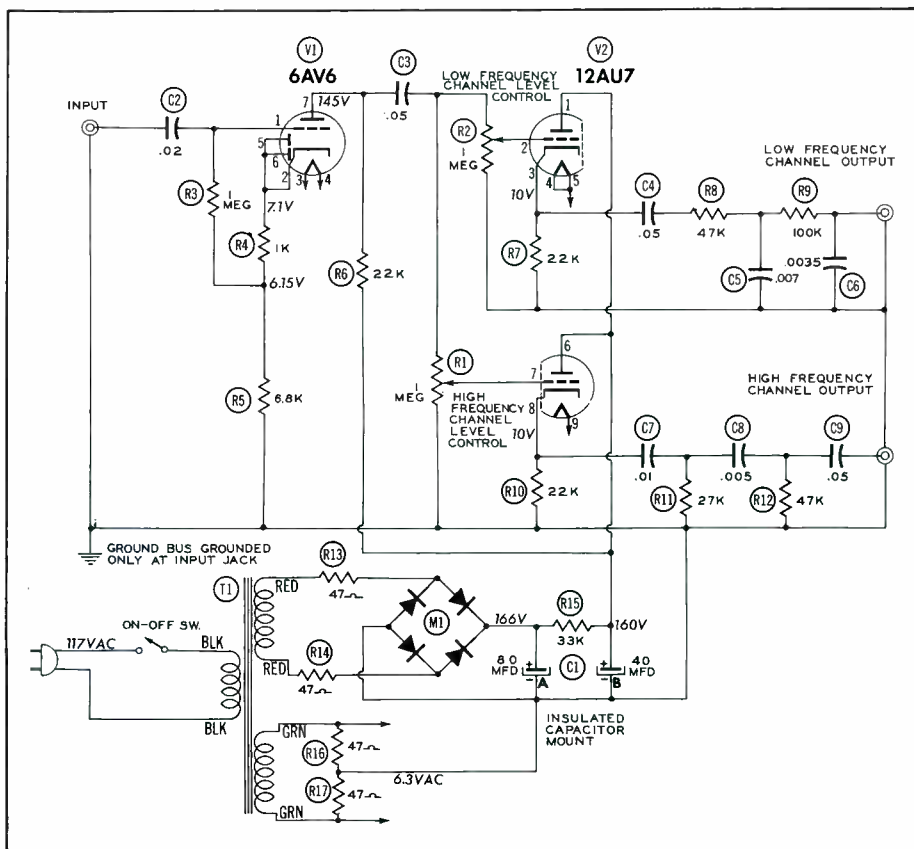

Fig. 4. Schematic of the Electronic Crossover Network.

Diamond Stylus Sales Increased 400% last year* Are you getting your share?

"High fidelity phonographs, once limited to an exclusive fraternity of enthusiasts, are close becoming standard home appliances. One indication is the sky-rocketing sales of diamond needles. One company reports a 400% jump for part of 1953."

POPULAR SCIENCE

* Figures released by the General Electric Company

Every one of your customers has been impressed by feature editorials in such leading periodicals as Fortune, Life, Saturday Review, New York Times, Esquire, Popular Mechanics, High Fidelity, Popular Science, House & Garden, Good House-keeping, and Time—editorials which have stressed the "must" value of a diamond stylus for the ultimate in hi-fi performance. These are pre-sold customers who are "naturals" for your sales pitch.

To cash in on these potential sales, contact the leading nationally advertised brand manufacturers. Ask for their dealer selling aids—envelope stuffers, counter display cards, etc.—all designed to make sales for you. Most important, though, is for you to point out to your customers

that they may be ruining their valued record collection with a worn out phonograph needle.

Be sure to get your share of the huge profits being made in this field by other service organizations such as Haynes-Griffin, New York; Lyon & Healy, Chicago; Paul Schmitt, Minneapolis; Sherman Clay, San Francisco; Ernstrom's, Dallas; J. G. Bradburn, Houston; Disc Shop, Washington, D.C.; Thearle's, Los Angeles; who are actively promoting the sales of diamond styli.

Don't wait any longer. 1954 will definitely see an even greater sales increase. Take advantage of this "big ticket" profit market—take advantage of all the pre-selling which has been done on the part of the nation's leading authorities.

TETRAD

62 St. Mary Street, Yonkers 2, New York

World's Largest Producer of Diamond Styli

Supplier to Manufacturers

Faster, Easier, more PROFITABLE

Get into the MASTER habit!

Brings you the product data of the industry in one handy book—all products vital to your daily sales and service operations. In the customer's home, across the counter or on the bench, you'll value the MASTER'S thoroughly complete descriptions, specs, illustrations and prices—all systematically organized in 18 big sections. Over 1300 pages of unabridged catalog data direct from the manufacturers. Keeps you abreast of all latest electronic products. Increase your sales and speed-up your buying—the MASTER way.

As **\$1.95** at your parts distributor. Publisher's price **\$6.50**.

Get your MASTER now from leading parts distributors or write to:

United Catalog Publishers, Inc., 110 Lafayette St., N. Y. 13



Eliminates Small Catalogs and Loose Literature

Operation

OFFICIAL BUYING GUIDE OF ELECTRONICS-TV RADIO INDUSTRY

• 1370 pages
• 8" x 11" - 3 lbs.
• Over 8,000 illus.

Just a few of the more than 85,000 items included:

Tubes—Transmitters
Test Equip.—Receivers
Transformers
Capacitors—Antennas
Resistors—Wire & Cable
Coils & Relays
Recording & PA
Hardware & Tools

Each filter network was assembled on a terminal board and mounted in the chassis, as shown in Fig. 2. These terminal boards made up of Alden parts are not absolutely necessary but were very convenient during the design and construction of the unit.

Visible in Fig. 2 are the .005-mfd and .002-mfd mica capacitors which are connected in parallel to make the .007-mfd capacitor C5. The .003-mfd and .0005-mfd capacitors that form C6 and the two .005-mfd capacitors used as C7 can also be seen. Most any reasonable value of capacitance can be made up in this manner.

Power Supply

The power-supply section had to be small in physical size; therefore, a small power transformer with two secondaries, one furnishing 125 volts AC at 15 milliamperes DC and the other furnishing 6.3 volts AC at 0.6 amperes AC, was selected. The Stancor PS8415 and the Halldorson P9100 power transformers conform to these specifications.

The selenium bridge rectifier is rather elaborate for a small supply such as this one, but it proved to be the correct choice for this application. The easy-to-filter, full-wave output provides 160 volts DC at the output of the simple filter during operation. This is practically twice the DC voltage that would be obtained with the usual half-wave rectifier used with this power transformer.

C1 is an electrolytic capacitor designed particularly for use with selenium rectifiers. With the 33K-ohm filter resistor R15 and the full-wave bridge rectifier, this capacitor C1 provides well-filtered high voltage (high for an application such as this).

Heater leads are twisted and grounded through resistors R16 and R17 to the ground bus which is grounded to the chassis only at the input jack. No hum which could be attributed to this unit has ever been detected in the sound output.

The general construction can be seen in the illustrations, although the polystyrene insulators which are under the output jacks to insulate them from the chassis may not be apparent.

See facing page for complete parts list.

ROBERT B. DUNHAM

PARTS LIST

TUBES

V1	6AV6
V2	12AU7

POWER TRANSFORMER

Primary	Secondary 1	Secondary 2	Manufacturer
T1	117V AC 15ma DC	125V AC @ 6.3V AC @ 0.6 Amp AC	Stancor Halldorson P9100 PS8415

CAPACITORS

Cap.	Volt.	Aerovox	Cornell-Dubilier	Mallory	Sprague
C1A	80.		XB012		TVL-2582
C1B	40.		XB012		TVL-2582
C2	.02	P688-02	CUB6S2	PT612	6TM-S2
C3	.05	P688-05	CUB6S5	PT615	6TM-S5
C4	.05	P688-05	CUB6S5	PT615	6TM-S5
C5	.007	1467-502	1W5D5	MC465	1FM-25
		1467-202	1W5D2	MC457	1FM-22
C6	.0035	1467-302	1W5D3	MC461	1FM-23
		1468-501	5W5T5	MC245	1FM-35
C7	.01	1467-502	1W5D5	MC465	1FM-25
		1467-502	1W5D5	MC465	1FM-25
C8	.005	1467-502	1W5D5	MC465	1FM-25
C9	.05	P688-05	CUB6S5	PT615	6TM-S5

CONTROLS

Resistance	Watts	IRC	Clarostat	Centralab	Mallory
R1	1Meg	Q11-137	A47-1Meg-S	B-69	U-54
			KSS-3		
R2	1Meg	Q11-137	A47-1Meg-S	B-69	U-54
			KSS-3		

RESISTORS

Resistance	Watts	IRC
R3	1Meg	BTS-1Meg
R4	1000Ω	BTA-1000
R5	6800Ω	BTA-6800
R6	22KΩ	BTA-22K
R7	22KΩ	BTA-22K
R8	47KΩ	BTS-47K
R9	100KΩ	BTS-100K
R10	22KΩ	BTA-22K
R11	27KΩ	BTS-27K
R12	47KΩ	BTS-47K
R13	47Ω	BW-1/2-47
R14	47Ω	BW-1/2-47
R15	33KΩ	BTA-33K
R16	47Ω	BW-1/2-47
R17	47Ω	BW-1/2-47

SELENIUM RECTIFIER

	Seletron	Federal	Mallory	Sarkes Tarzian	International
M1	(2) 16Y1 or (4) 8Y1	(4) 1159	(4) 8S20	(4) 35	(4) CR20

MISCELLANEOUS

1	Chassis 5in. x 7in. x 2in.
1	7-pin miniature tube socket with shield
1	9-pin noval tube socket with shield
3	Phono jacks
1	Toggle switch
1	AC line cord
	Miscellaneous hardware

Antenna Principles

(Continued from page 15)

are parallel to one another and have their currents in phase. The spacing between the elements is usually a half wavelength.

This array obtains its name because maximum response is broadside to a plane containing the elements.

Fig. 9 shows a two-element broadside antenna and also indicates two possible methods of feeding the

system. A high-impedance feed point is shown in Fig. 9A. An alternate system utilizing a low-impedance point is indicated in Fig. 9B. A high-impedance point occurs at a point where the voltage is maximum; a low-impedance feed point occurs where the current is maximum.

The response patterns for a broadside antenna are shown in Fig. 10. It may be seen from these patterns that the antenna is bidirectional. Fig. 10A indicates how the array may be made more directive by the addition of elements. The directivity

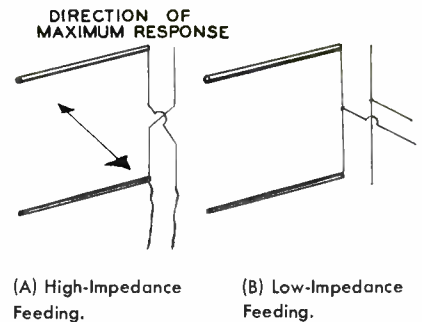
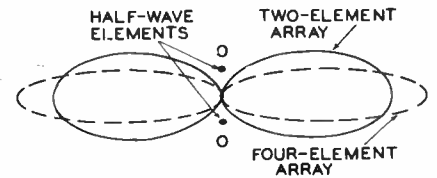

Fig. 9. A Broadside Antenna Showing Two Methods of Connecting Transmission Lines.

within the plane illustrated in Fig. 10B is virtually unaffected by an increase in elements. An increase in gain also occurs when elements are added.

If the elements are mounted parallel to the earth, the antenna is



(A) In a Plane Perpendicular to the Elements.

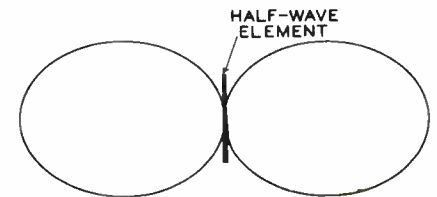

(B) In a Horizontal Plane Containing One of the Elements.

Fig. 10. Response Patterns of a Broadside Antenna.

horizontally polarized. This is the desirable arrangement for television reception. With this type of mounting, the most directive pattern is in the vertical plane which is illustrated in Fig. 10A.

End-Fire Arrays

By combining half-wave elements parallel to one another and

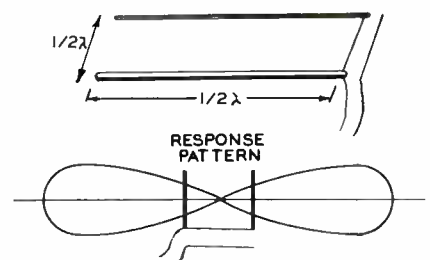

Fig. 11. An End-Fire Antenna With Elements Spaced a Half Wavelength Apart.

YOU CAN WIN A NEW FORD!

Nothing to Buy! Nothing to Sell! Nothing to Rhyme!

Just Illustrate and Explain a New Application for International Rectifier Corporation Selenium Diodes

GRAND PRIZE



—50 PRIZES—

2nd Prize: \$500.00 U.S. Savings Bond
3rd Prize: \$250.00 U.S. Savings Bond
4th Prize: \$100.00 U.S. Savings Bond
5th Prize: \$50.00 U.S. Savings Bond
6th Prize: \$25.00 U.S. Savings Bond
7th to 50th Prizes: \$10.00 Selenium Diode Kit

INTERNATIONAL RECTIFIER CORPORATION'S Selenium Diode Contest is Open to Everyone! Here's all you have to

do to enter—pick up an official entry blank from your favorite parts distributor (there's nothing to buy), then exercising your own ingenuity, illustrate and explain a new practical application for International Rectifier Selenium Diodes. Have the entry blank countersigned by your distributor's salesman and then forward it to us before January 1, 1955. Rules and regulations for this contest are included in the entry blank along with helpful hints on selenium diode applications. The prizes are well worth a little effort, so start developing your application TODAY.

JUDGES—Dr. Lee de Forest—United Engineering Labs., Los Angeles, California
J. T. Cataldo, F. W. Parish—International Rectifier Corp.

APPLICATION

EXPLANATION

Typical application for providing fixed bias for push-pull stage of an audio system using International Rectifier Corp. Selenium Diode in conjunction with a voltage divider and filter network, etc.

DON'T DELAY! ENTRY BLANKS ARE AVAILABLE FROM YOUR PARTS DISTRIBUTOR!

CONTEST ENDS JANUARY 1ST, 1955

INTERNATIONAL RECTIFIER CORPORATION, EL SEGUNDO, CALIFORNIA

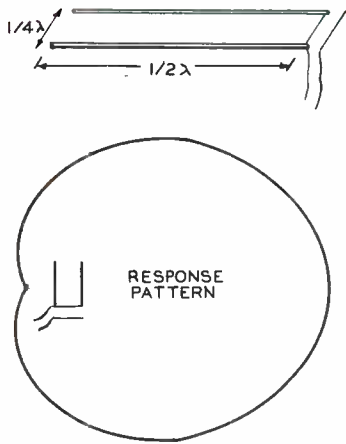

Fig. 12. An End-Fire Antenna With Elements Spaced a Quarter Wavelength Apart.

feeding them out of phase, it is possible to obtain maximum response in a line passing through the elements and perpendicular to them. This is the condition which exists with the end-fire antenna.

Fig. 11 shows a simplified version of one type of end-fire array. The spacing between elements in this case is a half wavelength, and the elements are fed 180 degrees out of phase. The response pattern, which is also shown in Fig. 11, indicates that this array is bidirectional.

An end-fire antenna with quarter-wavelength spacing between elements is pictured in Fig. 12. In this arrangement the currents in the elements are 90 degrees out of phase. The lagging current is in the element directly connected to the transmission line, and therefore the response pattern assumes unidirectionality, as indicated by the large arrow in the figure.

This type of antenna has a high Q which makes the bandwidth very narrow. Although a narrow bandwidth is not always desirable in television antennas, the end-fire antenna does have a relatively high gain.

Lazy-H Antennas

The Lazy-H antenna is a combination of two collinear arrays that

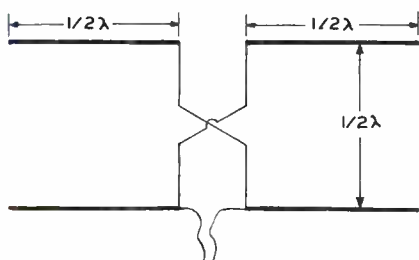

Fig. 13. A Lazy-H Antenna.

are phased to obtain broadside response. Although the Lazy-H is not a fundamental antenna, it is an application of the phased systems used in some commercial antennas.

The term "Lazy-H" is derived from the physical appearance of the antenna which looks like a reclining H. This is quite apparent by referring to the illustration in Fig. 13. This figure also shows one of the possible feed points. The one indicated is a high-impedance point offering a termination from 400 to 600 ohms. A

300-ohm line may be used to feed the system with some degree of mismatch. A more efficient method is possible with the addition of a stub to provide a better impedance match.

The Lazy-H is bidirectional and therefore is usually combined with a reflector to provide unidirectional characteristics.

DON R. HOWE

THANK YOU, Mr. Serviceman for naming



your preferred brand!

In a recent nationwide survey*, radio and TV servicemen were asked this question: "What brand of replacement speakers do you prefer? Why?" QUAM was first in number on mentions—almost 30% more than the next most preferred brand.

* Conducted by Brand Name Surveys of Chicago, Illinois, May 1954.

WHY?

here are some typical comments about QUAM speakers by these servicemen

- "Adjust-a-Cone feature-ruggedness"
- "Complete range of sizes and types"
- "Stand up best in service"
- "Include hardware for easier installation"
- "Good construction"
- "Listed in Sams' Photofacts"
- "Heavier magnets"
- "Good quality at a reasonable price"
- "Always satisfactory"

ask for **QUAM** the quality line, for **ALL** your speaker needs

QUAM-NICHOLS COMPANY

234 EAST MARQUETTE ROAD • CHICAGO 37, ILLINOIS

Wait'll you see what

Centralab

has
up its
sleeve!



It's the most important
development in years
in
dual concentric
controls!

Watch for early

Centralab

announcement
in this magazine

Dollar and Sense Servicing

(Continued from page 31)

TELEPHONES. The conversation of children is often interesting to grownups. A Brownie Scout who lives in a home having servants and extension telephones was visiting our little Brownie and wanted to call home for the chauffeur. Much to her disgust, she heard people talking when she picked up the phone and said scornfully to Elaine, "You got a party line." When pressed for the meaning of that, she willingly explained, "It's when people are talking and they're not in your family." Wish we could define some of those new color TV terms that easily.



OVERSEAS. In England, one TV firm reports that about 30 per cent of its customers' sets have not needed service for three years. Either they make sets better over there or people watch programs less; it could be a bit of both.



VACATIONS. Among the self-employed, such as independent service technicians, the temptation is to live right up to current monthly income. Then, when vacation time comes along, there's nothing in the kitty to take care of two weeks' living expenses or of the extras involved in a going-away vacation. Having a boss who pays for those vacation days then looks rather attractive.

But there's no need to sacrifice the advantages of being your own boss if you set up the summertime equivalent of a Christmas Savings Club. Just estimate your yearly income, divide by 26 to get a two-week average (assuming you want two weeks' vacation), and divide this result by 50 to find out how much you should put away each week in a separate vacation savings account. This will allow you to take a trip or to loaf at home for two weeks, which is oftentimes a lot more restful than going somewhere.

Let's say, for example, that income is \$5,200 a year. For two weeks, then, it's \$200; and dividing by 50 gives only \$4 a week to put away for vacation. Looking at it another way, that's the difference between being boss and being bossed.

SERVICE TECHNICIANS:

FOR YOUR SHOP!

THE COMPLETE

PHOTOFACT SERVICE DATA LIBRARY

(world's best TV-Radio service data)

in this one handy
file cabinet

YOURS FOR ONLY

\$25 DOWN
NO CARRYING
CHARGES

1. If you now own some Sets of PHOTOFACT Folders, you can COMPLETE your present library this EASY-PAY-WAY
2. If you've never used PHOTOFACT, you've never realized your full earning power. Put this file cabinet with its 220 Sets of PHOTOFACT Folders to work... starting right NOW!

YES, ONLY \$25 DOWN PUTS
THE COMPLETE PHOTOFACT
LIBRARY IN YOUR SHOP...

COVERS OVER 17,000
TV, RADIO, RECORD
CHANGER, RECORDER
AND AMPLIFIER
MODELS

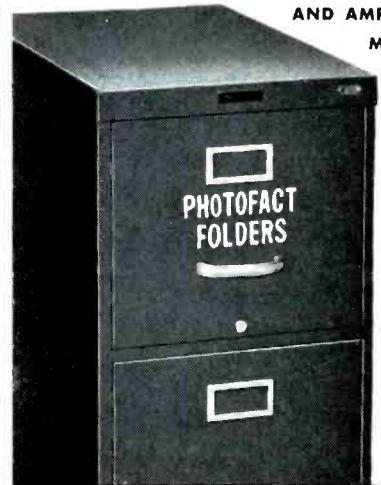

SEE YOUR PARTS DISTRIBUTOR
TODAY FOR FULL DETAILS

HOWARD W. SAMS & CO., INC.
INDIANAPOLIS 5, INDIANA

TV FRONTIERS. For those who've got the urge to move someplace yet would like to stay in TV sales and service, a recent survey indicates 14 major market areas where fewer than 10 per cent of the households had TVs as of January 1st of this year. The figures come from the fourth annual report by the J. Walter Thompson Company concerning TV households in the United States. Worth noting is the fact that four out of the fourteen are in a highly popular retirement state — Florida. All are in counties with one or more cities having 25,000 to 50,000 population. For each, the percentage of homes having TV is indicated:

Alexandria, Va.	7.5%
Eugene, Ore.	8.0%
Great Falls, Mont.	4.9%
Greenville, Miss.	6.7%
Hot Springs, Ark.	5.3%
Key West, Fla.	2.6%
Lakeland, Fla.	7.9%
Laredo, Texas	3.3%
Paducah, Ky.	8.0%
Panama City, Fla.	8.9%
Rapid City, S. D.	0.7%
Tallahassee, Fla.	8.5%
Wausau, Wis.	7.9%
Wilmington, N. C.	7.4%

Any decision based upon these figures should take into account such factors as income level, percentage of homes having electric power, availability of good network television programs, and the number of TV shops already in the area.

Although low percentages mean good opportunities for TV sales, they mean the opposite for service business. Areas approaching TV saturation would offer the most service business per thousand of population, but this would naturally have to be divided among the shops in the area. Here are the market areas in which more than 85 per cent of the homes have TV:

Akron, Ohio	87.5%
Albany-Troy-Schenectady, N. Y.	89.0%
Allentown-Bethlehem-Easton, Pa.	89.6%
Anderson, Ind.	86.2%
Baltimore, Md.	86.5%
Binghamton, N. Y.	88.2%
Bridgeport, Conn.	90.0%
Buffalo, N. Y.	89.0%
Chicago, Ill.	85.3%
Cincinnati, Ohio	89.9%
Cleveland, Ohio	89.8%
Columbus, Ohio	90.0%
Davenport, Iowa; Rock Island and Moline, Ill.	90.0%
Dayton, Ohio	88.2%
Erie, Pa.	90.0%
Hamilton-Middletown, Ohio	90.0%
Indianapolis, Ind.	90.0%
Johnstown, Pa.	86.0%

Kokomo, Ind.	85.2%
Long Branch, N. J.	90.0%
Milwaukee, Wis.	89.5%
New Haven-Waterbury, Conn.	90.0%
Omaha, Nebr.	85.0%
Philadelphia, Pa.	90.0%
Reading, Pa.	90.0%
Rochester, N. Y.	90.0%
Salt Lake City, Utah	87.1%
Springfield, Ohio	85.6%
Syracuse, N. Y.	90.0%
Trenton, N. J.	90.0%
Wilmington, Del.	90.0%
Worcester, Mas.	85.2%
York, Pa.	90.0%

Thus has TV taken hold across the nation to become the center of attraction in some 27,000,000 homes each evening. (This averages out as 57 per cent of the 47,500,000 homes in the United States.) In less than ten years TV has achieved this dominant position, for better or for worse. It makes us wonder — what would happen to our new way of living if all the TV service technicians in the country went on strike for a year?



RIBBONS. Out in the rural areas of Oregon, a blue ribbon waving in the breeze atop a TV antenna means the installation was made by a leading dealer in Medford. The ribbon is the insignia of a Blue Ribbon Service Contract. When one of the dealer's service technicians goes past on the way to another call, he'll stop for a courtesy visit to make sure the set is working properly. The unique technique cuts down costs, in terms of time and gas, of giving prompt service to outlying areas. Customers let little troubles go, knowing there'll be a routine call soon, and call the dealer only when real trouble occurs.



SIZES. According to TV Digest, about 80 per cent of the TV sets produced today use 21-inch picture tubes. One in ten of these is a combination, and the rest are divided 50-50 between consoles and table models.

Philco production to May of this year was all 21-inch; almost 90 per cent of RCA's production was 21-inch, the rest were bigger.

One out of ten RCA sets currently coming off the line is a 24-inch console. These figures foreshadow possible increased output generally of these super-big-screen sets.

TRAFFIC -LIGHTER. Now available for ambulances and other emergency vehicles is a radio remote-control system that automatically sets traffic signal lights to green just far enough ahead of the vehicle to permit maximum speed. Developed by engineers at North American Aviation, the system involves placing on each traffic light a small receiver. This feeds a relay that is connected to change the lights to red for cross traffic when actuated by a signal from a small transmitter in the moving emergency vehicle. The lights stay at red until five seconds after that crossing has been cleared. The signal then goes back to its regular timer-controlled operation. Tests are being made to evaluate the effectiveness of the system in relation to its cost.



CHECKS. When a stranger asks you to accept a check in payment for a profitable sale or service job, here's a way to find out quickly whether the check is good! Reach under the counter for a camera — any kind — and ask permission to snap his picture. Very, very few passers of bad checks will risk this, since the police could send the picture all over the country if the check proved to be bad.

Supermarket chains in Houston, Texas are using this technique to combat a wave of bad-check passers — and it works. One firm down there, Photect, Inc., has actually built up a camera-leasing business on the fact that almost any body likes to have his picture taken except a criminal during his working hours.



PARADOX. Small firms specializing in complex electronic measurement and control equipment for research and industrial applications are often desperately seeking competent service organizations throughout the country for keeping their equipment in good working order. At the same time, topnotch TV servicing organizations are seeking exactly that type of work to smooth out the dips in TV service business. Why the two can't get together on some satisfactory financial basis is a question we'll be probing throughout the summer, for the benefit of all concerned.

JOHN MARKUS

536K Multimeter Kit \$12.90
Wired \$14.90
1000 ohms/volt



425K 5" Scope
Kit \$44.95
Wired \$79.95

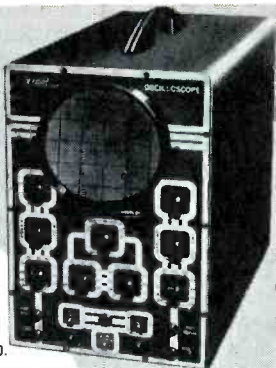

470K 7" Push-Pull Scope
KIT \$79.95. WIRED \$129.50.

YOU BUILD

EICO

**KITS
IN ONE
EVENING-**

**but they
last a lifetime...
and you
save 50%**

**38 Kits and 42 Instruments —
the Industry's most complete
line of MATCHED
TEST INSTRUMENTS**

¼-million EICO Instruments are now in use the world over! That's the proof of EICO's leadership in Value.

For latest precision engineering, finest components, smart professional appearance, lifetime performance and rock-bottom economy — see and compare the EICO line at your Jobber before you buy any higher-priced equipment! You'll agree with over 100,000 others that only EICO Kits and Instruments give you the industry's greatest values at lowest cost.

Prices 5% higher on West Coast.



221K VTVM Kit \$25.95
Wired \$39.95



565K Multimeter Kit \$24.95
Wired \$29.95
20,000 ohms/volt



377K Sine & Square Wave Audio Gen. Kit \$31.95. Wired \$49.95

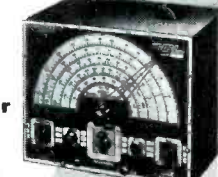

360K Sweep Gen. Kit \$34.95. Wired \$49.95



1050K Battery Elim. Kit \$29.95. Wired \$38.95

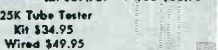

625K Tube Tester Kit \$34.95
Wired \$49.95

Write NOW for FREE latest Catalog PF-8

EICO
Laboratory Precision at lowest cost

©1954

ELECTRONIC INSTRUMENT CO., Inc.
84 Withers Street, Brooklyn 11, N. Y.

Horizontal AFC Circuits

(Continued from page 23)

fully in the negative direction, the grid voltage goes below cutoff, and the plate current ceases. These two modes of operation constitute one oscillatory cycle and are continually repeated.

The modifications made to the circuit of Fig. 8-19, in order to arrive at the oscillator in the schematic of Fig. 8-18, are numerous. First, the triode vacuum tube has been replaced by the pentode. In this circuit, the screen grid of the pentode is utilized as the plate of the oscillator; and the output signal is taken from the plate of the pentode. In this way, the oscillator is isolated so that any changes in the output loading cannot affect the oscillator frequency. This is called an electron-coupled oscillator, since the only coupling between the oscillator and the output is by means of the electron stream within the tube.

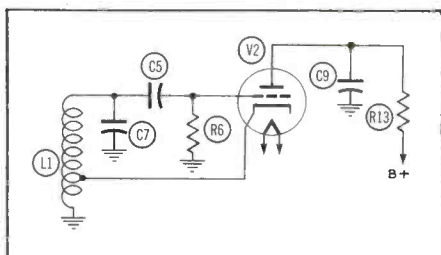

Fig. 8-19. Hartley Oscillator Circuit.

The free-running frequency of an oscillator of this type can be varied by changing the cutoff level of the grid. This can be done by changing the bias applied to the grid. Since the grid bias is developed by the discharge of capacitor C5 through resistor R6, a change of value of either component can alter the frequency. A variable resistor is more feasible than a variable capacitor; so R7 has been added as a frequency control. In a television receiver, this control would be labeled as the "Horizontal Hold Control."

An additional method of altering the oscillator frequency is to change the resonant frequency of the combination of coil L1 and capacitor C7. The capacitance of C7 could be varied or the inductance of L1 could be changed by adding an inductance in parallel. This latter method is used in the oscillator circuit chosen for illustration.

Since the plate current in the tube varies from cutoff to saturation, the plate-voltage waveform or output signal will not be a true reproduction of the sine wave which is applied to

RCA GOLD LABEL SPEAKERS

Make any set
"Talk-Up"

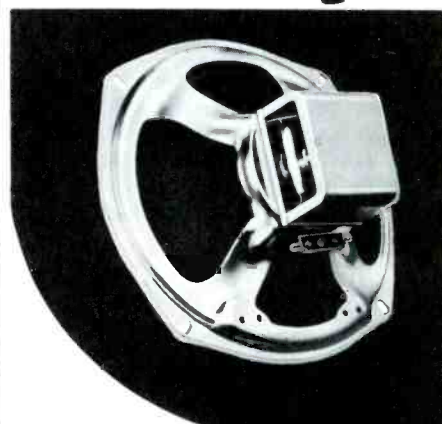

These Speakers talk for themselves, and for you, in every installation. They tell every customer of RCA quality—and build additional, profitable business for you in every home.

Continuous 100% testing and inspection assures you of speakers that have superior performance characteristics. That's why it's good business to use them exclusively in your replacement work. A complete line of every requirement—all smartly packaged to dress up your shelves.

- Alnico V Magnets
- High Sensitivity
- Welded Housing Assembly
- Moisture-Resistant Cones
- Dust-sealed
- Rugged Construction
- Mounting brackets supplied with certain sizes

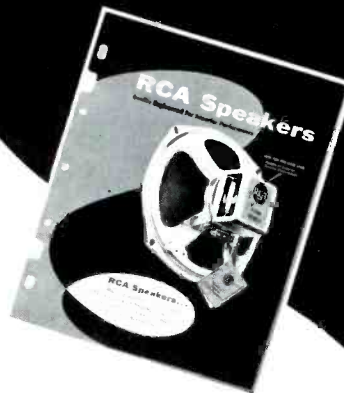

Ask your RCA Distributor for your copy of the new RCA Speaker Catalogue (3F687). Contains all essential mechanical and electrical specifications on 22 PM and Field-Coil Types.



**RADIO CORPORATION
of AMERICA**

ELECTRONIC COMPONENTS HARRISON, N. J.

the grid. The photographs in Fig. 8-20 show the waveforms in the oscillator circuit. Waveform W5 is the grid voltage and shows the sine wave which is developed across the tuned circuit. Waveform W6 is the cathode voltage and is also a sine wave. Waveform W7 is the plate voltage and shows that the sine wave is distorted or flattened during plate-current cutoff. This flat portion is essential in developing the pulses needed to drive the discharge tube.

The distorted sine wave is applied to a differentiating circuit composed of capacitor C10 and resistor R15. The output across the resistor is shown as waveform W8 in Fig. 8-21. The positive pulses in this waveform are due to the charging of capacitor C10 during the rapid positive-going portion of W7. The negative portion of W8 is formed by the remainder of the sine wave in W7. This waveform is applied to the grid of the horizontal-discharge tube, V3 in Fig. 8-18.

The discharge-tube circuit is grid-leak biased by the input signal. Plate current will flow only during the time that the positive peaks of waveform W8 are present on the grid. Point 1 on waveform W8 indicates the point at which plate current starts to flow. Capacitor C12 in the plate

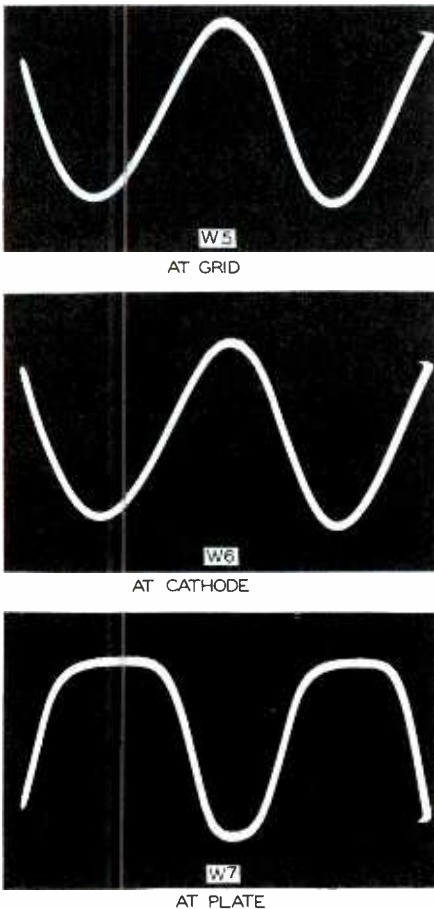

Fig. 8-20. Waveforms Observed in the Hartley Oscillator Circuit.

circuit of V3 is discharged when plate current flows and charges when the tube is cut off. The saw-tooth waveform, W9 in Fig. 8-21, is developed by the charge and discharge of this capacitor.

Reactance Tube

The plate-to-cathode circuit of a reactance tube can be made to appear as either a capacitive or inductive reactance by applying the proper voltages to the tube. The amount of reactance can be varied by changing the voltage applied to one electrode; this is the method used to control the oscillator in this AFC system. In Fig. 8-22, we have a tube connected so that the input signal is applied to the cathode. In a conventional amplifier, the signal component of the plate voltage is 180 degrees out of phase with the signal which is applied to the grid. Since the application of the signal to the cathode results in a 180-degree reversal of the operation of the circuit, the plate voltage is in phase with the signal when it is applied to the cathode. If the coupling capacitor to the cathode is made small in value, its reactance to the oscillator signal will be high in comparison to the 10-ohm cathode resistor. The circuit reactance will be predominantly capacitive; and because of the characteristics of a capacitive reactance, the signal voltage at the cathode will lead the applied voltage by approximately 90 degrees. Keeping in mind that the plate voltage is in phase with the signal applied to the cathode and that the applied signal leads the source voltage by 90 degrees, it can be seen that the plate voltage leads the source voltage by 90 degrees. Since the voltage developed at the plate leads the current by 90 degrees, the tube appears as an inductive reactance. This voltage is coupled to L1 by C7.

The waveform W11, shown in Fig. 8-23, is the voltage on the cathode of the reactance tube. By comparing this waveform with waveform W5, which was shown previously, one can see that W11 is approximately 90 degrees ahead of W5. Waveform W10 is the plate-voltage waveform and is basically the same as W5 because of the action of C7.

The amount of alternating current that flows in an inductor is a function of the amount of inductive reactance; therefore, if the current through the reactance tube is varied, the amount of reactance presented by the tube is also varied. This is best done by varying the bias on the grid. The amount of control exerted on the oscillator by the reactance tube must be determined by the difference in

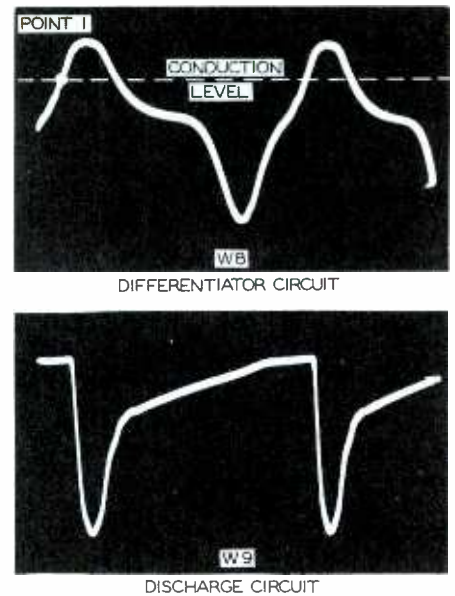

Fig. 8-21. Waveforms in the Differentiator and Discharge Circuits.

frequency and phase between the oscillator signal and the received sync pulses. The controlling action of the reactance tube is regulated by applying to the grid a DC voltage which is produced by a discriminator stage. This voltage is proportional to the difference between the oscillator signal and the sync pulses.

Discriminator

The discriminator, which is V1 on the schematic of Fig. 8-18, uses a double diode connected in a circuit similar to a standard FM discriminator. There are two signals applied to each plate, a sine wave from the oscillator and a sync-pulse signal. The sine-wave voltage is extracted from the oscillator circuit by means of coil L2 which is inductively coupled to the oscillator tank coil L1. The sine-wave voltage at one diode plate will be 180 degrees out of phase with the voltage at the other diode plate, but the two will have equal amplitudes. The applied sine-wave voltages will cause current to flow in each diode. The current of diode 1 will develop a voltage across its associated load resistor R1, and the current of diode 2 will develop a voltage across its load resistor R2. The currents will

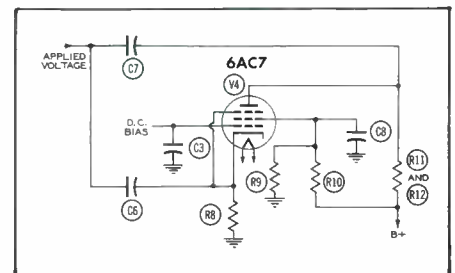

Fig. 8-22. Basic Reactance-Tube Circuit.

be equal because the applied voltages are equal, and the developed voltages across the load resistors will also be equal. The developed voltages will be opposite in polarity because of the connection of the diodes; and since the load resistors are connected in series, the output voltage from the discriminator will be zero.

The sync pulses are applied to the discriminator by means of a center tap on coil L2. In this way, a single sync-pulse source supplies the two diodes with sync pulses of equal amplitude. If the action of the sync pulses alone is considered, the output voltage of the discriminator will again be zero because the currents through the diodes will be equal.

When the sync pulses and the sine-wave voltage are applied simultaneously, the polarities of the two will add or subtract, depending upon the phase relationships between them. If the two have the same frequency and phase, the sync pulses will occur at the time that the sine wave is passing through its AC axis. The diodes will conduct equally, and no output voltage will be produced by the discriminator.

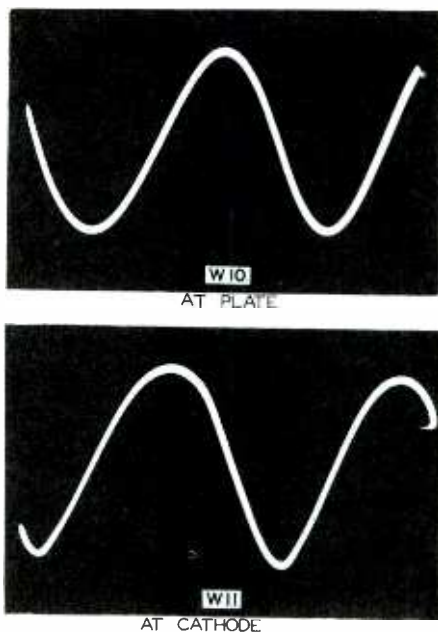

Fig. 8-23. Waveforms Observed in the Rectance-Tube Circuit.

When the sine wave and the sync pulses differ in frequency or phase, an unbalance will exist in the discriminator. The sync pulses no longer occur at the time of zero voltage but will ride up or down the curve, thus changing the effective voltage on each

plate. Each plate will have a positive or a negative voltage, depending upon the direction of the difference between the sync pulses and the oscillator signal; but the two plates will always have opposite sine-wave voltages because of the 180-degree phase difference between them. The two signals will add on one plate and subtract on the other. One diode will have a higher applied voltage, it will conduct more current, and it will produce a greater control voltage across its load resistor. The other diode will conduct less and will produce a smaller voltage output. When the two control voltages are added, the remaining voltage will have the polarity produced by the diode that is conducting the most current. The output voltage will thus have a polarity that is required to return the oscillator to the proper operating point.

Let us consider the circuit conditions when the oscillator is running slow in comparison to the sync pulses. Under this condition, the sync pulses will occur before the sine wave reaches the AC axis. On the plate of diode 1 of Fig. 8-18, the sync pulses will appear when the sine-wave voltage is positive, and the two voltages will add. On the plate of diode 2, the sync pulses will appear when the sine-wave

In this day and age with almost everyone shouting that his product is best, we would like to say . . . quietly and confidently . . .



just try
**AEROVOX
CAPACITORS**

FOR OVER
30
YEARS

EBY

MODEL
8-88



- SOCKETS (JAN APP)
- SHIELDS (JAN APP)
- BATTERY PLUGS
- BINDING POSTS
- PLUGS AND CONNECTORS
- RACK & PANEL CONNECTORS
- FUSE HOLDERS
- FUSE BLOCKS
- SUBMINIATURE SOCKETS
- TRANSISTOR SOCKETS
- UHF SOCKETS
- PRINTED CIRCUIT SOCKETS
- TURRET SOCKETS
- CRT SOCKETS
- HIGH VOLTAGE SOCKETS
- TELO CONTACT CLEANER
- TV HARNESSSES
- TV ANTENNA ACCESSORIES

OCTAL TEST ADAPTER

Simplify service measurements with this new octal test adapter. For use with any octal tube. Contact lugs are long enough to accommodate alligator clips. List \$1.75

All EBY Products are fully stocked in New York for immediate delivery.

WRITE FOR CATALOG P

EBY SALES CO. OF N Y
130 LAFAYETTE STREET
NEW YORK 13, N. Y.

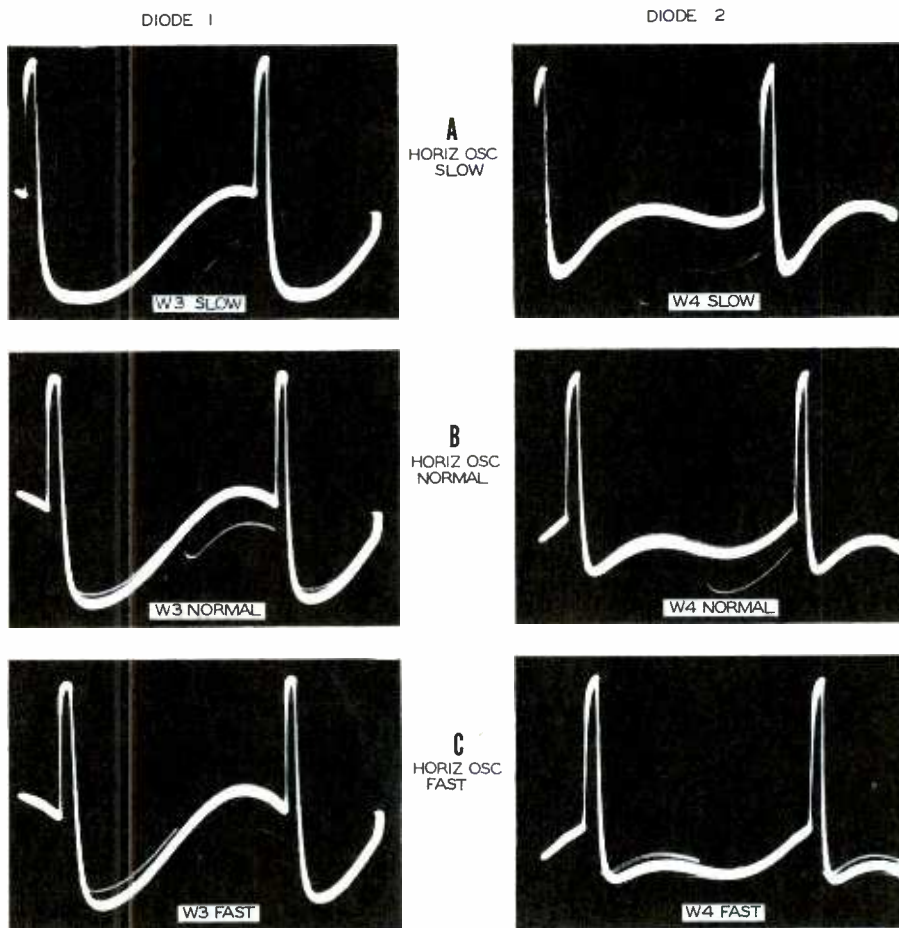

Fig. 8-24. Waveforms in the Discriminator Circuit.

voltage is negative, and the two voltages will subtract. Diode 1 will have more applied voltage and will conduct more than diode 2; the output voltage from the discriminator will be positive.

If the oscillator were running fast instead of slow, the sync pulse would occur after the sine wave had passed through the AC axis. The two voltages would then subtract on the plate of diode 1 and add on the plate of diode 2. Diode 2 would have the most applied voltage, it would conduct more than diode 1, and the output voltage would be negative.

The photographs in Fig. 8-24 show the waveforms at the two diode plates for the three possible conditions of phase or frequency difference. In part A, the oscillator is running slower than normal and the sync pulses are displaced to the left in comparison to the sine wave. The polarities of the two voltages add across diode 1 and subtract across diode 2. Diode 1 thus has more applied voltage than diode 2, and the output from the discriminator will be positive.

Part B of the same figure shows the conditions when the oscillator is at the correct frequency and phase. The sync pulses appear at the AC axis

of the sine wave, the diode currents are equal, and no output voltage is produced.

The photographs in part C show that the sync pulses are displaced to the right, which means that the oscillator is running fast. Diode 2 has more applied voltage and will conduct more current than diode 1; the developed output voltage will be negative.

The output voltage from the discriminator is applied to the control grid of the reactance tube. This voltage is placed in series with a bias voltage which sets the operating point for the reactance tube in order to assure approximately linear operation. In other words, equal increments of change in the control voltage will produce correspondingly equal changes in the oscillator frequency. The control voltage is filtered before it is applied to the reactance-tube grid so that noise interference cannot affect the oscillator frequency. Capacitors C2 and C3 make up a voltage divider and filter in which the noise pulses are attenuated by the high reactance of C2 so that they cannot charge C3. The sync pulses of longer duration are capable of charging C3 despite the presence of C2, and it is this charge which is

applied to the grid of the reactance tube.

Some of the earlier receivers which used this type of AFC system had an adjustable link on the rear of the chassis. The wiring of this link is shown in dotted lines on the schematic of Fig. 8-18. Position 1 of the link provided for normal operation of the circuit. Position connected capacitor C14 in parallel with C2 to provide a correction for any variation of the sync-pulse phasing. Such variations were common faults of the earlier transmitters. With the link in position 2, the AFC circuit is extremely susceptible to noise interference; and a compromise is always necessary when determining the proper position of the link for an individual receiver.

One important feature of this AFC circuit remains to be explained. This is the adjustment of the core of L2 to insure that the deflection cycle in the receiver is in phase with that in the transmitter. If this requirement is not met, the horizontal-blanking bar will appear in the picture. Retrace in the receiver should start each time a sync pulse appears.

Waveform W9 in Fig. 8-21 is the driving voltage to the horizontal-output stage. Retrace begins at the positive peak of this waveform. By comparing one waveform to another while proceeding backwards through the circuit, we can determine that retrace time begins when waveforms W3 and W4 are going through the AC axis. We are assuming that the oscillator is operating correctly.

Waveforms W3 and W4 are derived from the oscillator by means of coils L1 and L2. These two coils constitute a loosely coupled, tuned circuit. If they were tuned to the same frequency, there would be a 90-degree phase shift between primary and secondary; and the sync pulses would appear on the diode plates at the peaks of the sine waves instead of at the zero points. The discriminator would produce an output voltage even though the frequency and phase of the oscillator were already correct. Thus, the phase of the oscillator would be held at an incorrect point, and the blanking bar would appear in the picture.

By detuning the secondary L2, the 90-degree phase shift across the transformer can be eliminated, and the sync pulses will appear at the zero-voltage axis of the sine wave. This is the condition required for correct operation of the AFC system.

WILLIAM E. BURKE

3 SHURE CRYSTAL PICKUP CARTRIDGES replace the 192

cartridges you are most likely to encounter in your service work!



Lowest investment for broadest coverage! The RK-54 is beyond all doubt the *most practical* Replacement Kit on the market! Proof? Simply this—you get the broadest coverage at the lowest investment—only \$22.55 list! Think of it—3 Crystal Cartridges replace 192 of those specific Cartridges most likely to be in need of replacement! Two of the Cartridges consistently have been “best sellers” in the Shure line—as established by actual sales to Servicemen! The Cartridges are: Model W22AB, 3-Speed, 2-Needle Cartridge—Model W26B, All-Purpose, Single-Needle Cartridge—Model W78, 78 RPM, Dual-Volt, Dual-Weight Cartridge. Model W78 is the new, versatile Cartridge that replaces 149 other Cartridges. This Cartridge alone will become a sensation overnight! Order a Replacement Kit from your Distributor today—once you have worked with this practical kit you will find that these three Cartridges are dependable replacements—will make your service work faster, easier and more profitable!



TRANSPARENT PLASTIC BOX IS FREE!

This Handy Box is 5" long, 3½" wide, 1¼" deep.



The Mark of Quality

Notes on Test Equipment

(Continued from page 13)

will be indicated by ellipses with major axes which coincide with the straight line at 180 degrees. Phase differences between zero and 90 degrees and between 270 and 360 degrees will be indicated by ellipses with major axes which coincide with the straight line at zero degrees. Precisely at 90 degrees and at 270 degrees, the scope indications will be circles.

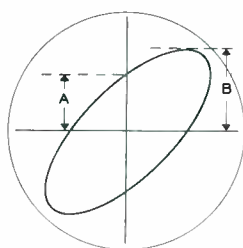

Fig. 3. Method of Calculating Phase Relationship From a Lissajous Figure.

The foregoing paragraphs have shown by graphical plotting how a known phase difference will appear on a scope. Normally, the opposite situation will be true; the technician will have a waveform of unknown phase relationship on the scope and will wish to determine the phase difference represented. This difference can be calculated in the manner illustrated by Fig. 3. The scope positioning controls should be adjusted so that with zero voltage applied to the horizontal and vertical-deflection plates, the spot is centered on the calibration screen of the scope. Then both signal voltages are applied and measurements A and B of Fig. 3 are noted. If the phase angle represented is considered to be θ , then the sine of θ can be found from the following formula:

$$\sin \theta = \frac{A}{B} \quad (1)$$

This value for sine θ can then be located in a trigonometric table and the phase angle θ determined from the table. The ratio of A to B will not be changed even though the horizontal and vertical signal voltages are of different amplitude and even though the deflection ratios are not equal. A point that must be considered, however, is the number of stages in the horizontal and vertical amplifiers of the scope, if the signal is not applied directly to the deflection plates. An odd number of stages in one amplifier and an even number of stages in the other will cause an apparent change of phase of 180 degrees from the true phase indication which should be obtained on the scope.



Centralab Snap-Tite* Replacement Controls

Speed servicing of “hidden” or rear-end TV volume controls



Two fingers are all you need to install a Snap-Tite. Just push it into the chassis mounting hole — it snaps into place.

You need no tools — no nuts, lock-washers, or other hardware.



Six spring clips grip panel for positive, non-twisting mounting.

Shaft is molded, high strength polystyrene, fingertip knurled and slotted for screw-driver adjustment. Extends ½" from face of mounting surface.



Snap-Tite replaces any “short-shaft” standard control — and, at 45¢ net, costs you about 35¢ less!

You have less stock to carry — ten values replace 75% of current rear-end TV controls.

Order a supply of Centralab Snap-Tite Replacement Controls today from your Centralab distributor.

Send coupon for new Centralab Catalog No. 29 describing this and other new Centralab developments.

*Trademark

For full details on this and other new Centralab developments, write for free copy of new Centralab Catalog No. 29 to CENTRALAB,

A Division of Globe-Union Inc.
986G E. Keefe Avenue
Milwaukee 1, Wisconsin

Centralab

When making phase measurements, it is important to remember this point in order to avoid false indications.

Intensity Modulation

Many scopes have provisions for applying a signal to some portion of the intensity-controlling circuit of the scope. In this manner, the beam intensity can be varied by a means other than the steady type of intensity control provided by an adjustment on the front panel. This provision enables the operator to blank or intensify certain portions of the scope trace, depending upon the nature of the modulating signal.

One application of intensity modulation is in marking a scope trace at regular intervals so that the speed of the trace or the interval between points can be measured.

When making frequency measurements through the use of Lissajous patterns, the simpler ratios such as 2 to 1, 3 to 1, or 2 to 3 are easily interpreted. When the ratio is much higher than these (for example 20 to 1), it is difficult to determine the exact ratio by the method commonly used. By applying one signal in a manner that will obtain a circular trace and using the other signal to modulate the intensity, the trace can be marked at regular intervals and the ratio of the two signals can be determined. A simple phase-shifting network for producing a circular sweep is shown in Fig. 4. The voltage across the capacitor has a 90-degree phase difference from that across the resistor; and when the reactance of the capacitor is equal to the resistance of the resistor, the two voltages will be equal. For a resistance of 5,000 ohms, the following formula can be used to obtain a capacitive reactance which is also 5,000 ohms.

$$C = \frac{31.8}{f} \quad (2)$$

where

C is in microfarads,

f is in cycles per second.

Driven Sweep

Some oscilloscopes have a provision which enables the input signal to initiate the horizontal-sweep action. The strongest negative or positive pulse in the input signal acts as the trigger. With the function switch set in the triggered-sweep or driven-sweep position, the sweep circuit in this type of scope begins a horizontal-sweep cycle the instant that a strong

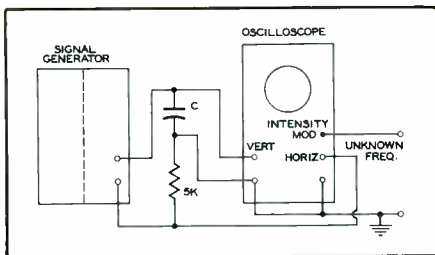

Fig. 4. Arrangement for Producing and Intensity Modulating a Circular Sweep for Frequency Determination.

pulse occurs in the signal. One cycle of sweep is completed and then the sweep action stops until the next triggering pulse occurs in the signal. One might call this action a "one-shot" type. It takes place regardless of the frequency of the horizontal sweep and produces a very stable picture of the signal waveform on the face of the scope. Furthermore, it can also be employed to expand a portion of a periodic waveform because it makes synchronization possible even when the horizontal-sweep frequency is several times higher than the fundamental frequency of the input signal. In the latter case, the sweep rate is so rapid that only the signal portion which is immediately after the triggering pulse appears on the scope.

Current Measurements

A good AC meter is one of the less common test instruments in the average service shop. Although the oscilloscope is primarily considered a device for voltage observation, it can be used as an AC milliammeter by connecting it across a low-value, noninductive resistor placed in series with the current source. The value of the resistor is a compromise between a very low value which would have least effect on the operation of the circuit under test and a higher value which would develop a higher signal voltage for application to the oscilloscope.

RECENT RELEASES

RCA WR-86A UHF Sweep Generator

The Radio Corporation of America has announced a new wide-range sweep generator for use in the designing, production-line testing, and servicing of UHF television equipment. The instrument is designed to meet the requirements of both color and black-and-white UHF television receivers, tuners, and converters.

The manufacturer's release states that the new WR-86A sweep generator is immediately available from RCA test-equipment distributors; suggested list price is \$275.

The new instrument supersedes RCA's two UHF sweep generators of the laboratory type and incorporates many of their design features.

A wide frequency range, continuous from 300 to 950 megacycles, is provided; the sweep width is continuously adjustable to a maximum of 10 per cent of the indicated dial frequency for any frequency below 850 megacycles, and is adjustable to 85 megacycles for frequencies from 850 to 950 megacycles. Output is claimed to have a maximum voltage-amplitude variation of 0.1 decibel per megacycle over the swept range. The output level is at least 0.6 volt across 50 or 300 ohms, and attenuation is continuously adjustable over a range of 60 decibels.

Other design features include: 50- and 300-ohm outputs, phased blanking for a reference base line, phased horizontal-deflection voltage for oscilloscope operation, and special shielding and termination to minimize RF leakage and radiation.

The WR-86A is supplied with a four-foot RF cable and a 50- to 300-ohm padded balun for matching the generator to 300-ohm loads. An instruction booklet is distributed with each generator.

The instrument is 9 3/4 inches high, 7 1/2 inches deep, and 13 1/2 inches long. Weight is 14 pounds.

RCA WR-36A Dot-Bar Generator

The RCA WR-36A dot-bar generator illustrated in Fig. 5 is designed to provide a pattern of rectangular white dots for making all convergence adjustments in color TV receivers. Horizontal bars, vertical bars, or a crosshatch pattern are also obtainable for linearity adjustments of monochrome TV receivers. The dot size chosen by the manufacturer was considered to be optimum for convergence adjustments and provides a dot of approximately 3/16 inch by 3/8 inch, as viewed on a 15-inch screen.



Fig. 5. RCA WR-36A Dot-Bar Generator.

A modulated RF signal and a video signal are available at front-panel terminals. The RF signal is continuously tunable from channels 2 through 6. An amplitude adjustment control is provided for the RF signal.

A V-BAR control provides adjustment to select from 11 to 13 vertical bars, and an H-BAR control provides adjustment to select from 8 to 15 horizontal bars.

The selector switch has five functions: OFF, STAND BY, VIDEO+, VIDEO-, and RF. The VIDEO+ and VIDEO- positions provide for selection of the proper polarity signal necessary at the point of application of the video signal.

A VERT SYNC SELECTOR switch allows selection of an internal, line-frequency sync signal or an external signal derived from some appropriate point in the circuit under observation. In the latter case, the sync signal is applied to the V-SYNC terminal on the front panel. Similarly, a horizontal sync signal can be obtained from the receiver circuit and applied to the H-SYNC terminal.

Physical dimensions are 13 1/2 by 6 5/8 by 9 3/4 inches.



Fig. 6. RCA WR-61A Color-Bar Generator.

The tube complement consists of the following tubes:

1	6X4
1	6U8
4	12AU7

RCA WR-61A Color-Bar Generator

The RCA WR-61A color-bar generator is illustrated in Fig. 6. This generator provides a signal that is useful in checking the over-all operation of color receivers and in adjusting the color phasing and matrixing. Ten color bars may be ob-

tained. Picture-carrier, color-subcarrier, and sound-carrier frequencies are provided on channel 3. All are crystal controlled.

The sound carrier provides a means for accurate tuning of the receiver and for checking sound rejection. A check for beat interference between the color subcarrier and the sound carrier can also be made. A push button on the front panel permits elimination of the sound carrier for identification of sound interference. Another front-panel push button provides for a horizontal bar of increased brightness to check for shift of hue in the bright areas of a picture.

Both video and RF signals are available, and a choice of plus or minus polarity of video signal can be selected by means of a front-panel switch. Two output connectors for the video signal are provided, one labeled HI for high impedance and the other LO for low impedance. The impedances are 5,000 ohms and 75 ohms, respectively. A test lead with an alligator clip is provided for the high video output, and shielded cables are provided for the low video output and for the RF output. The RF output cable is properly terminated with a matching network for 300-ohm receiver inputs. Another test lead with

New Low Price on Model 11 Equipto Cabinet



Larger production runs on the immensely popular Model 11 Equipto Small Parts Cabinet permit a substantial reduction in price without slightest change in quality. And look at these value-packed features—

- One-piece heavy gauge steel frame 34" x 13 3/4" x 12".
- Sturdy steel drawers that slide freely without swaying or sticking.
- Fully enclosed sides and bottom of drawers to prevent escape of parts.
- Adjustable dividers to separate each drawer into 3 compartments.
- Olive green baked enamel finish.

See your Equipto jobber or write us for complete catalog and prices.

Equipto

Steel Shelving.....Parts Bins.....Drawer Units

Division of
Aurora Equipment Company
830 Prairie Avenue, Aurora, Illinois



Reconing is Preferred..

WHEN exact replacement speakers are not available, reconing immediately solves mounting problems.

WHEN greater profits for you and greater savings for customers are desired.

WHEN you want quality and fidelity of performance.

Prove this to yourself!

Write to us for location of Reconing Station in your area.

**WALDOM
ELECTRONICS INC.**

4625 W. 53rd Street
Chicago 32, Illinois

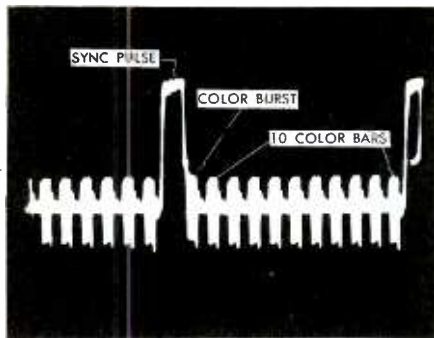

Fig. 7. Video Signal Available from the RCA WR-61A Color-Bar Generator.

alligator clip is provided for ground connections.

Front-panel controls permit adjustment of the subcarrier modulation level and the sync tip level. A metering switch connects a demodulated output signal from an internal rectifier circuit to a front-panel terminal for measurement with a VTVM while setting the aforementioned signal levels.

The HOR HOLD control changes the frequency of the horizontal sync pulse so that 10 color bars may be produced on the receiver.

When the video output signal from the low-impedance terminal is applied to the input of a wideband oscilloscope, the response appears as shown in Fig. 7. The signal consists of a horizontal sync pulse followed by regularly spaced pulses for producing the color bars. The first pulse following the sync pulse functions as the color burst, and each succeeding pulse has a definite phase shift with respect to the color-demodulating signals of the receiver so that their application produces a series of 10 color bars, progressing from orange through red, blue, and green, with intermediate hues between. The video signal just described combined with the picture-carrier signal, forms the RF signal available at the RF output jack of the generator.

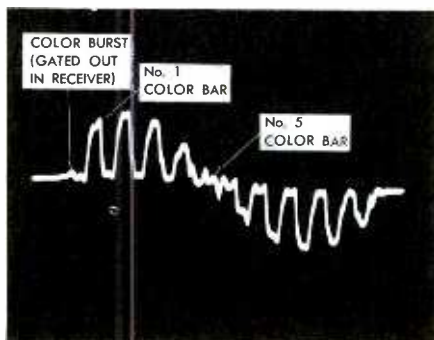

Fig. 8A. I Signal Showing Correct Adjustment of the Hue Control Circuit.

As one example of the way the WR-61A color-bar generator may be used to check the adjustment of a color receiver, the RF output of the generator was connected to the antenna terminals through the matching cable provided with the generator, and the waveform was viewed at two points of the receiver circuit. The first point of observation was at the cathode of the I-signal phase splitter where a plus I signal is available for application to the matrix of the receiver. An actual photograph of the oscilloscope waveform is shown in Fig. 8A.

Fig. 8B is diagram corresponding to Fig. 8A, and it can be seen that the ends of the pulses tend to describe a sine wave about an AC axis. The hue control for the receiver under consideration is a small variable capacitor which is in parallel with a tunable inductor. Adjustment of either of these components will cause the sine wave of Fig. 8B to shift to the right or left. The manufacturer's instructions state that the variable capacitor should be set at the center of its range (with plates half meshed), and the inductor slug should be tuned so that the signal for the fifth bar is on the axis. With improper adjustment, the fifth bar might appear either above or below the axis, depending upon the direction of the misadjustment; and some other bar might fall on the axis.

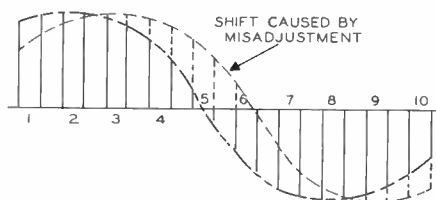

Fig. 8B. Diagram of Waveform of Fig. 8A Showing Effect of Misadjustment in the Hue Control Circuit.

If the oscilloscope is moved from the I channel to the second point, which is the cathode of the Q-signal phase splitter, the signal can be compared to the I signal just observed; and proper adjustment of the quadrature transformer can be determined. The average phase shift between each color bar of the generator is 30 degrees. Since the signal in the Q channel is at quadrature or 90 degrees phase difference with the I channel, we should expect a difference of 90 degrees in the color-bar signals which appear on the axis of the Q signal.

That is exactly the case in the example of Fig. 9 in which bars 2 and 8 are both on the axis, each being 90 degrees or 3 bars away from bar 5. If bars 2 and 8 were not on the axis,

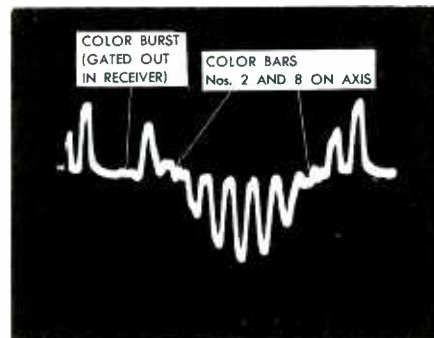

Fig. 9. Waveform of the Q Signal When the Quadrature Transformer Is Properly Adjusted.

this would indicate that the Q channel was not demodulating in exact quadrature with the I channel; and a slight adjustment of the quadrature transformer would be necessary for correction.

It should be mentioned that the oscilloscope was connected to the receiver at a point where the Q signal was of negative polarity — that is, a bar of a color that would normally produce a negative excursion in the Q channel will appear as a positive signal on the scope waveform and vice versa. (This is based on the assumption that the scope being used produces an upward deflection with a positive excursion.) Therefore, it can be seen that when an oscilloscope is used for viewing signals in color receiver circuits, a polarity-reversal switch will be of great help in presenting the waveforms in their proper polarity; and much confusion can thereby be avoided.

The following tubes are used in the WR-61A color-bar generators:

3	6U8
2	12AT7
1	6X8
1	6AS6
1	6BQ7A
1	6X4

Physical dimensions of the generator are 13 1/2 by 6 5/8 by 9 3/4 inches.

PAUL C. SMITH

Save More Time
Complete More Calls
Earn Extra Profits

Use **RCA VICTOR**
Service Parts

FACTORY-TAILORED

to fit right
to install fast

Remember. RCA Service Parts are the only genuine replacement parts for RCA Victor TV receivers, radios, and phonographs.



CUT YOUR INVENTORY...

Just 54 key RCA Service Parts can now serve as a working inventory to take care of practically all of your RCA Victor service requirements. They are listed and priced on a handy wall chart for quick reference. Ask your RCA Distributor for a free copy. (Form No. 3F502)

RCA RADIO CORPORATION
of AMERICA
SERVICE PARTS HARRISON, N. J.

Examining Design Features

(Continued from page 17)

the time constant of capacitors C1 and C2 and resistors R1 and R2 will be very long. The AGC voltage will then be primarily dependent upon the level of the incoming sync pulses.

For conditions of weak signals, R2 is set for minimum resistance. The time constant is short and the AGC voltage is dependent upon the average level of the video signal. The short time constant also reduces the effect of strong noise pulses.

A delay voltage is also provided for the AGC diode. The amount of delay is dependent upon the settings of the contrast control R10 and to a lesser degree upon the settings of the DX Range Finder. A voltage divider is formed by resistors R9, R8, R7, and by controls R2 and R10.

If the contrast control is set for maximum contrast, the cathode of the video amplifier is grounded. The maximum positive voltage may then be applied to the cathode of the AGC diode. The gains of the stages controlled by the AGC are greatest under these conditions.

When the DX Range Finder is adjusted to provide maximum AGC voltage, a switch (S1 in Fig. 2) that is ganged to the control will short a resistor in the screen circuit of the video amplifier. This results in an improvement of the signal-handling capabilities of the tube.

In areas where the received signal is weak, the DX Range Finder should be rotated toward the "300" mark until the picture is satisfactory. Medium signal strengths require the control to be set near the "zero" mark.

If very strong signals are encountered, the control should be rotated counterclockwise until the ganged switch is actuated.

Sound

The sound take-off is directly from the plate of the video detector. The signal present at the detector is fed through a capacitor to the grid circuit of the 6AU6 sound IF amplifier. The grid circuit contains a tuned circuit which is resonated at 4.5 megacycles. The amplified signal from this stage is then fed to the 6AL5 ratio detector. The detected signal is coupled to a 6AV6 amplifier which includes a volume and tone control. Additional amplification of the audio signal is provided by the 6AS5 audio output.

look for the
Howard W. Sams
"BOOK TREE"



at your
**PARTS
DISTRIBUTOR**

Make it a habit to "browse" at the Howard W. Sams "Book Tree". You'll find it at your Parts Distributor. It's loaded with the time-saving, profit-building books you want and need. Keep ahead with these timely, practical publications that help you learn more and earn more daily.

LOOK FOR THESE TITLES:

Television Books

"Telecasting Operations".....	\$7.95
"Photofact Television Course".....	3.00
"TV Servicing Short-Cuts".....	1.50
"TV Test Instruments".....	3.00
"UHF Converters".....	1.00
"UHF Antennas".....	1.50
"Television Antennas".....	2.00
"Servicing TV in the Customer's Home".....	1.50
"Making Money in TV Servicing".....	1.25
"TV Tube Location Guide" Vols. 4, 3, 2, each.....	2.00
"TV Tube Location Guide" Vol. 1.....	1.50

Audio Publications

"Recording & Reproduction of Sound".....	\$7.95
"Audio Amplifiers" Vols. 4, 3, 2, each.....	3.95

Record Changer Manuals

"Automatic Changer Manual" Vols. 5, 4, 3, each.....	\$3.00
"Automatic Changer Manual" Vol. 2.....	4.95

Handy Service Guides

"Radio Receiver Tube Replacement Guide".....	\$1.25
"AM-FM Servicing Short-Cuts".....	1.50
"Dial Cord Stringing Guide" Vols. 4, 3, 2, 1, each.....	1.00

Auto Radio Service Manuals

"Auto Radio Manual" Vols. 3, 2, each.....	\$3.00
"Auto Radio Manual" Vol. 1.....	4.95

Communications Receivers

"Communications Receivers" Vols. 2, 1, each.....	\$3.00
--	--------

Coyne and Boyce Books

"Coyne TV Servicing Cyclopedea".....	\$5.95
"Coyne Transistors".....	1.50
"Coyne Practical TV Servicing".....	4.25
"Coyne Latest Test Instruments".....	3.25
"Coyne TV & Radio Handbook".....	2.75
"Coyne Industrial Electronics".....	3.75
"Boyce Video Handbook".....	5.95
"Boyce Radio Handbook".....	4.95

See these and dozens of other
invaluable books on the
Howard W. Sams "Book Tree"!

HOWARD W. SAMs & CO., INC.
Indianapolis 5, Indiana

Look for these books—
order them at your Parts Distributor

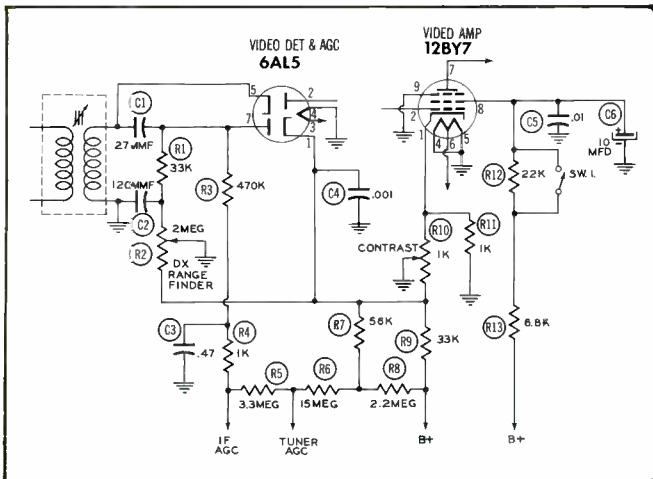

Fig. 2. The AGC Circuit of the Admiral Chassis 20A2.

Sync

The sync separator consists of a triode section of a 12AU7. The composite video signal applied to the grid of this tube is obtained from the plate circuit of the video amplifier. The resultant signal from the plate of the sync separator is coupled to the sync inverter consisting of the triode section of a 6U8. Two horizontal sync signals of opposite polarity are required for proper operation of the horizontal sync discriminator. These sync pulses are obtained from the sync inverter by taking the negative pulses from the cathode circuit and the positive pulses from the plate circuit.

The sync pulses appearing in the plate circuit of the sync inverter are coupled to an integrator network for use in the vertical sweep section.

Vertical Sweep

The vertical sync signals from the integrator network are used to trigger a blocking oscillator. A triode section of a 12AU7 is utilized for the blocking oscillator. The vertical hold control is contained in the grid circuit of the oscillator. The height control is included in the plate circuit to control the amplitude of the signal applied to the 6S4 vertical-output tube. Vertical linearity is adjusted by a potentiometer in the cathode circuit of the 6S4.

A signal from the vertical section is fed through an RC network to the grid of the picture tube to provide retrace blanking.

Horizontal Sweep

The horizontal-sweep section maintains synchronization by the action of a 6AL5 horizontal sync discriminator. The 6AL5 receives sync signals from the sync-inverter stage, as mentioned previously. In addition,

a sample signal is taken from the sweep circuits and applied to the discriminator. The signals are compared, and any phase difference results in an output from the sync discriminator. This correction voltage is then applied to one of the grids of the 6SN7GT horizontal multivibrator.

There are three adjustments in the multivibrator circuit. A variable inductance constitutes the horizontal lock control, and a potentiometer is used as the horizontal hold control. The third adjustment is the horizontal drive control which determines the amplitude of the signal applied to the 6BQ6GT horizontal output tube.

The two remaining tubes associated with the horizontal circuit consist of the 1B3GT high-voltage rectifier and the 6AX4GT damper tube.

Provisions are included for adjusting the width and linearity.

Low-Voltage Power Supply

A single 5U4G supplies rectification for the low-voltage supply. Filtering is accomplished by a pi-filter in which the speaker field acts as the choke.

The elimination of the customary bleeder networks with their associated power losses is an interesting feature of this power supply. The method used is illustrated in the diagram of Fig. 3. In order to clarify the B+ distribution system, the components associated with the individual tubes have been eliminated from the diagram.

PLUG-IN SELENIUM RECTIFIERS

Several television receivers employ selenium rectifiers in the low-voltage power supply. When the units are suspected of needing replacement, it often poses a rather difficult service problem to perform in the customer's home. It is usually necessary to remove the chassis from the cabinet and unsolder the leads to the rectifiers before they can be removed from the receiver. In order to alleviate this problem, recent television receivers such as the Arvin Model 21-553 TMU have incorporated a new type of selenium rectifier.

These rectifiers are the Sarkes Tarzian plug-in units. An example of the type which may be found in a receiver is shown in Fig. 4. For the purpose of illustration, the receptacles have been mounted on a small chassis. Ordinarily, these receptacles are mounted on the receiver chassis.

The terminals on the selenium rectifiers serve as the connectors

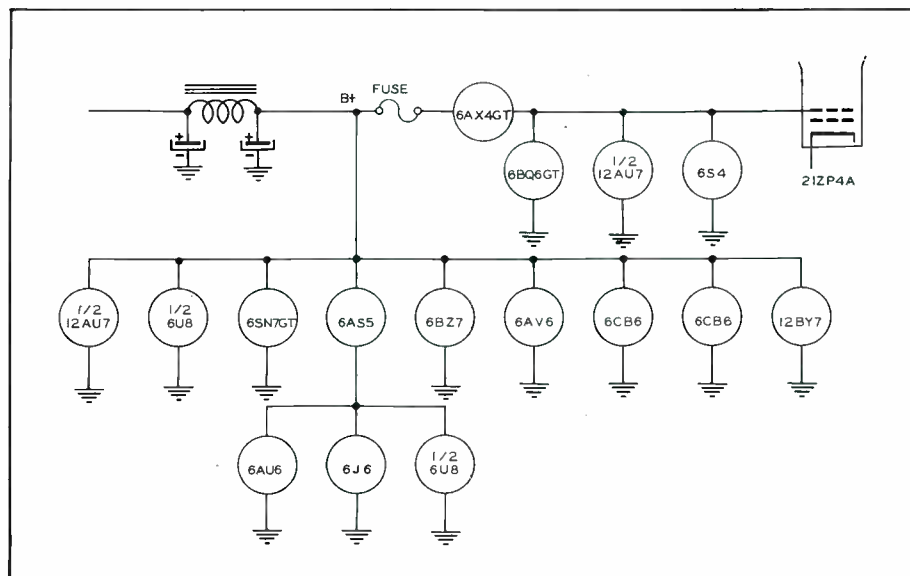
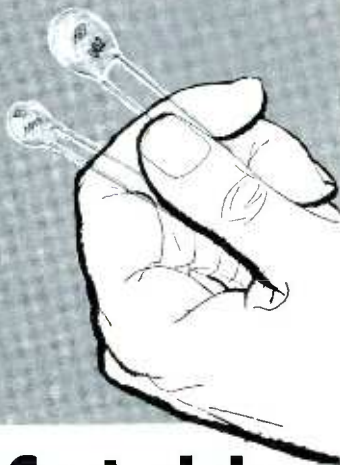





Fig. 3. The B+ Distribution System Used in the Admiral Chassis 20A2.

SAFER
...and less expensive



Centralab
Type DD 1000-VDCW
Ceramic
Disc Capacitors

Now a complete line of
"standard" disc capacitors —
but look at these advantages

-  There's no danger of an overload blowing out a Centralab DD Disc. Rated 1000 VDCW, every one is 100% tested before shipping — at twice rated working voltage. (2000 VDC)
-  Tolerances are stated honestly. You can install Centralab DD Discs with complete confidence.
-  You can't beat Centralab DD Discs for size or price. They're the smallest possible size—and cost only 12¢ net.
-  Double coating of Durez provides dependable insulation. Centralab DD Discs operate efficiently up to + 85° C.

Play safe — use Centralab 1000-VDCW DD Discs regularly, even when you replace discs under 1000 VDCW. Stock up at your Centralab distributor.

Send coupon for new Centralab Catalog No. 29 for full details on this and many new Centralab developments.

*Trademark

For full details on this and other new Centralab developments, write for free copy of new Centralab Catalog No. 29 to **CENTRALAB,**

A Division of Globe-Union Inc.
942H E. Keefe Avenue
Milwaukee 1, Wisconsin

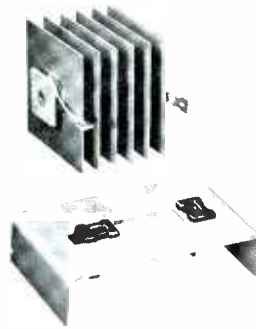

Fig. 4. A Sarkes Tarzian Plug-in Selenium Rectifier With Its Associated Receptacle.

for these units. With this system, no special plugs are required on the rectifiers. It may be seen in the figure that one of the terminals is twisted so that it is perpendicular to the other. This permits the correct polarization to be observed.

The receptacles on the chassis are positioned in a similar manner. The possibility of installing a replacement rectifier incorrectly is therefore minimized.

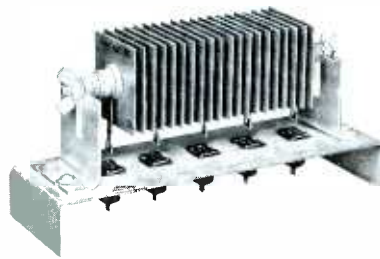

Fig. 5. The Plug-in Arrangement for a Multi-section Selenium Rectifier.

The receptacle mounted in the elongated slot may be moved in either direction to accommodate small differences in the spacing of the rectifier terminals.

In other applications where multiple-section rectifiers are used, a similar plug-in arrangement may be used. An example of this is shown in Fig. 5. For these rectifiers, additional support is obtained by the use of right-angle brackets. The rectifier stacks are fastened to the brackets by tightening the wing nuts on the threaded shafts. When removal of the units is desired, it is merely necessary to loosen the wing nuts and unplug the rectifier.

The use of the plug-in units should greatly simplify the replacement problem incurred with selenium rectifiers. It is now possible to replace the rectifiers as simply as replacing a tube.

Don R. Howe

Color Servicing

IS NOW IN THE FAMOUS
Mandl's TV Servicing



The new section on color servicing and color circuits gives you the same clear how-to-do-it instruction that has made this book a favorite with servicemen everywhere. You'll be FULLY prepared to service any set, do the best job of installation or trouble shooting in minimum time, either for color or for black and white.

EASY to learn

Simple, clear explanations show you how each unit in the TV receiver functions, with lists of the flaws that may occur in it, what points in the circuitry cause them, how they affect other components, how they show up on the TV screen. Every step is fully illustrated with large clear schematics, photographs of test patterns, scope patterns and other helpful illustrations.

How to locate trouble quickly

A complete master trouble index gives the possible causes of distortions or faults in picture or sound, with references to the pages on which servicing instructions are given. You can quickly and easily diagnose the source of trouble and know just what to do about it.

Methods used by experts

You'll learn the practical time-saving methods used by the most experienced servicemen and technicians:—ways of locating those hard-to-find troubles, simple signal tracing procedures, how to improve reception in fringe areas, how best to use test equipment. You'll learn the necessary why's and wherefore's of TV reception, but won't be confused by unnecessary theory or involved math—just what you need in order to do a skilled servicing job is given here.

Recent improvements

In addition to the instruction on color—how it works, how to service color sets—you'll have the latest data on such improvements as cascade tuners, automatically focused tubes, new types of high frequency I.F. systems, transistors, UHF-VHF receivers. You'll learn TV for today and TOMORROW from this book.

Make your Math
EASY!
See the **NEW**
Elements of
Mathematics for
Radio, TV & Electronics

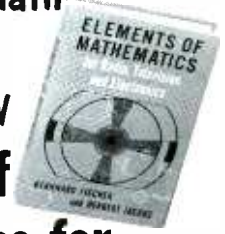

By Bernhard Fischer & Herbert Jacobs

The Macmillan Co.
60 FIFTH AVENUE, NEW YORK 11, N. Y.

Shop Talk

(Continued from page 5)

one section of the tuner from the other. Feed-through capacitors also provide effective bypassing for filament, B+, and AGC leads which enter the tuner from other sections of the circuit. Thus, these capacitors accomplish two purposes at the same time.

A feed-through capacitor usually employs a ceramic insulator; and should this crack because of physical shock or excessive heat from a soldering iron, a partial or total short circuit may develop. A resistance measurement will reveal this defect, although often a visual inspection or a physical check with the fingers will bring this situation to light.

6. Microphonics.

Microphonics are noise defects that are in both the electrical and mechanical categories. Such defects are mechanical in the sense that movements or jars cause tube elements or other electrical components to vibrate back and forth. They are electrical because these unwanted vibrations affect the circuit electrically. The most common offender with regard to microphonics is the oscillator tube (generally a 6J6); and if several tubes are tried in the oscillator socket, one which will operate quietly can usually be found. Microphonics appear as hollow, ringing sounds when the oscillator tube is jarred; when the volume is turned up, these sounds will frequently change into first-class howls. Another possible result of microphonics is the appearance of horizontal sound bars in the picture.

While the oscillator tube is the chief source of microphonics, it is important to note that other components can exhibit this phenomenon as well. Either a vibrating capacitor or a vibrating coil can easily alter the stray capacitance between it and the chassis or between it and some other component, with the net result that the oscillator frequency is varied at the vibratory rate. This condition introduces variations in the signal and results in the visual and aural effects previously mentioned.

The foregoing discussion concerned physical or mechanical defects. Let us now consider tuner operation that is impaired by electrical defects.

ELECTRICAL DEFECTS

1. Defective Tubes.

The No. 1 suspects in almost every section of a television receiver are the tubes; and in the front-end portion, a degradation in tube per-

formance can have a very noticeable effect upon the picture. The easiest and therefore the initial check in a suspected tuner should be the substitution of tubes. Very often an inoperative RF amplifier tube will not cause complete loss of picture; but instead, some of the available signal may feed through the interelectrode capacitance within the tube and provide a weak, snowy picture. An inoperative oscillator tube causes complete loss of picture, and a bad mixer tube usually does the same.

2. Low B Voltage.

Second in importance to tubes are their operating voltages. Reducing the B+ voltage by 10 per cent may well reduce receiver sensitivity by as much as 30 per cent; and dollar for dollar, increasing subnormal B+ voltage is the most economical way of improving set performance. This, then, is one of the critical features of a receiver and should receive full attention. If the B+ voltage is low, check the low-voltage rectifier, either tube or selenium. With age, both types are particularly vulnerable to decrease output.

In addition, consider the power line itself. A voltage value below 110 volts definitely indicates that some form of power-line booster and regulator should be considered if the set is to provide optimum performance. A good regulator is an expensive item, but its cost is still low in comparison to receiver cost, and it will do wonders for erratic and subnormal behavior.

3. Defective Components.

Of other defective components (capacitors, resistors, and coils), little can be said specifically except to make some general observations. The first step is to isolate the stage containing the defect because, while the tuner compartment is relatively



Fig. 2. Connection Into the Mixer Grid Circuit of the Tuner Can Be Made Easily Through the Projecting Loop Shown.

small, it still contains about 30 or more individual parts. To check each one independently is not an efficient procedure; consequently, after it has been ascertained that the B+ voltage coming into the tuner section is satisfactory, the next step is to find out which of the three stages — RF amplifier, mixer, or oscillator — is nonoperating.

The key point in the oscillator is its negative grid voltage. Values of approximately -5 to -10 volts are normal. There is seldom any operational trouble when this voltage is too high; the difficulty arises when lower-than-normal voltage or no voltage at all is present.

For the RF amplifier, a check of the control-grid, screen-grid, and plate voltages is the generally prescribed procedure. However, this writer has found that a more effective check — and also one that is capable of being carried out quite rapidly — is to bypass the RF stage completely and apply the signal directly to the mixer grid. In many tuners, access to the mixer grid is readily available through a looped wire projecting above the top of the tuner. See Fig. 2. In other units in which this facility is absent, signal injection can be achieved by removing the RF amplifier tube and applying the signal via a 50-mmfd capacitor to the plate pin of the socket.

The incoming signal may be used for this injection signal; but it has been our experience that unless you live in an exceptionally high-signal area, the use of this signal will frequently give no picture at all. A far better approach is to employ an AM signal generator to provide the test signal. Tune the generator to a frequency which is about 1 mc above the picture-carrier frequency of the channel to which the receiver is tuned, and then switch on the audio-modulating voltage in the generator. The appearance of black horizontal bars across the face of the screen indicates that the signal is reaching the picture tube.

If the RF amplifier is operating normally, moving the signal lead back to the antenna terminals from the mixer grid will result in a stronger output. On the other hand, a partially or totally inoperative RF amplifier will decrease or kill the picture pattern.

4. Weak Signal Strength.

A final consideration in any evaluation of tuner performance is the strength of the received signal. Just how much signal are you getting? For this, there are really only two methods of checking: using a field-strength meter or using another re-

ceiver. A good many service technicians use a type of portable receiver (generally with a 7-inch picture tube) to carry around with them on calls. The performance of such a unit is well-known; and by connecting it to the customer's antenna, a fairly accurate check can be made of the strength of the incoming signal through observation of the picture produced by the signal.

Signals that are too strong can be as detrimental to the operation of a set as signals that are too weak. This is especially noticeable in areas where the local station increases its power and changes what was a weak or barely moderate signal level to one that is definitely strong. A receiver operating with a strong signal must be adjusted differently, not only from the standpoint of internal adjustments but even at the front panel. The usable range of the contrast control, for example, is reduced. This, in turn, affects the brightness control. Excessive signal may lead to total or partial sync-pulse clipping; and hence, the vertical and horizontal hold controls will be more "touchy" in adjustment. The writer has seen this trouble occur in apartment houses where an antenna distribution system was just installed. Prior to the installation, the sets operated on indoor antennas and produced only fair pictures. With the new distribution system, signal strength rose considerably and led to many of the difficulties just noted. In a number of instances, sets had to be realigned; in nearly all cases, the customers had to be re-educated on set tuning and control adjustment.

An even worse problem arises when a set has been purposely aligned (or misaligned, if you wish) for weak-signal reception and then signal strength increases markedly. Some technicians meet this situation by inserting an attenuation pad between receiver and antenna. This, of course, leaves the receiver with the same limited bandpass that it possessed when it was set up for weak-signal reception and does not provide the set viewer with the picture to which he is entitled.

One booster manufacturer recently complained to this writer that part of the reason his unit was getting poor acceptance from service technicians stemmed from their reluctance to align a set to the signal conditions to which that set was exposed. If a set is geared to weak-signal reception and then a really "hot" booster is added, there is danger of signal clipping or compression or the possibility that circuit oscillations will take place. The same set, under the same con-

ditions, will apparently provide better reception with a less sensitive booster. The fallacy of this approach is obvious. Just as obvious is the solution — proper alignment.

REVIEW

One of the chief difficulties in becoming a good television service technician, aside from learning basic television theory, is the accumulation of practical experience with the sets themselves. Most ads for television technicians carry or imply the word "experienced." This is understandable. Just as understandable is the plight of the many hundreds, perhaps thousands, of young men who have by one means or another acquired a reading knowledge of television and who would like to engage in servicing but lack the experience.

One solution to this problem was recently offered by a gentleman who used the pseudonym of Henry Farad. (His real name is H. A. Highstone, of Santa Rosa, California.) The article, entitled "The Best Teacher," appeared in the March 1954 issue of *Radio-Electronics*. This magazine is published monthly by Gernsback Publications, Inc., 25 West Broadway, New York, N. Y. Subscription rates are \$3.50 for one year in the United States, its possessions, and Canada.

This problem of acquiring experience in television servicing was one that Mr. Highstone faced. He had studied the theory of television, and what he wanted was on-the-job experience to make the theory worth something in terms of dollars and cents.

There were several approaches that he could follow. One was through school training where you build a set and then service it as you go along. The author, however, was short of funds and could not afford this solution. Another possibility was as a helper or apprentice in a TV shop, but a shop helper's pay is quite low and his progress is not fast enough for a man who has a family to support.

In actual practice, simply observing a TV repairman at work is of little value to the novice. The reason is quite simple. Ninety-nine per cent of the effort is mental; and unless the service technician takes time out to explain every step, much of what he does will escape the apprentice.

Mr. Highstone's solution to this seeming dead end was to create his experience. His first step was to become a part-time dealer in what he termed TV junk. An ad was inserted in a local paper offering to buy for

cash old TV sets — any size, shape, or condition. He generally limited himself to sets which could be obtained for \$50 or less. Frequently, he paid no more than \$20 to \$30.

Having purchased a set, he took it home and proceeded to restore it to working condition. The first step was to get the set to develop a raster, then a picture. The longer it took to achieve these steps, the more he learned. And some of the relics he brought home required a great deal of work before a picture could be developed on the screen. After that, it was frequently only a matter of replacing old tubes with new ones and then realigning the RF and IF systems.

Work did not end with the return of the sets to good working condition. The next step was to twist every nonoperating control to find out what effect it had upon the picture. At first, this was done with caution; but after some experience, it was done with greater boldness. Soon he was able not only to restore a set to operating condition quickly and efficiently, but he even went so far as to introduce troubles in order to observe what their effects would be.

In a sense, part of this latter training is artificial. If you introduce a trouble, then there is no difficulty finding it; and so this method does not, in itself, help you sharpen your analytical skill. But it does possess considerable assistive potentiality if it teaches you to observe closely the results of a defect on the screen. Too many service technicians do not try to analyze in detail a distorted picture. Rather, they give it a cursory glance, catalog it into a certain classification, and then proceed to hunt the defect on the basis of this classification. If the trouble is not too difficult to find, this method will work well. But all too frequently, one obvious defect overshadows a less obvious but possibly a more significant distortion; and the service technician, in his quick analysis, completely misses the telltale signs.

To repeat, then, artificially introducing troubles can be of value if the visual and aural effects of the trouble are carefully analyzed.

After a set was returned to good operating condition and it had been "milked dry" of whatever knowledge and experience Mr. Highstone felt it could give him, it was sold. If a profit could be made on the deal, so much the better. More often than not, however, Mr. Highstone lost a small amount — he figures about \$7.50 per deal. The objective was not to make money but rather to gain as much

practical experience as possible at the lowest possible cost.

As time went on, Mr. Highstone not only gained experience; but what is perhaps more important, he developed confidence in his own ability to solve a problem. The calm, cool, and collected attitude is about 25 per cent of the requirements to make a top-notch technician. Move slowly and deliberately; it will reduce the number of chassis removed unnecessarily and the number of 6AU6 tubes blown by forgetting to return the filament knob of the tube tester back from the 12.6-volt position. In short, the less haste the more speed.

Another important lesson he learned was to change pace when the

going got rough and the cause of the trouble eluded him. Hang onto an idea or a deduction for just so long; then if it fails to work out, dump it. A good many men, far too many, make a quick deduction of the possible cause of a trouble and then stick doggedly to this decision even when their test equipment shows them that their guess was wrong. That is what we mean by the need for a change of pace.

Another thing which beginners are reluctant to do is to spend time on the circuit diagram of the receiver. They feel this is time more or less wasted when, in fact, just the opposite is true. With the diagram in front of you, consider the problem from every angle. If you get more than one faulty

symptom from the set, tie each one in with all the other symptoms. Play one against the other, so to speak, until you get one explanation which will explain every symptom you see. If you cannot obtain one over-all explanation, try to obtain one which will cover as many of the defect indications as you can. You might even list several possibilities and try out each one.

Above all, cautions the writer, don't be in a hurry, especially in gaining experience. A year is not a long time, and actually two years of experience in this field are required on an average for many men. Try to learn something from every repair job, even if it consists solely of changing tubes.

MILTON S. KIVER

A STOCK GUIDE FOR TV TUBES

The following chart has been compiled to serve as a guide in establishing proper tube stocks for servicing TV receivers. The figures have been derived by combining (1) a production factor (the number of models and an estimate of the total number of receivers produced by all manufacturers) and (2) a depreciation factor (based on an average life of six years for each receiver, and the figures are reduced accordingly each two months).

1. The figures shown are based on a total of 1,000 units. This was done in order to eliminate percentage figures and decimals. The figure shown for any tube type then represents a percentage of all tubes now in use. For example, a figure of 100 would imply that that particular tube type constitutes 10 per cent of all tube applications.

2. Some consideration should be given to the frequency of failure of a particular type of tube. A tube used in the horizontal-output stage will fail much more frequently than a tube used as a video detector. Thus, even though

the same figure may be given for both tubes, more of the horizontal-output type should be stocked.

3. The column headed '46 to '54 is intended for use in those areas where television broadcasting was initiated prior to the freeze. Entries in this column include all tubes used since 1946 except those having a value of less than one, which is the value of the minimum entry in this chart. The '52 to '54 column applies to the TV areas which have been opened since the freeze. Since the majority of receivers in these areas will be of the later models, only the tubes used in these newer sets are considered in this column. The minimum value of one also applies to this column.

4. The listing of a large figure for a particular tube type is not necessarily a recommendation for stocking that number of tubes. The large figure does indicate that this tube is used in many circuits and emphasizes the necessity for maintaining a stock sufficient to fill requirements between regular tube orders.

46 - 54 Models		52 - 54 Models		46 - 54 Models		52 - 54 Models		46 - 54 Models		52 - 54 Models	
1B3GT	40	44	6AU4GT*	-	-	6C4	10	10	6W4GT	30	32
1V2	1	-	6AU5GT	4	4	6CB6	98	138	6W6GT	7	12
1X2	5	2	6AU6	132	123	6CD6G	8	9	6X5GT	1	1
1X2A	4	6	6AV5GT	2	4	6CF6	1	1	6X3	4	6
5U4G	46	48	6AV6	15	17	6CL6	-	1	6Y6G	3	1
5V4G	8	-	6AX4GT	6	5	6CS6*	-	-	7C5	1	-
5Y3GT	4	2	6AX5GT	1	2	6J5	3	3	7N7	2	1
6AB4	3	2	6BA6	15	11	6J5GT	2	1	12AT7	15	14
6AC7	8	8	6BC5	10	7	6J6	33	30	12AU7	45	29
6AF4	2	2	6BE6	5	7	6K6GT	16	10	12AV7	3	4
6AG5	34	10	6BG6G	14	7	6S4	8	10	12AX4	2	4
6AG7	3	3	6BH6	8	-	6SH7GT	2	-	12AX7	4	5
6AH4GT	3	4	6BJ6	1	-	6SL7GT	3	2	12AZ7	1	2
6AH6	7	10	6BK5	2	2	6SN7GT	76	83	12VH7	9	12
6AK5	4	4	6BK7	3	6	6SN7GTA	2	2	12VY7	2	4
6AL5	76	76	6BK7A	1	1	6SQ7	3	3	12VZ7	2	-
#6AN4	-	-	6BL7GT	6	9	6SQ7GT	3	3	12SN7GT	6	4
6AQ5	13	13	6BN6	3	3	#6T4	-	-	25AX4GT*	-	-
6AQ7GT	2	2	6BQ6GT	17	26	6T8	14	14	25BQ6GT	3	4
#6AS4	-	-	6BQ7	6	14	6U8	5	8	25CD6G*	-	-
6AS5	2	2	6BQ7A	3	3	6V3	2	4	25C5*	-	-
6AT6	4	3	6BZ7	4	5	6V6GT	21	20	25L6GT	5	5
									25W4GT	1	2
									25Z6	1	-
									5642	2	2

A stock of these tubes should be maintained in UHF areas.
* New tubes recently introduced.

LOW LOSS— even at 800 Mc!



LIGHTNING ARRESTERS for

- Maximum Set Protection
- Minimum Signal Loss

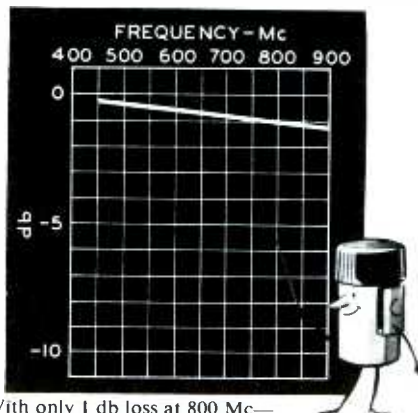

With only 1 db loss at 800 Mc—and even less at the lower frequencies—RCA UHF arresters are the best means of guarding your customers' receivers against damage by induced electrical charges—without affecting the strength of the incoming signal. Here's why:

- RCA UHF lightning arresters employ conductive-rubber resistive elements, molded in a special form to give low capacitance across the transmission-line conductors.
- The contacts are designed and positioned to provide minimum shunt capacitance.



Positive-contact design . . . so quick to install! Just tighten the screw cap and it's "in the line". Fits Tubular, Oval, Foam and Jacketed UHF lines. Standing-wave ratio approximately 2:1 at 800 Mc. Listed by Underwriter Laboratories, Inc.



RCA VHF arresters—like the UHF's—also are designed for positive contact and low loss. Weather resistant, built for service in fringe areas, they dissipate static charges continuously, do not unbalance line. Listed by Underwriter Laboratories, Inc.

RCA RADIO CORPORATION
of AMERICA
ELECTRONIC COMPONENTS HARRISON, N. J.

In the Interest of Quicker Servicing

(Continued from page 29)

used his oscilloscope as he used it with the previous problems. A check at the grid and at the plate of the video output tube would have indicated the absence of any gain in the tube. Then voltage and resistance readings at the video output tube would have led the technician to the trouble.

Problem No. 6

The picture was weak and washed out, even with the control set for maximum contrast. The substitution of a new video output tube did not help matters.

Since there appeared to be nothing harming the sound in either volume or quality, it was decided that the trouble must be in the output stage or in the picture tube. The picture tube was checked, and the test showed it to be good. A voltage check of the output stage was the next thing in order. The reason for voltage checks at this point is because the trouble appeared to be a simple case of loss of gain due to incorrect operating voltages.

Plate and screen voltages were found to be satisfactory; whereas the grid measured a -10 volts, which is much higher than normal. A voltage of -10 volts is almost sufficient to cut off the plate current in the tube, thus keeping the gain very low. Possibly the grid return or path to ground was open and allowed the coupling capacitor C6 to charge, having no path to discharge, it held the grid near cutoff.

Further checking with the ohmmeter showed that the grid resistor, which was hidden beneath other components, had broken in two.

The technician found this trouble rather quickly even though the trouble was one which is seldom encountered. If he had used his scope, he would have been able to isolate the difficulty to the video output stage without necessitating a test of the picture tube.

Problem No. 7

This problem was a failure that appeared to be AGC trouble because the picture had too much contrast. In addition, the high-frequency response was very poor. Yet, the fact that the sound seemed to be of very good quality and of sufficient amplitude seemed to disprove the AGC theory.

To settle the matter, the scope lead was placed in the video-detector

NOW!



COLOR TV COVERAGE IN PHOTOFACT!

FIRST COLOR TV FOLDER

the RCA Model CT-100

OVER 40 FACT-PACKED PAGES

It's a terrific FIRST—complete data based on actual analysis of the production model...full schematics, block diagrams, parts lists, tube placement, alignment, wave forms, set-up adjustments—*everything* you want to know about this actual color set—information you want and need to get out in front on Color TV!

here's how to get it!

- 1 Included with Photofact Folder Set No. 252—out Sept. 1st. You get it in addition to over 100 pages of regular Photofact TV-Radio coverage. Get the Color TV Folder at the regular price of the complete Set...Only \$1.75!
- 2 You can buy the Color TV Folder separately if you wish. Available from your distributor for only \$1.00!

GET IT EITHER WAY FROM
YOUR PARTS DISTRIBUTOR

RESERVE YOUR
COLOR TV FOLDER
TODAY!

circuit at the junction of R6 and R7. The signal at this point was excellent and indicated that the trouble was somewhere in the last stage. The signal on the plate, as viewed on the scope, appeared somewhat distorted. This was a clue that the tube was being overdriven.

When a tube is overdriven, it is usually because of incorrect operating voltages on the tube; consequently, the next step was to measure the voltages. The plate voltage was found to be very low. Instead of the 200 volts that were normally found on this plate, it measured 50 volts. This was causing the tube to cut off very easily so that the very light grays were darker than they should be, but the dark grays would quickly drive the tube to a cutoff condition, and the picture would be very dark with excessive contrast even with minimum contrast setting. An ohmmeter check of the plate-circuit components located the trouble very quickly. The plate-load resistor R13 had increased in value from the original 5.6K ohms to 55K ohms. Repair was just a matter of replacing the resistor with a new one.

The significant tests in the solution of this problem were the oscilloscope checks at the junction of R7 and R6 and at the plate of the video output tube. It can be stated that in general very pronounced symptoms call for preliminary oscilloscope checks followed by voltage or resistance measurements.

IN THE HOME

Moving TV Set for Customer

Quite frequently the television service technician may be called upon to change the location of a customer's television receiver. The customer may want it moved into the basement social room or into the bedroom of a member of the family confined by sickness or accident, or he may simply wish to rearrange the furniture in the living room. Although the movement of a television receiver seems to be a relatively simple matter, many things must be carefully considered if satisfactory receiver operation and customer acceptance is to be assured.

With Outside Antenna

If a suitable outside antenna system is available, some of the major items to be considered in moving the television receiver are as follows:

1. Determine a method of running the lead-in wire to the new location. If the lead-in enters the house through the basement or through a crawl space, it may be possible to splice the lead-in

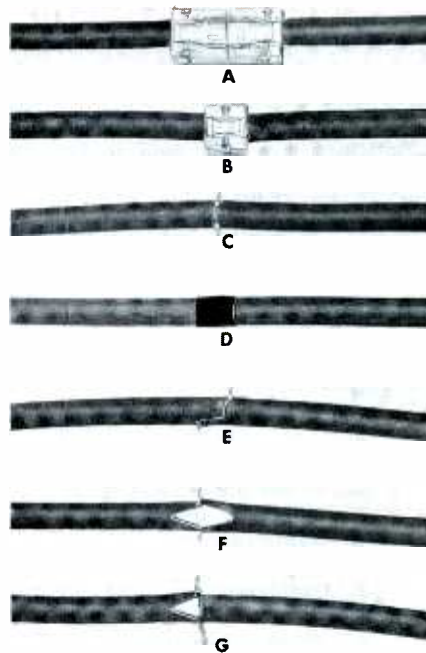

Fig. 2. Methods of Splicing Twin Lead.

wire and run it under the floor to the new receiver location. It would then be necessary to drill a hole in the floor near the new location. A very satisfactory place to drill such a hole is under the quarter-round molding which is found in most houses. The lead-in may then be run to the set between the quarter-round molding and the baseboard. Replacing the quarter-round molding will serve to clamp the lead-in wire between the molding and the baseboard. Then the likelihood of a disconnected lead-in slipping back into the basement or crawl space will be minimized.

In some cases the lead-in wire may be spliced and run to the new location by fastening the lead to the baseboard. Small fasteners are available for this purpose. The units are so constructed that the lead-in is supported very close to the baseboard.

Fig. 2 shows several methods of splicing twin line. The splices shown in Figs. 2A and 2B are made by using commercially available splice blocks. These provide a fast method of making a splice and require no soldering. This type of splice is best used indoors or in places where the splice is not subject to strain or exposure to weather. The splices shown in Figs. 2C and 2E are the types of splices which, when properly taped, are strong and should perform satisfactorily indoors or outdoors. The splice shown in Fig. 2D is a finished and taped splice of the type shown in Fig. 2C.

The splice shown in Fig. 2F is one which many service technicians use. This type is electrically satisfactory, but the splices shown in Figs. 2C, 2D, and 2E are mechanically stronger. The "Sad Sam" splice in Fig. 2G is not recommended for use, but it is sometimes seen in the field.

Should the customer desire to move the television set to the other side of a room in which there is wall-to-wall carpeting and the lead-in wire enters through a window, the best method of routing the lead-in wire to the new location should be determined. If there are no doorways or other openings to hinder the routing of the lead-in around the baseboard, this procedure may be used. If there are doorways or other obstructions, it may be necessary to remove the lead-in wire and run a new one from the antenna to a window near the new location of the set. In other cases, it may be advisable to install a wall feed-through bushing and have the lead-in enter the basement or crawl space. The lead-in may then be run under the floor to the new location. In running it under the floor, it should not be allowed to rest on the ground, on electric cables, or on metal objects such as water and gas pipes. Standoff

Fig. 3. Multiple Outlets Served by a Single Antenna.

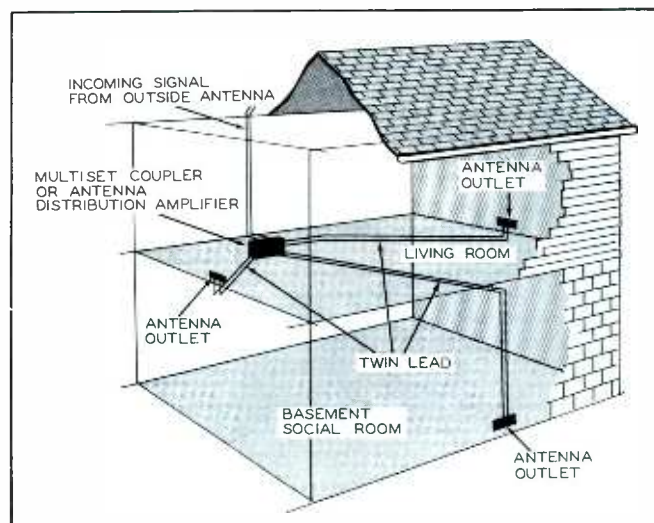

insulators can be used to support the lead-in.

2. Should the customer live in a UHF or UHF-VHF area, special considerations must be made to guard against possible impairment of UHF reception. Some of the more important items to be considered are listed as follows:

a. The lead-in wire should be kept as short as possible.

b. A minimum number of stand-off insulators should be used.

c. A lightning arrestor with a low attenuation factor at UHF frequencies should be used.

d. Use the type of lead-in wire found to operate most satisfactorily in the particular reception area.

3. The desirability of adding a multiple-outlet system to the existing antenna system should be considered. A block diagram of such a system is shown in Fig. 3. For reception in a primary service area, a multiset coupler may give satisfactory performance in this system. In suburban or secondary reception areas, however, it may be necessary to use an antenna distribution amplifier in lieu of the multiset coupler. The distri-

bution amplifier may be located near any convenient power source that is protected from the elements, and then lines may be routed from the output terminals to the desired room locations. Most antenna distribution amplifiers are designed to provide sufficient gain to overcome the losses caused by additional lead-in length and are designed to prevent feedback out of one receiver from affecting any other set that might be connected to the system.

4. Special tools and equipment may be required in moving a television set or in rerouting a lead-in:

- a. Ladders, step and extension.
- b. Brace and assorted bits.
- c. Masonry drills, assorted.
- d. Hammer.
- e. Nails and nail-set tool.
- f. Baseboard insulators for lead-in wire.
- g. Standoff insulators.
- h. Transmission line to match customer's existing lead-in wire.

With No Outside Antenna

There are points to remember in moving a television receiver which has no outside antenna. The major

considerations in this case are the following:

1. If the television set is to be moved into a basement social room, an outside antenna will probably be required to assure satisfactory reception. Reception in basements when only built-in antennas or rabbit ears are used is generally very poor.

2. If the customer agrees to have an outside antenna installed, conventional procedure should be followed in its selection and installation.

Service Aid

CBS-Hytron has announced that their recently released solder dispenser and refills are now available at local CBS distributors. Previously, the solder dispenser and refills were available only with the purchase of CBS-Hytron tubes. This solder dispenser will make a valuable addition to the field service kit, since solder may be carried with a minimum of disorder and space. A new tube caddy is also available at CBS-Hytron distributors.

Henry A. Carter and
Calvin C. Young, Jr.

NEW RCP AC-DC MULTITESTER
IMPROVED... ALL MOLDED

**Unequaled
in Appearance
and Performance
by any other
in its class**



Now within an all molded panel and case RCP has built a multimeter based upon the successful tradition of its famous Model 447, whose acceptance has been proven through the sale of 100,000 prototypes. The Model 480 provides greater multimeter value than ever before at a far lower price. Here is a must for every laboratory, shop and serviceman's kit... truly universal in design. Its smart looking appearance is only equalled by its quality of performance.

3" square meter with 800 microampere D'Arsonval movement gives 1000 ohms per volt sensitivity on DC. Battery for ohmmeter circuit is readily removable and replaceable without soldering or unsoldering. Special spring contact clips make replacement immediately and easily. Excellent rectifier characteristics and quality control of components in a very large production result in an unusually low price.

Model 480
An Exceptional Value at... **\$14.85** Complete with battery, ready to operate

Size 7" x 4 3/4" x 2 5/8", Weight 20 oz. Shipping Weight 34 oz.

RANGES

DC Voltmeter	0-5-50-250-500-1000 volts.
AC Voltmeter	0-10-100-500-1000 volts.
Output Voltmeter	0-10-100-500-1000 volts.
DC Milliammeter	1-10-100-1000 milliamperes.
Ohmmeter	0-10,000 ohms-100,000 ohms-1 megohm and 10 megohms external.
Decibel Meter	-8 to 55 Decibels.

RADIO CITY PRODUCTS CO.
EASTON
PENNSYLVANIA

See your local parts distributor, or write Dept. PF-8 for RCP catalog.

The Sensational NEW RADAR TV ANTENNA

Riviera

MONEY BACK GUARANTEED

**OUT DISTANCE
OUT GAIN
OUT PERFORM**
FROM *All* DIRECTIONS
EVERY **VHF** ANTENNA
ON THE MARKET TODAY

AVAILABLE FOR SEPTEMBER DELIVERY

ALL CHANNEL ANTENNA CORP.
47-39 49th STREET, WOODSIDE 77, N. Y.
EXETER 2-1336

Color TV Training Series

(Continued from page 9)

axes than along the R - Y and B - Y axes. This is particularly true in the reproduction of flesh tones, since they lie along the I axis. It was also found that for colors that are in small areas and are well-centered in the field of vision, the chromaticity diagram degenerates to a single line. This line is the I axis, and only two fully saturated colors, orange and cyan, are needed to reproduce colors under these conditions.

The I signal is formed by combining $.74 (E_R - E_Y)$ and $-.27 (E_B - E_Y)$. The Q signal is composed of $.48 (E_R - E_Y)$ and $.41 (E_B - E_Y)$. The equations for I and Q are written as follows:

$$E_I = .74 (E_R - E_Y) - .27 (E_B - E_Y), \quad (8)$$

$$E_Q = .48 (E_R - E_Y) + .41 (E_B - E_Y). \quad (9)$$

Substituting for E_Y of equation 4, we obtain E_I and E_Q in terms of the three primary colors:

$$E_I = .60E_R - .28E_G - .32E_B, \quad (10)$$

$$E_Q = .21E_R - .52E_G + .31E_B. \quad (11)$$

The mixing of the three output voltages of the camera to form the luminance signal and the color signals is performed in the matrix unit of the transmitter. See the partial block diagram of a color transmitter shown in Fig. 3-3. The output of the matrix consists of the luminance signal and the I and Q color signals. It should be pointed out that signals from the color camera are gamma corrected by passing them through gamma amplifiers. This correction is to compensate for the non-linear operation of the picture tube. Since gamma correction is also provided in the black-and-white transmitter, no block for this operation is shown in Fig. 3-3.

From the matrix, the luminance signal is fed through a bandpass filter to the adder section. The color signals are fed to the modulator sections where they are used to

modulate the color subcarrier. The I signal modulates a subcarrier, $\cos (\omega t + 33^\circ)$; whereas, the Q signal modulates a subcarrier, $\sin (\omega t + 33^\circ)$. As stated before, the carrier is generated by the subcarrier oscillator at a frequency of 3.579545 mc. The carrier, $\sin (\omega t + 33^\circ)$, is fed directly to the balanced modulator for the Q signal where it is modulated by this signal. Before being fed to the modulator for the I signal, the carrier goes through a phase-shifter stage where it is changed in phase by 90 degrees to $\cos (\omega t + 33^\circ)$. Then it is fed to the modulator where it is modulated by the I signal.

The outputs of the modulators are fed to an adder section where they combine with the luminance signal. The output of this adder section is the color picture signal, which is specified by the NTSC standards as follows:

$$E_M = E_Y + [E_Q \sin (\omega t + 33^\circ) + E_I \cos (\omega t + 33^\circ)]. \quad (12)$$

The sync, blanking, and color-burst signals are added to the color picture signal; then the composite color signal is fed to the radio-frequency transmitter for transmission.

Bandwidths of Luminance and Chrominance Signals

Let us consider the band limitations of the luminance and chrominance signals. It has been stated before that the luminance signal in color transmission must retain the same specifications that the video signal has in black-and-white transmission in order to meet compatibility requirements. Therefore, the luminance signal modulates the amplitude of the color picture carrier. Since the color video channel extends to 4.2 mc above the picture carrier so that the upper sidebands of the chrominance signal can be accommodated, the sidebands representing luminance information can also extend to 4.2 mc. This limit is 0.2 mc greater than the limit of the sidebands in monochrome transmission; consequently, a slight increase in fine detail is obtainable with color transmission in comparison to monochrome transmission.

Before learning the band limitations of the chrominance portion of the color picture signal, let us see what factors led to the specific limitations that were placed

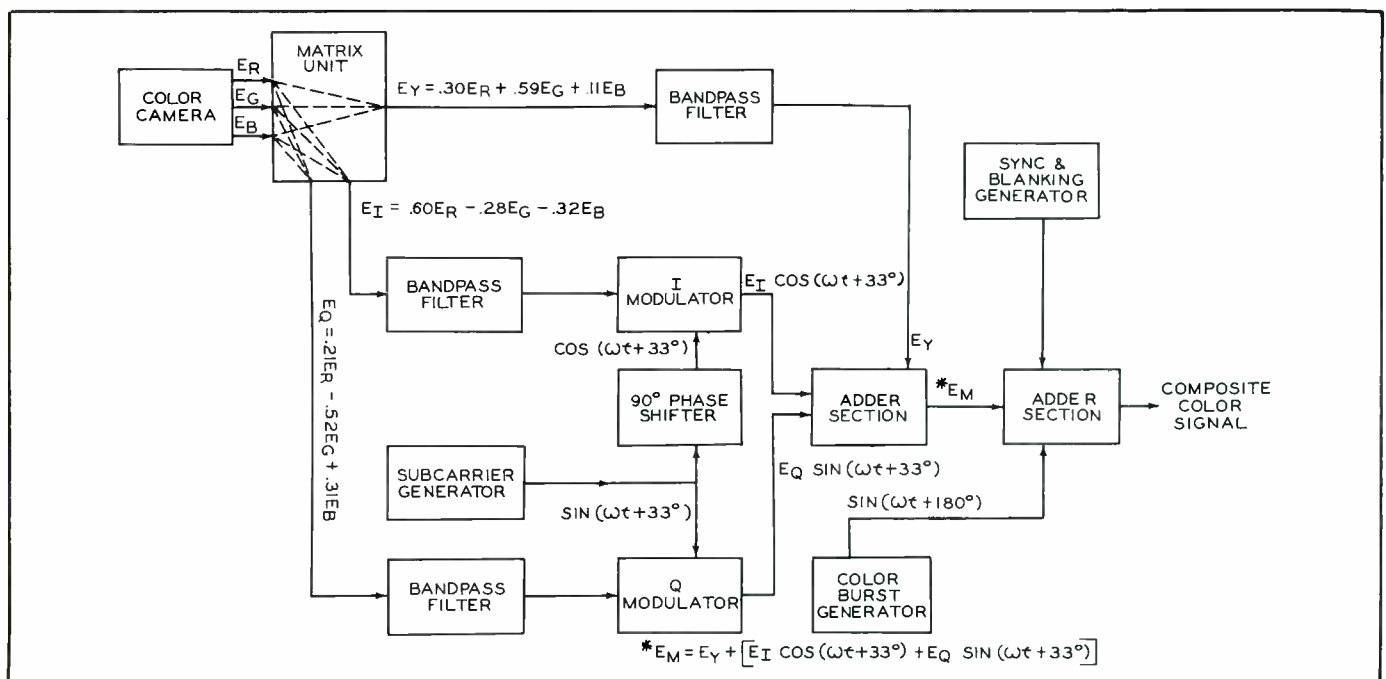

Fig. 3-3. Partial Block Diagram of a Color TV Transmitter.

upon the chrominance signal. Just what amount of color information should be transmitted was decided after known facts about the characteristics of the eye were taken into consideration.

From the results of experiments that were performed prior to color television, it was determined that fine detail in color cannot be seen by the average observer. Tests were made in which colored objects were reduced in size and viewed at a distance. When this was done, a number of things were found to be true. First, blues become indistinguishable from grays of equivalent brightness. Second, yellows become indistinguishable from grays. Within the same size range, browns become confused with crimsons and blues with greens, but reds remain clearly distinct from blue-greens. Colors with pronounced blue lose blueness; whereas colors lacking in blue gain blueness. Third, with a further decrease in size, reds merge with grays that have equivalent brightness and blue-greens become indistinguishable from grays. Finally, when viewing extremely small colored objects, the ability to identify color is lost entirely and only a response to brightness remains.

From the foregoing data which was obtained from the experiments on human color vision and from tests made with color receivers, the following choices of bandwidths were made.

1. Full-band transmission of the luminance (Y) signal for maximum detail.
2. Moderately wide-band partly single-sideband transmission of a single color-mixture signal (I signal) which distinguishes colors in the regions of orange

and cyan. The eye can see medium detail in these regions.

3. Narrow-band, double-sideband transmission of an additional color-mixture signal (Q signal). This signal distinguishes yellow-green from magenta. The least detail can be seen in these colors.

Shown in Fig. 3-4 is the passband of the color picture signal. The Q signal is limited to .5 mc and is transmitted double sideband. The I signal is also double sideband for frequencies up to .5 mc and single sideband for frequencies from .5 mc to 1.5 mc.

When frequencies of 0 to .5 mc are present, the three transmission channels Y, I, and Q are operative. A three-color system of transmission is used because both the I and the Q color channels and the luminance channel are in operation. For frequencies of .5 to 1.5 mc, only the I channel and the luminance channel are operating — the Q channel is inoperative. A two-color (orange-cyan) system is in effect at these frequencies. For frequencies above 1.5 mc, only the Y channel is in operation. The Y channel conveys the fine detail in the picture in terms of brightness variations.

Color-Bar Pattern

The make-up of the color picture signal can be illustrated by a color-bar chart like that in Fig. 3-5. Through the use of this chart, the relative level of each component of the color picture signal can be shown. Let us develop the color picture signal by analyzing the voltages which are present as each bar is being scanned. This

RADELCO

LIGHTNING ARRESTOR
FITS FLAT, OVAL, ROUND
AND OPEN CABLES!



Model R-122

IT'S NEW! IT'S BETTER!
 The only Underwriters Listed UHF-VHF Lightning Arrestor selling at 90c list.

ORDER FROM YOUR NEAREST PARTS JOBBER

LIST PRICE **90c**

FOR EXTRA PROFITS
 INSTALL A  **Tuner-Kleen'r**
ON EVERY TV SERVICE CALL!



- ★ Fits All Standard Tuners
- ★ Easy To Install
- ★ Builds Good Will
- ★ Improves Reception—Stops Noise

Every Standard Coil Tuner can use TUNER-KLEEN'R . . . and it takes only seconds to install. TUNER-KLEEN'R cleans both stationary and rotary contacts with every twist of the channel selector . . . assures better reception and stops noise. You'll make more on TV servicing . . . keep your customers happier, too!

AT LEADING DISTRIBUTORS . . . ONLY \$1.67 LIST

 **GENERAL CEMENT MFG. CO.**
 903 TAYLOR AVENUE
 ROCKFORD, ILLINOIS



*"In America even
 the workers can buy
 JENSEN NEEDLES"*

analysis should provide a better understanding of the mixing proportions.

Shown at the top of each column in Fig. 3-5 is a simple color-bar chart which represents each of the three primary colors. The colors in the chart are considered to be fully saturated, which means that they are completely free of white light. When this chart is scanned by the color camera, a color signal is produced. The development of the color signal can be illustrated by showing the waveforms that are formed during the process.

Directly below the test bars in column I of Fig. 3-5 are the waveforms which are representative of each of the camera output signals. The signal waveform shown for the red output of the camera reaches a maximum value of unity when the red bar is scanned. During the scanning of the green and blue bars, this signal drops to zero since no light reaches the red camera tube. The waveform for the green signal reaches unity during the scanning of the green bar. While scanning the other two color bars, the signal drops to zero. Similarly, the blue signal reaches unity during the scanning of the blue bar and goes to zero during the time the other two bars are scanned. From the three camera output signals shown in Fig. 3-5, the signals which make up the color picture signal are formed.

In column II of Fig. 3-5, the waveform for the luminance signal is shown. It was previously stated in equation 4 that the luminance signal was formed by taking 30 per cent of the red signal, 59 per cent of the green signal, and 11 per cent of the blue signal and adding them together. These percentages are represented by the waveform of the luminance signal shown. During the scanning of the red bar, E_Y reaches a level of .30; during the scanning of the green bar, it reaches .59; and during that of the blue bar, it reaches .11.

The next signals to be formulated are the three color-difference signals. These are shown in column III of Fig. 3-5. The expressions $E_R - E_Y$, $E_G - E_Y$, and $E_B - E_Y$ for these color-difference signals signify that the luminance signal is subtracted from each of the camera signals. Subtraction of the waveform for the luminance

signal from the waveform for E_R will give the waveform for $E_R - E_Y$. Subtraction of .30 from 1.00 leaves a value of .70 for the $E_R - E_Y$ signal during the scanning of the red bar. Since there is no voltage from the red output in the camera during the scanning of the green and blue bars, the remainder of $E_R - E_Y$ will be negative. It will be -.59 during the scanning of the green bar and -.11 during the scanning of the blue bar. The same method is followed for obtaining the waveforms for $E_G - E_Y$ and $E_B - E_Y$ as they are shown in Fig. 3-5. Note that the values which appear on the waveforms are the same as the coefficients previously given in the equations 5, 6, and 7 for these color-difference signals.

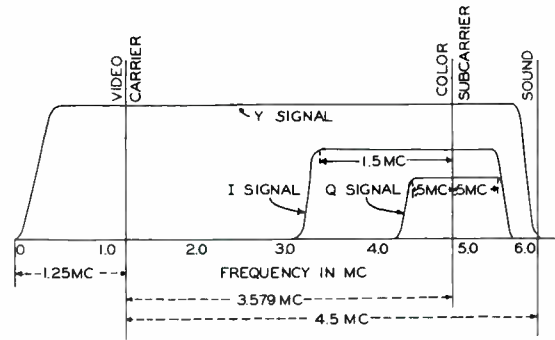

Fig. 3-4. Passband of the Color Picture Signal.

It has been stated that the color-difference signal representing green is not transmitted. It is obtained in the receiver by the mixing of $-.51(E_R - E_Y)$ and $-.19(E_B - E_Y)$. We have proved this mathematically. The manner in which $E_G - E_Y$ is obtained can be shown graphically by using the waveforms of the color-difference signals. By taking the numerical values of the $E_R - E_Y$ waveform shown in Fig. 3-5 and multiplying them by the factor of $-.51$, we obtain waveform A shown in Fig. 3-6. Waveform B is the result of multiplying the numerical values of the waveform for $E_B - E_Y$, in Fig. 3-5, by the factor of $-.19$. The addition of waveform A and waveform B together results in waveform C. This is the same wave-

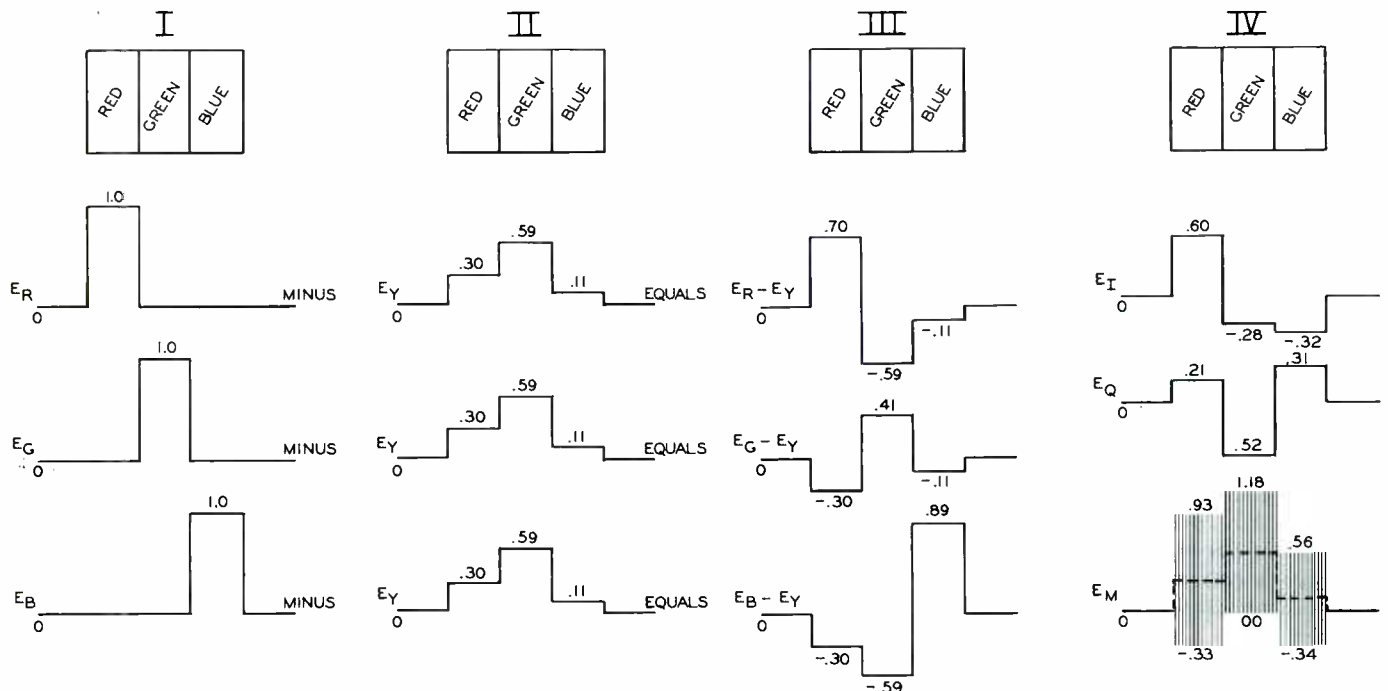

Fig. 3-5. Color-Bar Patterns Formed When Scanning a Chart Consisting of Red, Green, and Blue Bars.

form that is shown in Fig. 3-5 for $E_G - E_Y$. Again we have shown that the color-difference signal representative of green can be recovered by proportionately mixing the other two color-difference signals.

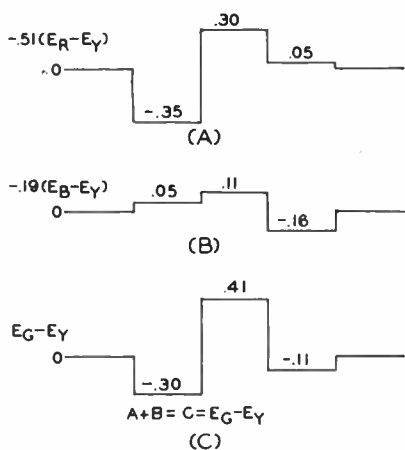

Fig. 3-6. Formation of $E_G - E_Y$.

In column IV of Fig. 3-5, waveforms for the I and Q signals are presented. The I waveform is obtained by adding .74 of the $E_R - E_Y$ signal and $-.27$ of the $E_B - E_Y$ signal. The Q waveform is obtained in a similar manner; however, this signal is formed by combining .48 of the $E_R - E_Y$ signal and .41 of the $E_B - E_Y$ signal. The numerical values shown in Fig. 3-5 for the I and Q signals correspond to those previously given in equation form.

The last waveform in Fig. 3-5 represents the color picture signal E_M which is the signal that is transmitted. The numerical values shown with the E_M waveform specify the levels of the maximum excursions of the

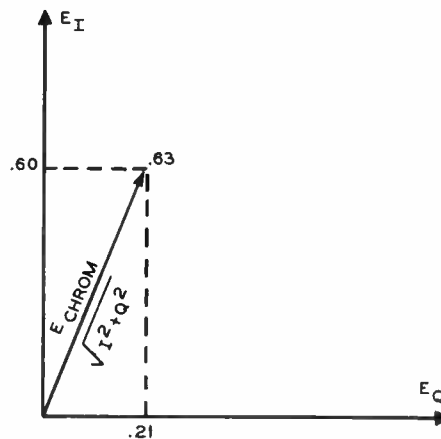
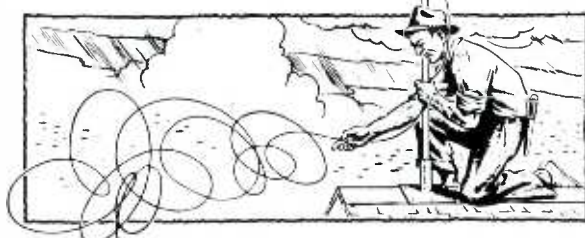
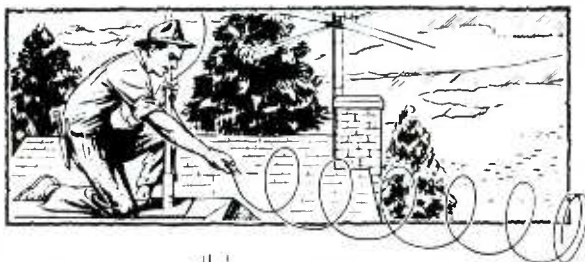

Fig. 3-7. Vectorial Addition of I and Q Amplitudes.

chrominance signal. To determine these levels, the values of I and Q are added together vectorially; and then the results are added to and subtracted from the luminance levels. Fig. 3-7 shows how the red portion of the signal is formed by this vectorial method. The resultant vector which represents the red portion is found by marking off the values of I and Q on their respective vectors. As shown on the waveforms for I and Q, the I value for red is .60 and the Q value for red is .21. The resultant vector is drawn from the origin of the vectors to the opposite

Non-Snarling, Pre-Measured Wire Strand

WRIGHT Wire Strand uncoils like this →



← WRIGHT unique process prevents this

Besides the important factor of no snarling, WRIGHT TV GUY WIRE is pre-measured. Every concentric coil measures two feet—time and money saver in guying antennas. WRIGHT TV GUY WIRE has great flexibility and is heavily galvanized . . . continuous connected coils.

Prompt deliveries from stocks in Worcester, Chicago, New Orleans, Houston, Dallas and Los Angeles.

G. F. WRIGHT STEEL & WIRE CO.

245 Stafford St. • Worcester, Mass.

ATLAS PROJECTORS



9 models to choose from for EVERY application

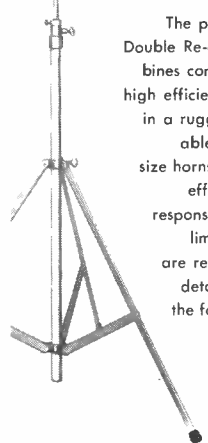

The performance-proved ATLAS Double Re-entrant ('DR') design combines compactness with unequalled high efficiency and uniform response in a rugged, stormproof, demountable construction. The larger size horns are excellent for greatest efficiency and low-frequency response. Where space and cost limits exist, the smaller horns are recommended. For complete details on 'DR' Projectors and the famous ATLAS line of Public Address and Microphone Stand equipment . . .

WRITE NOW for FREE Catalog 553



ATLAS SOUND CORP.
1448 39th St., Brooklyn 18, N. Y.
In Canada, Atlas Radio Corp., Ltd., Toronto, Ont.

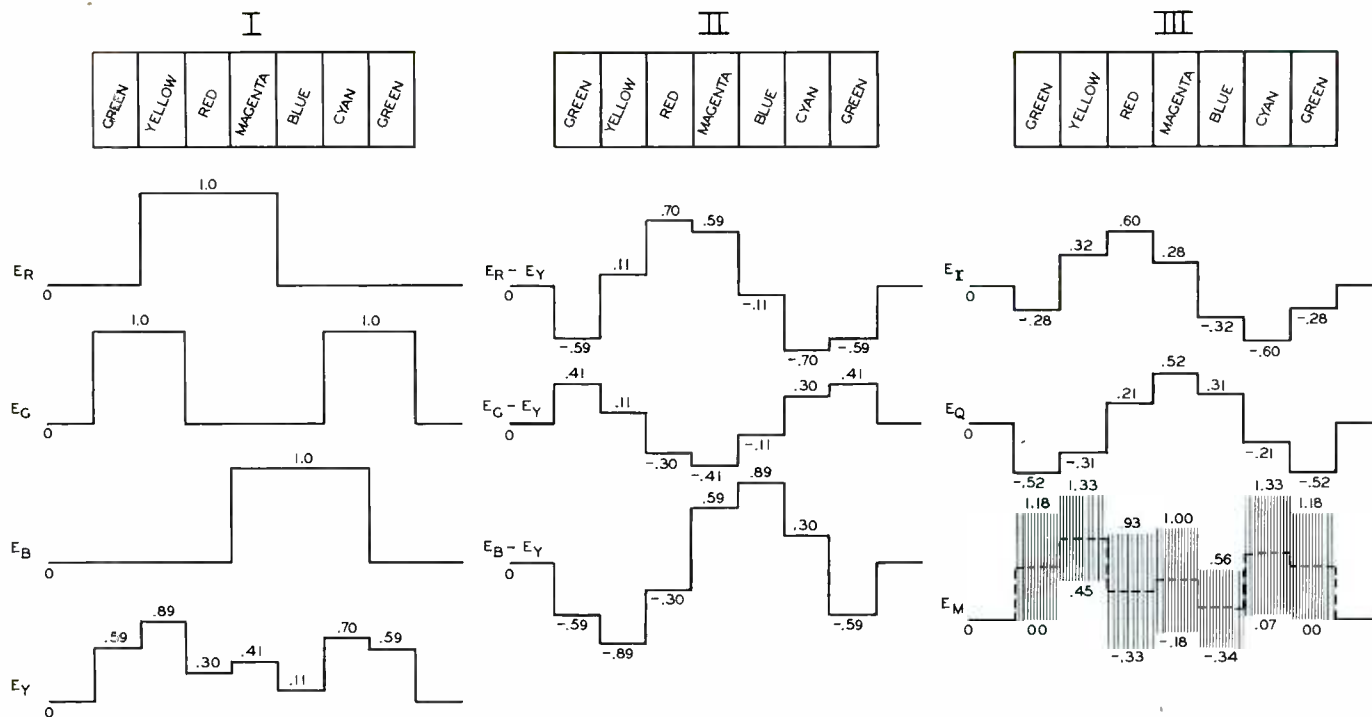

Fig. 3-8. Color-Bar Patterns Formed When Scanning a Color-Bar Chart Consisting of the Three Primaries and Their Complements.

corner of the parallelogram. The magnitude of the resultant vector is found by taking the square root of the sum of the squares. In algebraic form this process can be written:

$$\sqrt{I^2 + Q^2}.$$

Substituting the values for I and Q and solving we have;

$$\sqrt{(.60)^2 + (.21)^2} = .63.$$

The same procedure is followed for finding the values for the green and blue portions of the chrominance signal. Green has a value of .59 and blue .45.

Let us now consider the waveforms produced when scanning a color-bar chart which not only includes the three primary colors but also their complementary colors. Such a color-bar chart and the associated waveforms are shown in Fig. 3-8. The colors represented are green, yellow, red, magenta, blue, and cyan. These colors are assumed to be fully saturated.

The waveforms of first concern are the three outputs of the camera. During scanning of the green bar, a signal is produced at the output of the green camera tube only. When scanning yellow, the camera has outputs in red and green. This is to be expected since we must combine red and green in order to produce yellow.

While the red bar is scanned, a signal is present in the output of the red camera tube only. Since red and blue combine to produce magenta, outputs from the red and blue camera tubes occur while the magenta bar is being scanned.

During the scanning of the third primary color, blue, there is a signal in the output of the blue camera tube only. There is an output at both the green and blue camera tubes while the cyan bar is being scanned. These outputs are needed because green and blue combine to produce cyan.

The next waveform shown in Fig. 3-8 is the luminance signal. The levels of the luminance signal for red, green, and blue are the same as those shown in Fig. 3-5. Yellow, however, produces a luminance value of .89, which is made up of 59 per cent of green plus 30 per cent of red. Magenta has a level of .41, or 30 per cent of red plus 11 per cent of blue. Cyan contains 11 per cent of blue plus 59 per cent of green and has a luminance value of .70. Yellow has the highest luminance level, whereas blue has the lowest luminance level.

The color-difference waveforms are formed in the same manner as before by subtracting the luminance signal from each of the three color signals from the camera. After doing this with the waveforms shown in Fig. 3-8 we have the waveforms shown in column II for $E_R - E_Y$, $E_G - E_Y$, and $E_B - E_Y$.

The waveforms for I and Q are obtained by proportionately mixing the color-difference signals $E_R - E_Y$ and $E_B - E_Y$. By taking .74 ($E_R - E_Y$) and adding the result to $-.27$ ($E_B - E_Y$), we obtain the waveform for the I signal shown in column III of Fig. 3-8. The waveform for the Q signal is formed by taking .48 ($E_R - E_Y$) and adding this to .41 ($E_B - E_Y$).

The chrominance signal combined with the luminance signal is shown as the last waveform of Fig. 3-8. The values on this waveform were determined by vector addition of the I and Q signals, as previously described.

The relative saturation of a color is conveyed by the ratio of the chrominance-signal amplitude to the luminance-signal amplitude. The more highly saturated the color, the higher the ratio becomes. Moreover, the ratio remains fixed for a color with a given saturation regardless of the brightness of the color.

Shown in Fig. 3-9 is a color-bar pattern together with various signals which are produced at the color transmitter as the camera scans the pattern. The pattern consists of three bars which are all red and which have specific saturation and brightness levels. Red No. 1 is a

fully saturated red with a brightness that is equivalent to 30 per cent of white. Red No. 2 has the same brightness as the bar on the left, but it has a saturation of only 50 per cent. Red No. 3 is a red with a saturation of 50 per cent, but it has a brightness level of 65 per cent of white.

In column I, the three outputs from the camera are pictured. Naturally, only a red output occurs during the scanning of fully saturated red No. 1. For each of the red bars with a saturation of 50 per cent, the green and blue tubes in the camera have equal outputs but the red tube has twice the output of either of the others.

The luminance signal E_Y is shown in column II. Its value can be checked by computations based upon equation 4. In a similar way E_I and E_Q may be found through the use of equations 10 and 11.

Adding E_I and E_Q vectorially gives the peak values of the color subcarrier, and then the color picture signal E_M is formed by superimposing the color subcarrier on the luminance signal E_Y . See column III in Fig. 3-9.

The chrominance-signal amplitude during the scanning of a color is not necessarily a measure of the saturation of that color. Instead, the relative saturation is dependent upon the ratio of the chrominance amplitude to the luminance amplitude. In going from red No. 3 to No. 1, for example, the chrominance amplitude increases and the luminance amplitude decreases. This definitely indicates an increase in saturation. (The ratio of chrominance to luminance increases.) In going from red No. 2 to red No. 3, however, the chrominance amplitude increases but the luminance amplitude also increases. The observer has no assurance in this case that the saturation has in-

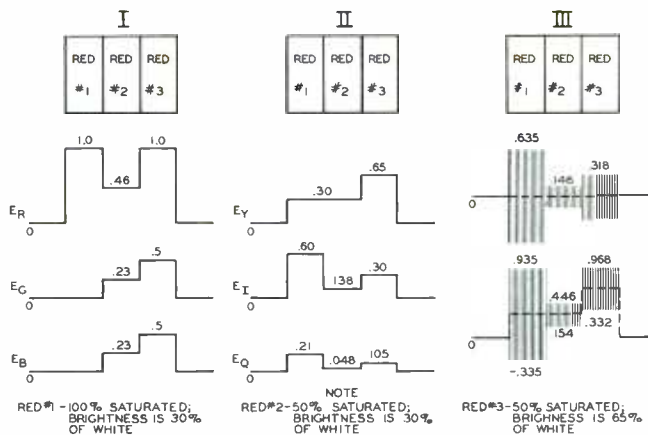

Fig. 3-9. Color-Bar Patterns Illustrating the Effects of Changes in Saturation and Brightness.

creased without considering the ratio of the chrominance amplitude to the luminance amplitude. Actually, we know these two colors have the same saturation because we have established this condition.

In the foregoing example, we have considered only one color — red. The ratio of chrominance to luminance for a fully saturated red is:

$$\frac{.635}{.3} = 2.1.$$

However, as the hue varies, the ratio will also vary. Table I is a list of the chrominance-to-luminance ratios

TABLE I

Chrominance-to-Luminance Ratios For Fully Saturated Colors

COLOR	RATIO
Red	2.1
Yellow	.5
Green	1.0
Cyan	.9
Blue	4.05
Magenta	1.45

for the three primary colors and their complements under fully saturated conditions. Since many color-bar generators produce fully saturated colors, the knowledge of these ratios should be helpful in servicing and adjusting color receivers.

Vector Relationship of Color Signals

A change in hue results in a corresponding change in phase of the color signals with respect to the reference burst. When we speak of the phase of a color signal, we are stating how many degrees it is removed from the reference signal. For example, if it is stated that a certain chrominance signal has a phase angle of 57 degrees, this means that the difference in degrees between that signal and the reference signal is 57 degrees.

Phase relationships are most conveniently shown by the use of vectors. Fig. 3-10 contains vector diagrams

NEW DUAL SECTION ELECTROLYTIC CAPACITORS HERMETICALLY SEALED IN ALUMINUM TUBES WITH COMPLETELY FLEXIBLE INSULATED LEADS. By riveting the leads directly to the condenser end disc, Planet has eliminated the use of rigid terminal risers ordinarily used on this type construction. This allows Planet Type IL capacitors to fit into a smaller space and eliminates the possibility of lead breakage.

PLANET "ENGINEERED FOR QUALITY" GUARANTEED FOR ONE YEAR

PLANET MANUFACTURING CORPORATION
 225 BELLEVILLE AVENUE
 BLOOMFIELD, N. J.

Write for Catalog 200—Lists Specifications on Stock Items

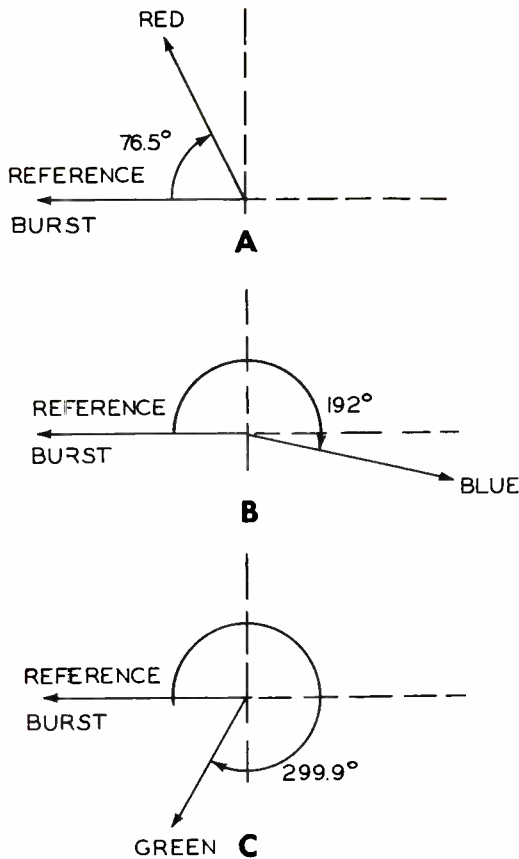

Fig. 3-10. Vector Diagrams Showing the Phase Displacement of Chrominance Signals With Respect to the Reference Burst.

showing the phase displacement of chrominance signals as they are related to the reference burst. It can be seen that each signal is associated with a particular phase angle. A change in phase of the chrominance signal is the only way a change in hue can be conveyed.

Each vector shown in Fig. 3-10 specifies a position of the chrominance signal at a certain instant during the scanning of a scene. Actually the chrominance vector and the reference vector are constantly rotating during the time that color is being transmitted. A color vector changes in phase whenever there is a change in hue, and it changes in length in accordance with brightness and saturation changes. The functions of the chrominance vector and reference vector can be analogized to the counterclockwise rotations of two wheels each having a radial line drawn on it. One wheel is rotating at a constant speed or frequency, and the second wheel is rotating at a variable speed. Since the first wheel rotates at a constant speed, we can let the line on it serve as a reference to which we can compare the rotation of the second wheel. The operation of this constant-speed wheel with its line of radius is similar to that of the reference-burst vector which rotates at a constant frequency of 3.58 mc and is held at this set frequency at all times. The speed of the second wheel is made to change, either to increase or to decrease. It can run at speeds higher than, lower than, or equal to the speed of the reference or constant-speed wheel. The line on the wheel of variable speeds performs in a manner which is analogous to that of the chrominance vector. If the two wheels are brought to a sudden stop, the phase difference between the positions of the two lines on the wheels can be determined.

This is in effect what has been done with the vectors that are shown in the drawings of Fig. 3-10. The rotating

chrominance vector and the reference-burst vector have been instantaneously halted. Part A of Fig. 3-10 shows the positions of the vectors at an instantaneous time. The position of the chrominance vector is shown as lagging the reference burst by 76.5 degrees. This difference in phase is representative of a particular color. The chrominance vector at this phase angle represents a red hue. Parts B and C of this figure show the positions of the vectors at two different times. In part B, the chrominance vector is lagging the reference burst by 192 degrees, and this represents a blue hue. In part C, it is lagging the reference burst by 299.9 degrees. With the chrominance vector in this position, a green hue is being represented.

Let us say that a color-bar pattern such as the one which was shown in Fig. 3-5 is being scanned. The vectors will operate as follows. While the red bar is being scanned, the vectors of Fig. 3-10A will rotate in the position as shown. The chrominance vector will lag the reference burst by 76.5 degrees and the angle between the two vectors will remain the same during the entire scanning of the red bar. When the camera starts to scan the green bar, the chrominance vector is changed in position to correspond to that shown in Fig. 3-10C. It will remain at this lagging angle of 299.9 degrees until the green bar is entirely scanned. Then its position will be changed to correspond to that shown in Fig. 3-10B when the blue bar is scanned. These two vectors for chrominance and for reference keep spinning but hold the same phase difference of 192 degrees while blue is scanned.

Shown in Fig. 3-11 is a color-phase diagram which represents the color vectors of the system in composite form. It shows the positions of the vectors for the three primary colors employed in color TV, their three complementary colors, the I and Q signals, and the color-difference signals. The positions of the vectors for the primary colors are as follows: (1) for red, reference burst minus 76.5 degrees; (2) for blue, reference burst minus 192 degrees; (3) for green, reference burst minus 299.9 degrees. This means that when one of these colors is being transmitted, the vector representing that color is lagging the reference burst by the number of degrees designated. The vectors for the three complementary colors are shown by dashed lines in opposite directions from those for the three primary colors. Each complementary color is 180 degrees out of phase with its corresponding primary. For instance, yellow which is the complement of blue has a lagging phase angle of 12 degrees with respect to the reference burst. Magenta has a lagging phase angle of 119.9 degrees with respect to the reference burst; and cyan has a lagging phase angle of 256.5 degrees with respect to the reference burst.

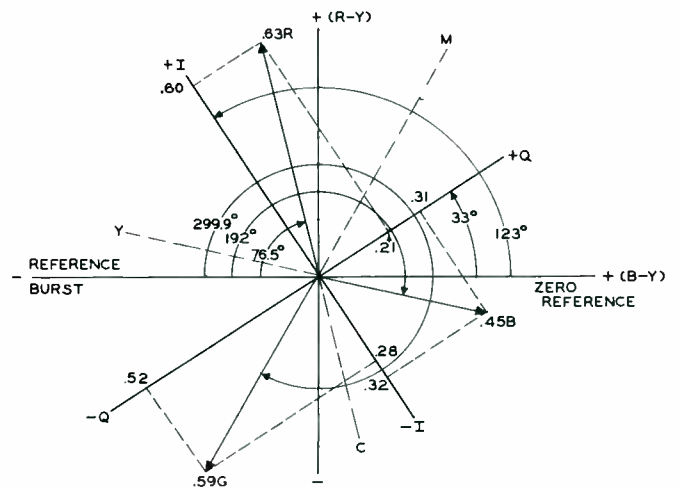

Fig. 3-11. Color-Phase Diagram.

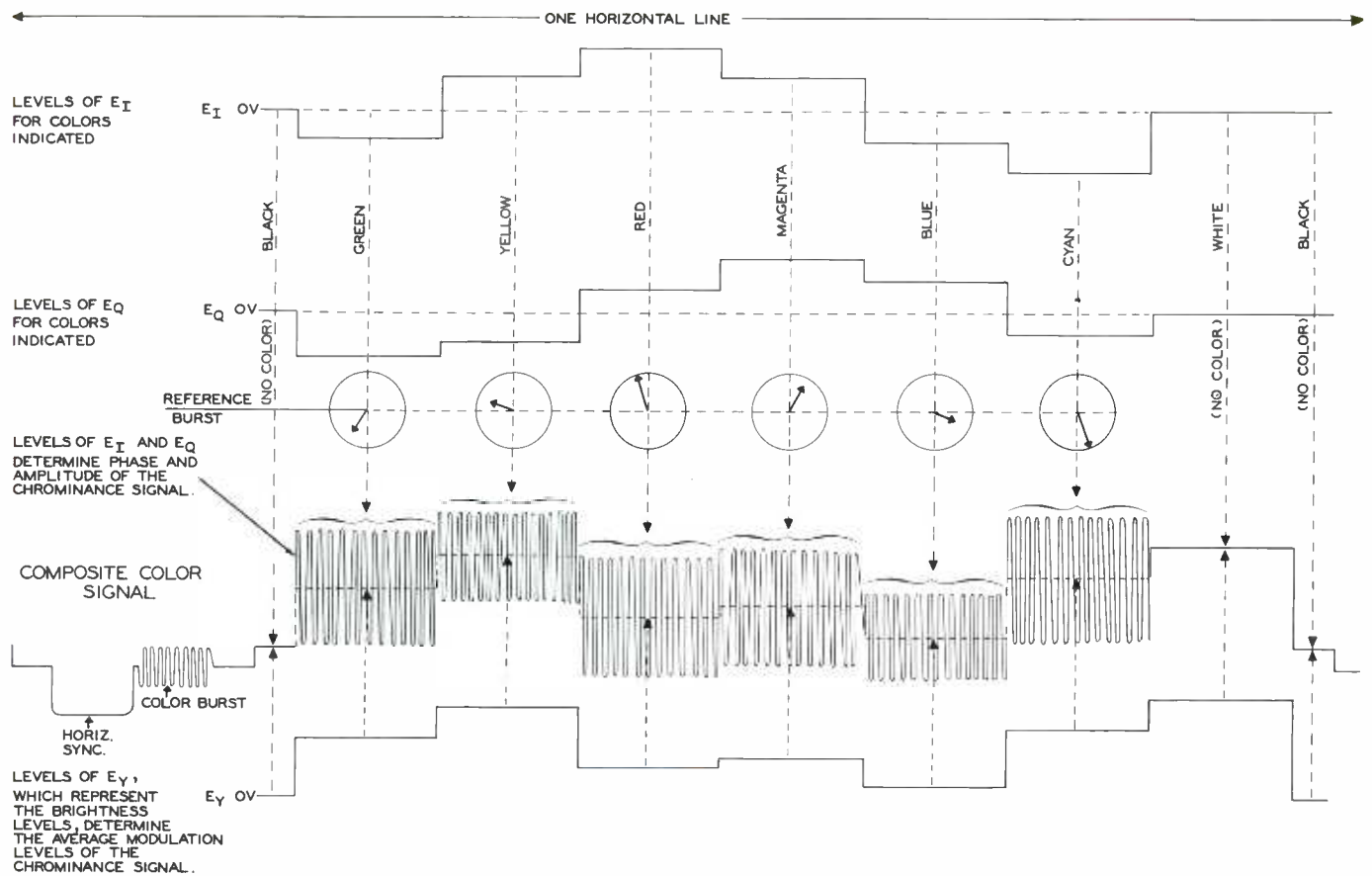

Fig. 3-12. An Expanded Horizontal Line Which Illustrates the Make-up of the Composite Color Signal.

The I and Q vectors are shown in relationship to the zero reference, which has a phase of 180 degrees with respect to the reference burst. The Q signal leads the zero reference by 33 degrees. (This angle can also be expressed as an angle which lags the reference burst by 147 degrees.) The I vector leads the zero reference by 123 degrees. (This angle can also be expressed as an angle which lags the reference burst by 57 degrees.) The difference in degrees between the I signal and R - Y and between the Q signal and B - Y is 33 degrees.

SUMMARY

The foregoing discussion has covered the make-up of the composite color signal. It has shown how the sig-

nal is formed at the transmitter and of what this signal consists. The mixing proportions of all the signals that combine to form the composite color signal have been discussed. It has also been shown how brightness, hue, and saturation are conveyed by the color signal. The make-up of the color signal is of great importance because the color receiver must accept this signal and must convert it back into the original colors of the televised scene.

Fig. 3-12 serves as a means of showing in graphic form the major points that have been previously covered. It shows that three different signals combine to form the color picture signal. As shown in the drawing, by the arrows progressing downward, the two signals E_I and E_Q combine together to form the chrominance portion of the color picture signal. The arrows pointing upward show the luminance level of the color picture signal. The chrominance signal is superimposed on the luminance signal which determines the average modulation levels of the chrominance signal. The relative saturation of a color is determined by the ratio of the chrominance-signal amplitude to the luminance-signal amplitude. Hue is determined by the phase of the chrominance signal with respect to the reference burst. The vectors shown in the circles represent the phase for each color. With blanking, sync, and color burst added to the color picture signal, the composite color signal is formed.

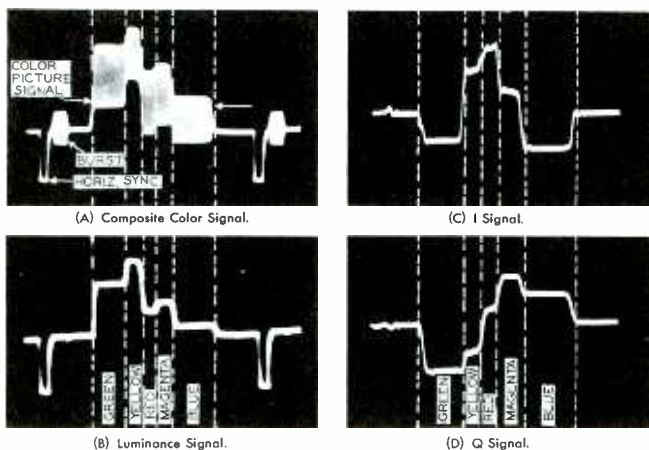
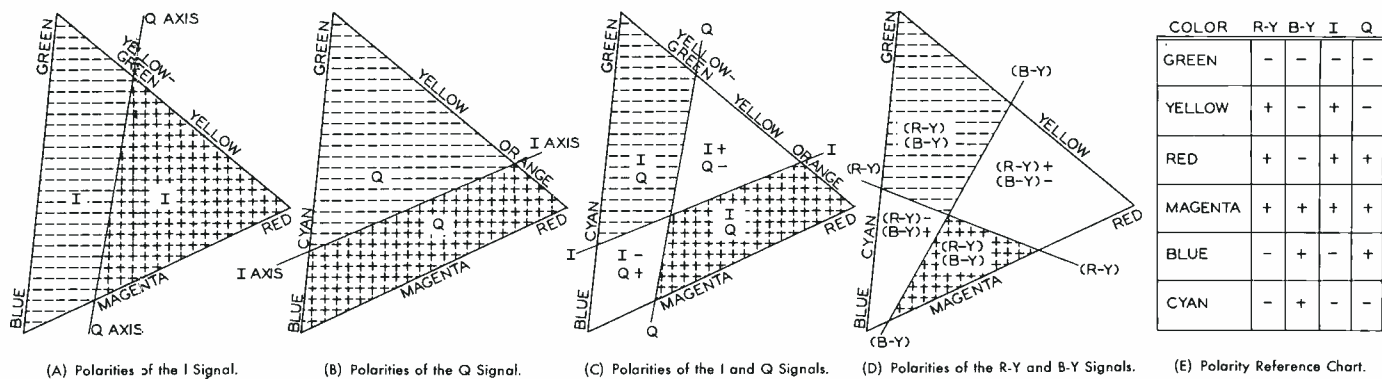

Fig. 3-13. Waveforms From a Color-Bar Generator.

Photographs of the various waveforms that are contained in the composite signal are shown in Fig. 3-13. They were taken from a Hickok color-bar generator, Model 655 XC. Fig. 3-13A shows the composite color signal. The color bars represented by this signal are (from left to right) green, yellow, red, magenta, and blue.



COLOR	R-Y	B-Y	I	Q
GREEN	-	-	-	-
YELLOW	+	-	+	-
RED	+	-	+	+
MAGENTA	+	+	+	+
BLUE	-	+	-	+
CYAN	-	+	-	-

Fig. 3-14. Color Triangles Showing Polarities of the Color Signals.

Fig. 3-13B is the luminance-signal waveform. Figs. 3-13C and 3-13D are the I and Q signals, respectively. Notice that each color bar produces signal levels which were illustrated graphically in previous drawings in this article.

A good way to remember the signal polarities associated with various colors is through the use of the color triangle. During this discussion, the reader may have noted that the I, Q, and color-difference signals for some color bars have a negative polarity and for other colors the signals have a positive polarity. By studying the color triangles of Fig. 3-14, the reader may find it easier to remember which colors produce an I, Q, or color-difference signal that is negative and which provide a positive signal.

On the color triangle of Fig. 3-14A, the polarities of the I signals for all colors are given. The colors which fall to the right of the Q-axis are represented by positive I signals, and the colors to the left of the Q-axis produce negative I signals. For instance, blue, cyan, and green are negative, magenta, red, and yellow are positive as to the I-signal polarity. Fig. 3-14B shows the polarities of the Q signals for all colors. As can be seen, the colors that lie above the I-axis are represented by negative Q signals, and those lying below the axis produce positive Q signals. Cyan, green, and yellow are negative; and blue, magenta, and red are positive as to the Q-signal polarity.

A composite drawing of triangles A and B is shown in Fig. 3-14C. Notice that the I and Q signals for colors which lie in the upper left-hand section of the triangle are negative and that the signals representing colors in the lower right-hand section are positive. Colors lying in the other two sections produce I and Q signals which are opposite in polarity. For instance, the Q signal is positive for blue, but the I signal is negative for blue.

The key for determining the correct polarity of these signals is in knowing the location of the colors on the triangle and in remembering the negative and positive areas shown in Figs. 3-14A and 3-14B. With this knowledge, the polarities of the signals for each color can be easily determined.

Fig. 3-14D shows the polarities of the R - Y and B - Y signals for all colors on the color triangle. This drawing can be used to determine the polarities of the R - Y and B - Y signals in the same manner that Fig. 3-14C can be used to determine the polarities of the I and Q signals. Fig. 3-14E lists the various signal polarities in tabular form for those who may prefer this type of presentation.

This completes the discussion on the make-up of the color picture signal. In the next issue, we will describe

in detail the operation of various circuits in the color receiver.

In order to give the reader an opportunity to test himself we are including a few questions the answers to which are given in this discussion.

1. What can be said about the outputs from the tubes in a color camera if the scene is colorless or gray?
2. What fully saturated primary color produces the darkest shade of gray on the screen of a monochrome receiver tuned to a color transmission?
3. What are the bandwidth limitations that have been set on the I, Q, and Y signals?
4. What are the polarities of the I and Q signals for each of the three primary colors? (See if you can determine them without having to refer to Fig. 3-14.)
5. What three signals in addition to the blanking, sync, and color burst signals are used to make up the composite color signal?

C. P. Oliphant and Verne M. Ray

GLOSSARY

COLOR-DIFFERENCE SIGNAL. The signal that results after the subtraction of the luminance signal from one of the color signals from the three outputs of the color camera.

COLOR PICTURE SIGNAL. That part of the composite color signal that conveys picture information.

DICHROIC MIRROR. A mirror that has the property of passing all the light of the spectrum except the color which it is designed to reflect.

I and Q SIGNALS. Signals which consists of certain proportions of the R - Y and B - Y signals.

REFERENCE BURST. A signal which is transmitted for the purpose of color synchronization in the receiver. This signal has a fixed phase and a frequency equal to that of the subcarrier.

VECTOR. A line representing both the direction and the magnitude of some force. As applied to color television, vectors are frequently used to express the instantaneous amplitude of the chrominance signal.

PF INDEX REPORTER

INDEX TO ADVERTISERS

August, 1954

Advertisers	Page No.
Aerovox Corp.	48
All Channel Antenna Corp.	62
American Television & Radio Co.	38
Atlas Sound Corp.	66
Belden Mfg. Co.	26
Bussmann Mfg. Co.	8
Centralab Div. Globe- Union, Inc.	44, 50, 56
Channel Master Corp.	16
Chicago Standard Trans. Corp.	30
Clarostat Mfg. Co., Inc.	18
Clear Beam Antenna Corp.	32
DuMont Labs., Inc., Allen B.	4
Eby Sales Co.	48
Electronic Instrument Co., Inc. (EICO).	46
Equipto Div., Aurora Equipment Co.	52
Federal Telephone & Radio Co.	24
General Cement Mfg. Co.	64
International Rectifier Corp.	42
International Resistance Co.	2nd Cover
Jackson Electrical Instrument Co.	36
Jensen Industries, Inc.	64
Jensen Mfg. Co.	28
JFD Mfg. Co.	Insert
Littelfuse, Inc.	4th Cover
Macmillan Co., The	56
Mallory & Co., Inc., P. R.	6
Planet Mfg. Corp.	68
Quam-Nichols Co.	43
Radelco Mfg. Co.	64
Radio City Products Co., Inc.	62
Radio Corp. of America	20, 46, 54, 60
Raytheon Mfg. Co.	10
Regency Div., I. D. E. A., Inc.	1
Sams & Co. Inc., Howard W.	44, 54, 60
Shure Bros., Inc.	50
Sprague Products Co.	2
Standard Coil Products Co., Inc.	Insert
Sylvania Electric Products Inc.	3rd Cover
Tetrad Co.	40
Triplett Electrical Instr. Co.	Insert
Unitea Catalog Publishers, Inc.	40
Waldom Electronics, Inc.	52
Walsco Electronics Corp.	12
Ward Products Corp.	34
Wright Steel & Wire Co., G. F.	66

While every precaution is taken to insure accuracy, we cannot guarantee against the possibility of an occasional change or omission in the preparation of this Index.



It is undoubtedly just as well that we haven't encountered any burning issues to editorialize about in this issue. The only burning issue recognizable here is the weather and we have previously been informed not to mess with it editorially lest we disturb a shaky status quo between newspapers, broadcasters, telecasters and the weather bureaus. No one, but no one, wants to take credit for this summer.

A couple of years ago when we were younger in this field (or just plain younger) it seemed a great idea to point out an apparent lack of zeal on the part of the electronic service field during the summer months. So, all fired up with the great contribution we were going to make we prepared a few hundred words with a dozen or so platitudes like "don't let the dust gather on your test equipment" and then stepped back to take appropriate bows when these pearls of wisdom appeared in print.

Lets be kind and say that these sentiments went over with a dull thud. May we be properly and eternally grateful that our industry is not a violent one, at least in this connection. Nobody threw anything.

We may not learn rapidly, but we do, I hope, learn well. We are not just about to try and cross nature again so may we wish to all of our readers a most pleasant vacation. We fully intend, to have one ourselves starting right now.

J. R. R.

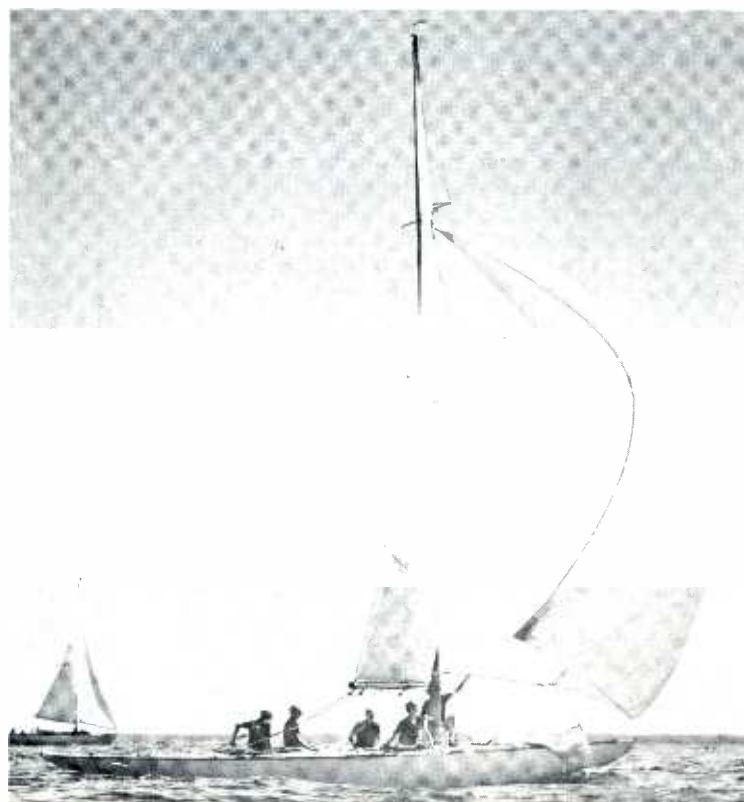

COLORBLOCK

Chart No. 2

NEL

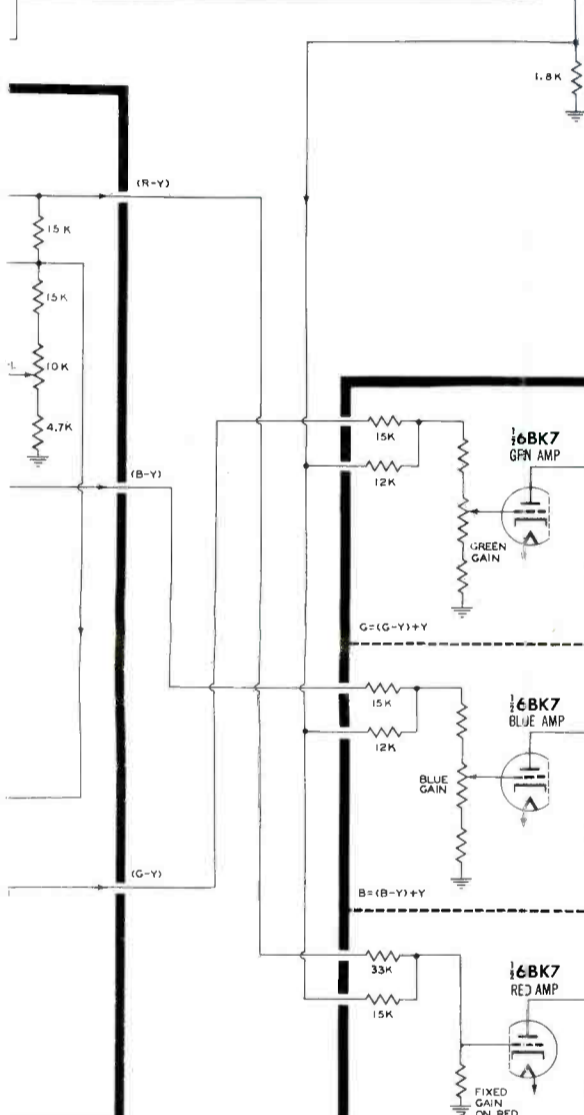
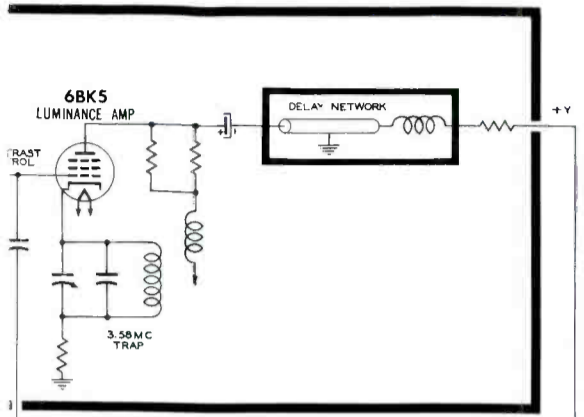

COLOR TRANSMISSION STANDARDS

- Horizontal-scanning frequency = 15,734.264 cps.
- Vertical-scanning frequency = 59.94 cps.
- Color subcarrier and burst frequency = 3.579545 mc.
- ERP of aural transmitter must not be less than 50% nor more than 70% of visual ERP.
- Equations of signals involved in color transmission:
 - $E_Y = 0.30E_R + 0.59E_G + 0.11E_B$
 - $E_R - E_Y = 0.70E_R - 0.59E_G - 0.11E_B$
 - $E_B - E_Y = -0.30E_R - 0.59E_G + 0.89E_B$
 - $E_G - E_Y = -0.30E_R + 0.41E_G - 0.11E_B$ (not transmitted as such)
 - $E_I = -0.27(E_B - E_Y) + 0.74(E_R - E_Y)$
 - $E_I = 0.60E_R - 0.28E_G - 0.32E_B$
 - $E_Q = 0.41(E_B - E_Y) + 0.48(E_R - E_Y)$
 - $E_Q = 0.21E_R - 0.52E_G + 0.31E_B$
 - $E_M = E_Y + [E_Q \sin(\omega t + 33^\circ) + E_I \cos(\omega t + 33^\circ)]$
 - For color-difference frequencies below 500 kc,

$$E_M = E_Y + \frac{1}{1.14} \left[\frac{1}{1.78} (E_B - E_Y) \sin \omega t + (E_R - E_Y) \cos \omega t \right]$$
- Hue determines the phase of the color subcarrier.
- Saturation determines the amplitude of the color subcarrier.

8. Frequency Distribution of the Color Signal

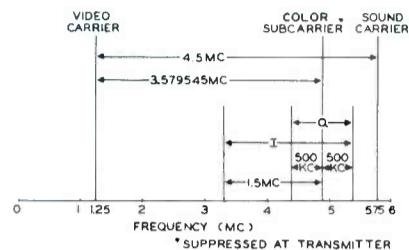

9. Color-Burst Specifications

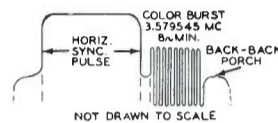

10. Color Phase Diagram

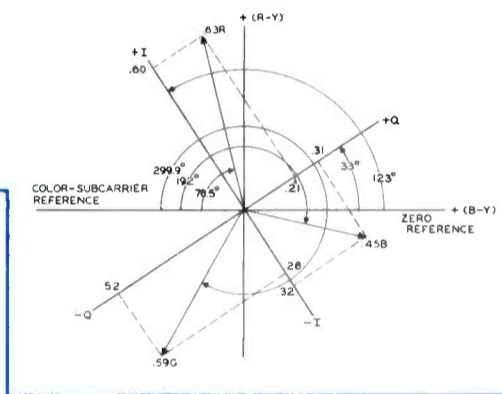

MATRIX

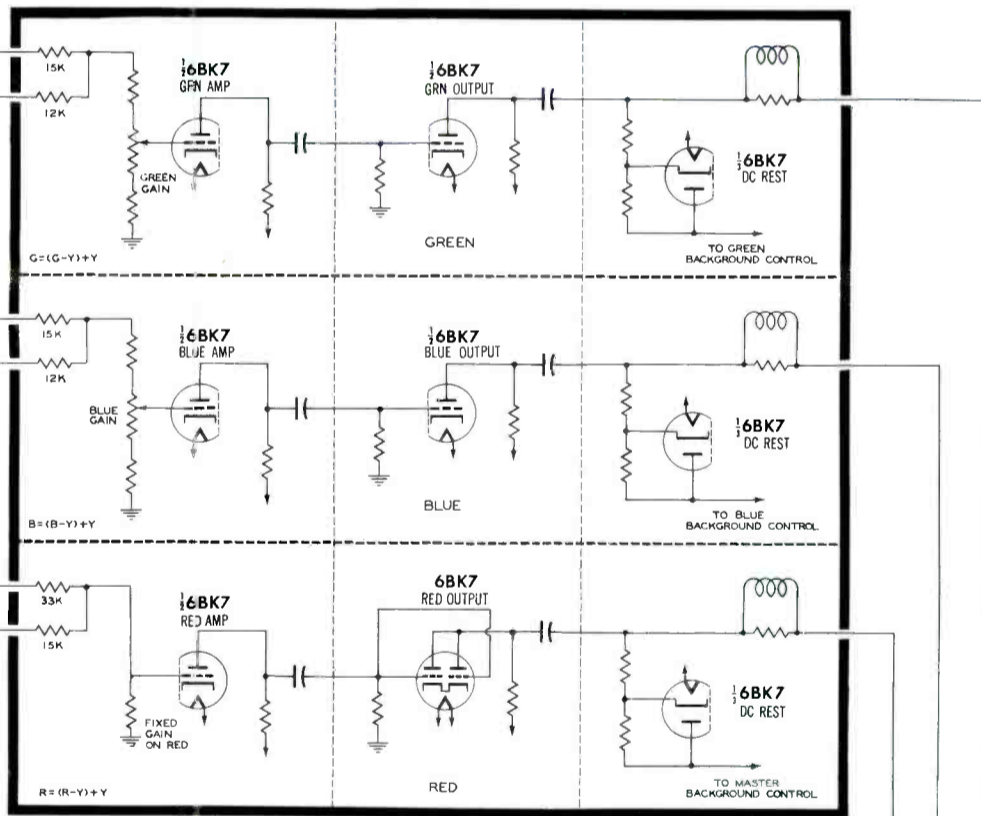

MATRIX

The purpose of the matrix is to combine the Y, R - Y, B - Y, and G - Y signals in proper proportions and to amplify the three color signals to the desired amplitude. These signals are applied to the three guns in the color picture tube and result in the reproduction of the color picture.

The inputs to the matrix consist of Y, R - Y, B - Y, and G - Y signals. The gain of the green and blue channels in the matrix can be varied to provide proper balance in the three channels. DC restoration is provided in each channel.

BEAM CONTROL

- BEAM-POSITIONING MAGNETS orient individual beams so that they may be made to strike the shadow mask at the proper point and at the correct angle.
- The PURIFYING COIL acts to align all three beams so that they strike their respective phosphor dots.
- The FOCUS ELECTRODE in the gun structure is provided with AC and DC voltages which properly focus the beams at all points on the screen.
- The CONVERGENCE ELECTRODE in the gun structure is provided with AC and DC voltages which properly converge the beams at all points on the shadow mask.
- The FIELD-NEUTRALIZING COIL and ANTI-MAGNETIC SHIELDS about the tube counteract the influence of external magnetic fields.

COLOR SYNCHRONIZATION

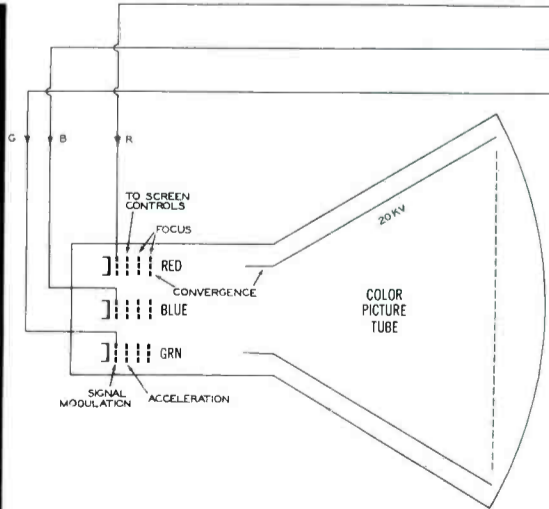
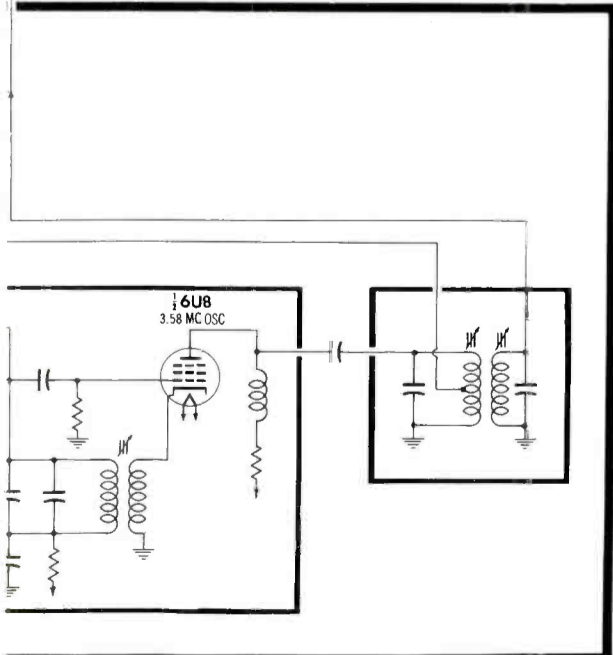

© Howard W. Sams & Co., Inc. 1954

PHOTOFACT* COLORBLOCK

Reference Chart No. 2

A COLORBLOCK of a Receiver Which Demodulates on the R-Y and B-Y Axes, Which Employs a 3.58-mc Oscillator That Is Controlled by a Phase-Detector and Reactance-Tube Combination, and Which Employs a Three-Gun Color Picture Tube.

PF INDEX, the Monthly REPORTER
for the Electronic Service Industry—August, 1954.

SOLVED! Your TV tuner

small parts problem!

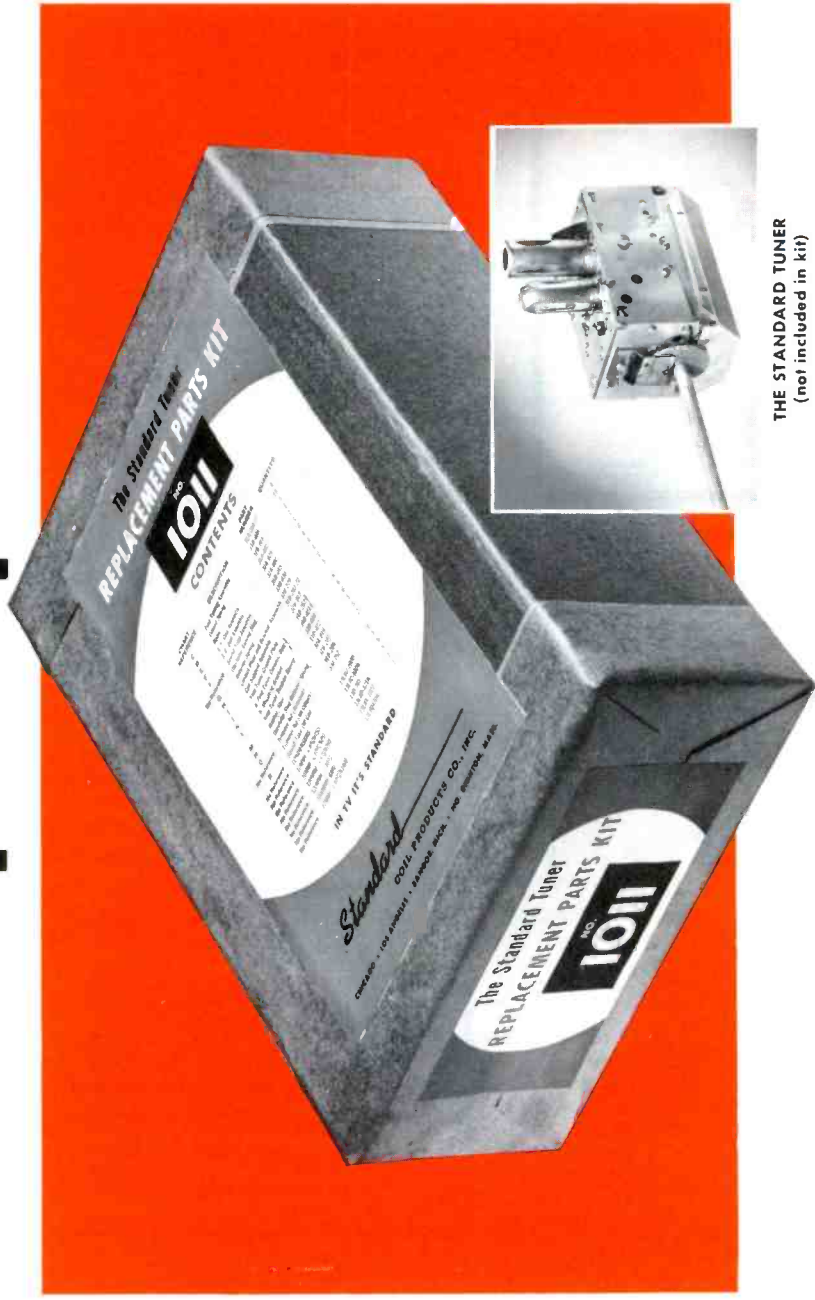

Get the handy, all-new STANDARD Tuner Replacement Parts Kit No. 1011

IN TV IT'S STANDARD

Standard
COIL PRODUCTS CO., INC.
CHICAGO LOS ANGELES BANGOR, MICH.
NO. DIGHTON, MASS.

Export Agent:
Rocke International Corporation, 13 E. 40th St., New York City

Now... 104 small TV tuner parts are at your fingertips in one convenient, low-cost kit that's sturdy, compact, fully labeled for quick reference. You get the most-called-for parts servicing Standard tuners series TV-200, TV-1500, TV-2000 and TV-2200. Each item is individually boxed, except the very small.

More Profit—Only \$22.50 for parts retailing at \$41.30.

Save Time—Hard-to-find tuner parts right at hand for quick, sure selection.

Build Customer Goodwill—Replace tuner parts direct from your Standard kit, so your customer will *know* each part is completely new.

Plan now to speed up your service work, bring new order and efficiency to every job. Get your Standard tuner replacement parts kits today! Call, write or wire your parts jobber, or address Standard Coil Products Co., Inc., 2085 N. Hawthorne Ave., Melrose Park, Ill.

THE STANDARD TUNER
(not included in kit)



PAUL H. WENDELL
EDITOR AND PUBLISHER OF
SERVICE MANAGEMENT
WRITES ABOUT

THE MARK of the PROFESSIONAL

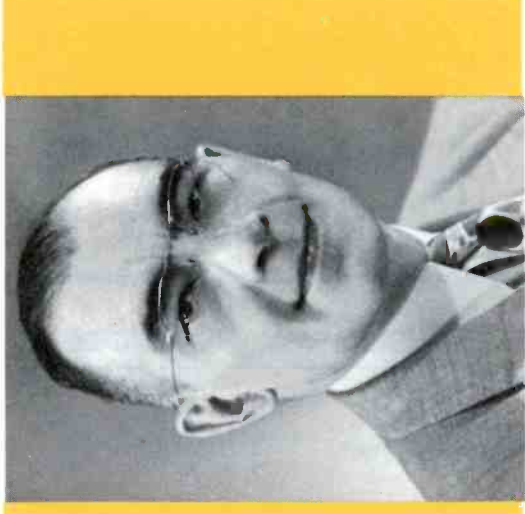

"... IN the television service shop of today an observer can quickly spot the expert professional technician by observing his *modus operandi* or manner of working. The tools of his profession are scopes, signal generators, tube testers and vacuum tube voltmeters. They are there at his fingertips—not for use on occasional jobs, but for consistent use on all jobs. 77

Burton Browne Advertising

Reprints of Mr. Wendell's complete article "The Mark of the Professional" are available at no cost from your parts jobber or from Triplet Electrical Instrument Co., Bluffton, Ohio.

TEST EQUIPMENT STANDARDS ARE SET BY

TRIPIETT

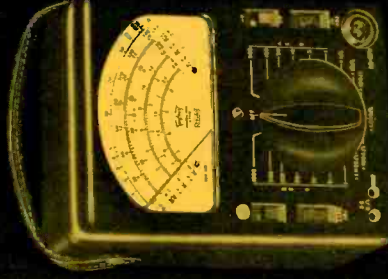

Model 650. Vacuum Tube Voltmeter \$69.50 net. One tube ACV and RF peak to peak measurements. One selector switch all ranges.



Model 3413-A. Tube Tester \$79.50 net. The only tester in its price range to get at each tube pin and make an open and short check.

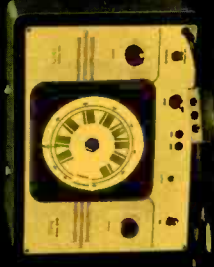

Model 3436 UHF Marker-Signal Generator \$169.50 net. For calibrating front ends and converters—all that is needed in one instrument.

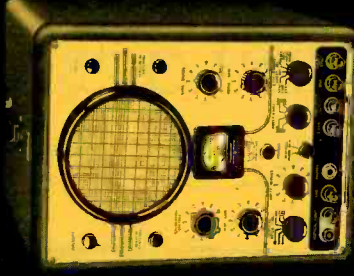

Model 3441 Oscilloscope \$199.50. Peak-to-Peak Voltmeter. Exclusive reversible polarity simplifies wave form reading.

LUMINANCE CHANNEL

The luminance channel amplifies and properly delays the composite color signal which is available from the video detector. The output of this channel is the Y signal which is fed to the matrix. The Y or luminance signal is such that it produces only brightness variations on the screen. For black-and-white transmissions, only the Y channel furnishes a signal to the matrix.

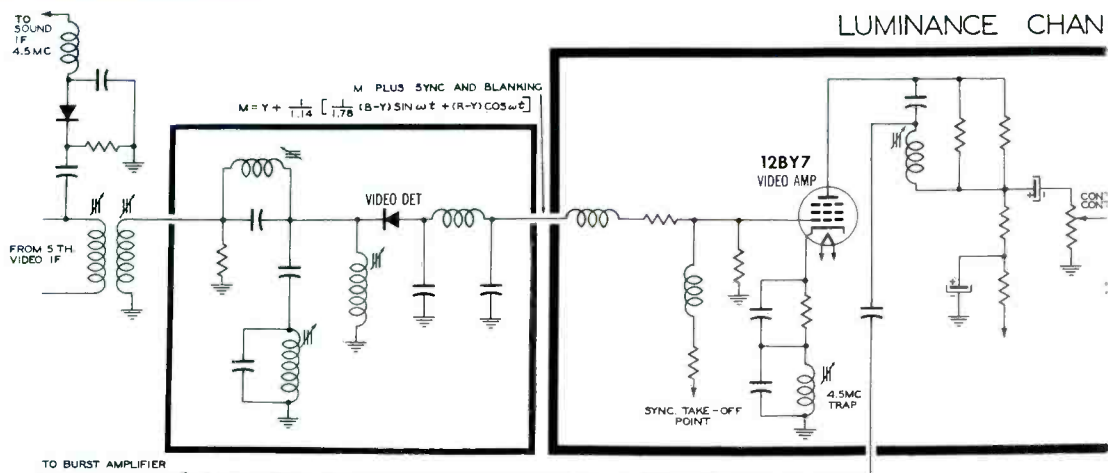

CHROMINANCE CHANNEL

The chrominance channel passes frequencies contained in the composite color signal between 3.1 and 4.1 mc. The take-off point for this signal is at the luminance amplifier. After being amplified in the chrominance amplifier, the signal is fed to the R - Y and B - Y demodulators where it is demodulated by synchronous detector action. Two CW signals of the proper phase are fed to the demodulators in order to accomplish this detection. The outputs of these demodulators are a plus (R - Y) signal and a plus (B - Y) signal which are then added to the Y signal to produce the color signals. Proper proportions of the R - Y and B - Y signals are fed to a G - Y amplifier, the output of which is added to the Y signal to produce the green signal.

A bias voltage from the color killer cuts off the chrominance amplifier during black-and-white reception.

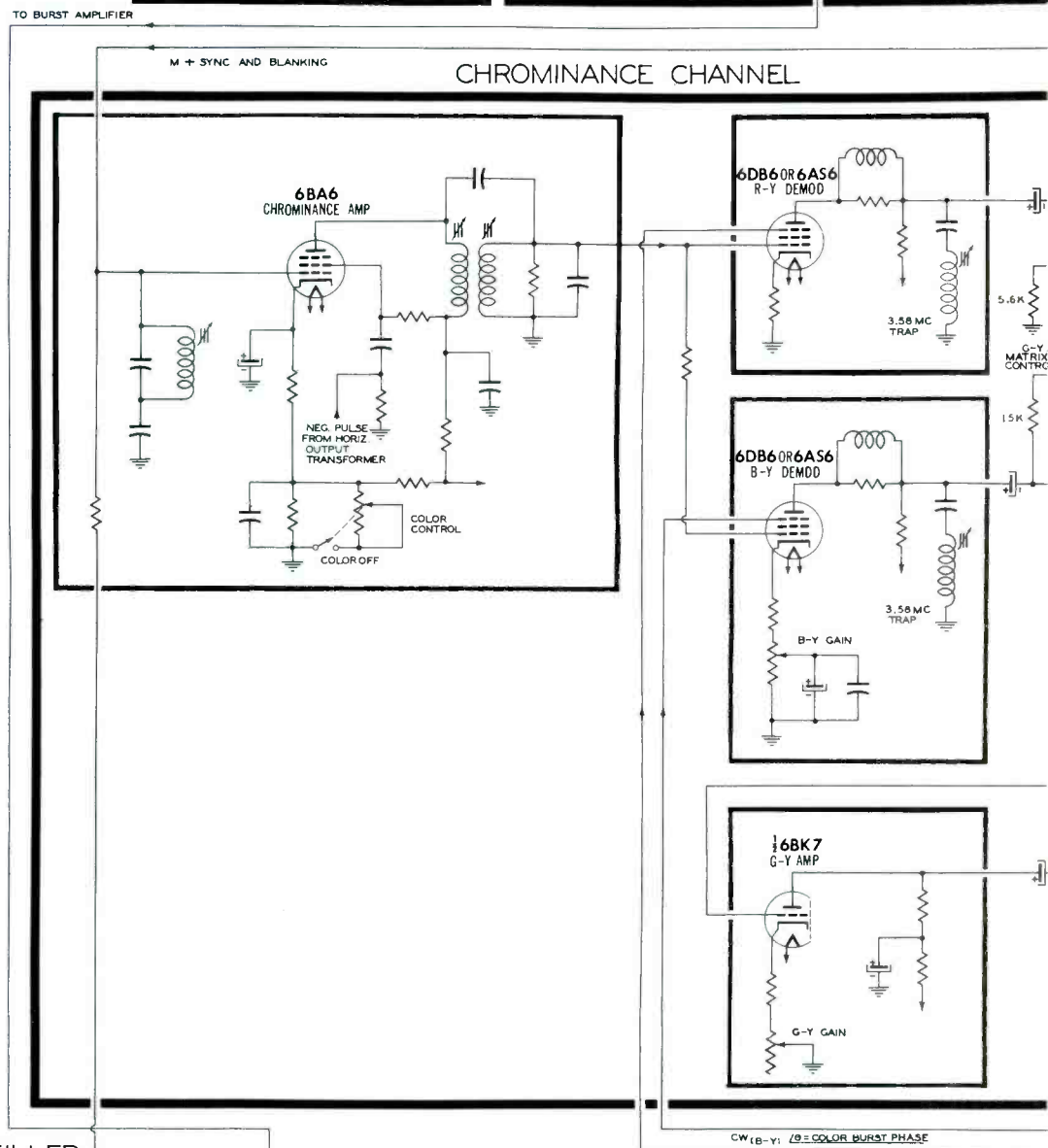

COLOR KILLER

The purpose of the color killer is to disable the chrominance channel during black-and-white reception. The operation of this stage is dependent upon a positive pulse from the horizontal-output transformer and upon a bias voltage from the phase detector. The voltage developed in the plate circuit of the color killer is coupled to the chrominance amplifier for biasing purposes. During color reception, the presence of the color burst results in a negative voltage being developed at the phase detector. This voltage biases the color killer to cutoff and this permits normal operation of the chrominance amplifier.

During black-and-white reception, no color burst is present. The color killer conducts and produces a negative voltage in its plate circuit. This voltage cuts off the chrominance amplifier and disables the chrominance channel.

COLOR KILLER

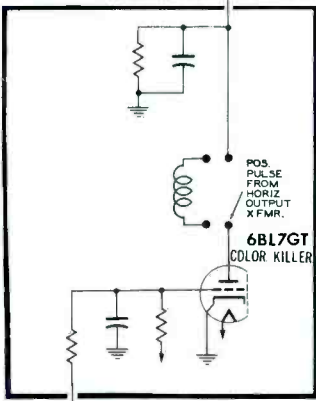

COLOR SYNCHRONIZATION

The purpose of the color-synchronizing section involves the generation of two CW signals which have a fixed relationship to the color-burst signal with respect to frequency and phase. These CW signals are fed to the R - Y and B - Y demodulators for the purpose of demodulating the color signals. The input signal to the color synchronization section consists of the composite color signal and is fed to a burst amplifier which is properly keyed to allow only the color burst to pass. A 3.58-mc oscillator is regulated by a phase detector and reactance tube combination so that it operates at the same frequency as the color burst and with a specific phase relationship to the burst. A phase-shifting network produces two 3.58-mc signals — one with a phase of -270 degrees with respect to the color burst and the other in phase with the color burst.

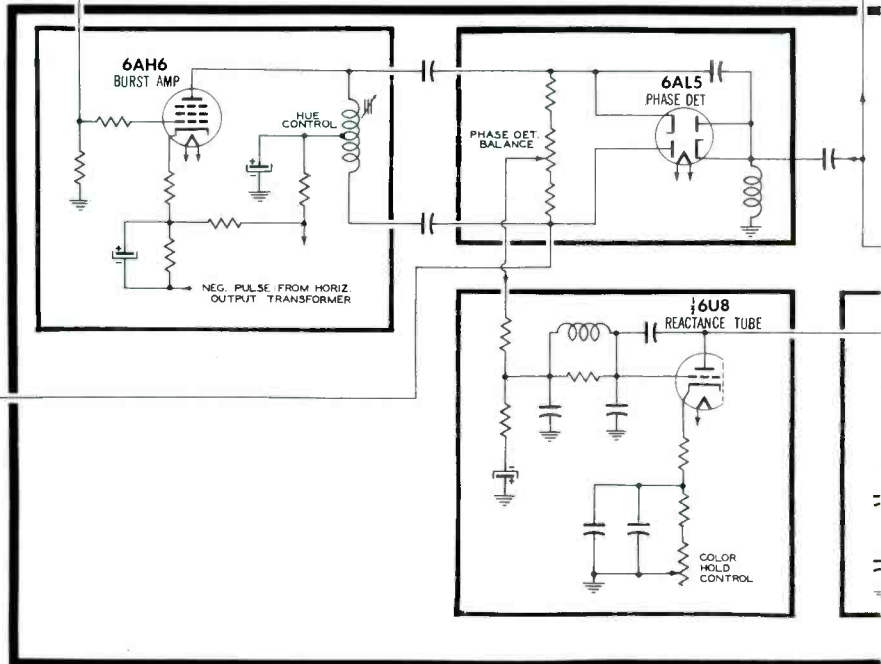

insist on seeing the SUPERJET

Before you buy another antenna

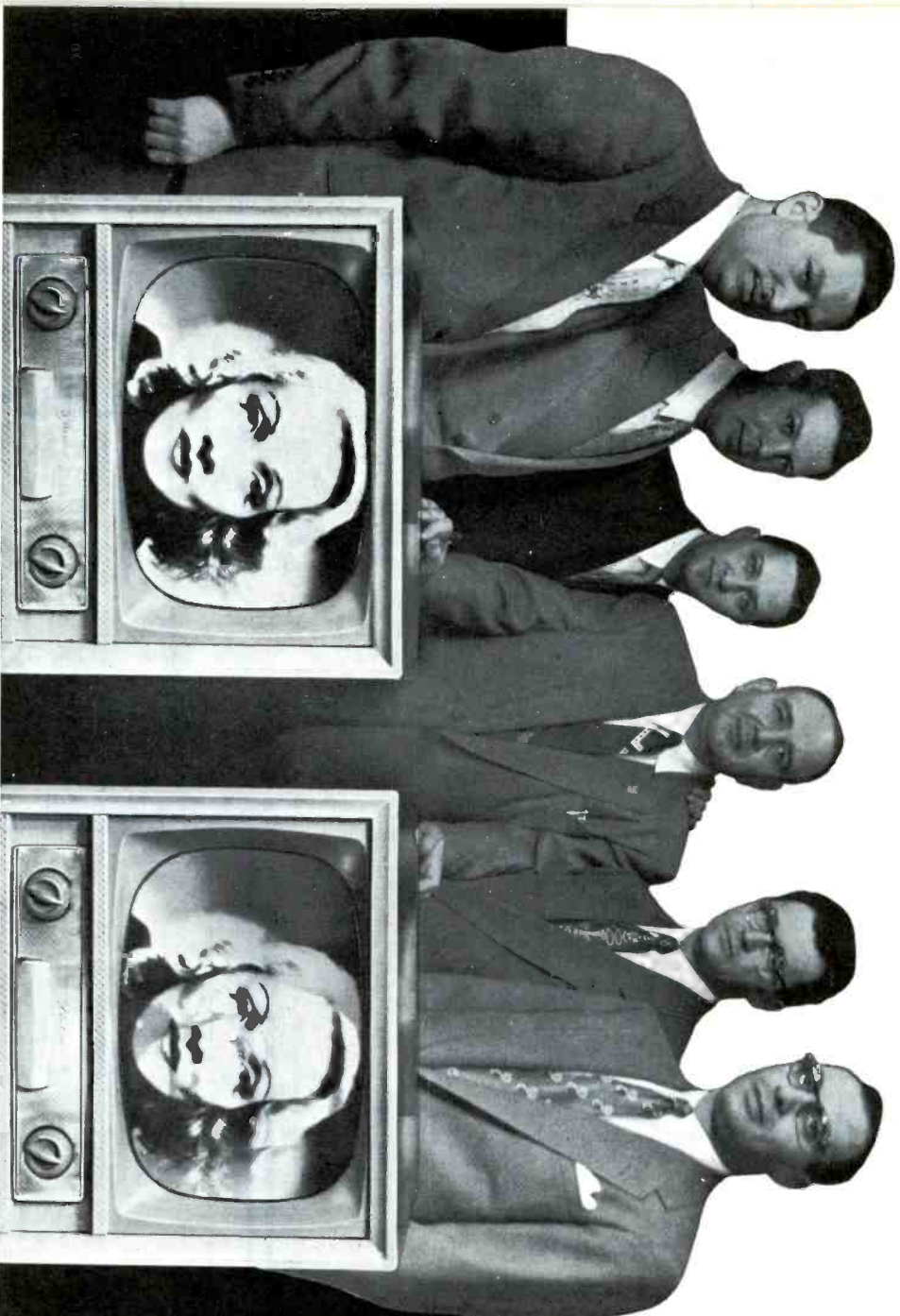

"look-test" yourself



Here is your clinical proof that only the JFD SUPERJET TV antenna Out-Performs all others on all channels

Top executives of Montreal's leading Electronics Distributors take the "look-test."

Sam Sokoloff, Commercial Radio Supplies
M. R. Rosenthal, Canadian Electrical Supply
Al Manns, Manns Radio and Electrical Supply
Jack Trehub, Excel Distributing
Roch Veillet, Payette Radio
I. "Sonny" Morris, Atlas Wholesale Radio
(reading from left to right).

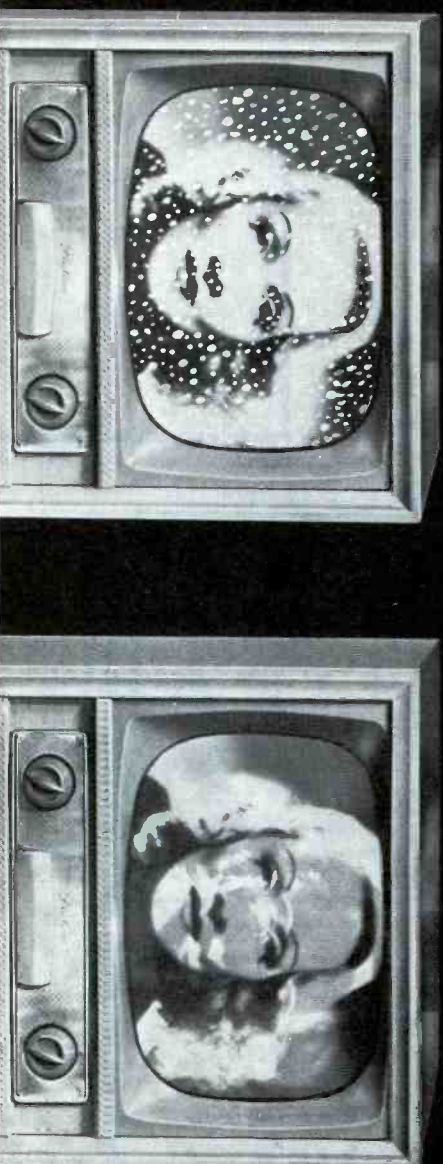

using **JFD SUPERJET** antenna

using antenna A

using antenna B

using antenna C

1. Four TV receivers of one brand, same model, same production run were set up. Technicians went over these sets to make sure they were identically aligned.
2. Three other leading high gain TV antennas were installed—each oriented for maximum performance. Each antenna was connected to a set by identical type lead-in.
3. Each receiver was tuned with infinite care to the same channel to make certain the reception was as good as possible. The picture is the proof—the result can be immediately seen—the JFD Super JeT outperforms all others.
4. The chart shows why the "Look-test" is your proof positive of sharper, clearer, more brilliant pictures . . . in Black and White or Color on all channels present and future.

Burton brown advertising

ANTENNA LIST	CHANNELS												
	2	3	4	5	6	7	8	9	10	11	12	13	
Competitor A Radar Screen with 3 dipoles (2-bay) Partly Pre-Assembled	\$42.36	4.5	4.3	7.3	7.0	7.0	10.00	10.75	11.5	11.7	11.0	11.5	11.6
Competitor B Radar Screen with 2 dipoles (2-bay) Not Assembled	\$34.95	0.75	3.25	4.5	3.5	3.5	6.0	7.0	6.5	7.75	8.0	7.5	6.0
Competitor C Bedspring (4-bay) Pre-Assembled	\$55.00	4.0	5.0	7.0	6.25	5.0	5.75	6.0	5.25	7.25	9.25	6.5	7.0
JFD SuperJet Model Jet 213 S (2-bay) Pre-Assembled	\$38.35	6.5	7.5	9.5	8.5	8.5	11.0	11.0	12.0	12.0	11.25	11.75	12.0

DB GAIN

U.S.A.
Jet 213 (Single Bay).....\$18.70, list
Jet 213S (2-Bay)\$38.35, list
Jet 213S-5* (2-Bay "Super Power Jet").....\$39.95, list
*1/2 WAVE WIDE-STACKED for up to 2 db. extra gain.

Canadian Representatives:
Ron Merritt Co., Saskatchewan, Alberta and British Columbia
John R. Tilton, Ltd., Long Branch, Ontario
JFD Manufacturing Company, Brooklyn 4, N.Y.
World's largest manufacturer of TV antennas and accessories
Write for Bulletin 1259

Insist on the genuine **JFD "SUPERJET"**

Look for the **Alcoa Label**

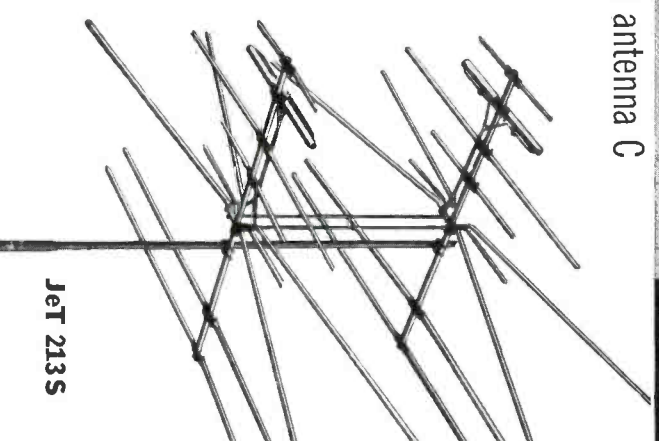

Jet 213S



**Better Contrast!
Longer Life!
Availability!**

SYLVANIA
*Aluminized
Picture Tubes*
**ARE PACKED
WITH PROFITS!**

Make old sets like new... have more satisfied customers!

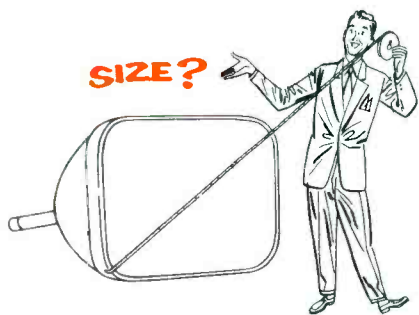

Interested in new sales records? You'll be heading in that direction when you replace old picture tubes with new Sylvania Aluminized Tubes.

Sylvania Aluminized Picture Tubes give terrific performance. They make old sets better and brighter than new by providing whiter whites—blacker blacks . . . a 6-times better picture contrast.

Sylvania Aluminized Picture Tubes are now available in most sizes for all popular TV sets. In other words, with Sylvania Aluminized Picture Tubes, you give your customers the best possible buy *and* the best possible service, including a full one-year warranty.

Remember, millions of set owners see and hear about Sylvania Picture Tubes on the nation-wide weekly television show "Beat The Clock." They know that they are famous for quality and dependability. For full details about aluminized tube replacement, write for Sylvania's "Aluminized Picture Tube Replacement Guide." Address: Dept. 4R-2908, Sylvania NOW!

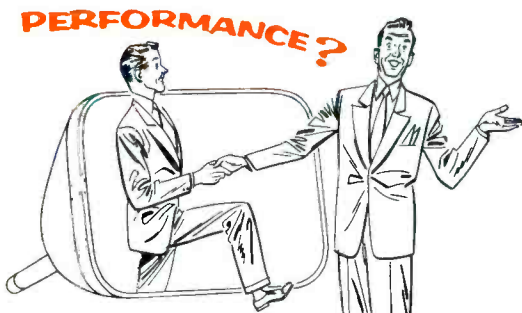
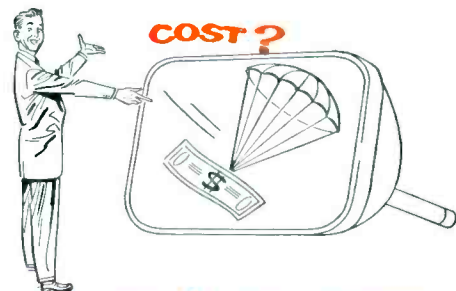

SYLVANIA

Sylvania Electric Products Inc.  1740 Broadway, New York 19, N. Y.

In Canada: Sylvania Electric (Canada) Ltd.
University Tower Building, St. Catherine Street, Montreal, P. Q.

LIGHTING • RADIO • ELECTRONICS • TELEVISION

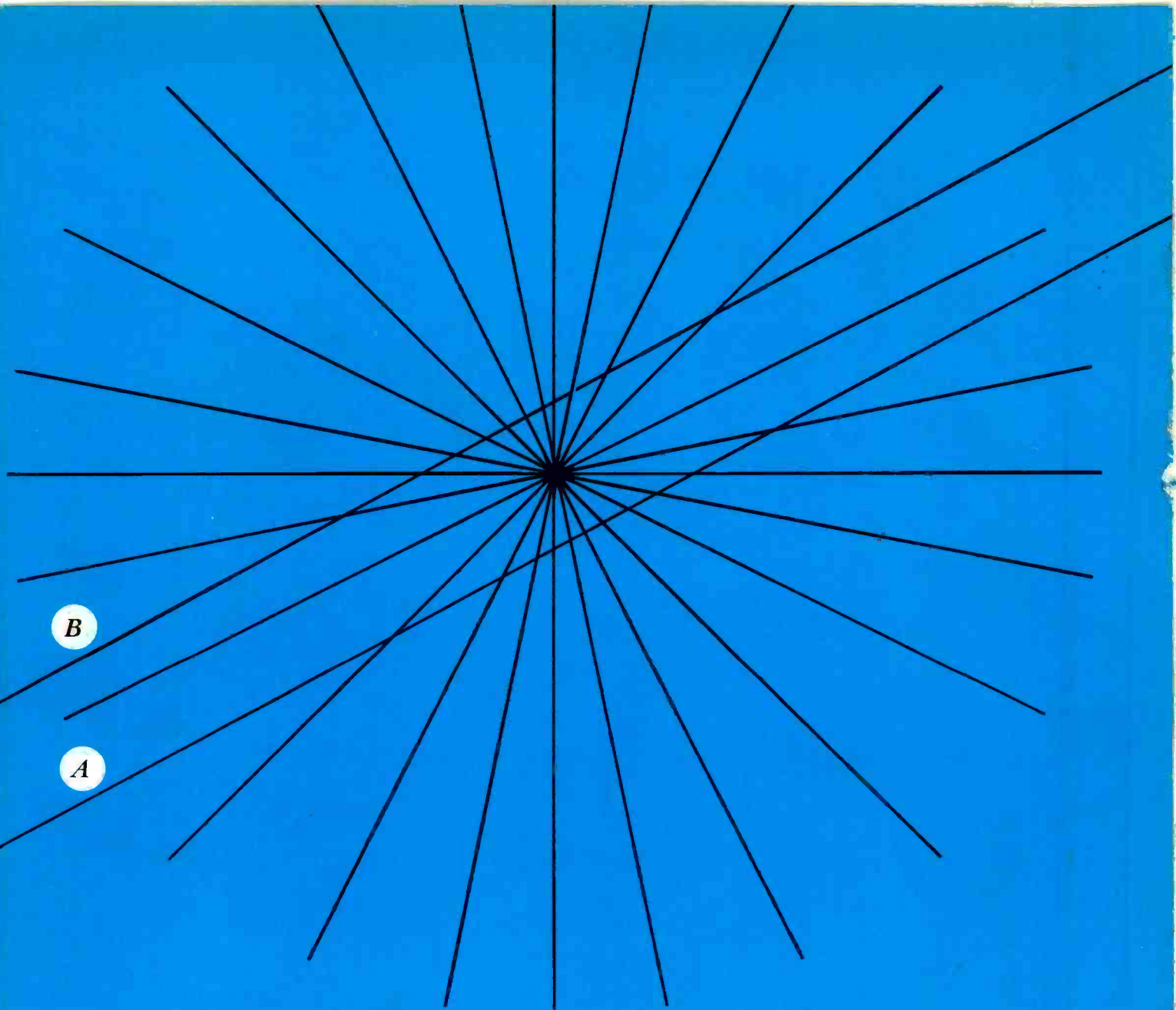

THINGS ARE **NOT** AS THEY SEEM...

Lines A and B are parallel.

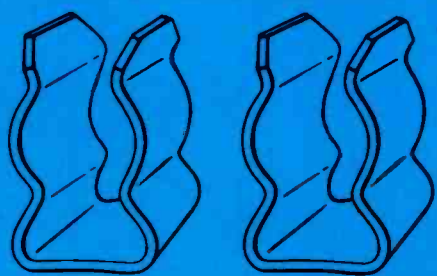

These two fuse clips look alike **BUT** this fuse clip makes only two-point contact.

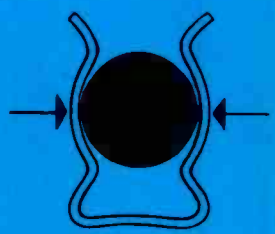

This **LITTELFUSE** clip makes wrap-around or multiple-point contact. Multiple-point contact lowers the resistance between the fuse and the fuse clip, allowing more efficient, cooler operation of the fuse. Poor contact can actually change the characteristics and rating of a fuse in operation.

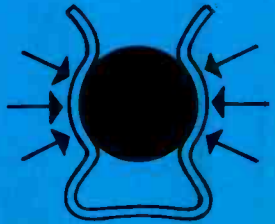

LITTELFUSE, INC.
DES PLAINES, ILLINOIS

Burton Browne Advertising